

THE Radio Constructor

RADIO
TELEVISION
AUDIO
ELECTRONICS

VOLUME 15 NUMBER 8
A DATA PUBLICATION
PRICE TWO SHILLINGS

March 1962

Stereo Tape Replay Pre-Amplifier for the "Ferrograph"

- High Gain RF-AF Signal Tracer
- Vest Pocket Transistor Loudspeaker Personal Receiver
- Making a Simple Transistor Tester
- Converting a Record Player into a Portable Radiogram
- Tape Recorder Hints
- Inexpensive Pick-up Coil
- Linear Scale Resistance-Capacitance Bridge
- Simple TRF Receiver
- Understanding Radio, Part 7

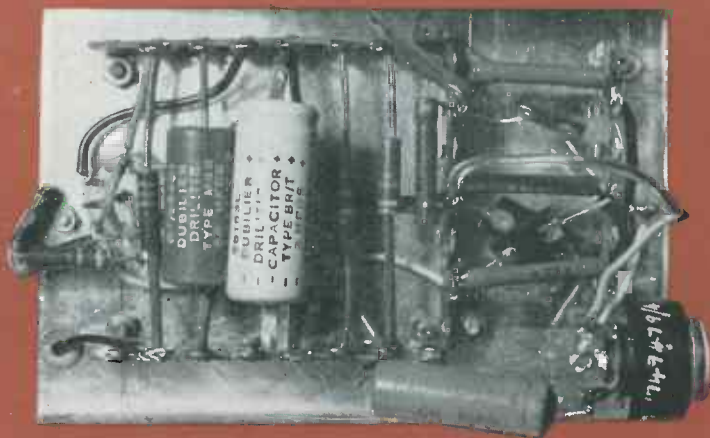

HARVERSON SURPLUS CO. LTD

QUALITY RECORD PLAYER AMPLIFIER KIT

A top quality record player amplifier in kit form. This amplifier (which is used in a 29 gn. record player) has a printed circuit and has an internal fully smoothed power supply (input AC/DC Mains) using a mains dropper and contact cooled rectifier. A flying panel is supplied accommodating BASS, TREBLE and VOL-ON/OFF controls. 2 valves (UL84 and UF89) and linear output transformer give crisp reproduction from all records at 4 WATTS. Our price for the complete kit of parts

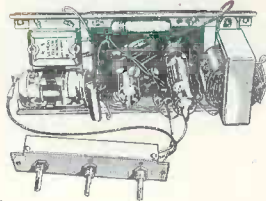

(including valves) only **59/6** plus P. & P. 6/6
Simple instructions 1/6. (Free with kit.)

Introducing . . .

HARVERSON'S Monaural Amplifier Kit

In response to numerous requests from delighted purchasers of our "SUPER STEREO KIT" we have produced a "MONAURAL AMPLIFIER" on similar lines.

★ A UCL82 valve provides a triode amplifying stage, and a pentode output stage (3 watts), enabling good amplification and sparkling reproduction to be combined with physical compactness (amplifier size 7" x 3 1/2" x 6 1/4" high).

★ Modern circuitry design, good quality o.p. transformer (to match 3Ω) keep hum and distortion to a low level.

★ The controls, volume on/off and tone, are complete with attractive cream and gold knobs.

★ The amplifier has a built-in fully smoothed power supply, using a good quality mains transformer (a.c. mains only) and metal rectifier.

★ All you need is supplied including easy to follow instructions which guarantee good results for the beginner and expert. All components, leads, chassis, valve, knobs, etc., are first grade items by prominent manufacturers.

OUR PRICE Plus 4/6 Post and Packing **39/6**
5" LOUDSPEAKER TO SUIT 14/6—EXTRA
ALL PARTS SOLD SEPARATELY

39/6

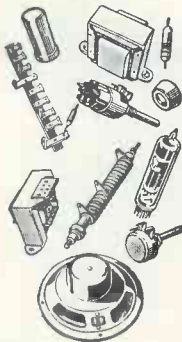
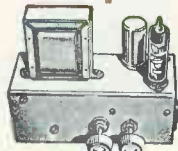

SPECIAL OFFER . . .

6 TRANSISTOR RADIO IN KIT FORM

Special offer. Limited quantity only of new ex-manufacturers' parts to make a 6 transistor 2 wave band superhet chassis. Ideal for portable or table radio. All parts including transistors, ferrite aerial, printed circuit, etc., but EXCLUDING speaker and cabinet.

Few Only. **£4.5.0** P. & P. 2/6
Simple instructions 1/6 (Free with kit.)

THE HARVERSON COMPLETE FM/VHF RECEIVER KIT **£6.19.6**

At last! A complete FM Receiver in kit form.

Specially designed with the home constructor in mind, this kit enables the construction of a completely self-contained VHF receiver at a fraction of the normal cost of comparable equipment. This is basically a quality self-powered FM tuner plus 2 separate audio amplifier stages and output transformer and speaker.

- ★ FM tuning head by famous maker
- ★ Guaranteed non-drift
- ★ Permeability tuning
- ★ Frequency coverage 88-100 Mc/s
- ★ OA81 balanced diode output
- ★ Two i.f. stages and discriminator
- ★ Self-powered, using a good quality mains transformer and valve rectifier
- ★ Valves used: ECC85, two EF80s, ECL82 and EZ80 (rectifier)
- ★ Fully drilled chassis
- ★ Good quality speaker
- ★ Well designed output transformer
- ★ Attractive maroon and gold glass dial
- ★ Two output stages (using ECL82 valve)
- ★ Everything supplied, down to the last nut and bolt
- ★ Compact size
- ★ All parts sold separately

OUR PRICE **£6.19.6** Plus 4/6 P. & P.

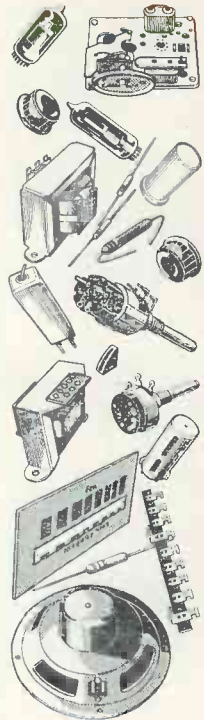

14 WATT HI-FI AMPLIFIER KIT

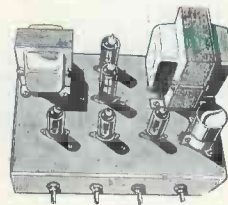

A kit designed to meet the exacting requirements of the audio enthusiast, yet remain within the price range of the average constructor. A stylishly finished monaural amplifier with an output of 14 watts from 2 EL84s in push pull. Super reproduction of both music and speech

(Frequency response $\pm 3\text{dB}$ c/s-60 kc/s with negligible hum). Separate inputs for mike and gram allow records and announcements to follow each other and make this amplifier ideal for small halls, youth clubs, etc. Fully shrouded Linear output transformer (to match 3-15Ω speaker), and fully shrouded mains transformer (these alone are worth over £3.10.0). 2 independent volume controls, and separate Bass and Treble controls are provided, giving good lift and cut. Valve line up 2 EL84s, ECC83, EF86 and EZ80 rectifier. All parts down to the last nut and bolt, including valves, heavy gauge metal chassis finished in glossy hammer green enamel (mains and output transformers finished to match.)

ONLY **£6.19.6** P.P. 6/6 (simple instruction booklet 1/6. Free with kit.)

HARVERSON SURPLUS CO. LTD.

PLEASE TURN OVER
FOR ADDRESS AND
MORE BARGAINS ▶

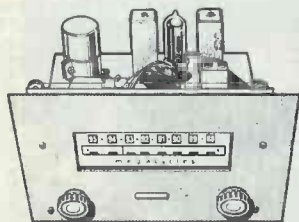

BUILD THIS FM TUNER FM Unit Mk. II

We proudly announce our Mk. II FM Tuner. This equipment combines quality (only specially selected top grade components are used) with simplicity of construction. The refinements provided, and the performance achieved are equal to many commercial models at twice the price. The completed tuner is supplied with an attractive metal front panel, finished in a choice of black crackle, glossy hammer green, or glossy hammer grey enamel.

- ★ FM Tuning Head by famous maker. ★ Guaranteed Non-drift.
- ★ Permeability Tuning. ★ Frequency coverage 88-100 Mc/s.
- ★ OA81 Balanced Diode Output. ★ Magic eye tuning. ★ Smart front panel. ★ Two I.F. Stages and Discriminator. ★ Attractive maroon and gold dial (7" x 3" glass). ★ Self-powered, using a good quality mains transformer and valve rectifier. ★ Valves used ECC85, two EF80s, EZ80 (rectifier) and magic eye. ★ Fully drilled chassis. ★ Everything supplied down to the last nut and bolt. ★ All parts sold separately.

Circuit diagram and illustrations, **£6.12.6** P. & P. 10/-
1/6, post free.

COIL and TRANSFORMER SET FOR TRANSISTOR SUPERHET

3 I.F. Transformers, one oscillator coil, one driver transformer, and wound ferrite aerial (Med., Long and aerial coupling). 28/6 complete, post 1/-. 6 transistor printed circuit board to match 8/6, post 9d. Circuit diagram 1/6 extra.

CONDENSER/RESISTOR PARCEL

50 mixed P.F. Condensers and 50 mixed Resistors. An assortment of useful valves. All popular sizes—all new—a must for the serviceman and constructor

ONLY 10/- P. & P. 1/-.

SPECIAL OFFER 54in LOUDSPEAKER SILKS

Heavily woven in ivory and gold. Original price 35/- per yard length. OUR SPECIAL PRICE, 13/6 per yard length. P. & P. 1/6.

THE HARVERSON 6 TRANSISTOR AND DIODE SUPERHET KIT

A first class 2 wave band transistor superhet in kit form.

- Printed circuit panel (size 8 $\frac{1}{8}$ " x 2 $\frac{3}{4}$ ").
- 3 Pre-aligned I.F. Transformers.
- Output Transformer.
- 5" 5 Ω Speaker.
- High gain Ferrite rod aerial.
- First grade G.E.C. transistors.
- Car aerial socket.
- Push/Pull output.
- All parts sold separately.

Owing to a fortunate purchase of components all parts down to the minutest item with simple instructions.

ONLY **£4.19.6** Plus 2/6 P. & P.

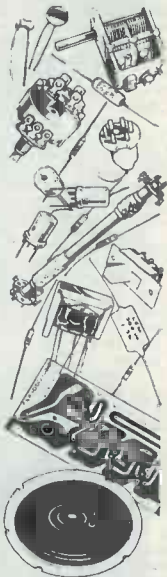

SUPER TABLE RADIO CABINET

A very fortunate purchase allows us to offer this quality table radio cabinet for only 18/6 (this cabinet cost the manufacturers 35/- each to make). The positions of the controls make it ideal for housing our 6 TRANSISTOR SUPERHET KIT described above. Beautifully finished in walnut and tygan.

OUR PRICE ONLY **18/6** Plus 1/6 P. & P. ins.

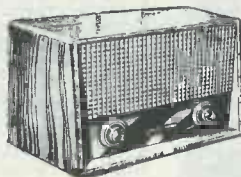

E.M.I. 4-speed
Player and P.U.



Heavy 8 $\frac{1}{2}$ " metal turntable. Low flutter performance 200/250V shaded motor with tap at 80V for amplifier valve filament if required. Turnover LP/78 head.

PRICE **89/6**
Plus 4/6 P. & P.

A FEW ONLY HARVERSONS MARK I FM TUNER

As previously advertised, this is a first class FM tuner. The basic design of this is similar to that of our Mark II Unit (described above) but does not incorporate some of the lavish refinements of the latter. Emphasis has been placed on simplicity of construction and this unit is quite within the capabilities of the comparative novice. Coverage 88-100 Megacycles. Self-powered, with valve rectifier. All parts complete with 4 valves, attractive glass dial and comprehensive instructions. **Only £4.19.6** plus 8/6 P. & P.

All parts sold separately.

METAL CASE FOR THE ABOVE TUNER

Metal case of robust construction (using front panel as supplied with our Mark II Unit), fully ventilated. Attractively finished in a choice of black crackle, glossy hammer green, or hammer grey enamel. **25/-**, P. & P. 1/9. (Front panel only, 10/6, P. & P. 9d.)





Aboard a B.O.A.C. Comet Jetliner

... and AVO is waiting on the tarmac

Highly skilled service crews are standing by at airports all over the world to carry out essential aircraft maintenance. Universal AvoMeters are used extensively by many of the largest overseas airlines for major and minor aircraft checks and in the repair and overhaul of components.

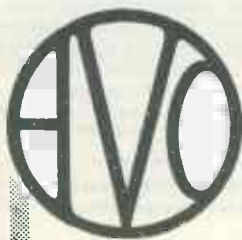

model 8 Universal AvoMETER

VOLTAGE	
D.C.	A.C.
2.5V	2.5V
10V	10V
25V	25V
100V	100V
250V	250V
1,000V	1,000V
2,500V	2,500V

CURRENT	
D.C.	A.C.
50μA	100mA
250μA	1A
1mA	2.5A
10mA	10A
100mA	—
1A	—
10A	—

RESISTANCE	
First indication 0 Ω	
Maximum indication 20M Ω	
0—2,000 Ω	using internal batteries
0—100,000 Ω	using external batteries
0—20M Ω	using external batteries

DECIBELS
-15 dB to +15 dB

Size 8 1/2 in. x 7 1/2 in. x 4 1/2 in.
Weight: 6 1/2 lb (including leads)



Write for Illustrated Brochure

AB/S

AVO LTD AVOCET HOUSE · 92-96 VAUXHALL BRIDGE ROAD · LONDON · S.W.1.

Telephone: VICtoria 3404 (12 lines)

Telegrams: AVOCET, LONDON S.W.1

TECHNICAL
TRAINING
in radio
television
and
electronic
engineering
with



The decision is **YOURS**. To be a success in your chosen career; to qualify for the highest paid job . . . to control a profitable business of your own. ICS home-study courses put your plans on a practical basis; teach you theory and practice; give you the knowledge and experience to take you, at your own pace, to the top.

Choose the RIGHT course.
RADIO & TELEVISION ENGINEERING . INDUSTRIAL TELEVISION . RADIO AND TV SERVICING . RADIO SERVICE AND SALES . ELECTRONICS . COMPUTERS AND PROGRAMMING

ICS provides thorough coaching for professional examinations: **A M BRIT. I R E, City and Guilds Telecommunications, C. & G. Radio and TV Servicing, C. & G. Radio Amateurs.**

LEARN AS YOU BUILD

Practical Radio Course
 Gain a sound up-to-professional-standards knowledge of Radio and Television as you build **YOUR** own 4 valve T R F and 5 valve superhet radio receivers, signal generator and high-quality multimeter. At the end of the course you have three pieces of permanent and practical equipment and a fund of personal knowledge and skill . . . ICS Practical Radio courses open a new world to the keen radio amateur.

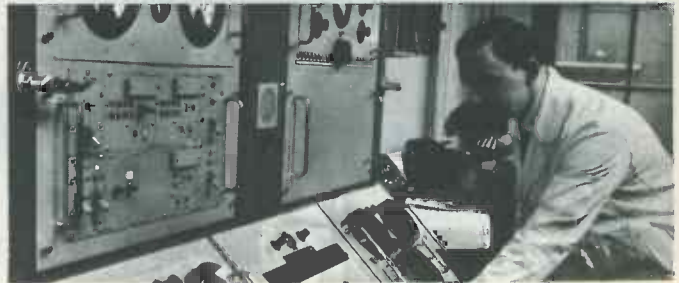

THERE ARE ICS COURSES TO MEET YOUR NEEDS AT EVERY STAGE OF YOUR CAREER.

Post this coupon today: In return you will receive the **FREE** 60-page ICS Prospectus listing technical examinations and their appropriate ICS courses **PLUS** details of over 150 specialised subjects.

Other ICS courses include:
MECHANICAL, MOTOR, FIRE, CHEMICAL, ELECTRICAL AND CIVIL ENGINEERING, ETC. SELLING AND MANAGEMENT, ARCHITECTURE, WOODWORKING, FARMING, GARDENING, ART, PHOTOGRAPHY.
Please state subject in which you are interested on coupon.

INTERNATIONAL CORRESPONDENCE SCHOOLS
 (Dept. 248) Intertext House Parkgate Road London SW11

NAME.....

ADDRESS

.....

OCCUPATION..... AGE.....

SUBJECT..... 3.62

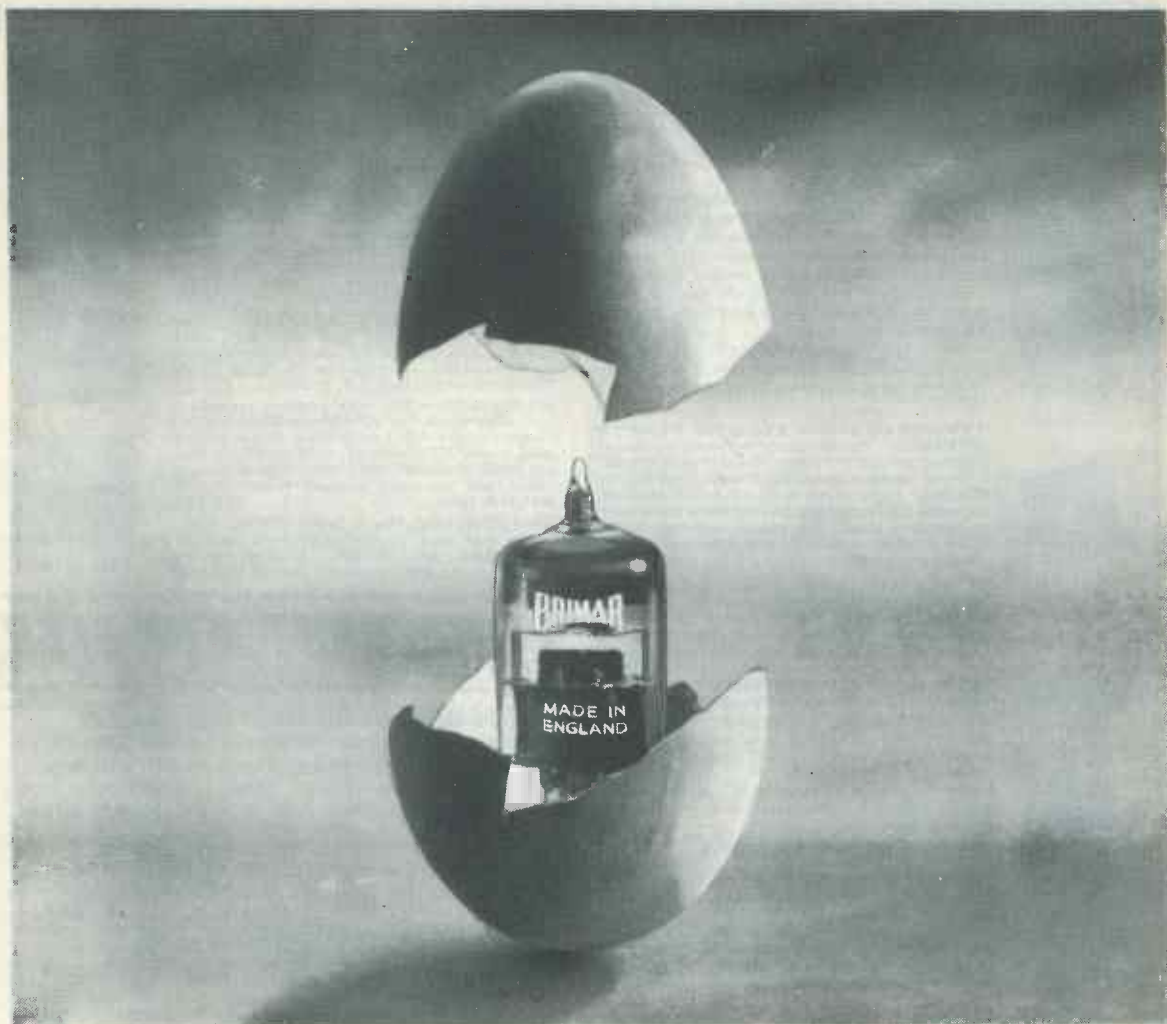

The shell of an egg contains the secret of reproduction.
So too, in a different sense, does a Brimar valve. For
true-to-life reproduction and consistent reliability,

better make it **BRIMAR**

Brimar Commercial Division

THORN—AEI RADIO VALVES & TUBES LIMITED · ROCHESTER · KENT TEL: CHATHAM 44411





THE FINEST ELECTRONIC KITS IN THE WORLD



RSW-1

4-WAVEBAND TRANSISTORISED PORTABLE RECEIVER, Model RSW-1. This model possesses Medium, Trawler and two Short-wave bands and is mid-way between the domestic broadcasting and professional general communications receiver. Ideal and inexpensive for those who wish to listen to world broadcasts, shipping and aviation communications. It is not the set to buy if you wish only to enjoy domestic broadcasting. In a handsome leather case, it has retractable whip aerial and socket for car radio use.

£22.10.0



GL-58

TRANSCRIPTION RECORD PLAYER (STEREO). Manufactured by Goldring-Lenco. This 4-speed unit is fitted with a G60 pick-up arm. Infinitely variable speed adjustment from 33 $\frac{1}{3}$ to 80 r.p.m. Fixed speed of 16 r.p.m., its balanced turntable (3 $\frac{1}{2}$ lb) reduces rumble, wow and flutter to very low level. The unique lowering device fitted provides absolutely safe means of placing pick-up on record

£20.12.2



TA-1M

5" OSCILLOSCOPE, Model O-12U. Has wide-band amplifiers, essential for TV servicing, FM alignment, etc. Vertical frequency response 3 c/s to over 5 Mc/s, without extra switching T/B covers 10 c/s to 500 kc/s in 5 ranges.

£36.10.0



O-12U

DECADE CAPACITOR Model DC-1. Capacity values 100 μ F to 0.111 μ F in 100 μ F steps.

£6.5.6



DC-1

AUDIO SIGNAL GENERATOR, Model AG-9U. 10 c/s to 100 kc/s, switch selected. Distortion less than 0.1%, 10V sine wave output metered in volts and dB's.

£19.19.6



AG-9U

HI-FI SINGLE CHANNEL AMPLIFIER, Model MA-12. 12W output, wide freq. range, low distortion.

£10.19.6



MA-12

RESISTANCE CAPACITANCE BRIDGE Model C-3U. Measures capacity 10pF to 1,000 μ F, resistance 100 Ω to 5M Ω and power factor. 5-450V test voltages. With safety switch.

£8.6.6

BALUN COIL UNIT, Model B-1U. Will match unbalanced co-axial lines to balanced lines of either 75 or 300 Ω impedance.

£4.9.6

AUDIO WATTMETER, Model AW-1U. Up to 25W continuous, 50W intermittent.

£14.14.0

AUDIO SINE-SQUARE WAVE GENERATOR, Model AO-1U. Covers 20 c/s to 150 kc/s and square waves to 50 kc/s in four ranges. Maximum output 10V, distortion less than 1%.

£12.18.6

AUDIO VALVE MILLIVOLTMETER, Model AV-3U. 1mV-300V A.C. 10 c/s to 400 kc/s.

£13.18.6

HI-FI STEREO/MONO PRE-AMPLIFIER, Model USP-1. Extremely versatile unit. Gain may be preset over a wide range. Input 2mV-20mV. Output 20mV-2V

£6.17.6

MATCHED HI-FI STEREO KIT

We offer as a "packaged deal" the following matched Hi-Fi Stereo Equipment:

4-speed Record Player (RP-1U) ... £12.16. 4
6W Amplifier (S-33) ... £12. 8. 6
Twin Speaker Systems (SSU-1) ... £21.15. 0

Cost of Units ... £46.19.10

At an "all in" price of ... £44. 9. 4

Pedestal Speaker legs £2.2.0 optional extra.

AMATEUR TRANSMITTER, Model DX-100.

The world's most popular, compact and completely self contained Amateur Transmitter covers all amateur bands: 160-10 m. 150w D.C. input. Careful design has achieved the stability and high performance for which the DX-100U is noted and no less than 35 disc ceramic capacitors reduce TVI to a minimum.

£81.10.0

SINGLE SIDEBAND ADAPTER, Model SB-10U. May be used with most A.M. transmitters. Less than 3w R.F. input power required for 10w output. Operation on 80, 40, 20, 15 and 10m bands on U.S.B., L.S.B. or D.S.B.

£37.6.0

HI-FI FM TUNER. This model is available as two units which, for your convenience, are sold separately: the R.F. Tuning Unit, model FMT-4U (£35.0 incl. P.T.) with I.F. output of 10.7 Mc/s, and the Amplifier Unit, with power supply, valves, and attractive cabinet, model FMA-4U (£11.11.0) total ...

£14.16.0

TRUVOX TD-1 Mk. 6 TAPE DECK. Mono/stereo tape deck of semi-professional standard. Two tracks, side by side. Limited quantity available at the greatly reduced price of

£29.15.0



DX-100U



FM Tuner



Truvox Mk. 6

THE BEST QUALITY

TAPE RECORDING AND REPLAY HI-FI AMPLIFIER

Mono. model TA-1M, Stereo model TA-1S

For use with most tape decks. Thermometer type recording indicators, press-button speed compensation and input selection, 3-position bias level and printed circuit construction

TA-1M	...	£18 2 6
TA-1M and Collaro "STUDIO"	...	£30 10 0
TA-1M and TRUVOX Mk. 6	...	£46 17 6
TA-1S	...	£23 6 0
TA-1S and Collaro "STUDIO"	...	£35 14 0
TA-1S and TRUVOX Mk. 6	...	£52 1 0

HEATHKIT ELECTRONIC WORKSHOP, Model EW-1. This new educational kit will teach and amuse your children; it can make 21 exciting experiments including transistor radios, burglar alarm, radio or TV silencer, intercom, etc.

£7.18.0

HI-FI EQUIPMENT CABINETS

Our four equipment cabinets meet a wide variety of tastes and requirements: the "CHEPSTOW" was designed for those who have little floor space, the contemporary "MALVERN" for the Tape and Gram. enthusiast, and the "GLOUCESTER" Mk. I and II for those with traditional tastes. All parts are pre-cut and drilled for easy assembly, and left "in the white". Prices from £11.5.6 to £17.18.6.

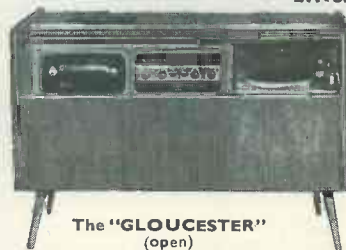

The "GLOUCESTER" (open)

Available directly from **DAYSTROM Ltd** Dept. RC3, Gloucester, England



GD-1U

GRID-DIP METER. Model GD-1U. Functions as oscillator or absorption wave meter. With plug-in coils for continuous frequency coverage from 1.8 Mc/s to 250 Mc/s. **£10.96**

Three Additional Plug-in Coils Model 34-1U extend coverage down to 350 kc/s. With dial correlation curves. **15/-**



DX-40U

TRANSISTORISED VERSION. Model XGD-1. Similar to GD-1U. Fully transistorised with a frequency range of 1.8 to 45 Mc/s. **£10.86**



AMATEUR TRANSMITTER, Model DX-40U. Covers all amateur bands from 80 to 10 metres; crystal controlled. Power input 75W C.W., 60W peak controlled carrier phone. Output 40W to aerial. Provision for V.F.O. Filters minimise TV interference. **£32.10.0**



S-33

6-W STEREO AMPLIFIER. Model S-33. 3 watts per channel, 0.3% distortion at 2.5 w/chnl., 20dB N.F.B. Inputs for Radio (or Tape) and Gram., Stereo or Monaural, ganged controls. Sensitivity 100mV. **£12.8.6**

COLLARO "STUDIO" TAPE DECK. The finest buy in its price range. Operating speeds: 1 1/2, 3 3/4 and 7 1/2 i.p.s. Two tracks. "Wow" and "flutter" not greater than 0.15% at 7 1/2 i.p.s. Long Term Speed Stability better than 0.5%. **£17.10.0**

AT LOWEST PRICES

MONEY-SAVING "PACKAGED DEALS"

For the benefit of customers wishing to purchase several units of their Hi-Fi equipment at the same time, useful price reductions are offered. Such "Packaged Deals" may include RECORD PLAYERS and TAPE DECKS of your preference, not necessarily featured in our catalogue. Two money-saving examples are given below and quotations for your own special requirements will gladly be sent on request.

GL-58 Transcription Unit	£20.12.2	TA-1M	£18. 2.6
S-33 Stereo Amp.	£12. 8.6	Collaro "STUDIO"	£17.10.0
Twin SSU-1 Speakers (Bookcase Type)	£21.15.0	USC-1	£18.18.6
		MA-12	£10.19.6
	£54.15.8		£65.10.6
Packaged	£50.19.0	Packaged	£59.10.0



THE "COTSWOLD"

THE "COTSWOLD". This is an acoustically designed enclosure 26" x 23" x 15 1/2" housing a 12" bass speaker with 2" speech coil, elliptical middle speaker together with a pressure unit to cover the full frequency range of 32-20,000 c/s. Capable of doing justice to the finest programme source, its polar distribution makes it ideal for really Hi-Fi Stereo. Delivered complete with speakers, cross-over unit, level control, Tygan grilles cloth, etc. All parts pre-cut and drilled for ease of assembly and left "in the white" for finish to personal taste **£21.19.0**

VARIABLE FREQUENCY OSCILLATOR. Model VF-1U. Calibrated 160-10 m. Fundamentals on 160 and 40 m. Ideal for our DX-40U and similar transmitters. **£11.2.0**

TRANSISTOR PORTABLE RADIO. Model UXR-1. Pre-aligned I.F. transformers, printed circuit and a 7" x 4" high-flux speaker. Real hide case. **£14.18.6**

HI-FI STEREO AMPLIFIER. Models S-88. 16W output, 10mV basic sensitivity. Ganged controls. Stereo/Monaural gram., radio and tape recorder inputs. Push-button selection. Two-tone grey metal cabinet. **£26.12.6**

HI-FI SPEAKER SYSTEM. Model SSU-1. Ducted-port bass reflex cabinet "in the white". Twin speakers. With legs **£11.18.6**

2 1/2 in. SERVICE 'SCOPE. Model OS-1. Light compact portable for service engineers. Dim. 5" x 8" x 1 1/2" long. Wt. 10 1/2 lb. **£19.10.0**

VALVE VOLTMETER. Model V-7A 7 voltage ranges d.c. volts to 1,500 a.c. to 1,500 r.m.s. and 4,000 peak to peak. Resistance 0.1Ω to 1,000MΩ with internal battery. D.C. input impedance 11mΩ. dB measurement has centre-zero scale. Complete with test prods., lead and standardising battery. **£13.0.0**

TRANSISTOR INTERCOM. Models XI-1U & XIR-1U. The master unit uses a 4-transistor amplifier, constructed on a printed circuit board, and an internal 9V battery. Remote stations use a similar battery for calls only. Up to five remote units can be ordered for each master. XIR-1U (remote) **£4.3.0** XI-1U (master) **£10.15.6**

ELECTRONIC SWITCH. Model S-3U (Oscilloscope Trace Doubler.) Enables a single beam oscilloscope to give simultaneous traces of two separate and independent signals. Switching rates approx. 150, 500, 1,500, 5,000 and 15,000 c/s. Sig. freq. response 0-100 kc/s. +1dB. Separate gain controls and sync. output. Sig. input range 0.1-1.8V r.m.s. **£10.15.6**

CAPACITANCE METER. Model CM-1U. Direct-reading 4 1/2" scale. Full-scale ranges 0-100μF, 0-1,000μF, 0-0.01μF and 0-0.1μF. **£14.15.0**

R.F. SIGNAL GENERATOR. Model RF-1U. Up to 100 Mc/s fundamental and 200 Mc/s on harmonics and up to 100mV output on all bands. **£11.18.0**

POWER SUPPLY UNIT. Model MGP-1. Input 100/120V 200/250V, 40-60 c/s. Output 6.3V, 2.5A A.C.; 200, 250, 270V, 120mA max. D.C. **£4.16.6**

MULTIMETER. Model MM-1U. Ranges 0-1.5V to 1,500V A.C. and D.C.; 150μA to 15A D.C.; 0.2Ω to 20MΩ. 4 1/2" 50μA meter. **£11.18.6**

THE "MOHICAN" GENERAL COVERAGE RECEIVER. Model GC-1U. With 4 piezo-electric transmitters, variable tuned B.F.O. and Zener diode stabiliser, this is an excellent fully transistorised portable or fixed station receiver for Amateur and Short wave listeners. Printed circuit boards, telescopic whip antenna, tuning meter and large slide-rule dial, 10 transistors. **£38.15.0**



VF-1U



UXR-1



S-88



SSU-1



OS-1



V-7A



GC-1U

All prices include free delivery U.K.
Deferred terms available over £10.

★ SEND THIS COUPON NOW FOR FURTHER INFORMATION

(Please write in BLOCK CAPITALS)

NAME

ADDRESS

Without obligation please send me (Tick here)

BRITISH HEATHKIT CATALOGUE.....
FULL DETAILS OF MODEL(S).....

DAYSTROM LTD DEPT RC3
GLOUCESTER ENGLAND

A member of the Daystrom Group, manufacturers of the
WORLD'S LARGEST-SELLING ELECTRONIC KITS

FREE TO AMBITIOUS ENGINEERS

— THE LATEST EDITION OF ENGINEERING OPPORTUNITIES

Have you sent for your copy?
ENGINEERING OPPORTUNITIES is a highly informative 156-page guide to the best paid engineering posts. It tells you how you can quickly prepare at home for a recognised engineering qualification and outlines a wonderful range of modern Home Study Courses in all branches of Engineering. This unique book also gives full details of the Practical Radio & Electronics Courses, administered by our Specialist Electronics Training Division—the B.I.E.T. School of Electronics, explains the benefits of our Employment Dept. and shows you how to qualify for five years promotion in one year.

We definitely Guarantee
“NO PASS — NO FEE”

Whatever your age or experience, you cannot afford to miss reading this famous book. If you are earning less than £20 a week, send for your copy of “ENGINEERING OPPORTUNITIES” today—FREE.

BRITISH INSTITUTE OF ENGINEERING TECHNOLOGY (Incorporating E.M.I. Institutes)
 (Dept. SE/23), 29 Wright's Lane, London, W.8

THE B.I.E.T. IS THE LEADING ORGANISATION OF ITS KIND IN THE WORLD

WHICH IS YOUR PET SUBJECT ?

Mechanical Eng.,
 Electrical Eng.,
 Civil Engineering,
 Radio Engineering,
 Automobile Eng.,
 Aeronautical Eng.,
 Production Eng.,
 Building, Plastics,
 Draughtsmanship,
 Television, etc.

GET SOME LETTERS AFTER YOUR NAME !

A.M.I. Mech. E.
 A.M.I.C.E.
 A.M.I. Prod. E.
 A.M.I.M.I.
 L.I.O.B.
 A.F.R. Ae.S.
 B.Sc.
 A.M. Brit. I.R.E.
 City & Guilds
 Gen. Cert. of Education
 Etc., etc.

PRACTICAL EQUIPMENT

Basic Practical and Theoretic Courses for beginners in Radio, T.V. Electronics, Etc., A.M. Brit. I.R.E. City & Guilds Radio Amateurs' Exam. R.T.E.B. Certificate P.M.G. Certificate Practical Radio Radio & Television Servicing Practical Electronics Electronics Engineering Automation

INCLUDING TOOLS!

The specialist Electronics Division of B.I.E.T. (Incorporating E.M.I. Institutes) NOW offers you a real laboratory training at home with practical equipment. Ask for details.

B.I.E.T. SCHOOL OF ELECTRONICS

POST COUPON NOW!

Please send me your FREE 156-page “ENGINEERING OPPORTUNITIES” (Write if you prefer not to cut page)

NAME

ADDRESS

SUBJECT OR EXAM THAT INTERESTS ME



With a VALTOCK AUTOMATIC BLOWLAMP

 <p>The “2000.” Ideal for model makers, hobbyists and service engineers for fine delicate work, soft soldering, glass bending, etc. PRICE 14/7</p>	 <p>The “Major.” A larger version of the “2000” fitted with flame shield to give large flames for most big soldering jobs about the house. PRICE 30/-</p>
 <p>The “No. 3.” The D.I.Y. man's best friend. Full size, powerful. For paint stripping, heavy soldering and all big plumbing jobs. PRICE 63/-</p>	 <p>Soldering iron attachment. Fits the “Major” and “2000”. Gives you a soldering iron anywhere—away from electrical supplies. PRICE 5/-</p>

YOU CAN DO SO MANY JOBS SO WELL



and the SLOTGRIP torsion Screwdriver

POSITIVELY GRIPS SCREWS ON THE END OF ITS BLADE

	<p>For putting screws in awkward places. Automatic action. Push—it grips. Pull—it's released. PRICE 5” 7/6 10” 12/-</p>
-------------------------------------------------------------------------------------	-------------------------------------------------------------------------------------------------------------------------------------------------

Get them at your local hardware shop or send to us for name of nearest stockist

VALTOCK LTD. Regency House 1-4 Warwick St. London W1 Telephone GERRard 1667

CHECK with these

BARGAINS



**EASY TERMS
AVAILABLE
EXCEPTING
AUTO-CHANGES**

- 3-TRANSISTOR POCKET RADIO** with miniature **SPEAKER FERRITE ROD**, and 2 **GERMANIUM DIODES**. Build it in 1 evening! Tunable over M/L waves. Complete with easy-to-follow instructions and all components (less batteries obtainable anywhere 1/3). 27/6. P. & P. 2/6. (All parts available separately.)
- SUPER 5-TRANSISTOR POCKET RADIO** incorporating printed circuit and miniature earpiece. Size $4\frac{1}{2}'' \times 3\frac{1}{2}'' \times 1\frac{1}{2}''$. Output 200 mW. Five first quality transistors. Push-pull output. Fitted 2" high-flux moving coil speaker. Medium and long wave. Internal high gain, ferrox aerial. Twin coloured case in red and black. All parts available separately. Circuit-diagram 1/6. Free with parts. No aerial or earth required. 59/6. P. & P. 3/6.
- OSCILLOSCOPE** for D.C. and A.C. APPLICATIONS. A high gain, extremely stable differential Y-amplifier (30 mV/CM). Provides ample sensitivity with A.C. or D.C. inputs. Especially suitable for measurements of transistor operating conditions where maintenance of D.C. levels is of paramount importance. Push-pull X amplifier; Fly-back suppression; Internal Time-base Scan Waveform available for external use; pulse output available for checking TV line O/P Transformers, etc. Provision for external—1/P and CRT Brightness Modulation. A.C. mains 200/250V £15.15.0, P. & P. 8/- or 30/- deposit, plus P. & P. 8/- and 12 monthly payments of 26/6. FULL 12 MONTHS' GUARANTEE INCLUDING VALVES AND TUBE
- A.C./D.C. POCKET MULTI-METER KIT**. 2" moving coil meter, scale calibrated in A.C./D.C. volts, ohms, and milliamps. Voltage range A.C./D.C. 0-50, 0-100, 0-250, 0-500. Milliamps 0-10, 0-100. Ohms range 0-10,000. Front panel, range switch, wirewound pot (for ohms zero setting), toggle switch, resistor and rectifier. 19/6. P. & P. 2/- Wiring diagram 1/- free with parts.
- CHANNEL TUNER** Will tune to all Band I and Band III stations. Complete with P.C.C.84 and P.C.F.80 valves (in series) I.F. 16-19 or 33-38. Can be modified as an aerial converter (instructions supplied). 32/6, plus 4/- P. & P. **HEATER TRANSFORMER** to suit above, 200-250V, 6/-, plus 4/- P. & P.
- MAINS TRANSFORMERS**. All with tapped primaries. 250-250V - 70mA, 6.3V 2A, 10/6. P. & P. 3/6. 280-0-280 70mA, 6.3V 2A, 6.3V 1A, 10/6. P. & P. 3/6. 280-0-280 120mA, 6.3V 2A, 6.3V 3A, 17/6. P. & P. 3/6.
- WOLSEY 3-ELEMENT FOLDED DIPOLE**. I.T.V. Aerial less mounting bracket for external use, complete with 12 yards coaxial cable, 15/-, P. & P. 4/-.

- SIGNAL GENERATORS**. Cash £6.19.6. or 25/- deposit and 6 monthly payments of 21/6. P. & P. 5/6. Coverage 100 kc/s to 100 Mc/s on fundamentals and 100 Mc/s to 200 Mc/s on harmonics. Case $10'' \times 6\frac{1}{2}'' \times 5\frac{1}{2}''$. Three miniature valves and Metal Rectifier. A.C. mains 200/250V. Internal modulation of 400 c.p.s. to a depth of 30 per cent; Modulated or unmodulated R.F. output continuously variable 100 millivolts. CW. and mod. switch, variable A.F. output. Magic eye as output indicator. Accuracy $\pm 2\%$.
- SIGNAL GENERATORS**. Cash £4.19.6. P. & P. 5/6. Coverage 120 kc/s to 84 Mc/s. Case $10'' \times 6\frac{1}{2}'' \times 4\frac{1}{2}''$. Size of scale $6\frac{1}{2}'' \times 3\frac{1}{2}''$, 2 valves and rectifier. A.C. mains 230-250V. Internal modulation of 400 c.p.s. to a depth of 30 per cent modulated or unmodulated R.F. output continuously variable 100 millivolts. C.W. and mod. switch variable A.F. output and moving coil output meter. Accuracy $\pm 2\%$.
- BATTERY RECORD PLAYER AND AMPLIFIER**. 45 r.p.m. "Star" motor "Acos" crystal pick-up, 3 transistor, push-pull amplifier complete with transistors. Output 500 milliwatts, 49/6. P. & P. 4/-.
- 8-watt PUSH-PULL 5 VALVE AMPLIFIER**. A.C. mains 200-250V Size $10\frac{1}{2}'' \times 6\frac{1}{2}'' \times 2\frac{1}{2}''$. 5 valves. For use with all makes and type of pick-up and mike. Negative feedback. Two inputs, mike and gram. and controls for same. Separate controls for Bass and Treble lift. Response flat from 40 cycles to 15 kc/s, ± 2 dB; 4db down to 20 kc/s. Output 8 watts at 5 per cent total distortion. Noise level 40 db down all hum. Output transformer tapped for 3 and 15 ohms speech coils. For use with Sd. or LP. records, musical instruments such as guitars, etc. Suitable for small halls, £3.19.6, P. & P. 7/- Crystal mike to suit 15/- P. & P. 2/- 8" P.M. Speaker to suit, 12/6. P. & P. 2/-.
- B.S.R. MONARCH UA8 WITH FUL-FI HEAD**. 4-speed, plays 10 records, 12", 10" or 7" at 16, 33, 45 or 78 r.p.m. Intermixes 7", 10" and 12" records of the same speed. Has manual play position; colour brown. Dimensions: $12\frac{1}{2}'' \times 10\frac{1}{2}''$. Space required above baseboard $4\frac{1}{2}''$ below baseboard $2\frac{1}{2}''$. Fitted with Ful-Fi turnover crystal head, £6.19.6, P. & P. 5/- With Stereo Head £7.19.6. P. & P. 5/6.
- TRANSISTOR TESTER**. For both P.N.P. and N.P.N. transistors incorporating moving coil meter. In metal case size $4\frac{1}{2}'' \times 3\frac{1}{2}'' \times 1\frac{1}{2}''$. Scale marked in gain and leakage, 19/6, P. & P. 3/-.
- PUSH-PULL OUTPUT STAGE** inclusive of transistors with input and output transformers to match 3 ohms speech coil, suitable for use with the POCKET RADIO. Kit of parts, including transistors, 19/6. P. & P. 2/- Wiring diagram 1/6, free with parts.
- PORTABLE AMPLIFIER**. On printed circuit for A.C. Mains 200/250V. Size $4'' \times 3''$ with tone and volume control. Complete with valves: ECL82 and EZ80. Output 2 watts. 39/6, P. & P. 3/-.

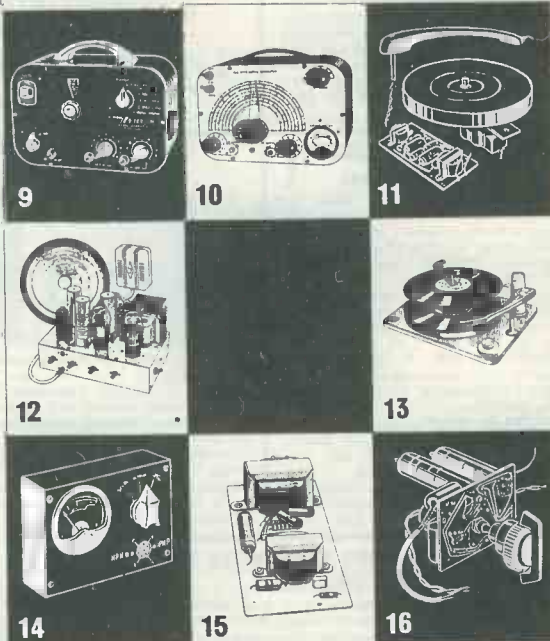

**RADIO & T.V. COMPONENTS
(Acton) LTD.**

**23d HIGH STREET, ACTON,
LONDON, W.3.**

ALL ENQUIRIES S.A.E.
GOODS NOT DISPATCHED OUTSIDE U.K.

HOME RADIO OF MITCHAM

Dept. AC, 187 London Road, Mitcham, Surrey. MIT 3282. Shop hours: 9.0 to 6.30 p.m. (Weds. 1.0 p.m.)

MULTI RANGE TEST-METER



New compact meter, sturdily built for reliable and accurate service. Ideal portable testmeter for engineers and constructors. Well damped moving coil movement. 13 ranges as follows:

AC volts and DC volts, 6V, 30V, 120V, 600V, 1,200V
DC current: 30mA and 300mA
Resistance: 0-100,000 ohms

PRICE 54/-

plus 1/6 post

TWO NEW GOODMANS SPEAKERS



AXIETTE 8. A 6 watt 15 ohm 8" unit with solid die-cast chassis with new FEROPA 11 magnet system giving increased range and excellent transient response. Ideal hi-fi speaker for domestic equipment. **PRICE £5.10.0**, post 1/6.
AXIOM 10. A 10 watt 15 ohm 10" unit also with die-cast chassis and the revolutionary FEROPA 11 magnet system and incorporating the latest design techniques. Leaflets on these speakers available on request. **PRICE £6.2.6.**

WE ARE ACTUAL STOCKISTS FOR HEATHKITS

METERS

A very fortunate purchase of high grade 50µA moving coil meters enables us to offer them while stocks last at this very low price. Made by Sangamo Weston, individually boxed. Size 3" x 2 1/2" x 1 1/8". **PRICE 19/6**, post 1/6.

PHILIPS HI-FI STEREO GRAM UNIT

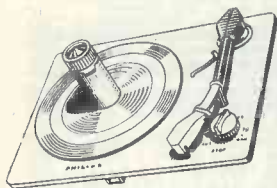

New 4-speed record unit specially designed for the hi-fi enthusiast building his own radiogram. Superb reproduction of mono and stereo records of all sizes. Precision engineered, robust construction, arm lifting and lowering device, negligible wow and rumble. Compact and easy to install. Bring your equipment up to date with this modern unit. Leaflet on request. **PRICE 13 1/2 gns.**, post 3/6.



NOMBREX SIGNAL GENERATOR

Completely portable transistor signal generator covering 200 kc/s to 220 Mc/s in eight ranges. Built to highest standards with quality components and representing the best value in the world in test equipment. Accuracy on all ranges better than 2%. RF output modulated or unmodulated. Audio output 1 k/c. Weighs under 2lb and size only 6 1/2" x 4 1/2". An essential instrument for all engineers and constructors. **PRICE £7.12.0** complete with battery. Post and packing 1/6.

TRANSISTORS

Brand new boxed transistors. Why risk inferior results with "surplus" transistors when the best can be obtained at these low prices.

MULLARD OC44 11/-, OC45 10/-, OC70 6/6, OC71 6/6, OC72 8/-, OC75 8/-, OC76 8/-, OC78 8/-, OC81 8/-, OC170 13/6, OC171 14/6, OA79, OA70, OA81 diodes 3/- each. Matched pairs of outputs available.

SEMI-CONDUCTORS SB305 surface barrier type, 6/6 each.

SYLVANIA type SYL 1750, 25/- each.

Please add 6d. postage to your order

COMPREHENSIVE COMPONENTS CATALOGUE

★ 170 Pages ★ 600 Pictures ★ Over 5000 items

PRICE 2/- Plus 9d Post



SOLDERING IRONS

ANTEX PRECISION. Ideal for all types of radio work from sub-miniature to ordinary wiring. Different sizes of interchangeable bits available. **PRICE (with standard bit) 29/6.**

SOLO 625. The most popular instrument iron. Detachable bit and robust construction. **PRICE 24/-**, post 1/6.

LITESOLD 610. A 10 watt iron, ideal for sub-miniature and transistor work. Detachable 1/8" bit. **PRICE 24/-**, post 1/-.

ADCOLA. High grade instrument model and favoured by many laboratories and technical institutes. Detachable bit. **PRICE 33/6.**

Please state voltage required. Many other models stocked in all voltages from 6 to 250 volts.

TRANSISTOR SIX



This well-tried pocket portable is now available with the new style cabinet. Sensitive superhet circuit with internal ferrite rod aerial and 2 1/2" speaker. Printed circuit for ease of construction. Medium and Long wave-bands. Start building now ready for the summer holidays. Full constructional data with detailed price list 1/6, post 6d. Complete kit of parts £8.19.6.

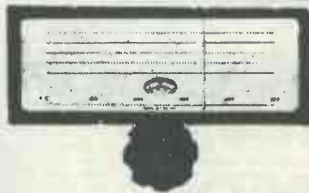

EDDYSTONE 898 SLOW MOTION DIAL

Without doubt the finest slow motion dial assembly available. Essential for really high grade receivers, tuners, test gear, transmitters, etc. Precision cut

Swiss gears give velvet smooth 110 to 1 reduction drive and vernier scale gives exact logging positions. Size 9 1/2" x 5 1/2" and supplied complete with knob, fixing screws and fitting template. **PRICE £3.11.4**, post 1/6 (overseas post 7/6).

WE STOCK FULL RANGE OF EDDYSTONE COMPONENTS AND RECEIVERS

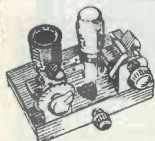

JOHNSONS SHORT-WAVE RECEIVER KITS

GLOBE KING 100

This amazing little one valve battery receiver gives really long distance reception at minimum cost. Short wave operates 24 hours a day. Start today and join the happy band of Short wave listeners. **KIT OF PARTS** with three plug-in coils £3.19.6, post 1/6. Leaflet on request.

SR2 METRES

A simple but very efficient one valve super-regenerative receiver for the VHF 2 metre band. Explore this exciting new band and listen in to aircraft, amateurs, etc. **KIT FOR RECEIVER 39/6**, P. 1/6. **POWER SUPPLY UNIT KIT 30/-**, P. 1/6.

HOLIDAYS AHEAD



Now is the time to invest in this easy modern way of electric shaving. The UNIC dry shaver operates from a single U2 battery and will give you a quick close shave anywhere. Ideal for holidays, rallies, in the car, etc. Swiss engineered. **PRICE £2.19.6** complete. Leaflet on request.

Beginner's Guide to Radio 7/6, Beginner's Guide to Television 7/6, Fun with Radio 12/6, Fun with Short Waves 12/6, Hi-Fi for Beginners 8/6, Teach Yourself Radio (Junior) 8/6, Television Explained 12/6, A to Z in Audio 15/6, Loudspeakers by Briggs 19/6, Mullard Transistor Circuits Manual 12/6, Basic Electronics Pt. 1 12/6 Please add 1/- P. & P. to your order.

THE

Radio Constructor

Incorporating THE RADIO AMATEUR

MARCH 1962

Vol. 15, No. 8
Published Monthly

Annual Subscription 29/-
(including postage)

*Editorial and
Advertising Offices*
57 MAIDA VALE LONDON W9

Telephone
CUNningham 6141
(2 lines)

Telegrams
Databux, London

Suggested Circuits No. 136: A High Gain RF-AF Signal Tracer, <i>by G. A. French</i>	574
Vest Pocket Transistor Loudspeaker Personal Receiver, <i>by D. May, A.M.Inst.E.</i>	577
Making a Simple Transistor Tester, <i>by Gordon J. King, Assoc.Brit.I.R.E.</i>	579
Converting a Record Player into a Portable Radiogram, <i>by F. H. Boardman</i>	581
Can Anyone Help ?	586
Understanding Radio, Part 7, <i>by W. G. Morley</i>	587
A New Magic Eye for Stereo	593
In Your Workshop	595
News and Comment	600
A Stereo Tape Replay Pre-Amplifier for the "Ferrograph", <i>by R. G. Harris</i>	601
Emitter Follower Circuits, Part 3, <i>by Peter Williams, B.Sc.(Hons), Grad.Inst.P., Grad.I.E.E.</i>	609
Tape Recorder Hints, <i>by K. Laycock and R. N. Hartop</i>	610
A Simple Transistor Heat Sink, <i>by Qutaipa Bassim El-Dhuwaib</i>	610
Book Reviews	610
Radio Astronomy, Part 6, <i>by Frank W. Hyde, F.R.S.A., F.R.A.S.</i>	611
Heater-Cathode Insulation, <i>by J. B. Dance, M.Sc.</i>	618
An Inexpensive Pick-up Coil, <i>by K. Balbirnie</i>	619
Radio Topics, <i>by Recorder</i>	620
A Linear Scale Resistance-Capacitance Bridge, Part 1, <i>by W. E. Thompson, A.M.I.P.R.E.</i>	622
A Simple TRF Receiver, <i>by S. G. Wood, G5UJ</i>	626

© Data Publications Ltd, 1962

CONTENTS may only be reproduced after obtaining prior permission from the Editor. Short abstracts or references are allowable provided acknowledgment of source is given.

CONTRIBUTIONS on constructional matters are invited, especially when they describe the construction of particular items of equipment. Articles should be written on one side of the sheet only and should preferably be typewritten, diagrams being on separate sheets. Whether hand-written or typewritten, lines should be double spaced. Diagrams need not be large or perfectly drawn, as our draughtsmen will redraw in most cases, but all relevant information should be included. Photographs should be clear and accompanied by negatives. Details of topical ideas and techniques are also welcomed and, if the contributor so wishes, will be re-written by our staff into article form. All contributions must be accompanied by a stamped addressed envelope for reply or return, and should bear the sender's name and address. Payment is made for all material published.

OPINIONS expressed by contributors are not necessarily those of the Editor or the proprietors.

TRADE NEWS. Manufacturers, publishers, etc., are invited to submit samples or information of new products for review in this section.

TECHNICAL QUERIES must be submitted in writing. We regret that we are unable to answer queries, other than those arising from articles appearing in this magazine; nor can we advise on modifications to the equipment described in these articles.

CORRESPONDENCE should be addressed to the Editor, Advertising Manager, Subscription Manager or the Publishers, as appropriate.

REMITTANCES should be made payable to "DATA PUBLICATIONS LTD."

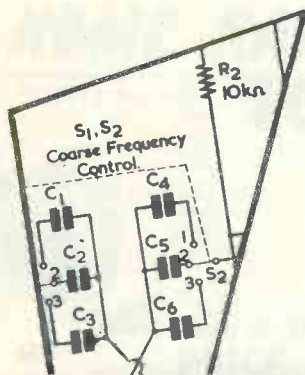

suggested circuits



The circuits presented in this series have been designed by G. A. FRENCH, specially for the enthusiast who needs only the circuit and essential data

No. 136 A HIGH GAIN RF-AF SIGNAL TRACER

A SIGNAL TRACER IS AN EXTREMELY useful item of test gear in the service workshop and it has the advantage that, unlike most other fault-finding equipment, it does not require critical components in its construction or any form of calibration. Basically, a signal tracer consists of an a.f. amplifier having an optional a.m. detector circuit at its input terminals. The tracer may then be employed to locate a signal in sound reproducing equipment by, say, working back in successive stages from the loud-speaker. A signal tracer may also be used to trace video and frame saw-tooth signals in a television receiver, although this application is not frequent. A more sophisticated type of signal tracer may include an amplifier working at a common a.m. intermediate frequency such as 465 kc/s, this enabling checks from the anodes of a.m. frequency changers and i.f. valves to be carried out more readily.

The signal tracer described in this month's contribution is a simple item of equipment, and consists of a three-stage a.f. amplifier together with a probe which may accept either a.f. or amplitude modulated r.f. signals. Despite its simplicity, the unit is extremely versatile and offers a high degree of sensitivity. The probe carries its own a.f.-r.f. switching circuit, and may be plugged into any stage in the signal tracer amplifier. The gain of the unit is sufficient to provide 100mW output

from its loudspeaker for an input a.f. voltage of some 0.25mV, and this sensitivity is adequate for reproduction of the a.f. available from such items as the playback head of a tape recorder. Further advantages of the unit are that all the components employed are generally available at low cost, and that its small power requirements enable a mains transformer with a single half-wave h.t. winding to be employed.

The Circuit

The circuit of the signal tracer accompanies this article. As may be seen, it consists of two separate items, these being the amplifier section and the probe section. We shall deal with the amplifier section first.

The first a.f. amplifying stage comprises the triode amplifier $V_{1(a)}$. Input jack J_1 couples to the grid of this triode, the amplified a.f. at its anode being passed, via C_3 , to the gain control R_5 . The slider of R_5 then couples to the grid of $V_{1(b)}$. Input jack J_2 is connected across the gain control.

The a.f. signal at the anode of $V_{1(b)}$ is next applied, via C_5 , to the grid of the output pentode V_2 , input jack J_3 appearing in this circuit also. V_2 amplifies in normal fashion, its anode feeding into the primary of the speaker transformer. Input jack J_4 couples to this primary via C_7 . Capacitor C_6 , connected across the transformer primary, is a "tone-

correction" component and serves to reduce the effect of shrillness given by the pentode output stage. The cathode bias resistor for V_2 , R_9 , is not bypassed, as the loss of gain resulting from the omission of a bypass capacitor is of a low order only. Nevertheless, a bypass capacitor may be added to the circuit, if desired, and this point is mentioned again later.

V_2 is a 6AM5 (or EL91) and is capable of an output of 1.4 watts for an h.t. potential of 250 volts. It has the advantage in the present application of requiring a combined anode and screen grid current of some 19mA only. V_1 is a 12AX7 (or ECC83), each stage of which, using the component values given in the diagram, is capable of a voltage gain in excess of 60 for an h.t. voltage of 250. In consequence, the statement that an output of 100mW is given by an input of 0.25mV would seem reasonable.

It will be noted that, apart from the unbypassed cathode bias resistor for V_2 , no negative feedback is applied in the amplifier. Negative feedback is not desirable in a unit of this nature since the reproduction is not intended to be in the "high fidelity" category, and because it would be preferable to avoid applying inputs to circuit points within a feedback loop.

The power supply circuits are of a very simple nature. H.T. is provided by a single 250 volt half-wave secondary on the mains transformer,

this being rectified by a "metal" or contact-cooled rectifier. C_9 , R_{10} , C_8 provide smoothing for $V_{1(b)}$ and V_2 , further smoothing for $V_{1(a)}$ being provided by R_4 and C_1 . A 6.3 volt winding having a minimum current requirement of 0.6A provides heater power. A "humdinger", R_{11} , is connected across the 6.3 volt winding, this component reducing hum pick-up in the first stage of the amplifier. It may be possible to omit R_{11} in some units built to the circuit, and this point is dealt with later.

The probe section consists of a probe unit which is connected to a

first switched on and allowed to warm up. The probe unit is then plugged into a jack in the amplifier section appropriate to the degree of a.f. gain required, and its flying lead is connected to the chassis of the faulty equipment. The probe connector is then applied to the circuit points under test in the equipment. When it is desired to trace a.f. voltages S_2 is set to the appropriate position, whereupon C_{10} functions as a d.c. isolating capacitor. For r.f. voltages C_{12} serves as the isolating capacitor, whilst C_{10} prevents the d.c. com-

ponent of $V_{1(a)}$ to chassis whenever the jack plug is removed. An arrangement of this nature is desirable because it prevents the noise generated in this grid circuit from reaching the following stages when the amplification offered by $V_{1(a)}$ is not required.

Points of Design

There are several points of design which need to be discussed.

The amplifier section output valve, V_2 , has low h.t. current requirements, with the result that a small and inexpensive h.t. power supply is all that is required. On the other

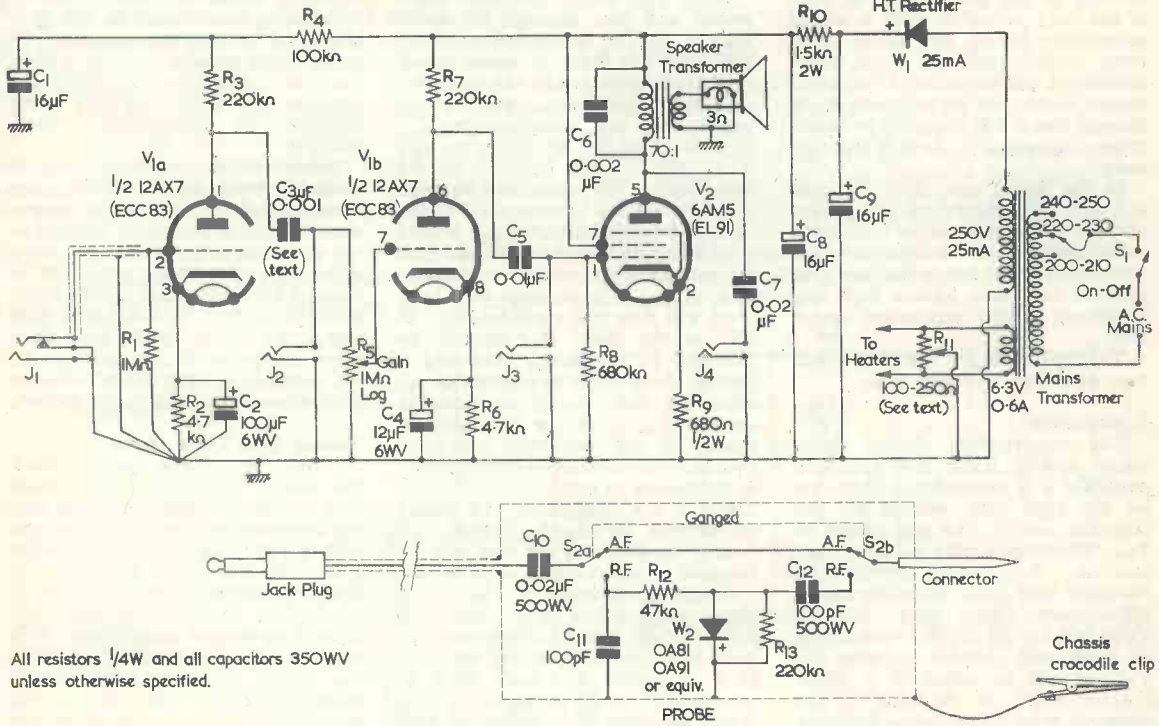

All resistors 1/4W and all capacitors 350WV unless otherwise specified.

M257

jack plug via flexible screened cable. When S_2 , in the probe unit, is set to the "A.F." position, the probe connector couples directly to the jack plug via the 0.02μF capacitor C_{10} . With S_2 in the "R.F." position the probe connector couples, by way of C_{12} , to the shunt detector diode W_2 . The demodulated a.f. appearing across this diode then passes through the filter R_{12} , C_{11} , before being applied to the jack plug via C_{10} . The probe unit is fitted with a flying lead terminated in a crocodile clip, the latter being intended to clip to the chassis of the equipment under test.

To use the signal tracer for fault-finding work, the amplifier section is

ponent of the rectified signal from being applied to the input circuits of the amplifier section. The value chosen for R_{13} is such that satisfactory a.m. detection, without peak clipping, will be provided when the jack plug is inserted into either J_1 , J_2 or J_3 . Input jack J_4 would not normally be employed for r.f. signal tracing (although an audible output would be provided with high level r.f. inputs if it were so used), as its main function is to provide an a.f. coupling to the primary of the speaker transformer when checking the output circuits of low-power domestic equipment.

The input jack J_1 has a close-circuit contact, this taking the grid

hand, V_2 is capable of a power output of 1.4 watts only and tends, in consequence, to overload at slightly lower signal input levels than do the more familiar 2 to 4 watt output valves employed in most mains operated radio or television receivers. This effect may be a little irritating in service workshops having high background noise levels and it is desirable, in consequence, to ensure that a high proportion of the output from V_2 is converted into sound energy. This point may be satisfied by employing a speaker transformer ratio equal to, or close to, that specified in the diagram, and by using a reasonably sensitive loudspeaker.

Four input jacks are shown in the diagram, and it was felt that these would offer a sufficiently versatile range of amplification for all normal servicing requirements. Since most fault-finding work will be carried out with the jack plug inserted in either J_1 or J_2 , it was considered that the single gain control in the input circuit of $V_{1(b)}$ would be adequate. If it were felt desirable, however, a second gain control could easily be fitted in the grid circuit of V_2 , such a control replacing R_8 (with its slider connected to V_2 grid) and having a value of $500k\Omega$ log. A gain control in the grid circuit of $V_{1(a)}$ is not very desirable since it would complicate layout and noise problems without offering much compensatory advantage. The on-off switch S_1 may be ganged with R_5 , if desired, but it will probably be found more convenient to have a separate switch.

In the probe unit, both C_{10} and C_{12} have been given working voltages of 500. A high working voltage in these components is necessary because the probe connector may be coupled to points having high d.c. potentials in the equipment under test.

The switch, S_2 , in the probe unit may be a d.p.d.t. toggle type.

Construction

The construction of the signal tracer should incur few problems provided it is remembered that, due to the high gain offered by the amplifier section, the grid circuit of $V_{1(a)}$ will be especially liable to hum pick-up. $V_{1(a)}$ should therefore be mounted well away from the mains transformer wiring, and close to input jack J_1 . To prevent hum loops, all grid and cathode returns for $V_{1(a)}$ should be taken to a single chassis point, as depicted in the diagram, even if this means isolating J_1 from the front panel. The heater

wiring to V_1 should be tightly twisted and kept well away from $V_{1(a)}$ grid circuit.

The probe unit needs to be well screened, and the flexible screened cable to its jack plug should have a close-mesh outer braiding. The probe case must be insulated as it will be held in the hand during servicing and may be at live mains potential via the chassis of equipment under test. The flexible screened lead to the jack plug must similarly be insulated.

Reducing Hum

After the tracer has been completed and put through its initial tests it will be necessary to finally eradicate any hum or noise which may find its way into the amplifier section. With $V_{1(a)}$ put out of circuit (by, say, disconnecting C_3) hum level should be negligible, and $V_{1(b)}$ and V_2 will function in the same way as the triode and pentode amplifier of any conventional mains operated sound radio. $V_{1(a)}$ should then be brought into circuit and jack J_1 opened by inserting a dummy jack plug. It is possible that hum level will now rise considerably. If this is the case, R_{11} should be adjusted for minimum hum and a careful check made to ensure that all screening and chassis connections around $V_{1(a)}$ grid are satisfactorily made. It may be found that hum reduces if the chassis of the amplifier is connected to earth via an $0.01\mu F$ 250 a.c. w.v. capacitor. (A direct connection to earth cannot, of course, be made as the unit will be required to test a.c./d.c. equipment.)

Coupling capacitor C_3 has been given rather a low value ($0.001\mu F$) and this will assist in reducing the hum level heard from the speaker. If it is found that hum level is satisfactory, it is advisable to increase the value of C_3 to $0.01\mu F$ and improve, thereby, the frequency

response of the amplifier section. In some instances it may be found that the "humdinger" R_{11} can be dispensed with, whereupon this component can be removed and one side of the heater supply (or a centre tap) connected direct to chassis.

As mentioned before, a slight increase in gain may be achieved by bypassing R_9 . If this course is decided upon, the bypass capacitor should be fitted during construction so that checks for hum and noise are made whilst the amplifier has the slightly enhanced gain which results. A suitable value for the bypass capacitor would be $25\mu F$, 25 w.v.

A high noise level in the grid circuit of V_1 may be caused by R_1 or R_2 . It is possible, in such a case, that an improvement would be obtained if these resistors were replaced by high-stability components.

When the dummy jack plug is removed from input jack J_1 , any hum and noise which may be present should become markedly reduced as the grid connects to chassis. Provided that the probe connector is clear of a.c. fields there should be no increase in hum, as compared with that given by the dummy jack plug, when the probe is plugged into J_1 . An increase in hum would indicate poor screening in the probe section.

Testing Tape Deck Heads

When the probe is used to check the output from tape deck heads care should be taken to ensure that the isolating capacitor C_{10} does not hold a high charge due to previous tests. If this were the case, the discharge current from this capacitor could flow through the head and cause it to become magnetised. This risk may be eliminated by holding the probe connector against the chassis crocodile clip for several seconds before applying it to the head.

EMI TAPE RECORDERS AID AIRCRAFT NOISE ABATEMENT RESEARCH

Giant airliners, taking off and landing at modern airports, pose one of the most difficult of noise abatement problems, as these airfields are naturally situated close to centres of population. As long as the trend towards bigger and faster aircraft continues, this problem will grow worse. Bristol Siddeley Engines Ltd. are using professional magnetic tape recorders supplied by E.M.I. Electronics Ltd. in a research programme aimed at modifying engine designs to reduce noise levels. One stage of the programme is to investigate the distribution of noise around an engine at various distances and to determine what ranges of frequencies predominate.

Tests have recently been taking place at an R.A.F. airfield in Gloucestershire, selected for its remoteness from residential areas and for the comparative absence of extraneous noise.

A mobile test bed is firmly secured to the ground to withstand engine thrust. Up to four microphones are sited at various distances and angles from the engine. E.M.I. tape recorders and associated noise measuring equipment are housed in a mobile laboratory 50 yards away, the engine being controlled from a second caravan.

High bypass ratio ducted fan engines are being designed and developed which reduce jet noise by 50 per cent, but this tends to emphasise the noise from the air intake. Considerable research work at present is, therefore, concentrated on the testing of intake silencing devices with a view to reducing compressor whine at source.

After an engine has been tested at various speeds and the resultant noises recorded, the tapes are sent to the Bristol Siddeley laboratories at Coventry. There they are analysed and, among other things, the various component noises are related to their respective sources within the engine. The design can then be modified, where practicable, to reduce the noise level.

Noise from aircraft in flight at various heights and speeds after taking-off from London Airport have also been recorded and analysed in the same way. This technique, of recording and analysing noise levels of moving objects, requires the use of a high-quality tape recorder.

VEST POCKET TRANSISTOR LOUDSPEAKER PERSONAL RECEIVER

By D. MAY, A.M.Inst.E.

THE LITTLE SET DESCRIBED HERE WAS DESIGNED with three objects in view: (1) It had to fit in the outside breast pocket of a man's jacket; (2) it had to be made with the minimum of "special" components; and (3) it had to operate with reasonable loudspeaker volume.

To reduce bulk and cost a straight reflex design was chosen using four transistors and two crystal diodes, the thinnest case available—a celluloid soap box reduced in thickness—was pressed into service, and only a 3V collector supply was provided.

The Circuit

Fig. 1 shows the theoretical circuit, from which it will be seen that TR₁ operates as an r.f. stage

with regeneration feeding a double diode detector, from which the a.f. signal is passed back to the bottom of L₁ and through TR₁ again, functioning this time as an a.f. stage. The signal then passes through two more a.f. stages, TR₂ and TR₃, whence it is passed to the loudspeaker by TR₄.

The four transistors are: one "white spot" r.f. transistor, TR₁, and three "red spot" transistors, TR₂, 3 and 4. All these are of the surplus variety and, together, cost least and take up less room than a smaller number of first grade transistors, together with sub-miniature interstage transformers, which would be capable of producing similar volume on the limited collector supply voltage.

The Loudspeaker

This is a low resistance balanced armature headset stripped of its plastic housing. It was found to work quite well in the "as received" condition, with a d.c. resistance of 30Ω, but worked even better when rewound with about 1,200 turns of 35 s.w.g. enamelled wire to a d.c. resistance of nearly 100Ω. This thought should not put anyone off; the rewind, including stripping the old winding and finally reassembling and adjusting the unit, only takes about two hours.

Components List

Resistors (all $\frac{1}{10}$ watt 20%)

R ₁	10kΩ
R ₂	220kΩ
R ₃	3.3kΩ
R ₄	2.2kΩ
R ₅	220kΩ
R ₆	3.3kΩ
R ₇	220kΩ
R ₈	4.7kΩ
R ₉	4.7kΩ
R ₁₀	47kΩ

Transistors

TR ₁	White spot
TR _{2, 3, 4}	Red spot

Capacitors

C ₁	0.01μF miniature tubular
C ₂	0.001μF miniature tubular
C ₃	8μF 6W.V. sub-miniature electrolytic
C ₄	8μF 6W.V. sub-miniature electrolytic
C ₅	8μF 6W.V. sub-miniature electrolytic
C ₆	8μF 6W.V. sub-miniature electrolytic
C ₇	0.01μF miniature tubular
VC _{1, 2}	Double 200pF trimmer

Miscellaneous

- 1 Medium wave ferrite aerial (see text)
- 1 Low resistance balanced armature headphone (see text)
- 2 Contact leaves from small relay (on/off switch)
- 2 1.5V cells (Slim Penlight)

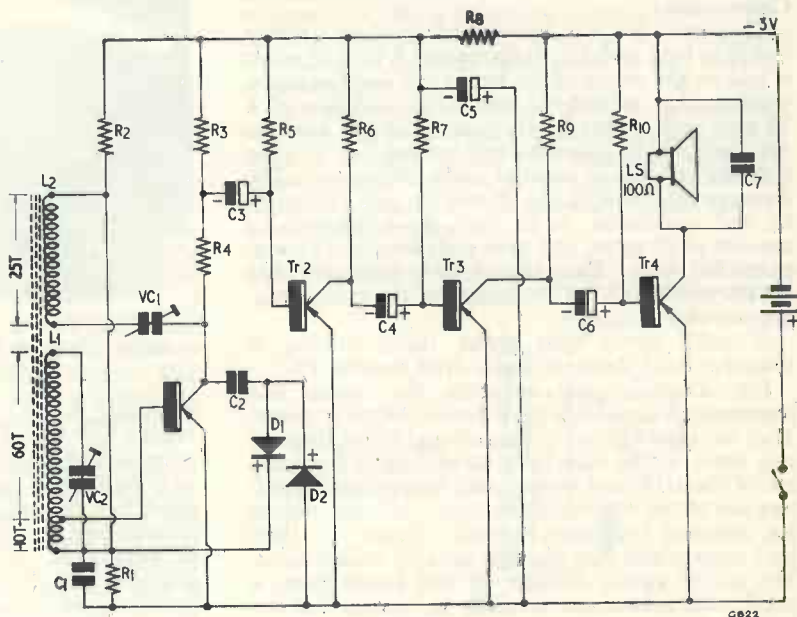
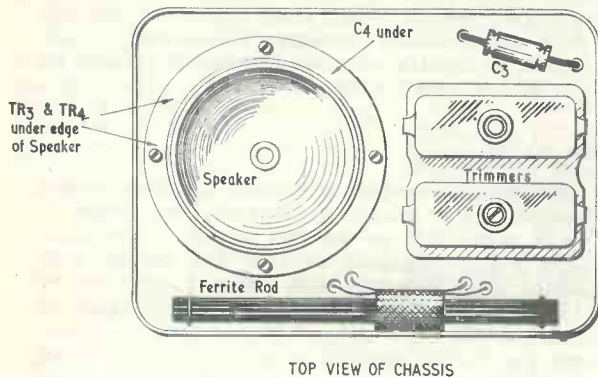

Fig. 1. Circuit of the receiver

The Batteries

The set works off two 1.5 volt Slim Penlight cells which give good battery life. The original set has been in use for many weeks with its first two cells and still produces adequate volume. It has also been run during this period for a stretch of 12 hours continuously without polarising the battery. To save space and the nuisance of possible bad contacts the batteries are soldered into the circuit and retained by their leads.



G023

Components

The ferrite aerial is home-constructed on a ferrite rod $2\frac{1}{2}$ in long and $\frac{1}{8}$ in in diameter. A turn of paper is laid on the centre of the ferrite rod and the signal winding, L_1 , wound on top. This consists of a 70 turn coil tapped at 10 turns from the bottom. Another turn of paper is fitted around this winding and the whole is secured with Sellotape. The regeneration winding, L_2 , is next wound on top of L_1 and is secured, in its turn, by Sellotape. L_2 consists of 25 turns, and both coils employ 33 s.w.g. enamelled wire. Experiments have indicated that the disposition of the windings and the exact s.w.g. are not very critical.¹

A small ferrite slab aerial, ready wound, is available from Repanco Ltd.—type number F53.

For simplicity and economy the tuning and regeneration capacitors are a double 200pF trimmer. They are used as pre-set controls and tuned through two holes in the case by a screwdriver. Resistors are of the 1/10 watt variety, and large-value capacitors are of the sub-miniature type. All components are mounted to a thin Paxolin "chassis" by their lead wires which pass through suitably drilled holes. The on/off switch consists of two leaves from a small relay which are normally in contact but are separated, to switch off, by an insulated washer on a nut and bolt sliding in a slot in the front of the case.

Performance

For simplicity, medium wave reception only is provided, thus avoiding an extra coil winding and

¹ The author obtained his ferrite rod from Messrs. TV Electronics (G. Matthews), Hurst Street, Birmingham 5.

another switch. The tuning capacitor, having a maximum capacitance of 200pF, just covers the Midland Regional and Third programmes. In this part of the country² the Light programme is not well received on medium waves, but elsewhere no doubt this would be available also. Volume is adequate for personal listening. The question of good volume has often puzzled the writer. The literature refers to "earpiece loudspeaker volume", "personal listening level" and the like, which does not really convey much; so be it said that this model will produce speech which is clearly intelligible at a distance of 60ft in the (quiet) open air.

Construction

The photograph and diagram show how the components are arranged. The circuit is quite stable and not at all critical as to where exactly the connecting wires run, but the usual rules of layout should be observed with r.f. leads being kept as short as possible. One thing is critical and this is the angle at which the speaker is mounted. This must be such that the speaker coil is at right-angles to the long axis of the ferrite rod aerial, or it will couple with it and howling will ensue.

It has been said before, but the writer knows that experienced constructors will bear with him if he



General view of the receiver constructed by the author. Note particularly the neat and professional appearance of the case

reiterates, for the sake of those who have not yet "had a go" with transistors, that these components must *never* be soldered into circuit without the use of a heat shunt on the lead wire between the transistor and the joint being made. Long-nosed pliers are excellent for the purpose but leave only one hand to work with. A better tool is that formed by a crocodile clip with two pieces of copper soldered into the jaws to clamp on the wire to be protected. Have at least two of these handy as it is often desirable to solder wires from two transistors at once.

Heat shunts should also be used, for preference, with all sub-miniature components when soldering; before making a joint look to see if there is any route by which heat might get to an unprotected transistor.

² Stratford-on-Avon.

THERE ARE VARIOUS WAYS OF TESTING TRANSISTORS and there are a host of excellent transistor testers available commercially. Some of these allow transistors to be checked for gain without the bother of having to remove them from the circuit. In such instruments the test transistor is applied to a form of bridge circuit, and the resistive elements in the circuits associated with the transistor are balanced out before the test is undertaken.

Nevertheless, even with testers of this somewhat complex nature it is still often necessary to remove the suspect transistor from the equipment to perform certain checks, notably collector leakage and the like. So far as the service technician is concerned, the procedure of balancing a transistor *in situ* is justified, for having to extract a suspect from a printed board is not only a tricky exercise wrought with hazards but it is also time consuming and frustrating, especially if it is eventually discovered that the transistor is all right after all.

The experimenter, on the other hand, is interested mainly in proving whether or not a transistor is usable and whether it has reasonable current gain and leakage. In home-constructed equipment the transistors are usually more accessible and removable than in commercial counterparts, and in many cases the constructor simply desires to know the condition of the transistors before building them into the equipment.

Simple Resistance Checks

Several simple checks on transistors are possible by the use of nothing more involved than an ohmmeter (or the "ohms" ranges of a multi-range testmeter). As the leads from such an instrument have across them a potential equal to the voltage of the internal battery, both the forward and reverse resistances of each diode junction can be measured by first checking with the meter leads connected one way round, and then again after reversing the leads.

Each diode junction is relative to the base, so the meter "sees" one diode between base and emitter and another between the base and collector. The ratio of resistances (reverse-to-forward) is usually in the region of 100-to-1 or greater on good transistors at normal room temperature.

Likewise, the collector leakage current (or resulting resistance), sometimes given the symbol I_{CO} , can be judged by connecting the meter between the collector and emitter, first one way round and then the reverse way. In both directions the resistance should be very high on a good transistor, but it should be remembered that a greater-than-normal ambient temperature will give the impression of a poor insulation.

If the ohmmeter is connected so that the battery negative lead is connected to the collector (p.n.p. transistors only) and the positive lead to the emitter the resistance should fall to a very low value if a resistor of about $33k\Omega$ is connected simultaneously between the collector and base. This is because the resistor puts a negative bias on the base, relative to the emitter, and thus promotes collector conduction.

Making a Simple Transistor Tester

By Gordon J. King, Assoc. Brit. I.R.E.

This is about the closest one can get to a measurement of current gain with an ohmmeter.

Transistor Test Circuit

The basic parameter of a transistor is its current gain. That is, a small change of current at the base produces a larger change of current at the collector. For example, if a $20\mu A$ increase of current in the base causes a $2mA$ increase of current in the collector, the transistor would be said to have a current gain of 100 ($2,000\mu A$ divided by $20\mu A$ equals 100).

The change of $2mA$ quoted above is a change from some collector current value as set by the base bias. With this in mind we can easily produce a circuit, that is capable of biasing the transistor to a reasonable working point and of introducing a pre-calculated change of base current so that the resulting change of collector current can be read in terms of current gain.

Such a circuit is shown in Fig. 1. With the switch S_1 in the "set bias" position, as shown, and with S_2 open, it is clear to see that variable resistor R_3 allows the base bias to be set to a reasonable working point, as indicated by the collector current reading in the milliammeter M_1 .

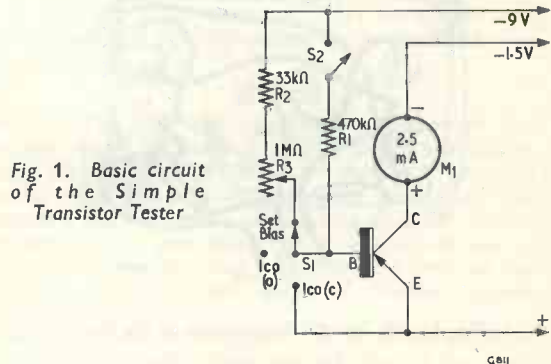

Fig. 1. Basic circuit of the Simple Transistor Tester

Now, when switch S_2 is closed a further base bias (or base current) is applied in parallel with that derived from the variable resistor circuit. The result is a further increase in collector current and this increase, in relation to the extra current introduced in the base to produce it, can be read off the meter directly in terms of current gain.

Meter Calibration

The process can be better understood by referring to Fig. 2. Here the outside scale gives the normal calibration points of a 0–2.5mA meter at 0, 0.5 and 2.5mA. With S_2 open, R_3 is adjusted to give the required standing bias which, in this tester, is 0.5mA. Between the 0.5 and 2.5mA points there is a range of 2mA available for gain measurements.

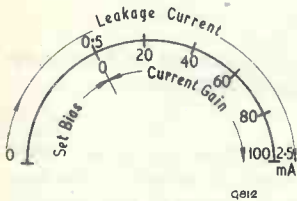

Fig. 2. The "set bias" control is adjusted for 0.5mA of collector current, and the range from 0.5 to 2.5mA is calibrated in current gain. The normal current calibration of the meter is used to measure leakage current

If full-scale is to represent a gain of 100 (which is quite a reasonable maximum value), then the extra base current that S_2 must introduce to give a full 2mA change is $\frac{2}{100}$ mA, or 20 μ A, as has been calculated previously.

Thus, when S_2 is closed R_1 must pass 20 μ A. The value required for this to happen can easily be discovered from Ohm's law, i.e. R_1 in $M\Omega$ equals 9 volts (the battery voltage at S_2) divided by 20 μ A. That works out to 0.45M Ω which, of course, is the same as 450k Ω . Clearly, then, if the scale between 0.5mA and 2.5mA is divided linearly as shown, intermediate current gain figures can be added.

The base is purposely fed from a higher-than-normal negative voltage so that the current may be fed through the high resistance circuit made up of R_3 and R_2 (current limiter) in series. In this way the base current is made somewhat independent of

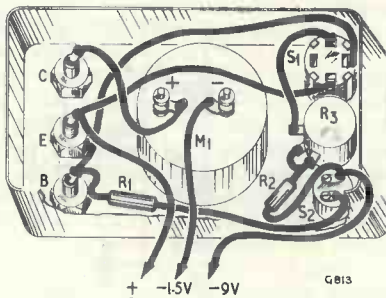

Fig. 3. The internal construction of the tester

the transistor input resistance. As the accuracy of the gain test relies essentially on the current in R_1 , this component should be chosen with care, and should preferably be of the close-tolerance, high stability variety.¹

¹ If difficulty is met in obtaining a 450k Ω resistor (which is not in the preferred range of values) it may be pointed out that the parallel combination of a 1M Ω and an 820k Ω resistor provides a resistance very close (450.5k Ω calculated) to the required figure.—Editor.

Leakage Tests

Switch S_1 also provides for collector leakage tests with the base open-circuit or connected to the emitter, the switch positions being indicated as $I_{co(o)}$ and $I_{co(c)}$ respectively. The leakage current is shown on the normal current scale of the milliammeter, as shown in Fig. 2.

A Practical Tester

Fig. 3 shows how the various components can be assembled into a small box made of tin-plate or other material to produce a very compact instrument. The plastic boxes sold by popular stores as sandwich cases make excellent housings for this type of instrument. These are manufactured in various sizes, and one should be selected which will adequately accommodate the meter movement employed.

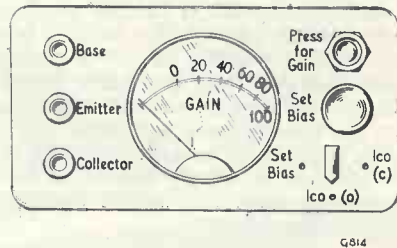

Fig. 4. Front-panel view of the tester

Three small socket-type terminations allow the test transistor easily to be connected to the instrument through flyleads. It is important that the sockets are given clear identification as shown by the panel view of the instrument in Fig. 4.

The instrument is energised by a 9 volt grid bias battery with a 1.5 volt tap for the collector circuit. This can be external to the instrument or, if the case allows, can be installed inside. The power requirements are, of course, negligible, so a very small battery is perfectly suitable provided the required 9 volts and a 1.5 volt tapping can be obtained. The internal wiring can easily be followed from Fig. 3, but for the sake of completeness a schematic diagram is given in Fig. 5.

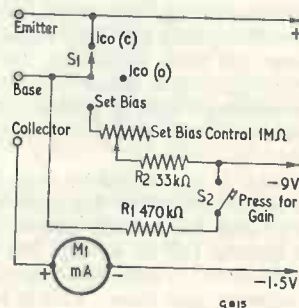

Fig. 5. Complete circuit of the tester

Points to Observe when Testing Transistors

The foregoing tester is perfectly safe so far as the transistor under test is concerned because the collector potential is limited to 1.5 volts. Nevertheless, if a meter deflection greater than full-scale is given the bias control should be backed-off immediately, as a collector current in excess of 5mA or so may damage small transistors. Always ensure that the test transistor is connected correctly to the instrument. It is a good plan to commence each test with R_3 set to insert maximum resistance.

Transistors should not be handled during a test as the heat of the hand may be sufficient to give false readings and, in some cases, may cause the current rating to be exceeded.

All tests should be carried out as speedily as possible as testers rarely embody a method of stabilising the working point. This means that if a small transistor is left working in a tester for any length of time unattended it is liable progressively to increase in temperature and undergo thermal runaway, finally resulting in failure of the transistor and, possibly, the collector meter.

Light can affect the performance of some transistors, particularly if the light source is very bright, such as a bench lamp, and is very close to the transistor.

Components List

Resistors

- R_1 450k Ω , close-tolerance, high stability. (See text.)
- R_2 33k Ω , $\frac{1}{4}$ watt, 10%.
- R_3 1M Ω , variable.

Switches

- S_1 1-pole, 3-way rotary
- S_2 Single-pole push switch

Meter

- M_1 Milliammeter 2.5mA full-scale (or meter with greater sensitivity suitably shunted and calibrated).

Miscellaneous

- 3 Single insulated sockets
- 1 Plastic box approximately $4\frac{1}{2} \times 4\frac{1}{2} \times 2$ in, or larger to suit milliammeter
- 1 9 volt grid bias battery, or smaller 9 volt battery with 1.5 volt tapping
- Plastic covered wire for wiring and for battery leads
- Solder tags, nuts, bolts, etc.

converting A RECORD PLAYER into a PORTABLE RADIOGRAM

By. F. H. Boardman

This article describes a single valve Medium and Long wave reflex receiver which may be incorporated into a record player converting it to a portable radiogram. A basic circuit is discussed, together with modifications to enable Radio Luxembourg on 208 metres to be received and to allow the use of an alternative valve

THE NEED IS OFTEN FELT IN A HOUSEHOLD FOR AN extra radio receiver. Sometimes this is because members of the family want to listen to different programmes at the same time, or because television and radio interests clash. Again, it may be that there is sickness in the house—or even a courting couple! The following article is the result of an attempt to comply as economically as possible with the desire for a second set.

Initial Planning

Various ideas were set in motion at the planning stage. A battery portable, while being in many ways ideal for such a purpose, was considered too expensive in initial cost and in the replacement cost of the batteries. A transistor set, although economical on batteries, was also considered too costly. Since the second set was for use in the home, it was decided finally to use the a.c. mains for power supply, and to build the receiver into a portable record

player. The h.t. and l.t. power supplies of the record player, its audio amplifier and loudspeaker, could all be used with the receiver enabling a saving to be made at the outset. This plan naturally imposed the limitation of ensuring that the power requirements of the radio receiver section should be low. This problem was overcome by limiting the receiver section to one valve of modest current consumption.

The personal requirements, in addition to those already listed, were that the set should be completely self contained, and, within the limits set by the need for a mains electricity supply, should be portable. The set must therefore have an internal aerial. Also required were Medium and Long wave reception in addition, of course, to the reproduction of records.

The solution to the foregoing is indicated in the circuit of Fig. 1. This circuit incorporates a dual-wave ferrite rod aerial, a pentode valve reflex

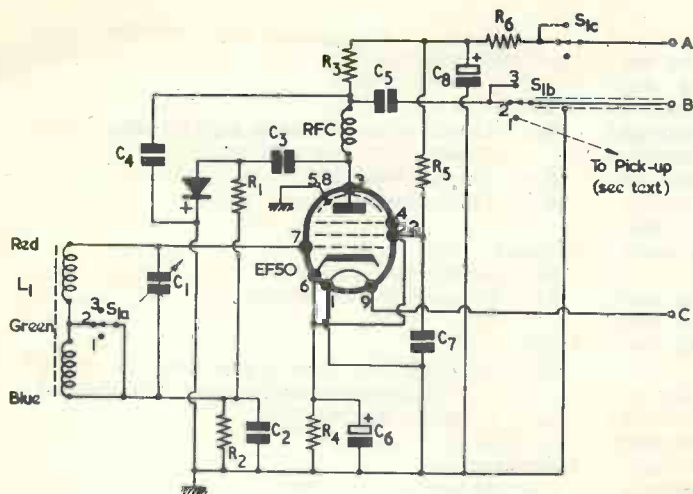

Fig. 1. Circuit incorporating a dual-wave ferrite rod aerial, a pentode valve reflex amplifier and a germanium diode. S₁ a, b are ganged. Position 1—Gram, 2—Medium waves and 3—Long waves

amplifier, and a germanium diode.

The advantage of the reflex amplifier is that the one valve is used twice, amplifying both the r.f. signal from the tuned circuit, and the a.f. signal from the detecting circuit. The r.f. signal from the tuned circuit is amplified normally, and the amplified r.f. signal appears at the anode of the pentode; this being detected by the circuit incorporating the germanium diode, and the a.f. component passed back to the grid of the valve. The amplified a.f. signal then appears across the load resistor, R₃, and is passed to the audio amplifier of the record player for normal amplification and reproduction through the speaker. The successful working of a reflex amplifier depends upon keeping the signals (in this case r.f. and a.f.) in their own "compartments". In other words, the r.f. component of the amplified r.f. signal must not be fed back to the grid circuit of the valve, otherwise instability will result. The r.f. filtering in the demodulating circuit must therefore be efficiently arranged, and stray coupling through badly arranged wiring must at all costs be avoided.

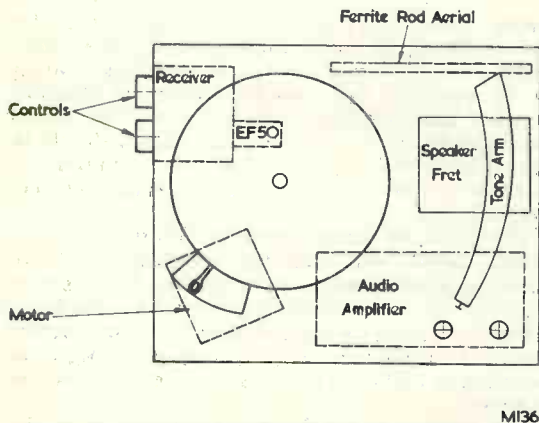
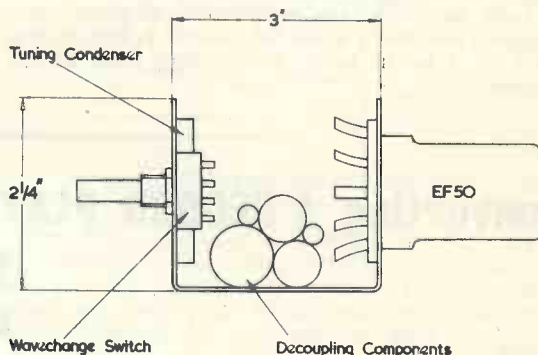

Fig. 2. Method of mounting the receiver within the record-player cabinet

MI35



MI37

Fig. 3. Measurements and method of component layout on the U shaped chassis

The valve chosen for the circuit of Fig. 1 was the popular EF50, though, if necessary, a valve of smaller dimensions could be employed. (A modification to allow the use of a smaller valve is given later.) No trouble should be experienced in building the receiver, though it should be emphasised again that care in the disposition of the wiring is essential.

Practical Points

It is difficult to give a precise layout for the receiver, because so much depends on the dimensions and layout of the record player to be used. However, the layout employed by the writer will now be described as this should fit, or be readily adaptable, to the majority of record player cases. The player converted had a suitable vacant space under the turntable (Fig. 2), and this was employed for the receiver, the knobs of which projected through the side of the cabinet. The chassis measured 3 1/2 x 3 x 2 1/4 in (Fig. 3) and was made in the form of a letter

Fig. 4. Alternative methods of connecting the receiver to the existing player-amplifier. (See text)

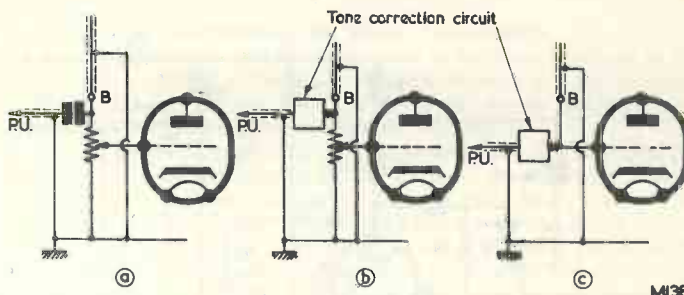

MI38

U. On one upright of the U the tuning capacitor (which was of the solid dielectric type, and whose spindle, it should be noticed, has to be insulated from chassis) and wavechange switch were mounted. On the other upright was mounted the valve holder, the valve projecting outwards from the chassis in a horizontal position. In individual cases the size and shape of the chassis, and the disposition of these main components, will be largely dictated by the shape, size and position of the space available, but

ferrite rod aerial is mounted inside the record player away from the chassis, and wired up. Keep this aerial away from ferrous metals, and keep its connecting wires reasonably short to avoid hum pick-up.

Connecting to the Amplifier

Switch S_1 (a) and (b) gives Gram-Medium wave-Long wave positions. On the Gram position the a.f. output from the receiver section is disconnected from the audio amplifier. This is to prevent incorrect loading of the pick-up head when playing records, with consequent loss in volume and distortion.

Connecting the receiver to the existing player amplifier should present little difficulty, but the exact method of doing this will depend upon the design of the amplifier. Typical alternatives are now described.

If there is no tone connection circuit between the pick-up and the first grid of the amplifier, lead B from the receiver may be connected direct to that first grid, as in Fig. 4 (a). This leaves the pick-up in circuit when the radio is being used. If a tone-correction circuit is fitted, as in Fig. 4 (b), lead B is connected to the first amplifier grid *after* this circuit. Again, the pick-up remains connected when the radio is switched on. If there is no volume control available at the first amplifier grid, lead B is connected direct to that grid, as in Fig. 4 (c). In some

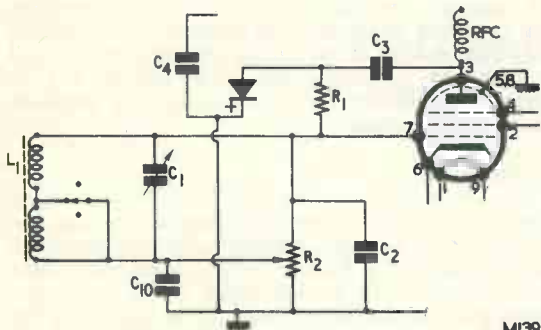

MI39

Fig. 5. Showing the method of inserting a volume control, where required, into the circuit of Fig. 1

there should be little difficulty in altering the suggested layout to suit such circumstances. The remaining components, with the exception of the ferrite rod aerial, were mounted between the two uprights of the chassis.

Whatever the shape of the chassis, it will be convenient to proceed as follows. Consider the components as being divided into two sections: one section consists of the decoupling components (R_4 , R_5 , R_6 , C_6 , C_7 , C_8 (all capacitors here should be of the tubular type) and the other section comprising the signal-carrying components R_1 , R_2 , R_3 , C_2 , C_3 , C_4 , C_5 , RFC, and the germanium crystal diode. Commence by wiring up as much of the wavechange switch, variable capacitor, and valve holder as possible without components; then wire in the decoupling components. Keep the decoupling components together in a group between the valve holder and the wavechange switch, and solder to the valve holder tags as appropriate. (See Fig. 3.) Signal carrying components should then be added, keeping wiring as short and direct as possible. The

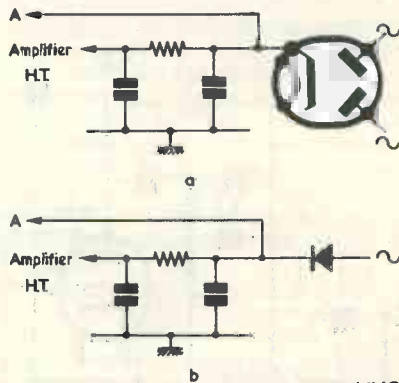

MI40

Fig. 6. (a) Deriving an h.t. supply for the receiver direct from the valve rectifier cathode. Fig. 6 (b). Obtaining an h.t. supply direct from a metal rectifier

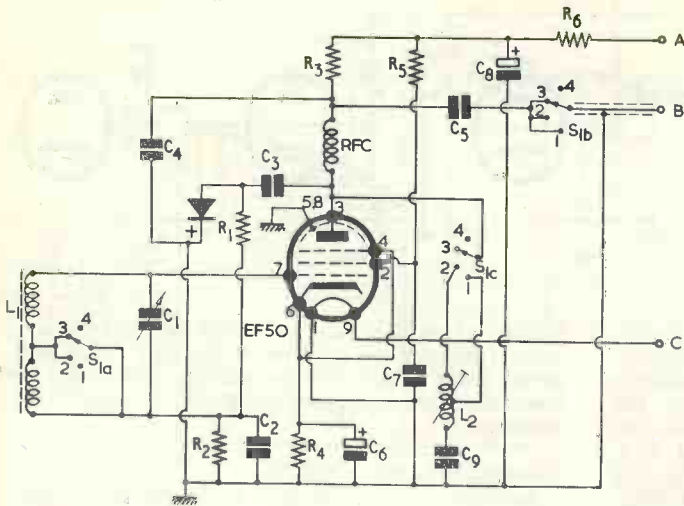

Fig. 7. Circuit of the modified receiver having two extra components, C_9 and L_2 , added in order to produce a degree of regeneration thus increasing both the amplification and the selectivity. $S_1 a, b, c$ are ganged. Position 1—Long waves (with regeneration), 3—Medium waves (without regeneration) and 4—Gram

MI41

cases it may be found that keeping the pick-up in circuit when switched to radio causes excessive loss of a.f. This may be overcome in the cases of Fig. 4 (a) by connecting the pick-up to the lower contact of S_1 (b) in Fig. 1, and, in the cases of Figs. 4 (b) and (c), the output of the tone correction filter (at the points marked X) to that contact.

If it is found impossible to use the volume control of the amplifier to control the signal from the receiver section, a volume control can be incorporated in the receiver by making R_2 an $0.5M\Omega$ volume control, inserting the additional capacitor, C_{10} , and reducing the value of C_2 to $100pF$, as in Fig. 5. Screened lead should be used for all a.f. connections between receiver and amplifier and the screening provides the chassis to chassis connection. H.T. should normally be derived from the rectifier valve cathode side (or the metal rectifier side) of the smoothing circuit (Fig. 6), and not from the amplifier

h.t. line. This is to prevent feedback through the h.t. supply. The filament supply of the amplifier will normally have one side earthed, and therefore only one lead (as shown in the circuit diagram) will be required to supply the EF50 heater, but be prepared to modify the wiring to suit the amplifier circuit in this respect.

Performance

The receiver just described was found to be capable of providing the audio amplifier (which was designed for a crystal pick-up) with a more than adequate signal; in fact, on local stations the volume control had to be turned down to prevent overloading of the audio amplifier. The quality of the output could not be expected to rival Hi-Fi!—but it was considered to be superior to that obtained from records. The level of hum from the speaker was exceedingly low.

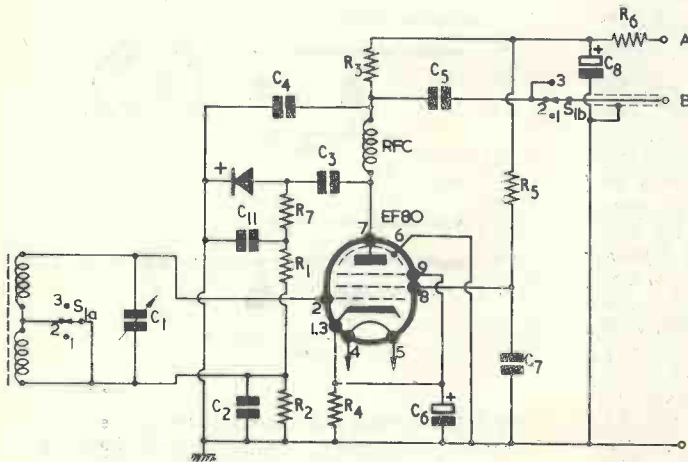

Fig. 8. Employing an EF80 in the circuit of Fig. 1. Note that various changes in the values of some components are required. (See Components List)

MI42

Components List

Values applicable to Fig. 1

- R₁ 100k Ω
- R₂ 470k Ω
- R₃ 56k Ω 1w
- R₄ 180 Ω
- R₅ 150k Ω
- R₆ 10k Ω

(All $\frac{1}{2}$ w except where stated.)

- C₁ 500pF, solid dielectric; variable
- C₂ 600pF, mica
- C₃ 100pF, mica
- C₄ 100pF, mica
- C₅ 0.1 μ F, 500V, paper
- C₆ 25 μ F, 25V, electrolytic, tubular
- C₇ 0.5 μ F, 500V, paper, tubular
- C₈ 8 μ F, 450V, electrolytic, tubular
- Germanium crystal diode
- Valve—EF50, with holder
- S₁ (a), (b) 2-pole 3-way, wavechange switch
- Ferrite rod aerial
- Teletron dual wave, type FRD (L₁)

Values applicable to Fig. 5

As for Fig. 1 but with the following additional or altered components.

- R₂ 0.5M Ω volume control, long track
- C₂ 100pF, mica
- C₁₀ 600pF, mica

Values applicable to Fig. 7

As for Fig. 1 but with the following additional or altered components.

- C₂ 100pF, mica
- C₉ 100pF, mica
- C₁₀ 600pF, mica
- L₂ See text
- S₁(a), (b), (c) 3-pole 3-way, wavechange switch.

Values applicable to Fig. 1 with EF80

As for Fig. 1 but with the following altered components.

- R₁ 470k Ω
- R₃ 33k Ω
- R₄ 220 Ω
- R₅ 120k Ω
- C₂ 1,600pF, mica

Values applicable to Fig. 8

As for Fig. 1 but with the following additional or altered components.

- R₁ 100k Ω
- R₃ 33k Ω
- R₄ 220 Ω
- R₅ 120k Ω
- R₇ 100k Ω
- C₂ 100pF, mica
- C₁₁ 100pF, mica

Modification for Radio Luxembourg

The modification now to be described was in fact made to the above circuit, though it is by no means necessary and the receiver works perfectly well (within its own limits) without it.

The modification arose from the desire on the part of the writer's family to "get" a certain Continental station working on 208 metres! With a ferrite rod aerial and virtually an (amplified) one-valve receiver this was considered to be expecting rather a lot. And just to prove how impossible the task would be a mock-up of an idea (similar to that to be described) was linked to the circuit—whereupon the station required was received almost immediately, "loud and clear"! There being no excuse, the modification was ordered—and fitted.

It will be seen from the modified circuit, shown in Fig. 7, that two extra components (C₉ and L₂) are used to introduce a degree of regeneration, this increasing both the amplification and the selectivity of the receiver. The switching is amended so that Medium wave reception is possible at two positions of the switch with, and without, regeneration. It will be seen that on Long wave reception the LC circuit is also in operation, this time using a tapping on L₂. This improves the reception of the Light Programme, which in some localities may suffer interference from powerful local Medium wave transmitters. L was wound on a $\frac{1}{2}$ in diameter former with an adjustable dust core, and 200 turns (tapped at 100 turns) of 37 s.w.g. and s.s.c. copper wire were scramble wound to occupy a length of $\frac{3}{8}$ in in all. The former when wound should be so situated in the case that the dust core can be adjusted when the record player is fully assembled. The adjustment of this core is as follows: with the set tuned to the station required on Medium wave (in our case 208m), best reception will be found to correspond to two positions of the core—note these positions. Switch to Long wave, and choose the better of these two positions with regard to reception of the Light Programme. Switch back to Medium wave and tune the "difficult" station again in order to make the final adjustment of the core (this last operation should be carried out with the player completely assembled). After making sure that all is well for the Light Programme and the Medium wave station, the core can be fixed permanently with a touch of suitable cement.

The modification just described could be used on the Medium wave band without it necessarily being incorporated for use on the Long wave band. If this method of working is desired, it is only necessary to omit the connection from the tap on L₂ to the switch contact.

The effect on Medium wave reception in either case is only operative over a small portion of the band. To extend the operation over the whole band it would be necessary to make C₉ variable, and to adjust it very much in the same way as a reaction condenser while the set was in use.

Employing an EF80

The reflex circuit has also been tried using an

EF80 valve in place of the EF50. The circuit with the EF80 is exactly the same as that of Fig. 1 except for changes in the values of some of the components. The new values are as follows: $R_1 = 470k\Omega$, $R_3 = 33k\Omega$, $R_4 = 220\Omega$, $R_5 = 120k\Omega$, $C_2 = 1,600pF$; and are given in the components list. These new values accommodate the different characteristics of the EF80 and provide a higher degree of r.f. filtering in the demodulation circuit. They do, however, introduce rather a lot of top-cut in the audio frequencies. If the higher audio frequencies are desired, the revised circuit (Fig. 8)

should be adopted. It will be seen that it incorporates one extra stage of r.f. filtering, namely R_7 and C_{11} , that R_1 is reduced to $100k\Omega$ again, and that the value of C_2 has been reduced to $100pF$.

It may be necessary in some cases to take the h.t. + line (that is, A in Figs. 1, 6, 7 and 8) to the smoothed side of the existing amplifier h.t., rather than to the unsmoothed side as was the case with the EF50 circuit described above. This is a matter for experiment, as the particular design of the power supply and amplifier in the record player determines which is the better connection.

CAN ANYONE HELP?

Requests for information are inserted in this feature free of charge, subject to space being available. Users of this service undertake to acknowledge all letters, etc., received and to reimburse all reasonable expenses incurred by correspondents. Circuits, manuals, service sheets, etc., lent by readers must be returned in good condition within a reasonable period of time

Philips Projection TV.—W. J. Robins, 7 Cedar Avenue, Birstall, Leicester, would like to obtain circuit diagrams or service manuals of models 704, 1700 or 1800, or any useful information—Sutton Coldfield if possible.

* * *

Marconi CR150 and ex-Govt. Receiver type 1547.—M. J. Wood, Kebir Cottage, Alford Road, Sutton-on-Sea, Alford, Lincs, wishes to buy or borrow any possible information on the above, particularly the circuit diagrams.

* * *

Double-Tube Indicator Unit 110QB/13.—B. Whitehouse, 1 Richmond Park Road, Clifton, Bristol 8, requires explicit details of the connections to the rear panel of this American unit. Also required, if possible, are details for using the equipment as a TV monitor.

* * *

Halicrafters S20R.—H. Ross, 37 Middlefield Place, Hilton, Aberdeen, Scotland, urgently requires the handbook or circuit diagram.

* * *

R1392 VHF Receiver.—W. J. Mackie, 31 Dell Road, Inverness, Scotland, needs the circuit diagram, and any other details, on loan for a few days only. Willing to cover all costs.

* * *

Range Unit type 1 and RF/EHT Unit 846.—A. G. Gaunt, 6 The Bungalow, Leeming Bar, Northallerton, Yorks, would like to obtain any information on these units—particularly with reference to connections.

* * *

No. 18 Set Mk. III.—L. Browne, 2 Percy Street, Coventry, would be very grateful for any information on converting this receiver to amateur band coverage—or any other use.

Computer.—R. A. Pyatt, 23 Arundel Drive, Orpington, Kent, would like to hear from any readers who have constructed an experimental computer using transistors.

* * *

3BP1 CRT.—T. C. Rickard, 10 Berridge Road, Sheerness, Kent, wishes to acquire data and base connection details.

* * *

21 Mc/s Bandsread Coil for HRO.—L. Boor, 18 Lime Tree Avenue, Gainsborough, Lincs, requires information, or the loan of *The Radio Constructor* August 1958 containing details of coil construction.

* * *

Beam Echo BM611/2 AM/VHF Tuner.—N. Hoare, Brockenhurst, Penmaen Road, Pontllanfraith, Blackwood, Mon, wishes to acquire the circuit of this tuner unit.

* * *

APN1 Altimeter.—R. A. King, 15 Scarborough Road, Torquay, Devon, would greatly appreciate the circuit, or any other information, on this unit. Also required are the base connections of the 5CP1 tube (U.S.A.).

* * *

Double Tube Indicator Ref. No. 110QB/13.—B. Careless, 36 Marne Lines, Catterick Camp, Yorks, wants to convert this unit to a general purpose oscilloscope—has any reader the circuit or service manual of this equipment?

* * *

Indicator Unit APN4.—J. Kennedy, 1 Barff Road, Salford 5, Lancs, wishes to convert this unit into an oscilloscope and requires any conversion data or other details of this indicator.

* * *

1392 VHF Receiver.—G. Foster, 4 Thompson Avenue, Ormskirk, Lancs, would like to obtain the circuit of this unit and any modification details.

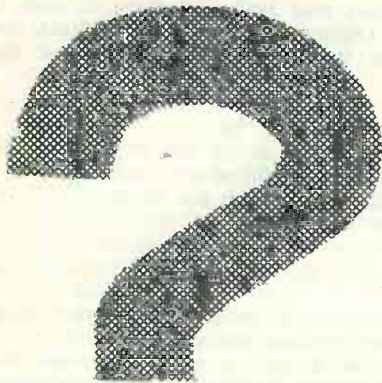

The seventh in a series of articles which, starting from first principles, describes the basic theory and practice of radio

part 7

understanding radio

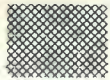

By W. G. MORLEY

IN THE JANUARY ISSUE WE DISCUSSED RESISTORS IN parallel and series, and introduced the concept of internal resistance in a battery or other source of e.m.f. We have some remaining aspects of resistance to discuss, after which we shall carry on to capacitance.

Meter Shunts and Series Resistors

An excellent method of visualising the action of resistors in practical applications is given by considering their use as meter *shunts* and *series resistors*. Not only does the simple theory involved demonstrate typical resistor functions but it also provides an early introduction to some of the instruments employed for radio measurements.

The basic unit in a large proportion of electrical measuring equipment is the *moving coil meter*. This consists of an instrument having a needle which moves across a scale, and two terminals between which the "moving coil" is connected. If a current is caused to flow through the moving coil by way of the two terminals of the meter, the needle is deflected by an amount which is proportional to the magnitude of the current. Should a current be passed through the moving coil in the opposite direction, the needle is deflected in the opposite direction also. When we come to consider magnetism we will be able to understand more fully how the moving coil meter works, but for the present we will simply assume that it is a device capable of indicating the magnitude of the current which flows through it. An important feature of the moving coil meter is the inevitable resistance of the coil (plus the resistance of internal connecting wires, etc.) which appears between its two terminals.

Practical moving coil meters may appear as in Fig. 25 (a) or (b). In Fig. 25 (a) the meter needle

is at rest (as occurs when no current passes through the moving coil) and takes up a position at the left-hand end of the scale. When a current is passed through the moving coil in the correct direction the needle moves to the right, indicating on the scale the

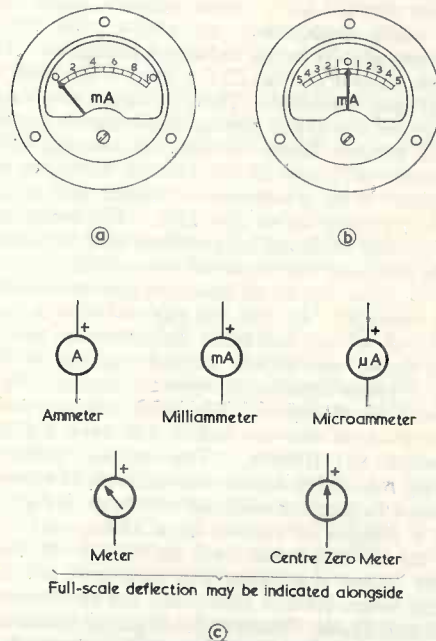

Fig. 25 (a). A typical panel-mounting moving coil meter. A full-scale deflection of 10mA is shown here (b). A centre zero meter. The instrument illustrated has a full-scale deflection of 5mA in either direction (c). Typical current reading meter circuit symbols

magnitude of the current. The furthest right-hand point marked on the scale corresponds to the *full-scale deflection* (or f.s.d.) of the meter. Currents greater than the full-scale deflection figures will cause the needle to pass beyond the right-hand end of the scale until it is stopped by an internal "end-stop" in the instrument. If the current is passed through the meter in the wrong direction the needle will move off-scale to the left, whereupon it will once more be stopped by an end-stop.

Fig. 25 (b) shows a moving coil meter having a *centre zero*. In this instance the needle may move either to the right or to the left of the central zero point on the scale, with the result that it can measure currents flowing through the moving coil in either direction.

A number of alternative circuit diagram symbols for current-reading meters are shown in Fig. 25 (c). In each case the meter is represented basically by a circle. The letter A in the circle indicates that the meter has a full-scale deflection consisting of one, or a number of, amps. Such a meter may be described as an *ammeter*. If the legend in the circle is "mA", then the meter has a full-scale deflection which may be expressed in terms of milliamps, and it may be described as a *milliammeter*. Similarly, the legend "μA" indicates a full-scale deflection of one, or a number of, microamps, and the meter may be called a *microammeter*. Sometimes, however, the letter A appears in the circle to indicate a current reading instrument, regardless of whether full-scale deflection is in amps, milliamps, or microamps. Another symbol for a meter consists, quite simply, of a circle containing an arrow, the full-scale deflection usually being indicated alongside. All the symbols shown in Fig. 25 (c) show a positive (plus) sign at one terminal. This indicates the required polarity (of the e.m.f. appearing across the terminals when a current flows through the moving coil) for the needle to travel in the correct direction across the scale. With a centre-zero meter this direction would normally be to the right. The positive sign is frequently omitted in practical circuit diagrams, usually because the required polarity is obvious.¹

Let us now return to the question of shunts and series resistors. In Fig. 26 (a) we have a moving coil meter whose full-scale deflection is 1mA, and whose resistance, which we can express as R_m , is 100Ω. (These figures are typical, incidentally, of a practical instrument.) We wish to convert this meter in some way so that it will have a full-scale deflection of 100mA. The easiest method of carrying out such a conversion consists of connecting a resistor in parallel with the meter, as in Fig. 26 (b). Such a resistor is known as a *shunt*, and we will refer to its resistance here as R_s . If R_s has the correct value, the meter will now give a full-scale reading when 100mA flows into the combination of meter and shunt. What is the required value for R_s ?

Since the meter gives a reading of 1mA when 100mA is applied to the combination of meter and

shunt, it follows that 1mA still flows through its moving coil. Obviously, the remaining 99mA then flows through the shunt. Now, we know that

$$R_m = \frac{E}{I_m}$$

where E is the e.m.f. across the terminals of the meter and the ends of the shunt; and where I_m is the current flowing through the meter. We know similarly that

$$R_s = \frac{E}{I_s}$$

where E is the same as before and where I_s is the current flowing through the shunt.

All we have to do now is to combine these two equations and find a value for R_s . There are various ways of effecting such a combination; and one simple method consists of dividing both sides of the second equation by R_m , giving us:

$$\begin{aligned} \frac{R_s}{R_m} &= \frac{\frac{E}{I_s}}{\frac{E}{I_m}} \\ &= \frac{I_m}{I_s} \\ &= \frac{E}{I_s} \times \frac{I_m}{E} \end{aligned}$$

The E's cancel out and we get:

$$\frac{R_s}{R_m} = \frac{I_m}{I_s}$$

We know that I_m is 1mA, that I_s is 99mA, and that R_m is 100Ω. Therefore:

$$\frac{R_s}{100} = \frac{1}{99}$$

$$R_s = \frac{100}{99}$$

= 1.01Ω (to three significant figures).

So the shunt needed to give the meter a full-scale deflection of 100mA should have a value of 1.01Ω.

We saw just now that

$$\frac{R_s}{R_m} = \frac{I_m}{I_s}$$

which means that the currents flowing through R_s or R_m are inversely proportional to their resistances. This makes further calculations of the same type much shorter. Let us next assume that we require a shunt which will cause the meter of Fig. 26 (a) to read 10mA full-scale deflection. This time the shunt is called upon to pass 9mA when 1mA flows through the meter so from

$$\frac{R_s}{R_m} = \frac{I_m}{I_s}$$

¹ It will also be omitted if the meter is used to measure alternating current, as we shall see in a later article.

we get:

$$\frac{R_s}{100} = \frac{1}{9}$$

$$\therefore R_s = \frac{100}{9}$$

$$= 11.1\Omega \text{ (correct to three significant figures).}$$

The required shunt should have a value of 11.1Ω.

Apart from its application to meters and shunts, this last exercise has also shown us that the currents flowing through two resistors in parallel are inversely proportional to their values. This applies to any two resistors connected in parallel.

In addition to measuring current, it is also desirable to be able to measure e.m.f. It is feasible to indicate voltage by connecting a moving coil meter directly across the source of e.m.f. to be measured, but this is very rarely done in practice because the meter terminals present rather a low resistance, and because the full-scale deflection will be low in terms of voltage. Our typical meter of Fig. 26 (a), with its resistance of 100Ω, would for instance give full-scale deflection when the voltage applied across its terminals was 0.1 volts only.²

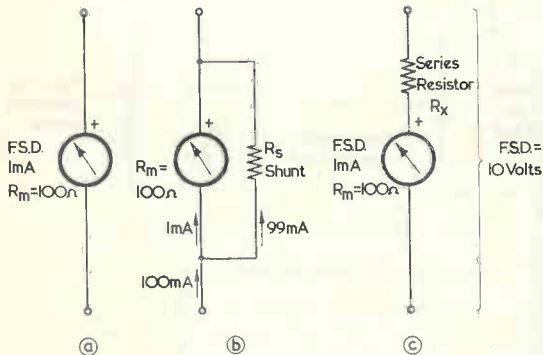

Fig. 26 (a). A typical moving coil meter may have a full-scale deflection of 1mA and a resistance of 100Ω (b). The meter of (a) can be made to have a full-scale deflection of 100mA by connecting a shunt of suitable value across it

(c). The meter may also be given a full-scale deflection of 10 volts by connecting a resistor in series with it

How can we convert a meter of this type to give full-scale deflection when, say, 10 volts is applied?

The process of conversion may be achieved by connecting a resistor in series with the meter, as in Fig. 26 (c). In this diagram the series resistor is shown as R_x , and it has a value such that 1mA flows through the circuit when an e.m.f. of 10 volts is applied to the terminals. It is a very simple matter to find the value of R_x because we know

$$^2 E = IR = \frac{1}{1,000} \times 100 = 0.1 \text{ volts.}$$

that, for a current of 1mA at 10 volts, $R_x + R_m$ must (from $R = \frac{E}{I}$) be equal to 10,000Ω. Since

R_m is 100Ω, R_x must equal 9,900Ω, or 9.9kΩ.

For the meter to have a full-scale deflection of, say, 100 volts, $R_x + R_m$ will need a total value (again from $R = \frac{E}{I}$) of 100,000Ω. Therefore R_x will be 100,000 - 100Ω = 99,900Ω or 99.9kΩ.

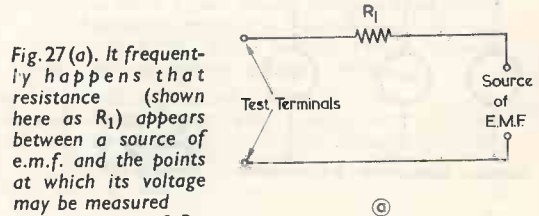
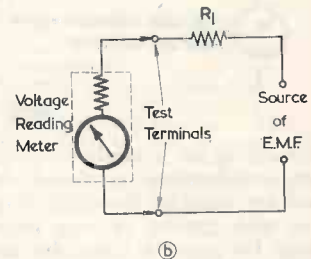

Fig. 27 (a). It frequently happens that resistance (shown here as R_1) appears between a source of e.m.f. and the points at which its voltage may be measured (b). Because of R_1 , the voltage reading obtained is always less than the true voltage



M249

It is interesting to note that, with the particular meter we have chosen, the value of $R_x + R_m$ in ohms is always 1,000 times the full-scale deflection expressed in volts. A voltage-measuring arrangement such as this can, therefore, be described as having a sensitivity of 1,000 ohms per volt. A little thought will reveal that, if the basic meter had a full-scale deflection of 10mA, then the corresponding voltage-measuring arrangement would have a sensitivity of 100 ohms per volt. If the meter had a full-scale deflection of 0.1mA, or 100μA, then a sensitivity of 10,000 ohms per volt would be given.

In radio work it is almost always desirable to use sensitive meters for measuring voltage. Fig. 27 (a) illustrates a typical instance, wherein a source of e.m.f. which we wish to measure has a resistor R_1 in series with it. (Such a circuit would be given by up a meter, as in Fig. 27 (b), current flows through R_1 , with the result that the voltage reading obtained at the test terminals is less than the true voltage which exists across the source of e.m.f. The reading we obtain will, however, more closely approach the true voltage if the sensitivity of the measuring instrument is increased (or if it has a higher ohms per volt figure). This is because less current will flow through R_1 , and less voltage will be dropped across it.

The combination of meter and series resistance shown in Fig. 26 (c) is known as a *voltmeter*. The terms *millivoltmeter* and *microvoltmeter* may sometimes be encountered, these referring to full-scale deflection in the same manner as did milliammeter and microammeter. Circuit symbols for voltmeters are given in Fig. 28. It should be noted that these symbols do not show a resistor in series with the basic meter. The presence of such a resistor is assumed. As in Fig. 25 (c) we encounter a symbol

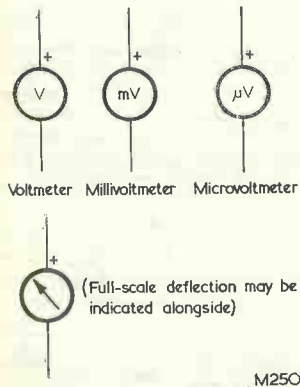

Fig. 28. Circuit symbols for voltage reading meters

consisting of a circle containing an arrow. Full-scale deflection, expressed this time in terms of voltage, may be indicated alongside such a symbol. As with current reading meters, the positive sign may be omitted from the voltmeter symbol in a practical circuit diagram. Also, the letter V in the circle may indicate a voltage reading instrument, regardless of the units in which full-scale deflection is expressed.

Multi-Range Testmeters

Multi-range testmeters are commonly employed in radio work, these being instruments which allow a wide range of currents and voltages to be measured. Such testmeters may employ a single basic meter across which various shunts are switched to provide different full-scale current deflections, and in series with which various resistors may be switched to provide different voltage ranges.

The Potential Divider

Fig. 29 (a) illustrates a resistor connected across a battery. An e.m.f. of 3 volts appears across the resistor. At intermediate points in the resistor, we will find potentials with respect to either end, which are less than 3 volts. Since a constant current flows through all sections of the resistor, the potentials at tapping-points have a direct relationship with the resistance values on either side, and such a relationship is illustrated by Fig. 29 (b). In this diagram we have a resistor into which a single tap is made, the resistance above the tap being shown as R_1 and that below the tap as R_2 , with corresponding e.m.f.'s of E_1 and E_2 . The relationship is:

$$\frac{E_1}{E_2} = \frac{R_1}{R_2}$$

If the tap is made one-third of the way up the resistor, R_1 (two-thirds of the resistance) will be twice as great as R_2 (one-third of the resistance). Thus:

$$\frac{E_1}{E_2} = \frac{2}{1}$$

In other words E_1 will be twice as great as E_2 . The total e.m.f. across the resistor is $E_1 + E_2$, and it follows that E_2 will then be equal to one-third of this total e.m.f.

If we employ a variable resistor or potentiometer in place of the tapped resistor, as we do in Fig. 29 (c), then we will be able to tap off at will any e.m.f. with respect to one end of the resistor. The

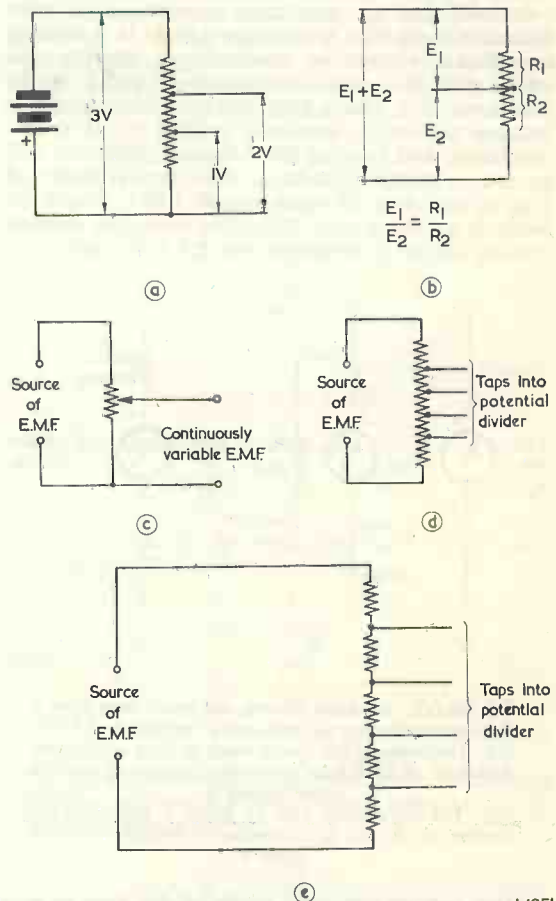

Fig. 29 (a). If a resistor is connected across a source of e.m.f., intermediate voltages appear at points along the resistor
 (b). The relationship between voltage and resistance in the potential divider
 (c). A potentiometer offers a continuously variable e.m.f.
 (d). A potential divider with four taps into a single resistor
 (e). The same result as in (d) is given if five separate resistors are used

*There's more money for Repair Men
now sets are being kept longer*

- More repairs and overhaul
- More adjustments

**MORE NEED THAN
EVER FOR NEWNES**

RADIO AND TELEVISION SERVICING

**THE ONLY WORK OF ITS
KIND IN EXISTENCE**



*Judge for yourself
by 7 days' free
examination*

Until Colour and 625-line TV transmission are ready most viewers can be expected to retain current sets—and pay for the servicing that longer life entails!

In addition, there are more radios and transistor portables, stereo radiograms, transistor record reproducers, tapes, car radios, than ever before . . . which means profitable times now and in the months ahead for you, the servicing engineer. So more than ever you need Newnes Radio and Television Servicing which places at your elbow more than 4,500 Circuits, Component and Layout Diagrams . . . practically every model you are ever likely to be called upon to service—1961 models right back to 1954. All the famous makes are included—everything you want for yourself or your staff. Many thousands of sets of Radio and Television Servicing are in daily use making money for their owners. And the set goes on earning for you for years! Send for Free Examination to-day, and you will quickly realise why each volume is quite worth its weight in gold!

**Television • Radios • Radiograms • Car Radios
Tape Recorders • Record Reproducers**

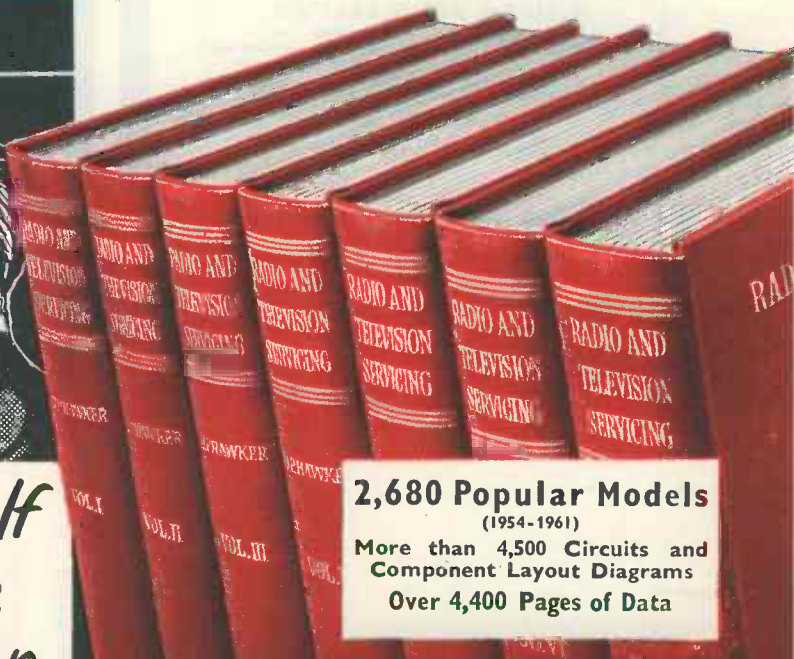

2,680 Popular Models
(1954-1961)

**More than 4,500 Circuits and
Component Layout Diagrams
Over 4,400 Pages of Data**

PRESENTED TO YOU

SEE OVER

NEWNES TELEVISION ENGINEERS' POCKET BOOK

NEWNES Radio and Television Servicing

(1954-1961)
In Seven Volumes

DATA FOR ALL THESE MAKES —sturdily bound so that you cannot mislay or lose wanted circuits

Ace, Alba, Ambassador, Argosy, Armstrong, Baird, Banner, Beethoven, Berec, Brayhead, B.S.R., Bush, Capitol, Champion, Channel, Collaro, Cossor, Cyldon, Dansette, Decca, Defiant, Dynatron, E.A.R., Eddystone, Ekco, Elizabethan, E.M.I., Emerson, English Electric, Ever Ready, Ferguson, Ferranti, Ford Motor Co., Garrard, G.E.C., Gramdeck, Grundig, H.M.V., Invicta, K-B, McCarthy, McMichael, Marconiphone, Masteradio, Motorola, Murphy, Pageant, Pam, Perdio, Peto Scott, Philco, Philips, Pilot, Portadyne, Portogram, Pye, Pye Telecommunications, Radiomobile, Rainbow, Raymond, Regentone, R.G.D., Roberts' Radio, Sobell, Sound, Spencer-West, Stella, Strad, Ultra, Valradio, Vidor, Walter, Webcor.

GIVES TIME-SAVING SERVICING HINTS, TOO

This comprehensive library provides you with the data you must have—component sketches and layout diagrams, chassis removal instructions, servicing and repair hints and information for tuning; data on picture tubes and valve functions, component values. All the information you need is here—to cut time costs on the bench and help you "turn round" repair jobs quickly.

DEALS WITH THESE IMPORTANT DEVELOPMENTS

V.H.F. Transistors. A.M./F.M. Transistor Receivers. All-Transistor Car Radios. Four-track Tape Recorders. Servicing Tape Decks. Stereo Broadcasting. TV Push Button Controls. Automatic Contrast Controls. TV Remote Control Systems. New Flywheel-sync Circuit. Line Stabilisation. 19 in. and 23 in. Tubes. Bright Spot Suppression. High Gain Automatic Picture Control Systems. Transistorised TV Receivers, etc.

PLUS THESE EXTRA FEATURES

Quick-ref list for valve line-ups and intermediate frequencies for over 800 older radio models that still turn up for servicing. Transistor chart showing base connections. Crystal Diode substitution chart. Replacement chart for obsolete picture tubes. Latest valve data, etc.

2 YEARS' POSTAL ADVISORY SERVICE FOR EVERY OWNER

C.—Fold back along here

Postage
will be
paid by
George Newnes
Ltd.

No Postage
Stamp
necessary if
posted in
Gt. Britain or
Northern Ireland

BUSINESS REPLY SERVICE
Licence No. W.C. 1129

GEORGE NEWNES, LIMITED,
15-17 LONG ACRE,
LONDON, W.C.99

B.—Fold back along here and tuck into flap C (above)

Complete here for FREE Examination

Send me Newnes RADIO AND TELEVISION SERVICING (in 7 Volumes) and TV ENGINEERS' POCKET BOOK without obligation to purchase. I will return them in 8 days or send 16/- deposit 8 days after delivery, then twenty monthly subscriptions of 16/-, paying £16 16s. 0d. in all. Cash price in 8 days is £16.

Name

Address

Occupation

Your Signature

(Or Parent signs if you are under 21)

(RV)533/16

Tick (✓) where applicable

HouseOWNER	<input type="checkbox"/>
Householder	<input type="checkbox"/>
Living with Parents	<input type="checkbox"/>
Lodging Address	<input type="checkbox"/>

Fold the complete leaflet at A, B & C, tuck flap B into C and post without stamp.

A.—First fold this strip under

Presented FREE

TELEVISION ENGINEERS'
POCKET BOOK

Value 12/6

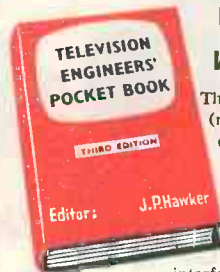

This 272-page book (now in its 3rd edition) is the perfect companion to your servicing set. Covers basic circuitry, valves, fault-finding,

interference, alignment, Cathode Ray tubes, etc. Packed with diagrams and data.

It is yours free as an additional service with Newnes Radio and TV Servicing.

potentiometer in Fig. 29 (c) offers a continuously variable e.m.f. ranging from zero to the full value of the applied e.m.f.

When taps are made into a resistor to provide intermediate values of e.m.f., the arrangement is frequently described as a *potential divider*. It is possible to have more than one tap, typical instances being shown in Fig. 29 (d) and (e). In (d) the taps are made into a single resistor, whilst in Fig. 29 (e) five separate resistors are employed. Both arrangements are potential dividers.

Potential dividers are frequently used in radio work in order to provide intermediate voltages. An external circuit may connect between a tap and one end of the potential divider and, if a current flows through it, can be represented as a "load resistor" (Fig. 30). The presence of the load resistor will

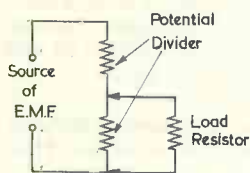

Fig. 30. Connecting a "load resistor" across a section of a potential divider causes a change in the voltage appearing across that section

M252

cause a change in the potential available at the tap to which it connects, but this change of potential will be low if the value of the load resistor is much higher than that of the section of the potential divider across which it connects. Another way of putting this is to say that change of potential will be low if the current drawn by the load resistor is much lower than that flowing through the potential divider.

An interesting application of the potential divider may now be briefly described. Fig. 31 shows a potentiometer connected to a battery, the e.m.f. across the potentiometer being measured by a voltmeter. A second battery is connected up, as shown, to the slider of the potentiometer, via a centre-zero meter (which could be a milliammeter) and a key.³ The object of the experiment is to measure the e.m.f. of the second battery.

Readings are taken by pressing the key, the slider of the potentiometer being adjusted until there is no deflection of the centre-zero meter when the key is pressed. The potential between the slider and the lower end of the potentiometer track will now be exactly equal to that of the second battery, and may be determined by evaluating R_1 and R_2 . This calculated potential will then be that of the second battery, whereupon the object of the experiment has been achieved. The important thing to observe, however, is that the measurement is made under conditions where no current is drawn from the second battery, with the result that there is no voltage drop across its internal resistance and a true reading of e.m.f. is obtained.

³ A key causes two conductors to make contact when it is pressed, a familiar example being given by the Morse key. The circuit symbol for a key is shown in the inset to Fig. 31.

Measuring Resistance

A conventional method of measuring resistance consists of inserting the unknown resistor between a battery, or cell, and a current reading meter as in Fig. 32 (a). To take a resistance reading the test terminals are temporarily connected together and the series variable resistor shown in the diagram adjusted until the meter gives full-scale deflection. The resistor to be measured is next connected to the test terminals, whereupon the meter will give a

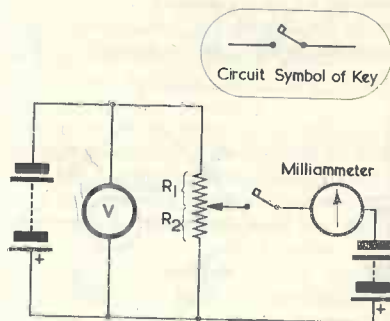

M253

Fig. 31. A method of measuring the e.m.f. of a battery without drawing current from it

reading which is less than full-scale deflection. The value of the resistor may then be read from a previously-calibrated scale fitted to the meter. The variable resistor in Fig. 32 (a) is needed to allow for ageing in the battery, it being assumed that the e.m.f. provided by the latter remains constant and that its internal resistance increases with age. In practice, this assumption is not entirely correct, but the circuit is still quite adequate for measuring resistance where a high degree of accuracy is not required.

An alternative circuit is shown in Fig. 32 (b). In

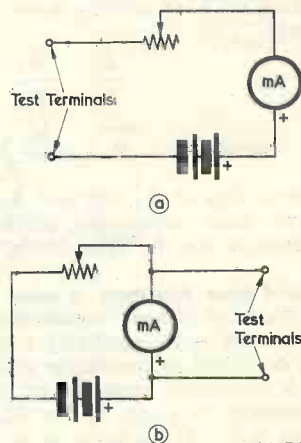
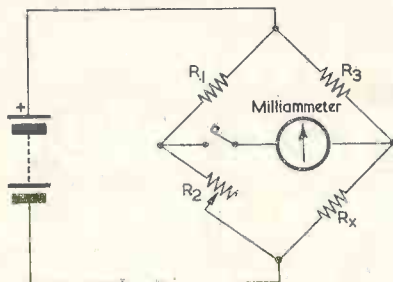

Fig. 32. Two simple ohmmeter circuits. In (a) the unknown resistor is connected in series with the meter and the battery, and in (b) it is connected across the meter

M254

this case the variable resistor is set up to give full-scale deflection as before but the unknown resistor is now connected *in parallel* with the meter. The unknown resistance functions as a shunt and varies the meter reading according to its value. This circuit is capable of measuring low values of resistance. Resistance-measuring instruments having circuits such as those shown in Figs. 32 (a) and (b) may be described as *ohmmeters*. Such circuits may also be incorporated in multi-range testmeters to enable resistance to be measured.

A very accurate device for measuring resistance is the *Wheatstone bridge*, as illustrated in Fig. 33.



M255

Fig. 33. The Wheatstone bridge

In this diagram, the unknown resistance is indicated as R_x . When R_x has been connected into circuit, resistor R_2 is adjusted until the centre-reading meter suffers no deflection when the key is pressed; whereupon the bridge is said to be *balanced*. As may be seen, the bridge consists of two potential dividers, R_1 , R_2 and R_3 , R_x , each being similar to that shown in Fig. 29 (b). Also, when the bridge is balanced the potential at the junction of R_1 and R_2 will be the same as that at the junction of R_3 and R_x . Bearing in mind the direct relationship between potential and resistance in the potential divider, which we have already discussed, we may now say that:

$$\frac{R_1}{R_2} = \frac{R_3}{R_x}$$

therefore:
$$R_x = \frac{R_3 \times R_2}{R_1}$$

The values of R_1 , R_2 and R_3 are known (R_2 will have been previously calibrated) and we may therefore find the value of the unknown resistor.

Non-Linear Resistors

We have already noted⁴ that components whose resistance varies markedly with applied e.m.f. may be described as non-linear resistors.

A commonly encountered example of non-linear resistance is given by the filament of an electric light bulb. If we take, as an example, a 100 watt

200 volt light bulb we would expect to find (from $P = \frac{E^2}{R}$) that the filament had a resistance of 400Ω.

However, if we measured the resistance of the filament whilst cold (by applying an ohmmeter to its terminals) we would obtain a reading of some 20 to 50Ω only.

The reason for this wide disparity is that the material employed for the filament has a resistance which increases markedly as its temperature increases.

For some radio applications, components are employed whose resistance *decreases* as their temperature increases. These are known as *thermistors*, and one of their functions is to counteract the effects of components⁵ whose resistance increases with temperature. Thermistors may be encountered under trade names, such as *Brimistors* (manufactured by Standard Telephones & Cables Ltd.) or *Varistors* (manufactured by Mullard Ltd.).

Capacitance

We may now leave resistors and resistance, and carry on to the next basic property of radio. This is capacitance.

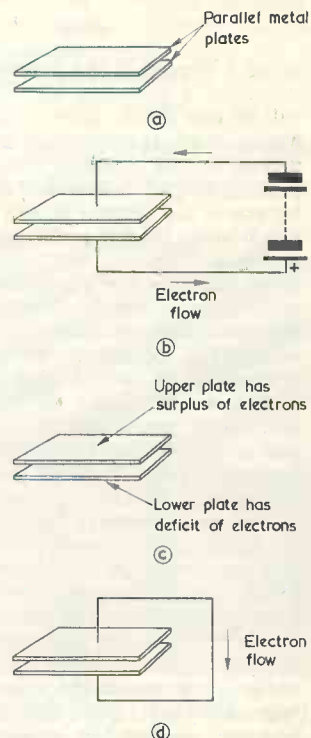

M256

Fig. 34 (a). Two parallel metal plates, as shown here, function as a capacitor

(b). If a battery is connected to the plates a momentary charge current flows

(c). When the battery is disconnected, the plates retain their surplus and deficit of electrons respectively

(d). Short-circuiting the plates allows a discharge current to flow

Let us assume that we have two metal plates making parallel to each other without actually making contact, as in Fig. 34 (a).

In Fig. 34 (b) we connect a battery to the two plates. At the instant of connecting the battery, its

⁵ Actually, the heaters of valves.

⁴ "Understanding Radio", Part 3, October 1961 issue.

electromotive force will cause a redistribution of electrons in the two plates. Electrons in the lower plate will be attracted towards the positive terminal of the battery, whilst a similar quantity of electrons will pass into the upper plate from the negative terminal of the battery. The lower plate will now have a deficit of electrons whilst the upper plate has a surplus of electrons.

Let us next disconnect the battery, as in Fig. 34 (c). There is now no external circuit between the two plates, with the consequence that the deficit of electrons on the lower plate continues, as also does the surplus on the upper plate. The two plates can remain in this state indefinitely⁶ because of their proximity, the surplus of electrons on the upper plate being attracted towards the lower plate which has the deficit of electrons.

In Fig. 34 (d) we connect the two plates together by means of a piece of wire. Whereas, previously, the plates were isolated from each other, there is now an electrical path between them. At once, the surplus electrons from the upper plate flow through the wire to make up the deficit in the lower plate; after which the two plates are in the same condition as they were before the battery was applied.

Let us summarise the operations we have just

⁶ Assuming perfect insulation between them.

carried out. In Fig. 34 (b) we apply the battery and a momentary current flows which results in an excess of electrons in one plate and a deficit in the other. In Fig. 34 (c) we disconnect the battery, but the plates still retain their surplus and deficit of electrons, respectively. In Fig. 34 (d) we connect the plates together, whereupon a second momentary current flows as the surplus electrons flow into the plate having the deficit of electrons.

The two plates of Fig. 34 form a *capacitor*, or *condenser*. The current which flows when the battery is applied is a *charge current*, and it causes the capacitor to be *charged*, as it is in Fig. 34 (c). Connecting the two plates together allows a *discharge current* to flow, with the result that the capacitor becomes *discharged*.

It is important to note that, although a current flows when a battery is connected to the capacitor and when the plates are *short-circuited* (i.e. connected together) no current flows *through* the capacitor. Electrons cannot flow between the plates because these are insulated from each other. The flow of charge current is needed to set up the charged condition, and the flow of discharge current to allow the capacitor to revert to its discharged state.

Next Month

In next month's issue we shall continue with the subject of capacitance.

A NEW MAGIC EYE FOR STEREO

WHEN STEREO RECORDINGS ARE BEING MADE, it is most desirable that the modulation levels of both channels should be monitored. In the past this has necessitated the use of two separate modulation indicators, or the extremely inconvenient switching of an indicator from one channel to the other.

Messrs. Brimar Ltd. have recently introduced a Magic Eye which has two entirely separate deflection systems. It is known as the EMM802 and is primarily designed for use in stereo tape recorders as a dual recording level indicator. It can also be used as a normal single indicator, for example in an f.m. receiver as a tuning indicator. The display is in the form of two vertical strips placed end to end.

The EMM802 has a noval or B9A base. Its heater is rated as 6.3 volts, 0.5 amp.

Limiting Ratings

Anode supply voltage	550 volts max.
Anode Voltage	300 volts max.
Anode Dissipation	0.5 watts per section max.
Target Voltage	300 volts max. 150 volts min.
Cathode Current	3mA per section max.
Grid circuit resistance	3M Ω max.

Operating Characteristics (Typical, per section)

Anode Supply Voltage	250 volts
Anode Resistor	470k Ω
Target Voltage	250 volts
Grid Resistor	2.7M Ω
Grid Voltage	0
Anode Current	0.45
Target Current	0.06mA
Length of Illuminated Strip	7/32
	9/16in.

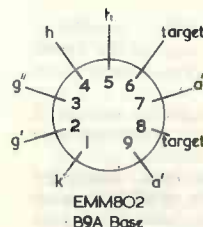

M262

Maximum Dimensions

Diameter $1\frac{1}{8}$ in. Seated Height $2\frac{1}{8}$ in. Overall Length $2\frac{3}{4}$ in.

IN YOUR WORKSHOP

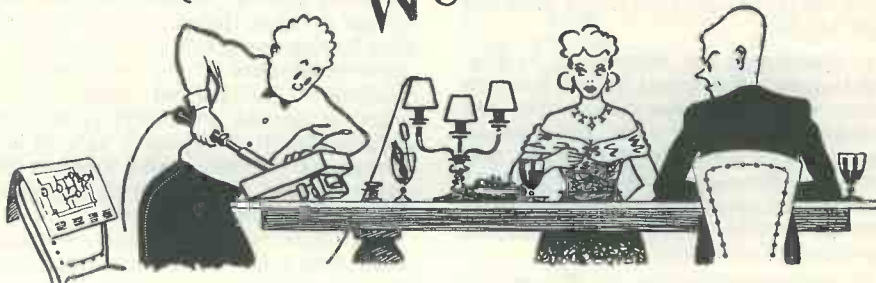

"IN THE SERVICES," SAID SMITHY severely, "those would be described as self-inflicted injuries. And you'd get put on a charge for them."

His dejected assistant looked forlornly at the strips of Elastoplast which terminated the fingers of his hands.

"Well," he said, "I must admit that we *did* have a bit of a sesh last night."

He slowly removed his mackintosh, and visibly brightened as his mind wandered over the events of the previous evening.

"In fact," he continued enthusiastically, "it was dead groovy. Way out, man!"

"That's no consolation to me," grunted the Serviceman. "All I know is that you've just come in to work, and that you're incapable of doing anything but the lightest of jobs."

"Ah, but it was worth it, Smithy!" exclaimed Dick. "You should have heard us when we swung into 'When The Saints Come Marching In.' Out of this world it was!"

"I bet it was."

"The only trouble", continued Dick, a shadow crossing his brow, "is our drummer. Too energetic by half, he is."

"I always thought", remarked Smithy, "that a jazz drummer *had* to be energetic."

"I suppose you're right," conceded Dick. "The trouble is he makes so much noise that you have to play as loudly as you can to make yourself heard. If it wasn't for our drummer I wouldn't be sheathed up in sticking plaster this morning."

"I still call your wounds self-inflicted injuries," said Smithy, reverting to his previous severe tone.

"There is no question, indeed, but that they are brought about by your outlandish choice of instrument."

Indignantly, Dick drew himself up to his full height.

"That", he remarked bitterly, "is a remark which could only be uttered by a man with no regard for the finer things in life. Every musician specialises in one particular instrument. For instance, Larry Adler specialises in the harmonica, Louis Armstrong in the trumpet, and Semprini in the piano. It just so happens that I specialise in the harp!"

Easy Jobs Only

Smithy looked down at his assistant's injured fingers and suppressed a grin.

"Well," he remarked drily. "All I can say is that you must have specialised no end last night."

He turned round, picked up a television chassis, and carried it over to Dick's bench.

"As you're on Light Duties and Excused Marching today", he continued, "you'd better spend your time doing a little mild fault-finding. You can locate the snag in this set for a start, and if there's any heavy work involved in the repair I'll come and do it for you."

"Fair enough," said Dick cheerfully. "What's wrong with it?"

"That's for you to find out," replied Smithy. "I'd only just got it ready to start on it myself. It's got uncontrollable contrast, and I should have a shufti around the vision a.g.c. circuits."

"Okeydoke," said Dick, as he examined the receiver.

He plugged the chassis into the mains, connected an aerial and

switched on. After some moments the line output stage came to life, followed by the appearance of a heavily over-contrasted picture. Experimentally, Dick adjusted the contrast control, only to find that it had no effect on the picture. He switched to the alternative local channel, to find the same state of affairs as before.

Dick next decided to have a quick look for obvious faults. Clipping the negative test lead of his meter to chassis; he experimentally touched the tags of the contrast control with the positive prod. There was a positive voltage of 90 on one outside tag and another of 60 on the remaining outside tag. Dick applied his prod to the centre tag and rotated the control. The voltage varied smoothly between 60 and 90 as he turned the knob. Dick sighed. The potentiometer was working quite satisfactorily.

Dick sat down thoughtfully. It occurred to him suddenly that the voltages on the contrast control seemed a little out of the ordinary and he wondered whether these might lead him to the fault. One of Smithy's oft-repeated injunctions crossed his mind, and he walked over to the cupboard and located the service manual for this particular receiver. Returning, he opened it out and laid it on his bench.

"Oh, no!"

"What's up?" called out Smithy.

"It's this set," said Dick, woefully, "it's got gated a.g.c."

"Well, that's no hardship!"

"I suppose not," said Dick, doubtfully, "but I thought you were going to give me something nice and easy."

"Press on at it, anyway," replied

Smithy. "Besides, there's nothing particularly difficult about gated a.g.c. snags."

Dick raised a disbelieving eyebrow, and turned back to the circuit diagram of the receiver. He concentrated on the gating circuit (Fig. 1) and noted, firstly, that the potentiometer he had just checked connected to chassis via a 180kΩ resistor and to the h.t. positive rail via a 390kΩ resistor. So the positive voltages on the contrast control tags were pretty well the sort of thing he could have expected. Dick noticed next that the slider of the potentiometer coupled to the grid of one of the triodes in the circuit via a 180Ω resistor. He applied his test prod to the grid and found that the voltage varied here in the same manner as the contrast control was turned. So the 180Ω resistor was satisfactory too.

Dick next decided to try another double-triode in the gating circuit. The replacement valve did not clear the fault. He noticed that the video amplifier and sync separator connected into the circuit, and he experimentally changed these also. Again, no luck.

"Smithy,"

"Hallo!"

"I'm stuck!"

"What, *already*?"

"It's just", said Dick helplessly, "that I don't understand the circuit. I might spend hours searching for the snag when you could put your finger on it straight away."

Smithy sighed and trod the well-worn path over to Dick's bench.

"That's quite a common gated a.g.c. circuit," he commented, after a brief glance at the service manual. "The left hand triode in the ECC82 develops a voltage on its cathode which varies according to blanking level on the signal, and the right hand triode amplifies this before passing it on to the a.g.c. line."

"Ah, yes," said Dick impatiently, "but how does it *work*? For instance, how does the left hand triode develop the voltage proportional to blanking level?"

Smithy realised that the process of explanation was going to take a little while, so he adroitly purloined Dick's stool and sat on it.

"With this sort of thing," he said, "you've got to start at the beginning. Now you know that, with the 405 line system, sync pulse tips correspond to minimum signal from the transmitter, and peak white corresponds to maximum signal. O.K.?"

"I know," said Dick. "It's what is known as positive vision modulation."

"Right!" confirmed Smithy. "With

positive vision modulation, one way of getting an a.g.c. voltage consists of rectifying the signal from the video amplifier in such a manner that the average voltage goes more negative as transmitter output increases. You then use this average voltage for a.g.c. The necessary rectification takes place on the grid of the sync separator in a conventional receiver, and you merely have to pot down the voltage on this grid before applying it to the a.g.c. line."

"Pot down?"

"Er, yes. By 'pot down' I mean connect a fixed or variable potentiometer between the grid and chassis and take the a.g.c. voltage from a

of the gated a.g.c. circuit we have here."

Gated A.G.C.

Smithy paused and drew a pad of paper towards him.

"Now," he continued, "if you look at our circuit diagram, you will see that the grid of the left hand triode of the ECC82 has a d.c. coupling from the anode of the video amplifier. This anode also feeds the cathode of the tube, so we know, without any further head-scratching, that the signal polarity here has picture information going negative." Smithy drew a waveform on the pad. (Fig. 2 (a).) "Like this."

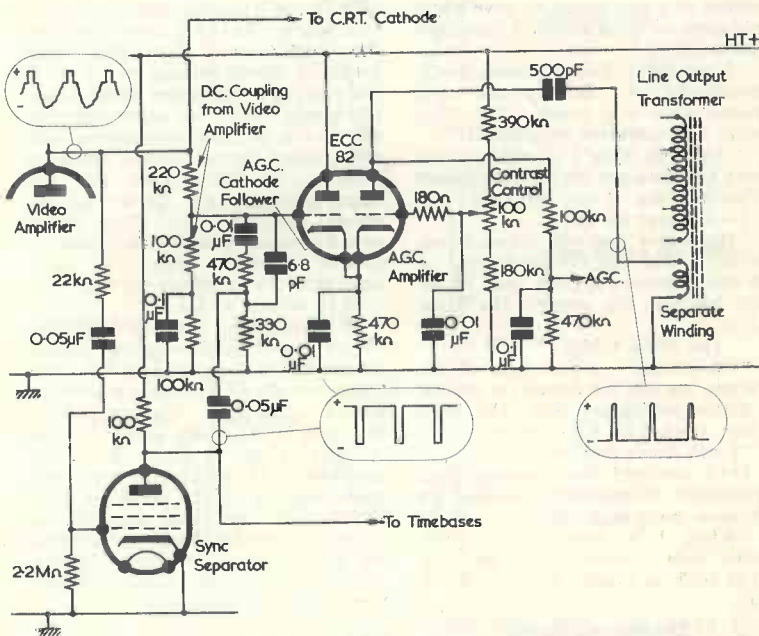

M274

Fig. 1. The gated a.g.c. circuit discussed by Dick and Smithy. The component values shown are representative of commercial practice

tap or slider in this potentiometer. Usually you have a clamp diode to prevent the a.g.c. line going positive; and the system is known as mean level a.g.c."

"And it has the disadvantage," chimed in Dick, "that a.g.c. voltage increases when picture brightness increases. With the result that bright scenes cause contrast to be reduced and vice versa."

"That's the hammer," agreed Smithy. "I don't want to spend any more time on mean level a.g.c., as I only wished to emphasise this particular shortcoming. A shortcoming which is obviated by the use

"That's O.K. so far," commented Dick. "The sync pulse tips are the most positive part of the waveform, and so I suppose they correspond to minimum anode current in the video amplifier."

Smithy beamed.

"There are moments", he remarked affably, "when your genius transcends even the lofty heights I had hopefully anticipated before you actually started work here."

"Thank you," said Dick, pleased. "It looks as though I've pointed out an important factor in this circuit."

"You have, indeed," replied Smithy. "Since the sync pulse tips

correspond to minimum anode current in the video amplifier they take up a reasonably steady potential relative to chassis, regardless of signal strength. This being so, what happens if signal strength varies?"

"Well," said Dick thoughtfully. "If the signal strength increases the picture information will go negative. Assuming a constant brightness level in the picture, of course."

"Anything else?"

Dick looked at the waveform Smithy had sketched.

"So also", he continued, "will the front and back porches of the sync pulse."

"That's my boy!" commended Smithy. "You know, that jazz session of yours seems to have put a real edge on your cerebral processes this morning."

"I wouldn't know about that," remarked Dick. "But we were really groove-some last night. 'Le Chat Noir' has heard nothing like it!"

"'Le Chat Noir'? Don't say that Joe's Caff has got yet another name! What's he put in new this time?"

Dick's eyes lit up.

"He found this old piano somewhere. And that's what started us on the combo. There's four of us, and we call the group 'The Nine Lives'."

"'The Nine Lives'?"

"Of course," pronounced Dick. "When we become famous it will be a matter of history that 'The Nine Lives' started at 'Le Chat Noir'."

"I still don't understand it."

Dick assumed the condescending expression of one who explains an obvious point to an idiot.

"What it is, Smithy," he said, gently and carefully, "is that 'Le Chat Noir' is French for 'The Black Cat.'"

"I know that, you blockhead," exploded Smithy. "But why do you call yourselves 'The Nine Lives' when there are only four of you?"

"Oh, that," said Dick carelessly. "You never have the same number of people that you say in a band. Anyway, what about those front and back porches?"

"Front and back porches?" queried Smithy, startled at the abrupt change of subject. "Oh, yes, of course. I'd forgotten all about them."

"I'd just said that if signal strength increases, the front and back porches go negative."

"That's right," said Smithy, recovering himself. "And in saying so you pointed out another important feature of the circuit. The front and back porches are at blanking level in the signal and, if we can derive an a.g.c. voltage from

them, we shall have a voltage which is truly proportional to signal strength."

"Because blanking level is constant regardless of picture information?"

"That's right," agreed Smithy. "Now we next come to a really cunning part of the circuit. If you look at the service manual circuit you will see that the sync separator anode couples to the grid of the left hand triode of the ECC82 via a 470k Ω resistor and a 0.01 μ F capacitor in series."

"It also couples via a 6.8pF capacitor," Dick interjected.

"We'll forget that for the moment," said Smithy, "and concentrate on the 470k Ω and 0.01 μ F components. As you know, the sync separator has the video signal from the video amplifier anode passed to its grid, the picture information being negative-going. The sync separator cuts off during picture information and only passes current during the sync pulses. In consequence you get negative-going sync pulses on its anode (Fig. 2 (b)), these being negative-going because they are, of course, formed when the sync separator draws anode current.

"I'm with it so far."

"Fair enough," continued Smithy. "Now these negative-going pulses are applied to the grid of the left hand triode via the 470k Ω resistor and the 0.01 μ F capacitor. Also applied to this grid is the video signal I drew earlier. (Fig. 2 (a).) So what happens? At the instant when the positive-going sync pulse in the signal from the video amplifier is passed to the left hand triode grid, we get an amplified negative-going sync pulse from the sync separator applied to the same grid."

"I should imagine", remarked Dick, "that the amplified pulse overrides the positive-going pulse."

"And that is perfectly correct," said Smithy. "The result is a waveform which can look something like this. (Fig. 2 (c).) The amplified pulse has completely cancelled out the original sync pulse on the video signal. And there is next an important point to observe, this being that the most positive parts of our signal are now the front and back porches of the sync pulse. The left hand triode of the ECC82 is nothing more than a cathode follower, with the consequence that a voltage proportional to the most positive potential on the grid signal appears across the 0.01 μ F capacitor in the cathode circuit. This capacitor will charge each time the front and back porches appear and will discharge in between."

"If the capacitor discharges, isn't it likely to be affected by picture information near the end of each line?"

Smithy looked at his assistant in amazement.

"You are", he remarked, "completely brilliant this morning. What you have said is perfectly correct, and it is to overcome this risk that the 6.8pF capacitor from the sync separator anode is coupled in parallel with the 470k Ω resistor and the 0.01 μ F capacitor. This is the 6.8pF capacitor I said we'd forget for the moment just now. Its function in life is to provide a little differentiation of the negative-going pulses from the sync separator and, in so doing, it causes an overshoot to appear at the end of the leading edge and another at the end of the trailing edge. This overshoot shows up as spikes at the ends of the leading and trailing edges, and causes our composite waveform to look like this. (Fig. 2 (d).)

"We next come to the final stage in this part of the circuit. The most positive point in our waveform is, now, not the front or back porch but the tip of the spike in the trailing edge overshoot. This spike causes the 0.01 μ F capacitor in the cathode circuit of the triode to charge at one point only during the line period, and the spike raises the voltage on its upper plate sufficiently high for it to ride clear of picture information during all the time it discharges. The voltage on the 0.01 μ F capacitor in the cathode circuit now looks something like this." (Fig. 2 (e).)

Dick looked excitedly at the circuit.

"Well, that's a knobby scheme," he said enthusiastically. "By suitably combining the two waveforms you now have a reasonably steady voltage on that 0.01 μ F capacitor which varies with signal strength. Which way does it vary, now?"

"I'll leave you to work that one out," smiled the Serviceman.

"Okey-dokey," said Dick. "The voltage on the upper plate of the capacitor varies according to the height of the spike. Now, if signal strength increases, the front and back porches from the video amplifier go negative. So, also, will the spike. So the voltage on the upper plate of the capacitor will go negative also. Is that right, Smithy?"

"That's dead correct," said Smithy. "Increasing signal strength causes the upper plate of that 0.01 μ F capacitor in the cathode circuit to go negative. Now apply your test prod to the upper plate, or to the cathode of the triode—which is the

same thing, anyway—and see what voltage you get.”

Dick dutifully applied the test prod.

“The cathode’s about 75 volts positive of chassis,” he announced.

“Fair enough,” said Smithy. “And that’s with a signal applied. I’m now going to pull out the aerial. What happens to the voltage?”

“It’s shot up,” announced Dick.

“I should imagine this part of the circuit’s O.K. then,” said Smithy, replacing the aerial plug in the socket. “The voltage goes positive when the signal is removed and this shows that the left hand triode is doing its job pretty well. To do the test properly we should have inserted an attenuator in the aerial lead because, by pulling out the aerial, we’re robbing the circuit of the sync pulses it needs to work properly. Anyway I think it’s safe to assume that the circuit to the left hand triode is O.K.”

Smithy stood up and made ready to leave.

“Well, there you are then,” he remarked. “You’d better have a look at the amplifier section now.”

Amplifier

“You’re surely not going to leave me at this stage, are you?” protested Dick. “I’m just as lost with the amplifier part as I was with the bit you’ve explained up to now!”

“There’s nothing difficult there,” said Smithy. “It’s a pretty straightforward amplifier circuit. The varying voltage goes in at the cathode and you get a varying voltage which is negative with respect to chassis from the anode.”

Dick’s mouth dropped open.

“But that’s impossible!” he protested. “The cathode is already 75 volts above the deck. And you then say that you get a voltage from the anode which is *negative* of chassis. In other words the anode of an amplifier valve is negative of its cathode. I simply cannot believe it!”

Smithy raised his eyes to the ceiling.

“This is too much,” he groaned. “I have spent half an hour of my valuable time in explanation, after which we take *one* practical measurement and learn that the circuit concerned is O.K. anyway. You now want me to devote more time in explaining the other half. This occurring at a time when you’re already half-incapacitated as a result of twanging that wretched harp of yours! Where did you get the darned thing from anyway?”

Dick turned a reproachful eye upon the Serviceman.

“That harp”, he said, with dignity, “is a family heirloom, and it has been passed down through the decades from the time of my Great Great Aunt Thomasina, whom my Great Great Uncle Jonathon used to refer to as ‘his old Tom’. What is more, it has held a revered position in the attic ever since the day she fled to Canada to start a new life. I might add”, continued Dick, forgetting the solemnity of his pronouncement for the moment, “that it didn’t half take a bit of cleaning

up after I dragged it down, too. It needed a quarter of an hour with the blower end of the vacuum cleaner just to get the fluff out of the wires and the screw-up things.”

“Presumably”, remarked Smithy, “you mean the strings and the tuning pegs.”

“I suppose you could call them that,” said Dick off-handedly. “There’s one thing I’m not too sure about, though, Smithy. There’s a whole lot of pedals at the bottom

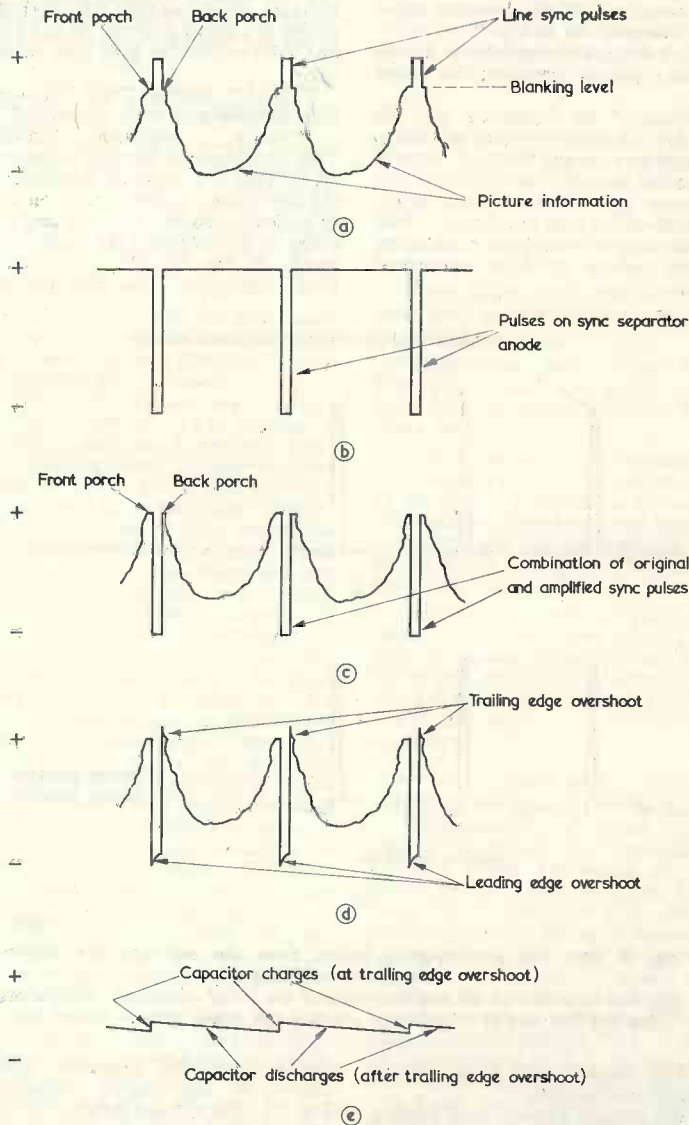

Fig. 2. The waveforms which appear in the circuit of Fig. 1

M275

and I'm not quite certain what they're for."

"Those pedals", said Smithy, "change the key."

"Key?"

"Yes, you know," explained Smithy. "Tunes are played in different keys. C, or G, or F sharp, and things like that."

"Are they really? I just pluck away and it sounds all right to me. But how do you mean that the pedals change the key?"

"Well," said Smithy, racking his brains to find a way of explaining the mysteries of musical keys, "if you press one of those pedals down you sharpen the strings."

Dick looked thoughtfully at the sticking plaster encasing his finger tips.

"Blimey," he remarked, "so far as I'm concerned they're sharp enough as they are."

Smithy gave up.

"Let's get back to that a.g.c. amplifier," he said hurriedly. "And I'll explain to you how it gives an output voltage which is negative of chassis."

we also know that this cathode goes negative when signal strength increases. Right?"

"Right."

"The cathode of the right hand triode is strapped to that of the left hand triode", continued the Serviceman, "with the result that this has the same potential above chassis and also goes negative when signal strength increases. O.K.?"

"O.K."

"Now the grid of the right hand triode is connected to the slider of the contrast control. And this slider can be set so that the range of voltages over which the cathode varies is always positive of the grid and falls within the grid base of the valve."

"That is", queried Dick, "between zero cathode-grid volts and cut-off?"

"Exactly," confirmed Smithy.

"We now come to another ingenious bit. There is a separate winding on the line output transformer, one end of which connects to chassis and the other to the anode of the right hand triode of the ECC82 via a series 500pF capacitor. You can see this

a series of pulses, each pulse occurring at flyback. Also, we connect up to the coil in such a manner that these pulses are positive-going." (Fig. 3 (a).)

"Everything is fine so far," commented Dick.

"Fair enough," said Smithy. "Every time a positive pulse is applied to that 500pF capacitor it receives a charge, because the circuit to chassis is completed via the right hand triode. The charge the capacitor receives is greater if the right hand triode is capable of passing a high current than it is when the triode is capable of passing a low current."

Smithy paused for a moment and surveyed his frowning assistant.

"One minute," said Dick. "Let's just get this clear. To start with, providing the right hand triode is conducting, the 500pF capacitor must always receive a charge on each pulse from the line output transformer. The valve will be capable of passing more current if its cathode goes negative, because this is the same as the grid going positive. Increased signal strength causes the cathode to go negative so it also causes the 500pF capacitor to have a greater charge."

"You're in the straight now," said Smithy approvingly. "The next thing to observe is the polarity of the charge on the 500pF capacitor. Obviously, the plate which connects to the line output transformer winding must be positive. Equally obviously, the plate which connects to the anode of the right hand triode must be negative. Now this negative plate connects to a 100kΩ resistor and thence to chassis by a 470kΩ resistor which is paralleled by a 0.1μF capacitor."

"You get your a.g.c. voltage from the junction of the 100kΩ and 470kΩ resistors," observed Dick, examining the service manual circuit.

"That's right," agreed Smithy. "We next add the voltage across the capacitor to the pulses provided by the line output transformer winding. This we can do by showing the voltage above chassis which appears on its negative plate (Fig. 3 (b)). Starting at one of the pulses, we can see that the voltage on this plate will follow the pulse from the line output transformer, but it will be more negative because of the charge held by the capacitor. When the pulse comes to an end the voltage from the line output transformer winding is virtually at chassis potential. In consequence, the voltage on the negative plate of the capacitor goes negative of chassis. Whilst the voltage from the line output winding

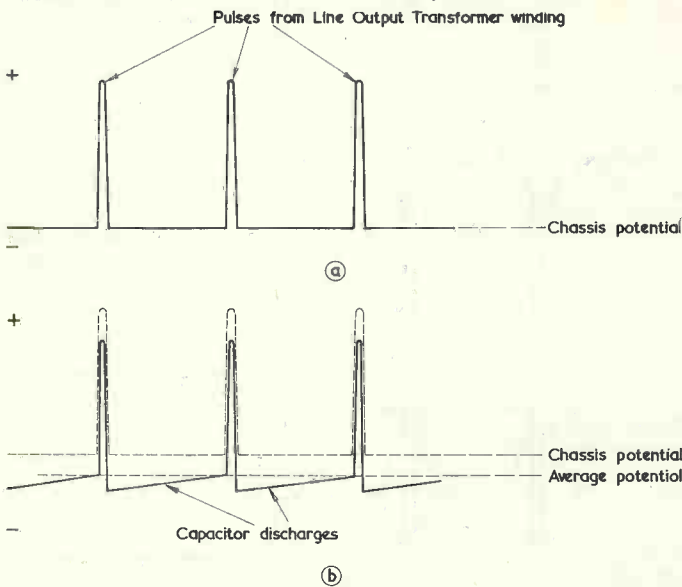

M276

Fig. 3 (a). The positive-going pulses from the separate line output transformer winding

(b). The potential on the negative plate of the 500pF capacitor. The pulses from the line output transformer winding are shown here in dotted line

"Fire away," said Dick, settling himself comfortably.

"We already know," said Smithy, "that the cathode of the left hand triode of the ECC82 is sitting above chassis by a voltage around 75. And

winding and the capacitor quite clearly in the circuit diagram. (Fig. 1.) The voltage induced in this separate winding has pretty well the same waveform as that in the e.h.t. overwind, and we can represent it as

special clamp diode circuit to prevent the a.g.c. voltage from being at zero level as the set warms up. You see, you get no pulses from the line output transformer until the booster diode reaches operating temperature, and this occurs later than the other valves in the set. And a fourth point is that you may have another capacitor between the anode of the right hand triode of the ECC82 and chassis. With the existing capacitor between the line output transformer winding and the anode of the right hand triode, this additional capacitor forms a capacitive potentiometer which reduces the pulse applied to the anode. However, it doesn't much alter the basic working of the circuit. I should add, of course, that component values in some receivers will differ somewhat from those we've got in our own particular circuit."

Dick digested this information.

"What puzzles me", he said eventually, "is that, as soon as you looked at the circuit, you straight away identified the type of gated a.g.c. system it used."

"That was easy," grinned Smyth. "This is the only gated a.g.c. circuit I know of which uses a double triode with strapped cathodes coupled to chassis via a parallel resistor and capacitor. Those strapped cathodes and the resistor and capacitor are a dead give-away."

"Well, I'm dashed," said Dick. "It's always easy when you know how."

He paused.

"Just a minute," he said suddenly. "We've still got to cure the fault in this set!"

"That shouldn't take long," remarked Smyth. "We know first of all that we're getting a sensible voltage on the cathode of the right hand triode of the ECC82. What about grid voltage?"

"I've checked that," said Dick "and it's O.K."

"Fair enough," Smyth commented. "Then all that's left is the anode circuit. Either you aren't getting the pulses through from the line output transformer winding because this, or the 500pF capacitor, has gone open. Or you've got a simple short-circuit or open-circuit in the a.g.c. network. You should be able to measure a negative voltage direct from the anode with an ordinary test meter if the pulses are getting through. Waggle the contrast control while you're doing this to ensure that the right hand triode isn't accidentally cut off. If the pulses are getting through you just have to chase the voltage through the a.g.c. smoothing and potential

is at chassis potential the capacitor now discharges into the series 100k Ω and 470k Ω resistors until the next pulse arrives, whereupon the capacitor receives a further charge.

"During the cycle the voltage on the negative plate of the capacitor goes highly positive for the duration of the pulse. However, this occurs for only a very short part of the total time in each cycle. For nearly all of the time the voltage is negative of chassis and, because of this, the average voltage is negative of chassis also. We obtain this average voltage in steady form by way of the simple smoothing circuit offered by the 100k Ω resistor and 0.1 μ F capacitor. It then becomes available for use as an a.g.c. voltage."

Smyth paused and lit a cigarette. His assistant looked extremely impressed.

"Now that," he remarked eventually, "is a circuit! All I can add to what you've said is that if the 500pF capacitor gets a bigger charge, the average voltage on the negative plate goes more negative. You get a bigger charge when the cathode of the right hand triode goes negative, and that occurs with increased signal strength. The final result being that increased signal strength causes increased a.g.c. voltage."

"With the advantages", added Smyth, "that the a.g.c. voltage is amplified, and that it is proportional to blanking level in the received signal. There are a few points I should clear up at this stage. First of all, the contrast control varies the grid voltage of the right hand triode of the ECC82 and, therefore, the charge received by the 500pF capacitor. So it also varies a.g.c. voltage and thereby provides an adjustment of contrast. It can also offer an a.g.c. delay, since it can hold the grid at cut-off potential until the cathode goes sufficiently negative for the valve to pass current. Secondly, it isn't really true to say that the voltage from the line output transformer winding is at chassis potential between pulses. Actually it will vary slightly about chassis potential as the line scan proceeds. However, the voltages here are much lower than the pulse voltage and do not detract from the effect of the amplifier."

"How big would the pulse voltages be, Smyth?"

"Around two to five hundred volts, rough check," said Smyth, "depending, I would suppose, on the designer of the set in which the circuit is used. A third point to tidy up is that the smoothed a.g.c. voltage may go into a small conglomeration of potential dividers, together with a

dividing circuit. If they're not getting through, check the line output winding for continuity and suspect the 500pF capacitor."

"I could check the pulses through with a 'scope," remarked Dick.

"By the time you've got the 'scope set up," said Smyth, "you'll probably have found the fault! Anyway, I'll leave it to you."

Smyth had hardly returned to his bench before a cry of triumph came from his assistant.

"It's the line output tranny," called out Dick, "and I don't even have to replace it! The lead-out wire from the coil has broken at its tag and I should be able to tack it on again quite easily."

Off the Record

Smyth heaved a sigh of relief and, several minutes later, noted with satisfaction that Dick had now repaired the broken connection and that the television receiver worked satisfactorily, with correct contrast and a.g.c.

"Let's hope", said Smyth, "that your next snag won't take up quite so much time as this one did."

"Sorry about that," replied Dick contritely. "Still, I've got a special treat for you which will, I'm sure, make up for it."

Smyth watched interestedly as Dick walked over to the clothes pegs at the door. Suddenly, a feeling of utter dismay passed over the Serviceman as he saw that his assistant was taking a reel of recording tape from his mackintosh pocket.

"Here we are, Smyth," said Dick cheerfully. "I've got all of last night's session recorded on this. We've got plenty of recorders in the Workshop to play it on, and I reckon it will just nicely take up our full lunch-hour . . ."

Editor's Note

The circuit reproduced in Fig. 1 is representative of gated a.g.c. circuits employed in commercial receivers which are based on the *Synchronising Pulse Derivative Cancelled A.G.C. Gate with D.C. Amplifier* developed at Mullard Research Laboratories. The basic circuit was described in *A.G.C. Circuits for Positive Modulation Television Receivers*, published in Mullard Technical Communications, Vol. 3, No. 27, from a report by P. L. Mothersole of Mullard Research Laboratories. The basic circuit appeared later in "Understanding Television", part 36, by W. G. Morley, in the January 1961 issue of *The Radio Constructor*.

News and Comment . . .

Oscilloscopes in Cars

Most readers will be aware of uses for oscilloscopes other than in the conventional radio sense, a somewhat unusual one will be in a study which is shortly to be held in the U.S.A. to measure the ability of a driver to steer a car at the same time as he looks for place names signs.

The driver will sit in front of an oscilloscope, representing the road ahead, across which will move horizontally a point of light indicating the position of the vehicle. First he will try to keep the point of light centred in the c.r.t. by means of a control—a task similar to keeping his vehicle correctly positioned in the traffic stream of a winding roadway.

When he has learned to "stay on the beam", a film will be projected on a screen behind the oscilloscope to give the illusion of moving along a highway. The driver will be asked to watch for certain place names signs along the road and to depress a foot pedal as he spots them.

The tests will show whether a driver is able to maintain adequate control while looking for specific signs, and will measure the speed of his reactions.

The investigation is to be carried out by the U.S.A. Bureau of Public Roads.

Plated Circuits

We are all familiar with the term printed circuit, but how many of us are aware of "plated circuits"? Plated circuits are a type of printed circuit produced by quite a different process. We have not the space in this feature to give details of the manufacture, except to say that the "basic ingredient" is Formica.

Radio & Allied Industries Ltd., who have manufactured enormous numbers of these circuits in their factory at Slough, include in their advantages—improved layout as conductors are on both sides of a board interconnected by plated-through holes, thus eliminating jumper wires and enabling cross-overs to be easily achieved; more effective and robust soldered joints because of solid fillet solder in the holes; plating through of holes

enables them to be larger thereby simplifying removal and assembling of components; greater thickness of conductors making them exceptionally strong; there is also no possibility of corrosion. Plated circuits will be dealt with more fully in Radio Topics' next month.

Sewer Maintenance

Axbridge, in Somerset, has been quick to harness modern electronic techniques to the problem of maintaining the efficiency of the local sewage system. Sewers in certain areas were installed sixty years ago, and in those sections serious infiltrations were suspected. The local council are using a special closed-circuit television camera, manufactured by EMI Electronics Ltd., to determine the sources and extents of the faults.

This camera, which is contained in a stainless steel case only four inches in diameter, can be pulled through the sewage pipes by a rope attached to a winch. A special lens and lighting attachment enable pictures of the interior of each pipe to be displayed on a television receiver located on a nearby motor vehicle. It is possible to photograph any faults from the picture on the television screen.

Use of an EMI television system in this way enables a pipe to be surveyed quickly and accurately, without the necessity of excavating along its entire length; depths of more than 25 feet are often involved.

Amateur Radio

It is very pleasant to refer to the great success of Oscar—Orbital Satellite Carrying Amateur Radio. The satellite was built by radio amateurs in California as a goodwill gesture and to foster the interest of their fellow radio enthusiasts throughout the world in space communications.

A lively interest was shown by amateurs in Britain. The first English report was made by Angus McKenzie of London, G3OSS, who is blind, and is chairman of the British Cultural Society of the Disabled. The Radio Society of

Great Britain is reporting on the project to the Amateur Radio Relay League of America, one of the sponsors.

The fact that Amateur Radio can, and does, foster goodwill between people of different nationalities would seem to be verified by the world-wide support given to the annual international contest sponsored by the American magazine *CQ*. The winner of the individual event was Vladimir Serenov of Russia and the team victory went to the Donetz Regional Club of the Ukraine.

Viewing Figures

In a recent issue we referred to the circulation figures of this magazine, still increasing, by the way, and to the exaggerated claims to readership made by some magazines not our radio contemporaries. It may be remembered that the adequacy of sampling was the key factor.

No complaints on this score can be made about the B.B.C.s' Audience Research Department. They question no less than 4,000 different people every day, and there is no doubt that their findings are substantially accurate. During the last quarter of 1961 the relative proportions of viewing time was B.B.C. 48% and I.T.V. 52%, of those who had a choice of programmes. Their findings also showed a small decline in the average amount of time viewers looked-in. Sound Radio audiences showed a small increase compared to a year ago, but this change was caused by day-time listening; evening programme listening figures were less than previously.

Thought for Tomorrow

Mr. Abram Games speaking on "The Poster in Modern Advertising" to a meeting of the Royal Society of Arts, forecast that the old style advertisement hoardings will eventually disappear and be replaced by colour T.V. posters. Pictures would be transmitted from a central station by means of television tape and would be shown on plastic screens, the picture changing every few seconds.

A Stereo Tape Replay Pre-amplifier for the "Ferrograph"

BY R. G. HARRIS

THE FERROGRAPH 4S TAPE RECORDERS HAVE provision for an auxiliary stereo tape head. Earlier machines can also be fitted with this head after some small modifications. The head is of low impedance and is not electrically connected to the recorder, the leads being terminated by sockets at the rear of the machine.

The stereo head used in the prototype is the Ferrograph type FR14. This has now been superseded by the type FR16 which represents the latest design. Constructors may fit the FR16 head, but both types are referred to in this article.

Many stereo amplifiers do not have facilities for tape replay direct from the head. Even with amplifiers having this facility it is difficult to obtain optimum performance for several reasons.

- (1) The input is almost invariably for high impedance heads, so that matching transformers must be "tacked on" externally.
- (2) The input stage has to perform several functions and cannot be designed for optimum results on tape only.
- (3) As the designer does not know what head will be used, a compromise design must be used for equalising.
- (4) It seems common practice to provide equalisation for the bass only and hope that the treble control lift curve will suit the treble equalisation required.

The above considerations led to the construction of a stereo replay pre-amplifier for use with an existing amplifier and designed to give optimum results at $7\frac{1}{2}$ in/sec, directly from the Ferrograph auxiliary head.

Circuit

Fig. 1 shows the circuit of one channel. Owing to the high gain coupled with the large degree of bass boost, care is necessary over layout, decoupling and screening, if the hum and noise level is to be kept inaudible at normal listening levels.

The first stage is a voltage amplifier using an EF86 valve. The input matching transformer type 973 is manufactured by The Ferrograph Co. Ltd., for use with the stereo head. High stability resistors are used in order to keep the noise level as low as possible.

The second stage also uses an EF86, equalising being carried out by means of a parallel-T network in a feedback loop. Resistance-capacitor equalisers were chosen in preference to L.C. circuits because they have less tendency to ring and because components can easily be obtained to close limits, this latter point being of importance if close matching of channels is to be achieved.

The component valves are chosen to give maximum feedback at about 4 kc/s. Below this frequency feedback falls off and at 40 c/s is quite low, giving the high degree of bass boost required to compensate for the falling (6 dB/octave) bass output from the replay head; this is to C.C.I.R. specification ($100\mu\text{s}$). Above 4 kc/s the feedback

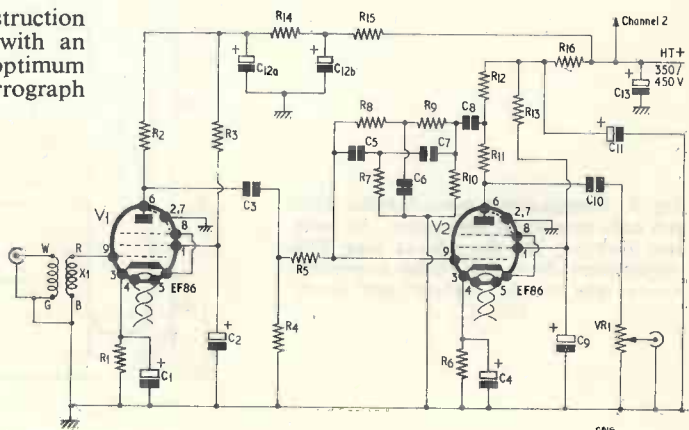

Fig. 1. Circuit diagram—one channel

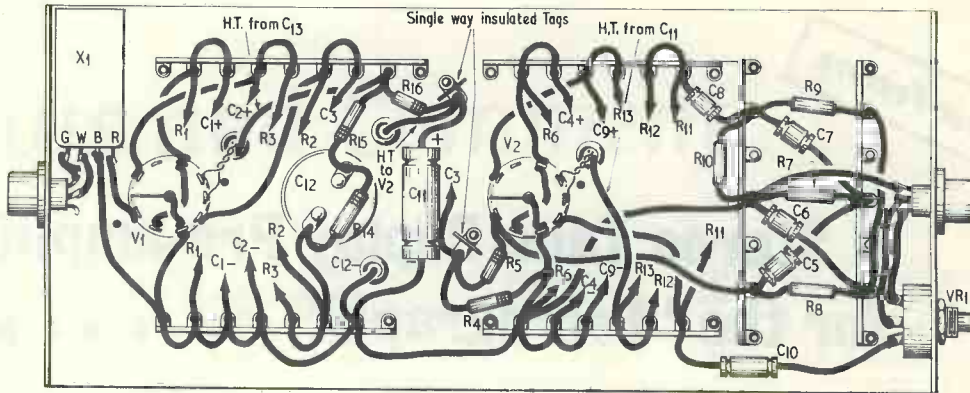

Fig. 2. Wiring diagram for one channel. H.T. and heater wiring is sited above the chassis

again falls off giving the treble boost necessary to correct for head losses, etc. The response curve for the equaliser is approximately as shown in Fig. 6.

Equalisation was only provided for 7½ in/sec as quality considerations led the author to use this speed almost exclusively. The extra components and complication to the circuit which would be required for other tape speeds were not then justified.

The output is of the order of 0.5V across VR₁, which can be used to correct differences in gain between channels or as an attenuator if main amplifier overloading is experienced.

The constructor may question the use of high stability and close tolerance components throughout, together with the generous decoupling used. It must be remembered that the unit was designed for the best possible results, and to maintain its performance over a long period of time. However, the constructor may relax the specification, at his discretion, and still obtain satisfactory results.

Construction

Details of the chassis and practical wiring are shown in Figs. 2, 3 and 4. The chassis is divided in halves by a screen, an aluminium cover serving to completely screen the wiring after construction.

The construction is straightforward, and the main points to be observed are the avoidance of earth loops and hum pick-up. Single point earthing is used, all earth returns being made to the main earth line which is connected to chassis at V₁ only. It is important to note that there is no chassis connection at the coaxial sockets, as the type specified have insulated housings. The heater leads are tightly twisted and are run above the chassis together with the h.t. lines, interconnecting being carried out with small tagstrips which also serve as connections for the main h.t. and l.t. feeds. C₁₁, C₁₂, C₁₃ have insulating sleeves over the cans, the negative leads being returned to the main earth line. C₁₃ is mounted above the chassis. C₁₂ is fitted vertically, its two positive lugs protruding through the appropriate hole in the chassis.

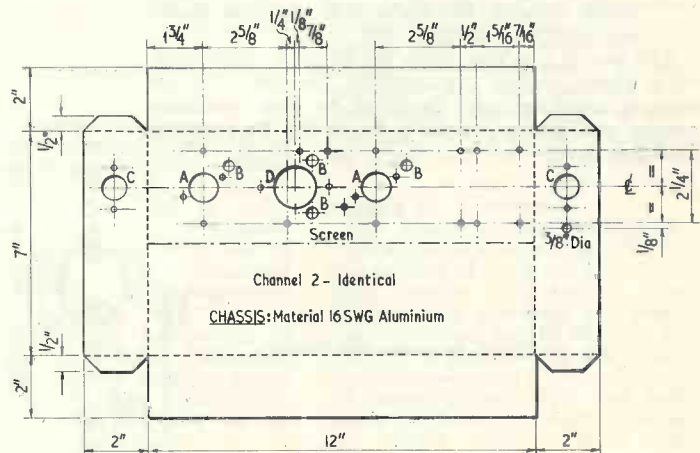

Fig. 3. Chassis dimensions. The four sides are bent up towards the reader. All holes not identified ½ in dia.; A—to take B9G valveholders; B—to take rubber grommets; C—to take coaxial sockets; and D—to take C₁₂

After the main components have been bolted in place, the main earth lines and tagstrip loops should be wired. Next, the equalising components should be installed, care being taken during soldering to avoid overheating as the close tolerances of those components can easily be ruined by carelessness. The best procedure is to fit all wiring to any tag first, so that only one application of the iron is necessary. A careful check must be carried out afterwards since it is surprisingly easy to leave a tag unsoldered.

The heater and h.t. leads should then be wired up followed by the leads from the tagstrips to V₁, V₂, X₁, VR₁, etc. When all remaining connecting leads have been wired, the wiring should be checked for dry joints, incorrect connections, or short circuits. Only then should the remaining components be soldered across the tagstrips. A final inspection is well worthwhile. The author usually gives the chassis a good shaking and a few thumps—it is amazing how much foreign material this removes!

Connecting Up

If the power supplies are derived from the main amplifier the only earth connection must be via the h.t. negative lead. The braid on the output coaxial cables must not be earthed at the main amplifier or an earth loop will be set up, giving rise to severe hum. For a similar reason it was found advisable with the prototype to remove the tape recorder earth lead from the power plug and run it to the earthing point on the pre-amplifier chassis. The whole system is now earthed via the power plug earth lead to the main amplifier.

As the stereo replay lead is of low impedance (FR14—40Ω at 1000 c/s, FR16—130Ω at 1,000 c/s) the coaxial leads to the pre-amplifier may be 6 ft or so in length without trouble. The output from the unit must feed into a high impedance (0.5MΩ) and the capacitance across the output must be kept low. In consequence, the coaxial leads to the following amplifier should be less than 2ft

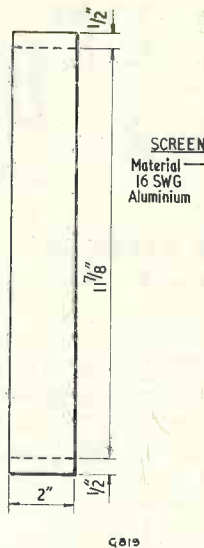

Fig. 4. The dividing screen. This fits under the chassis between the two channels. The mounting holes at the ends are not shown here, or in Fig. 3

long, otherwise the performance of the equalisers would be seriously affected. The same input circuit (as shown in Fig. 1) is used with both the FR14 and the FR16 head.

The author added an external switch to disconnect h.t. and l.t. supplies when the main amplifier was used on Disc or Radio, also fitting a warning light to ensure that the unit was not left running unnecessarily.

Testing

The frequency response of the whole replay chain was measured using EMI test tape TBT.1 and an output meter across the loudspeaker leads. It was found to be virtually flat within test tape limits (40–10,000 c/s) and, more important, there were no noticeable dips or peaks. The balance between channels remained close throughout the range. The hum and noise was very low, being

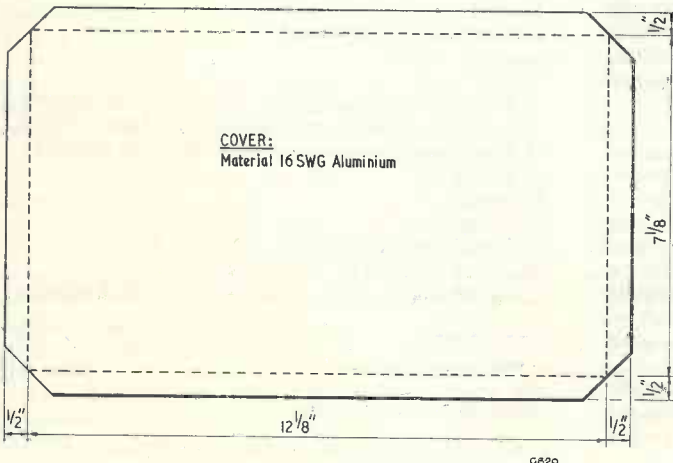

Fig. 5. The under-chassis cover

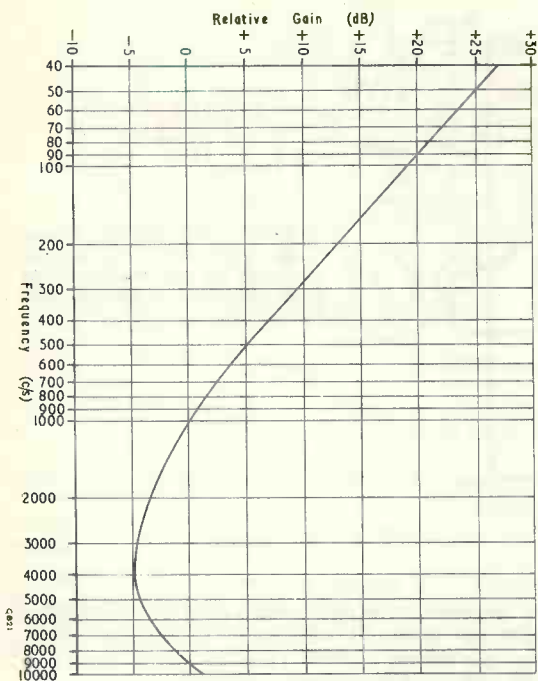

Fig. 6. Equaliser response curve

undetectable at more than a foot or so away from the loudspeaker. The system remained stable, even at maximum gain and high sound levels.

Fitting the Head

Before concluding, a few notes on fitting the head may be of value. As was mentioned previously, the latest type is the FR16. This is slightly different from the FR14 head in that the spacing between the tracks is greater, so that, when it is fitted, shims should be inserted beneath the head until 0.010in of the upper and lower track laminations are visible above and below the tape when running through on playback. With the FR14 head, the outside edges of the upper and lower track laminations should be 0.010in below and above the tape edges.

Conclusion

During the last twelve months the unit has given very pleasing results without a moment's trouble, and still performs as well as when first built. It was found that the stereo head cross-talk was quite low, so that the unit can be used for mono playback as well. In fact, the only time the Ferrograph electronics are used is during recording. As a stereo recording unit is under construction the built-in amplifier will be reserved for portable use at $3\frac{1}{2}$ in/sec. etc.

The best comment the author can make on the pre-amplifier unit is to say that he has stopped "listening to the amplifier" and now listens to the music!

Components List

Resistors (all $\frac{1}{2}$ watt) (each channel)

R ₁	1k Ω 5% H.S.
R ₂	100k Ω 5% H.S.
R ₃	390k Ω 5% H.S.
R ₄	470k Ω 5% H.S.
R ₅	470k Ω 5% H.S.
R ₆	2.2k Ω 5% H.S.
R ₇	51k Ω 1% H.S.
R ₈	100k Ω 1% H.S.
R ₉	100k Ω 1% H.S.
R ₁₀	470k Ω 1% H.S.
R ₁₁	47k Ω 5% H.S.
R ₁₂	270k Ω 5% H.S.
R ₁₃	1M Ω 5% H.S.
R ₁₄	47k Ω 20%
R ₁₅	47k Ω 20%
R ₁₆	47k Ω 20%
VR ₁	100k Ω Log (Miniature)

Capacitors

C ₁	100 μ F 12 W.V.
C ₂	2 μ F 450 W.V.
C ₃	0.02 μ F 500 W.V.
C ₄	50 μ F 12 W.V.
C ₅	120pF 1%
C ₆	180pF 1%
C ₇	120pF 1%
C ₈	390pF 1%
C ₉	2 μ F 450 W.V.
C ₁₀	0.05 μ F 500 W.V.
C ₁₁	16 μ F 450 W.V. Can isolated
¹ C ₁₂	16+16 μ F 450 W.V. Can isolated
² C ₁₃	16 μ F 450 W.V. Can isolated

Valves

V ₁	EF86 Mullard
V ₂	EF86 Mullard

Tagstrips

3	8-way, mounting centres $2\frac{1}{2}$ in, end tags earthed
2	7-way, mounting centres $2\frac{1}{2}$ in, end tags earthed
1	9-way, mounting centres 3in, end tags earthed
2	1-way
3 ¹	3-way
3 ¹	4-way
2	coaxial sockets, Belling-Lee type L603
X ₁	27:1 Wright & Weaire type 973
2	valveholders. B9A, nylon or p.t.f.e. with screens

¹ With vertical mounting clip.

² Only one capacitor required.

³ Only one tagstrip required (mounted above chassis).

Emitter Follower Circuits

EMITTER COUPLED MULTIVIBRATOR

By PETER WILLIAMS,

B.Sc.(Hons.), Grad.Inst. P., Grad.I.E.E.

This is the third of a series of four articles, each of which describes a particular application employing emitter follower transistor circuits. A special feature of the series is that a standard set of components may be employed, if desired, to construct all the devices discussed. Despite this, the circuits are extremely non-critical so far as component tolerances are concerned, and alternative values are dealt with fully.

Of particular interest are the d.c. coupling and negative feedback arrangements employed by the writer, these not only reducing the number of components required but also permitting excellent stability to be maintained, together with flexibility in component values.

The devices described can provide a valuable introduction for the newcomer to transistor theory, and have the advantage of being somewhat more sophisticated than the "beginners' circuits" which are normally published.

WHEN A PORTION OF AN AMPLIFIER'S OUTPUT IS fed back to its input, it may or may not oscillate. The exact limits within which oscillations occur are not easy to decide as both the amplitude and phase of the output are important. In general if the output can supply more power than is consumed by the input, then oscillation is possible.

With valves, the grid consumes no power at normal frequencies and only voltage gain is required. Since the base of a transistor draws current then current gain is also needed. The obvious way to cause a single transistor to oscillate is by collector-base feedback because both current and voltage levels are greater at the collector. The snag is that as the base is driven negative, the base and collector currents increase, lowering the collector voltage. Direct feedback thus opposes the input signal, i.e., it is negative feedback, and the transistor cannot oscillate.

Nor is it possible to feed from collector to emitter and produce oscillation directly, since the collector current is always slightly less than the emitter current. Comparing these two arrangements we see that the first has sufficient amplitude but is in the wrong phase, while the second lacks the amplitude. That it has the correct phase is clear because the collector current increases as does the emitter (differing from it only by the small amount drawn by the base).

Two alternatives now present themselves for producing a single transistor oscillator: either to reverse the phase of the collector-to-base feedback,

or to increase the current derived from the collector when feeding back to the emitter. The first of these two methods leads to a set of phase shifting components or a transformer, and the second to a tuned circuit with either tapped inductor (Hartley oscillator) or tapped capacitor (Colpitts oscillator).

Adding a Second Transistor

None of these arrangements permits wide variation in frequency unless we are prepared to change several components at once. If we are willing to use a second transistor the problem is immediately eased, for we can now produce the necessary current gain so that collector-emitter feedback may succeed. Clearly the second transistor should change the phase of the signal because that is already correct, and so we are led naturally to the emitter follower circuit.

Having ensured that the phase and amplitude of the feedback are correct we can choose the kind of waveform we require. If sine wave, then the collector load of the first stage is made into a tuned circuit, and if square or sawtooth then an RC arrangement will suffice. Here the second of these possibilities will be described, the LC oscillator being described in the article which follows next month.

The diagram (Fig. 1) shows the stages through which we pass in setting the conditions for oscillation, and then simplifying the arrangement. In Fig. 1 (a) the feedback path from collector to emitter is indicated. Current amplification is required for oscilla-

tion and a second stage is shown with capacitive coupling of the signal back into the emitter of the first (Fig. 1 (b)). The waveform produced is distinctly non-sinusoidal and no purpose is served by a "Hi-Fi" second stage with careful biasing. The emitters can therefore be connected directly as in Fig. 1 (c), thereby eliminating bias components and a coupling capacitor with a quite remarkable degree of simplification.

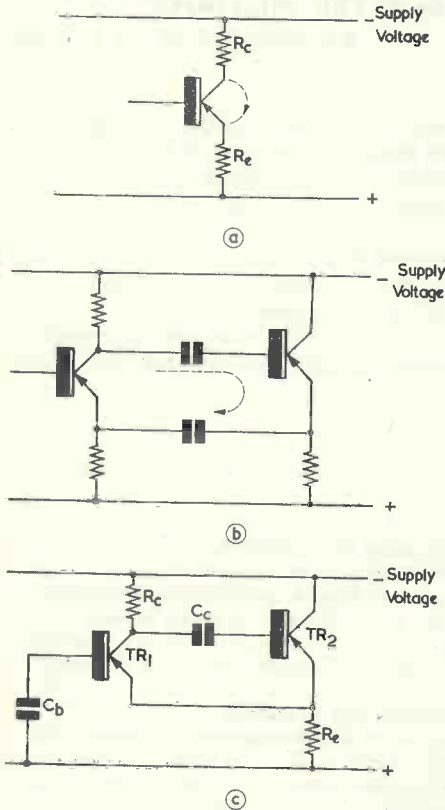

M269

Although simple in appearance the "sausage" of Fig. 1 (c) has a particularly deceptive "skin" and it is not easy to give an accurate description of the way in which each component modifies the frequency of oscillation. Frequency is in fact fixed mainly by the RC time constant, the apparent value of R being reduced by the loading due to the comparatively high input impedance of the second stage. Similarly the value of C is increased by the internal capacitances of the transistors and to a much lesser extent by circuit capacitance.

Circuit Operation

At the instant of switching on the circuit of Fig. 1 (c) the base of TR₂ is connected via the coupling capacitor C_c and the previous collector load R_c to the negative pole of the battery. The capacitor has

had no time to charge and develop an opposing voltage, the bias current to the second stage being large and therefore "bottoming" it. This continues to be true only during the short time it takes the capacitor to charge up and neutralise the effect of the supply voltage. Throughout this period the base of the first transistor has been held firmly by its large capacitor and the emitter has been held negative by that of TR₂. Cut-off is complete and TR₁ takes no part in the changing cycle. Soon the coupling capacitor, in charging, allows the base of TR₂, and with it the emitters, to fall below the level of the base of TR₁. A rapid changeover follows due to regenerative action around the closed loop. The slight initial conduction thus induced in TR₁ lowers its collector potential, this fall being transferred via the coupling capacitor to the base of TR₂. The reduced biasing of TR₂ makes itself felt by a loss in current through the emitter resistor increasing the base-emitter potential of TR₁ and causing thereby a further rise in TR₁ current. The feedback is clearly positive as any tendency for the current to rise is strongly augmented by the amplified signal coupled back again.

When the changeover is completed, with TR₁ fully "on" and TR₂ cut-off, the cycle reaches its second phase, and the capacitor now commences to discharge. In due course this allows the base of TR₂ to rise back to emitter potential and begin to conduct slightly.* Increased emitter current narrows the gap between base and emitter of TR₁ and the resulting decrease in collector current of that transistor allows the collector to rise in potential. This pulls with it, through the capacitor, the base of TR₂, biasing this transistor more fully "on" and completing the regenerative switching.

The circuit has now returned to its initial state and will continue to switch as described. The above explanation assumes that the large base capacitor of the first transistor has acquired a small but definite negative potential. This would not be true for the first fraction of a second after switch-on and, until the capacitor does charge, oscillation will not occur. Charging takes place through the collector base diode of the first transistor and the multivibrator should commence within, at most, a second or two. The only exception noted by the writer whilst checking the circuit was in the case of one distinctly middle-aged capacitor when nothing happened for several seconds after switching on. Depending on the values of components used, it was found that this particular capacitor required up to half-a-minute before permitting the circuit to start. Presumably the capacitor was rather leaky and the charging rate was barely greater than the leakage rate, the difference representing a very small net accumulation of charge. If the reader has an apparent failure, a wait of a few extra seconds could show up this fault and prevent a time wasting hunt elsewhere in the circuit.

* The discharge path for C_c, via the base of the cut-off transistor TR₁, differs from the charge path, via R_c. It is found, in practice, that charge and discharge times for C_c are equal, or approximately equal.—Editor

Measured Frequencies

To turn now to the measured values of frequency (more important for most purposes than complex explanations) it was found, as expected, that the main frequency determining components were the load and coupling capacitor. In fact the frequency was almost exactly inversely proportional to both R_C and C_C . This is not a convenient relation to express graphically and so frequency was replaced by the "period" or duration of a single cycle, e.g., a frequency of 100 c/s has a "period" of $\frac{1}{100}$ second, i.e., 0.01 secs.

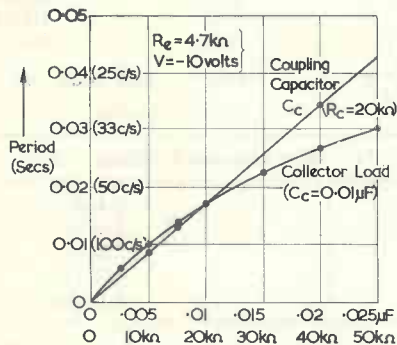

(a)

M270

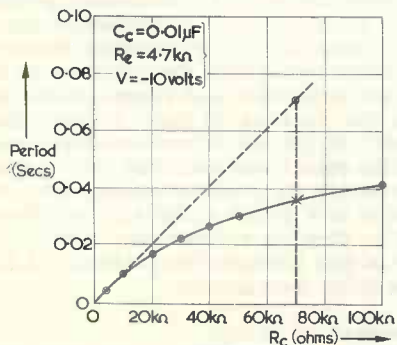

(b)

M271

This period was proportional to C_C from $0.001\mu F$ to $1\mu F$, while the frequency varied from 500 c/s to 1.5 seconds per cycle! (By increasing the load from $20k\Omega$ to $60k\Omega$ this could be extended still further to 3 seconds per cycle and, with a larger capacitance, longer periods should be possible.) The difficulty at lower values of capacitance is the effect of circuit capacitances on the period and waveform. Below a few hundred picofarads, r.f. transistors and short wiring may be needed to maintain linearity.

Coming to the case of variation with R_C we see a rather different picture. At low values of collector load the graph, Fig. 2 (b), is fairly linear, but larger loads fail to produce the expected increase in period. Inspection shows that on extending the lower part of the curve as a straight line it would reach twice the measured height at $R_C = 70k\Omega$. From this we

deduce that there is an impedance in parallel with the collector load, the combination having only half the impedance of R_C . The parallel resistance must also be $70k\Omega$ for this to be so, and it must be the input impedance of the second stage. This impedance prevents the effective load from rising linearly and in any case limits it to a practical value somewhere in the $30-40k\Omega$ region.

To show that the parallel impedance is that of the succeeding stage we must return briefly to the properties of the emitter-follower described in the previous articles. It is an impedance increasing stage with an input impedance equal to the emitter resistance multiplied by the current gain of the transistor. Taking the rather low gain of 15 this gives approximately the correct value of $75k\Omega$ when using a $5k\Omega$ emitter load. The correctness of this



(a)



(b)



(c)

M272

"guesstimate" is verified by varying the emitter resistance. At low values of one or two $k\Omega$ there is a strong loading of the collector circuit with a fall in period, while at high values the period is little affected and the period/ R_C graph straightens out.

Summarising the operation of the circuit, the period is proportional to the product CR , where C is taken as the coupling capacitor plus strays, and R is the parallel combination of the actual collector load together with the reflected impedance of the emitter load.

Waveforms

Ideally the circuit would produce a perfect square-wave at the collector and something approaching a sawtooth at the emitter. This is true only in the middle range of frequencies from about 50 c/s to 1kc. Below that the top and bottom of the square waves show the usual exponential droop and above 1kc the high frequency losses cause a steady increase in curvature of the edges of each pulse, deteriorating eventually to a low output, distorted, sine wave.

The various waveforms available are shown in Fig. 3 for a frequency of 100 c/s, and the effect of changing frequency on the collector waveform is shown in Fig. 4. Fig. 4 (f) is *not* a misprint but is

the result given by trying to persuade a poor quality audio transistor to operate at high frequencies!

Fortunately this kind of circuit is very tolerant of components and will do its best to operate under somewhat extreme conditions. To quote some examples: collector loads of up to 100k Ω may be used provided the supply voltage is fairly high;

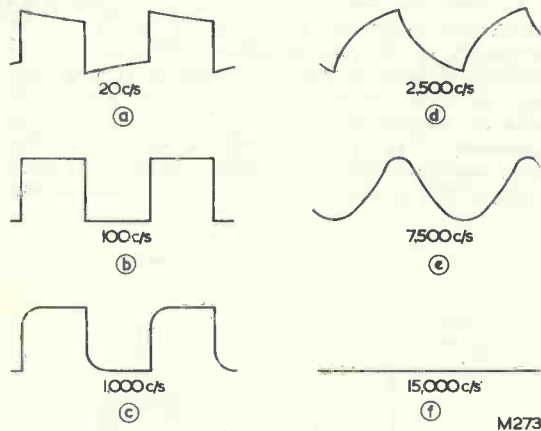

coupling capacitors may be varied from below 100pF to above 1 μ F; the base capacitor of the first transistor can go as low as 0.1 μ F at moderate frequencies and as high as 100 μ F or more.

Power Supply

Finally, perhaps the most amazing thing of all is the minute amount of energy on which the circuit is capable of working. Under most conditions it will operate with one or two volts and with care in selecting the right components some transistors actually continued to oscillate with a supply of 0.1 of a volt! It should be a relatively simple matter to make a unit using a 1.5V pen-cell. The life of the cells in such low consumption circuits is prodigious—in many cases it would not be worthwhile using a switch because the cell would last almost its shelf-life.

An unusual demonstration of this low power action is to drive the multivibrator from a homemade cell of copper and zinc strips immersed in vinegar, using the zinc as the negative terminal. A penny serves as the copper terminal and many small

plated components, including screws of the plated variety, can be used for the negative pole. To make operation yet more dramatic, there should still be enough power if the rods are pushed into a lemon!

The full range of operating conditions under which the circuit has been tried is listed in the Table. The

TABLE

Range of Operating Conditions		
C_c	100pF	1 μ F
C_b	0.1 μ F	100 μ F
R_c	4k Ω	100k Ω
R_e	1k Ω	5k Ω
TR ₁ TR ₂	OC71's, Red Spot, etc.	
V	0.1 to 20 volts	
Recommended Values		
C_c	0.1 μ F	
C_b	8 μ F	
R_c	22k Ω	
R_e	4.7k Ω	
V	9 volts.	

writer was unable to find any absolute lower limit of frequency; the highest non-electrolytic capacitor available (1 μ F) gave a period of 3 seconds per cycle. Upper limits are set by the transistors themselves, and with r.f. transistors, oscillation in the Mc/s range is a possibility. The maximum limits set by the manufacturers should be observed as far as voltages are concerned, and commonsense used in avoiding the extremes of high voltage and low resistances. If the set of recommended values is studied, the reader will note that they correspond to those used in the previous pre-amplifier circuits. This unit is very similar in form to the other two, differing in that the emitters are joined and the collector of TR₁ is coupled to the base of TR₂ by a capacitor rather than directly.

Next Month

In the last of these articles, to be published next month, adaptation as an LC oscillator will be described together with suggestions for switching arrangements which allows the same set of components to do service in each of the units in turn.

(To be continued)

ALL-BRITISH ORDER FOR GHANA

Six new fishing vessels being built in British yards for the Ghana Supply Commission will be fitted with Marconi Marine radio equipment and electronic navigational and fishing aids.

Four of the new vessels are purse-seiners and two are stern trawlers. Each of the six is to be fitted with a "Martinet" automatic helmsman and communications equipment consisting of a "Fulmar" radiotelegraph/telephone transmitter, with high frequency facilities, and two "Guardian V" receivers, one of which will be used for normal speech and morse reception and the other, in conjunction with a loop aerial and goniometer, for direction finding.

The purse-seiners will use "Graphette" echometers as navigational and fishing aids, while the stern trawlers are to be fitted with powerful "Fishgraph" echometers, with "Fishscope" cathode-ray tube indicators and "Fishgong" aural monitor units.

Each vessel will also have a comprehensive MIMCO talk-back installation enabling the skipper to issue orders to, and receive replies from, every working point in the vessel and, in the case of the purse-seiners, control the vessel from the mast-head while fishing.

Marconi's Wireless Telegraph Company Limited has supplied and installed the communications equipment for a controlling station in the fish docks at Tema. The equipment—a transmitter type NT302 and two receivers type NS305 and NS702—will be used to maintain contact with the vessels while on the fishing grounds and will enable efficient shore marketing arrangements to be made for a vessel bringing in her catch.

Tape Recorder Hints . . .

by

K. LAYCOCK

and

R. N. HARTOP

THE HINTS GIVEN IN THIS SHORT ARTICLE ARE presented for tape recorder enthusiasts including, especially, those who are just commencing to interest themselves in this fascinating hobby.

Simple Superimpose

Some tape recorders do not have facilities enabling sound effects to be superimposed on tape which is already recorded. With these recorders, attempts to superimpose sound effects are defeated because the erase head wipes off any existing programme before the record head is reached. A means of overcoming this situation consists of taking a small piece of wallboard and putting this between the erase head and the tape and thereby preventing or reducing erasure. After a little practice it will be found possible, then, to superimpose on the already recorded tape. Take care to avoid damaging the head or tape pressure pads during this process, and start off with tapes which do not carry important recordings in case they accidentally become partly or fully erased.

Mixer Unit

A simple mixer unit capable of handling three high impedance inputs (for connection to a similarly high impedance input on the recorder) is shown in the accompanying diagram. The purpose of

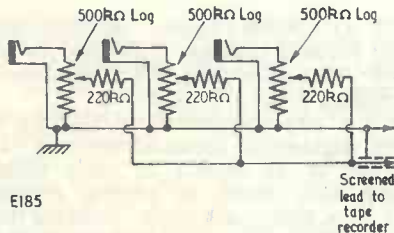

the 220kΩ resistor is to reduce the effect on other channels when one of the gain controls is adjusted. This mixer could handle a radio, a pick-up (provided

that any equalisation required is inserted before the mixer unit) and a microphone. The latter may require a pre-amplifier to boost its output to the same level as the other two sources of signal. The mixer unit should be mounted in a metal box for screening, and connection to the recorder should be via screened cable.

This mixer enables superimposition to be given if a second recorder is available.

Sound Effects

The following sound effects may enliven a play or any other production.

Rain. Shake dried peas around in an iron container.

Thunder. A piece of cloth may be suddenly pulled taut in front of the microphone.

Fire. If greaseproof paper is squeezed into a ball in the palm of the hand it crackles like the flames of a large fire.

Walking on a gravel path. If an old, worn-out recording tape is to hand, this can be shaken in front of the microphone.

Echoes. Here a mixer is required. Microphones are placed some distance apart. The person speaking stands near to one of them and speaks loudly. The other microphone picks up the sound slightly later than the one near to the speaker. The outputs are mixed and fed to the recorder.

Skidding Car. This requires some practice. It is achieved by scraping a penny along the surface of a piece of glass until a screeching noise is obtained.

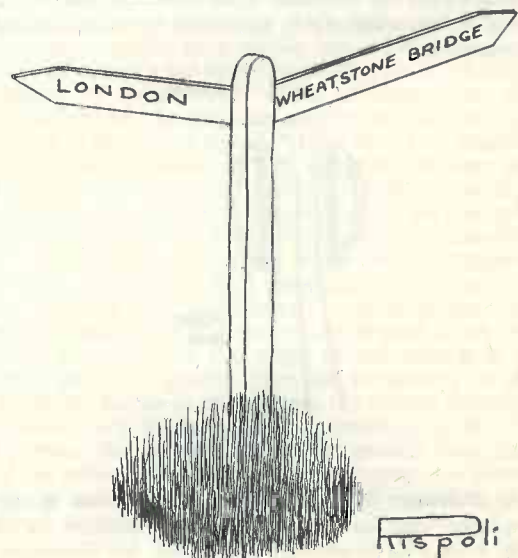

A simple Transistor Heat Sink

by
Qutaipa Bassim El-Dhuwaib

A SIMPLE AND INEXPENSIVE HEAT SINK FOR transistors having cylindrical bodies may be readily obtained with the aid of copper wire.

The copper wire is first wound on a former having a semi-circular cross-section, as in Fig. 1. The dimension "x" of this former should be slightly less than the length of the transistor to which the sink is to be fitted.

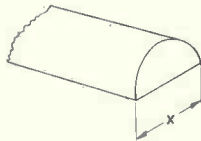

FIG.1 M266

The coil of copper wire is then removed from the former and its two ends fastened, or soldered together. It is then fitted to the transistor as shown in Fig. 2, the flat section of the winding bearing against the body of the transistor and the individual turns of wire being disposed radially. The wire in contact with the transistor body conducts heat to the radial turns, whence it is dissipated by radiation and convection.

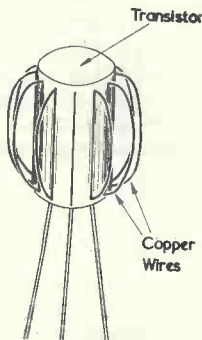

FIG.2 M267

If a former with a semi-circular section is not available, one having a rectangular section, as in Fig. 3, may be employed. As before, the dimension

"x" should be slightly less than the length of the transistor.

Wires around 25 s.w.g. lend themselves especially well to the construction of the sink, and 100 cms. of

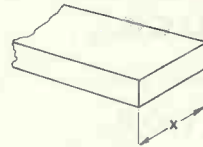

FIG.3 M268

such wire can offer an effective radiating area of some 15 sq. cms. The number of turns required in the coil may be found by experiment.

If desired, the copper wire can be reclaimed from burnt out transformers, etc., but it is important to ensure that all insulation is removed before the wire is used.

Book Reviews . . .

THE R.T.T.Y. MANUAL. Published by the British Amateur Radio Teleprinting Group. Available from the Hon. Sec. BARTG, "East Keal", Romany Road, Oulton Broad, Lowestoft, Suffolk. Price 5s. 9d. post paid.

This is quite a unique publication in more ways than one. Several members of the group took part in its production, which is a photostatically reproduced volume of articles on RTTY from recent radio magazines such as those recently published entitled "Getting Started on RTTY", etc., in *The Radio Constructor*; an article dealing with an RTTY Converter and the Type 7 Teleprinter in *The Short Wave Magazine*, and so on, etc. Apart from its unique mode of production, it must be the only publication on this side of the Atlantic which will give all the information required for setting up an Amateur Radio Teleprinter Station. Those interested in this subject will find all they need to know in this volume. At 5s. it is very good value indeed. Any profits accruing will be devoted to group funds, and we think they deserve a good measure of success with this enterprising project.

RADIO TRANSMITTERS. By Laurence Gray and Richard Graham. Published by McGraw-Hill Book Company, 95 Farringdon Street, London, E.C.4. Price 97s.

This is a very comprehensive book for the professional engineer or advanced amateur. It covers the design of all aspects of radio transmitters, including such details as cooling arrangements, control units, testing and so on. Both the theoretical and practical aspects of the subject are dealt with in detail, and each chapter concludes with plenty of references for further study. The final chapter on Hazards Associated with Transmitters makes very interesting reading.

Radio Astronomy

PART 6

by

FRANK W. HYDE
F.R.S.A., F.R.A.S.



This is the last of the series of articles which we especially commissioned for publication in this magazine. Readers requiring further detailed information on this subject are informed that our author has written a comprehensive book—Radio Astronomy for Amateurs—due to be published in the autumn by Lutterworth Press Ltd. Mr. Hyde will be appearing in the B.B.C. TV programme "The Sky at Night" on the 14th of this month when an outside broadcast will feature his Radio Astronomy Observatory and the equipment currently in use.

IN AN EARLIER INSTALMENT OF THIS SERIES THE resolution obtainable with the radio telescope was compared with that of an optical telescope.¹ High resolving powers are only obtained when the wavelengths in use are small compared with the aperture of the telescope. Jodrell Bank radio telescope has, in the centimetre ranges, a very high degree of resolution. When, however, we come to the meter wavelengths resolution is considerably reduced. The problem is one of sheer physical size; for example, at a frequency of 200 Mc/s, the size of the aerial required to achieve a resolution of 1 square degree would cover an area of nearly $\frac{1}{4}$ of an acre.

Drift Interferometers

In 1946 a solution to this problem was provided by Ryle and Vonberg, they combined two aerial systems in the form of an interferometer. In operation this system is analogous to the Michelson optical interferometer. Michelson mounted two mirrors some distance apart on the front end of the 100in Mount Wilson telescope, the purpose of this being to measure the diameter of stars. The mirrors were so arranged that they could reflect light from the star into the telescope, the light following two different paths and producing fringes in the eyepiece

of the telescope. Optical theory shows that the diameter of a star is a function of the wavelength of the light at which it is examined, and the distance apart of the two mirrors. Utilising this principle Ryle and Vonberg set up two aerial systems on a long baseline, the energy collected by these aerials being fed into a receiver. With this arrangement, the aerial system as a whole has a polar diagram in the shape of a fan beam containing an interference pattern of lobes. The width of each lobe will depend upon the angular separation between the points of minimum signal. (Fig. 30.) This angular separation decreases as the distance between the aerials of the system is increased. For a separation of the two aerials in the system of 10 wavelengths the minimum points are separated by approximately 6°. If the separation of the two aerials is increased to 100 wavelengths then the angular separation of the minima will be reduced to 36 minutes (36') approximately. If now this system is used to observe radio sources, and the angle of the source is so large that it is greater than the separation of the minimum points in the pattern, the output from the receiver will show a nearly constant level. If, however, the source is an angle smaller than that of the separation of the minimum points the power output will vary in a certain periodic manner, and this is illustrated in Fig. 31 (a).

From what has been stated it will be clear that

¹ Part 1, page 195 *The Radio Constructor*, October 1961—Editor.

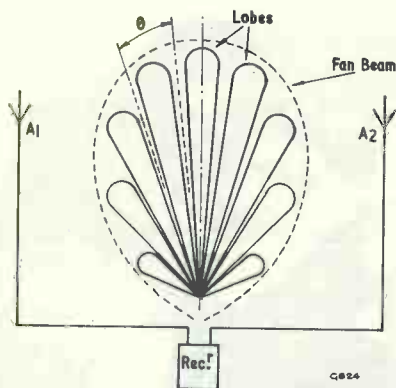

Fig. 30: Lobe formation in fan beam of a 2-aerial interferometer

this method of approach enormously increases the resolution of the radio telescope. The record shown in Fig. 31 (a) illustrates the type of pattern produced on the recorder with the simple form of interferometer, which is called a drift interferometer. The arrangement is shown in Fig. 32. The block diagram shows the two aerials feeding into a common input of the receiver, the latter providing output for an audio monitor, d.c. amplifier and pen recorder.

Applying these principles to our own radio telescope, it will be seen that two aerials having a frequency of around 200 Mc/s could be accommodated in an average sized garden. The distance between the centres of the aerials at 200 Mc/s for a 10 wavelength spacing is a little less than 50ft. A suitable installation will therefore be possible, if an east to west baseline (or nearly east to west) is available, since the total length required will be something like 65ft. The usefulness of the amateur's

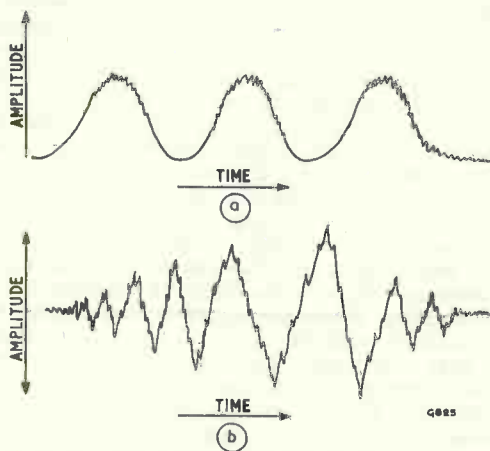

Fig. 31 (a). Pen recordings of a simple drift interferometer compared with (b) a phase switching interferometer

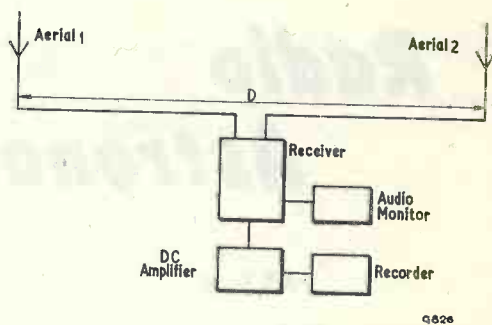

Fig. 32. Block diagram of a simple drift interferometer

telescope will be greatly increased by this arrangement.

There are certain disadvantages with the simple drift interferometer in that, if a source is fairly well extended, and near to it there is a smaller source,

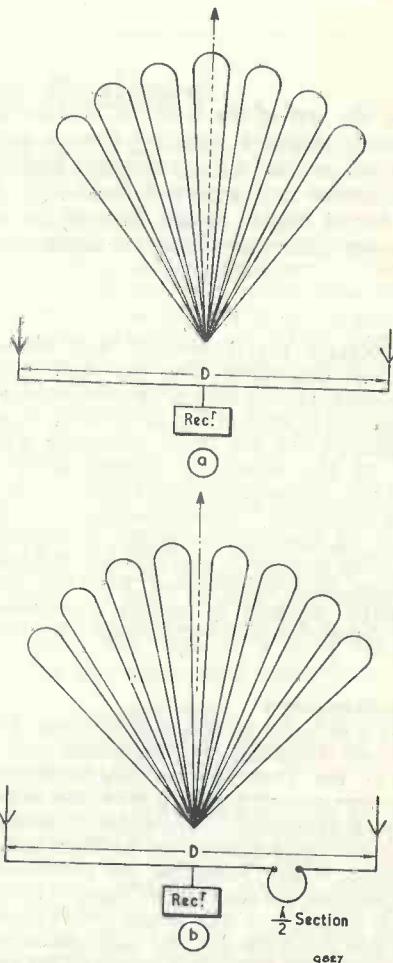

Fig. 33 (a) (b). Phase switching interferometer reception patterns

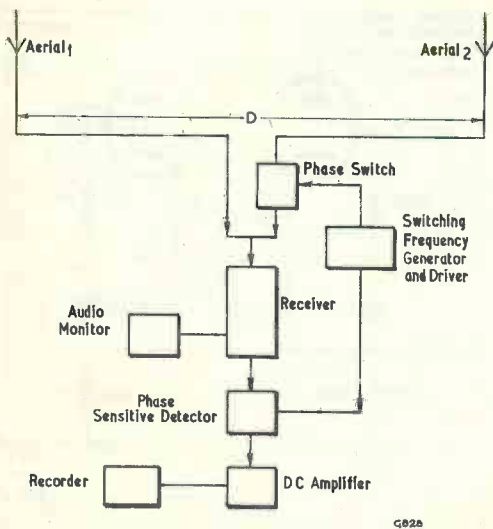

Fig. 34. Block diagram of a phase switching interferometer

it may be impossible to accurately identify either of the two sources. The larger source will give a continuous level and the smaller source will produce the fringe patterns superimposed upon this. Unless the exact position of the lobes is known without any ambiguity, positional work for this type of interferometer has certain drawbacks.

Phase-Switching Interferometer

An improvement on the drift interferometer was

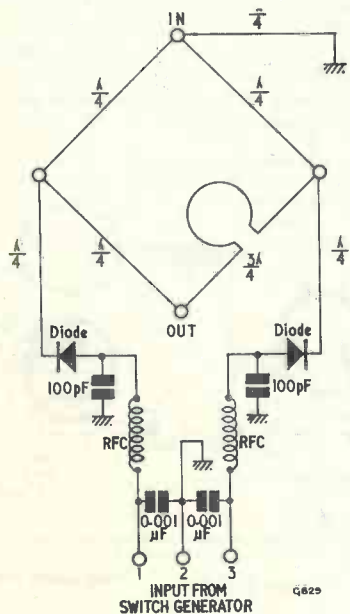

Fig. 35. Circuit of the phase switch

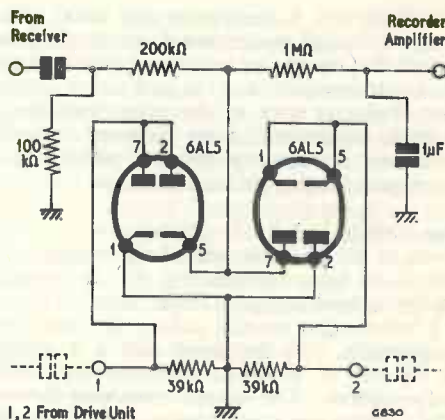

Fig. 36. Circuit of the phase sensitive detector

provided by Ryle. This arrangement we know as the phase-switching interferometer. Referring to Fig. 33 it will be seen that at (a) both aerials are connected in phase, while at (b), by the insertion of an extra half-wavelength of line between one aerial and the receiver, the two aerials are out of phase. Comparing the two lobe patterns it will be seen that at (a) the maxima is in the direction of the signal, while at (b) the minima is in the direction of the signal. Ryle arranged for this extra half-wavelength to be switched in and out at a predetermined rate. This, of course, means that the input of the receiver is alternately at maximum and minimum. The arrangement for this phase-switching interferometer is shown in block form in Fig. 34. Aerial 1 is connected direct to the receiver, while aerial 2 is fed via a phase switch to the receiver. The phase switch is operated by the switching generator, which also operates the phase sensitive detector, and the resultant trace appears as in Fig. 31 (b). Using this method it is possible to discriminate between two sources quite close together and having different amplitudes; faint sources can be identified with precision.

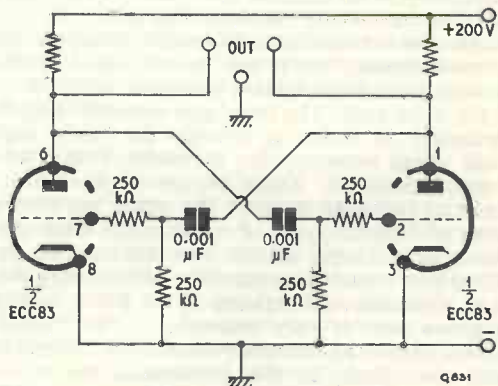

Fig. 37. A switch frequency generator

To apply this technique to our radio telescopes certain additional equipment is required. It will be assumed that the reader has already set up the simple drift interferometer and gained some experience before changing over to the phase switching type. The basic equipment of the receiver, recorder and monitor will remain as before, the additional equipment required being shown in Fig. 34.

Phase Switch

First of all there is the phase switch. This is shown in its basic form in Fig. 35. It consists of a modified hybrid bridge. Three sides of the bridge are $\frac{1}{4}$ wavelength coaxial cable, the fourth side is $\frac{3}{4}$ wavelength. On the input side a $\frac{1}{4}$ wavelength stub, which is earthed, provides the necessary transformation. The actual switching devices are diodes. These are connected via the $\frac{1}{4}$ wavelength sections from each side of the bridge and are operated via the radio frequency chokes by the switch generator. The radio frequency chokes should be resonant at the particular frequency in use. The output is fed to the receiver at the junction of the $\frac{1}{4}$ wavelength and $\frac{3}{4}$ wavelength section. In operation the switch generator closes first one section and then the other, allowing the signal to pass either via the two $\frac{1}{4}$ wavelength section or the $\frac{1}{4}$ wavelength plus the $\frac{3}{4}$ wavelength section. Thus the insertion of the extra $\frac{1}{4}$ wavelength of line is accomplished. In order that the output may follow this switching sequence it is necessary to operate the phase sensitive detector in sympathy with the phase switch. The switching generator is therefore connected to the arrangement of diodes shown in Fig. 36. This is the phase sensitive detector. (See note, page 618). Typical component values are shown for the valves (6AL5). This system has worked very satisfactorily over a long period.

Switch Frequency Generator

The switch frequency generator is a straightforward multivibrator as illustrated in Fig. 37. The frequency chosen may be any value up to, say, 900 or 1,000 c/s. Care, however, should be taken to avoid exact multiples of the main frequency. The values shown in the diagram will result in a frequency which lies somewhere between 900 and 1,000 c/s. It is possible to substitute an audio generator for the multivibrator, but it will be necessary in this case, of course, to provide a push-pull amplifier to feed the drive unit. The drive unit shown in Fig. 38 is necessary in order to provide the fairly high voltage swing necessary for the phase switch and the phase detector. These require approximately 30 volts to swing the diodes. The writer has used a number of different types of valves in the drive unit but any valve having similar characteristics to the 6AS7 will be found quite suitable. When using this type of equipment the stability of the mains supply and power unit is very important. The receiver oscillator should be extremely stable and preferably crystal controlled. In this connection the writer has used a Franklin oscillator with considerable success.

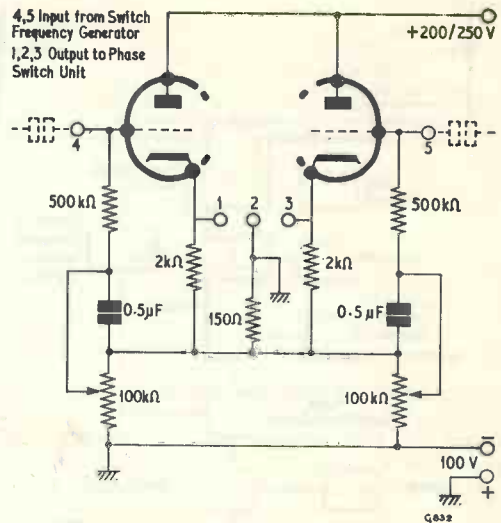

Fig. 38. A driver unit for the phase switch

Power Supply

The power supply unit should be as rugged as possible with plenty of power to spare. If the mains supply can be stabilised with one of the special stabilising transformers so much the better. Whenever a power pack is in use it should be stabilised. Figs. 39, 40 and 41 illustrate typical circuits. When the power pack used is one of the ex-Government types now available—and these are ideal for the purpose—that part of the circuit to the right of the dotted lines can be added to the unit in order to stabilise the voltage output.

Throughout these articles it has been assumed that those interested in building the equipment already have at least some of the equipment available or are of sufficient experience to work from the block diagrams and simple circuits given. In the past there have appeared in this magazine many

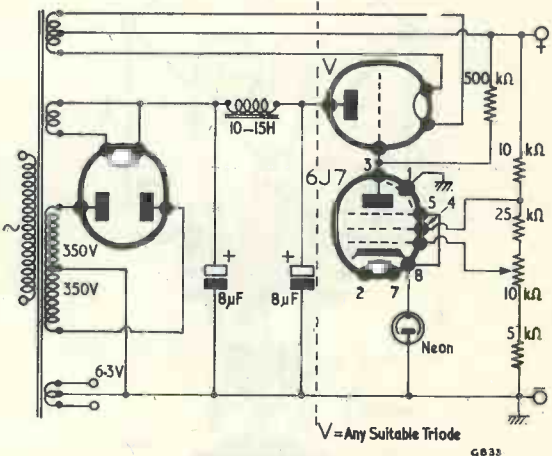

Fig. 39. Circuit of a stabilised power unit using a 6J7 and suitable triode

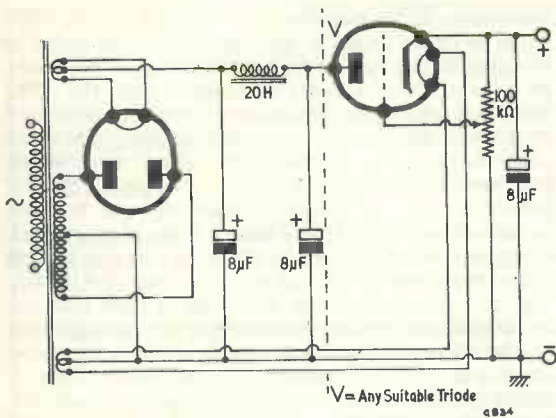

Fig. 40. Stabilised power unit using a suitable triode

tested circuits which could be applied to these purposes. There is, however, plenty of scope for further work and experiment. Many amateurs will find it interesting to design and build highly stabilised intermediate frequency amplifiers and r.f. units of high gain and low noise. Similarly, there is scope for further improvement of the translator unit, and it is certain that many readers who decide to embark upon this particular hobby will have many ideas to contribute.²

As mentioned in last month's article it is hoped that some readers will at least be in a position to take part in a countrywide experiment—the measurement of the Sun's corona—during June of this year.

² See page 446, *The Radio Constructor*, January 1962.—Editor.

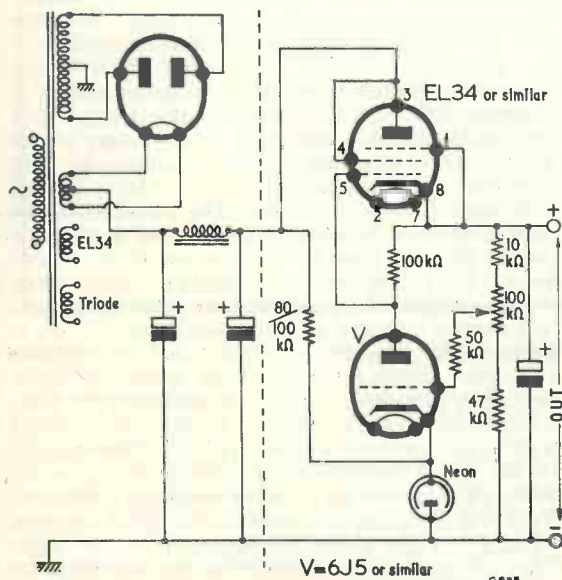

Fig. 41. Stabilised power unit incorporating an EL34 and triode

Rotating Lobe Interferometer

There are a number of applications which have not so far been mentioned in these articles. For example, the rotating lobe interferometer; this is a system which has been extensively used in Australia. The measurement of solar flares, for example, are too rapid to be detected by the ordinary interferometer which depends upon the speed of the rotation of the earth. Flares, being rapid transient phenomena, can be studied when the lobes of the interferometer are made to rotate electrically. Such a system is not beyond the average amateur and a block diagram of the arrangement is shown in Fig. 42.

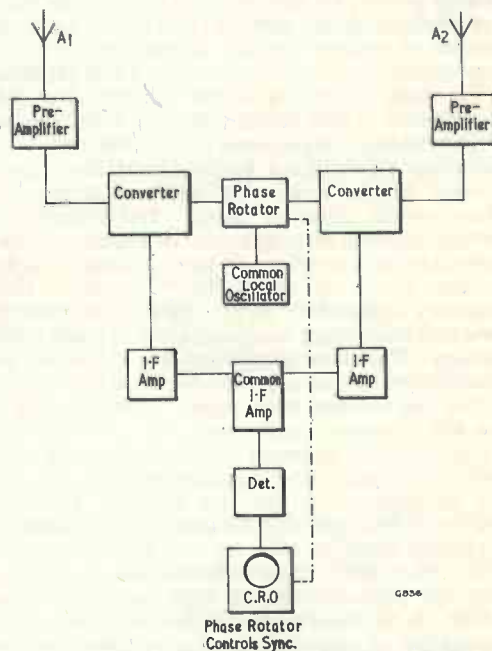

Fig. 42. Block diagram of a swept lobe interferometer devised by Little and Payne-Scott

This series would not be complete without mention of certain other techniques which, although beyond the reach of the amateur, are nevertheless important to anyone who is taking an interest in the subject.

Aperture Synthesis

One of these techniques is that of aperture synthesis. This is a development by Martin Ryle of Cambridge and it was this system which he used to detect radiation from the most distant point so far observed in the universe. The results of his work caused some considerable stir in the early part of 1960 when the headlines carried the sensational news that new measurements supported the idea of an exploding universe rather than that of a steady state universe. The principle of aperture synthesis is that a large fixed aerial is used together with a

smaller and movable one. The smaller one can be arranged in any position relative to the large one. This gives the effect of a large square aerial whose sides are equal to the length of the larger of the two aerials. Successive scans are made with the small aerial in various positions. The output from the receivers is coded on punched tape and eventually fed into a computer. The result of this is that the whole of the area covered by the aerial is synthesised, and it is from this procedure that the name aperture synthesis derives.

British Radio Observatories

Radio astronomy has now reached a stage where it is recognised as one of the most important branches of modern science. At the time of writing a new committee has been set up by Lord Hailsham for the study of this particular subject. The three observatories in this country have been established at Cambridge, Manchester and Malvern. At Cambridge the Mullard Radio Observatory under Professor Martin Ryle, F.R.S. has been foremost in certain special types of work. The principle of aperture synthesis already mentioned has established Cambridge in a position of having ranged further into the depths of space than any other radio astronomy observatory in the world. The need for a new and even larger instrument has become highly necessary. This new instrument will also make use of interferometry and aperture synthesis, and a grant for this has recently been made. It will consist of three 60ft diameter paraboloids, two of which will be fixed and one mounted on a railway track some 2,500ft in length. The distance between the two fixed parabolas will also be 2,500ft. Thus the movable instrument will be enabled by means of the railway track to take up any position relative to the other two. This will provide a resolving power far beyond anything that has so far been possible. It has been primarily designed for detailed investigation of individual sources and the examination of the distribution of faint sources which extend far beyond the range of present instruments. It will enable much higher frequencies to be used and the Cambridge instruments will, therefore, have extension into the high frequency range. The use of the latest techniques and receivers will be possible and full advantage will be taken of modern low noise apparatus involving the use of mazers and parametric amplifiers.

These cosmological investigations form one of the most important branches of radio astronomy at the present time. The doubt thrown upon the steady state theory will be investigated still further to determine both distances and magnitude of these fainter sources, and endeavours will be made to discover why these peculiar galaxies radiate. The new instrument will, in fact, be equivalent to a paraboloid one mile in diameter.

At Manchester the observatory is under the control of Sir Bernard Lovell, F.R.S. It is here that the great 250ft Jodrell Bank radio telescope is installed. The work that has been done with this instrument has amply justified the faith and the

enormous difficulties that Sir Bernard Lovell overcame in order to get it into operation. In order to investigate the very high frequencies it is necessary to have a more accurate instrument than the 250ft telescope. A new design has therefore been produced which will not only have greater resolution but will contain the benefit of the several years' work which has been done with the 250ft telescope. The new telescope will not replace the existing one, but will be an adjunct to it. It will have a bowl of sheet steel, being paraboloidal with an elliptical aperture having a major axis of 125ft and a minor axis of 83ft 4in. The focal length of the telescope is 40ft and the aerial with its associated equipment will be supported at the focus by four legs standing from the bowl structure. The mounting is altazimuth with a travel of more than 360° in azimuth and from 0-90° in elevation. The drive will be by the Ward Lennard system with computer control, and the accuracy with which it can be set will be better than one minute of arc. The beam width and power gain of the new telescope at 10 centimetre wavelength will be about the same as that of the 250ft telescope at a wavelength of 30 centimetres. It will be used together with the 250ft telescope as an interferometer. Positional measurements of radio sources by lunar occultation will be made with this interferometer. In addition the telescope's time will be devoted to the 21 centimetre programmes investigating extra-galactic nebulae and the measurements of cosmic magnetic fields. This telescope has been designed by Messrs. Husband & Company, the designers of the original 250ft telescope.

The third observatory at Malvern under the direction of Dr. J. S. Hey is at the Royal Radar Establishment. To the equipment already in use there has been added recently a new interferometer. This comprises two mobile steerable radio telescopes with bowls 80ft in diameter. This equipment is to be used for research into space environment observable by radio and radar methods, and it is expected that useful information about conditions and radio processes within the solar system will be undertaken. Research of this nature is very important for future applications of military or civil techniques involving missiles. The installation was devised to be accurate and provide a versatile system different from that at Cambridge or Jodrell Bank. The aerials have been designed to work down to wavelengths of 10 centimetres. The instrument will form a variable spacing interferometer and is suitable for many types of radio and atmospheric research. Investigations will be made of radio emissions from different sources including the Sun, the Moon, and the planets. In the solar system itself radar methods will be applied. Observations of the upper atmosphere can be made by radio waves passing through it and by obtaining reflections from free electrons in meteor trails. Each separate telescope weighs about 250 tons and is 120ft high. They are mounted on horizontal and vertical axes and can be pointed in any direction with an accuracy of better than three minutes of arc. Each is mounted on two sets of double railway tracks spaced 90ft

TABLE

Constellation	I.A.U. No.	Right Ascension	Declination		Identifications
Cassiopeia	00N6A	00h22m±2m	64°15'±35'	(12)	Supernova 1572 (no visible remnants)
Andromeda	00N4A	00h40m15s±30s	40°50'±20'	(11)	M31 NGC224
Perseus	03N4A	03h16m37s±4s	41°25'±6'	(17)	NGC1275 Colliding galaxies
Auriga	04N4A	05h08m±4m	46°±1°	(13)	Angular size of source is 1°4'. Identified with galactic nebulosity
Taurus	05N2A	05h31m35s±5s	22°04'±5'	(4)	M1 NGC1952 Crab Nebula
Orion	05S0A	05h33m.0±0m.2	-05°27'±5'	(18)	Orion nebula M42, NGC1976
Gemini	06N2A	06h13m37s±4s	22°38'±5'	(19)	IC443
Monoceros	08S0A	08h08m±10m	-06°±30'	(13)	
Lynx	08N4A	08h09m±2m	48°±1°	(8)	
Puppis	08S4A	08h20m±4m	-42°30'±1°	(13)	Galactic nebulosity
Lynx	09N4A	09h16m±4m	47°±1°	(8)	
Hydra	09S1A	09h16m±2m	-12°±2°	(13)	
Ursa Major	09N6A	09h51m20s±2m	69°±1°	(15)	NGC3031
Vela	10S4A	10h10m±4m	-42½°±20'	(2)	
Ursa Major	10N5B	10h30m±2m.5	57°±2°	(11)	
Crater	11S1A	11h38m±8m	-15°±2°	(13)	
Canes Venatici	12N4A	12h15m±3m	47°±1½'	(11)	NGC4258
Virgo	12N1A	12h28m11s±37s	12°41'±10'	(1)	M87 NGC4486
Centaurus	13S4A	12h22m24s±1m	-42°37'±8'	(1)	NGC5128
Canes Venatici	13N4A	13h27m30s±3m	47°±1°	(11)	NGC5195
Boötes	14N5A	14h10m±2m	51°30'±1°	(11)	NGC5457
Serpens Caput	15N1A	15h10m±4m	11°±1½°	(2)	
Triangulum					
Australis	16S6A	16h10m±8m	-60¾°±5'	(2)	
Hercules	16N4A	16h36m±10m	41°±2°	(13)	
Hercules	16N0A	16h45m±2m	6°±1°.5	(2)	
Sagittarius	17S2A	17h42m±1m	-28°.5±0°.2	(21)	May be associated with the galactic nucleus. The presence of neighbouring intense emission regions makes the measurements of flux density difficult
Ophiuchus	18S0A	18h16m±4m	-8°±2°	(13)	
Sagittarius	18S1A	18h17m.9±0m.2	-16°14'±5'	(18)	Omega nebula M17, NGC6618
Cygnus	19N4A	19h57m44s±2½s	40°35'±1½'	(3)	Colliding galaxies
Cygnus	20N4A	20h22m	40°	(11)	Cyg X extended source possibly associated with galactic nebulosity
Cassiopeia	23N5A	23h21m36s±30s	58°35'±10'	(11)	Galactic nebulosity

apart, and the spacing between the aerials can be varied from 2,500 to about 3,600ft. Each radio telescope is automatically controlled so that it points continuously towards the chosen object which is being observed.

The Post Office has now entered the field of satellite communication, and a telescope will be set up at a site near the Lizard in Cornwall. It will operate at frequencies up to 6,000 Mc/s and at this frequency it will have a beam width of 0.15°. As communication satellites will move fairly rapidly across the sky the amount of time available for the reception of signals will be between 25 and 30

minutes. It is therefore necessary that the tracking of the instruments should be very accurate. The Ward Lennard system will be used to operate this telescope. The structural and mechanical design of the aerial and the electric drive system is in the hands of the same consulting engineers as that for Jodrell Bank.

The Radio Research section of the Department of Scientific and Industrial Research is under the directorship of J. A. Ratcliffe, F.R.S. A large part of the work of this station is now devoted to space research and part of this effort is devoted to experimental equipment which is put into rockets and

satellites. The other part deals with the reception of telemetry signals from satellites with which British experimenters have arranged programmes. In addition, as part of a world-wide chain of tracking stations, other satellites are kept under constant observation.

It is for the purpose of receiving high frequency telemetry that the new telescope has been designed for the Radio Research Station. This will be set up near Crowthorne and will have facilities to receive signals at frequencies up to 3,000 Mc/s. The aerial will consist of a parabolic reflector 85ft in diameter. This will be large enough to receive the weak signals which are likely to be encountered, and will also be suitable for moving rapidly in the angles necessary to follow the path of a satellite. Arrangements are to be made so that it will automatically follow a satellite when necessary.

Another purpose to which this telescope will be applied will be the reflection of radio waves from the Moon, as a method of measuring the concentration of electrons in space.

A further application for this highly-sensitive aerial will be the investigation of some of the problems involved in the propagation of high frequency waves through the troposphere. Small irregularities in the density of the atmosphere cause these to be weakly scattered and reflected. No doubt it will also be used in the investigation of radio noise radiated from the atmosphere itself and that due to rain, snow and clouds.

As this is the last article of the series a table of radio sources which may be identified by the amateur is included.

It is also right and proper that due acknowledgement should be made of the work of my chief assistant Mr. D. G. Martin on whom fell the responsibility of the prototype receiver, not forgetting Clyde Flemming the apprentice who did the hack work of assembly and soldering.

It should be noted that the name given to this circuit could lead to misunderstanding. The purpose of the device is to detect the position of the source relative to the lobes. It therefore is in the form of a switch which switches the output to the recorder on and off in synchronism with the insertion of the additional half wavelength of feeder. This sampling of the signal will indicate whether the aerials are additive or subtractive and so lead to the tracing of the curve on the recorder. The reason for using two valves is to balance the circuit with reference to the switching generator.—EDITOR.



"I think I've got a few dry joints, doctor!"

Heater-Cathode

Insulation

By J. B. Dance, M.Sc.

VALVE MANUFACTURERS NORMALLY QUOTE A value for the maximum permissible voltage which can be applied between the cathode and heater of a valve. This is usually expressed as a d.c. value and varies from about 50 to 750 volts or more according to the type of valve.

The value of the maximum heater-cathode voltage rating when the cathode is positive may be different from that when the cathode is negative. For example, the EF86 has a maximum rating of 100 volts when the cathode is positive and 50 volts when it is negative with respect to the heater.

There may also be a maximum value quoted for the resistance to be placed between the heater and cathode. In the case of the EL37, this is as low as 5kΩ. The ECC82 and ECC83 (equivalent to the 12AU7 and 12AX7 respectively) have a maximum permissible heater-cathode resistance of 20kΩ, although this may be increased to 150kΩ when one of these valves is used as a phase inverter immediately preceding the output stage. The large maximum heater-cathode voltage rating of these two valves (180 volts) is especially useful when they are to be used as phase splitters with equal resistors in their anode and cathode circuits, as voltages (d.c. plus signal peak) exceeding 100 may easily be developed across the cathode resistor in this type of circuit.

Valves should not be rendered inoperative by disconnecting the cathode unless there is a resistor between the heater and cathode not exceeding the maximum specified value.

Rectifiers frequently have a high maximum heater-cathode voltage rating; this is often approximately equal to the maximum d.c. voltage output which can be obtained when the input to the anode(s) is equal to the maximum permissible r.m.s. value.

The insulation resistance between the heater and cathode in the valve should not be included as part of any r.f. oscillator circuit or frequency instability due to changes in the heater-cathode capacitance may occur. In addition modulation hum is likely to appear. Similarly the insulation resistance between the cathode and heater should not be included as part of an a.f. circuit if the signal level is low in the valve concerned, or the amount of hum introduced may be comparable with the signal voltage.

A valve may be tested for heater-cathode leakage in the following way. A steady voltage of the maximum rated value should be applied between the heater and cathode using a 0-500 microammeter and a 100kΩ resistor in series in the circuit. The

current passing should be less than $20\mu\text{A}$ for a heater rated at 6.3 volts, 0.3A. If a fairly large power valve is being tested with a potential of about 100 volts between the heater and cathode, a current of up to about $100\mu\text{A}$ can be considered as being reasonably satisfactory. The $100\text{k}\Omega$ resistor protects the meter from damage if a heater-cathode short circuit has developed in the valve.

AN INEXPENSIVE PICK-UP COIL

By T. R. Balbirnie

REQUIRING AN EFFICIENT AND INEXPENSIVE PICK-UP device which would enable telephone conversations to be recorded, the writer constructed a number of low impedance coils which could be coupled to a tape recorder via a matching transformer. Unfortunately, none of these coils functioned satisfactorily, the main reason for their failure being excessive induction of hum in the matching transformer. It was considered that efficient shielding of the latter could not be carried out at low cost, and it was decided eventually to employ a high impedance coil which could be coupled directly to the tape recorder via screened cable.

The Coil

A suitable coil was found in an old high impedance earphone which had lost its diaphragm and had been abandoned in the junk box. The only parts required from the earphone were the coil and its core, and

Fig. 1. Earphone showing the coil before removal

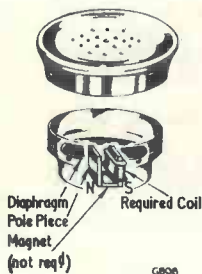

these were removed carefully from the magnet assembly, care being taken to prevent damage to the coil connections. Figs 1 and 2 show the coil before and after removal from the earphone.

Connection to the coil was made via television co-

Fig. 2. The coil removed from the earphone



axial cable because this happened to be available, but a lighter screened cable would have been just as efficient and less cumbersome. The coaxial cable was then coupled to the high impedance input of the recorder offering greatest gain and it was found that the system gave excellent results.

In order to protect the coil from damage it was fitted with a protective cover of thin black rubber tubing, of the type used for joining lengths of glass tubing in chemistry work. The rubber tubing was found to stretch quite easily over the coil, it being passed over the upper flange and extending approximately one inch below the lower flange as shown in Fig 3. The tapering effect of the tubing was most



Fig. 3. The coil with protective rubber covering

useful in providing an effective grip for the screened leads.

Applications

The coil was capable of providing adequate pick-up of telephone conversation by mounting it against the earpiece with the aid of a small rubber suction cup. In the writer's case it was found that adequate pick-up was not available from the base of the telephone instrument.

The coil has also been used to record the audio output from radio and television receivers. In this case it was merely necessary to hold the coil against the cabinet of the receiver close to the speaker transformer. Whilst this method of coupling offers a fidelity lower than that given by direct connection to the detector or discriminator load, it has the advantage of obviating the necessity of connecting into the receiver circuits. This latter point has special significance if the receiver concerned has an a.c./d.c. chassis.

Coupled to a standard amplifier, the coil is very useful for detecting a.c. fields, and has been employed for checking the results of mains transformer orientation and the presence of stray fields. A particularly useful application became evident when it was used to trace mains wiring leading to a power point. Although the wiring was an inch below the surface of the wall, the a.c. field set up enabled its path to be traced with no difficulty at all, the pick-up coil searching in order to produce the loudest hum from the amplifier loudspeaker.



RADIO

topics

By RECORDER

WHILST I WOULD INDIGNANTLY refute any suggestion that I am a square (provided I've taken my vitamin tablets I can jive as well as anybody in a dignified sort of way) I must confess that I *have*, over the last year or two, fallen slightly out of touch with teenage interests and affairs. The recent round of Christmas and New Year parties has, however, brought me up to date.

For some reason, many of the people I know presented their teenage progeny with record players this last Christmas, these players consisting either of single-play types or auto-change models. Everyone plumped for the more inexpensive players which have single pentode amplifiers; and I must confess that the models of this type which I encountered gave quite a creditable performance despite their limitations.

Simple Circuits

The "standard" circuit for these record players is centred around a fairly high power pentode such as the UL84. For a 200 volt h.t. supply, this valve is capable of offering over 5 watts output at a total distortion of 10%, and there would appear to be little risk of its overloading considering the direct input to its grid from the associated crystal pick-up. The available output volume is, indeed, surprisingly high and is certainly sufficient to provide dancing music at quite noisy parties.

Screen-grid and anode consumption for a UL84 runs around 70mA or so, and the necessary h.t. is normally provided in record players

of the type I am discussing by a valve rectifier such as the UY85. A UY85 and a UL84 require 83 volts at 100mA for heater supply: this is provided by a tap in the gram motor windings, thereby saving the expense of a dropper. Hi-fi purists may raise a pained eyebrow at the performance of single amplifier valve record players but they seem adequate for their purpose, especially when the question of cost is considered. Furthermore, they are capable of giving much pleasure.

The youngsters, of course, take all the electronics and mechanics of record players for granted, and one hears them gravely explaining to their elders such technical points as why the 78 stylus should not be used with L.P.'s and so on. The sight, at one family's house, of a diminutive 8-year-old standing on a chair and expertly loading ten 45 r.p.m. pop discs (at 6s. 9d. a time!) on an auto-changer fully brought home to me the fact that the rising generation is quite competent to handle the gadgets which are showered on it by our affluent society.

I must ask my colleague, G. A. French, to give us a single valve (plus rectifier) record player circuit in a future contribution to his "Suggested Circuit" series. In the meantime, anyone for the Twist?

Statics

Another thing I learnt over the recent festive season is that if you rub an inflated balloon against a woollen pullover or jumper, the rubbed surface of the balloon will adhere to a wall or ceiling.

"It's static electricity", explained my 12-year-old mentor.

Phoning Via Satellites

If my information is correct, I understand that the G.P.O. is not over-keen on the use of stationary satellites for world-wide telephone communication. One of the big

snags, apparently, is the time delay which occurs between the transmission of a message from one part of the earth and its reception at another, far-distant, point. It seems that, with satellites, this delay could in some cases be as much as a second or so, and that this can cause difficulties with what is intended to be a simultaneous two-way telephone conversation. A delay of a second does not seem very large; but it is instructive, nevertheless, to look at the sweep hand of a watch and judge subjectively the period taken up by this single unit of time.

Intrigued by my information, I decided to do some rough calculations on my own. These are based on the times taken by a signal passing right round the world when it travels along the surface and when it travels via satellite links. I appreciate that working from a complete circuit of the earth is not fully representative of telephone communication requirements, but it still enables a good idea to be obtained of the sort of delays which are likely to be encountered in practice. A more realistic approach would be given by calculating the time needed to send a signal *half* way round the earth, but the three-satellite system which I shall refer to does not enable a direct comparison to be made in this case.

Let us start by considering a signal which passes round the world at surface level. The circumference of the earth is approximately 25,000 miles so that, if a radio signal were to travel round the equator at the speed of light (186,000 miles per second) it would arrive at its starting point approximately 134 milliseconds after its initial transmission. I've shown the path of such a signal in Fig. 1.

In practice, the signal would not be required to go around the world in one hop, as it were. It would be carried part of the way

by land lines, part of the way by under-water cable, and part of the way by radio. In the first two instances, the velocity of the signal may be lower than that of light. Nevertheless, the figure of 134

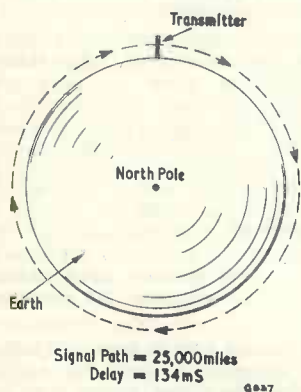

milliseconds offers a useful rough comparison with the figures we could expect when stationary satellites are used to achieve the same result.

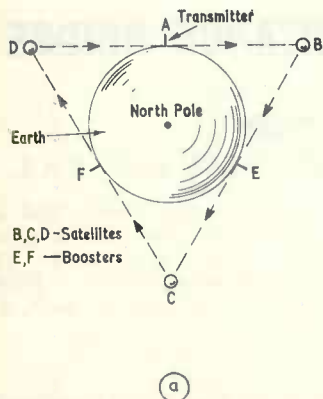

We could, at first sight, send a signal round the earth with the aid of three stationary satellites positioned as shown in Fig. 2 (a). These satellites maintain a constant position with reference to the surface of the earth by completing their orbits once in 24 hours, and it is assumed that these orbits lie in the same plane as the equator. It is also assumed that the satellites lie on three tangents to the equator, these being equi-spaced around the circumference. If a signal is now transmitted from point A it can be reflected or re-transmitted by the satellite at B to that at C, which then repeats the process to the satellite at D. This last satellite finally returns the signal to the

original transmitter, it having travelled along the path ABCDA. To assist the signal, it would be helpful to have boosters at points E and F, these receiving and re-transmitting the signal to the next satellite.

The length of path ABCDA may be easily calculated, a simple method being shown in Fig. 2 (b). In this diagram OA is a radius to the equator meeting the tangent DB, and is at 120° to the radii meeting tangents BC and CD. Angle BOA is obviously 60° , with the result that AB is equal to $OA \tan 60^\circ$. The radius of the earth (OA) is approximately 4,000 miles, so that AB becomes equal to some 7,000 miles. The total path traversed by the signal is 6 times AB (=42,000 miles) and this corresponds to a signal delay of some 225 milliseconds; which is not a great deal larger than the 134 millisecond figure given by surface working.

In Fig. 2 the three satellites have as low an altitude as possible whilst still retaining a continuous signal path around the earth. The system could not, however,

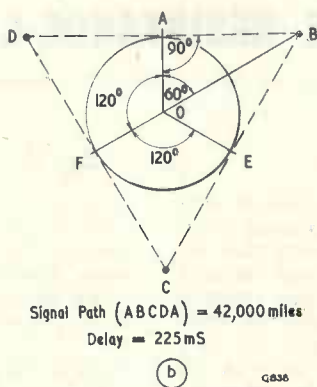

work in practice, partly because of the losses incurred when signals are received or transmitted along

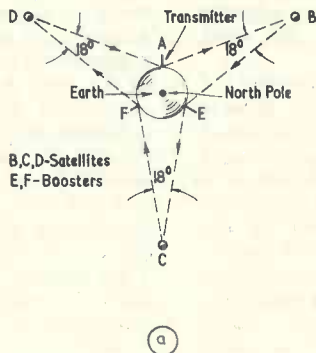

a tangent to the earth's surface at the frequencies likely to be employed on a project of this nature. The signals need to be at least slightly inclined to the horizon for best conditions of reception and transmission, and this means that the satellites have to be further away from the earth. The second reason for the impracticability of Fig. 2 is that it would probably be impossible to keep suitable stationary satellites at the height shown anyway. To maintain a constant orbit they would need to be much further away from the earth.

A more practical arrangement has been referred to by L. Pollack¹ in a paper presented at the U.R.S.I. XIII General Assembly, London, September, 1960² and, in this, stationary satellites are described as in Fig. 3 (a), where lines from each satellite to equi-distant points on the earth's equator include an angle of 18° . Such satellites have a much wider orbit than those of Fig. 2 (a), and it is once more quite easy to calculate the total path taken by a signal travelling around the earth with their aid. Fig. 3 (b) shows that angle OBA is 9° and that angle BOA is 60° . In consequence, AB equals $OA \frac{\sin 60^\circ}{\sin 9^\circ}$, which is 22,200 miles.

The total path is 6 times this figure (=133,000 miles) which corresponds to a delay of some 715 milliseconds. Quite a big increase this time.

All the above calculations are approximate only, and they are comparable only for a signal which travels completely around the earth. In practice, two-way conversations between people on opposite sides of the earth would have to be relayed either via one or via two satellites, and it would appear almost

¹ I.T.T. Laboratories, Nutley, N.J., U.S.A.

² Published under the title "Active Satellites" in *Wireless World*, February 1961.

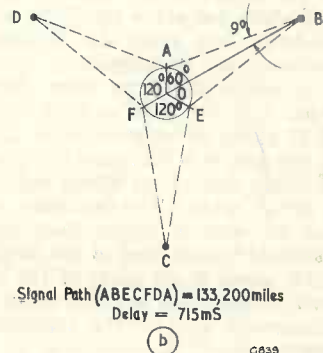

inevitable that there would be surface links in addition. In any event, the delay offered by a practical satellite link would always be considerably greater than that offered by a comparable surface route.

Stereo Headphones

Although they were introduced into the United Kingdom over a year ago, I find that few of my acquaintances have had the experience of listening to the K50 dynamic (i.e. moving coil) headphones manufactured by A.K.G. of Austria. Indeed, it was only during a recent call at H. L. Smith's of Edgware Road that I first had a chance of hearing their capabilities for myself.

The A.K.G. K50 headphones are true high fidelity units and are employed in radio, TV, recording and film studios. By suitably connecting the leads coupling to the individual phones they may be employed for mono or stereo reproduction. Impedance per ear-

phone is $400\Omega \pm 15\%$ from 30 to 20,000 c/s, and they may be matched to cathode follower outputs via a 4:1 transformer. A suitable transformer is the A.K.G. type U50. It is stated that the phones may also be coupled directly to voice-coil amplifier output terminals (the latter presumably being suitably loaded to ensure correct amplifier operation). A great feature of the K50 phones is their considerable lightness (2.8 oz. less cable) and the fact that, due to a patented feature, a tight coupling to the ear is not required for good low frequency performance. The phones just rest lightly and comfortably against the ears. The frequency response is stated as 30 to 20,000 c/s, normal power requirement being 0.156 mW (=250 mV) per unit only, whilst distortion for 1 mW input is 1% or less over the entire range.

At H. L. Smith's we had the headphones coupled to a standard Cooper-Smith stereo amplifier, and I found their performance to be

exceptionally impressive. Apart from their excellent reproduction, the sensation of having the orchestra located in space around one was most strikingly vivid. I have never before heard headphone reproduction so startlingly life-like.

I appreciate that evaluation of the performance of high fidelity reproducers must inevitably be partly subjective and I am, in consequence, always chary of making definite recommendations from my own impressions. Nevertheless, I would suggest to any high fidelity enthusiast who has an interest in headphone reproduction that he listens to the K50 units for himself before making any final choice. They certainly merit the investigation.

I should add before concluding that the general agency for A.K.G. products in Great Britain and the Commonwealth is held by Politechna (London) Ltd., 3 Percy Street, London, W.1.

A LINEAR SCALE RESISTANCE-CAPACITANCE BRIDGE

PART 1

IF ONE EXAMINES THE NUMEROUS DESIGNS FOR resistance-capacitance bridges published from time to time, one cannot help noticing that the calibrated scale of the bridge balance control invariably takes the form of the typical example shown in Fig. 1. Another feature is that the scale covers at least two powers of 10, usually 0.1 to 1 and 1 to 10, disposed each side of the arc with the 1 mark at "12 o'clock". There may also be extensions at each end covering 0.01 to 0.1 at the extreme left, and 10 to 100 at the right, both having calibration marks which are even more cramped than those at the centre-parts. Even if good accuracy is not important for some readings, interpolation of scale readings can often be difficult when the scale divisions are so irregularly spaced.

It would therefore seem that some method of expanding the scale so that it covers fewer powers of 10 could be an advantage. The design presented in this article is the result of investigations into ways of doing this which finally led to the production of a linear scale. The accuracy to which this scale can be read is better than the tolerance of the standard values used in the bridge, and this feature holds good at all parts of the scale. The development is described in some detail, as is the prototype instrument used in the experimental work. Some improvement in switching is possible to make

By W. E. THOMPSON, A.M.I.P.R.E.

evaluation of the measured values easier, and a suitable circuit is given which does not involve altering the panel layout of the original design. It does, however, cause switch wiring to be a little more involved, although this is not, in itself, a serious drawback.

Basic Principles

Component bridges of the type under discussion are based upon the simple Wheatstone principle for measuring resistance, as shown in Fig. 2. A known resistance R_s of good accuracy is used as a standard against which the unknown value R_x is compared, and a source of potential supplied across the bridge. A ratio arm of some sort, denoted by R_a and R_b , is capable of adjustment so that if R_b is proportional to R_s , then R_a can be made to assume the same proportion of R_x . In this condition there is no difference of potential across the balance indicator D , and the value of R_x can be interpolated. By suitable design R_a can be made to indicate the value of R_x directly, or by adopting some predetermined multiplying factors the bridge can be made to indicate the value of R_x in terms of R_s .

To simplify setting of the balance control, it is often the practice to combine R_a and R_b in a single potentiometer, as shown in Fig. 3. This side of the bridge then becomes a continuously variable ratio

arm, and can be calibrated in terms of R_s . As is well known, with three standard values of 100Ω , $10k\Omega$ and $1M\Omega$ for R_s , it is possible to measure values ranging from 10Ω to $10M\Omega$ with continuous coverage, and to obtain some rough indications of values down to 1Ω , or up to $50M\Omega$ or more.

Considering the condition when R_x has the same value as R_s , the bridge will balance when RV is at its mid-point, that is, when the upper half a has the same value as the lower half b . The scale at this point is marked 1 (see Fig. 1). But, if R_x is one-tenth the value of R_s , the slider of RV must be moved upwards over the part a until a position is reached where a and b are in the ratio of 1:10. This point on the scale is marked 0.1. It is to be noticed that both a and b parts of RV have been changed in value to achieve balance, but another way of regarding the change is to consider b as a fixed resistance whose value is half of RV, to which has been added some portion of a . The remainder of a then becomes a fixed value suitable for indicating a ratio of 1:10. It is therefore only that part of a moved over by the slider of RV that is the true variable arm of the bridge for reading between 0.1 and 1, and it must of necessity have a value that is less than half of RV.

A little arithmetic will show that for a ratio of 1:10, a must be one-eleventh of $a+b$. If more values are calculated for ascending ratios, viz., 2:10, 3:10, 4:10, etc., and the points plotted around the arc of the scale, the non-linear scale of Fig. 1 will be produced. This non-linearity is clearly the result of plotting ratios of a and b , both of which are varied until they assume the required ratio to each other.

By this means, one power of 10 has been covered. To obtain balance points for the next higher power of 10, or ratios from 1 to 10, R_x will obviously have a higher value than R_s . To secure a balance at 10, R_x will be ten times R_s , and the slider of RV must be moved downwards over part b until a is ten times b . In effect, the same thing has happened to RV as occurred before, but in the opposite direction, for it is now part a that can be regarded as the fixed resistance, and the part b moved over by the slider now becomes the "true" variable. Consequently, if values are again plotted for ratios between 1:1 and 10:1 the scale of Fig. 1 between 1 and 10 will be produced.

It can be seen on examination that this scale is not a replica of the scale between 0.1 and 1, and the reason for this is that for points between 1 and 10



FIG. 1

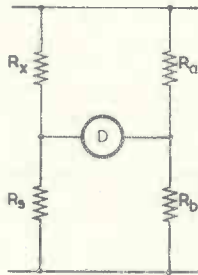

FIG. 2

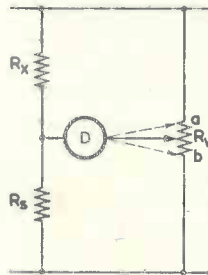

FIG. 3

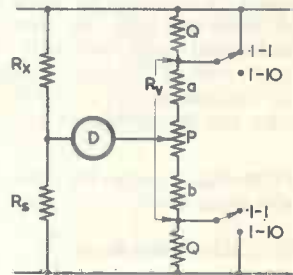

FIG. 4

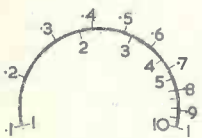

FIG. 5

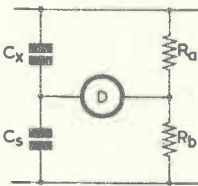

FIG. 6

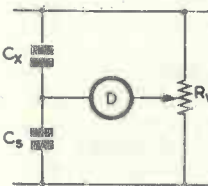

FIG. 7



FIG. 8

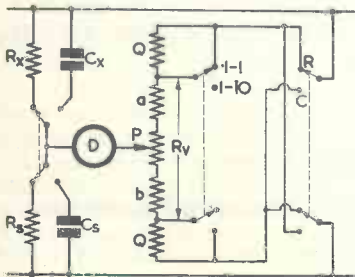

FIG. 9

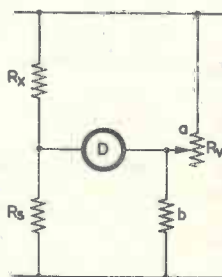

FIG. 10

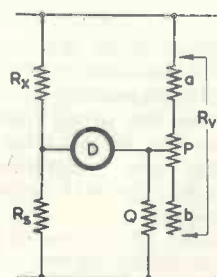

FIG. 11



FIG. 12

M263

the ratios of a to the total resistance of RV are 0.67:1, 0.75:1, 0.8:1, 0.83:1, etc., whereas previously for points between 0.1 and 1 a had the ratios 0.09:1, 0.167:1, 0.231:1, 0.268:1, and so on. These progressions are not regular or similar, so the only points of coincidence will be at 0.1, 1 and 10. The relative lengths of arc between these three points will be similar, and the non-coincident points produce the two different scale shapes each side of the centre-point, 1, in Fig. 1.

Lengthening the Scale

It is possible to expand the scale so that only one power of 10 (say 0.1 to 1) appears as the main part of the scale, and the clue to the problem has already been implied if not actually stated. The potentiometer RV has been regarded as a variable resistance which has a fixed resistance in series, first on one side of it and then on the other, in order to get two scales. It has been shown that the two halves of the scale are of similar length; consequently, the unused parts of a and b at each end of RV are of equal value. If, then, a suitable resistance is switched to either side of RV as required, its value being such that the end-parts of a and b become equal values, the scales of 0.1 to 1, and of 1 to 10, could be made to coincide at their ends. This can be achieved with the circuit of Fig. 4, where the additional fixed resistance is denoted by Q , and P is the part of RV to be calibrated. The unused ends are represented by a and b . The value of the resistance can be calculated as follows:

$$\text{From Fig. 4, when } R_x = R_s, \quad a + P = b + Q$$

$$\text{and since } a = b, \quad P = Q \quad \dots (1)$$

$$\text{Similarly, when } R_x = \frac{R_s}{10}, \quad a = \frac{P + b + Q}{10}$$

$$\text{so } 9a = P + Q$$

$$\text{and from Eqn. (1) } 9a = 2P$$

$$\text{so } 9a - 2P = 0 \quad \dots (2)$$

$$\text{Now } RV = a + P + b, \quad \therefore 2a + P = RV \quad \dots (3)$$

$$\text{Multiplying Eqn. (3) by 2}$$

$$\text{and adding to Eqn. (2),} \quad 13a = 2RV$$

$$\text{so } a = 0.154RV \quad \dots (4)$$

$$\text{From Eqn. (3),} \quad P = RV - 2a$$

$$\text{so from Eqn. (4),} \quad P = (1 - 0.308)RV$$

$$= 0.692RV \quad \dots (5)$$

$$\therefore \text{ from Eqn. (1),} \quad Q = 0.692RV \quad \dots (6)$$

It is to be noticed that the end-parts of a and b of RV, the calibrated part of RV denoted by P , and the required value of fixed resistance Q , are all deduced without reference to the actual ohmic resistance value of RV; they are all ratios of it. They will obviously retain their relationships irrespective of the value used for RV, so the formulae have general application.

To show that the same values are arrived at for the conditions when Q is connected to the other side of RV for ratios between 1 and 10, it is seen from Fig. 4 that:

$$\text{When } R_x = R_s, \quad Q + a = P + b$$

$$\text{and since, again, } a = b, \quad P = Q \quad \text{as in Eqn. (1)}$$

$$\text{Similarly, when } R_x = 10R_s, \quad Q + a + P = 10b$$

$$\text{so } 9a = P + Q$$

$$\text{which resolves to } 9a + 2P = 0 \quad \text{as in Eqn. (2)}$$

The remainder of the previous calculations were derived from these same two relationships, so it is obvious that the same values will be resolved for this other condition of the bridge. It is thus proved that with P having the same value in each condition calculated, with a and b both equal, the scale falls in the centre of travel of RV. Also, the scale will be coincident for either ratio when Q is switched to each side of RV.

Now since the calibrated part P of RV is equal to 0.692RV, it will contain an arc that is 69.2% of the total rotation of RV, so, if as is usual, RV should have a full sweep of 300°, the scale will cover about 207°. In Fig. 1, as can be seen if the previous discussions are considered, a similar calibration of from 0.1 to 1 will cover only about 123°, so the arrangement of Fig. 4 has expanded the scale by about 70%. Although this should make interpolation a little easier, there is a disadvantage in that two calibrated scales are necessary, one from 0.1 to 1, and the other from 1 to 10. A typical scale of this sort is shown in Fig. 5. Compared to the scale in Fig. 1 there is the disadvantage of possibly reading values off the wrong scale.

Measuring Capacitance

So far, these considerations have been confined to the functioning of the bridge on resistance measurements, so it is now necessary to look into the conditions that arise when measuring capacitance. If the resistances R_x and R_s of Fig. 2 are replaced by an unknown capacitance C_x and known standard capacitance C_s , as in Fig. 6, the bridge will measure either resistance or capacitance as required, provided that the voltage source is alternating. For the purpose of capacitance measurement the bridge can be regarded as looking at capacitors as if they were equivalent resistances. To be strictly correct, the bridge will "look" at the impedance offered to the voltage source by the capacitances, but since good capacitors have very low inherent resistance, the impedance value can be regarded as a reactance. As is known, the reactance of a capacitor can be expressed in ohms, and has the relationship:

$$X_c = \frac{1}{2\pi f C}$$

where X_c = reactance in ohms,
 π = 3.14,
 f = frequency of alternating voltage source,
 C = capacity in Farads.

As the reactance value is inversely proportional to the frequency, a bridge operated at a constant

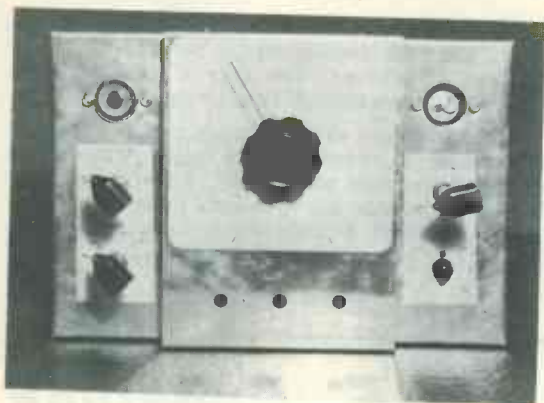

Front panel view of the completed instrument.

frequency will follow an inverse law for capacitance, relative to resistance. It can be seen that a capacitance of $1\mu\text{F}$ will have a reactance ten times smaller than one of $0.1\mu\text{F}$, so when C_x and C_s appear in the bridge in places of R_x and R_s , the slider of RV must move in the opposite direction to achieve a balance. Thus, where the resistance calibration numbered from left to right, the scale for capacitance will now number from right to left.

It is an easy step to combine Fig. 3 with Fig. 6 to obtain the basic circuit shown in Fig. 7. As stated in the foregoing paragraph the scale will read in the opposite direction, so the bridge would have a scale like that shown in Fig. 8. Here again it would be easy to read the wrong scale and obtain a false value, but if the scales are expanded as already described, no less than four separate scales would be needed. This could provide so much confusion that some simplification is more than desirable.

There are two ways of reversing the capacitance scale. The positions of C_x and C_s can be interchanged, or the connections at the ends of the ratio arm RV can be reversed. Of the two methods the second is to be preferred since only two test terminals are necessary, and the switching circuits can be simpler. The circuit of Fig. 9, which is a development from Figs. 4 and 7, requires only two scales calibrated from 0.1 to 1, and 1 to 10, both of which are used for either resistance or capacitance measurements. The scale shape would thus revert to that shown in Fig. 5.

The Linear Scale

The next step in simplification is clearly one of making all points of the two scales exactly coincident, for then only one scale will cover all four calibrations for the circuit of Fig. 9.

To see how this can be done requires a little more concentration on Fig. 3. As shown by the dotted arrows representing the movement of the slider over RV, balance is produced by varying the values of both a and b parts of RV. A hint at the linearisation problem was given when it was stated that under certain conditions, either a or b parts of RV could

be regarded as fixed resistances. The standard R_s is, in fact, the only true fixed value in the bridge, and it is because part b of RV is made variable that a non-linear law results. It is quite clear (when it is pointed out!) that if b is a fixed value always (as is R_s) then only the two upper halves of the bridge, R_x and a are variable. Further, since R_x will always be in direct proportion to R_s , a would have to be in direct proportion to b to produce a balance anywhere on the bridge arm RV, since b is again directly proportional to R_s . Put in another way, the voltage gradient at the top of R_s will always be the same as that at the junction of a and b , so must follow a linear law in consequence. The circuit configuration which will produce such a condition is shown in Fig. 10, and its close resemblance to the circuit in Fig. 3 needs no comment.

If now Fig. 10 is redrawn to resemble Fig. 4, the circuit of Fig. 11 appears, and this can be used, like Fig. 4 was, to find the values of the various resistances.

$$\text{From Fig. 11,} \\ \text{when } R_x = R_s, \quad a + P = Q \quad \dots (1)$$

$$\text{Also, when } R_x = \frac{R_s}{10}, \quad a = \frac{Q}{10}$$

$$\text{In addition, } a = b, \text{ so } 2a + P = RV \quad \dots (3)$$

$$\text{From Eqn. (2),} \quad Q = 10a \\ \text{so Eqn. (1) becomes} \quad a + P = 10a \\ \text{from which } P = 9a \quad \dots (4)$$

$$\text{Combining Eqns. (3) and (4),} \quad a = \frac{RV}{11} \quad \dots (5)$$

$$\text{And putting this in Eqn. (4),} \quad P = \frac{9RV}{11} \quad \dots (6)$$

$$\text{Since, from Eqn. (1),} \quad Q = a + P$$

$$\text{Eqns. (5) and (6) will give} \quad Q = \frac{10RV}{11} \quad \dots (7)$$

This, then, covers the range from 0.1 to 1, and to cover the range from 1 to 10 the resistance Q is not switched to the other side of RV since this would destroy the linearity of the scale. The value of Q must therefore be altered so that it provides the correct multiplying factor for the required range. The calculations above can be used to derive the values of Q .

In the prototype bridge a value for Q was calculated to provide a calibration of resistance values between 1Ω and 10Ω , that is, ratios of 0.01 to 0.1. The object of this was to provide a means of measuring capacitances in the range $10\mu\text{F}$ to $100\mu\text{F}$, as the circuits to be given later will show.

Calculations for three ranges give the values in the table below:

Range	a or b	P	Q
0.01-0.1	$RV/11$	$9RV/11$	$100RV/11$
0.1-1	$RV/11$	$9RV/11$	$10RV/11$
1-10	$RV/11$	$9RV/11$	$RV/11$

It is immediately apparent that the calibrated part P of the balance control RV has the same length in all cases, so provided that the multipliers Q are

accurately adjusted the scale will coincide on all ranges. Also, since a and b are equal in all three cases, P occupies the centre part of RV always. Furthermore, as in the earlier calculations for Fig. 4, the actual value of RV does not appear, so again the formulae are generalised.

Another factor arises from this table of values, for P is always nine-elevenths of RV . If RV , as before, has a total rotation of 300° , P will now cover an arc of some 245° , or twice the arc for the same decade (say, 0.1 to 1) of Fig. 1. The scale length has therefore been doubled as a result of linearisa-

tion. The resultant scale is depicted in Fig. 12, and in practice each division would be subdivided into ten smaller divisions. The ease of reading such a scale is not more difficult than using a foot-rule!

Proceeding now to capacitance measurements, it is necessary to reverse RV in order to make the scale read the right way round. This proves to be delightfully simple, for it is only necessary to disconnect the end a from the voltage source and connect end b in its place.

(To be continued)

A Simple T.R.F. Receiver

By S. G. Wood, G5UJ

THE SIMPLE T.R.F. RECEIVER DESCRIBED IN THIS article has much to commend it as it combines both simplicity and economy. As a glance at the diagram will show, the circuit consists of two EF50's in the well tried O-V-1 arrangement. Regeneration is obtained in the orthodox manner, but an additional feature is the incorporation of the potentiometer VR_1 in the cathode circuit of V_1 . This potentiometer varies the cathode bias of V_1 and provides a somewhat smoother control of regeneration.*

The Circuit

The remainder of the circuit is fairly straightforward. The two variable capacitors C_2 and C_3 are solid dielectric types and were found to give quite satisfactory results. A slow-motion drive could be fitted to C_3 , but this was omitted with the prototype for the sake of economy. The r.f. coil is a standard Repanco component, covering both medium and long-waves.

It was found that an increase in signal strength was obtained by the use of an a.f. choke in the anode circuit of V_1 as compared with the more conventional anode load resistor. This choke may be any reasonably small component having an inductance of 7 or 8 henries and being capable of carrying some 10mA. It needs to be positioned carefully with respect to the mains transformers if hum is to be avoided.

The output stage, V_2 , has no unnecessary frills. The speaker transformer may be any small component having a ratio of 50:1.

The power supply employs two mains transformers, one offering a secondary voltage of 250 at 50mA, and the other a secondary voltage of 6.3 for

the heaters. If desired, a single transformer having a half-wave 240 to 250 volt h.t. secondary and a 6.3 volt heater winding could be employed instead of the two separate components shown in the diagram. The h.t. secondary should have a minimum current rating of 30mA, and the heater secondary a minimum rating of 0.6A.

Rectification is carried out by a contact cooled rectifier, adequate smoothing being provided by C_9 , C_{10} and the smoothing choke. The smoothing choke is not a critical component and that used in the prototype had an inductance of 20 henries and a current capability of 50mA. If desired, it could be replaced by a 5 watt resistor having a value of 2.2 or 3.3k Ω , without any serious increase in hum level. The use of the resistor may cause a drop in h.t. potential with a corresponding loss in output power.

The use of EF50's incurs an economy and any surplus types may be used. Best results were given with "red Sylvania" valves.

Construction

Construction should not raise many problems provided that a reasonable layout is employed. As was mentioned above, the a.f. choke in the anode circuit of V_1 needs to be positioned carefully with respect to the mains transformers. The chassis employed by the writer had dimensions of 8 x 4 $\frac{1}{2}$ x 2 $\frac{1}{2}$ ins, this being fitted with a front panel measuring 8 x 5 $\frac{1}{2}$ ins. The chassis was made from 16 s.w.g. aluminium and the panel from dural.

Performance

With a receiver of this class a good aerial and earth are desirable. Thirty or forty feet of aerial wire should, in good reception areas, be adequate. Such an aerial should then enable reception of the local B.B.C. stations and the more powerful European transmitters to be achieved. Reception will be improved by the use of a reliable earth connection.

* It would appear that V_2 functions more as an anode-bend than as a leaky-grid detector. No decoupling capacitor between cathode and chassis was employed in the author's prototype, and the addition of such a capacitor might form a useful basis of experiment in receivers built to this circuit.—Editor

Components List

Resistors

R ₁	1M Ω	$\frac{1}{4}$ watt	20%
R ₂	1k Ω	$\frac{1}{4}$ watt	20%
R ₃	47 Ω	$\frac{1}{4}$ watt	20%
R ₄	470k Ω	$\frac{1}{4}$ watt	20%
R ₅	150 Ω	$\frac{1}{4}$ watt	20%
R ₆	330k Ω	$\frac{1}{4}$ watt	20%
VR ₁	2k Ω	wirewound	

Switches

S ₁	Wavechange s.p.s.t.
S ₂	Mains on/off s.p.s.t.

Valves

V_{1, 2} EF50

Rectifier

Contact-cooled.
250V, 30mA minimum

Capacitors

C ₁	100pF
C ₂	500pF variable, solid dielectric
C ₃	500pF variable, solid dielectric
C ₄	100pF
C ₅	0.005 μ F
C ₆	16 μ F 350 W.V.
C ₇	0.05 μ F
C ₈	25 μ F 12 W.V. electrolytic
C ₉	16 μ F 350 W.V. electrolytic
C ₁₀	32 μ F 350 W.V. electrolytic

Transformers

- T₁ Speaker transformer, 50:1
 T₂ Mains transformer (h.t.). Secondary 250V, 50mA. Radiospares miniature.
 T₃ Mains transformer (heater). Secondary 6.3V, 0.6A minimum
 N.B. T₂ and T₃ may be combined in a single transformer. (see text)

Inductors

- L_{1, 2, 3} Repanco High Gain (Dual Range)
 L₄ A.F. Choke, 7-8H (see text)
 L₅ Smoothing Choke, 20H, optional (see text)

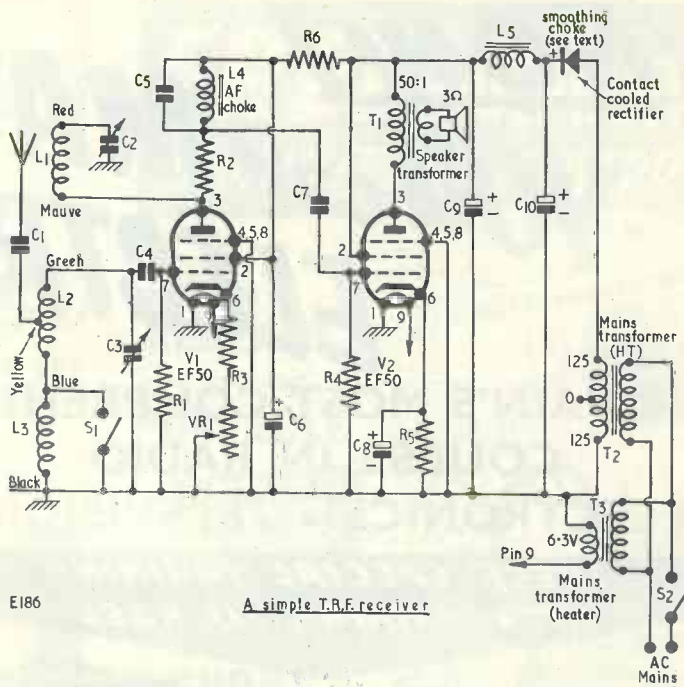

THE CELLOBOND POLYESTER STORY

The increasing industrial use of polyester/glass as a material of construction is well illustrated in a new 24-page booklet entitled "The Cellobond Polyester Story" just published by British Resin Products Ltd.

The booklet opens with an introductory section (4 pages) on the manufacture, properties and use of Cellobond Polyester Resins. It then goes on to show how the needs of nine major industries are being met by the special properties of polyester/glass—high strength/weight ratio, and resistance to chemicals and weathering without the protection of paint.

The industries covered include the motor industry, commercial vehicle building, ships and boats, building and construction, chemical plant, electrical equipment, railways, caravans and shop-fitting and furnishing. The booklet sets out to explain, by text and copious illustrations, the reasons why the uses of polyester/glass in each industry are expanding.

For example, the motor industry has found that polyester/glass laminated bodies with their high strength/weight ratio, can produce remarkable power/weight ratios in the finished vehicle. Car bodies can be moulded easily into an aerodynamic shape and body drumming and rattling are eliminated. The maintenance requirements of self-coloured polyester/glass bodies and panels are negligible.

Boat hulls from polyester/glass need no maintenance and can be left immersed in sea water for long periods without harm.

The lightness, rigidity and exceptional weathering qualities of polyester/glass laminates makes them ideal for use in building and constructional work. They are extensively used for guttering, window frames, curtain walling, and artificial stone cladding.

These materials are also being increasingly used for the construction of chemical plant, and isophthalic-based Cellobond polyester resins reinforced with glass fibre are rapidly replacing traditional materials where severely corrosive conditions are encountered.

Designers are creating attractively styled instrument housings and covers in polyester/glass and special grades of resin have been developed to meet the special needs of the electrical industry. Other uses featured include a variety of railway applications, street furniture, litter bins, aircraft parts and two unusual display items.

Copies of "The Cellobond Polyester Story" are available free from Information Department, British Resin Products Ltd., Devonshire House, Piccadilly, London, W.1.

NOW YOU can MASTER ELECTRONICS!

**BRITAIN'S MOST COMPREHENSIVE PRACTICAL
COURSE IN RADIO
ELECTRONICS • TELEVISION!**

**THESE SPECIAL TRAINING
KITS — YOURS TO KEEP**



**Multi-Range
TEST METER**



**CATHODE RAY
OSCILLOSCOPE**

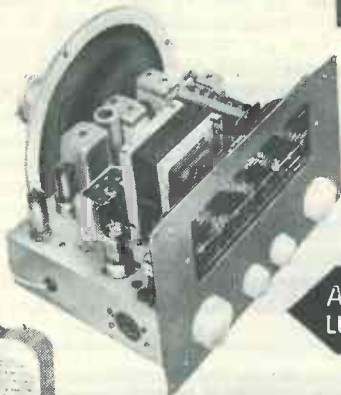

**AM and VHF/FM
LUXURY RECEIVER**



SIGNAL GENERATOR



**Complete set of
Picture Way books and
Experimental Manuals**

**LEARN BY BUILDING
NOW for your
CAREER • HOBBY
OWN BUSINESS**

YOU RECEIVE

- Complete kits of equipment as illustrated.
- Complete set of experimental manuals.
- Complete set of "picture-way" theory books.
- Modern test-yourself examination sheets.
- Study programme.
- Unlimited consultation with Tutors.

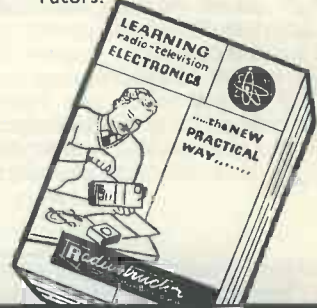

**FREE
BROCHURE**

POST

NOW

RADIOSTRUCTOR

TO RADIOSTRUCTOR (DEPT. M.31)
READING, BERKS.

Name.....

Address.....

**BLOCK
CAPS
PLEASE**

(We do not employ representatives)

3.62

SO SENSITIVE...
but not temperamental!

from Salford - the NEW
minitest
POCKET-SIZED MULTIRANGE TEST SET



Only recently introduced, this instrument is proving an outstanding success. Its high sensitivity makes it ideal for testing and fault location in all types of electrical and electronic circuits. The instrument is well built and economically priced. Each instrument supplied with test leads. (Leather carrying case available as an extra).

RANGES: A.C. Volts. 2.5, 10, 25, 100, 250, 1000.
D.C. Volts. 2.5, 10, 25, 100, 250, 1000.
D.C. Amps. 50 μ A, 1mA, 10mA, 100mA, 1A.
Ohms. 2000 200,000 20 M Ω

ACCURACY: D.C. Volts & Amps. \pm 2% of full scale deflection
A.C. Volts \pm 3% of full scale deflection
 \pm 5% at centre scale.

SEI

Send for leaflet MIN 6009/R.C.

SALFORD ELECTRICAL INSTRUMENTS LIMITED
PEEL WORKS · SILK ST · SALFORD 3 · LANCs · TEL · BLACKFRIARS 6688
London Sales Office · Magnet House · Kingsway, W.C.2. Temple Bar 4668
A SUBSIDIARY OF THE GENERAL ELECTRIC CO. LTD. OF ENGLAND

FREE DOUBLE-SIDED
BLUEPRINT
to build 2 GRAND RECEIVERS

★ The
REGENCY
4-Transistor
PORTABLE

FOR THE MORE
ADVANCED
CONSTRUCTOR

★ The
International
SHORT
WAVE TWO

FOR
BEGINNERS



This FREE Double-Sided Blueprint is just the first in a series of presentation Blueprints given month by month inside PRACTICAL WIRELESS. Make sure of the complete series by placing a regular order!

INSIDE
APRIL **Practical** 2/-
WIRELESS

APRIL ISSUE ON SALE MARCH 7



SCOTTISH INSURANCE CORPORATION LIMITED

38 EASTCHEAP · LONDON · EC3

TELEVISION SETS, RECEIVERS AND TRANSMITTERS

Television Sets, Receivers and Short Wave Transmitters are expensive to acquire and you no doubt highly prize your installation. Apart from the value of your Set, you might be held responsible should injury be caused by a fault in the Set, or injury or damage by your Aerial collapsing.

A "Scottish" special policy for Television Sets, Receivers and Short Wave Transmitters provides the following cover:

- (a) Loss or damage to installation (including in the case of Television Sets the Cathode Ray Tube) by Fire, Explosion, Lightning, Theft or Accidental External Means at any private dwelling-house.
- (b) (i) Legal Liability for bodily injury to Third Parties or damage to their property arising out of the breakage or collapse of the Aerial Fittings or Mast, or through any defect in the Set. Indemnity £10,000 any one accident.
- (ii) Damage to your property or that of your landlord arising out of the breakage or collapse of the Aerial Fittings or Mast, but not exceeding £500.

The cost of Cover (a) is 5/- a year for Sets worth £50 or less, and for Sets valued at more than £50 the cost is in proportion. Cover (b) and (ii) costs only 2/6 a year if taken with Cover (a) or 5/- if taken alone.

Why not BE PRUDENT AND INSURE your installation—it is well worth while AT THE VERY LOW COST INVOLVED. If you will complete and return this form to the Corporation's Office at the above address, a proposal will be submitted for completion.

NAME (Block Letters).....

If Lady, state Mrs. or Miss

ADDRESS (Block Letters).....

J/B

THE MODERN BOOK CO

The Amateur Radio Handbook. By R.S.G.B. 34s. Postage 2/-.

Short Wave Receivers for the Beginner. A Data Pub: 6s. Postage 6d.

How to Listen to the World. (New Edition). 12s. Postage 8d.

A Beginner's Guide to Radio. By F. J. Camm. 7s. 6d. Postage 6d.

Guide to Broadcasting Stations. Compiled by "WW". 3s. 6d. Postage 6d.

Radio & Electronic Laboratory Handbook. By M. G. Scroggie. 55s. Postage 1s. 3d.

Handbook for Radio Operators. G.P.O. 6s. Postage 1/-.

Radio for Examinations. By H. I. J. Peel. 55s. Postage 1s.

Maintenance Manual. By Mullard. 16s. Postage 1s.

International Transistor Substitution Guidebook. By K. A. Pullen, Jr. 12s. Postage 6d.

Radio Valve Data. 7th Ed. Compiled by "WW". 6s. Postage 10d.

Radio Control Manual. By E. L. Safford, Jr. 25s. Postage 1s.

Amateur Radio Call Book. By R.S.G.B. 1962 ed. 4s. 6d. Postage 6d.

Tape Recording Year Book 1961-62 ed. 6s. Postage 1s.

Tape Recorder Manual. By W. S. Sharps. 21s. Postage 1s.

A Guide to Amateur Radio. By R.S.G.B. 3s. 6d. Postage 6d.

We have the Finest Selection of British and American Radio Books in the Country

Complete catalogue 1s.

19-21 PRAED STREET (Dept RC) LONDON W2

Telephone PADdington 4185

Mk. 2 CIRCUIT

Uses latest ceramic transmitters in place of the normal I.F. transformers. This saves alignment problems and improves performance. Price 10/- extra.

AGENTS WANTED

To build up our Companion Receivers. Send addressed envelope for full particulars.

THE

"POCKET COMPANION"

This is without doubt the most modern and best pocket set available. It uses the very latest transmitters, Philco R.F. transistors, airspaced tuning condensers in superhet circuit covering M.W. and L.W. **£6.15.0** Complete building cost Battery 2/- Post and ins. 2/6. Data free with parts or separately 2/6.

THE

"TREMENDO COMPANION"

If you don't mind the battery consumption being a little higher and you want really big output then order The Tremendo. This has an undistorted output of almost 1 1/2 watts and is probably the most powerful home constructor set available today. Complete building cost of this is **£10.15.0** which includes the transfilter (Mk. circuit) batteries cost 3/6, (Two required).

A proved success . . .

THE "GOOD COMPANION" CAR RADIO AND PORTABLE

One of the finest of its kind available. The design is the combined efforts of our technicians and of those of several of the leading manufacturers in the country, and the resulting set has a performance as good as if not superior to those selling at £20 and more. It has the eight transistor set performance.

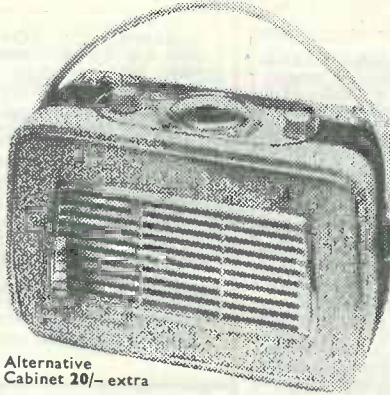

Alternative Cabinet 20/- extra



Features include American Philco R.F. transistors and Mullard A.F. transistors—Q.P.P. output giving 750 mW—full coverage on Medium and Long—very fine tuning arrangement—excellent reception of difficult stations like 208—variable feed-back control—full tonal qualities—really superior looking cabinet size 11" x 8" x 3" approximately—car aerial attachment—several months' operation from battery costing only 3/6. Circuit employs six transistors and two diodes, it incorporates all latest refinements, and oscillator I.F. Transformers are pre-aligned so no instruments are necessary. Anyone who can solder competently can make this set. The instructions are fully comprehensive with plenty of illustrations. Service is available in the unlikely event of your getting into difficulties. All components fully guaranteed. Price of all components and cabinet to make set as illustrated.

£9.19.6 Post and insurance 5/-, Battery 3/6 extra.

ELECTRONIC PRECISION EQUIPMENT LTD

★ Orders received by post are despatched from our warehouse, Dept. 34, 66 Grove Road, Eastbourne, and to save time, please post your order to this address. Please include enough for postage. Callers, however, should use one of the following addresses:

520 High Street North 42-46 Windmill Hill 266 London Road 29 Stroud Green Road 246 High Street
Manor Park, E.12 Ruislip, Mddx. Croydon Finsbury Park, N.4 Harlesden, N.W.10

Premier RADIO

23 Tottenham Court Road London W1 Telephone MUSEum 3451/2 and 309 Edgware Road London W2 Telephone PADdington 6963

4-TRANSISTOR PORTABLE RADIO



MAY BE BUILT FOR **95/-** Plus 3/6 P. & P.

PP7 Battery Extra 3/3

A 4-transistor and 1-diode portable receiver ideally suited for the young enthusiast, having full medium waveband coverage and internal ferrite rod aerial. It incorporates a pre-tagged circuit chassis ensuring ease of construction, a hi-flux 5" speaker is used and the receiver is housed in an attractive two-tone rexine-covered cabinet.

The "Petite" PORTABLE



MAY BE BUILT FOR **£7.7.0** plus 5/- P. & P. Batteries extra

HT 10/- (Type B126) or equiv. LT 1/6 (Type AD35) or equiv.

- ★ Size only 8" x 8" x 4 1/2"
- ★ Instruction book 1/6

Battery Eliminator, available in component form price 37/6 plus 2/- P. & P.

BARGAIN OFFER

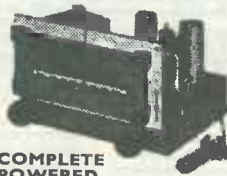

THE COMPLETE SELF-POWERED

FM TUNER MK II

MAY BE BUILT FOR **£6.12.6** plus 7/6 P. & P.

STAR FEATURES

- ★ Self-powered ★ EM84 Magic Eye Tuning Indicator ★ Permeability tuning
- ★ Attractive metal front plate ★ Philips FM tuning unit ★ Absolutely no drift
- ★ Frequency coverage: 88-100 Mc/s
- ★ Two IF stages and discriminator ★ OA 81 balanced diode output ★ Valve line-up: ECC85, two EF80, EM84 Magic eye. EZ80 rectifier

Attractive full vision maroon and gold glass dial size 7" x 3". Overall dimensions of tuner 8" x 7 1/2" x 5 1/2". FM Tuner MK I still available at £4.19.6

TRANSISTOR SUPERHET RADIO

May be built for

£9.19.6

Plus 2/6 P. & P.

PP3 Battery extra at 2/6

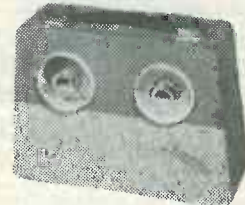

Using 6 Transistors and one Diode and internal Ferrite Rod Aerial, with provision for Car Radio Aerial. Full medium and long waveband coverage and 6 x 4 High Flux Speaker. When constructed the Receiver is housed in an attractive two tone case, size 10 1/2" x 7 1/2" x 3 1/2".

THE "MID-FI" A NEW DESIGN



44W AMPLIFIER KIT MAY BE BUILT FOR **95/-** plus 3/- P. & P.

A new circuit for the home constructor requiring a good quality med. powered amplifier for reproduction of records or f.m. broadcasts. Technical spec.: sep. bass and treble controls. Valves: EF86, EL84, EZ80. Voltage adjustment for a.c. mains from 200/250V, 3 or 15Ω imp. Neg. feedback. Size 7" x 5" x 2", overall ht. 5". Silver hammered finished chassis.

EVERYTHING FOR THE ENTHUSIAST

HEADPHONES. DHR5B (very sensitive), 2,000 ohms 22/6. P. & P. 2/-.

NATIONAL H.R.O. CRYSTAL FILTER UNITS. 455 kc/s with crystal. Sel. and phasing controls. New boxed. ONLY 19/6. P. & P. 1/6.

MULTI-WAY CABLE. 3-core screened 1/- yd.; 12-core screened 2/- yd. First grade Mike Cable 9d. yd. P. & P. 2/-.

10-WAY CABLE (5 pairs), screened and plastic covered. Any length cut, 1/8 per yd. P. & P. 1/6 min.

TOUGH POLYTHENE LINE. Type ML1 (100 lb) 2d. per yd. or 12/6 per 100 yds. Type ML2 (220 lb) 4d. per yd. or 25/- per 100 yds. Post free.

ABSORPTION WAVE-METERS. 3.00 to 35.00 Mc/s in 3 switched bands, 3.5, 7, 14, 21 and 28 Mc/s ham bands marked on scale. Complete with indicator bulb. A MUST for any ham shack. ONLY 22/6. Post free.

SPECIAL OFFER

Bumper Bargain Parcels of Resistors, Condensers and Pots. 10/- and 5/- Post Free

GELOSO V.F.O. UNITS. 4/102 with new dial and escutcheon. Outputs on 80, 40, 20, 15 and 10. For 2-807 or 6146 tubes. Only £8.5.0. 3 valves to suit, 24/- All post free.

ROTARY CONVERTERS 6V input, 250mA output. Only 5½" x 3" x 3". 17/6 each. P. & P. 3/-.

12V MINIATURE ROTARIES. Only 4½" x 2½" overall. Output 360V, 30mA or 310V, 70mA. NEW LOW PRICE 12/6 each or 22/6 for 2. P. & P. 2/-.

SUPER BANDCHECKER AND MONITOR. This new, sensitive, absorption wavemeter is fitted with 0-500 microammeter and is also a most useful phone monitor. Covers 3.5-35 Mc/s in 3 switched bands. only 3 gns.

RACK MOUNTING PANELS. 9" x 5½", 7", 8½" or 10½" black crackle finish, 5/9, 6/6, 7/6 and 9/- respectively, postage and packing 2/-.

SHADED POLE MOTORS. 230V or 110V operation. Ideal for fans, blowers or models. One only: 12/6, plus 2/- P. & P. Or pair: £1, plus 2/6 P. & P.

CERAMIC COIL FORMERS. 2½" x 1½". IDEAL FOR VFO or P.A. on Mobiles, 1/9 each or 17/6 doz.

BTX. 3½" x 1½" with 32 Grooves for P. Tanks 6/- ea.

TFX. 2½" Dia. 5" WINDING SPACE. Ideal Hi Power Lin. Amps 8/6.

MOSLEY TRI-BAND BEAMS

T33, JR, 3 EL ... £24.15.0
TA32 JR, 2 EL ... £17.10.0
V3 JR, Vertical 3 Band ... £7.10.0
PLACE YOUR ORDER EARLY

AERIAL EQUIPMENT

COPPER WIRE. 14g. h.d.: 140' 17/-; 70' 8/6; 7/25 stranded. 140' 10/-; 70' 5/-, plus 2/- P. & P.

RIBBED GLASS INSULATORS. 3" 1/9 each. P. & P. 1/6 up to 12.

TWIN FEEDER. 300 ohm twin ribbon feeder, similar K25, 6d. per yd. K358 Telcon (round) 1/6 per yd. Post on above feeder and cable 1/6 any length.

SUPER AERIAL CABLE 1/8 per yd. P. & P. 2/-.

CERAMIC FEEDER SPREADERS. Type F.S. 6" 10d. each. P. & P. 2/- up to 12.

CERAMIC "T" PIECES. Type AT for centre of dipoles, 1/6 each. P. & P. 1/-.

NEW MOSLEY POWER BEAMS. Write for details. 300 watt, 50 ohm COAX, 1½" dia., very low loss, 1/9 yd. P. & P. 2/-.

CHAS H. YOUNG LTD (Dept. R)

110 DALE END BIRMINGHAM 4

(Tel. all departments) CEN 1635

SIMTECH

Bookshop

QUALITY TECHNICAL BOOKS ON NO INTEREST TIME PAYMENT PLAN!

Look over the list. Select up to three books you wish to see. Send only ONE THIRD of the total purchase price (including postage) with order, then 20/- per month or 10/- each two weeks until books are paid for. (Offer open to all HOUSEHOLDERS, money refunded if not satisfied and books returned in clean condition within 7 days).

No. 39 NOW YOU CAN TAKE A COURSE IN RADIO & ELECTRONICS FOR ONE TENTH THE USUAL COST!

As the result of a special exclusive arrangement, we are able to offer for the first time a complete home study course of 35 lessons designed to train any beginner to be an expert in radio and electronics. Lessons include test equipment, VHF/FM, TV, Radio, etc. All lessons are bound into one giant 8½" x 11", 216 page volume, together with instructor's notes and test questions. Price for the complete course. Only 36/- (Paper covers).

EARN A CERTIFICATE! For a small additional fee a B.Sc. (Physics) on the Simtech staff will mark problems set in the course and you can qualify for the "SIMTECH CERTIFICATE OF PROFICIENCY IN ELECTRONICS" Details sent with each course ordered.

No. 9
Pin-Point Transistor troubles in 12 minutes

Trouble-shoot every type of circuit in ALL transistorised equipment! 525 pages; hundreds of illustrations; 120 check charts. 47/6.



No. 8
Pin-Point TV Troubles in 10 minutes

Find the exact sound of picture trouble in ANY TV set from 700 possibilities, 300 pages; 300 diagrams; check charts, 31/6.

No. 1. SPECIAL OFFER COYNE ELEMENTARY PRACTICAL RADIO-TELEVISION SET OF THREE VOLUMES total 1,038 pages, sturdy Vinyl washable covers. £3.12.6 the set!

These three volumes present the principles of construction, operation and testing of radio and television equipment in a SIMPLE, EASY TO FOLLOW manner.

One very important way in which these books differ from many other radio and television books is that the publishers did not try to assume the "extent of technical knowledge" of the reader. Every subject is explained COMPLETELY—while at the same time keeping it brief and to the point.

You will find hundreds of photos, charts, diagrams, etc., in these books. These have been provided to make it easier to understand the explanations.

To SIM-TECH BOOK COMPANY (U.K.)
Mail Order Division, DEPT. RC 11, Gaters Mill, West-End Southampton, Hants.

- SEND (Insert Book number here) () () ()
 Tick here if enclosing full price, we pay postage. Same 7 day money-back guarantee.
 ENCLOSED please find ONE-THIRD purchase price amounting to £ : s. d. with order. I agree to remit the balance as per offer.

NAME _____
ADDRESS _____
City _____ County _____
Postage charges: Orders under £3 allow 1/6. Over £3 allow 2/- extra.

"6 plus 1" TRANSISTOR RADIO KIT BEST EVER VALUE!

MANUFACTURERS' SURPLUS BARGAIN OFFER

—Further Kit supplies now available. Original purchases of this popular kit were rapidly sold out. This kit is a modern sensitive quality circuit Receiver Unit with all the latest features. Six BVA transistors and 1 diode, printed circuit, Med. and Long waves. Ferrite aerial, car radio coupling coil 500mW. Push-pull output into 3 ohm speaker, attractive gilt dial and slow-motion tuning, etc. Size approx. 8" x 2 1/2". Cabinet size 9" x 3 1/2".



Kit of Parts including printed circuit, 5 gns. Set of 6 Transistors and 1 Diode 45/- P. & P. 2/6.

BARGAIN OFFER
Complete Kit £6.19.6

3 ohm Speaker 7" x 3 1/2" ONLY 15/6. P. & P. 1/6. Send 3d. stamp for full details. Circuit and Instructions 1/6. Cabinets 25/- extra.

New Boxed	VALVES	Guaranteed	All	Electrolytics All Types New Sct.					
1T4	6/-	ECC83	8/6	PCC84	9/6	25/25V	1/9	8+8/450V	4/6
1R5	7/6	ECL82	10/6	PCF80	9/6	50/12V	1/9	16+16/450V	5/6
1S5	7/6	ECL80	10/6	PCL83	12/6	50/50V	2/9	32+32/275V	4/6
3S4	7/6	EF80	8/6	PCL84	12/6	100/25V	2/9	50+50/350V	6/6
3V4	7/6	EF86	12/6	PL81	12/6	8/450V	2/3	60+250/	
DAF96	9/6	EL84	8/6	PL82	9/6	4/350V	2/3	275V	12/6
DF96	9/6	EY51	9/6	PL83	10/6	16+16/450V	5/6	100+200/	
DK96	9/6	EY86	10/6	PY32	12/6	32+32/450V	6/6	275V	12/6
DL96	9/6	EZ81	7/6	PY81	9/6				
ECC81	8/6	GZ32	12/6	PY82	7/6				
ECC82	8/6	EM81	9/6	U25	12/6				

RECORDING TAPE—BARGAIN PRICES

Famous American Columbia (CBS) Premier Quality Tape at NEW REDUCED PRICES. A genuine recommended Quality Tape —TRY IT! Brand new, boxed and fully guaranteed. Fitted with leader and stop foils.

Standard	Long Play	Double Play
5" 600ft, 15/-	900ft, 19/6	1,200ft, 31/6
5 1/2" 900ft, 17/6	1,200ft, 22/6	1,800ft, 39/6
7" 1,200ft, 21/-	1,800ft, 32/6	2,400ft, 47/6

Post and Packing, per reel, 1/-, plus 6d. each for additional reels.
SPECIAL OFFER—3" mfrs. surplus tape, 225ft, 5/6. P. & P. per reel 6d. Plastic Tape Reels, 3" 2/6, 5" 3/-, 5 1/2" 3/3, 7" 3/6.

Volume Controls—5K-2 Meg-ohms, 3" Spindles Morganite Midget Type. 1 1/4" diam. Guar. 1 year. LOG or LIN ratios less SW. 3/-. DP. Sw. 4/6. Twin Stereo less SW. 6/6. D.P. Sw. 8/-.

COAX 80 OHM CABLE
High grade low loss Cellular air spaced Polythene—1/4" diameter. Stranded cond. Famous mfrs. Now only 6d. per yard. Bargain Prices—Special lengths 20 yds. 9/-. P. & P. 1/6. 40 yds. 17/6. P. & P. 2/-. 60 yds. 25/-. P. & P. 3/-. Coax Plugs 1/-. Sockets 1/-. Couplers 1/3. Outlet Boxes 4/6.



Tape Recorder Kit Special Offer Latest 5 valve circuit based on Mullard's design. Magic eye and tone controls. Printed circuit already wired. A sensitive quality recorder BSR Amp Kit 95/-, B.S.R. Tape Deck £8.10.0. Collaro Amp. Kit £6.5.0. Collaro Tape Deck £12.10.0. Set of 5 valves 45/-. Special Unit Kit Prices—Send stamp for detailed list. Construction and circuit details 2/6. Bargain Complete Kit £16/10/0 Carriage 4/6.

Condensers—Silver Mica. All values, 2pF to 1,000pF, 6d. each. Ditto, Ceramics 9d. Tub. 450V T.C.C., etc. .001 mfd., .01 and .1/350V, 9d. .02-1/500V 1/- .25 Hunts 1 1/6. .5 T.C.C. 1/9, etc., etc. Close Tol. S/Micas—10% 5pF-500pF 8d. 600-5,000pF 1/- .1% 2pF-100pF 9d. 100pF-500pF 11d. 575pF-5,000pF 1/6. **Resistors**—Full Range 10 ohms-10 megohms 20% 1/2 and 1/3W 3d., 1/2W 5d. (Midget type modern rating) 1W 6d, 2W 9d. Hi-Stab 10% 1/2W 5d., 1/2W 7d. 5% 1/2W 9d., 1% 1/2W 1/6. **W/W Resistors** 25 ohms to 10K 5W 1/3, 10W 1/6, 15W 2/-. **Pre-set T/V Pots.** W/W 25 ohms.-50 K 3/-. 50 K-2 Meg. (Carbon) 3/-.

JASON FM TUNER UNITS
Designer-approved kits of parts:
FMT1, 5 gns. 4 valves, 20/-
FMT2, £7. 5 valves, 37/6.
JTV MERCURY 10 gns.
JTV2 £13.19.6. 4 valves, 32/6.
NEW JASON FM HAND-BOOK, 2/6. 48 hr. Alignment Service 7/6. P. & P. 2/6.

Speakers P.M.—3 ohms 2 1/2" Elac 17/6. Goodmans 3 1/2" 18/6. 5" Rola 17/6. 6" Elac 18/6. 7" x 4" Goodmans 18/6. 8" Rola 20/- .10" R. x A. 25/- . 9" x 6" Goodmans 25/- . E.M.I. Tweeter 29/6.

Est. 1946

Speaker Fret—Expanded bronze anodised metal 8" x 8" 2/3, 12" x 8" 3/-, 12" x 12" 4/6, 12" x 16" 6/-, 24" x 12" 9/-, 36" x 12" 13/6, etc. etc.

TYGAN FRET (contemp. pat.) 12" x 12" 2/-, 12" x 18" 3/-, 12" x 24" 4/- . Up to 48" width cut.

BARGAINS 4-SPEED PLAYER UNITS

Single Players	carr. 3/6
Garrard 4 S.P.	£6.19.6
Garrard TA Mk. 2	£7.19.6
Collaro "Junior"	75/-
B.S.R. Latest Model TU12	79/6
E.M.I. Junior	89/6
Auto-Changeers	carr. 5/-
Garrard "Auto-Slim"	£8.12.6
Collaro C60	£7.15.0
B.S.R. (UA14) De-Luxe Model	£7.15.0

SINGLE SCREENED LEAD—Standard size, 8d. yd.; Ditto Lightweight for Pick-up, etc., 7d. yd.; ditto lightweight for PVC sheathed, 9d. yd.; Twin screened sheathed, 1/- yd.

VALVE HOLDERS—Paxolin: Int. Oct., 6d. Moulded: B8G, 9d. each; Nylon or Moulded Ceramic: B7G, B9A unskirted, 9d. each; B7G, B9A skirted, 1/- each; B7G with Can, 1/6 each; B9A with Can, 1/9 each; EF50, B7G, 1/- each; B9A ditto, 1/3 each.

ENAMELLED COPPER WIRE—1lb reels: 14g-20g, 2/6; 22g-28g, 3/-; 30g-40g, 3/9. Other gauges quoted for.

PVC CONNECTING WIRE—10 colours (for chassis wiring, etc.)—Single or stranded conductor, per yd., 2d.

SPECIAL BARGAIN OFFER! Record Player Kits

Auto Changer Kit. Comprising three units. Contemp. styled cabinet size 17" x 14 1/2" x 8 1/2". 2 valve 2 watt amp. and 7" x 4" quality speaker. Variable tone and volume controls with feedback circuit and B.S.R. 4-speed 10 record mixer auto. changer unit.
BGN. PRICE only £12.10.0. Carr. 7/6.

Single Player Kit. Similar spec. to auto. changer kit except player is 4-speed B.S.R. T.U.9 single record player unit. Attractive contemp. styled cabinet. Size 13 1/2" x 13" x 6" with splendid volume and reproduction.
BGN. PRICE only £8.19.6. Carr. 5/-.

All units ready wired, simple screw-driver, assembly only Full Satisfaction Refund Guar.

TRANSISTOR COMPONENTS

Midget I.F.'s—465 Kc/s 1/2" diam. 5/6
Osc. Coil—1/2" diam. M/W. 5/3
Osc. coil M. & L.W. 5/9
Midget Driver Trans. 3.5:1 6/9
Midget O/Put Trans. Push-pull to 3 ohms. 6/9
Elect. Condensers—Midget Type 1mf-50mf, ea. 1/9. 100mf, 2/- 12V w/g.
Ferrite Aerial—M. & L.W. with car aerial coupling coil 9/3
Condensers—150V. w/g. .01 mfd., to .03 mfd. 9d. .05 mfd., .1 mfd. 1/- .25 mfd. 1/3. 5 mfd. 1/6. Etc.
Vol Controls—Midget Type with edge Control Knob. 5K, 47K, 1 M/ohm, ea. 2/6.
Speakers P.M.—2 1/2" EMI 3 ohms 17/6. 7" x 4" Plessey 35 ohm 23/6.
Ear Plug Phones—Min. Continental type, 3ft lead, jack plug and socket. High Imp. 8/- . Low Imp. 7/6.

SLEEVEING—Various Colours 1mm, 2mm, 2d. yd.; 3mm, 4mm, 3d. yd.; 6mm, 5d. yd.
FUSES—Cartridge Type, Standard 1 1/4". All standard values 6mA-10mA, 4d. each.
KNOBs—Modern Continental types: Brown or Ivory with Gold Rings, 1" dia., 9d. each; 1 1/2", 1/- each; Brown or Ivory with Gold Centre, 1" dia., 10d. each; 1 1/2", 1/3 each. LARGE SELECTION AVAILABLE.
METAL RECTIFIERS, STC Types—RM1, 4/9; RM2, 5/6; RM3, 7/6; RM4, 16/-; RM5, 21/-; RM4B, 17/6.
STC RECTIFIERS—E.H.T. Type Fly-back Voltages: K3/25, 2kV, 5/-; K3/40, 3.2kV, 6/9; K3/50, 4kV, 7/9; etc.
SIEMENS TYPES—Contact Cooled: 250V, 50mA, 7/6; 250V, 85mA, 10/-; 250V, 125mA, 15/-; 250V, 300mA, 26/6.

TV FAULT FINDING

Data Book Series No. 5

Contains information and fault finding details of both the B.B.C. and I.T.A. transmissions. Lavishly illustrated by photographs taken from the screen of a television set exhibiting the faults under discussion. A comprehensive fault finding guide is included, and this is cross referenced to the book itself.



Over 100 Illustrations and Diagrams

104 pages, high quality paper with laminated plastic board cover

Price 5/- Postage 5d.

"... A book that should be in every television dealer's service workshop, and in every home-constructor's, for that matter."—*Journal of the Television Society*

"... The book will undoubtedly be of value to TV service engineers, particularly those who are not fully experienced in translating the appearance of faulty pictures into the necessary adjustments or receiver fault location."—*Wireless and Electrical Trader*.

Available from your usual supplier, or direct from

DATA PUBLICATIONS LTD 57 Maida Vale London W9

OUR NEW 5-STAGE POCKET TRANSISTOR PORTABLE

In attractive two-tone contemporary case, with gold plated speaker grill and attractive dial. Size only 5½" x 3½" x 1½". No aerial or earth required — completely self-contained. Genuine 3" high flux p.m. speaker. First grade transistors. Push pull output—250mW. Volume control with on/off switch. Condenser tuning. Easy assembly on eyeleted circuit board. Socket for personal listening. Full instructions, etc., 1/6 (Free with order). **TOTAL BUILDING COSTS £4.19.6** P.P. 2/6. Earpiece 9/- extra if reqd.

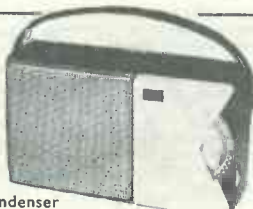

EXPLORE THE WORLD ON THIS 1-VALVE SHORT WAVE RADIO

Total Building Costs only 35/- P. & P. 2/-

- ★ Receives speech and music from all over the world.
- ★ Construction price includes valve and one coil covering 40-100 metres.
- ★ Can be extended to cover 10-100 metres.
- ★ Can be converted to 2 or 3 valve.

Send 2/- for wiring diagram and components price list.

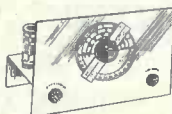

5 STAGE SUPER SENSITIVE TRANSISTOR PORTABLE

THE "BOBETTE"

- ★ Simple to Build.
- ★ All first grade components.

A truly portable transistor radio giving full medium wave reception. Incorporates 5" High Flux Speaker, push pull output, first grade transistors, High-Q ferrite aerial, socket for car aerial, pre-tagged circuit board for easy construction. Attractive two-tone case.

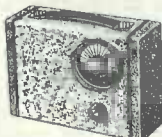

Total Building Costs £5.2.6 P. & P. 2/6

All parts sold separately. Send 1/6 for itemised price list and full assembly instructions (free with order).

R.C.S. PRODUCTS (Radio) LTD
11 Oliver Road · London · E17 (Mail Order Only)

NEW

P.W. POCKET S'HET

NEW CONTEMPORARY CASE



STEP-BY-STEP INSTRUCTIONS

1/6

12/6 Retail

The Pocket Superhet is a high quality miniature receiver for operation on Medium and Long Waves. Circuit uses 6 special transistors and incorporates modern miniature matched components of the best quality which combine to give superb performance. Printed board construction ensures success by the simple Step-by-Step instructions.

OSMOR 418 BRIGHTON ROAD
S. CROYDON SURREY

SMALL ADVERTISEMENTS

Private: 3d. per word, including address.
Minimum charge 2/6.
Use of Box Number, 2/- extra.

Trade: 9d. per word. Minimum charge 12/-.
Terms: Cash with order.

All copy must be received by the 6th of the month for insertion in the following month's issue. The Publishers cannot be held liable in any way for printing errors or omissions, nor can they accept responsibility for the *bona fides* of advertisers.

PRIVATE

FOR SALE. First class v.h.f. receiver type 1392, unmodified and complete with 15 valves, "S" meter, etc. Cover 95 to 150Mc/s., £3.10.0. Carriage paid. Beadle, 6 Chapel Cottages, Thearne, Nr. Beverley, E. Yorks.

FOR SALE. Double beam oscilloscope 13A, £15. Elektron single speed recorder, £12. Wharfedale 12RS/DD speaker, £7. Connoisseur L.P. diamond head, £4. London area. Box No. F142.

CLEARANCE OF SHACK. About 2 cwt high grade components consisting of assorted chokes, mains transformers, output ditto, loudspeakers, several Tx and Rx capacitors, copper tube Tx coils, relays, 50 assorted pots, switches, morse keys, mikes, HV fixed capacitors, knob, dials, valves, etc. All perfect, no rubbish. Easily worth £40. The lot crated and delivered for £8.10.0 Transit case containing 130 boxed and tested valves including over 80 octals and many useful types such as 6V6GT, 5R4GY, 6SN7, 6SK7, etc. Carriage paid, the lot for £7.—G5FH, 17 Knottsall Lane, Oldbury, Birmingham. Telephone: Broadwell 1338 (after 7 p.m.).

WANTED. Connoisseur magnetic pick-up. 17 Warwick Road, Ash Vale, Surrey.

FOR SALE. Eddystone 680X, perfect condition, speaker, mains filter and stand, spare valves. £70 o.n.o. 7-Crathie Close, Wyken, Coventry.

ELECTRONICS AMATEUR selling up. Real bargains. Valves, transistors, meters, components, equipment. Money back if dissatisfied. S.A.E. for list. Box No. F143.

FOR SALE. Pye 9 valve push-pull 11 wave bandspread receiver, 11-2000 metres, cost £38, good condition—£12. Weymouth bandspread tuning unit equipment, new unused EF50 (HF) ECH35, cost over £10, 13-2000 metres (465), large Perspex dial, 9 scales, gram position. What offers? 4 connections. New unused mains transformers. U80, 120 milliamps. 275-0-275, 325-0-325, 6.3, 5, 4 volt, 6X5, 350-0-350, 70 milliamps, 6.3 4 amps, 10/- . R1155 with valves, £4.10.0. Heavy duty mains transformers, 460V 250 milliamps, 6.3V 5 amps, 8/- . 400V 200 milliamps, 7 LT's, 6.3V 6 amps (2) 4V 6 amps (2) 4V 3 amps (3) 5V 3 amps, 10/- . New unused Plessey coil pack, 4 waveband, 465 kc/s i.f., HF stage 13-2000 metres, 3 gang, 2 i.f.t.'s circuit, 15/- . New 3-waveband, 465 kc/s, coil packs, Weymouth (7/6), others (2/6). Medium, 2 shorts, (5/-). Large pentode 80 milliamp KT66/ KT44 30 to 1 output, prim. sec., c.t. Transformers 2500-3 ohms, 8/- . 6V6G, 7C5, CL33, KT33C, 6F6, KT44, EL35, 142BT, KT61, ECL80, 25A6, EL32, PEN36C, EF39, 12A6, KT71, U50, ECH35, CCH35, X65, EF80, 6SN7, U18/20R3, 4/- each. 6B6G, 6B8, DH63, EF36, U76, EF35, KT41, PEN46, AC6PEN, FC4, 4 volt rectifiers, 2/6 each. SP61, SP41, 15D2, 8D2, 6H6, EB34, 6SH7, 12J5, output transformers, 1/- each. Speakers: 10", 8", 6½", 5", P.M., 5/-; energised, 4/- . Goods guaranteed. Postage extra. Cordingley, 86 Tennant Street, Bradford 5, Yorks.

continued on page 637



ORYX

MINIATURE SOLDERING INSTRUMENTS

make all
soldering jobs
easy



ALL THE HEAT IS IN THE TIP

MAIN VOLTAGE

200/220 and 230/250 volts with 10 watts for
670°F or 15 watts for 715°F.

Price **32/6**

LOW VOLTAGE

Range of 6, 12, 24 and 50 volts, with 6 to 24
watts for up to 932°F operation,

Prices from **25/-**

W.G.

W. GREENWOOD
ELECTRONIC LTD

677 FINCHLEY ROAD
LONDON N.W.2

Tel: SWISS Cottage 3383/4

JACKSON

the big name in **PRECISION** components

Precision built radio components are an important contribution to the communications industry. Be sure of the best and buy Jackson Precision Built Components

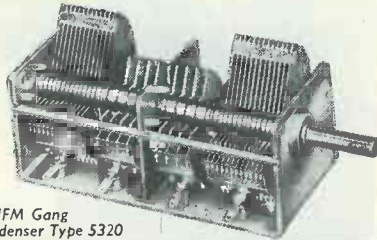

AM/FM Gang
Condenser Type 5320

JACKSON BROS. (LONDON) LTD
KINGSWAY, WADDON, SURREY

Telephone Croydon 2754-5
Telegrams Walfico, Souphone, London

TRANSISTOR POCKET RADIOS



**BULK PURCHASE
ENABLES US TO
MAKE THIS
FANTASTIC OFFER
AND WITH MONEY
BACK GUARANTEE!**

The "SAN REMO" . . . so tuned that it brings the voices of star entertainers and vocalists dramatically to life—in your home, office, etc. . . . Only $4\frac{1}{2}$ " x $2\frac{3}{8}$ " x $1\frac{1}{2}$ " fits easily into your pocket or handbag. **Works for months off 8d. battery.** Should last a lifetime. Anyone can assemble it in an hour or two with our easy plan. Complete set of parts including miniature speaker, carrying case—everything only **32/6** plus 2/6 P. & P. C.O.D. 2/6 extra. (Parts can be bought separately.) **Limited period—so order before it's too late.**

DEMONSTRATIONS DAILY

CONCORD ELECTRONICS (DEPT. B25/2)
210 Church Road Hove Sussex

EDDY'S (NOTTM) LTD

Dept. RC
116 ALFRETON ROAD · NOTTINGHAM

CAR RADIO 7 Trans. Long & Med. 2 watts out. R.F. stage & Auto gain control. Size $7\frac{1}{2}$ " x $7\frac{1}{2}$ " x $2\frac{1}{2}$ " 6 or 12V supplied with full instr. 10/- gns. Speaker ext. 17/11 P. & P. 5/6.

NIFE ACCUMULATORS 1.25V. size 3 " x $2\frac{1}{2}$ " x $\frac{3}{4}$ " 7 amp hrs. weight 13 ozs. 2/11 ea. P. & P. 2/- one only, add 9d. per cell.

POCKET RADIO 2 Transistor with miniature speaker. Complete with all parts, wiring diagram and full instructions 27/6 Batteries 1/- P. & P. 2/-.

NEON MAINS TESTERS—SCREWDRIVERS 3/6 P. 6d.

THROAT MIKES 2/- ea. P. 10d. Could be used for elec. musical instruments

GERMANIUM DIODES 9d. each 7/- dozen. P. 6d.

VIBRATORS 12 volt 4 pin 4/11. 6 volt 4 pin 9/11. P. 1/6.

MORSE TAPPERS Plated contacts, adjustable gaps. 3/6 P. 1/-.

HAND MIKES Carbon 4/11. P. 2/-.

LUXEMBOURG EXPANDING AERIALS compact and easy to fit. No technical knowledge required. Greatly improves reception. 3/11. P. 6d

ALL ABOVE ARE NEW & GUARANTEED

NEW OR SURPLUS VALVES GUARANTEED AND TESTED BY RETURN POST.

AC2/	EF50	1/9	PL36	13/6	5Z4G	7/6	6SL7GT	6/6
PENDD	EF91	3/6	PY80	6/6	6AG5	3/11	6SN7GT	4/3
CL33	EL32	6/11	PY82	5/11	6AC7	4/-	7C5	6/11
CY31	EL91	4/6	PZ30	9/6	6C4	3/6	10F1	4/6
DAF91	EZ4D	6/3	PEN4	9/11	6F1	6/11	10P13	9/6
DF91	EZ41	7/-	PEN46	4/6	6F13	6/6	12A6	5/-
DK91	EZ80	6/3	PEN36C	8/-	6F15	6/6	12AH7	2/6
EB91	GT1C	6/11	TDD4	12/6	6F33	6/6	20D1	8/6
ECC81	HL23DD	6/6	U25	12/6	6I7G	5/-	20P1	9/6
ECC85	KT33C	6/6	VP23	6/6	6K8G	5/6	25L6GT	8/6
ECH42	MU14	7/-	ID5	7/6	6P25	9/6	80	6/11
EF36	OZ4	5/11	IR5	5/6	6OTG	5/11	954	1/6
EF39	PCF82	9/6	IS5	4/9	6SA7M	5/9	955	3/6
EF41	PCL84	12/6	IT4	3/6	6SG7M	4/9	956	2/6
EF42	PCL85	12/6	IL4	3/6	6SJ7M	5/9		

Any parcel insured against damage in transit for only 6d. extra per order. All uninsured parcels at customer's risk. Post and packing 6d. per valve extra. C.W.O. or C.O.D. only. C.O.D. charge 3/- extra. S.A.E. with enquiries.

THE RADIO CONSTRUCTOR BOUND VOLUMES

Attractively bound in blue cloth, with gold-blocked spine

Volume 12, August 58 to July 59 £1.5.0
(postage 2/3)

Volume 13, August 59 to July 60 £1.5.0
(postage 2/3)

Volume 14, August 60 to July 61 £1.5.0
(postage 2/3)

Where all issues of a volume are returned for exchange 12/6
(postage 2/3)

Indexes for volume 14 are now available, price 6d., postage 3d. A limited number are also available for volumes 4, 6, 11, 12 and 13 at the same price.

Easibinders for the old format 12/6
(postage 9d.)

DATA PUBLICATIONS LTD

57 MAIDA VALE LONDON W9

SMALL ADVERTISEMENTS

continued from page 635

PRIVATE—continued

FOR SALE. Compact phone/c.w. top band transmitter, table top, £15. S.A.E. for details. Box No. F144.

ENTHUSIAST selling up. S.A.E. for list. Marshall, 46 St. James Road, Harpenden, Herts.

FOR SALE. Universal Avo meter. Model 8 Mk2, almost new, £17. Also good quality 30 watt P.A. amplifier, £11. Box No. F145.

WANTED. Engineer or home constructor to build transistor r.f. oscillator. Box No. F146.

GRAMDECK tape deck, pre-amp., complete. Offers? Griffiths, 51 Moscow Drive, Liverpool 13.

WANTED. Communications receiver covering top band. Lucking, 62 Ember Farm Way, East Molesey, Surrey. Telephone: Emberbrook 3603.

FOR SALE. Signal tracer, as per *The Radio Constructor*, July 1959. Complete, unused, untested. Polished cabinet. Offers? 51 High Street, Sproughton, Ipswich, Suffolk.

TRADE

LEARN RADIO AND ELECTRONICS the NEW Practical way. Very latest system of experimenting with and building radio apparatus—"as you learn"—FREE Brochure from: Dept. RC10 Radiostructor, Reading, Berks.

PANL, recognised for many years as the unique one-coat black crackle finish. Brush applied, no baking. Available by post in eighth-pint cans at 3s. 9d. from G. A. Miller, 255 Nether Street, London, N.3.

THE INCORPORATED PRACTITIONERS IN RADIO AND ELECTRONICS (I.P.R.E.) LTD. Membership conditions booklet 1s. Sample copy of I.P.R.E. Official Journal 2s. post free.—Secretary, 20 Fairfield Road, London, N.8.

"THE FIRST ONE". Covers the construction of a highly efficient single valve mains receiver. Price 1s. 3d.—High Fidelity Co., 18 Melville Road, Birmingham 16.

CATALOGUE No. 14. Government surplus and model radio control, over 500 illustrated items, 2s. 6d. (refunded on purchase of £2) post free.—Arthur Sallis Radio Control Ltd., 93 North Road, Brighton.

JOIN THE INTERNATIONAL S.W. LEAGUE. Free Services to members including Q.S.L. Bureau. Amateur and Broadcast Translation. Technical and Identification Dept.—both Broadcast and Fixed Stations, DX Certificates, contests and activities for the SWL and transmitting members. Monthly magazine, "MONITOR", containing articles of general interest to Broadcast and Amateur SWLs, Transmitter Section and League affairs, etc. League supplies such as badges, headed notepaper and envelopes. QSL cards, etc., are available at reasonable cost. Send for League particulars. Membership including monthly magazine, etc., 21s. per annum.—Secretary ISWL, 12 Gladwell Road, London, N.8.

continued on page 639

SMITH'S of Edgware Road BLANK CHASSIS

Precision made in our own works from commercial quality half-hard Aluminium. Two, three or four sided.

SAME DAY SERVICE

of over 20 different forms made up to YOUR SIZE. Order EXACT size you require to nearest $\frac{1}{16}$ " (maximum length 35", depth 4").

SPECIALS DEALT WITH PROMPTLY

SEND FOR ILLUSTRATED LEAFLET

Or order straight away, working out total area of material required and referring to table below, which is for four-sided chassis in

18 s.w.g. (for 16 s.w.g. add 1/4 th)		304 sq. in. 12/-	
48 sq. in. 4/-	176 sq. in. 8/-	304 sq. in. 12/-	
80 sq. in. 5/-	208 sq. in. 9/-	336 sq. in. 13/-	
112 sq. in. 6/-	240 sq. in. 10/-	368 sq. in. 14/-	
144 sq. in. 7/-	272 sq. in. 11/-	and pro rata	
P. & P. 2/- (2/6)	P. & P. 2/6 (2/9)	P. & P. 2/9 (3/-)	

Discount for quantities. Trade enquiries invited, Spray finish arranged for quantities of 25 or over.

FLANGES ($\frac{1}{4}$ ", $\frac{3}{8}$ " or $\frac{1}{2}$ " 6d. per bend.

STRENGTHENED CORNERS, 6d. each corner. **PANELS.** The same material can be supplied for panels, screens, etc. Any size up to 3ft at 4/6 sq. ft. (16 s.w.g. 5/3). P. & P., up to 72 sq. in. 1/- (1/3), 108 sq. in. 1/9 (2/), 144 sq. in. 2/- (2/6), 432 sq. in. 2/6 (2/9), 576 sq. in. 2/9 (3/3).

Prices in brackets are for P. & P. on 16 s.w.g.

H. L. SMITH & CO. LTD

287/289 EDGWARE ROAD LONDON W2
Telephone PAD 5891/7595

RETURN-OF-POST SERVICE

All cash orders are dealt with on the day of receipt.
H.P. orders subject to slight delay but kept to minimum.

GRAMOPHONE EQUIPMENT

ALL LATEST MODELS ALL POST FREE	Hire Purchase		
	Cash Price	Deposit	Mthly Pmts.
RECORD CHANGERS			
GARRARD AUTOSLIM (GC8 PU)	£8. 5.0	£1.13.0	12 of 12/8
COLLARO C60 (GP67 PU)	£8. 5.0	£1.13.0	12 of 12/8
B.S.R. UA14 (TC8 PU)	£7.19.6	£1.12.6	12 of 12/3
B.S.R. UA14 Monarch (TC8S Stereo/LP/78)	£8.19.6	£1.16.6	12 of 13/7
SINGLE RECORD PLAYERS			
GREENCOAT 45 UNIT (Battery 9v)	£5. 8.0	£1.11.0	3 of £1.9.0
GARRARD TA (GC8 PU)	£8.10.0	£1.14.0	12 of 13/-
B.S.R. TU12 (TC8 PU)	£4.10.0	£1. 5.0	3 of £1.5.0
E.M.I. (Acos Stereo/Mono PU)	£6.15.0	£1. 7.0	12 of 10/8

TRANSCRIPTION UNITS

GARRARD 4HF (GC8 PU)	£18.18.0	£3.16.0	12 of £1.7.8
PHILIPS AG1016	£14. 3.6	£2.17.6	12 of £1.0.9

Many of the above can be supplied for stereo working. Send for our Gramophone Equipment List for details.

LATEST TEST METERS

	Cash Price	Hire Purchase	
		Deposit	Mthly Pmts.
AVO Model 8 Mark II	£24. 0.0	£4.16.0	12 of £1.15. 2
AVO Model 8 with leather carrying case	£27.18.0	£5.12.0	12 of £2. 0.11
AVO Model 7 Mark II	£21. 0.0	£4. 4.0	12 of £1.10.10
AVO Multiminor	£9.10.0	£1.18.0	12 of 14/4
AVO Multiminor with leather carrying case	£11. 9.0	£2. 5.0	12 of 17/-
TAYLOR Model 127A	£10. 0.0	£2. 0.0	12 of 15/-
CABY A-10	£4.17.6	£1. 7.6	3 of 1.6.8
CABY B20	£6.10.0	£2. 0.0	3 of £1.13.4

Full details of any of the above supplied free on request.

The AVO Models 7 and 8 are both latest models from current production —NOT to be confused with Government surplus.

All items Post Free. (C.O.D. fee extra on orders up to £10.)

WATTS RADIO (MAIL ORDER) LTD

54 CHURCH ST. WEYBRIDGE SURREY Weybridge 4556
Please Note: Postal business only from this address.

★ VALVES New Tested & Guaranteed

1R5	6/6	6X4	7/6	DK96	8/-	EZ40	6/6
1S5	6/6	6X5GT	6/6	DL92	6/9	EZ80	6/6
1T4	4/6	12A17	6/-	DL94	7/6	EZ81	7/-
3S4	6/9	12A17	6/-	DL96	8/-	GZ32	10/6
3V4	7/6	12AX7	7/6	EB91	4/6	KT66	15/6
5L4G	6/-	12BH7	10/6	EBC41	9/6	PL81	13/6
5Y3GT	7/6	12K7GT	8/6	ECC81	6/-	PL82	10/6
5Z4G	9/-	12K8GT	13/6	ECC82	6/-	PY81	8/-
6AK6	6/6	12Q7GT	6/6	ECC83	7/6	PY82	7/-
6AL5	4/6	25A6G	10/6	ECC84	7/6	PCC84	9/6
6AM6	4/-	25L6GT	9/-	ECC85	8/6	PCF80	9/-
6AT6	7/6	35Z4GT	8/6	ECC87	7/6	PCF82	11/-
6BA6	8/6	35L6GT	9/6	ECH81	10/6	PCL82	7/6
6BE6	7/6	5763	10/6	ECH42	8/6	R19	12/6
6BR7	10/6	DAF91	6/6	ECL80	9/6	U26	10/6
6BW6	8/6	DAF96	8/-	EF41	8/6	U76	8/6
6I7GT	8/6	DF91	4/6	EF80	8/-	UBC41	10/-
6K7G	7/6	DF96	8/-	EF86	9/6	UCH42	10/6
6Q7G	7/6	DH76	8/6	EF91	4/-	UF41	10/-
6SL7GT	8/-	DH77	7/6	EL41	9/-	UL41	8/-
6SN7GT	8/6	DK91	6/6	EL84	8/-	UY41	8/-
6V6G	7/6	DK92	7/6	EY51	7/6	W76	8/6

MATCHED PAIRS. EL84, 17/-; EL85, 25/-; 6V6G, 17/-; 6BW6, 18/-; KT33C, 19/6; 807 14/6 pair; KT66, 32/6.

SETS OF VALVES

DK96, DF96, DAF96, DL96 "REGENT"	29/6 per set
DK91, DF91, DAF91, DL92, or DL94	21/- per set
1R5, 1T4, 1S5, 3S4, or 3V4	21/- per set
6K8, 6K7, 6Q7, 6V6, 5Z4, "G" Types	27/6 per set
12K8, 12K7, 12Q7, 35L6, 35Z4, "GT" Types	35/- per set
ECH42, EF41, EBC41, EL41, EZ40	37/6 per set
UCH42, UF41, UBC41, UL41, UY41	35/- per set

P.P. OP. TRANSFORMERS. MR 3-15 ohms for EL84, 6V6, 6BW6, etc., 18/6; Op. Pen. 50mA, 5/6; 30mA, 4/6.

P. & P. 6d., over £1 post paid. C.O.D. 3/-

R. COOPER G8BX 32 SOUTH END CROYDON SURREY CROYDON 9186

POCKET RADIO. Astounding results. M. & L. Wave.

Completely portable, personal earphone. All parts, 65/- plus post 2/-. Write for details (3d. stamp) before you buy elsewhere.

Red Spot Transistors, 2/3; White Spots, 2/3; Yellow/Green, 3/3; OC71, 6/-; OC72, 7/6; OC44, 9/6; OC45, 9/-; Sub-min. Electrolytics 2, 4, 8, 10 16, 32, 50µF, 2/-; 100µF, 2/9; 250, 500, 1,000µF, 3/3. Silicon Rectifier bargain, 70 piv. ¼A, 3/3. Packard Bell Amplifiers, new, 12/6. PERSONA Pocket Radio Kit, 52/6. Transistor Tape Recorder, £11.11.0. (£15 elsewhere). Ardente Trans. D239, 8/6; D240, 8/6; D131, 10/-; D132, 10/-. Transformer, 250-0-250V, 6V and 5V, 15/-. Hearing Aid Mike, 31/6. Super Coax., 75 ohms, 6d. yd. Valves, 6X5, 5/6; 6V6, 5/6; 1L4, 5/6. Electrolytics: 8µF 500V, 2/3; 8+16µF, 3/3; 100+100 (375V), 3/9. V. Cond. 0.0005 t. gang trimmers and slow m., 9/6. Transistor Holders, 1/-. Resistors, 10% tol., 4d.; 5% tol., 9d. Tannyo Mike, 3/6. Crystal Inserts (new), 7/6. Gorker Units 1 watt amplifier, 92/6; I.F. amplifier (460 kc/s pre-aligned), 92/6. 3-waveband Converter, 90/3. Manual No. 167 describing and circuits, 2/9 post free. High and low imp. ear phone, 8/6. 4µF Block Condenser, 600V, 3/6. TSL Speakers, CMS50, 2¼", 17/11. Sub-min. Jack and Socket, 3/- pr. Min. Slide Switches, 2/6. V15/10P Transistors, 15/-; V30/20P, 28/6. Crystal Mike Input Transf., 12/-. Battery charger 6 or 12V. 4 amp, 69/11. H/R Headphones, 17/6. L/R Headphones, 8/6. Transistorised Car Radio, all parts, £14.10.0. Morse Key, 2/6. Test Meter TK-70A, £5.12.6.

Terms—Cash with order. Post extra, excess refunded. Our Reflex Rx, best 2-transistor Receiver, Send 10d. stamps for notes.

MOORE'S EXPERIMENTAL SUPPLIES
8 & 10 GRANVILLE ST. SHEFFIELD 2

Telephone 27461

LEARN

RADIO & TV SERVICING

For your own business / hobby

by a new exciting no maths system, using practical equipment recently introduced to this country

FREE BROCHURE FROM

RADIOSTRUCTOR

DEPT. G103 READING BERKS.

3.62

SURPLUS RADIO SUPPLIES

2 LAING'S CORNER MITCHAM SURREY

OUR CATALOGUE CONTAINS OVER

400 BARGAINS

AT PRICES BELOW MANUFACTURERS' COSTS
SEND FOR IT TODAY, PRICE 1/6

A CRYSTAL TRANSISTOR KIT

Ideal for beginners. Can be built using just a small screwdriver (no soldering required). Aerial and earth required. Price 37/6 Post free.

SPARES, VALVES, TUBES 1930-1960

Guaranteed perfect, set tested, ex-working equipment

5U4	4/6	10P13	6/-	ECH42	6/-	PL33	4/6	U25	10/-
5Z4	6/-	12A7	3/-	EAF42	6/-	PL81	4/6	U35	4/6
6AQ5	6/-	12A17	4/6	EL33	6/-	PL82	4/6	U37	12/6
6AU6	4/6	12AX7	4/6	EL38	6/-	PL83	4/6	U107	7/6
6BA6	4/6	12BH7	7/6	EL41	6/-	PY31	4/6	U191	10/-
6BE6	4/6	20L1	6/-	EL90	6/-	PY82	4/6	U403	6/-
6CH6	6/-	20P1	6/-	KT36	6/-	U08	10/-	UAF42	6/-
6U4	7/6	20P3	7/6	KT61	6/-	PY80	4/6	UCH42	6/-
6X4	4/6	185BT	12/6	KT63	6/-	PZ30	6/-	U411	4/6
757	7/6	B36	6/-	N37	6/-	U14	5/-	UL46	4/6
7C5	6/-	ECC85	6/-	PCC84	6/-	U22	4/6	UL44	6/-
10F1	4/6	ECC80	6/-	PCF80	6/-	U24	10/-	UY41	4/6

Most pre-war 4, 5, 7, 9-pin valves 5/- each. P. & P. 6d. per valve
VALVE PARCEL. 12 assorted, all different, 8/6. Postage 1/6.
CONSTRUCTOR'S PARCEL. 2 lb mixed resistors, condensers pots, valveholders, electrolytics, etc. 7/6, postage 2/6.
Send S.A.E. with enquiries or for list of 1,000 valves

ST. JOHN'S RADIO 3 Jews Row, SW18 Tel. VAN 8822

RADIO and T.V. SPARES

SEND NOW FOR OUR

FREE 1962

CATALOGUE

OVER 2,000 VALVE TYPES
AVAILABLE FROM STOCK

ALPHA RADIO SUPPLY CO
103 LEEDS TERRACE, WINTOUN ST., LEEDS 7
Telephone 25187



SMALL ADVERTISEMENTS

continued from page 637

TRADE—continued

FIND TV SET TROUBLES IN MINUTES from that great book *The Principles of TV Receiver Servicing*, 10s. 6d., all book houses and radio wholesalers. If not in stock, from Secretary, I.P.R.E., 20 Fairfield Road, London, N.8.

SERVICE SHEETS (1930-1962) from 1s. Catalogue 6,000 models, 1s. 6d. S.A.E. enquiries.—Hamilton Radio, 13 Western Road, St. Leonards, Sussex.

"MEDIUM WAVE NEWS". Monthly during DX season.—Details from B. J. C. Brown, 196 Abbey Street, Derby.

"MEDICINE". For home, factory or first aid post. The book that everyone should have on hand. Price 3s. 6d.—Edgbaston Electro-Medical Laboratories, 18 Melville Road, Birmingham 16.

METALWORK. All types cabinets, chassis, racks, etc., to your specifications. Philpott's Metalworks Ltd., Chapman Street, Loughborough.

THE INTERNATIONAL HAM HOP CLUB is a non-profit making organisation open to **RADIO AMATEURS AND SHORT WAVE LISTENERS**. **OBJECT**: To improve international relationships through an organised system of hospitality. **MEMBERS** offer overnight hospitality to visiting members, subscription 10s. per annum. **ASSOCIATE MEMBERS** invite radio amateurs to visit their stations. **ASSOCIATE MEMBERSHIP** 5s. per annum. **FAMILY EXCHANGE** holidays arranged, also **FRIENDSHIP LINKS** between radio clubs. The Club's official journal is free to both Full and Associate members.—Hon. Gen. Secretary: G. A. Partridge, G3CED, 17 Ethel Road, Broadstairs, Kent.

I.T.V. CONVERTERS, Stirling, Aerialite, 50/-. 12 volt car clock, 17/6. P.P.—O.D.B., 25 Ramshead Approach, Leeds 14.

SITUATIONS VACANT

RADIO MECHANIC required for work on transistor kits. Good wages and prospects for capable person. Savoy Electronics Ltd., 15 Maiden Lane, Strand, London, W.C.2. Telephone TEM 5484.

NEW REPANCO TRANSISTOR TRANSFORMERS

Type TT45 Push Pull Driver Ratio 4.5:1+1

Type TT46 Push Pull Output Ratio 4+4:1

Type TT49 Interstage Ratio 4.5:1

All with High Permeability Nickel Iron Cores

Size: $\frac{3}{4}$ " x $\frac{1}{2}$ " x $\frac{1}{8}$ "

5/- Each

Radio Experimental Products Ltd

33 MUCH PARK STREET COVENTRY

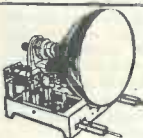

5/6 TV CHASSIS

Working when stored, less tube and valves.

Valves 9d to clear, see list.

Carr. 7/6, Ireland & Scotland 10/-

TV sets 25/- 12" 14" 35/- inc. chassis.

tube, valves, cabinet, etc. Not guaranteed. Sent at customer's risk. Carr. 15/6, Ireland & Scotland 20/-.

35/- TUBES 36-24, Ex-Rental. Ser-vice stock. Carr. 10/--1. & S. 15/6.

P. P. COMPONENTS LTD Stamp, free list. 623 Romford Rd. Manor Pk. E12 Mail order only.

SITUATIONS VACANT

MINISTRY OF AVIATION

(INSPECTION DIVISION)

SKILLED INSPECTORS

required for

- (1) Radio, Radar, Components and Electrical Ancillaries.
- (2) Gauges, Tools, Instruments and Engineering Products. Posts, (including some for aircraft engines and guided weapons) exist at Bromley, Woolwich, London and Home Counties areas, Manchester and elsewhere in United Kingdom.

Varied and interesting work with opportunities for gaining valuable experience and further training.

Pay £13. 6s. 0d.—£14. 1s. 0d. per week or £14. 6s. 0d.—£15. 6s. 0d. per week (London rates (slightly less elsewhere) for 5 day week) according to ability and class of work available. Excellent prospects of promotion to grades with pay ranging up to £1,400 a year,

Post coupon (or telephone Imperial 2600.Ext. 19), for further information.

To: **The Personnel Officer, Inspection Division, Aquila, Golf Road, Bromley, Kent.** (RC)

Please send me further details of skilled inspector posts in(Type of work desired).....

at(area).....

Name

.....

.....

The thrills of VHF can now be yours for only 39/6d, complete kit! Tunable 150-100 Mc/s, simplified construction, write today for leaflet. Also, if a newcomer to Amateur Radio, ask for free copy of the world famous "Globe-King" kits and receivers, stamp please to cover postage:

Johnsons (Radio) St. Martin's Gate Worcester

H.A.C. THE ORIGINAL SUPPLIERS OF SHORT-WAVE KITS

One valve Super Sensitive All-dry Short-wave Receiver, Model "K". Complete kit including valve and chassis, 77/-. (Other S.W. kits from 25/-) Before ordering call and inspect a demonstration receiver, or send stamped envelope for full specification, catalogue and order form.

H.A.C. SHORT-WAVE PRODUCTS (DEPT. R) 44 OLD BOND STREET LONDON W1

3-TRANSISTOR POCKET RADIO WITH MINIATURE LOUDSPEAKER

Absolutely NO soldering

39/6 Superb appearance. Simple instructions. Built in an evening. No drilling. No soldering. Complete in every detail. Receives entire broadcast band. Aerial required in certain areas. Pocket size 4 1/2" x 2 1/2" x 1 1/4".

Or the more powerful SAVOY SUPER-3: 3 transistors and 2 diodes in a 5-stage reflex circuit. Dimensions as above. **55/6**



Battery 1/- extra P. & P. 2/- ALL PARTS SOLD SEPARATELY
Savoy Electronics Ltd 15 Maiden Lane, London WC2 (Back of Adelphi Theatre)

$$X = \frac{-b \pm \sqrt{b^2 - 4ac}}{2a}$$

DON'T FUMBLE with Formulae. Master Mathematics quickly and easily the Understandable Way.

1st lesson and details FREE from

THE DRYDEN SCHOOL OF UNDERSTANDABLE MATHEMATICS

11k Dryden Chambers Oxford Street London W1

Name
Address

G2ACC offers you . . . A proven dependable service

We have been established 27 years and are one of the original pre-war mail order businesses.

- All the best makes from one source.
- Aluminium chassis, paxolin and ceramic rotary switches made to individual design.
- A 56 page illustrated catalogue No. 12 Your buying guide for short wave, broadcast and transmitting components. 9d. post free (refundable on first order). U.K. and H.M. Forces anywhere.

SOUTHERN RADIO & ELECTRICAL SUPPLIES
So-Rad Works Redlynch Salisbury Wiltshire
Telephone Downton 207

NYLON P.T.F.E. ROD BAR SHEET TUBE STRIP WIRE
No quantity too small List on application
BRASS COPPER BRONZE ALUMINIUM LIGHT ALLOYS

H. ROLLET & CO LTD
6 CHESHAM PLACE, LONDON, SW1 BELGRAVIA 4300
Also at Liverpool, Birmingham, Manchester, Leeds

Quality Components FOR CONSTRUCTORS

capacitors, resistors, coils, valves, diodes, controls, chassis, transformers, speakers, pick-ups, cartridges, stylis, and all types of components in stock.

PRICE LISTS AVAILABLE ON REQUEST

J. T. FILMER 82 DARTFORD ROAD DARTFORD KENT Telephone Dartford 24057

BETTER BRIGHTER PICTURE TUBES BRAND NEW THROUGHOUT

excepting glass		
12"	...	£4.10.0
14"	...	£5. 5.0
15"-17"	...	£5.15.0
21"	...	£7.15.0

REBUILT MULLARD AND MAZDA TUBES		
12"	...	£3. 0.0
14"	...	£4. 0.0
15"-17"	...	£4.10.0
21"	...	£6.10.0

Carriage and Insurance 10/-

S.T.S. LTD. 35 Pound Street Carshalton Surrey Telephone Wallington 9665

RECORD CHANGERS AND PLAYERS

New Garrard Autoslim £8.0.0 each
B.S.R. UA14 £7.15.0 each

In Makers Sealed Cartons

B.S.R. TU12 £4.5.6 each
COLLARO Three-Speed Tape Deck (Studio) £10.10.0

All prices include carriage

Large stacks of Valves, Transistors and other Components

NEW LIST NOW READY

H. F. JAMES 21 Claremont Road Twickenham Middx Telephone POPesgrove 3579

The NEW "SAVOY" 4-TRANSISTOR RADIO

WITH MOVING COIL SPEAKER Absolutely NO Soldering : NO Drilling

NO Aerial Required

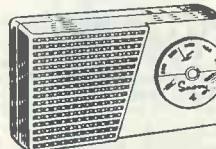

4 transistors and 2 diodes; 5-stage reflex circuit; push-pull output; size 5 1/2" x 3" x 1 1/4"; full medium wave; simple instructions and assembly tool provided. All parts sold separately.

95/- plus battery 2/- extra postage and packing 3/-.

(RC) **Savoy Electronics Ltd** 15 Maiden Lane, London, WC2 (Back of Adelphi Theatre)

The thrills of VHF can now be yours for only 39/6d, complete kit! Tunable 150-100 Mc/s, simplified construction, write today for leaflet. Also, if a newcomer to Amateur Radio, ask for free copy of the world famous "Globe-King" kits and receivers, stamp please to cover postage:

Johnsons (Radio) St. Martin's Gate Worcester

H.A.C. THE ORIGINAL SUPPLIERS OF SHORT-WAVE KITS

One valve Super Sensitive All-dry Short-wave Receiver, Model "K". Complete kit including valve and chassis, 77/- (Other S.W. kits from 25/-) Before ordering call and inspect a demonstration receiver, or send stamped envelope for full specification, catalogue and order form.

H.A.C. SHORT-WAVE PRODUCTS (DEPT. R) 44 OLD BOND STREET LONDON W1

3-TRANSISTOR POCKET RADIO WITH MINIATURE LOUDSPEAKER

Absolutely NO soldering



39/6 Superb appearance. Simple instructions. Built in an evening. No drilling. No soldering. Complete in every detail. Receives entire broadcast band. Aerial required in certain areas. Pocket size 4 1/2" x 2 1/4" x 1 1/4".

Or the more powerful **SAVOY SUPER-3: 3 transistors and 2 diodes in a 5-stage reflex circuit. Dimensions as above.**

55/6

Battery 1/- extra P. & P. 2/- ALL PARTS SOLD SEPARATELY
Savoy Electronics Ltd 15 Maiden Lane, London WC2 (Back of Adelphi Theatre)

$$X = \frac{-b \pm \sqrt{b^2 - 4ac}}{2a}$$

DON'T FUMBLE with Formulae. Master Mathematics quickly and easily the Understandable Way.

1st lesson and details FREE from

THE DRYDEN SCHOOL OF

UNDERSTANDABLE MATHEMATICS

11k Dryden Chambers Oxford Street London W1

Name

Address

G2ACC offers you . . .

A proven dependable service

We have been established 27 years and are one of the original pre-war mail order businesses.

- All the best makes from one source.
- Aluminium chassis, paxolin and ceramic rotary switches made to individual design.
- A 56 page illustrated catalogue No. 12 Your buying guide for short wave, broadcast and transmitting components. 9d. post free (refundable on first order). U.K. and H.M. Forces anywhere.

SOUTHERN RADIO & ELECTRICAL SUPPLIES

So-Rad Works Redlynch Salisbury Wiltshire
Telephone Downton 207

NYLON P.T.F.E.

ROD BAR SHEET TUBE STRIP WIRE

No quantity too small List on application

BRASS COPPER BRONZE ALUMINIUM LIGHT ALLOYS

H. ROLLET & CO LTD

6 CHESHAM PLACE, LONDON, SW1 BELGRAVIA 4300
Also at Liverpool, Birmingham, Manchester, Leeds

Quality Components FOR CONSTRUCTORS

capacitors, resistors, coils, valves, diodes, controls, chassis, transformers, speakers, pick-ups, cartridges, stylis, and all types of components in stock.

PRICE LISTS AVAILABLE ON REQUEST

J. T. FILMER

82 DARTFORD ROAD DARTFORD KENT
Telephone Dartford 24057

BETTER BRIGHTER PICTURE TUBES BRAND NEW THROUGHOUT

12"	...	£4.10.0	New Silver Screen and
14"	...	£5. 5.0	Aluminising. All makes:
15"-17"	...	£5.15.0	Mullard, Mazda, Emiscope,
21"	...	£7.15.0	Cossor, Brimar, Emitron, etc.

REBUILT MULLARD AND MAZDA TUBES

12"	...	£3. 0.0	All Tubes FULLY
14"	...	£4. 0.0	GUARANTEED 12 MONTHS.
15"-17"	...	£4.10.0	Dispatch same day.
21"	...	£6.10.0	Cash with order.

Carriage and Insurance 10/-

S.T.S. LTD. 35 Pound Street Carshalton Surrey
Telephone Wallington 9665

RECORD CHANGERS AND PLAYERS

New Garrard Autoslim £8.0.0 each
B.S.R. UA14 £7.15.0 each

In Makers Sealed Cartons

B.S.R. TU12 £4.5.6 each
COLLARO Three-Speed Tape Deck (Studio) £10.10.0

All prices include carriage

Large stocks of Valves, Transistors and other Components

NEW LIST NOW READY

H. F. JAMES 21 Claremont Road Twickenham Middx
Telephone POPesgrove 3579

The NEW "SAVOY" 4-TRANSISTOR RADIO WITH MOVING COIL SPEAKER

Absolutely NO Soldering: NO Drilling

NO Aerial Required

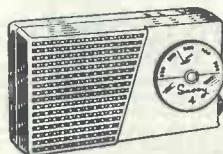

4 transistors and 2 diodes; 5-stage reflex circuit; push-pull output; size 5 1/2" x 3" x 1 1/4"; full medium wave; simple instructions and assembly tool provided. All parts sold separately.

95/- plus battery 2/- extra postage and packing 3/-.

(RC) **Savoy Electronics Ltd** 15 Maiden Lane, London, WC2 (Back of Adelphi Theatre)



MODEL TH-L33

2,000 ohms per volt AC/DC. Size 5" x 3 1/2" x 1 1/2".
79/6
P.P. 1/6.
with test leads, battery and instructions.

0/10/50/250/500/1000 volts D.C.,
0/10/50/250/500/1000 volts A.C.,
0/500µA/10/250mA., D.C.
3 ranges resistance 0/10K/100K/1 Meg. Capacity and dB ranges.

FULLY GUARANTEED

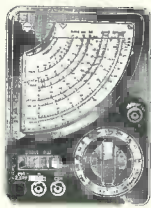

MODEL 200H

20,000 ohms per volt
Size 4 1/2 x 3 1/4 x 1 1/2 in.
£6.19.6 P.P. 1/6.
With Test Leads, Battery and Instructions.

6 Ranges D.C. voltage to 2 1/2 kV.
5 Ranges A.C. voltage to 1 kV.
3 Ranges D.C. current to 250 mA.
Resistance to 6 megs.
Capacity and dB ranges

ALSO MODEL TE10

10,000 ohms/volt version of above, identical in appearance.
£5.19.6 P.P. 1/6. Fully Guaranteed.

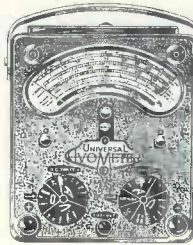

AVO-7

Famous Multi-meter. Reconditioned and fully guaranteed. Full A.C./D.C. voltage and current, resistance, dB, power, etc., etc. Supplied with Batteries, Leads and Instructions.

£11.10.0 Regd. Post 5/-.

(Normal Price £19.10.0.)

LEATHER CASE 30/- EXTRA

MODEL TP55

A.C./D.C. voltage up to 1,000 in 5 ranges. D.C. current 4 ranges up to 500 mA. 4 range resistance to 10 megs. Capacity, dB scales, etc. 20,000 ohms/volt
Size 5 1/4" x 3 1/4" x 1 1/2"

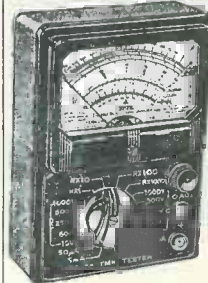

£5.19.6

P.P. 1/6.
With Test Leads, Battery and Instructions

PRINTED CIRCUIT AMPLIFIER

NEW MINIATURE 4-TRANSISTOR PUSH-PULL AMPLIFIER. READY BUILT WITH LEADS. SIZE ONLY 3" x 1 1/2". SUPPLIED WITH CIRCUIT AND DETAILS.

READY TO USE 52/6 P.P. 1/-

MATCHBOX RADIO

All parts in stock for this circuit as per Feb. edition. Send for details.

SUB-MINIATURE JACK PLUGS AND SOCKETS, 3/6 pair.

BATTERY ELIMINATOR AND CHARGER

9 volt charger for pocket transistor radios. Charges PP3 or equivalent to give 5 times life. Also runs radio from 200/250 volt mains. Price 29/6, p.p. 1/-.

MINIATURE PANEL METERS (D.C.)—Brand new

0/50 microamp **39/6**
0/500 microamp **32/6**
0/1 milliamp **27/6**
Yu meter **42/6**
"S" meter **35/-**

TELEPHONE ADAPTOR

★ Ideal for recording telephone conversations. Supplied with screened cable. Fitted rubber sucker. **14/-**. P.P. 9d.

1000 ohm IMPEDANCE MINIATURE PERSONAL EARPHONE

Complete with jack plug and socket **12/6** P.P. 1/-.

GUITAR PICK-UP

High impedance contact microphone for guitars etc. Complete with lead. **12/6** P.P. 1/-.

CRYSTAL MIC. INSERTS

★ ACOS 43-2 2 1/4" round, 10/-, P.P. 6d.
★ ACOS 1 1/2" round, 7/6. P.P. 6d.
★ 1" square, 3/6. P.P. 6d.

TAPE HEADS.

Wright and Wearite Record and Erase Heads, Type FE7 and FR7. Brand new. **19/6** pair. P.P. 2/-.

PRACTICAL TRANSISTOR CIRCUITS

3/6
Post Free.
Contains easy to follow plans of 40 all transistor units, including light operated switches, amplifiers, transmitters, receivers, test oscillators, signal tracers, hearing aids, radio control, etc. All parts available separately. ★ Designed for the Home Constructor



CRYSTAL MICROPHONES

ACOS 39-1. Stick Microphone with screened cable and stand (list 5 gns), **32/6**. P.P. 1/6.

ACOS 40. Desk Microphone with screened cable and built-in stand (list 50/-), **15/-**. P.P. 1/6.

ACOS 45. Hand Microphone with screened lead, very sensitive, 25/-, P.P. 1/6.

TYPE 38. TRANSMITTER RECEIVER

Complete with 5 valves. In new condition. These sets are sold without guarantee but are serviceable. 7.4 to 9 Mc/s. **22/6** P.P. 2/6. Headphones 7/6 pair. Junction Box 2/6. Throat Mike 4/6. Aerial Rod 2/6.

1 WATT TRANSISTOR AMPLIFIER

★ EMI 4-Transistor Amplifier with 7" x 4" speaker, tone and volume controls. Ready assembled. For use with crystal pick-ups. 6-9 volt operated. **89/6**. P.P. 1/6.



BATTERY RECORD PLAYER

● 6-7 1/2 volt Garrard turntable with crystal pick-up. Plays 45 r.p.m. Ideal for above amplifier. **65/-** P.P. 1/6.

★ PORTABLE RECORD PLAYER CABINET for above player & amp. **22/6** P.P. 1/6

TUBULAR LOUDSPEAKER UNIT

Extension portable speaker unit to give big set performance from any transistor pocket radio. Fitted 2 sizes of jack plug. Just plug into earphone socket, **57/6**. P.P. 1/6.

★ CRYSTAL LAPEL MICROPHONE

Ideal for tape recording. Very sensitive. **15/-** P.P. 1/-.



★ LIGHT-WEIGHT 4,000 OHM HEADPHONES,

12/6 P.P. 1/-.



TRANSISTOR PORTABLE TAPE RECORDER

● Play/record up to 30 mins. ● Built-in speaker volume control, batteries and play/record/rewind. ● Quality reproduction. ● Sturdy case 6" x 8 1/4" x 2 1/4"

Supplied complete with microphone, tape, batteries and personal phone.



£11.19.6 (POST FREE) FULLY GUARANTEED

R208 Short Wave Communications Receiver

- ★ Fully tunable three wavebands 10 to 60 Mc/s (3 to 30 metres).
- ★ 110 to 250 volt AC mains
- ★ Built-in 6 1/2" speaker
- ★ Headphones, muting, line sockets
- ★ BFO-RF stage slow-motion vernier tuning

Repeat offer of the well-known "Sputnik Special" short wave receiver operating from household mains or 6 volt accumulator. 6 valve superhet circuit with RF stage. Supplied with spares, handbook, etc. In absolutely new condition.

£11.19.6 Carriage 15/-

★ WE CAN SUPPLY MOST OF THE COMPONENTS USED ON CIRCUITS PUBLISHED IN THIS AND OTHER MAGAZINES QUOTATIONS BY RETURN ★

★ TRANSISTORS ★
Transistor prices have been reduced again with special low prices for guaranteed matched sets. Send for new price list. ★

Henry's Radio Ltd

PLEASE TURN PAGE
PADddington 1008/9
5 HARROW ROAD LONDON W2
Open Monday to Sat. 9-6, Thurs. 1 o'clock
Send 1/- stamp for Illustrated Price List

"CAPRI"-POCKET SIX RADIO



Size only
4½ x 2½ x 1¼ in.

Really Pocket Size!

£7.10.0 P.P. 2/-
(Battery 2/6)

A new design 6-Transistor Printed Circuit Superhet for Medium and Long Waves. Uses all sub-miniature parts. Sub-min. Mullard Transistors. Quality speaker output, fitted earphone. Record Sockets. Cabinets Red/White or Blue/White with Gold fittings.

PERFECTION

"RANGER 3"

Size 4½ x 3 x 1¼ in.



79/6 P.P. 1/6

A Three Transistor Three Diode Personal Radio for Medium Waves. Amateur top band and shipping. Quality output on 'phone. Fitted airspaced tone, vol. control, Mullard transistors. No aerial or earth. **Luxembourg guaranteed.**

"TRANSFIVE" PORTABLE RADIO



Medium and Long Wave Portable

8½ x 6½ x 3½ in.

£6.19.6

P.P. 2/6

A 5-Transistor (Mullard) and Diode, Printed Circuit, Medium and Long Wave Portable. Features 5in. speaker Car aerial socket Mullard transistors and carded components. Excellent results guaranteed.

750mW 4-TRANSISTOR PUSH-PULL AMPLIFIER

(over 1 watt peak output).

- ★ Uses OC71/OC81D, 2-OC81.
- ★ ±3dB 70 c/s to 12 kc/s.
- ★ Overall size 4" x 2½" x ¾".
- ★ Built on printed circuit.

BUILT & TESTED **69/6** P.P. 1/6 OR COMPLETE KIT **62/6** P.P. 1/6

Ideal for Record Player, Intercomm., Baby Alarm for Tuners, etc.

3 ohm output, fully guaranteed, 9 volt operated Descriptive leaflet with uses FREE on request.

PLEASE

TURN

PAGE

Send 1/- Stamps for Illustrated Price Lists

Henry's Radio Ltd

PADDington 1008/9

5 HARROW ROAD LONDON W2

Open Monday to Sat. 9-6, Thurs. 1 o'clock

TRANSISTOR RADIOS TO BUILD YOURSELF

- ★ FULLY ILLUSTRATED BUILDING PLANS AND DETAILS.
- ★ AFTER SALES SERVICE
- ★ ALL PARTS GUARANTEED AND SOLD SEPARATELY
- ★ CALL FOR DEMONSTRATION

Details of any model free on request

"CONTESSA"

6 TRANSISTOR MEDIUM AND LONG WAVE SUPERHET

- ★ TERRIFIC SENSITIVITY
- ★ UNBEATABLE IN PERFORMANCE AND APPEARANCE

COMBINED PORTABLE AND CAR RADIO

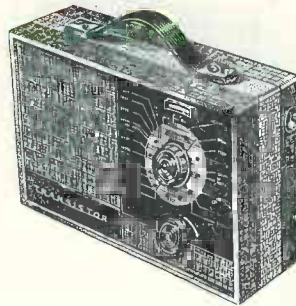

Employs the latest techniques. Double tuned IFS AVC and first-grade components are standard features. Excellent tone, sensitivity and selectivity on both wavebands.

Descriptive Leaflet on Request.

- ★ 425mW Push-Pull Output.
- ★ 6 "Top-Grade" Ediswan Transistors.
- ★ New Type Printed Circuit with all Components marked.
- ★ Full Medium and Long Wave Tuning.
- ★ High "Q" Internal Ferrite Aerial.
- ★ Car Radio Adaptation and AVC.
- ★ Slow Motion Fingertip Tuning with Station Names clearly marked.
- ★ "Hi-Fi" Quality Speaker.
- ★ Attractive Rexine Covered Cabinet, Red/White or Blue/White.

TOTAL COST OF ALL PARTS

£10.19.6 P.P. 3/6

★ NO EXTRAS TO BUY ★

WITHOUT DOUBT THE "CONTESSA" IS THE FINEST PORTABLE AVAILABLE TO THE HOME CONSTRUCTOR. GOOD LOOKS, QUALITY OUTPUT, AMAZING SENSITIVITY, EASE OF CONSTRUCTION. SIZE 10½ x 8 x 3½ ins.

POCKET SOLDERING IRON

● Pocket Soldering Iron, 220/250V A.C./D.C. 30 watts, complete with mains plug, case, etc. Handle unscrews to cover element enabling iron to be carried in pocket, 18/6. P.P. 1/-.

LET US QUOTE FOR COMPONENTS FOR YOUR CIRCUIT

MAKE YOUR OWN PRINTED CIRCUIT BOARDS

Complete kits supplied with all necessary chemicals, brush, dishes, etc. Fully detailed instructions. 3-boards 5½ x 3½", 19/6, p.p. 1/-.

"QUINTET" POCKET RADIO

Size

5½ x 3 x 1¼ in.

Red or Blue with Gold trim



£5.10.0 P.P. 2/-

A Five Transistor Medium and Long Wave Printed Circuit Loudspeaker Radio, with Excellent Results including Luxembourg, guaranteed with full station separation. Supplied with Mullard Transistors and Carded Components. Fitted earphone/record socket.

Performance will amaze you

"RANGER 2"

A Two Transistor Two Diode Personal Pocket Radio. Covering medium waves and top band.

Supplied with battery and quality Personal 'Phone.

Size 4½ x 3 x 1¼ in.

No aerial or earth. **59/6** P.P. 1/6.



"PW-6" SUPERHET RADIO

Medium and Long Wave Radio

Size

5½ x 3½ x 2 in.



£8.10.0 P.P. 2/-

Modified version of previously advertised "PW" Superhet. Now with new style Two Tone Cabinet. 1st grade components and transistors. Printed circuit.

ALL-TRANSISTOR

TIME SAVER

OFFICE OR HOME TELEPHONE PICK-UP AMPLIFIER

No more "holding on" wasting time waiting for your call to come through. When it does the amplifier can be switched off if required. No connections, just press the pick-up coil to back of phone as below. Fully Guaranteed.

★ 3 months battery life. 400mW output.

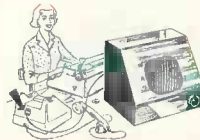

BUILT, TESTED, READY TO USE

£5.10.0

P.P. 2/6

ALSO ALL-TRANSISTOR BABY OR INVALID ALARM **£5.10.0** P.P. 2/6

TRANSISTOR SIGNAL INJECTOR

A new design pocket size tester for fault finding on valve or transistor radios, T.V., amplifiers, etc. Built-in indicator and batteries with detachable probe, 52/6