

THE Radio Constructor

RADIO
TELEVISION
AUDIO
ELECTRONICS

VOLUME 15 NUMBER 5

A DATA PUBLICATION

PRICE TWO SHILLINGS

December 1961

"Quintet" 5-Transistor Pocket Loudspeaker Radio

- 2-Transistor Signal Generator for Broadcast Band Receivers
- Novel Power Supply
- Gadgets for your Christmas Party
- The "Aberdonian" Simple Transistor Receiver
- Small Capacitance Measuring Instrument
- Constructor Visits the Hallicrafters Factories
- Converting the Bendix MN26C Receiver
- Interpretation of Transistor Data
- Radio Astronomy, Part 3
- Understanding Radio, Part 5

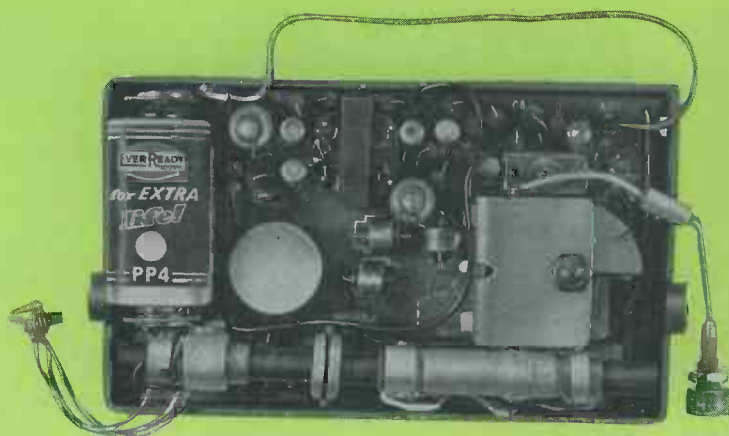

over
30
 new
 circuits
 are
 in
 the
Mullard
REFERENCE
MANUAL
OF
TRANSISTOR
CIRCUITS

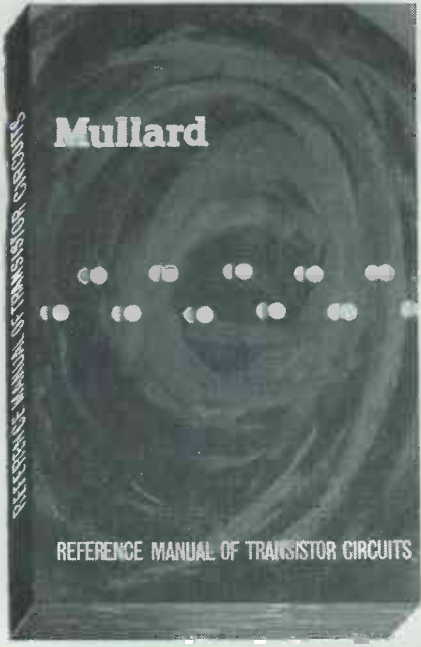
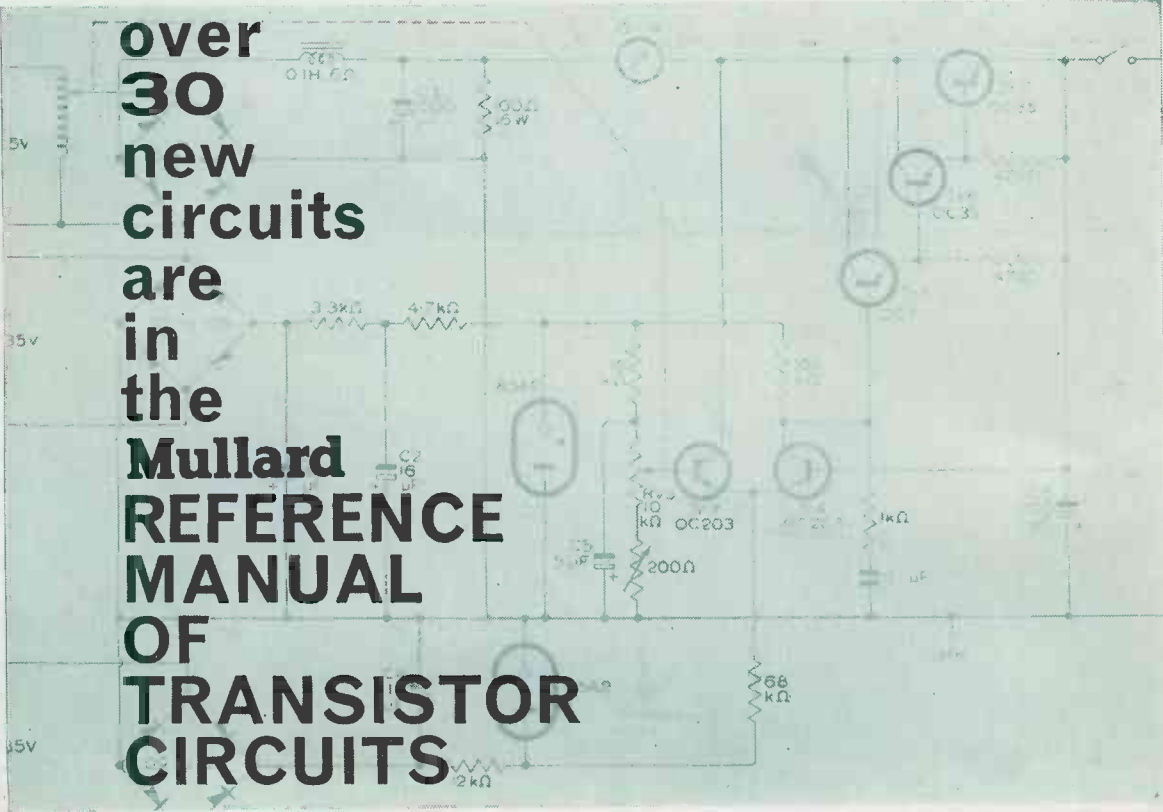

This manual of transistor circuitry has been prepared by Mullard engineers, as an up-to-date and readable volume which will be of use and interest to technicians, service engineers, junior designers and electronics students. It has a page size of 8½" x 5½" and describes more than 60 circuits — over 30 are made generally available for the first time—including both domestic and industrial applications.

308 PAGES · 241 DIAGRAMS · U.K. PRICE 12s. 6d.
 PUBLISHED BY MULLARD LTD.

Get your copy of the Mullard "Reference Manual of Transistor Circuits" today from your radio dealer, or order direct from Mullard Ltd. (postage and packing 1s. 0d. extra in U.K.).

MULLARD LIMITED · MULLARD HOUSE · TORRINGTON PLACE · LONDON W.C.1
 Overseas readers should enquire of their local Mullard Agents.

2-BAND SUPERHET CHASSIS WITH SPEAKER ONLY £4.19.6

Plus 6/6 post and packing

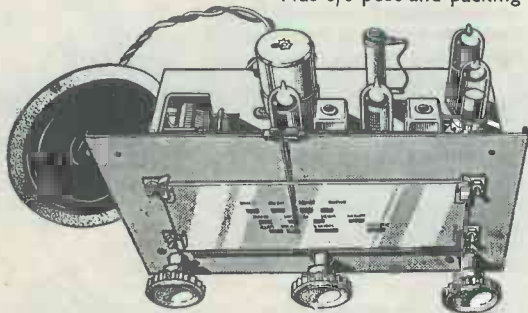

A quality 4 valve AC/DC superhet chassis made by a world famous manufacturer. Long and Medium wave coverage. Fitted with a cord and drum reduction tuning drive and attractive illuminated glass dial (size 6½" x 2½"). Controls: volume on/off, tuning and wave change. The receiver is self-powered, employing a mains dropper and a valve rectifier. Chassis dimensions 6½" x 9" x 5½" high. Supplied complete with a good quality 5" loudspeaker, valves (UCH42, UAF42, UL41, UY41), AC/DC mains input lead, ivory knobs, etc.

Don't hesitate, order now! This unbeatable bargain is bound to sell out quickly at only £5.17.6, plus 6/6 post and packing.

4-STATION PRESET CHASSIS ONLY £4.17.6 WITH SPEAKER

Plus 6/6
post and packing

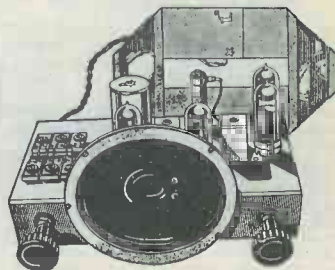

A compact, 4-station preset mains transportable receiver for operation from AC/DC mains. Two simple controls, volume on/off and 4-position station selector. The latter is set to Light Programme (Long Wave), Third

Programme, Home Service and Light Programme (Medium Wave), but may of course be adjusted to alternative selections if required. A frame aerial with throw-out extension is supplied, making this receiver ideal as a general purpose transportable set for the home. A fully smoothed power supply is provided from AC/DC mains input by a mains dropper and a valve rectifier. The good tonal qualities are assisted by the provision of a quality 5" speaker, which is ready-mounted on the chassis (this is easily detachable if alternative positioning is required). Valve line-up: UCH42, UAF42, UL41, UY41. This chassis (size 9" x 6½" x 5½" high) is supplied complete with valves, knobs, mains lead, and a first-class buy at the rock bottom price of only £4.17.6 plus 6/6 post and packing.

AM RADIOGRAM CHASSIS

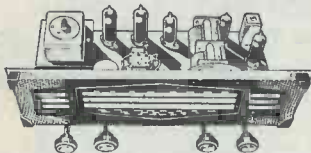

A chassis of distinction by a famous maker. Covering Long, Med. and Short waves, plus gram position, this chassis (size 15½" x 7" x 6½" high) incorporates the latest circuitry, using fully delayed a.v.c. and negative feedback. Controls: tone, volume on/off, wave-change (L.M.S. and gram), tuning. Tapped input 200-250V a.c. only. An attractive brown and gold illuminated dial with matching knobs make this one of the most handsome, in addition to being one of the best performing, chassis yet offered. Complete with valves (ECH81, EF89, EBC81, EL84, EZ81), knobs, output transformer, leads, etc. OUR PRICE ONLY £9.19.6 plus 4/6 post & packing

THE WORLD FAMOUS E.M.I. ANGEL TRANSCRIPTION P.U. (Model 17A)



A Pick-up for the connoisseur originally priced at £17.10.0. The last remaining few offered at £5.15.0 Plus P. & P. 5/-

HARVERSON'S FM TUNER

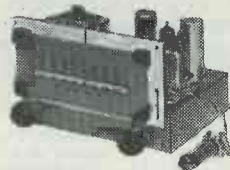

At last a quality FM Tuner Kit at a price you can afford. Just look at these fine features, which are usually associated with equipment at twice the price!

NOW AVAILABLE

A robust cabinet made from heavy gauge metal which has been specially designed to house the above F.M. Tuner. Beautifully finished in a choice of glossy hammer green, or hammer grey enamel, or black crackle. The front panel (illustrated) has holes for control spindles, and apertures for tuning dial and magic eye. PRICE 25/- P & P. 1/9. (Front panel only, 10/6. P. & P. 9d.)

- ★ FM tuning head by famous maker.
- ★ Guaranteed non-drift. ★ Permeability tuning. ★ Frequency coverage 88-100 Mc/s. ★ OA81 balanced diode output.
- ★ Two i.f. stages and discriminator.
- ★ Attractive maroon and gold glass dial (7" x 3").
- ★ Self powered, using a good quality mains transformer and valve rectifier. ★ Valves used ECC85, two EF80s and EZ80 (rectifier). ★ Fully drilled chassis. ★ Everything supplied, down to the last nut and bolt. ★ Size of completed tuner 8" x 6" x 5½". ★ All parts sold separately.

£4.19.6 Plus 8/6 P.P. & Ins.
Circuit diagram and illustrations, 1/6 post free.

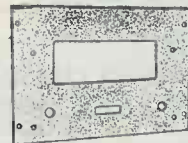

MINIATURE EARPHONE WITH CORD, SUB-MINIATURE PLUG AND SOCKET

A deaf aid type earpiece of top grade quality. Gives an exceptionally crisp reproduction of both speech and music. Brand new and fully guaranteed. Two types available. CR-5 high impedance crystal, MR-4 low impedance magnetic. ONLY 7/6 Plus 1/- P. & P.

MAINS PORTABLE SOLDERING IRON

Probably one of the most outstanding soldering instruments yet produced, this iron has a detachable handle which can be placed over the bit and barrel, enabling it to be carried in complete safety even when hot. The provision of an extremely stable 30W element makes this ideal for transistor and all similar lightweight applications. Brand new in P.V.C. bag, with lead and plug. ONLY 18/9, plus 1/3 P. & P.

FM TUNER HEAD



A permeability tuned tuner head by a famous maker, supplied without valve (ECC85).

18/6 plus 1/9 P. & P.
Valve 8/6 extra

HARVERSON SURPLUS CO. LTD

Introducing . . .

HARVERSON'S

Monaural Amplifier Kit

In response to numerous requests from delighted purchasers of our "SUPER STEREO KIT" we have produced a "MONAURAL AMPLIFIER" on similar lines.

★ A UCL82 valve provides a triode amplifying stage, and a pentode output stage (3 watts), enabling good amplification and sparkling reproduction to be combined with physical compactness (amplifier size 7" x 3½" x 6¼" high).

★ Modern circuitry design, good quality o.p. transformer (to match 3Ω) keep hum and distortion to a low level.

★ The controls, volume on/off and tone, are complete with attractive cream and gold knobs.

★ The amplifier has a built-in fully smoothed power supply, using a good quality mains transformer (a.c. mains only) and metal rectifier.

★ All you need is supplied including easy to follow instructions which guarantee good results for the beginner and expert. All components, leads, chassis, valve, knobs, etc., are first grade items by prominent manufacturers.

OUR PRICE 39/6
Plus 4/6 Post and Packing

5" LOUDSPEAKER TO SUIT, 14/6 EXTRA

39/6

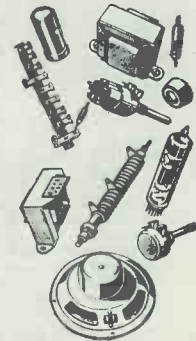

THE HARVERSON 6 TRANSISTOR PLUS DIODE SUPERHET KIT

A first class 2 waveband transistor superhet in kit form.

- ★ Printed circuit panel (size 8½" x 2¾")
- ★ 3 Pre-aligned I.F. Transformers
- ★ Output Transformer
- ★ 5" 5Ω Speaker
- ★ High gain Ferrite rod aerial
- ★ Car aerial socket
- ★ First grade G.E.C. transistors
- ★ Push-Pull output

All parts down to the minutest item with simple instructions.

ONLY £6.19.6 Plus 2/6 P. & P.

Cabinet to Suit (if available)
15/- extra.

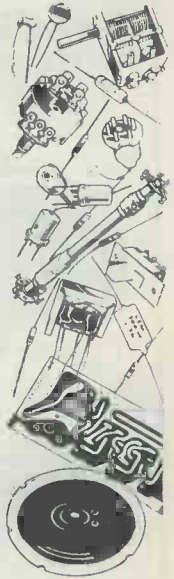

BARGAIN MONTH FOR TRANSISTORS

POWER			
OC36	10/-	GET15	9/-
OC44	9/-	GET15 (matched pair)	16/6
OC45	8/-	GET102	7/6
OC71	5/-	XA103	8/6
OC75	6/6	PXA101	9/6
OC76	6/6	PXA102	9/6
OC78	6/6	DIODE	
OC78D	6/6	OA81	3/-

Please add 6d. postage for each transistor.

TRANSISTOR SPEAKER

Weston Electric 3Ω or 80Ω speaker. Size 2½" x 1½" deep. 12/6 P.P. 1/-

SUPERHET CHASSIS — LESS VALVES & CABINET

Modern AC/DC chassis with printed circuit and ferrite rod aerial. Although not completely built, the main components are mounted. L. & M. wave coverage, 4 valves (UBF89, UCL83, UCH81, UY85). Everything supplied except valves and cabinet. With simple instructions.

£3.6.6 Plus 3/6 P. & P.

COIL AND TRANSFORMER SET FOR TRANSISTOR SUPERHET

3 I.F. Transformers, one oscillator coil, one driver transformer, and wound ferrite aerial (Med., Long and aerial coupling) 28/6. complete, post 1/- . 6 transistor printed circuit board to match 8/6. post 9d. Circuit diagram 1/6 extra.

CONDENSER/RESISTOR PARCEL

50 mixed pF Condensers and 50 mixed Resistors. An assortment of useful values. All popular sizes—all new—a must for the serviceman and constructor.

ONLY 10/-
P. & P. 1/-

THE HARVERSON COMPLETE FM/VHF RECEIVER KIT

£6.19.6

At last! A complete FM Receiver in kit form.

Specially designed with the home constructor in mind, this kit enables the construction of a completely self-contained VHF receiver at a fraction of the normal cost of comparable equipment. This is basically a quality self-powered FM tuner plus 2 separate audio amplifier stages and output transformer and speaker.

- ★ FM tuning head by famous maker
- ★ Guaranteed non-drift
- ★ Permeability tuning
- ★ Frequency coverage 88-100 Mc/s
- ★ OA81 balanced diode output
- ★ Two i.f. stages and discriminator
- ★ Self-powered, using a good quality mains transformer and valve rectifier
- ★ Valves used: ECC85, two EF80s, ECL82 and EZ80 (rectifier)
- ★ Fully drilled chassis
- ★ Good quality speaker
- ★ Well designed output transformer
- ★ Attractive maroon and gold glass dial
- ★ Two output stages (using ECL82 valve)
- ★ Everything supplied, down to the last nut and bolt
- ★ Compact size
- ★ All parts sold separately

OUR PRICE £6.19.6 Plus 4/6 P. & P.

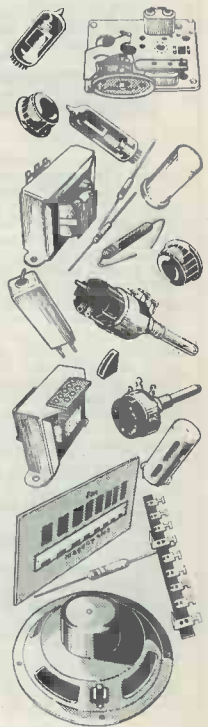

14 Watt Hi-Fi Amplifier Kit

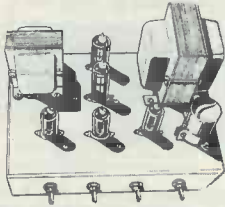

A kit designed to meet the exacting requirements of the audio enthusiast, yet remain within the price range of the average constructor. A stylishly finished monaural

amplifier with an output of 14 watts from 2 EL84s in push pull. Super reproduction of both music and speech. (Frequency response $\pm 3\text{db}$ c/s-60 kc/s with negligible hum). Separate inputs for mike and gram allow records and announcements to follow each other and make this amplifier ideal for small halls, youth clubs, etc. Fully shrouded Linear output transformer (to match 3-15 Ω speaker), and fully shrouded mains transformer (these alone are worth over £3.10.0). 2 independent volume controls, and separate Bass and Treble controls are provided, giving good lift and Cut. Valve line up 2 EL84s, ECC83, EF86 and EZ80 rectifier. All parts down to the last nut and bolt, including valves, heavy gauge metal chassis finished in glossy hammer green enamel (mains and output transformers finished to match.)

ONLY **£6.19.6** P.P. 6/6 (simple instruction booklet 1/6. Free with kit).

Super Table Radio Cabinet

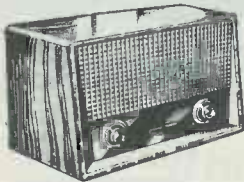

A very fortunate purchase allows us to offer this quality table radio cabinet for only 16/6 (this cabinet cost the manufacturers 35/- each to make). The positions of the controls make it ideal for housing our

6 TRANSISTOR SUPERHET KIT described opposite. Beautifully finished in walnut and tygan. OUR PRICE

ONLY **18/6** plus 1/6 P. & P. and ins.

QUALITY RECORD PLAYER AMPLIFIER KIT

A top quality record player amplifier in kit form. This amplifier (which is used in a 29 gn. record player) has a printed circuit and has an internal fully smoothed power supply (input AC/DC Mains) using a mains dropper and contact cooled rectifier. A

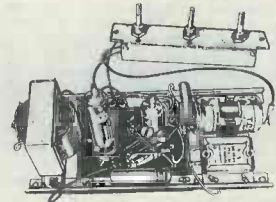

flying panel is supplied accommodating BASS, and TREBLE and VOL-ON/OFF controls. 2 valves UL84 and UF89) and linear output transformer give crisp reproduction from all records at 4 WATTS. Our price for the complete kit of parts

(including valves) only **59/6** plus P. & P. 6/6 simple instructions 1/6. (Free with kit)

Super Stereo Kit Mark II

A kit of ready-built units only requiring inter-connection. Comprising two midget 3W amplifiers, push-button switch, transformer, control unit (bass, treble and vol.), power pack, two speakers, indicator light, valves (ECL82, EZ80 range), and comprehensive instruction.

£3.19.6

Plus 6/6 P. & P.

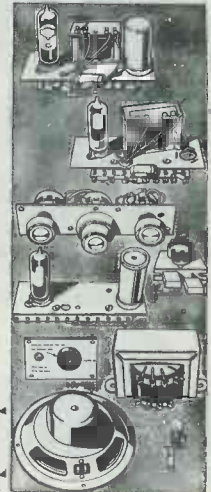

VALVES

WE HAVE 20,000 IN STOCK—ALL AT BARGAIN PRICES SEE OUR LIST IN NOVEMBER RADIO CONSTRUCTOR OR SEND FOR YOUR REQUIREMENTS

E.M.I. 4-SPEED PLAYER AND P.U.



Heavy 8 1/2" metal turntable. Low flutter performance 200/250V shaded motor with tap at 80V for amplifier valve filament if required. Turnover LP/78 head. Price 89/6. Plus 4/6 P. & P.

SPECIAL OFFER ...

6 TRANSISTOR RADIO IN KIT FORM

Limited quantity only of new ex-manufacturers parts to make a 6 transistor 2 wave band superhet chassis. Ideal for portable or table radio. All parts including transistors, ferrite aerial, printed circuit etc., but EXCLUDING speaker and cabinet. Few only, £4.19.6 plus 2/6 P. & P. Simple instructions 1/6. (Free with kit).

SPECIAL OFFER

54" wide loudspeaker silk. Heavily woven in ivory and gold. Original price 35/- per yard length. OUR BARGAIN PRICE 13/6 per yd. length P. & P. 1/6.

TAPE DECKS

B.S.R. Monardeck (single speed) 3 1/2" per sec., simple control, uses 5 1/2" spools, £7.5.0 plus 5/6 carr. and ins. (tapes extra)
COLLARO STUDIO DECK £10 plus 5/6 carr. and ins. (tapes extra)

CRYSTAL MIKES

T.S.L. Stick Mike ... 22/6
ACOS (latest model) ... 18/6

PLESSEY SPEAKER

8" x 5" 3 Ω speaker, large pot, 12/6, 1/6 P. & P.

HI-FI STEREO MONAURAL AMPLIFIER

A 5 valve hi-fi amplifier with switched stereo/monaural operation. Output 3 watts per channel, provision for bass and treble speakers on each. Volume and tone controls fitted both channels. All housed in stylish blue/grey metal case, with gold finished knobs and trimmings.

£9. 19. 6 Plus 4/6 P. & P.

3-PUSH BUTTON SWITCH

A really attractive 3-push button switch, ideal for putting that "professional finish" to your transistor radio. Each button is approx. 1" long and the following functions are provided:

On/Off, Medium Wave, and Long Wave. In addition the underside of the switch carries a rack for mounting a ferrite rod aerial. Easily 15/- value.

ONLY 5/6. P & P. 1/-.

A NEW LOOK FOR The "GOOD COMPANION" CAR RADIO & PORTABLE

One of the finest of its kind available. The design is the combined efforts of our technicians and those of several of the leading manufacturers in the country, and the resulting set has a performance as good as if not superior to those selling at £20 and more. It has the eight transistor set performance. Features include American Philco R.F. transistors and Mullard A.F. transistors—Q.P.P. output giving 750mW—full coverage on Medium and Long—very fine tuning arrangement—excellent reception of difficult stations like 208—variable feed-back control—full tonal qualities—really superior looking cabinet size 11" x 8" x 3" approximately—car aerial attachment—several months' operation from battery costing only 3/6. Circuit employs six transistors and two diodes, it incorporates all latest refinements, and oscillator I.F. transformers are pre-aligned so no instruments are necessary. Anyone who can solder competently can make this set. The instructions are fully comprehensive with plenty of illustrations. Service is available in the unlikely event of your getting into difficulties. All components fully guaranteed. Price of all components and original cabinet.

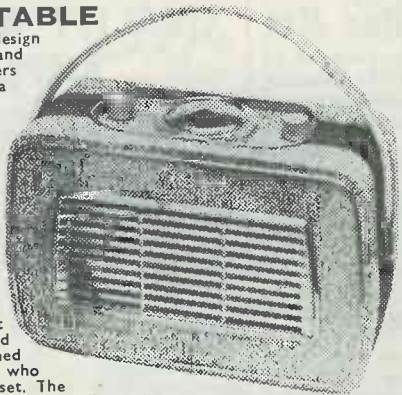

£9.19.6

or, with new cabinet as illustrated, £1 extra.

Post and insurance 5/-
Battery 3/6 extra.

POCKET COMPANION
should now be ready for constructors. Constructional details 2/6, or all parts complete **£6.15.0** Post and Ins. 2/6

MOST AMAZING BARGAIN!

All components for a
5 Transistor Radio
that really works!

**ONLY
69/6**

Postage and
Insurance 2/6
Battery 2/-

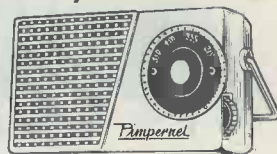

This remarkable little receiver uses 5 transistors and 2 diodes, 3" moving coil speaker, tuning condenser, volume control with on/off switch, latest type circuitry giving excellent station separation and ample volume at good tone. Push-pull output circuit ensures long life from PP4 battery.

All components included for Medium wave operation in handsome plastic case with carrying handle as illustrated.

Demonstrations at all branches.

Circuit diagram Free with parts or separately, 2/-

OPTIONAL EXTRAS

Fully punched printed circuit board 6/6
All components and switch for Long waves 8/6
Motif "Pimpernel" 2/-

ELECTRONIC PRECISION EQUIPMENT LTD

★ Orders received by post are despatched from our warehouse, Dept. 34, 66 Grove Road, Eastbourne, and to save time, please post your order to this address. Please include enough for postage. Callers, however, should use one of the following addresses:

520 High Street North
Manor Park, E.12

42-46 Windmill Hill
Ruislip, Mdx.

266 London Road
Croydon

29 Stroud Green Road
Finsbury Park, N.4

246 High Street
Harlesden, N.W.10

Premier RADIO

23 Tottenham Court Road London W1 Telephone MUSeum 3451/2 and 309 Edgware Road London W2 Telephone PADdington 6963

4-TRANSISTOR PORTABLE RADIO



MAY BE
BUILT FOR **95/-**
Plus 3/6 P. & P.

PP7 Battery Extra 3/3
A 4-transistor and 1-diode portable receiver ideally suited for the young enthusiast, having full medium waveband coverage and internal ferrite rod aerial. It incorporates a pre-tagged circuit chassis ensuring ease of construction, a hi-flux 5" speaker is used and the receiver is housed in an attractive two-tone rexine-covered cabinet.

The "Petite" PORTABLE



MAY BE
BUILT FOR **£7.7.0** plus 5/-
P. & P.

Batteries extra
HT 10/- (Type B126) or equiv.
LT 1/6 (Type AD35) or equiv.

- ★ Size only 8" x 8" x 4½"
- ★ Instruction book 1/6

Battery Eliminator, available in component form price 37/6 plus 2/- P. & P.

BARGAIN OFFER

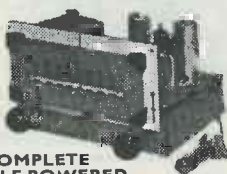

A COMPLETE
SELF-POWERED

FM TUNER

MAY BE
BUILT FOR **£4.19.6** plus 5/-
P. & P.

STAR FEATURES

- ★ Self-powered
- ★ Permeability tuning
- ★ Philips FM tuning unit
- ★ Absolutely no drift
- ★ Frequency coverage: 88-100 Mc/s
- ★ Two IF stages and discriminator
- ★ OAB1 balanced diode output
- ★ Valve line-up: ECC85, two EF80, EZ80 rectifier

Attractive full vision maroon and gold glass dial size 7" x 3". Overall dimensions of tuner 8" x 7½" x 5½"

Introducing THE TELEFUNKEN STEREO

HI-FI AMPLIFIER

For only
£19.6

P. & P. 5/-

Brief specifications:

- Power Output 5 Watts total (2½ watts per channel).
- ★ Frequency Response 30 c/s to 40 Kc/s 2dB.
45 c/s to 30 Kc/s ½dB.
- ★ Sensitivity sufficient for all normal inputs from Tape Recorders, Pick-ups, Microphones Radios.
- ★ Power Requirements 110, 125, 150, 220, 240 volts A.C.
- ★ Piano key selecting.
- ★ Preselected tone control.
- ★ Size 12" wide x 9" deep x 2" high.
- ★ Finish: Hammered enamel in grey/green with gold trimmings, Controls and press buttons in cream with black, blue and red lettering.

THE "MID-FI"

A NEW DESIGN

4½W AMPLIFIER KIT
MAY BE plus 3/-
BUILT FOR **95/-** P. & P.



A new circuit for the home constructor requiring a good quality med. powered amplifier for reproduction of records or f.m. broadcasts. Technical spec.: sep. bass and treble controls. Valves: EF86, EL84, EZ80. Voltage adjustment for a.c. mains from 200/250V, 3 or 15Ω imp. Neg. feedback. Size 7" x 5" x 2", overall ht. 5". Silver hammered finished chassis.

For Safety's Sake
use
AVO Prodclips



Safety first every time with these patented spring-loaded AVO Prodclips.

Cleverly designed for use as insulated prods, they are invaluable for reaching and holding test points which are difficult of access.

Suitable for use with AvoMeter, Multiminor, and Avo Electronic Test Meter Leads.

Post Free 15/- per pair

AVO LTD

AVOCET HOUSE

92-96 VAUXHALL BRIDGE RD · LONDON · SW1
VICtoria 3404 (12 lines)

A Member of the Metal Industries Group of Companies

REPANCO

Transistor Amplifier and Feeder Unit Circuits

Envelope of theoretical and practical layout diagrams for:

350/500 milliwatt Transistor Amplifier

Simple TRF Band Pass Feeder Unit

Medium wave TRF Feeder Unit with R.F. Stage

Medium and Long wave Unit with R.F. Stage

Medium and Long wave Superhet Feeder Unit

Microphone Pre-amplifier

Send now 2/- (post free) for envelope

RADIO EXPERIMENTAL PRODUCTS LTD
33 MUCH PARK STREET · COVENTRY

SO SENSITIVE...
but not temperamental!

from Salford - the NEW
minitest
POCKET-SIZED MULTIRANGE TEST SET



Only recently introduced, this instrument is proving an outstanding success. Its high sensitivity makes it ideal for testing and fault location in all types of electrical and electronic circuits. The instrument is well built and economically priced. Each instrument supplied with test leads. (Leather carrying case available as an extra.)

RANGES: A.C. Volts. 2.5, 10, 25, 100, 250, 1000.
D.C. Volts. 2.5, 10, 25, 100, 250, 1000.
D.C. Amps. 50 μ A, 1mA, 10mA, 100mA, 1A.
Ohms. 2000 200,000 20 M Ω

ACCURACY: D.C. Volts & Amps. \pm 2% of full scale deflection
A.C. Volts \pm 3% of full scale deflection
 \pm 5% at centre scale.

SEI

Send for leaflet MIN 6009/R.C.

SALFORD ELECTRICAL INSTRUMENTS LIMITED
PEEL WORKS · SILK ST · SALFORD 3 · LANCs · TEL · BLACKFRIARS 6688
London Sales Office · Magnet House · Kingsway, W.C.2. Temple Bar 4668
A SUBSIDIARY OF THE GENERAL ELECTRIC CO. LTD. OF ENGLAND

THE WORLD-FAMOUS RANGE OF EQUIPMENT

For the Discerning who require THE BEST PERFORMANCE AT MINIMUM PRICE

4-WAVEBAND TRANSISTORISED PORTABLE RECEIVER, Model RSW-1



This possesses Medium, Trawler and two Short-wave bands and is 'mid-way between the domestic broadcasting and professional general communications receiver. Ideal and inexpensive for those who wish to listen to world broadcasts, shipping and aviation communications, etc. It is not the set to buy if you wish

only to enjoy domestic broadcasting. In a handsome solid leather case, it has retractable whip aerial and socket for car radio use. **£22.10.0**

TRANSCRIPTION RECORD PLAYER (STEREO)



Model G.L.58

Manufactured by Goldring-Lenco. This 4-speed unit is fitted with a G60 pick-up arm. Infinitely variable speed adjustment from 33 $\frac{1}{3}$ to 80 r.p.m. Fixed speed of 16 r.p.m. Its balanced turntable (3 $\frac{3}{4}$ lb) reduces rumble, wow and flutter to very low level. The unique lowering device fitted provides absolutely safe means of placing pick-up on record. **£20.12.2**

HI-FI FM TUNER

This model is available as two units which, for your convenience, are sold separately. They comprise an R.F. Tuning Unit, Model FMT-4U (£3.5.0 including purchase tax) with I.F. output of 10.7 Mc/s, and an Amplifier Unit complete with attractively styled cabinet, also power supply and valves. Model FMA-4U (£11.11.0) making a total equipment cost of **£14.16.0**



AMATEUR TRANSMITTER Model DX-100U

The most popular Amateur transmitter in the world requires no introduction to Amateurs the world over. It covers all bands from 160-10 metres. Self-contained, including power supply, modulator and V.F.O. 150W D.C. input. **£81.10.0**



TRUVOX TD-1 Mk. 6 TAPE DECK

This mono/stereo Tape Deck, designed to semi-professional standards, is a very high quality piece of equipment. Limited quantity available at the greatly reduced price of **£29.15.0**



THE "MOHICAN" GENERAL COVERAGE RECEIVER Model GC-1U **£38.15.0**

In the forefront of design, with 4 piezo-electric transfilters, variable tuned B.F.O. and Zener diode stabiliser, this is an excellent fully transistorised portable or fixed station receiver for both Amateur and Short wave listeners. Other features include printed circuit boards, telescopic whip antenna, tuning meter and large slide-rule dial of approximately 70". Uses 10 transistors.



MONEY-SAVING "PACKAGED DEALS"

For the benefit of customers wishing to purchase several units of their Hi-Fi equipment at the same time, useful price reductions are offered. Such "Packaged Deals" may include RECORD PLAYERS and TAPE DECKS of your personal preference, not necessarily featured in our catalogue. Two money-saving examples are given below and quotations for your own special requirements will gladly be sent on request.

GL-58 Transcription Unit	£20.12.2	TA-1M	£18.2.6
S-33 Stereo Amp.	£12.8.6	Collaro "STUDIO"	£17.10.0
Twin SSU-1 Speakers (Bookcase Type)	£21.15.0	USC-1	£18.18.6
	£54.15.8	MA-12	£10.19.6
Packaged	£50.19.0		£65.10.6
		Packaged	£59.10.0

PRICE OF TAPE DECK PURCHASES WITH AMPLIFIERS

TA-1M with Collaro "STUDIO"	£30.10.0
TA-1S with Collaro "STUDIO"	£35.14.0
TA-1M with TRUVOX Mk.6	£46.17.6
TA-1S with TRUVOX Mk.6	£52.1.0

All prices include free delivery U.K.
Deferred terms available over £10.

Available direct from

DAYSTROM LTD

DEPT. RC12 GLOUCESTER



THE "COTSWOLD"

THE "COTSWOLD". This is an acoustically designed enclosure 26" x 23" x 15 $\frac{1}{2}$ " housing a 12" bass speaker with 2" speech coil, elliptical middle speaker together with a pressure unit to cover the full frequency range of 32-20,000 c/s. Capable of doing justice to the finest programme source, its polar distribution makes it ideal for really Hi-Fi Stereo. Delivered complete with speakers, cross-over unit, level control, Tygan grille cloth, etc. All parts pre-cut and drilled for ease of assembly and left "in the white" for finish to personal taste. **£21.19.0**

HI-FI EQUIPMENT CABINETS



The "GLOUCESTER" (open)

left "in the white" for finish to personal taste. Send for details of whole range. Prices from £11.5.6 to £17.18.6.

You have four different equipment cabinets designed to meet the wide variety of tastes and requirements. There is the 'CHEPSTOW', for those who have minimum floor space; the 'MALVERN' in contemporary design for the Tape and Gram. enthusiast, and the 'GLOUCESTER' Mk. I and II for those with traditional tastes. All parts pre-cut and drilled for ease of assembly and

Easily-built Equipment of excellent quality AT MUCH LOWER COST



TA-1M



O-12U



DC-1U



S-33



DX-40U



AG-9U



UJR-1



MA-12

TAPE RECORDING/REPLAY AMPLIFIERS, Models TA-1M and TA-1S. Available both monophonic (TA-1M) and stereophonic (TA-1S) and the former can be modified later to stereo with modification kit TA-1C. Special features include bias level control, thermometer type recording level indicators, press-button control. Attractive metal case. TA-1M £18.2.6 TA-1S £23.6.0

GRID DIP METER Model GD-1U. A very handy instrument for the lab., the amateur, or Service Engineers. Complete set of plug-in coils provided covering 1.8 Mc/s to 250 Mc/s. Additional plug-in coils at 15/- extending range to 350 kc/s. 1mA panel meter used. £10.9.6

TRANSISTORISED version of above, model XGD-1, 1.75 Mc/s to 45 Mc/s £10.8.6
5" OSCILLOSCOPE: O-12U. "Y" sensitivity 10mV/cm, 3 c/s to over 5 Mc/s. Rise time, 0.08 µsecs or less. Sweep, 10 c/s to 500 kc/s. Electronically stabilised. £36.10.0

2½" PORTABLE SERVICE OSCILLOSCOPE: OS-1. Ideal instrument for service and portable use. Size 5" x 8" x 14". Wt. 10½lb. £19.10.0

DECADE CAPACITANCE BOX: DC 1U. Provides capacity values from 100 mmf to 0.111 mfd in 100 mmf steps. Ideal for experimental development and design work. £6.5.6

VALVE VOLTMETER: V-7A. The world's largest-selling VVM. Measures volts to 1,500 (DC & RMS) and 4,000 pk. to pk.; resistance 0.1Ω to 1,000MΩ DC. D.C. input impedance 11 Megohms. £13.0.0

HI-FI STEREO 6 WATT AMPLIFIER: S-33. Low-priced but high quality; less than 0.3% distn. at 2½ watts per channel. £12.8.6

HI-FI STEREO 16 WATT AMPLIFIER: S-88. Superb reproduction for the man who wants the best in Hi-Fi. Only 0.1% distortion at 6 W/chnl. Many special features. £26.12.6

AMATEUR TRANSMITTER: DX-40U. 75W CW; 60W pk. c/c phone; 40W into Aerial. £32.10.0

HI-FI SPEAKER SYSTEM: SSU-1. Ideal twin speaker/ducted-reflex cabinet for stereo/mono in average room (left "in the white"). Legs £1.1.0 extra. £10.1.6

AUDIO GENERATOR: AG-9U. 10 volts, 10 c/s to 100 kc/s pure sine-wave. Switch-selected frequency and attenuator. £19.1.6

JUNIOR TRANSISTOR RADIO: UJR-1. Youngsters are not excluded from our kit programme. This special single transistor set is an excellent introduction to radio and an instructive present. £2.16.6

TRANSISTOR PORTABLE RADIO UXR-1 In elegant solid hide case, with golden relief. Six transistors, dual-wave, fine reproduction, very easy to build. £14.18.6

SINGLE CHANNEL 12 WATT HI-FI AMPLIFIER: MA-12. Ideal for stereo conversions, etc. Generous auxiliary power provided. £10.19.6

COLLARO "STUDIO" TAPE DECK. This extremely attractive and compact 3-speed monaural tape deck features digital counter, pause control and piano-key switches. £17.10.0

(Following models not illustrated)

MULTIMETER, Model MM-1U. Sensitivity 20,000 ohms per volt D.C. .5000 ohms A.C. Ranges 0-1.5, 5, 15, 50, 150, 500 and 1500V. AC and DC. Current 0-150 micro-amps to 0-15 amps in 5 ranges. Resistance ranges RX1(15 ohm centre scale) RX100 and RX10,000. 4½" 50 micro-amp meter. £11.18.6

CAPACITANCE/RESISTANCE BRIDGE: C-3U. Measures capacity 10pF to 1,000µF. Resistance 100Ω to 5MΩ; Power factor. £8.6.6

VARIABLE FREQUENCY OSCILLATOR: VF-1U. 10V output calibrated on 160m and 40m fundamentals. £11.2.0

AUDIO WATTMETER: AW-1U. Up to 25W continuous, 50W intermittent. £14.14.0

AUDIO VALVE-MILLIVOLTMETER: AV-3U. 1mV to 300V AC. 10 c/s to 400 kc/s. £13.18.6

ELECTRONIC SWITCH: S-3U. This extremely useful device extends your single-beam "scope" for double-beam uses. £10.15.6

DIRECT READING CAPACITANCE METER: CM-1U. Full-scale ranges of 0-100 mmf, 1,000 mmf, 0.01 mfd and 0.1 mfd. £14.15.0

AUDIO SINE-SQUARE WAVE GENERATOR. AO-1U. Inexpensive generator covering 20 c/s to 150 kc/s and square waves to 50 kc/s in four ranges. Maximum output 10V., distortion less than 1 per cent. £12.18.6

R.F. SIGNAL GENERATOR, RF-1U. Up to 100 Mc/s fundamental and 200 Mc/s on harmonics and up to 100mV output on all bands. £11.18.0

HI-FI STEREO/MONO PREAMPLIFIER, Model USP-1. This extremely versatile and inexpensive unit has a very favourable signal-to-noise ratio and a thousand uses. Gain may be preset over a wide range. Input 2mV to 20mV. Output from 20mV to 2V. £6.17.6



GD-1U and XGD-1



OS-1



V-7A



S-88



SSU-1



UXR-1



"STUDIO"

All prices include free delivery in U.K. Deferred terms available on orders above £10

★ SEND THIS COUPON NOW FOR FURTHER INFORMATION

(Please write in BLOCK CAPITALS)

NAME

ADDRESS

Without obligation please send me

BRITISH HEATHKIT CATALOGUE..... (Tick here)

FULL DETAILS OF MODEL(S).....

DAYSTROM LTD DEPT RC12 GLOUCESTER · ENGLAND

A member of the Daystrom Group, manufacturers of the

WORLD'S LARGEST-SELLING ELECTRONIC KITS

VOLUME CONTROLS

Long spindles. Midget 5K ohms to 2 Meg.
No. sw. D.P. Sw 3/- 4/6
Linear or Log Tracks.

80 ohm Coax

Semi-air spaced $\frac{1}{2}$ in. Stranded core, 6d. yd. 40 yds. 17/6; 60 yds. 25/-
Fringe Quality, Air Spaced 1/- yd.

EXTENSION SPKR. CONTROL 10 Ohm 3/-
RESISTORS. Preferred values. 10 ohms to 10 meg. $\frac{1}{2}$ w., 4d.; $\frac{1}{4}$ w., 4d.; 1 w. 6d.; $1\frac{1}{2}$ w. 8d.; 2 w. 1/-

HIGH STABILITY. $\frac{1}{2}$ w. 1%, 2/- Preferred values. 10 ohms to 10 meg. Ditto 5%, 100 ohms to 5 meg. 9d.
WIRE-WOUND RESISTORS 1/3 15 watt 25 ohms-10,000 ohms 1/6
12.5K to 50K 10 w. 2/-
12.5K to 50K 10 w. 3/8

WIRE-WOUND POTS. 3 WATT. Pre-set Min. TV Type. All values 10 ohms to 25K, 3/- ea.; 30K, 50K, 4/- (Carbon 30K to 2 meg., 3/-)

WIRE-WOUND 4 WATT POTS. Long Spindle, Values, 50 ohms to 50K, 6/6; 100K, 7/6.

TRIPLEXERS, Bands I, II, III, 12/6
COAXIAL PLUGS, 1/- PANEL SOCKETS, 1/-
LEAD SOCKET, 2/- OUTLET BOXES, 4/6
BALANCED TWIN FEEDER, per yd. 6d., 80 ohms or 300 ohms.
TWIN SCREENED BALANCED FEEDER, 1/6 yd. 80 ohms.
TRIMMERS, Ceramic 30, 50, 70 pF. 9d.; 100 pF. 150 pF. 1/3; 250 pF. 1/6; 600 pF. 750 pF. 1/9; Philips, 30 pF. 1/- each

BLACK CRACKLE PAINT. Air drying, 3/- tin.
NEON MAINS TESTER SCREWDRIVER, 5/-
SOLDER RADIOGRADE, 4d. yd., $\frac{1}{2}$ lb. 5/-

HIGH GAIN TV PRE-AMPLIFIERS BAND I B.B.C.
Tunable channels 1 to 5. Gain 18 dB. ECC84 valve. Kit price 29/6 or 49/6 with power pack. Details 6d. (PCC84 valves if preferred.)
BAND III I.T.A.—Same prices
Tunable channels 8 to 13. Gain 17 dB.

PAXOLIN PANELS, 10in. x 8in., 1/6.
MINIATURE CONTACT COOLED RECTIFIERS, 250 v. 50 mA. 7/6; 250 v. 60 mA. 8/6; 250 v. 85 mA. 9/6. 200 mA. 21/-; 300 mA. 27/6.
SELENIUM RECT. 300 v. 85 mA. 7/6.
COILS. Wearite "P" type, 3/- each. Osrom Midget "Q" type, adj. dust core from 4/- each. All ranges.
TELETRON D.W.R. L. & Med. T.R.F. with reaction, 3/6.
FERRITE ROD AERIALS. M.W., 8/9; M. & L., 12/6.
FERRITE ROD AERIALS. L & M. for transistor circuits, 10/- each.
FERRITE RODS 8in. x $\frac{1}{2}$ in., 2/6.
H.F. CHOKES, 2/6.
T.R.F. COILS A/HF, 7/- pair; HAX, 3/-, DRR2, 4/-.

ALUMINIUM CHASSIS. 18 s.w.g. Plain, undrilled. 4 sides, riveted corners, lattice fixing holes. 2 1/2in. sides. 7in. x 4in., 4/6; 9in. x 7in., 5/9; 11in. x 7in., 6/9; 13in. x 9in., 8/6; 14in. x 11in., 10/6; 15in. x 14in., 17/6; 18in. x 16in. x 3in., 16/6.
ALUMINIUM PANELS. 18 s.w.g., 12in. 12in. 4/6; 14in. x 9in., 4/-; 12in. x 8in., 3/-; 10in. x 7in., 2/3.

AUTOCHANGER ACCESSORIES
Amplifier player cabinets with cut boards, 63/-.
2-valve amplifier and 6 $\frac{1}{2}$ speaker for above, ready mounted on baffle, 12in. x 7in., 3in. deep. Wired and tested ready for use. £4.15.0.

QUALITY 2-STAGE HI-FI AMPLIFIER. A.C. only. 200-250 v. Valves ECL82 and EZ80. 3 watt quality output. Mullard tone circuits, bass boost, treble and volume controls. Separate engraved Perspex front-panel with deluxe finish. Heavy duty output transformer 3 ohm. Shrouded mains transformer. Stove enamelled chassis size 6in. x 5in. x 3in. Bargain price £4.10.0. Circuit supplied.

ALADDIN FORMERS and cores. $\frac{1}{2}$ in. 8d., $\frac{1}{2}$ in. 10d. 0.3in. FORMERS 5937 or 8 and cans TV1 or 2, $\frac{1}{2}$ in. sq. x 2 $\frac{1}{2}$ in. or $\frac{1}{2}$ in. sq. x 1 $\frac{1}{2}$ in., 2/- with cores.
SLOW MOTION DRIVES. Epicyclic ratio 6-1, 2/3.
SOLENOID IRON, 25 w., 200 v. or 230 v. 24/-
PRECISION Sub-miniature Iron. 200 or 240 v. 29/6;
MAINS DROPPERS. 3in. x 1 $\frac{1}{2}$ in. With adj. sliders, 0.3A, 1,000 ohms, 4/3; 0.2A 1,000 ohms, 4/3.
LINE CORD, 0.3 A 60 ohms per foot, 0.2 A 100 ohms per foot, 2-way, 1/- per foot; 3-way 1/- per foot.
MIKE TRANS. 50:1, 3/9; 100:1 potted, 10/6.
P.V.C. CONN. WIRE, 8 colours, single or stranded, 2d. yd. Sleaving, 1.2 mm, 2d.; 4 mm, 3d.; 6 mm, 5d. yd.
SPEAKER FRET. Gold cloth, 17in. x 25in., 5/-; 25in. x 35in., 10/-; TYGAN, 52in. wide, 10/-; 26in. wide 5/- ft. Samples S.A.E. Expanded Metal, Gold, 12in. x 12in., 6/-.

AMERICAN "BRAND FIVE" PLASTIC RECORDING TAPE

Double Play 7" reel, 2,400 ft.	60/-	Spare Plastic Reels
5" reel, 1,200 ft.	37/6	
Long Play 7" reel, 1,800 ft.	35/-	
5 $\frac{1}{2}$ " reel, 1,200 ft.	23/6	3" 1/6
5" reel, 900 ft.	18/6	4" 2/-
		5" 2/-
Standard 7" reel, 1,200 ft.	25/-	5 $\frac{1}{2}$ " 2/-
5" reel, 600 ft.	16/-	7" 2/6

"Instant" Bulk Tape Eraser and Head Defluxer, 200/250V A.C. 27/6. Leaflet S.A.E.

QMAX CHASSIS CUTTER
The cutter consists of three parts: a die, a punch and an Allen screw.

Sizes	Price	Key
$\frac{1}{2}$ in.	12/9	1/-
$\frac{3}{4}$ in.	12/9	1/-
1in.	13/9	1/-
1 $\frac{1}{4}$ in.	13/9	1/-
1 $\frac{1}{2}$ in.	16/-	1/6
1 $\frac{3}{4}$ in.	16/-	1/6
2in.	18/-	1/6
2 $\frac{1}{4}$ in.	18/-	1/6
2 $\frac{1}{2}$ in.	20/6	1/6
2 $\frac{3}{4}$ in.	30/-	2/3
3in.	33/6	2/3
3 $\frac{1}{2}$ in.	38/6	2/3
4in. square hole	29/-	1/6

"REGENT" 4 VALVE

"96" RANGE VALVES

Kit Price £6.6.0
corr. 4/-



PRINTED CIRCUIT BATTERY PORTABLE KIT

Medium and long wave. Powerful 7 x 4 in. high Flux Speaker. T.C.C. Printed Circuit and condensers. Components of finest quality clearly identified with assembly instructions. Osrom Ferrite Aerial Coils. Rex ne covered attache case cabinet. Size 12 in x 8 in. x 4 in. Batteries used B126 (L5512) and AD35 (L5040), 10/- extra. Instructions 9d. (free with kit). Mains Unit ready made for above 39/6. Sold separately. Details free.

MONARCH RECORD PLAYER



SAVE POUNDS

BUILD IT YOURSELF using 4-SPEED BSR MONARCH AUTOCHANGER READY BUILT 3W AMPLIFIER, HAND-SOME PORTABLE CASE, HIGH FLUX LOUDSPEAKER. FULL INSTRUCTIONS SUPPLIED

Total Price Carr. and ins. 5/- **£12.10.0**

RECORD PLAYER BARGAINS

4 Speed Autochangers: POST 2/- each
BSR, U.A. 14..... £7.10.0
Collaro Autochanger..... £7.19.6
Garrard RC209..... £9.9.0
Garrard RC 210..... £10.10.0
4 Speed Single Players:
Garrard TA Mk. II..... £8.0.0
Garrard 4 HF Transcription..... £17.19.6
Garrard Stereo Heads, £2 extra.
All Sapphire Stylus available from 6/-
All Crystal Cartridges available from 21/-

ARDENTE TRANSISTOR TRANSFORMERS
Type D3035, 7.3 CT:1 Push Pull to 3 ohms for OC72, etc., 1in. x $\frac{1}{2}$ in. x $\frac{1}{2}$ in., 9/6.
Type 3034, 1.75:1 CT. Push Pull Driver for OC72, etc., 1in. x $\frac{1}{2}$ in. x $\frac{1}{2}$ in., 9/6.
Type D3058, 11.5:1 Output to 3 ohms for OC72, etc., 1in. x $\frac{1}{2}$ in. x $\frac{1}{2}$ in., 9/6.
Type D167, 18.2:1 Output to 3 ohms for OC72 etc., $\frac{1}{2}$ in. x $\frac{1}{2}$ in. x $\frac{1}{2}$ in., 12/-.
Type D239, 4.5:1 Driver Transformer, $\frac{1}{2}$ in. x $\frac{1}{2}$ in. x $\frac{1}{2}$ in., 10/-.
Type D240, 8.5:1 Driver Transformer, $\frac{1}{2}$ in. x $\frac{1}{2}$ in. x $\frac{1}{2}$ in., 10/-
ARDENTE TRANSISTOR VOLUME CONTROL. Type VC1545, SK with switch, dia. $\frac{3}{16}$ in., 8/-.
Type VC1760, SK with switch, dia. $\frac{1}{2}$ in., 10/6.
DEAF AID EARPIECE Xtal or magnetic 7/6.

WEYRAD

COILS AND TRANSFORMERS FOR A 2-WAVE TRANSISTOR SUPERHET WITH PRINTED CIRCUIT AND FERRITE ROD AERIAL

Long and Medium Wave Aerial—RA2W. On 6in. rod, $\frac{1}{2}$ in. diameter, 208 pF. tuning, 12/6. Oscillator Coil P50/1AC. Medium wave. For 176 pF. tuning, 5/4.
1st and 2nd I.F. Transformer—P50/2CC. 470 kc/s, $\frac{1}{2}$ in. diameter by $\frac{1}{2}$ in. high, 5/7.
3rd I.F. Transformer—P50/3CC, to feed diode detector, 6/-.
Driver Transformer—LFDT2, 1 $\frac{1}{2}$ in. x $\frac{1}{2}$ in. x $\frac{1}{2}$ in., 9/6.
Printed Circuit—PCAL. Size 2 $\frac{1}{2}$ in. x 8 $\frac{1}{2}$ in. Ready drilled and printed with component positions, 9/6.
7in. x 4in., 35 ohm Speaker, 25/-.
Wavechange Switch 3/6.
These components are approved by transistor makers and performance is guaranteed. Constructor's Booklet with full details, 2/-.

NEW MULLARD TRANSISTORS

Audio OC71 ... 6/-	R.F. OC44 ... 10/6
OC72 ... 7/6	OC45 ... 9/6

Sub-miniature Electrolytics (15 V). 1 mfd. 2 mfd., 4 mfd., 5 mfd., 8 mfd., 25 mfd., 100 mfd., 2/6. Diodes OA71, OA81, 3/-; GEX 34 4/-.

B.B.C. Pocket 2 Transistor. M.W. and L.W. Radio Kit, 32/6. Phones 7/6 or deaf aid carpiece, 7/6.

"P.W." Pocket 6. Transistor kit. All parts, printed circuit and cabinet. Osrom Designed Kit, £8.15.0. Mk. II all the latest modification.

READERS OF 'RADIO CONSTRUCTOR' "
SPECIALISTS 337 WHITEHORSE ROAD
WEST CROYDON Telephone THO 1665
& P. charge 1/-, over £3 post free. C.O.D. 2/- (Export welcome. Send remittance and extra postage)

TEST EQUIPMENT OF EXCEPTIONAL QUALITY

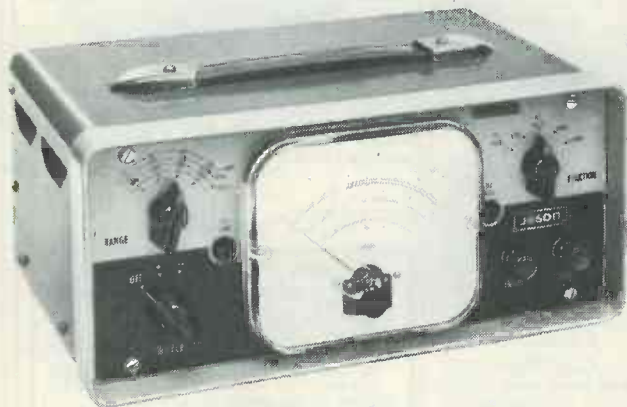

by

Jason

in

KIT FORM

• TEST EQUIPMENT

● VALVE VOLTMETER (illus.)

4-valve Bridge Circuit. 23 ranges inc. D.C. Kit inc. valves, 4½" sq. meter and case. £23.0.0
High voltage probes £3 extra.

● OSCILLOSCOPE OG.10 (illus.)

Sensitivity of 10 mV/cm. with bandwidth 2 c/s. to 2 Mc/s. Push/pull amps. on X and Y plates. With 2½" tube, valves and case. £22.10.0

● AUDIO GENERATOR A.G.10

Tunes from 10 c/s to 100 Kc/s with output constant within 1dB. Square wave rise time better than 2 microseconds. With valves and case. £15.19.0

● AUDIO ATTENUATOR AA.10.

Nine steps by switches from 1dB to 40 dB. £7.15.0

● WOBBLATOR W.11

For all IF and RF alignment. Complete kit. £14.19.0

● CRYSTAL CONTROLLED CALIBRATOR C.C.10.

For use in 10 Kc/s to 250 Mc/s range with 0.01% basic accuracy. £19.19.0

Literature on all Jason items gladly sent on request.

● New Argus Transistor Radio Tuner for Recorder and Amp. £7.10.0

● NEW STEREO/MONO DE LUXE TAPE UNIT JTL

In Kit Form, complete with Valves and Instructions 20 gns.

Ready Built 29 gns.

AMPLIFIERS • TUNERS

(Built).

J.2-10. Mk. III Stereo/Mono Amp: £40.19.0

J.10 Mono Amp., 10 watt £24.0.0

FMT.4 FM Fringe Tuner £23.6.9

(inc. £6.15.7 P.T.)

JTV/2. Switched FM and TV Sound Tuner (inc. £6.15.7 P.T.) £25.19.7

Monitor—as JTV/2 but for cabinet mounting (inc. £5.4.1. P.T.) £19.19.1



Jason

ELECTRONIC TEST EQUIPMENT HIGH FIDELITY TEST EQUIPMENT

JASON ELECTRONIC DESIGNS LIMITED, KIMBERLEY GARDENS, LONDON N.4.

Telephone STA 5477

CLYNE RADIO LTD.

THE COMPONENT SPECIALISTS



18 TOTTENHAM COURT ROAD, W.1
162 HOLLOWAY ROAD, LONDON, N.7
9 CAMBERWELL CHURCH STREET, S.E.5

MUSEum 5929/0095
NORth 6295/6/7
RODney 2875

All post orders and correspondence to 162 HOLLOWAY ROAD, LONDON, N.7

OPEN: Tottenham Court Rd. 9 a.m. to 6 p.m. Mon. to Fri., Sat. 1 p.m. Holloway Rd. and Camberwell: 9 a.m. to 6 p.m. daily, Thurs. 1 p.m., Sat. 5.30 p.m.

Our Advantageous H.P. and Credit Sale Terms are available on any single item over £5. Your enquiries invited. Please print your name and address.

NEW! THE "CLYMAX"

At last a 6-transistor pocket size superhet for Medium and Long Wave at a price you can afford. All required components at ONLY



£6.16.6

Plus
2/6
P & P

Nothing
more
to buy

- ★ Completely self contained. No external aerial or earth required.
- ★ Full medium wave coverage, plus switched Light programme on long wave.
- ★ Push-pull output—250 milliwatts.
- ★ Matched set of latest type Mullard transistors.
- ★ Genuine 3in P.M. Speaker.
- ★ High-Q Coils.
- ★ Ferrite rod aerial with high selectivity.
- ★ Size 5½ x 3¼ x 1½in.
- ★ Two tone cabinet.
- ★ Precision etched printed circuit with component references clearly marked.
- ★ Alignment service available. All parts available separately. Full assembly instructions and individually priced parts list, 2/-, post free.

1 VALVE SHORT WAVE RADIO

World-wide coverage at most reasonable cost.

Covers 40-100 metres with the coil supplied. Can be extended to cover 10-100 metres. Provision is also made for the addition of two extra valve stages. Employs the famous Acorn-type 954 valve. All necessary components can be supplied Complete with full assembly instructions at ONLY 35/- plus 2/- P. & P. Send 2/- for point-to-point wiring diagram and price list.

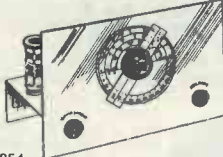

THE "CITIZEN"

Our Sensitive 5 Stage (4 transistor plus diode) pocket transistor receiver—for full medium wave reception—with the following outstanding features:

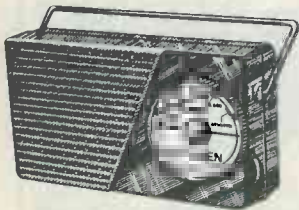

NEW
LOW
PRICE

85/-
Plus
2/6
P. & P.

- ★ Completely self-contained—No external aerial or earth required.
- ★ Genuine 2in. High Flux P.M. Speaker.
- ★ Push-pull output—250 milliwatts.
- ★ Genuine Ediswan transistors.
- ★ Socket provided for personal listening.
- ★ Socket provided for connection to Car Aerial.
- ★ Volume Control with on/off switch—Condenser tuning.
- ★ Easy assembly on colour coded pre-tagged circuit board.
- ★ Attractive red polystyrene cabinet measures 5½ x 3 x 1½in., chrome handle, attractive dial.
- ★ All required components including full instructions, solder, etc. and battery at special inclusive price of only 85/- (Yes, Eighty-five Shillings Only) Plus 2/6 P. & P. Nothing more to spend. Suitable crystal deaf-aid type miniature ear-piece fitted with miniature jack plug at 7/6 extra only if req. All parts available separately—temised list and full assembly instructions, sent for 1/6 post free. Hear this amazing little receiver working, at any of our branches.

NEW! The "HIGHWAYMAN"

Ready shortly!

At last a quality Car Radio to build yourself, at an economical price

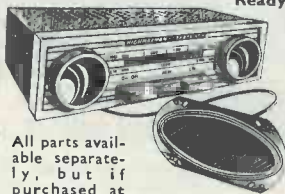

All parts available separately, but if purchased at one time, the whole will be supplied at a special inclusive price of only

£10.19.6 Plus

4/- P. & P.

Parts list and comprehensive instruction booklet 2/6, post free. (Deducted from cost if complete parcel purchased later.)

Look at these features:

- ★ Attractive styling
- ★ Push pull output.
- ★ 3 latest Mullard transistors, plus valves type EBF 83 and ECH 83.
- ★ No Buzz, High Output and sensitivity.
- ★ Printed circuit (newest type).
- ★ 7" x 4" High flux p.m. speaker.
- ★ FULL Medium and Long Wave Coverage.
- ★ Push Buttons for fingertip control.
- ★ Extremely low Battery consumption (less than ½ amp).
- ★ Easy to fit—any make car. (Positive earth only.)
- ★ 12 volt operation.
- ★ Compact size measures only 7" x 7" x 2" deep.
- ★ Easy assembly, supplied with dial and drive already mounted.

"POPULAR FOUR"



Improved Appearance & Performance

A new three valve plus miniature contact-cooled rectifier, mains T.R.F. Receiver is now available. New De Luxe Cabinet polished walnut finish, cream trim, attractive horizontal dial (as illustrated). Quality 5in. P.M. speaker. Specially wound high gain super-sensitive Denco coils. Medium and Long Wavebands. Excellent Continental reception! Overall dimensions: 12in x 6in x 5in. A.C. 200/250 v. Simple construction with guaranteed results. Easy to follow practical and theoretical diagrams supplied. All necessary components, down to the last nut and bolt, are offered at a SPECIAL INCLUSIVE PRICE OF £5.5.0, plus 3/6 P. & P. Instruction book available separately 1/6, post free. ALL PARTS AVAILABLE SEPARATELY.

STOP PRESS! The well known Brayhead Trans Tronic "SUPER 60" Radio Kit. A complete construction kit to make your own transistorised Transmitter and Receiver. No soldering reqd. 7 different circuits to build. Ideal Xmas Gift—beautifully presented in original manufacturers' coloured box with all necessary instructions. (As nationally advertised at £5.4.8). Limited quantity only at 49/6. Plus P. & P. 4/-.

OUTSTANDING METER IMPORT!

20,000 ohms

per volt!

MODEL 200H.

Volt-ohm-Milliammeter

Ranges: A.C. Voltage: 10, 50, 100, 500 and 1,000 volts (10,000 ohms per volt). D.C. Voltage: 5-25, 50, 250, 500, and 2.5k. (20,000 ohms per volt). D.C. Current: 0-50 microamps. 0-2.5 ma. 0-250 m/a. Resistances: 0-6k, 0-6 meg. (300 ohm and 30k at centre scale). Capacitance: 10 pF to 0.01 mfd. .001 mfd. to 1 mfd. Decibels: —20 to +22 dB.



A fully guaranteed pocket size meter, (actual size: 4½in. x 3½in. x 1in.) knife edge pointer, top quality supplied complete with test leads and full operating instructions at: £6.19.6 ONLY. Post free. JUST ARRIVED!! Model TE.10. Identical in appearance and size, with rotary type switch, but 10,000 o.p.v. Ranges: DC: Voltage: 0-6-30-120-600-1200 Volts (10,000 Ohms per Volt). AC Voltage: 0-6-30-120-600-1200 Volts (10,000 Ohms per Volt) DC Current: 0-120 microamp. 0-3-300mA. Resistance: 0-30 K. 0-3. Meg (150 Ohm and 15 K at centre scale). Capacitance: 50 pF to 0.01 mfd. 0.001 mfd. to 0.15 mfd. Decibels: —20 to +63 dB in 5 ranges. PRICE £5.19.6. Post Free. Optional extra, attractive carrying case 15/- only. (Bonafide trade enquiries invited). Leaflet available. H.P. AVAILABLE

RADIO JACK

Covers local medium wave stations variably tuned. Compact self contained unit requiring only connection to aerial (no power supplies reqd.) for 1st class reception when used in conjunction with your tape recorder or high gain amplifier. All necessary parts available at a special inclusive price of ONLY 19/6, P. & P. 1/6.

THE "WAVEMASTER 7-TRANSISTOR LUXURY PORTABLE"

★ New Low Price £9.19.6 ★

400
Milliwatt
Output



To build yourself, Medium and Long Waves — Push-Pull Superhet A.V.C. Perfect Car Radio reception. Size 10in. x 6in. x 4½in. at base tapering to 4in. at top. Very attractive

two-tone grey Vynide covered cabinet with black and gold printed escutcheon plate, cream and gold knobs, handle and cabinet fittings ★ Weight—complete with long-life 7½ v. battery—4½ lb. ★ Mullard high-grade transistors throughout. ★ High-Flux 7in. x 4in. Elliptical Speaker. ★ Slow motion tuning. ★ Co-axial socket at rear for direct connection to Car Radio Aerial ★ Improved reception by use of five-section plated telescopic aerial disappearing into Cabinet when closed. 34in. above Cabinet when fully extended. Construction simplified by Bakelite chassis board with the following components already mounted: I.F. Transformers (3), Oscillator Coil, Trimmer Bank, Output Transformer, Interstage Transformer, Aerial Brackets and Earth Bar. SPECIAL INCLUSIVE PRICE for all required components, full assembly instructions—nothing more to buy—is £9.19.6. plus 3/6 P. & P. Alignment service available. Full assembly instructions and individually priced parts list, all of which are available separately, 2/6, post free.

HOME RADIO OF MITCHAM

Dept. AC, 187 London Road, Mitcham, Surrey. MIT 3282. Shop hours: 9.0 to 6.30 p.m. (Weds. 1.0 p.m.)

WE ARE ACTUAL STOCKISTS OF HEATHKITS

INCLUDING THE WONDERFUL NEW EW-1 ELECTRONIC WORKSHOP

20 exciting experiments with this one kit, transistor radios, intercom sets, burglar alarms, electric eye, TV silencer, etc. No soldering! No tools required! Wonderful and instructive gift for any youngster (and Dad). Learn basic principles of radio and electronics this easy and absorbing way. Kit complete with circuit boards, transistors, speakers, earphone, photo-cell, relay, resistors, condensers and comprehensive instruction manual. PRICE **£7.18.0**, post paid.

MINIATURE TRANSISTOR ASSEMBLIES

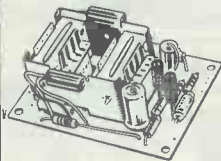

1 WATT AMPLIFIER. Suitable for microphone, gram, radio, or guitar, this compact amplifier measures only 3" x 2 1/4" x 1 1/4", completely assembled and tested with four top-grade transistors. 1 watt output to 3 ohms speaker. PRICE **£4.12.6**, post paid.

SUPERHET CONVERTER UNIT. Fully transistor push-button all-wave converter covering Long, Medium, and Short wave. Output 460 kc/s. PRICE **£4.7.8**, post paid.

I.F. AMPLIFIER STRIP. Beautifully engineered miniature strip measuring only 3 1/2" x 1 1/2" x 1". Fully aligned and tested, using two OC169 in new circuit with five tuned circuits and AVC. PRICE **£4.12.6**, post paid.

FM/VHF TUNER. Fully assembled and factory aligned covering the full FM band, 87-108 Mc/s with output at 10.7 Mc/s. Size only 4" x 1 1/2" x 1 1/2". Very sensitive. PRICE **£6.3.9**, post paid.

10.7 Mc/s. I.F. AMPLIFIER. Fully assembled, aligned and tested, with three OC170 transistors and six tuned circuits. Size only 2" x 4 1/2" x 1", including ratio detector giving audio output. PRICE **£6.6.0**, post paid.

Leaflet giving full details and specification on request.

MULLARD TRANSISTORS NEW AND BOXED

OC44 11/-, OC45 10/-, OC70 6/6, OC71 6/6, OC72 8/-, OC75 8/-, OC76 8/-, OC78 8/-, OC81 8/-, OC170 13/6, OC171 14/6, OA70, OA79, OA81 all 3/- each. Matched pairs of output transistors and OA79 diodes available. Why risk inferior results with "surplus" transistors when the best are available at these new low prices. **PLEASE ADD 6d. POSTAGE TO ORDER**

IMPORTANT NOTICE

We will be closed
ALL DAY Monday
1st January
for stocktaking

HIGH FIDELITY LOUDSPEAKERS

FULL RANGE STOCKED OF
GOODMANS, WHARFEDALE, W.B. etc.



STENTORIAN HF1012. 10" high-flux speaker with universal speech coil for 3, 7, or 15 ohms. Die-cast chassis. Response 30 to 14,000 cycles. 10 watts handling. The most popular HI-FI speaker on the market. PRICE **£5.2.6**, post 2/-.

GOODMANS AXIOM 110. Full range 10" unit with hyperbolic diaphragm giving smooth response 40 to 15,000 cycles. 12,000 gauss magnet and aluminium voice coil. 15 ohms only. PRICE **£5.2.6**, post 2/-.

WHARFEDALE GOLDEN 10". FSB. As used by B.B.C. Foam suspension for clean bass response. Die-cast chassis and 14,500 gauss magnet. Superb reproduction, and will transform any amplifier or radio. PRICE **£8.6.7**, post 2/-.

TRIPLETONE AMPLIFIER

HI-FI MAJOR

Inputs for Mic. and gram. with mixing facilities. Boost on Treble, Middle, and Bass. Spare power for Tuner. Push-pull output giving 12 watt high quality audio. Suitable for 3 and 15 ohm speakers. Beautifully engineered and wired. Response 15 to 20,000 cycles. PRICE Chassis only **£15.18.9**. Complete in case **£17.8.9**, post paid.



GEMINI

Brand new integrated amplifier and pre-amp for mono or stereo reproduction. Boost on Treble, Middle, and Bass. 4 watts high quality output on each channel for stereo and 8 watts for mono. Output matched for 3 ohms speakers. Complete with handsome front panel and in neat shelf mounting case. PRICE **£15.15.0**.



RECORDING TAPES

Brand new proprietary tapes in makers' boxes. EMITAPE. 3" 175 ft. 7/6, 5" 600 ft. 21/-, 5" 850 ft. 28/-, 5 1/2" 850 ft. 28/-, 7" 1,200 ft. 35/-, 7" 1,800 ft. 50/-, SCOTCH BOY. 3" 150 ft. 5/3, 5" 600 ft. 18/-, 5 1/2" 850 ft. 24/6, 5 1/2" 1,275 ft. 35/-, 7" 1,200 ft. 30/-, 7" 1,800 ft. 50/-, BASF. 4" 300 ft. 13/6, 5" 600 ft. 21/-, 5" 850 ft. 27/6, 5 1/2" 850 ft. 27/6, 7" 1,200 ft. 35/-, 7" 1,800 ft. 55/-, GRUNDIG. 5 1/2" 1,200 ft. 35/-, 7" 1,800 ft. 50/-, FERRODYNAMICS (U.S.A.) 5" 600 ft. 16/6, 5" 900 ft. 18/6, 5 1/2" 1,200 ft. 23/6, 7" 1,200 ft. 25/-, 7" 1,800 ft. 35/-.

PLEASE ADD 1/- POSTAGE TO ORDER

SUPER NEW CATALOGUE

- 170 PAGES
- 600 PICTURES
- 5,000 ITEMS

PRICE 2/-

Plus 1/- Postage

NEW EDDYSTONE 840C



The latest of the famous EDDYSTONE range of communications receivers, smart, streamlined and a delight to operate. Advanced design, rugged construction, and highest quality components used throughout, and made for continuous operation under all conditions. High grade gear-driven slow-motion drive with full-width dial. Five ranges covering 480 kc/s to 30 Mc/s. Just the set for the serious short-wave listener or amateur PRICE **£58.0.0** (Overseas shipping arranged).

ANTEX PRECISION IRON

A wonderful iron for the constructor. Five different sizes of interchangeable bits available so that all types of work from sub-miniature to ordinary wiring can be tackled. All voltages from 6 to 240 volts in stock. Model as illustrated with one bit 29/6, post paid. Leaflet on request. Please state voltage required. Ideal gift.

HI-FI EQUIPMENT

Stockists for
LEAK, QUAD, PYE, H.M.V., ARMSTRONG

MULLARDS

Circuits for Audio
Amplifiers 8/6 Post 1/-

ARMSTRONG STEREO 12

The most complete radio and Hi-Fi chassis ever produced. Everything you want on one compact modern streamlined chassis. Long and Medium wave plus FM/VHF, push-pull Mono or Stereo output, pre-amp tone control unit, facilities for tape. PRICE **£44.15.0**. ALL OTHER ARMSTRONG MODELS IN STOCK FROM 22 GNS.

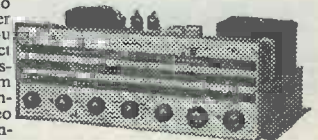

THE Radio Constructor

Incorporating THE RADIO AMATEUR

Vol. 15, No. 5

Published Monthly

Annual Subscription 29/-
(including postage)

*Editorial and
Advertising Offices*

57 MAIDA VALE LONDON W9

Telephone
CUNningham 6141
(2 lines)

Telegrams
Databux, London

DECEMBER 1961

Suggested Circuits No. 133: 2-Transistor Signal Generator for Broadcast Band Receivers, by G. A. French	334
Novel Power Supply, by S. G. Wood, G5UJ	337
Gadgets for your Christmas Party, by W. Holmes	338
The "Aberdonian", A Simple Transistor Receiver, by J. Anderson	343
Can Anyone Help?	344
Understanding Radio, Part 5, by W. G. Morley	345
In Your Workshop	350
Should a Glowing Valve be Discarded?	355
News and Comment	356
Trade Review, Martin Recordakits	357
Small Capacitance Measuring Instrument, by P. A. Robinson	358
A Constructor Visits the Hallicrafters Factories	361
The "Quintet", 5-Transistor Pocket Loudspeaker Radio, designed by D. J. French, Grad.I.E.E.	363
Radio Astronomy, Part 3, by Frank W. Hyde, F.R.S.A., F.R.A.S.	367
Converting the Bendix MN26C Receiver, by A. Foord	374
Radio Topics, by Recorder	381
Interpretation of Transistor Data, Part 3, by V. T. Rolfe	384
The 1961 Electronic Computer Exhibition	385
Kit Review, the "Mini-4" Pocket Transistor Receiver	387

© Data Publications Ltd, 1961

We wish all our readers a very Happy Christmas and a Prosperous New Year - Editor.

CONTENTS may only be reproduced after obtaining prior permission from the Editor. Short abstracts or references are allowable provided acknowledgment of source is given.

OPINIONS expressed by contributors are not necessarily those of the Editor or the proprietors.

TRADE NEWS. Manufacturers, publishers, etc., are invited to submit samples or information of new products for review in this section.

TECHNICAL QUERIES must be submitted in writing. We regret that we are unable to answer queries, other than those arising from articles appearing in this magazine; nor can we advise on modifications to the equipment described in these articles.

CORRESPONDENCE should be addressed to the Editor, Advertising Manager, Subscription Manager or the Publishers, as appropriate.

REMITTANCES should be made payable to "DATA PUBLICATIONS LTD."

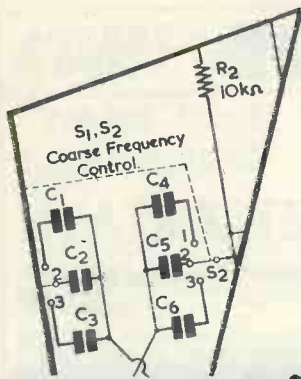

The circuits presented in this series have been designed by G. A. FRENCH, specially for the enthusiast who needs only the circuit and essential data

suggested circuits



2 TRANSISTOR SIGNAL GENERATOR FOR BROADCAST BAND RECEIVERS

THIS MONTH'S CIRCUIT IS FOR A two transistor signal generator covering the Medium and Long wave bands, together with the frequencies commonly employed in broadcast receiver i.f. stages. As such, the instrument is completely suitable for the alignment of valve or transistor Medium and Long wave receivers. The r.f. output of the signal generator may be modulated, and both a continuously variable attenuated output at low impedance and a high level output are provided. A separate a.f. output socket is also available.

Because of the relatively small number of components required the signal generator may be built into a small case suitable for servicing work in the field as well as on the bench. A single 9 volt battery provides the power supply, and current consumption is of the order of 6mA.

The frequency coverage of a prototype made up to the circuit was: Range 1, 1,500 to 380 kc/s; Range 2, 310 to 135 kc/s. In consequence Range 1 covers Medium waves and extends beyond the 455-475 kc/s band normally employed for broadcast receiver i.f. stages. Range 2 covers the Long wave band. In a simple signal generator of this nature it would be difficult to maintain a constant r.f. output at all frequencies without considerable complication of the circuit, and the present design was aimed at maintaining a sufficiently level output for normal servicing applications. On

Range 1 the attenuated output of the prototype (with the attenuator set to maximum output) varied between 70 and 35mV peak, according to frequency; whilst on Range 2 it varied between 60 and 20mV peak. Higher output levels (with the same proportional variation) may be obtained by simple changes to component values, and this point is discussed later. The output available at the high r.f. output socket is approximately 25 times that given at the attenuator.

Some of the component values given in the circuit diagram may need to be adjusted in individual models. Also, it is necessary to have a Medium and Long wave superhet receiver available during construction in order to carry out simple checks on oscillator performance.

Circuit Functioning

In the circuit, which accompanies this article, TR₁ is the r.f. oscillator. When S_{1(a)}, (b), (c) and (d) are set to Range 1, the collector of TR₁ couples to the tuned winding, L₃, of L₃L₄ via the 50pF capacitor C₆. L₃ is tuned by C₄ and C₅ in parallel. Switch S_{1(b)} connects the coupling winding L₄ to the base of the transistor by way of R₃ and C₇ in parallel, and the transistor oscillates at the resonant frequency given by L₃ and C₄C₅. A small amount of frequency selective negative feedback is applied to the emitter of TR₁ by R₇ and C₁₀, this feedback assisting in maintaining a level r.f. output for all settings of

C₄C₅. When S_{1(a)}, (b), (c) and (d) are set to Range 2 the collector of the transistor couples to L₁, and the base to L₂. To enable a reasonably level r.f. output to be obtained, Range 2 is restricted at the low frequency end by reducing the total tuning capacitance. This is achieved by S_{1(c)} which disconnects C₅, allowing tuning to be carried out by C₄ alone. There is also a very small degree of restriction at the high frequency end of the range, this being offered by C₁ which is connected permanently across the tuned winding L₁. Despite the restriction offered, the signal generator covers the Long wave band quite adequately and it is possible to retain the simple circuit around the transistor which is associated with Range 1 operation. Switch S_{1(d)} modifies the feedback to the emitter of TR₁ on Range 2 by connecting C₁₁ in parallel with R₇ and C₁₀.

The r.f. voltage at the collector of TR₁ is fed to R₆, R₅ and R₄ in series. A high level output is available at the junction of R₆ and R₅, and a continuously variable output from the slider of R₄.

The a.f. oscillator employs a phase-shift circuit around TR₂. This oscillator circuit has been introduced in a previous article in this series,* and it has the advantage of offering a sine wave output at good amplitude. If small components are employed

* Suggested Circuits No. 118, "A Single Transistor Phase-Shift Oscillator". *The Radio Constructor*, September 1960.

for the capacitors in the phase-shift network, the oscillator need occupy little more space than an equivalent transformer coupled circuit. The phase-shift network is provided by C_{12} to C_{15} , and R_9 , R_{10} , R_{11} , R_{12} and R_{14} . Resistors R_{14} , R_{12} and R_{13} stabilise the transistor, R_{14} , serving also to bring the transistor onto its optimum operating point. C_{16} bypasses the emitter resistor R_{13} .

Modulation of the r.f. oscillator by TR_2 is achieved by the simple process of coupling the two collectors together by R_8 . An a.f. output for servicing work is also available from the collector of TR_2 , this being obtained via C_{17} .

range covered. The value of the emitter capacitor C_{10} is rather critical. Too high a value in this component may cause squegging at the high frequency end of the range, whilst too low a value may cause reduced oscillation amplitude at the low frequency end. This point is discussed further when the construction of the unit is described.

An important feature of Range 1 is that the wide frequency range available enables not only the Medium wave band to be covered, but also the intermediate frequencies employed in broadcast band receivers.

Range 2 is only required to cover

shown in the diagram, approximately 1/50th of the r.f. voltage on the collector appears across R_4 , and the r.f. output given here should be adequate for general servicing purposes. No noticeable detuning of the signal generator tuned circuit occurred in the prototype when differing loads were presented to this potentiometer. If desired, the value of R_4 could be doubled, thereby doubling the r.f. output available, but it would be inadvisable to increase the value of R_4 by any greater amount because of the possible risk of signal generator detuning with different loads (or as the attenuator is adjusted). The

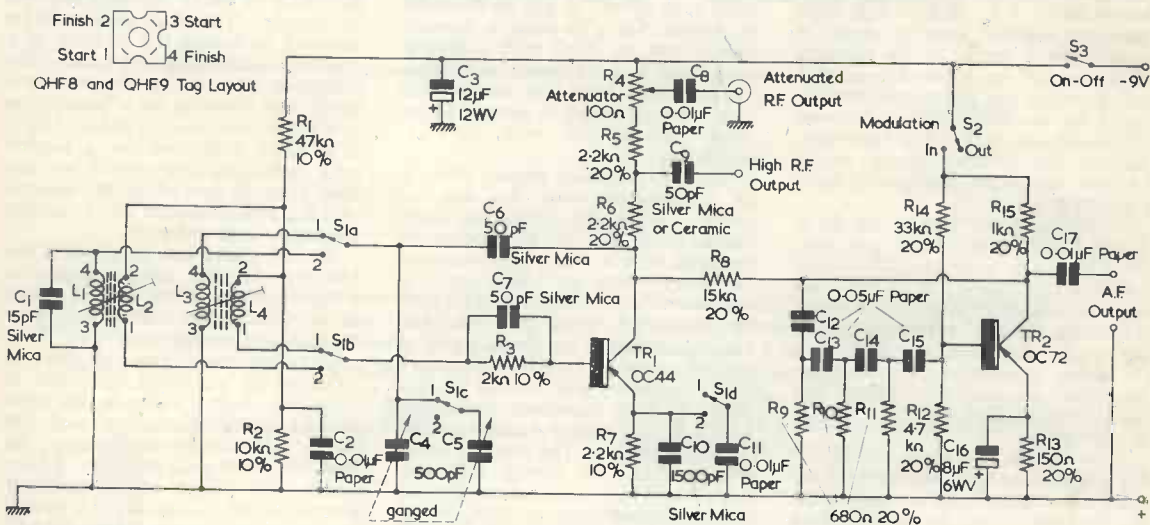

All Resistors 1/8W

Some component values may need adjustment (see text)

L_1, L_2 Osmor QHF9

L_3, L_4 Osmor QHF8

$S_{1a-b-c-d}$ ganged range switch, 4-pole, 2-way

Range 1 - 1500 to 380 Kc/s nominal

Range 2 - 310 to 135 Kc/s nominal

MI97

Design Points

There are a number of design points which need consideration and these will now be discussed.

When the r.f. oscillator is on Range 1 the transistor circuit employed is one which the writer has found to give reliable results in practice despite the extremely wide tuning capacitance swing of some 1,000pF. The coil employed for L_3L_4 is a conventional miniature Medium wave r.f. coupling type, and is readily available through normal home-constructor channels. On Range 1 R_3 limits base current whilst C_7 boosts oscillator amplitude at the low frequency end of the range. Together, the two components help to maintain oscillation amplitude reasonably level over the

the Long wave band. It was found in the prototype that, by restricting the tuning range offered by L_1 in the manner described above, adequate performance could be achieved and the only modification to the TR_1 circuit consisted of connecting C_{11} across R_7 and C_{10} . It should be mentioned that the value of C_{11} , like that of C_{10} , is somewhat critical. The coil L_1L_2 is a standard component, readily available through normal retail channels.

It is a little difficult to obtain a satisfactory point in the oscillator circuit from which to take an output voltage; and it was decided finally to take this from the collector of TR_1 , even though the collector couples to the tuned winding of the r.f. circuit. Using the circuit values

single potentiometer shown in the diagram could be replaced by an attenuating step switch and potentiometer arrangement if something more comprehensive were required.

The high r.f. output offered at the junction of R_5 and R_6 may be useful for some applications but it must be borne in mind that varying capacitive loads at this point may cause noticeable detuning of the oscillator. If the high r.f. output facility is not required, R_5 and R_6 may be replaced by a single 4.7k Ω 20% resistor.

The phase-shift oscillator given by TR_2 has a nominal frequency of 1,000 c/s. Low tolerance components are specified in the phase-shift network (20% for resistors, and 20 or 25% for capacitors, according to make) because it is much cheaper

to commence with such components and make slight adjustments afterwards, if variations in the frequency obtained are required, than it is to start with close tolerance components. If, after the phase-shift oscillator has been completed, it is found that the output varies widely from 1,000 c/s, one or more of the 680Ω resistors may be adjusted accordingly.

The a.f. output sockets from TR₂ may be connected to any load down to 100Ω without oscillations ceasing. As would be expected, output voltage commences to drop for loads below some 15kΩ, and output frequency changes slightly for loads below 2kΩ. A.F. amplitude is such that an audible tone is given if connection is made to the primary of a speaker transformer, and this factor makes the a.f. output facility useful for servicing work. A lower a.f. amplitude, with better frequency stability for differing loads, would be given by taking the output from a tap in R₁₅.

It will be noted that, when S₂ is in the "Out" position, a d.c. path from the h.t. negative rail to the collector and base of TR₂ is provided via the collector load of TR₁ and R₈. The voltage appearing across TR₂ under this condition is too low to permit oscillation and there is, therefore, no need to change the simple modulation switching shown in the circuit.

With certain exceptions, the working voltages of the fixed silver-mica and paper capacitors employed in the unit need only be greater than the 9 volt supply potential, and this point may be of assistance if miniature components with low working voltages are available. C₈, C₉ and C₁₇ should, however, have a working voltage of at least 350, since these capacitors may be coupled to high voltage points in equipment under test. The capacitances specified for C₃ and C₁₆ are minimum values. Larger capacitances in these components should not upset circuit functioning.

It must be pointed out that the circuit is designed for use with the coils and transistors specified. Other coils and transistors will probably require different circuitry.

Supply potentials greater than 9 volts should not be applied to the unit, as this figure approaches the maximum limiting collector voltage for TR₂ when it has the external base resistance employed here.

Construction

The signal generator should be built into a metal case connected to

the h.t. positive rail in order to prevent radiation from the r.f. oscillator circuits. The battery should, preferably, be mounted inside the case, but this is not essential. The attenuated r.f. output socket may be a coaxial type, the remaining sockets being of the wander-plug type. The capacitance between the high r.f. output socket and chassis should be kept low.

Layout is not critical provided that r.f. tuned circuit leads are kept short and well spaced away from chassis. The two coils should be clear of the sides of the metal case to prevent loss of Q. The r.f. and a.f. oscillator components need not be screened from each other. It will be desirable to mount C₄C₅ in such a manner that it can be fitted with a clearly read scale and a slow-motion drive.

The circuit may best be brought into working order in several steps, these commencing with the a.f. oscillator.

The a.f. oscillator should initially be constructed with R₁₄ out of circuit. After the circuit has been checked over, R₁₄ may be temporarily replaced with a 50kΩ potentiometer in series with a 15kΩ limiting resistor. The a.f. output sockets may be connected to a pair of high resistance phones or to the input of an a.f. amplifier. The temporary 50kΩ potentiometer should be adjusted to offer maximum resistance, and a 9 volt supply applied to the TR₂ circuit only. The potentiometer should then be slowly adjusted, whereupon a.f. oscillations should commence and pass through a fairly flat peak in amplitude as the slider moves along the track. The resistance of the potentiometer at peak setting in series with the 15kΩ resistor should then be measured, and the two components replaced by a fixed resistor of the same value plus or minus some 5kΩ. (The writer has found, in several oscillators built to this circuit, that 33kΩ in the R₁₄ position appears to represent an average working value and allows reliable oscillation to occur immediately after construction. It is still, nevertheless, desirable to find an optimum value for this resistor with the aid of the potentiometer if best results from the signal generator are required.)

If the a.f. oscillator frequency varies widely from 1,000 c/s it may be corrected by changing the value of one or more resistors, say R₉ or R₁₀, in the phase-shift network. Increasing the value of a resistor will lower the frequency of oscillation, and vice versa.

The r.f. oscillator may then be brought into working order. Initially,

the dust cores in both coils should be adjusted to provide maximum coupling between the two windings. S₁ should be set to "Range 1" and S₂ to "Out". The aerial of a receiver switched to Medium waves is then coupled to the oscillator by holding a wire from the aerial socket close to the coils in the signal generator. H.T. may now be applied to the oscillator. If the oscillator is functioning correctly it should be possible to obtain clean heterodynes with stations spaced around the Medium wave band by adjusting C₄C₅. Unless the receiver has an efficient i.f. trap it should also be possible for the output of the signal generator to break through into the i.f. circuits. The latter point may be checked by tuning the receiver to a station (preferably at the low frequency end of the Medium wave band) and listening for a heterodyne as C₄C₅ passes through 455-475 kc/s. If a valve voltmeter (or a similar peak indicating instrument) is available it may be coupled to the collector of TR₁, and a measure of r.f. voltage over the range obtained.

Should a loud hiss be heard in the receiver as the signal generator frequency approaches that to which it is tuned, the signal generator oscillator is squegging. This is an undesirable condition and may be obviated by adjusting the value of C₁₀. Too high a value in this component causes squegging, and too low a value causes amplitude at the low frequency end to drop. Other components which affect oscillator operation are C₇ and R₃. C₇ boosts amplitude at the low frequency end of the range and may be increased or decreased accordingly. Too low a value in R₃ may cause oscillator amplitude to change abruptly, instead of smoothly, as C₄C₅ is swung. After the oscillator has been brought into working condition on Range 1, S₂ may be switched to "In". Modulation depth should compare favourably with that of broadcast stations on the Medium wave band.

The signal generator may then be switched to "Range 2", and the receiver to the Long wave band, whereupon it should be possible to receive oscillations at all points in the range. If squegging occurs at the high frequency end of the range, C₁₁ should be reduced in value, bearing in mind that too low a reduction will cause oscillator output to drop excessively at the low frequency end of the range. It is worth pointing out that some domestic Medium and Long wave receivers tend to be unstable at the extreme high frequency end of the Long wave band and that this effect should not be con-

fused with signal generator squeegging.

The final process consists of the calibration of C_4C_5 . This should be carried out when the signal generator is completely enclosed in its case. Calibration points may be obtained by beating the output of the signal generator with stations whose frequencies are known, or by beating with another signal generator.

Results with the Prototype

The frequency range offered by the prototype was 1,500 to 380 kc/s on Range 1 and 310 to 135 kc/s on Range 2. These ranges were measured by beating with a calibrated signal generator.

The peak r.f. voltage on the collector of TR_1 varied between 3.5 and 1.8 on Range 1, greatest amplitude occurring around 900 kc/s and

lowest amplitude at the low frequency end. On Range 2 the peak r.f. voltage was 3 at the high frequency end of the range, dropping to 1.5 volts around 150 kc/s and to 1 volt at 135 kc/s.

The current consumption, for an applied voltage of 9, averaged at 1mA with modulation switched out and 6mA with modulation switched in.

Novel Power Supply

By

S. G. WOOD

G5UJ

USED SUCCESSFULLY BY AN AMATEUR FRIEND, THE rather unusual circuit described here may be of interest to readers. Briefly, it consists, as a glance at Figs. 1 and 2 will show, of an orthodox

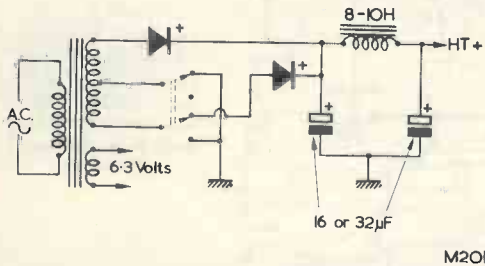

M201

Fig. 1. Operation of the d.p.d.t. switch provides either full or half-wave rectification using metal rectifiers

mains transformer suitably switched in order to provide either full or half-wave rectification. As will be appreciated, this arrangement has the advantage of two alternative outputs: in the full-wave position normal output is available whilst, with the switch in the half-wave position, double the output voltage at half the current can be expected. The metal rectifiers employed in Fig. 1 may be conventional components, and any suitable selenium, or contact cooled components, would function here.¹

¹ The lower rectifier in Fig. 1 should be capable of functioning with half the total a.c. voltage appearing across the transformer h.t. secondary. The upper rectifier should be capable of functioning with the total a.c. voltage appearing across the h.t. secondary. Care should be taken to ensure that the maximum voltage rating to the rectifier securing bolt, or rectifier case when contact cooled rectifiers are used, is not exceeded.—EDITOR.

The necessary smoothing arrangements are quite straightforward, consisting of a fairly high inductance choke—8 or 10 Henries—and two 16 or 32µF electrolytic capacitors.

Should valve rectification be preferred, then the answer will be found in Fig. 2 and the rectifier here may well be a 5Z4 type.²

The layout is by no means critical so long as the usual precautions are taken, both as regards ventilation and good insulation.

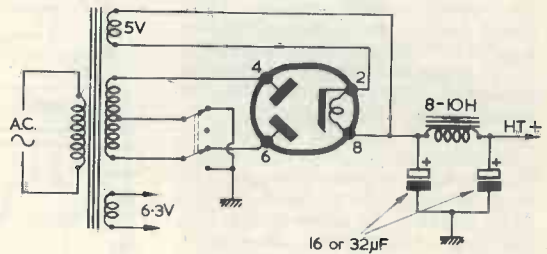

M202

Fig. 2. Circuit similar to that of Fig. 1 but employing a 5Z4 or similar valve rectifier

These circuits are quite suitable for low voltage work and offer a versatile source of power supply for small amplifiers, receivers and oscillators, etc.

² For half-wave operation, the upper diode of the rectifier has applied to it the full voltage appearing across the h.t. secondary of the transformer. With the 5Z4 (assuming a capacitor input filter as shown in Fig. 2) this would normally be kept to 350 volts r.m.s. maximum, although higher voltages at reduced currents are permissible. A possible alternative, the 5R4GY, has considerably higher anode input voltage ratings.—EDITOR.

Gadgets for your Christmas Party

By W. HOLMES

In this article, our contributor discusses the use of electronics at the Christmas party, and describes some simple devices which can add distinction to this year's festivities

THERE ARE, OF COURSE, PARTIES and parties.

Your particular Christmas party may be a sedate occasion which culminates in Aunt Tabitha reverently pouring out two fingers of the family's invalid port to each guest whilst the "Consequences" papers are being collected. Or it may be one of those more boisterous affairs which wind up with an energetic knees-up and the foreboding that the morning after is going to be very, very terrible. However, regardless of the form your own party takes it is possible to increase the fun and pleasure to a considerable extent with the aid of electronics, and this article sets out to discuss some of the various ways in which the resourceful home-constructor can add his contribution to the season's festivities.

Whose Finger on the Button?

A simple gadget which may be incorporated into a number of parlour games, especially with children, could be described as "Electronic Snap". Each participant has a push button and it is the purpose of the game or contest that these be pressed at a particular occasion, the person who presses first being the winner. With the "Electronic Snap" circuit, the button which is pressed first causes a corresponding light to be illuminated and all other buttons to be disabled. In consequence, this particular button may be readily identified, even if it preceded the others by only a fraction of a second. The device may be employed for the game of "Snap" itself, or for any derivatives of that game. It may also be used for panel games in the same way as occurs in B.B.C. sound and television quiz programmes. In these programmes a question is "thrown open" if a contestant cannot reply, whereupon the light illuminated by means of the device indicates the first of the remaining contestants who is ready with an answer. Other simple applications will readily suggest themselves to the reader.

Fig. 1 illustrates a two-way "Electronic Snap" circuit. Two relays are employed, each having a set of changeover contacts and a set of make contacts.¹ If the left hand push button is pressed before the right hand button it causes the coil of relay A to energise via contact B₁ of relay B. Contact A₁ now moves to the energised position and locks relay A on. This contact also breaks the supply connection to the right hand push button, thereby disabling this button and making it impossible to energise relay B. Lamp A is

push button is released. Should it happen, on the other hand, that the right hand button is pressed first, relay B energises and locks on. Relay A cannot then be energised and lamp B remains continually illuminated. The circuit is returned to its previous condition by pressing the "Release" button.

It should be noted that the disabling of the second relay in this circuit occurs at the instant when either contact A₁ or B₁ breaks. If one of these contacts breaks marginally before the other the second relay

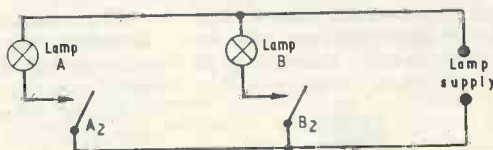
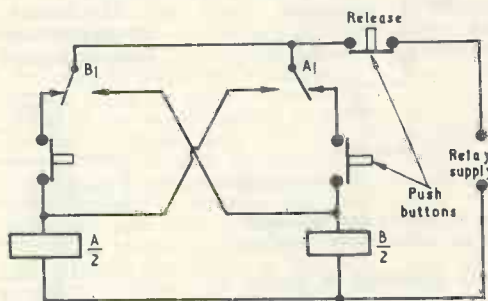

Fig. 1. A two-way "Electronic Snap" circuit. The button first pressed causes the corresponding lamp to be continually illuminated



E163

illuminated by contact A₂ and stays illuminated even when the left hand

¹ The diagrams in this article illustrate the relays with the "detached" presentation. With this presentation relay coils are shown as rectangles and are identified by a letter over a number, the latter indicating the quantity of sets of contacts. The contact sets may appear anywhere in the diagram and are shown in the de-energised position. They are identified by the relay letter and a suffix number. Thus, the rectangle depicted $\frac{B}{2}$

in Fig. 1 represents the coil of relay B and indicates that this relay has two sets of contacts. These contacts are then identified as B₁ and B₂.

cannot energise further, and the first relay is allowed to complete its energising function. The circuit is not entirely foolproof because, if both A₁ and B₁ contacts break at exactly the same instant, it is theoretically capable of oscillating whilst both buttons remain pressed. If either relay has sufficient inertia to enable its contacts to make under this condition it will lock on. In practice this border-line case would occur very rarely, if at all, provided that reasonably quick acting relays are employed. Normal G.P.O.

relays, with sufficient energising voltage to enable them to snap on smartly when energised, should be more than adequate.

A three way "Electronic Snap" circuit is shown in Fig. 2 (a). In this diagram, the circuit to the left hand push button is "guarded" by contacts B₁ and C₂, the circuit to the centre push button is "guarded" by contacts C₁ and A₂, and the circuit to the right hand push button is "guarded" by contacts A₁ and B₂. Thus, as soon as any relay is sufficiently energised for its contacts to break, the remaining two relay-energising circuits are disabled. At the same time, the energised relay locks on via its own contact (A₃, B₃ or C₃, as the case may be). Appropriate lamps are lit, as before, by a further contact set on the energised relay; and the circuit may be returned to its original state by pressing the "Release" button.

requires two sets of changeover contacts only. In Fig. 2 (b), one side of the lamp supply is made common with one side of the relay supply. Because of this, the "Release" button is now inserted in the lower leg of the relay supply line. (It could, of course, be similarly inserted in either Fig. 1 or 2 (a).)

Increasing the number of positions to four makes the relay circuitry a little cumbersome, although relay contact requirements are still not excessive. Fig. 3 gives a four position circuit in which each relay is required to have only two changeover contacts and one break contact. The principle of operation is the same as before: as soon as one relay is sufficiently energised for its contacts to break it disables the energising circuits of the other three.

The oscillation effect mentioned with the circuit of Fig. 1 may occur also with the circuits of Figs. 2 and 3

a reasonably well smoothed output as relay chatter may cause the circuit to become unreliable. The lamps may be powered by a battery or by a low voltage secondary on a mains transformer. To avoid shock risk, all circuits should be reliably isolated from the mains.

Who Goes There ?

Simple proximity detectors can provide quite a lot of amusement at a party. There are many applications: the lights of a cocktail cabinet or Christmas tree may be caused to switch on automatically whenever they are approached, the front door bell may be operated before a guest has even had time to ring it, and so on.

A sensitive proximity detector is shown in Fig. 4. This circuit requires a short-wave superhet receiver, and it functions by reason of the detuning of an oscillator whenever a person approaches the sensing wire.

In Fig. 4, the oscillator V_{1(a)} comprises one half of a 12AU7 and employs a conventional short-wave oscillator coil such as the Osmor QO7. (The QO7 is a superhet oscillator coil for the range 18-50 metres.) However, any short-wave coil covering approximately the same range, and having a coupling winding which may be used for feedback, can be used instead of the QO7. It is essential that, under the conditions in which it is used here, the oscillator coil provides a frequency within the range of the associated receiver.

The oscillator coil is coupled to V_{1(a)} in conventional manner, no tuning capacitor being connected across the tuned winding. The upper end of the tuned winding is connected to the sensing wire. When the latter is approached, the resulting increase in capacitance to earth causes the oscillator frequency to shift, this shift being proportionately high because the standing capacitance across the winding is the small value provided by strays and the input capacitance of the oscillator valve only.

The short wave receiver is loosely coupled to the oscillator by means of a lead from the aerial input socket positioned close to the sensing wire. When the receiver is tuned to oscillator frequency it develops a high a.g.c. voltage, this falling when the oscillator detunes. In Fig. 4 the second triode, V_{1(b)} is connected to the receiver a.g.c. line via the 1MΩ isolating resistor R₃. In consequence, a high a.g.c. voltage causes the relay in the anode circuit of V_{1(b)} to remain de-energised. When a.g.c.

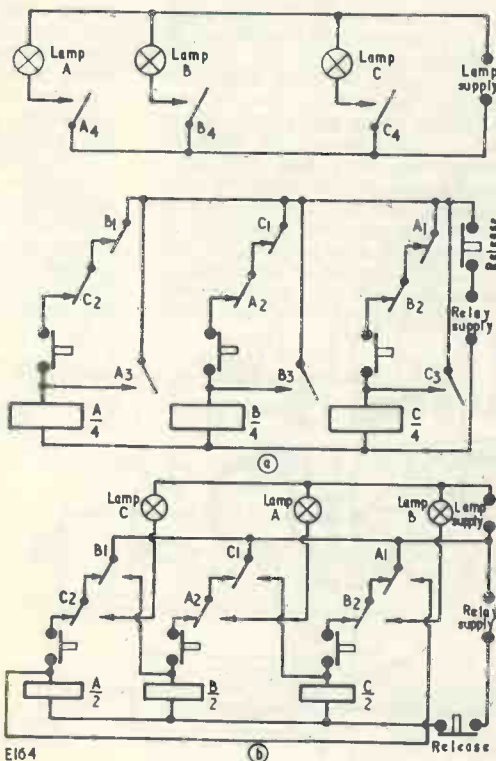

Fig. 2 (a). A three-way version of Fig. 1 (b). An alternative to (a) which reduces relay contact requirements

The circuit of Fig. 2 (a) has the disadvantage that each relay is required to have four contact sets, these being two make and two break. A reduction in contact requirements is given by the circuit of Fig. 2 (b), in which pairs of make and break contact sets are combined as change-over sets. Each relay in Fig. 2 (b)

if two or more relay contacts break at exactly the same instant. As before, the risk becomes negligible if reasonably quick acting relays are employed.

The relay energising d.c. supply for any of the relay circuits may be obtained from batteries or from a mains unit. The latter should have

voltage drops, due to the sensing wire being approached and the oscillator detuning, the anode current of $V_{1(b)}$ increases and the relay energises, switching on the external circuit.

oscillator is desirable. The relay in the anode circuit of $V_{1(b)}$ should have an energising current of some 10mA or less if it is to be operated by the valve specified. However, the circuit is not critical

to quarter of an hour after it has been switched on before tuning the short wave receiver to its final setting. An open layout for the oscillator, with consequently adequate cooling, will considerably reduce long term drift. It is desirable, also, to employ a ceramic, or good quality moulded, valveholder. If long-term drift is very troublesome it may be alleviated by connecting a 10pF silver mica capacitor across the tuned winding. This will partly swamp stray capacitances, although it will result in a loss of sensitivity.

Another proximity detector is illustrated in Fig. 5. This is considerably less sensitive than that of Fig. 4, but it has the advantage of being much simpler.

The detector consists basically of an oscillator triode whose oscillations are just maintained by a critical setting of the feedback capacitor C_2 . The triode is leaky-grid biased and, in the oscillating condition, draws a low anode current. If a hand is brought close to the sensing plate the losses introduced into the tuned grid winding cause the valve to stop oscillating. A secondary effect is that the additional tuning capacitance causes oscillator frequency to drop, whereupon feedback becomes insufficient to maintain oscillation. Cessation of oscillation results in the triode drawing a considerably increased current, and the relay in its anode circuit energises and operates the external circuit.

Fig. 3. The "Electronic Snap" principle may be applied to four positions, as shown here

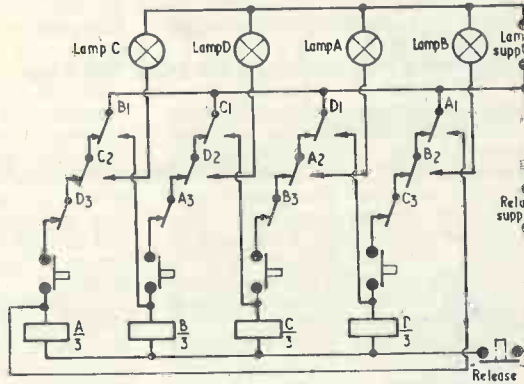

E165

The sensitivity of the proximity detector depends, amongst other things, upon the selectivity of the short-wave receiver. Best results will be given if the latter is a communications type, because its i.f. selectivity will be sharper than that of a domestic receiver and, also, because this selectivity will in some cases be controllable. It is desirable to ensure that a.g.c. voltage drops to a low level when the oscillator detunes, and this point may be catered for by reducing the r.f. gain of the receiver so that random pick-up of broadcast signals does not occur. If r.f. gain cannot be reduced by a panel control (whilst retaining a.g.c.) a simple attenuator would be given by inserting a series resistor of some 5 to 50kΩ at the aerial input terminal. The use of such an attenuator avoids modifications to the internal circuits of the receiver.

To prevent excessive radiation the oscillator should run at low power. This may be achieved by the simple process of reducing anode voltage by means of the series resistor R_2 . The value of R_2 needs to be determined experimentally, but the oscillator should run comfortably if values of the order of 470kΩ or more are employed.

The sensing wire must be kept well away from earthed objects such as mains wiring and the like. Since its function is to sense the approach of people it should be mounted vertically and have a length of some five feet. A single strand of lighting flex should prove adequate in practice and, if a dark-coloured insulation is employed, will also be relatively inconspicuous. An earth connection for the chassis of the receiver and

so far as valve types are concerned, and any conventional triodes may be employed instead of the 12AU7. Other triodes, or pairs of triodes strapped, in the $V_{1(b)}$ position may be capable of energising less sensitive relays. Care should be taken to ensure that $V_{1(b)}$ does not draw excess anode current when the relay energises, and this current may be reduced by inserting resistance in series with the relay coil. Heater and h.t. supplies are left to the choice of the reader, and it is quite possible that sufficient power may be available

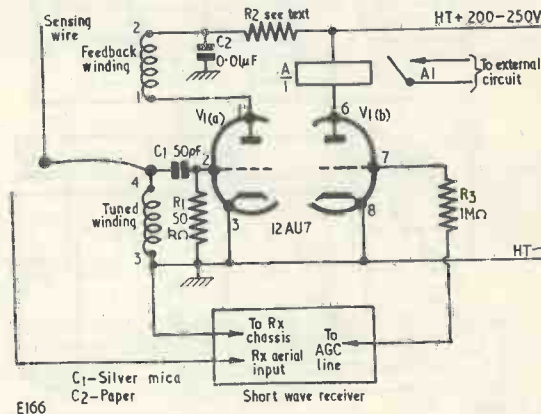

E166

Fig. 4. A very sensitive proximity detector which incurs the use of a short wave receiver. The number references at the tuned and feedback windings apply to the Osmor Coil type QO7

from the receiver itself. If the latter is of the a.c./d.c. type, care must be taken to avoid shock, and the sensing wire should be isolated by a 250 a.c. w.v. capacitor having a value lying between 0.001 and 0.01μF.

The oscillator will be subject to short-term warm-up drift and it is advisable to wait some ten minutes

In practice, the oscillator coil employed may be an Osmor QO7 or any similar type. One half of a 12AU7 is shown in the diagram, but any similar triode, or pair of triodes strapped, should cope. Care should be taken to ensure that maximum anode current for the triode is not exceeded when oscillation ceases and

this point should be checked with a meter.² Excess current may be reduced by inserting resistance in series with the h.t. positive supply. The circuit may be a little tricky to bring into the operating condition at first, and it may be found helpful to experiment with the value of C₁. As with the circuit of Fig. 4 it is desirable to allow some ten to fifteen minutes warm-up time after switching on to allow the circuit to settle down.

Fig. 5. A less sensitive, but much simpler, proximity detector. Again, the coil number references apply to the Osmor Q07

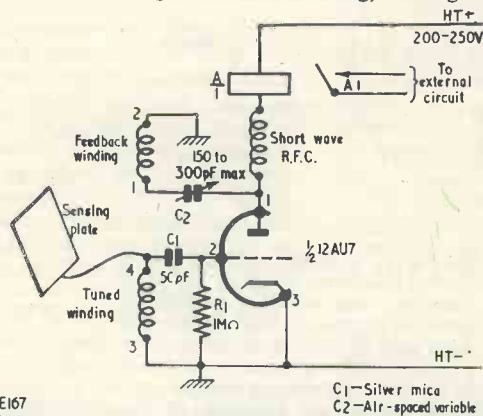

E167

C1—Silver mica
C2—Air-spaced variable

Similarly, a 10pF silver mica capacitor across the tuned winding will help to swamp long-term drift at the expense of sensitivity. An earth connection to the oscillator chassis is necessary.

The sensing plate may be covered with some form of insulation to prevent direct contact when the hand is placed on it. A good plan is to mount it behind a sheet of glass, whereupon the fact that a circuit is operated by placing the hand on the other side of the glass can provide considerable mystification. For further effect, the sensing plate can be cut into the shape of a hand's outline, it being then covered with paper painted to represent a hand. Connection to the plate from the oscillator may be made with thin gauge enamelled wire (32 to 38 s.w.g.). This has a low capacitance to surrounding earthed objects and is relatively inconspicuous.

Steady As You Go

The gadget shown in Fig. 6 is a real "oldie". Nevertheless, the writer includes it here because he has found that few people seem to have heard about it these days, and because it can provide quite a lot of fun.

In Fig. 6 a metal rod some 2ft 6in to 3ft long is connected to one

terminal of the battery. A metal ring, mounted on a handle, is connected via a length of flex and an electric bell to the other terminal of the battery. Both ends of the rod are covered with insulating tape for approximately 3 inches.

At the commencement of the game the ring is hung on the insulating tape at the left hand end of the bar. The participant is then challenged to move the ring, holding it

by its handle, over to the right hand end of the bar without at any time causing the bell to sound. The bell will, of course, sound whenever the ring touches the bar. Surprising as it may seem, it takes a very steady hand to move that ring across successfully!

In order that good contact may be given whenever the ring touches the rod, the latter should have a clean surface. Brass curtain rod presents an excellent choice here. The ring may be easily fashioned from heavy gauge copper wire ($\frac{1}{8}$ to $\frac{1}{4}$ in diameter) or any similar material having a surface which will ensure reliable connection.

This device is quite a good fundraiser, incidentally, if your Christmas function is for charitable purposes. The participant pays a sum of money and has it returned if he moves the ring across successfully. In this instance it might be helpful to give the ring an internal diameter somewhat greater than that shown in the diagram so that one person in about five may be successful. The gamble then becomes more attractive.

Incidentally, there is little point in adding "electronics" to this particular gadget. It is extremely effective as it is.

The Fred Smith Show

All the best parties have at least one or two guests who are prepared to provide a little entertainment in the form of, say, a song or monologue. When these guests are talented, as frequently occurs, the success of the party is almost certainly assured.

Occasionally, the question of a microphone and amplifier is raised and most electronically minded hosts hurriedly point out that these cannot



² A meter is required because, on the cessation of oscillations, the grid will not return to chassis potential but to a level dictated by contact potential.

be used in the average-sized room because of the difficulties of feedback from the loudspeaker to the microphone.

two adjacent walls. See Fig. 7, in which the cross indicates the position of the performer. Back radiation from the speakers should be reduced

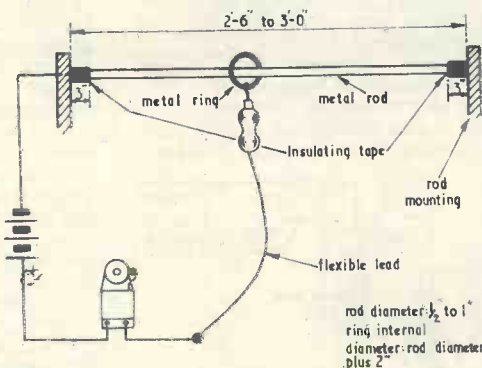

Fig. 6. A simple device which is especially suited for children's parties

E168

In practice it is, nevertheless, sometimes possible to obtain quite pleasing results with a microphone and amplifier in a single room provided that the limitations of this system are realised and that the performer understands these limitations. If the performer does not appreciate the shortcomings of the system the results are usually horrible!

Feedback from the loudspeaker of an amplifying system to the microphone causes a howl to be set up, the frequency of which is largely determined by resonances in the room and by any peaks in the response of the system. Feedback problems may be reduced in a room

as far as possible with the aid of sound-absorbent material. If at all possible, the speakers should be directed at sound-absorbent furnishings such as curtains or sofas, etc.

The amplifying system should have a smooth response overall, since a peak encourages feedback at that frequency. The choice of microphone is important, and the writer has obtained surprisingly good results with moving coil types.

When the system has been set up and tried out it may often be found that it is possible to obtain sufficient gain, before the onset of feedback, to enable quite good reproduction to be given when the microphone is held close to the mouth of the performer. It is necessary for the performer to realise that the microphone may be easily overloaded under these conditions, and this is the main limitation of the system. It should be added that the very wide range of sound intensity applied to the microphone places heavy demands upon the amplifier. The latter should be capable of amplifying low-level signals without distortion, and it needs an output capability of, at the very minimum, five watts in order that it may handle the louder sounds applied to the microphone.

To prevent feedback occurring whilst the party is in progress, the amplifier may be fitted with a pre-set gain control in addition to the panel gain control. (See Fig. 8.) The pre-set control may then be set up, before the party, such that gain is just short of feedback level when the panel control is at maximum. When the party is taking place the panel gain control may then be operated at will without the risk of a feedback howl.

A very popular party act is given by miming to a gramophone record.

The relationship of performer and speaker indicated in Fig. 7 is very helpful here. This is because the speakers are in front of the performer, and the spectators' subjective impression (long ingrained by visits to theatres and other functions which employ P.A. systems) that the sound originates from the performer's lips may be considerably strengthened. The choice of gramophone record obviously depends on the performer's tastes, but the writer would suggest (after seeing hilarious versions put on by a friend of his) that two excellent choices are "Last Train To San Fernando" and Jimmy Durante's "My Nose's Birthday".

Only 18 Shopping Days Left

The devices and hints discussed in this article represent only a small

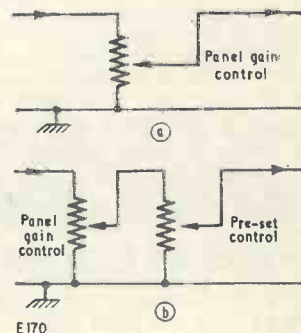

E170

Fig. 8. Adding a pre-set gain control to the amplifier to prevent feedback howl whilst the party is in progress. The existing circuit is shown in (a) and the modified circuit in (b). The pre-set control should have the same value as the panel gain control

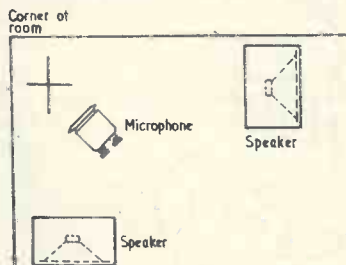

E169

Fig. 7. Despite the considerable feedback problems involved, a microphone and amplifier can sometimes be used successfully in a room provided the limitations of this arrangement are appreciated. The performer takes up the position indicated by the cross

by having the performer take up a position near a corner, with the loudspeakers, of which two are preferable, mounted alongside the

fraction of what the really ingenious home-constructor can do to increase the fun at his Christmas festivities, and to make his Christmas party an occasion which will be remembered with pleasure for a very long time to come. There are still some three weeks to go before 25th December, and so there is plenty of time to knock up any of the gadgets described.

The writer would like to conclude by stating that he wholeheartedly wishes all his readers a really Merry Christmas, to be followed, of course, by the Happiest and most Prosperous of New Years!

"The Aberdonian"

A Simple Transistor Receiver

By J. ANDERSON

WHILST AT FIRST SIGHT THIS SET APPEARS TO employ the usual simple detector and a.f. amplifier circuit, with all its attendant lack of selectivity and other shortcomings, there is a little more to it than that. Firstly, the heavy loading imposed on the tuned circuit by the normal set of that type, with the resultant broad tuning, has been overcome by matching the diode to the tuned circuit with an r.f. transformer. The receiver has the further advantage that base bias may be varied to suit particular circumstances. The value of the base bias resistor, R_1 , depends on the strength of the signal received, and on the headphone being used. For $4k\Omega$ phones, with a weak signal, a value of about $1M\Omega$ is best, but if available signals are strong then low-impedance phones will give a greater output and R_1 may have a value around $100k\Omega$. The precise value for R_1 is best found by experiment.

Components

Tuning is effected by a small $500pF$ trimmer, mainly to save space, and the power supply is obtained from a Deac or Mallory cell, both of which again have the great advantage of small size. The transistor used in the original was a Green-Yellow audio, but any audio frequency transistor capable of working in the range 1.5 to 6 volts can be used in this circuit. Although the quality of the sound is surprisingly good it is hardly worth purchasing a new transistor unless it can be obtained cheaply, for whilst this circuit functions efficiently with very little trouble in construction, it is not sufficiently grandiose to deserve a large expenditure.

In an area of high signal strength, a ferrite rod aerial will work quite well. Alternatively, the set will function satisfactorily and remain small if about three feet of wire is used as an aerial.

Components List

- R_1 See text
- $1VR_1$ $50k\Omega$ (with on/off switch)
- C_1 $0.5\mu F$, 6 w.v.
- L_1 MW coil (commercial) dust cored
- L_2 10-15 turns 18 s.w.g. enamelled wire
- Small plastic case
- Two sockets
- Transistor See text
- Diode See text
- $500pF$ trimmer
- Phones See text

The volume control was the most expensive item, being one of the small "button" type having a rotating rim and a switch incorporated: even so, the entire set can be made for a very small sum, and probably for nothing more than the cost of this component if the junk box is examined carefully first.

The case used was a small plastic box which was originally sold as a "housemaid" kit. This employed a fairly strong plastic, and had dimensions of about $1\frac{1}{2} \times 1\frac{1}{2} \times \frac{3}{4}$ in. After the set had been in use for

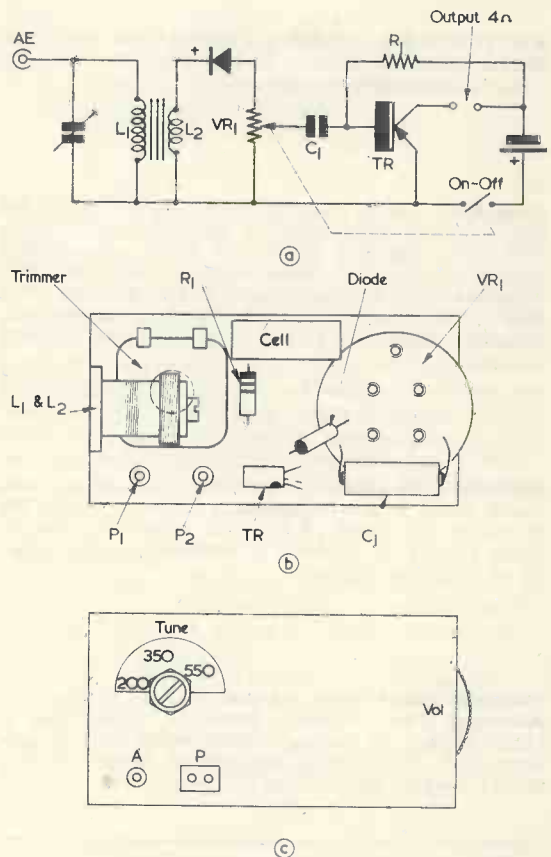

Fig. 1 (a). Circuit of the "Aberdonian" simple transistor receiver

(b). Layout of components within the case
(c). Front external view of the case

M208

¹ The potentiometer employed in the prototype was U.S. Army surplus having dimensions of $\frac{3}{4}$ in diameter and $\frac{3}{4}$ in depth.

some time, a small knob was attached to the trimmer screw with Bostik adhesive, which is more than strong enough for this purpose. The earpiece used was a deaf-aid type, with a resistance of $5k\Omega$, and this was found to be very satisfactory.

Aerial

The steel frame of a bed has been used as an aerial, this being connected to the positive cell terminal with the aerial terminal left free. Such an aerial seems to be adequate for bedside usage, although

there is, of course, some slight loss of sensitivity.

Any crystal diode will work in the circuit. The set has been used as far down as 41 Mc/s, with the appropriate coils and a television aerial, using a Mullard OA81 diode and tinfoil screening between the coils and audio stages.

The name of the receiver derives from the fact that Scottish relatives were visiting the author at the time when the set was first made: it is probably as good as any other name, and certainly lends it a little distinction.

CAN ANYONE HELP?

Requests for information are inserted in this feature free of charge, subject to space being available. Users of this service undertake to acknowledge all letters, etc., received and to reimburse all reasonable expenses incurred by correspondents. Circuits, manuals, service sheets, etc., lent by readers must be returned in good condition within a reasonable period of time

R107 (T) Receiver.—D. Illing, 2 Walton Dene, Aylesbury, Bucks, wishes to borrow, or preferably purchase, the circuit diagram for this receiver.

* * *

Pamphlets.—Ian B. Jolly, 13 Abbots Park, Chester, has been trying to obtain copies of the following pamphlets without success, can any reader supply or suggest a source of supply. War Office Code No. 7567, Pamphlet No. 26, Switchboard U.C. 10 Line, 1940; War Office Code No. 1529, Working Instructions, Telephone Set D Mk. V, Y.A.7975. Willing to purchase if required.

* * *

Indicator Unit 248.—C. Galloway, 105 Dumbarton Road, South Reddish, Stockport, Cheshire, would like to obtain the circuit of this unit which, he believes, forms part of the Monitor 56 equipment—information on which is also required.

* * *

Eddystone Short Wave Manual.—K. J. Gordon, 22 Alexandra Park, Redland, Bristol 6, would like to obtain a copy of this publication which features constructional details of a bandspread battery receiver (DF33, DAC32, DAC32 and DL33).

* * *

Marconi B29 LF Receiver.—J. Garner, "Hurst", 178 Ringmer Road, Worthing, Sussex, requires help in obtaining the circuit and any conversion data that may be available.

R1155L or N Communications Receiver.—C. P. Burrell, 18A York Road, Northampton, requests any information relevant to the "Range 2A" of these models.

* * *

APN-1 Radio Altimeter.—S. C. Barnes, "Barwood", 96 Glossop Road, Gamesley, Glossop, Derbyshire, would much appreciate the circuit of this unit.

* * *

Ex-W.D. Receiver Unit type 300, Amplifier Unit type 500.—A. Hill, Croft Lane, Yaddletorpe, Scunthorpe, Lincs, wishes to acquire all possible details, circuit diagram, etc., of these two units.

* * *

Osmor Inductor QAFM.—R. K. Lloyd, P.O. Box 1164, Lusaka, North Rhodesia, is in urgent need of this inductor and has been informed that it is no longer in production—has any reader a QAFM spare? Please write in first instance and quote price.

* * *

Transmitter/Receiver type TR3152 AM.—J. A. Moody, P.O., Station Road, Holywell Green, Halifax, Yorks, requires the circuit of this unit.

* * *

R1143A Receiver, type 71.—D. P. Sladen, 13 Fitzjohns Avenue, London, N.W.3, would like to borrow the service manual or circuit diagram of this receiver. He would also like to get into touch with any other reader currently operating this set.

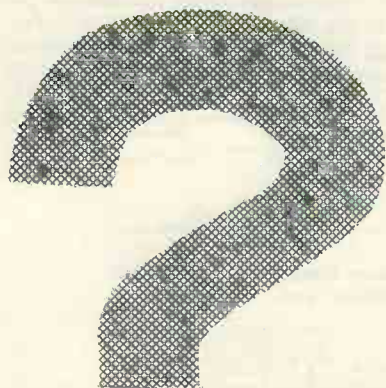

The fifth in a series of articles which, starting from first principles, describes the basic theory and practice of radio

part 5

understanding radio



By W. G. MORLEY

IN LAST MONTH'S CONTRIBUTION TO THIS SERIES WE continued our discussion on resistors by examining composition and high-stability types. We also dealt with values and tolerances, and the article included a table showing "preferred" resistances from 10Ω to $22M\Omega$.

We shall now carry on to carbon resistor wattage ratings and colour coding.

Carbon Resistor Wattage Ratings

As with wirewound resistors, the wattage ratings of carbon resistors increase with physical size. Table IV shows typical wattage ratings for non-insulated composition rod resistors of various dimensions. Insulated carbon rod resistors will have somewhat larger dimensions than those given in the Table, owing to the bulk of their protective insulating coating.

The wattage ratings listed correspond approximately to those which would be observed by commercial manufacturers in this country. Under low ambient temperature conditions such ratings permit a small overload without damage to the resistor.¹

High-stability resistors are normally manufactured to wattage ratings of 0.25 to 2 watts. Dimensions in this range tend to be similar to those of insulated carbon rod resistors of the same wattage rating.

¹ It should be pointed out that many composition resistors now available on the home-constructor market are quoted as having wattage ratings *twice* as great as the typical figures listed in the Table. If quoted ratings of this type are exceeded, the resistor may suffer damage. Indeed, home-constructors would be wise to keep wattage dissipation below *half* such quoted figures.

Colour Coding

After a resistor has completed its manufacturing process, it has to be marked with its value and tolerance rating so that it may later be recognised. One method of marking the resistor consists of printing the appropriate information on its outside surface. Wirewound resistors are almost always marked in this way as, also, are some high-stability and composition resistors. However, printing has disadvantages, particularly with the smaller carbon resistors, and it is general practice for carbon resistors to be identified by a simple colour code.

TABLE IV

Non-insulated composition rod resistor wattage rating	Typical overall dimensions of resistor (excluding lead-out wires or printed circuit connectors)	
	Diameter	Length
0.1	0.1in	0.25in
0.25	0.15in	0.4in
0.5	0.2in	0.7in
1	0.35in	1.75in
2	0.5in	2in
2.5	0.7in	2.5in

The resistor colour code employs three colours to represent the value of the resistor in ohms, a fourth colour to represent tolerance, and a fifth colour to indicate a high-stability component. As we shall see, the fourth and fifth colours are omitted

when it is desired to indicate a specific tolerance or (in a negative sense) resistor type. We shall now deal with the first three colours, which represent value.

The first three colours appear on all coded resistors and they take up the positions shown in Figs. 12 (a), (b) or (c). In Fig. 12 (a) the colours are applied as three bands around the body of the resistor at one end. These three colours are read from the end of the resistor in the order depicted in the diagram. Fig. 12 (b) illustrates an alternative positioning for the colours. In this instance the first colour is applied to the body of the resistor, the second colour is applied to one end, and the third colour is applied as a spot in the centre of the body. These colours are read in the order: Body, End, Spot. Fig. 12 (c) shows a slight variation on Fig. 12 (b), in that the spot now appears as a coloured band around the centre of the resistor body. The colours are still read in the same order. It should be pointed out that the colour positioning shown in Fig. 12 (a) has largely superseded those of Figs. 12 (b) and (c) except for resistors having radial lead-out wires wrapped around a composition rod. The irregularly shaped ends of the latter type of resistor make it difficult to apply colour bands with production-line machinery.

The three colours on the resistor are interpreted in the following manner: the first two colours represent the first two significant figures in the value of the resistor, and the third represents a multiplier by which these two figures must be multiplied. Table V lists the colours employed, together with the figures they represent.

A few examples will assist in showing how the colour code functions. Let us assume that we have a resistor, of the type shown in Fig. 12 (b), whose body is yellow, whose end is violet and whose spot is red. Yellow is the first colour, and this corresponds to 4. Violet is the second colour and this corresponds to 7. So our first two figures in the resistor value are 47. The third colour is red and

this corresponds to the multiplier 10^2 , or 100. If we multiply 47 by 100 we get 4,700, and that, in ohms, is the value of the resistor.

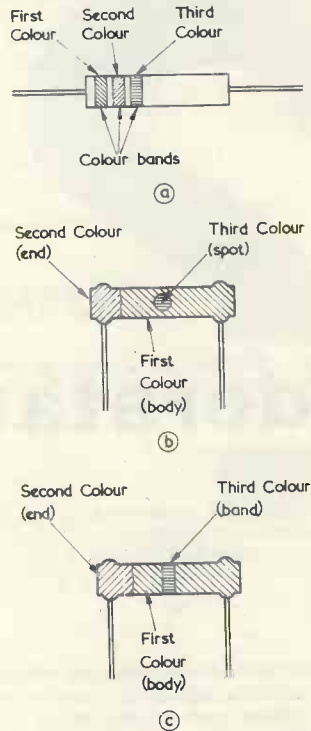

M203

Fig. 12. The first three colours of the resistor colour code may be applied in several ways. In (a) they appear as three coloured bands at one end of the resistor and are read from that end. In (b) they appear in the order: Body, End, Spot. An alternative to (b) is shown at (c), in which a coloured band takes the place of the spot

TABLE V

The Resistor Colour Code

Colour	Significant Figure (First two colours)	Multiplier (Third colour)	Tolerance (Fourth colour)	Resistor Type (Fifth colour)
Black	0	1	—	—
Brown	1	10	±1%	—
Red	2	10 ²	±2%	—
Orange	3	10 ³	±3%	—
Yellow	4	10 ⁴	±4%	—
Green	5	10 ⁵	±5%	—
Blue	6	10 ⁶	±6%	—
Violet	7	10 ⁷	±7%	—
Grey	8	10 ⁸	±8%	—
White	9	10 ⁹	±9%	—
Gold	—	10 ⁻¹	±5%	—
Silver	—	10 ⁻²	±10%	—
No Colour	—	—	±20%	—
Salmon Pink	—	—	—	High-stability

Let us now consider a resistor, as shown in Fig. 12 (a), whose three colour bands, reading from the end, are orange, orange, brown. Orange corresponds to 3, so the first two orange bands represent 33. The multiplier, brown, corresponds to 10. Multiplying 33 by 10 gives us 330, and this, in ohms, is the value of the resistor.

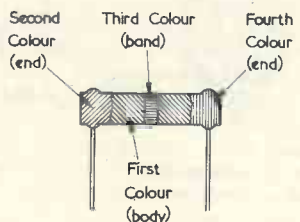
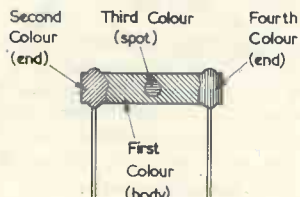
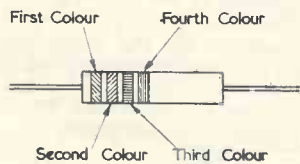

M204

Fig. 13. If the resistor is other than $\pm 20\%$ a fourth colour is added to indicate tolerance. In (a) it is added as a fourth band and, in (b) and (c), it appears on the unoccupied end of the resistor. The fourth colour will be either gold or silver in (b) and (c) and there is, in consequence, no risk of confusion between the two ends

Another colour combination could be brown, black. This gives us 10 as the first two figures and a multiplier of 1. Thus the resistor has a value of 10 ohms. Resistors having values below 10 ohms may also be represented by the code. Thus, a 6 ohm resistor could be coded black, blue, black. These colours translate as 06 multiplied by 1, and the first zero may obviously be ignored. Another example would be given by a 4.7 ohm resistor. This would be coded yellow, violet, gold, the first two colours giving 47 and the third a multiplier of 10^{-1} , or 0.1. 47 multiplied by 0.1 is 4.7, which is the value of the resistor. In practice, colour coded resistors rarely have values below 10 ohms and so the last two examples, whilst illustrating the capabilities of the code, are unlikely to be encountered in normal radio work.

Most people using the colour code find it helpful to think of the third colour as a figure which defines the "number of zeros" in the value rather than as acting as a multiplier. This method of working considerably eases the interpretation of the code, as a few further examples will illustrate. Let us assume we have a resistor coded blue, grey, yellow. Reading from the "significant figure" column in Table V, these colours correspond to 6, 8 and 4, so we may say that the resistor value is 68 plus "four zeros", that is 680,000 ohms. Similarly, a resistor coded, red, red, green has a value of 22 and "five zeros", or 2,200,000 ohms. The "number of zeros" method of employing the code has the disadvantage that it does not cover instances where the multiplier is 10^{-1} or 10^{-2} , but, as we have just noted, resistors coded with such multipliers are only encountered rarely in any case.

The fourth colour in the colour code defines tolerance and, for composition rod or composition-coated resistors, is gold for $\pm 5\%$ and silver for $\pm 10\%$. If the resistor has a tolerance of $\pm 20\%$ no fourth colour is applied, and the resistor has the appearance of those in Fig. 12 (a), (b) and (c), which we have already discussed. The fourth colour appears on the resistor either as a fourth colour band, as in Fig. 13 (a), or is applied to the end not already used if the resistor is of the Body, End, Spot (or Band) variety. See Figs. 13 (b) and (c). It will be noted that, whilst Table V lists the tolerances applicable to gold, silver and "no colour", it also shows tolerances corresponding to the other colours in the code. We shall return to these after considering the fifth colour.

When it is used, the fifth colour is always salmon pink and its only function is to indicate that the resistor is a high-stability component. If the fifth colour is absent, the resistor is other than a high-stability type. The fifth colour may appear either as a fifth band, as in Fig. 14 (a), or it may appear as an overall body colouring as in Fig. 14 (b), the previous four colour bands being printed over it. Coding of the Body, End, Spot variety is not employed with high-stability resistors.

Because high-stability resistors are manufactured to closer tolerances than composition rod or composition-coat resistors, their tolerance ratings cannot be adequately conveyed by gold for $\pm 5\%$ and silver for $\pm 10\%$. In consequence, the fourth colour on a high-stability resistor may consist of any of the colours from brown to white, these corresponding to tolerances of $\pm 1\%$ to $\pm 9\%$ as shown in Table V. For most commercial applications high-stability resistors are made to tolerances of $\pm 1\%$, $\pm 2\%$ and $\pm 5\%$, and so the colours brown, red and green would be employed in the fourth position in the code. It will be noted that both green and gold stand for a tolerance of $\pm 5\%$. Either colour could be used to indicate a tolerance of $\pm 5\%$ on a high-stability resistor according to the preference of the manufacturer.

In conclusion, it should be pointed out the resistor colour code occasionally produces results

which may puzzle the newcomer. It is, for instance, possible to have a resistor which is covered overall with a single colour. All this infers is that the resistor is of the Body, End, Spot variety and that the three colours happen to be the same. Thus, a resistor with a completely red body corresponds to the code group red, red, red; and would have a value of 2,200 ohms. The absence of a fourth colour indicates a tolerance of $\pm 20\%$, and the fact that Body, End, Spot coding is employed shows that the resistor is not a high-stability component.²

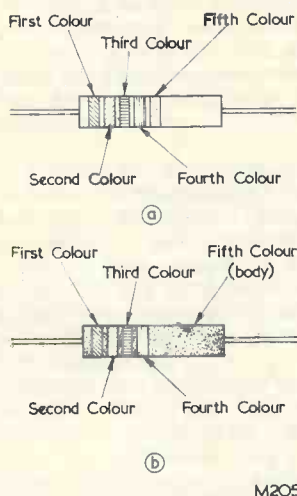

Fig. 14. If the resistor is a high-stability component a fifth colour, which is always salmon pink, is added. This may appear as a fifth colour band, (a), or as an overall body colour, (b)

Variable Resistors

It frequently happens that a radio or electrical circuit requires a resistor whose value may be varied by means of a simple control. Such a resistor consists basically of a resistance element along which a contact may move. Resistors whose values are capable of being adjusted are known as *variable resistors*. The types we have considered up to now may not have their values adjusted and are, in consequence, described as *fixed resistors*.

Variable resistors take up several forms according to the means employed for moving the contact along the resistance element. In radio work, variable resistors almost always employ a mechanism which allows the contact to travel in a circular direction, and these we shall now examine.

Fig. 15 illustrates a typical *wirewound variable resistor*. In Fig. 15 (a) we have the resistance element, this consisting of a length of fibre, or a similar semi-flexible insulating material, on which is wound a length of resistance wire. In Fig. 15 (b) the length

² There is a colour code for wirewound resistors with axial leads which is read in the same manner as that for carbon resistors. This employs four colour bands as in Fig. 13 (a), and the colours have the same meaning as for carbon resistors. However, the first colour band is made twice as wide as the others to indicate a wirewound resistor

of fibre is bent into a circular shape and is fitted into an insulated housing. Two metal clips secure the ends of the resistance element and are connected to solder tags on the outside surface of the housing. In Fig. 15 (c) we add the moving contact. The moving contact consists of a springy piece of metal and it is coupled to a shaft, or spindle, passing through the centre of the housing. The end of the moving contact bears down on the upper edge of the resistance element. At the same time, a second contact bears continually against the centre section

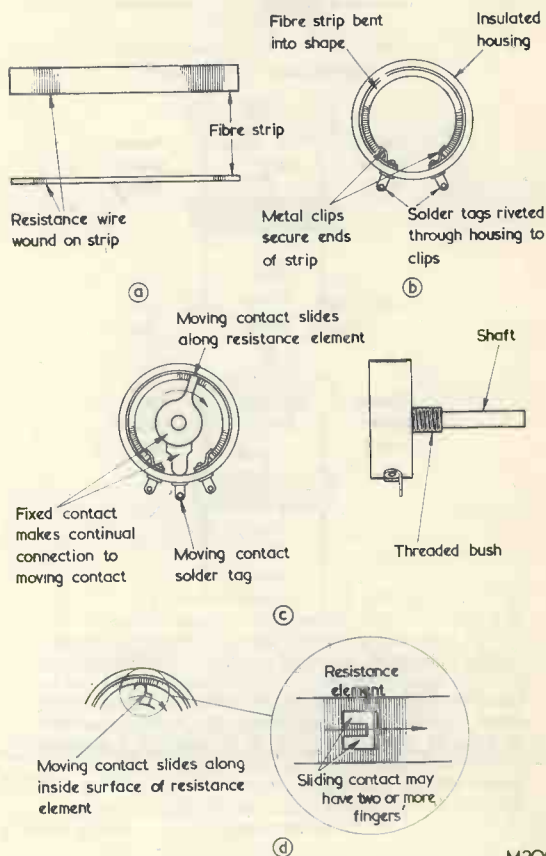

Fig. 15 (a). The resistance element of a wirewound variable resistor as used in radio work consists initially of resistance wire wound on a strip of fibre or similar material

(b). The strip is bent into shape and fitted to an insulated housing, as shown here. The two solder tags connect to the ends of the resistance wire via their mounting rivets and the metal clips which secure the element

(c). Adding the moving contact. Continual connection to this contact, as it rotates, is made via a second contact coupled to the centre solder tag. Rotating the shaft causes the moving contact to travel along the resistance element

(d). An alternative type of moving contact slides along the inside surface of the resistance element, instead of along its edge

of the moving contact, this second contact leading to a third solder tag positioned between the two previously fitted. When the variable resistor shaft is rotated, the end of the moving contact is caused to travel along the resistance element, whereupon a varying value of resistance appears between the centre solder tag and either of the two outside tags. If the moving contact rotates in the direction of the arrow illustrated in Fig. 15 (c), the resistance between the centre and left hand tag increases, and the resistance between the centre and right hand tag decreases. Thus, by connecting an external circuit to the centre and either outside tag it is possible to obtain a resistor whose value is adjusted by rotating the shaft.

The assembly shown in Fig. 15 (c) represents the basic wirewound variable resistor, as employed for radio applications. The moving contact which travels along the resistance element is described as the *slider*, and it may make contact with the resistance element along one edge, as is shown in Fig. 15 (c) or along the inside surface, as shown in Fig. 15 (d). In the latter instance, the large surface area offered by the resistance element enables the slider to have two or more springy "fingers" in contact with the resistance wire, and this may ensure a more reliable contact. Other variations from the basic arrangement of 15 (c) would be given by differences in the design of the housing and in the method of obtaining the continual connection to the moving contact. Variable wirewound resistors intended to dissipate relatively high powers may have the resistance element wound on a former which is already of the desired shape; after which part of the wire may be covered by a protective "cement" or resin, the surface contacted by the slider being left bare. Such variable resistors are, however, encountered only occasionally in radio applications.

Carbon track variable resistors operate in the same manner as wirewound variable resistors, the main difference being that the resistance element is provided by a circular *track* of carbon composition. The latter may be formed by applying the carbon composition to an insulating material, such as paper, or by depositing it in a groove in the insulated housing of the resistor. A flat track is most convenient to produce, and the slider travels along this as shown in Fig. 16.

Rheostats and Potentiometers

Both wirewound and carbon track variable resistors may be employed in circuits wherein connection is made to the slider and one end of the resistance element only. When used in this manner the variable resistor offers adjustable resistance between the two terminals chosen, and may be

described as a *rheostat*. Alternatively, all three terminals of the variable resistor (i.e. the slider and the two outside ends of the resistance element) may be connected into circuit. In this case the variable resistor is described as a *potentiometer*. In practice, the second method of connection is used in radio work much more frequently than the first method and, for this reason, radio engineers almost always employ the term "potentiometer", instead of "variable resistor", to describe the component. (This holds true even when the variable resistor is used as a rheostat.)

The term "track" applies, by definition, to the resistance element of a carbon track variable resistor. Although the usage is not entirely correct, this term may also be found applied to the resistance element of a wirewound variable resistor.

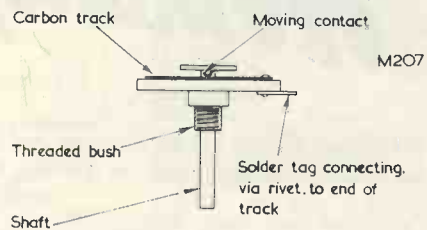

Fig. 16. A carbon track variable resistor functions in the same basic manner as the wirewound version. The carbon track is, however, usually mounted flat in the housing, as illustrated in this internal side view

Values and Wattage Ratings

Wirewound resistors are normally available with resistance values ranging from some 10Ω to $100k\Omega$. Resistances greater than $100k\Omega$ are not normally used because the winding of the fine resistance wire involved makes the component difficult to manufacture and costly. Wirewound variable resistors have a wide range of wattage ratings, these increasing with size. A typical rating for a small component having housing dimensions of $1\frac{1}{4}$ in diameter and $\frac{1}{2}$ in depth is of the order of 3 watts. The rating applies to the complete resistance element.

Carbon-track variable resistors have resistance values varying normally from some 100Ω to $20M\Omega$. Again, wattage ratings depend on physical size, a typical figure for a component with housing dimensions of 1 in diameter and $\frac{1}{2}$ in depth being 0.5 watt.

Next Month

In next month's article we shall conclude our examination of variable resistors by discussing mounting and adjusting arrangements, tapered tracks, and the slide-wire. We shall then carry on to resistors in electrical circuits.

THE JR1/JTL STEREO TAPE RECORDER UNIT

We regret that the concluding article in this series has been held over until next month. We apologise to those readers who are especially interested in constructing this unit.

In your Workshop

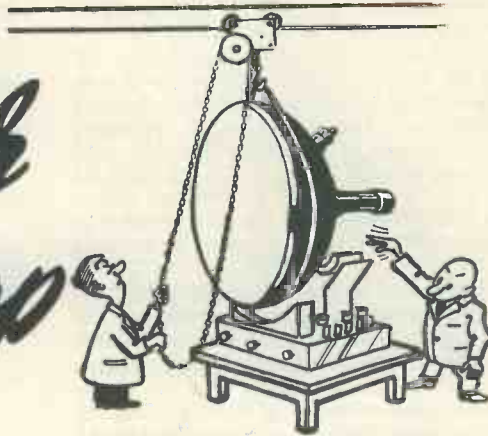

This month Smithy the Serviceman, and his able assistant Dick, are embroiled in the seasonal Christmas rush. However, as always, they battle through to success, even if Smithy does suffer in the process!

BUT IT'S NEARLY Christmas, Smithy," protested Dick.

"I know it's nearly Christmas," replied the Serviceman testily, "and I know also that we've still got quite a few sets left on the shelves which must get finished today. Tomorrow is a Sunday and it's also Christmas Eve. Just for once," Smithy added wistfully, "I was hoping to have a Christmas Eve which was actually free."

"It won't take you a second," persisted Dick. "You've only got to pull it."

The distracted Serviceman turned round and started to grasp the Christmas cracker proffered by his assistant. Just at this moment the television sound programme playing from the loudspeaker at the corner of his bench dropped abruptly in volume, and Smithy shot to the printed circuit board to which the speaker was coupled. Eagerly he applied the test prods of his meter to the board. However, as soon as they touched the copper foil the loudspeaker came to life again, and reproduced the sound programme at the same level as before.

Intermittent

Furiously, Smithy threw the test prods down on the bench.

"Three days I've had that intermittent on my hands," he snorted, "and for three days it's baffled me."

Smithy stared balefully at the loudspeaker, which reproduced its programme serenely.

Regretfully, Dick put away the cracker. This was obviously not the moment to remind Smithy of the approaching festivities.

"What's the snag?"

"It's just an ordinary TV set," replied Smithy wearily, "and all that's wrong with it is that the sound drops down every now and again. The picture stays normal and nothing else goes wrong whatsoever. What annoys me is that the set is probably suffering from the easiest fault in all the world. But, whenever I get anywhere near the dratted thing, the fault clears up like magic."

"Have you tapped the components?"

Smithy paused and threw a stony glance at his assistant.

"You're joking, of course," he remarked eventually.

"No, I'm not," replied Dick innocently. "I mean tapping the components quite often leads to the diagnosis of an intermittent fault."

Smithy drew a deep breath.

"Over the last three days," he grated, "I have not only tapped the components in that intermittent receiver but I have also thumped them, wagged them, pushed them, and pulled them. I have checked valves until I'm blue in the face with checking valves. I have taken the printed circuit board and I have flexed it this way, that way, and every other possible way known to the science of stresses. I have draped the sound section of the board with a cloth and I have cooked it; and I

have turned the set on and off at irregular periods in case that caused the fault to come up. This morning I went mildly doolally and I resoldered almost every joint that exists in the sound circuits. No sooner had I walked away after doing this but the sound dropped out! And no sooner had I walked back again but the sound returned!"

Dick examined the receiver critically.

"There are screened leads going from the board to the volume control mounted in the cabinet," he remarked tentatively.

"I've replaced them," said Smithy shortly.

"And the leads to the speaker?" continued Dick. "They end in those single plug-pins which go open sometimes, even when they're fully home in the sockets."

"The sockets have been tightened and the plugs cleaned."

"Valveholders?"

"Perfect."

"Well," commented Dick, "it looks as though you've done pretty well everything to that set which you possibly can do."

"The only thing I haven't done," said Smithy malevolently, "is to make a wax image of it and stick pins in it."

Dick was shocked.

"That's a wicked thing to say," he remarked, "especially at this time of year."

"It's because it's this time of the year that I'm so niggled," replied

Smithy. "I've got all the other jobs on my plate which have to be cleared by Christmas, and I just can't afford to be bothered with a sticker like this."

Smithy sighed and lit a cigarette.

probably introduce distortion as well."

"That's quite good reasoning," said Smithy approvingly. "Quite a few snags in the audio stages would introduce distortion as well, but

"The sound i.f. strip in this set", continued Smithy, "is really only a single valve stage. The output of the tuner couples to the common i.f. amplifier (Fig. 1) which handles both vision and sound. Pretty well the only thing in the common i.f. stage which could cause the sound level to drop is an intermittent detuning effect in the tuned circuits. But we can forget about a fault of this nature because it would be bound to do something to the picture as well. The same reasoning applies to the tuned circuits in the tuner. So our fault is bound to lie in the sound circuits after the common i.f. amplifier. You suggest the i.f. stage so, O.K., we'll put tabs on that first."

"How do you propose to do that?" "By hanging a meter somewhere in the circuit," replied Smithy. "That is to say, I'll connect it in permanently so that I can sneak up and read it whenever the snag appears. Now, if you look at the sound i.f. circuit you will see that the manufacturer has very obligingly provided us with a built-in valve voltmeter, this consisting of the sound diode feeding an a.g.c. voltage back to the pentode. (Fig. 2.) So I'm going to temporarily solder

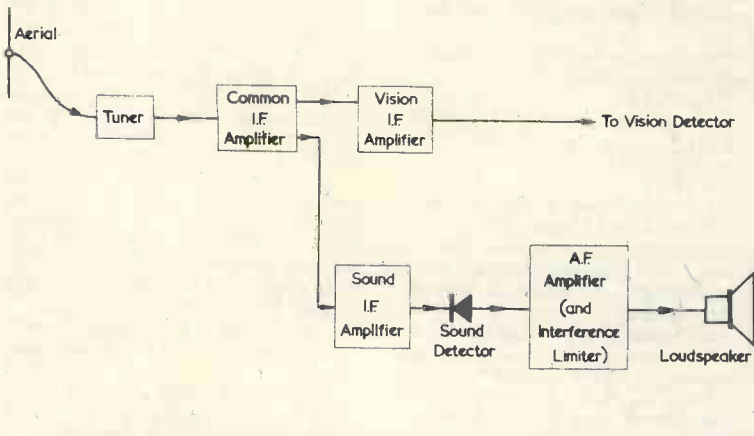

Fig. 1. In the intermittent receiver serviced by Smithy, a single valve sound i.f. amplifier follows a common vision and sound i.f. amplifier

"Anyway," he continued, "I'm not going to be beaten. Up to now I've been carrying out a simple general attack on that receiver. I'm now going to move into Phase II."

"Phase II?" queried Dick.

"Phase II," confirmed Smithy.

"Which, incidentally, I would have started a lot earlier if I hadn't been so plagued by other work. Phase II is in the nature of reconnaissance. We must first determine the area of battle. After that we shall install scouts at strategic points."

"This sounds interesting."

"It is interesting," replied Smithy, cheering visibly at the thought of constructive action. "Now, let us first analyse the fault. When this fault condescends to appear the sound goes down in volume. As you may have heard just now, however, the sound does not cease completely; it carries on at much reduced level. When I've managed to listen closely to the reduced volume level I have noticed that it's quite free from distortion. Also, whilst the fault is on there is no noticeable effect whatsoever on the picture."

"It sounds to me", cut in Dick, "like a fault in the sound i.f. amplifier."

"Why's that?"

"Because when the sound goes down there's no distortion. If the snag was in the audio stages it would

none in the i.f. strip, apart from perhaps self-oscillation, would do that."

Dick looked pleased at the Serviceman's comments.

a testmeter across the cathode load of the pentode."

Smithy found two lengths of single flex and, picking up the soldering iron, lightly patched their

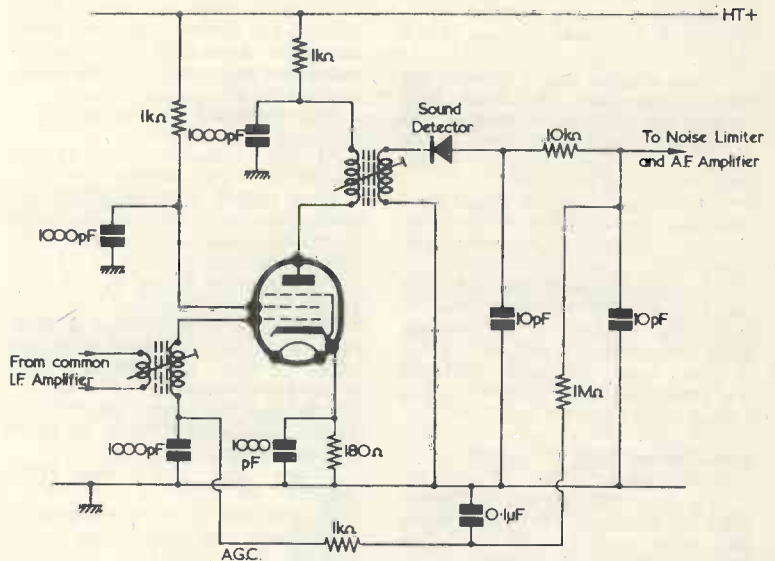

Fig. 2. A typical single valve sound i.f. amplifier with a.g.c. Component values are representative and a suitable valve would be the EF80

ends to chassis and the pentode cathode. He connected the other ends of the leads to a testmeter, and swung the tuner to a blank channel and back again, noting the two readings.

"Right," he remarked with satisfaction. "On a dead channel the cathode voltage is 1.2 volts. The live channel causes this to drop to 0.8 volts because of a.g.c. action. Not a great drop, mind you, but that's partly because you've got the vision a.g.c. holding back the signal before it hits the sound circuits anyway. And it's enough for our needs."

"What are you going to do now?" "Wait until the fault reappears," replied Smithy, "then creep up on that meter and see what it reads before I do anything else. If its reading has dropped well below 0.8 volts I shall know that the pentode is passing a very low current, probably because its anode or screen-grid feeds have gone open. It won't be the valve, incidentally, because I've already swapped that. If the reading's gone above 0.8 volts I'll know that the fault is stopping the i.f. getting through to the diode without altering valve feed arrangements. The fault would then possibly be a shorted tuned circuit or something equally horrible."

"And if the meter remains at 0.8 volts?"

"Then I shall know almost for certain that the i.f. stage isn't causing the trouble, because it will be passing the signal through to the diode at the same level as it did before the snag appeared."

"Well, that's neat, I must say," said Dick approvingly. "That single meter covers quite a lot of eventualities."

"It covers enough for the time being anyway," replied Smithy guardedly. "And now we must get back to work and finish off the rest of these sets. As I said just now it's Christmas Eve tomorrow, and I want to be clear by then."

A Satisfying Bang

Dick started.

"I'd forgotten all about Christmas," he admitted. "Anyway, seeing that we're practically in the festive season, how about a tug at the old Christmas cracker then?"

"I must confess I feel a bit more Christmassy now than I did before," remarked the Serviceman. "It must be the psychological effect of tackling that intermittent in a different way."

He pulled away at the cracker offered to him by his assistant. It broke with a satisfying bang, and the major part of the casing was left in Dick's hand.

"That means," said Smithy magnanimously, "that the innards belong to you."

"Fair enough," replied Dick, examining the contents. "Ah, there's a hat here!"

Dick carefully unfolded the paper and revealed a multi-coloured hat of mammoth proportions. He tried it on.

"You're not wearing it properly," said Smithy severely.

"Aren't I?"

"Of course not," said Smithy.

"What you've got there is a Napoleon hat."

"Well?"

"You're wearing it fore and aft."

"How should I wear it?"

"Athwartships," replied Smithy firmly. "All Napoleon hats are worn athwartships. Orientate it through ninety degrees."

Obediently, Dick turned the hat as Smithy directed. He then examined the contents of the cracker.

"There's a piece of paper as well."

"Read it out," commanded Smithy.

"Why," read Dick, "is a cold like a Parliamentary debate?"

Smithy looked puzzled.

"Would this be in the nature of a riddle?"

"I should think so," replied Dick.

"Here's the answer. 'Because sometimes the Ayes have it and sometimes the Noes have it.' Corluvaduk, *that's* corny!"

The perplexed expression on Smithy's face deepened.

"I don't understand it," he said eventually. "Pass it over."

Dick passed over the paper and Smithy studied it intently for some moments. Suddenly he gave out a great bellow of laughter.

"It's not as funny as all that, surely," commented Dick.

"Of course it is," roared Smithy.

"Don't you see? You can either say 'Ayes' or 'Eyes', or 'Noes' or 'Nose'. It's a pun on the words!"

"Do you honestly think," said Dick indignantly, "that I didn't realise it was a pun?"

"Then why didn't you laugh then?"

Dick started to speak, but gave up the attempt. He knew when he was beaten.

"That's quite cheered me up," chuckled Smithy. "We'll have to pull another of those crackers soon. Anyway, we must really get some work out of the way now or we'll never get done."

Getting Down To It

Still chuckling, the Serviceman turned back to his bench. His assistant, a little aggrievedly, re-

turned also to his labours. The pair were soon almost completely lost in their work. Every now and again a satisfied grunt would rise from either bench as an elusive fault was finally run to earth and cured, to be followed by the pleasant sound of a chassis being returned to its cabinet and the triumphant march across the Workshop, as the receiver was carried to the 'Repaired' rack. The two diligent workers were not entirely absorbed, however, because each listened subconsciously to the programme reproduced from Smithy's intermittent receiver.

An hour had passed before the sound from this receiver suddenly ceased. In unison the Serviceman and his assistant, the latter still wearing his paper hat, dropped their soldering irons on their rests and rushed over to the faulty chassis.

"Don't get too close now," warned Smithy. "It's very temperamental."

"What's the meter reading?"

"0.9 volts," replied Smithy.

He sounded a little worried.

"That's not exactly the same as we had before, is it?" asked Dick.

"It isn't" replied Smithy. "It's shifted just enough to be annoying. Anyway, you keep an eye on that meter, and I'll see if I can find any dirty voltages by prodding around with another."

Smithy picked up a second test-meter and switched it to read h.t. volts. The loudspeaker continued to reproduce its attenuated version of the previous signal.

Cautiously, Smithy applied one test prod to the chassis. At once, the fault cleared and the receiver played again at full volume.

"*Drat* the thing," snapped Smithy. "I've had some intermittents in my time but this is just about the worst yet!"

"I can't offer you any help either," commiserated Dick. "The meter just stayed fixed at 0.9 volts when the sound came up again."

Smithy turned round quickly.

"But that's fine," he exclaimed.

"Are you sure the needle didn't move?"

"Dead certain. It didn't even flicker."

"Then that means the i.f. stage is O.K.," said Smithy. "I was worried about the original 0.8 volts going up to 0.9, but the increase could have been due to long-term shifts in valve operating conditions or in signal level. The fact that the reading remained constant for fault-on and fault-off conditions means that the same amount of i.f. was being pumped into the diode all the time. So we can now consider the i.f.

stage to be blameless."

"Why, of course we can!" exclaimed Dick. "I hadn't looked at it in that light. What do we do now, tackle the a.f. stages? Incidentally, couldn't the noise interference circuit cause the trouble?"

"Yes," replied Smithy, "to the first question, and 'doubtful' to the second! I know that sound interference resistors often go open-circuit, but they usually cause the sound to be weak and distorted.¹ In this case the weak sound is not distorted."

"Fair enough," said Dick. "How about hanging our meter on to one of the a.f. valve cathodes then?"

"Not so fast," replied Smithy. "Let's have a look at the circuit first and make some preliminary guesses. Now the a.f. stages use a single triode-pentode (Fig. 3) in a fairly conventional circuit. The output pentode has an unbypassed cathode resistor and the cathode of the triode taps into a 10Ω resistor at the bottom end of this. A little gain will be lost by omitting the bypass capacitor for the pentode. I would guess that the common 10Ω resistor would give some positive feedback, but this would certainly not be enough, of course, to cause oscillation. The important point for the present is that the heavy pentode current flowing through the 10Ω resistor will be so much greater than the small cathode current of the triode that it would swamp out any changes in the latter. So there wouldn't be any point in tacking our meter on to that triode cathode after all."

"How about the pentode cathode?"

"Well, I don't honestly think the fault is in the pentode stage at all," replied Smithy. "Let's examine the possible faults. If the pentode anode circuit goes high resistance the screen-grid will dissipate most of the power and it will glow red-hot. I haven't noticed a red-hot screen-grid when the snag is on. Also, the fault would cause distortion. Shorted turns in the speaker transformer would also cause distortion, particularly if they reduced volume by the amount that occurs here. A leaky grid coupling capacitor to the pentode would cause distortion, whilst a partly open circuit in this component would give heavy bass cut. Changes in cathode bias would also increase distortion. The effect could, conceivably, be caused by an open-circuit feed to the screen-grid but I have carefully checked the connections here and, also, no components are involved. I wouldn't

dismiss the screen-grid possibility, but it's still improbable."

"What if the resistor and capacitor across the speaker transformer went faulty?"

"If they went faulty enough to cause the present snag," replied Smithy, "they would pretty certainly introduce distortion as well."

"There you are," he said cheerfully, "the meter's now reading 85 volts when the set is working O.K."

A Second Bang

The pair walked away from the intermittent receiver and Dick examined the remainder of the stock awaiting repair.

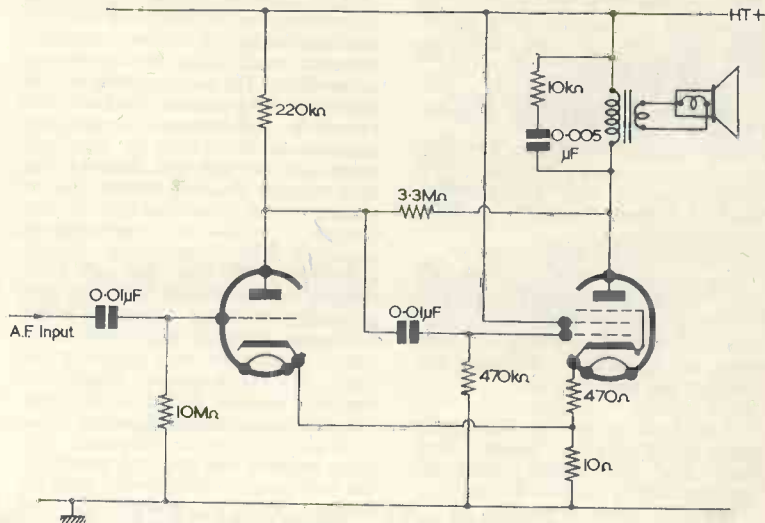

Fig. 3. An a.f. amplifier similar to those employed in present-day television receivers. The input would be obtained from the volume control and a suitable triode-pentode would be the PCL82. The 3.3MΩ resistor between anodes provides negative feedback

"That leaves us the circuit between the sound detector diode and the triode grid, and the triode stage itself," said Dick. "Bearing in mind that we've already assumed that the interference limiter is O.K."

"That's it," agreed Smithy. "We'll tackle the triode stage first because that's got voltages on it which are easier to measure. We've already seen that there's no point in checking cathode voltage, so we'll hitch our meter on to the anode."

"Isn't the meter going to draw too much current?"

"We have a nice 10,000 ohm per volt meter in the Workshop," said Smithy, "which, when switched to 200 volts, or thereabouts, offers a resistance of no less than 2MΩ, and is ideal for this job. However, we would probably get away with a 1,000 ohm per volt job here if we switched it to a sufficiently high range. Anyway, let's pop our meter on."

Smithy unsoldered the flex previously attached to the i.f. amplifier cathode and re-affixed it to the triode anode.

"Well", he remarked, "it looks as though we'll clear things up nice and early today after all. There aren't many sets left to do now."

"Neither are there," said Smithy cheerfully. "And I've got a hunch that we're on the last lap with that intermittent receiver as well. How about pulling another of those crackers of yours?"

"Okeydoke," said Dick equably.

There was a second satisfying bang and it was Smithy who now became the recipient of the cracker's contents. He unfolded his hat and looked at it uncertainly.

"That's a Davy Crockett hat," said Dick helpfully.

"It seems to have a lot of tinsel on it."

"Ah yes," replied Dick. "That long length of paper with the tinsel on it is the tail, and it hangs down the back of your neck. And the round bit goes on your head."

"There's tinsel all over that, too," said Smithy doubtfully.

"Of course there is," said Dick impatiently. "You're supposed to have bright and shiny things around

¹ See *In Your Workshop*, October 1961

Christmas time."

"Yes, but isn't it a bit garish?" questioned Smithy. "Isn't it rather an ostentatious thing to wear while you're working?"

"I've been wearing mine all the time," Dick reminded him.

Reluctantly, Smithy put on his hat.

"I suppose it's all right," he commented. "Anyway, I've got a riddle here too. It says 'Why do ducks like the water?'"

"I'll buy it."

"'Because,'" continued Smithy, "they're quackers!"

Dick looked at Smithy's blank face and broke into a chuckle.

"That's not too bad," he remarked. "And it's a darned sight better than the last one!"

"I don't get it," said Smithy.

"It's another pun," explained Dick, "on 'quackers' and 'crackers'."

"I still don't understand it," continued Smithy. "I can see that ducks are 'quackers', but it's the 'crackers' bit that gets me."

Dick sighed.

"You have to assume that most people don't like the water. But ducks do," he added helpfully, "because they're quackers. See?"

"It's not even a proper pun," complained Smithy. "The two words are different."

"Well, all I can say," replied Dick, defeated once more, "is that you got a better hat out of your cracker than I did out of mine."

Light shone in Smithy's face.

"Ah, that may be the reason," he remarked.

"Hey?"

"Yes, well they're not going to put the best jokes and the best hats in the same crackers, are they?"

Dick held up his hands in helpless wonder as Smithy turned back to his work. As Dick walked back to his own bench, he just caught what sounded like a hastily suppressed chuckle from the Serviceman. Dick paused and wondered whether Smithy had finally seen the joke. A faint suspicion that the Serviceman had, all the time, been pulling his leg passed fleetingly across his mind, but he dismissed it immediately. Nobody could keep it up as consistently as that. Nevertheless, he stayed still for a moment. The trouble with Smithy was that you could never be quite certain.

Clearing Them Up

Dick soon forgot all about jokes and, even, about Christmas, as he and Smithy tackled the remaining sets left to be repaired. He deposited a sound receiver on the "Repaired"

rack and returned to the remaining stock which required service. To his surprise there was only one receiver left: an early 14 inch television set.

Jubilantly, Dick carried this over to his bench, plugged in an aerial, and switched it on. After some minutes the line output stage came audibly to life. Dick waited but no picture appeared on the tube despite adjustments to the brilliance control. He checked sound on both the local channels and this was perfectly acceptable. He switched the set off again, quickly removed the back and peered in, keeping an eye open for obvious faults. One of the first points he checked was that the ion trap magnet had not slipped out of position and, thereby, cut off the picture. However, the magnet assembly was firmly and reliably clamped around the tube neck and, judging by the caked dirt that had gradually built up around it, had obviously not been moved for many years. After he had switched on again, the valves glowed brightly in the dark interior of the cabinet and Dick's glance finally fell on the e.h.t. rectifier. This was a wire-ended type hung between the two end panels of the line output transformer and its filament was, very obviously, not glowing. Dick removed the chassis from its cabinet.

"Have we got any EY51's, Smithy?"

"There's a couple in the cupboard," Smithy replied, over his shoulder. "But if you've got an old set make certain it is an EY51 you want. Some of those old sets used to have wire-ended rectifiers with 1.4 volt heaters."

Dick wiped the grime away from the rectifier in his set.

"This one's marked 'R12,'" he called out.

"Fair enough," called out Smithy. "That's the Brimar equivalent of the EY51. 6.3 volt heater, 90mA."

Impressed, as he usually was, by Smithy's encyclopaedic memory for valve numbers and ratings, Dick found a replacement rectifier. He had just soldered this in when Smithy wandered over to look at the receiver.

"That's quite an oldie," he remarked, a note of nostalgia in his voice. "It's got the open final anode connector on the tube and everything."

Dick finally rounded off the solder in the anti-corona tags on the line output transformer, after which he examined them with considerable satisfaction and switched on. At the same instant the sound on Smithy's intermittent receiver ceased abruptly.

The pair dashed over once again, and Smithy pointed exultantly at the meter he had previously coupled to the triode anode.

"There you are," he said triumphantly. "Ten volts!"

Dick looked at the meter.

"What does that mean?"

"It means", said Smithy, "that the intermittent in this receiver which has been plaguing me for the last three days is nothing more than an open-circuit resistor in the triode anode. I told you it would be a simple fault!"

"Wouldn't it be high-resistance?" remarked Dick doubtfully. "You're still getting 10 volts there you know."

"It *could* be high resistance," agreed Smithy, "but don't forget that you're bound to get some voltage on to that anode anyway because of the 3.3MΩ feedback resistor coupling over from the pentode anode. The only other possibility is that there's leakage through the board or valveholder between the anode and some point which is at chassis potential. But, to give us a reading of 10 volts, such a leak would have to have a steady value around 10kΩ or so and that's unlikely. Also, steady low-resistance leaks don't usually come on and off as suddenly as this one does. So that's got this little Christmas job cleared up, my lad."

"And I've just cleared up the last job on my bench, too," replied Dick.

"Let's have a look at it," said Smithy.

The Serviceman walked briskly back to Dick's receiver and bent over it. As he did so, the tinsel tail of his hat fell over his shoulder and, came to rest on the exposed e.h.t. terminal of the cathode ray tube. Dick, following the Serviceman, was amazed to see Smithy's head suddenly assume a bright halo of corona before the latter jumped frenziedly away from the bench. Dick guided the stricken Serviceman to a stool and waited whilst he collected his senses. The receiver on Dick's bench was now displaying a perfect picture and, diplomatically, Dick switched it off.

After a short while, the Serviceman tore the paper hat off his head and, with emphatic gestures, ripped it carefully into very tiny pieces.

He then stood up dramatically and addressed his watching assistant.

"I am now", stated Smithy impressively, "calling it a day."

"I don't blame you," sympathised Dick.

"I have laboured without pause", continued Smithy, "over the past week, including overtime mark you,

on every manner of major and minor snag. During all that time I have allowed myself only one relaxation. Just *one!*"

"That's right."

"Because of the approach", intoned the Serviceman, "of the festive season, I have indulged in the single innocent frivolity of placing a paper hat upon my head."

"I saw you."

"And what happens?" said Smithy, his voice rising. "What happens?"

"You get a belt!"

Smithy sat down on his stool again, and suddenly burst into laughter.

"You're dead right," he chuckled.

"I get a belt! And I'll be the first to admit that it was through nobody else's fault but my own. Anyway, I've had enough! I'll leave you to finish off the sets yourself."

One and All

Obediently, Dick attacked the out-

standing receivers. He replaced the triode anode resistor in Smithy's intermittent receiver and put the chassis in its cabinet. He similarly cleared up his own receiver. The set on which Smithy had been working before the intermittent receiver had finally gone faulty had already been repaired by the Serviceman and required only a final test. This set was quickly despatched by Dick.

Together, Smithy and Dick sat and looked around the Workshop with satisfaction. Then Smithy walked quietly over to his bench and busied himself mysteriously. Returning, he placed a glass alongside Dick and retained another in his own hand. They clinked the glasses together and settled themselves more comfortably.

"Well," said Dick, sipping appreciatively, "that's got another Christmas rush over."

Smithy chuckled.

"It's always a panic around Christmas time," he said.

"Do you know what I think?" asked Dick.

"What?"

"This servicing game," replied Dick. "It isn't really half a *lark!*"

"It has its moments," grinned Smithy. "Anyway, Dick, this is the time for me to wish you a really Merry Christmas."

"And the same to you, too, Smithy," replied Dick warmly. "But aren't we forgetting someone?"

"Who's that?"

"Why, the readers who've put up with our adventures over the last year, of course!"

With Dick following his movements, Smithy stood and held his glass up.

"A very Merry Christmas to you all," said Smithy.

"And we'll end as we did last year," continued Dick, "by adding 'God Bless Us, Every One!'"

Should a Glowing Valve be Discarded?

UNDER CERTAIN CIRCUMSTANCES A VALVE MAY emit a bluish glow, but this does not necessarily indicate that the valve concerned is faulty. This blue glow is, of course, quite distinct from the light emitted from a red hot cathode or heater.

Soft Valves

Valves which contain a small amount of gas will usually glow in operation, this glow being emitted from the gas between the electrodes. Voltage stabiliser tubes and thyatron tubes, which contain some gas, always glow in normal operation. Similarly, mercury rectifiers always glow, as they contain mercury vapour. If, however, any ordinary valve which should have a high vacuum within its envelope emits a bluish glow from between the electrodes, this shows that the valve is soft (i.e. it contains some gas). Such a valve should be replaced as soon as possible, as the reverse grid current will be very high and this will affect grid bias and alter operating conditions.

In extreme cases there may be too much air in the valve for a glow to be emitted and the "getter" (a deposit on the glass which should be of a bright

metallic appearance) becomes white. Such a valve cannot be used at all.

Electron Bombardment

Power valves may sometimes emit a bluish glow from their glass envelopes or from the mica supports within the valve. The intensity of the glow may rise and fall with changes of anode current or signal amplitude. Providing that this glow comes from a solid surface and not from the space between two electrodes, this is not an indication that the valve is faulty. The glow is caused by electron bombardment of the glass or the internal surface.

Practical Example

On one occasion known to the writer it was found that, if the input to a large audio amplifier was short-circuited, an extremely loud sharp noise was emitted from the speaker. The trouble was traced to the first valve in the amplifier, which had become soft. The resulting grid current flowing through the grid resistor had produced a steady voltage across it. When this voltage was short-circuited, the voltage change was amplified and resulted in the very loud "crack" just referred to. The valve concerned emitted a slight glow from the space between its electrodes.

NEWS AND COMMENT . . .

An Oscar

American amateurs hope to have a satellite in space soon as part of a programme to utilise the tremendous source of technical ability that amateur radio provides.

Orbital Satellite Carrying Amateur Radio is the full title of the project, hence the name "Oscar".

The plan is to launch two small satellites. The first experiment will consist of putting a simple beacon transmitter into orbit to transmit in the 2-metre band. Oscar I will be a canister only 6in long and 2in in diameter.

Oscar II will be a more complicated affair 16in long and 6in in diameter. It will be capable of receiving signals on the 6-metre band and simultaneously transmitting on the 2-metre band.

This second satellite will "serve" a ground area 2,000 miles in diameter.

It is hoped that amateurs throughout the world will take an active part in the scheme thus expanding their ability to contribute to similar projects in the future.

Aerials

Many readers will probably remember the photograph we published, at the beginning of this year, showing a mass of aerials on the roof of a block of flats situated within a few minutes walk of our Editorial office. We quoted from an accompanying article on Television Distribution Systems "... the roofs became a forest of aerials and the situation chaotic. . . ."

In large numbers, we would probably all agree that t.v. aerials are not very handsome and therefore news of arrangements whereby unsightly aerial arrays are dispensed with is always welcome. It is therefore with pleasure that we give news of an estate of 800 bungalows and flats being built at Bognor Regis on the Westmeads Estate, where in each home a wired television aerial system has been installed. This is believed to be the first estate in this country where a television aerial system has been built-in at the same time as other essential services, and where the owners have to undertake not to erect individual t.v. aerials on their properties.

Tansley and Cook Ltd., of Bognor Regis, have placed a contract with E.M.I. Electronics Ltd. to supply and install an aerial tower and wide-band distribution system which will provide the B.B.C. television programme on Channel 3, I.T.A. programme on Channel 11, B.B.C. v.h.f. Home, Light and Third programmes, and Radio Luxembourg programme picked up direct and redistributed on v.h.f.

To preserve the estate's amenities in every possible way, cabling from the aerial tower to all dwellings will be buried underground and amplifier cabinets along the route will be camouflaged.

Readership

From time to time publishing organisations ask us to break down our readership into various categories of age, profession, nationality, etc. We find this impossible to do, knowing of readers who have not yet reached their teens and of others who are nonagenarians. Apart from our many readers who are professionally employed in the radio industry, every conceivable type of occupation seems to be represented; as to nationality, we can only say that readers write to us from all over the world, iron curtains notwithstanding, and most of them are native to the country from which they write.

As you are probably aware, publications sometimes claim a readership which considerably exceeds the number of copies they sell, these figures being based on the assumption that, on the average, a certain number of people will read each copy of their periodical. These figures may be estimates worked out by proper sampling, or extravagant guesses. We do not know the extent of our readership—we can only say that chartered accountants certify that we sell nearly 35,000 copies of each issue.

We are frequently surprised to learn of the response some of our readers obtain from requests for help which we have published in this magazine. Mr. A. Lee, of 77 Yew Tree Lane, Manchester 23, has written to us stating that as a result of his request for particulars of valve types used in a civilian wartime

receiver, he received no less than 281 replies! He is most grateful to all these readers and, as he cannot possibly write to them all, has asked us to express his thanks.

It leaves us wondering just how many people on the average do, in fact, read *each* copy of the *Constructor*.

Warning

In a recent issue of *Mobile News*, the journal of the Amateur Radio Mobile Society, is related, very amusingly, a little adventure that befell one of its prominent members, G3KVF.

He had parked his car near the coach station very late one evening to await the arrival of his wife who had been to a firm's theatre outing. To while away the time he began to work local radio amateurs from his mobile rig. His activities, however, were soon interrupted by a knock on the side window—a very large police officer was in attendance!

After G3KVF had given a lengthy explanation of why he was there and what he was doing, the policeman departed. Within the next 20 minutes, he was twice visited by individual policemen, who also required explanations.

Finally, just after midnight, a police car with bell ringing at full blast tore up and pulled right across the bonnet of his car, several police officers tumbled out, and the explanations were given all over again.

By this time the radio amateur concerned felt that an explanation was due to him. In the nicest possible way he was informed "We don't mind you waiting for your wife at all, sir, but the next time. . . DON'T WAIT AT THE SIDE OF A BANK."

Computer Problem

At a recent appeal by Granada TV Network against the decision not to derate their premises in King's Road, Chelsea, the Lands Tribunal held that an electrical impulse was not an article.

This reminds us of the remark of an accountant as he left the Computer Exhibition at Olympia: "How on earth do I audit an electrical impulse?"

TRADE REVIEW . . .

Martin Recordakits



MARTIN ELECTRONICS LIMITED ANNOUNCE A series of new kits to enable the non-technical home constructor to build his own tape recorder. Whilst the idea of such kits in other fields is far from new, the technical problems associated with tape reproduction are such that considerable thought and care has been required in order to make it possible for a recorder to be built at home. Martin Electronics are a company with considerable experience in the design and manufacture of amplifiers for manufacturer's requirements, and in turning their attention to the home construction market, their experience shows to excellent advantage in their products so far. There are basically three types of constructional kits offered and these are based upon a well developed "brick-by-brick" system.

each is individually tested before leaving the factory. (See illustration.) To help the constructor, wires are cut to length and attached by one end to the relevant component part. Exceptionally detailed instructions are included with each kit and as an added facility there are case and loud speaker assemblies offered, with or without the appropriate deck.

In this way the would-be constructor can build a 3-speed 2 track recorder using a Collaro Studio deck, or a 4 track or 2 track recorder using a BSR Monardeck.

The Martin Recordakit Amplifiers are also recommended for building into existing installations

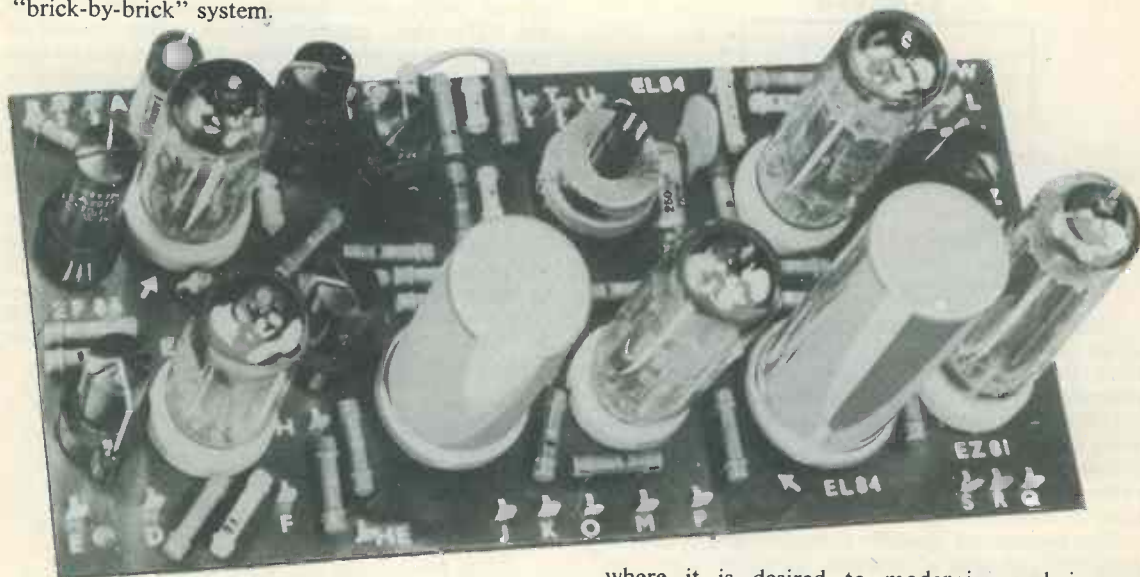

This means that by designing to the availability of well-known decks which can easily be bought anywhere, the constructor is able to build a recorder to professional standards of performance and appearance. Martin Recordakits are centred upon the printed circuit amplifiers developed by Martin Electronics. They come assembled with valves and

where it is desired to modernise and improve standards of reproduction from tape and/or disc.

Prices for these excellently presented Amplifier Kits are most reasonable, starting at £8 8s. 0d. for Type 8312-M (for BSR 2 track deck) to £11 11s. 0d. for Type 8311-V (for Collaro deck). Everything is complete, to labelled knobs, indicator plates, nuts, bolts, wire, etc., and all equipment is guaranteed.

SMALL CAPACITANCE MEASURING INSTRUMENT

(0 to 110pF and 110 to 500pF)

By P. A. ROBINSON

FIG. 1 (a) SHOWS TWO SIMILAR RESISTORS IN SERIES across the 240V mains supply. Because they are of the same value, the voltage across each will be one half of the total mains volts. If the resistors are of unequal value, the voltage distribution will also be unequal as shown in Fig. 1 (b).

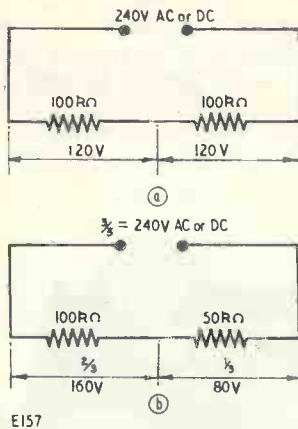

E157

Fig. 1. Illustrating the voltages appearing across series resistors which have (a) equal values and (b) unequal values

Much the same result applies to capacitors in series across an a.c. supply; Figs. 2 (a) and (b). Here the capacitor of higher reactance (smaller capacitance) has the higher voltage across it.

Unfortunately the current in a circuit of this type, using small value capacitors, is far too low to actuate a true reading in a voltmeter, or indeed in many valve-voltmeters. However, a small neon bulb will glow as soon as its striking voltage is obtained.

The instrument described here employs such a neon bulb to give a reference indication from the voltage appearing across a variable capacitor. The value of the variable capacitor is adjusted until the striking voltage of the neon appears across it, using the circuit shown in Fig. 3. The value of the unknown capacitor may then be determined from the setting of the variable capacitor. Fig. 3 shows, in simplified form, the circuit employed in the instrument for measuring capacitance,

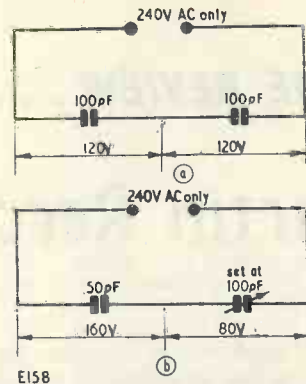

E158

Fig. 2. The same situation as in Fig. 1 occurs with capacitors, resistance now being replaced by reactance

Capacitor Leakage

As the current in the measuring circuit is minute, it is obvious that any leak in the capacitor to be measured could cause a current to flow which would be much greater than that due to its capacitance. It is, therefore, essential to test for leaky insulation in a capacitor before measurement of its capacitance is made. A circuit capable of doing this is illustrated in Fig. 4.

The transformer and neon in Fig. 4 can be the same as those used by the measuring instrument of Fig. 3. The 33kΩ resistor limits switching-on current, whilst the 470kΩ resistor provides smoothing. The 1MΩ component is a safety resistor to prevent shocks while handling the terminals and to safeguard the neon. Without it the neon would be wrecked if a short-circuited capacitor were put across the test terminals. The 2.2MΩ resistor discharges the large smoothing capacitors after switching off and also lowers the voltage at the test terminals to about 210.

A potential of 210 volts was decided upon as being the lowest voltage allowable for striking the Osram type G neon specified; yet it is not too high to distress capacitors of the 150V working type. Any lower working voltage capacitors should not be checked on this instrument if it incorporates the type G neon bulb.

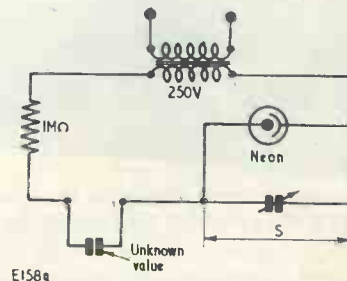

E158a

Fig. 3. The basic circuit employed for capacitance measurement. S=Neon striking voltage

There is, however, an Osram type LNI miniature neon of the same physical dimensions which requires a much lower striking voltage. This bulb allows capacitors of lower working voltage to be measured, and its use is discussed later:



Top view of unit connected up for measurement of a 30pF capacitor

The Complete Instrument

The first thing to decide, so far as capacitance measurement is concerned, is the value to be employed in the variable position of Fig. 3. It was found that a swing of 170pF was best for measuring capacitors up to 100pF and it was eventually decided to employ a two-gang 500pF component in the variable capacitor position. One section of this could have a series capacitor to restrict its swing, and the second section could then be added in parallel to provide a higher capacitance range.

Fig. 5 shows the complete instrument. As may be seen, it incorporates the leakage check circuit of Fig. 4. At the same time it employs the basic

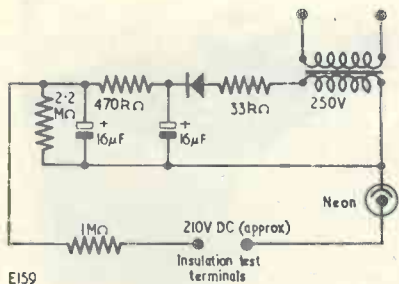

Fig. 4. A simple, but effective, leakage indicator. Leakage is indicated by a continual or intermittent glow in the neon bulb

measuring circuit of Fig. 3, with some modifications—these applying mainly to the variable capacitor.

When the wander plug, in Fig. 5, is inserted into socket 1, the variable capacitance in the circuit is given by one section, C₃, of the two-gang capacitor in series with the 300pF fixed capacitor, C₅. This combination enables values ranging approximately

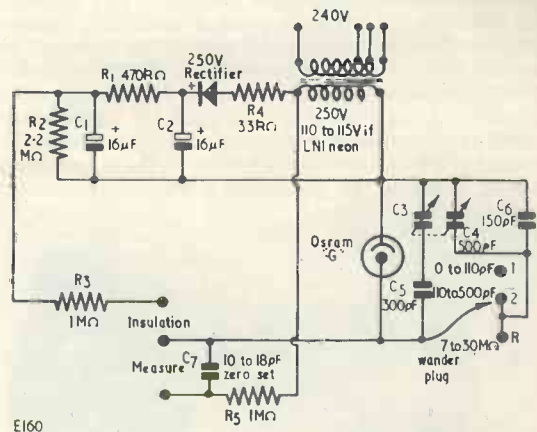

Fig. 5. The circuit of the complete instrument

Components List

Resistors (all 1/4 watt 10%)

- R₁ 470kΩ
- R₂ 2.2MΩ
- R₃ 1MΩ
- R₄ 33kΩ
- R₅ 1MΩ

Capacitors

- C₁ 16μF 250 w.v.
- C₂ 16μF 250 w.v.
- C₃ } 500pF 2-gang
- C₄ }
- C₅ 300pF mica
- C₆ 150pF mica
- C₇ See text

Neon Bulb

Osram type G

Transformer

Secondary voltage 250

Rectifier

DRM1B (S.T.C.) or equivalent

Miscellaneous

- 3 terminals
- 3 sockets
- 1 wander plug
- Insulated panel
- etc., etc.

from 0 to 110pF to be measured. When the wander plug is inserted into socket 2, both C₄ and C₆ are connected in parallel with the series combination of C₃ and C₅. The resultant capacitance enables a range of 110 to 500pF to be measured.

The zero-set capacitor, C₇, is adjusted such that the neon just flashes when the variable capacitor is

at its minimum capacitance position. The value of C_7 will vary for different types of variable capacitor and for different neons, and should lie between 10 and 18pF. A fixed component, or combination of fixed components, may be used here; and it is possible to take up small increases of capacitance up to 4pF by twisting two p.v.c. leads together, as shown in Fig. 6. A small trimmer in the C_7 position would, however, be preferable.

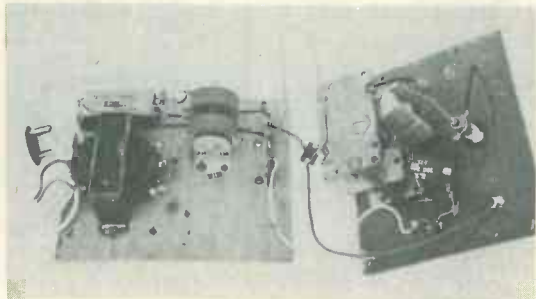

Internal appearance of the measuring instrument

In use, the unknown capacitor (after having been checked for leakage) is connected across the "Measure" terminals. The wander plug is fitted to the appropriate range socket, and the variable capacitor adjusted to a value which causes the neon to be extinguished. The variable capacitor is then adjusted in the anti-clockwise direction (i.e. reducing capacitance) until the neon just flashes. The value of the unknown capacitance may then be read from the scale fitted to the variable capacitor.

The unit is capable of measuring resistance in addition to capacitance, and a range of 7 to 30M Ω is available by plugging the wander plug into socket 3. This gives the same variable capacitor combination as is given by socket 2, and resistance readings are taken in the same manner as capacitance readings.

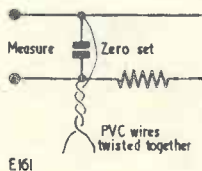

Fig. 6. Small values of capacitance, up to 4pF, may be added to the zero-set capacitor, C_7 , by twisting together two p.v.c. covered leads, as shown here

The Prototype

The prototype unit is illustrated in the accompanying photographs. The mains isolating transformer employed was especially wound for the development of the instrument and it was given secondary tappings of 210, 240 and 250 volts. The 250 volt tapping was that finally employed. Constructors

making up the unit may, of course, employ any transformer having a 250V secondary, any other secondary windings which may be fitted being ignored.

The panel on which the terminals are mounted *must* offer excellent insulating properties. That employed in the prototype consisted of p.v.c. A high quality electrical grade sheet should normally be satisfactory.

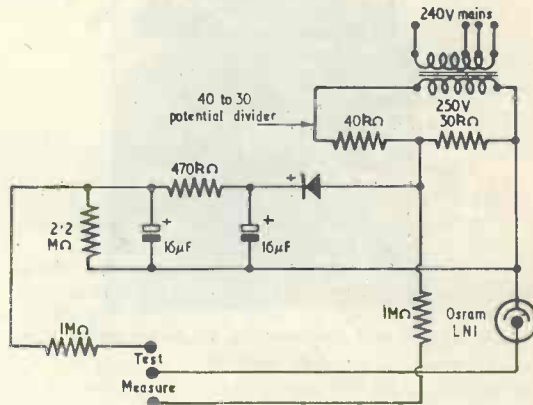

Fig. 7. Reducing the supply potential for the Osram LNI neon

The neon was found to be susceptible to hand capacity effects if the glass bulb touched the panel, and so it was supported on its wiring and kept about $\frac{1}{2}$ in down inside the case. This method of mounting is helpful, also, when capacitances below some 100pF are measured. The light given by the neon with such capacitances is very weak but, when wired through a $\frac{1}{2}$ in hole in the panel, shows up quite well in the dark exterior of the case.



Checking the insulation of a paper tubular capacitor

Calibration

The best method of calibrating the instrument consists of checking capacitances of known value and of marking their corresponding positions on the scale.

A good plan consists of purchasing four capacitors with tolerances of $\pm 1\%$ and having values of 10, 20, 40 and 80pF. (Such components are available, at low cost, from advertisers in this journal.) Calibration of the lower range can then be made in 10pF steps by using these capacitors on their own or in parallel combinations. Thus, the 20 and 10pF capacitors in parallel give 30pF; the 40 and 10, or 20pF capacitors in parallel give values of 50, or 60pF; the 40, 20 and 10pF capacitors together give 70pF; and so on.

For the higher scale, two further capacitors of 200 and 400pF enable the calibration to be continued up to the maximum of 500pF.

Using a Low Voltage Neon

If it is desired to measure capacitors having working voltages below 150, it is necessary to reduce the potential applied to the circuit and to employ a neon bulb having a lower striking voltage.

Whereas the Osram type G strikes at 200 volts, the Osram type LNI strikes at 90 volts d.c. or 65

volts a.c. It may be employed with a supply potential of 105–125 volts a.c. or d.c. provided it has a limiting resistor in series with it of not less than 200k Ω . For the present purpose, the 1M Ω series resistance used for the type G neon is equally suitable for the type LNI.

Two ways of reducing the a.c. supply voltage may be employed. One method consists of using a mains transformer having a secondary voltage of 110 to 115, as indicated in Fig. 5. An alternative method is illustrated in Fig. 7. In this diagram a 250 volt secondary is connected across the potential divider given by the 30 and 40k Ω resistors in series. The leakage tester and measuring circuit is then fed from the voltage appearing across the 30k Ω resistor, this being $\frac{3}{7}$ of the total 250 volts (i.e. 107 volts). In practice the values in the resistors forming the voltage divider are not critical provided the 3:4 ratio is observed. Suitable components having preferred values would be given by 27k Ω and 36k Ω 5% resistors. It will be noted that the 33k Ω resistor R₄, is not needed with the circuit of Fig. 7.



A Constructor Visits the Hallicrafters Factories

IF YOU GO TO CHICAGO, MAKE SURE to see Hallicrafters," I was told. So I did. A phone call to the office of Mr. Fritz Franke, Assistant to the Chairman of their Board, and the appointment was made there and then. Hallicrafters have five locations in Chicago, the head office being situated in one of these at 4401 West Fifth Avenue, twenty minutes from the city centre or slightly longer on the Loop, Chicago's elevated railway.

Development

At this address, apart from administrative functions, the main activity is development work. Even a well-established company must constantly review its product range, adding new features to existing models and evolving completely new equipment to meet the latest trends in radio communication. One cannot fail to be impressed by the sight of a

prototype receiver or transmitter on the test bench connected to every conceivable type of instrument, a new model for next year or the year after. Even the most competitive market conditions, said Mr. Franke, must not justify any skimping of the development work on new amateur equipment, as the purchaser is making an investment involving major capital outlay; he may buy for a lifetime's use, or with an eye to the re-sale value, if his interests are likely to switch to other bands later. In either case, a great premium is placed on excellence in design and reliability. In the welter of technicalities, it is refreshing to know that style and finish are given due emphasis. Hallicrafters equipment has over the years evolved a styling which is quite distinctive and does credit to their team of designers. This has not passed unnoticed and indeed the company has received many awards for the appearance of its products.

It is not surprising that the Hallicrafters Company with its pre-eminence in the short wave field for

over 25 years, should be actively engaged in experimental work for the U.S. Government. Development projects of national importance are constantly in progress and attached to the staff at West Fifth Avenue are many of the best young brains in the industry; at any one time as many as fifteen Ph.Ds are on the Hallicrafters payroll. Few of the projects which are commissioned at these laboratories ever appear under the company's name, and if they are produced in quantity later this is nearly always taken on by other firms.

Manufacturing Plant

One of the principal manufacturing plants is housed in a factory about two miles from the head office. The application of assembly line technique to equipment of outstanding performance is well illustrated here. Great reliance is placed on the skill of the operators. Hallicrafters enjoy a steady market and in these conditions it is possible to retain the services of their key employees for many years, and on this kind of

production line—from sub-assemblies to final test and inspection—every man can claim to be a key employee. Not that men occupy the whole scene in this plant, by any means. A well established member of the testing section is a young woman whose work is very highly rated, and Mr. Franke explained that where the necessary knowledge and skill are apparent there is no question of discrimination against female operators either with regard to payment or responsibility.

One problem notably absent at this factory was that of warehousing the finished product. With no lack of demand for all types of equipment, shipment to the wholesalers follows without delay. Hallicrafters are fortunate here in having a railway siding which allows trucks to be brought right into their despatch department. A distinct asset when you consider that Chicago is regarded as the hub of the American railway system.

Electronic Organs

While having lunch in the works canteen I remarked on the piped music, which is a much criticised feature of so many public buildings in the U.S.A. (The limit was reached, I felt, when the faint strains of an orchestra penetrated the ceiling of a lift in one large office block in the city.) On this occasion however the music was of an unusual fidelity and power, completely dominating the usual clatter of plates and cutlery, and proved, upon investigation, to be coming from an electronic organ within the dining room itself on which one of the employees was displaying his musical skill. Hallicrafters are in fact the makers of a well-known range of electronic keyboard instruments which are at present having a great vogue in America. Production is carried on side by side with the short wave equipment, and rows of operators can be seen shaping the intricate wiring harnesses by twisting lengths of wire of a seemingly infinite variety of colours around the pegs of a wooden jig. Not far from the benches where communications receivers were receiving a final check for selectivity, a technician in a sound-proofed room was playing chords and arpeggios on one of the organs while the last adjustments to

pitch and tone were being made—a nice combination of science with the arts!

Exports

I asked Mr. Franke about exports, since his company's products are known all over the world, and his reply surprised me. The domestic market is still the main factor in deciding the company's policy. Many Hallicrafters receivers and transmitters are sold abroad, but perhaps

to North America, with its vast consumer spending power.

The Future

As to the future, Hallicrafters are as conscious as others in the radio industry of the trend towards miniaturization, so long as there is no compromise on quality. The day cannot be far off when semi-conductors will replace the vacuum tube in all normal receiver and transmitter applications; the printed circuit and other prefabrication

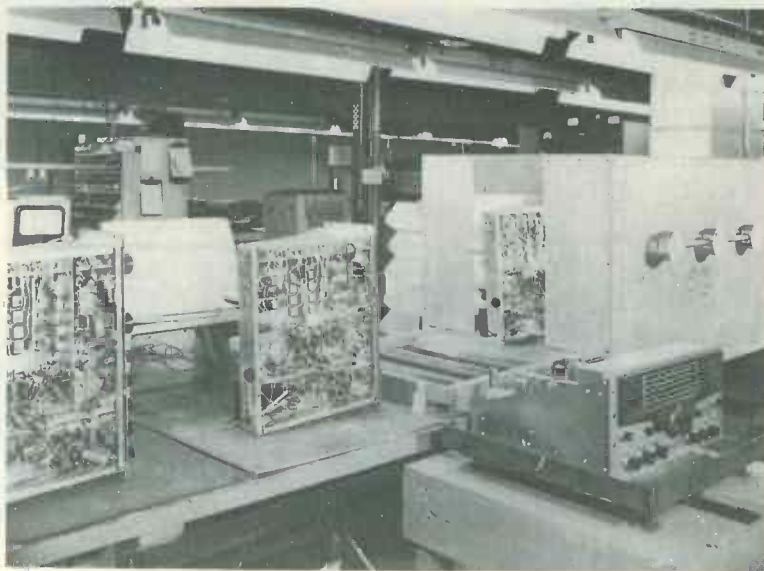

Assembled SX101 communications receivers pass along the production line at the Hallicrafters manufacturing plant.

as many reach the dealers of other countries, especially Europe, by way of the American Servicemen who find a ready market for good second-hand equipment. As Hallicrafters themselves bring out in their recent pamphlet on *The Amazing World of Short Wave Listening*, interest in communications equipment is not confined to professionals and ham operators. It is a way for the general public to keep up with events and to be informed. There is a direct appeal to the wider market for short wave radio which is still mainly confined

methods must in turn be considered on their merits. But where reliability comes before all else these new ideas must prove themselves in performance before they can be accepted for normal use in communications work.

Hallicrafters take a justifiable pride in showing their factories to the visitor from overseas. Mr. Franke asked me to pass on an open invitation to any readers who, on business or vacation, should ever find themselves in Chicago. This I now do, confident of the generous reception you may expect.

EMI TELEVISION CAMERAS FOR POLAND

Following a successful demonstration of equipment in Warsaw earlier this year, two EMI vidicon camera channels have been ordered on behalf of Polskie Radio, Poland.

These channels comprise camera, camera control unit, remote control panel and four-position lens turret. They are of the type widely used by the B.B.C. and Independent Television programme contractors in the United Kingdom.

Orders for EMI vidicon camera channels have already been obtained from Australia, Canada, U.S.A., Eire and Nigeria.

Cover Feature

"The Quintet"



5-TRANSISTOR POCKET
LOUDSPEAKER RADIO

Designed by

D. J. FRENCH, Grad.I.E.E.*

THE INTEREST SHOWN BY THE HOME CONSTRUCTOR in compact and efficient transistor portable receivers undoubtedly continues apace and the present design is offered to further satisfy the ever increasing demand, especially for comparatively inexpensive sets.

The "Quintet" receiver is fully tunable over both the medium-wave and long-wave bands, and selectivity is such that full station separation, with no overlapping, is obtained. Both a car aerial input socket and an earphone/recording socket are fitted as standard, and the whole assembly is mounted on a printed circuit "chassis".

The overall dimensions of the plastic case for the receiver are $5\frac{1}{4} \times 3 \times 1\frac{1}{2}$ in, the controls fitted being a miniature volume control with combined on/off switch, a wavechange switch and a tuning capacitor. The tuning plate is marked with popular station names as well as wavelength, thereby making the selection of the required programme an easy matter.

Push-pull output into a high impedance speaker gives adequate volume up to 250mW. Automatic selection of the speaker is achieved at the earphone/recording socket.

The 9-volt battery (EverReady PP4 or equivalent) will provide up to some six months average listening (i.e. 300 hours) without replacement.

The printed circuit board used is clearly marked with type numbers corresponding to those on the component card, thus greatly facilitating construction—especially for those who have little experience with this type of receiver.

Circuit

The circuit is shown in Fig. 1 and from this it will be seen that the required frequency is selected by the tuned circuit given by C_1 and either the medium or the long-wave winding of the ferrite aerial MLs. The first transistor TR_1 (Mullard OC44) amplifies the signal, which is then passed to the diode for rectification via C_4 . A proportion of the amplified signal is fed back, via C_3 and preset capacitor CT,

to provide a measure of reaction. This results in increased sensitivity and selectivity comparable to the performance provided by a superhet. The volume control regulates the amount of reaction and, hence, the volume output.

The rectified signal from the diode is fed back to the input of TR_1 which now carries out its second function of audio amplifier. The resultant increased audio signal is next passed through RFC₁ and C_5 to the audio stages given by TR_2 (Mullard OC71), TR_3 (Mullard OC78D), and the push-pull output stage TR_4 and TR_5 (Mullard OC78, matched pair). The $75/80\Omega$ speaker is coupled, via C_{10} , to the push-pull stage. The earphone socket connects points 2 and 3 together and thereby automatically cuts out the speaker when an earphone is used. Negative feedback is applied by way of R_{15} and R_{16} in order to improve the frequency response.

As TR_1 is used both as an r.f. and an audio amplifier, the overall effect is similar to that of a 6 transistor plus diode design. The current consumption, under no signal conditions, is about 7mA, this rising under maximum signal condition to 30mA. Consumption at average listening level is 15mA. Overall sensitivity is such that no problems should be met concerning reception over the range of the receiver.

In addition to the version described here, a further design—the "Transfive"—based on the same circuit but having a modified output stage giving up to 325mW output via a 5in loudspeaker, is also available.

Assembly and Construction

When soldering components to the printed circuit board, it is good practice to first cut and clean the lead-out wires, ensuring that these are of the correct length. Place the component in its appropriate position and apply both the iron and the solder to the joint at the same time until the solder just runs smoothly. Only a few moments are required to make a good joint. Should the iron be applied for too long a period, the copper foil may separate from the board.

* Henry's Radio Ltd.

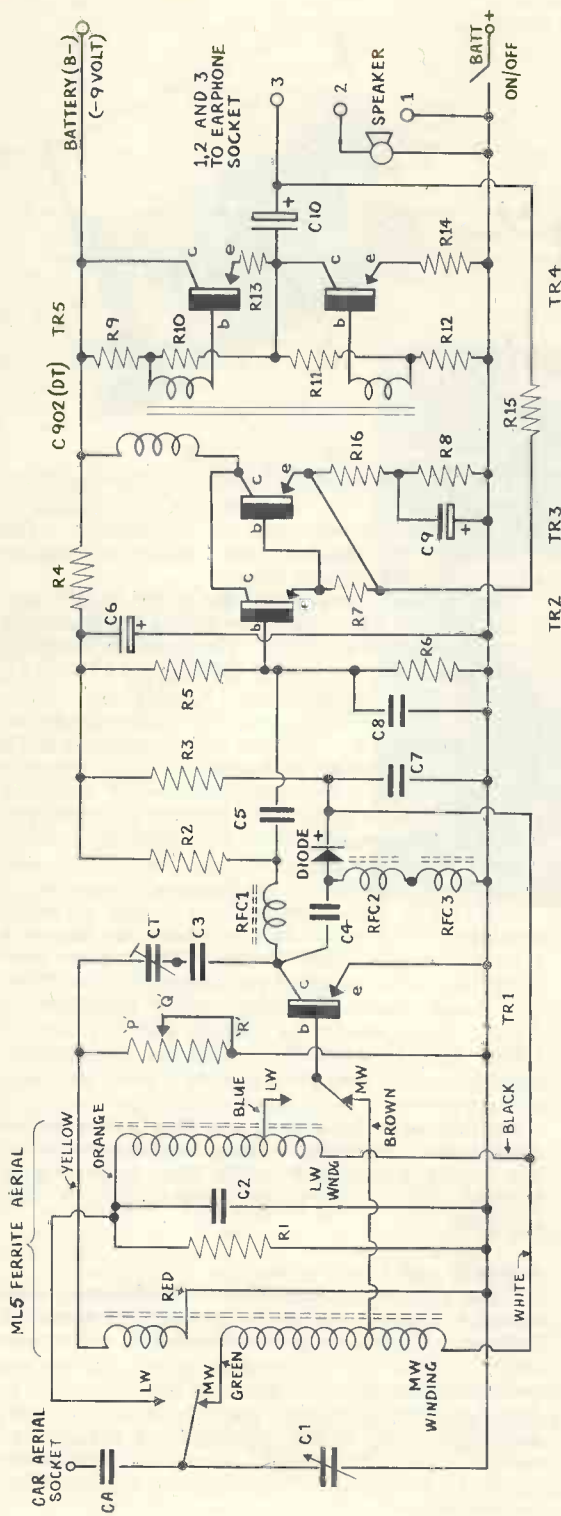

Fig. 1. Circuit of the "Quintet" 5-transistor pocket transistor radio

Components List

(Set out for easy reference to Fig. 1)

Resistors (10% except where stated)

- R1 100kΩ
- R2 3.9kΩ
- R3 82kΩ
- R4 1kΩ
- R5 56kΩ
- R6 4.7kΩ
- R7 1kΩ
- R8 470Ω
- R9 2.7kΩ 5%
- R10 100Ω 5%
- R11 2.7kΩ 5%
- R12 100Ω 5%
- R13 4.7kΩ 5%
- R14 4.7kΩ 5%
- R15 2.2kΩ
- R16 15Ω

Capacitors

- CA 22pF
- C1 365pF variable
- C2 180pF
- C3 100pF
- C4 2,000pF
- C5 0.1μF
- C6 100μF
- C7 0.04μF
- C8 0.01μF
- C9 100μF
- C10 100μF
- CT 80pF preset

Transistors

- TR1 OC44 Mullard
- TR2 OC71 (Mullard)
- TR3 OC78D (Mullard)
- TR4 OC78 (Mullard)
- TR5 OC78 (Mullard)

Battery

EverReady PP4 or equivalent

Diode

OA70 (Mullard)

Speaker

2¼in 75/80Ω

Inductors

- RFC1,2,3 (Henry's Radio Ltd.)
- Ferrite Aerial ML5 (Henry's Radio Ltd.)
- Volume Control 5kΩ (VC1545) (Henry's Radio Ltd.)

Transformer

Type C902 (Henry's Radio Ltd.)

Miscellaneous

- Printed circuit board and bracket
- Moulded cabinet, dial plate, station plate
- 2 pole 2-way slide switch
- Battery clip
- Earphone socket
- Car aerial socket, etc., etc. (Henry's Radio Ltd.)

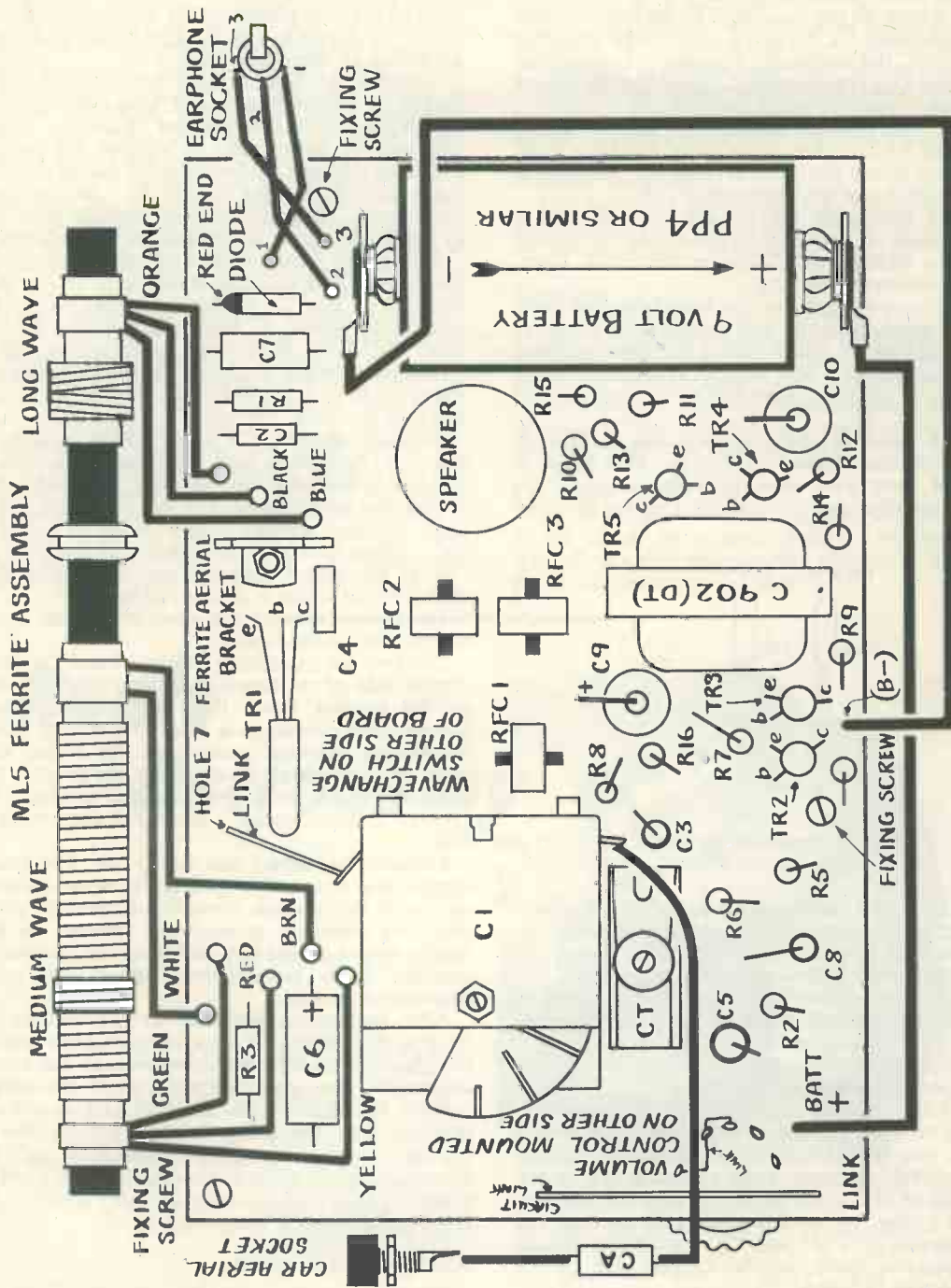

Fig. 2. Practical layout diagram of the receiver

Firstly, solder all the resistors at their appropriate positions, as marked on the board, R_1 and R_3 are mounted flat, the remainder being mounted vertically (see front cover illustration).

Next, solder all the capacitors to the board except CA. Capacitors C_4 , C_6 and C_7 should be mounted horizontally, the remainder vertically. Ensure that C_6 , C_9 and C_{10} are connected correctly with respect to polarity—red end being positive.

Follow this by connecting into circuit RFC₁, RFC₂ and RFC₃, these being all of the same type. Solder into circuit the diode D₁ (red end to junction of R_3 and C_7) and the transformer DT.

Dealing now with the volume control, feed a small amount of solder on to the copper at the five holes into which it fits, keeping the holes clear. Tin the volume control tags.

Place the control on to the board (copper side) and then carefully solder into position. The control must lie flat on the board after it has been soldered into place. Solder a link wire, as illustrated, to the three tags of the control on top of the board. (See Fig. 2.)

Fit and solder a length of bare wire to provide the "circuit link" shown in Fig. 2. Also solder a length of bare wire into the hole marked "7", leaving the other end of this wire free for the time being.

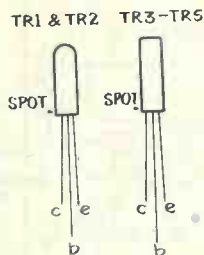

Fig. 3. Transistor connections

Deal next with the wavechange switch. Insulate the switch from the copper side of the board by means of tape, or a similar material, and mount the switch with two 10BA nuts and bolts. Do not tighten the nuts. Place the chassis into the case to ensure that the switch aligns correctly with its slot. Take out the chassis and tighten the nuts. Using a screwdriver, gently bend the switch tags down on to the copper and solder each tag in turn.

Solder the trimmer capacitor CT to the board. Bolt the tuning capacitor to the board and connect the link wire from hole "7" to the tag on the side of the tuning capacitor. Ensure that the tag on the other side of the tuning capacitor does not foul C_3 .

Next, solder 3in insulated leads to each of the holes marked "1", "2" and "3" and follow this by connecting 4in leads, on the copper side, to the holes marked "1" and "2".

Solder transistors TR₂ (OC71), TR₃ (OC78D), TR₄ and TR₅ (OC78) into their correct positions.

Remember that the spot on the side of each transistor indicates the collector (C). The base (B) is in the centre and the emitter (E) on the other side. (See Fig. 3.) The leads on TR₁ (OC44) should be bent so that the transistor lies horizontally over the switch as shown in Fig. 2. Use a heat shunt whilst soldering all transistor leads.

Connect the positive (+) battery clip to a 6in length of insulated wire and solder the other end of this lead to the hole marked "Batt +". Connect the negative battery clip to another 6in length of insulated wire and solder the other end to the "B—" point located between R_9 and R_4 . Do not connect the battery. Place tape over the outside metal parts of the clips in order to insulate them effectively.

Obtain the ferrite aerial and bolt the bracket to the board. The windings must be as shown in the diagram of Fig. 2. Solder the aerial leads to the appropriate holes, as indicated, keeping the wires short but, at the same time, ensuring that they are of sufficient length to enable the ferrite aerial to be removed up to some 1½in from the board. Clip the rod into the aerial bracket.

Connect capacitor CA to the tuning capacitor tag near CT, insulating both lead-out wires with the sleeving provided. Do not cut the leads short. Solder the earphone socket, as illustrated, to the three 3in leads already fitted to holes "1", "2" and "3". Make sure that the solder on tags "2" and "3" of the socket does not run down and short-circuit to the metal frame of the socket.

Place tape around the speaker cut-out on the copper side of the board.

The two 4in wires from holes "1" and "2" on the copper side of the board should now be connected to the speaker tags. Push the speaker magnet through the cut-out hole from the copper side of the board, exerting pressure on the frame edges only. It is important to note that the speaker cone is rather fragile and should not be handled. The speaker assembly makes a somewhat tight fit on the board.

Connect the battery and switch on. The volume control is at full volume immediately upon switching on, i.e. in the position normally occupied by potentiometers when set at minimum volume. A faint hissing sound should be heard from the speaker and possibly some transmissions when the tuning capacitor is rotated.

Affix the station indicator to the cabinet (see heading illustration.) Score a line across the centre of the plastic dial; this line now acts as the station indicator. Next, glue the speaker cloth into case.

Place the chassis into the case and secure into position with the fixing screws. Follow this by bolting into position the plastic dial plate such that the scored line is in the horizontal position when the vanes of the tuning capacitor are fully meshed. Do not over-tighten the dial fixing screw.

Selectivity and Sensitivity

In order to obtain the maximum selectivity and sensitivity, the following adjustments should now be carried out.

Switch to the medium-wave position and, with volume at maximum setting, turn the dial plate to indicate the local B.B.C. station. Slide the medium-wave winding (see Fig. 2) along the ferrite aerial rod until the station is heard. Place the long-wave winding at the very end of the ferrite rod. Turn the volume control to the half volume position and adjust trimmer capacitor CT until the station is heard at maximum strength without oscillation taking place. This may necessitate some slight repositioning of the medium-wave winding. Next turn the dial to indicate Radio Luxembourg or a station near this frequency and rotate the volume control to obtain oscillation free reception. The trimmer capacitor CT should be set such that the volume control will effectively remove oscillation on any required station. The tuning will be found to be very sharp and increases in volume control setting, whilst tuned to a station, may necessitate appropriate re-adjustments in tuning.

Switch to the long-wave position and slide the long-wave winding to agree with the indicated Light programme setting on 1500 metres. If oscillations are apparent on the long-wave band, adjust the position of the long-wave winding. Should this fail to remove oscillations remove R_1 from the board and replace it with a resistor having a value ($47k\Omega$ minimum) which is sufficiently low to clear the oscillations. Conversely, should oscillations be weak or unobtainable, increase the value of R_1 .

Rotating the receiver will provide adequate volume control on the long-wave position. Return to the medium-wave position and readjust the trimmer capacitor CT, if necessary.

Both the medium and long-wave windings should be taped or waxed firmly into position once the foregoing instructions have been carried out.

Bolt the car aerial input socket to the rear of the case and solder capacitor CA to its tag. Bolt the earphone/record socket into the appropriate hole.

Personal Earphone

The earphone should have a d.c. resistance of about 100Ω and the volume control setting should be reduced when it is used.

Recording

To record into a high impedance tape recorder, a type D129 transformer will be required. The red/green leads of this transformer should be connected to the receiver and the blue/yellow leads to the recorder. For low impedance tape recorders, connect a 100Ω resistor in parallel with the jack plug and apply the output direct.

Car Radio Aerial Socket

To counteract the screening effect of a car on the ferrite aerial, an external aerial is required. Any type of car aerial may be used, and this is connected to the car aerial input socket.

Radio Astronomy

PART 3

by

FRANK W. HYDE
F.R.S.A., F.R.A.S.



WHEN CONSIDERING THE DESIGN OF AN AERIAL array there are a number of factors to be taken into account. Firstly, the frequency of operation has to be decided. This will be determined primarily by the programme of study that has been undertaken. The frequency having been chosen, the next step is to determine the type of array that will fulfil the requirements of the programme. This will involve consideration of beam width and the effective collecting area of the completed array.

These points having been decided the mechanical details must next be settled. Here the decision must be made as to whether the array should be fully steerable; that is, whether it is required to follow any radio source as the earth rotates. If the array is to be used for the dual purpose of radio astronomy and satellite or probe tracking, then a fully steerable array will be necessary. If it is planned to locate

the position of radio sources then the array may be semi-steerable, that is it would be fixed in an east-west direction allowing the rotation of the earth to carry the array past the radio sources. It would be steerable in altitude to enable it to scan successive strips of the sky. The overall size of the array is determined by the frequency that has been chosen, the amount of space available being one of the primary considerations. For this reason the two frequencies chosen for the aerial arrays to be described in this article are such that one requires a fairly large space whilst the other can be accommodated in the average back garden. As extra-terrestrial radiations are of a greater intensity at the lower frequencies of the spectrum than at the higher, the low frequency aerial can be kept to at least a reasonable size because we can reduce the number of aerial elements necessary to achieve the required sensitivity.

CHART 1



FREQUENCY MC/S	$\frac{\lambda}{2} = L$	W
80	70 inches	8 inches
85	65 "	8 "
90	60 "	8 "
170	33 "	4 "
180	30 "	4 "
190	28 "	4 "
200	26 "	4 "
210	25 "	3 "
220	24 "	3 "
230	23 "	3 "
240	22 "	3 "

Q751

Krooman Array

The two frequencies chosen were 85 and 200 Mc/s. These two frequencies represent approximately the middle of each band which is to be used and essential details of these elements are given in Chart No. 1. The arrangement of the elements is based on the Krooman, or pine tree, array. In its original form this consisted of a number of halfwave elements connected together in the form of a broadside array. The driven elements were backed by reflecting elements which enabled the beam to be concentrated in a particular direction. The whole of the array was usually slung between two masts and is sometimes called a curtain array. In the modified form which we shall use for radio astronomy, the individual reflectors are replaced by a reflecting screen consisting of 1in wire netting, which is satisfactory for our purpose. The aerial elements themselves are constructed from 3/029 plastic covered cable which is a common commodity used by electrical contractors and is of quite reasonable price. It has the advantage that its insulation protects the aerial from the weather. As our basic design we shall choose a fully steerable-aerial; that

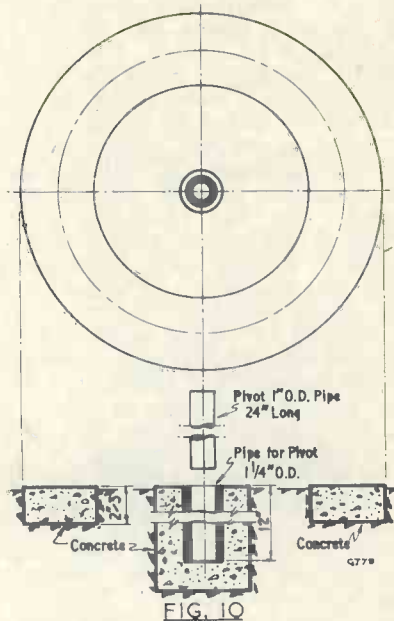

FIG. 10

is, the aerial array itself will be mounted on a framework which is arranged to move in altitude about its main supports and this support will be carried on a framework, with wheels at each of the corners, to enable it to be rotated in azimuth. It will then be possible to turn the aerial array to face any position in the sky. Wood has been chosen for the construction although those who are interested in developing a metal design can, of course, modify the framework according to their own tastes provided that they adhere to the dimensions of the aeriels. Preparation of the site that is required

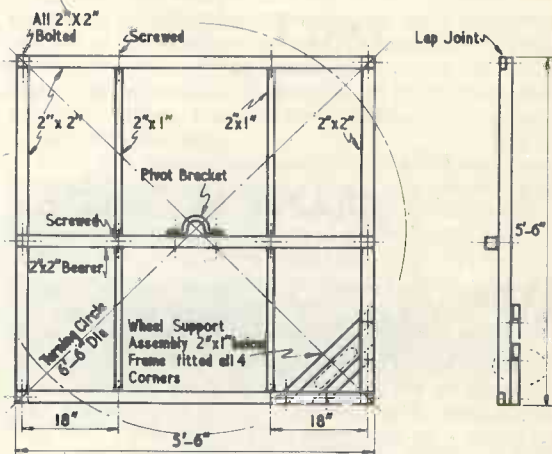
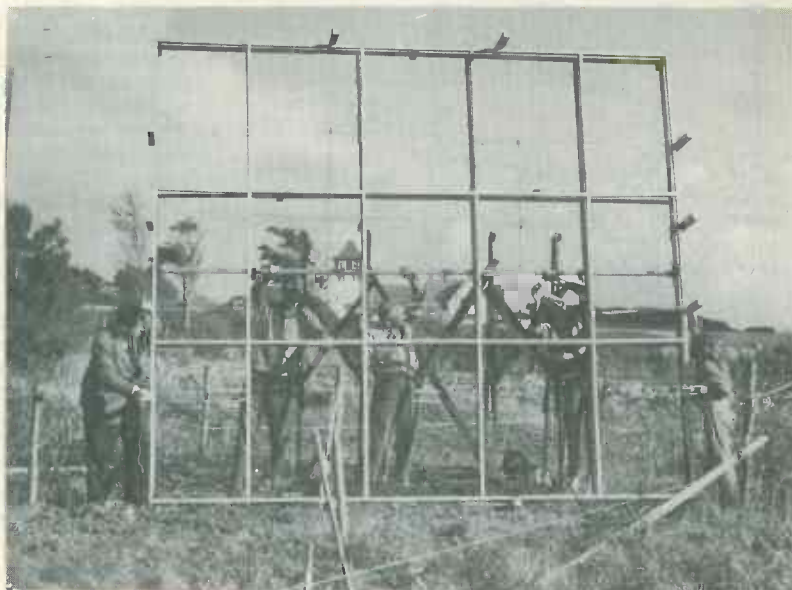

FIG. 11
BASE

Q780

Main frame with aerials about to be lifted into position



involves the construction of a circular concrete track. This may consist of concrete about 1ft. wide and 2in thick, or it may be made from concrete blocks laid in the form of a circle. In the centre there must be provision for a pipe protruding from the ground around which the azimuth motion can be made. This is shown in Fig. 10. The base of the mounting is made of 2 x 1in and 2 x 2in timbers so arranged that four wheels which should be not less than 6in in diameter, can be fixed thereto. These wheels are for the purpose of rotating the aerial in azimuth. Throughout this construction the timber used is known as "rough sawn", this being all that is required to make a perfectly satisfactory job. Finished timber will add nothing to the strength or to the operation of the assembly and will, of course, be more expensive. The choice of finish for the timber can be either creosote or aluminium paint. Aluminium paint is preferable because it is more satisfactory from the point of view of weathering. It is, however, considerably more expensive than creosote or one of the other patent wood preservatives. Fastenings used are coach bolts and ordinary screws, and the screws should be well greased before use. If aluminium paint is used for finishing, then each of the nuts and bolts should also be painted. The aluminium paint will then preserve them so that they can be unfastened at any time in the future. If creosote is used for the general finish then it would be as well to dab each of the bolt-ends, and the nuts, with either grease or aluminium paint. This point has been dwelt on at some length because the writer's experience has shown that with some of the apparatus built nearly ten years ago, where aluminium paint was used, the bolts could be unfastened just as easily as the day they were put together. The order in which construction begins does not matter very much but, for the sake of regularity, it will be described as starting from the base.

First of all, it is necessary to construct the rectangle which supports the uprights and carries the aerial assembly. This is illustrated with details in Fig. 11. It will be noted that the method of construction is by bolt and screw. This is a very satisfactory way of doing the job, for a bolt secures it from the point of view of strength and the screw imparts rigidity. It is recommended that all the wooden members are first cut and the assembly completed afterwards. By following this method all the timber purchased will be used economically. The wheels for the base may be obtainable from almost any hobby or do-it-yourself shop, the actual choice being left to the individual. The important

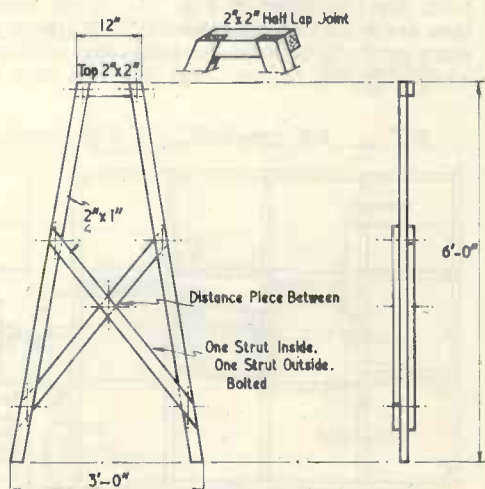

FIG. 12

SUPPORT FRAMES — 4 REQUIRED

9701

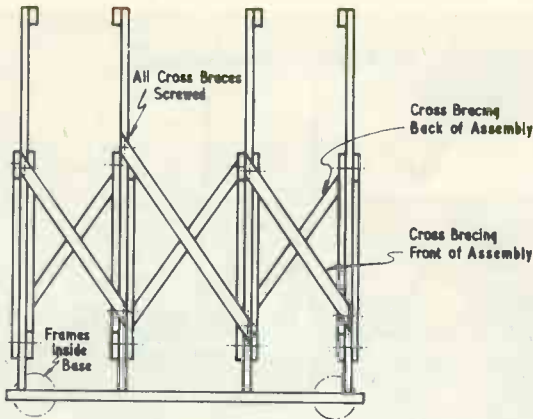

FIG. 13

G782

thing, as has been stated before, is that they should be not less than 6in in diameter. If the wheels were less than this diameter they would bring the frame very close to the ground where, even under the best conditions, there would be difficulty with growing tufts of grass. It should perhaps again be emphasised that the aerial does not have to stay in its fixed position should it be difficult to find a site which can only be used from time to time, as would occur if its position in the garden were such that it interfered with other domestic activities. Should this be the case then it will be necessary to make provision for two extra wheels so that the whole thing can be wheeled to one side. The method of construction that is used has been well tried and will withstand all normal winds and even gales.

Having completed the base and ensured that it runs smoothly, the next step is to complete the vertical supports. These frames, of which there are four, are illustrated in Fig. 12. When completed, they are bolted to the main carrying frame and the extra supports between the individual units are then added. It will be seen that this is a step by step

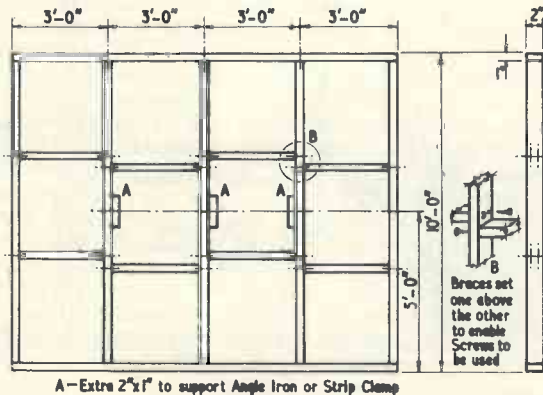

FIG. 14

AERIAL FRAME - 2 REQUIRED

G783

process and that from the base the uprights are fixed. The work of connecting the uprights together is done in situ (Fig. 13). Even when the work is done single handed, it is remarkable how quickly and easily the parts go together. Most amateurs will, of course, already have the necessary power tools with which to do the work.

The Reflector Assembly

Having got the main frame assembly completed the reflector assembly for the aerals can now be attempted. This consists of two main frames which are identical (Fig. 14), and which are constructed first. The two frames are mounted, one on top of the other, by means of the short distance pieces shown in the exploded drawing (Fig. 15). These supporting pieces are so placed that, when the strain of pulling the wire netting tight is made, the whole assembly forms a very rigid structure. Before adding the wire netting reflector it will be as well to complete the suspension assembly, the most suitable

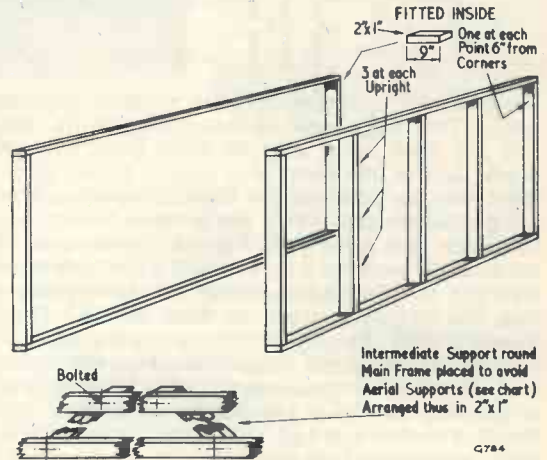

FIG. 15

G784

arrangement for this being a length of $1\frac{1}{2}$ or 2in water pipe. This will be laid across the centre of the vertical supports of the main frame in the position shown in Fig. 16. There are two alternative methods of fixing, (a) by the use of angle iron and U-bolts, and (b) by the use of flat strip shaped to fit the pipe in such a way that, when it is finally bolted into position, it grips the pipe. Having fixed the pipe in position on the main frame it can now be lifted up and rested across the top of the rotating support.

The position of the hinges, which can again be angle iron with U-bolts or flat strip as on the main frame, must be such that provision is made so that they can be tightened or released to allow the reflector to move in altitude. As the whole assembly will be secured in position by means of wire or nylon guys it is only necessary that the hinge be free to move.

Having satisfactorily arranged the hinges and made sure that the whole assembly rotates without

difficulty and is in balance, the reflector assembly can then be dismantled. Fixing of the wire netting needs some care. It is not possible to do this by oneself without great difficulty and therefore help should be obtained so that, when stapled along the bottom edge, the whole of the length of netting can be stretched tightly and stapled to the cross pieces. It is not necessary to bond the wire netting if staples are used at equal intervals of two inches, as the consequent contact between the reflecting sections will be quite adequate. Ordinary wire staples are used, not those of the insulated variety.

Having completed the reflector with its wire netting, it is now necessary to add the supports for the aerial array itself. Now these will, of course, vary in position according to the frequencies that are to be used. At the low frequency, that is the 85 Mc/s band, the number of aerial elements will total four. These will be arranged horizontally with connections as shown in Fig. 17. Dimensional details of the elements themselves are given in Chart No. 1.

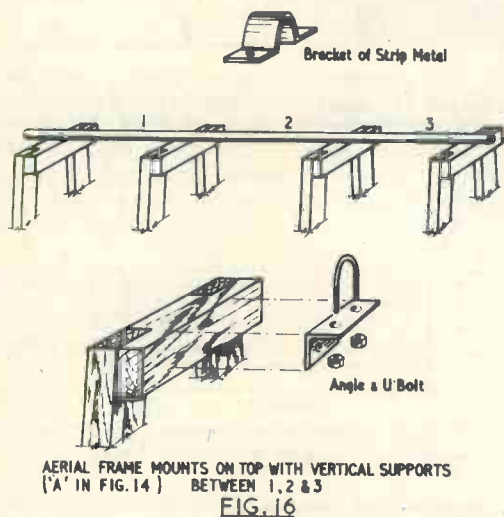

Supporting pieces for the aerial elements and the connections are made from 2 x 2 in uprights and the height at which the aerial is affixed above the reflector is shown in Chart No. 2. It is recommended that nylon cord be used in the first instance to support the aerial elements, since this will enable adjustments to be made quickly and simply. The connections of the elements are made in "chocolate blocks", as shown in detail in Fig. 18. Spacers made of "chocolate blocks" are also shown. The spacers can, of course, be of alternative material and provided it accomplishes the reversal of the connections almost any insulating material that is to hand can be used. The "chocolate blocks" are chosen because they are simple to fix and serve the dual purpose of being used as connections and also as spacers. The main insulators are either porcelain or Pyrex. All these materials are available from advertisers in the radio press.

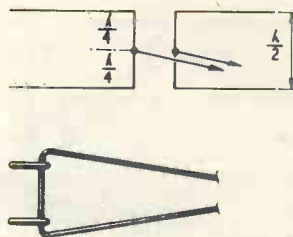

High Frequency Elements

The high frequency elements are, of course, more numerous than at the low frequency end, and in this particular case we have what is known as the 4 x 4 x 2 array, this following the original Krooman method. There are two sets each of four fullwave aerials connected at their halfwave points and suitably reversed by the connections in order to provide the right phase in each element. Each group is centre-fed at the point shown in Fig. 19. Two lengths of 300Ω flat twin feeder lead from the centre feed point to the balun which connects the 75Ω standard coaxial to the junction of the 300Ω feeder lengths. This is shown in Fig. 20.

There is an alternative method of connecting the Krooman array and it is shown in Fig. 21. Either method is quite satisfactory though possibly the balun and the coupled 300Ω feeder is the easier to adopt.

The whole aerial is now ready for its first test. A number of methods may be adopted here. It may be that a suitable receiver is already available for a particular frequency that has been chosen, and it will be remembered that the ordinary television receiver was recommended as a method of detecting

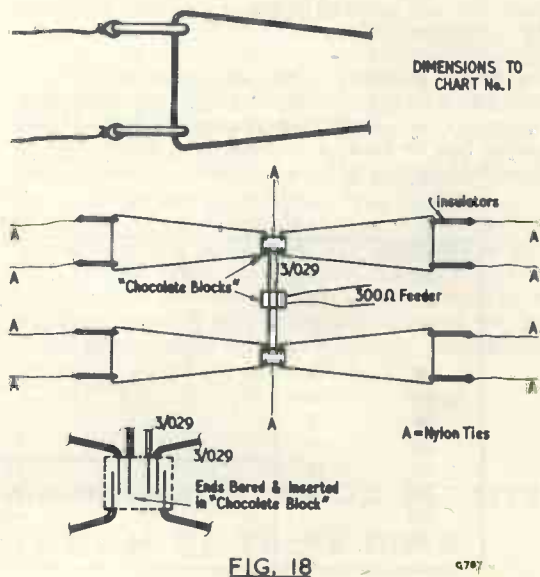

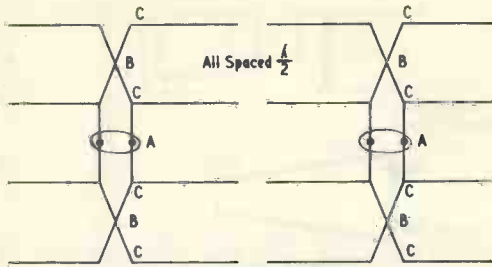

- A POINT AT WHICH 300Ω FEEDER IS ATTACHED WITH "CHOCOLATE BLOCK"
- B "CHOCOLATE BLOCK" WITH INSERTS REMOVED OR OTHER SUITABLE INSULATOR
- LINE IS FIRST PARALLEL THEN BOTTOM END ROTATED 180° BEFORE CONNECTING INTO NEXT "CHOCOLATE BLOCK" C

FIG. 19

Q788

extra-terrestrial radiations. The aerial should be tilted in altitude to the height of the sun above the horizon and, with the receiver connected, it should be swung from east to west and west to east. If the receiver is properly aligned and sensitive enough it will then be possible to hear either in phones or the loud speaker the rise in intensity of the radiations.

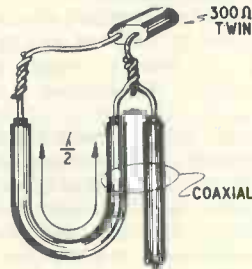

FIG. 20

Q789

It is usually possible to hear all smaller changes of signal and a little experimenting will soon determine whether in fact there is a change or not. If the receiver has to be at a considerable distance from the aerial, then it will be necessary to add a pre-

amplifier. At the higher frequencies this may present some difficulty in keeping the noise level sufficiently low to enable the aerial to add its quota to the receiver. It should be pointed out here that merely pulling the aerial out of the receiver and replacing it again whilst listening for a change in level is not a satisfactory method of measurement. It may well be that the radiation level is not sufficiently high to enable this to be detected but that when the tuning is swung through the point at which the aerial resonates a rise in noise level is heard.

The Theoretical Aspect

Having now completed the practical part of this article we will deal briefly with the theoretical aspect.

The arrays described in this article may be regarded as part of the group of reflector type aerials. When a sheet reflector is placed behind a dipole the resulting polar diagram is considerably modified. Radiations arriving from the area behind the reflector are almost completely attenuated. At the same time, with close spacing between the dipole

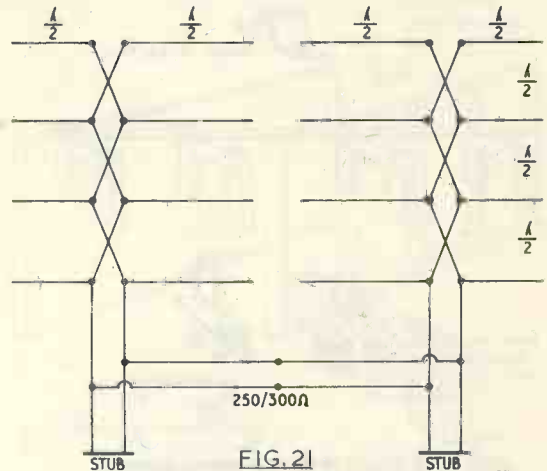
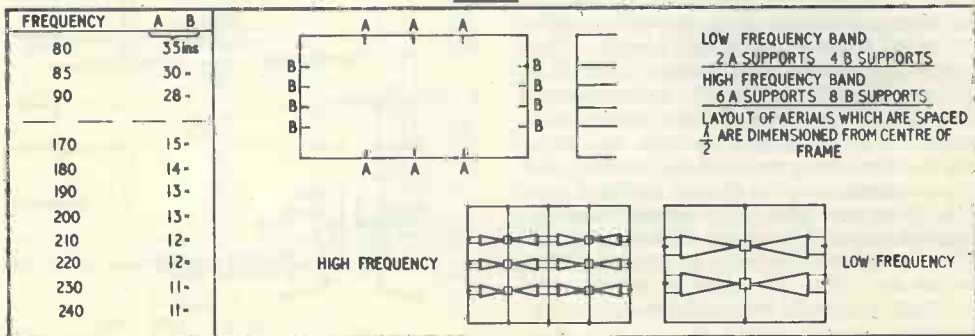

FIG. 21

Q790

and the reflecting sheet a substantial gain in the forward direction is achieved. At the frequencies at which we are working a plain sheet of metal is not necessary. If the reflector consists of parallel wires then, providing the spacing between these does not

CHART 2



Q792

A view of the assembled aerial with the author fixing the U-bolts. Patrick Moore is busily engaged in photographing this event

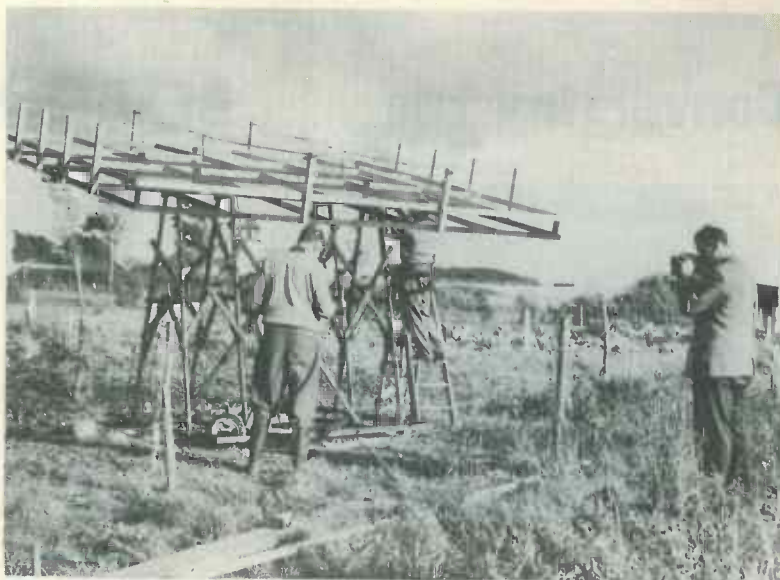

exceed a certain value, the reflector will behave substantially as a continuous sheet. If the reflector is of wire mesh then the size of the mesh should again agree with this certain maximum size. Generally speaking the effectiveness of the reflector will not be reduced by more than a few per cent providing the spacing, in the case of wires, or the

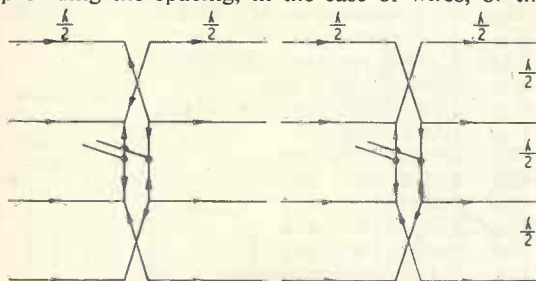

CURRENT RELATIONSHIP
IN BROADSIDE ARRAY

FIG. 22

6799

size of the mesh, in the case of a mesh reflector, does not exceed one-sixteenth of the wavelength. If the area of the reflector is large compared with the aerial elements then we may regard it substantially as an infinite reflector.

In order to further increase the forward gain and reduce the width of the beam, we may multiply the number of elements. In the case of the 200 Mc/s array we have two groups of eight elements; each

of these elements being a half wavelength long. In this arrangement they are end-fed. It is necessary to ensure that the currents in each of the elements are additive. Fig. 22 shows the direction of the currents in the form we have selected in this design. The spacing between the dipoles and the reflector has been chosen to give the best gain with a required bandwidth. If we apply the formula given in Part II we find that our aerial system is two wavelengths in extent in the horizontal direction, and therefore, will give us a beam width of approximately 30° . In the vertical plane we have three halfwave spacings which give us a $1\frac{1}{2}$ wavelength total; this provides a beam width of just under 40° . The beam width is, as you will recall, a point at which the gain is reduced to 0.707 of the maximum, or when the signal is 3dB below maximum. The total gain of the 200 Mc/s array, referred to a half-wave dipole—the usual way of stating the gain of an aerial—is equal to 19dB. In the case of the 85 Mc/s array we have a rather different system, and it is often referred to as the Lazy "H". The gain of this array with a reflector is of the order of 9dB over a single halfwave dipole. The beam width is, of course, considerably wider than that of the high frequency array, being some 60° wide in the horizontal plane. This, however, does not detract from its usefulness and when, as we shall see later in the article on applications, it is combined with another of the same size in an interferometer, considerable increase in directivity is obtained.

(To be continued)

NEXT MONTH

**PRINTED CIRCUIT MATCHBOX RECEIVER
INTERPRETATION OF VALVE DATA**

Converting the

BENDIX MN26C

Receiver

By A. FOORD

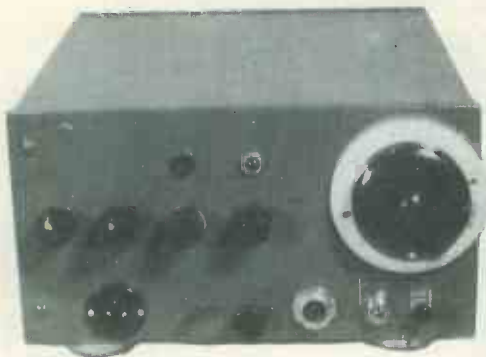

THE MN26C, AS RECEIVED, IS A 3-WAVEBAND Bendix aircraft receiver intended for remote control and 28V working. The writer was unable to obtain a circuit diagram and worked from scratch by tracing out the circuit. The MN26C is a Long and Medium wave receiver covering the frequencies 150–1,500 kc/s in 3 bands. This coverage makes it ideal for use as a broadcast receiver, all modifications being carried out with this object in mind. The modifications will, however, apply to other models of this receiver, some of which cover Short waves. When converted, the MN26C is an excellent receiver and its quality is above average, this being due to the low i.f. used (110 kc/s with wide bandwidth). Selectivity is excellent due to the number of r.f. stages and the high Q resulting from the use of potted coils.

Prior to modification the receiver consisted of two 6K7 r.f. stages, 6L7 mixer, 6J5 oscillator, 6K7 i.f. stage, 6B8 detector and a.f. amplifier, 6F6 output, 6J5 b.f.o., plus three valves—6K7 and two 6N7's—in the direction finding circuits.

After modification the receiver will consist of two 6K7 r.f. stages, 6L7 mixer, 6J5 oscillator, 6K7 i.f. stage, 6B8 detector and 1st a.f. stage, 6J5 or 6SJ7 2nd audio stage, 6F6 output and 5Y3GT rectifier. As supplied, the unit contains all the valves required for the conversion about to be described, using a 6J5 as the 2nd audio, except for the rectifier. All valves used are metal types.

Stripping Down

All valve references given here refer to the valve numbers printed on the chassis.

First remove all the wire lacing, this making stripping down and rewiring very much easier. The 28V dynamotor and smoothing unit will have to be replaced by a mains power unit. Commence with the smoothing unit under the chassis, this being completely encased in a metal cover and positioned at the rear of the chassis. Remove the cover and

Additional Components

Resistors

R ₈	330Ω 1 watt
R ₁₂	1kΩ ¼ watt
R ₁₃	330Ω ¼ watt
R ₁₄	220kΩ 1 watt
R ₁₅	1MΩ ¼ watt
R ₁₆	1MΩ ¼ watt
R ₁₇	1MΩ ¼ watt
R ₁₈	2.2kΩ ¼ watt
R ₁₉	220kΩ ¼ watt
R ₂₀	1MΩ ¼ watt
R ₂₁	3.9kΩ ¼ watt
R ₂₂	500kΩ ¼ watt

Capacitors

C ₁₅	25μF electrolytic, 25V wkg.
C ₁₆	32μF electrolytic, 350V wkg.
C ₁₇	32μF electrolytic, 350V wkg.
C ₁₈	0.001μF, 350V wkg.
C ₂₃	25μF electrolytic, 25V wkg.
C ₂₄	100pF mica
C ₂₅	0.01μF 350V wkg.
C ₂₆	0.01μF 350V wkg.
C ₂₇	0.01μF 350V wkg.
C ₂₈	0.01μF 350V wkg.
C ₂₉	0.01μF 350V wkg.
C ₃₀	1μF 25V (or more) wkg.
C _a	0.01μF 250V a.c. wkg.
C _b	0.01μF 250V a.c. wkg.
C _c	0.01μF 250V a.c. wkg.
C _d	0.01μF 250V a.c. wkg.

} See Fig. 2

Potentiometers

1MΩ log, 25kΩ linear, 2.5kΩ wirewound

Rectifier

5Y3GT

Choke

20H, 80mA

Miscellaneous

Muirhead slow motion drive, pilot light, 4 knobs, Plessey plug and socket (see text), mains input socket and plug, on/off switch, 3Ω speaker, wavechange switch assembly and coupler, fuse holder (chassis mounting), speaker transformer (45 : 1)

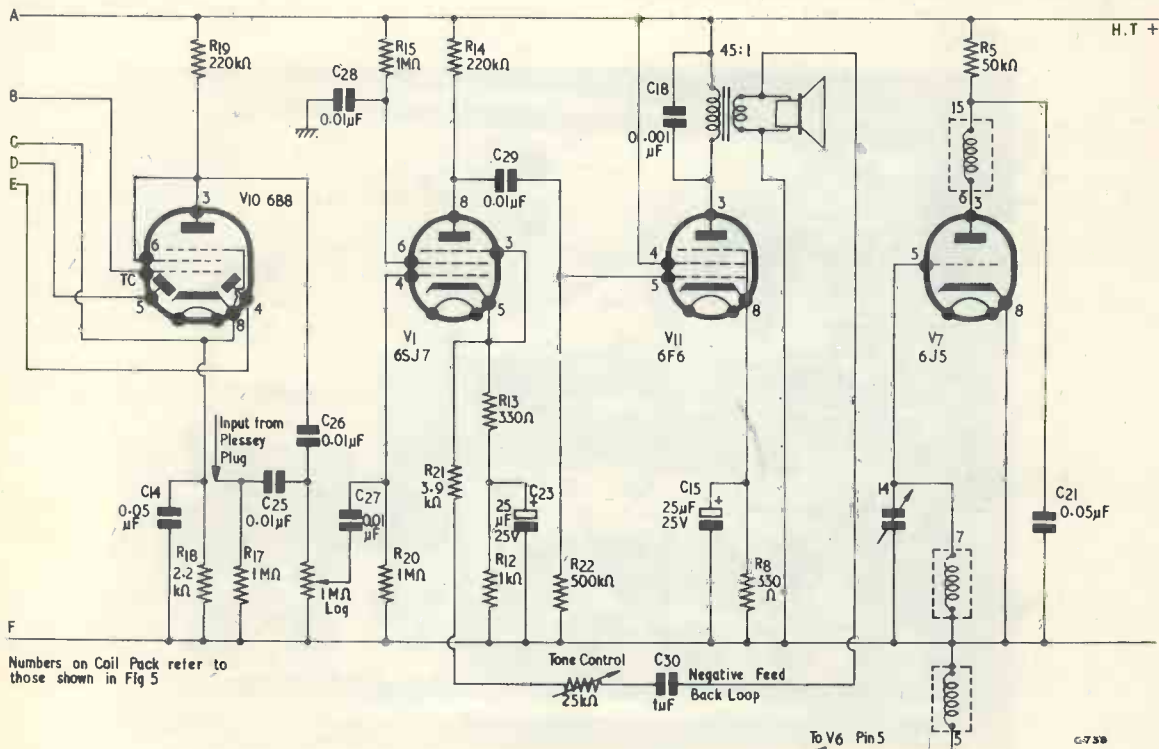
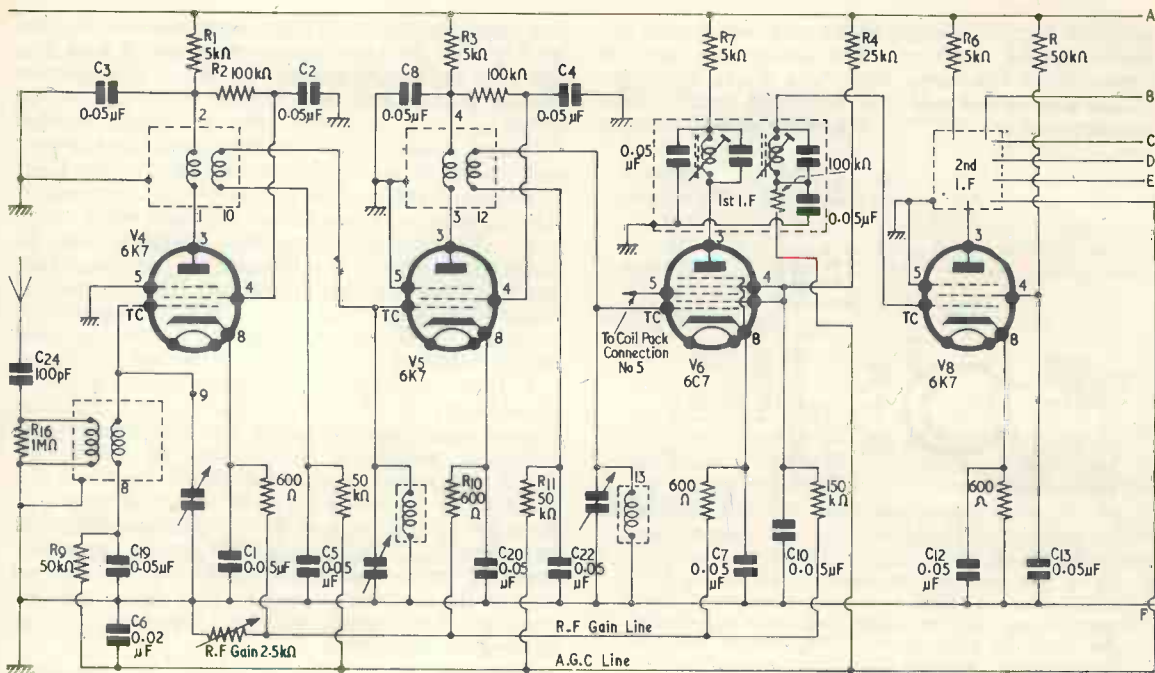

Fig. 1. The circuit of the modified receiver

snip the wires connected to the unit, whereupon the latter can be removed. The dynamotor may be removed at the same time. All wires from the smoothing unit should now be traced back to their sources and cut off. The following should next be

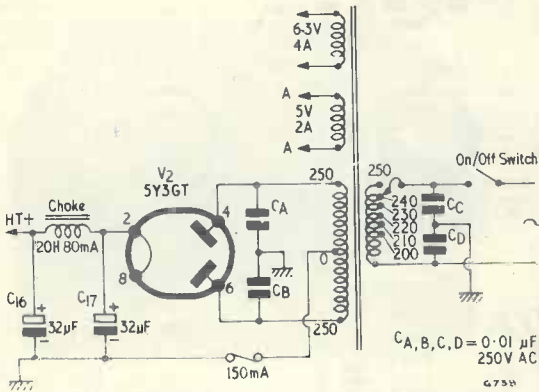
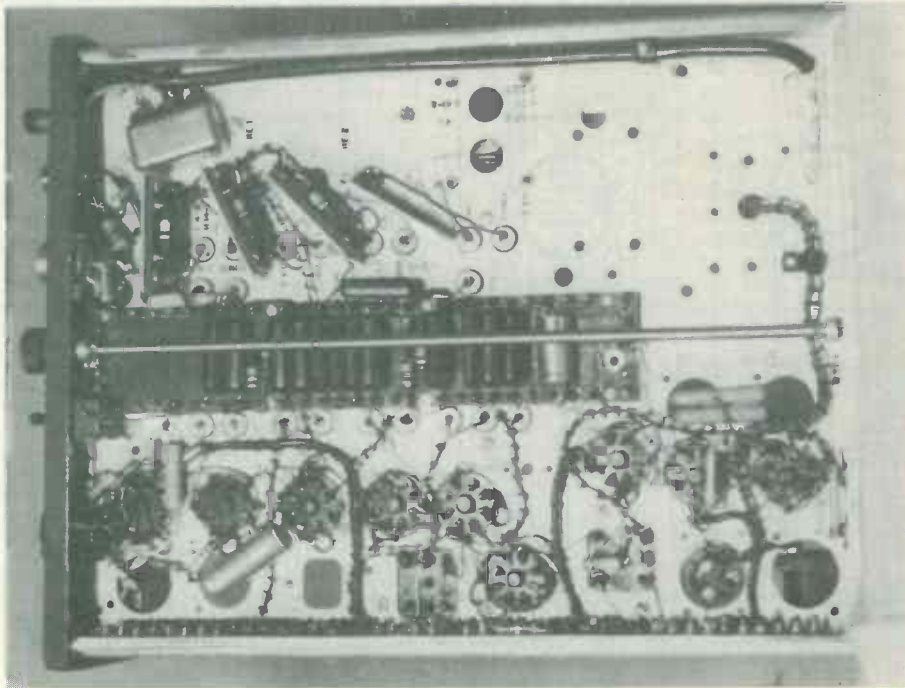

Fig. 2. The power supply circuit. Capacitors A, B, C and D may be added to prevent interference from switches, etc., and to reduce modulation hum should the latter be experienced. They should only be included where earthing the receiver or reversing the a.c. mains plug does not effect a cure. If these capacitors are added, the receiver should be adequately earthed to prevent shock (which could occur should both the receiver and an earthed object be touched at the same time)

removed, together with their associated components and wiring, the latter again being traced back and cut off. V_1 , V_3 and V_{12} are all part of the direction finding circuits and these should be removed. The metal can at the front of the chassis marked "Phaser" is also part of the direction finding circuits and should be similarly removed, as may the b.f.o. valve, V_9 , together with its associated components. The b.f.o. is not required for Medium wave reception. The output stage, V_{11} , together with its components should also be removed, this stage later being rewired to give a 3Ω output. The i.f. trap was designed to prevent the pick-up of aircraft generator noise and therefore does not serve any useful purpose in the modified receiver. This trap has the legend "IF Trap" marked on the chassis alongside and it should next be removed. The two relays under the chassis were used for aerial and direction finding switching, and these should now be taken out. T_{15} is the output transformer (600Ω line) and T_{16} the chokes (intended for dynamotor smoothing). Both are clearly marked on the chassis and should be removed. The large dual paper capacitor mounted behind the tuning capacitor also forms part of the h.t. smoothing and this should next be removed, being replaced later by a higher capacitance electrolytic component.

Since the heaters were wired for 28V d.c., they must be rewired, the existing heater wiring and associated series resistors being removed.

The 27-way plug on the panel must also be taken out and all the associated leads cut off at their



Below-chassis view of the receiver

sources. Next, remove the dial assembly, this being coupled to the tuning capacitor.

The last items to remove are the D/F coil assembly (above chassis and at the front) and the remote control wavechange motor and assembly (at the rear). Remove the retaining screws of the D/F box, marked "D/F", and remove all connecting leads. Remove the screws of the remote wavechange assembly (complete with motor) and all leads. Withdraw the wavechange spindle through the hole in the front panel covered by the Bendix nameplate. Lift out the wavechange motor and assembly, also

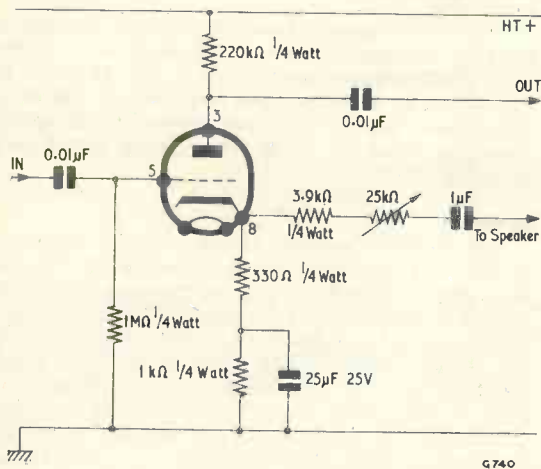

Fig. 3. Employing a 6J5 instead of a 6SJ7 for V₁

the D/F box. Push the wavechange spindle back through the wavechange switch. It will be noted that the spindle has no clicker plate and can now turn freely.

If it is thought that the receiver may be used as an amplifier only, the r.f. stages could be switched off by means of a fourth position on the wavechange switch. It will be found that this switch has three waveband positions and a fourth blank position. The switch positions are 1, 2, 3 and off—in the latter position the anode supply of the r.f. stages are cut

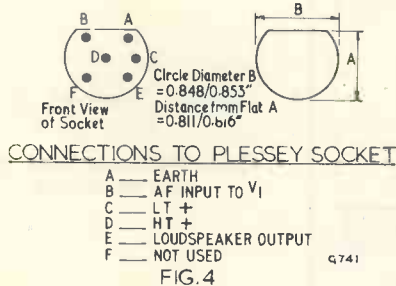
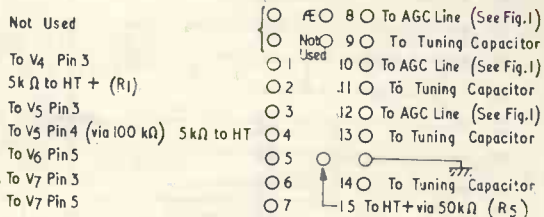

Fig. 4. Details of the Plessey socket employed by the writer

FRONT OF SET



BACK OF SET

Fig. 5. The connections to the coil pack

off. The screen-grids will not overrun due to the high value of the series resistors.

A Plessey socket is fitted to the front panel of the modified receiver and this provides h.t.+, l.t.+, earth, speaker and gram input. When obtaining the plug and socket it is necessary to ensure that they

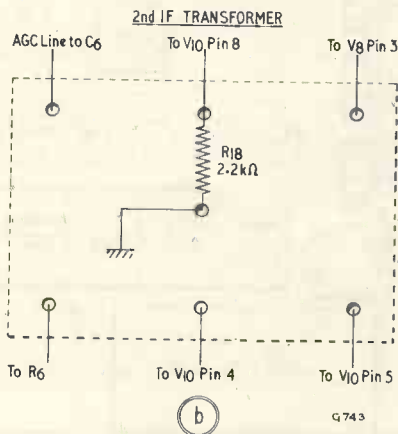
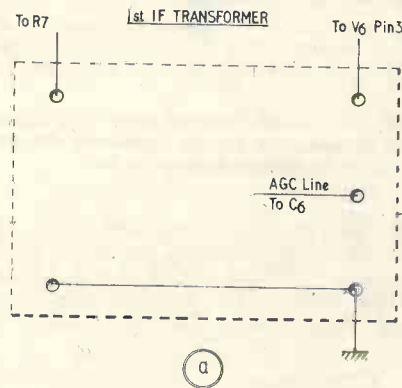

Fig. 6. The connections to the i.f. transformers

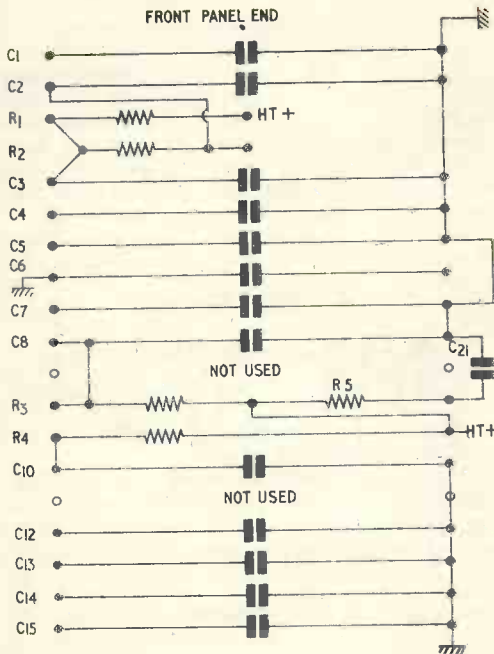

FIG. 7

G744

Fig. 7. The central tagboard after modification. It should be noted that the only component added to the original tagboard is C₁₅

mate correctly, as they are supplied in five differing types having various locating positions. (Although these locating positions can be changed around by dismantling the plug, this is rather difficult without the use of special tools.) The fixed socket reference

numbers are as follows: Plessey CZ49223, Government Joint Services Z560260. The free plug reference numbers are: Plessey CZ49222, Government Joint Services Z560300. Details of the Plessey socket are shown in Fig. 4.

If the constructor is unable to obtain the Plessey plug and socket, as suggested, any type of mating plug and socket will suffice.

The gram input should conform to the equalising circuit required for the particular pick-up in use. Since the gram input is always connected to the set, it could be used to provide a high impedance output to a pair of headphones. This was found to give a comfortable volume with the r.f. gain control at maximum.

The writer made a new front panel in order to enhance the appearance of the receiver, and this used the dimensions shown in Fig. 10. It would be preferable to mark out the positions of the panel fixing holes, the chassis release knob and the tuning capacitor holes by using the original panel as a template.

Rewiring

The modified receiver circuit diagram is shown in Fig. 1. Ensure that one side of each valve heater is connected directly to chassis; this connection will require to be added in some cases. Wire the remaining heater connections to the mains transformer in the normal manner. The mains transformer easily fits in the space formerly occupied by the dynamotor; and the dynamotor fixing bracket can be removed, if required, by drilling out the bracket mounting spot welds. Next, wire the h.t. and rectifier circuit as shown in Fig. 2.

The detector and output stages were originally intended to feed 50mW into a 600Ω load. In order to power a speaker, the circuit must be modified. After the detector stage (V₁₀—6B8), an audio stage

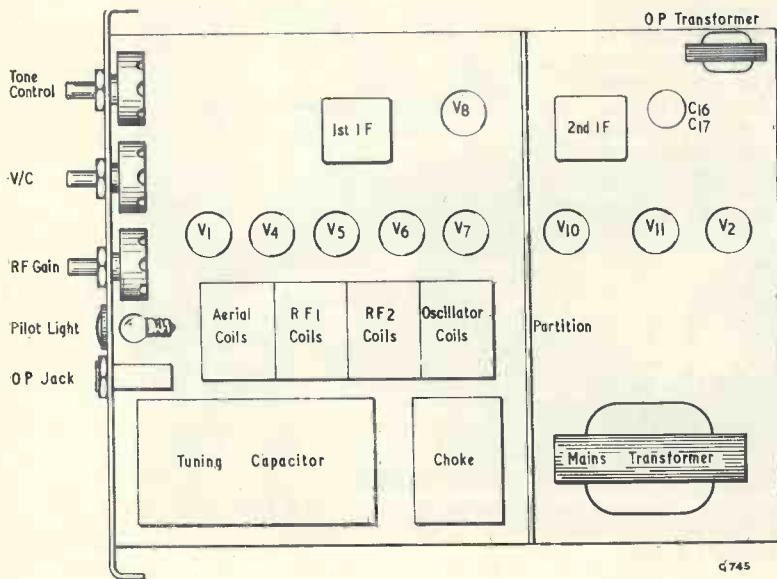
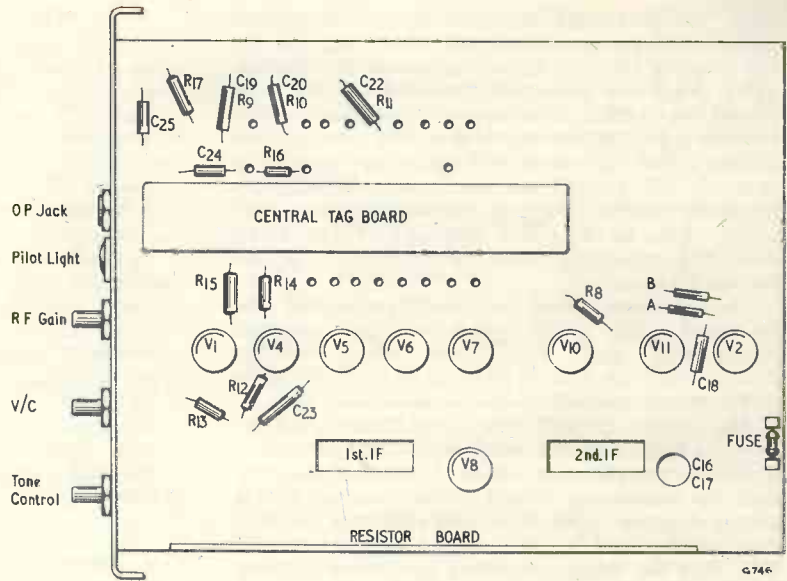

Fig. 8. The above-chassis layout after modification

Fig. 9. Under-chassis layout



is added immediately prior to the output stage. The added audio stage is placed in the old V_1 position (as printed on the chassis). The writer altered both the anode and cathode resistor values of the detector V_{10} , this valve then being connected to the audio stage as shown in the circuit of Fig. 1. The connecting leads to the control-grids and anodes of V_{10} , V_1 and the output valve V_{11} should be screened, the metal braiding being bonded to chassis. If desired, the circuit incorporating a 6J5 shown in Fig. 3 could be used instead of the 6SJ7 for the V_1 position. The 6SJ7 was used by the writer in order that the 6J5 could be retained as a spare for the oscillator position. In point of fact, however, this added audio stage could be omitted entirely if the constructor requires moderate volume only. The 6B8 loads the

6F6 output valve to the level normal in a communications receiver but not that of a broadcast set.

An r.f. gain control ($2.5k\Omega$) has to be added between chassis and V_4 , V_5 and V_6 as shown in Fig. 1. The output stage has also to be added, the 6F6 used originally being quite suitable and providing some 4 watts of audio. The negative feedback shown connected from the speaker to V_1 improves the quality and provides a bass tone control. It must be remembered when switching on that, should the feedback connection from the output transformer be incorrect, a high pitched whistle will result, this being corrected by a reversal of the connections to the output transformer.

The aerial socket must be connected to the coil

Fig. 10. Dimensions of the new front panel

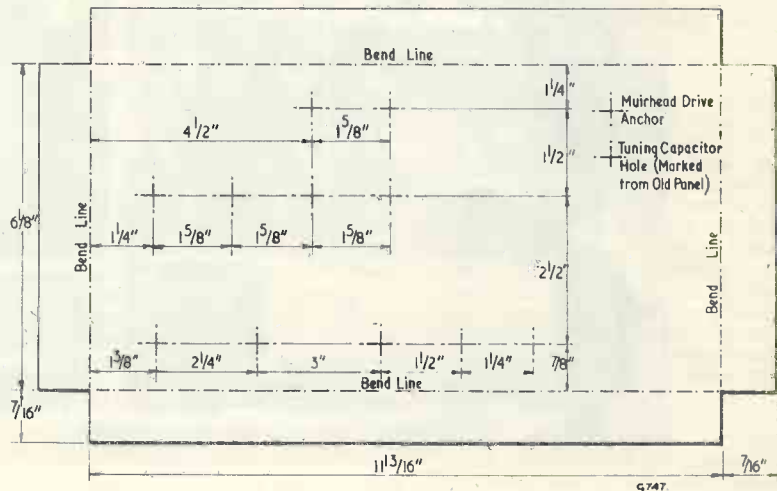

pack, not forgetting R_{16} and C_{24} . The original aerial socket and earth terminal can be used. During the rewiring process, the writer moved the detector valve (V_{10}) into the old b.f.o. position (V_9) and placed the output valve in the V_{10} position. The rectifier was fitted in the original V_2 position. In adopting this method, it will be found that a large space is left around the mains transformer, this becoming useful later in accommodating such additions as an inter-com amplifier or f.m. tuner unit. The smoothing choke fits into position behind the tuning capacitor.

The a.c. mains side of the transformer should now be wired. The on/off switch, r.f. gain control, output jack, panel light, tone control, volume control, etc., can now all be fitted to the front panel and wired into circuit.

The constructor will have noted that, during the rewiring procedure, the writer has simply stated that a certain stage should be wired. It has been assumed that the constructor would prefer to work with a circuit diagram rather than with elaborate point to point instructions.

It may be found that the particular receiver obtained has been modified for 12V d.c. working, in which case a 12V dynamotor and wavechange motor will be fitted instead of the 28V version. Similarly, the heater wiring will also have been modified for 12V working. If this should be the case, conversion of the receiver for use in a car will be possible, using the original dynamotor. All other modifications would, however, apply.

VOLTAGE READING TABLE

	Anode	Screen-Grid	Cathode
V_1 (6SJ7) <i>1st Audio</i>	20	10	1
V_4, V_5 (6K7) <i>R.F. Stages</i>	220	130-160	2-20
V_6 (6L7) <i>Mixer</i>	230	130-170	3-20
V_7 (6J5) <i>Oscillator</i>	70		zero
V_8 (6K7) <i>I.F.</i>	200	140-160	4-6
V_{10} (6B8) <i>Detector</i>	60	60	1
V_{11} (6F6) <i>Output</i>	220	250	13
<i>Rectifier</i>	250 a.c.		270 d.c.

$HT+ = 250V$ d.c. HT current (r.f. gain control at max.) 60mA.
HT current (r.f. gain control at min.) 55mA.

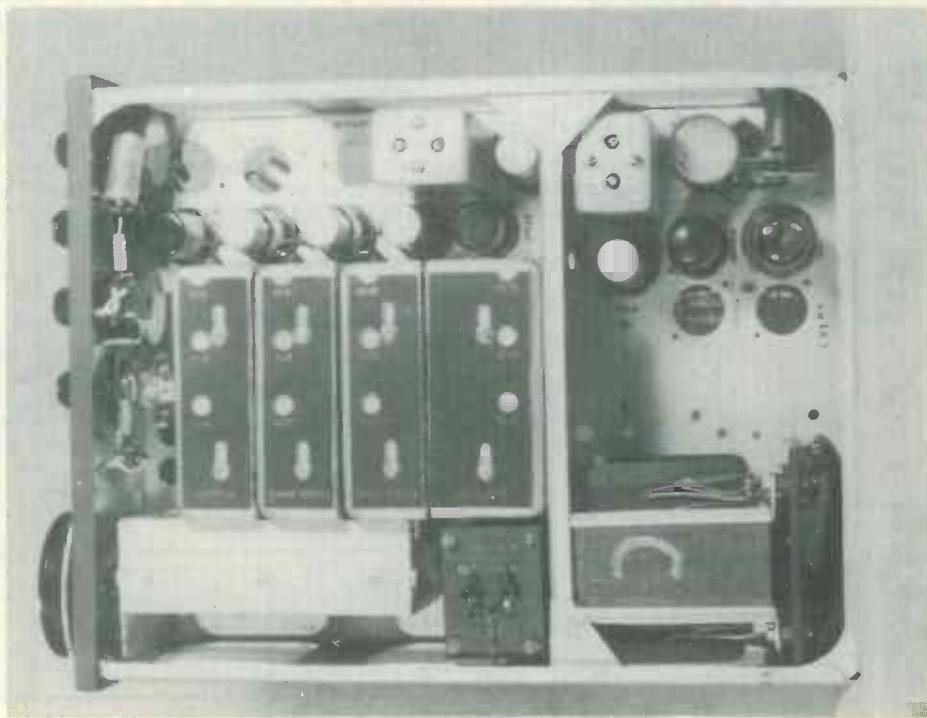

Above-chassis view of the MN26C receiver

Testing

When all the constructional work has been carried out, the completed receiver should be carefully checked against the circuit diagram and tagboard layout. Having ensured that all is correct, switch on. Full h.t. should appear within about 20 seconds. The voltages at various parts of the circuit should then be checked against the table provided. Any voltages within about 15% of the readings given should be taken as normal. The voltages shown were measured with a 1,000 Ω per volt meter. If a meter having a sensitivity greater than this is used then the readings for V_{10} and V_1 will be greater, since the meter will not draw as much current. Some of the other readings may also be greater than those shown. All voltages were measured under no-signal conditions.

The constructor should find that no adjustments are necessary to either the r.f. or i.f. stages. Should the receiver not function immediately, check with the voltages given in the table and, if there prove to be approximately correct, check the valves.

General Notes

A neat and attractive appearance can be obtained by re-lacing the wires after modification, the under-chassis illustration showing the neatness that can be obtained by taking moderate care.

If the receiver is supplied mounted upon its spring base, it will be found that this can be removed by

taking off the base retaining screws and breaking off the springs, leaving the receiver resting on four feet. The writer's model was of brand new appearance and did not really require re-painting. Nevertheless the case was painted in order to match the new front panel. Before painting, the case was sanded down with wet and dry emery paper,

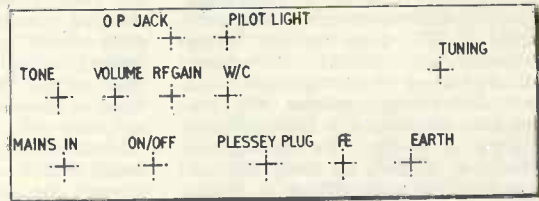

Fig. 11. The modified front panel layout

G746

finishing off with three coats of brushing cellulose which resulted in a plastic like finish. It was found that a $\frac{1}{4}$ pint tin of brushing cellulose was sufficient for three coats.

If desired, Panel-Sign transfers could be used with good effect on the front panel, this undoubtedly imparting a professional appearance to the completed receiver.



By RECORDER

ONE OF THE MORE FASCINATING things about electronics is that the further you look into a particular detail the more supporting detail do you uncover. This is

especially true of electronic components, which offer an almost limitless field of enquiry ranging back from the various methods of testing and manufacture to the raw materials of which each constituent part is made.

One of the integral parts of electronic equipment, and one which is taken largely for granted, is the

wire employed for coils, chokes and transformers. Quite a number of home-constructors and service engineers tend, for instance, to look upon such wire as being, quite simply, "bare", "enamelled" or "cotton or silk covered". In practice, there are at least six different types of insulating enamel, each with varying thicknesses, in everyday use, as well as three or four common fibre coverings!

Winding Wire Enamels

The function of a wire enamel is, obviously, that of providing insula-

tion. However, winding wires are subjected to all manner of stresses when being wound into coils, such stresses including stretching, bending, and rubbing (or abrasion). After being wound, the subsequent coil is further liable to undergo stress, this being given by such things as heat, the chemical action of impregnating materials, and electrical potential differences between adjacent turns. All these factors place demands upon enamel insulations, and they cause such a wide variation in enamel requirements that it becomes economically impossible to employ a single type of enamel which is capable of satisfying all practical demands. There is, therefore, a wide range of wire enamels currently available, these being chosen by the manufacturers of coils to meet the particular needs of their individual products.

The most inexpensive wire enamel is oil-based or "ordinary" enamel. Oil-based enamel has been used in the electrical and electronic industry for very many years and is available in coatings of two thicknesses, these being known as "Normal" and "Thick". To give an example of the thickness of an oil-based enamel let us consider 26 s.w.g. bare copper wire, the diameter of which is 0.018 ± 0.0002 in. The specified minimum increase in overall diameter for a normal covering of oil-based enamel on 26 s.w.g. wire is 0.0013in, whilst the minimum increase for a thick covering is 0.002in. A tolerance has to be placed on maximum thickness, and 26 s.w.g. wire with a normal covering of oil-based enamel should not have an overall diameter greater than 0.0199in; with a thick covering the overall diameter should not be greater than 0.0208in. (The tolerances on enamel thickness are arrived at in this apparently round-about way—minimum being defined by increase in diameter, and maximum by overall diameter including the wire—because they ensure that the practical requirements of the insulation are met. Firstly, sufficient enamel is applied and, secondly, the wire is not so fat after being enamelled that it will not fit into a particular winding space. Also, quoting a maximum overall diameter simplifies manufacturing and inspection problems.)

Oil-based enamel is an excellent and inexpensive covering for the winding wires used on such components as mains transformers and the like in which interleaving paper is applied between layers of wire. In manufacture, coils of this type are normally wound in "sticks" of a

dozen or so on a single common mandrel, the wire being laid in its correct position in each layer by guide pulleys which travel from side to side. When a layer is completed a piece of interleaving paper is automatically introduced under the wire and the next layer is wound with the guide pulleys travelling in the reverse direction. When the winding is completed, the individual coils on the "stick" are separated by cutting blades. Under conditions of this nature the abrasion on the winding during manufacture is very low, and can easily be withstood by oil-based enamel. Practically all mains transformers, speaker transformers and smoothing chokes using interleaving paper employ wire with a normal thickness of oil-based enamelled wire. A thick covering of oil-based enamelled wire could also be used here, but the extra cost would only be justified if there were a high voltage between turns or if, for some reason, abrasion during winding was liable to be high. Oil-based enamels are not affected by the usual wax, bitumen or shellac impregnation processes subsequently applied to the coils.

Whilst oil-based enamels are adequate for run-of-the-mill jobs like mains transformers and smoothing chokes, their low abrasion resistance does not allow them to be used for many of the other components employed in present-day electronics. Also, the oil-based enamels tend to dissolve somewhat readily in some solvents of the type used for r.f. coil impregnants. In consequence, they may be replaced by the tougher and more expensive "synthetic" enamels for these applications.

Synthetic enamels, introduced after the war, can be applied to copper wire in one of four thicknesses, these being "Fine", "Medium", "Thick" and "Extra Thick". These thicknesses are identified by the letters "F", "M", "T" and "X". The minimum increase in overall diameter on a 26 s.w.g. wire for an "F" enamel covering is 0.001in, for "M" is 0.0018in, for "T" is 0.0026in, and for "X" is 0.0034in. Maximum overall diameters respectively are 0.0199in, 0.0207in, 0.0215in, and 0.0229in.

Synthetic enamels are employed where toughness and resistance to solvents are required. They would be used, for instance, in television deflector coils, where the wire has to be wound around sharp corners and may be subjected to considerable strain and jerking during manufacture. They would also be employed in television i.f. and tuner unit coils

where they can stand up to the solvents employed in polystyrene dopes. Many speaker transformers and smoothing chokes these days have "random" windings, the winding wire being wound on a former with two cheeks at the ends, no interleaving paper being employed. Considerable abrasion between turns can occur during the manufacture of random windings and synthetic enamel has the toughness required to stand up to it. Synthetic enamels are also employed in many line output transformers, even when there is little abrasion during winding, and small risk of enamel attack during impregnation. Experience has shown that they stand up well to the high electrical strains (of the order of 10 volts *per turn*!) given in use by these components.

Self-soldering Wires

Introduced some eight years or so ago were the "self-soldering" enamels based on polyurethane enamels. Such wires are made to the same thicknesses ("F", "M", "T" and "X") as the synthetic enamels but they have the ability to melt, and act partly as a flux, at fairly high soldering temperatures. There is, therefore, no need to strip the ends of a coil wound with self-soldering enamelled wire. Instead, the wire is merely fitted to its tag, complete with enamel, the joint being soldered by dipping the tag and wire into a hot soldering bath or by applying a hot soldering iron. (The term "hot" here indicates temperatures somewhat higher than those required for a conventional solder joint.) Nowadays, most wire manufacturers claim that their self-soldering enamels have the same tough properties as their synthetic enamels, with the added advantage of the self-soldering facility.

An interesting off-shoot of the self-soldering enamels is the "Polyflux" enamel available from Concordia Electric Wire and Cable Co. Ltd. "Polyflux" is roughly similar in properties to oil-based enamel, and it enables soldering to be carried out at conventional soldering temperatures.

Yet another enamel is now available in this country, it having appeared over the last three years. This new enamel is based on polyester, and is exceptionally tough. It is available in the same thicknesses as synthetic enamel and is employed for applications where excessive abrasion is applied during manufacture. (An application encountered by myself consisted of the wave-winding of a bifilar coil of some 500-odd turns, two wires being fed

into the machine at the same time. Despite the fantastic abrasion between turns and between the wire and the winding button, coils wound with polyester enamelled wire gave no rejects for shorts, either between turns or between the two bifilar windings.) Polyester enamels may be fairly readily identified by the home- constructor and service engineer because of the difficulty of removing the tough enamel film.

Before concluding on the subject of wire enamels, I should add a quick word about self-bonding wires. These wires are employed mainly in deflector coils and have the advantage that they may be wound to a particular shape and then set in that position. Those stiff "flared" line coils you see in TV deflector yokes are made with self-bonding wire. The wire comprises a synthetic enamel over which is added a coating of glue. The wire is wound into the required shape in a mandrel or jig, after which a current is passed through it. This heats the wire and causes the glue to melt and spread through the body of the coil. When the glue sets, the coil then remains fixed rigidly in the shape imparted to it by the mandrel. Modern self-bonding wires may, incidentally, employ polyester or even self-soldering enamel under the glue. Whatever the basic enamel, the bonding glue causes the overall diameter to be increased by approximately 0.001 in.

Fibre Covered Wires

So far as radio and television is concerned, fibre covered wires are usually encountered as single or double coverings over bare or enamelled copper wire. A double covering consists of two layers of the fibre, one wound on the wire one way, and one, on top, the other way. The fibre normally employed is rayon, or "art silk", this being significantly cheaper than silk or cotton. The main advantages of a fibre covering are that it provides bulk and that it enables wave-winding to be readily carried out. The bulk of the fibre covering causes the copper wires in a coil to be physically displaced from their neighbours, thereby keeping self-capacitance down. A high insulation resistance between turns is also achieved when the coil is later impregnated, because the impregnant fills in the relatively large spaces and interstices between the wires. Wave-winding with fibre covered wires may be readily carried out because the outside filaments of the covering "hook into" each other and help to keep the wire "laid" in position.

A frequently encountered fibre covered wire is known as T.N.A. T.N.A. wire, which was introduced some five years ago, consists of tinned copper wire covered first with a thick layer of nylon fibre and, finally, a thin lapping of acetate fibre (or unregenerated cellulose). The name T.N.A. is, by the way, short for Tin, Nylon, Acetate. Both the nylon and acetate coverings melt at soldering temperatures and so there is no need to strip the wire when making connections. When a single layer coil has been wound with T.N.A. wire it may be fixed in position and roughly impregnated by brushing with acetone. The acetone initially dissolves the outside acetate, after which it very quickly evaporates. The coil then becomes covered with a coating of redistributed acetate which holds it rigidly in position. For further rigidity, the former on which the coil is wound may similarly have an outside coating of acetate, whereupon the application of acetone causes both the coil and the former to be rigidly held together by the redistributed acetate. Single layer T.N.A. windings are extensively used in current television receivers, appearing in i.f. and tuner coils. In many cases, such coils may be completely automatically wound.

Under the Surface

In the preceding paragraphs I have touched only briefly on the various types of winding wire which are employed in the electronics industry. I hope, nevertheless, that I have shown that such wires are not just merely "enamelled", or "single or double" fibre covered! As I said at the beginning, one of the more fascinating things about electronics is the continuing detail you encounter when you start examining just one single facet of the subject.

Transatlantic TV ?

Just after I had sent in last month's contribution, Mr. I. C. Beckett of Buckingham wrote in to say that he may have received the first Transatlantic TV Dx to be reported in this column. With his receiver line time-base set for 625 line reception he suddenly received, at 5.33 p.m. B.S.T. on 21st September, a negative modulation picture on a vision carrier of 55.25 Mc/s. This would not lock in until line frequency was raised. A half black, half white, test pattern was then resolved with considerable variations in signal strength. The signal faded out from 5.57 to 6.02. At 6.05 a test card was put on and, altogether, Mr. Beckett obtained 55 minutes reception of this unidentified signal. Unfortunately,

Mr. Beckett did not have his camera with him at the time, but he has sent me sketches of the test card. Regrettably, no recognisable station identification could be observed. Later, after the picture had faded, an Italian signal came up, and Mr. Beckett had to reduce line frequency to make this synchronise properly.

Everything certainly points to Transatlantic reception here. North American Channel 2 is 55.25 Mc/s vision carrier, and the line frequency is 15,750 as compared to the 15,625 lines per second of the 625 line system. Also the receiver used by Mr. Beckett will not lock at the 819 line frequency of 20,475 lines per second. So, this may well be our first Transatlantic TV Dx report, even if it can't be reliably verified!

One of the readers I mentioned last month has sent me a long letter concerning his TV Dx reception, and I much regret that lack of space prevents me from quoting it in full. This reader, Mr. C. N. Rafarel, eschews the B.B.C. and makes the 819 line transmissions from France his regular viewing! He points out also that the first TV Dx was between Leeds and London (200 miles) in 1935! Mr. Rafarel has considerable TV Dx experience and very kindly offers to help readers who have difficulty in identifying test cards. He states that they may write to him at 10 Netley Close, Parkstone, Poole, Dorset.

By the time this contribution appears in print, Tv Dx will have almost certainly faded out for the year. So there may well be no further reports for several months. I would like to take this opportunity of warmly thanking all the interested readers who have written to me on the subject, and of telling them how much pleasure I have obtained from reading their letters. And the best of Dx hunting for 1962!

A Vintage Year

And so we come to another December issue.

This time last year I said that 1961 would bring us plenty of interest and variety so far as *The Radio Constructor* was concerned. Wasn't I right? I only wish my crystal ball at that time had been sufficiently sensitive for me to predict the new, enlarged, format which we launched in August!

The Editor tells me that *The Radio Constructor* in 1962 will be even better than in 1961. With this cheerful augury in mind, I will now sign off for this year, and offer my sincere wish that every reader has a Christmas which is truly Happy and Merry.

Interpretation

of Transistor Data

Part 3

By V. T. ROLFE*

R.F. Parameters

WHEN TRANSISTORS ARE USED AT HIGH FREQUENCIES, the equivalent circuits considered so far are no longer valid and the effects of capacities must be included. In addition the base resistor r_b must be considered to consist of two components, one of which is the active area of the base, and the other the ohmic resistance of the wafer between the active area and the base lead itself. A high frequency equivalent circuit, based on the T network already considered is shown in Fig. 15. At high frequencies the capacity $c_{eb'}$ shunts some of the input current.

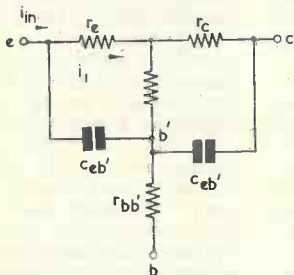

b' indicates the internal base connection

Fig.15

M198

The output current is a function of the current in $r_{eb'}$. Thus there is an apparent drop in the current gain

$$\alpha = \frac{i_{out}}{i_{in}}$$

The low frequency α , frequently referred to as α_0 , is given by

$$\alpha_0 = \frac{i_{out}}{i_1}$$

$$\therefore \alpha = \frac{\alpha_0 i_1}{i_{in}}$$

When $\frac{\alpha}{\alpha_0} = \frac{1}{\sqrt{2}}$, the current gain is 3dB down.

The frequency at which this occurs is known as the Cut-Off Frequency f_a .

The cut-off frequency in grounded emitter is lower than this. It is termed $f_{a'}$ or f_b and is given by:

$$f_{a'} = \frac{f_a}{\alpha_0}$$

Another frequency sometimes quoted, is the frequency (f_1) at which the current gain α' is unity.

A frequently used equivalent circuit for r.f. transistors, is the hybrid π circuit. (Fig. 16.) This can be derived from the r.f. T-network. The derivation is straightforward, but involves several equivalent circuit conversion "tricks", which may be unfamiliar to the reader.

Perhaps the most interesting components in this equivalent circuit are $r_{b'c}$ and $c_{b'c}$ the feedback resistance and capacity respectively. These two components introduce feedback between the input and output circuits in a similar fashion to the c_{a-g} of a valve.

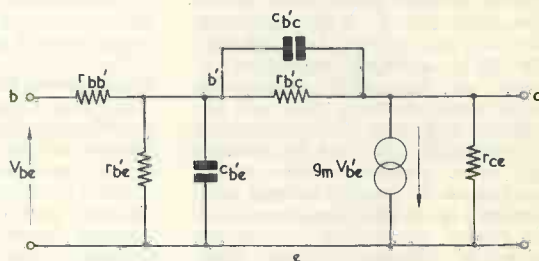

b' indicates the internal base connection

Fig.16

M199

The values given in the hybrid π circuit are independent of frequency. But if we wish to consider the circuit at one fixed frequency, as in the case of an i.f. amplifier, these two parallel components can be replaced by a series resistor and capacitor. If the

* Mullard, Ltd

output circuit consists of a 1:1 transformer, an antiphase feedback component can be obtained from the secondary, and by using a series resistor R_f and capacitor C_f between input and output

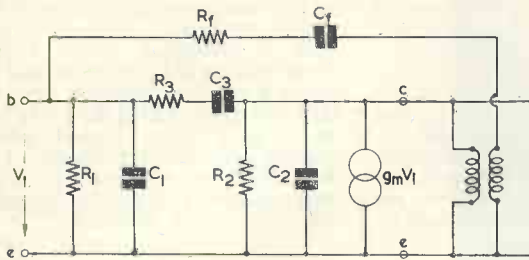

Fig.17

M200

circuits equal to the values quoted the internal feedback can be entirely neutralised. (Fig. 17.) This is known as the unilateralised condition, and under these circumstances the input and output impedances are independent of one another.

"Y" Parameters

These are high frequency parameters somewhat similar to the "h" parameters already mentioned.

They are defined as follows:

$$Y_{11} = \frac{i_{in}}{v_{in}} = \text{input admittance with output short-circuited.}$$

$$Y_{22} = \frac{i_{out}}{v_{out}} = \text{output admittance with input open-circuited.}$$

$$Y_{21} = \frac{i_{out}}{v_{in}} = \text{mutual conductance, } g_m, \text{ with output short-circuited.}$$

$$Y_{12} = \frac{i_{in}}{v_{out}} = \text{feedback admittance with input open-circuited.}$$

The mutual conductance, g_m (or Y_{21}) is comparable with the mutual conductance of a valve, but it is important to note that the μ used in transistor data is h_{21} , and is not the same thing as the valve μ . It is in fact the reciprocal of the valve μ .

Compared with valve data, transistor data is at present much more difficult to read. This is due partly to the fact that the manufacturer is anxious to present as much information as possible to the user, who may not know as much as he should about circuit theory. It is hoped that this situation will eventually resolve itself, whereupon a simpler form of presenting transistor data can then be devised.

(Conclusion)

The 1961

Electronic Computer Exhibition

THE ELECTRONIC ENGINEER OR enthusiast whose interests lie mainly with radio, television or audio reproduction is liable to be disconcerted when he first approaches the computer. In the equipment he normally handles circuit operation is a function of resistors, capacitors and other electronic components, all of which are dealt with directly. In a computer, the resistors and capacitors take up subsidiary positions in the many cells of a machine which is fed with information and instructions at one end, and which offers the subsequently processed information at the other. The best thing the enquiring engineer can do at first, therefore, is to hold his nose tightly and jump in at the deep end, accepting what computers can accomplish overall and leaving the functions of the individual computer components until a later date.

An approach rather like this is, indeed, that adopted by quite a few people employed in the computer industry, as the writer discovered

when he visited the 1961 Electronic Computer Exhibition held at Olympia in October. On one stand, for instance, he was given a detailed description of the capabilities of a particular computer, the demonstrators putting the machine through its paces and explaining the mathematical processes involved with complete authority. But, when the electronics of the equipment were examined the demonstrators quite literally did not know a resistor from a crystal diode!

Types of Computer

There are two main categories of computer, these being the digital computer and the analogue computer.

The digital computer works directly in figures. Figures passed into the computer in decimal form are first translated to the binary scale, in which each digit, instead of being any number between 0 and 9, may only be 0 or 1. Electronic devices are able to handle the binary

scale because they can represent 0 by being "on" and 1 by being "off", or vice versa. A binary digit (0 or 1) is referred to by the contraction "bit". The bits obtained from the decimal input may then be added, subtracted, multiplied or divided by the computer, the latter handling them in the form of a sequential train of pulses.

A digital computer is a large piece of equipment because each individual circuit in it may handle one simple operation only. To illustrate this point it is possible, for instance, to wire up a flip-flop circuit such that it gives one output pulse for every two pulses fed into it. Such a flip-flop then becomes capable of dividing by 2. However, a flip-flop circuit requires, say, a double-triode or two transistors, and a large number of these circuits would be needed in a practical computer. Other sections of the computer will similarly only be able to carry out a simple operation and they will still require at least one valve or semi-conductor

each. A "powerful" computer (i.e. one capable of carrying out a wide range of operations) will need a considerable number of these individual circuits and it becomes a large machine in consequence. On the other hand, the digital computer is capable of carrying out calculations at prodigious speed, the only foreseeable limiting factor to pulse repetition frequency being given when pulse spacing approaches the time taken for each pulse to travel along the interconnecting wires. Because of these facts, digital computers are economically desirable only when they may be loaded with sufficient work to justify their initial high cost.

A digital computer is set up to do a particular job by feeding a "programme" into it. This programme may be fed into the machine by means of punched paper tape, punched cards, or magnetic tape.

An analogue computer does not deal directly with figures. Instead, it is used for providing continual solution of an expression whilst one or more of its variables are being changed. The behaviour of each term in the expression is simulated by an electrical circuit. Each term may then be represented by voltage (or current), the output voltage then corresponding to the solution. Analogue computers may be small or large according to the complexity of the work they are called upon to carry out. A computer which may produce results similar to an analogue computer is the digital differential analyser, or D.D.A. This is basically a digital computer but it can function in the same way as an analogue computer by continually sampling the terms in an expression.

Tape Handlers

In the Computer Exhibition, Ampex (Great Britain) Ltd. exhibited their new TM2 digital tape handler. In this, the two tape reels are mounted vertically above each other, tape from the upper reel feeding via the head mechanism to the lower one. For computer requirements it is necessary for the tape to be stopped and started repeatedly, and free loops of tape must appear between the reels and the head mechanism to prevent strain on the tape and permit quick acceleration and deceleration. In the Ampex tape handler a triangular space on either side of the head mechanism permits the storing of two large free loops. Tape speed with the TM2 handler is up to 150in per second with 1.5 millisecond start/stop times. Versions for 1in and $\frac{3}{4}$ in tape are available.

Decca Radar Ltd. showed their type 4000 tape transport which is also available in 1in and $\frac{3}{4}$ in versions. This incorporates pneumatic tape drive, a technique which permits rapid and smooth acceleration and deceleration. At a tape speed of 150in per second the length of tape lost during starting and stopping is less than 0.3in. Dual write/read heads are available with 0.39in separation, these providing immediate check-back of recorded information. Standard data rates for the type 4000 tape transport are 45,000, 90,000 and 180,000 bits per second, the latter being achieved by an interlaced track arrangement.

Complete Computers

An impressive display staged by EMI electronics Ltd. consisted of a complete Emidec 1100 data processing system set up and working. Typical jobs demonstrated by this computer were the calculation and printing out of part of the payroll for British Motor Corporation's Longbridge factory, and sales invoicing for EMI Records Ltd. The computer site was air-conditioned so that the exhibit would represent a typical layout as employed in a user's premises. The output of the computer was coupled to an Anelex high speed printer which is capable of printing 15 feet of solid copy on a sheet some 12in wide every minute.

Elliott-Automation Ltd. had on display the National-Elliott "803" Solid-State computer. This incorporates a battery power supply to shield the computer from fluctuations in mains voltage and power failures. Also to be seen on the Elliott stand was the "503" computer, this combining high speed with relatively low cost. The "503" runs nearly 100 times faster than the "803", but it is fully compatible with the latter for programme feeding.

Leo Computers Ltd. exhibited their new Leo III range. These are transistorised throughout and may be set up as small or large installations, according to the volume of the work they will be required to perform. Typical operating times for the Leo III are 420 microseconds for the multiplication of two four-digit decimal numbers and 610 microseconds for the division of two numbers to produce an eight-digit quotient.

A Computer in Action

It is difficult to appreciate the capabilities of a computer at an exhibition, and Leo Computers Ltd. offered visits to typical installations around London to enable Leo computers to be seen at work under

practical conditions. The writer went on one of these visits to see the Leo II computer in action at the Ford Motor Co. plant at Dagenham.

One of the jobs carried out by the Leo II computer at the Ford plant is the calculation of the payroll for 28,000 employees. This mammoth task is completed in 16 hours. Programming of the machine may be carried out by magnetic tape or punched cards, the latter being fed in a "pack" to a machine which handles each card individually. The first card in the pack carries information which kills all previous instructions held by the computer.

The Ford computer also handles stock control and ordering for the production line. Each car in production is identified by a "package code", the characters in this code indicating the type of vehicle, its colour, whether it has a heater or not, the type of tyres, and so on. At the end of the line a checker transfers the package code information to a punched card for each vehicle. These cards are then collected at the end of the day. Production schedules specifying the quantity and types of vehicle to be manufactured are raised regularly and these are fed into the computer, which calculates and prints out the component parts needed for the schedule. When the schedule is under way the punched cards from the end of the line are also fed to the computer which then assesses the usage of parts as the schedule proceeds on a day-to-day basis. With such information the computer may also advise when particular component parts should be re-ordered so that economic stock control may be achieved.

The computer is maintained by engineers on site. A daily routine check is carried out each morning, or whenever the machine is switched on, by feeding in a special test programme which checks all circuits. A socket field and meter is available at the control desk and a supply voltage overload may be applied to make the test more vigorous. Valves are changed after a specific number of running hours. During use the performance of the computer may be evaluated with the aid of three c.r.t. displays, these being coupled by means of switches into any desired section of the machine. A loud-speaker offers an audible indication that the computer is running by reproducing a tone varying in frequency with each cycle of operations in the computer. This changes to a steady tone if the computer stops, as would occur if it had processed all the information passed to it.

KIT REVIEW . . .

The Repanco Mini-4 Pocket Transistor Receiver

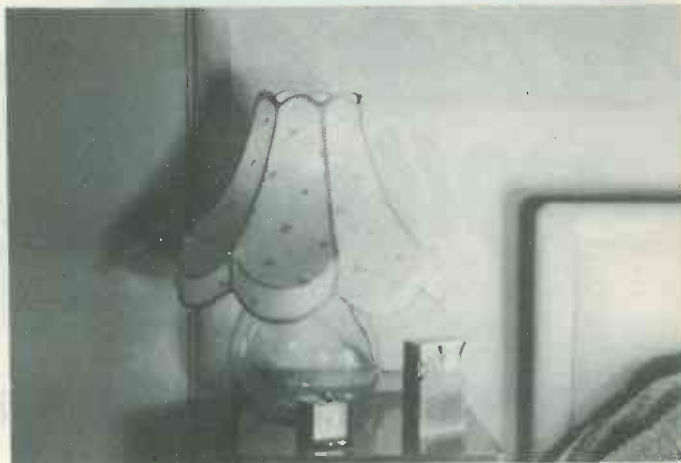

We have had on test for some weeks now one of the Repanco "Mini-4" pocket transistor receivers. These miniature receivers are supplied to home constructors in kit form, the instructions commencing with the words "This pocket receiver really works . . .". Not only does the completed unit really work, it works extremely well!

As may be seen from the photograph this receiver is small, its dimensions being approximately 3 x 5 x 1½ in. The circuit includes four transistors and covers both the Medium and Long wavebands. By reason of its small size, miniature components have been used throughout and a small PP3 battery included, this of course having a somewhat limited life. However, if the receiver is used as a bedside

set, listening for short periods at a time—such as the news—it will work at good volume for quite an extended period of time.

The instructions recommend that, due to its compactness, the following should be observed: an instrument type of soldering iron be used in construction, the specified components only be used, check every step before proceeding to the next and follow the instructions exactly. We feel that if these few simple rules are followed, the average constructor should be able to complete this kit without much difficulty and, once he has done so, he will have a little personal receiver with which he will be well satisfied.

MULLARD STEREO AMPLIFIER CIRCUITS

Mullard Ltd. have just released a leaflet describing the design and construction of two stereophonic amplifier circuits based on the new audio triode-pentode type ECL86.

The first of these is a ten-watt high-quality stereophonic amplifier circuit using two EF86's, four ECL86's and a GZ34 rectifier. Overall negative feedback of approximately 20dB has been applied giving the amplifier a frequency response flat to within 3dB from 12 c/s to 35 c/s at a power output of 10W per channel. The total harmonic distortion at full output is less than 0.2% and the level of hum and noise measured at the output, with the input short-circuited, is typically 75dB below 10W. Bass, treble and balance controls are incorporated.

An inexpensive three-watt stereophonic amplifier circuit using two ECL86's and one EZ81 rectifier is the second type described. Overall negative feedback of 18dB has been applied which gives the amplifier a frequency response flat to within 5dB from 20 c/s to above 40 c/s at a power output of 3W per channel. The total harmonic distortion at 3W is 3%. With the bass and treble controls set for a flat response the level of hum and noise appearing at the output is better than 65dB below 3W.

Full constructional details (including two versions of the 10W amplifier using a printed circuit), response curves and test results are given for each circuit.

Copies of this leaflet, ref. TP456, are available from Mullard Ltd., T.S.D., Mullard House, Torrington Place, London, W.C.1, or through radio dealers.

NOW YOU can MASTER ELECTRONICS!

**BRITAIN'S MOST COMPREHENSIVE PRACTICAL
COURSE IN RADIO
ELECTRONICS • TELEVISION!**

**THESE SPECIAL TRAINING
KITS — YOURS TO KEEP**



**Multi-Range
TEST METER**



**CATHODE RAY
OSCILLOSCOPE**

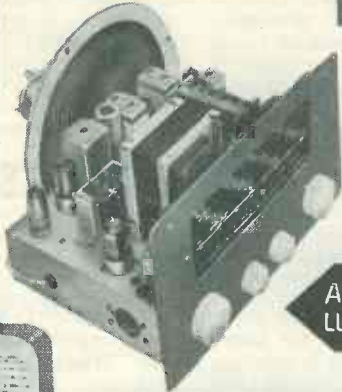

**AM and VHF/FM
LUXURY RECEIVER**



SIGNAL GENERATOR



**Complete set of
Picture Way books and
Experimental Manuals**

**LEARN BY BUILDING
NOW for your
CAREER • HOBBY
OWN BUSINESS**

- YOU RECEIVE**
- Complete kits of equipment as illustrated.
 - Complete set of experimental manuals.
 - Complete set of "picture-way" theory books,
 - Modern test-yourself examination sheets.
 - Study programme.
 - Unlimited consultation with Tutors.

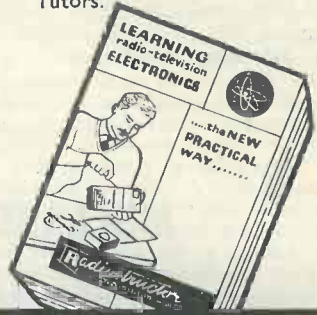

**FREE
BROCHURE
POST NOW**

RADIOSTRUCTOR

TO RADIOSTRUCTOR (DEPT. M.31)
READING, BERKS.

Name.....
Address.....
.....
.....

**BLOCK
CAPS
PLEASE**

(We do not employ representatives) 12.61

CHECK with these

BARGAINS



**EASY TERMS
AVAILABLE
EXCEPTING
AUTO-CHANGES**

- 9 **SIGNAL GENERATORS.** Cash £6.19.6 or 25/- deposit and 6 monthly payments of 21/6. P. & P. 5/6. Coverage 100 kc/s to 100 Mc/s on fundamentals and 100 Mc/s to 200 Mc/s on harmonics. Case 10" x 6 1/2" x 5 1/2". Three miniature valves and Metal Rectifier. A.C. mains 200/250V. Internal modulation of 400 c.p.s. to a depth of 30 per cent; Modulated or unmodulated R.F. output continuously variable 100 millivolts. CW. and mod. switch, variable A.F. output. Magic eye as output indicator. Accuracy $\pm 2\%$.
- 10 **SIGNAL GENERATORS.** Cash £4.19.6. P. & P. 5/6. Coverage 120 kc/s to 84 Mc/s. Case 10" x 6 1/2" x 4 1/2". Size of scale 6 1/2" x 3 1/2". 2 valves and rectifier. A.C. mains 230-250V. Internal modulation of 400 c.p.s. to a depth of 30 per cent modulated or unmodulated R.F. output continuously variable 100 millivolts. CW. and mod. switch variable A.F. output and moving coil output meter. Accuracy $\pm 2\%$.
- 11 **BATTERY RECORD PLAYER AND AMPLIFIER.** 45 r.p.m. "Star" motor "Acos" crystal pick-up, 3 transistor, push-pull amplifier complete with transistors. Output 500 milliwatts, 49/6. P. & P. 4/-.
- 12 **8-watt PUSH-PULL 5 VALVE AMPLIFIER.** A.C. mains 200-250V. Size 10 1/2" x 6 1/2" x 2 1/2". 5 valves. For use with all makes and type of pick-up and mike. Negative feedback. Two inputs, mike and gram. and controls for same. Separate controls for Bass and Treble lift. Response flat from 40 cycles to 15 kc/s, ± 2 dB; 4db down to 20 kc/s. Output 8 watts at 5 per cent total distortion. Noise level 40 db down all hum. Output transformer tapped for 3 and 15 ohms speech coils. For use with Sd. or L.P. records, musical instruments such as guitars, etc. Suitable for small halls. £3.19.6. P. & P. 7/- . Crystal mike to suit 15/- . P. & P. 2/- . 8" P.M. Speaker to suit, 12/6. P. & P. 2/- .
- 13 **B.S.R. MONARCH UA8 WITH FUL-FI HEAD.** 4-speed, plays 10 records, 12", 10" or 7" at 16, 33, 45 or 78 r.p.m. Intermixes 7", 10" and 12" records of the same speed. Has manual play position: colour, brown. Dimensions: 12 1/2" x 10 1/2". Space required above baseboard 4 1/2" below baseboard 2 1/2". Fitted with Ful-Fi turnover crystal head, £6.19.6. P. & P. 5/- . With Stereo Head £7.19.6. P. & P. 5/6.
- 14 **TRANSISTOR TESTER.** For both P.N.P. and N.P.N. transistors incorporating moving coil meter. In metal case, size 4 1/2" x 3 1/2" x 1 1/2". Scale marked in gain and leakage, 19/6. P. & P. 3/- .
- 15 **PUSH-PULL OUTPUT STAGE** inclusive of transistors with input and output transformers to match 3 ohms speech coil, suitable for use with the POCKET RADIO. Kit of parts, including transistors, 19/6. P. & P. 2/- . Wiring diagram 1/6, free with kit.
- 16 **PORTABLE AMPLIFIER.** On printed circuit for A.C. Mains 200/250V. Size 4" x 3" with tone and volume control. Complete with valves: ECL82 and EZ80. Output 2 watts. 39/6. P. & P. 3/- .

- 1 **3-TRANSISTOR POCKET RADIO** with miniature SPEAKER, FERRITE ROD, and 3 GERMANIUM DIODES. The only 3-transistor radio available at the price. Build it in 1 evening! Tunable over M/L waves. Complete with easy-to-follow instructions and all components (less batteries obtainable anywhere 1/3). 27/6. P. & P. 2/6. (All parts available separately.)
- 2 **5-TRANSISTOR POCKET RADIO.** Size: 4 1/2" x 3 1/2" x 1 1/2". Output 200 mW. Five first quality transistors. Push-pull output. Fitted 2" high-flux moving coil speaker. Medium and long wave. Internal high gain ferrox aerial. Twin coloured case in red and black. 'All parts available separately. Circuit-diagram 1/6. Free with kit. No aerial or earth required. 59/6. P. & P. 3/6.
- 3 **OSCILLOSCOPE** for D.C. and A.C. APPLICATIONS. A high gain, extremely stable differential Y-amplifier (30 mV/C.M.). Provides ample sensitivity with A.C. or D.C. inputs. Especially suitable for measurements of transistor operating conditions where maintenance of D.C. levels is of paramount importance. Push-pull X amplifier; Fly-back suppression; Internal Time-base Scan Waveform available for external use; pulse output available for checking TV line O/P Transformers, etc. Provision for external I/P and CRT Brightness Modulation. A.C. mains 200/250V £15.15.0. P. & P. 8/- or 30/- deposit, plus P. & P. 8/- and 12 monthly payments of 26/6. FULL 12 MONTHS' GUARANTEE INCLUDING VALVES and TUBE.
- 4 **A.C./D.C. POCKET MULTI-METER KIT.** 2" moving coil meter, scale calibrated in A.C./D.C. volts, ohms and millamps. Voltage range A.C./D.C. 0-50, 0-100, 0-250, 0-500. Millamps 0-10, 0-100. Ohms range 0-10,000. Front panel, range switch, wirewound pot (for ohms zero setting), toggle switch, resistor and rectifier. 19/6. P. & P. 2/- . Wiring diagram 1/- free with kit.
- 5 **CHANNEL TUNER.** Will tune to all Band I and Band II stations. Complete with P.C.C.84 and P.C.F.80 valves (In series) I.F. 16-19 or 33-38. Can be modified as an aerial converter (instructions supplied). 32/6, plus 4/- P. & P. HEATER TRANSFORMER to suit above, 200-250V, 6/-, plus 4/- P. & P.
- 6 **MAINS TRANSFORMERS.** All with tapped primaries. 250-250V 70mA, 6.3V 2A, P. & P. 3/6. 280-0-280 70mA, 6.3V 2A, 6.3V 3A, 17/6. P. & P. 3/6.
- 7 **NO MORE FLAT BATTERIES.** 6 and 12 volt, 2 amps. Charge your own battery overnight with this wonderful little charger. A.C. mains 200/250V, 6" x 3" x 3" incorporating mains fuse. Attractive silver hammer finish, complete with leads and battery clips. Only 21/- . P. & P. 3/6.

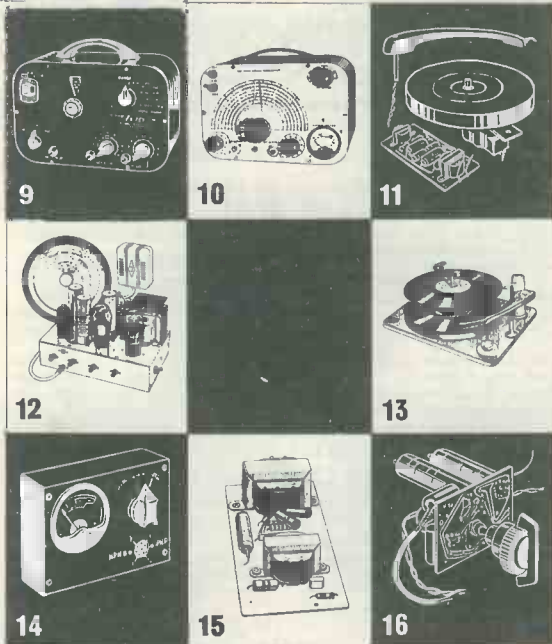

RADIO & T.V. COMPONENTS
(Acton) LTD.

**23d HIGH STREET, ACTON,
LONDON, W.3.**

ALL ENQUIRIES S.A.E.
GOODS NOT DISPATCHED OUTSIDE U.K.

RETURN-OF-POST SERVICE

We offer a really efficient Mail Order Service on all items stocked. All cash orders are dealt with on the day of receipt. Hire purchase orders are subject to slight delay but this is kept to the absolute minimum

● LOUDSPEAKERS

GOODMANS: Axiom 110 10" £52.0; Axiom 112 10" £84.40; Axiette 8" £6.15.0; Axiom 300 12" £11.5.9; Axiom 400 12" £16.1.0; Audio 60 Bass, 12" £9.12.9; Trebax Tweeter £6.4.0; CX5000 Cross-over unit £1.19.0.

WHITELEY: HF1016 10" £8.4.0; HF1012 10" £5.2.6; HF816 8" £7.0.9; T816 8" £6.10.0; T10 Tweeter £4.8.3; T359 Tweeter £1.15.10; CX3000 Cross-over unit £1.11.6; CX1500 Cross-over unit £2.0.0. H.P. Terms available.

● SPECIAL OFFER OF TAPE HEADS

Bradmatic Tape Recording Heads as fitted to Collaro Studio Deck, Erase and Record Playback. 32/6 per pair, post paid.

● TRANSISTORS

MULLARD. Reduced prices. Current production types, not rejects. All in makers' boxes. OC44 11/-; OC45 10/-; OC70 and OC71 6/6; OC72 8/-; OC72 Matched Pairs 16/-; OC78 8/-; OC81 8/-; OC170 13/6; OC171 14/6. Postage 3d. on each transistor.

● AMPLIFIER KITS

We have full stocks of all components for the Mullard 510, Mullard 3-3, Mullard 2 and 3 Valve Pre-amp, Mullard Stereo, Mullard Mixer, G.E.C. 912 Plus. Fully detailed list on any of these sent upon request. Instruction Manuals: All Mullard Audio Circuits in "Circuits for Audio Amplifiers" 9/5. G.E.C. 912 4/6. All post free.

● STEREO COMPONENTS

Morganite ganged potentiometers as specified for the Mullard circuits. ● Log/Anti-Log, 500k, 1 meg, 2 meg. ● Log/Log, 50k, 250k, 1 meg, 2 meg. ● Lin/Lin, 250k, 500k, 1 meg, 2 meg. All 10/6 each. Pick-up cartridges. B.S.R. TCBS £2.5.11. Turn-over type for Stereo, L.P. and 78 records. List of all components for Mullard Stereo Designs is available.

● "P.W. TUTOR"

Everything in stock. Stage 1, including brand-new light-weight headphones, 39/6. Less headphones 23/6. Stage 2, 19/-, Stage 3, 21/6. Stage 4, 11/6. All Stages 1 to 4, £4.8.6. Less headphones, £3.13.6. All post free. Please note that the hardboard, wood, Terry clips and cement not included. All items available separately—send for list.

● "P.W. MINI-AMP"

Complete kit for Amplifier £4.2.6. Whiteley speaker P2.585 £14.0. Greentape Gramophone unit £5.8.0. All parts available separately—send for list.

● "P.W. TUNER UNIT" Send for parts list.

● GRAMOPHONE EQUIPMENT

ALL LATEST MODELS
ALL POST FREE

	Cash Price	Deposit	Hire Purchase Mthly Pmts.
--	------------	---------	------------------------------

RECORD CHANGERS

GARRARD			
AUTOSLIM (GC8 PU)	£8. 5.0	£1.13.0	12 of 13/-
COLLARO C60 (GP67 PU)	£8. 5.0	£1.13.0	12 of 13/-
GARRARD RC210 (GC8 PU)	£10. 6.0	£2. 2.0	12 of 15/4
B.S.R. UA14 (TC8 PU)	£7.19.6	£1.12.6	12 of 12/3
B.S.R. UA14 Monarch (TC8S Stereo/LP/78)	£8.19.6	£1.16.6	12 of 13/7

SINGLE RECORD PLAYERS

GARRARD TA (GC8 PU)	£8.10.0	£1.14.0	12 of 13/-
B.S.R. TU9 (TC8 PU)	£4.12.6	£1. 6.6.	3 of £1.5.4
E.M.I. (Acos Stereo/Mono PU)	£6.15.0	£1. 7.0	12 of 10/6

TRANSCRIPTION UNITS

GARRARD 4HF (GC8 PU)	£18.18.0	£3.16.0	12 of £1.7.8
PHILIPS AG1016	£14. 3.6	£2.17.6	12 of £1.0.9

Many of the above can be supplied for stereo working. See our Gramophone Equipment List for details.

● OUTPUT TRANSFORMERS

GILSON: W0696A, W0696B 50/6, post 2/6. W0710, W0710/8K 55/6, post 2/6. W0892 62/3, post free. W0767 27/-, post 1/6.
PARTRIDGE: P3667 52/6, post 2/6. P4014 98/6, post free. P4131 60/-, post free. P3591A 99/-, post free. P5202, P5203 95/-, post free.
PARMEKO: P2641 28/-, post 2/-.

● ILLUSTRATED LISTS

Illustrated lists are available on LOUDSPEAKERS, TAPE DECKS, TEST GEAR, RECORDING TAPES, GRAMOPHONE EQUIPMENT or AMPLIFIERS. Any will be sent free upon request.

● TERMS OF BUSINESS

Cash with order or C.O.D. We charge C.O.D. orders as follows. Up to £3, minimum of 3/2. Over £3 and under £5, 1/6. Over £5 and under £10, 1/8. Over £10, no charge. Postage extra on CASH orders under £3 except where stated. Postage extra on Overseas orders irrespective of price.

WATTS RADIO 54 CHURCH STREET WEYBRIDGE SURREY
(MAIL ORDER) LTD. Telephone: Weybridge 4556
Please note: Postal business only from this address

● JASON FM TUNER KITS

We supply kits for all the Jason FM Tuners. Fully detailed lists available. Kits are complete with all valves and instruction manuals—definitely nothing else to buy. **FMT1 Standard Tuner** with ext. power supply £6.19.6. Power pack kit £2.12.6 extra. **FMT2 Standard Tuner** with internal power supply £10.9.6. Less power supply £8.9.6. **FMT3 Fringe Tuner** with internal power supply £12.7.6. Less power supply £10.9.6. **Mercury 2 FM/TV Sound Switched Tuner.** External power supply. £11.7.6. Power pack kit £2.12.6 extra. **JTV2 FM/TV Sound Switched Tuner.** Internal power supply. £15.17.6. **IMPORTANT.** Please state TV channels required when ordering Mercury and JTV Kits. **INSTRUCTION MANUALS.** Booklet for FMT1, 2 and 3, 2/10; Mercury 2, 3/10; JTV2 3/10. All post free. **HIRE PURCHASE** terms available on any kit.

● TRANSISTORISE YOUR CRYSTAL SET

We have two new designs for transistor amplifiers which can be used to greatly improve the signal from any crystal set. Leaflet available. **RLD4 Kit.** One stage, 12/- post free. **RLD5 Kit.** Two stage 21/- post free. The kits are easy to build and very detailed instructions are supplied.

● MULLARD CATHODE RAY TUBES

ALL AT THE NEW REDUCED PRICES

We supply both Mullard Radiant Screen (brand new, factory fresh) and Mullard Lumenar (rebuilt by Mullard with reclaimed bulbs—all other parts brand new). List of types available with prices and hire purchase terms.

● LATEST TEST METERS

	Cash Price	Deposit	Hire Purchase Mthly Pmts.
AVO Model 8 Mark II	£24. 0.0	£4.16.0	12 of £1.15. 2
AVO Model 8 with leather carrying case	£27.18.0	£5.12.0	12 of £2. 0.11
AVO Model 7 Mark II	£21. 0.0	£4. 4.0	12 of £1.10.10
AVO Multiminor	£9.10.0	£1.18.0	12 of 14/4
AVO Multiminor with leather carrying case	£11. 9.0	£2. 5.0	12 of 17/-
TAYLOR Model 127A	£10. 0.0	£2. 0.0	12 of 15/-
CABY A-10	£4.17.6	£1. 7.6	3 of £1. 6.8
CABY B20	£6.10.0	£2. 0.0	3 of £1.13.4

Full details of any of the above supplied free on request. The AVO Models 7 and 8 are both latest models from current production—not to be confused with Government Surplus.

● "BRAND FIVE" RECORDING TAPE

Standard Play: 600 ft (5") 16/-; 1,200 ft (7") 25/-.
Long Play: 900 ft (5") 18/6; 1,200 ft (5 1/2") 23/6; 1,800 ft (7") 35/-.
Double Play: 1,200 ft (5") 37/6; 2,400 ft (7") 60/- (All Post Free!)

● B.A.S.F. RECORDING TAPE

Long Play: 210 ft (3") 9/-; 900 ft (5") 28/-; 1,200 ft (5 1/2") 35/-; 1,800 ft (7") 50/-.
Double Play: 300 ft (3") 14/-; 600 ft (4") 25/-; 1,200 ft (5") 42/-; 1,800 ft (5 1/2") 58/-; 2,400 ft (7") 77/6. All post free.

● TAPE RECORDING EQUIPMENT

	Cash Price	Deposit	Hire Purchase Mthly Pmts.
ALL CARRIAGE FREE			
B.S.R. TD2	£8.19.6	£1.16.6	12 of 13/7
COLLARO Studio	£12.19.6	£2.12.6	12 of 19/-

TAPE AMPLIFIERS

We now stock the Martin Recorder Kits. These are partly assembled kits for complete tape recorders. The Amplifier Printed Circuit panels are completely wired, but the assembly of this and external components is left to the constructor. Very complete instructions are supplied. Send for leaflet.

MODEL C for Collaro Studio Deck, £11.11.0.

MODEL B for BSR TD2 Deck, £8.8.0.

CARRYING CASES. Smart carrying cases are available to take the above amplifiers and decks. Fitted with speaker. For Model C Amplifier and Collaro Deck £5.5.0. For Model B Amplifier and BSR Deck £4.4.0.

H.P. terms available for amplifiers, cases and decks.

TAPE PRE-AMPLIFIERS

ARMSTRONG PABO-3. This is a ready made version of the Mullard Tape C Pre-amplifier. Price £16.16.0. Hire Purchase: Deposit £3.8.0 and 12 monthly payments of £1.4.7.

MULLARD TAPE C PRE-AMPLIFIER. We stock complete kits and all components. Send for list.

MARTIN KIT for Collaro Studio deck, £8.8.0.

● HIRE PURCHASE TERMS

are available on any item. Repayments may be spread over 3, 6 or 12 months. Details as follows: Three months: Deposit 6/- in the £. Service charge 5 per cent but minimum charge of 10/- . Six and twelve months: Deposit 4/- in the £. Service charge 10-per cent, but minimum charge 20/-.

7 VALVE AM/FM RADIOGRAM CHASSIS

Valve Line-up: ECC85, ECH81, EF89, EABC80, EL84, EM81, EZ80.

Three Waveband and Switched Gram positions Med. 200-500 mm., Long 1,000-2,000 m., VHF/FM 88-95 Mc/s. Philips Continental Tuning insert with permeability tuning on FM and combined AM/FM I.F. transformers, 460 kc/s and 10.7 Mc/s. Dust core tuning all coils. Latest circuitry including AVC and Neg. Feedback. Three watt output. Sensitivity and reproduction of a very high standard. Chassis size 13 1/2" x 6 1/2". Height 7 1/4". Edge illuminated glass dial 11 1/4" x 3 3/4". Vertical pointer. Horizontal station names. Gold on brown background. A.C. 200/250V operation. Magic-eye tuning.



Aligned and tested ready for use. £13.10.0 Carr. & Ins. 5/-.
Complete with 4 knobs—walnut or ivory to choice. Indoor FM aerial 3/6 extra.

3 ohm P.M. Speaker only required. Recommended Quality Speakers 10" H/DUTY PLESSEY 30/-, 8" H/DUTY ROLA 25/- P. & p. 2/6.

New Boxed	VALVES	Guaranteed	All Electrolytics	All Types New Stk.
1T4	6/-	ECC83 8/-	PCC84 9/6	25/25V 1/9
1R5	7/6	ECL82 10/6	PCF80 9/6	50/12V 1/9
1S5	7/6	ECL80 10/6	PCL83 12/6	16+16/450V 5/6
3S4	7/6	EF80 8/-	PCL84 12/6	100/25V 2/-
3V4	7/6	EF86 12/6	PL81 12/6	8/450V 2/3
DAF96	9/-	EL84 8/6	PL82 9/6	4/350V 2/3
DF96	9/-	EY51 9/6	PL83 10/6	16+16/450V 5/6
DK96	9/-	EY86 10/-	PY32 12/6	32+32/450V 6/6
DL96	9/-	EZ81 7/6	PY81 9/6	
ECC81	8/-	GZ32 12/6	PY82 7/6	
ECC82	8/-	EM81 9/6	U25 12/6	
				ERsin Multicore Solder 60/40 3d. per yard. 1/2 lb. 2/6, etc.

RECORDING TAPE—BARGAIN PRICES
Famous American Columbia (CBS) Premier Quality Tape at NEW REDUCED PRICES. A genuine recommended Quality Tape—TRY IT! Brand new, boxed and fully guaranteed. Fitted with leader and stop folds.

Standard	Long Play	Double Play
5" 600ft. 15/-	900ft. 19/6	1,200ft. 31/6
5 1/2" 900ft. 16/6	1,200ft. 22/6	1,800ft. 39/6
7" 1,200ft. 21/-	1,800ft. 32/6	2,400ft. 47/6

Post and Packing, per reel, 1/-, plus 6d. each for additional reels.
SPECIAL OFFER—3" mfrs. surplus tape, 225ft. 5/6. P. & P. per reel 6d. Plastic Tape Reels, 3" 2/6, 5" 3/-, 5 1/2" 3/3, 7" 3/6.

Volume Controls—SK-2 Meg-ohms, 3" Spindles Morganite Midget Type, 1 1/2" diam. Guar. 1 year. LOG or LIN ratios less Sw. 3/-. DP. Sw. 4/6. Twin Stereo less Sw. 6/6. D.P. Sw. 8/-.

COAX 80 OHM CABLE
High grade low loss Cellular air spaced Polythene—1/4" diameter. Stranded cond. Famous mfrs. Now only 6d. per yard. **Bargain Prices**—Special lengths 20 yds. 9/-, P. & P. 1/6. 40 yds. 17/6. P. & P. 2/-. 60 yds. 25/-. P. & P. 3/6. Coax Plugs 1/-. Sockets 1/-. Couplers 1/3. Outlet Boxes 4/6.



Tape Recorder Kit Special Offer
Latest 5 valve circuit based on Mullard's design. Magic eye and tone controls. Printed circuit already wired. A sensitive quality recorder **BSR Amp Kit 95/-**. **B.S.R. Tape Deck £8.10.0**. **Collaro Amp. Kit £6.5.0**. **Collaro Tape Deck £12.10.0**. Set of 5 valves 45/-, Special Unit Kit Prices—Send stamp for detailed list. Construction and circuit details 2/6. **Bargain Complete Kit £16/10/0** Carriage 4/6.

Condensers—Silver Mica. All values, 2pF to 1,000pF, 6d. each. Ditto, Ceramics 9d. Tub. 450V T.C.C., etc. .001 mfd., .01 and 1/350V, 9d., .02-1/500V 1/-, .25 Hints 1 1/6, 5 T.C.C. 1/9, etc. etc. **Close Tol. S/Micas**—10% 5pF-500pF 8d., 600-5,000pF 1/-, 1pF-2pF-100pF 9d., 100pF-500pF 11d., 575pF-5,000pF 1/6. **Resistors**—Full Range 10 ohms-10 Megohms 20% 1/4 and 1/2W 3d., 1/2W 5d. (Midget type modern rating) 1W 6d., 2W 9d., Hi-Stab 10% 1/2W 5d., 1W 7d., 5% 1W 9d., 1% 1/2W 1/6. **W/W Resistors** 25 ohms to 10K 5W 1/3, 10W 1/6, 15W 2/-, Pre-set T/W Pots. W/W 25 ohms-50 K 3/-, 50 K-2 Meg. (Carbon) 3/-.

JASON FM TUNER UNITS
Designer-approved kits of parts:
FMT1, 5 gns. 4 valves, 20/-.
FMT2, £7. 5 valves, 37/6.
JMV MERCURY 10 gns.
JTV2 £13.19.6. 4 valves, 32/6.
NEW JASON FM HANDBOOK, 2/6. 48 hr. Alignment Service 7/6. P. & P. 2/6.

Speakers P.M.—3 ohms 2 1/2" Elac 17/6. Goodmans 18/6. 5" Rola 17/6. 6" Elac 18/6. 7" x 4" Goodmans 18/6. 8" Rola 20/-, 10" R. x A. 25/-, 9" x 6" Goodmans 25/-, E.M.I. Tweeter 29/6.



Send for detailed bargain lists, 3d. stamp.
We manufacture all types Radio Mains Transf. Chokes, Quality O/P Trans., etc. Enquiries invited for Specials, Prototypes for small production runs. Quotation by return.
RADIO COMPONENT SPECIALISTS
70 Brigstock Rd Thornton Heath Surrey Hours: 9 a.m.-6 p.m., 1 p.m. Wed. THO 2188
Terms C.W.O. or C.O.D. Post and Packing up to 1/2 lb, 7d.; 1 lb, 1/1; 3 lb, 1/6; 5 lb, 2/-; 10 lb, 2/9

Speaker Fret—Expanded bronze anodised metal 8" x 8" 2/3, 12" x 8" 3/-, 12" x 12" 4/6, 12" x 16" 6/-, 24" x 12" 9/-, 36" x 12" 13/6, etc. etc.

TYGAN FRET (contemp. pat.)
12" x 12" 2/-, 12" x 18" 3/-,
12" x 24" 4/-.

BARGAINS 4-SPEED PLAYER UNITS
Single Players carr. 3/6
Garrard 4 S.P. £6.19.6
Garrard TA Mk. 2 £7.19.6
Collaro "Junior" 75/-
E.M.I. Junior 79/6
E.M.I. Junior 89/6
Auto-Changers carr. 5/-
Garrard RC210 £10.10.0
Collaro "Conquest" £7.15.0
B.S.R. (UAB) £6.19.6
B.S.R. (UAB Stereo) £7.10.0
B.S.R. (UA14) £7.15.0

TURRET TUNER BAND 1/BAND III
Ex-mfrs. current production offer—standard type 13-channel unit, 35/38 Mc/s I.F. Complete with PCC84 and PCF80 valves and coils for channels 1/3/9. No knobs or circuit diagram, but connection data supplied.
Clearance Bargain only 32/6. Carriage 2/6. Worth 5 Gns.

TRANSISTOR BARGAINS
Brand New—BVA 1st Grade
OC44 10/6 873 9/-
OC45 9/6 GET114 6/6
OC81 7/6 OC72 7/6
2/OC81 15/6 OC70 5/6
XA102 10/- OC70 5/6
XA101 9/6 OC71 6/-
XB103 7/6 GEX34 2/9
XC101 8/6 OA70 2/9
874 9/6 OA81 2/9
Surface barrier type SB305 9/6 each All Post Free
CRT. HTR. ISOLATION TRANSFORMERS
New improved types, low capacity small size and tag terminated a.c. 200/250V. Secondaries nil, +25% +50% BOOST for 12V, 4V, 6.3V, 10.5V, 12V or 23V tubes. Each type 12/6 each. P. & P. 1/6.

TRIMMERS, Ceramic (Compression Type)—30pF, 70pF, 9d.; 100pF, 150pF, 1/3; 250pF, 1/6; 600pF, 1/9.
PHILIPS, Bee Hive Type (Conc. Air Spaced)—2-8pF, 1/-; 3-30pF, 1/-.
FUSE HOLDERS—Chassis Type: Single, 6d.; Double, 9d.; Panel Mounting Bulgin Type, 1/9.

SINGLE SCREENED LEAD—Standard size, 8d. yd.; Ditto Lightweight for Pick-up, etc., 7d. yd.; ditto lightweight for PVC sheathed, 9d. yd.; Twin screened sheathed, 1/- yd.
VALVE HOLDERS—Paxolin: Int. Occ., 6d. Moulded: B8G, 9d. each; Nylon or Moulded Ceramic: B7G, B9A unskirted, 9d. each; B7G, B9A skirted, 1/- each; B7G with Can, 1/6 each; B9A with Can, 1/9 each; EF50, B7G, 1/- each; B9A ditto, 1/3 each.
ENAMELLED COPPER WIRE—1 lb reels: 14g-20g, 2/6; 22g-28g, 3/-; 30g-40g, 3/9. Other gauges quoted for.
PVC CONNECTING WIRE—10 colours (for chassis wiring, etc.)—Single or stranded conductor, per yd., 2d.

SPECIAL BARGAIN OFFER! Record Player Kits
Auto Changer Kit. Comprising three units. Contemp. styled cabinet size 17" x 14 1/2" x 8 1/2". 2 valve 2 watt amp. and 7" x 4" quality speaker. Variable tone and volume controls with feedback circuit and B.S.R. 4-speed 10 record mixer auto. changer unit. **BGN. PRICE only £12.10.0. Carr. 7/6.**
Single Player Kit. Similar spec. to auto. changer kit except player is 4-speed B.S.R. T.U.9 single record player unit. Attractive contemp. styled cabinet. Size 13 1/2" x 13" x 6" with splendid volume and reproduction. **BGN. PRICE only £8.19.6. Carr. 5/-.** Send for detailed leaflet 3d. stamp.
All units ready wired, simple screw-driver assembly only. Full Satisfaction Refund Guar.

TRANSISTOR COMPONENTS

Midget I.F.'s—465 Kc/s 2/6 diam. 5/6
Osc. Coil—2/6 diam. M/W. 5/3
M. & L.W. 5/9
Midget Driver Trans. 3.5:1 6/9
Midget O/Put Trans. Push-pull to 3 ohms. 6/9
Elect. Condensers—Midget Type 1mfd-100mfd, ea. 1/9. 6V/12V wkg. Ferrite Aerial—M. & L.W. with car aerial coupling coil 9/3
Condensers—150v. wkg. .01 mfd., .03 mfd. 9d., .05 mfd., .1 mfd. 1/-, .25 mfd. 1/3. 5 mfd. 1/6. Etc.
Vol Controls—Midget Type with edge Control Knob. 5K, 47K, 1 Mj/ohm, ea. 2/6.
Speakers P.M.—2 1/2" EMI 3 ohms 17/6. 7" x 4" Plessey 35 ohm 23/6.
Ear Plug Phones—Min. Continental type, 3ft lead, jack plug and socket. High Imp. 8/-, Low Imp. 7/6.

SLEEVING—Various Colours 1mm, 2mm, 2d. yd.; 3mm, 4mm, 3d. yd.; 6mm, 5d. yd.

FUSES—Cartridge Type, Standard 1 1/2". All standard values 6mA-10mA, 4d. each.

KNOBS—Modern Continental types: Brown or Ivory with Gold Ring, 1 1/4" dia, 9d. each; 1 1/2" each; Brown or Ivory with Gold Centre, 1 1/2" dia., 10d. each; 1 1/2" 1/3 each. LARGE SELECTION AVAILABLE.

METAL RECTIFIERS, STC Types—RM1, 4/9; RM2, 5/6; RM3, 7/6; RM4, 16/-; RM5, 21/-; RM4B, 17/6.

STC RECTIFIERS—E.H.T. Type Fly-back Voltages: K3/25, 2kV, 5/-; K3/40, 3.2kV, 6/9; K3/50, 4kV, 7/9; etc.

SIEMENS TYPES—Contact Cooled: 250V, 50mA, 7/6; 250V, 85mA, 10/-; 250V, 125mA, 15/-; 250V, 300mA, 26/6.

now on sale

completely revised edition of
a popular practical handbook

Radio and Electronic Laboratory Handbook 7th ed

M. G. SCROGGIE B.Sc. M.I.E.E.

Contents

- Preface
- The end and the means
- Premises and layout
- Fundamental principles of measurement
- Sources of power and signals
- Indicators
- Standards
- Composite instruments
- Choice and care of equipment
- Measurement of circuit parameters
- Signal measurements
- Measurements of equipment characteristics
- Very high frequencies
- Dealing with results
- For reference

Due primarily to the growing use of semi conducting devices, including transistors, this new edition has been completely revised. It now covers techniques applicable to many fields beyond that of radio.

Electronic instruments have increased in number, cost and complexity and technicians will find invaluable guidance made easily accessible by a concise summary of all relevant information which may be required.

55s net by post 57s 3d 537 pp Illustrated

from leading booksellers

Published for "Wireless World" by

ILIFFE BOOKS LTD

DORSET HOUSE STAMFORD STREET LONDON SE1

"BUILD IT YOURSELF" THIS XMAS!

5 STAGE SUPER SENSITIVE
TRANSISTOR PORTABLE

THE "BOBETTE"

- ★ Simple to Build.
- ★ All first grade components.

A truly portable transistor radio giving full medium wave reception. Incorporates 5" High Flux Speaker, push pull output, first grade transistors, High-Q ferrite aerial, socket for car aerial, pre-tagged circuit board for easy construction. Attractive two-tone case.

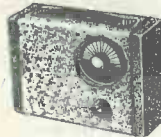

Total Building Costs

£5.2.6 P. & P. 2/6

All parts sold separately. Send 1/6 for itemised price list and full assembly instructions (free with order).

EXPLORE THE WORLD
ON THIS 1-VALVE
SHORT WAVE RADIO

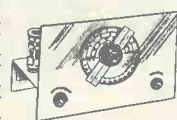

Total Building Costs only **35/-** P. & P. 2/-

- ★ Receives speech and music from all over the world.
- ★ Construction price includes valve and one coil covering 40-100 metres.
- ★ Can be extended to cover 10-100 metres.
- ★ Can be converted to 2 or 3 valve.

Send 2/- for wiring diagram and components price list.

R.C.S. PRODUCTS (Radio) LTD

11 Oliver Road London E17 (Mail Order Only)

Easy to Build Two Stage Transistor Set

The 'Bijou'
The set that looks like a Radiol



- ★ Attractive Case
- ★ Mini 0.0005µF Tuner
- ★ High Q Litz-Coil
- ★ Works for months off No. 8 Battery
- ★ Simple to construct in 15 minutes

Total Building Costs **25/-** P.P. 1/6

You can't go wrong—We guarantee good results. Components Price List and Layout Plans 1/6 (free with order).

in a revised & enlarged edition MODERN CAR RADIO RECEIVERS

This new edition of the popular Data Book No. 13 contains three designs, covering Medium and Long Waves, and each being fully described with point-to-point wiring.

The Jason-designed "Everest 6" and "Everest 7" employ transistors throughout and both now contain the latest modifications, together with extra illustrations and step-by-step instructions. A completely new section, "Tackling Car Radio Interference" has been added.

Fully illustrated with photographs and circuit diagrams, this Data Book should prove of interest to all car owners requiring a car radio.

48 pages, with varnished board cover

Price **3/6** postage 4d.

DATA PUBLICATIONS LTD
57 MAIDA VALE LONDON W9

COYNE'S NEW PIN-POINT T.V. TROUBLES

Takes Headaches Out of All Servicing Problems!

Your most useful on-the-job "tool"! Quickly and easily pin-points the exact trouble in any TV set. Covers 70 symptoms, 700 trouble spots. Over 340 cross-indexed pages; 50 time-saving Check-Charts; 290 diagrams and photos; explanation of circuits and designs.

SIMPLE CHECK CHART SYSTEM SAVES TIME!

This amazingly practical handbook shows you how to find the trouble in any TV circuit FAST! Simple cross-index tells you in what section you'll find cause of trouble. Handy Check-Charts then help you accurately locate the EXACT trouble spot. Cut waste time, eliminate hours of aggravation, get right to the heart of the trouble in minutes!

USE THIS BOOK RIGHT ON THE JOB NO NEED TO MEMORISE!

This Pin-Point Book was designed specially for on-the-job trouble-shooting. You simply turn to the indexed section, locate the circuit description and Check-Chart, and in minutes you have the trouble spot located and ready for repair. No complicated theory or mathematics. Down-to-earth, practical circuit description, service methods and trouble-shooting techniques. Published by the famous Coyne Electrical School and approved by leading authorities in the field. No. 8. Price 31/6d

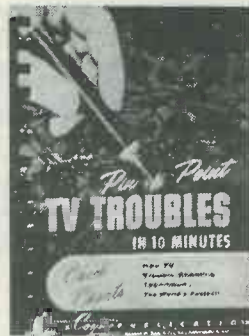

TRY ANY THREE BOOKS ON NO RISK FREE TRIAL

SPECIAL OFFER COYNE ELEMENTARY PRACTICAL RADIO-TELEVISION SET OF THREE VOLUMES total 1,038 pages, sturdy Vinyl washable covers. £3 12s. 6d. the set!

These three volumes present the principles of construction, operation and testing of radio and television equipment in a SIMPLE, EASY TO FOLLOW manner.

By using NEW & DIFFERENT methods of explanation these books clearly explain the direct relation between the various parts of sets. This information is especially helpful in repair work where many times a burned out valve, resistor or transformer is actually caused by some other defective part of a circuit. Until the cause of the trouble is removed the parts would continue to burn out. For this reason, each part of the radio or television unit is explained, thus, making the material especially helpful to the experienced radioman, as well as the amateur.

One very important way in which these books differ from many other radio and television books is that the publishers did not try to assume the "extent of technical knowledge" of the reader. Every subject is explained COMPLETELY—while at the same time keeping it brief and to the point.

You will find hundreds of photos, charts, diagrams, etc., in these books. These have been provided to make it easier to understand the explanations. To get this special offer, send no money now, then 12/6d. plus postage, after free examination, and 20/- per month.



No. 9 Pin-point Transistor troubles in 12 minutes

Trouble-Shoot every type of circuit in ALL transistorized equipment! 525 pages; hundreds of illustrations; 120 check charts; Includes portable transistor Wireless Sets, Pre-amplifiers, Hearing Aids, Amplifiers, Car Radios, T.V. Sets and special types of equipment. Test procedures, trouble shooting charts and much useful reference data. Price 47/6d.

No. 4. LATEST INSTRUMENT FOR SERVICING RADIO AND TELEVISION. Coyne.

This up-to-the-minute book tells all about modern radio, TV and electrical testing equipment and how to use it. Money-making short cuts on trouble-shooting, servicing, construction, and other jobs. Over 350 pages, 220 photos and diagrams. Covers Multimeters, Resistors, Ohmmeters, Oscilloscopes and many others. All data has been pre-tested in the Coyne radio shops. Vinyl cloth covers. 26/-

No. 5. PRACTICAL TELEVISION SERVICING AND TROUBLE SHOOTING MANUAL. Coyne.

A book of fast time saving methods for servicing TV receivers. Includes dozens of new testing ideas all of which have been proven on the job. This book shows how radio knowledge can be applied to help solve television problems. Contents include TV servicing methods, TV Servicing Instruments, Tuners, Video I.F., Amplifiers, alignment, etc., with 200 crystal clear photos and diagrams. 437 pages. Washable vinyl cloth covers. Price 34/-.

No. 22. PIN POINT COLOUR TV TROUBLES IN 15 MINUTES. Edited by Robert G. Middleton. (Coyne.)

This book deals with 150 types of faulty pictures and sound with over 1,000 troubles which may be the cause. Some of the subjects covered are, Antenna, Tuner, Video and Luminance Amplifiers, Matrices, Picture Tubes (Black and White, and Colour), One-Gun Tubes, Set up of Colour Tube, Colour Killer and Automatic Chroma Control, Low Voltage, Power Supply, TV Sound, etc. Picture Pattern Section—362 Check Charts, Diagrams and Photos. 548 pages. Price 47/6d.

No. 18. REFERENCE MANUAL OF TRANSISTOR CIRCUITS. Mullard.

Features 60 circuits you can build, 241 diagrams. 308 pages. 12/6.

No. 6. COYNE TELEVISION SERVICING CYCLOPEDIA. Harold P. Manly. Coyne.

Quick and concise answers to TV problems in alphabetical order, cross indexed, fully illustrated, covers hundreds of questions involving radio, TV, electronics operation and repair. 450 illustrations; photos, diagrams, charts, test patterns, etc., 860 pages. Vinyl cloth covers. Price 47/6.

No. 19. REFRIGERATION SERVICE MANUAL. H. P. Manly.

Learn Refrigeration! This manual is a course in itself. Packed solid with information to enable you to do that repair job yourself. Used by many leading refrigeration firms as a standard reference. Features 364 pages together with 157 illustrations bound in cloth. An excellent buy at only 24/-, plus postage.

No. 7 TRANSISTOR CIRCUIT HANDBOOK. Louis E. Garner (Coyne) 39/6.

No. 12. RADIO DESIGNER'S HANDBOOK. F. Langford-Smith. Iliffe. 55/-.

No. 16. PRINCIPLES OF FREQUENCY MODULATION. B. S. Camies. Iliffe. 21/-.

No. 11. PRINCIPLES OF TRANSISTOR CIRCUITS. S. W. Amos. Iliffe. 21/-.

No. 20. PRINCIPLES OF SEMICONDUCTORS. M. G. Scroggie. Iliffe. 21/-.

No. 10. TELEVISION RECEIVER SERVICING. Vol. 1. Spreadbury. Iliffe. 25/-.

No. 17. ELECTRONIC COMPUTERS. Principles and Applications. Iliffe. T. E. Ivall, 2nd Edition. 25/-.

No. 15. WIRELESS SERVICING MANUAL. W. T. Cocking. Iliffe. 17/6.

No. 38. COLOUR TELEVISION. NTSC System, Principles and Practice. P. S. Carnit, G. B. Townsend. Iliffe. 85/-.

No. 21. BASIC MATHEMATICS FOR RADIO AND ELECTRONICS. Iliffe. 17/6.

No. 23. INTRODUCTION TO LAPLACE TRANSFORMS. For radio and electronic engineers. W. D. Day. Iliffe. 32/6.

No. 24. RADIO VALVE DATA. Compiled by "Wireless World". Iliffe. 6/-.

No. 25. THE OSCILLOSCOPE AT WORK. A. Haas and R. W. Hollows. Iliffe. 18/-.

No. 26. NUMERICAL METHODS FOR HIGH SPEED COMPUTERS. G. N. Lance. Iliffe. 42/-.

No. 27. SECOND THOUGHTS ON RADIO THEORY. Cathode Ray of "Wireless World. Iliffe". 25/-.

No. 28. FOUNDATIONS OF WIRELESS. M. G. Scroggie. Iliffe. 16/-.

LIMITED OFFER! ACT NOW!

Just mail coupon for free trial. After 7 days send only low price or return books and pay nothing. If you keep more than one book, send £1 after 7 days and £1 each month until completed (not exceeding £5.0.0. maximum.) To buy one book send one-half in 7 days, and one-half in 30 days.

To SIM-TECH BOOK COMPANY (U.K.)
Mail Order Division, DEPT. RC8, Gaters Mill, West-End, Southampton, Hants.

Please send me the Elementary Radio TV Set as per special offer.

RUSH (Insert Book number here) () () ()

Tick here if enclosing full price, we pay postage (Coyne Books only). Same 7-day money-back guarantee.

NAME _____

ADDRESS _____

City _____ County _____

Postage charges: Orders under £3 allow 1/6, £3 or over allow 2/- extra. Overseas Orders Promptly Shipped on receipt of full amount. Same guaranteed satisfaction.

BUILD THIS HIGH GRADE SIX TRANSISTOR RADIO!!

USING OUR MATCHED COMPONENTS

- ★ PRINTED CIRCUIT, READY DRILLED, 8½" x 2½"
- ★ MW/LW FERRITE AERIAL, CAR AERIAL PROVISION
- ★ OSC./I.F. TRANSFORMERS
- ★ DRIVER & OUTPUT TRANSFORMERS—500 mW OUTPUT!

BASIC COMPONENTS AND PRINTED CIRCUIT, AS SHOWN BELOW **55/-** Post 2/-
 WITH FULL PARTS LIST OF COMPLETE RECEIVER AND DETAILED ASSEMBLY INSTRUCTIONS. **TOTAL COST UNDER £8.0.0**

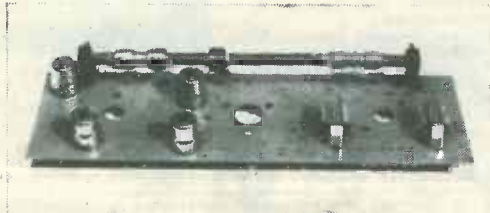

CIRCUIT, LAYOUT AND PARTS LIST (SEPARATE) 2/6

SPECIAL INTRODUCTORY OFFER!—December orders only

With each Basic Components order we offer a Free Set of Tuning Knobs and Printed Tuning Scale, as illustrated.

When ordering state types required and mention—Sales Dept. R1.

Trade and export enquiries welcomed. Prompt despatch.

No C.O.D. under £2 in value. Please include some postage.



A PROFESSIONAL FINISH FOR YOUR SET!

Set of high-lustre clear plastic knobs, push-on type, suitable for any transistor or valve radio set. Attractive red, centre discs.

- LIST**
- 47/48 A. Three knobs, as illustrated, for direct drive tuning condenser ... 7/6
 - 46/48 B. Three knobs, as illustrated, with extra hair line cursor dial for S.M. ... 8/6
 - 49 C. Metal tuning dial. Dia.: 2½" printed M.W. and L.W. Station names, and wavelengths, red and black on lustre gilt background. 2-hole fixing ... 2/6
- Knob sets A and B available with gold lustre centres at 1/- extra per set.

SUNDRY MINIATURE COMPONENTS

- 51 Case handle clip, red plastic, to suit 3/4" wide flexible straps, 4BA x 1/4" fixing ... pair 2/9
- 52 Speaker escutcheon, 5" x 3½". Suitable for fabric or metal mesh background, red plastic, to match above knobs ... 6/6
- 53 Speaker escutcheon, 5" x 3½", beautifully finished gilt lustre plated, otherwise same as Type 52 ... 7/9
- 35/37 Set of 4 miniature transistor coils 1/4" diam. ROUND. 450/475 kc. Q160 ... 23/-
- 39 Miniature Driver Transformer 3/4" x 3/8", with clamp. Ra 3.6/1+1, for single-ended push-pull ... 10/3
- 38/40 Pair miniature Driver and O/P transformers 500 mW. 3/4" x 3/8". With clamps ... pair 18/-
- 30 Ferrite aerial MW/LW, with clips. 7" x 1/4" for standard sets ... 9/3
- 31 Ferrite aerial MW/LW with clips. 4½" x 1/4" for personal sets ... 8/-

NOMBREX LTD

SALES
DEPT RI

ESTUARY HOUSE
EXMOUTH

CAMPERDOWN TERRACE
DEVON
Telephone 3515

BUILD A BETTER RECORDER WITH A MARTIN RECORDAKIT



- HI-FI QUALITY PRINTED CIRCUIT AMPLIFIERS
- SIMPLIFIED BUILDING—PROFESSIONAL STANDARDS

for building into two and four track models

- COMPLETE WITH VALVES DOWN TO WIRE CUT TO LENGTH
- BETTER PERFORMANCE—LESS OUTLAY

All amplifiers supplied assembled on printed circuit boards with valves. Case and Speaker assemblies available.

Produced by the makers of amplifiers for some of today's best known recorders, the specially designed kits offered here set brilliant standards of performance and styling. Amplifiers, case and speaker assemblies and kits complete with decks are available. Well presented instructions are included. All equipment guaranteed. Instructions are easy to follow and success is assured. From radio dealers, or in cases of difficulty please write direct.

- AMPLIFIER "C" for Collaro Studio Deck ... 11 gns.
- KIT "C" with Deck, Case and Speaker ... 28½ gns.
- AMPLIFIER "A" (4-TRACK) for BSR Monardeck ... 9 gns.
- AMPLIFIER "B" (2-TRACK) for BSR Monardeck ... 8 gns.
- KIT "A" with Deck, Case and Speaker ... 24 gns.
- KIT "B" with Deck, Case and Speaker ... 21 gns.

MARTIN ELECTRONICS LIMITED
 155 HIGH STREET BRENTFORD MIDDXX
 Leaflet on Martin Recordakits please. (Write in Block Letters)

NAME

ADDRESS

R.12

FREE TO AMBITIOUS ENGINEERS

— THE LATEST EDITION OF ENGINEERING OPPORTUNITIES

Have you sent for your copy?
ENGINEERING OPPORTUNITIES is a highly informative 156-page guide to the best paid engineering posts. It tells you how you can quickly prepare at home for a recognised engineering qualification and outlines a wonderful range of modern Home Study Courses in all branches of Engineering. This unique book also gives full details of the Practical Radio & Electronics Courses, administered by our Specialist Electronics Training Division—the *B.I.E.T. School of Electronics*, explains the benefits of our Employment Dept. and shows you how to qualify for five years promotion in one year.

We definitely Guarantee
"NO PASS — NO FEE"

Whatever your age or experience, you cannot afford to miss reading this famous book. If you are earning less than £20 a week, send for your copy of "ENGINEERING OPPORTUNITIES" today—FREE.

BRITISH INSTITUTE OF ENGINEERING TECHNOLOGY (Incorporating E.M.I. Institutes)
 (Dept. SE/23), 29 Wright's Lane, London, W.8

THE B.I.E.T. IS THE LEADING ORGANISATION OF ITS KIND IN THE WORLD

WHICH IS YOUR PET SUBJECT?

Mechanical Eng.,
 Electrical Eng.,
 Civil Engineering,
 Radio Engineering,
 Automobile Eng.,
 Aeronautical Eng.,
 Production Eng.,
 Building, Plastics,
 Draughtsmanship,
 Television, etc.

GET SOME LETTERS AFTER YOUR NAME!

A.M.I.Mech.E.
 A.M.I.C.E.
 A.M.I.Prod.E.
 A.M.I.M.I.
 L.I.O.B.
 A.F.R.Ae.S.
 B.Sc.
 A.M.Brit.I.R.E.
 City & Guilds
 Gen. Cert. of Education
 Etc., etc.

PRACTICAL EQUIPMENT

Basic Practical and Theoretic Courses for beginners in Radio, T.V., Electronics, Etc., A.M.Brit.I.R.E. City & Guilds Radio Amateurs' Exam. R.T.E.B. Certificate P.M.G. Certificate Practical Radio Radio & Television Servicing Practical Electronics Electronics Engineering Automation

INCLUDING TOOLS!

The specialist Electronics Division of B.I.E.T. (Incorporating E.M.I. Institutes) NOW offers you a real laboratory training at home with practical equipment. Ask for details.

B.I.E.T. SCHOOL OF ELECTRONICS



POST COUPON NOW!

Please send me your FREE 156-page "ENGINEERING OPPORTUNITIES"
 (Write if you prefer not to cut page)
NAME.....
ADDRESS.....

SUBJECT OR EXAM THAT INTERESTS ME.....

SMITH'S of Edgware Road

BLANK CHASSIS

Precision made in our own works from commercial quality half-hard Aluminium. Two, three or four sided.

SAME DAY SERVICE

of over 20 different forms made up to YOUR SIZE. Order EXACT size you require to nearest 1/16" (maximum length 35", depth 4").

SPECIALS DEALT WITH PROMPTLY

SEND FOR ILLUSTRATED LEAFLET

Or order straight away, working out total area of material required and referring to table below, which is for four-sided chassis in 18 s.w.g. (for 16 s.w.g. add 10%)

48 sq. in. 4/-	176 sq. in. 8/-	304 sq. in. 12/-
80 sq. in. 5/-	208 sq. in. 9/-	336 sq. in. 13/-
112 sq. in. 6/-	240 sq. in. 10/-	368 sq. in. 14/-
144 sq. in. 7/-	272 sq. in. 11/-	and pro rata
P. & P. 2/- (2/6)	P. & P. 2/6 (2/9)	P. & P. 2/9 (3/-)

Discount for quantities. Trade enquiries invited. Spray finish arranged for quantities of 25 or over.

FLANGES (1/4", 3/8" or 1/2") 6d. per bend.

STRENGTHENED CORNERS, 6d. each corner.

PANELS. The same material can be supplied for panels, screens, etc. Any size up to 3ft at 4/6 sq. ft. (16 s.w.g. 5/-). P. & P., up to 72 sq. in. 1/- (1/3), 108 sq. in. 1/9 (2/), 144 sq. in. 2/- (2/6), 432 sq. in. 2/6 (2/9), 576 sq. in. 2/9 (3/3).

Prices in brackets are for P. & P. on 16 s.w.g.

H. L. SMITH & CO. LTD
 287/289 EDGWARE ROAD LONDON W2
 Telephone PAD 5891/7595

REPANCO

MINI-4 POCKET SUPERHET TRANSISTOR RECEIVER

(As reviewed in this Issue)

Envelope of easy wiring plans and instructions with detailed price list

1/6 post 3d

Radio Experimental Products Ltd.

33 MUCH PARK ST COVENTRY

Telephone 27114

Red Spot Transistors 2/3; White Spot 2/3; Yell./Gr. 3/3; Ediswan XA102 (Mixer Stage) 9/-; XA104 (I.F.s) 8/-; XA103 (I.F.s) 8/-; XB104 (A.F. Stage) 6/-; Mullard OC71 6/6; OC72 8/-; OC44 11/-; OC45 10/-; Bargain sets 6 Transistors plus Diode—Ediswan 42/6, Mullard 47/6, Newmarket 42/6. P.W. Superhet complete Kit £7.15. (Ediswan or Newmarket transistors); £8.5. (Mullard transistors). Diodes 1/-, 2/-, 3/- Sub. Min. Electrolytics 1, 2, 4, 8, 10, 16, 32µF 2/- each. Ardenite Trans. D239 8/6; D240 8/6; D131 10/-; D132 10/-. Balanced Inserts (as earpiece or speaker) 3/6; Silicon Rectifier 70 p.i.v. ½A 3/3; Westalite Contact Rectifier 250V 60mA 7/6; Transformer 250-0-250V, 6V and 5V 15/-; Garrard Record Player Motor (45 r.p.m.) and Pick-up for Transistor Amplifier 70/-; Meter 200mA M.C. F.M. 2½" 12/6; 5A R.F. (2mA) 8/6; Hearing Aid Mike 31/6; Super Coax. 75 ohms 6d. yd; Valves 6X5 5/6, 6V6 5/6, 1L4 5/6; Speaker 18/6; Electrolytics: 8µF 500V 2/3; 8+16µF 3/3; 100+100 (375V) 3/9; V. Cond. 0.0005 T. Gang, Trimmers and Slow M. 9/6; Transistor Holders 1/-; Resistors 10% tol. 4d.; 5% tol. 9d. Tannyo Mike 5/-. Crystal Inserts (new) 7/6. Gortler Units, 1 watt Amplifier 92/6; I.F. Amplifier (460 kc/s pre-aligned) 92/6; 3 waveband Converter 90/3. Manual No. 167 describing and circuits 2/9 post free. Earphone Hi-imped 10/-; Min. Variables 350pF 8/9; 4 mfd Block 600V. 3/6; TSL. Speakers CMS50. 2½" 17/11; Submin. Jack and Socket 3/- pr; Min. Slide Switches 2/6; V15/10P Transistors 15/-; V30/20P 28/6; Crystal Mike Input Transf. 12/-

Terms—Cash with order. Post extra, excess refunded. Our Reflex Rx, best 2-transistor Receiver. Send 10d. stamps for notes.

MOORE'S EXPERIMENTAL SUPPLIES
8 & 10 GRANVILLE ST. SHEFFIELD 2
Telephone 27461

★ **VALVES** New Tested & Guaranteed

1R5 6/6	6X4 7/6	DK92 7/6	EL84 8/-
1S5 6/6	6X5GT 6/6	DK96 8/-	EL91 7/6
1T4 4/6	12AH8 10/6	DL92 6/9	EY51 7/6
3S4 6/9	12AT7 6/-	DL94 7/6	EZ40 6/6
3V4 7/6	12AU7 6/-	DL96 8/-	EZ80 6/6
5U4G 6/-	12AX7 7/6	EB91 4/6	EZ81 7/-
5Y3GT 7/6	12BH7 10/6	EBC41 9/6	PL81 13/6
5Z4G 9/-	12K7GT 8/6	EBF80 10/6	PL82 10/6
6AK6 6/6	12K8GT 13/6	ECC81 6/-	PY81 8/-
6AL5 4/6	12Q7GT 6/6	ECC82 6/-	PY82 7/-
6AM6 4/-	25A6G 10/6	ECC83 7/6	PCC84 9/6
6AT6 7/6	25L6GT 9/-	ECC84 7/6	PCF80 9/6
6BA6 8/6	35Z4GT 8/6	ECC82 7/6	PCF82 11/-
6BE6 7/6	35L6GT 9/6	ECH81 10/6	PCL82 7/6
6BR7 10/6	5763 10/6	ECH42 8/6	R19 12/6
6BW6 8/6	DAF91 6/6	ECL80 9/6	U76 8/6
6J7GT 8/6	DAF96 8/-	EF41 8/6	UBC41 10/-
6K7G 7/6	DF91 4/6	EF80 8/-	UCH42 10/6
6Q7G 7/6	DF96 8/-	EF86 9/6	UF41 10/-
6SL7GT 8/-	DH76 8/6	EP91 4/-	UL41 8/-
6SN7GT 8/6	DH77 7/6	EP92 5/6	UY41 8/-
6V6G 7/6	DK91 6/6	EL41 9/-	W76 8/6

MATCHED PAIRS. EL84, 17/-; EL85, 25/-; 6V6G, 17/-; 6BW6, 18/-; KT33C, 19/6; 807 14/6 pair; KT66, 32/6.

SETS OF VALVES

DK96, DF96, DAF96, DL96 "REGENT"	29/6 per set
DK91, DF91, DAF91, DL92, or DL94	21/- per set
1R5, 1T4, 1S5, 3S4, or 3V4	21/- per set
6K8, 6K7, 6Q7, 6V6, 5Z4, "G" Types	27/6 per set
12K8, 12K7, 12Q7, 35L6, 35Z4, "GT" Types	35/- per set
ECH42, EF41, EBC41, EL41, EZ40	37/6 per set
UCH42, UF41, UBC41, UL41, UY41	35/- per set

P.P. OP. TRANSFORMERS. MR 3-15 ohms for EL84, 6V6, 6BW6, etc., 18/6; Op. Pen. 50mA, 5/6; 30mA, 4/6.
P. & P. 6d., over £1 post paid. C.O.D. 3/-

R. COOPER G8BX 32 SOUTH END
CROYDON SURREY CROYDON 9186

EX-RENTAL SETS

11 Ford 6001/3

TV TUBES

17 inch
£11.10.0



Excellent Table Models. ITA/BBC. Famous manufacturer.

12 months guarantee on tube, 3 months on chassis and valves. Ins., carr. 25/- (Regret some delay).

Various makes and sizes available for inspection.

14 inch £7.10.0
ITA/BBC. Identical to 17" TV. Ideal for Caravans, Weekend Bungalows, Chalets, etc. Carriage 20/-

12 months Guarantee

Insurance and Carriage 15/6

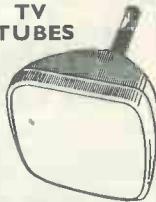

21".....99/6 17".....90/-
15", 14", 12".....70/-

£1 extra without old bowl, refundable if same received within 14 days.

14 inch TV TUBES

14KP4 and 36/24
Due to large purchase of Rental replacement stocks. Carr. 5/-

35/-

SOLO SOLDERING TOOL 12/6

110V, 6V or 12V (special adaptor for 200/250V, 10/- extra). Automatic solder feed including reel solder and spare parts. A tool for electronic soldering or car wiring. Revolutionary in design. Ready for use, cannot burn. In metal case with instructions for use. Post 4/-



VALVES
1/9 Each Salvage Guar. 17/6 Doz. 6AT6, 6F1, 6L1, 6K7, 6P25, 6P28, 7AN7, 10D1, 30C1, 30L1, 30L2, 30PL1, 30PL13, 1625, B36, DH77, 2/9 Each 30/- Doz. 6AB8, 6C10, 6L18, 6SN7, 6U4GT, 10F1, 10P13, 12AT7, 12AU7, 12K7, 20D1, 20P3, B152, B309, DH76, 5/9 Each 60/- Doz. 6F6, 6Q7, 6V6, 9BV6, 12AX7, 12Q7, 15A6, 16A5, 17Z3, 19Y3, 20F2, 20L1, 20P1, 21A6, B339, POSTAGE on 1-7d. 6-1/6. 12-2/6.

DUKE & CO. (London) LTD 621/3 ROMFORD RD MANOR PARK E12

P.W. POCKET SUPERHET

TRANSISTORISED PRINTED BOARD

A-Z CONSTRUCTIONAL BOOKLET 1/6 including "BLOWN-UP" DIAGRAM

Simple Modifications to above
Giving Boosted Performance
Free on Request with S.A.E.

New Contemporary Case
(Photo Illustration on Request)

Ask your Dealer or write for Illustrated Price List and Free Information

OSMOR RADIO PRODUCTS LTD

418 BRIGHTON ROAD SOUTH CROYDON SURREY Telephone CRO 5148/9

SMALL ADVERTISEMENTS

Private: 3d. per word, including address.
Minimum charge 2/6.
Use of Box Number, 2/- extra.

Trade: 9d. per word. Minimum charge 12/-.
Terms: Cash with order.

All copy must be received by the 6th of the month for insertion in the following month's issue. The Publishers cannot be held liable in any way for printing errors or omissions, nor can they accept responsibility for the *bona fides* of advertisers.

PRIVATE

SALE OR EXCHANGE. Premier T901 television, complete, working, requires adjustment. Also quantity spares; *Radio Constructors*, etc., suit experimenter. **WANTED.** Portable tape recorder.—Spencer, 47 Templars Firs, Wootton Bassett, Wilts.

FOR SALE. AR77 Communications receiver. Good condition. £20.—Vickerman, 96 Prince of Wales Mansions, London, S.W.11. Telephone MACaulay 5179.

FOR SALE. Ferrograph 3S complete with Stereo-ad in walnut console cabinet. Cost £150, will accept £85. Weyrad signal generator, £6. Wal tape eraser, £3.10.0. Sangamo time switch, £3.—4 Northcote Place, Newcastle, Staffs.

FOR SALE. 12 watt ultra-linear hi-fi amplifier, to Cooper-Smith design. Fully tested. £10. Try offer. S.A.E.—Carter, 14 Gough House, Essex Road, London N1.

FOR SALE. Magnaview units, £2. Power pack, £2. Cyldon tuner, £2. Cabinet, £1. Signal generator 120 kc/s to 84 Mc/s, £2.10.0.—Telephone Acorn 0262.

FOR SALE. Eight volumes *Radio & Television Servicing*, complete to 1960, new condition, £10 —Haliburton, 58 Inchgarvie Road, Kirkcaldy, Fife.

FOR SALE. BC348R with built-in power unit, 230 volt mains, £10. Also BC348N in original form for 28 volt d.c., £8. Both fully serviceable. Inspection invited, London area.—Box No. F137.

FOR SALE. AVO 8, £12. Hickock signal generator, crystal controlled, valve voltmeter indicator, £14. Linear Conchord 30 watt amplifier, £12.—Lea, 5 Chelsea Embankment, London, S.W.3. Telephone FLAxman 4500.

FOR SALE. MN26C receiver unmodified, £4. (Less valves £2). Army No. 22 Tx/Rx, much stripped but many useful items including chassis and case, 10/- . 12V power pack for same, less rectifiers in metal case, 7/- . G73 frequency meter (100 kc/s to 25 Mc/s) with charts, £6. 12V Dynamotors, 10/- . S.A.E. List. Carriage extra.—G3JMU, 121 London Road North, Lowestoft, Suffolk.

TRADE

LEARN RADIO AND ELECTRONICS the NEW Practical way. Very latest system of experimenting with and building radio apparatus—"as you learn"—FREE Brochure from: Dept. RC10 Radiostructor, Reading, Berks.

MORSE CODE TRAINING. Special courses for Beginners. Full details from (Dept. R.C.) Candler System Company, 52b Abingdon Road, London, W.8.

PANL, recognised for many years as the unique one-coat black crackle finish. Brush applied, no baking. Available by post in eighth-pint cans at 3s. 9d. from G. A. Miller, 255 Nether Street, London, N.3.

THE INCORPORATED PRACTITIONERS IN RADIO AND ELECTRONICS (I.P.R.E.) LTD. Membership conditions booklet 1s. Sample copy of I.P.R.E. Official Journal 2s. post free.—Secretary, 20 Fairfield Road, London, N.8.

"THE FIRST ONE". Covers the construction of a highly efficient single valve mains receiver. Price 1s. 3d.—High Fidelity Co., 18 Melville Road, Birmingham 16.

CATALOGUE No. 14. Government surplus and model radio control, over 500 illustrated items, 2s. 6d. (refunded on purchase of £2) post free.—Arthur Sallis Radio Control Ltd., 93 North Road, Brighton.

FIND TV SET TROUBLES IN MINUTES from that great book *The Principles of TV Receiver Servicing*, 10s. 6d., all book houses and radio wholesalers. If not in stock, from Secretary, I.P.R.E., 20 Fairfield Road, London, N.8.

continued on page 399

BBC

ENGINEERS
and **TECHNICAL ASSISTANTS** for
OPERATIONAL and MAINTENANCE

Requires

DUTIES at
TRANSMITTING STATIONS

Initial appointments to the following stations—

Davertry, Northamptonshire
Skelton, near Penrith, Cumberland
Woolferton, near Ludlow, Shropshire
Moorside Edge, near Huddersfield, Yorks
Westerglen, near Falkirk, Stirlingshire

There will be opportunities for transfer to other transmitting stations, including television and v.h.f. stations, after initial training and gaining some experience.

ENGINEERS

Qualifications; age 21–30 B.Sc., or H.N.C. in Electrical Engineering, preferred specialist subjects radio, electronics or telecommunications. C. & G. Final Certificate in Telecommunications, Engineering (old scheme) or Full Technological Certificate (new scheme). Salary £885–£1,060 according to experience rising by annual increments of £50–£55 to £1,335 p.a.

TECHNICAL ASSISTANTS

Qualifications; age 18–26 G.C.E. Advanced Level Mathematics and Physics or suitable O.N.C. Salary age 18–£490, 19–£605, 20 and over £715 rising by £45 to £985 p.a. Technical Assistants are expected to qualify for promotion to Engineers in three years with a salary of £905 rising to £1,335 p.a.

There are very good prospects for candidates with ability to progress on merit to more senior posts with roof salaries of £1,555, £1,780 or higher.

For further particulars and application form write stating whether "Engineer" or "T.A." to Engineering Recruitment Officer, Broadcasting House, London, W.1. quoting reference 61.E.232. (R.C.)

Quality Components FOR CONSTRUCTORS

capacitors, resistors, coils, valves, diodes, controls, chassis, transformers, speakers, pick-ups, cartridges, stylis and all types of components in stock.

CONSTRUCTIONAL PUBLICATIONS

Mullard Circuits for Audio Amplifiers	8/6
Mullard Tape Pre-amp "C"	2/6
Quality Amplifiers, 7 designs	4/6
Jason F.M. Variable Tuners	2/6

Price lists available on request

J. T. FILMER

82 DARTFORD ROAD
DARTFORD KENT
Telephone Dartford 24057

SURPLUS RADIO SUPPLIES

2 LAING'S CORNER MITCHAM SURREY

OUR CATALOGUE CONTAINS OVER

400 BARGAINS

AT PRICES BELOW MANUFACTURERS' COSTS
SEND FOR IT TODAY, PRICE 1/6

50 Microamp Meters by Sangamo Weston
19/6, postage and packing 1/6

3-TRANSISTOR POCKET RADIO

WITH MINIATURE LOUDSPEAKER

Absolutely
NO soldering



39/6 Superb appearance. Simple instructions. Built in an evening. No drilling. No soldering. Complete in every detail. Receives entire broadcast band. Aerial required in certain areas. Pocket size 4½" x 2½" x 1½".

Or the more powerful **SAVOY SUPER-3**; 3 transistors and 2 diodes in a 5-stage reflex circuit. Dimensions as above. **55/6** No aerial required.

Battery 1/- extra P. & P. 2/- ALL PARTS SOLD SEPARATELY
Savoy Electronics Ltd 15 Maiden Lane, London WC2
(Back of Adelphi Theatre)

LEARN RADIO & TV SERVICING

For your own business / hobby
by a new exciting no maths system, using practical
equipment recently introduced to this country

FREE BROCHURE FROM

RADIOSTRUCTOR

DEPT. G103 · READING · BERKS.

12.61

BETTER BRIGHTER PICTURE TUBES BRAND NEW THROUGHOUT

excepting glass

12"	£4.10.0	New Silver Screen and
14"	£5. 5.0	Aluminising. All makes:
15"-17"	£5.15.0	Mullard, Mazda, Emiscope,
21"	£7.15.0	Cossor, Brimar, Emitron, etc.

REBUILT MULLARD AND MAZDA TUBES

12"	£3. 0.0	All Tubes FULLY
14"	£4. 0.0	GUARANTEED 12 MONTHS.
15"-17"	£4.10.0	Dispatch same day.
21"	£6.10.0	C.W.O. or C.O.D.

Carriage and Insurance 10/-

S.T.S. LTD. 35 Pound Street Carshalton
Surrey Telephone Wallington 9665

RECORD CHANGERS AND PLAYERS

Garrard RC210	£9.8.6	each
New Garrard Autoslim	£8.0.0	each
B.S.R. UA14	£7.15.0	each

In Makers Sealed Cartons

B.S.R. TU9	£4.5.6	each
B.S.R. TD2 Tape Deck	£7.10.0	each
Collaro Tape Deck	£8.10.0	each

Large stocks of Valves, Transistors and other Components

AUTUMN LIST NOW READY

H. F. JAMES 21 Claremont Road Twickenham Middx
Telephone POPesgrove 3579

$$X = \frac{-b \pm \sqrt{b^2 - 4ac}}{2a}$$

DON'T FUMBLE with Formulae.
Master Mathematics quickly and
easily the Understandable Way.

THE DRYDEN SCHOOL OF

UNDERSTANDABLE MATHEMATICS

11k Dryden Chambers Oxford Street London W1

Name

Address

1st lesson
and details
FREE
from

SPARES, VALVES, TUBES 1930-1960

Guaranteed perfect, set tested, ex-working equipment

5U4	4/6	10P13	4/6	ECH42	4/6	PL33	4/6	U25	10/-
5Z4	4/6	12AT7	3/-	EAF42	4/6	PL81	4/6	U35	4/6
6AQ5	4/6	12AU7	3/-	EL33	4/6	PL82	4/6	U37	10/-
6AV6	4/6	12AX7	3/-	EL38	4/6	PL83	4/6	U107	10/-
6BA6	4/6	12BH7	4/6	EL41	4/6	PY31	4/6	U191	7/6
6BE6	4/6	20L1	4/6	EL90	4/6	PY80	4/6	U403	7/6
6CH6	4/6	20P1	4/6	KT36	4/6	PY81	4/6	UAF42	4/6
6U4	6/-	20P3	6/-	KT66	7/6	PY82	4/6	UCH42	6/-
6X4	4/6	185BT	12/6	KT88	7/6	PZ30	4/6	UL41	4/6
7S7	4/6	B36	4/6	N37	4/6	U14	5/-	UL44	6/-
7Y4	4/6	ECC84	4/6	PCC84	4/6	U22	4/6	UL46	4/6
10F1	3/-	ECCF80	4/6	PCF80	4/6	U24	7/6	UY41	4/6

Most pre-war 4, 5, 7, 9-pin valves 5/- each. P. & P. 6d. per valve
VALVE PARCEL. 12 assorted, all different, 8/6. Postage 1/6.
CONSTRUCTOR'S PARCEL. 2 lb mixed resistors, condensers
pots, valveholders, electrolytics, etc. 7/6, postage 1/6.
Send S.A.E. with enquiries or for list of 1,000 valves

ST. JOHN'S RADIO 3 Jews Row, SW18 Tel. VAN 8822

15/- TUBES
12" 31/7.4, 124, 153. EX-SERVICE
STOCK CARR. 5/-

35/- TUBES
14KP4 36/74 EX-RENTAL
REPLACEMENT CARR. 5/-

**5/6 TV CHASSIS
FOR SPARES**

Chassis used, but work-
ing when stored. Circuit
with order. Carr. 7/6.
Badly stored.



VALVES 9d — Post 7d
4D1, 6AL5, 6D1, 6D2, VR35, VR51, 8D3,
9D2, 15D2, 78, 6F12, VR107, VR109, VR137,
4P2, 6F14, 6F15, C2C, VR201, Z77, ECC34,
D1, D157, EA50, EB91, At1/9, 6F1, 6L1, 6P25,
ECC31, EF50, EF91, 10D1, EB41, EL32,
L53, P61, PM202, U22, Many others,
UB41, SP61, T41.

P. P. COMPONENTS LTD. E12
c/o 623 Romford Road Manor Park
Regret Mail Order Only, Stamp for Free List

The NEW "SAVOY" 4-TRANSISTOR POCKET RADIO

Self-contained:
WITH MOVING COIL SPEAKER

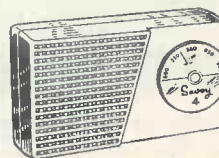

Absolutely NO Soldering
NO Drilling

4 transistors and 2 diodes; 5-stage
reflex circuit; push-pull output; size
5½" x 3" x 1½", full medium wave;
simple instructions and assembly tool
provided. All parts sold separately.

95/- plus battery 2/- extra.
postage and packing 3/-.

(RC) Savoy Electronics Ltd 15 Maiden Lane, London, WC2
(Back of Adelphi Theatre)

SMALL ADVERTISEMENTS

continued from 397

JOIN THE INTERNATIONAL S.W. LEAGUE. Free Services to members including Q.S.L. Bureau, Amateur and Broadcast Translation, Technical and Identification Dept.—both Broadcast and Fixed Stations, DX Certificates, contests and activities for the SWL and transmitting members. Monthly magazine, "MONITOR", containing articles of general interest to Broadcast and Amateur SWLs, Transmitter Section and League affairs, etc. League supplies such as badges, headed notepaper and envelopes. QSL cards, etc., are available at reasonable cost. Send for League particulars. Membership including monthly magazine, etc., 21s. per annum.—Secretary ISWL, 12 Gladwell Road, London, N.8.

SERVICE SHEETS (1930-1962) from Is. Catalogue 6,000 models, 1s. 6d. S.A.E. enquiries.—Hamilton Radio, 13 Western Road, St. Leonards, Sussex.

WANTED. Instrument Speedometers: ex R.A.F. Type AM 1940 ref. 50698. Made by Hasler Telegraph Works. These are speedometers apparently designed for measuring instrument shaft revolutions and would be very useful for checking teleprinter shaft speeds. A number required for resale to British Amateur Radio Teleprinting Group members: c/o Hon. Sec. B.A.R.T.G., "East Keal", Romney Road, Oulton Broad, Lowestoft, Suffolk.

"MEDIUM WAVE NEWS." Monthly during DX season.—Details from B. J. C. Brown, 196 Abbey Street, Derby.

THE INTERNATIONAL HAM HOP CLUB is a non-profit making organisation open to RADIO AMATEURS AND SHORT WAVE LISTENERS. OBJECT: To improve international relationships through an organised system of hospitality. MEMBERS offer overnight hospitality to visiting members, subscription 10s. per annum. ASSOCIATE MEMBERS invite radio amateurs to visit their stations. Associate membership 5s. per annum. FAMILY EXCHANGE holidays arranged, also FRIENDSHIP LINKS between radio clubs. The Club's official journal is free to both Full and Associate members.—Hon. Gen. Secretary: G. A. Partridge, G3CED, 17 Ethel Road, Broadstairs, Kent.

VHF UNIT—ready built. Front end f.m. unit. Coverage 85-100 Mc/s, i.f. 10.7 Mc/s. Single valve (ECC85). Price, including circuit and data but without valve, £2 12s. 3d., plus 2s. postage. Also

VHF TUNER UNIT—ready built without dial and valves. Price, including circuit and data, £6 16s., plus 3s. 6d. postage. Delivery ex-stock.—(Dept. E/1) Rotopons Limited, 54 Beddington Lane, Croydon, Surrey.

"MEDICINE". For home, factory or first aid post. The book that everyone should have on hand. Price 3s. 6d.—Edgbaston Electro-Medical Laboratories, 18 Melville Road, Birmingham 16.

CAR CIGARETTE LIGHTERS. 6 or 12 volts, 8s. 6d. Post free.—Whitsam Electric, 18 Woodrow Close, Perivale, Middlesex.

CLEARANCE SALE. Electronic and electrical components, all values, sizes, voltages, fixed, pre-set, and variable. Over 40,000 resistors, 20,000 condensers, 6,000 coils, 1,000 transformers, 10,000 lamps, 20,000 switches, 7,000 veneered cabinet panels, 10,000 rectifiers, 2,000 valveholders, 30,000 tag strips, 1,000 sq. ft. Paxolin sheeting, 8,000 knobs and handles, 200,000 yds. Systoflex sleeving, 5,000,000 Helleman sleeves, 15,000 springs, any quantity supplied, at fraction of cost. Also large quantity of ex-government Radar equipment and components. Send for catalogues or call at:—Albatross Engineering Co., High Street, Gosberton, Spalding, Lincs. Telephone Gosberton 458.

VENNER TIME SWITCHES. Reconditioned, 250V, 1 amp. Ideal for automatic switching—aquarium lighting, car lights, radios, etc., 25/-. Also synchronous flashing units, fully suppressed, 25/-.—Batchelor, Dept. RC4, 4 Park Road, Bromley, Kent.

GUARANTEED VALVES AT REAL BARGAIN PRICES BOXED AND POST FREE

0A2, 0B2, 6AG7, 6AH6, 6AQ5/EL90, 6AK5/EF95, 6AU6/EF94, 6Y6, 807, 12AT7/ECC81, 12AU7/ECC82, 5/- each 6 for 25/-, 5R4G, 6AS7 8/- each 6 for 42/-, 6AL5, 6SN7 3/- each 6 for 15/-.

RAWSON & PANTON LTD 107a Lion Rd Bexleyheath Kent

The thrills of VHF can now be yours for only 39/6d, complete kit! Tunable 150-100 Mc/s, simplified construction, write today for leaflet. Also, if a newcomer to Amateur Radio, ask for free copy of the world famous "Globe-King" kits and receivers, stamp please to cover postage:

Johnsons (Radio) St. Martin's Gate Worcester

BRASS · COPPER · DURAL · ALUMINIUM · BRONZE ROD, BAR, SHEET, TUBE, STRIP, WIRE. 3,000 STANDARD STOCK SIZES.

No Quantity too small

List on application

H. ROLLET & CO LTD
6 CHESHAM PLACE SW1 BELGRAVIA 4300

Also at Liverpool, Birmingham, Manchester, Leeds

H.A.C. THE ORIGINAL SUPPLIERS OF SHORT-WAVE KITS

One valve Super Sensitive All-dry Short-wave Receiver, Model "K". Complete kit including valve and chassis, 77/-. (Other S.W. kits from 25/-) Before ordering call and inspect a demonstration receiver, or send stamped envelope for full specification, catalogue and order form.

H.A.C. SHORT-WAVE PRODUCTS (DEPT. R)
44 OLD BOND STREET LONDON W1

RADIO AMATEURS . . .

Get your Licence in

Half the Usual Time!

You must be a good Morse operator!

A "slap-dash" 12 w.p.m. neither satisfies the authorities, yourself, nor your operator friends. Morse operating is an exacting art unless your training is made simple and is based on sound fundamentals. For this reason the Candler System was invented to take the "grind" out of Code tuition, turning a tricky subject into a pleasurable pursuit.

★ Send 3d. stamp for the "Book of Facts"

CANDLER SYSTEM CO

(Dept. 55 RC) 52b Abingdon Road, London, W8
Candler System Company, Denver, Colorado, U.S.A.

G2ACC offers you . . .

A proven dependable service

We have been established 27 years and are one of the original pre-war mail order businesses.

- All the best makes from one source.
- Aluminium chassis, paxolin and ceramic rotary switches made to individual design.
- A 56 page illustrated catalogue No. 12 Your buying guide for short wave, broadcast and transmitting components. 9d. post free (refundable on first order). U.K. and H.M. Forces anywhere.

SOUTHERN RADIO & ELECTRICAL SUPPLIES

So-Rad Works Redlynch Salisbury Wiltshire
Telephone Downton 207

RADIO and T.V. SPARES

SEND NOW FOR OUR

1962 CATALOGUE

FREE

OVER 2,000 VALVE TYPES
AVAILABLE FROM STOCK

ALPHA RADIO SUPPLY CO

103 LEEDS TERRACE, WINTOUN ST., LEEDS 7
Telephone 25187



MODEL TP55

A.C./D.C. voltage up to 1,000 in 5 ranges. D.C. current 4 ranges up to 500 mA. 4 range resistance to 10 megs. Capacity, dB scales, etc.

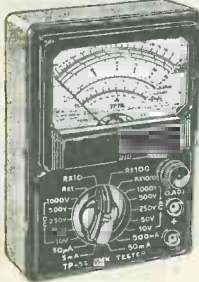

20,000 ohms/volt
Size 5 1/2" x 3 1/2" x 1 1/2"
£5.19.6
P.P. 1/6.
With Test Leads, Battery and Instructions

MODEL 200H

20,000 ohms per volt

£6.19.6 P.P. 1/6.

With Test Leads, Battery and Instructions.



6 Ranges D.C. voltage to 2 1/2 kV.
5 Ranges A.C. voltage to 1 kV.
3 Ranges D.C. current to 250 mA.
Resistance to 6 meg.
Capacity and dB ranges

ALSO MODEL TE10

10,000 ohms/volt version of above, identical in appearance.
£5.19.6 P.P. 1/6. Fully Guaranteed.

AVO-7

Famous Multi-meter. Reconditioned and fully guaranteed. Full A.C./D.C. voltage and current, resistance, dB, power, etc. etc. Supplied with Batteries, Leads and Instructions.

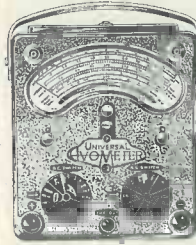

£11.10.0 Regd. Post 5/-.
(Normal Price £19.10.0.)
BARGAIN OFFER

MODEL TP10

A.C./D.C. voltage up to 1 kV. in 4 ranges. D.C. current up to 500 mA in 2 ranges. 2 Range resistance to 1 meg.
Capacitance, dB ranges, etc.

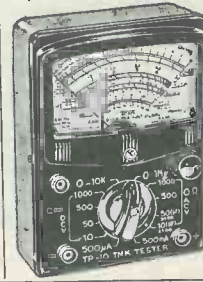

2,000 ohms/volt.
Size 5" x 3 1/2" x 1 1/2".
79/6
P.P. 1/6.
With Test Leads, Battery and Instructions.

★ STEREO AMPLIFIER ★

BARGAIN OFFER

- 2 watts per channel.
- Full tone, balance and volume controls.
- Complete with sockets, dials, etc.

BRAND NEW 97/6 P.P. 2/6.

Suitable Speakers, 10" x 6", 49/6 pair.
UA14 Stereo Deck, **£8.19.6**. P.P. 2/6.
READY BUILT AND TESTED.



Transistors

We stock a transistor for every need from 3/6 each.

SEND FOR LATEST PRICE LIST

- 1st Grade Fully Guaranteed

★ RECORD PLAYER AMPLIFIER ★

- 2-watt quality output.
- Ready built with Valves and 8" x 5" Speaker, Tone and Volume Controls on printed circuit.

75/- P.P. 2/-

Ideal for Portable Record Player.

- UA8 4-speed Record Changer, ideal for above. **£6.19.6**. P.P. 2/6.

1 WATT TRANSISTOR AMPLIFIER

- EMI 4-Transistor Amplifier with speaker, tone and volume controls. Ready assembled. For use with crystal pick-ups. 6-9 volt operated. **89/6** P.P. 1/6.



BATTERY RECORD PLAYER

- 6-7 1/2 volt Garrard turntable with crystal pick-up. Plays 45 r.p.m. Ideal for above amplifier.

79/6 P.P. 1/6.

TELEPHONE PICK-UP COIL. Supplied with screened cable and rubber sucker. Just press on to back of telephone. Designed for tape recording telephone calls, 14/- . P.P. 9d.

SUB-MINIATURE JACK PLUG AND SOCKET, 3/6. P.P. 6d.

PERSONAL EARPHONE. 600 ohm miniature type with Jack and socket, 10/6. P.P. 9d.

BRAND NEW PORTABLE HAND-HELD LOUDHAILERS, £14.10.0.



CRYSTAL MICROPHONES

ACOS 39-1. Stick Microphone with screened cable and stand (list 5 gns), **39/6**. P.P. 1/6.

ACOS 40. Desk Microphone with screened cable and built-in stand (list 50/-), **19/6**. P.P. 1/6.

ACOS 45. Hand Microphone with screened lead, very sensitive, **29/6**. P.P. 1/6.

100C STICK MICROPHONE with muting switch, detachable table stand, neckcord, screened lead, **39/6**. P.P. 1/6.

★ Brand New—Fully Guaranteed ★

CRYSTAL MICROPHONE INSERTS. Acos 43-2 2 1/4", 12/6. Acos 1 1/2", 7/6. 3/4" Ex-units, 3/6. P.P. 6d. any type.

TUBULAR LOUDSPEAKER UNIT

Extension portable speaker unit to give best performance from any transistor pocket radio. Fitted 2 sizes of jack plug. Just plug into earphone socket, **57/6**. P.P. 1/6.

★ **CRYSTAL LAPEL MICROPHONE** Ideal for tape recording.

Very sensitive.
17/6
P.P. 1/-.



★ **LIGHT-WEIGHT 4,000 OHM HEADPHONES,**

12/6
P.P. 1/-.



● BRAND NEW METERS ●

- 1 1/2 in square 0/50 microamp, 39/6.
- 1 1/2 in square 0/500 microamp, 32/6.
- 1 1/2 in square 0/1 milliamp, 27/6.

★ **VU METER** (Volume Level Indicator). Calibrated in standard ranges, 42/6.

★ **"S" METER.** Standard "Ham" signal strength indicator, 35/-.

★ TRANSISTOR STANDARD AND MINIATURE COMPONENTS

We stock the largest range of components in the country for the home constructor.



WE HAVE YOUR ITEM IN STOCK.

Just ask and we will quote competitive prices.

ALL TRANSISTOR MEDIUM LONG AND SHORT WAVE PRE-BUILT UNITS IN STOCK: FULLY ILLUSTRATED BOOKLET 2/6.

TRANSISTOR INTERCOMM

- ★ Two-way Intercomm. with clear reproduction. Incorporates unique buzzing system. 2 speakers, volume control. Cabinet sizes about 3 1/2 x 1 1/2 x 3 1/2 in. Ready to use. Fully guaranteed.

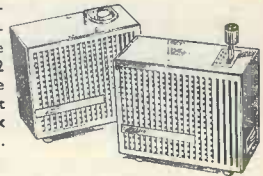

- ★ Printed Circuit Amplifier.

SUPPLIED IN PRESENTATION BOX WITH BATTERY AND 60ft WIRE. **10 gns.**

★ RANGER 2 ★

PERSONAL POCKET RADIO



- Two Transistor Two Diode, fully tunable over Medium waves. Good reception of Radio Luxembourg. Size 4 1/8 x 3 x 1 1/2 in.

All Parts **59/6**

No extras to buy.

- **PICTORIAL PLANS AND DETAILS FREE ON REQUEST**

PRACTICAL TRANSISTOR CIRCUITS

3/6
Post Free.
Contains easy to follow plans of 40 all transistor units, including light operated switches, amplifiers, transmitters, receivers, test oscillators, signal tracers, hearing aids, radio control, etc. All parts available separately.
• Designed for the Home Constructor

CRYSTAL MICROPHONE with lapel clip and cable. Ideal for portable tape recording, 17/6. P.P. 1/-

1000 OHM MINIATURE MAGNETIC MICROPHONE. Small but sensitive. With cable and table top stand, 49/6. P.P. 1/-.

ALL TRANSISTOR FM TUNER PRE-BUILT UNITS: FULLY ILLUSTRATED BOOK, 3/6.

Henry's Radio Ltd

PADdington 1008/9

5 HARROW ROAD LONDON W2

Open Monday to Sat. 9-6, Thurs. 1 o'clock

Send 4d. stamp for New Illustrated Price List

PLEASE



TURN

PAGE

★

THE MODERN BOOK CO

Radio Control Manual. By E. L. Safford
Jr. 25s Postage 1s.

Transistors. How to Test Them.
Gernsback Lib. 16s. Postage 9d.

Records & Gramophone Equipment.
By E. N. Bradley. 8s. 6d. Postage 6d.

Guide to Broadcasting Stations. Com-
piled by "WW". 3s. 6d. Postage 6d.

Service Valve Equivalents. An R.S.G.B.
Pub: 2s.. Postage 4d.

Valve & Teletube Manual. No. 9.
Brimar. 6s. Postage 1s.

Radio Valve Data. 7th ed. Compiled
by "WW". 6s. Postage 10d.

**Short Wave Receivers for the Begin-
ner.** A Data Pub: 6s. Postage 4d.

Telecommunications. By W. T. Perkins.
21s. Postage 9d.

TV Fault Finding. A Data Publication.
5s. Postage 6d.

The All In One Tape Recorder Book.
By J. M. Lloyd. 12s. 6d. Postage 6d.

Principles of Semiconductors. By
M. G. Scroggie. 21s. Postage 1s.

Handbook for Radio Operators. G.P.O.
6s. Postage 1s.

A Guide to Amateur Radio. An
S.S.G.B. Publication. 3s. 6d. Postage 6d.

We have the Finest Selection of British and American Radio Books in the Country

Complete catalogue 1s.

19-21 PRAED STREET (Dept RC) LONDON W2

Telephone PADDington 4185

THE RADIO CONSTRUCTOR BOUND VOLUMES

Volume 14, August 60 to July 61 **£1.5.0.** postage 2/3
Attractively bound in blue cloth, with gold-blocked spine

Also available:-

Volume 12, August 58 to July 59 **£1.5.0.** postage 2/3

Volume 13, August 59 to July 60 **£1.5.0.** postage 2/3

**Where all issues of a volume
are returned for exchange** **12s. 6d.** postage 2/3

Indexes for volume 14 are now available, price 6d. postage 3d. A limited
number are also available for volumes 4, 6, 11, 12 and 13 at the same price.

DATA PUBLICATIONS LTD 57 MAIDA VALE LONDON W9

Published in Great Britain by the Proprietors and Publishers Data Publications Ltd. 57 Maida Vale London W9

Printed by A. Quick & Co. (Printers) Ltd. Oxford Road Clacton-on-Sea England

Obtainable abroad through the following Collets Subscription Service Continental Publishers & Distributors Ltd. William Dawson & Sons Ltd.
Australia and New Zealand Gordon & Gotch Ltd. Electronics Publications (Australia) South Africa Central News Agency Holland "Radio Electronica"
Registered for transmission by Magazine Post to Canada (including Newfoundland)

**NEW EASY TO BUILD
TRANSISTOR RADIOS**
ALL PARTS SOLD SEPARATELY

Ideal Presents for Any Occasion

DETAILS OF
ANY MODEL
ON REQUEST

NO TECHNICAL KNOWLEDGE NECESSARY

Announcing a Completely New Pocket Radio

THE "CAPRI" POCKET SIX

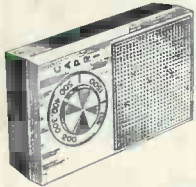

- Full medium wave tuning—preset Light on long wave.
- 6 Mullard transistors and diode.
- Push-pull speaker output.
- Printed circuit.
- Moulded two-tone cabinet with mesh grill.

Size 4 3/8" x 2 3/4" x 1 3/8"

● **REALLY POCKET SIZE**

TOTAL COST OF ALL PARTS
£7.10.0 P.P. 2/-
NO EXTRAS TO BUY

- FULL AFTER SALES SERVICE AND GUARANTEE
- ALL PARTS SOLD SEPARATELY

DESCRIPTIVE LEAFLET AND DETAILS ON REQUEST.

A REMARKABLE EASY TO BUILD POCKET RADIO GIVING OUTSTANDING RESULTS.

COMPLETELY NEW PRINTED CIRCUIT SUPERHET DESIGN WITH COMPREHENSIVE BUILDING INSTRUCTIONS

"QUINTET" (As described on page 363)
**MEDIUM AND LONG WAVE
POCKET LOUDSPEAKER
RADIO**

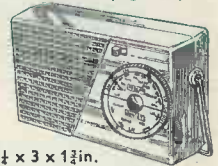

Size 5 1/2 x 3 x 1 3/8 in.

TOTAL COST OF ALL PARTS
£5.10.0 P.P. 2/-.
NO EXTRAS TO BUY.

VERY EASY TO BUILD AND USE

You will be amazed by the performance

- 250mW Push-Pull Output.
- Plainly marked Printed Circuit Board.
- 5 Mullard Transistors.
- Carded Components.

A new design, fully tunable on both wavebands. Guaranteed reception of Continental and local stations, including Luxembourg, anywhere with full station separation. Fitted Car Aerial and Earpiece Sockets.

● Illustrated Instructions FREE ON REQUEST ●

**3/4 WATT 4 TRANSISTOR
AMPLIFIER**



1 watt peak output.
±3dB 70 c/s to 12 kc/s.
Output to 3 ohm speaker.
9 volt operated.
Details on request.

Built and Tested
69/6 P.P. 1/6.

2-OC81 Transistors. Ideal for Intercomm., Record Player, Tuner Amplifier or any application requiring a quality and reliable amplifier.

"CONTESSA"
**6 TRANSISTOR MEDIUM AND
LONG WAVE SUPERHET
TERRIFIC SENSITIVITY**
UNBEATABLE IN PERFORMANCE AND
APPEARANCE
**COMBINED PORTABLE AND
CAR RADIO**

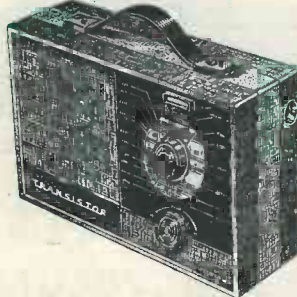

Employs the latest techniques. Double tuned IF's, AVC and first-grade components are standard features. Excellent tone, sensitivity and selectivity on both wavebands.
Descriptive Leaflet on Request.
★ 425mW Push-Pull Output.
★ 6 "Top-Grade" Ediswan Transistors.
★ New Type Printed Circuit with all Components marked.
★ Full Medium and Long Wave Tuning.
★ High "Q" Internal Ferrite Aerial.
★ Car Radio Adaptation and AVC.
★ Slow Motion Fingertip Tuning with Station Names clearly marked.
★ "Hi-Fi" Quality Speaker.
★ Attractive Rexine Covered Cabinet, Red/White or Blue/White.

TOTAL COST OF ALL PARTS
£10.19.6 P.P. 3/6

★ NO EXTRAS TO BUY ★

WITHOUT DOUBT THE "CONTESSA" IS THE FINEST PORTABLE AVAILABLE TO THE HOME CONSTRUCTOR. GOOD LOOKS, QUALITY OUTPUT, AMAZING SENSITIVITY, EASE OF CONSTRUCTION. SIZE 10 1/2 x 8 x 3 1/2 ins.

TRANSISTOR TAPE RECORDER
IDEAL FOR HOME, OFFICE OR TRAVEL



- ★ Built-in Quality Speaker.
- ★ Fast Rewind.
- ★ Over 1 hour Play/Record.
- ★ Volume Control.
- ★ Size 6" x 8 1/2" x 2 3/4".
- ★ Weight 2 1/2 lb.
- ★ Two Tone case with carry strap.

SUPPLIED COMPLETE WITH MICROPHONE, TAPE BATTERIES AND PERSONAL PHONE (cuts out speaker). FULLY GUARANTEED. **12 GNS**

★ **RANGER 3** ★



Size 4 3/8 x 3 x 1 1/8 in.

ALL COMPONENTS
79/6 P.P. 1/6
NO EXTRAS TO BUY
Everything Supplied

NO EXTERNAL AERIAL OR EARTH—3-TRANSISTOR and 2 DIODES

Personal Pocket Radio with 5 stages giving clear reception on medium wave, amateur top band and shipping.

- Easy to follow instructions with pictorial layout.
- Reception of Radio Luxembourg guaranteed (most areas).
- Free Instructions and Price List on request.
- Easy to build.

**3 TRANSISTOR AND DIODE
PERSONAL POCKET RADIO**



Quality Output on Personal Earphone.

A simple to build local station with personal earphone output. Built-in Ferrite Aerial and Battery lasting 9 months.

Size 4 3/8 x 3 x 1 1/8 in.

ALL PARTS **37/6 P.P. 1/6**

PLEASE **Henry's Radio Ltd**

PADdington 1008/9
5 HARROW ROAD, LONDON W2

Open Monday to Sat. 9-6, Thurs. 1 o'clock

Send 1/- Stamps for New Illustrated Price Lists

★

POCKET IRON

● Pocket Soldering Iron, 220/250V A.C./D.C. 30 watts, complete with mains plug, case, etc. Handle unscrews to cover element enabling iron to be carried in pocket, 18/6. P.P. 1/-

"TRANSFIVE" PORTABLE

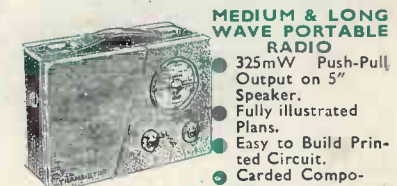

MEDIUM & LONG WAVE PORTABLE RADIO

- 325mW Push-Pull Output on 5" Speaker.
- Fully illustrated Plans.
- Easy to Build Printed Circuit.
- Carded Components.
- 5 Mullard Transistors.

Size 8 1/2 x 6 1/2 x 3 1/2 in.

After Sales Service and Fully Guaranteed

TOTAL COST OF ALL PARTS
£6.19.6 P.P. 2/6.
NO EXTRAS TO BUY

- Full coverage on Medium and Long wavebands. Excellent quality with full station separation. Car aerial socket.

● BUILDING PLANS AND PRICES
FREE ON REQUEST ●

WE CAN SUPPLY MOST OF THE COMPONENTS USED ON CIRCUITS PUBLISHED IN THIS AND OTHER MAGAZINES. QUOTATIONS BY RETURN.

Now available. The new improved "P.W." Pocket Superhet £7.14.6 P. & P. 2/6. Send for details.