

RADIO AMATEURS
get your Licence in
HALF THE USUAL TIME!

You must be a good Morse operator!
A "slap-dash" 12 w.p.m. neither satisfies the authorities, yourself nor your operator friends. Morse operating is an exacting art unless your training is made simple and is based on sound fundamentals. For this reason, the Candler System was invented to take the "grind" out of Code tuition, turning a tricky subject into a pleasurable pursuit.

★ Send 3d. stamp for the "Book of Facts"
CANDLER SYSTEM CO
(Dept. 55 RC) 52b Abingdon Rd., London W8
Candler System Company, Denver, Colorado, U.S.A.

G2ACC offers you . .

Catalogue No. 11
9d. post free

56 pages, 108 photographic illustrations,
over 2,000 new guaranteed items by
the leading manufacturers with data.

**SOUTHERN RADIO
and ELECTRICAL SUPPLIES**
Sorad Works Redlynch Salisbury Wilts

MULLARD 2 Valve Pre-Amplifier

| T.C.C. CAPACITORS | | each |
|------------------------|-----|------|
| 1 82pF, 5%, 101SMP | ... | 1/4 |
| 1 150pF, 5%, 401SMP | ... | 1/7 |
| 1 390pF, 5%, 425SMP | ... | 1/7 |
| 2 560pF, 5%, 601SMP | ... | 1/7 |
| 1 680pF, 5%, 601SMP | ... | 1/7 |
| 1 8,200pF, 10%, 701SMB | ... | 5/- |
| 4 0.1µF, CP37N | ... | 2/3 |
| 1 8µF, CE99LE | ... | 3/3 |
| 2 25µF, CE87C | ... | 2/9 |

| RESISTORS | | |
|-----------------------|-----|-----|
| 15 Erie type 9 | ... | 6d. |
| 6 Erie type 9, 5% | ... | 1/- |
| 7 Erie type 108HS | ... | 1/9 |
| 3 Type 'A' 250 k/ohms | ... | 5/- |

| COMPONENTS | | |
|--|-----|------|
| 2 McMurdo B9A, screened | ... | 2/6 |
| 6 Belling-Lee L604S sockets | ... | 1/3 |
| 1 2-pole 6-way Switch | ... | 12/- |
| 4 Bulgin K370 knobs | ... | 1/6 |
| 1 8" x 3 1/2" x 2 1/4" Screened chassis, drilled | ... | 14/- |
| 2 Mullard EF86 valves (P.T. 6/10) | ... | 17/6 |

These are the specified Mullard TP.331 components. Please send for our list MPA2 which includes suitable alternatives at lower prices. Any component supplied separately
TERMS: C.W.O. or C.O.D. (minimum C.O.D. £1)
Orders over £1 post free

J. T. FILMER
82 DARTFORD RD DARTFORD KENT
Telephone Dartford 4057

MARCH '58

Aluminum Chassis. 18 s.w.g. Plan, undrilled, with 4 sides, riveted corners and lattice fixing holes, with 2 1/2" sides. 7" x 4", 4 1/2" x 7", 5 1/2" x 7", 6 1/2" x 9", 8 1/2" x 11", 10 1/2" x 14", 12 1/2" x 16" x 3", 16 1/2"

Volume Controls
Midget size
Long spindles. Guaranteed 1 year. All values 10,000 ohms to 2 Meg. No Sw. S.P.Sw. D.P.Sw. 3/- 4/- 4/9
Linear or Log Tracks

80 Ω Coaxial cable
Semi-air spaced Polythene insulated 1/2" dia. stranded core. Ideal Band III 9d. yd Losses cut 50%

FRINGE QUALITY
Air-spaced Coaxial 1/6 yd

Coaxial Plugs 1/- **Double Socket** 1/3
Sockets 1/- **Outlet Boxes** 4/6
Balanced Twin Feeder per yd 6d. 80Ω or 300Ω
Twin Screened Balanced Feeder 1/- yd, 80 ohms
Trimmers. Ceramic, 30, 50, 70pF, 9d.; 100pF, 150pF, 1/3; 250pF, 1/6; 600pF, 750pF, 1/9. Philips 1/- each
BLACK CRACKLE PAINT. Air drying, 3/- tin
P.V.C. CONN. WIRE, 10 colours, single or stranded, 2d. yd. Slewing, 1, 2mm 2d., 2, 3mm 3d., 6mm 5d. yd
5" RADIO SCREWDRIVERS, 6d. each
NEON MAINS TESTER SCREWDRIVERS, 5/3
MULTICORE SOLER, 60/40, 18 s.w.g., 3d., 16 s.w.g., 4d. yd; 1/2b 2/6
Sentercel Rectifiers. E.H.T. Type Fly-back. Voltages: K3/25 2kV, 5/-; K3/40 3.2kV, 7/-; K3/45 3.6kV, 7/6; K3/50 4kV, 8/-; K3/100 8kV, 14/6
50 cps voltage 30% of above ratings

Mains Type RM1, 125V 60mA, 5/-; RM2 100mA, 6/-; RM3 120mA, 8/-; RM4 250V 275mA, 16/-; RM5, 20/-
Miniature Contact Cooled Rectifiers. 250V 50mA, 8/6; 250V 85mA, 9/6. Selenium Rect. 300V 85mA, 7/6
Coils. Wearite 1" type, 3/- each. Osmor Midget "Q" type adj. dust core, from 4/- each. All ranges
Teletron. L. & Med. T.R.F., with reaction, 3/6
Ferrite Rod Aerials. M.W., 8/9; M. & L., 12/6
T.R.F. Coils A/HF, 7/- pair. **H.F. Chokes,** 2/6
Speaker Fret. Gold cloth, 17" x 25", 5/-; 25" x 35", 10/-
Expanded metal, silver, 15 1/2" x 9 1/2", 2/- each; Tygan, 4' 6" wide, 10/- ft; 2' 3" wide, 5/- ft

HANDY VOLTMETERS. 2" Twin Range 0-25V, 0-250V d.c. with leads and leather case, 12/6 each

Condensers. New stock, 0.001µF 7kV T.C.C., 5/6; ditto 20kV, 9/6; 100pF to 500pF Micas, 6d.; Tubular 500V 0.001 to 0.01µF, 9d.; 0.05, 0.1, 1/-; 0.25, 1/6; 0.5, 1/9; 0.1/350V, 9d.; 0.1/2,000V, 1/9; 0.1/2,000V, 3/6
Ceramic Condensers. 500V 0.3pF to 0.01µF, 10d.
Silver Mica. 10% 5pF to 500pF, 1/-; 600pF to 3,000pF, 1/3; close tolerance (plus or minus 1pF), 1.5pF to 47pF, 1/6; ditto 1% 50pF to 815pF, 1/9; 1,000pF to 5,000pF, 2/-

| NEW ELECTROLYTICS. | | FAMOUS MAKES | |
|--------------------|---------|------------------|-----|
| TUBULAR | TUBULAR | CAN TYPES | |
| 1/350V | 2/- | 100/25V | 3/- |
| 2/450V | 2/3 | 8+16/450V | 5/- |
| 4/450V | 2/- | 16+16/500V | 6/- |
| 8/450V | 2/3 | 6,000µF 6V | 6/6 |
| 8/500V | 2/3 | 32+32/350V | 4/6 |
| 16/450V | 3/6 | 32+32/450V | 6/6 |
| 16/500V | 4/- | 64+120/275V | 7/6 |
| 32/450V | 5/6 | 60+100/350V/11/6 | |
| 25/25V | 1/9 | 64/350V | 5/6 |
| 50/25V | 1/9 | 100/275V | 5/6 |
| 50/50V | 2/- | 50+50/350V | 7/- |
| | | 1,000+1,000/6V | |
| | | 50/12V | 3/- |

Full Wave Bridge Selenium Rectifiers, 2, 6 or 12V 1 1/2A, 8/9; 2A, 11/3; 4A, 17/6. Free circuit
Charger Transformers. Tapped input 200/250V for charging at 2, 6 or 12V 1 1/2A, 15/6; 2A, 17/6; 4A, 22/6

12 1/2 PURETONE RECORDING TAPE
1,200ft on standard fitting 7" metal reels
Spare reels 7" metal, 2/3; 7" plastic, 4/3
FERROVOICE 1,200ft Plastic Tape, 25/-

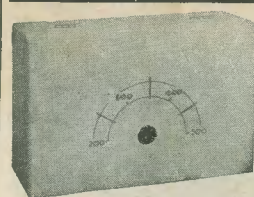

**TELETRON
CRYSTAL
SET KIT**

Complete with cabinet, chassis and all components.
Special price 15/- or with H.R. Phones 30/-

"MULLARD 3-3" Quality Amplifier. Full specification Ready Built £7.18.6

JASON FM TUNER COIL SET, 26/-. H.F. coil, aerial coil, oscillator coil, two i.f. transformers 10.7 Mc/s, detector transformer and heater choke. Circuit and component book using four 6AM6, 2/-; J.B. Chassis and dial, 19/6. Complete kit, £5.18.6. With Jason superior calibrated dial, £6.15.0

Wavechange Switches. 2 p 2-way, 3 p 2-way, short spindle, 2/6; 5 p 4-way 2 wafer, long spindle, 6/6; 2 p 6-way, 4 p 2-way, 4 p 3-way, long spindle, 3/6; 3 p 4-way, 1 p 12-way, long spindle, 3/6; Wave change "MAKITS," 1 wafer, 8/6; 2 wafer, 12/6; 3 wafer, 16/-; 4 wafer, 19/6; 5 wafer, 23/-; 6 wafer, 26/6
Toggle Switches, s.p. 2/-, d.p. 3/6, d.p.d.t. 4/-
Morse Keys, good quality, 2/6. **Buzzers** 3/6

Knobs, Gold Engraved. Walnut or Ivory. 1 1/2" diam., 1/6 each. "Focus," "Contrast," "Brilliance," "Brilliance-On/Off," "On-Off," "Volume," "Volt-On/Off," "Tone," "Tuning," "Treble," "Bass," "Wave-change," "Radio-Gram," "S.M.L.-Gram," "Record-Play," "Brightness." Ditto, not engraved, 1/-

Valveholders. Pax. int. oct., 4d. EF50, EA50, 6d. B12A, CRT, 1/3. Eng. and Amer. 4, 5, 6, 7 and 9 pin, 1/-
MOULDED Mazda and int. oct., 6d., B7G, B8A, B8G, B9A, 9d. B7G with can, 1/6. VCR97, 2/6. B9A with can, 2/6. Ceramic, EF50, B7G, B9A int. oct., 1/-, B7G with can, 1/9; B9A with can, 2/9

THE HI-GAIN BAND 3 PRE-AMP
Cascade circuit using Valve ECC84. Complete kit 27/6 less power; or 49/6 with power pack

TV Fault Finding. Data Publications, 5/- each
Radio Valve Guide. Books 1, 2 or 3, 5/- each

All Boxed VALVES New & Guaranteed

| | | | | | | | |
|------|------|-------|------|--------|------|--------|------|
| 1R5 | 8/6 | 6K8 | 8/6 | EABC80 | 8/6 | EZ81 | 11/6 |
| 1S5 | 8/6 | 6L6 | 10/6 | EB91 | 6/6 | E1148 | 1/6 |
| 1T4 | 8/6 | 6Q7 | 7/6 | EBC33 | 8/6 | HABC80 | 12/6 |
| 3S4 | 8/6 | 6SA7 | 7/6 | EBC41 | 10/6 | HVR2A | 7/6 |
| 3V4 | 8/6 | 6SN7 | 8/6 | EBF80 | 8/6 | MU14 | 10/6 |
| 5U4 | 8/6 | 6V6G | 7/6 | ECC84 | 12/6 | P61 | 6/6 |
| 5Y3 | 8/6 | 6V6GT | 8/6 | ECC80 | 10/6 | PCC84 | 12/6 |
| 5Z4 | 10/6 | 6X4 | 7/6 | ECC82 | 10/6 | PCC80 | 10/6 |
| 6AM6 | 8/6 | 6X5 | 7/6 | ECH42 | 10/6 | PCF82 | 10/6 |
| 6B8 | 5/6 | 7S7 | 8/6 | ECL80 | 12/6 | PLB2 | 10/6 |
| 6BE6 | 7/6 | 12A6 | 7/6 | ECL82 | 12/6 | PEN25 | 6/6 |
| 6BH6 | 10/6 | 12AH8 | 10/6 | EF39 | 7/6 | PLB2 | 10/6 |
| 6BV6 | 8/6 | 12AT7 | 10/6 | EF41 | 10/6 | PY80 | 10/6 |
| 6BW7 | 8/6 | 12AU7 | 10/6 | EF50 | 5/6 | PY81 | 10/6 |
| 6CH6 | 10/6 | 12AX7 | 10/6 | Equip. | | PY82 | 10/6 |
| 6D6 | 7/6 | 12BE6 | 10/6 | EF50 | 8/6 | SP61 | 5/6 |
| 6F6 | 7/6 | 12BH7 | 10/6 | Sylv. | | UBC41 | 10/6 |
| 6H6 | 3/6 | 12K7 | 8/6 | EF80 | 10/6 | UCH42 | 10/6 |
| 6J5 | 6/6 | 12Q7 | 8/6 | EF92 | 5/6 | UF41 | 10/6 |
| 6J6 | 7/6 | 35Z4 | 10/6 | EL32 | 5/6 | UL41 | 10/6 |
| 6J7 | 8/6 | 80 | 8/6 | EL84 | 10/6 | UY41 | 10/6 |
| 6K6 | 6/6 | 954 | 1/6 | EY51 | 11/6 | U22 | 10/6 |
| 6K7 | 5/6 | EA50 | 1/6 | EZ40 | 10/6 | X79 | 10/6 |

| ★ VALVES | | NEW TESTED AND | | ★ GUARANTEED | |
|----------|------|----------------|------|--------------|------|
| 1R5 | 8/6 | 6L6G | 9/- | EH76 | 8/6 |
| 1S5 | 7/6 | 6Q7GT | 7/6 | DK91 | 8/6 |
| 1T4 | 7/6 | 6SA7 | 8/- | DK92 | 9/- |
| 3S4 | 7/6 | 6SL7GT | 8/- | DK96 | 9/- |
| 3V4 | 8/6 | 6SN7GT | 8/6 | DL92 | 7/6 |
| 5U4G | 8/6 | 6SS7 | 6/6 | DL94 | 8/6 |
| 5Y4G | 7/6 | 6V6G | 7/6 | DL96 | 9/- |
| 5Z4G | 9/6 | 6V6GT | 7/6 | EA50 | 1/6 |
| 6AG5 | 6/9 | 6X4 | 7/6 | EB91 | 6/6 |
| 6AM6 | 8/6 | 6X5GT | 7/6 | EBC41 | 8/- |
| 6AL5 | 6/6 | 12AT7 | 9/- | EBC33 | 8/6 |
| 6AT6 | 8/- | 12AX7 | 9/- | EBF80 | 10/6 |
| 6B8 | 7/6 | 12A7 | 9/- | ECC81 | 10/6 |
| 6B8G | 7/6 | 12K8GT | 13/6 | ECC84 | 11/6 |
| 6BA6 | 8/6 | 12K7GT | 8/6 | ECC82 | 11/- |
| 6BE6 | 7/6 | 12Q7GT | 8/6 | ECH81 | 10/6 |
| 6BR7 | 10/6 | 35Z4GT | 8/6 | ECH42 | 10/- |
| 6BV6 | 8/6 | 35L6GT | 9/6 | ECL80 | 10/6 |
| 6GG6 | 4/9 | 807 | 6/9 | EF36 | 7/6 |
| 6J5G | 5/6 | 5763 | 10/6 | EF37A | 14/6 |
| 6J5GT | 6/6 | DAF91 | 7/6 | EF39 | 5/6 |
| 6J7GT | 8/6 | DAF96 | 9/- | EF41 | 10/- |
| 6K7G | 5/6 | DF91 | 7/6 | EF80 | 9/6 |
| 6K8G | 9/6 | DF96 | 9/- | EF85 | 10/6 |

Matched Pairs. EL84, 23/-; 6V6G & GT, 17/-; 6BW6, 18/-; KT33C, 19/6; 27/6; 807 14/6 pair

P.P. Op. Transformers. Mr 3-15 ohms for EL84, 6V6, 6BW6, etc., 18/6; Op. Pen. 50mA, 5/6; 30mA, 4/6
Volume Controls. All values, long spindle. L/S 3/-, s.p. 4/-, d.p. 4/9, ext. spkr, control 3/-
W.W. Pots. Pre-set 3/-; 3W long spindle 5/6, s.p. 6/6
P.M. Speakers. 3 ohm. 5" 16/6, 6 1/2" 17/6, 8" 21/-, 10" 25/-, 12" 30/-
Coaxial Cable. 75 ohm 1/2" stranded, 8d. yd; semi-air spaced, 9d. yd; screen cable single and twin, 9d. yd
Coaxial Plugs 1/- each; **Sockets** 1/- each

R. COOPER G8BX 32 SOUTH END CROYDON SURREY CROYDON 9186
P. and p. 9d. to £1; 1/6 to £2; over £2 post free. C.O.D. 2/6

Please address all Mail Orders correctly as below
NT SPECIALISTS
337 WHITEHORSE ROAD WEST CROYDON
Telephone THO 1665 Catalogue 6d.
Service, P. & P. 1/-, over £2 post free. C.O.D. 1/6 (Export C.W.O. post extra, no H.P.) OPEN ALL DAY (Wed. 1 p.m.)

Smith's
of
EDGWARE ROAD

BUILD THE
COOPER-SMITH B.P.I.
HIGH FIDELITY
10-12 Watt AMPLIFIER
and CONTROL UNIT

(as described in this Magazine)

For the highest possible enjoyment of FM radio and Hi-Fi disc and tape recordings

- SIMPLE LAYOUT
- ULTRA-LINEAR OUTPUT
- BALANCED PHASE INVERSION
- UNCONDITIONAL STABILITY
- NEW, EXCLUSIVE CIRCUIT

Any part sold separately

See December, January and February numbers or send 2/10 for Radio Reprint (now in preparation) which gives full instructions, additional material and price list of parts

Complete kit of parts for Amplifier (including valves) ... £12.12.0
Complete kit of parts for Control Unit (including valves) ... £8.3.0

Carriage free in U.K.

Hundreds of delighted users

H. L. SMITH & CO LTD

287/9 EDGWARE ROAD . LONDON W2 . Telephone Paddington 5891

'Q' - Fidelity FM

Reliable FM Tuners of High Performance for Hi-Fi amplifiers or as add-on units for existing radios or radiograms. Fullest information supplied

Model 1. The "Mini-Magic." Economy is the watchword of this clever unit which is achieved without sacrifice of performance or reliability. 5 gns incl. P.T. Kit £4 10s.

Model 2. Simple switch-tuning with automatic frequency control. A high-quality, stable and completely drift-free unit. Kit or separate components. Size 4½" x 4½" x 5½"

High "Q" Coils

4/- EACH
Iron dust cores. Clip in fixing. EXTREMELY SMALL
AMAZING EFFICIENCY
For Superhet T.R.F. or Transistor operation.

All coils for Collaro Tape

Transcriber pre-amp.
BIAS OSC. Type QT9
Coil 7/6

STATION SEPARATOR

HOME-LIGHT-THIRD-LUX ETC.
10/6

STOP! T.V. Patterning

10/-
An easily fitted—Simple Remedy

I.T.A. Converter

To fit inside T.V. complete
KIT 65/-
Very efficient. Can be built in an evening. State Channels

OSMOR COILS ARE BEST FOR Selectivity & Performance

FREE!

Send 1/- (stamps) for fully descriptive literature including OSMOR DESIGNS—5-valve Superhet, Miniature ditto, Battery and Battery/Mains Receiver, Mains T.R.F. Superhet and T.R.F. Feeders. Band III Converters, Wiring Diagrams, Chassis Templates, Coils and Coilpack information and price lists and information on circuits in *Wireless World*, *Practical Wireless*, *The Radio Constructor*.

OSMOR

(Dept. RC20) 418 BRIGHTON ROAD SOUTH CROYDON . SURREY Telephone CROYdon 5148/9

EMI "HIS MASTER'S VOICE"
MARCONIPHONE · COLUMBIA
Announce NEW PRACTICAL WAY OF LEARNING AT HOME

NEW—completely up-to-date methods of giving instruction in a wide range of technical subjects specially designed and arranged for self-study at home under the skilled guidance of our teaching staff.

NEW—experimental outfits and lesson manuals are despatched on enrolment and remain the student's property. A tutor is allotted to each student for personal and individual tuition throughout the course.

Radio and television courses, with which specially prepared components are supplied, teach the basic electronic circuits (amplifiers, oscillators, detectors, etc.) and lead, by easy stages, to the complete design and servicing of modern Radio and T/V equipments.

If you are studying for an examination, wanting a new hobby or interest, commencing a career in industry or running your own full-time or part-time business, these practical courses are ideal and may be yours for moderate cost. Send off the coupon to-day for a free Brochure giving full details. There is no obligation whatsoever.

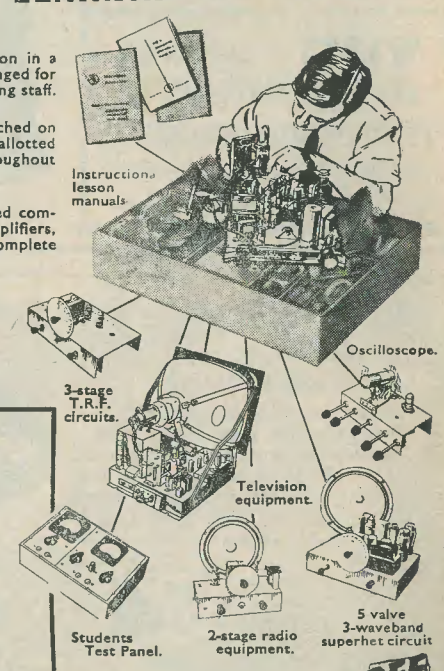

- Courses with Equipment
- RADIO · SHORT WAVE RADIO
 - TELEVISION · MECHANICS
 - CHEMISTRY · PHOTOGRAPHY
 - ELECTRICITY · CARPENTRY
 - ELECTRICAL WIRING · 'HI-FI'
 - DRAUGHTSMANSHIP · ART, etc.

E.M.I. Factories at Hayes, England.

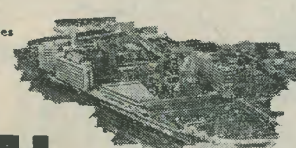

EMI INSTITUTES

The only Home Study College run by a World-wide industrial organisation

Fill in for FREE BROCHURE
E.M.I. INSTITUTES, Dept. 179X, London, W.4.

Name _____ Age _____
(if under 21)

Address _____

I am interested in the following subject(s) with/
without equipment _____
(We shall not worry you with personal visits)

1C107
MAR/58

BLOCK CAPS PLEASE

FREE

www.americanradiohistory.com

PREMIER RADIO COMPANY

B. H. MORRIS & CO. (RADIO) LTD

Open till
6 p.m. Saturday

(Dept. R.C.I) 207 EDWARE ROAD LONDON W2

Telephone
AMB 4033
PAD 3271

Build the New "MAYFAIR" Televisor

which gives complete SAFETY to the constructor!

These Televisors use a double wound mains transformer which gives you complete safety from contact with the mains supply when handling the chassis or controls.

★ B.B.C. & I.T.A. DESIGN ★
WITH NEW TURRET TUNER

MAY BE BUILT FOR **£33·7·11** PLUS COST OF C.R.T.

Build in 5 easy stages. Full construction details available. Instruction Book 3/6 post free

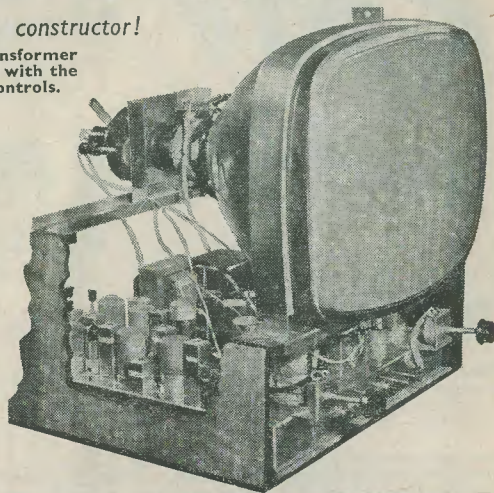

VISIT our New
Hi-Fi Showroom at
23 TOTTENHAM COURT RD

The best Hi-Fi Showroom in the district
Telephone MUSEum 3451

BUILDING A TAPE RECORDER ?

Then you owe it to yourself to install the best Tape Deck. This superb unit includes a three-speed control knob among its many outstanding features. Apply for full details and judge for yourself.

Patents pending

MOTEK-K9

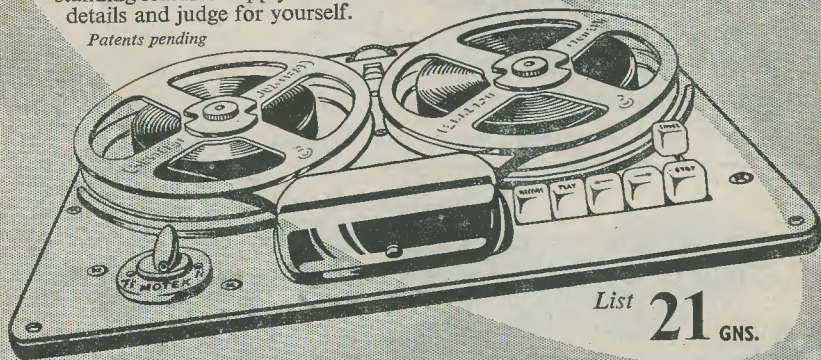

List **21** GNS.

MODERN TECHNIQUES

Wedmore Street, London, N.19. Tel: ARChway 3114

Wanted!

QUALIFIED MEN AND WOMEN

Industry and Commerce offer their best posts to those with the qualifications — appointments that will bring personal satisfaction, good money, status and security. As part of a modern industrial organisation, we have skilled knowledge of what is required and the best means of training personnel for its present day and future requirements. We specialise also in teaching for hobbies, new interests or part-time occupations in any of the subjects listed below. Write to us to-day for further information. There is no obligation of any kind.

PERSONAL & INDIVIDUAL TRAINING IN —

| | | | |
|---------------------------------------|----------------------------------|------------------------------|----------------------------------|
| Accountancy | Electronics | Production | Planning |
| Advertising | Electronic | Radio | Radio Amateur's (C&G) Licence |
| Aeronautical Eng. | Draughtsmanship | Radio & Television Servicing | Refrigeration |
| A.R.B. Licences | Eng. Drawing | Sales Management | Sanitary Eng. |
| Art (Fashion, Illustrating, Humorous) | Export | Salesmanship | Secretaryship |
| Automobile Eng. | General Certificate of Education | Shorthand & Typing | Short Story Writing |
| Banking | Heating & Ventilating Eng. | Short Wave Radio | Sound Recording & Reproduction |
| Book-keeping | High Speed Oil Engines | Telemmunications | Television Time & Motion Study |
| Building | Industrial Admin. | Tracing | Welding |
| Business Management | Jig & Tool Design | Workshop Practice | Works Management and many others |
| Carpentry | Journalism | | |
| Chemistry | Languages | | |
| City & Guilds Exams | Management | | |
| Civil Service | Maintenance Eng. | | |
| Commercial Subjects | Mathematics | | |
| Commercial Art & Drawing | M.C.A. Licences | | |
| Customs Officer | Mechanical Eng. | | |
| Draughtsmanship | Metallurgy | | |
| Economics | Motor Eng. | | |
| Electrical Eng. | Painting & Decorating | | |
| Electrical Installations | Photography | | |
| | P.M.G. Cert. | | |
| | Police | | |
| | Production Eng. | | |

OUR BACKGROUND!

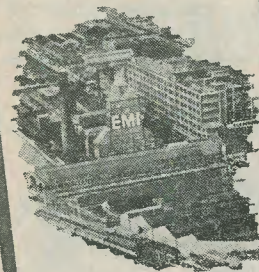

The E.M.I. Factories at Hayes, England.

NEW! Courses with PRACTICAL EQUIPMENT

The only Home Study College operated by a world-wide manufacturing organisation

IN RADIO · TELEVISION · MECHANICS · CHEMISTRY
ELECTRICITY · DRAUGHTSMANSHIP
PHOTOGRAPHY, ETC., ETC.

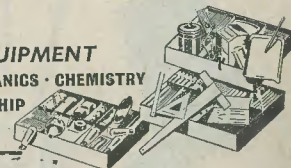

EMI INSTITUTES

POST THIS TODAY

E.M.I. INSTITUTES, Dept. 179K, London, W.4

NAME _____ AGE _____
(if under 21)

ADDRESS _____
I am interested in the following subject(s) with/without equipment

MAR/58

(We shall not worry you with personal visits).

FREE

BLOCK CAPS PLEASE

IC 92

The only Home Study College run by a World-wide industrial organisation

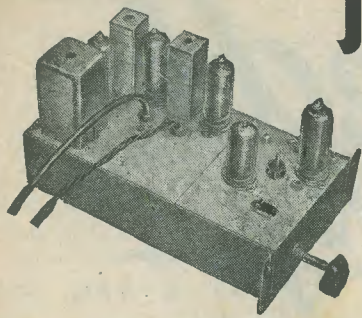

JASON "Mercury" SWITCHED FM TUNER

An Easy-to-Build All-British Design by JASON

- All parts including assembled Front End with 2 valves (we regret we are unable to supply remaining valves) come to

£9.0.0

- Switch Tuned Front End only with 2 valves, ready wired, tested and aligned

£6.5.0 Inc. £1.15.0 P/Tax

- **POWER PACK** suitable for use with above. Parts to come **£2.1.9**

- Please send S.A.E. for complete list of components and prices

THE
JASON MOTOR & ELECTRONIC CO

3-4 GT. CHAPEL ST. OXFORD ST. LONDON W1
Phone GERrard 0273/4

CONSTRUCTORS CORNER

PERSONAL PORTABLE RADIO

Ideal for the holiday, hiking, fishing, camping, cycling, etc. Use it at home, at the office, in bed, or just anywhere.



30/-

TRANSISTOR COMPONENTS

Miniature A.F. Transformers, specially designed for coupling transistor output stages, fully coded, 7/6 each.
Transistors, Red spot, 100% tested, 10/- each
Crystal Diodes, 100% tested, 2/6 each
Miniature Condenser, variable, single-hole fixing, 0.0004µF, 4/- each

ALL-WAVE RADIO

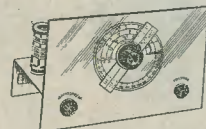

30/-

This 1 valve S.W. receiver can be built for 30/- from our list of components, which can be purchased separately. It includes valve and 1 coil covering 24-40 metres. Provision is made to increase to 2 or 3 valves if required, and all components are colour-coded so that the beginner can build this set quite easily.

Headphones, 1,000 ohms impedance, specially designed for above receivers, 14/- Per Pair

Power Unit type PU1. Input 250V a.c.; output 120V at 20mA, 6.3V at 1.5A. Ideal for small receivers, test equipment, etc. Kit of Parts 32/6
Built and tested £2 each

All components for the receivers advertised are sold separately. Full construction data, point-to-point wiring diagrams, parts lists, etc., are available at 2/- for each receiver.

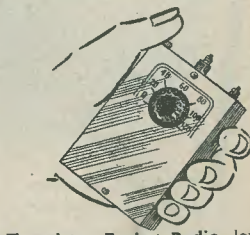

Transistor Pocket Radio, low cost and ideal for the beginner. Using the Variloopstick aerial (see below) and miniature condenser, the whole Medium Wave is covered. Fits the palm of the hand. 30/-

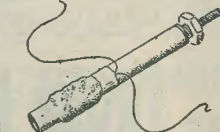

Variloopstick, specially designed for maximum transistor receiver performance, high 'Q' 4/6

Postage: Under 10/-, 9d. Under 40/-, 1/6. Over 40/-, post free

R.C.S. PRODUCTS (RADIO) LTD

11 OLIVER ROAD (Mail order only) LONDON E17

Tape Recorders!

FOR BEST RESULTS use

BRIMAR VALVES

the BRIMAR 12BH7*
is employed in the
Push Pull Bias Oscillator
described in this
issue

* Another fine valve made exclusively
in Gt. Britain by BRIMAR



Standard Telephones and Cables Limited

FOOTSCRAY · KENT
Telephone Footscray 3333

◆ ◆ ◆ ◆ REPANCO ◆ ◆ ◆ ◆

HIGH GAIN COILS and QUALITY COMPONENTS for the constructor

TRANSISTOR COMPONENTS

- FERRITE SLAB AERIAL TYPE FS2.** A new super-sensitive aerial, Long and Medium Wave, specially designed for transistor portable receivers. Complete with fixing brackets. Length $5\frac{1}{2}$ " 13/6
- COMBINED OSCILLATOR AND 1st I.F. TRANSFORMER TYPE OT1** (315 kc/s), fully screened, $\frac{1}{2}$ " x $\frac{1}{2}$ " x $1\frac{1}{2}$ " ... 11/6
- 2nd I.F. TRANSFORMER TYPE TT2** (315 kc/s), $1"$ x $\frac{3}{8}"$ dia... 5/-
- 3rd I.F. TRANSFORMER TYPE TT3** (315 kc/s), $1"$ x $\frac{3}{8}"$ dia... 5/-
- PUSH-PULL INTER-STAGE TRANSFORMER TYPE TT4.** Ratio 1:1 ct. Stack $1\frac{1}{8}"$ x $1\frac{1}{16}"$ x $\frac{7}{16}"$ 8/6
- PUSH-PULL OUTPUT TRANSFORMER TYPE TT5.** Ratio 15:1 ct. Stack $1\frac{3}{8}"$ x $1\frac{1}{16}"$ x $\frac{7}{16}"$ 8/-

MINIATURE RANGE—For pocket receivers

- FERRITE SLAB AERIAL TYPE FS3.** Medium Wave only. With fixing grommets. Size $3"$ x $\frac{3}{4}"$ x $\frac{3}{32}"$ 7/6
- OSCILLATOR COIL TYPE XO8.** Medium Wave only. Overall size $\frac{1}{2}"$ dia. x $1"$. Enclosed in Ferrite pots ... 5/-
- I.F. TRANSFORMER TYPE XT6.** Suitable for 1st and 2nd I.F. 455 kc/s. Size $\frac{1}{2}"$ sq. x $\frac{1}{16}"$... 10/-
- I.F. TRANSFORMER TYPE XT7.** Designed for 3rd I.F.T. or detector I.F.T. 455 kc/s. Size as XT6 ... 10/-
- PUSH-PULL INTERSTAGE TRANSFORMER TYPE TT9.** Ratio 1:1 ct. Radiometal Core. Size $\frac{3}{8}"$ x $\frac{3}{8}"$ x $\frac{1}{16}"$... 12/6
- PUSH-PULL OUTPUT TRANSFORMER TYPE TT10.** Ratio 8-1 ct. Matched to 3 ohm speaker. Size as TT9 ... 12/6

Practical and Theoretical circuits enclosed with each Repanco Transistor Component

HIGH GAIN COILS

- Dual-range Miniature Crystal Set Coil with circuit, type DRX1 ... 2/6
- Dual-range Coil with Reaction. With 2 mains, 2 battery and Transistor Circuit type DRR2 ... 4/-
- Ferrite Rod Aerial, Long and Medium Wave. With fixing brackets, type FR1... 12/6
- Matched pair TRF Dual-range Coils with Reaction. With mains, battery and feeder unit circuits, type DRM3 pr. 8/-
- Pair Dual-range Superhet Coils. With mains and battery circuits, type SH4 pr. 8/-
- Miniature I.F. Transformers, pre-aligned, 465 kc/s $\frac{1}{8}"$ x $\frac{1}{8}"$ x $1\frac{1}{2}"$, type MSE ... 12/6

REPANCO EASY-TO-BUILD RECEIVERS

Constructors' Envelopes of easy wiring plans, instructions and detailed price lists of components

- THE HIWAYMAN** ... Envelope 1/6 (post 3d.)
- Four-valve superhet Dual-range Portable using Ferrite Rod Aerial
- REPANCO ONE-VALVE** ... Envelope 9d. (post 3d.)
- Beginner's Dual-range Radio Set for use with headphones
- REPANCO FM TUNER UNIT** ... Envelope 1/6 (post 3d.)
- Using 4 EF91, 1 EB91, 1 EM80 Valves, Ratio Detector
- REPANCO "THREE DEE"** ... Envelope 9d. (post 3d.)
- Dual-range Transistor Radio using 3 Transistors and Crystal Diode. Amazing loudspeaker reception from $7\frac{1}{2}$ volt battery supply
- REPANCO "TRANSEVEN"** ... Envelope 1/6 (post 3d.)
- A new 7 Transistor superhet Portable with preset station tuning using Repanco transistor components
- REPANCO "MINI-7"** ... Envelope 1/6 (post 3d.)
- The amazing new transistor pocket portable radio with all the technical features of a standard receiver. Seven transistors, superhet circuit, fully tunable over medium wave. Size $5\frac{1}{8}"$ x $3\frac{1}{8}"$ x $2\frac{3}{8}"$

JUST RELEASED

MAIL ORDER and TRADE—

RADIO EXPERIMENTAL PRODUCTS
LIMITED
33 MUCH PARK STREET COVENTRY
Telephone 62572

WHOLESALE and EXPORT—

REPANCO LTD
O'BRIENS BUILDINGS
203-269 FOLESHILL ROAD COVENTRY
Telephone 40594

BRIDGE COMPONENTS

If you require a stockist of High Grade Components, we are the people for the job.

$\frac{1}{2}$ W High Stability Resistors (to British Grade I Standard). Stock values 1, 10, 100, 1,000, 10,000, 100,000, 1,000,000, 10,000,000 ohms. A wide range of intermediate values are stocked—most values obtainable.

1-4 ohms, 1% 7/-, 2% 6/-; 5-9 ohms, 1% 5/3, 2% 4/6; 10-24 ohms, 1% 3/6, 2% 3/-; 25-74 ohms, 1% 2/6, 2% 2/3; 75-99 ohms, 1% 2/3, 2% 1/9; 100 ohms to 10M, 1% 2/-, 2% 1/6.

Precision wire-wound Potentiometers for balance arms, wide range of values stocked, others to order: $1\frac{1}{2}"$ dia., linear, 6/3 each; 3" dia., linear, 23/- each.

The High Fidelity Co

18 MELVILLE ROAD EDGBASTON
BIRMINGHAM 16

(Proprietors Kendall & Mousley Ltd)

DALY MINIATURE ELECTROLYTICS

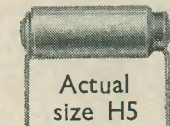

Send for descriptive leaflet giving full details of complete new range

DALY (CONDENSERS) LTD

West Lodge Works, The Green,
Ealing, London, W5.

Telephone: EALing 3127/8/9

For a really
professional finish
use . . .

PANEL-SIGNS TRANSFERS

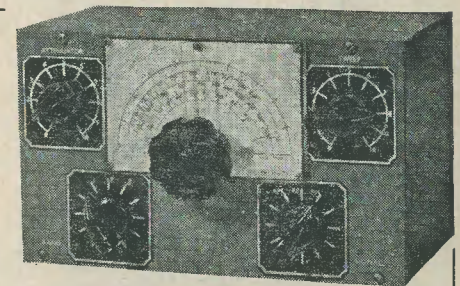

Set No. 1: Receivers and Amplifiers
Five sheets $8\frac{1}{2}"$ x $5\frac{1}{2}"$ containing one Large scale, twelve control panels and wording. 3s. 6d. Postage 2d.

Set No. 2: Test Instruments
Five sheets $8\frac{1}{2}"$ x $5\frac{1}{2}"$ containing two Medium scales, twelve control panels and wording. 3s. 6d. Postage 2d.

Set No. 3: Wording
Wording for Receivers, Amplifiers, Transmitters, Test Equipment and other Radio Apparatus. 4 Sheets, Approx. 400 words, 2s. 6d. Postage 2d.

Panel-Signs Transfers Fixing Varnish 1s. per bottle. Postage 4d.

Note—all wording is in white

Published by

DATA PUBLICATIONS LTD

57 MAIDA VALE · LONDON W9

Telephone CUNningham 6141 (2lines)

Telegrams Databux London

HOME RADIO OF MITCHAM

stock all
the parts for
these fine kits—

THE "VIRTUOSO" AMPLIFIER

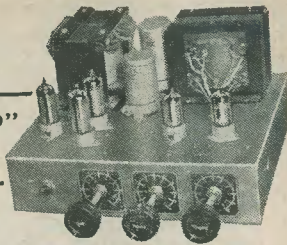

I.T.V. BAND III PRE-AMP

| | | | |
|-------------------------|-----|-------------------------|---------|
| Ready punched chassis | 3/9 | 3-way tag strip | 3d. |
| Teletron 20/T coil | 4/6 | Mains transformer | 10/6 |
| Teletron 21/T coil | 1/- | ECC84 valve | 10/6 |
| Teletron 22/T coil | 3/6 | Set of resistors | 2/3 |
| Coaxial sockets (2) ea. | 1/3 | 8+16µF 350V (2), | ea. 4/- |
| B9A ceramic holder | 1/- | Ceramic condensers, ea. | 9d. |

Complete Kit **£2.12.6** plus 1/6 post

MULLARD 2-VALVE AUDIO PRE-AMP

| | | | |
|-----------------------|--------|--------------------------|----------|
| Punched chassis work | 14/- | Coaxial sockets (6), ea. | 1/3 |
| Set of resistors | 15/- | Bulgin K.370 knobs, ea. | 1/6 |
| Set of condensers | £1.2.6 | Miniature group boards | 2/3 |
| EF86 valves (surplus) | 12/6 | B9A nylon and screened | each 1/9 |
| EF86 valves Mullard | £1.4.4 | | |

Complete Kit **£5.5.0** plus 1/6 post

| | | | |
|---------------------------|-----|------|---------|
| Ready punched chassis | ... | ... | 14/6 |
| 2 meg linear controls | ... | each | 5/- |
| 500k log control | ... | ... | 3/3 |
| Set of fixed resistors | ... | ... | 17/6 |
| Set of condensers | ... | ... | 35/- |
| 6BR7 valve, new, surplus | ... | ... | 12/6 |
| 12AX7 valve, new, surplus | ... | ... | 10/6 |
| 6BW6 valve, new, surplus | ... | each | 9/- |
| EZ80 valve, new, surplus | ... | ... | 9/- |
| Gilson 710/8K transformer | ... | ... | £2.12.6 |
| Mains transformer | ... | ... | £1.5.6 |
| Mains switch | ... | ... | 2/3 |
| B9A valveholders | ... | each | 9d. |
| Bulgin P73 mains input | ... | ... | 4/6 |

Complete Kit **£10.10.0** plus 2/- post

For detailed price lists of these kits send S.A.E.

HOME RADIO

(MITCHAM) LTD

187 London Road Mitcham Surrey
Telephone: MITcham 3282

ARTHURS HAVE IT!

Large Stocks of Valves and C.R.Ts
Full Range of Meters available
Avo, Taylor, Cossor, Advance, etc.
Particulars on Request

FM Kit of Parts £5, less valves
(Ref. Radio Constructor July 1954)
Amplifier Tape Recorders and
Loudspeakers

| | |
|---------------------------------------|----------|
| Jason FM Tuner Unit | £15 17 0 |
| Jason Power Pack | £3 10 0 |
| Radios and Television always in stock | |

VALVE MANUALS

| | |
|--|-----|
| Mullard, 10/6; Brimar No. 6, Osram, Part 1, 5/-; | |
| Osram, Part 2, 10/- | |
| Publications "Lodestar" Tape Recorder | 3/6 |

Goods offered subject to price alteration and being
unsold

Arthurs first
Est. 1919

Proprietors ARTHUR GRAY LTD

OUR ONLY ADDRESS **Gray House**
150-152 Charing Cross Road
London WC2

TEmple Bar 5833/34 and 4765

High Sensitivity
Miniature moving coil

LOUD SPEAKER

As used in the Perdio Pocket
Transistor Radio

Diameter 2 $\frac{7}{8}$ " Depth $\frac{13}{16}$ "
Impedance 3 ohms

Price including tax, post and pack-
ing 27/6. Cash with order. For
this and other miniature com-
ponents.

Apply

SPECIALISED ELECTRICAL COMPONENTS

9-11 Monmouth Street · London
WC2

The Radio Constructor

incorporating THE RADIO AMATEUR



CONTENTS FOR MARCH

VOL. 11 NO. 8

MARCH 1958

ANNUAL SUBSCRIPTION 25/-
including postage

Editorial and
Advertising Offices

57 MAIDA VALE LONDON W9

Telephone
CUNningham 6141
(2 lines)

Telegrams
DATABUX, LONDON

Editor
C. W. C. OVERLAND, G2ATV

Advertising Manager
F. A. BALDWIN, AMIPRE

- 542 Suggested Circuits: A Periodic Switching Device,
by G. A. French
- 545 In Your Workshop
- 553 Understanding Television, Part 3, by W. G. Morley
- 558 The "Ajax" Crystal Receiver, described by P. Vernon
- 561 A Versatile 2-Valve Pre-Amplifier, by R. Hayes
- 568 The "Hi-Gain" Band III Pre-Amplifier,
by Derek Winters
- 576 Can Anyone Help?
- 577 Radio Miscellany, by Centre Tap
- 579 A General Purpose Superhet, by S. E. Addis
- 582 Power Transistors, by E. G. Bulley
- 583 Technical Forum—Rumble in Hi-Fi Systems
- 585 A Push-Pull Bias Oscillator, by A. S. Torrance
- 587 Testing an Audio Amplifier with a Square Wave
Generator, by G. R. Woodville
- 591 Book Reviews

THE CONTENTS of this magazine are strictly copyright and may not be reproduced without obtaining prior permission from the Editor.

ARTICLES appearing in this magazine which describe kits are inserted only on condition that such kits, or special components thereof, are freely available at a trade discount to all retail advertisers.

OPINIONS expressed by contributors are not necessarily those of the Editor or proprietors.

NOTICES

THE EDITOR invites original contributions on construction of radio subjects. All material used will be paid for. Articles should preferably be typewritten, and photographs should be clear and sharp. Diagrams need not be large or perfectly drawn, as our draughtsmen will redraw in most cases, but all relevant information should be included.

All MSS must be accompanied by a stamped addressed envelope for reply or return. Each item must bear the sender's name and address.

TRADE NEWS. Manufacturers, publishers, etc., are invited to submit samples or information of new products for review in this section.

QUERIES. We regret that we are unable to answer queries, other than those arising from articles appearing in this magazine; nor can we advise on modifications to the equipment described in these articles.

ALL CORRESPONDENCE should be addressed to THE RADIO CONSTRUCTOR 57 Maida Vale London W9

REMITTANCES should be made payable to "DATA PUBLICATIONS LTD."

Suggested Circuits

The circuits presented in this series have been designed by G. A. FRENCH, specially for the enthusiast who needs only the circuit and essential relevant data.

No 88 A PERIODIC SWITCHING DEVICE

FROM TIME TO TIME THE WRITER RECEIVES requests from readers for periodic switching devices which are capable, without any attention, of continually turning equipment on and off at regular intervals. In most instances, the switching devices appear to be required for shop displays, or for ornamental lights, whereupon it is desired that the controlled circuits be continually switched on and off at cycles varying from some five to twenty seconds or so. Quite a proportion of the writer's correspondents have stressed their desire that, if a periodic switching device is described in these columns, it should be as simple as possible and have no more circuitry or components than is associated with an electronic timer.

This Month's Circuit

A practical relay switching circuit is illustrated in Fig. 1 and it is intended to answer these requests. As may be seen, it is extremely economical in components. Indeed, the writer feels that, if it were possible to make a periodic relay switch circuit any simpler than that shown in Fig. 1 he would be very

interested to hear of it! The device consists of a relay having a fairly high resistance coil and two contact sets (one of which must break when the relay energises), an electrolytic condenser, and a resistor. A source of high voltage lying between, say, 100V and 250V, and capable of providing sufficient current to energise the relay, is also needed. Since current requirements are low, a normal h.t. supply of the type used in a mains receiver should be more than adequate for the device. If it is intended to provide the switching circuit with its own source of energising voltage, the simple arrangements shown in Fig. 2 or 3 will be suitable. It should be possible to obtain switching cycles up to twenty seconds and beyond with the circuit of Fig. 1, the cycle time required being provided by experimental selection of the value of the electrolytic condenser connected across the relay coil.

Operation

The operation of the device is as follows. Before the h.t. supply is connected to the series resistor and the relay coil, the voltage

across the latter is zero and the relay is in the de-energised position. As soon as h.t. is applied, the voltage across the relay coil at once commences to rise. However, this rise in voltage is slow, it being controlled by the charging current of the electrolytic condenser. When the coil voltage has risen to a value sufficiently high to energise the relay, its contacts A open, and the connection between the coil and the series resistor is broken.

The voltage across the relay coil now commences to drop. Again, a delay occurs, this being caused once more by the presence of the condenser across the relay coil. When the coil voltage has dropped sufficiently low for the relay to de-energise, its contacts A close once more. In consequence the voltage across the relay coil starts to rise again, and it enters a further switching cycle.

As may be seen from this description of circuit operation, the two factors which enable the device to switch on and off at regular intervals are, firstly, the condenser across the relay coil which causes voltage rise or fall to be delayed and, secondly, the fact that the coil voltage at which a relay de-energises is lower than that at which it energises. Whilst the relay contacts A enable the periodic switching operation to take place, a second set of contacts (B) are used for switching external circuits. Fig. 1 illustrates a set of "break" contacts, but any other type of contact—"make" or "changeover"—could be employed according to the desires of the constructor.

Practical Points

As was stated earlier, a relay having a fairly high resistance coil should be used for the device. Best results will probably be given by coils having resistances around 2,000 ohms. Post Office relays should function well in the circuit, and may prove more reliable than the less mechanically robust types employed for such functions as model control, etc. The relay should, preferably, be capable of energising at a current of 10mA or less. Relays requiring high energising currents need proportionally higher capacities in the parallel electrolytic condenser, such values becoming uneconomically large when long time cycles are required.

The value of the series resistor is determined empirically, it being slightly lower than that needed for reliable energising. (A value some 5 to 10% lower than that which just causes the relay to operate would represent a

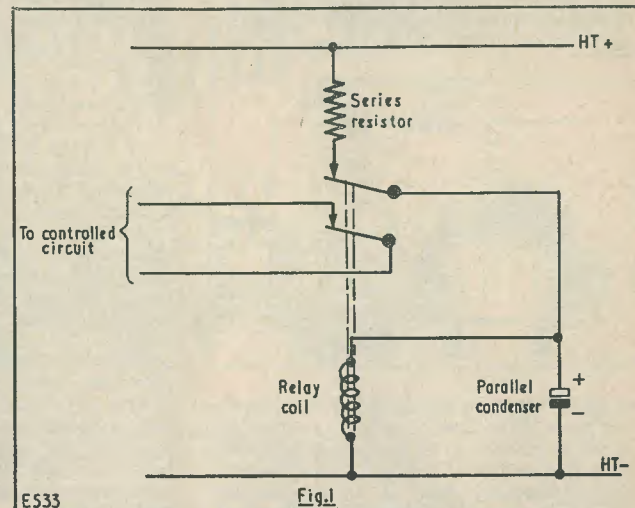

good practical choice.) The resistor and the relay are next connected into the circuit as shown in Fig. 1, different values of electrolytic condenser being connected experimentally across the coil until the required time cycle is obtained. It will probably be found that condensers around 200 μ F will give short timing cycles of some 4 seconds or so, whilst condensers around 1,000 μ F will give proportionately longer cycles, of the order of 20 seconds. (Large value electrolytic condensers

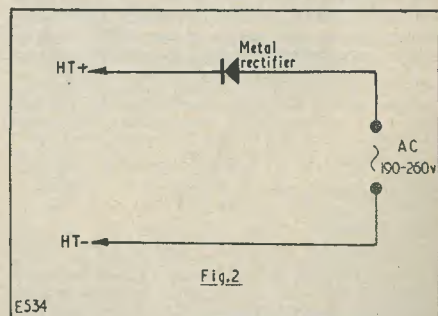

are readily available as television spares, or from surplus equipment.) Unfortunately, it is impossible to specify any particular condenser value in this article, owing to the extremely large number of variables existing in the circuit. The working voltage of the condenser should, of course, be greater than

that needed by the relay to energise. Condensers having working voltages considerably higher than the relay coil energising voltage may be used without detriment to the operation of the circuit. When completed, the switching device should provide on and off periods which are approximately equal in length to each other. If it is found the relay

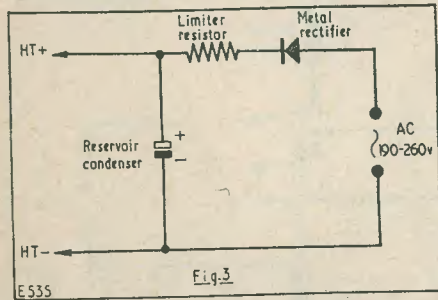

tends to "stick" in the energised position, this will probably be due to too low a residual gap in the armature. (The residual gap prevents the armature from forming a closed magnetic circuit when the relay is in the energised position, and is adjustable with some relays.) If the relay tends to "stick" in the non-energised position it might be found that the leakage current of the electrolytic condenser is excessive, in which case, a partial solution may be given by slightly reducing the value of the series resistor. Poor mechanical operation, or excess friction, in the relay will also, of course, affect reliability.

Power Supply

Although the device will function from any h.t. supply capable of offering the few milliamps required, the writer feels that some constructors may desire to provide it with its

TWO NEW PHILIPS LOUDSPEAKERS

Philips Electrical Limited have introduced two new models in their range of loudspeakers for use with indoor sound reproduction installations. Both are of modern styling with a sloping front cabinet finished in grey "Rexine" and beige "Vynair." They replace the existing ET3011, ET3018 and ET3012. The two-directional effect of the latter may be achieved by placing two ET3090 models back to back.

Type ET3089

This is a 7in moving coil speaker rated at 1W, designed for desk or wall mounting. In the former position it stands on four small feet affixed to the broader end of the cabinet; when wall-mounted, the broader end is uppermost so that the sound is directed downwards. It is suitable for use in conjunction with any 100V line P.A. amplifier and can easily be adapted for a 30V line when required. Dimensions: Height 9½in, width 8in, depth at broad end 5in, depth at narrow end 3½in. Price £4.15.0 (free of tax). A volume control costs 10/- extra.

Type ET3090

This is similar in style and shape to the ET3089. It has, however, an 8in speaker and the transformer is tapped for 1, 3 or 6W. Dimensions: Height 14in,

own power supply. In such an instance the circuit of Fig. 2 could be used.

Fig. 2 employs a series rectifier, thereby enabling half-wave rectified d.c. to be applied to the relay circuit. In most instances this should be all that is required, the electrolytic condenser across the relay coil preventing chatter due to the unsmoothed output from the rectifier. When the simple arrangement of Fig. 2 is used, it will be necessary to connect a condenser of some 5 to 20µF across the relay coil to prevent chatter whilst the value for the series resistor is being initially found, remembering that such a condenser will cause a slight delay before full voltage appears across the relay coil.

It may, in some instances be found that the h.t. available from the circuit of Fig. 2 is inadequate, whereupon that shown in Fig. 3 should be used. Fig. 3 includes a reservoir condenser whose value should be 4µF or more. The circuit of Fig. 3 will cause a considerably higher d.c. voltage to be available than occurs with that of Fig. 2. There is also no necessity to shunt the relay coil with a condenser whilst initially finding the value of the series resistor. The limiting resistor included in Fig. 3 may be a half-watt component having a value lying between 200 and 400 ohms.

It must be emphasised that both the power supply circuits of Figs. 2 and 3 result in the relay circuit proper being connected directly to the mains. If the relay contact insulation is of the low-voltage variety, or if any part of the controlled circuit is capable of being touched, it is essential that an isolating transformer be connected between the a.c. input points indicated in Figs. 2 or 3 and the mains supply. An ordinary mains transformer having secondary tapings offering 190 to 260 volts will prove adequate here. When such a mains transformer is used, the limiter resistor of Fig. 3 is not required.

width 12in, depth at broad end 6½in, depth at narrow end 4in. Price £6.0.0 (free of tax).

NEW LOUDSPEAKERS FOR PORTABLE RECEIVERS

The latest addition to the range of loudspeakers produced by the Plessey Company Limited is a 3in shallow unit which has been specially developed for use in the smaller types of portable receivers.

The overall depth and volume of the speaker have been reduced to the minimum proportions that are consistent with obtaining high sensitivity and maximum value from a very small input. It can be supplied either with a circular chassis for mounting with a clamp around the magnet yoke, or with a square chassis which has four fixing holes.

Features of the unit are the flat chassis and the window cut-outs, which are shaped to facilitate maximum use being made of the space behind the speaker for mounting other components. Overall depth of the standard model is 1in and the flux density is 8,500 gauss; it also employs a magnet with a ½in dia. pole. In instances where a greater depth can be accommodated, a magnet with the value of 10,000 gauss can be supplied. The standard voice coils are 3 or 5 ohms impedance, but high impedance coils up to 80 ohms may be fitted if required.



Aided by his able assistant, Dick, Smithy the Serviceman continues to run the Workshop

ALTHOUGH HE, HIMSELF, WOULD HAVE indignantly denied such a charge, Smithy was essentially a man of habit. Over the years, he had subconsciously worked out for himself the routine which he followed each day during the time he spent at the Workshop. His hat and mackintosh, for instance, always found their way to the same familiar peg on the wall; his newspaper, projecting always from the same pocket of the mackintosh, was always read carefully at lunchtime; and the solving of its crossword was always (or very nearly always) triumphantly completed some two minutes before it was time to start the afternoon's work. Dick had once arrived early and had mischievously unscrewed Smithy's peg and refitted it several feet away from its customary position, with the result that Smithy had nearly been tricked into hanging his hat and overcoat on a bare expanse of wall.

During the previous summer Smithy had, however, made a small change in his routine, this consisting of discarding his heavy mackintosh and replacing this with a rolled-up plastic raincoat. Smithy had marked this change in habit by carefully "miking up" the plastic material of the raincoat, and solemnly pronouncing its thickness to be 0.008 inches. This particular episode had greatly amused Dick until, after reflection, he had suddenly wondered if it was *he*, and not Smithy, who was having his leg pulled. . . .

Whether they were assumed or not, some of Smithy's customs had a seasonal long-term

rhythm, wherein quite abrupt changes in routine were liable to occur at intervals of some six months or so. What was probably the most predictable of these evinced itself one cold February morning when Smithy's arrival at the Workshop was not punctuated by his normal early-morning cough. Dick, who had preceded him, looked round and stared at the Serviceman's unusually set and stern face. With a sigh Dick realised that Smithy had, once again, decided to Give Up Smoking.

Smithy greeted Dick a little curtly and immediately proceeded to the chassis which had been lying on his bench overnight. Dick, who was also half-way through a job he had started the previous day, similarly settled down to work.

Feedthrough Condensers

After a while, Smithy broke the silence and called Dick over to give him a hand. Reaching the Serviceman's bench, Dick saw that Smithy had plugged two large soldering irons into the mains and that he was checking their temperature.

"This is just a quick job," explained the Serviceman to Dick. "What has happened is that this chassis had a faulty 1,000pF feedthrough condenser; and one soldering iron just isn't sufficient to melt the solder all around it so that I can get it free."

Under Smithy's instructions Dick held one of the large soldering irons against the chassis on one side of the feedthrough condenser

whilst Smithy held the second iron on the other side (Fig. 1). With the concerted heat from the two irons the solder around the feedthrough condenser soon melted, whereupon Smithy was able to quickly pull it out of the chassis with a pair of pliers. Smithy next inserted a replacement condenser in the hole left by the faulty component and he and Dick re-applied their irons, together with a small amount of cored solder. The new condenser became reliably soldered into position in a matter of seconds.

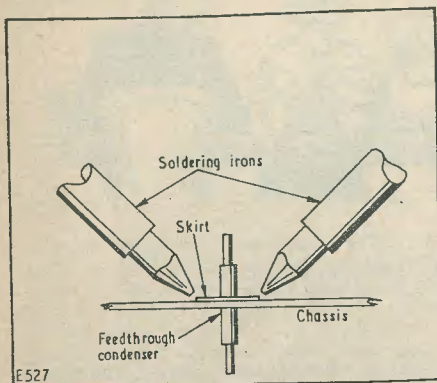

Fig. 1. When removing or fitting feedthrough condensers to a chassis it is often very difficult to ensure that the solder all around the condenser is melted at one time. This difficulty is obviated if two irons are employed, as shown here

"Well, that didn't take long," commented Dick.

"It rarely does, when you use two irons," replied Smithy. "Although I must point out that you can usually solder a feedthrough condenser into a chassis fairly easily with one iron, because it isn't entirely necessary for the solder around it to melt all at once. On the other hand, and especially if you have a chassis made of fairly heavy gauge metal, it can often be the very devil to get one out with only one iron. The difficulty of removal becomes all the harder if the feedthrough has a circular skirt around its body instead of two lugs on either side.

"Returning to the question of fitting new feedthroughs, I often think it's worthwhile using two irons for this operation because this cuts down the amount of time during which the condenser is subjected to a high temperature. I've known feedthroughs shift as much as 50 per cent from their nominal capacity when they have been overheated, and this is something which should never be allowed to occur."

"How, exactly, are feedthroughs made?" asked Dick.

"If you break one open," replied Smithy, "you can usually get an excellent idea of their construction. They consist basically of a ceramic tube, the inside and outer surfaces of which are silvered (Fig. 2). The connector, which passes down the inside hole, is soldered to the inside silvering, whilst the skirt is soldered to the outside silvering. So far as I know, the solder used in the assembly is very similar to the 60:40 tin:lead mixture that we use ourselves, plus the addition of a small silver content, with the result that you are quite likely to momentarily melt the solder holding the skirt to the outer silvering whenever you fit the condenser to a chassis. If you overheat the condenser seriously, not only is the solder joint to the skirt liable to become unreliable, but you may also find that the silvering blackens up. When that happens, your condenser has well-nigh had it. In any case, there's something wrong with your methods if you treat feedthroughs as badly as that. Normally, the necessity for quick soldering of the feedthrough is the prevention of capacity shift, which I mentioned a little earlier, this being possible well before the condenser, as such, becomes physically damaged."

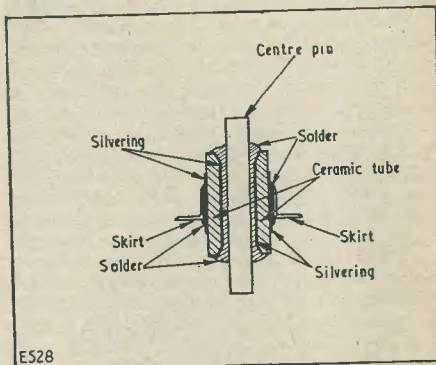

Fig. 2. A cross-section through a typical feedthrough condenser, showing the manner in which the skirt is soldered to the outside silvering and the centre pin to the inside silvering

"I see," said Dick. "In other words, feedthroughs should always be fitted fairly quickly, or you are liable to run into more trouble than that you're trying to cure."

"That's right," said Smithy. "What is required is a quick, common-sense joint using an iron—or irons—which can comfortably give the required heat."

"What are the advantages of feedthroughs?" asked Dick.

Smithy settled himself down comfortably on his chair and felt absent-mindedly in his pocket, only to realise that he was now undergoing a period of self-imposed self-denial. A frown creased his face and he had visibly to collect his thoughts before he was ready to answer Dick's question.

sort of repair, especially if the feedthrough was intended to decouple a v.h.f. circuit or is completing a tuned circuit.

"When I talked just now about the inductance of a straight piece of wire you might have thought that I was painting rather too exaggerated a picture, but quite honestly this is not the case. At frequencies around Band II and Band III, component lead-out induct-

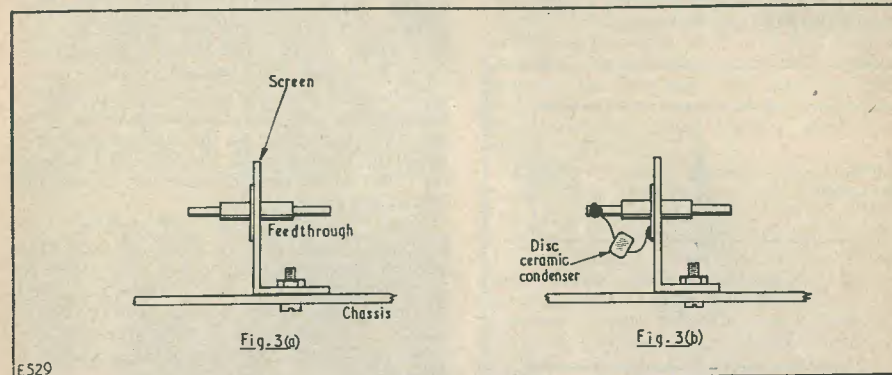

Fig. 3a. The function of feedthrough condensers is that of providing circuit links between screened stages, together with low-inductance decoupling to chassis. (b) If a feedthrough condenser becomes open-circuit a quick repair may sometimes be effected by soldering a disc or tubular condenser of the same value between its centre pin and skirt. A repair of this nature is not recommended for v.h.f. circuits

"Well, the main advantage of feedthroughs," he commenced, a little distractedly, "is that they are ideal for connecting together circuits in separate screening compartments whilst automatically providing decoupling (Fig. 3(a)). However, this is by no means the entire answer because, due to the way in which feedthroughs are made and are soldered to their associated chassis, they also provide a decoupling path whose inductance is very low indeed. Due to this second factor you find feedthroughs employed in decoupling circuits where all the connections to them are made at one end only. In such an instance, it is almost certainly the low inductance feature of the feedthrough which is being exploited. An ordinary tubular or disc decoupling condenser has noticeably more inductance than a feedthrough, this being almost entirely due to the fact that such condensers have essentially to be connected into circuit by means of their lead-out wires. These lead-out wires, usually very thin, are the main contributors to the extra inductance. Incidentally, the inductance of a straight piece of wire increases as it becomes thinner. When a feedthrough goes open-circuit you can quite often effect a quick repair by soldering an ordinary condenser across it (Fig. 3(b)). However, you may not always get away with this

ance becomes extremely important. In fact, you will find in some turret tuners that feedthroughs which are used for completing tuned circuits are mounted in positions where they are not soldered to the chassis at all. Instead, their outside silvering is soldered direct to valveholder or component tags, their bodies being 'in mid-air.' In practice, the use of a feedthrough in this slightly unconventional manner has a great deal to commend it. Not only does the feedthrough present a low inductance to the circuit in which it is inserted, but it also presents a constant inductance. In such mass-production things as turret tuners, constant wiring inductances, from turret to turret, are quite essential."

"I certainly didn't think things were as critical as that," remarked Dick. "Still, I suppose that the higher we go in frequency, the more attention we have to pay to 'hidden' inductances, and points like that."

"Believe it or not," commented Smithy, "but things are dead easy right now. When Bands IV and V open up, then t.v. design and servicing will become really interesting!"

Modulation Hum

Smithy ended the conversation somewhat abruptly at this stage and turned to his bench,

whereupon he moodily surveyed the chassis whose feedthrough condenser he had just changed. Dick decided to leave him to his thoughts and walked back to his own work. Smithy was already beginning to exhibit marked signs of grumpiness, and Dick wondered how long it would be before the Serviceman finally gave up his struggle. Dick made a private bet with himself that a cigarette would be burning away on Smithy's bench before the day was over.

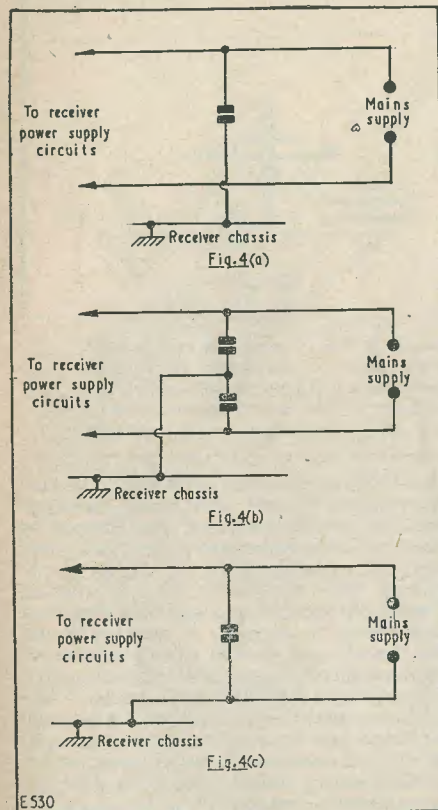

Fig. 4. Three conventional methods employed in receivers to reduce mains modulation. The circuits shown in (a) and (b) apply to receivers having mains transformers, and that in (c) to a.c./d.c. receivers

Dick soon became engrossed with his work, and it wasn't until he decided to prepare the tea for their morning break that he remembered about Smithy. As he looked over, he saw that the Serviceman was now checking,

with a remarkable lack of interest, a faulty sound receiver.

"Drat this set," remarked Smithy as Dick passed by him. "I've just cleared what I thought was the only snag it had—a low-capacity h.t. electrolytic—and I now find that the blamed thing has got modulation hum as well."

To prove his point, Smithy turned the tuning knob of the receiver. Between stations the background hiss seemed clear and of average quality, but when a station was tuned in a loud hum became evident.

"The annoying thing," continued Smithy aggrievedly, "is that this modulation hum may only be present on the mains supply and aerial in the workshop. I bet that, if I were to try it out in the customer's home, the trouble would not occur at all."

Dick regarded the Serviceman with sympathy, marking the fact that the great man was so distracted that he was now defeated even by modulation hum. Gently he pulled the mains plug of the receiver from the bench socket and reinserted it experimentally the other way round. All trace of the modulation hum cleared.

Smithy looked round, startled out of his apathy.

"Ye gods and little fishes, am I slipping!" he exclaimed. "Perhaps I'll feel better after a cup of tea."

A cup of tea soon cheered up the distraught Serviceman and, before long, he had almost retrieved his normal confident and competent outlook on life.

"Well, Dick, you certainly showed me up there," he chuckled. "Fancy me forgetting to do a simple thing like that!"

"Mains modulation doesn't seem to be a very frequent fault these days," Dick volunteered.

"You're perfectly right there," replied Smithy. "I suppose that the main reason for its relative rarity is that sound receiver power supplies are so simple and straightforward now that there is little risk of the stray coupling that existed in some of the more fancy circuits employed before the war. Also, almost all manufacturers employ the simple device of connecting a condenser of $0.01\mu\text{F}$ (or thereabouts) between one side of the mains input and chassis (Fig. 4(a)). Sometimes you have two condensers (Fig. 4(b)) or, in an a.c./d.c. set, a condenser straight across the supply (Fig. 4(c)). Either of these arrangements is usually sufficient to kill mains modulation altogether. T.V. receivers also employ a condenser across the mains supply, but the value in these sets may be notably higher, up to $0.1\mu\text{F}$ or so. Incidentally, if ever you replace a condenser used in an anti-mains modulation position you should always try to use one having an a.c. working voltage rating

which is higher than the mains voltage. Such a condenser is not then liable to break down in use. In point of fact, the question of anti-mains modulation condensers breaking down is really quite important, this being due to safety considerations. The situation isn't too bad in a.c./d.c. sets because, if the condenser breaks down, it merely blows the house fuse. With sets employing isolating mains transformers, however, the state of affairs is much more dangerous due to the chassis becoming live as a result of the breakdown. This may mean that the external cabinet metal work of the set may also become live, as well as the aerial lead. Quite a hazardous condition."

"Are condensers in the mains input circuit usually sufficient to clear modulation hum?" asked Dick.

"Normally they are," replied Smithy, "but they are not always successful. Modulation hum can sometimes be very tricky to tackle. We saw just now that, by merely reversing the receiver mains plug, the modulation hum cleared up in that set on the bench. As a matter of fact, assuming an a.c. mains supply, reversing the mains plug is usually the first thing you should try. With some of the older receivers modulation hum might be extremely strong in one house and completely absent in another. An old dodge used to consist of adding $0.01\mu\text{F}$ condensers between either one or both anodes of the h.t. rectifier and chassis. I have heard a number of claims for success with this idea but, quite frankly, it has never worked for me."

"Is the aerial input circuit liable to contribute to modulation hum?" asked Dick.

Smithy did not answer immediately, and Dick saw that his eyes were focused on a point behind him. Carefully he poured out a second cup of tea for the Serviceman. Under Dick's ministrations, Smithy slowly returned to the world. Dick revised his previous estimate and gave Smithy no more than two hours at the outside before cigarette smoke once more filled the Workshop.

"What was that?" said Smithy.

Dick repeated his question. "Oh yes," responded Smithy. "The aerial circuit! Ah, now, that *can* have quite an effect on modulation hum. Let us assume that you have an a.c./d.c. receiver whose chassis is connected to one side of an a.c. mains supply. We then connect an aerial to its aerial input terminal. Like this (Fig. 5(a)). I've assumed in my sketch that there is a condenser C_1 in series with the aerial socket to isolate this from the chassis. Now the aerial will have a capacity to earth which we could reproduce in a simple equivalent circuit (Fig. 5(b)) as C_A . We could also state that some form of input impedance, Z , exists inside the receiver between the aerial socket and chassis. So far so good! Now, let's see

what happens when a 50 c/s voltage exists between the chassis of the set and earth. At once (Fig. 5(c)) we have the case where we can represent this voltage by an a.c. generator. The voltage from the a.c. generator will, of course, be very high—approximately equal to the mains voltage itself—if the chassis is connected to the live side of the mains."

"I think I can guess what your next point will be," interrupted Dick. "What happens now is that you apply a 50 c/s a.c. voltage via C_A and C_1 to the input impedance Z of the receiver. It then becomes possible for a proportion of the a.c. to be built up across this input impedance, thereby giving you modulation hum."

"Exactly," Smithy replied. "And we now come to the all-important question of the input impedance, Z , itself. If this input impedance is that presented by a tuned circuit with a coupling winding (Fig. 5(d)), the impedance presented to 50 c/s a.c. by Z will be only that of a small number of turns of wire. This impedance would be so low compared with that given by C_1 and C_A in series that only a negligible amount of 50 c/s a.c. would appear across it. An input coil of this type would not allow modulation hum via the aerial circuit to appear. As I really wish to talk more about bottom-end coupled input circuits, I want to make the quick statement just now that a 50 c/s voltage across the primary coil has also to reach the grid of the first valve via the mutual inductance between this primary and the tuned coil. The relatively low value of this mutual inductance will further help to eradicate mains modulation."

"A bottom-end aerial coupling circuit, which is still used fairly frequently in present-day receivers, gives a very different picture. In its simplest state, a bottom-end coupled circuit would take the form of a condenser at the bottom of a tuned coil (Fig. 5(e)), whereupon our input impedance Z becomes the reactance of this condenser. Such a reactance may easily be comparable with that of C_1 and C_A in series, with the result that quite a considerable amount of 50 c/s a.c. may be built up across it and be applied to the grid of the first valve. In practice, bottom-end coupled circuits employing a simple condenser are rarely, if ever, used mainly because they give rise to—guess what!"

"Modulation hum?" queried Dick.

"Precisely," replied Smithy. "So it is usual to use an input circuit for bottom-end coupled receivers wherein a low value resistor effectively reduces the input impedance, so far as 50 c/s a.c. is concerned, without excessively upsetting r.f. performance (Fig. 5(f)). Values for this resistor, which is connected in parallel with the bottom-end condenser, lie normally between 2 and $10\text{k}\Omega$. Unfortunately, even the presence of this low

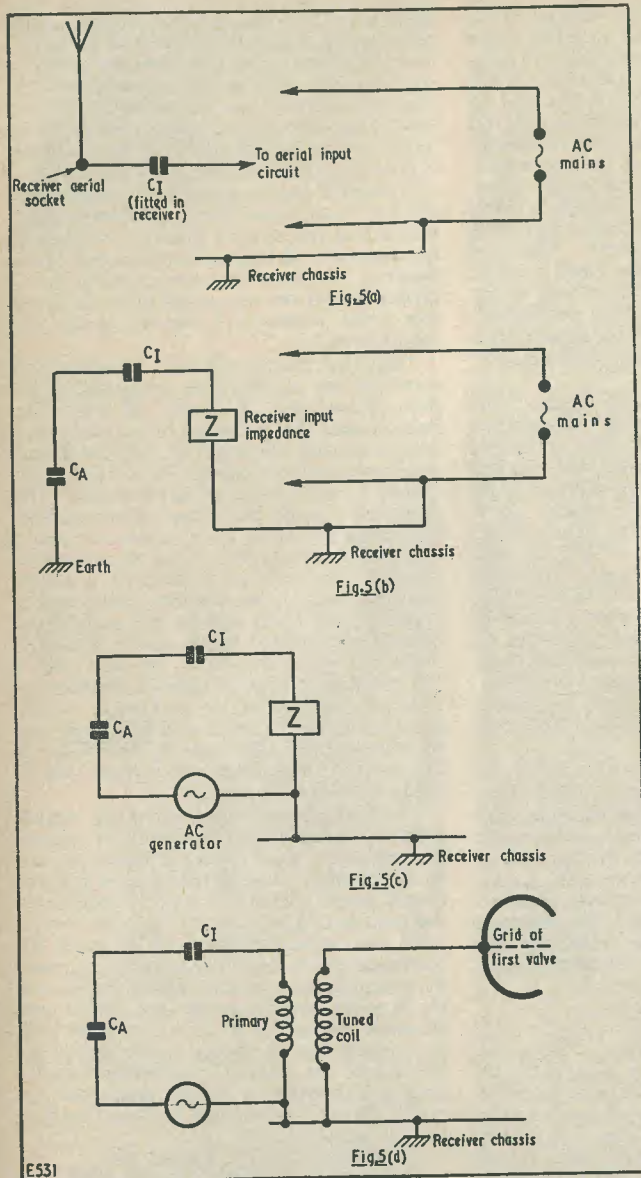
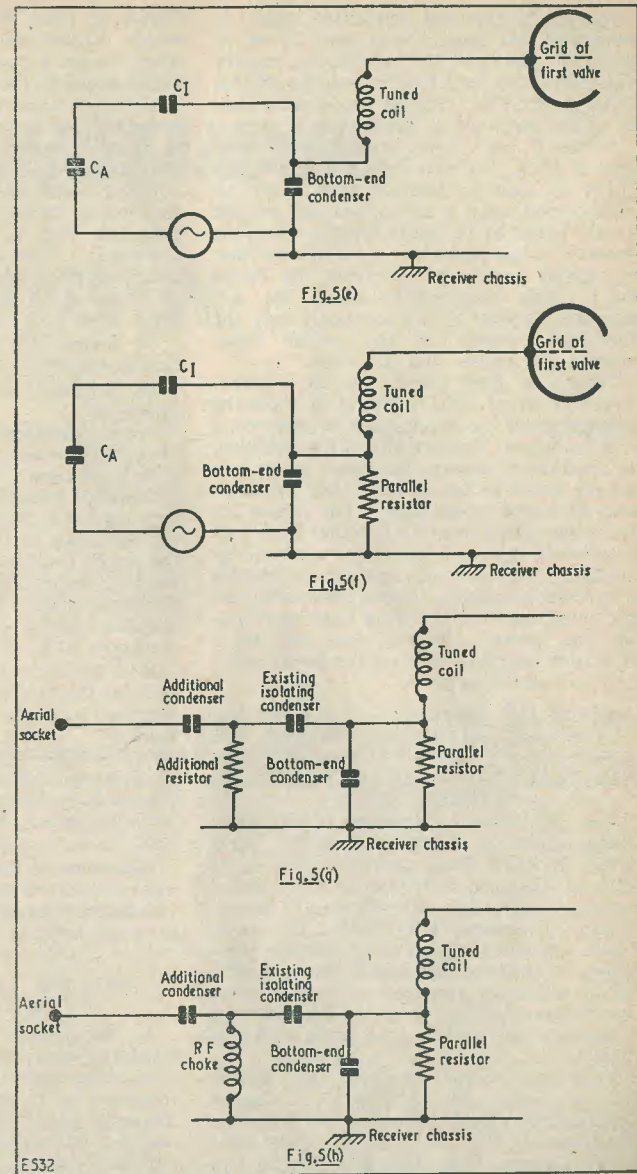

Fig. 5a. Aerial and mains input circuits in a typical a.c./d.c. receiver. (b) The circuit of (a) altered to show aerial-earth capacity, C_A , and the input impedance, Z . (c) The a.c. generator shown here represents the 50 c/s a.c. voltage existing between the receiver chassis and earth. (d) When the receiver input is provided by a tuned coil with a coupling winding, the low impedance of the latter, together with the relatively low mutual inductance between the two windings, prevents a.c. voltages being impressed on the grid of the first valve

value resistor does not entirely eradicate the trouble, and circuits of this type are still liable to suffer from modulation hum in 'awkward' localities."
 "Are there any cures for the trouble?" asked Dick.
 "Well, it's fairly easy to reduce the hum if the aerial input circuit is causing the trouble,"

replied Smithy. "One method consists of reducing the series aerial condenser, and this can usually be done by simply inserting a low-value series condenser—say 50 pF or so—between the aerial and the receiver input socket. There is no need, in this instance, even to take the back off the receiver. Inserting the low-value condenser is equivalent to

Fig. 5e. With a bottom-end coupled circuit, the input impedance to 50 c/s a.c. is high and a low impedance connection to the grid of the first valve is provided by the tuned coil. (f) The high impedance of the bottom-end condenser may be reduced by connecting a low value resistor across it. (g) Adding an R-C filter to reduce mains modulation. (h) Mains modulation may be almost entirely eradicated by employing an r.f. choke, as shown here



reducing the value of C_A and C_1 in series. Alternatively, you can try reducing the value of the resistor across the bottom-end condenser; but, as you are liable to lose gain seriously if you go below 1 kΩ here, this course does not give you much scope. Often, quite a considerable improvement can be made by adding a simple R-C filter (Fig. 5(g))

between the bottom-end condenser and the aerial input socket. A value of 5 kΩ for the resistor and of 50 to 100pF for the condenser would be typical, and there wouldn't be too much loss in gain. The 5kΩ resistor then presents a low impedance to 50 c/s a.c., whilst the 50 to 100pF series condenser gives a high impedance, thereby causing less a.c. to appear

across the bottom-end condenser itself. If you have a real 'toughie' you could try an r.f. choke in place of the additional resistor (Fig. 5(h)), the very low impedance of this choke to 50 c/s a.c. clearing modulation hum out of the aerial circuit altogether."

"What I don't quite understand," commented Dick, "is why you go to all this bother to clear modulation hum from the aerial circuit when it seems that this trouble is only liable to be really serious when the chassis is at live potential. Couldn't the hum be cleared merely by reversing the mains plug? This would then cause the a.c. generator in your circuit to supply only the small a.c. voltage, if any, which exists between the neutral line and earth."

"That's a good point," agreed Smithy, "and I'm afraid that, in trying to show the importance of the aerial input impedance, I have somewhat over-simplified the problem. In practice, reversing the mains plug only reduces and does not entirely clear obstinate cases of mains modulation. The reason for this is that, apart from the fact that there may be a small voltage between the neutral line and earth, there may also be a certain amount of capacitive coupling between the aerial and any unscreened mains wiring inside and outside the house. Thereby, you still get a capacitive coupling between the aerial and a high voltage mains point."

Oscillator H.T. Ripple

"This raises another point," said Dick. "A

friend of mine has a short-wave receiver which exhibits modulation hum, but only when the set is tuned slightly off the station. What would be the reason for that, Smithy?"

However, Smithy was not listening and had reverted, instead, to staring past Dick's shoulder. Suddenly Dick realised that the Serviceman had his eyes fixed on the valve cupboard behind him. With a somnambulistic motion the Serviceman finally rose from his chair and, walking stiffly, reached the cupboard. After some moments he turned round again, a cigarette in his mouth, a cloud of smoke above his head, and a gleam in his eye.

"I thought I'd left a packet in there," Smithy remarked triumphantly.

He returned to his bench and inhaled luxuriously.

"Now, what's all this?" he said briskly to Dick. "Hum on a short-wave set when you're slightly off-tune? That's almost certainly *not* modulation hum at all, my boy. Instead, it's very probably ripple on the h.t. line causing the oscillator to be frequency modulated at the ripple frequency. When you're off-tune the f.m. becomes a.m. on the skirts of the i.f. response, and you then hear it from the speaker. Remedy? Check your smoothing. And now let's get down to the grind!"

With which comment Smithy ended discussion for the morning and, coughing happily, sent the protesting Dick scurrying back to his work.

Electronics Limited, W. Vinten Ltd., the Wayne Kerr Laboratories Ltd., Mr. R. W. Wells (member exhibit), Wolsey Electronics Ltd.

Admission is by ticket only, available free from the Secretary, the Television Society, 166 Shaftesbury Avenue, London, W.C.2, or from any exhibitor.

PHILIPS TAPE RECORDERS A New Accessory

A programme indicator (three-digit revolution counter) designed to clip on to the edge of the carrying case of the AG 8109 tape recorder is a new accessory now being marketed by Philips Electrical Limited. It can also be used by clipping to the carrying handle of the case, with models AG 8105 and AG 8107. A programme indicator is already available for model AG 8106. Known as Type EL 3979/17, the new indicator is finished in grey plastic to match the AG8109, and the digits are in white. There is a plastic cap at the end of the drive cable, and this is pushed over the top of the spool spindle. The accessory can, therefore, be very quickly and easily fitted and removed as required. It sells at £3.7.6 (free of tax).

UNDERSTANDING

TELEVISION

PART 3

By W. G. MORLEY

The third in a series of articles which, starting from first principles, describes the basic theory and practice of television

THE TELEVISION SOCIETY ANNUAL EXHIBITION

The 15th annual exhibition of the Television Society is being held at the Royal Hotel, Woburn Place, London, W.C.1, as follows: Tuesday, 4th March, 11.30 a.m.—8 p.m.; Wednesday, 5th March, 12 noon—8 p.m.; Thursday, 6th March, 12 noon—7 p.m. A wide range of equipment and new apparatus will be demonstrated, including colour television receivers. The exhibition covers many facets of the television field and is the only one dealing specifically with this subject.

Exhibitors include: Aerialite Ltd., Belling & Lee Ltd., The British Broadcasting Corporation, Bush Radio Ltd., Cintel, Chapman & Hall Ltd., E. K. Cole Ltd., A. C. Cossor Ltd., the Ever-Ready Co. (G.B.) Ltd., the General Electric Co. Ltd., Hallam, Sleigh & Cheston Ltd., Livingston Laboratories Limited, Mullard Limited, Murphy Radio Ltd., Norwood Technical College, Post Office Engineering Dept. (W. E. Branch), Siemens Edison Swan Limited, the Standard Insulator Co. Ltd., the Telegraph Construction & Maintenance Co. Ltd., Thorn Electrical Industries Ltd. (Ferguson Radio Division), 20th Century

IN THE SECOND ARTICLE IN THIS SERIES, published in last month's *Radio Constructor*, we dealt in very general terms with the nature of the transmitted television signal. This month and next we shall carry on to discuss the television signal in greater detail, paying especial attention to its constituent parts when considered in terms of frequency and time.

We shall not, however, concern ourselves with examining the British 405 line system only, but will also pay attention to the American 525 line system, the "C.C.I.R. 625 line" system employed on the continent and in Australia, and the French 819 line system. The writer feels that, even at this early stage, it is worthwhile examining television from the viewpoint of the major systems employed throughout the world instead of merely working in the narrow field of our own 405 line standard. Much development and design work is in progress with all the systems currently employed, and too great a pre-occupation with a standard which does not conform with the best that modern television can provide is liable to give a somewhat limited horizon.

The 405 line System

The British 405 line system employs the waveform shown in Fig. 13. This diagram illustrates the appearance of the waveform

around the frame synchronising pulses for the even and odd frames, the remainder of the signal consisting of the picture information and line sync pulses which occur in the frames themselves. Commencing with the first waveform ("Even") we encounter several lines of picture or video information. (Video qualifies picture signals in the same way as audio qualifies sound signals.) We have the irregular line normally employed to denote the picture signal provided during the scan period, this being followed by the line sync pulse which was discussed last month. At the end of the last line in the frame (No. 405) we enter into the frame blanking period. The first part of this period is devoted to frame synchronising pulses, these occupying a time equal to four complete lines. It should be noted that, although the shape of the frame sync pulses is considerably different from that of the line sync pulses, we still have downward-going pulse edges which are spaced out at intervals equal to one line. Since these downward-going pulse edges are equivalent to the leading edges of line sync pulses, they initiate the line flyback at the requisite instant in just the same manner as occurred before we entered the frame blanking period. As a result, the line deflection circuits in the receiver still keep running at correct, synchronised frequency during the frame blanking period. The diagram shows twice as

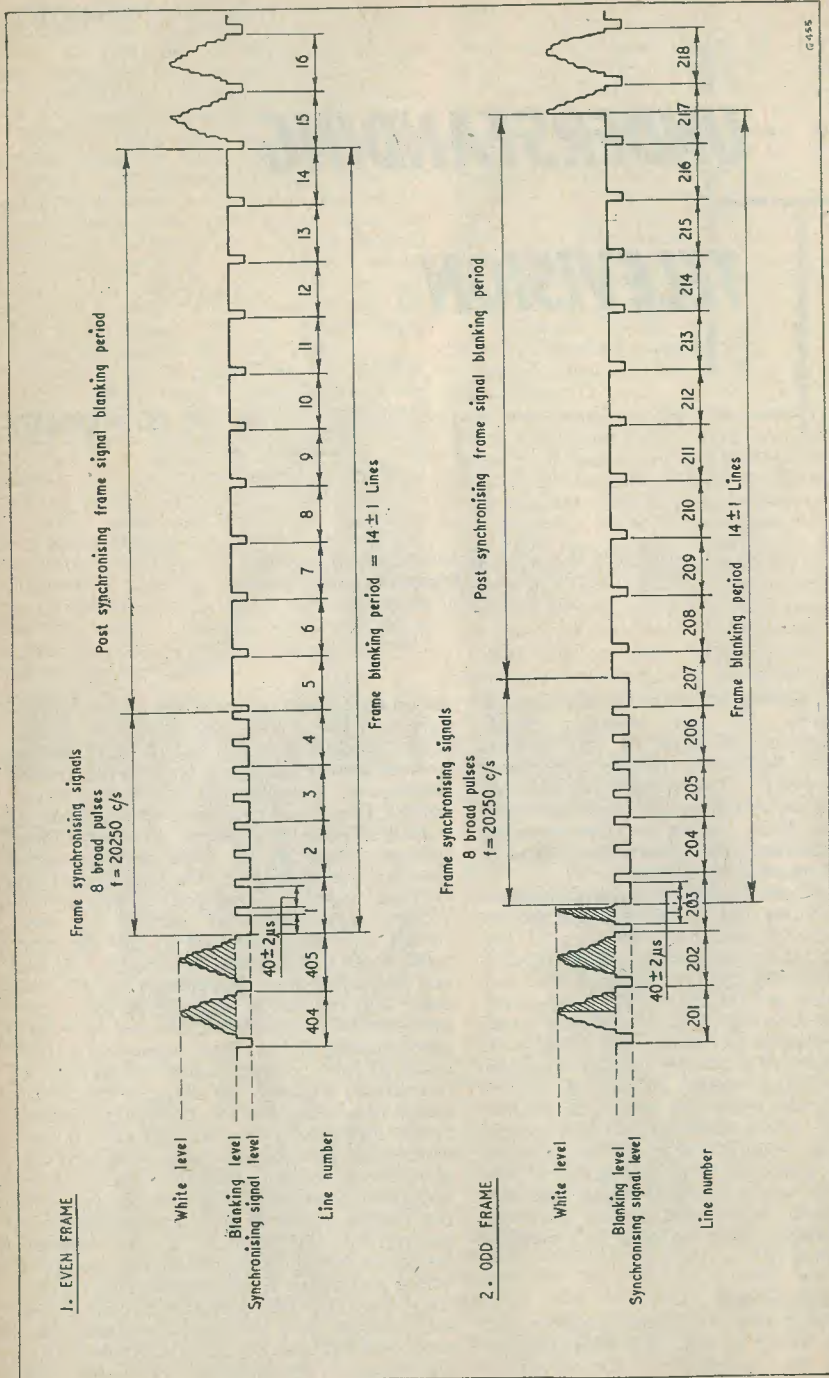

Fig. 13. Synchronising waveform of the 405 line system. The shaded part of the signal may consist either of picture information, as shown, or it may be occupied by a blanking period up to 2 lines in length

many downward-going pulse edges as are needed for line synchronisation, the receiver line synchronising circuits being such that they respond only to the first, third, fifth, seventh and ninth pulse edges, those in between being ignored.

At the end of the frame synchronising signal section, we enter into the remainder of the frame blanking period. Over this remaining part, the transmitted signal remains at blanking level, downward-going pulse edges continuing to be transmitted at intervals of one line. The overall length of the frame blanking period is 14 ± 1 lines, with the result that the second part, the "post synchronising frame signal blanking period" occupies 10 ± 1 lines.

The last downward-going pulse edge in the frame suppression period could be considered as being the leading edge of the first line sync pulse of that part of the frame which follows, since it is succeeded by the familiar line sync pulse shape and a back porch. After the back porch we have the commencement of video information in the first active line of the frame (i.e. the first line containing picture information), whereupon the waveform proceeds, down the frame, in normal position.

The second waveform shown in Fig. 13 is that applicable to the odd frame blanking period, and it differs slightly from that for the even frame blanking period. As before, we start off with several lines of video information, together with their now-familiar line sync pulses, but, this time, we enter the frame blanking period after only half of the last active line of the frame (No. 203). The frame sync pulse section of the frame blanking period, once more, occupies the same time as four lines, but this time the downward-going pulse edges, which keep the receiver line circuits in synchronism, are the second, fourth, sixth and eighth. After the frame sync signal section the waveform enters the same "post synchronising frame signal blanking period," as occurred with the even frame. It will be observed, however, that the first part of this period at blanking level is equal in length to only half a line, this enabling its first downward-going pulse edge to follow, after the correct time of one line, the eighth downward-going pulse edge in the frame sync signal period.

The odd frame suppression period continues until we reach the ultimate downward-going pulse edge, after which we have a half-line at blanking level before picture information commences. Following the first half-line of picture information (half of line 217) a normal line sync pulse appears and the next line, and those subsequent to it, are transmitted in the usual fashion.

It will be obvious from the waveforms illustrated that at no time does the signal rise

above blanking level during the entire frame blanking period, with the result that, theoretically, the screen of the television receiver should remain blanked out during this period. A minor point of interest is the existence of the half-lines of picture information at the beginning and end of the odd frame blanking period. It is possible to see these half-lines very readily at the top and bottom of the picture on any television receiver having acceptable interlace and focus.

In Fig. 13 part of the picture information section before the frame blanking period is shown shaded. This shaded section can either consist of the picture signal, as shown, or of a signal whose amplitude is at blanking level.

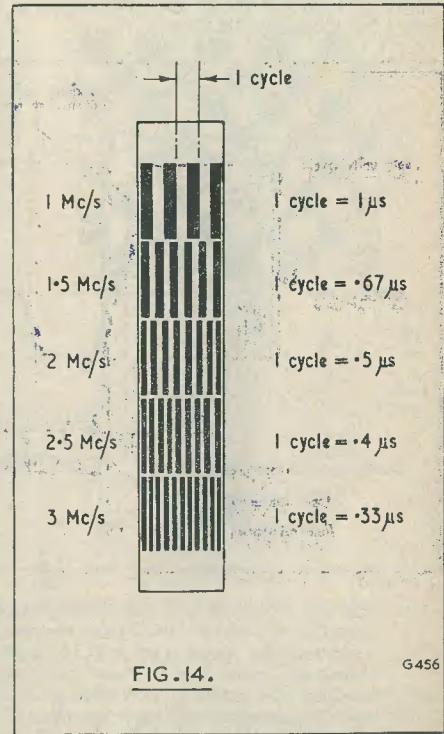

FIG. 14.

G456

Fig. 14. The frequency gratings on the left-hand side of the 405 line Test Card C

Time and Frequency

We have just considered the formation of the transmitted 405 line television signal, but we have not yet appended any "dimensions" to it. The "dimensions" in which we are interested now are those which define the

length of time taken up by each constituent part of the waveform, and the units we use are, as is to be expected, units of time.

We know that, in the 405 line system, we have 25 pictures per second, each consisting of 405 lines (including the "lines" which occur during the frame blanking period). It follows from this that the *line frequency* of the 405 line system must be 25 multiplied by 405 cycles per second; that is, 10,125 cycles per second. Since there are 10,125 cycles per second, it follows again that the length of each

line cycle must be $\frac{1}{10,125}$ seconds; viz. 98.7 microseconds. (One microsecond—or μs —is one-millionth of a second.) The length of each complete line cycle shown in Fig. 13 is, therefore, 98.7 μs .

picture information in each line of the 405 line system is approximately 80.7 μs . If, for any reason, a B.B.C. or I.T.A. transmitter radiated a test signal having, say, a single 10 μs pulse in each line, these pulses would then appear on the screen of a receiver as a vertical bar whose width was approximately one-eighth of the total picture width.

Time and frequency are obviously inter-related, and it is interesting to calculate the time taken up by parts of a signal with which we are familiar. Thus, with Test Card C we can evaluate the time taken up by the alternate black and white lines in the frequency gratings. The top grating in the left-hand side of Test Card C (see Fig. 14) represents a modulation frequency of 1Mc/s. The time taken up by each cycle of a 1Mc/s signal is one-millionth of a second, so we can state that each cycle (a

will be seen in this diagram that the sync pulse does not have the idealised shape assumed in Fig. 13. A slight delay occurs when the amplitude of the signal changes, and the out-lines of the pulse become somewhat sloping and rounded in consequence. Fig. 15 also illustrates the application of the term "blanking level." The blanking level in the 405 line waveform is 5% of full amplitude below the black level, and is encountered only during synchronising periods.

Fig. 15 gives information on the various proportions of the waveform together with their times. It may first of all be noted that peak white corresponds to 100% waveform amplitude. This is, of course, due to the fact that the 405 line system employs positive modulation, wherein maximum transmitter output is given when the television camera scans a peak white part of a scene. All other amplitudes are then quoted as a percentage of peak white. Also, tolerances are given for the amplitude of the black and blanking levels. Tolerances are necessary here because it is impossible to hold these amplitudes to an exact percentage. No tolerance is given for line period time of 98.7 μs , as this figure represents the length of a cycle whose frequency is closely controlled.¹ However, fairly wide tolerances are given to the lengths of time taken up by the front porch, back porch and sync pulse. Such tolerances are necessitated in practice by the nature of the transmitting equipment.

Picture Elements
In the previous article it was stated that horizontal detail of the same standard as that given in the vertical sense is given by the 405 line system when this has a limiting picture information frequency of 3 Mc/s. With such a limiting frequency it would be theoretically possible to transmit a chequer-board pattern, the sides of whose squares were equal to the width of one scanning line. We are now in a position to examine this point in greater detail.

Picture Elements

A term which is frequently used when referring to television reproduction is *picture element*. Fig. 16 shows part of the chequer-board pattern we have just referred to. Each black square, and each white square, in this pattern could be described as a picture element. The waveform given by a camera scanning along line XY of the chequerboard would be that shown below the pattern. We know that each *cycle* of picture information corresponds to *two* picture elements; or in other words that, if a cycle commences at a point where a black square changes to a white square, it ends at the point where the

next black square changes to a white square.

A second term employed to describe a television picture is its *aspect ratio*. The aspect ratio of a picture is the ratio of its width to its height and, in the 405 line system, is 4:3. Thus the width of the television picture is 4/3 times its height.² The number of active horizontal lines in a 405 line system is 405 minus the number lost in the frame blanking period. An average of 28 lines (each of the two frame periods are equal to 14 ± 1 lines) are lost here, so the number of active lines left in the picture is 377, each of which is capable of reproducing, in the vertical sense, one picture element; i.e., a white square of the chequerboard appears on one line, a black square on the line above, and so on.

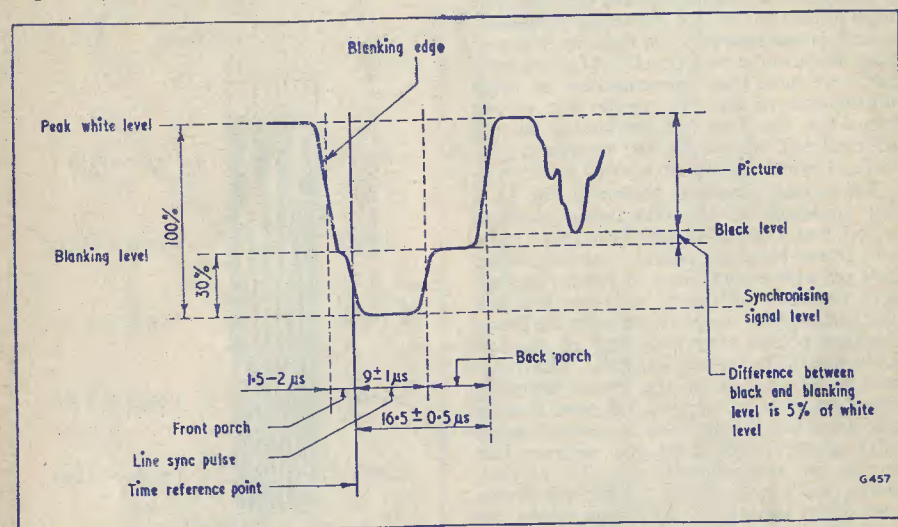

Fig. 15. The line sync waveform of the 405 line system. This signal is shown in its video form, before it modulates the transmitter. The modulated carrier signal has synchronising signal level at 0.3% and blanking level at $30 \pm 3\%$ of peak carrier amplitude (white level). Pulse durations are measured at half-amplitude points on a white level signal. (Rise time of leading and trailing edges of sync pulse—10% to 90% amplitude—is not less than 0.25 μs . Rise time of leading and trailing edges of blanking pulse—10% to 90% of its amplitude—is between 0.25 and 0.5 μs

Of the line cycle, part of the 98.7 μs is taken up by the line sync pulse, together with its front and back porches. The total time occupied by this part of the waveform, allowing for tolerances in the transmitter, lies between 17.5 and 19 μs (see Fig. 15); and we could assume a mean of approximately 18 μs in the average transmission. This means that the average time devoted to

black signal plus a white signal) of the 1 Mc/s vertical bars is 1 μs . Similarly, each cycle of the 2Mc/s bars has a length of 0.5 μs , and each cycle of the 3Mc/s bars 0.33 μs . The frequencies and cycle times of all the Test Card C gratings are shown in Fig. 14.

In Fig. 15 is shown a detail illustrating the shape taken up by the 405 line sync pulse, together with its front and back porches. It

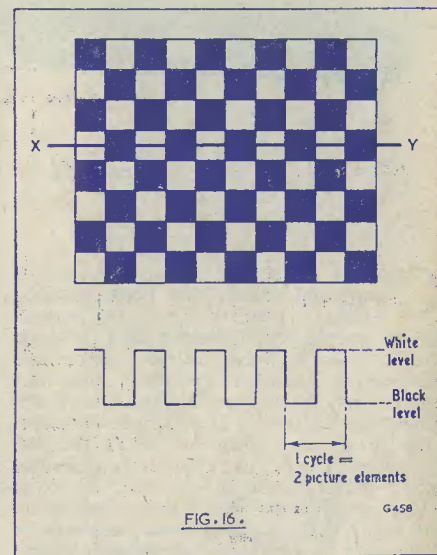

Fig. 16. The "chequerboard" concept employed for evaluating horizontal versus vertical resolution

Let us now work from the assumption that 3 Mc/s represents our top picture information frequency. Each cycle of this frequency will occupy $1/3 \mu\text{s}$ of time with the result that, in our average line of 80.7 μs picture information time (see above) we may reproduce 3×80.7 cycles; that is, 242. Each cycle contains two picture elements, so we may say that 3 Mc/s corresponds to 484 picture elements in each line of the picture. However,

¹ This assumes a mains supply frequency, to which the transmitted frame frequency is tied, of 50 c/s.

² This figure is equivalent to the aspect ratio of commercial moving picture film. Or was, in the pre-CinemaScope days.

(continued on page 592)

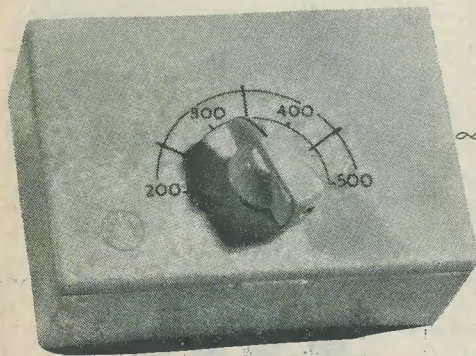

The AJAX Crystal Receiver

Described by P. VERNON

CRYSTAL RECEIVERS ARE ALWAYS IN THE news and several have been described within the pages of *The Radio Constructor* in recent years. Despite this, however, the demand for these relatively simple and inexpensive receivers continues unabated among our younger readers. As an introduction to the hobby, and to radio construction in general, they are ideal for the enthusiast. The receiver about to be described offers nothing new in the way of either circuit or technique—but it does bring within the reach of the “out-of-town” constructor the means by which all the components can be purchased from several of the advertisers in this issue all in one parcel. A further advantage is that a well designed casing of attractive appearance, together with a suitable tag board, is available. The cream plastic case, together with the red figured dial and white pointer knob, makes an attractive ensemble and has considerable eye appeal. The lid of the case is robustly fixed to the casing body by means of a metal hinge.

Circuit

This is shown in Fig. 1, from which it will be seen that it is a perfectly straightforward crystal detector circuit. Although the quality of a crystal detector is excellent, there usually remains the great disadvantage of lack of selectivity, the greatest cause of this being the dampening load across the tuned circuit caused by the detector itself. In the circuit shown, the selectivity problem has been

largely overcome by using a triple-wound coil. This particular coil (Teletron type HAXM/MW) has been specially designed by the manufacturer for use with germanium crystal diodes. The maximum selectivity, together with a high signal output, has been achieved through the minimum dampening of the tuned circuit achieved by the inclusion of a separate winding for the crystal diode. The employment of these new miniature type coils largely removes the main problem—associated with crystal receiver design and construction.

Alongside the circuit is shown the point-to-point wiring diagram, both being simplicity itself and therefore requiring little explanation. The tuning condenser is of the variable mica dielectric type—these being more compact than the normal air-spaced types and thus being admirable for crystal sets which are usually required to be of small physical dimensions.

No particular germanium diode is specified, the reader being free to choose any that he may prefer. Types such as the Brimar GD4 or the Mullard OA71, or others such as the GEX34, GEX44, GEX55, GEC45, 1N34, or the BTHCG1 will all perform equally well in this circuit. All of these crystal diode types have a very low forward resistance, being of a few hundred ohms only, while their reverse resistance is very high.

The headphones used should be of the high impedance type—4,000 Ω if possible.

Construction

Assuming that the reader has purchased the complete kit as offered by an advertiser, the method of construction is very simple indeed. For the benefit of the beginner readers, these instructions are set out below.

First, mount the Teletron type HAXM/MW coil on the paxolin chassis by means of the long screws provided. It will be noted from the photograph shown here that this coil is positioned so that the slot in the tag ring is towards the bottom end of the case. Three holes are already drilled in the paxolin chassis, and the two lowest should be used for mounting the miniature coil. The remaining hole at the top is for use with the standard type HAX coil—this being somewhat larger than that shown here. Should this standard type coil be used, the two outer

position, using a pair of pliers as a heat shunt, i.e. gripping the lead between the joint and the glass. The red, or positive, end of the diode should be soldered to tag 3 of the coil situated at the top right of the tag ring (see photograph and Fig. 1). The black end of the diode should next be soldered to the bottom right hand socket looking at the chassis from the front, this tag being one of the 'phone output sockets. The eventual position of the diode may be seen from the illustrations. Next, with a suitable length of bare wire, solder together the top left hand socket (earth connection), to the bottom left hand socket (remaining 'phone output socket), and from there to coil tag 1 at the bottom left hand of the tag ring. From this latter tag ring, also solder one end of a small length of p.v.c. wire of sufficient length to reach the tuning condenser when mounted.

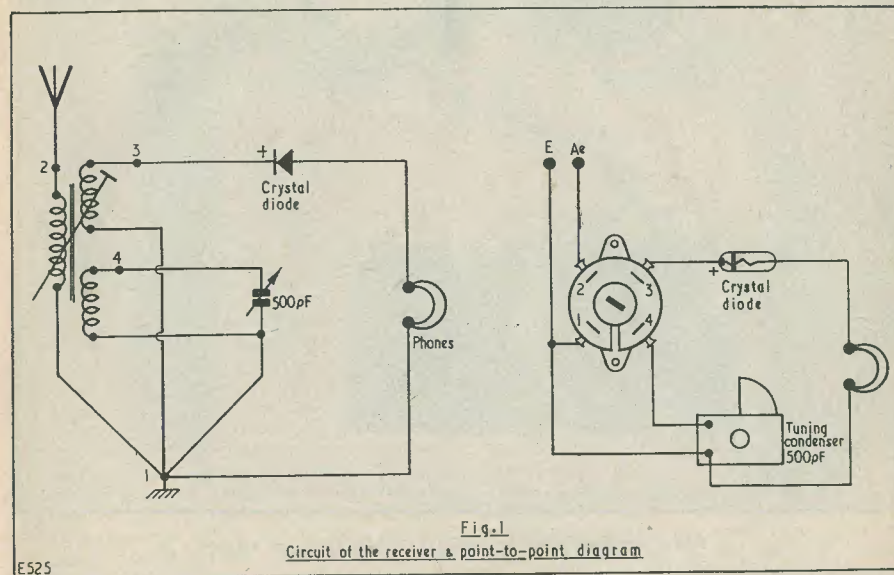

Fig. 1

Circuit of the receiver & point-to-point diagram

Component List

Crystal Receiver Case and Paxolin Chassis complete with sockets, Teletron.
Crystal Diode (see text).
Pointer knob.

Headphones 4000 Ω Impedance.
500pF Variable Condenser (Mica Dielectric).
Coil—Teletron HAXM/MW.
Screws, nuts, connecting wire.

holes will, of course, be used for mounting the coil—in which case the coil connecting tags will require to be carefully bent downwards in order to permit the casing lid to be fully closed.

Having mounted the coil, the wiring should now be carried out with the chassis outside the case. First, solder the crystal diode into

From tag 2 of the coil at the top left of the tag ring, solder one end of a length of p.v.c. wire, the other end of which should now be secured to the top right hand socket of the chassis (this being the aerial input terminal). Having completed the above, fix the chassis into the case by means of the two small screws and nuts provided.

The next item to place into position is the tuning condenser. Mount this, by means of the nut and threaded spindle, into the case lid. Secure the pointer to the spindle in such a manner that the pointer fully covers the dial readings in conformity with the condenser "swing."

at the bottom left of the tag ring, is connected to the larger of the solder tags on the tuning condenser (this tag being secured to the condenser spindle by a large nut).

This completes the wiring and assembly of the crystal receiver. Connection of an aerial, earth and headphones will enable the con-

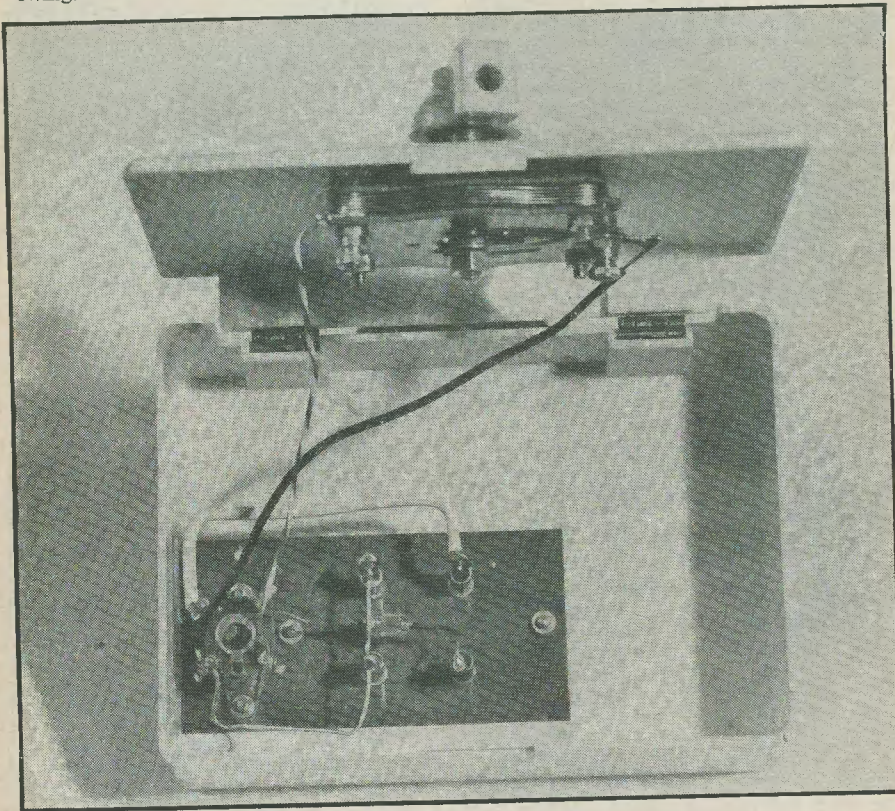

The completed receiver with lid opened to show wiring

The final connections are those to the tuning condenser and these are best carried out by approximately half closing the lid (see photograph for this position) and then soldering the respective connections. Connect by means of a suitable length of p.v.c. wire tag 4 of the coil (lower right hand of the tag ring) to the smaller of the condenser solder tags. The remaining length of p.v.c. wire, that we have previously soldered to tag 1,

structor to tune in most of the local stations; but it should be pointed out that a really good aerial and earth system are required to enable the receiver to perform with its maximum efficiency.

This little crystal receiver is not only ideal for the beginner but would also make an attractive present for the junior members of the family.

ERRATA. In the circuit diagram of the Virtuoso Amplifier on page 488, last issue, R₁₀ was inadvertently omitted. It should be connected between R₃-R₂-C₁ and C₂.

A similar error occurred in Suggested Circuits No. 87, where in Fig. 1, page 463, R₁₂ (between R₁₃ and h.t.+) was indicated but not shown.

A VERSATILE 2-VALVE

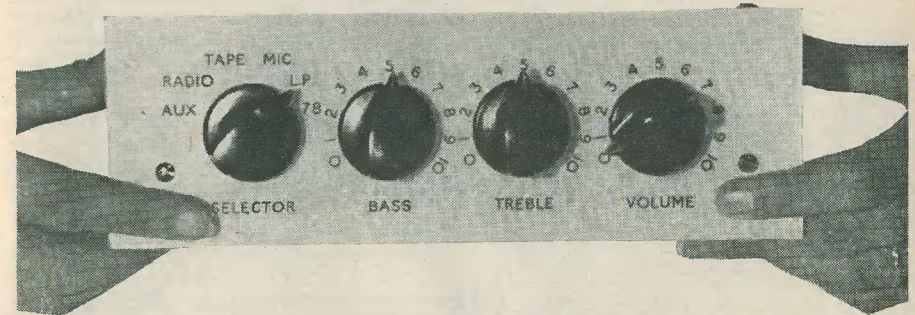

PRE-AMPLIFIER

By R. HAYES

AT THE NATIONAL RADIO SHOW LAST YEAR, the writer was looking for a pre-amplifier design which would enable him to obtain all the facilities provided by the better-class commercially made "Hi-Fi" amplifier equipments at which one is inclined to look so longingly. An extremely interesting array of items on the Mullard stand, who devote a special section to cater for the needs of the amateur constructor each year, attracted my attention and subsequently ended my search. Having discussed the question of pre-amps with an enthusiastic Mullard attendant there, I was shown a prototype version of an extremely useful and flexible 2-valve pre-amp which would give me the required facilities, all provided by the operation of a single rotary switch. Originally this piece of equipment was designed for constructors who had built the Mullard "5-10" 10-watt High Quality Amplifier and who wished to arrange for it to accept a number of varying inputs. The addition of this pre-amp to that amplifier can be carried out quite easily by removing the existing input circuit of the "5-10" in "one lump," as it were, and substituting the new pre-amp. This would seem a worthwhile addition to make to the original "5-10" as by so doing the following inputs can be accepted, and provides the link by which the main amplifier can be put to many uses and which would form the basis of a very classy complete "Hi-Fi" outfit. Such an equipment could

compare favourably with the best money can buy, provided that care is taken in selecting the ancillary equipment such as loudspeaker, tape-deck, f.m. tuner, pick-up, etc.

The writer now has such an outfit and felt that, in view of the fact that the Mullard leaflet issued so far on the pre-amp only gives the circuit, description and component list, the constructional details should be of interest to the many constructors who have built the main amplifier and merely use it for gramophone reproduction or in conjunction with an f.m. tuner.

Description

The circuit (Fig. 1) used here gives the output connections to the Mullard "5-10" (from the junction of R₂₂ and R₂₃). The full output can be taken, if required, directly from the anode of the second valve via the usual condenser, from which it is true to say that the pre-amp will serve admirably in front of many other well-known amplifiers, including the Mullard "20 watt."

Mullard Ltd. state that the original and only leaflet issued (their ref. TP331 Aug. 1957) is now being revised so that the circuit details and component numbering used in this article are as will appear on a forthcoming publication by them.

Before describing the construction of this amplifier, let us look over the specification quoting from the above-mentioned leaflet.

Mullard EF86 high gain pentode valves are

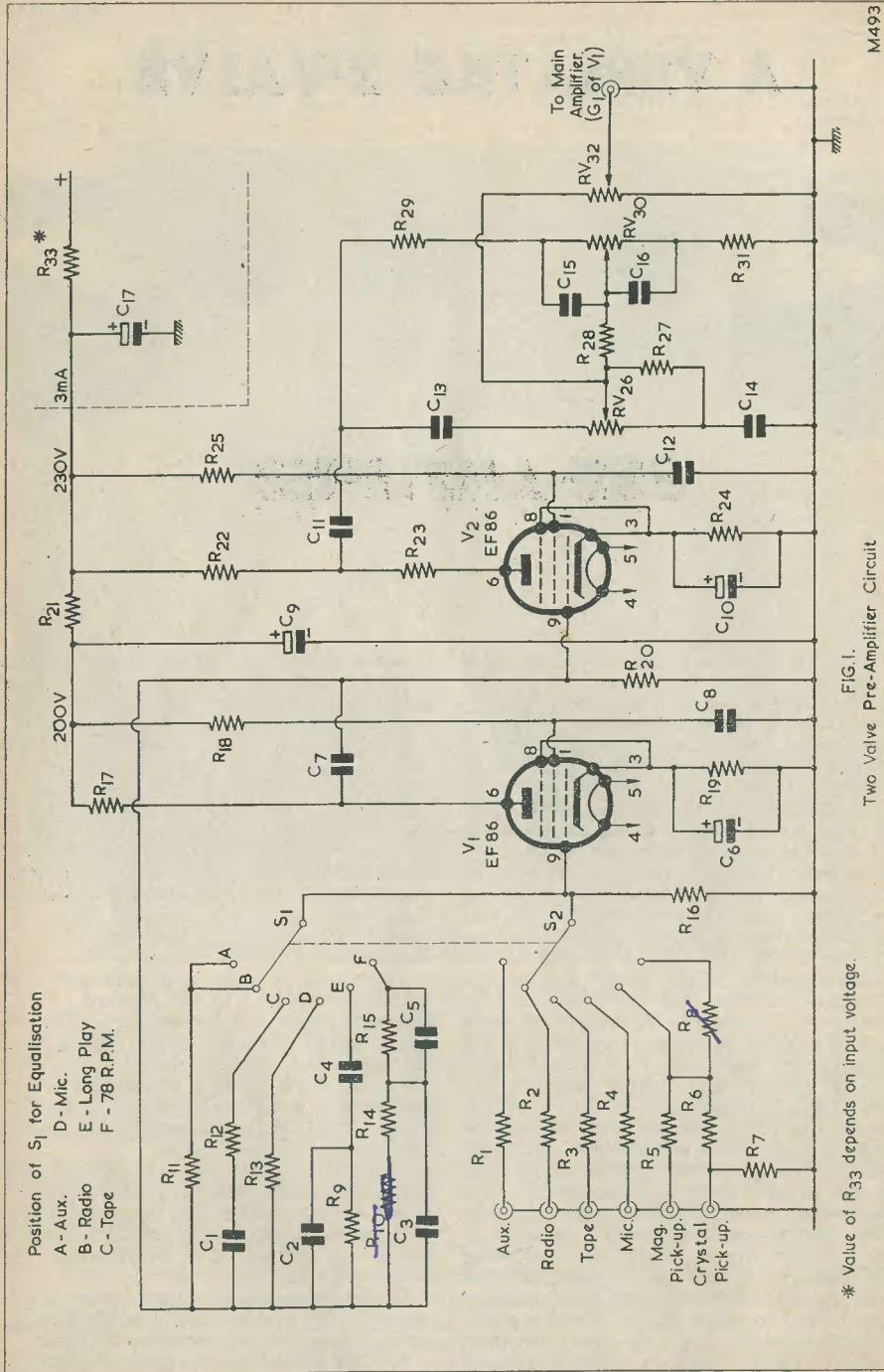

* Value of R33 depends on input voltage.

FIG. 1.
Two Valve Pre-Amplifier Circuit

M493

delete R10
q R8

used in each of the two stages, all equalisation being achieved in the first stage by means of frequency-selective feedback applied from anode to grid of V₁. The second stage embodies no feedback, but arrangements are made to determine the sensitivity of the amplifier by altering the ratio of R₂₂ and R₂₃. An alternative method consists of adjusting each input channel individually by altering the series grid resistors of V₁ (R₁ to R₈). You will see, therefore, that either the overall sensitivity can be set at maximum or minimum, and either of these conditions can be maintained whilst individual input channel sensitivity and impedance can be adjusted as required. The input impedance of any one channel is the sum of the series grid resistor and the effective grid impedance, which latter can be taken at 20kΩ.

Switch Position Summary

1. **Auxiliary Position**
This position can be used for Mullard Tape

amplifier insertion or high-output crystal pick-ups. If required for low-output crystal pick-ups, R₁ can be cut down to 1MΩ. Otherwise it is identical with the radio input channel. As it is shown, input impedance is 2MΩ, sensitivity 250mV.

2. Radio Position

With the impedance and sensitivity as for "Auxiliary" position (these values being most suitable for normal requirements) any alteration to the circuit can be achieved by varying the feedback resistor R₁₁ and series resistor R₂. For example, if the input impedance is too high it can be decreased by a resistor of the requisite value from the input end of R₂ to chassis.

3. Tape Playback Position

Intended for the replaying of pre-recorded tapes using high impedance heads, the input impedance is arranged to be 80kΩ as shown—but if more sensitivity is required, R₃ can be decreased until a satisfactory level is reached.

2-VALVE PRE-AMPLIFIER COMPONENT LIST

Set out for easy reference to Fig. 1.

Resistors

- R₁ 2.2MΩ ±10% ½W
- R₂ 2.2MΩ ±10% ½W
- R₃ 56kΩ ±10% ½W
- R₄ 1MΩ ±10% ½W
- R₅ 68kΩ ±10% ½W
- R₆ 1MΩ ±10% ½W
- R₇ 100kΩ ±10% ½W
- R₈ 180kΩ ±10% ½W
- R₉ 560kΩ ±5% ½W
- R₁₀ 10MΩ ±5% ½W
- R₁₁ 330kΩ ±5% ½W
- R₁₂ 560kΩ ±5% ½W
- R₁₃ 10MΩ ±5% ½W
- R₁₄ 5.6MΩ ±5% ½W
- R₁₅ 220kΩ ±5% ½W
- R₁₆ 100kΩ ±10% ½W
- *R₁₇ 220kΩ ±10% ½W
- *R₁₈ 1MΩ ±10% ½W
- R₁₉ 2.2kΩ ±10% ½W
- R₂₀ 1MΩ ±10% ½W
- R₂₁ 33kΩ ±10% ½W
- R₂₂ 18kΩ ±10% ½W
- R₂₃ 82kΩ ±10% ½W
- R₂₄ 1.2kΩ ±10% ½W
- R₂₅ 390kΩ ±10% ½W
- R_{V26} 250kΩ log. potentiometer
- R₂₇ 47kΩ ±10% ½W
- R₂₈ 39kΩ ±10% ½W
- R₂₉ 68kΩ ±10% ½W
- R_{V30} 250kΩ log. potentiometer
- R₃₁ 6.8kΩ ±10% ½W
- R_{V32} 250kΩ log. potentiometer
- R₃₃ 30kΩ ±10% ½W

* High stability

Capacitors

- C₁ 390pF ±5% silvered mica
- C₂ 150pF ±5% silvered mica
- C₃ 680pF ±5% silvered mica
- C₄ 560pF ±5% silvered mica
- C₅ 82pF ±5% silvered mica
- C₆ 25µF electrolytic 12V
- C₇ 0.1µF paper 350V
- C₈ 0.1µF paper 350V
- C₉ 8µF electrolytic 350V
- C₁₀ 25µF electrolytic 12V
- C₁₁ 0.1µF paper 350V
- C₁₂ 0.1µF paper 350V
- C₁₃ 560pF ±10% silvered mica
- C₁₄ 8,200pF ±10% silvered mica
- C₁₅ 2,200pF ±10% silvered mica
- C₁₆ 0.02µF paper 150V d.c. wkg.
- C₁₇ 1µF electrolytic 350V

Chassis punched and drilled (see text)

Valves V₁, V₂ EF86 Mullard

Switch, 2-pole 6-way double wafer Yaxley type

7 sockets, co-axial panel mounting

Control panel, engraved (see text)

Control knobs, 4 as required

Power cable plug, to suit main amplifier outlet socket

Group boards, 2 × 10-way to fit chassis mounting holes

Connecting wire

6BA screws (4in), nuts and washers

Valveholders, 2 B9A nylon loaded with screen

See April '58 p 660

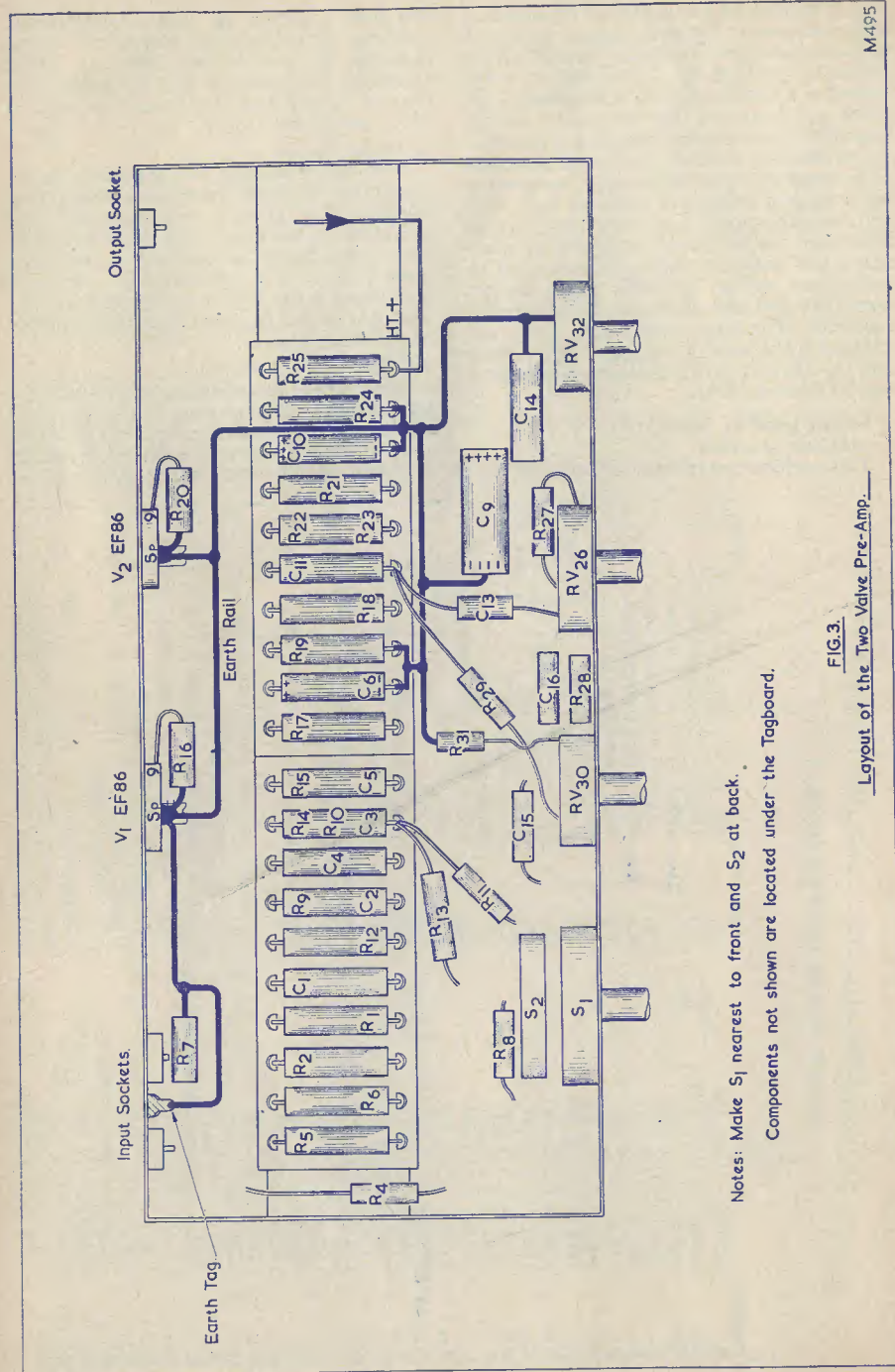

Notes: Make S1 nearest to front and S2 at back.
Components not shown are located under the Tagboard.

FIG. 3.
Layout of the Two Valve Pre-Amp.

M495

Sensitivity as shown is 3mV and the C.C.I.R. characteristic is followed down to 100 c/s; below this frequency less boost is evident.

4. *Microphone Position*
High impedance microphone equipment is catered for on this channel, the usual crystal, or magnetic type with matching transformer, being the two forms usually encountered. With an input impedance of 1MΩ the sensitivity is 6mV.

5. *Magnetic Pick-up Position*
This position is ideal for those fortunate enough to possess a variable-reluctance type

kindly to this loading, or its output is too high, you can use the auxiliary switch position as described, when the exact loading required can be provided. In comparison to Position 5 the sensitivity of this channel, as given, is 50mV at 1 kc/s for L.P. and 150mV for the 78 r.p.m. position, and you can compare this with the figures given for the auxiliary position.

N.B.—Regarding Switch Positions 5 and 6, it is essential that these two input sockets do not have the magnetic and crystal pick-ups plugged in together.

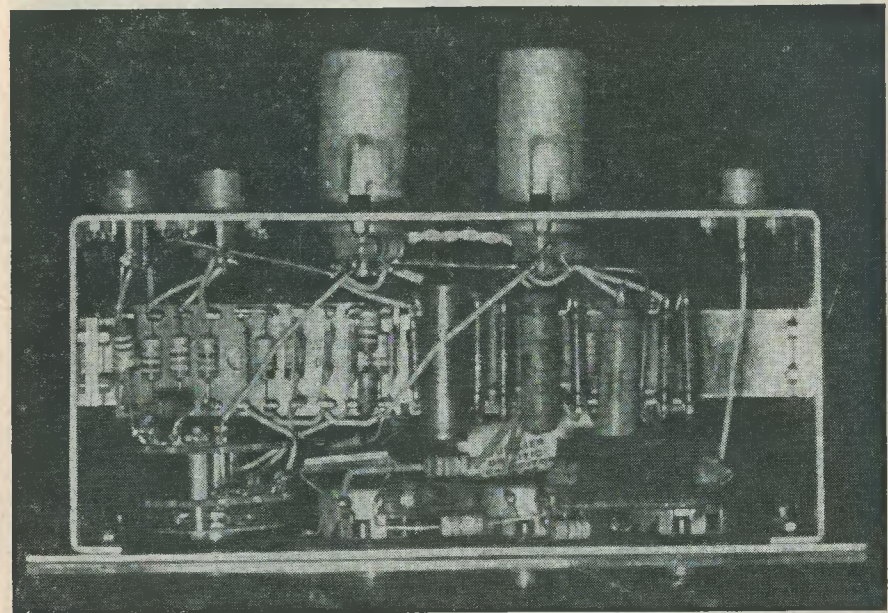

Illustration of a prototype showing appearance of completed pre-amplifier, with cover plates removed

pick-up, but moving-coil pick-ups with higher outputs can be used if a larger value of series resistor R5 is inserted. The change in sensitivity between the L.P. and 78 r.p.m. is secured partly by the differing amounts of feedback applied at positions 5 and 6, but mostly by the attenuation given by R8. With component values as shown, the input impedance is near enough 100kΩ, whilst sensitivity for the L.P. position is 3mV and 9mV at 1 kc/s for the 78 position.

6. *Crystal Pick-up Position*
With sensitivity and impedance as for the Magnetic Pick-up channel at 100kΩ, some bass loss results with a crystal pick-up, but it is felt that the values given provide the best compromise for most types of pick-up. If you find your particular pick-up does not take

Other points of interest to note are that the equalisation for the pick-up positions conforms to the latest R.I.A.A. characteristics which are in use by most of the well-known recording companies, whilst the tape playback characteristic is suitable for replaying pre-recorded tapes at 7½ inches per sec.

It will be noted that low impedance tone controls covering a wide frequency range are used, making the pre-amplifier give sufficient control for most applications today, and making it possible to use reasonable lengths of co-axial input cables without their attendant capacity effects.

With regard to the h.t. supply, the current drawn by the unit is 3mA. The smoothing circuit shown in dotted inset should be included in the main amplifier chassis, a good

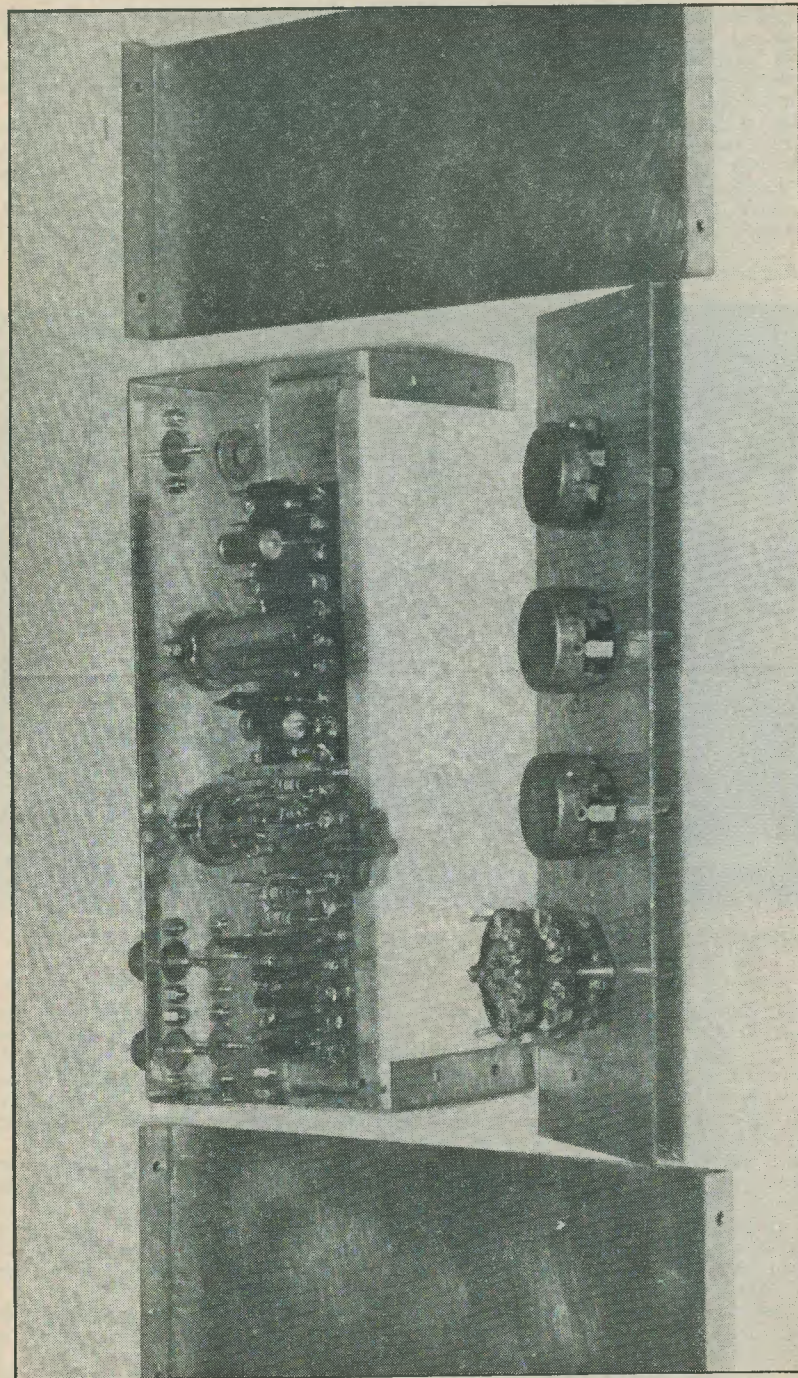

Illustration showing chassis components ready for assembly and wiring

place usually being to attach it to the supply socket provided. With 320V available from the main amplifier supply it is quite easy to calculate that R_{33} should be volts to be dropped
current drawn

The value of the resistor is, therefore $30k\Omega$ $\frac{1}{2}$ watt, which is a suitable one to insert in the above case, and can be made up from two $15k\Omega$ $\frac{1}{2}$ watt in series. This value should be within $\pm 10\%$, and alteration can be made to suit a particular h.t. supply. The capacitor should be a $16\mu F$ electrolytic.

Construction

A ready-punched chassis can be obtained from a number of retailers, details of which will be found among the advertisements in this issue. The usual "box" type of chassis is not employed, it being felt that the home constructor would best be served by a unit construction type of assembly.

Figure 2 shows the chassis with component parts in position. This photograph in conjunction with the layout diagram (Fig. 3) will enable the constructor to get a start at assembling. It was found advisable to solder the resistors and capacitors on to the two group boards before fixing their supporting bracket on to the main chassis. With these in position and the two group boards bolted on, there is very little difficulty in following out a wiring sequence which becomes obvious if a start is made at the output socket, tackling the valveholder connections to the group board assembly first. Certain of the wiring to the control panel components is best accomplished with the front panel detached, and the channel selection switch is best left until last.

One very important point concerns the earthing arrangements. It is important that the "earth rail" system be used which only

makes contact with the chassis at one point and one point only. Fix a soldering tag at a convenient point in the middle of the six input sockets, and use this as the terminal point of the "earth rail." It will be found that, starting at the earth tag, a lead can be run along to spigot (V_1), on to spigot (V_2), across to the join of C_{10} , R_{24} , and thence to the join of C_{14} , RV_{32} and the join of C_6 , R_{19} , R_{31} . The following can then be "hooked on" to the "earth rail" where convenient: R_7 , R_{16} , R_{20} , C_{12} , C_8 , C_9 .

The h.t. + line is best secured to the end of R_{25} which comes nearer the front panel.

A hole to which a rubber grommet should be fitted is provided, through which the supply cables are run. Some form of retention should be made on the cable inside the box to prevent undue strain on the soldered joints. This can be achieved either by a whipping, tied to the chassis, or by means of a cable cleat which can be placed in the space on the bracket carrying the group boards. The heater pair should be separately twisted along themselves, and for neatness the h.t. positive and the twisted heater pair again twisted together. The writer understands that a suitably engraved panel is being prepared for sale through dealers. This is necessary in order to present an acceptable exterior when fitted into your cabinet.

In conclusion, no difficulty should be encountered in the construction; and there is no reason why, with reasonable care and provided your various pieces of equipment are correctly plugged into the requisite input socket, you should not enjoy immediately the very great advantages of being able to switch over from gramophone to tape or f.m. or microphone, and so on, by the operation of a single switch.

Films for Electrical Trades

A number of 16mm films which are of interest to the electrical, radio and allied trades have been added to the G.B. Film Library's hire list of industrial subjects. They include *Project Tinkertoy* from America, which demonstrates the application of machine assembly methods to the production of electronic components.

Others are *Water Power* (describes methods of utilising water for generating electricity); *The Steam Turbine* (showing its development from Hero of Alexandria to Parsons); *Electro-Magnetic Induction* (principles demonstrated by animated diagrams); *Cathode Ray Oscillograph* (construction and application); *The Microphone* (explanation of carbon and ribbon types); *A Switch in Time* (illustrates the principle of motion study in the assembly of a light switch); *Elements of Electric Circuits* (the concept of electric currents and

flow electrons); *Series and Parallel* (the relationship between resistance, current and pressure in series and parallel circuits); *How Television Works* (explains how a television camera analyses a picture into electrical impulses for broadcasting); and *Primary Cell* (a study of dry cell operation in terms of electron action).

In addition to these, further titles are available on free loan. They are *Power Tools in Industry* (covers the building operations by various trades from the foundations to the completion of a house); *Golden Minutes* (illustrates creative electrical tool selling with special emphasis on good display); *Modern Meter Manufacture* (describes the manufacture of the Ferranti single-phase type f.m. meter); and *Opportunity Knocks* (demonstrates effective sales approaches for salesmen of power tools).

The

HI-GAIN BAND III PRE-AMPLIFIER

By DEREK WINTERS

The "Hi-Gain" pre-amplifier is intended for insertion between the aerial and 75 ohm input circuit of any television receiver capable of reception on Channels 8, 9 or 10. Low noise performance, a gain of 17 dB or more, and simplicity of trimming adjustments make this pre-amplifier a very attractive item for the home-constructor.

WHEN BAND III TRANSMISSIONS COMMENCED in this country several years ago much public interest was aroused. This concerned itself not only with the programmes to be broadcast, but also with the aerial and receiver equipment needed for their reception. A considerable amount of sets were "converted," many Band III aerials were erected, and large numbers of receivers capable of working in both bands replaced the older single-channel models in dealers' shop windows and people's homes. As was to be expected, it was soon found that, at most sites, signal strength in Band III tended to be noticeably lower than that in Band I, whereupon greater care in aerial positioning, etc., had to be exercised if best advantage of the Band III transmissions was to be obtained.

The effect of lower signal strength in Band III, as compared with Band I, is a fairly prevalent condition and, to the writer's mind, indicates that there should be quite a demand for inexpensive and efficient Band III pre-amplifiers. This article describes a home-constructor Band III pre-amplifier which is

capable of giving a high degree of gain and which has been designed especially for ease of building by the amateur.

Design Progress

The writer feels that it would be of interest to readers if the steps involved in the design and manufacture of the prototype Band III pre-amplifier were detailed here in more or less "chronological" order, because such a procedure not only assists in giving an insight into the technical functioning of the pre-amplifier but also enables the constructor to understand the necessity for arriving at certain decisions concerning the overall design.

It was considered from the outset that the pre-amplifier should be completely self-contained, it consisting of a unit having a 75 ohm input socket, a 75 ohm output socket, and a mains supply lead. No on-off switch would be fitted, as the constructor would probably prefer to connect the mains input of the pre-amplifier to the mains circuit of the associated television in such a manner that

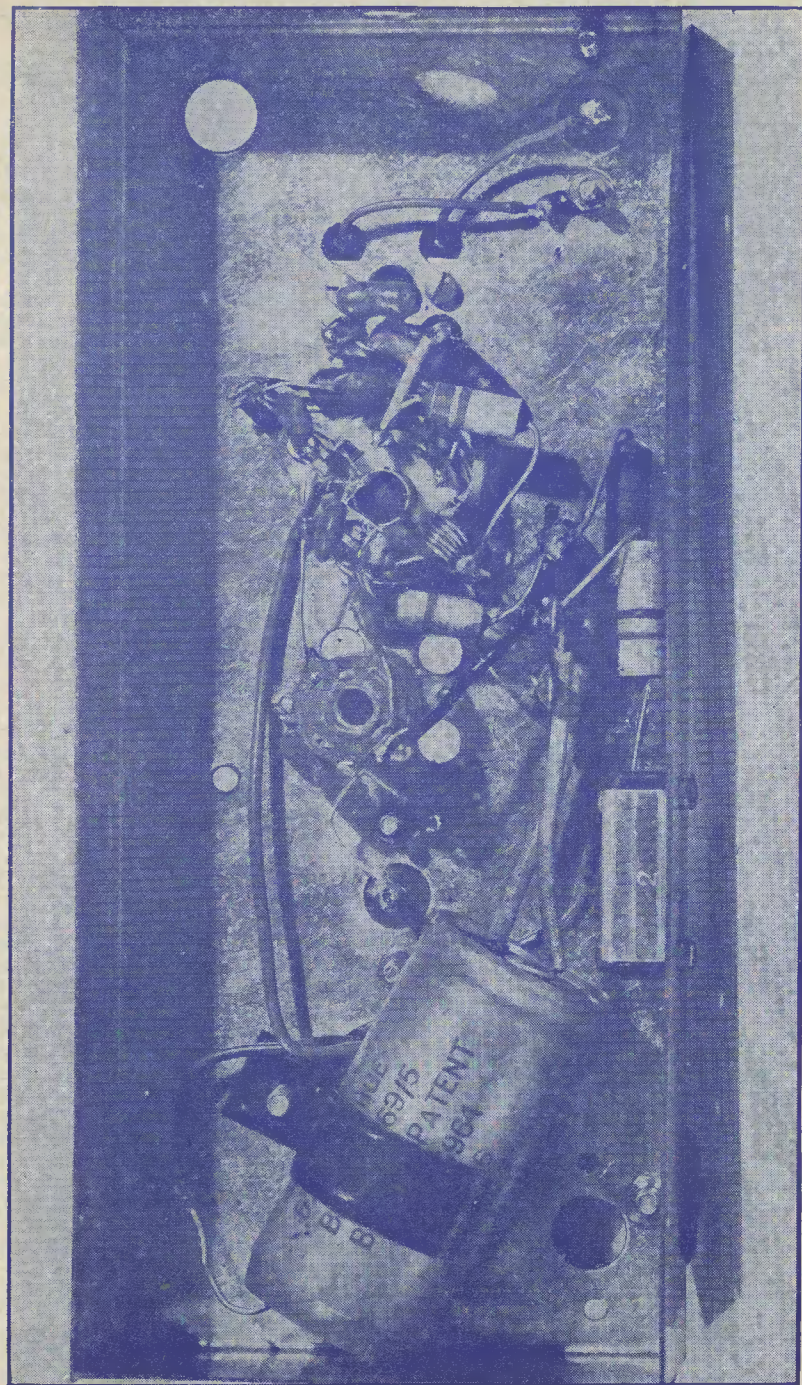

Under-chassis layout of components—compare with wiring diagrams

switching on the latter automatically switched on the pre-amplifier. A mains transformer power supply for the pre-amplifier was considered to be an essential point, not only on account of safety factor but also because a "live" pre-amplifier chassis would necessitate the use of isolating condensers both at its input and output sockets. It is necessary to keep losses to a minimum in a pre-amplifier of this nature, and isolating condensers would not be helpful in this respect. They are also liable to introduce mismatches at the sockets to which they are connected, a further undesirable feature. The h.t. and l.t. current consumption of the pre-amplifier would, in any event, be low; whereupon the mains transformer employed could be a small and inexpensive component.

The circuit design of the pre-amplifier proper was next considered, and it was felt that a single cascode valve should provide enough gain for normal requirements provided that care was taken with its operating potentials and that best use was made of the tuned coils in its input and output circuits. This last requirement raised what was probably the greatest design problem of all. The difficulty here was due to the almost certain fact that the average home-constructor building the pre-amplifier would be without access to a wobulator and oscilloscope capable of displaying a response at Band III frequencies, whereupon alignment would have to be carried out on received signals only. The response curve of the pre-amplifier would, in consequence, have to be fairly flat if tuning on received signals was to be undertaken, incurring thereby a possible loss in gain. In practice, the conflicting requirements of a flat response and good amplification are, however, met quite successfully in the Hi-Gain unit. The overall response of the prototype drops some 1 to 1.5 dB at 2 Mc/s on either side of centre frequency and the overall gain is of the order of 17 to 18 dB (input and output loads being 75 ohms resistive).

The final decision which had to be made during initial design concerned the chassis on which the pre-amplifier was to be built, and it was found that the Teletron Converter chassis, already widely available at a reasonable price, lent itself excellently for the purpose. It is necessary to drill about half a dozen holes in the Teletron Converter chassis to fit it for its new role, but this means far less work than would be required if the pre-amplifier chassis had to be made entirely from scratch. (In order to ease drill requirements, satisfactory results can be given if all the extra holes are drilled 6BA clearance only). There is the further advantage that the use of an already-tooled chassis ensures that the all-important layout of the r.f. section of

the pre-amplifier is copied exactly by the constructor.

Having proceeded thus far, work commenced on the prototype, with the result that the circuit shown in Fig. 1 was evolved.

The Circuit

The circuit of Fig. 1 illustrates a fairly conventional cascode amplifier plus a small power pack. In the diagram the Band III aerial is applied, via the input socket, to the coupling winding L_1 of the input tuned circuit $L_2 C_1$. The turns ratio of L_1 to L_2 is that which was found to offer greatest transference of energy from a 75 ohm input source. So far as can be determined the standing wave ratio on a feeder connected to the pre-amplifier input circuit is low, the feeder being "dead," whatever its length, to hand-capacity and similar effects whilst the response of the pre-amplifier is displayed by a wobulator and oscilloscope. It is important to maintain a low standing wave ratio in the input circuit of a Band III pre-amplifier, not only to prevent losses and ghosting but also to avoid feedback between input and output feeders. During tests, the pre-amplifier output was connected to the aerial sockets of several commercial sets and no instability or shift in response was evident when the aerial feeder was held close to the pre-amplifier output feeder.

Instead of relying entirely on tuning by valve and stray capacities, a small fixed condenser, C_1 , connects across the input tuned coil, L_2 . This condenser is fitted for a number of reasons. Firstly, the use of a condenser at this position assists in achieving the response characteristic desired from the pre-amplifier. Secondly, despite its low capacity of 2 pF, C_1 helps in swamping the capacities which are presented to the coil by the input capacity of the cascode, its valveholder, and the immediate wiring. Such capacities are liable to vary rather widely from unit to unit when the equipment is of the home-constructor variety. Thirdly, the use of the condenser assists in easing the very tight inductance tolerances which have to be met by L_2 , thereby enabling this coil, if produced commercially, to meet the requisite frequency range more reliably. When it is considered that a very large number of Band III coils used in commercial tuners are adjusted to their shape *after* they have been fitted into their immediate circuits, the difficulties of producing reliable coils for home-constructor apparatus may be more readily appreciated.

The tuned circuit $L_2 C_1$ connects to the first triode $V_{1(a)}$ of the cascode in a conventional neutralising arrangement. Neutralising is provided by C_2 and C_3 , and functions by reason of the fact that the triode anode

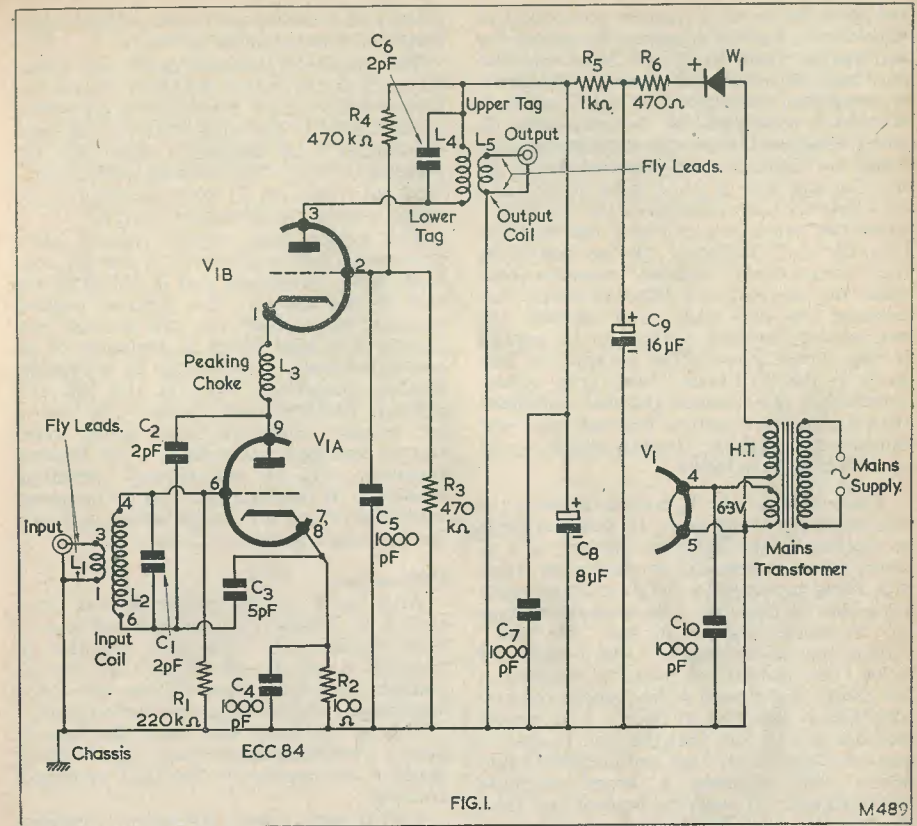

FIG. 1.

M489

Fig. 1. The complete circuit of the "Hi-Gain" pre-amplifier

Parts List

Resistors

| | |
|---------------------------------|-----------|
| R ₁ | 220 kΩ ½W |
| R ₂ | 100 Ω ½W |
| R ₃ , R ₄ | 470 kΩ ½W |
| R ₅ | 1 kΩ ½W |
| R ₆ | 470 Ω ½W |

Condensers

Note.—It is essential that C_1 to C_7 and C_{10} be of the types specified.

| | |
|---------------------------------|--|
| C ₁ , C ₂ | 2 pF ceramic |
| C ₃ | 5 pF ceramic |
| C ₄ , C ₅ | 1000 pF disc ceramic |
| C ₆ | 2 pF ceramic |
| C ₇ | 1000 pF disc ceramic |
| C ₈ , C ₉ | 8+16 μF electrolytic 350v. wkg. (with side-mounting clip). |
| C ₁₀ | 1000 pF disc ceramic |

Valve

V₁ ECC84

Rectifier

Miniature contact-cooled 250V. 30mA (or greater). H. L. Smith, Edgware Road.

Mains Transformer

Input 230V.
H.T. Sec. 200V. 30 mA.
L.T. Sec. 6.3V. 0.6A.
Mounting Centres 2½ in.
H. L. Smith, Edgware Road.

Coils

L₁, L₂ Input Coil. Teletron type 20T.
L₃ Peaking Choke. Teletron type 21T.
L₄, L₅ Output Coil. Teletron type 22T.

Chassis

Teletron Converter Chassis, modified.

Miscellaneous

2 Coaxial sockets. Belling-Lee type L.604/S.
1 B9A valveholder, ceramic.
1 3-way tag-strip, end tag earthed.
Mains lead.
Wiring, sleeving, nuts, screws, etc.

voltage is fed to the condenser potentiometer given by C_2 and C_3 in series, the end of the coil remote from $V_{1(a)}$ grid connecting into the tap between these two condensers. Although not obvious at first sight, coil L_2 is effectively paralleled by two capacities in series, their junction being at chassis potential. These two capacities are provided mainly by the C_{ak} and C_{gk} of $V_{1(a)}$ (plus strays) and they have the same effect as do the "hidden" capacities across the coil of a conventional Colpitts v.h.f. oscillator. In the case of L_2 the presence of the "hidden" capacities provides the coil with an effective earthy tap between its two ends, and enables the neutralising feedback voltage to be applied in the correct phase. The neutralising network in the "Hi-Gain" unit gives a very satisfactory performance and this, combined with the double screening between input and output coils, enables extremely stable overall operation to be achieved.

The peaking choke L_3 couples together the two triodes of the cascode, its function being to operate as the inductive element of a pi filter, the two capacities to chassis on either side being provided by the output and input capacities of the triodes. By taking advantage of the stability given in the "Hi-Gain" circuit, and by keeping its Q to a fairly low value, the choke L_3 is made to resonate at the centre of the band of frequencies the pre-amplifier is intended to cover. It is mainly because of this fact that the unit is able to provide its relatively high amplification figure whilst still retaining a broad response characteristic. It must be pointed out that, due to the function it carries out in this particular circuit, L_3 becomes rather a "critical" component. In practice, the choke needs to be handled carefully in order to prevent displacement of its turns. It should also be carefully soldered to the appropriate valve pins in the manner described in the assembly instructions.

Two important components in the cascode circuit are R_3 and R_4 . These two resistors regulate the h.t. voltage applied to the grid of the second triode, and their ratio was determined empirically under working conditions. The fact that both resistors possess the same value is incidental. The condenser C_5 is also of importance, since it decouples the grid of the second triode, this being usually the "hottest" point in a cascode amplifier. It is essential to use a good quality condenser in the C_5 position, and to connect it into circuit by short leads. The bias resistor R_2 also has an important bearing on cascode performance. In the prototype, the value shown for this resistor resulted in a cathode current of 14 mA, this being comparable with the figures given by commercial appli-

cations and comfortably within the manufacturers' limiting value of 18mA.

The anode of the cascode second triode connects to the output tuned circuit $L_4 C_6$. Here again, a 2pF condenser is paralleled across the coil, this being fitted for the same reasons as were discussed earlier for the presence of C_1 . The coupling coil L_5 provides an output at 75 ohms impedance for connection to the subsequent receiver.

The power pack circuit requires little comment. The rectifier, W_1 , is a small contact-cooled component and is bolted to the side of the chassis. The thermal contact between the rectifier and the chassis then enables any heat which is dissipated to be conducted away. The resistor R_6 is a ripple-limiting component, and at the low h.t. currents involved here, causes little loss in h.t. voltage. Since the small mains transformer specified has a fairly high internal resistance, R_6 is not entirely essential. However, its presence provides an increased safety factor and it is worth including if only for that single purpose.

Performance

After work on the prototype was completed, a number of performance checks were carried out. The gain provided at channels 8 and 9 was 18dB; and that at channel 10, 17dB. These figures were taken with resistive input and output impedances of 75 ohms, and may vary somewhat (up or down) when impedances other than 75 ohms resistive are applied to the input or output sockets.

Checks with several commercial receivers and an aerial fed via attenuators to reduce input level gave promising results, and the writer's aim, that of providing a picture of entertainment value where no picture previously existed, seemed to be satisfied. The pre-amplifier was then checked on a fringe site where it resulted in a very considerable improvement in picture level. (So much so, indeed, that the set-owner was very loath to part with it for tests elsewhere!). Further checks on other sites also gave good results. So far as noise level was concerned, the prototype gave a good account of itself, and it compared favourably with the noise level given by a number of commercial tuners.

Construction

The construction of the amplifier is fairly simple to carry out, and the only point to which especial attention must be given is the necessity of ensuring that layout of r.f. components conforms accurately to that given in the wiring diagrams.

It is first of all necessary to drill the extra holes required by the pre-amplifier circuit in the Teletron Converter chassis. The posi-

tions of these holes are indicated in Fig. 2. Many constructors will drill the extra holes after carrying out the normal workshop practice of marking out their centres, but others may wish to follow the somewhat less accurate (but still practicable enough) process of using the components themselves as "templates." If this latter course is followed,

be quite satisfactory if a smaller drill is not available. The contact-cooled rectifier is mounted by 6BA nuts and screws situated at the points marked "D". These holes correspond to the particular rectifier employed in the prototype. If an alternative rectifier is used the position of holes "D" may vary, but the general siting of the alternative rectifier

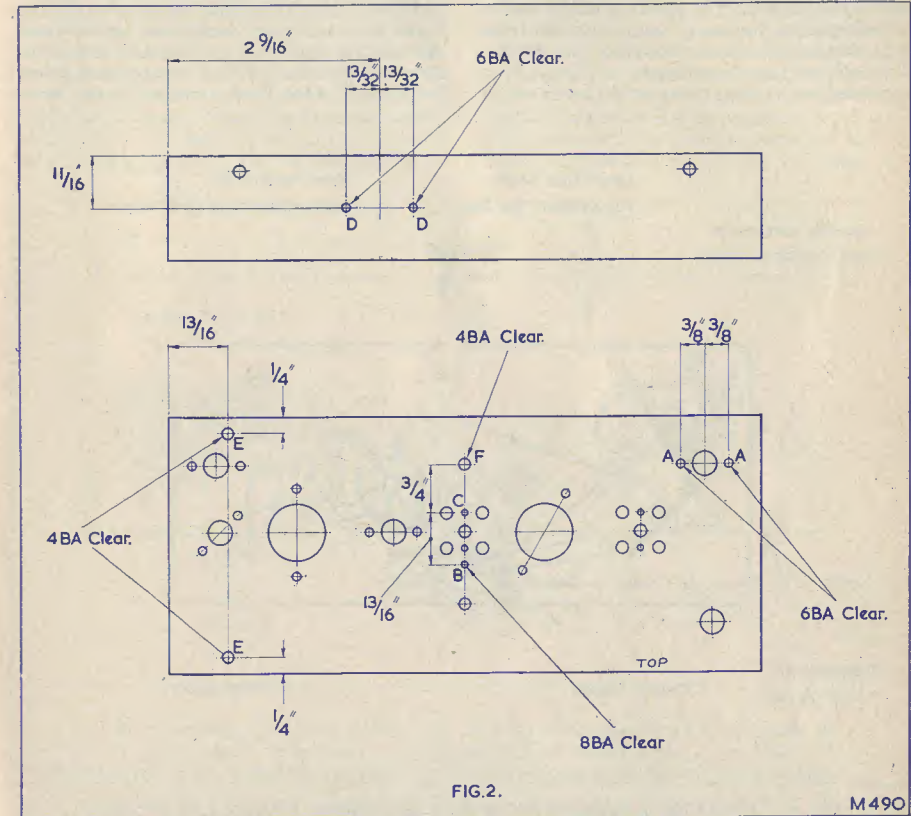

Fig. 2. The extra holes required in the Teletron Converter chassis for the pre-amplifier components. The chassis is viewed from the top, the side view being a third angle projection. If a rectifier other than that specified is employed it should be centred approximately at the point mid-way between holes D

the following information will be of assistance. The two holes marked "A" in Fig. 2 are for mounting a Belling-Lee 75 ohm coaxial socket. The single hole "B" accepts one of the mounting screws for the output anode coil, the other mounting hole being that designated "C" which is already punched in the chassis. The output anode coil should be mounted with 8BA nuts and screws, but a 6BA clearance hole at the "B" position will

should still be the same as is indicated in Fig. 2. The mains transformer is bolted to the holes marked "E." These should, preferably, be 4BA clearance, although 6BA clearance would cope if washers were fitted under the bolt heads. The final hole "F" is intended for mounting the 3-way tag-strip, and should preferably be 4BA clearance although—once more—6BA clearance will cope. As may be seen from this paragraph,

all the extra holes required in the chassis could be made with a single 6BA clearance drill, this point being of possible advantage to those constructors who do not have extensive metalworking facilities.

The main components may now be mounted, those taking up the positions illustrated in Fig. 3. This diagram does not show the mains transformer, which is mounted above the chassis. The position of the mains transformer is, however, readily evident from the photographs accompanying this article. The electrolytic condenser, C_8-C_9 , is mounted on its side, being held in place with

of C_8-C_9 which connects to the junction of R_5 and R_6 .

The 470 ohm resistor R_6 connects to that tag of the rectifier which is marked with a positive sign. Connections from the coils to the coaxial input and output sockets are also made at this stage. Where it is necessary to shorten the insulated leads from the coils this should be done carefully, taking care not to exert too much tension during stripping. Three leads from the mains transformer travel through the large hole immediately under this component and connect to components below the chassis. One lead connects to the same

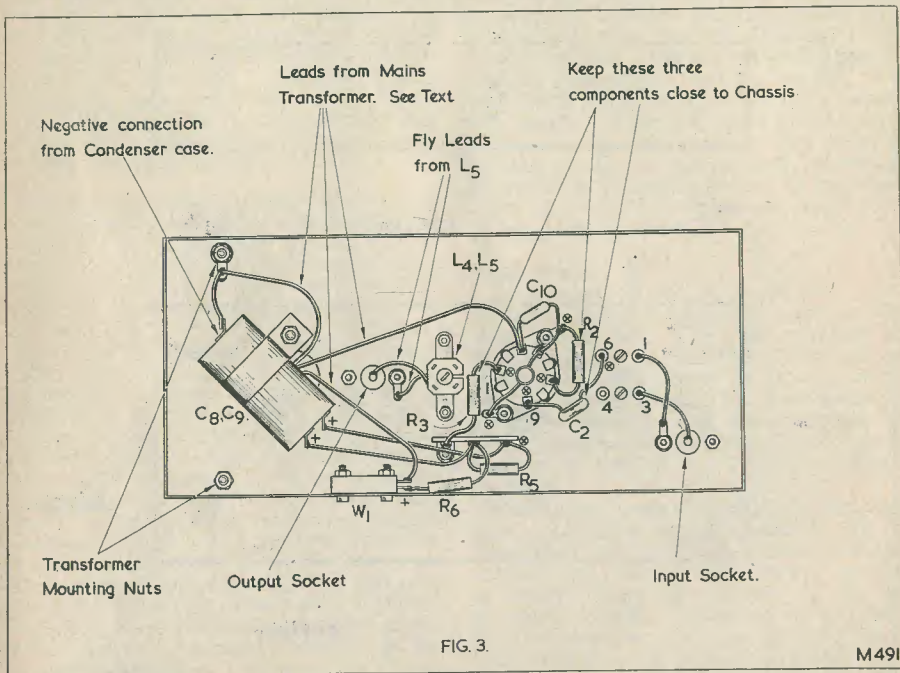

FIG. 3.

M491

Fig. 3. The positions taken up by the main components, together with the initial stage in wiring. The three leads from the mains transformer are discussed in the text

the clip with which it should be provided. The clip is secured to one of the holes already punched in the chassis. It will be noted that five solder tags are held under component mounting nuts, and it is important to ensure that these are held down very securely, as intermittent operation at v.h.f. can easily result from poor chassis connections. The screws, or screws and nuts, securing the two coils should not be tightened excessively, as damage to the plastic former bases may result.

Fig. 3 also illustrates the power supply wiring, plus the first stage of r.f. wiring. It should be noted that it is the 16 μ F section

chassis tag which provides the earth connection for the electrolytic condenser case. This lead connects, above the chassis, to one side of the heater secondary and one side of the h.t. secondary. The second lead passing through the large hole connects, above chassis, to the remaining h.t. secondary tag and, below chassis, to the rectifier. The third lead connects the remaining tag of the heater secondary to pin 4 of the valveholder. There is no mains wiring below the chassis. All points marked "X" in Fig. 3 should be left unsoldered at this stage, as further connections are made to them later.

Fig. 4 shows the second stage in wiring, and

brings the pre-amplifier almost to completion. Several ceramic condensers requiring short lead-out connections are fitted at this stage. If it is found that varnish coatings on condenser lead-out wires make short connections difficult, this varnish should be gently removed with the aid of the thumb-nail.

The final step in below-chassis wiring is carried out in Fig. 5. Two important components are fitted here. One is C_5 , which must be fitted with short leads; and the other is the peaking choke, L_3 . L_3 should be handled carefully to avoid distorting its turns, and it should take up the position illustrated in Fig. 5. There should be approximately $\frac{1}{16}$ to $\frac{1}{8}$ inch between the bottom of the coil and the solder joints at the valveholder tags.

any other indication of optimum tuning which may be advised by the manufacturers).

The Band III aerial is then disconnected from the receiver and inserted into the input socket of the pre-amplifier. A further length of coaxial cable then couples the output socket of the pre-amplifier to the aerial socket of the television. It would be worthwhile mentioning at this stage the somewhat obvious fact that the output socket of the pre-amplifier is close to the tags of the mains transformer and that, in order to prevent shock, the pre-amplifier should be disconnected from the mains when plugs are being fitted to, or removed from, this socket.

The pre-amplifier is next connected to the mains and the ECC84 allowed to warm up.

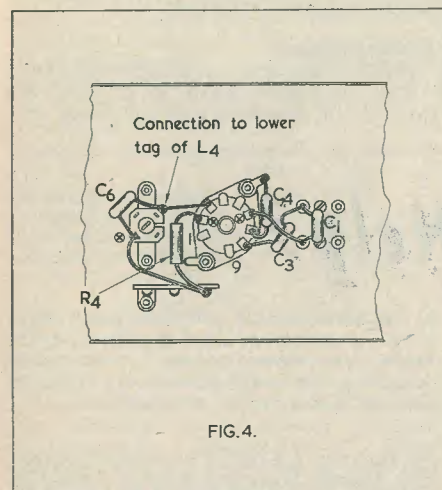

FIG. 4.

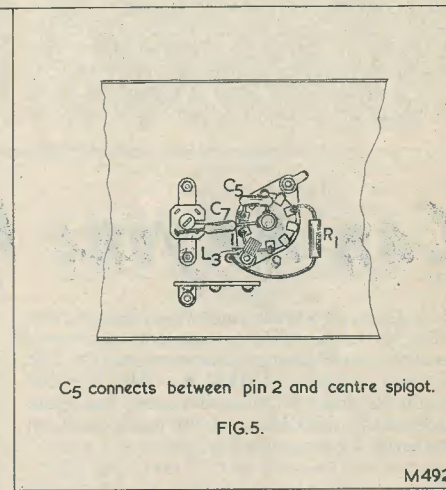

FIG. 5.

M492

Fig. 4. The second stage in wiring. C_6 should be mounted close to the turns of L_4 , L_5 , using short connections. Fig. 5. The final wiring stage. C_5 should be connected via very short leads, and L_3 should be positioned at the angle shown here

The final process consists of connecting the mains lead to the mains transformer. This is carried out above the chassis at the appropriate transformer tags. If so desired, the mains lead may be anchored to the chassis by means of a suitable clip secured under one of the transformer mounting screws.

Alignment

The pre-amplifier is now complete, and is ready for testing and alignment. Before it is coupled to the television with which it is to be used, the latter should be set up to receive the Band III channel desired, and its fine tuner adjusted for optimum sound (or for

Assuming that everything is well, all that is then required is to align the cores of the pre-amplifier coils, these being adjusted for maximum signal strength. It will very probably be found that adjustment of the cores may give an impression of flatness of tuning. The main reason for such an impression is that the cores do not cause a large change in inductance in the particular coils which are employed in the pre-amplifier. (Incidentally, it should be pointed out that the cores still have an effect on inductance when they are some way out of their formers, and it may be necessary for them to be so positioned when alignment is carried out on Channel 10.) A second reason for the

impression of flatness of tuning is due to the fact that indications of signal strength will be obtained by observing the received picture, this method of indication not normally giving so positive an effect as would be given by, say, increases in volume in a sound signal. If necessary, it may be found easiest to set the pre-amplifier cores to a position mid-way between the points where the picture level obviously becomes degraded. The impression of flatness of tuning will be very apparent in receivers employing vision a.g.c. and/or a.c. couplings to the tube.

Before concluding, it would be advantageous to deal with one or two points concerning the pre-amplifier installation. Although the pre-amplifier should be inherently stable, it is inadvisable to run the coaxial lead from its output socket very close to its input feeder. As was mentioned earlier in the article, no instability or detuning occurred when this was done with the prototype. Nevertheless, such troubles could occur if either the Band III aerial or the input circuit of the televisor

presented an impedance widely removed from 75 ohms, and it is obviously worthwhile avoiding such a risk. Bad input matching at the televisor aerial socket may also cause difficulties due to the consequent appearance of standing waves on the feeder between this socket and the pre-amplifier output; and it may be necessary to avoid lengths of coaxial cable between the two sockets which are odd multiples of a quarter-wavelength of the signal being received. (This situation is complicated if a further length of coaxial cable inside the receiver cabinet couples its aerial socket to the tuner chassis.) If poor results are obtained on first installing the pre-amplifier it might be worth-while experimentally shortening (or extending) the length of feeder between the two units in one or two successive steps of six inches.

Acknowledgments

Before concluding, the writer would like to express acknowledgments to the Teletron Co. Ltd., for assistance with coil design.

Can Anyone Help?

Requests for information are inserted in this section free of charge; subject to space being available

R. J. DEAS, 108 Woodland Way, Winchmore Hill, London, N.21, requires technical, servicing and aligning instructions for the ex-Govt. receiver R.1132.A. He has the circuit diagram fitted in the case, but more detailed information is needed, particularly on the aerial feeder and b.f.o. unit.

CAPT. G. A. DAWE, 19 Coy R.A.S.C. (Tk Tptr), Ranby Camp, Retford, Notts., wishes to obtain information on the battery/mains portable receiver TEKADE, type GBW.167, No. 096784. Valve line-up DF91, DK92, DF91, DAF91, DL94 (or equivalent). In particular he would be grateful for details of the coil pack, and is willing to pay for information, service sheets, etc.

J. AYRES, G3DQT, 7 Berrylands Road, Surbiton, Surrey, wishes to buy or borrow the circuit of the Army R.209 receiver.

E. M. STEVENSON, "Foxwood," 14 Trevose Gardens, Sherwood, Nottingham, would like to buy or to borrow a copy of Bernards No. 1 Amplifier Manual (now out of print).

L. WOODLEY, "Nokomis," Great Stambridge, Rochford, Essex, wishes to borrow or purchase the circuit of the Marconiphone model 392 a.c./d.c. 4-valve superhet radiogram.

C. MCCHESENEY, c/o 10 Ella Street, Hull, Yorks., requires the back numbers of *The Radio Constructor* or any other details describing the conversion of the Indicator Unit 182A to a 'scope, on sale or loan.

M. BUTTON, 7 Upper Flowerfield, Nunney, near Frome, Somerset, requires details for converting the R.1132 receiver for use on 144 Mc/s, and is willing to pay for any circuits, etc.

W. PHILLIPS, 130 Hillbury Road, Warlingham, Surrey, would like to buy or borrow the manual and/or operating instructions for the type 52A Signal Generator, ref. no. 10SB/6087.

J. HILL, 177 Hillyfields, Loughton, Essex, would like to borrow or buy a service manual for the Eddystone 358 or 358X receiver.

J. A. MORAN, La Cotte Cottage, Route Orange, St. Brelade, Jersey, Channel Islands, is anxious to obtain data, service sheets, circuits, etc., on the 8-valve receivers made by R.A.P. (England) Ltd. up to about 1952, when they went out of business. Valve line-up is 6K7G, 6K8G, 6K7G, 6Q7G, p.p. 6V6G's, 6G5 and 5Z4. Speaker 10in Rola energised.

Radio Miscellany

A COUPLE OF MONTHS AGO I RELATED HOW, in the early days, an ex-R.F.C. type started, to my horror and near heart failure, to warm up a bright emitter valve in an obstinate receiver by holding it in the flame of a lighted match. Two very interesting letters from Old Timers have come to hand on this point. I never cease to marvel at the number of Old Timers that come to light, especially those like A.V.S. of Smithills, Bolton, who merely mention it in passing when writing. He not only remembers No. 1 of the *Wireless World* in April 1913, but still has a copy and remembers its forerunner, *The Marconigraph*, from which title it changed to the present one. He mentions also the letter from J. W. Tilley of Redditch, who kindly supplied this column with gen on *Work* and the *Amateur Mechanic*.

A.V.S. has quite a private museum and intends to reconstruct a genuine period piece. This is to be "A Long Distance Receiving Set" described in the *Amateur Mechanic*. Unfortunately, I cannot find Mr. Tilley's address, but I hope that when he reads these lines he will get in touch with Mr. A. V. Simpson, M.BRIT.I.R.E., SEN.M.I.R.E. (U.S.A.) at 51 Knowsley Road, Smithills, Bolton. Perhaps others among our Vintagers can help with details regarding this receiver. I know from the number of friendly letters I receive from readers, especially the Old Timers, that there is a fine help-one-another spirit, so I am confident that J.W.T. (Redditch) and others who can supply any details will rally round. A.V.S. in his turn is going to let this column have details of the set and its behaviour under modern conditions with a genuine contemporary type valve—the performance of which might well require the match trick to bring it to the point of maximum sensitivity.

Not Without a Light!

A.S., of Prittlewell, Southend-on-Sea, writes on the same point and also recalls the valve requiring the match technique to give it that little extra. He believes it was the Captain Round valve introduced by the Admiralty about 1915. It was a large valve

by modern standards, and the "pip" at the end extended about half an inch. Inside there was a "wool" packing, and it was to this part that the match was applied to generate gas inside the envelope to make the valve "soft." A length of resistance wire was also used, coiled over the pip and wired in series with the h.t. supply, its gentle warmth keeping the valve in a beautifully soft condition.

In the early 'twenties soft valves were in great favour. They were many times more sensitive as detectors than the ordinary hard pumped type, and required only about 30 volts h.t. If one gave them more they glowed a beautiful shade of blue—then the anode arced over to the filament and you'd had it. In any case you soon had it however niggardly you were with the h.t.—unless you kept it so low that it gave no better results than the hard type. Thus my would-be helper was only copying something he had seen done with another type of valve, although obviously he didn't know why he was doing it. Nor did I until our good friends came to the rescue.

Boys Will Be Boys

Apparently the little incident I related of the female relative who, startled by the stark realism of my new hi-fi receiver, dropped the tray, was widely read and carefully noted. Since then I have had numerous requests from readers for details of the amplifier used. It certainly seems remarkable that so many grown-up men want to scare nervous female relatives into dropping trays, but there you are. There must be a broad streak of school-boy mischievousness among the followers of our hobby. No wonder the Old Timers manage to keep so young!

Seriously, though, I have managed to reply to all those sending s.a.e.'s, recommending constructional items I judged from their letters to be most suited to their experience. Most of them talked of converting existing sets or re-vamping old components. If you really want hi-fi, don't; that is, unless you are certain the substitute parts are the exact electrical equivalents to those recommended.

For the information of more advanced constructors, the original amplifier uses a UF86 and a pair of UCL82s. The circuit arrangement and components values were based on those used in a 7-watt high-quality amplifier designed by the Technical Service Dept. of Mullards. A 4-page folder giving full details (TP325), circuit and layout was published by them in August last year and, I believe, is still available.

alternative plan if it doesn't work. The alternative is somewhat more complicated as it involves a system which doesn't merely "suck" the lightning back up the aerial (and presumably passing it on to your neighbour) but blows it down the earth lead before it has time to interfere with the picture.

Personally I should never have thought of such a simple and direct way of tackling the job. You and I would have started by adding

Centre Tap talks about Items of General Interest

Blow—or Suck?

Almost every other week one reads of educationalists and others urging young women and girls to seriously take up technical and scientific careers. Perhaps I may be old-fashioned, but somehow I feel the prospect of large numbers of female engineers and scientists rather frightening. It is rather alarming to think that maybe in a couple of generations some poor chap will have to look after the babies and wash-up the breakfast things while his wife, as Director of an Atomic Pile, dashes off to catch the 8.10. Encouraged by these constant appeals for brainy women to equip themselves for important jobs, even the amateur movement might be overwhelmed by a feminine invasion, and the poor husband will find himself bathing and putting the kids to bed while his wife is out in her workshop bending and drilling a chassis for their new t.v.

Already a few young women do take radio seriously. Even this column, on the odd occasion, has been honoured by a letter from a YL reader. I have never discovered whether the liking for the hobby is natural or the result of the exuberance of a persuasive science mistress.

A newcomer to the cult is Miss Nola Brown (Fitzharry Road, Abingdon)—aged 9½ years. She has applied herself to the problem of t.v. interference—especially lightning. Her system uses a "Sterryscope" (costing 10/6) attached to the rear of the set. She explains "All the interference is reflected on to the sterryscope while the machine switches itself on and causes the interference to get sucked through the sterryscope and out of the back down the wire that leads to the aerial. This wire has wire-netting over the funny pipes, and the interference runs along the wire and out through the funny pipes on the aerial."

Nola agrees this idea is so far only theoretical and she is quite prepared for an

circuits using valves for amplitude limiting—an arrangement which at its best only *reduces* interference by punching holes in the signals. Children, of course, see things far more clearly. I remember P. R. Reid in his prisoner-of-war escape adventures telling how, disguised as a woman, he walked along the streets. The grown-ups took no notice, but the children stared in incredulity and then ran off to tell their parents that they had seen a man dressed as a woman. The grown-ups, of course, being grown-up, knew better. They smiled indulgently, humoured the kids for a minute, and then told them to run off and play.

Perhaps it is the same with this Interference Eliminator—it's probably much too obvious for we grown-ups to believe it might work!

A Lot of Bricks

In our January issue I mentioned an obscurely worded circular letter from ex-DLICU who, as a result of a private war against higher authority, became the subject of diplomatic exchanges and forfeited his transmitting licence. I have since received an interesting letter from a British "exile," Gerald Lander (G.3952, DL3952) which fills in many of the details. It was only after reading Gerald's letter I realised that I already knew something of ex-DLICU's past exploits and reputation as an indefatigable fighter against officialdom. On this occasion, apparently exasperated by the unwillingness in official circles to take action about broadcast intrusion in exclusively amateur bands, he organised a protest. The protest took the form of enjoining as many DL amateurs as possible to put on their 40-metre transmitters one Sunday morning. The immediate result was incredible pandemonium. A later result was the revocation of DLICU's licence; but in view of his reputation for coming back fighting, quite a lot of people feel that may

continued on page 592

A GENERAL PURPOSE SUPERHET

RADIO

By S. E. ADDIS

THIS RECEIVER HAS BEEN DESIGNED TO fulfil a requirement for a receiver for occasional or everyday use in the home.

In considering such a design, battery operation was given some thought, but even with low consumption valves and long life batteries it is possible for the receiver to be out of action just at the moment that it is required for some special event.

Having decided on mains operation for the receiver, the a.c./d.c. type of circuit was considered, but finally rejected because of too much heat from the mains dropper resistance and also the presence of a live chassis.

The final design was made up for a.c. mains operation using a double-wound mains transformer and so avoiding the disadvantages of the a.c./d.c. type of circuit.

It was decided that the ideal type of receiver would be one that could be carried about but at the same time would have a fair tonal quality and a good performance without the need for a large outdoor aerial.

In order to bring the work on the receiver down to a minimum, a cabinet with chassis was purchased complete with drum drive, etc.

These cabinets are available from advertisers in *The Radio Constructor* and are ideal for this type of receiver. Most of the chassis are punched for octal valveholders, but the design about to be described used the B7G range of valves and so the constructor may wish to make a new chassis to fit the cabinet to be used. As an alternative it is possible to obtain "Radiospares" type 3 adaptor plates. These are lemon shaped plates which can be screwed over an octal valveholder hole and then accept a B7G valveholder.

Having decided on a mains operated receiver, the choice of valve line-up became the next consideration. It is possible to use a large number of different valve combinations in a superhet circuit, and many were considered and rejected for this receiver.

The final combination of valves was chosen because they were all B7G-based, gave a good performance in the chosen circuit, and finally

provided what the writer believes to be an entirely new valve line-up for this type of set.

Circuit Description

As will be noted from the circuit diagram, the receiver is a 4-valve superhet receiver using all B7G-based valves and with a half-wave rectifier for h.t. supply. V1 is a Brimar 6BE6 heptode operating as frequency changer with electron coupling. The input to this valve is from a short throw-out aerial via Osmor aerial coils type QA8 and QA9 for medium and long waveband operation, or as an alternative Osmor medium and long waveband ferrite rod aerial type QFR 2.

A single oscillator coil, Osmor type QO8, is used for medium waveband operation and is additionally tuned by a 100pF trimmer and parallel 300pF silver mica condenser for long waveband operation. It will be noted that the oscillator section is somewhat different from the usual type of superhet receiver in that the feedback winding of the oscillator coil is in the cathode circuit of the valve. This type of operation is ideal for the type of valve in use and gives a very good performance. It is advised that only the type of coil specified be used as this coil has a very tight coupling between primary and secondary windings, a factor which contributes to the performance of the receiver.

V2 is a Brimar 6BJ6 variable-mu h.f. pentode operating as i.f. amplifier in conjunction with the two i.f. transformers tuned to 465 kc/s.

V3 is a Brimar 6BH6 h.f. pentode which is used as 1st a.f. amplifier. As this valve has no signal diode, a Brimar GD3 germanium diode is used for signal rectification and a.v.c. voltage.

It will be found that with this combination of valve and separate signal diode, a very high gain is available with the added advantage of hum free operation. This is very noticeable when searching for a station with the volume control at maximum.

V4 is a Brimar 6AK6 output pentode feeding the 5in. loudspeaker via the output transformer.

Technical Forum

If the receiver is fitted with the aerial coils, attach a short length of wire to the aerial socket. Carefully rotate the tuning condenser until the local station is heard. Now carefully adjust the cores of the i.f. transformers for maximum volume. If no signal can be received when using the ferrite rod aerial, a short length of wire may be attached to the input grid of V_1 to assist in signal pick-up.

Switch receiver to the long waveband and set the dial at 1500 metres. Slowly adjust the oscillator coil core until the Light programme is heard at maximum volume. Now switch to the medium waveband and locate a station between 200 and 215 metres. Adjust medium waveband aerial and oscillator trimmers for maximum volume and correct calibration.

Tune to a station near to 460 metres and adjust oscillator core for correct calibration and medium waveband aerial coil core for maximum volume. Return to 200 to 215 metres and repeat the operation until no further improvement can be made. Again switch to the long-waveband and correct the calibration of the Light programme by use of the long waveband oscillator trimmer. Trim for maximum volume with the long waveband

aerial trimmer. If this trimmer will not peak, slightly re-adjust the core of the long waveband aerial coil.

If the ferrite rod aerial is being used, the coils will have to be moved on the rod instead of aerial core adjustment. Moving the coils towards the centre of the rod will increase the inductance.

In the construction of this receiver special note should be given to the connections to the QO8 oscillator coil. It will be found that the normal earthy end of the secondary or reaction winding is connected to the cathode of the valve and that the "hot" end of the winding is earthed to chassis. This is quite normal for this type of circuit. Regarding the 100pF trimmer and 300pF silver mica condenser for parallel trimming on the long waveband, the exact values will depend on the type of tuning condenser and the tuning scale used. If good calibration cannot be obtained, the value of C_4 can be increased or decreased over the range 250 to 350pF.

It should be noted that if a ferrite rod aerial is used there will be no primary windings on the aerial coils and the wavechange switch may, therefore, be a double-pole change-over unit.

ELECTRONICS

Power Transistors

By E. G. BULLEY

THESE TRANSISTORS ARE NOW BECOMING more readily available upon the commercial market and it is to be hoped that before long the radio amateur and constructor will be able to evolve around them many circuits and equipments for their own purposes. Such transistors are used mainly for large power applications such as audio amplifiers. Their physical size is much larger than their counterparts used in portable radio receivers. Nevertheless, they are much smaller than the conventional valve and have the advantage that associated components are much smaller and lighter in weight, thus equipment suitable for amateur use will be produced which is portable and lighter in weight.

Power transistors are used in what is termed a heat sink. This sink comprises a flat piece of copper or aluminium and to this is secured the transistor. The sink must be insulated from the chassis by mica or such like material, when the transistor is used in a circuit whereby the collector is not grounded.

In collector grounded circuits, the transistors are secured direct to the metal chassis; the chassis in this instance acts as the heat sink. One must, of course, bear in mind that in most cases of power transistors, the

collector electrode is connected to a metal flange or screwed stud. It is through this flange or stud that the heat is dissipated out to the heat sink.

Power transistors will be coming into more use not only for incorporation in audio amplifiers and portable public address equipments, but as protective devices in electronic equipments.

A typical example is where the transistor can be used to protect sensitive meters, especially where a d.c. ammeter is incorporated into an electronic circuit to measure an unknown current. Power transistors are also finding their way into d.c. voltage amplifiers wherein two power transistors oscillate and set up an a.c. voltage across the primary of a transformer. The output from the transformer secondary is naturally determined by the turns ratio and by the voltage applied to the transistors.

The reader must take due precautions when using or installing power transistors such as he would take when using the conventional types. Such precautions have, however, already been dealt with in this journal and it is not, therefore, necessary to repeat them.

Surge Limiting

THE MAJORITY OF READERS WOULD, WE feel, agree with the statement that good radio components are expensive, and it follows that they require careful operation in order that a long period of use may be obtained. We know, in fact, from correspondence that when a constructor is not following a well-designed circuit he will make careful measurements to ensure that components are not being overrun. These tests are usually made to determine the maximum dissipation of resistors, the working voltage of capacitors and the current and voltage operating conditions of valves. Sometimes, in spite of such care, the failure rate of one particular component is high. Obviously either the component itself has been badly designed or some aspect of its working conditions which can cause early failure has been overlooked. Usually it is the operation which is at fault, and here we would make a plea on behalf of the constructor; all too often components are sold over the counter with insufficient technical details being made available to the purchaser. Should the buyer be aware of possible pitfalls he can request further details about the item being purchased, even if this may mean contacting the manufacturers. The best assurance against short component life is, therefore, a good general knowledge of the special operation conditions to which certain parts may be subjected. The special conditions usually arise due to high surge voltage or current values appearing on the component. The measurement of these voltages and currents requires special care and at least a calibrated oscilloscope, and as such may well be outside the scope of many constructors. However, measurement is not necessarily essential so long as certain precautions are taken.

It will be useful at this stage to list some of the components of a radio or t.v. receiver

where peak operating conditions can cause trouble.

- Line output transformer
- Line output valve
- Boost diode valve
- E.H.T. rectifier
- Frame output valve

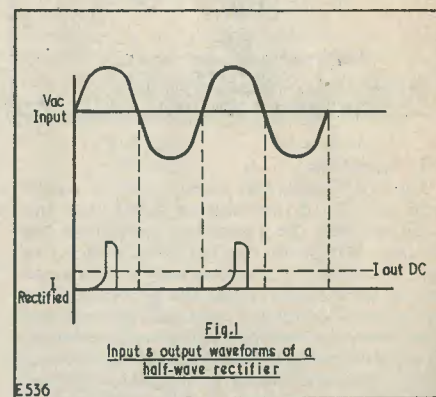

Fig. 1
Input & output waveforms of a
half-wave rectifier

The operation of these components is almost entirely a function of the way in which they are designed. It follows that providing reputable makes are purchased and that the recommended circuit and values are closely followed the working conditions of all parts will be correct if the h.t. supply voltage is correct. This latter point is most important and is a measurement which can easily be made

- Blocking oscillator valves
- Blocking oscillator transformers

Most suitable triode valves will stand a peak grid or anode voltage of 500V. Where this figure or the peak voltage rating

of the blocking transformer is exceeded, a reduction may be obtained by connecting a damping resistor (about 56k Ω) across one winding of the transformer.

(h) H.T. rectifier valves

(i) H.T. reservoir capacitors.

This list can be extended quite considerably, but we have commenced by including only the most important items and those which have given trouble in the past. Let us confine our attention now to the mains rectifier circuit.

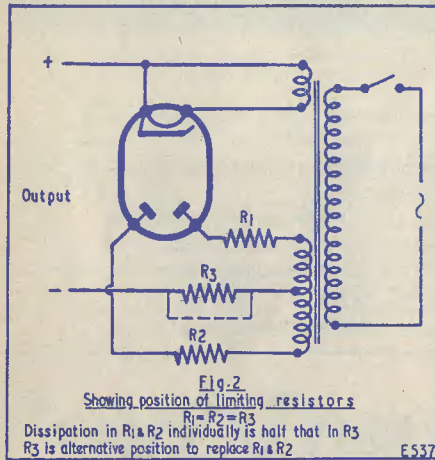

H.T. Rectifiers

The h.t. rectifiers in radios and t.v. equipment may be of the valve or metal type, but in either case the operating conditions are similar. Whilst the rectifier is fed with a sine wave of voltage it conducts only over a small part of each cycle. After the h.t. smoothing components the load current may be measured as a steady d.c. value, but the rectifier has to supply this in short pulses. These short pulses must, therefore, be of considerably greater amplitude than the d.c. current. The waveforms shown in Fig. 1 indicate the voltage fed to a half-wave rectifier with the rectifier current plotted on the same horizontal line scale. To give some idea of the peak to d.c. output current ratio the straight line on the current diagram has been included to indicate the output value. For a valve rectifier this ratio of peak to d.c. output is usually taken as 6 : 1. Thus a rectifier rated to give a d.c. output of 250mA will be capable of passing a peak current of 1.5 amps. If the rating applies to a full-wave valve rectifier, each half will be rated separately at half the figures quoted.

Generally, the valve makers do not publish maximum peak values of current for their

small rectifiers, but rather quote minimum values of series limiting resistors for various input voltages. These resistors also have a secondary function as they are required to limit the peak current which occurs under "hot switch" conditions. This is a term used to describe the conditions which occur when the set is switched off after obtaining normal operation, and then almost immediately switched on again. When this happens, the cathode of the rectifier is still hot and capable of emission, and the reservoir capacitor is discharged. Thus the valve instantaneously bears the full mains voltage and without the resistor would most likely suffer serious damage. This occasional short-term overload current is usually set several times in excess of the 6 : 1 peak to mean ratio quoted for steady operation. Thus the importance of limiting resistors in valve rectifier circuits cannot be too highly stressed. Their value may be found in the maker's published data, and in circuits which are fed directly from the mains the quoted value is the one which must be used in the circuit. If a mains transformer is included in the circuit its winding resistance is included in the limiting value. The winding resistance as seen from half the secondary is given by the formula: $R = R_s + n^2 R_p$. Where R_s and R_p equal the secondary and primary resistance, and n the turns ratio of half the secondary to primary windings. The full-wave circuit of Fig. 2 shows the positions which the resistors may take.

Switching Surges

The life of a metal rectifier working within its voltage rating is dependent largely upon the temperature at which it operates, and this in turn is governed largely by the output current and is independent of peak current. The use of a surge limiting resistor with a metal rectifier is not always essential for rectifier safety, but another difficulty may arise. At the instant the mains switch is closed the reservoir capacitor will be discharged, and the peak current may easily be in excess of 5 amps. This has caused trouble where a switch rated at 3 amps has been used. The remedy is, of course, to either use a larger switch or to include some small value of limiting resistor, something in the region of 22 ohms being adequate.

When estimating the reduction in output voltage which will occur with the introduction of a limiting resistor, it must be remembered that they only conduct current during a part of each cycle, so that the voltage drop will approximate to the product of their resistance value and the peak current.

We shall have more to say on surge limiting next time, when some practical suggestions on methods of measurement will be made.

A Push-Pull

Bias Oscillator

By A. S. TORRANCE

ONE OF THE MOST IMPORTANT REQUIREMENTS of a first-class tape recorder is a bias-generator producing a pure waveform. Where the sine-wave contains parasitics, second and third harmonics, or is seriously non-symmetrical, poor results are inevitable. Agitation of the signal and the ferrous particles on the tape will occur. Distortion, particularly to the high frequency end of the spectrum, will arise and objectionable hiss and background noise may completely ruin a recording.

With all recorders, a periodical check should be made to appraise the general noise level. This is easily done by using a virgin tape and running part of it through the recorder in the Record position but with no signal input. Play this back, noting the difference when the tape runs on to the untouched virgin tape again. Little difference in noise level should be noticed. If possible before this test, all heads should be demagnetized.

Single-ended Oscillators

Some very good designs have been in use, but these are seldom free from one disadvantage or another, and to be really successful an elaborate filter system is normally necessary.

Coupling to the heads requires special care to block d.c. that might otherwise burn out a head winding or, at the least, cause complete magnetization.

Push-Pull

It has been found that push-pull circuits are a great improvement and they are often to be found in commercial or high priced recording equipment. A range of coils for push-pull oscillators and to cover most combinations of Erase and Record heads, is now available from The Teletron Co. Ltd.

The Circuit

It will be seen that these coils are wound transformer fashion. No d.c. is present on the

secondary, and possible risks of magnetizing the heads are eliminated.

Direct coupling may be effected to the Erase head, and a simple type of capacitor fed to the Record head may be confidently employed. At the same time, due to the tapped secondary, a closer impedance matching is achieved for differing combinations of Erase and Record heads.

A conventional flip-flop type of circuit is employed.

Frequency is determined by the total capacitance, but tests have been carried out, and the following table indicates the approximate frequency to be expected when the capacitor C_1 (750pF) is altered:

| Frequency | Capacity in pF |
|-----------|----------------|
| 40 kc/s. | 1600 |
| 50 " | 1000 |
| 60 " | 700 |
| 62 " | 660 |
| 70 " | 520 |
| 80 " | 400 |
| 90 " | 300 |
| 100 " | 250 |

It must be noted, however, that with an excessive increase of frequency a progressive reduction of bias current will occur. Thus, for example, more power is available at 40,000 cycles per second than at 100,000 cycles. Similarly the output voltage will be affected by the h.t. voltage. Unfortunately, it is not possible to give a useful formula for this as each recorder must be considered individually and each set of heads brought to optimum performance.

The circuit as shown produces a most excellent waveform, but some further improvement can be achieved in symmetry by balancing the two resistors R_1 - R_2 (68 k Ω).

It is not very likely that the two sections of a circuit such as this will have identical characteristics.

Obviously, an oscilloscope is the best method to observe a waveform. Those con-

degeneration (feedback), instability of the whole amplifier would be almost certain. Transformer No. 2 is, however, more satisfactory with triode connected valves, Fig. 6, since the latter are less critical with regard to transformer design because the lower anode impedance damps the overshoot which occurs with the pentode valve. The characteristic of the transformer responsible for overshoot and ringing is the leakage inductance between primary and secondary, which in transformer No. 2 is nearly ten times that of No. 1—forty millihenrys and five-millihenrys respectively. It is often possible to change from pentode to triode connection to obtain an improved performance at a sacrifice of power output.

An amplifier deficient in high frequency response will exhibit a waveform similar to Fig. 7. Usually no overshoot will then occur, since the poor high frequency response is insufficient to excite the output transformer and cause it to "ring." This picture would also be obtained if a tone control were included in the circuit under test, and represents a loss of about 6db at 10 kc/s.

An amplifier producing serious "ringing" as shown in Fig. 5 can be made to give a more satisfactory response by the use of a capacitor and resistor connected in series across one of the amplifier stages. The values are adjusted until the minimum overshoot is obtained. Transformer No. 2 gave an oscillogram similar to Fig. 6 when a resistor and capacitor of 2,300 ohms and 0.005 μ F were connected across the two anode terminals of the transformer. The overshoot is reduced to approximately 10%.

We have so far compared the performance of two different output transformers when used with triode or pentode valves. Within the last three years a third method of valve operation has become increasingly popular. This is the so-called "ultra-linear" connection (UL) in which the screen grids are connected to taps at 20% to 50% of the turns on each half-primary, counting from the centre tap. The advantage of the UL circuit is that the high efficiency of the pentode is combined with the low distortion and low output impedance of the triode.

This arrangement is, however, more critical with regard to the output transformer than either the triode or pentode, and it is necessary to have a low order of leakage inductance from the primary to the two screen grid taps, in addition to the secondary. Transformers that have an excessive leakage inductance will give serious ringing and, in the worst cases, self-oscillation of the circuit either continuously or at some particular output power.

The square wave generator is probably the most satisfactory method of examining the

performance. Inferior "ultra linear" type transformers can be stabilised usually by a capacitor and resistor connected from the anode to the screen terminal of each half-primary, with some sacrifice in frequency range. Suitable values are 0.001 to 0.005 μ F and 470 to 4,700 ohms, though, of course, the correct procedure is to change the design of the output transformer to give low leakage inductances between the various windings. One of the writer's transformers (No. 1), which is suitable for UL operation in addition to triode or pentode, has leakage inductances of approximately five millihenrys between

- (1) Primary and secondary.
- (2) Half primary and half primary.
- (3) Half primary and UL tapping.

This transformer is available from one of the well-known makers.

A typical UL circuit is shown in Fig. 8.

When a satisfactory performance has been obtained at the higher audio frequencies, attention should be paid to the low-frequency behaviour. Less difficulty is usually found, provided that the output transformer has an adequate primary inductance. The square wave generator is useful as a means of determining quickly whether an amplifier has an adequate frequency response, but it can only supplement, and not replace, the conventional distortion measurements. Distortion can be considerable at the low frequencies due to flux saturation in the output transformer; this is most easily observed with a sinusoidal input signal.

If a square wave having a frequency about ten times that of the lowest frequency required is applied to an amplifier, the output waveform will give a good indication of the frequency response. The flat top of the square wave will slope downwards, and should this exceed 30% it is probable that the i.f. response is inadequate. A temporary increase in the value of the coupling or cathode bypass capacitors will then show which circuit requires attention. In a push-pull amplifier a temporary linking of the two cathodes of the output stage will also show if the capacitors are low in value or defective, when separate cathode resistors are used.

A typical oscillogram is shown in Fig. 9 which was obtained from a good quality amplifier known to have a drop of 3db at 25 c/s.

The frequency of the square wave is 250 c/s and the slope of the flat top is 30%—as solid line. Almost all this drop is due to the selected value of cathode bypass capacitors, and the dotted line shows the effect of an increase from 20 to 250 μ F, though, of course, the smaller value is quite adequate for high-quality sound reproduction with the 600 ohm resistors normal to KT66 valves.

The dashed line shows the effect of replac-

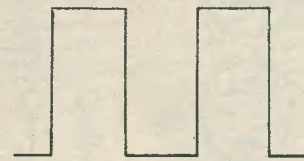

FIG. 1.

Oscillogram of square wave

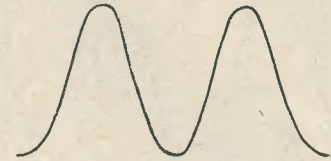

FIG. 2.

Oscillogram of sine wave

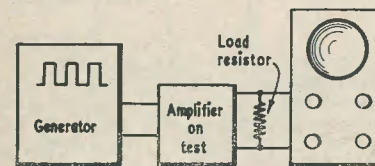

FIG. 3.

Block diagram of connection of equipment

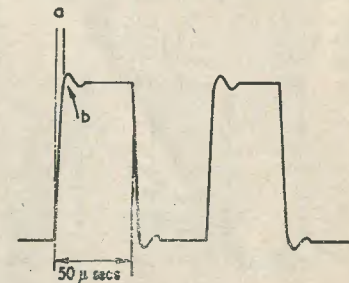

FIG. 4.

Square wave obtained with high grade transformer (No. 1)

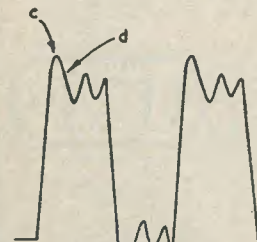

FIG. 5.

Square wave after passing through inferior transformer (No. 2)

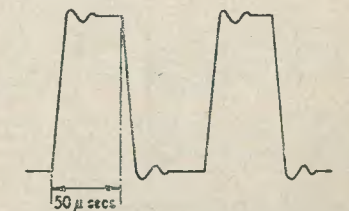
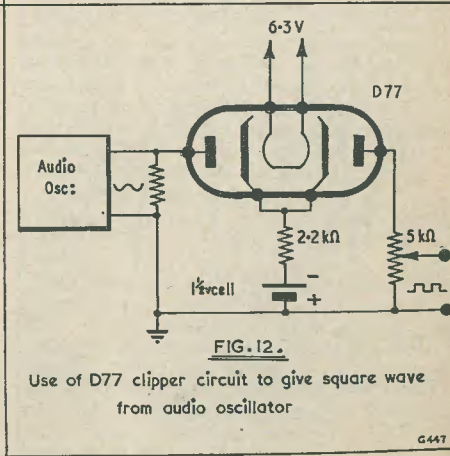
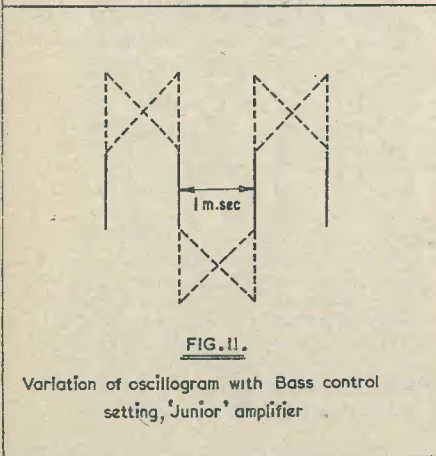
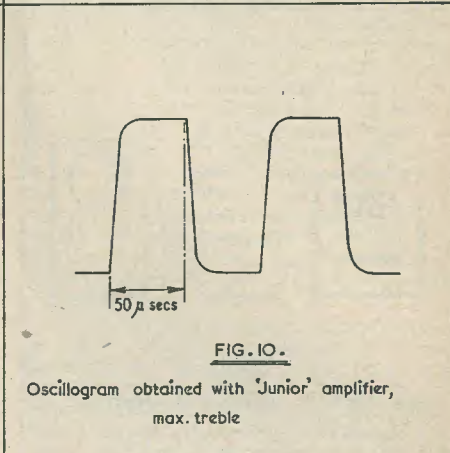
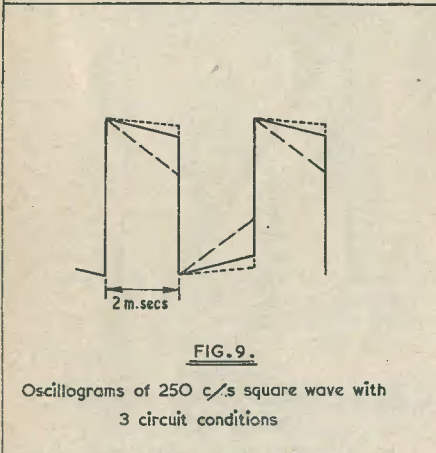
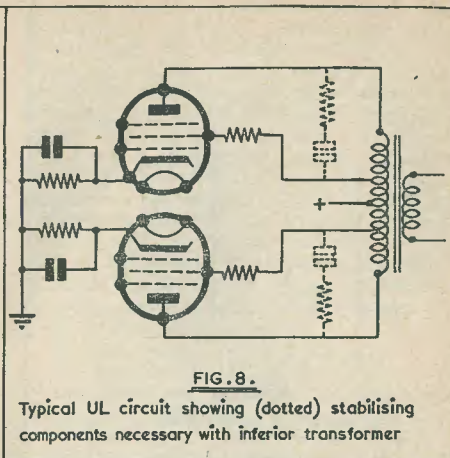
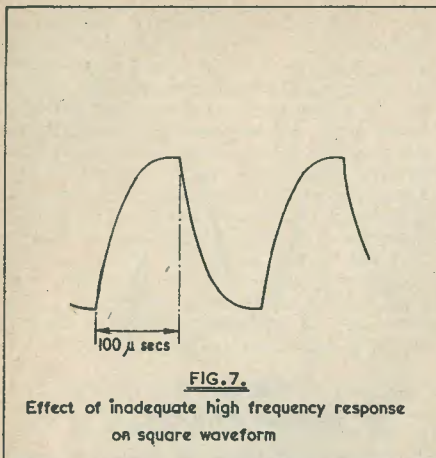

FIG. 6.

Transformer No. 2 used with triodes instead of pentodes (as in Fig. 5)



ing the high grade output transformer with one having an inadequate primary inductance.

Square Wave Generator

In Fig. 12 is shown the circuit of a clipper which, when inserted between the output of an audio oscillator and the amplifier under test, will produce a close approximation to a square waveform. An output of about three-quarters of a volt peak-to-peak is obtained.

The resistor shown across the output of the audio oscillator is not necessary if a d.c. path exists internally. The other values are not critical.

The oscillator should deliver to the diode 25 volts r.m.s. or more, and a check should be made by connecting the c.r.o. to the 5,000 ohm output control to ensure that a satisfactory square wave is being produced and that the c.r.o. is capable of reproducing it. A table showing the equivalent pulse duration for various square frequencies is given in Fig. 13.

The double diode D77 has its heater connected to a pair of flying leads, which may be clipped to the heater supply of the amplifier under test.

Conclusion

In conclusion, a few oscillograms obtained from the 5 watt "JUNIOR" amplifier designed by the writer and described in the November and December 1956 issues of this magazine are reproduced.

| Frequency (or Repetition Rate) | Duration of each half-cycle pulse |
|--------------------------------|-----------------------------------|
| 100 c/s | 5 milliseconds |
| 250 c/s | 2 milliseconds |
| 500 c/s | 1 millisecond |
| 1 kc/s | 500 microseconds |
| 2.5 kc/s | 200 microseconds |
| 5 kc/s | 100 microseconds |
| 10 kc/s | 50 microseconds |

Fig. 13. Table of Pulse Duration versus Frequency

Fig. 10 shows the overall response from the input socket to the fifteen ohm output position with the bass control set level and the treble control set to maximum treble. This amplifier was designed to have a level response to approximately 20 kc/s, but no overshoot of the 10 kc/s square wave is present. The first treble cut position gives a response similar to Fig. 7, and in the second and third positions the waveform becomes increasingly sawtoothed.

The response to a 500 c/s square wave with the bass control set level and the treble control to maximum treble is similar to Fig. 1, showing that the response is level down to 50 c/s. The dotted lines of Fig. 11 show the behaviour as the bass control is rotated from minimum to maximum.

Book Reviews

FM RADIO SERVICING HANDBOOK. By Gordon J. King, M.I.P.R.E. 192 pages, 117 diagrams and illustrations. Published by Odhams Press Ltd., 96 Long Acre, London, W.C.2. Price 25s. 0d.

The author of this book is well versed in the subject of f.m. receivers, and is no mean exponent of writing clearly on his knowledge. He has produced a very useful book which is of value to service engineers and home enthusiasts alike.

The first two chapters describe the nature of the f.m. signal, and the advantages to be gained from its use. These two chapters are thought to be particularly well written, for they make the understanding of a complex subject quite easy.

Other chapters are concerned with various stages in f.m. receivers, namely r.f., i.f., frequency-changer and detector arrangements. Following these are discussions on combined a.m./f.m. receivers, f.m. adaptors, v.h.f. aerials, and the audio section of the receiver. Two chapters are given over entirely to servicing and aligning f.m. receivers, though in the other chapters there is further information concerning the particular circuits under discussion.

The diagrams and photographs are very clear, and the book as a whole is well produced. The text is up to date, liberal use being made of the most recent circuits and receiver designs.

In the chapter on frequency-changers, mention is made of precautions necessary to prevent radiation of oscillator harmonics. It is thought that more could have been said about spurious radiation that can occur with f.m. receivers, for several manufacturers have, in the past, produced service modifications to overcome troubles of this sort.

THE BOYS' BOOK OF RADIO, TELEVISION AND RADAR. 143 pages, 130 diagrams and illustrations. Published by Burke Publishing Company Ltd., 55 Britton Street, Clerkenwell Road, London, E.C.1. Price 9s. 6d.

The application of electronics to science and industry is now so wide that it has become almost part of our lives. The boys of today start life in an age of electronics, and it is understandable that many of them seek to learn how use is made of the simple concepts of electron theory in the many examples of complex apparatus in general use.

This book sets out to describe such matters in simple terms. It does so in a commendable manner, for not only is the text informative and instructive, but the diagrams and illustrations add much to the clarity of the discussions.

The earlier chapters deal with the principles of electrons, wave motion and radio communication, introducing thermionic valves and cathode ray tubes in a way that should make their principles of operation easily understood.

Other chapters describe the use of television in underwater applications, and for industrial purposes. A good idea can be gained of the principles of radar, and navigational aids for aircraft. The final chapter deals briefly with electron microscopes.

This latest edition of a popular boys' book has been revised, and serves a useful purpose in enlightening the younger generation in a way they should enjoy reading.

W. E. THOMPSON

Understanding Television

continued from page 557

our line is 4/3 times longer than the picture height, with the result that, over a line width equivalent to the height, we would be able to reproduce $484 \times \frac{1}{3}$ picture elements; that is: 363. Thus, when a top picture information frequency of 3 Mc/s is employed, the ratio of horizontal resolution to vertical resolution in the 405 line system is 363 : 377 or, very nearly, 1 : 1.

(It is frequently found, when horizontal to vertical resolution is evaluated, that either the period taken up by the line sync pulse is ignored, or that both line and frame sync periods are ignored. The ratio then found for horizontal to vertical resolution becomes less accurate, although the discrepancies involved are not excessive.)

Radio Miscellany

continued from page 578

not be the final result. Many amateurs of all nationalities will have considerable sympathy with his object, whatever they feel about his method of drawing attention to the original breach of good faith.

G.L.'s reminder of ex-DL1CU's earlier brushes with officialdom reminds me how in 1949 this column missed an exclusive story, due to slowness in confirmation and lack of detail. Eventually, when I did get the full story, I thought it must be stale. Instead, no British radio journal, as far as I could discover, mentioned a word about it—so it would still have been exclusive, if belated.

In 1949 the question of restoring the transmitting licences of DL amateurs lay in the "in" tray of officialdom. Every time it got to the top of the pile it was immediately shuffled down to the bottom and conveniently forgotten. Our own officialdom is painfully slow, but incredible as it may seem to us officialdom in most other countries is very much slower. At that time I received a letter from an amateur in Austria mentioning that in the following week all German ex-amateurs were to beg, borrow or steal a brick, neatly parcel it up, and send it to the German P.M.G. These were timed to arrive by the same post, and the Press, etc., were tipped off to have photographers on the spot. Apparently enough bricks turned up to build a couple more Central Post Offices. My informant named ex-DL1CU as being the prime mover in this campaign. This one paid off—the first licences were issued some three weeks later!

As far as I know, this little story has never

The Eavesdropper

price 1/6 postage 2d

A reprint of this MINIATURE TRANSISTOR LOCAL STATION RECEIVER is available, from your local supplier, or

Data Publications Ltd
57 Maida Vale London W9

been told in any British radio journal, and when I confirmed the details when on the Continent months after I was a little peeved with myself at missing the boat, especially after an advance "tip-off."

Austrian amateurs were much slower in getting their licences back, and older readers will recall my accounts of beer-garden parties in different parts of Austria with radio "pirates." They assumed secret call-signs and ran secret QSL Bureaux. Even the R.S.G.B. and other National Societies forwarded cards to OE-land. At least all cards sent via the Bureau seemed to get to their destination OK, and cards came back without any address on them. When I mentioned the "brick trick" or something on similar lines, they just shrugged it off. The excitement of being "illegal" seemed to add something to the hobby which, in addition to being an enjoyable thing in itself, took on much of the quality of being a very gentlemanly underground movement. I certainly found it great fun being among them and hearing some of the subterfuges they employed.

Later "piracy" became so widespread that apparently officialdom knew as much about it as the pirates did themselves, and a blind eye was turned so long as they (a) were not too brazen and (b) didn't make a nuisance of themselves. Oddly enough, when licences were re-issued there were less applications than there were pirates. Apparently the interest diminished in proportion to the excitement. When I was last in Austria (a couple of years ago) there were only about 180 licensed amateurs in the eight zones—and piracy simply didn't exist!

SUB-MINIATURE SPEAKERS

(By W.B.)

1 $\frac{1}{2}$ " round. Depth 1". Impedance 3 Ω 27/- tax paid
2" x 3" elliptical. Depth 1 $\frac{1}{2}$ ". Impedance 3 Ω 33/- tax paid
Sub-miniature Output Transformers for above:

Type A single ended, ratio 18.2/1
Type B push-pull, ratio 10.3/1
Type C push-pull, ratio 8/1
All $\frac{1}{2}$ " x $\frac{1}{16}$ " x $\frac{1}{8}$ " approx. 12/6 each

TRANSISTOR COMPONENTS

Volume Controls. Only $\frac{3}{8}$ " diam. and $\frac{1}{4}$ " depth. Full length spindle (2") $\frac{1}{2}$, 1 and 2M Ω . Log track. Unrepeatable at this price ... 4/3 only

Paper Condensers. Approx. $\frac{15}{16}$ " diam. and $\frac{3}{8}$ " length, 0.01, 0.001 and 0.002 μ F 8d. each
Also 0.005 μ F ($\frac{1}{4}$ " dia. x 1 $\frac{1}{8}$ "^h) 7d. each

TRANSISTORS

Red Spot (Brand New) ... 10/-
Blue Spot (1.6 Mc/s) ... 15/-
Yellow/Green (Audio) ... 10/-
Yellow/Red (2.8 Mc/s) ... 21/-

TRANSISTOR HOLDERS

Enable transistors to be plugged in and out like valves, without danger from heat of soldering iron. For any type of transistor. Recommended by R.C. (June). 1/- each, 6 for 5/6, 12 for 10/9

SUB-MINIATURE CAPACITORS

(Mullard)

25 μ F 6V 5 μ F 12.5V
16 μ F 12.5V 5 μ F 40V
8 μ F 25V 2.5 μ F 25V
8 μ F 6V 1.6 μ F 6V
32 μ F 3V All at 4/- each

(See review on page 232 Nov)
Trade enquiries invited

THE TELETRON CRYSTAL RECEIVER

(See page 558)

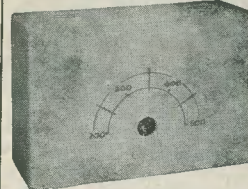

Promptest Delivery Specified Parts

Case and chassis with A, E and phone sockets. With screws and silk screened dial 5/9
Miniature HAX Coil 3/- (HAXL Coil 3/6)
Crystal Diode 1/2
Tuning Condenser 4/2
Knob 10d.
COMPLETE KIT ... 14/6 (With HAXL Coil 15/-)
Superior Headphones 14/- pr

HI GAIN BAND 3 PRE-AMPLIFIER

(See page 568)

Resistor Set 1/6
Capacitor Set (with clip) 8/9
Valve ECC84 17/-
Rectifier (50mA) 7/6
Transformer 13/-
Coil Set (L₁-L₅) 9/-
Chassis (punched for coils, space for Power Pack) ... 3/9
Coax Sockets, V/holder, Tag Strip, Nuts, Bolts ... 5/6
COMPLETE KIT AS ABOVE
£3.3.0

NEON INDICATORS

Miniature mains neon indicators with built-in resistor. Domed front with chrome bezel. Only 1" length and $\frac{1}{2}$ " diameter.
Opal, red or amber 3/10, green 4/7

SPECIAL OFFER

Recording Tape by famous manufacturer. 1,200ft on 7" standard spool.

Limited stock at 23/- each (Normal price 35/-)

MISCELLANEOUS ITEMS

KNOBS. All types from 10d. Send sketch and sizes for quotation.
TYGAN. Assorted offcuts (none less than 3" x 3"). Parcels of 3 sq ft, 10/-; 5 sq ft, 15/-.
CAPACITORS. Paper from 10d. Silver Mica from 7d. Assorted mixed s/m and small paper 16/- for 25. RESISTORS. All types and ratings from 3d. Wirewound from 1/3. Mixed carbon resistors $\frac{1}{4}$ to 1 watt, 20% to 5%, 50 for 7/-. Hi Stabs. 10% $\frac{1}{2}$ W 6d.; 10% 1W 9d.; 1% $\frac{1}{2}$ W 2/-.
Most usual values available. (A few values in 5%, 2% and 1% available at 1/-.)
NEON BULBS (as used in mains testers). Strike about 80V, $\frac{3}{8}$ " x $\frac{3}{8}$ " diam., 1/6. P.V.C. WIRING. Assd. colours, 2d. yd.
FILES. 6" plastic wallet, 12/6.
SCREWDRIVERS. 2 blades, file and Bradawl in hollow handle, 3/6.
Mainstester type, 5/-. Flexible blade, 7/9. Wallet containing 3 blades, 2 Phillips blades, 2 Bradawls and handle, 12/-.
SOLDERING IRONS. Litesold, 6" long, weighs 1oz, $\frac{1}{2}$ " non-wearing bit. For mains or 6 volt (state voltage), 21/6.
SOLDER. Savbit (ensures long bit life), 4d. yd, 20ft reels, 2/6, 11b reels (approx. 160ft), 14/9.
INSULATING TAPE $\frac{1}{2}$ " wide, 25 yds in tin, 1/6.
SWITCHES. Toggle On/Off, s.p. 2/3, d.p. 3/6; rotary from 2/-.
COIL FORMERS with CANS. Having easily removable coil, $\frac{3}{8}$ " x $\frac{3}{8}$ " x $\frac{1}{2}$ " or 2 $\frac{1}{2}$ ", 1/6.
FERRITE RODS 8" x $\frac{1}{4}$ " dia., 2/-.
SLEEVING p.v.c., from 1 $\frac{1}{2}$ d. yd.

"THE MERCURY" FM SWITCHED TUNER

(All parts as specified)

Complete front end (ready built, with 2 valves) ... £6.5.0
Coils, chokes and transformers £14.6
Condenser set 9/8
Resistor set 5/-
All other components (including valveholders, diodes, knob, wire, etc.) 16/7
Complete kit with 2 front end valves but less EF80's £9.0.0
Complete Power Pack kit ... £2.1.9
All other Jason components stocked

• Send for Catalogue, price 5d. • QUOTATION gladly given. (Please send S.A.E.) • Please add postage to above prices

R. Fagelston (MAIL ORDER)

46 HARDWICKE ROAD • LONDON N13

HOME RADIO OF MITCHAM

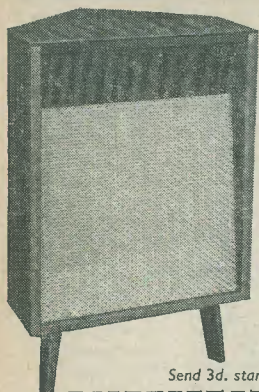

carry the full range of
**W.B.
STENTORIAN
CABINETS**
for speakers and
equipment

The range comprises eleven different models, each beautifully made and finished, which can easily be assembled with only a screw-driver. Packed flat in cartons, they are ready for despatch to anywhere in the U.K.

Send 3d. stamp for illustrated leaflet

High stability RESISTORS

We are pleased to announce that we now stock a complete range of 97 different preferred values of $\frac{1}{2}$ watt 5% high quality-high stability resistors. All at 9d. each. Please add 3d. postage to your order.

HOME RADIO
(MITCHAM) LTD

Telephone
Mitcham 3282

187 London Road Mitcham Surrey



CONSTRUCTOR CHASSIS SERVICE

Chassis for Mullard Two-valve Pre-amp. as described in this issue.

Special enamelled and lettered control panel (for above).

Chassis for Mullard "Type C" Tape Amplifier.

All completely punched with a real professional finish

LIBERAL DISCOUNTS TO BONA FIDE DEALERS ON THE ABOVE AND OTHER CHASSIS. PROMPT DELIVERY

WRITE TO

BERON LTD

34 NAPIER ROAD BROMLEY KENT

TELETRON "Ajax" Crystal Set

CABINET AND CHASSIS KIT (See page 558 this issue)

SIZE—Length $4\frac{1}{2}$ ", Width 3",
Depth $1\frac{1}{2}$ "

Cabinet constructed of unbreakable plastic material, finished in cream. Chassis designed to fit the Teletron HAX Coil. Aerial, Earth and Phone Panel provided.

Retail Price **5/9d.**

Write for descriptive leaflets
Trade enquiries only invited

SOLE DISTRIBUTORS TO THE TRADE

SAM MOZER LTD

288 HEDGE LANE LONDON N13

EDM 7707

PAL 1748



Just published!

The latest in the Data Book series (DB11). 64 pp., plus laminated plastic board cover. The contents include a selection of popular Quality Amplifiers, including the Mullard "3-3" and "5-10" Amplifiers complete with the very latest modifications. Amplifier designs to suit all needs and pockets are featured—a chapter dealing with the reproduction of records (an important part of quality reproduction) also being included. Full circuit and constructional details, together with a number of point-to-point wiring diagrams, make this book a welcome addition to the available literature on Hi-Fi.

Price **4/6** Postage **4d.**

Published by

DATA PUBLICATIONS LTD

57 MAIDA VALE · LONDON W9

Telephone CUNningham 6141 (2 lines)

Telegrams Databux London

EDDY'S (NOTTINGHAM) LTD DEPT. (RC) · 172 ALFRETON ROAD · NOTTINGHAM

MIDGET BATTERY ELIMINATORS to convert all types battery Portables (please state make and model No.) to mains operation, 5/7/6, plus 2/6 postage and packing
SINGLE PIECE THROAT MIKES, 1/- each, post, etc., 4d. Could be used for electrifying musical instruments
ACOS CRYSTAL MIKE INSERTS, 4/11 each. High quality. Can be used for tape recorders, baby alarms, musical instruments, etc. Post and packing 8d. extra.
GERMANIUM DIODES, 1/- each, 10/- dozen, post 4d.

ALL NEW AND GUARANTEED

| ANY PARCEL INSURED AGAINST DAMAGE IN TRANSIT 6d. EXTRA | | SURPLUS, NEW AND GUARANTEED VALVES ALL TESTED BEFORE DESPATCH | | POSTAGE AND PACKAGE 6d. PER VALVE EXTRA OVER £3 FREE | | | | | | | |
|--|-------|---|-------|--|-------|--------|-------|-------|-------|-------|-------|
| 1A7GT | 12/6 | 6J5G | 3/11 | 12AH7 | 7/6 | 954 | 1/6 | ECH35 | 10/6 | EY86 | 16/11 |
| 1C5GT | 10/6 | 6J7G | 7/11 | 12AH8 | 9/11 | 955 | 3/11 | ECH42 | 9/11 | EZ80 | 8/3 |
| 1H5GT | 10/6 | 6K7G | 3/11 | 12AT6 | 9/11 | 956 | -2/11 | EP39 | 5/11 | EZ81 | 9/6 |
| 1N5GT | 10/6 | 6K8G | 7/11 | 12I7GT | 8/11 | 958 | 3/11 | ECC80 | 14/11 | PCC84 | 9/6 |
| 1R5 | 7/11 | 6L6G | 7/11 | 12K7G | 7/6 | AZ1 | 12/11 | EP40 | 13/11 | PCF80 | 6/11 |
| 1S5 | 7/3 | 6S17 | 7/6 | 12K8GT | 13/11 | DAF96 | 9/6 | EP41 | 9/6 | PL81 | 19/- |
| 1T4 | 7/3 | 6SK7 | 6/11 | 12Q7G | 7/6 | DF96 | 9/6 | EP89 | 9/11 | PL82 | 9/11 |
| 3Q4 | 9/- | 6SN7 | 7/11 | 12S17 | 7/6 | DL96 | 9/6 | EP80 | 9/11 | PY80 | 8/6 |
| 3Q5GT | 9/6 | 6U4GT | 13/11 | 12SK7 | 7/6 | DK96 | 9/6 | EP91 | 7/11 | PY81 | 8/6 |
| 3S4 | 8/6 | 6X5GT | 7/11 | 19AQ5 | 11/6 | EB91 | 6/11 | EP42 | 12/6 | PY82 | 8/6 |
| 3V4 | 8/6 | 6X4 | 6/6 | 25L6GT | 9/- | 6BC41 | 9/11 | EL32 | 4/11 | PY82 | 8/6 |
| 5U4G | 6/6 | 7B7 | 8/11 | 25Z4G | 9/- | 6ABC80 | 8/6 | EP85 | 9/6 | U25 | 13/6 |
| 5Z4G | 8/11 | 7C5 | 8/11 | 35A5 | 10/11 | EBF80 | 9/6 | EP91 | 7/11 | UBC41 | 8/6 |
| 6BA6 | 6/6 | 7C6 | 8/11 | 35Z4G | 7/6 | ECC81 | 8/11 | EL41 | 9/11 | UBF80 | 9/6 |
| 6AT6 | 8/11 | 7H7 | 8/11 | 35W4 | 7/6 | ECC82 | 8/11 | EL84 | 9/11 | UCH42 | 8/11 |
| 6BB8G | 3/11 | 7S7 | 8/11 | 35L6GT | 9/11 | ECC83 | 8/11 | GZ32 | 12/6 | UF41 | 8/- |
| 6F1 | 13/11 | 7Y4 | 7/11 | 80 | 8/6 | ECC84 | 10/6 | MU14 | 8/6 | UL41 | 9/6 |
| 6F13 | 13/11 | 10F1 | 15/11 | 807 | 6/6 | ECC85 | 9/6 | EY51 | 11/6 | UY41 | 7/6 |
| 6F15 | 13/11 | 10F9 | 11/6 | | | | | | | | |

17" TV CHASSIS — £19.19.6

Latest improved circuits. Higher E.H.T. (brilliant picture). Improved sensitivity (for greater range). Chassis easily adapted to any cabinet. 17" rectangular tube on adapted chassis. All channels. 12 months guarantee on tube, 3 months guarantee on valves and chassis. Valve line-up (5 valves): 6SN7, 6V6, EY51, 2 6D2. Others: 6L18, EL38, 7 6F1. With 5 valves £21.19.6. With all valves £25.19.6. Turret Tuner 50/- extra. Ins. carr. (incl. tube), 25/-, State B.B.C. channels (and I.T.A. if Turret Tuner required).

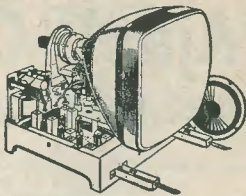

14" TV CHASSIS, TUBE AND SPEAKER — £13.19.6

As above with 14" round tube. Less valves. 3 months guarantee. With 5 valves, £15.19.6. With all valves, £19.19.6. Turret Tuner 50/- extra. Ins. carr. 25/- (incl. tube)

RECTANGULAR TV TUBES

17" £7.10.0.

14" £5.10.0

12 months guarantee. 6 months full replacement, 6 months progressive. Made possible by the high quality of our tubes. Ins. carr. 15/6. Convert your 9", 10", 12" to our special offer of 14", 15", 16" round tubes at £5. Details on how to "do-it-yourself" in our FREE catalogue. 12" t.v. tubes, £6. 3 months guarantee on all round tubes. 15/6 ins. carr. on all tubes. TV TUBES with burns, 15/- and only 5/- ins. carr.!! This price owing to slight screen burns. Perfect picture. Ideal for stand-by and for testing. 14" and 17" rectangular.

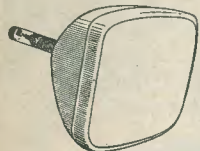

TV CONSTRUCTOR CHASSIS SOUND & VISION STRIP 9/6. Superhet. Complete s/vision strip. Less valves. Free drawing. P. & p. 2/6

TIMEBASE 4/9. Including scanning coil, focus unit, etc. Less valves. FREE drawing. P. & p. 2/6
POWER PACK & AMPLIFIER 19/6. O/p stage 6V6 with o/p trans. Smoothed h.t. 350V 250mA, 6.3V 5A, 22V 3A, 6.3V 4A, 4V centre tapped. Less valves. FREE drawing. Carr. 5/6

ELECTRIC CONVECTOR HEATER 99/6

Cleaner, cheaper, safer than paraffin. A.C./D.C. Switched for 1 or 2kW. Illuminated grille. Size 26" x 18" x 7 1/2" deep. Ins. carr. 10/6.



CASH
or
TERMS

CAR RADIO AERIALS 6/9

Whip antennae, 50" long collapsing to 11". One-hole fixing. Post 1/-

Self-feed Soldering Tool 19/6. 6-12V, 100-125V, (converter for 200-240V, 10/- extra). Made for the American market. Export quality. Complete in light carrying case. Reel of solder and spare parts. P. & p. 2/9. Export enquiries invited.

Coax Cable 6d. yd. Good quality, cut to any length. Allow 1/6 on 20 yds, 45/- 100 yds. P. & p. 3/6.

Insulating Tape 1/6. 75" x 1/2" wide, finest quality. Large roll in metal container. P. & p. 9d.

TV Aerial 25/6. For all I.T.A. and FM channels. For outdoor or loft. 3-element type. P. & p. 2/6

Headphones 1/9. Single earphone and band, C-LR type. Ideal for crystal sets, extension on radio, etc. P. & p. 1/3

BEAUTIFUL EXTENSION SPEAKERS 29/9

Fitted with 8" p.m. speaker "W.B." or "Goodmans" of the highest quality. Standard matching to any receiver (2-5 ohms). Switch and flex included. Unrepeatable at this price. Money back if not completely satisfied. Ins. carr. 3/6, 8" p.m. Speakers 8/9. At this price you can have one in every room. Let the lady of the house listen to that radio or t.v. programme! P. & p. 1/9



Chassis 1/- each, 6 or 8 valves. Latest type midget valve design for a.m. and f.m. New cadmium-plated on s.w.g. steel. 12 1/2" x 7 1/2" x 2 1/2". P. & p. 1/6. Post on 4, 3/-, 12 for 10/-, Carr. 5/-

Send for FREE 1958 Catalogue

Liverpool St. to Manor Park Stn.—10 mins.

OPEN SATURDAY ALL DAY

DUKE & CO (Dept. 1) 621/3 ROMFORD ROAD MANOR PARK E12 Telephone ILF 6001/3

DENCO RADIOGRAM CHASSIS 97/6

3 and 4 waveband turret tuned. S/het. A.C./D.C. Chassis with 6" or 8" speaker. Size 8 1/2" x 10" x 12". Valve line-up: CCH35, EF39, EBC33, CL33 and CY31. (C1C or dropper). Ins. carr. 7/6



SUPER CHASSIS 99/6

5-valve superhet chassis including an 8" speaker. 4 control knobs (Tone, Volume, Tuning, W.C. Switch), 4 waveband with position for gram. P.U. for extension speaker. A.C. P. & p. 5/6

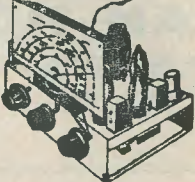

Popular Radio or Radiogram Chassis 39/9

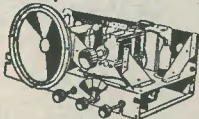

3 w/band and gram, s/het. 5 valve international octal. Ideal table gram, but still giving high quality output. 4 knob control. 8" p.m. speaker, 7/9 extra with order. Set of knobs, 2/- Chassis 12" x 6" x 9". Less valves. Ins. carr. 5/6

BOXED VALVES 3 MONTHS GUARANTEE

| | | | |
|-----------|-----------|-----------|-----------|
| 12AU7 5/9 | E92 3/9 | ECH8110/9 | PEN45 6/9 |
| 12BE6 6/9 | EB34 1/9 | EF50 2/9 | RL37 1/9 |
| 6B8 3/9 | ECC81 8/9 | EL32 6/9 | SP61 2/9 |
| CY18 3/9 | ECH42 8/9 | EL91 3/9 | 6SG7 3/9 |
| 2C22 3/9 | EF39 6/9 | 6F12 7/9 | TT11 6/9 |
| DF66 5/9 | EF91 7/9 | 6H6H 1/9 | 451U 10/9 |
| 8D2 3/9 | EF36 3/9 | KTW61 6/9 | Z77 7/9 |
| 4D1 2/9 | EF37 4/9 | 6P28 10/9 | 77 3/9 |

| | |
|-------------------|-----------------|
| American Types UX | All at 1/9 each |
| 18 75 | 25RE 42 |
| 78 1D6 | 6A7 6D6 |
| | 6C6 |

TV CHASSIS 49/6. Complete chassis by famous manufacturer. R.F. e.h.t. unit included. Drawing 2/6 or FREE with order. Chassis in 3 separate units (power, s/vision, timebase, inter-connected). These chassis can easily be fitted into existing console cabinets. Less valves and tube. Channels, 1-2, 3-5. Easily converted to I.T.A. Ins. carr. 10/6

Visit the City's new acoustically designed

HI-FI Centre

Come and hear the leading makes in Amplifiers and Tuners side by side

AMAZING OFFER

Brand new in maker's carton. The latest Collaro 4-speed auto-changer with Studio t/over cartridge. Our price £7.16.6 plus 5/- post and ins.

A Snip. Garrard 4-speed non-auto gram unit with GC2 t/over cartridge. L.P. and 78 r.p.m. Our price £7.10.0 plus 4/6 post and ins.

Ready Built Printed Circuit 2 valve 3 watt amplifier. Astounding value at £2.12.6 plus 2/6 post and ins.

Transistor and Sub-miniature Components. Jackson "00" tuning condenser, 9/6; 2 1/2" round speaker, 1 1/2" deep, 3 ohms impedance, 16/6, plus 1/6 post and ins.

New Range Sub-miniature Capacitors by well-known Manufacturer

| | | | |
|-----------|-----|------------|-----|
| 1µF 18V | 2/6 | 16µF 12.5V | 3/6 |
| 1.6µF 6V | 2/6 | 25µF 6V | 3/6 |
| 2.5µF 6V | 3/- | 8µF 25V | 3/6 |
| 5µF 12.5V | 3/- | 32µF 3V | 3/6 |
| 8µF 6V | 3/6 | 25µF 25V | 3/6 |

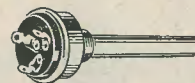

Sub-miniature Pots. 1/2 meg, 1 1/2" spindle, 2/-

THIS MONTH'S BARGAIN

Plessey 4 1/2" p.m. Speaker, 14/9, plus 1/6 post & ins.

PICK-UP SNIP

Featherweight pick-up with HGP 59/1 t/over cartridge and pick-up rest, 32/6

TRANSISTORS

Junction type PNP

| | | |
|---------------------------------------|-----|------|
| Red-spot audio frequency | ... | 6/6 |
| Blue-spot mixer and frequency changer | ... | 15/- |
| White spot | ... | £1 |

Ivalek Vari Loopstick Aerial for transistor circuit 4/6

Ivalek Inter-stage 5-1 TXF for transistor circuit 8/3

1958 AM/FM RADIOGRAM CHASSIS

8-valve AM/FM chassis with printed circuit FM tuner section. Illuminated dial in 4 colours; 4 waveband; coverage 1,000-2,000 metres, 200-550 metres 15-50 metres, 88-100 Mc/s. Dimensions 13" x 9" x 6". Fully guaranteed. Exceptional value—only £22.10.0 plus 7/6 post and ins.

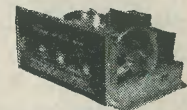

The New B.S.R. TU9 4-speed non-auto, with new ful-FI crystal pick-up. Amazing value, £4.12.6, plus 3/6 post and ins.

Collaro Junior 4-speed motor and t/table with Acos HGP59/1 cartridge. Our price £4.10.0 complete plus 3/6 post and ins.

Teltron and Repanco transistor components always in stock

SPECIAL OFFER

0.0005µF miniature twin gang condenser with 3/2" long spindle by famous manufacturer; 6/9, plus 1/- post and ins.

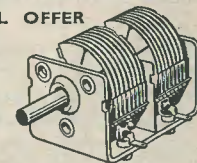

One of our Repeat Lines

Brand new recording tape, 1,200ft, Kraft paper base, 10/6 per spool. Standard 5" plastic take-up spools, 3/- Standard 7" plastic take-up spools, 3/9, plus 1/- post

New Crystal Diodes 10d. each

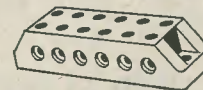

New 6-way Bake-lite Terminal Block. Base fixing, 2/-

STOP PRESS

Limited number brand new 10" Rola p.m. Speakers, 3 ohms impedance. Our price 24/6. 12" Plessey p.m. Speakers, 3 ohms impedance. Our price 32/6 plus 2/6 post and ins.

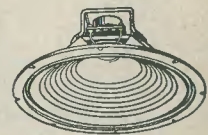

H.P. Terms are available to personal shoppers

This Company is no longer one of the ELPREQ group, but for the convenience of customers we shall continue to stock most of their advertised lines.

Dept. D 152/3 FLEET STREET LONDON EC4

Telephone FLEet 2833

Business hours 9-6 weekdays 9-1 Saturdays

Electronics (FLEET ST) Ltd

TELETRON Type FX.25

Self-tuned, dual wave
Ferrite rod aerial. 15/- each



Specified for the "Companion" 3 Transistor regenerative pocket receiver.
Type 24 Inductor 3/6 each



TRANSISTOR I.F. TRANSFORMERS

High Q "potted" construction, with Ferrite screw cores. Mounted in screening cans 1" x 3/4" dia., 6/6 each. Oscillator coil, 6/6. Transistor type Ferrite rod aerial for MW band, 10/- . Selective crystal diode coil type HAX, 3/- each. Type HAX.L (for LW band), 3/6. Dual wave TRF coils, type A/HF, matched pair, 7/-, with adjustable iron dust cores.

FERRITE ROD AERIALS



Wound on high permeability Ferro-cube rod. No external aerial required. Full sensitivity. Ideal for battery portable receivers. Medium wave, type FRM 4" x 5/16", 8/9. Dual wave type FRD, 8" x 5/16", 12/9. Miniature R.F. Chokes, wound on iron dust cores, with wire end terminations. 2.5 and 5mH, 3/- each; 10mH, 3/6.

TAPE OSCILLATOR COILS

Type TO.10, TO.10/1, TO.10/2 8/6 each
(as illustrated)

Top Lift Inductor, 200mH,
type TL.2 6/6 each
Bias Rejector Coil, type
BR.10 4/6 each

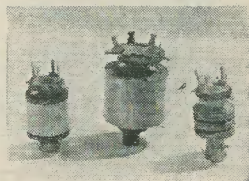

BAND III PRE-AMP COIL SET

(as featured in this issue)
Types 20T, 21T and 22T 9/- per set

Send 5d. in stamps for complete data and circuits. All types available from advertisers in this Magazine and local component stockists

THE TELETRON COMPANY LIMITED

266 Nightingale Road . London N9

Telephone HOW 2527

Trade enquiries to sole distributor

S. Mozer Ltd 288 Hedge Lane NI3 Telephone PAL 1748 or EDM 7707

GLYNE RADIO LTD.

ALL MAIL ORDERS AND CORRESPONDENCE TO
162 HOLLOWAY ROAD . LONDON N7
NOR 6295/6/7 Callers welcome at both branches



18 TOTTENHAM COURT RD. LONDON W1

MUS 5929/0095

6 1/2" WAFER TYPE
LOUDSPEAKER
3 ohm speech coil.
Few only. BRAND NEW, 22/6

1/- p. & p.
DECCA Lightweight Pick-up complete with Scudio "O" turn-over crystal insert and sapphire styli. Only 47/6 plus 1/6 p. & p. Brand new ACOS CRYSTAL MIKE INSERTS. Ex-equipment but new condition. Ideal for tape recorders, etc. 4/6 plus p. & p. 9d.

WIRING WIRE. Five 10yd coils in different colours, contained in cellophane bag. 5/- per bag plus 9d. p. & p.

CONTACT COOLED RECTIFIERS. Westinghouse type 14RA12/8/2, 250V, 200mA, 21/-, 14RA12/8/3 250V, 300mA, 27/6. Both plus p. & p. 9d. Few only, brand new

VALVES. We have perhaps the most up-to-date valve stocks in the trade. A stamp will bring complete list of brand new imported valve types, fully guaranteed, P.T. paid. Also all usual surplus types available such as 6V6GT, 6X5GT, etc.

ALL "TELETRON" COMPONENTS IN STOCK

CRY-BABY ALARM

Enjoy your leisure free from anxiety. This extremely sensitive unit may be installed in a matter of minutes, is completely SAFE and thoroughly reliable. Finished in Red and Grey "LIONIDE." For use on A.C. mains 200-250V. In kit form, complete with mike ONLY 72/6 plus p. & p. 2/6., or assembled and tested 89/6 plus p. & p. 2/6. Suitable mike lead available 3d. a yd. extra. Instruction book and price list 1/- post free.

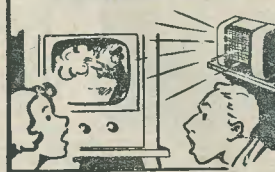

AMERICAN SUPER-LIGHT-WEIGHT HEADPHONES. Magnetic type, fitted with rubber earmoulds. Impedance 50 ohms. Brand new 15/- pr. plus 1/- p. & p.

ROTHERMEL LIGHT-WEIGHT CRYSTAL HEADPHONES. Limited stocks of these well-known headphones are available once again. Suitable for all purposes. Only 21/- pair plus 1/- p. & p.

RECORDING TAPE. P.V.C. based on plastic spool, by leading manufacturer. Brand new. 1,200 ft on 7" spool, also 1,200ft L.P. on 5" spool. Both at 21/- per spool or 3 for 60/- plus p. & p. 1/6

BRAND NEW RECORDING TAPE. 1,200ft Kraft paper based, 10/6 or 3 for 30/-

BARGAIN PACK (CERAMICS). 55 ceramic capacitors, 11 values. FIVE of each from 5pF to 5,000pF in cellophane bag. 18/6, post 9d.

Have YOU had a copy of our 109 page comprehensive CATALOGUE? This invaluable publication is only 2/-, post free

G2AK FOR QUALITY AND SERVICE

HEADPHONES, H.R. type. 4,000 ohms. Very sensitive, only 12/6 pair, post 1/6. C.L.R. type (low res.) 8/6, post 1/6

BRITISH BREAST MIKES (carbon). Ideal for mobiles, 7/6, p.p. 1/6

PLUG-IN NOISE LIMITERS. 3-position limiting. No rewiring. Best with h.r. 'phones. Only 8/6. p. & p. 1/6

SEMI-MIDGET I.F. TRANSFORMERS. 10.7 Mc/s and 465 kc/s (can be used as 10.7 Mc/s and 465 kc/s only), 9/11 per pair, postage 9d.

TWIN FEEDER. 300 ohm twin ribbon feeder, similar K25, 6d. per yard. K35B Telcon (round), 1/6 per yard. Post on above feeder and cable, 1/6 any length

Full range of Denco, Repanco and Eddystone coils and components available. Also most comprehensive range of Hi-Fi equipment in the Midlands including Quad, R.C.A., W.B., Leak, Rogers, etc.

ABSORPTION WAVEMETERS. 3.00 to 35.00 Mc/s in 3 switched bands, 3.5, 7, 14, 21 and 28 Mc/s. Ham bands marked on scale. Complete with indicator bulb. A must for any ham shack. Only 17/6 each post free

100 kc/s CRYSTALS. American makes, in 3-pin based holder. New condition, worth £3.10.0. Our price only 25/-, post free

SPECIAL OFFER!

AMERICAN OCTAL BASED
1,000 kc/s PRECISION
XTALS

Replacements for BC221

30/- post free

Very limited quantity available—

DON'T BE TOO LATE

CHOKES. 2.5mH, 120mA R.F. chokes. Pie wound. 2/- each. Three or more—post free

REPANCO TRANSEVEN

Portable, using 7 transistors. Complete kit of parts including wiring plan and instructions. NOW AVAILABLE FROM STOCK Send for building instructions and priced parts list, 1/6

RACK MOUNTING PANELS 19" x 5 1/2", 7", 8 3/4" or 10 1/2" black crackle finish, 5/9, 6/6, 7/6, 9/- respectively, p. & p. 2/-

AERIAL EQUIPMENT

COPPER WIRE 14g. h.d.; 140' 17/-; 70' 8/6; 7/25 stranded: 140' 10/-; 70' 5/- plus 2/- p. & p. RIBBED GLASS INSULATORS, 3" 1/6 each or 6 for 7/6. Postage and packing 1/6

HEAVY DUTY SHROUDED CHOKES. 10H, 150mA, 80 ohms. Only 10/-, p. and p. 2/6

PLEASE PRINT YOUR NAME AND ADDRESS

CHAS. H. YOUNG LTD Dept. 'R',

110 DALE END, BIRMINGHAM 4 Telephone: Central 1635

Big stocks of all types of components are kept at all depots. Some special component bargains are also listed below.

MORGANITE

POTENTIOMETERS

Single and 2-gang types available, standard size with good length spindle, all new and boxed. Gang type 3/- each. Values available: 5kΩ + 5kΩ, 100kΩ + 100kΩ, 1MΩ + 1MΩ. Single types 1/- each, values available: 10kΩ, 25kΩ, 50kΩ, 100kΩ, 250kΩ, 1MΩ, 2MΩ

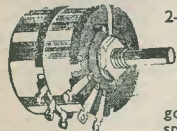

By one of our best makers. 3-pole, 3-way, 2/6 each, also standard type switches 12-pole, 2-way, 1/6 each, 3-pole, 6-way, 2/6 each, 6-pole, 4-way, 2/6.

CERAMIC SWITCHES

Well mixed and useful values, 1/2 and 1/4 watts. Price 5/- per 50.

Well mixed and useful values, 1 watt. Price 6/6 per 50.

Well mixed and useful values, 1 watt. Price 6/6 per 50.

Well mixed and useful values, 1 watt. Price 6/6 per 50.

Well mixed and useful values, 1 watt. Price 6/6 per 50.

Well mixed and useful values, 1 watt. Price 6/6 per 50.

Well mixed and useful values, 1 watt. Price 6/6 per 50.

Well mixed and useful values, 1 watt. Price 6/6 per 50.

Well mixed and useful values, 1 watt. Price 6/6 per 50.

Well mixed and useful values, 1 watt. Price 6/6 per 50.

Well mixed and useful values, 1 watt. Price 6/6 per 50.

Well mixed and useful values, 1 watt. Price 6/6 per 50.

Well mixed and useful values, 1 watt. Price 6/6 per 50.

Well mixed and useful values, 1 watt. Price 6/6 per 50.

Well mixed and useful values, 1 watt. Price 6/6 per 50.

Well mixed and useful values, 1 watt. Price 6/6 per 50.

Well mixed and useful values, 1 watt. Price 6/6 per 50.

Well mixed and useful values, 1 watt. Price 6/6 per 50.

TAPE DECK.—Made by the famous Truvox Company. This contains exactly the same essentials as the current model. Only the styling is different. It also takes the stereophonic head. Specification: 3 B.T.H. shaded pole motors with silent friction drive eliminating wow and flutter. Push-button controls, electrically and mechanically interlocked. Patented electric type push-button controlled brake. Tape loading on the drop-in principle, accommodation for reels of 7" diameter. Tracking sense to British and American standards. Playing times: up to 3 hours with L.P. Tape or 2 hours with standard tapes. Two tracks side by side with safety gap. Positive azimuth adjustment of record/player head. High impedance heads. Overall size 14 1/2" x 12 3/4" x 5" approx. 120 only of these fine decks offered at non-repeatable price of £17.10.0. Non-callers add 10/- carr. and ins.

High impedance heads. Overall size 14 1/2" x 12 3/4" x 5" approx. 120 only of these fine decks offered at non-repeatable price of £17.10.0. Non-callers add 10/- carr. and ins.

High impedance heads. Overall size 14 1/2" x 12 3/4" x 5" approx. 120 only of these fine decks offered at non-repeatable price of £17.10.0. Non-callers add 10/- carr. and ins.

High impedance heads. Overall size 14 1/2" x 12 3/4" x 5" approx. 120 only of these fine decks offered at non-repeatable price of £17.10.0. Non-callers add 10/- carr. and ins.

High impedance heads. Overall size 14 1/2" x 12 3/4" x 5" approx. 120 only of these fine decks offered at non-repeatable price of £17.10.0. Non-callers add 10/- carr. and ins.

High impedance heads. Overall size 14 1/2" x 12 3/4" x 5" approx. 120 only of these fine decks offered at non-repeatable price of £17.10.0. Non-callers add 10/- carr. and ins.

High impedance heads. Overall size 14 1/2" x 12 3/4" x 5" approx. 120 only of these fine decks offered at non-repeatable price of £17.10.0. Non-callers add 10/- carr. and ins.

High impedance heads. Overall size 14 1/2" x 12 3/4" x 5" approx. 120 only of these fine decks offered at non-repeatable price of £17.10.0. Non-callers add 10/- carr. and ins.

High impedance heads. Overall size 14 1/2" x 12 3/4" x 5" approx. 120 only of these fine decks offered at non-repeatable price of £17.10.0. Non-callers add 10/- carr. and ins.

High impedance heads. Overall size 14 1/2" x 12 3/4" x 5" approx. 120 only of these fine decks offered at non-repeatable price of £17.10.0. Non-callers add 10/- carr. and ins.

High impedance heads. Overall size 14 1/2" x 12 3/4" x 5" approx. 120 only of these fine decks offered at non-repeatable price of £17.10.0. Non-callers add 10/- carr. and ins.

High impedance heads. Overall size 14 1/2" x 12 3/4" x 5" approx. 120 only of these fine decks offered at non-repeatable price of £17.10.0. Non-callers add 10/- carr. and ins.

High impedance heads. Overall size 14 1/2" x 12 3/4" x 5" approx. 120 only of these fine decks offered at non-repeatable price of £17.10.0. Non-callers add 10/- carr. and ins.

High impedance heads. Overall size 14 1/2" x 12 3/4" x 5" approx. 120 only of these fine decks offered at non-repeatable price of £17.10.0. Non-callers add 10/- carr. and ins.

High impedance heads. Overall size 14 1/2" x 12 3/4" x 5" approx. 120 only of these fine decks offered at non-repeatable price of £17.10.0. Non-callers add 10/- carr. and ins.

High impedance heads. Overall size 14 1/2" x 12 3/4" x 5" approx. 120 only of these fine decks offered at non-repeatable price of £17.10.0. Non-callers add 10/- carr. and ins.

High impedance heads. Overall size 14 1/2" x 12 3/4" x 5" approx. 120 only of these fine decks offered at non-repeatable price of £17.10.0. Non-callers add 10/- carr. and ins.

High impedance heads. Overall size 14 1/2" x 12 3/4" x 5" approx. 120 only of these fine decks offered at non-repeatable price of £17.10.0. Non-callers add 10/- carr. and ins.

High impedance heads. Overall size 14 1/2" x 12 3/4" x 5" approx. 120 only of these fine decks offered at non-repeatable price of £17.10.0. Non-callers add 10/- carr. and ins.

High impedance heads. Overall size 14 1/2" x 12 3/4" x 5" approx. 120 only of these fine decks offered at non-repeatable price of £17.10.0. Non-callers add 10/- carr. and ins.

High impedance heads. Overall size 14 1/2" x 12 3/4" x 5" approx. 120 only of these fine decks offered at non-repeatable price of £17.10.0. Non-callers add 10/- carr. and ins.

High impedance heads. Overall size 14 1/2" x 12 3/4" x 5" approx. 120 only of these fine decks offered at non-repeatable price of £17.10.0. Non-callers add 10/- carr. and ins.

High impedance heads. Overall size 14 1/2" x 12 3/4" x 5" approx. 120 only of these fine decks offered at non-repeatable price of £17.10.0. Non-callers add 10/- carr. and ins.

TUBE TESTER & REACTIVATOR

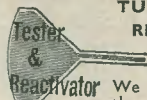

We can supply all the main components for making this unit which will not only test cathode ray tubes but also will reactivate them. Supplied complete with full instructions. Price £3, plus 2/6 post and ins.



BAND III CONVERTER
Suitable Wales, London, Midlands, North, Scotland, etc. All the parts including 2 EF80 valves, coils, fine tuner, contrast control, condensers and resistors. (Metal case available as an extra.) Price only 19/6, plus 2/6 post and ins. Data free with parts or available separately 1/6

CONDENSER TESTER AND REACTIVATOR
This unit tests condensers under correct working conditions at proper voltages. It can also be used for "reforming" electrolytics. All basic parts and full instructions, 50/-, plus 2/6 post and ins.

BUILD THIS 14" or 17" TV IN ONE EVENING
Undoubtedly the most up-to-date television for the home constructor. You can build it in an evening and other constructor TV has all these features?

- No technical knowledge required
- All miniature valves
- Metal rectifier
- Turret tuner 12 channel
- Ferroxcube, E.H.T. and scan coils
- Suitable for any modern 12", 14" or 17" tube

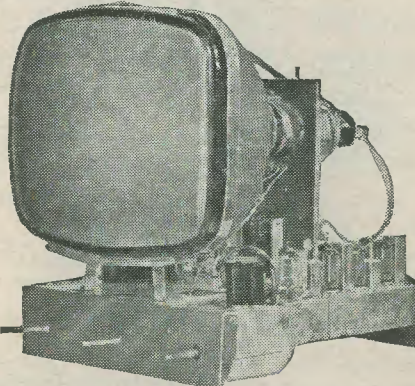

The building cost (less tube) is only £29.10.0 plus 10/- carriage and insurance. All parts guaranteed twelve months. Full information and data free with parts or available separately, price 3/6

BAND 3 TV CONVERTER

185 Mc/s—199 Mc/s
Suitable London, Birmingham, Northern and Scottish ITA Transmissions

Mk. 2 Model. Latest Cascade circuit using ECC84 and EF80 valves giving improved sensitivity (12 db) over standard circuits, built-in power supply a.c. 200-250V. Dimensions only 6 1/2" x 3" x 4". Simple and easy to fit — only external plug-in connections. Wired, aligned and tested ready for use. State channel required. Guaranteed. Bargain offer—good results or full refund, only £3.19.6. Carr. and pkg. 2/6

CONVERTER ACCESSORIES. Band 1—Band 3 Cross-over Unit, 7/6. Var. attenuators 6 db—36 db, 6/9 BBC pattern filter, 8/6. Band 3 aerials—outside single, dipole with 4 yds coax., 13/9. 3-element beam, 27/6. 5-element, 35/-, etc., etc.

MULLARD "3-3" QUALITY AMPLIFIER

An ideal companion unit to the IASON Tuner. A really first-class 3-valve 3W Amplifier giving hi-fi quality at a reasonable cost. Mullard's latest circuit. Valve line-up: EF86, EL84, EZ81. Extra h.t. and l.t. available for Tuner Unit addition. Variable treble cut and bass boost controls, sensitivity 100mV for 3W output. Frequency response + or — 1db, 40 c/s to 25 kc/s. Complete kit (as illustrated) £6.19.6, carr. 3/6. Ready built 8 gns.

FM TUNER-UNIT (87 Mc/s—105 Mc/s) by Jason. Designer Approved Kit of Parts for only 5 gns, post free. Set of 4 spec. valves 30/-, post free. Illustrated handbook with full details, 2/-, post free. 48-hr alignment service, 7/6, p. & p 2/-

CONDENSERS. Mica or S. Mica. All pref. values. 3pF to 680pF, 6d, each. Ceramic types, 2.2pF to 5,000pF, 9d. each. Tubulars, 450V, Hunts and T.C.C. 0.0005, 0.001, 0.005, 0.01 and 0.1, 350V, 9d.; 0.02, 0.05, 0.1, 500V Hunts, T.C.C., 1/-; 0.25 Hunts, 1/6; 0.5 Hunts, 1/9; 0.001 6kV T.C.C., 5/6; 0.001 20kV T.C.C., 9/6

TRANSISTORS. Mfrs. surplus PNP junction type. Audio Type, 800 kc/s 250mW, 9/6; R.F. and L.O. Mixer Type, 2.5 Mc/s, 19/6. All tested and guaranteed

TRANSISTOR COMPONENTS. Midget i.f. transf. 315 kc/s, 5/-; Ferrite Slab Aerial (dual range), 13/6; M. and L.W. Osc. and 1st I.F., 11/6; Push-pull interstage transf., 8/6; Push-pull output transf., 8/-; M/coil phone inserts dia. 2", 4/6; M/1 dynamic inserts dia. 1 1/8", 3/9

RESISTORS. Pref. values 10 ohms to 10 megohms, 20% tol., 1/2W, 3d.; 1/2W, 5d.; 1W, 6d.; 2W, 9d.; 10% tol., 1/2W, 9d.; 5% tol., 1/2W, 1/-; 1% h-stab, 1/2W, 2/-

PRE-SET W/W POTS. TV knurled slotted knob type. 25 ohms to 30,000 ohms, 3/-; 50,000 ohms, 4/-; 50,000 ohms to 2 Megohms (carbon), 3/-

S.T.C. RECTIFIERS. E.H.T. types, K3/25 2kV, 5/-; K3/40 3.2kV, 6/9; K3/45 3.6kV, 7/3; K3/50 4kV, 7/9; K3/100 8kV, 13/6, etc. Mains types: RM1, 125V 60mA, 4/9; RM2 125V 100mA, 5/6; RM3 125V 120mA, 7/6; RM4 250V 250mA, 16/-; RM4B type 250V 275mA, 17/6, etc.

LOUDSPEAKERS. P.M. 3 ohm, 2 1/2" Elac, 16/6; 3 1/2" Goodmans, 18/6; 5" R. & A., 17/6; 6" Celest., 18/6; 7" x 4" Goodmans, 18/6; 8" Rola, 20/-; 10" R. & A., 25/-

SPEAKER FRET. Expanded bronze anodised metal: 8" x 8", 2/3; 12" x 8", 3/-; 12" x 12", 4/3; 12" x 16", 6/-; 24" x 12", 8/6, etc. **TYGAN FRET** (Murphy pattern): 12" x 12", 2/-; 12" x 18", 3/-; 12" x 24", 4/-, etc.

RECORD PLAYER CABINETS
Contemporary style rexine covered cabinet in two-tone grey and green. Size 18 1/2" x 13 1/2" x ht. 8 1/2", fitted with all accessories, including speaker baffle board and plastic fret. Space available for all modern amplifiers and auto-changers, etc. Uncut record player mounting board 14" x 13". Cut mounting boards available.

Cabinet Price £3.3.0 Carr. and ins. 3/6
2 VALVE AMPLIFIER (to fit above cabinet), modern circuit with EL84 output, ready built, with 6" speaker and output transformer, £3.12.6 carr. and ins. 2/6

RECORD PLAYER BARGAINS
SINGLE PLAYERS—3 speed BSR (TU8), 92/6; 4 speed BSR (latest model, TU9), 99/6; 4 speed COLLARO, 5 gns; 4 speed GARRARD (4 S.P.), £7.10.0, carr. and ins. 3/6
AUTO CHANGERS—3 speed COLLARO (RC54), £7.19.6; 4 speed BSR (UA8), £8.15.0; 4 speed COLLARO (RC456), £9.15.0; 4 speed GARRARD (RC120/4H), 9 1/2 gns; carr. and ins. 4/6. All above models brand new and guaranteed. Fitted latest style lightweight Xtal PU, with turnover head and twin sapphire stylii.

VOLUME CONTROLS
Log. ratios, 10,000 ohms—2 Megohms. Long spindles. 1 year guarantee. Midget Edison type. No Sw. S.P.Sw. D.P.Sw. 3/- 4/- 4/9

Linear Ratio, 10,000 ohms —2 Megohms. Less switch, 3/- each. **Coax Plugs, 1/2. Coax Sockets, 1/-.** **Couplers, 1/3. Outlet Boxes, 4/6**

80 ohm cable COAX
STANDARD 1/4" diam. Polythene insulated. Grade "A" only. 8d. yd.
Special. Semi-air spaced polythene. 80 ohm. Coax 1/4" diam. Stranded core. Losses cut 50%. Ideal Band 3, 9d. yd

MAINS TRANSFORMERS. Made in our own workshops to top grade spec. Fully interleaved and impregnated. **RADIO AND AMPLIFIER TYPE** 250V 60mA, F.V. sec., 5V or 6.3V 1A rect. 6.3V 2.5A set htrs., 22/6, etc. **C.R.T. HTR. ISOLATION TYPE.** Low leakage with or without 25% sec. boost voltage. Ratio 1 : 1 or 1 : 1.25, 2V, 4V, 6V or 13V, 10/6 each. Ditto with mains primaries 200/250V, 12/6 etc.

L.F. CHOKES—10H 65mA, 5/-; 15H 100mA, 10/6; 10H, 120mA, 10/6; 20H 150mA, 15/6
OUTPUT TRANSF.—Standard pentode, 4/6; push-pull 12 watt, 13/6. Small pentode, 3/9. Midget battery pentode (154, etc.), 4/6

I.F. TRANSFORMER 465 kc/s
Brand new ex-manufacturer's midget I.F.T., size 2 1/2" x 3" x 3", dust core tuning. Litz wound coils, high Q. Bargain offer, 7/6 pair

ELECTROLYTICS—ALL TYPES—NEW STOCK
Tubular Wire Ends Can Types, Clips 3d. each
25/25V, 50/12V 1/9 8+8/450 T.C.C. 4/6
50/50V, 4/500V 2/- 8+16/450 Hunts 5/-
100/25V, 2/450V 2/- 16+16/450 T.C.C. 5/6
8/450V B.E.C. 2/3 32/350V 4/-
8/500V Dub. 2/9 32+32/275V Hunts 4/6
8+8/500V Dub. 4/6 32+32/450 T.C.C. 6/6
8+16/450V T.C.C. 5/- 250/350 B.E.C. 8/6
16/450V B.E.C. 3/6 100+200/275V 12/6

MIDGET TRANSISTOR TYPES. 2μF, 4μF, 8μF 6V, 3/6; 6μF, 10μF, 16μF 3V, 3/6; 32μF 1 1/2V, 3/6

8" P.M. SPEAKER (3 ohms)
Ex-manufacturers' Units: Rola, W.B., Celestion, etc. All reconditioned and guaranteed. Ideal ext. unit. Bargain, 7/6, carr. 1/6

VALVES—NEW BOXED—ALL GUARANTEED
1R5, 1T4, 7/6; 1S5, 1S4, 7/6; 354, 3V4, 8/-; 5Z4, 9/6; 6AT6, 8/6; 6K7, 6/6; 6K8, 8/6; 6Q7, 8/6; 6SN7, 8/6; 6V6, 7/6; 6X4, 7/6; 6X5, 7/6; 7CS 9/6; 7Y4, 8/6; DAF96, 9/6; DP96, 9/6; DK96, 9/6; DL96, 9/6; 35L6 10/6; EABC80, 9/6; EB91, 6/6; EBC41, 10/6; EVC33, 8/6; ECC84, 12/6; ECH42, 10/6; ECH81, 10/6; ECL80, 10/6; EF41, 10/6; EF80, 10/6; EF86, 12/6; EF91, 8/6; EY51 10/6; EZ40, 8/6; EZ80, 8/6; MU14, 9/6; PCC84, 10/6; PCF80, 10/6; PCF82, 10/6; PCL83, 12/6; PL81, 11/6; PL82, 10/6; PL83, 11/6; PY80, 9/6; PY81, 9/6; PY82, 8/6; U22, 8/6; U25, 11/6; UY41, 8/6

SPECIAL—1R5, 1T4, 1S5, 1S4 or 354 or 3V4 per set 27/6

TRS RADIO COMPONENT SPECIALISTS
70 Brigstock Road
Thornton Heath Surrey

THO 2188. Hours 9 a.m.—6 p.m.
1 p.m. Wed. Terms: C.W.O. or C.O.D. Post and packing up to 3lb 7d., 1lb 1/1, 3lb 1/6, 5lb 2/-, 10lb 2/9. Bargain lists 3d.

ELECTRONIC PRECISION EQUIPMENT LTD

POST ORDERS SHOULD BE ADDRESSED TO DEPT. 34 66 GROVE ROAD EASTBOURNE.

Personal shoppers, however, can call at

42/46 Windmill Hill
Ruislip Middlesex
Telephone RUIslip 5780
Half-day Wednesday

266 LONDON ROAD CROYDON
Telephone CROydon 6558 Half-day Wednesday

29 Stroud Green Road
Finsbury Park N4
Telephone ARChway 1049
Half-day Thursday

HENRY'S

(RADIO) LTD

5 Harrow Road Edgware Road
Paddington London W2

Opposite Edgware Road Station

PADddington 1008/9

OPEN MONDAY to SAT. 9-6 THURS. 1 o'clock

HUNDREDS OF BARGAINS AVAILABLE IN
TRANSISTOR COMPONENTS, VALVES, ETC.
SEND 6d. for 28-PAGE CATALOGUE

TRANSISTORS

JUNCTION TYPE P-N-P
(British Manufacture)

| | |
|---|------|
| RED-SPOT 800 kc/s Audio Frequency | 10/- |
| BLUE SPOT 1.6 Mc/s Mixer and Frequency Changer | 15/- |
| WHITE-SPOT 2.5 Mc/s R.F. and I.F. Amp. | 20/- |

All Transistors are Tested and Guaranteed
N.B.—The Red-Spot is similar to Mullard OC71
TRANSISTOR BASES 9d. each

TRIPLETT AC/DC POCKET TEST-METER

Type 666H—15 ranges
1000 ohm p.volt

AC/DC 10/50/250/1000/5000V

Milliamps 0-10/100/500

Ohms 0-300/250,000 ohms

£5. 10. 0

In new condition with prods
and internal battery

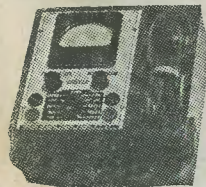
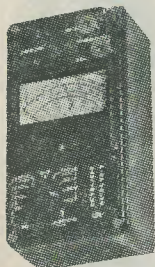

U.S.A. TESTMETER

Type "834-S"

AC/DC 15 Ranges

AC/DC Volts 12/60/

300/600/1200/6000V

Milliamps 1.2/12/60/

600mA

Ohms 0-5,000/5 meg

F.S.D. 1,000 p.v.

£6. 19. 6

Complete in wooden

carrying case with leads

and internal batteries

17/6 p.p 1/6

Or, complete with high

resistance phones 29/6,

p.p 1/6

CRYSTAL CALIBRATOR No. 7 Mark 2

10 kc/s, 100 kc/s, 1 Mc/s

Battery operated input 60V and 2V. Complete with
6 valves, 5 IT4 and 1R5 and Xtal. and phones. This
instrument is a modern version housed in small
metal case. Brand new in transit case

£5. 19. 6

EVERSHED WEE-MEGGERS

500V new condition, with leather case

£8. 19. 6

500V brand new, with leather case

£12. 10. 0

100V new condition, with case

£6. 0. 0

SPUTNIK-SPECIAL

SHORT-WAVE RECEIVER 10-60 Mc/s (5-30
Metres) RECEPTION SET TYPE 208

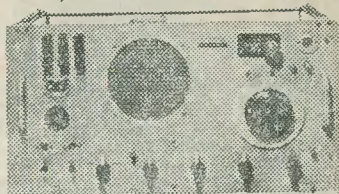

Complete with 6 valves, 2-6K8G, 2-EF39, 6Q7G and
6V6G. Internal mains power pack and 6V vibrator
pack. Built-in 6 1/2" speaker. Muirhead slow-motion
drive. B.F.O. and R.F. stage. I.F. freq. 2 Mc/s.
Provision for phones and muting and 600 ohms.
Dual input 100/250V a.c. and 6V d.c. Size 24" x
18" x 12". Weight 70lb. In metal transit case.
All sets in new condition and air tested.

£6. 19. 6 Carr. 15/6

BE PREPARED TO LISTEN TO THE SATELLITES

5-VALVE A.C./D.C. PORTABLE RADIOGRAM CHASSIS THREE WAVE BAND SUPERHET

200/250V A.C./D.C.
(With Internal Aerial)

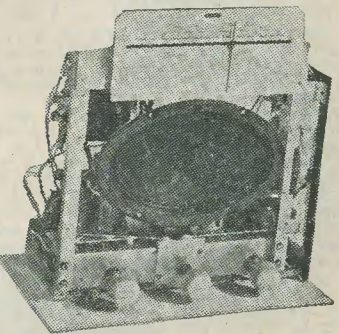

Short 160-50m. Med. 187-575m. Long 900-2,000m.
(With gram. switching.) Five Marconi valves, type:
X109, W107, DH107, N108 and U107, and 7" x 4"
elliptical speaker. Ideal for Portable Radiogram.
Chassis size 10" x 4" x 4"

£7. 12. 6 P.P 7/6

Also available as above at the same price, similar
chassis with following specifications: Short Wave
11.27-31.9m. Short Wave 31.2-91m. Medium 187-
575m. and gram. switching.

WALKIE-TALKIE TRANSMITTER/ RECEIVER ARMY TYPE "38"

Complete with 5 valves in new condition with
circuits. These sets are sold without guarantee but
are serviceable 22/6 p.p. 2/6. Headphones 7/6 per
pair. Junction box 2/6. Microphone 4/6. Canvas
Bags 4/-, Aerial Rods 2/6.

"373" MINIATURE 9.72 Mc/s I.F. STRIP

The ideal FM Conversion Unit as described in
P.W. April/May 1957. Complete with 6 valves:
3 EF91, 2 EF92 and EB91. I.F.T.s, etc., in absolutely
new condition. With circuit and conversion data.

12/6 (less valves) 42/6 (with valves)

Postage 2/6 on either type

The "TRANSISTOR - 8"

Push-Pull Portable Superhet

Can be built for £11/10/-

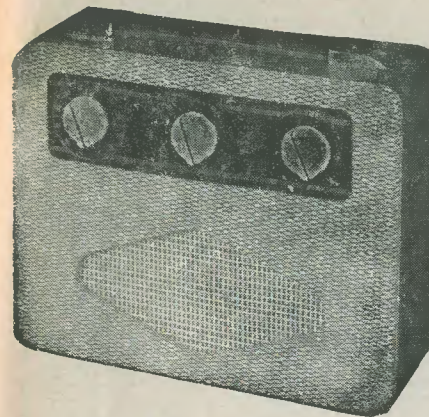

TEN STAR FEATURES

- ★ 8 specially selected Transistors
- ★ 250 Milliwatts output push-pull
- ★ Medium and Long Waves
- ★ Internal Ferrite Rod Aerial
- ★ 7" x 4" elliptical Speaker
- ★ Drilled plastic Chassis 8 1/2" x 2 1/4"
- ★ Point to point wiring and practical layout
- ★ Economical. Powered by 7 1/2V battery
- ★ Highly sensitive
- ★ Attractive lightweight contemporary case

We can supply all these
items including cabinet
for £11.10.0
All parts sold
separately

Send for circuit dia-
grams, assembly data il-
lustrations and instru-
ctions, and full shopping
list FREE, post 3d.

This Portable 8-Transistor Superhet is tunable for
both Medium and Long Waves and is comparable
in performance to any equivalent Commercial
Transistor Set. Simplified construction enables
this set to be built easily and quickly into an attrac-
tive lightweight cabinet supplied.

N.B.—Pair of XC101's supplied at additional cost of 40/-
Call and hear demonstration model

As featured in August issue and described on page 28

ALL PARTS FOR "CONTESSA" TRANSISTOR PORTABLE IN STOCK

"HOMELIGHT"

2-Transistor Personal Portable

Variable Tuning

We can supply all components, including 2 transistors,
diode, resistors, condensers and miniature hearing-aid
and plastic case, size 4 1/4" x 2 3/4" x 1 1/8", and 1 1/2V battery for
52/6. All items sold separately.

TRANSISTOR SIGNAL TRACER

Complete Kit with 2 Transistors, components, phones,
with circuit and plastic case

42/6

TRANSISTOR SQUARE WAVE GENERATOR

Complete Kit with 2 Transistors, components, circuit
and plastic case

25/-

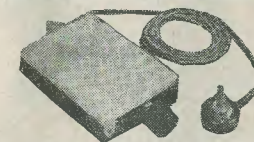

MINI-TWO

2-TRANSISTOR MINIATURE POCKET RADIO

The smallest transistor set offered on the market.
Variable tuning. Drilled chassis, plastic case size 3" x
2" x 3/4", miniature hearing aid, 2 transistors and all
components including 1 1/2 volt battery, circuits and full
practical layout diagrams.

Total cost 49/6 complete

"EAVESDROPPER"

THREE-TRANSISTOR POCKET RADIO

(No Aerial or Earth required)

Medium wave. Variable tuning. Total cost, as specified, including Transistors,
Transformers, Coils, Condensers and Battery, etc., with circuit and plastic case.

All items sold separately

77/6

POST FREE

With single 'phone, 81/- With Acos Mike, 90/- With Min. Hearing Aid, 90/-

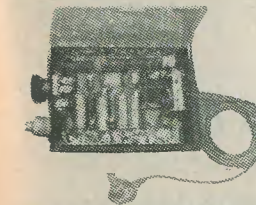

HENRY'S RADIO LTD • 5 HARROW ROAD • LONDON W2

Telephone PADddington 1008/9

SIGNAL GENERATOR

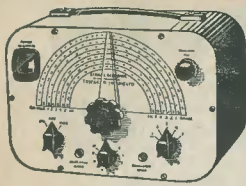

£6.19.6 or 25/- deposit and 6 monthly payments of 21/6. P. & p. 5/- extra. Coverage 100 kc/s-100 Mc/s on fundamentals and 100 Mc/s-200 Mc/s on harmonics. Metal case 10" x 6 1/2" x 5 1/2", grey hammer finish. Incorporating three miniature valves and metal rectifier. A.C. mains 200/250V. Internal modulation of 400 c.p.s. to a depth of 30%; modulated or unmodulated r.f. output continuously variable; 100 millivolts, c.w. and mod. switch, variable a.f. output. Incorporating magic eye as output indicator. Accuracy $\pm 2\%$.

SIGNAL GENERATOR

£4.19.6 or 25/- deposit and 4 monthly payments of 21/6. P. & p. 5/- extra. Coverage 120 kc/s-230 kc/s, 300 kc/s-900 kc/s, 900 kc/s-2.75 Mc/s, 2.75 Mc/s-8.5 Mc/s, 8 Mc/s-28 Mc/s, 16 Mc/s-56 Mc/s, 24 Mc/s-84 Mc/s. Metal case 10" x 6 1/2" x 4 1/2". Size of scale 6 1/2" x 3 1/4". 2 valves and rectifier. A.C. mains 230-250V. Internal modulation of 400 c.p.s. to a depth of 30 per cent, modulated or unmodulated r.f. output continuously variable 100 millivolts. C.W. and mod. switch, variable a.f. output and moving coil output meter. Grey hammer finished case and white panel. Accuracy $\pm 2\%$.

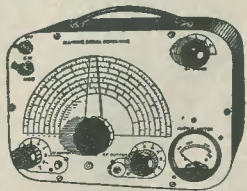

SIGNAL & PATTERN GENERATOR

£6.19.6 or 25/- deposit and 6 monthly payments of 21/6. P. & p. 5/- extra. Coverage 7.6 Mc/s-210 Mc/s in five bands, all on fundamentals, slow-motion tuning, audio output, 8 vertical and horizontal bars, logging scale. In grey hammer finished case with carrying handle. Accuracy $\pm 1\%$. A.C. mains 200-250V.

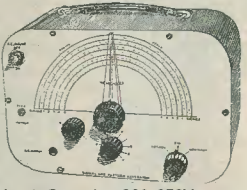

AC/DC POCKET MULTI-METER KIT

Comprising 2" moving coil meter, scale calibrated in a.c./d.c. volts, ohms and milliamperes. Voltage range a.c./d.c. 0-50, 0-100, 0-250, 0-500, milliamperes 0-10, 0-100. Ohms range 0-10,000. Front panel, range switch, wire-wound pot (for ohms zero setting), toggle switch, resistors and rectifier. In grey hammer-finish case. 19/6 plus p. & p. 1/6. Point-to-point wiring diagram 1/-, free with kit. Built and tested, 7/6 extra.

COMPLETELY BUILT PORTABLE AMPLIFIER

Approx. size 6 1/2" x 2 1/2", incorporating 2 valves, contact-cooled metal rectifier, bass and treble lift controls, and double wound mains transformer 230-250V 39/6 plus p. & p. 3/6. 5" P.M. Speaker and O.P. Transformer, if purchased with above, 18/6, plus p. & p. 1/6

COLLARO 4-SPEED AUTOMATIC CHANGER Model 457 (suitable for use with above amplifier). A.C. mains, 200-250V, turnover crystal head. Brand new, fully guaranteed, £8.19.6, plus p. & p. 5/-. Or 25/- deposit plus p. & p. 5/- and 7 monthly payments of £1.5.0

RADIO & TV COMPONENTS (Acton) LTD

23 HIGH STREET ACTON LONDON W3
GOODS NOT DESPATCHED OUTSIDE U.K.
All enquiries S.A.E.

GOOD BUYS AT

The Walk-around Shop

MULTI-RANGE TEST METER Ranges 0-1.5V, 0-30V; 0.60mA; 0-500 and 0-5,000 ohms. Easily read open scale. Simply extended to provide useful pocket fault finder. Size 2 1/4" x 3 3/4" x 3 3/4". Brand new ... 8/6

TRANSFORMERS—250 volts 50 c/s 6.3V, 1.5A, 6/6. 230V at 40mA and 6.3V at 1.5A, 12/6. 9V and 17V at 3A (for charging), 15/6. Mains isolating—250V/220V or 250V/110-0-110V out OR double wound auto 250V in 110V out ... 5/6

I.F. UNIT—460 kc/s Tunable to other nearby I.F. frequencies. Fully screened plug-in box unit with IT4 valve. Brand new ... 10/6

MINIATURE I.F. STRIP—9.72 Mc/s Complete and unused with circuit less valves—2 EF92, 3 EF91, 1 EB91 ... 8/-

AN/APNI 14 Valve Tx/Rx Frequency modulated and tuned to 445 Mc/s with 40 Mc/s bandwidth. Easily converted for radio control or 70 cms. Brand new with 14 valves. Worth more for breakdown ... 30/-

ELECTRIC TIME SWITCHES 6V battery-driven precision clock. Current negligible. Settings from 15 mins to 44 days. Ideal for automatic lighting-up of parked cars, etc., and many other uses. Brand new in plastic case ... 12/6

PROOPS BROS. LTD. Open all day Saturday Dept. R, 52 Tottenham Ct. Rd. W1
Hours 9-6 p.m. Thursday to 1 p.m. LAngham 0141

THE VERSATILE PRE-AMPLIFIER

We stock all items needed for the latest Mullard Pre-Amplifier described in this issue. A fully drilled chassis is available. Our detailed list will be sent free upon request.

MULLARD TAPE AMPLIFIER

We can supply from stock all items for the Mullard Tape Amplifiers Types A, B and C. Our lists giving full details are free.

WATTS RADIO

(Mail Order) Ltd.

54 CHURCH ST WEYBRIDGE SURREY

Telephone Weybridge 4556

NOTE: Post orders only to this address

SMALL ADVERTISEMENTS

Readers' small advertisements will be accepted at 3d. per word, including address, minimum charge 2/-. Trade advertisements will be accepted at 9d. per word, minimum charge 6/-. If a Box Number is required, an additional charge of 2/- will be made. Terms: Cash with order. All copy must be in hand by the 8th of the month for insertion in the following month's issue.

PRIVATE

A BEGINNER'S MORSE COURSE. Up to 14 W.P.M. on L.P. 3-speed record with instructions. Pass G.P.O. Test easily. New, only 45/-. Complete course by return. Advanced course also available. Please send S.A.E. WANTED, Collins 75A4 or similar receiver. BENNETT, 45 Green Lane, Purley, Surrey. (UPLands 2896).

FOR SALE, CHEAP—New 10-valve Feeder and Amplifier.—Details from Box E155.

SALE—30 copies Practical Television, 15s.; 20 copies Practical Wireless, 12s.; 20 copies Radio Constructor, 16s.; 9in TV, Baird, for spares, valved, and tube, £2. TV chassis, most valves, working, £4 (superhet); TV signal and pattern generator, as new, 1% accurate, £4 10s. 0d.; 8in Cossor electrostatic tube, 15s.; console cabinets, two, at 15s. each; 2V isolating transformer, 230V output, new, 7s. 6d.; 2V 2A, 230V input, 5s.; 6.3V 0.3A, 230V input, 7s. 6d.; RM4 rectifier, 7s. 6d.; frame output choke and scan coils, Denco, 15s.; small woodwork lathe and angle iron stand, £2 10s. 0d.; heavy polishing head and two 10in cotton buffs, £1.; Green Arrow space heater, needs adjusting, 10s.; approx. 30ft heavy shielded mike cable, 7s. 6d.; rotary converter, run on a.c. as meter, fitted right-angle drive, £1. Please add postage on above.—R. E. King, 4 Bridge House, Beeches Avenue, Carshalton, Surrey.

REQUIRED URGENTLY November 1955 copy *The Radio Constructor*.—Box E156.

COMPLETE HI-FI OUTFIT. Mullard 5-10, Baxendale Pre-Amp (W.W.), Wearite tape deck and amp., Lenco transcription motor, Goldring V.R. pick-up, Goodmans enclosure, Axiom 150 with cross-over and tweeter, M.R.G. radio unit with f.m. and three a.m. bands—£100 o.n.o., or would separate.—Write Mattingly, Coped Hall, Wootton Bassett, Wilts.

NEW MAINS TIME SWITCH, bench Anglepoise lamp, Radiospares de luxe O/P transformer, multi-matching, No. 19 set, unused, £7 or exchange R107. Collect London area.—Box E157.

NEW AND GUARANTEED VALVES—6C4, 3s.; 6AM6, 6/6, 4s. 6d.; 12AT7, 5s.; 12E1, 15s.; 832, 15s.; Receiver CR100, £10.—Details O'Brien, 18 St. Helens Road, Dorchester, Dorset.

WANTED, AVO model 8 or similar, also signal generator.—Price and details to Brandwood, 92 De Villiers Avenue, Liverpool 23.

RELAYS, P.O. 2,000 type, 4s. 6d. each, post 6d. (please state voltage or resistance preferred). Rack mounting power pack, 250V 150mA, 6.3V 4A, with h.t. ammeter, 25s. o.n.o.—J. D. Denby, "Hillside," Coldshaw, Haworth, Keighley, Yorks.

WANTED URGENTLY Practical Wireless from October 1953 to April 1954 inclusive.—Particulars please to I.S.W.L., 86 Barringer Road, London, N.10.

CHASSIS, CP3F coil pack, i.f. transformer, J.B. 2-gang condenser and S.L.8 dial, all unused, and as specified in Denco DB9 booklet for the 4-Band Tuner, £5.—Blackwood, Oast Cottage, Kensing, Kent.

continued on page 607

NEW SURPLUS ...

| | | | | | | | |
|-------|-------|--------|------|---------|------|----------|------|
| 1A3 | 2/6 | 6SA7M | 7/6 | 866A | 12/6 | EL91 | 7/6 |
| 1L4 | 5/- | 6SG7M | 7/6 | 959 | 7/6 | EM80 | 10/- |
| 2A3 | 8/6 | 6SH7M | 5/- | 1616 | 5/- | EZ40 | 8/6 |
| 2X2 | 3/6 | 6SJ7M | 7/6 | 1629 | 4/6 | EZ80 | 8/6 |
| 3A4 | 6/6 | 6SK7M | 6/6 | EAS0 | 1/6 | HK24G | 25/- |
| 3B4 | 8/6 | 6SL7GT | 7/6 | EABC80 | 10/- | KT33C | 9/6 |
| 50A | 25/4M | 6SN7GT | 6/6 | EAC91 | 4/6 | PCC84 | 10/6 |
| | 21/- | 6SQ7M | 7/6 | EAF24 | 10/6 | PCF82 | 10/- |
| 5R4CY | 10/6 | 6X4 | 6/6 | EB34 | 2/6 | PL82 | 9/6 |
| 5Y4G | 6/6 | 6X5GT | 7/6 | EB91 | 6/6 | PL83 | 10/6 |
| 6AC7M | 5/- | 7B7 | 9/6 | EBC33 | 7/6 | PCL83 | 12/6 |
| 6AG5 | 3/6 | 7C5 | 9/6 | EBC41 | 10/6 | PY80 | 9/6 |
| 6AK5 | 5/- | 7C6 | 9/6 | EBF80 | 10/6 | PY81 | 9/6 |
| 6AL5 | 6/6 | 7Y4 | 8/6 | EBF89 | 10/6 | PY82 | 9/6 |
| 6AM6 | 7/6 | 12A6M | 7/6 | ECC82 | 9/6 | PY83 | 11/6 |
| 6AQ5 | 8/6 | 12AT6 | 8/6 | ECC83 | 9/6 | R19 | 12/6 |
| 6AT6 | 8/6 | 12AT7 | 9/6 | ECC84 | 11/6 | SP61 | 3/- |
| 6AU6 | 8/6 | 12AU6 | 9/6 | ECC85 | 10/6 | TT11 | 4/6 |
| 6B8G | 4/6 | 12AU7 | 8/6 | ECC80 | 12/6 | UAF42 | 10/6 |
| 6BA6 | 8/6 | 12BE6 | 8/6 | ECH82 | 11/6 | UBC41 | 10/6 |
| 6BE6 | 7/6 | 12C8M | 7/6 | ECH82 | 10/6 | UBF89 | 10/6 |
| 6BR7 | 11/6 | 12Q7GT | 9/6 | ECH81 | 10/6 | UCC85 | 10/6 |
| 6C4 | 5/- | 12K7GT | 9/6 | ECL82 | 12/6 | UCH42 | 10/6 |
| 6C5M | 5/6 | 12SC7M | 2/6 | EF36 | 4/6 | UF41 | 10/6 |
| 6F6M | 5/6 | 12SK7M | 7/6 | EF37A | 8/6 | UF89 | 10/6 |
| 6F8G | 4/6 | 12SQ7M | 8/6 | EF39 | 5/6 | UL41 | 10/6 |
| 6GG6 | 4/6 | 35L6GT | 9/6 | EF41 | 10/6 | UY41 | 8/6 |
| 6J5GT | 5/- | 35Z4GT | 8/6 | EF50 | 3/6 | UY85 | 10/6 |
| 6J5M | 6/- | 35Z5GT | 8/6 | EF50(S) | 5/6 | UABC80 | 10/6 |
| 6J6 | 4/- | 42 | 7/6 | EF55 | 7/6 | 10/6 | |
| 6K7G | 5/6 | 50L6GT | 9/6 | EF80 | 9/6 | VU39 | 9/6 |
| 6K8G | 8/6 | 80 | 8/6 | EF85 | 10/6 | VR150/30 | |
| 6K8M | 10/6 | 446A | 10/6 | EF89 | 10/6 | 7/6 | |
| 6H6M | 3/6 | 801A | 7/6 | EF91 | 7/6 | VR116 | 4/6 |
| 6L6G | 9/- | 803 | 20/6 | EL32 | 4/6 | V570 | 3/6 |
| 6L7M | 7/6 | 808 | 17/6 | EL41 | 10/6 | XP1.5 | 3/6 |
| 6Q7GT | 9/6 | 830B | 15/6 | EL84 | 9/6 | Z77 | 7/6 |

SPECIAL OFFER

Units of the Famous R107
1. Complete Front End, r.f. mix, osc., 3 bands 1.2-18 Mc/s with large half-moon calibrated dial and slow-motion drive
2. Power Pack for either 12V d.c. or 100-250V a.c. input. You only need an i.f. strip and output stage to make a first-class Short Wave Receiver. We offer both units brand new and boxed (less valves and vibrator) or only 52/6 the pair, plus 7/6 carriage

Special Valve Offer. 6J6, 6AG5, EF39, EL32, 37/6 doz; 6G6G, 6B8G, TT11, 30/- doz; 12SC7M, EF50, 21/- doz
Command Receivers BC454B. 3-6 Mc/s. Brand new in maker's cartons with 6 valves, 45/- each. Few only used, good condition, 1.5-3 Mc/s, 55/- each

Modulator 67. Contains a.c. power pack, input 230V 50 c.p.s., output 350V 120mA (transformer rated 200mA), 6.3V 5A with heavy duty choke. 5Z4, 11 other valves, switches, pots, etc. Brand new, boxed, 45/- each carr. paid. Orders or 3, less 10%

M.C. Meters. 0-30mA, 0-250mA, 0-500mA, 0-2A, 13/6 each; 0-150V a.c. (1mA Basic with Rect.), 28/6; 2 1/2" rd. fl. (2" dial), 0-500µA, 17/6 each; 0-1mA, 21/-, post paid

Midget Mains Transformers (same size as std. spkr. o/p). Input 230/250V, o/p 220V 20mA, 6.3V 0.6A. Ditto but 175V 25mA, both types 11/9 each, post paid

Transmitter/Receivers. Army Type 17 Mk. 2. Complete with h.r. phones, hand mike and valves. 44-61 Mc/s. In good used condition, 45/- each, 79/6 per pair

SPECIAL OFFER

Performance Meters No. 2. Comprising 230V 50 c/s mains trans. 250-0-250V 30mA 6.3V 1 1/2A 5V 2A (60mA h.t. may safely be drawn), 20H choke, 5Z4, Y65 magic eye, 2 EF50, 1 EC52, 1 EA50, dozens of components, all in smart grey louvered case 10" x 9" x 9". Made by Parmeko. Brand new and boxed. Unrepeatable component value at only 37/6 each plus 5/- carriage (U.K. only)

Post 9d. Free over £2

S.A.E. Enquiries

JOHN ANGLIN

385 CLEETHORPE ROAD GRIMSBY LINCS
Telephone 56315