

# RADIO



# BOOKS

**Tape and Wire Recording.** A selection of articles reprinted from the pages of *The Radio Constructor*, covering both the theory and practical applications. A really useful book on this latest development of the hobby. 2/8

**Receivers, Preselectors and Converters.** Practical articles, again reprinted from past issues of *The Radio Constructor*, which will prove of interest to many radio enthusiasts. 2/8

**TV Fault Finding.** Profusely illustrated with photographs taken from a television screen depicting the faults under discussion, and containing a wealth of technical information, with circuits, enabling those faults to be eradicated. 5/3

**Inexpensive Television.** Build yourself a televisor from surplus. Latest edition includes all the data necessary for any area. 2/8

**World Radio Handbook (1955 edition).** The S.W. broadcast enthusiasts' handbook. You are missing something from your hobby if you have not a copy of this excellent publication. 9/9

**Report Pads.** If you need that QSL card, send a comprehensive report. A convenient and accurate form for reporting. 3/9

**Radio Amateur Operator's Handbook.** An indispensable aid to the amateur transmitter and listener, containing all details of information which are constantly required. Prefix Lists, Zone Boundaries, Call Areas, Codes, and Mileage Tables, together with Maps and much other useful operating data. Revised edition. 3/2

**Inexpensive Car Radio.** In which two versions, one constructed from surplus and one from new components, are described. 1/8

**Radio Control for Model Ships, Boats and Aircraft,** by F. C. Judd, G2BCX. A comprehensive work on this fascinating subject. Standard edition, 8/9  
Cloth bound edition, 11/9

*All above prices include postage and packing*

All available from your local bookseller, or from

## DATA PUBLICATIONS LTD

57 MAIDA VALE LONDON W9

Telegrams Databux London

Telephone CUNNINGHAM 6141 (2 lines)

Printed in Great Britain for the Proprietors and Publishers Data Publications Ltd., 57 Maida Vale, London, W.9, by A. Quick & Co. Ltd., Oxford House, Clacton-on-Sea, Essex. Is obtainable abroad through the following: Collets Subscription Service, Continental Publishers & Distributors, Ltd., William Dawson & Sons Ltd., Australia and New Zealand: Gordon & Gotch Ltd., South Africa: Central News Agency, U.S.A.: Giffler Associates, Holland: "Radio Electronica," Scandinavia: Intrapress. Registered for transmission by Magazine Post to Canada (including Newfoundland).



Volume 9  
Number 2  
SEPTEMBER  
1955

# The RADIO CONSTRUCTOR

for the *Radio and Television Enthusiast*

## The METEOR Mini-Receiver

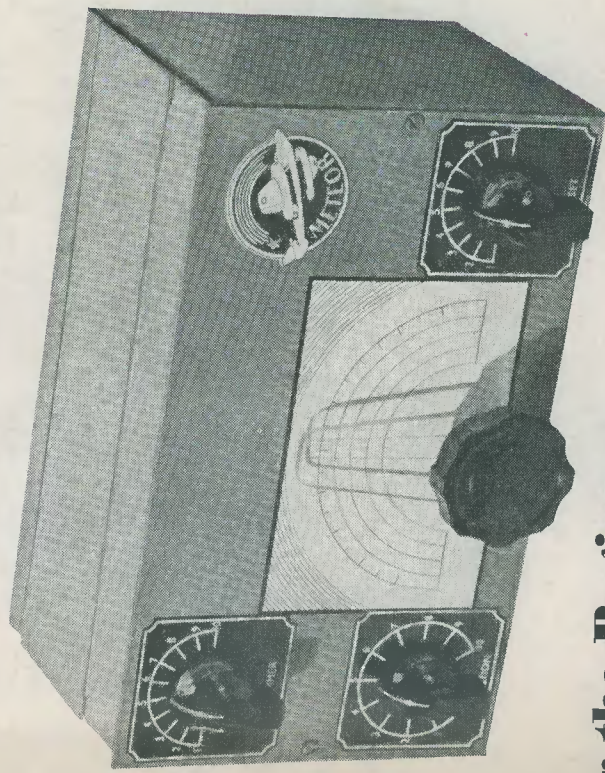

for the **Beginner**

ALSO IN THIS ISSUE

PRACTICAL BAND III TELEVISION, Part 3

THE MICROAMP HI-FI AMPLIFIER

AMPLIFYING BLACK-SPOTTER SYSTEMS

STROBOSCOPIC LIGHT SOURCE • FRANKLIN V.F.O.

VIBRATOR DATA, Part 2 • RADIO CONTROL NOTES

In Your Workshop • End-on Chassis Construction

Query Corner • Radio Miscellany, etc. etc.



## THE MODERN BOOK CO

**Frequency Modulation Tuner Units for Fringe and Local Area Reception.** Reprinted from *The Radio Constructor*. 2s. 0d. Postage 2d.

**TV Fault Finding.** A Data Publication. 5s. 0d. Postage 3d.

**Radio Control for Model Ships, Boats and Aircraft.** By F. C. Judd. 8s. 6d. Postage 4d.

**Questions and Answers on Radio and Television.** By E. Molloy. 6s. 0d. Postage 4d.

**Practical TV Aerial Manual for Bands I and III.** By R. Laidlaw. 4s. 6d. Postage 3d.

**Basic Radio Course.** By J. T. Frye. 18s. 0d. Postage 6d.

**TV Preamplifiers for Bands I and III.** By B. L. Morley. 5s. 0d. Postage 3d.

**The "Lodestar" Tape Recorder.** By A. S. Torrance. 3s. 6d. Postage 3d.

**Practical Wireless Service Manual.** By F. J. Camm. 17s. 6d. Postage 6d.

**Electronic Musical Instruments.** By R. H. Dorf. 55s. 0d. Postage 1s.

**High-Fidelity Techniques.** By J. R. Langham. 8s. 0d. Postage 4d.

**Simple Electronic Musical Instruments for the Constructor.** By A. Douglas. 5s. 0d. Postage 3d.

**An Introduction to Colour Television.** By G. G. Gouriet. 8s. 6d. Postage 4d.

**The A.R.R.L. Antenna Book.** 18s. 0d. Postage 1s.

**The A.R.R.L. Handbook 1955.** 30s. 0d. Postage 1s.

**Radio Valve Data.** Compiled by Wireless World. 3s. 6d. Postage 3d.

We have the Finest Selection of British and American Radio Books in the country

Complete list on application

19-23 PRAED STREET (Dept RC) LONDON W2

Telephone PADDINGTON 4185

## BAND III CONVERTER COIL KIT

Complete set of coils, with wiring diagram and alignment instructions, 15/-. A two-valve converter for use with TRF or Superhet TV receivers.

## SUPER INDUCTOR COILS · MINIATURE DUST CORE TYPES

Type HAX selective crystal diode coil, as specified for the "Paragon" Tape Recorder, 3/-; HAX L (LW), 3/6. Dual wave TRF coils type A/HF with adjustable iron dust cores, matched pairs, 7/- (as illustrated). Type WA5 for the "R.C. Simple Wobbulator," 4/- each. Complete range of superhet coils, I.F. transformers, wavetraps, etc., etc., 3d. Stamps for complete list and circuits. All types available from leading stockists.

## TELETRON FERRITE ROD AERIALS

Wound on high permeability Ferroxcube rod. No external aerial required. Full sensitivity. Reduces static and whistles. Extremely selective. Simply fitted as replacement for Ae coil or frame aerial. Ideal for battery portable receivers.



Medium wave type FRM, 4" x 1/8" 8/9  
Dual wave type FRD, 8" x 1/8" 12/9

## THE TELETRON COMPANY LIMITED

266 Nightingale Road · London N9

HOW 2527

Trade enquiries to sole distributor S. Mozer, 95 Kendal Ave N18 Telephone EDMonton 7707

200,000 ohms plus  
per volt overload  
AUTOMATIC Overload Protection

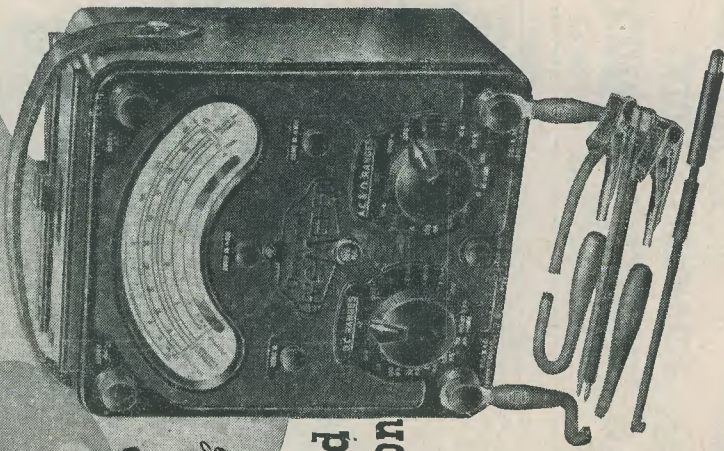

Sizes: 8 1/2 in x 7 1/2 in x 4 1/2 in  
Weight: 6 1/2 lb (including leads)

£23 : 10s.

The following accessories are available to widen still further the ranges of the instrument: A Resistance Range Extension Unit to extend the limits of measurement from 0.025 ohm to 200MΩ, a 10kV D.C. multiplier and a number of A.C. current transformers.

D.C. Voltage	D.C. Current	A.C. Voltage	A.C. Current	Resistance
2.5V	500A	2.5V	100mA	First indication 0.5Ω
10V	250A	10V	1A	Maximum indication 20MΩ
25V	1mA	25V	2.5A	0.2-2000Ω
100V	10mA	100V	10A	0-200,000Ω } using internal batteries
250V	100mA	250V		0-20MΩ
1,000V	1A	1,000V		0-200MΩ } using external batteries
2,500V	10A	2,500V		

It is of importance to note that this model incorporates the "AYO" automatic cut-out for protection against inadvertent overloads.

Produced in response to a demand for a high sensitivity version of the world-famous Universal AvoMeter, this model incorporates the traditional design features of its predecessors, so highly valued for simplicity of operation and compact portability. It has a sensitivity of 20,000 ohms per volt on all D.C. voltage ranges and 1,000 ohms per volt on A.C. ranges from 100V upwards. A decibel scale is provided for audio frequency tests. In addition, a press button has been incorporated which reverses the direction of current through the moving coil, and thus obviates the inconvenience of changing over test leads when the current direction reverses. It also simplifies the testing of potentials both positive and negative about a common reference point. A wide range of resistance measurements can be made using internal batteries, separate zero adjustment being provided for each range.

THE AUTOMATIC COIL WINDER & ELECTRICAL EQUIPMENT CO. LTD.  
WINDER HOUSE · DOUGLAS STREET · LONDON S.W.1 Telephone VICtoria 3404-9

**MAXI-Q**  
REGD.

WE PROUDLY PRESENT OUR LATEST HIGH STANDARD LOW PRICED INSTRUMENT WHICH WE KNOW WILL BECOME A PRIZED AND INDISPENSABLE POSSESSION IN EVERY CONSTRUCTOR'S SHACK

**MODULATED TEST OSCILLATOR MTO.1**

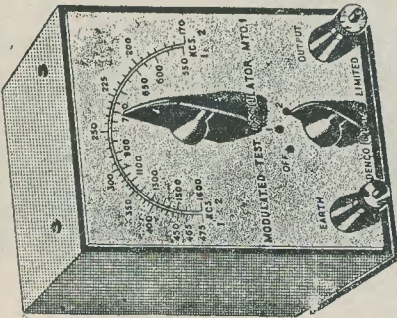

- ★ Provides a modulated signal suitable for I.F. alignment, also trimming and tracking R.F. circuits.
- ★ Frequency is continuously variable from 170-475 Kc/s and 550-1,600 Kc/s
- ★ Operates from a single 9 volt grid bias battery (not supplied) which is housed within the unit.
- ★ The case is manufactured from steel and is finished in black bearing white lettering. Dimensions are 5 1/16 in. x 4 1/16 in. x 3 in.
- ★ Supplied with full operating instructions.

PRICE £3.15-0.  
Obtainable from all reputable stockists or in cases of difficulty direct from works. General Catalogue covering technical information on full range of components, 1/- post paid.

**DENCO (CLACTON) LTD**  
357/9 Old Road · Clacton-on-Sea · Essex

STOP PRESS: "MULLARD F.M. TUNER COILS", I.F. Rejectors, 510/IFF, 2/6 each. Aerial Coil L1/L2, 510/AE, 4/6. Choke L3, 510/RF, 2/-. R.F. Coil L4, 510/RF, 2/6. Osc. Coil L5/L6, 510/OSC, 4/6. 1st IFT L7/L8, 510/IFT1, 7/6. 2nd IFT L9/L10, 510/IFT2, 7/6. Ratio Detector Transformer L11/L12/L13, 510/RDT, 12/6. Aluminium Chassis punched with all holes, 12/-.  
"OSRAM F.M. TUNER COMPONENTS" Aerial Coil O/11, 2/9. R.F. Coil O/L1, 2/6. Osc. Coil O/L2, 2/-. 1st, 2nd and 3rd I.F.T.'s IFT 11/10/7, 6/- each. Ratio Discriminator Trans. O/T2(T5) complete with crystals, 19/6. Chassis, Front Panel, Printed Dial Plate and drive mechanism, 37/6 complete.

**Scottish Insurance Corporation Ltd.**

62-63 CHEAPSIDE · LONDON · EC2

Established 1877

Telephone CITY 4936-9 (4 lines)

**THE SHEDDING OF A LOAD**

An ACCIDENT can cause serious financial embarrassment. Could you meet your commitments on the National Insurance Benefit?

A "SCOTTISH" Policy will carry the load for you if you are disabled by ANY ACCIDENT and will pay compensation for as long as two years for any one accident.  
For a BENEFIT of £5 PER WEEK the annual premium varies between £1 10s. and £2 2s. 6d. according to occupation, and the premium can be paid half-yearly or quarterly if desired.

If you will complete and return this form to the Corporation's office at the above address, a quotation will be sent with a proposal for completion, or write for details quoting reference /JB.

NAME (Block Letters) .....

OCCUPATION .....

ADDRESS (Block Letters) .....

/JB

**NEW!**  
**EXPERIMENTAL KITS**  
**in Radio, T.V. etc.**

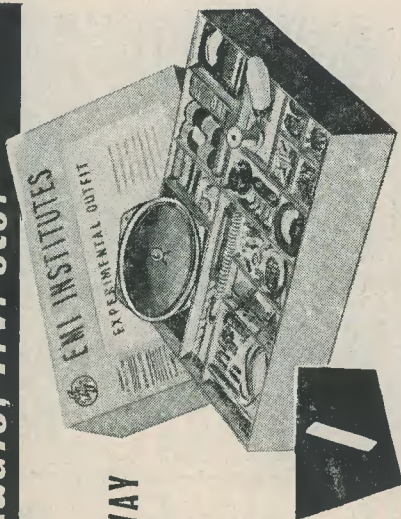

**LEARN THE PRACTICAL WAY**

Specially prepared sets of radio parts from which we teach you, in your own home, the working of fundamental electronic circuits and bring you easily to the point when you can construct and service radio sets. Whether you are a student for an examination; starting a new hobby; intent upon a career in industry; or running your own business — these Practical Courses are intended for YOU — and may be yours at very moderate cost.

**EASY TERMS FROM 15/- A MONTH**

With these outfits, which you receive upon enrolment, you are instructed how to build basic Electronic Circuits (Amplifiers, Oscillators, Power Units, etc.) leading to complete Radio and Television Receiver Testing and Servicing.

**BEGINNER'S RADIO OUTFIT**

— For carrying out basic practical work in Radio and Electronics, from first principles and leading to the design and building of simple Receivers.

ALL EQUIPMENT SUPPLIED IMMEDIATELY (AND) REMAINS YOUR PROPERTY

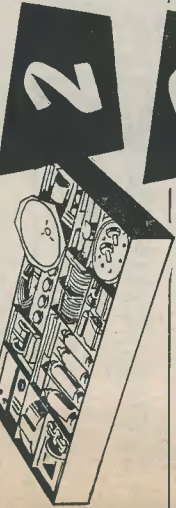

**TELEVISION** — With this equipment you are instructed in the design, construction, servicing and testing of a modern high quality Television Receiver.

**ADVANCED RADIO OUTFIT**

— With this equipment, you are instructed in the design, construction, testing and servicing of a complete modern T.R.F. Superhet Radio Receiver.

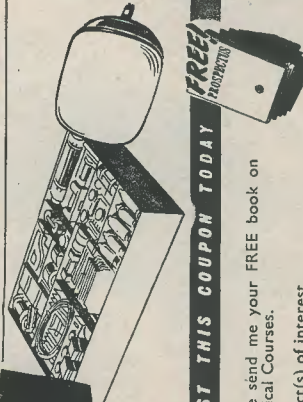

**POST THIS COUPON TODAY**

Please send me your FREE book on Practical Courses.

Subject(s) of interest .....

To: E.M.I. INSTITUTES, Dept. 179x, Grove Park Road, London, W.4.

NAME .....

ADDRESS .....

**OTHER COURSES WITH EQUIPMENT**

INCLUDE:

**MECHANICS · ELECTRICITY  
CHEMISTRY · PHOTOGRAPHY  
CARPENTRY**

ALSO

**DRAUGHTSMANSHIP · COMMERCIAL ART  
AMATEUR S.W. RADIO · LANGUAGES · ETC.**

**E.M.I. INSTITUTES**

The only Postal College  
which is part of a world-wide Industrial Organisation

1955

CS6



# Bring your equipment up-to-date with ACOS REPLACEMENT PICK-UP HEADS

If you already own a fine radiogram or record-player you now have the opportunity of rejuvenating it—of bringing it right up to date for a quite modest sum. The latest types of Acos Hi-g crystal pick-ups are now available in a range of specially designed "plug-in" models to suit most famous makes of record reproducing equipment. These Acos "Hi-g" pick-ups, you will find, represent a truly phenomenal advance in pick-up design—with regard to both reproduction and tracking characteristics (so important with many of the new microgroove recordings). Ask your Dealer!

If you have a	You need a
<b>COLLARO</b> RC 532 AC 534 AC 3/534 3 RC 532 Studio Pick-up	<b>HGP 37-1 COLLARO</b> OR <b>HGP 41-1</b>
3 RC 511 3 RC 531 AC 3/511 AC 3/531 3 RC 521	<b>HGP 57-1</b>
<b>GARRARD</b> RC 75M RC 80M RC 90 RC 111 TA Player	<b>HGP 37-1 GARRARD</b> OR <b>HGP 35-1</b>
RC 72 RC 72A RC 75A RC 80 Model M Unit	<b>HGP 63-1</b> OR <b>HGP 39-1</b> OR <b>HGP 45-1</b>
<b>BURNE-JOVES</b> Pick-up	<b>HGP 55-1</b>
<b>ACOS GP 20</b> Pick-up Arm	<b>HGP 39-1</b>
<b>GARRARD C TYPE</b> Adaptor GP 19 Heads	

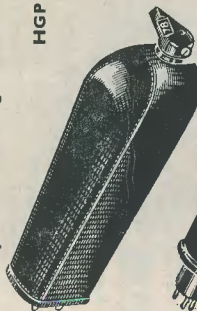

**HGP 37-1 Collaro**  
A Hi-g pick-up head incorporating the HGP 37-1 turnover cartridge with cantilever sapphire styli. Designed for both standard and microgroove records.  
Ask for Data Sheet No. 4800

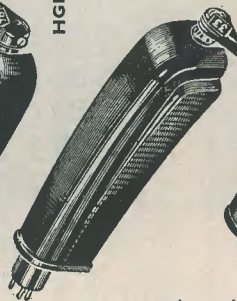

**HGP 37-1 Garrard**  
A Hi-g pick-up head incorporating the HGP 37-1 turnover cartridge with cantilever sapphire styli. Designed for both standard and microgroove records.

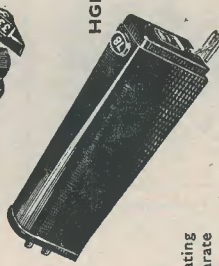

**HGP 63-1 Garrard**  
As HGP 37-1 but slightly longer.  
Ask for Data Sheet No. 5000 for both heads.

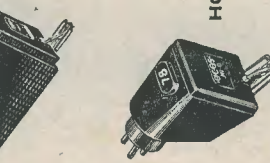

**HGP 41-1**  
Separate Hi-g plug-in type heads for standard and microgroove records incorporating the crystal unit as used in the HGP 39-1 above. Available in cream or walnut.



**HGP 57-1**  
As HGP 41-1 above but shorter. In walnut only.  
Ask for Data Sheet No. 5400 for both heads.



**HGP 39-1**  
Hi-g pick-up heads incorporating cantilever sapphire styli. Separate heads for standard and microgroove records.  
Ask for Data Sheet No. 4400

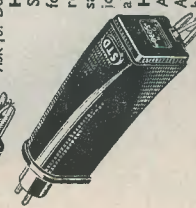

**HGP 35-1**  
Separate plug-in type Hi-g heads for standard and microgroove records; fitted with cantilever sapphire styli. The crystal unit is identical to that of the HGP 39-1 above.  
**HGP 45-1**  
As HGP 35-1 but slightly longer.  
Ask for Data Sheet No. 5600 for both heads.



... always well ahead

Price 32/6 (Plus 10/5 P.T.) for all types except the HGP 39 & 55 models which are 32/- (Plus 10/3 P.T.)

ACOS devices are protected by patents, patent applications and registered designs in Great Britain and abroad.

**GOSMOCORD LTD ENFIELD MDX. • ENFIELD 4022**

The

# Radio Constructor

incorporating THE RADIO AMATEUR

CONTENTS FOR SEPTEMBER

- 72 Suggested Circuits: Amplifying Black-Spotter Systems, by G. A. French
- 75 In Your Workshop, by J.R.D.
- 77 Club News
- 78 A Stroboscopic Light Source, by J. W. Bagnall
- 80 Can Anyone Help?
- 81 Band III Television for the Home Constructor, Part 3, by S. Welburn
- 88 Query Corner—A Service for Readers
- 90 The "Meteor" Mini-Receiver for the Beginner, Part 1, by F. A. Baldwin, A.M.I.P.R.E.
- 96 The "Microamp"—A Miniature High Fidelity Amplifier, by O. J. Russell, B.Sc.(Hons.), G3BHU
- 99 Radio Miscellany, by Centre Tap
- 100 Franklin V.F.O. from Surplus Components by G. A. Tiel
- 103 Let's Get Started, 27: Timebases, by A. P. Blackburn
- 108 Notes on Radio Control, 10: An Auto-Switch for the Transmitter, by Quench Coil
- 111 End-On Chassis Construction, by F. C. Warren
- 115 Vibrator Data, Part 2, compiled by E. G. Bulley

VOL. 9 NO.2

SEPTEMBER 1955

ANNUAL SUBSCRIPTION 18/-

Editorial and Advertising Offices  
57 MAIDA VALE LONDON W9

Telephone  
CUNNINGHAM 6141  
(2 lines)

Telegrams  
DATABUX, LONDON

Editor  
C. W. C. OVERLAND, G2ATV

Advertising Manager  
F. A. BALDWIN, A M I P R E

THE CONTENTS of this magazine are strictly copyright and may not be reproduced without obtaining prior permission from the Editor. Opinions expressed by contributors are not necessarily those of the Editor or proprietors

## NOTICES

THE EDITOR invites original contributions on construction of radio subjects. All material used will be paid for. Articles should preferably be typewritten, and photographs should be clear and sharp. Diagrams need not be large or perfectly drawn, as our draughtsmen will redraw in most cases, but all relevant information should be included.

All MSS must be accompanied by a stamped addressed envelope for reply or return. Each item must bear the sender's name and address.

TRADE NEWS. Manufacturers, publishers, etc., are invited to submit samples or information of new products for review in this section.

ALL CORRESPONDENCE should be addressed to THE RADIO CONSTRUCTOR 57 MAIDA VALE LONDON W9

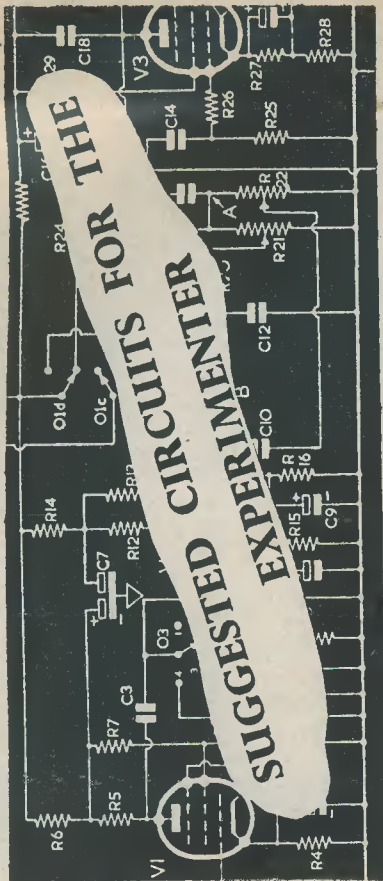

The circuits presented in this series have been designed by G. A. FRENCH, specially for the enthusiast who needs only the circuit and essential relevant data

No. 58: AMPLIFYING BLACK-SPOTTER SYSTEMS

A DISTRESSING FEATURE INHERENT IN television reception of the positive modulated signals employed in this country is given by the fact that impulsive interference results in "wither-than-white" voltages being fed to the picture tube. In consequence, interference becomes far more noticeable and annoying than would occur if a negative modulation transmission system were used instead.

The interference circuits which are fitted to many televisions do not prevent the pulses of interference from appearing on the screen in the form of white dots or lines. However, they effectively limit the amplitude of the interference pulse, thus preventing it from causing overloading of the video circuits or the picture tube. More effective arrangements, "grey-spotters," use voltage delayed circuits which reduce the amplitude of the interfering pulse to a value which is lower than peak white. The most ambitious circuits of all employ some degree of amplification and phase inversion, causing the interference pulses to appear on the screen as black spots or lines. The fact that the interference pulses are altered in nature from white to black results in their becoming far less irritating to the eye. They are also, of course, practically invisible against dark backgrounds.

Quite a few black-spotter circuits have been published in the technical press from time to time. Some of these suffer from the disadvantage that the pulse voltages derived from the black-spotter amplifier are built up across relatively high-value resistors connected in series with one of the modulating electrodes of the picture tube. High resistor values in these positions are not normally to be recommended, since they are liable to attenuate the high-frequency response of the tube. In the two circuits described this month, good results should be obtained when the series resistors have values as low as 10kΩ.

Cathode Modulation

Fig. 1 illustrates a circuit suitable for receivers employing cathode modulation. Considered as an "add-on" unit, the modifications to the associated receiver would consist of connecting V1 to the cathode of the picture tube, the anode of V2(b) to its grid, and inserting R3 in series with the brilliance control voltage applied to this same grid. Heater and h.t. supplies would also, of course, be required.

The double-triode V2 should be a 12AU7, or equivalent. The anode of V2(a) is connected to the full h.t. supply and, in the absence of any voltage being passed to its

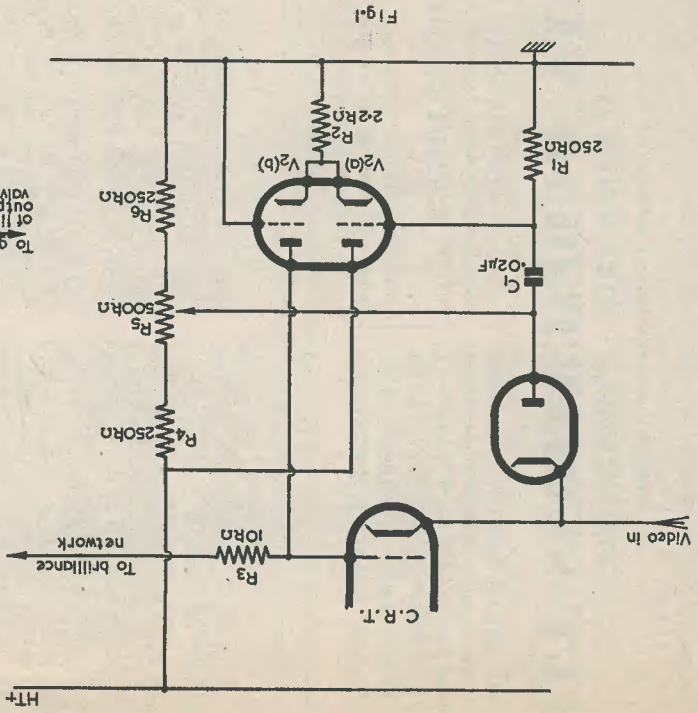
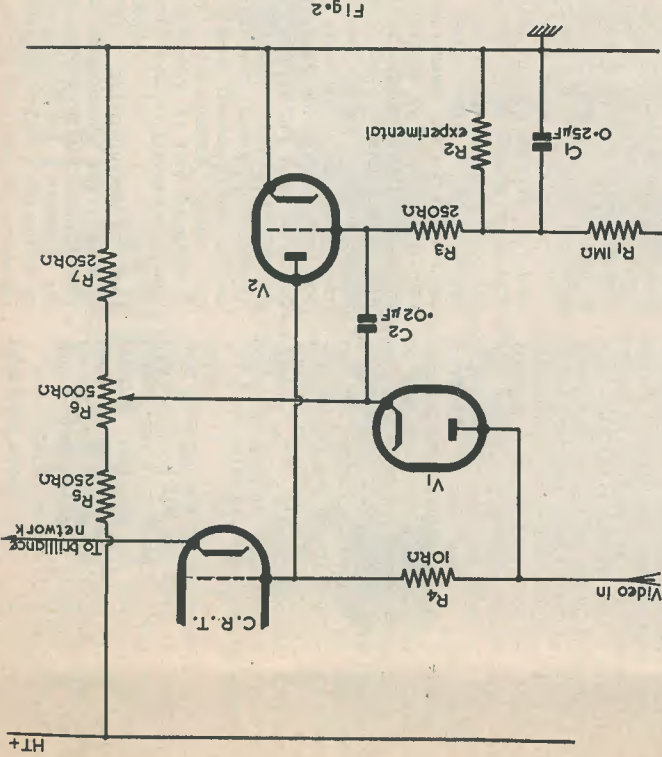

grid via  $C_1$ , builds up a voltage across  $R_2$  which is capable of biasing  $V_2(b)$  almost to cut-off.  $V_2(b)$  receives its h.t. supply via  $R_3$  and the brilliance control network; and its anode, in consequence, has a positive potential equal to approximately half that of the h.t. supply.

As the picture tube is cathode modulated, the video intelligence at this electrode is negative-going. Interference pulses will result in negative pulses having higher amplitudes than the peak-white potential. The anode of  $V_1$  is biased by  $R_5$  to approximately the same potential with respect to chassis as is given by peak-white video. As a result, it conducts on the arrival of an interference pulse, passing a negative pulse to the grid of  $V_2(a)$ .  $V_2(a)$  functions as a cathode follower, applying a further negative pulse to the cathode of  $V_2(b)$ .  $V_2(b)$  then draws a heavy current via  $R_3$ , causing the grid of the picture tube to go negative. The negative excursion at the grid of the picture tube should be greater than that at the cathode; thereby causing the interference spot or line to be blacked out.

The circuit of Fig. 1 should be quite easy to put into practice, but care must be taken to prevent leads which carry pulses from having too high a capacity to chassis. It is possible that the small standing current drawn by  $V_2(b)$  may upset the existing brilliance control circuits on some receivers such that the optimum setting is outside the range of the control. In such cases  $R_2$  should be increased in value until the trouble clears.

Adjustment of the black-spotter is carried out with the aid of  $R_5$ . The slider of this potentiometer should be advanced from the negative end of its track until deterioration of peak-white signals is just visible. It should then be slightly retarded from this point.

### Grid Modulation

A somewhat similar circuit suitable for grid modulated tubes is shown in Fig. 2. As may be seen, the diode  $V_1$  is reversed, since interference pulses will now have a positive, and not a negative, potential higher than that given by peak white.  $V_2$  is a triode of the 6J5 class, whose grid is held negative via  $R_3$ . Normally  $V_2$  is at cut-off.

On the arrival of an interference pulse  $V_1$  conducts, passing a positive pulse to the grid of  $V_2$ .  $V_2$  then conducts, causing a volts drop across  $R_4$ . As a result of this, the grid of the picture tube goes negative and the interference pulse is blacked out.

The negative voltage applied to the grid of  $V_2$  in Fig. 2 is obtained from the grid of the line output valve. In almost all modern receivers this valve is biased by leaky-grid action and a high negative potential is, in consequence, available. The voltages at the line output grid is decoupled by means of  $R_1$  and  $C_1$ , the voltage required for  $V_2$  being obtained with the aid of the potential divider given by  $R_1$  and  $R_2$ . The value of  $R_2$  is found experimentally. This component should have a value which causes  $V_2$  to be just at cut-off when the line output stage is in a synchronised condition, and  $R_6$  is set to the positive end of its track.

Constructional points apposite to the circuit of Fig. 2 are similar to those for Fig. 1. Adjustment is also carried out in the same manner; with the exception that the slider of  $R_6$  is in this case brought forward from the positive end of its track; and not from the negative end, as occurred with  $R_5$  of Fig. 1.

The diodes  $V_1$  in both diagrams may be replaced by suitable germanium diodes, should this be desired.

# IN YOUR WORKSHOP

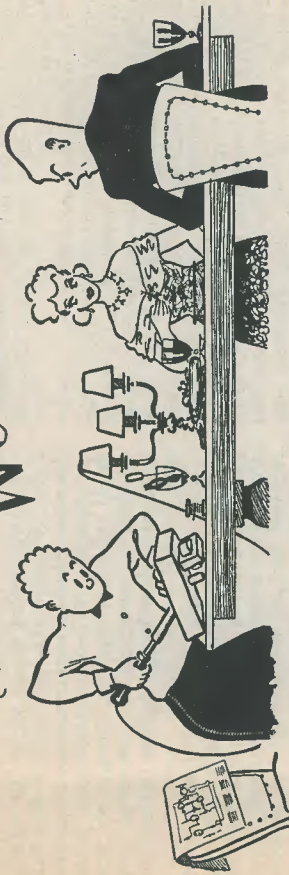

In which J. R. D. discusses Problems and Points of Interest based on Letters from Readers and his own experience

AT THE TIME OF WRITING, THERE IS THAT slight lull in the radio industry which presses the usual autumnal storm. Activity during the next few months will be continually increasing, especially in the London area, as the weeks advance towards two important dates. The first of these is that marking the opening of the Annual Radio Show; and the second is the inception of Band III transmissions. One or two seasoned engineers attached to manufacturers have been known to get extremely flustered in the past during last minute "panics" for the Show. Add to the normal activities the anticipated Band III rush and there may be, this year, quite a few more people getting severely worked up! As is common with almost every exhibition which has ever been held, no matter how well things are organised beforehand something is always sure to go wrong at the very last moment.

### Seasonal Sales

Despite the "slight lull" I mentioned in the opening paragraph, the radio trade in Great Britain is in the comfortable state of enjoying a minor boom just now. Nevertheless, it still exhibits fairly marked "seasonal" tendencies—although these are, fortunately, by no means as severe as they used to be before the war.

During the summer of each year, things begin to go quietly. Sales commence to drop; and orders appear not quite so readily as they did during the spring. Most members of the public are out in the open air and the sun (when it shines), and interest in radio and television naturally decreases. As the

summer continues, things get quieter and quieter; until the Show arrives. The Show gives emphasis to all the new models which have become available, and the orders start to roll in again. Gradually, the tempo increases until what is known as the "Christmas rush" comes into being.

This "Christmas rush" is something of a phenomenon, but it definitely exists. It is probably partly due to the fact that people who have ordered receivers earlier in the winter start worrying their suppliers to deliver them before Christmas Day. Receivers which are intended as Christmas presents also become in short supply. Delivery dates begin to suffer. After Christmas Day activity eases off slightly, but, as the winter is now beginning to set in more heavily, sales of receivers still stay at a high level.

Then, spring appears; public interest in radio and television drops; and things begin to get quieter once more. Until the next Show!

### Conversion Troubles

This year there will certainly be an added complication due to the fact that a large number of televisions will still require conversion to Band III when the I.T.A. programmes commence. Retailers are already converting as many receivers as possible at the time this article is being written, but there are sure to be plenty of set-owners who will leave things to the last moment. There is little doubt that some people will find it difficult to make up their minds whether to convert their existing sets or to buy new ones instead. If the existing receiver has

### READERS' COPIES (Vol. 8 only)

can be bound by us for 8s.6d. postage and packing 1s.6d. extra (index supplied free).

This offer does not apply where readers wish to remove pages, and is valid only for orders received before the 12th Sept.

INDEXES for Vol. 8, Aug. 1955—July 1955 are now available, price 6d. post free.

BOUND VOLUMES A limited number of bound volumes (Vol. 8 only) are available, price £1. 1. 0 post free.

## DATA PUBLICATIONS LTD

57 MAIDA VALE • LONDON W9

Telephone CUNningham 6141 (2 lines)

already given a good number of years' service, this is not an easy problem to solve. Others may wait to see if the prices of converters will "come down." It is doubtful if the latter will occur, since practically all Band III converters are tied, in some way or another, to the standard 2-voice circuit arrangement; and existing prices already seem to be pretty close to the bone.

It is possible that one or two minor "firms" may try to cash in on the situation by undertaking to carry out Band III conversions at bargain prices; the actual jobs being done in a slipshod and careless fashion. Such things have been known to happen before. The best safeguard for the domestic set-owner is to have his television converted by a good, reputable dealer, who is an accredited retailer for the manufacturer who made the original receiver. (In most instances this will, of course, be the dealer who sold the receiver in the first place.) Such a retailer will have access to any technical information and equipment issued by the manufacturer for converting the receiver, and he will be the man who is capable of doing the job correctly and properly.

Another word of advice concerns, especially, superhet televisions. If the receiver is a superhet and a converter unit is available from the manufacturer who made the existing receiver (the unit being especially designed to feed into the i.f. strip of the receiver), then that converter will be the one which it is definitely most advisable to employ. In such a case it would be better to wait a little while for delivery of the correct converter than to use one which feeds direct into the aerial socket of the receiver. One of the reasons for this is that with the second type of converter the whole arrangement becomes a double superhet, and it is possible that whatever oscillator and i.f. harmonics are generated may cause interference with the received picture. Also, of course, it is obviously preferable to use a converter which is expressly designed for the job.

So far as converters whose i.f. output is at a Band I frequency are concerned, there is also the question of breakthrough of the Band I signal. Unless the existing receiver is sited close to the Band I transmitter this trouble may not be so severe as has earlier been anticipated. Further, if a strong Band III signal is available it may tend to swamp out the Band I breakthrough. Since the Band I breakthrough signal will be carried mainly by the co-axial lead from the Band I aerial, it should often prove to be advantageous to insert an attenuator in this lead before it connects to the converter switching circuits. The trouble of Band I breakthrough will not prove too difficult,

of course, if channel switching over Band I is available on the existing receiver. The converter i.f. output frequency may then be set to a channel other than that of the local Band I transmitter while receiving Band III.

#### F.M.

A third feature which should be causing a lot of bustle this year is the fact that frequency modulation transmissions are now on the air. However, things seem to be fairly quiet on the f.m. front, and it is possible that manufacturers are seeing "how the land lies" before going into full production.

The difficulty, of course, lies in cost. People have become so used to buying sound receivers at fairly low prices that they are not keen on spending the few extra pounds required for a combined a.m.-f.m. receiver. Perhaps some enterprising firm will introduce an f.m.-only receiver that would combine low price with reasonably good reproduction (accepting the necessarily small cabinet dictated by price) and this may go down quite well. However, as the only transmitter in use at present is at Wrotham, and as most of the existing bad reception areas have yet to be offered an f.m. service, such a receiver might not be a good financial proposition at this stage.

Quite a few members of the public do not even know that there is such a thing as f.m. available! Still, with time, the fact should become accepted. It is quite possible, also, that a few f.m. sets will be bought purely on account of their "snob" value. For once in a while, I am not at all certain that such an occurrence may not turn out to be a good thing. This is because a few people, after listening for some time to a receiver which has a top response extending above 3 or 4 kc/s, will really be content to return to those all-too-frequently encountered a.m. receivers which can only offer "deep, rich, bass" and "one-note-thump."

One does not expect the whole nation to become high-fidelity minded just because f.m. is here. Nevertheless, now that the necessity for narrow bandwidth a.m. superhets is being obviated there is every chance of receivers being made and sold which offer pleasant and balanced reproduction over a much larger part of the audio spectrum than is at present possible. Would it be too much to hope that, in several years time, receivers which give strong bass accentuation will be considered as being old-fashioned?

#### Shock Hazard

Twice in the last fortnight I have read in the newspapers of people being killed by

faulty pieces of electrical equipment. One of these cases concerned a radio receiver.

I know I have mentioned the question of shock hazard before, but I do not think that it is something which can be overstressed. This is especially true when one considers that there are newcomers to radio swelling this Magazine's readership every month.

What has to be remembered all the time whilst working with radio is that under certain conditions the domestic electric mains supply is lethal. The greatest care must be taken always, particularly when one is working with "live" chassis. There is, incidentally, no guarantee whatsoever that because a piece of equipment has a mains transformer its chassis is automatically isolated from the mains. In some cases the mains transformer is an auto-transformer, and a direct mains connection to chassis is still in existence. In others, it requires

only the breakdown of a mains-modulation condenser, the fraying of a lead, or any other similar cause, to make a seemingly safe chassis become "live." The on-off switch on the chassis itself also offers no certain protection, since it is frequently inserted in one mains lead only.

One golden rule is: never keep one's hand on a chassis whilst reaching with the other for a tool, a soldering iron, or anything else. If the chassis is "live" and the other hand touches any "earthy" metal work a very nasty circuit will be completed. Similar circuits can also be completed by the feet, or any other part of the body, through the floor, or bench, etc. Particularly dangerous are concrete floors and any metalwork.

There is nothing "clever" in receiving a shock. Commonsense and continual attention to the risks incurred when handling mains equipment are the only safeguards.

## CLUB NEWS

*Details for insertion in this section should reach us not later than 7th of the month before publication*

#### EDGWARE AND DISTRICT RADIO SOCIETY

Meetings are held on Wednesday evenings, 8 p.m., at 22 Goodwyn Avenue, Mill Hill. Talks on a wide range of subjects of interest to the amateur radio enthusiast are given, and there are also practical evenings and regular junk sales.

New members, especially beginners, are welcomed. Hon. Sec.: E. W. Taylor, G3GRT, 99 Portland Crescent, Stanmore, Middx.

#### BRITISH TWO-CALL CLUB

Membership is open to all British subjects who have held two calls—one of which is overseas. Application forms can be had from the Hon. Secretary, G2DHW. New members this year include G3JFC/VISGN, G2CDN/EISB/SUICX/ZCIAR/ZC6AR, ARILA, G3JY/ZSIRC, G3JY/ZLIAIO, G3DFI/ZD6BX, G3M3T/DL2YL. Hon. Sec.: G. V. Haylock G2DHW, 63 Lewisham Hill, London, S.E.13.

#### CLIFFTON AMATEUR RADIO SOCIETY

The first Clifton transmitting field day, held on Sunday, 24th July proved so popular that members have requested another contest later in the year. This has been fixed for 2nd October and will take place in the vicinity of Farnborough, Kent. Five stations took part in the first contest and the winner was C. Hanfill, G3HZI, who used 0.5 watt on 80 metres. Other contestants were G3DIC, G3FNZ, G3FVG and G3IWL, together with club members, who acted as log-keepers, etc.

#### Programmes for October:

2nd—Transmitting field day. 7th—Field Day discussion. 14th and 28th—Constructional Evening, by Ragsheew. 21st—Radio Frequency Cabinets, by Mr. R. J. Slaughter of Telcon.

Meetings are held every Friday at 7.30 p.m., at the clubrooms, 225 New Cross Road, London, S.E.14. Details of membership can be obtained upon application to the Hon. Secretary: C. H. Bullivant, G3DIC, 25 St. Fillans Road, Catford, S.E.6.

#### QRP SOCIETY

The end of the month will see the final judging of the Portable Amateur Radio Equipment Contest. Entries can still be accepted up to 30th September.

The Society is fast making a name for itself overseas, and is keen to enrol low-power enthusiasts everywhere to help further the cause of QRP.

Transmitting amateurs, SWL's and experimenters in the low-power field are assured of a warm welcome, and are invited to write for particulars of membership. Hon. Sec.: John Whitehead, 92 Rydens Avenue, Walton-on-Thames, Surrey.

#### RADIO AMATEURS' EXAMINATION COURSES

The Grafton Radio Society have again made arrangements with the Islington L.C.C. Men's Evening Institutes to hold an official course of instruction for the Radio Amateurs' Examination during the coming winter months at GRAFTON SCHOOL, EBURNE ROAD, HOLLOWAY, N.7 (one minute from the "Nags Head").

Classes (for beginners) are as follows:— Mondays: Radio Theory 7.9 p.m.; Morse 9.10 p.m. Wednesdays: Practical 7.9 p.m.; Morse 9.10 p.m., the full fee being 10s. Classes commence on Monday, 26th September (enrolment week 19-23rd Sept.) under the instruction of Messrs. A. Perry (G3DKX) and L. Barber.

In addition, the Grafton Society also meet on Friday evenings at 7 p.m. for the usual club activities (including lectures by leading "hams" and the trade) at which Morse will be available, 9-10 p.m.

Application in the first instance should be made to the Grafton Radio Society Hon. Secretary: A. W. H. Wonnell (G2CJN) at 145 Uxendon Hill, Wembley Park, Middlesex.

Courses of instruction have been arranged at the Ilford Literary Institute (High School for Girls), Cranbrook Road, Ilford. (Adjacent to Gants Hill station, Central Line.)

An eight-months course for those intending to take the examination: Wednesdays, 7.30 to 9.30 p.m.; Morse and Codes of Practice. A six-month course for those who wish to learn Morse up to G.P.O. requirements for an amateur licence. Arrangements have been made for those who, in the opinion of the instructors, have reached the required speed, to be tested at the Institute by a representative of the Post Office. For students living in the Essex County Council area the fee for either course is 10s. or 17s. 6d. for both. Students from other areas will be admitted provided the Local Authority is informed.

Enrolment nights: 5th to 8th September, inclusive, 7 to 8.30 p.m. Classes commence 19th September.

To ensure a place in the classes, please write to Mr. C. H. L. Edwards, G8TL, 28 Morgan Crescent, Theydon Bois, Epping, Essex, in the first instance.



# A STROBOSCOPIC LIGHT SOURCE

by J. W. BAGNALL

THE READER WILL NO DOUBT BE FAMILIAR with the stroboscopic disc used to check the speed of a record turntable. It consists of a disc which is divided into a predetermined number of black and-white bars. When placed on the revolving record and viewed under a lamp fed from a 50 c/s supply, the bars appear to be stationary at the correct r.p.m.

The device about to be described performs a similar function, namely the ability to "stop" any rotating machinery when viewed by the light of a neon lamp which is part of the instrument. To accomplish this there are a number of conditions which have to be met.

necessary for one light flash to be produced for each cycle of movement. For instance, if a motor shaft is revolving at 2,000 r.p.m., to make it appear stationary a frequency of 33.3 c/s would be required.

The light source has to be turned "on" for the shortest time possible; this will be more clearly understood when it is considered that while the light is on, the object continues to move. If the light flash is too long it will result in a blurred outline due to the object having appreciable movement during the viewing time.

After consideration of the above, the reader will realise that an incandescent lamp

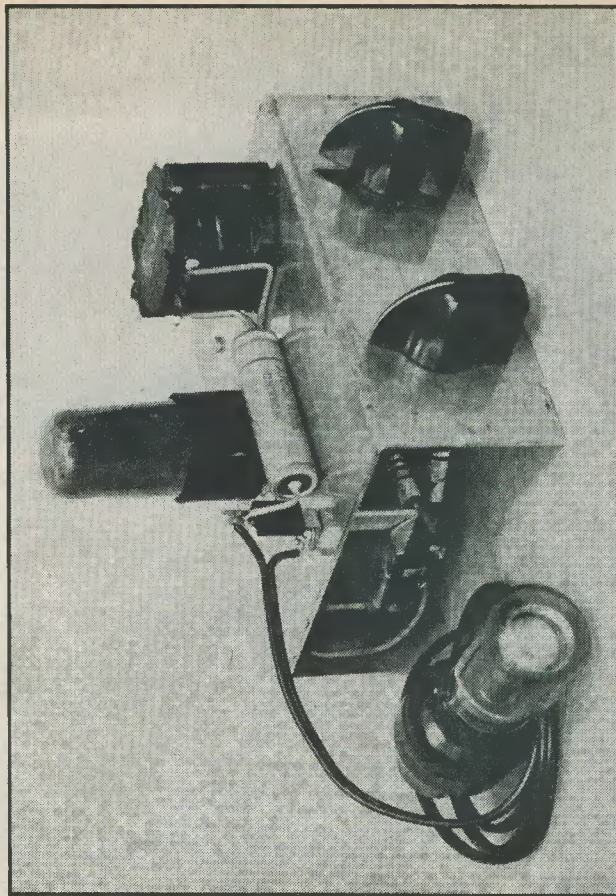

The Prototype Stroboscope

The electronic stroboscope has to be capable of generating short duration light flashes over a wide range of frequency. To create the illusion of a stationary object it is

strom," which has a high peak light intensity. As the question of cost had to be considered, a 0.5 watt neon lamp has been used in this design. While this has limitations regarding light output, it has proved to be quite satisfactory in use providing it is used in darkened surroundings.

## The Circuit

It will be seen that a double triode valve has been used, the section  $V_{1a}$  acting as a variable frequency blocking oscillator. The circuit is essentially that of the ordinary grid detector with reaction. The coupling between the transformer windings is very tight so that the valve oscillates violently for one half-

by the special characteristics of the feedback transformer.

The speed or repetition rate at which the valve oscillates may be controlled in two ways. Changing the value of the grid condenser will provide a number of coarse ranges, while the use of a variable grid leak will give a smooth intermediate control. With the component values shown a frequency coverage of 10 c/s to 11 kc/s has been achieved in four overlapping ranges.

When the valve oscillates, current is drawn through the resistance  $R_1$  causing a voltage drop across the resistor. This produces a short negative-going pulse which is passed to the grid of  $V_{1b}$  via the condenser  $C_5$ . This

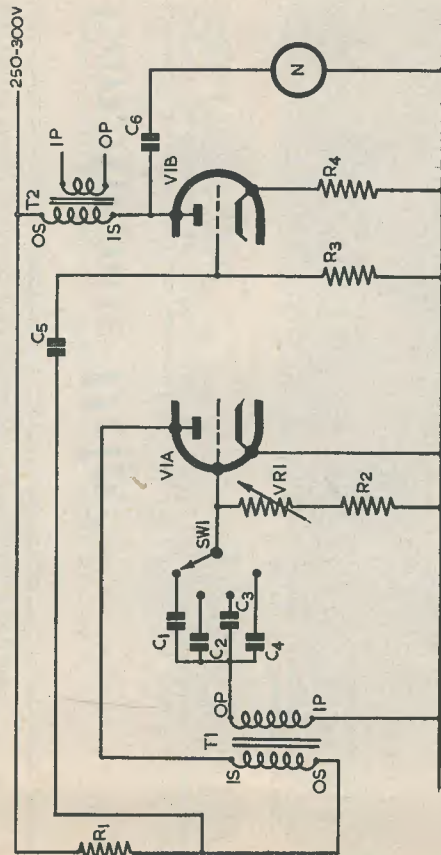

E203

## COMPONENT LIST

$R_1$	2.2k $\Omega$ $\frac{1}{2}$ W	$C_6$	0.1 $\mu$ F 500V wkg
$R_2$	100k $\Omega$ $\frac{1}{2}$ W	$V_1$	6SN7
$R_3$	220k $\Omega$ $\frac{1}{2}$ W	N	230V 0.5W Neon
$R_4$	150 $\Omega$ $\frac{1}{2}$ W	$T_1$	TV Frame Blocking Osc. Igranic
$C_1$	0.1 $\mu$ F 350V wkg	$T_2$	See text
$C_2$	0.01 $\mu$ F 350V wkg	SW1	1-pole 4-way switch
$C_3$	500pF 350V wkg	VR1	2M $\Omega$ variable
$C_4$	50pF 350V wkg		
$C_5$	0.01 $\mu$ F 350V wkg		

cycle. Heavy grid current flows during oscillation and charges up the grid condenser so that the grid goes rapidly negative and the valve can no longer oscillate. The capacitor then discharges through  $V_{1b}$  and  $R_2$  until the grid potential becomes low enough for the valve to restart the cycle of operation again. Most blocking oscillators can be designed to provide nearly rectangular pulses of plate voltage and current, which is made possible

triodes has very little bias and passes a current of some 12mA. On arrival of the negative pulse, the valve is suddenly cut off. As the current through the valve begins to fall, a large self-induced voltage is generated across the secondary of  $T_2$  in the form of a positive-going voltage pulse approximately 500 volts in amplitude. This is condenser coupled to the neon, causing it to strike and remain alight for the duration of the pulse.

### Construction

No power supply has been shown in the circuit diagram as the prototype has been connected to the bench supply when needed. A power pack giving 250 to 300 volts of h.t. at some 15mA, with the appropriate heater voltage, will be sufficient. The layout is in no way critical, although the appearance would be improved by the addition of a front panel and the use of Panel Signs. The "Test Equipment" series containing a suitable scale would enable the instrument to be calibrated in terms of frequency.

The transformer T<sub>2</sub> was removed from a surplus unit Type 25 receiver where it was used as a microphone transformer; it may be identified by the numbers 10K/245. Should this not be readily available, a loudspeaker

output transformer could be used in this position.

The constructor is recommended to use a bakelite lamp holder for the neon, and also plastic covered flex for its connection. Owing to the high peak voltages that exist at the output, the gear should not be run without the neon being in circuit.

A further use for the device, which has not been mentioned, is that of an audio and r.f. signal source. As the output is far from being sinusoidal, it may be used for this function due to the fact that a large number of harmonics are generated which extend well into the broadcast range. The output for this purpose should be taken from the terminals marked I.P.-O.P. via a suitable volume control. Enough power is available to run a loudspeaker, if required.

## Can Anyone Help?

S. BARDEN, 5 Andlers Ash Farm Cottages, Liss, Hants, would like to obtain a list of values of ex-Govt. condensers, fixed and variable, to correspond with 10C numbers, etc. \*

Novice W. LAWS, M/V Camroux II, 79 Crabtree Lane, Fulham, S.W.6, would like to buy or borrow a circuit, wiring diagrams and other information on a 3 or 4-valve t.r.f. or superhet receiver for 100/110V d.c. ship's mains. \*

DOUGLAS BYRNE, 3 St. Saviour's Road, St. Helier, Jersey, C.I., requires information on the Hambander receiver. \*

R. INGLIS, 8 St. Alfege Passage, Greenwich, London, needs the manual, circuit or crystal frequency for the R.C.A.F. GR-10 10-valve communications receiver. \*

F. G. MILES, 113 Westbourne Street, Hove 3, Sussex, needs, and is willing to pay for, the circuits and/or information on the ex-Army Receiver R109 and the ex-R.A.F. Transmitter 1154. \*

R. O. GAUNT, 69 South View Crescent, Sheffield 7, wishes to convert a U.S. Signal Corps Indicator type BC 929A (R.A.F. ref. No. 110QB/29) to a 'scope, and would like to obtain a copy of the original circuit (or on loan). \*

J. FORTNUM, "Pype Hayes," Old Lane, Crowborough, Sussex, still has a 30-Line Scanner, and would like to obtain, or borrow to have copied, one of the records which were made of t.v. signals at that time. \*

T. COX, 77 Crescent Road, Leyton, London, E.10, will gladly reimburse anyone who can supply him with the circuit, data, valve line-up, etc., of the Air Ministry Receiver type R.1082. \*

K. T. ROBERTS, c/o Borough Engineer, Town Hall, Blackburn, Lancs, needs a service sheet for (1) the Emerson t.r.f. a.c./d.c. receiver line-up 12SF5, 12K7, 12J5, 50L6, 35Z5; (2) the circuit for the B.36 Communications receiver, 1-20 Mc/s; (3) Valve line-up of the English Electric C.R.T. Ignition Tester, patt. 563562, 6-12-24V d.c., 230V a.c. \*

J. McFALL, 3 Woodridings Avenue, Hatch End, Middx., requires information, buy or borrow, on the Transmitter/Receiver TR1196. The manual is the A.P. 2535C, Vol. 1. \*

C. L. TUCKER, 24 Melbury Road, Kenton, Middx., wishes to buy or borrow the circuit or service sheet of the Gamage 1950 10in T.V. Receiver, manufactured by Felgate Radio, London. \*

J. A. EDWARDS, "Windy Ridge," 18 Tyndall Avenue, Moston, Manchester 10, would like to obtain the circuit and details of the Spartan model 457 receiver. \*

D. R. COAD, 14 Sandy Lane, Fair Oak, nr. Eastleigh, Hants, needs information such as circuits, power supplies and conversion data on the ex-R.A.F. Receiver type R1125A, code 10D/6, and the Receiver type 81A, code 10D/1342. The latter is the receiver section of a transmitter/receiver, and has the number 1120 painted above the 12-watt power and output plug. He would also like to obtain information on the modulator and output stage of this job. \*

# BAND III TELEVISION for the HOME CONSTRUCTOR

PART 3. by S. WELBURN

*This article gives full constructional details of a Band III converter which may be built at home; and is the third in our Band III series written by that popular writer on television topics, S. Welburn.*

**M**ANY READERS HAVE WRITTEN TO *The Radio Constructor* asking for particulars of a converter which may be built at home. It is, therefore, with great pleasure that the writer is enabled to present a Band III converter which can not only be constructed at home, but which may also be brought into operation without a signal generator. The converter (developed by the Teletron Co. Ltd.) can be relied upon to give good results provided that reasonable care is employed in its manufacture. Several models have been built and tested (using the experimental Belling-Lee transmissions from Croydon) and satisfactory operation has been reported to us in every case.

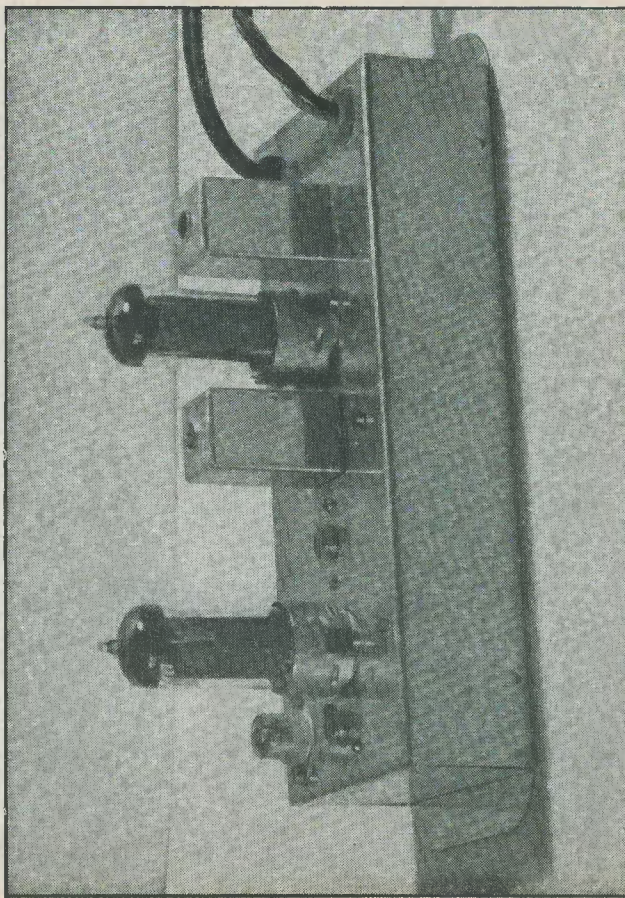

*This model was built and supplied for review by Clyne Radio Ltd. The Teletron Band III Converter.*

### The Circuit

The circuit of the converter is given in Fig. 1. This diagram includes all components, but does not show a power pack. However, the latter can be quite a simple arrangement employing, say, a mains transformer and metal rectifier. Alternatively, the converter may obtain its supplies from the existing television.

In Fig. 1, the signal from the Band III aerial is applied, via  $L_1C_1$ , to the grid of  $V_1$ . The input impedance of  $V_1$  at Band III frequencies is very low, and the match to the nominal 75  $\Omega$  aerial impedance is in consequence quite satisfactory.  $L_1C_1$  form a reflector circuit and are tuned to the Band I frequency. Their function is to attenuate Band I signals picked up on the Band III aerial, which might otherwise cause interference with the received I.T.A. signal.

$V_1$  is a high-slope r.f. pentode. Its anode feeds into the pi-network provided by  $L_2$  and the capacities to chassis at either end of this coil.  $L_2$  connects into a nodal point on the oscillator coil,  $L_3$ , and thus allows additive mixing to take place at the grid of  $V_2$ . The anode h.t. feed to  $V_1$  is supplied via  $R_4$ ,  $R_5$  and  $L_2$ . The h.t. feed to the oscillator section of  $V_2$  is supplied, similarly, via  $R_4$  and  $R_5$ .

$V_2$  functions as a mixer, its control grid and screen grid forming the effective grid and anode, respectively, of a triode oscillator. The tuned inductance for this oscillator is provided by  $L_3$ . In practice, the oscillator is a Colpitts—the two condensers forming the capacitive earthy tap being provided by  $C_5$ , in series with the capacity between grid and cathode of  $V_2$ , to one end of the coil; and by the capacity between screen-grid and cathode,

in parallel with that between screen-grid and suppressor, to the other end. There are further stray wiring and valvoholder capacities which affect the earthy tap into the tuned circuit. It cannot be emphasised too strongly that, as a certain amount of tuning capacity must inevitably be supplied by circuit strays, great care must be taken to follow the layout given in this article when building the converter. An additional important point is given by the desirability of providing  $V_2$  with a ceramic valvoholder in order to reduce frequency drift. A ceramic valvoholder for  $V_1$  is desirable also, but is not essential. Condenser  $C_{12}$ , shown in the diagram, is required only for the London frequencies.

The intermediate frequency appears at the anode of  $V_2$ . Transformer  $T_1$  is tuned to this i.f. output, its primary being damped by  $R_6$  to provide adequate bandwidth for the video passband. The value chosen for this resistor, 5.6k $\Omega$ , will enable a flat 3Mc/s bandwidth to be obtained with all television receiver input circuits. With some televisions it may be possible to increase the value of  $R_6$  whilst still retaining an adequate bandwidth. Such a course can be proceeded with, if desired; and may result in a slight increase in gain.

The secondary of  $T_1$  is specially wound to enable the tuned circuit provided by  $C_6$  and the primary to match into 75  $\Omega$  cable. The other end of this cable may then be plugged into the aerial input socket of the existing receiver.

Since the i.f. of the converter is equivalent to the Band I input signal, the oscillator must tune below the input Band III signal. If it were to tune above the Band III carrier the vision and sound signals will be reversed, the

### COMPONENTS LIST

Resistors (All  $\frac{1}{2}$  watt unless otherwise specified)  
 $R_1$  1k $\Omega$   
 $R_2$  15k $\Omega$   
 $R_3$  180 $\Omega$   
 $R_4$  470 $\Omega$   
 $R_5$  2.2k $\Omega$   
 $R_6$  5.6k $\Omega$   
 $R_7$  22k $\Omega$   
 $R_8$  2.2k $\Omega$  1 watt  
 $R_9, 10$  2M $\Omega$  (required only for live version)

### Condensers

$C_1$  25pF, ceramic  
 $C_2, C_3, C_4, C_7, C_8, C_9$  0.001 $\mu$ F, ceramic  
 $C_5$  10pF ceramic  
 $C_6$  2–8pF. Concentric trimmer  
 $C_{10}$  0.001 $\mu$ F 350V a.c. working (required only for live version)  
 $C_{12}$  2–8pF Concentric trimmer (required only for London area)

### Valves

$V_1, V_2$  Z719

### Valvoholders

2 B9A Ceramic

### Inductors

$L_1$  Teletron (Green spot)  
 $L_2$  Teletron (Blue spot)  
 $L_3$  Teletron (Red spot)  
 $T_1$  Teletron (Yellow spot)  
 Supplied separately or as a kit by the Teletron Co. Ltd.

### Power Supply

Mains Transformer, Electrovoice type 104 (H. L. Smith & Co. Ltd., Edgware Rd.)  
 Rectifier, 6X4, DRMB or to suit  
 Resistors, 1 120 $\Omega$   $\frac{1}{2}$  watt  
 Condensers, 24 + 24  $\mu$ F electrolytic

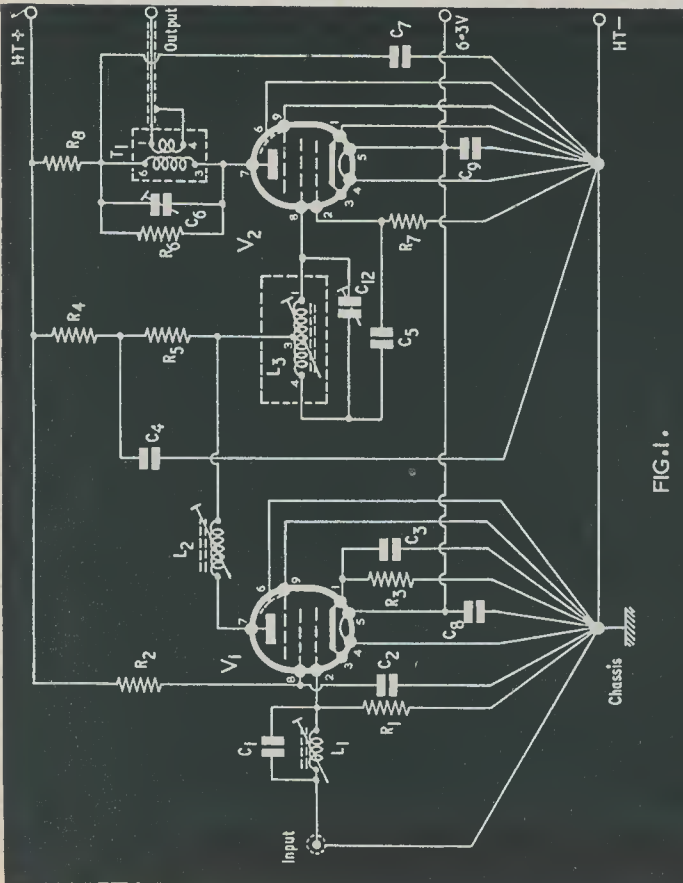

FIG. 1.

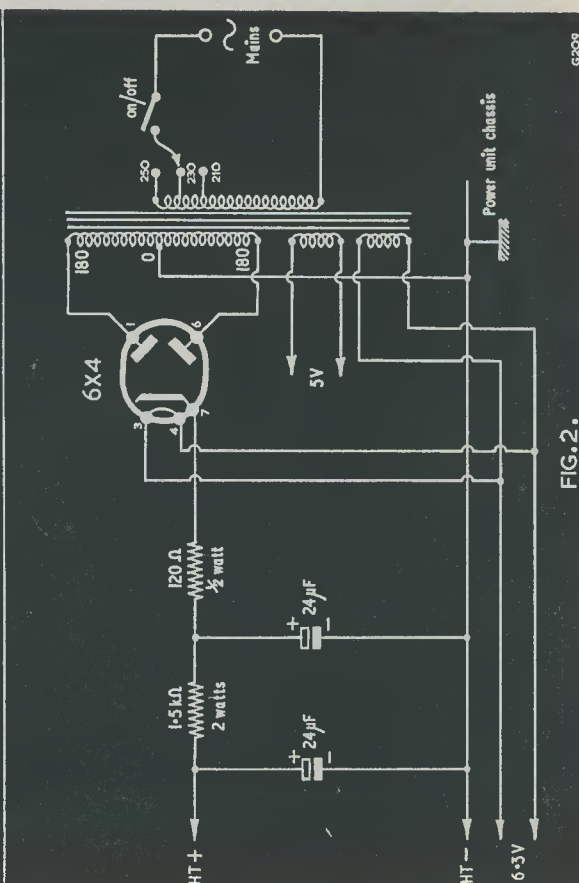

FIG. 2.

Fig. 1. The circuit of the Band III converter.  $C_{12}$  is required only for the London area

Fig. 2. A suitable power unit for the converter. The mains transformer is Electrovoice type 104 (H. L. Smith & Co. Ltd., Edgware Road)

vision appearing in the i.f. at a lower instead of a higher frequency than the sound.

To summarise the operation of the converter, it can be stated that V<sub>1</sub> amplifies the Band III signal and applies it to the mixer, V<sub>2</sub>. V<sub>2</sub> provides an intermediate frequency equivalent to that of the Band I frequency of the existing television receiver. This i.f. signal is then fed into the aerial socket of the receiver. In London, the i.f. will be that of Channel 1 (i.e. 45 Mc/s vision, 41.5 Mc/s sound).

smoothing filter. If desired, the 6X4 may be replaced by a metal rectifier, such as the Brimar DRMB, this working in a half-wave circuit. When a metal rectifier is employed, only half of the h.t. secondary winding is required, the other half being left disconnected. Other rectifier arrangements may also be employed, as this part of the circuit is not at all critical. The smoothed h.t. voltage finally obtained should lie between 180 and 240 volts.

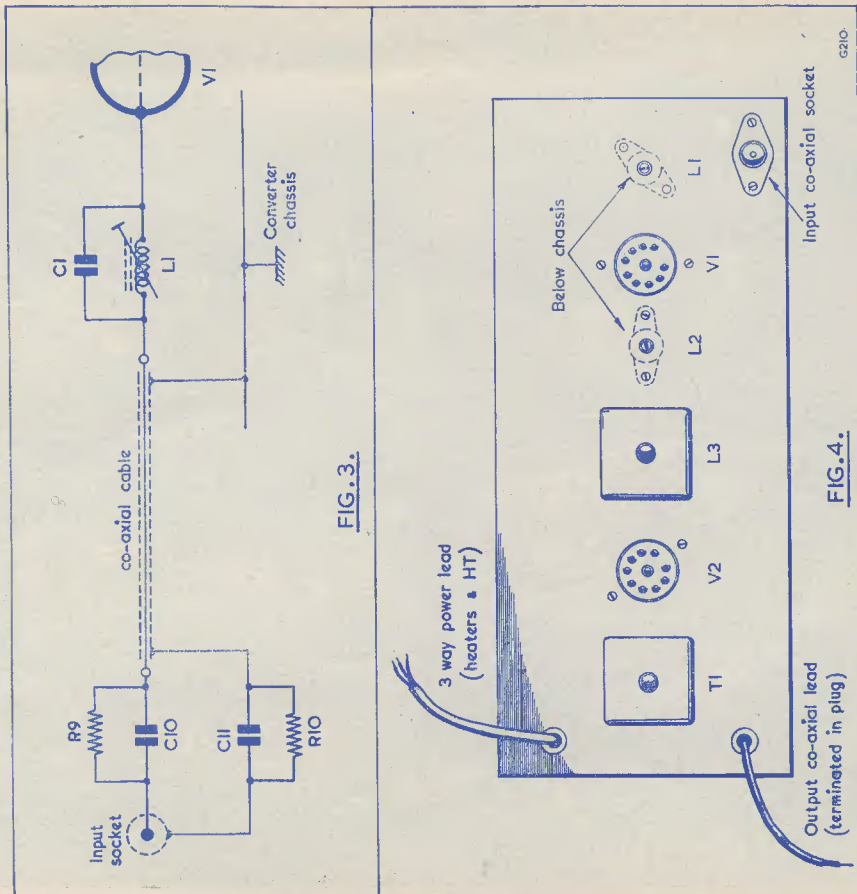

Fig. 3. The isolating components needed for the aerial input circuit when a transformerless mains supply is employed

Fig. 4. Top layout of the converter

### Power Supply

A suitable power supply circuit is illustrated in Fig. 2. This employs a mains transformer, a 6X4 rectifier, and a conventional low-pass

A transformerless power supply may also be used if considered necessary, although care must be taken to ensure that the consequently live chassis of the converter is adequately

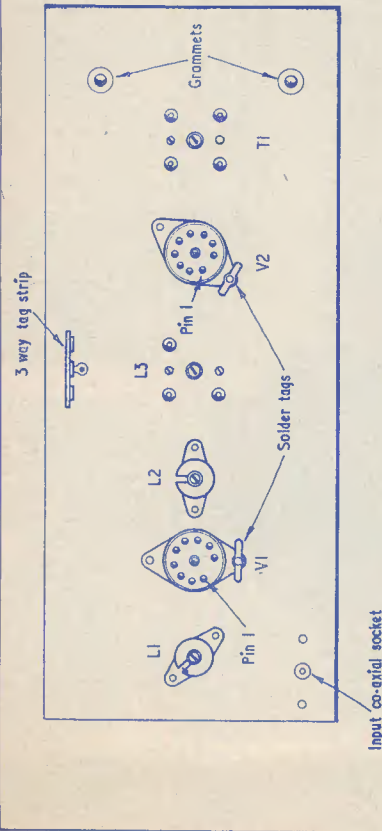

FIG. 5.

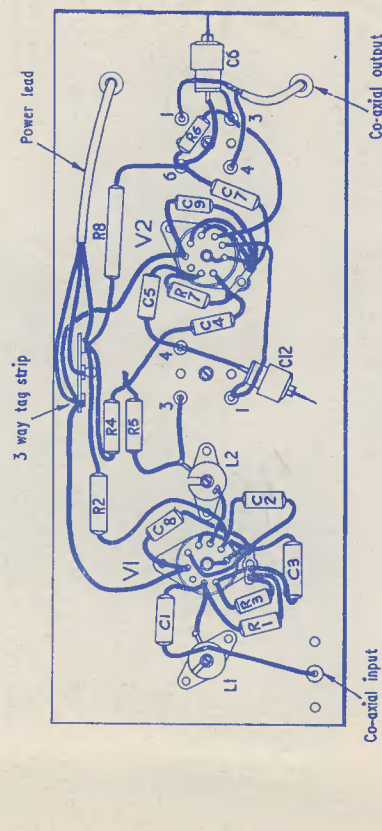

FIG. 6.

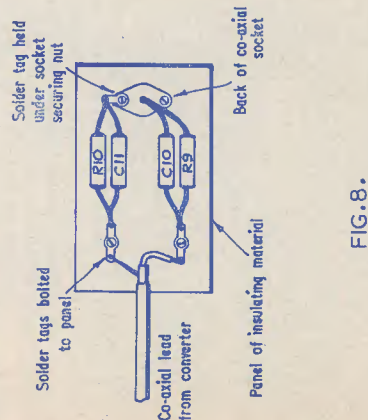

FIG. 7.

G211

Fig. 5. Layout of the principal components below the chassis  
Fig. 6. Wiring layout. All component leads must be kept short  
Fig. 7. Alternative input wiring when a live chassis is employed  
Fig. 8. How the isolating components shown in Fig. 3 may be fitted

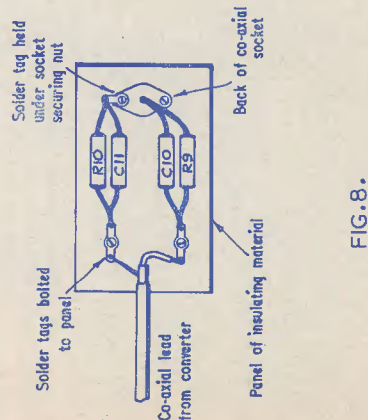

FIG. 8.

isolated from the aerial and the subsequent television receiver. The additional components required at the input circuit are illustrated in Fig. 3. It is of importance to ensure that the isolating condensers shown in this circuit,  $C_{10}$  and  $C_{11}$ , are capable of withstanding the full mains voltage without risk of breakdown. If possible, the chassis of the converter unit (assuming that this is live) should be connected such that it is always at neutral mains potential. This method of connection may sometimes help to obviate mains modulation troubles.

#### Construction

The layout of the completed converter, viewed from above, is illustrated in Fig. 4. This diagram shows the principal components on the chassis and will be of assistance in following the wiring instructions given below. Fig. 5 illustrates the layout below the chassis. This diagram indicates, in addition, the positions at which pins No. 1 of  $V_1$  and  $V_2$  should appear when they are mounted. Correct orientation of these valveholders is essential for short wiring. Power supply components are not shown in either Figs. 4 or 5.

The writer understands that, by the time this article appears in print, completely-drilled chassis will be available from advertisers. Since these will be readily and cheaply available it is not proposed to give full drilling dimensions in this particular article.

#### Wiring

To commence construction, all those components which are bolted to the chassis may primarily be mounted. It should be noted that solder tags are fitted to the nuts securing  $V_1$  and  $V_2$  valveholders. The positions of these tags are illustrated in Fig. 5. Two single-ended solder tags (or a double-ended tag) are fitted under each nut.

Fig. 6 shows the wiring layout. This is the layout employed for the transformer-isolated version. For the live chassis version the small modification given in Fig. 7 must be employed. This requires a short length of co-axial cable to be soldered direct to the top tag of  $L_1$ , and to the solder tag adjacent to  $V_1$  valveholder. This co-axial cable then passes through the hole previously occupied by the Belling-Lee input co-axial socket. The output co-axial lead is, of course, already isolated by the separate winding fitted to  $T_1$ .

To simplify presentation, Fig. 6 shows the components slightly more spaced out than would be the case in practice. It cannot be emphasised too strongly that *short* leads are essential. It may happen that some of the condensers used have a protective enamel covering, this enamel sometimes extending from the body of the condenser along the

lead-out wires. The reason for this is that the condensers are dipped in the enamel during production. If the enamel on the lead-out wires prevents a short connection being made, it may be carefully scraped off with the finger nail or melted with a *quick* application of the soldering iron.

Owing to the short connections employed, no joint should be heated for too long a period or its associated components may suffer damage. The only way to ensure a quick joint is, of course, to employ a clean, well-tinned soldering iron.

#### Live Version

As may have been seen from Fig. 7, the live version of the converter differs from the transformer-isolated version only insofar that the co-axial input socket is not mounted directly to the chassis. The reason for this precaution is that it prevents any mains voltage reaching the o-axial outer conductor.

To ensure isolation, the input co-axial socket should be mounted on an insulating material, such as Paxolin. A suitable method of doing this is shown in Fig. 8. It will be seen that, in this diagram, the co-axial socket is mounted on a small panel of the insulating material, together with the necessary isolating components and their solder tags. Two of these solder tags anchor the co-axial lead from the converter unit and provide a useful mounting for the isolating condensers and their parallel resistors. The insulated panel of Fig. 8 may be mounted anywhere on the converter unit chassis, or anywhere on any cabinet in which it may be housed.

#### Alignment

After completion, the converter should be carefully checked to ensure that all wiring is correct. It may then be aligned.

To carry out this process, the existing television receiver should be switched on and allowed to warm up such that it is receiving the normal Band I signal. The converter should be switched on also at the same time. The Band I aerial lead should next be taken out of the television and plugged into the input socket of the converter. The output plug of the converter is then connected to the aerial socket of the receiver.

In consequence of this altered mode of connection, the Band I signal now has to pass through the converter. The contrast control of the television should be advanced until the Band I signal re-appears.  $T_1$  should then be adjusted for *maximum* Band I signal. (This transformer should be adjusted both by means of its core and by means of  $C_6$ . It is possible, in some cases, that a particular combination of settings of the core and of  $C_6$  will give optimum picture strength. This combination can easily be determined

experimentally and is that which is most desirable.)  $L_1$  is next to be adjusted. Its core should be set for *minimum* Band I signal. If necessary, the contrast control of the television may be further advanced during this process to ensure that the Band I picture can still be

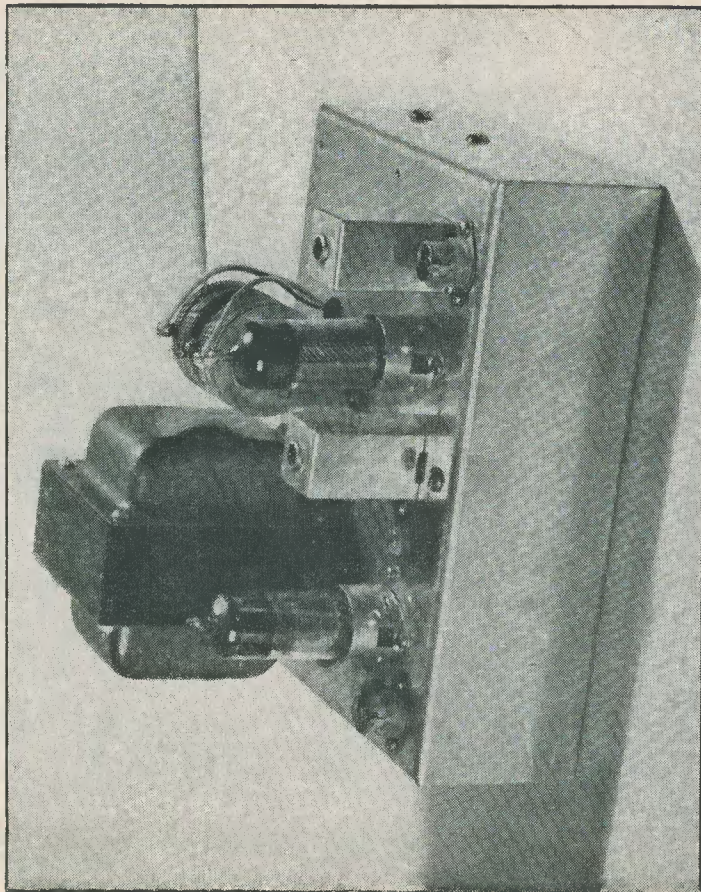

Another version of the Teletron Converter as built by H. L. Smith & Co., Ltd. Employing a similar layout to the original, it has a larger chassis and a self-contained power supply

resolved.  $T_1$  and  $L_1$  should then be re-adjusted once more. If the ultimate setting of  $L_1$  causes the Band I signal to disappear altogether, its final setting should be that which is mid-way between the settings at which the picture just commences to re-appear.  $L_1$  and  $T_1$  are now set up and should not be touched again.

The next process consists of adjusting the

(It is possible that this procedure may have to be repeated several times for different settings of  $C_5$ .) Contrast on the television should be reduced as necessary, and  $L_2$  next adjusted for maximum Band III signal. After this process,  $L_3$  should be slightly re-trimmed, and  $L_2$  finally adjusted.

The converter is then ready for use. (To be continued)

## Next month . . . A High Quality 10-watt Ultra-Linear Amplifier

by L. F. SINFIELD

# Query Corner

A Radio Constructor Service  
for Readers

## E.H.T. Rectifier

*After some two years my home-built television receiver has developed an intermittent picture fault. The defect usually occurs during the first hour of operation, and appears as a sudden collapse of the picture, accompanied by a sharp click. The picture then returns to normal almost immediately.*

E. Swain, Guildford

Faults of this nature in which a sharp click or crack accompanies the sudden disappearance or dimming of the picture invariably indicates intermittent flashover in the e.h.t. circuit. The point at which the trouble occurs can usually be located by examining the suspected parts in subdued lighting. When the effect occurs it should be possible to pin-point it by the appearance of the spark. This class of fault should be corrected as soon as it develops, otherwise further damage can be done which may make the repair a costly business. It is most unlikely that once a flashover has occurred the trouble will correct itself; usually the effect becomes more frequent until finally the insulation breaks down completely.

In certain of the earlier television receivers it was not unusual for the insulation between the filament winding of the e.h.t. rectifier and the core of the line transformer to become punctured. If this happens it is advisable not to try to effect a temporary cure by adding small pieces of insulating material at the point of breakdown. A good repair can only be effected by completely removing the filament winding and renewing the wire. Before disturbing the winding it is important to count the number of turns and note the

attention. First, the lead-out wires of the "wired-in" type of rectifier must not be bent close to the glass bulb; the glass can very easily be broken by careless lead bending, and invariably this ruins the valve. A good plan is to grip the lead close to the glass with a pair of thin-nosed pliers and then bend the lead. The second precaution concerns the method of soldering the valve leads to the terminal points. One rectifier manufacturer recommends that the anode lead is not soldered closer than 10mm from the glass seal, whilst the heater leads must not be soldered closer than 5mm from the end of the bulb. This precaution is necessary to prevent thermal expansion of the lead-out wires occurring at the glass-to-metal seal, as this may easily damage the seal.

The final likely place at which e.h.t. flash-over can occur is at the tube anode connector. Arcing usually arises here because a film of dirt has collected between the anode connector and the earthed coating around the tube cone. This dirt may easily be removed with a spirit-damped pad, care being taken not to wipe off any of the external coating (aquadag). In some cases this may only form a temporary cure, and it is advisable in such circumstances to use an anode connector which is fitted with a moulded p.v.c. cap. A little silicone grease smeared around the inside of the cap before it is applied to the tube will act as an excellent barrier against moisture and prevent any further sparking. Finally, check that the earthing connection to the external coating on the tube is properly made; should the coating not be earthed it will collect a charge which may approximate to the e.h.t. voltage, and arcing between the coating and some adjacent earthed object will occur.

## L.T. Drain

*I have been servicing a mains/battery portable of a well-known make and have succeeded in obtaining good results. I was surprised, however, to find that when operating the set on mains there was still a small discharge from the l.t. battery. Can this be prevented?*

L. Glover, Cowes

Presumably this general purpose portable is of the type in which the l.t. battery remains in circuit when the set is operated on the mains. This method of connection is quite normal, but it does mean that if the l.t. voltage derived from the mains via the rectifier is lower than it should be, the l.t. battery will endeavour to make up the difference. Check, therefore, that the

# Query Corner

## RULES

(1) A nominal fee of 2/6 will be made for each query.

(2) Queries on any subject relating to technical radio matters will be accepted, though it will not be possible to provide complete circuit diagrams for the more complex receivers, transmitters and the like. Queries relating to ex-W.D. surplus or commercial equipment cannot be accepted.

(3) Complete circuits of equipment may be submitted to us before construction is commenced. This will ensure that component values are correct, and that the circuit is theoretically sound.

(4) All queries will receive critical scrutiny and replies will be as comprehensive as possible.

(5) Correspondence to be addressed to "Query Corner," Radio Constructor, 57 Maida Vale, Paddington, London, W.9.

(6) A selection of those queries with a more general interest will be reproduced in these pages each month.

receiver is being operated on the correct mains tapping and that the components in the power pack are in good order. Metal rectifiers are usually fitted in this type of set, and it may be found that the forward resistance of the rectifier has increased. This causes a larger volts drop across the rectifier and consequently reduces its output.

## Picture Break-Up

*I have recently purchased a secondhand television receiver made by a well-known firm.*

*After operating satisfactorily for some time, a defect has developed causing the picture to break up into horizontal bands. There also appears to be some corona which causes a white spot pattern to appear on the image. Any suggestions for a cure?*

E. Melvil, London

It sounds rather as though the receiver in question is fitted with some form of flywheel sync circuit, and that the smoothing in the line flyback e.h.t. circuit is inadequate. Smoothing is normally obtained by the capacitance between the final anode of the c.r. tube and the external coating on the tube. If the coating is not effectively earthed there will be an appreciable a.c. component on the e.h.t. line which can easily feed back into the vision channel and upset the line sync. This condition may easily cause the picture to break up into a number of horizontal bars.

# The "METEOR" MINI- RECEIVER

for the  
Beginner

by F. A. BALDWIN, A.M.I.P.R.E.

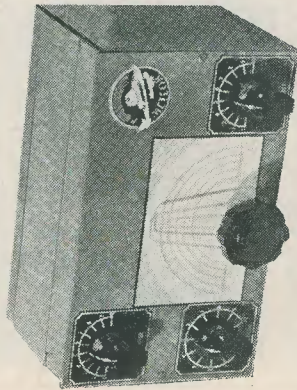

PART 1.

(A receiver using modern miniature components, specially designed for, and directed at, our beginner readers. In this issue the circuit and drilling details are outlined so that construction may be commenced. Part 2 will contain wiring instructions, etc.)

EVERY YEAR HUNDREDS OF PEOPLE BECOME interested in radio as a hobby, and one of the first things they require, apart from the necessary interest and tools, is a simple receiver design which they can start to build with every confidence in the final outcome. To an old hand at the game this seems an easy thing to come by, with a library of radio books accumulated over the years and a vast stock of magazines to fall back on if required. To a newcomer, however, this is not possible. For them, no library exists, and they must live in the hope that sooner or later a magazine will come to their assistance by publishing such a design. One of the greatest headaches for an editor is not only the apportioning of available space between the various subjects of interest (amplifiers, receivers, etc.), but also to balance each issue between the various stages of advancement within the hobby—beginner to old-timer. Add to this the division between practical and theoretical articles and it will be understood that it is not possible to cater for beginners in all issues—or for that matter any other specialised interest.

## General

Before designing this receiver we had to consider which type of circuit was most suitable. Apart from the obvious choice of

a straight circuit to ensure simplicity, consideration had to be given to the availability of components easily obtained from our advertisers for the convenience of readers living far outside the main centres of the country. Also, in order to present an up-to-date design, it was considered advisable to incorporate modern miniature components, it being of little practical use to offer an out-of-date receiver using old parts to the up-and-coming enthusiasts of to-day. Miniaturisation being the order of the day, we have followed the present trend; at the same time, we have used as few components as possible in order to keep the cost to a reasonable level, and also to obviate a crowded chassis, both for practical reasons and for clarity in the layout. Similarly, we have adopted coils of the plug-in type, thus also making the receiver into an all-wave type consistent with the coil ranges. With the coils specified (see component list), a range of some 32 Mc/s to 730 kc/s can be expected, allowing for the additional capacitance of the wiring and bandspread condenser. Again, for simplicity, headphone output is employed, while other refinements such as tone controls, etc., have been omitted.

The power supply is taken from a very handy little power supply unit which may be obtained commercially either in com-

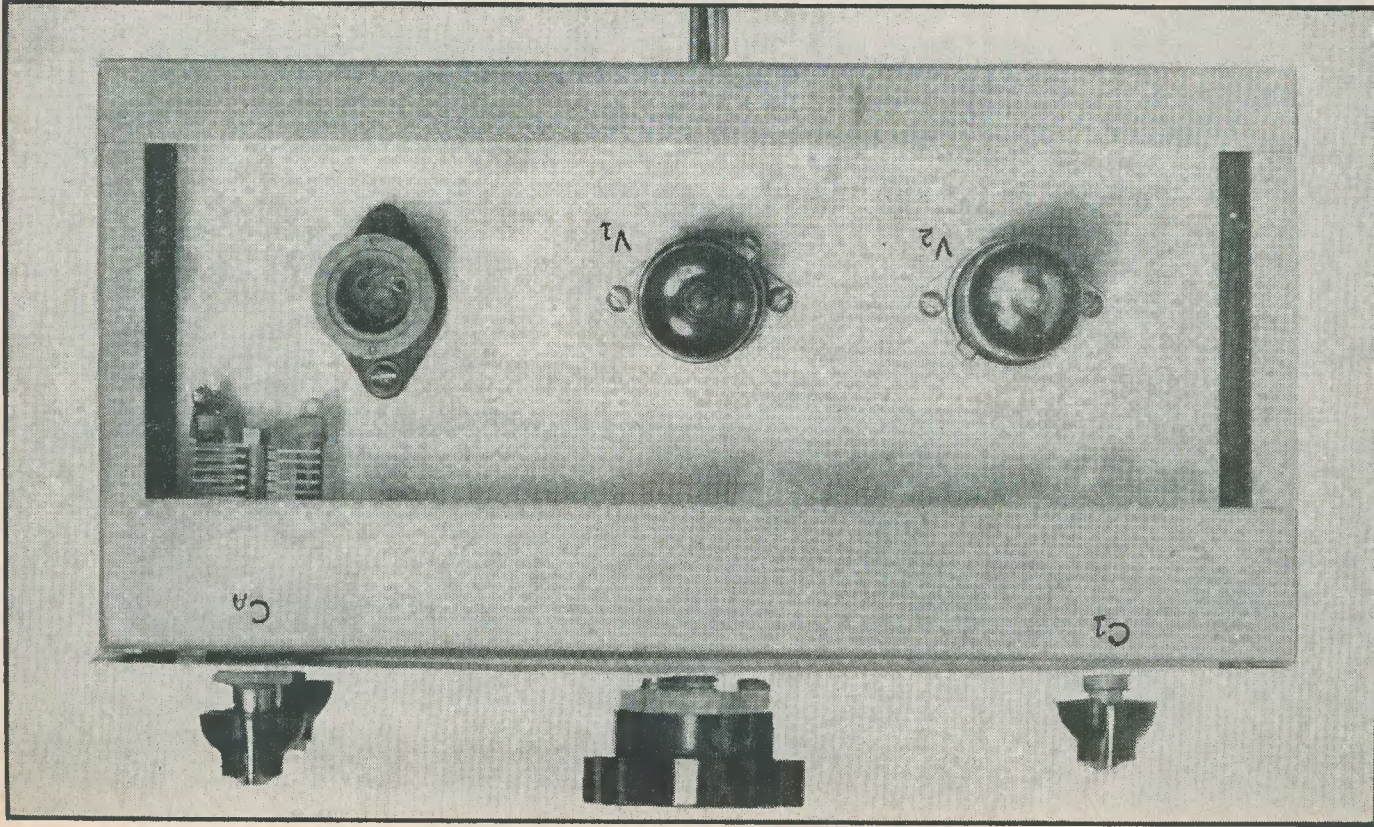

View from above with cover removed, showing easy accessibility to plug-in coil

ponent form or already wired and tested. This is the R.C.S. Products power unit type PU1 which has an output of 120 volts at 20mA, and 6.3 volts at 1.5A for the valve heater supply. This is to be preferred instead of the battery supply and valves usually presented to the beginner, in that a start is made at the outset with mains valves and equipment. Later progression into the more advanced receivers and equipment will then no doubt include these valves, whereas those of the battery supply type would, more often than not, be consigned to the junk box. The power unit is small, neat, and compact, being totally enclosed in an attractive grey-sprayed metal cabinet. The overall cost of this is reasonable compared to the rather expensive continual replacement of batteries. The front cover illustration shows the receiver unit as it would appear when in actual operation. Both units are sprayed grey enamel and this, together with the use of Panel Signs transfers, presents a very attractive ensemble.

#### Circuit

The detector stage is built around the Mullard EF41 r.f. pentode, one of the B8A range. In the circuit diagram (Fig. 1), all the valve base connections are shown. For example, valve pin number eight is connected to chassis, which is, in effect, the earth. In Part 2 of this article, to be published next month, further details of these connections are given, so that no possible mistakes with regard to valveholder wiring are made.

The aerial is connected to the coil primary winding via C<sub>a</sub>, the inclusion of this ensuring smooth reaction without dead spots over the entire receiver range; for operation of this see Part 3. The feedback winding is connected to the detector anode via C<sub>2</sub>, a 70pF silver mica condenser. The tuned winding is that connected to the grid via C<sub>3</sub>, a 100pF ceramic condenser. C<sub>1</sub> is the bandset condenser while C<sub>b</sub> is that used for bandspread. The h.t. + supply to the anode is via R<sub>2</sub>, a 22kΩ resistor, and the r.f. choke (Eddystone Cat. No. 737). The screen supply is via R<sub>3</sub>, a 200Ω resistor, R<sub>4</sub>, a 50kΩ potentiometer, and R<sub>5</sub>, a 200Ω resistor and is bypassed to earth via C<sub>6</sub>, a 0.1μF condenser. The variable potentiometer R<sub>4</sub> acts as reaction control by varying the applied voltage to the screening grid of the valve. This method of obtaining reaction is preferred in that no alteration to the receiver tuning is made by varying the voltage. Positive feedback (reaction) is obtained by the inclusion of both C<sub>2</sub> and C<sub>4</sub> in the anode feed to the reaction winding. The grid condenser and grid leak, C<sub>3</sub> and R<sub>1</sub>, are of carefully chosen values in order

to obtain efficient operation over the entire range of the receiver. The output of the detector stage is taken via C<sub>5</sub> into the grid of V<sub>2</sub>.

For those who are rather apprehensive about trying out the receiver only when both valves are included, it is perfectly possible to complete only the detector stage as a first step, and, having connected the power supply, insert the phones between C<sub>5</sub> and chassis in order to obtain a signal. The phone socket, of course, will have to be wired into circuit before this can be done. This is shown in dotted line in Fig. 1, for those who wish to adopt this method and would rather advance stage by stage. The connection to the grid of V<sub>2</sub> and R<sub>6</sub> need not, of course, have to be broken if this is done.

The output stage is constructed around the Mullard EL42 Output Pentode. The circuit is perfectly straightforward and its purpose is to amplify the audio voltages arriving at the grid (pin 6), so that a much greater output is available for the headphones connected into the anode circuit. Once again the values have been carefully chosen and all are standard values easily obtainable. The resistor R<sub>6</sub> is the grid leak, or load across which the input voltage is built up, while the cathode bias voltage is obtained from R<sub>8</sub> decoupled by C<sub>8</sub>, both connected to pin 7 of the valveholder. The anode load resistor is R<sub>7</sub> and the phones are connected to the anode via C<sub>7</sub>. This last condenser must be of the 350 volts working type as a precaution against the phones becoming "live" through the possible breakdown of a lower rated component. Provided this precaution is observed there is no danger inherent in this portion of the circuit. It is recommended, of course, that this condenser should be that specified, and most certainly not one of the surplus components which quite probably has deteriorated through long, and often bad, storage conditions. So much for the circuit—we now progress to the initial stages preparatory to wiring up the actual circuit. The power unit will be described in Part 2.

#### Initial Practical Preparations

Obviously, the first thing is to obtain the components that are specified in the component list. For the convenience of readers, the firms concerned are stated after the individual components. For younger readers whose available cash may be limited, it should not be forgotten that this receiver is capable of being constructed in stages, i.e., as a one-valve in the first instance. Ideally, the tools required are—small pliers, screwdriver, wheelbrace complete with drills, a chassis punch complete with tommy bar

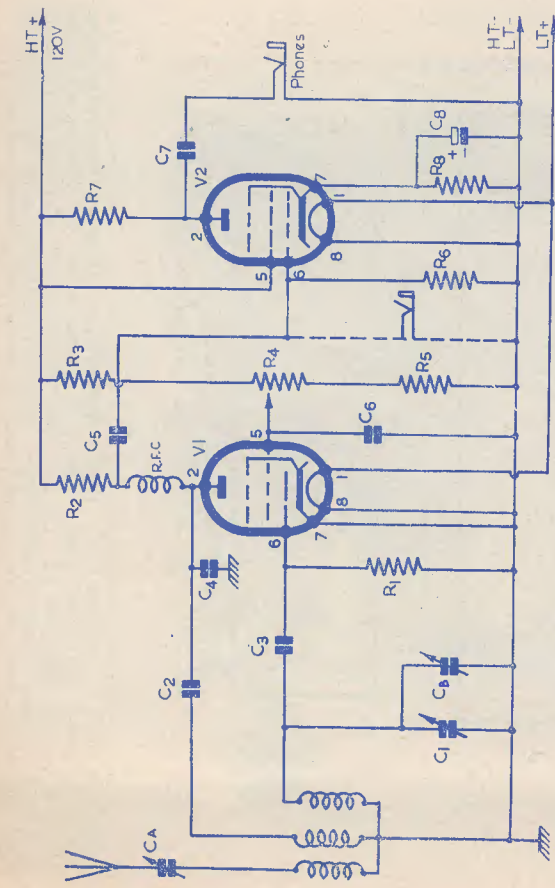

Fig. 1  
Circuit of the 'Meteor' mini-receiver

E208

#### COMPONENTS LIST

- Resistors**  
R1 2MΩ ½ watt  
R2 20kΩ ½ watt  
R3 200Ω ½ watt  
R4 50kΩ potentiometer  
R5 200Ω ½ watt  
R6 470kΩ ½ watt  
R7 200Ω ½ watt  
R8 150Ω ½ watt
- Valves**  
V1 Mullard EF41  
V2 Mullard EL42
- Panel, Chassis and Cabinet—R.C.S. Products (Radio) Ltd.  
Headphones—(high impedance type)  
R.F. Choke—Eddystone type 1022.  
Power Unit type PU1—R.C.S. Products (Radio) Ltd.  
Phone Jack and Plug.  
Aerial Wire—14 swg enamelled copper—in
- 35, 50, 70, 100, 140 or 270 ft. lengths (according to individual requirements).
- Condensers**  
C<sub>a</sub> 100pF variable, Eddystone type 585  
C<sub>b</sub> 25pF variable, J.B. type C804  
C<sub>1</sub> 140pF variable, Eddystone type 586  
C<sub>2</sub> 70pF Silver Mica  
C<sub>3</sub> 100pF Ceramic  
C<sub>4</sub> 100pF Ceramic  
C<sub>5</sub> 0.01μF TCC type CP45W  
C<sub>6</sub> 0.1μF TCC type CP45N  
C<sub>7</sub> 0.1μF TCC type CP45N  
C<sub>8</sub> 25μF Electrolytic, Dubilier
- Coils—Eddystone Miniature Plug-in types —706/LB, 706/Y, 706/R, 706/W and 706/P.  
Coil Base—Eddystone type 707.  
Coil Stand—Eddystone type 775.  
Valveholder—B8A McMurdo  
PVC Wire, Nuts, Bolts, Solder, Solder Tags, 3-way Strip, Aerial/Earth Strip, Rubber Grommet, Knobs etc.



for valveholder holes, soldering iron (preferably of the pencil bit type) and, of course, solder (Multicore). A centre punch and scriber would also be desirable if available. that the paintwork is not scratched or

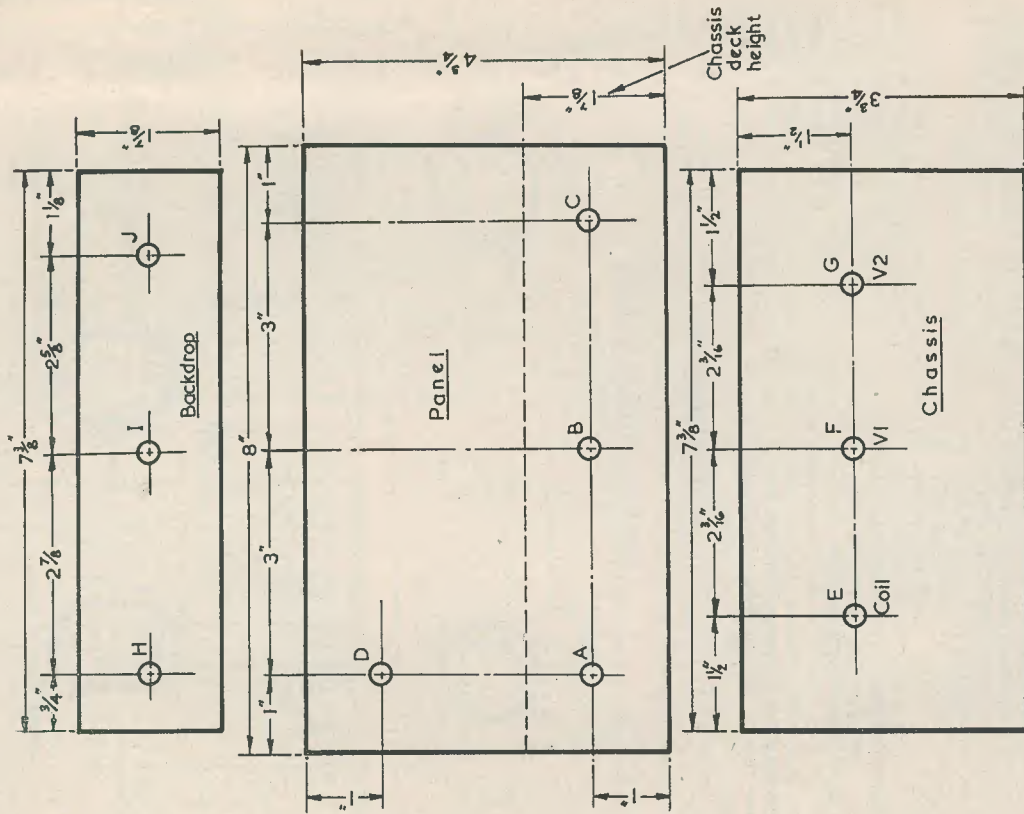
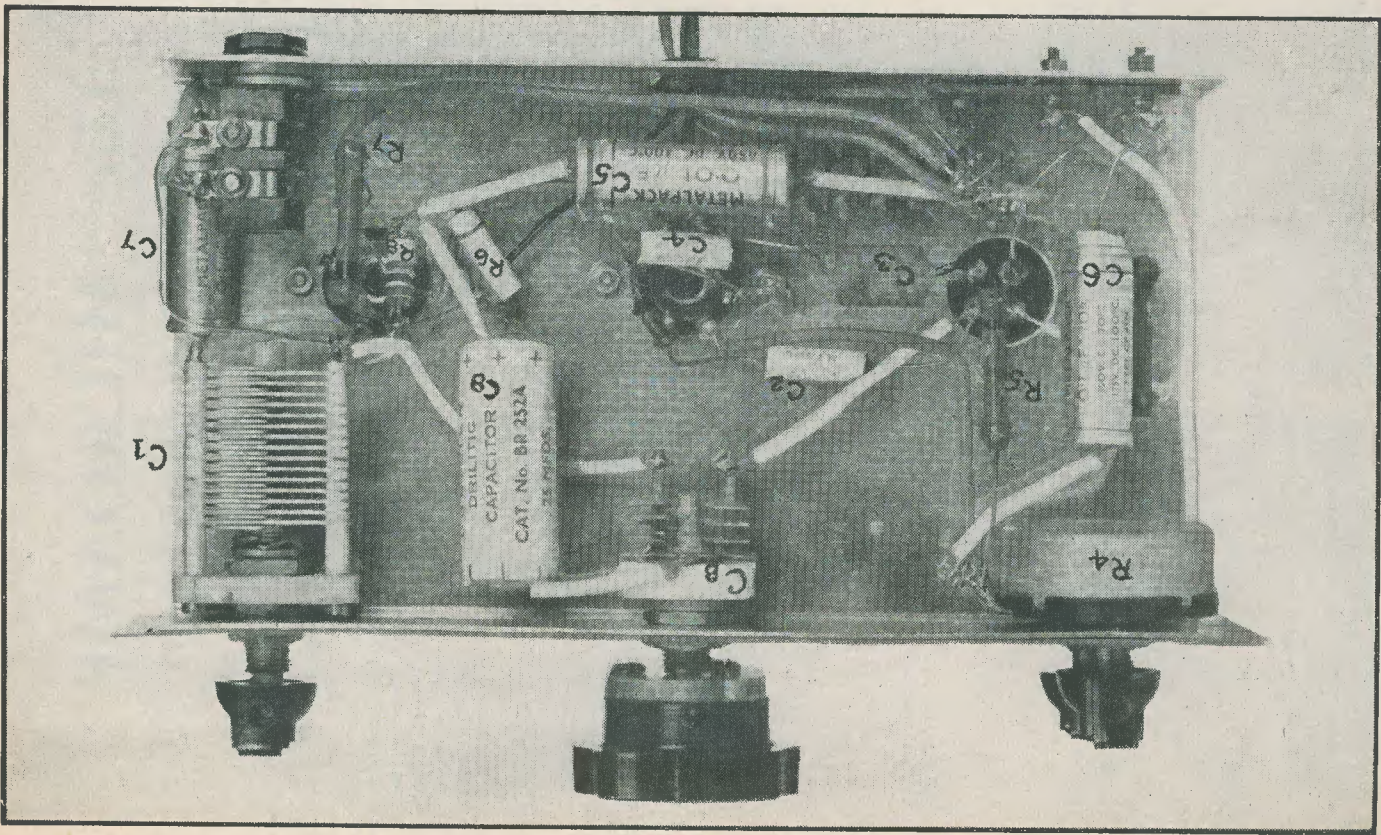

Fig. 2  
Drilling dimensions of chassis panel & backdrop

From Fig. 2, all the information required regarding drilling details may be obtained. As received, the front panel and chassis, together with the cabinet, are separated, i.e., not bolted together. First, drill the



Under-chassis layout showing location of main components

# The "MICROAMP"

## A MINIATURE HIGH FIDELITY AMPLIFIER

by O. J. RUSSELL, B.Sc. (Hons.), G3BHU

THERE IS CONSIDERABLE INTEREST IN THE high fidelity reproduction of records, particularly in view of the superb quality and virtually noiseless background obtainable from long-playing records. Unfortunately, the cost of modern high fidelity equipment, particularly when preamplifiers, tone control units and equalisers, to say nothing of loud-speaker enclosures and multiple speaker systems with crossover networks are included, is high. The constructor with a modest pocket must often feel the need for a medium priced amplifier which will give good results, without costly trimmings. Unfortunately there are very few low cost amplifiers or designs available.

include tone correction and/or equalising facilities for optimum reproduction of records. The cost was to be as low as possible, and in fact enable the home constructor to use pieces in stock, or even in the junk box, and still obtain reasonable quality even when using, say, a small surplus speaker rather than an expensive super high fidelity model. In fact, owners of super high fidelity speakers would normally be able to afford an amplifier to suit. However, the amplifier will, of course, feed a super high fidelity speaker if one is available.

After some thought, the amplifier was reduced to the ultra-simple line-up of just two valves, a 6J7 amplifier and a 6V6 output

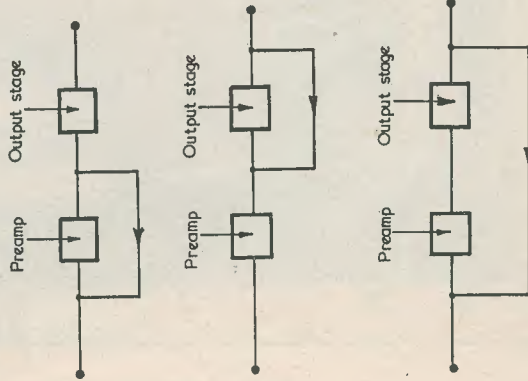

Feedback over the output stage. This is the least effective system. Output distortion is not reduced.

Feedback over the preamp stage. This reduces output distortion. A better proposition than the first system.

Feedback over both stages is the most effective method.

Fig. 1

The object of the "Microgram" design was to evolve the simplest amplifier which would provide negative feedback for the advantages obtainable therefrom, and also

6V6 to full output. Accordingly negative feedback of from some ten to twenty db may be applied with a consequent reduction of distortion.

As a study of some negative feedback designs will reveal, there are considerable stumbling blocks in the way of applying feedback. Multi-stage amplifiers using a heavy degree of feedback require quite advanced design if stability is to be achieved with a wide frequency response. In fact, the application of feedback to even a two-stage amplifier can be achieved in several ways. (Fig. 1).

In other cases feedback is applied over the output stage only. This is helpful in reducing distortion. However, it is generally impossible to apply feedback from the output stage via the speaker transformer secondary. This is because, measured at the output secondary, the output stage, far from having a gain, may have a reduction in voltage as compared with the grid input, as the output transformer has a high step-down ratio. Thus with feedback over the output stage only, we must take output from the anode and not from the transformer output. However, feedback from the secondary

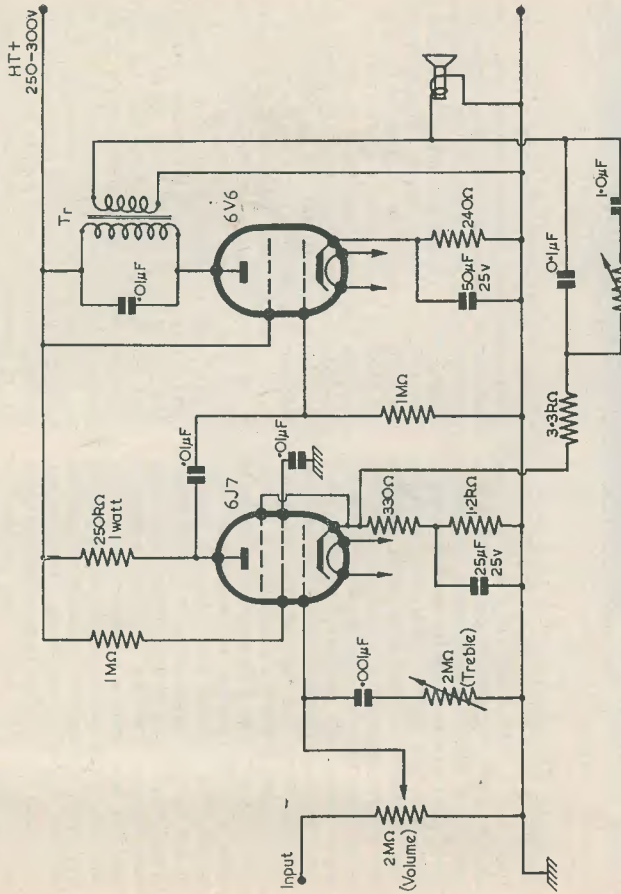

Fig. 2

Tr transformer to match 5000 ohms to 5ohms. All resistors are 1/2 watt except the anode resistor of the 6J7

E 214

Several two-stage amplifiers have been described in which feedback has been applied only in the pentode preamplifier. It is difficult to see the reason for this, as this is the least effective method of applying feedback. The output stage operates at high level, so distortion there is far higher than in the preamplifier, which has only to provide some ten volts or so of audio at the most. Hence the overall distortion is hardly affected in such an amplifier, where one is merely feeding slightly purer audio into a stage capable of appreciable distortion. The effect is that of a cupful of pure water in an ocean of sewage.

winding helps to reduce transformer defects, an especially important point with single-ended amplifiers.

The most satisfactory method, therefore, is to use feedback over the whole amplifier from speech coil to input. This overall feedback reduces distortion irrespective of whether it arises in the preamplifier, output valve or output transformer. It is the customary solution in complex amplifiers, but is seldom applied to simple two-stage amplifiers of the economy type. Nevertheless, it is just as advantageous.

However, readers will quickly discern a snag or an apparent snag. Having thrown

away surplus gain in negative feedback, we have no gain to spare for tone control circuits. As tone control circuits generally operate as attenuators of various sections of the audio spectrum, we need considerable "surplus" gain if tone control is to be achieved. However, for record reproduction, top is boosted on the record. Therefore we can safely use a top corrector of variable attenuation to give the effect of top boost, correctly equalised top, or even top cut without sacrificing gain. This effectively disposes of the problem of top correction.

For bass correction, a different solution is adopted. The bass correction progressively decreases negative feedback in the bass, so that output rises in the bass region, and bass boost is achieved without sacrificing gain. Moreover, feedback increases as the frequency rises in the bass, and so harmonic distortion products being of higher frequency than the bass fundamentals will be fed back appreciably. Thus the value of feedback in reducing distortion is not lost to any great extent. So without going to any greater complication than two valves, the above tricks enable the best possible use to be made of such a simple combination.

Fig. 2 shows the circuit of the amplifier constructed to test the overall performance of such a circuit design. It is so simple that no layout is considered necessary, provided the usual simple precaution of keeping the grid circuit of the 6J7 well away from the anode circuit of the output is observed. The pick-up leads and 6J7 grid lead should, of course, be carried out in screened cable, and short leads used in wiring up the top corrector components in the input circuit.

A simple power pack providing some 250 to 300 volts at, say, 60mA will be perfectly adequate. In the writer's case a general purpose power pack having a double 8J.F. condenser and smoothing choke was used, and the hum level (probably due to the hum reducing effect of feedback) was low.

No elaborate speaker system was used; in fact, a surplus 6in speaker and transformer were used in a "table top" miniature vented enclosure constructed for the occasion. The definition of both bass and treble was very satisfactory on both L.P. and 78 r.p.m. discs when using a modern crystal pick-up. The equipment was loaned to the owner of a popular three-speed playing desk, who reported that he had discovered a previously unsuspected background treble register counter-melody on a favourite record that he had never noticed previously! While no exaggerated claims are made, the writer is confident that the suggested arrangement will give about the best possible results obtainable in a two-stage amplifier. It may be that the results will be surprising to those who suppose that "high fidelity" is only possible with elaborate and costly equipments. Certainly it is a considerable improvement on the use of the usual domestic receiver for record reproduction. Owners of two-stage amplifiers not incorporating feedback may like to try modification to the Fig. 2 circuit, if they have enough gain in hand to provide adequate negative feedback, as in many cases a considerable improvement in quality may be achieved. Moreover, where a large speaker adequately baffled or housed is available, results should be correspondingly improved.

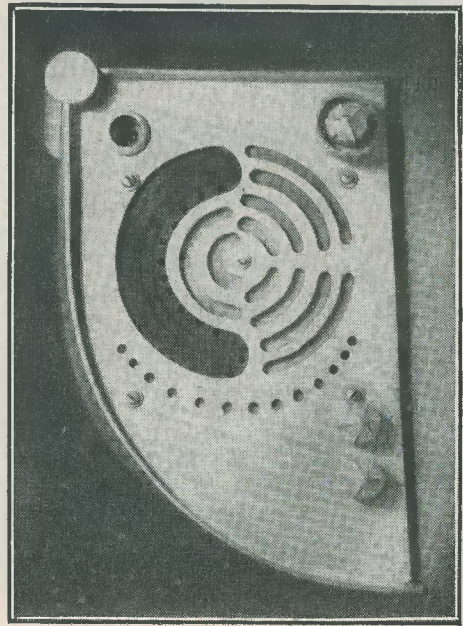

The illustration shows a modern-looking cabinet designed and built by an Indian reader, S. N. Nautiyal. The material used was hardboard bent to shape, with the side and bottom members braced with wood. The dial has been fitted so that it occupies the position usually taken by the speaker fret, and holes have been drilled so that no undue obstruction of the sound waves takes place.

# Radio Miscellany

**A** RATHER UNSETTLED COLUMN THIS month, I'm afraid. Have not yet got over the holiday season, having just returned from Central Europe where, for part of the time, I was half-way under the Iron Curtain. In fact, for three weeks I did not hear the sound of a British voice other than three radio contacts on 20 metres. Believe it or not, one of them, a GM station, Test match without dashing into another room to find the morning paper!

Nor could I find anybody who listens to the B.B.C. European programmes. I have never yet found anyone who does, so I guess their number must equal those of British listeners to Russian propaganda programmes. Of course, during the war years, when listening in the occupied countries was forbidden (and many sets capable of getting London were confiscated), there was plenty of it. Older readers will recall that some years ago I wrote of a number of ingenious little home-made receivers made by Dutch constructors. Many of them were of miniature proportions with standard parts and sometimes with the most unlikely bits and pieces used as substitutes.

## First Steps

It was on the homeward journey that the news of America's "flying saucers" broke. The real ones, I mean, announced by President Eisenhower's press secretary, the first of which is to be projected in 1957. Plenty of warning, of course. If they had been let off secretly somebody might have panicked and started "retaliation" with H-bombs. These "space ships" are scarcely twenty inches across but we must learn to crawl before we can walk, so mankind must be content to learn by mistakes on a small scale first. They will encircle the earth between 200 and 300 miles up, at a speed of some 18,000 miles per hour.

It was not exactly a coincidence that this column touched upon space travel recently. A first step on these lines has been anticipated for some time, and as soon as the announcement was made rumour had it that the Russian version was equally advanced.

Both "saucers," apparently, will start their journey by multi-stage rockets, and on reaching the intended height will be started on a parallel-to-the-earth's-surface course by side blast.

## CENTRE TAP

talks about

HOLIDAYS  
SATELLITES  
CHEAP TV

Equally ingenious were the hiding places. Usually in the "smallest room" where a locked door would not arouse overmuch suspicion. No doubt many a cunningly contrived hidey-hole in the cistern or under a floor-board still remains as a reminder of those grimmer days. As, during my stay this year, the only news I heard was of the Big Four Geneva talks and the resultant high hope of a permanent peace, let's not dwell on war-time radio.

It is quite possible the first one will not even carry instruments. Even so, much can be learned from its behaviour, although we shall be denied the opportunity of listening for its radio signals. We may, at least, stand a chance of seeing it. It should be fairly easy to track with a good telescope and ought to be visible, reflecting the sun at twilight, to the naked eye.

(continued on page 102)

# FRANKLIN VFO

## FROM SURPLUS COMPONENTS

by G. A. TIEL

THE FRANKLIN OSCILLATOR IS KNOWN FOR its inherent stability and freedom from drift provided it is run in the correct manner and not overloaded; whilst the simplicity of its circuit makes it an ideal driver unit for the beginner to construct. This piece of equipment described herein has been in constant use for a period of four years driving a 160/80m transmitter, and over that period has remained completely free from trouble. The complete unit was built from surplus components out of the junk box, so its cost was practically negligible.

As this is a well-known oscillator of conventional circuit design there would appear to be no reason to detail its characteristics, other than the way to lay out and screen the components in the most suitable manner, and to adjust it for satisfactory operation.

fit a box 7½ in. by 8½ in. by 11 in., which was originally used to house a piece of M.O.S. equipment. As can be seen from the photo, a second box 6½ in. by 5½ in. is mounted on the chassis, this to completely screen the coil and variable condensers and to keep them at an even temperature away from the valves. This could quite satisfactorily be made smaller if desired.

The three valves are mounted along one edge of the chassis, and all components, other than the coil and condensers, are canned below it. A front aluminium panel 8½ in. by 7½ in. was cut out and bolted to the chassis, this carrying the slow motion dial, bandset condenser, dial lamp, h.t./l.t. switches, jack and co-axial socket. There is also a hole through which adjustment can be made to the 100pF variable condenser which

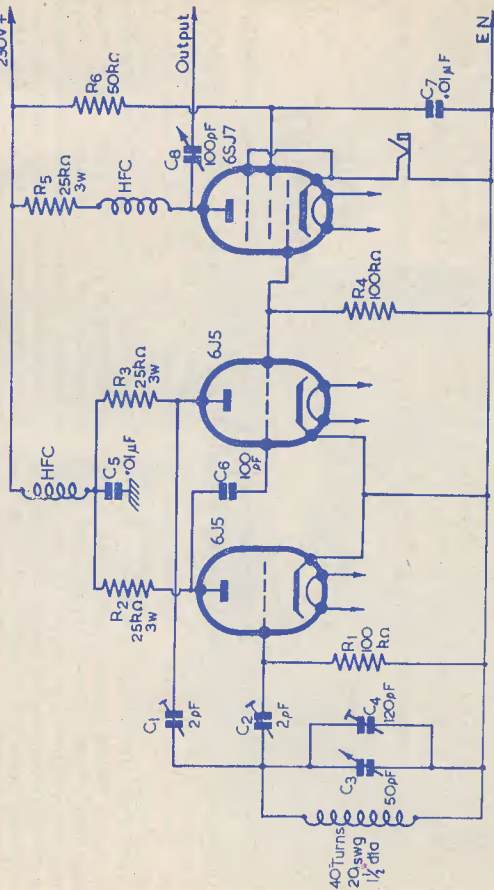

EN1

### Construction

The oscillator can be built to fit any suitable box which the constructor may have available. The one described was built to

couple to the next transmitter stage, so that the drive can be varied.

The excellent slow motion dial (10A/15319) is available in most surplus stores for a few

shillings and is a precision piece of equipment. This is secured to the panel by two screws, and a strip of polished aluminium is swept around the circumference of the dial in order to improve its appearance and to hide the gap between the outer edge and the panel. The spindle is pinned to the dial mechanism, and the condenser, which is carried on a bracket in the box, is lined up to it. Small 0-10pF trimmers C1, C2 are used for producing oscillation and these

drawn and cut into short lengths. This ensures that the wiring is rigid, and will not flop about if the oscillator is moved or jarred. Also pay particular attention to the soldered joints, as a dry joint can cause no end of trouble afterwards. Use if possible silver mica condensers for coupling and decoupling; these are also easily obtainable. The r.f. chokes, if supported in the wiring, should be rigid and not free to move. Where wiring carries voltage and passes through

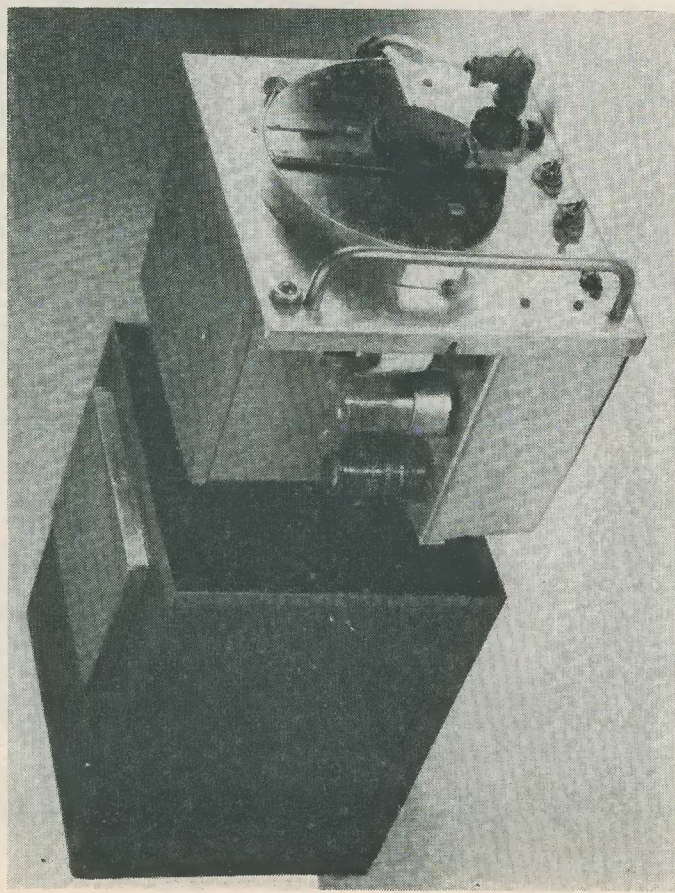

The completed instrument shown withdrawn from case

are mounted in the box adjacent to the coil. This latter consists of a paxolin former 1½ in. diameter on which is wound 40 turns of 20 s.w.g. enamel wire, suitably doped, the former being mounted rigidly towards the centre of the box. It should be at least one diameter away from the sides. All resistors in the h.t. line to the anodes of the valves are of the heavy duty 3 to 5 watt pattern (R2, 3, 6), this to ensure that everything runs cool to maintain stability. These resistors are readily available for a few pence each.

When wiring the oscillator it is advisable to use 18 gauge tinned copper wire, hard

metal screens, these should be bushed or grommetted.

### Calibrating and Adjustment

To adjust the oscillator, all that is required is to set C1 and C2 to the smallest value consistent with steady oscillation. Once this is done the frequency will remain constant provided that the temperature in the box does not vary, and that the structure and wiring of the set is rigid. The output is taken from the 6SJ7 buffer stage, via a 100pF variable condenser, fed to a co-axial socket on the front panel. For c.w. operation a jack is provided in the cathode of this

latter stage. To calibrate the oscillator using a calibrated receiver, set this to the h.f. end of the band and open the band-spread condenser (main tuning dial) of the oscillator. Move the bandset condenser until the signal beats into the receiver, and lock the knob. Obviously for accurate reading it is desirable to spread the band right across the dial if possible, so next swing the receiver to the other end of the band (i.f.) and move the bandspread dial until the signal beats into the receiver. If only half of the dial is covered in this process, pull out one of the moving vanes in the condenser and repeat the check until a reasonable spread over the dial is obtained. Calibrate in the usual manner using a frequency meter, or 100 kc/s crystal, and plot a graph so that the frequency can be read off easily and quickly when required.

#### List of Components

R1, R4 100kΩ ½ watt, Dubilier  
R2, R3 25kΩ 3-5 watt, Dubilier

R5 25kΩ 3-5 watt, Dubilier  
R6 50kΩ 1 watt, Dubilier  
C1, C2 2-10pF, either fixed or trimmer pattern  
C3 50pF variable air-spaced, Eddystone  
C4 120pF variable air-spaced, Eddystone  
C5, C7 0.01μF T.C.C. 500V wkg  
C6 100pF T.C.C. Silver Mica  
C8 100pF air-spaced variable pre-set Eddystone  
2 H.F. chokes, Eddystone 1010  
1 Jack, Bulgin  
1 Panel lamp, Bulgin  
1 Slow motion dial, Eddystone  
2 Single pole toggle switch, 3 Amp, Bulgin  
2 6J5 Valves, Brimar  
1 6SJ7 Valve, Brimar  
1 Co-axial socket, Bellings-Lee

For those amateurs who are short of components, the makers names of suitable types have been included in the above list.

## RADIO MISCELLANY—continued from page 99

### Old Iron

To revert to holiday talk, while I was in Styria I paid a visit (people made me feel it was almost a pilgrimage) to the Iron Mountain, Erzberg.

Everyone seemed astonished that I should want to make a trip there as part of a holiday, but I remembered learning about it at school, and I was afraid the desire to see it might become an obsession. Eventually I managed to persuade a couple of local amateurs to make the trip with me, despite their insistence that there were far better things to see with less than half the trouble. It is of no very great height as mountains go, but it is so rich in iron that it merely has to be chipped off the sides. The ore has been worked since the time of the Romans, and surface excavations have turned it into a veritable pyramid of nearly sixty steps, each some forty feet high.

I was curious to know how it would affect radio reception—it seemed on the face of it a wonderful screen. However, nobody much seems to live around there, and when I enquired about it they shrugged it off as being no worse than any other mountain.

One thing I have always noticed in mountainous regions. Everybody, from the toddlers up, can tell you the exact height above sea level of all the local high points. In Britain, unless the height a.s.l. is of any especial interest, such as being the highest point in the county, only radio amateurs trouble to find out these things. Not one in twenty,

especially among town dwellers, can tell you the a.s.l. height even of his own home.

Just after the war I bought an ex-W.D. altimeter for next to nothing. It is quite good fun to carry about in a car or on a motor-bike, even in London, and watch it when travelling over higher ground such as Hampstead, Eltham or Crystal Palace.

### Anti-TVI

However, I wasn't really disappointed in Erzberg. I should have been far more disappointed to have come away without seeing it, but I was easily persuaded to push on for the higher point of Schöckl, where there has long been a v.h.f. f.m. relay station. The station and the mountain top are served by a cable railway one side and a chair-lift the other, although it is a tortuous hill climb to reach the foot of either. The engineer in charge, who showed us round, does a tour of a fortnight's duty up there. In the summer visitors go up for the thrill of the ride, a drink at the top and on a clear day to look out into Hungary and Yugoslavia with a telescope. You can hire one to see if you can tell the time on a distant clocktower. The only other humans seen in winter are skaters, so what with the snow and the bitter wind a broadcasting engineer's job isn't all fun.

We watched them put the finishing touches to a t.v. aerial (on a separate tower) which was to go into service a few days later. It (continued on page 114)

## Let's Get Started 27:

# TIMEBASES

by A. P. BLACKBURN

IN LAST MONTH'S ARTICLE ON THE CATHODE ray tube, we arrived at the decision that a saw-tooth waveform was necessary to sweep the tube. It was mentioned that circuits which do produce this waveform are called "timebases."

Indeed, when we begin to consider circuits of this type, we leave ordinary radio circuit practice, and enter a vast field of electronic circuitry. The use of oscilloscopes in an ever-increasing range of applications has brought timebase techniques to a relatively high standard of precision. Typical uses of the oscilloscope, outside radio and electronic work, are in nuclear physics, medical research, automobile and aircraft engine testing, and a host of others.

In view of the work that has gone into timebases, and the number of types that have been developed, we can only hope to examine a few of the commoner types here.

### The Neon

Just to keep in mind what we want ideally from our circuit, Fig. 1 has been included. The basis of most timebase circuits is to charge a capacitor through a resistor. Then when the capacitor has charged to some predetermined level, an automatically operated switch discharges it. Such a circuit is shown in Fig. 2a. Its operation is very simple.

In a previous article\* it was shown that if a battery were suddenly connected to a series resistance and capacitor, the voltage across the capacitor would rise slowly. If the switch S in Fig. 2a were depressed, the voltage across the capacitor would slowly rise. Fig. 2b shows a graph of this. The switch is closed at A and the capacitor charges until it reaches B. The capacitor is actually charging up to 120V, which is the battery voltage as shown by the dotted line.

Up to the point B, the neon has had insufficient voltage across it to "strike" it, and therefore no current passes through it and it appears to be an open circuit. However, when the voltage across the

capacitor reaches 80V the neon will strike and will, therefore, act as a low resistance. This will discharge the capacitor and the voltage across it will drop to C in Fig. 2b. At this point the voltage across the neon will be insufficient to keep it struck, and the glow discharge will be extinguished. As the neon is again open circuit the capacitor will begin to recharge toward D. The process will, therefore, repeat itself indefinitely, or, in other words, it will oscillate.

It is interesting to compare the waveform in Fig. 2b with Fig. 1.

Ignoring the part of 2b between points A and B, because that is only the switching-on condition, we can see that there are two distinct differences between Figs. 2b and 1. The first is that the forward stroke, (i.e., that part C to D on Fig. 2b and A to B on Fig. 1) is not straight in 2b. You may remember that linearity, as it is called, is necessary so that the spot is driven across

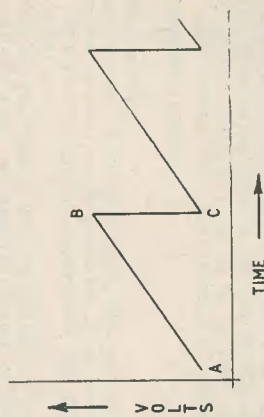

the c.r.t. at the same speed all the way across. In Fig. 1 this would be so, but in Fig. 2b, the non-linearity is considerable. The second comparison is that in Fig. 1 the voltage between B and C changes very quickly. This period is called the "fly-back." In Fig. 2b, however, the fly-back (B to C, D to E, etc.) occurs quite slowly. This brings us to an interesting point.

\* Phase Shift—A. Blackburn, *The Radio Constructor*, November 1954

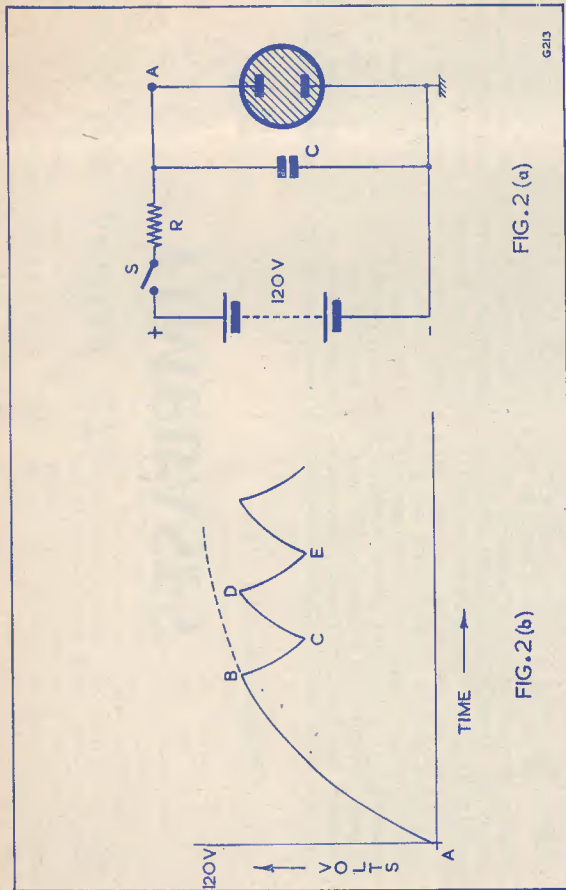

The spot has travelled across the screen from left to right, say, under the influence of the voltage waveform depicted in Fig. 1. When the voltage reaches point B, the spot will be at the right-hand side of the tube. From B to C, however, it will be returned very rapidly to the left-hand side. Ideally, this fly-back should be so rapid that it would not be seen. Fig. 2b is not, however, any where near ideal because the fly-back is relatively slow, so that the return of the spot would probably be slow enough to be visible.

The two points of comparison are the indications of the disadvantages of the neon type circuit. There is another that we shall mention later.

#### Constant Current

Non-linearity may be overcome by using a pentode valve in place of R in Fig. 2a. The pentode has a very interesting anode characteristic. Considerable changes in anode voltage (grid 1 and screen voltages constant) produce little change in the current flowing through the valve. The new circuit would look something like Fig. 3a. In this case, the capacitor will charge until the neon strikes, when it will return to its original condition, as in Fig. 2. However, the capacitor will charge through the pentode  $V_1$ . As it charges, the anode voltage of  $V_1$  will drop, but the charging current through the valve will remain comparatively constant. The waveform shown in Fig. 3b will result. This is an inverted version of Fig. 1,

linearity is not important, and the highest frequency required is 20-30kc/s. The types using a simple neon are not easy to synchronise to the applied signal and therefore find only a limited use.

#### The Miller Timebase

This type of timebase is one of the commonest in use to-day. It has good linearity, a high top frequency limit, but a poor fly-back time.

A basic form of the Miller circuit is shown in Fig. 4a. The suppressor grid is held at a negative potential which cuts off the current in the valve. If the suppressor were caused to rise to cathode potential, current would flow and the anode voltage would drop. This drop would be transferred to the control grid via the capacitor C. If the control grid were cut off by this voltage, the current would cease in the valve, and the anode would rise. The grid, therefore, drops to a negative potential just short of cut-off and current will flow in the valve.

From this point onward, one way of describing the action is to consider the "Miller effect." This states that the capacity between anode and grid 1 is multiplied by the gain of the valve and appears as an imaginary capacitor between cathode and grid. The dotted capacitor  $C'$  therefore

has a value of approximately  $A \times C$  where A is the gain of the valve. Now the grid leak R is returned to a positive potential, so C' begins to charge toward that potential. The anode, therefore, falls in potential because of the positive "movement" of the grid. The capacitor C' will be charging non-linearly, but the change in voltage across it will be quite small, say four or five volts. The anode, however, will fall perhaps 200V. Such a tiny portion of the total charging excursion of C' is actually used, however, that it is almost perfectly linear, and the anode waveform will therefore be linear also. Fig. 4c shows the grid excursion considerably enlarged to show the comparative linearity of the charging curve used. When the voltage has fallen to a very low value, the valve will "bottom." This means that the anode voltage has fallen to a value where the grid no longer has any control over the anode voltage.

The "run-down," as the anode voltage excursion is called, will cease and the grid will return to its normal potential, i.e., approximately at ground. If, as the instant of bottoming occurs, we cause the suppressor grid to be cut off again, the anode voltage will return to the h.t. voltage. Note that during the run-down, the real capacitor C has been discharging, and upon cessation

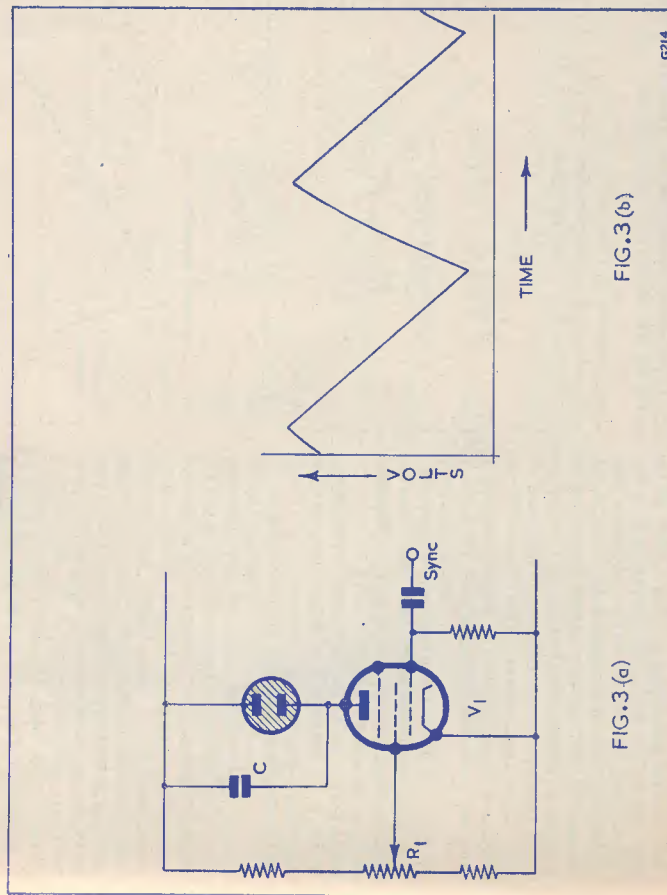

Normally, the load resistor  $R_1$  is large so that a high gain is obtained from the valve, and  $R$ , the charging resistor, is also large in order to avoid excessive grid current. The rate at which the anode runs down is given by:

$$\frac{V}{CR} \text{ volts/sec.}$$

where  $V$  is the potential to which the grid leak  $R$  is returned;  $C$  and  $R$  are as indicated on the circuit.

As an example, if the grid leak were returned to +250V,  $C$  were 0.01 $\mu$ F and  $R$  1M $\Omega$ , the rate of the run-down would be:

$$\frac{250}{0.01 \times 1} = 25 \text{ kV/sec.}$$

If the total anode excursion were 200V, then the time taken to run down would be:

$$t = \frac{200}{25,000} = 0.008 \text{ secs.}$$

#### Fly-back Suppression

The fly-back time will be long because, as already mentioned, the anode load  $R_1$  must be large to obtain high gain from the valve, but  $C$  recharges through it, ready for the next run-down. In order to overcome this difficulty, it can be arranged to switch off the current in the c.r.t. during the fly-back period.

In Fig. 4b the suppressor waveform is shown. This takes the form of a "square wave," that is, a sudden change from one constant voltage to another. Now if this waveform were applied to the grid of the c.r.t., it would drive it positive during the run-down and current would flow. The spot on the c.r.t. screen would, therefore, be visible. When the fly-back occurred, however, the grid would be driven negative, the current in the tube cut-off, and the spot would disappear during fly-back.

At this point, it is worth mentioning that there are two modes of timebase operation. When the circuit is operating in a freely-oscillating condition and producing a waveform as in Figs. 1 or 2, it is said to be "free-running." This is suitable for observing sine waves or any waveform where the part to be observed is comparable in duration with one complete cycle.

In some applications, however, one may wish to examine a short pulse of perhaps 1 microsecond, which only occurs every tenth of a second. The timebase would have to run at 10c/s if it were free-running, in order to observe the pulse steadily on the screen. However, if the pulse only lasts 1 microsecond and the spot moves across the tube in one-tenth of a second, the pulse will be too short to be seen. Fig. 5a illustrates this.

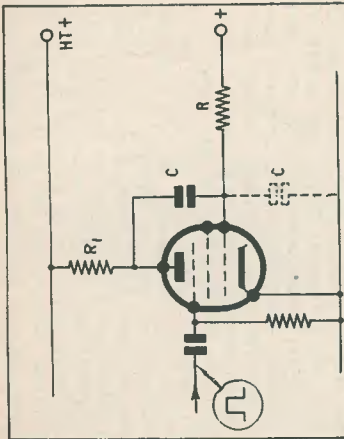

FIG. 4(a)

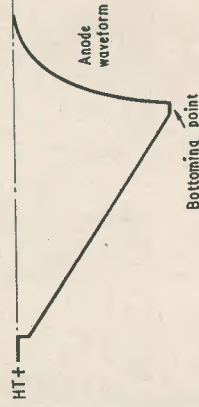
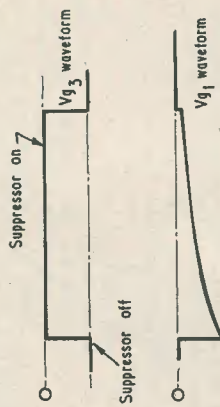

FIG. 4(b)

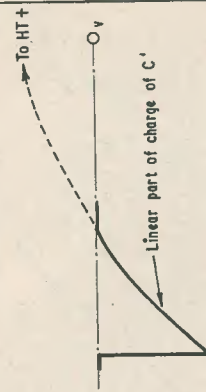

FIG. 4(c)

of the run-down it will recharge toward h.t.+, through the anode load resistor  $R$ .

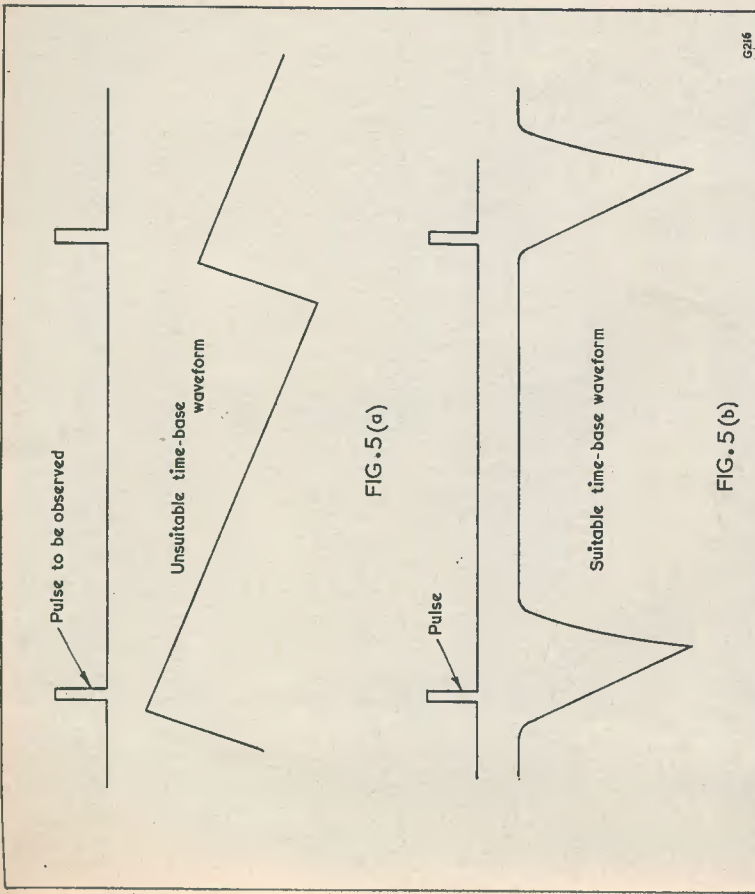

FIG. 5(a)

FIG. 5(b)

In order to overcome this effect, a timebase may be used in the "triggered" or "single stroke" mode. Here the timebase is started on receipt of a "trigger" which may be the pulse to be observed. The timebase will produce one sweep, fly back and then rest until the next pulse occurs. This mode of operation can be very useful for television work, where complex waveforms have to be examined, some of which are short compared to the time in which they occur.

Fig. 5b shows a typical short pulse and the timebase waveform required to enable complete examination of it.

This digression on the modes of timebase

operation does not, however, explain where the square wave comes from in Fig. 4a. There are many ways of generating square waves, but for the Miller timebase a frequently used one is the "transitron," which may use the same valve as the timebase itself. The combination of Miller and transitron produce a timebase oscillator with linear sweep for the tube, automatic fly-back suppression and quite good synchronising characteristics. The transitron may also be used as an ordinary oscillator, a frequency divider, or even a t.v. sync separator.

It is, in fact, such a useful circuit it would be worth a closer look next month.

## THE "FULL-TONE" AMPLIFIER

We understand that some readers have had difficulty in obtaining the output transformer specified for the Full-Tone Amplifier. A suitable alternative transformer is the "Winrad" type OPT7, and this is available from Messrs. Home Radio of Mitcham at 17s. 6d. This alternative transformer functions as efficiently as that originally specified, but the mounting holes differ slightly.

# NOTES ON RADIO CONTROL

## 10: An Auto-switch for the Transmitter

by QUENCH COIL

**M**OST READERS OF THESE NOTES WHO have done much practical work will be very familiar with the awkwardness of having to get an assistant to switch the transmitter off and on whilst testing, or tuning up the receiving equipment some distance from the transmitter, and the even more annoying procedure of often having to shout directions "On" — "Off" — "On" — "Off" numerous times, over considerable distances. Quite obviously some automatic means of doing this would prove a great boon to the radio-controlled-model maker. The writer felt that the construction of an automatic

It is quite a simple matter to design and construct a rough-and-ready mechanism to do this switching for one, but it is worth while building the unit up nicely and incorporating one or two switching devices which will add convenience to the operation of the transmitter.

Fig. 1 shows one such unit recently built by the writer and Fig. 2 shows the "works." Two such mechanisms are illustrated in Fig. 2, that on the right being the one incorporated in the completed unit shown in Fig. 1. Fig. 3 shows the wiring diagram and general layout of the parts.

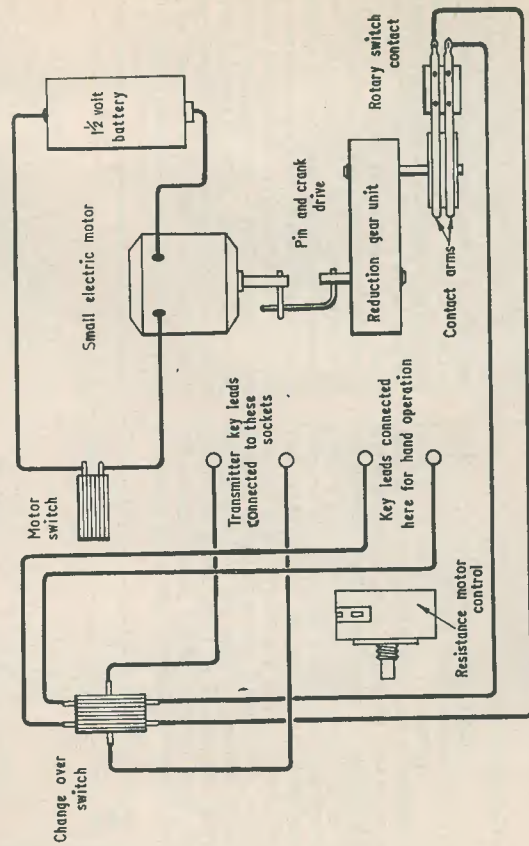

If the resistance is fitted, connect in battery supply. It should be of a type with an off position or a separate switch will be required

6203

FIG. 3.

switch to do this would be very well worth while. In designing it he felt that one feature must be that the time intervals of "Signal On" and "Signal Off" should be adjustable.

Fig. 1. Auto switch in its cabinet; note the clean lines

Fig. 2. Two types of auto transmitter switch; that on the right is fitted with a speed control

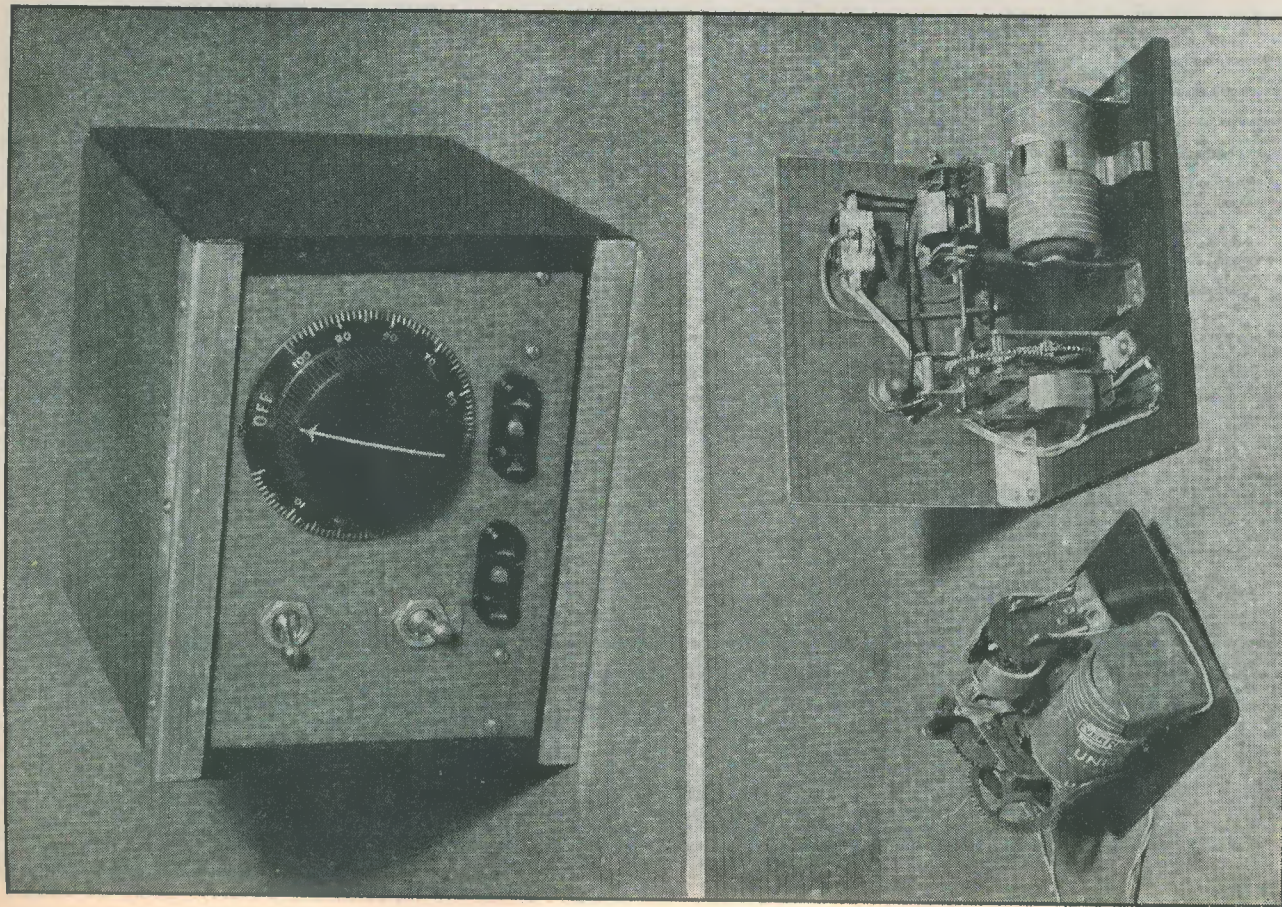



high speed miniature motors is used. These motors run quite well off flash lamp batteries and, provided the gear train runs freely, they will provide ample power.

Obtaining a suitable gear train may prove something of a difficulty, however. The writer used a set of gearing from an old gas meter indicator unit. Another possible source is from a child's clockwork train mechanism, and similarly, an old alarm clock may be located in one's own or a friend's junk box and pressed into service. Coupling between the motor and the gearing can be made via a pin and crank drive.

The rotary switch can be made up from a circular piece of wood cut from the end of a broom handle. Drill a hole squarely in the

centre small enough to allow the disc of wood to be forced on to the gearing spindle from which the drive is to be taken. Cut a shallow slot across the face of the disc and force a piece of brass strip into it, bend it round half the circumference of the disc and fix the other end similarly. Arrange two arms of spring brass strip as shown to make contact with the brass contact on the wooden disc. This will make up into a perfectly satisfactory rotary switch. Speed variation is obtained by wiring a variable resistance suitable for the motor in series with it and the battery.

In the writer's unit, a two-way double-pole switch is wired up as shown in Fig. 3, so that a rapid change-over can be made from auto switch to manual as required.

### THE "METEOR"—continued from page 94

Remembering that these holes must also coincide with the chassis front wall, carefully hold these together in the position they normally occupy when bolted together and use these holes as markers for the chassis wall. Alternatively, take the chassis wall measurements direct from Fig. 2. Having drilled both the panel and the chassis wall, these holes must now be enlarged sufficiently to take the various condensers and the potentiometer. This may be done either with a file, in which case it is apt to be rather laborious, or, better still, with a  $\frac{1}{8}$ " bit fitted into a carpenter's brace—if one is available. The hole edges are then cleaned off with a small file. The chassis backstop should next be similarly treated as shown in Fig. 2. Finally, the chassis deck itself should be marked as previously described, punched and drilled and the chassis cutter brought into operation.

Drilling etc., completed, we now proceed with bolting and fixing the various components into position. Commence with the valve and coil holders. A careful study of the photographs will reveal the manner in which this is done. Looking towards the rear of the chassis, i.e., from the front panel, the coil holder should be so placed that the white spot (not seen in the photograph), is at the left rear. Mark the fixing holes, drill and bolt into position. Valveholder number one should be so placed that the spigot guideway is at the right rear. Valve number two guideway is positioned at the left front. When bolting these two into position, two earthing tags (one for each valve), should be fixed into place on the bolt, and under the nut, nearest the coil holder. Thus, each valve has its own earthing point; for  $V_1$ —nearest the coil; and for  $V_2$ —nearest the valve  $V_1$ .

# END-ON CHASSIS CONSTRUCTION

by F. C. WARREN

THIS ARTICLE DESCRIBES A TYPE OF CHASSIS construction and component layout which possesses several novel features, and which can be used with advantage in certain applications.

Probably, in nine cases out of ten, a piece of electronic apparatus, whether it be receiver, amplifier test gear or some other equipment, is built on the conventional type of chassis consisting of a horizontal platform provided with two or more sides which support the platform and enclose a space beneath it in which many of the components and much of the wiring can be accommodated. In the majority of the remaining cases, either the components are secured directly to the inside walls of a casing, and no chassis, as such, is employed; or alternatively a chassis in the form of a vertical metal plate is used. In the latter arrangement components can be mounted on both sides of the plate, which is often convenient, but it suffers from the disadvantage that valves usually have to be mounted in a horizontal position, which position is not suitable for all types of valves and furthermore is actually detrimental to many valves unless they are carefully oriented about the horizontal axis, in accordance with the makers' instructions. However, a "vertical" arrangement in which the apparatus as a whole forms a "vertical block," can prove more suitable in some cases.

For example, it is sometimes desired to fit a receiver or amplifier into a deep but narrow space in an existing cabinet—perhaps when an old radiogram is being rebuilt and modernised, or where it is desired to build a record player into a piece of furniture. Sometimes also, a particular piece of test equipment has to be housed in a narrow space in a transmitter layout or in a mobile equipment, and it is in such applications that the "end-on" construction finds favour.

A further attractive feature, from the amateur constructors point of view, is that the "end-on" chassis construction to be described can easily be made from a standard aluminium or steel chassis, and it can be easily made with only a few simple tools.

A general perspective view of an "end-on" chassis is given in Fig. 1. Basically, this consists of a conventional aluminium or steel chassis in which a three-sided cut has been made in what is normally the top of the chassis (but which now forms one side) and the piece of metal bounded by the cut has been bent outwardly to form a platform. This platform is generally used for supporting the valves of the apparatus built on the chassis which itself rests on a base formed by what is normally one of its sides.

The platform can easily be cut out with the aid of a padsaw, or one of the thin round blades which can be fitted in a hacksaw frame; a hole being drilled at one end of the line marking the path to be cut to obtain a start for the blade similar to the generally well-known method employed in fretwork.

The size of the platform will depend upon the type and number of valves which it is to support, and more about sizes will be said later on. The lines marking where to cut with the saw are best made with the aid of a scriber. After the cuts have been made the platform is bent up at right angles to the surrounding metal. The easiest way to do this is to start the bend by hand, by pushing the platform outwardly, and then continuing to bend it out by light blows with a hammer. The final bending should be done over a right-angled corner, such as the edge of a bench or table as shown in Fig. 2, so that a nice square angle can be obtained between the platform and the surrounding metal by tapping the metal with a hammer to conform to the edge of the bench or table.

After the platform has been bent up at right angles to the surface of the chassis, its sawn edges and those of the aperture which it occupied should be smoothed-off with a file. In order to support the platform and make a rigid structure, angle brackets are secured at each end between the platform and the chassis proper. These are cut from strip metal, or any scrap sheet metal available, and can be easily bent in a vice. They are fastened in position by means of nuts and bolts passed through appropriate holes drilled in the ends of the angle brackets

and in the chassis. A sketch of a completed bracket is shown in Fig. 3.

Fig. 1 gives certain measurements for an "end-on" chassis made from a 9in. x 12in. aluminum chassis with 2½in. deep sides, which is amply large enough for building a 5-valve receiver or amplifier, and can easily be housed in a space some 4½in. wide by 10in. deep x 13in. long. The measurements given for the platform and its relative position on the chassis are convenient where international octal base valves of the American type "GT" series are employed, but the size and positioning of the platform will depend on the number and type of valves to be employed and on the other components of the apparatus.

As can be seen from Fig. 4, a horizontal shelf is arranged inside the chassis extending between the two ends and at a level which is substantially that of the bottom of the aperture where the platform has been bent-up. The shelf is cut from a piece of sheet metal and is provided with side flanges bent down at each end by means of which it is bolted to the sides of the chassis. This shelf serves to divide the interior of the chassis into two compartments, namely an upper and a lower compartment; the latter being conveniently employed to house the power unit components, in which case the shelf forms a useful screen in addition to supporting the components.

One or more brackets also formed from

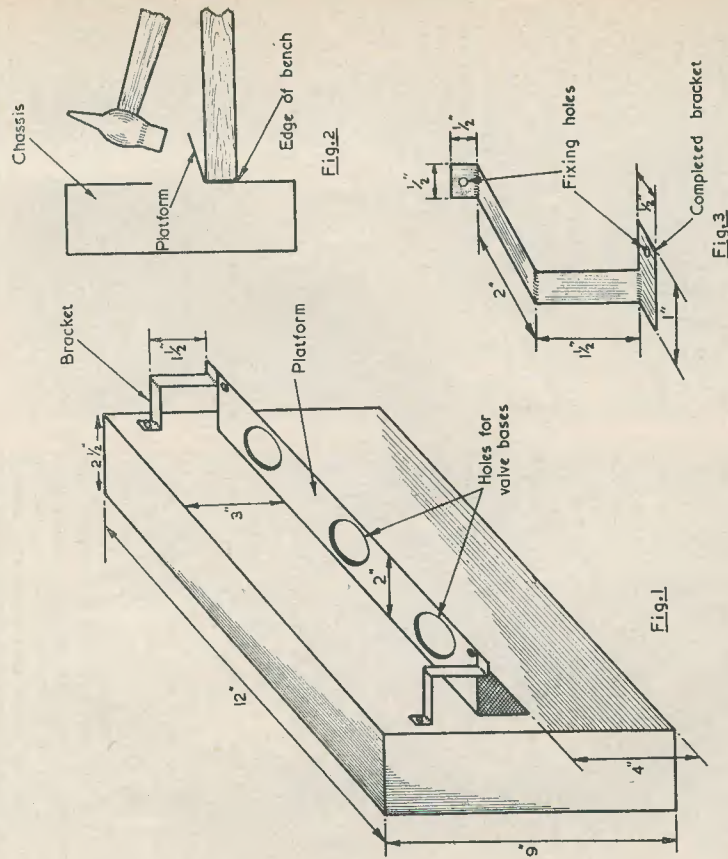

E200

Fig. 4 shows a rear elevational view of the chassis, illustrating further stages in construction and showing some components mounted in position. It will be appreciated that the components are shown only to give an impression of the type of layout which may be employed, and are not intended to represent a particular piece of equipment.

One advantage of the "end-on" construction is that it affords a wide variety of possible positions for locating controls, which can conveniently extend in any of the three planes of the chassis.

Fig. 5 is a vertical section through an "end-on" chassis giving another view of the relative positions of the components.

Having got so far, suitable layouts of components will be discussed. Generally

rectifier, if desired, mounted below the shelf in the lower compartment.

3. Controls mounted on the top or ends of the chassis or on brackets in the upper compartment.

Having disposed of the major components, the smaller condensers, resistors and the like can be mounted on tag panels secured to convenient points on the chassis or platform, or in the wiring below the platform and

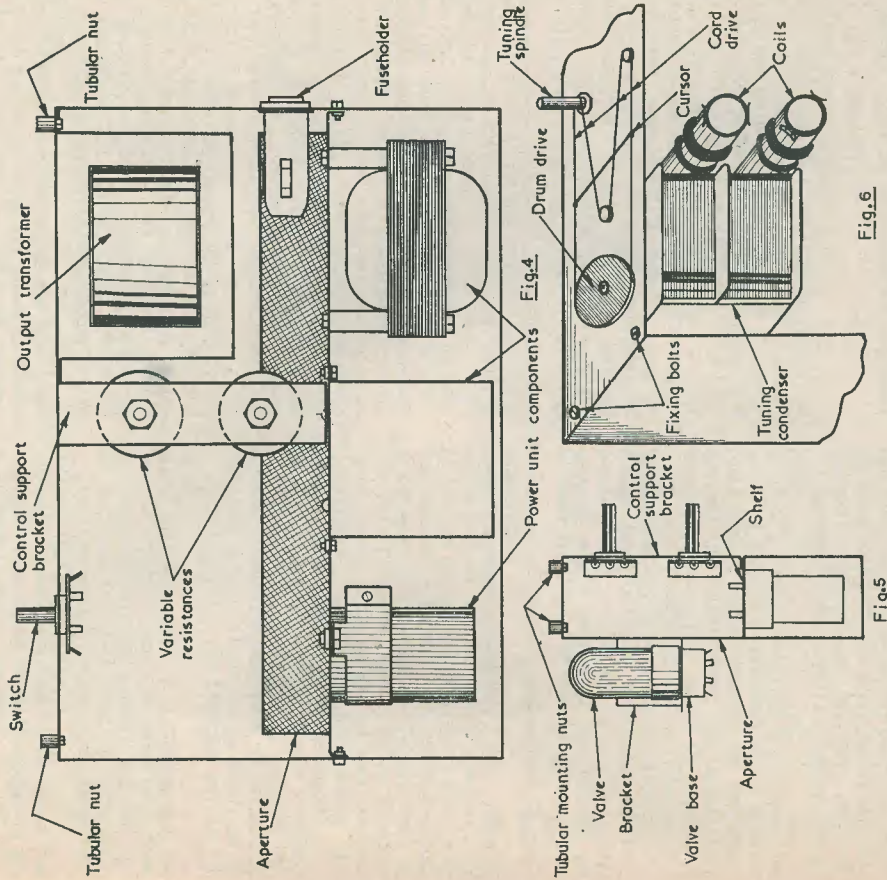

E201

speaking, the following disposition of the major parts will prove most suitable.

1. Valveholders mounted on the platform.

2. Power pack components—including

adjacent the valveholders. The h.t. leads will extend through the shelf or along its upper surface and will be convenient for feeding through the aperture to the valves and

associated components mounted on the platform. Decoupling condensers can be mounted in clips on the upper side of the shelf.

The upper compartment can also house components such as coils, and tuning condensers in the case of a receiver, as well as intervalve and output transformers, which are bolted to the chassis and spaced so as to be near their associated valves.

Fig. 6 is a perspective view of a suggested mounting arrangement for a tuning condenser together with its associated cord drive for a horizontal cursor intended to move over an oblong dial. Tuning coils can also be seen mounted inside the upper compartment, and these are bolted to the side of the chassis.

The next point to be considered is the mounting of the chassis inside the casing or cabinet. In some instances this can be simply accomplished by securing flanges along the bottom edges of the ends of the chassis, which are drilled to take screws, by which the chassis may be secured to the casing or cabinet.

Another convenient arrangement for mounting the chassis, particularly where control spindles extend through the top surface, is shown in Figs. 4 and 5. This comprises tubular nuts mounted at each corner of the chassis, which is intended to be suspended beneath a horizontal control panel by means of bolts passing downwards into the threaded bore of the tubular nuts; the control spindles also extending through apertures in the panel.

In case some readers are not familiar with the tubular nut, this consists of a short

**RADIO MISCELLANY—contd. from p. 102**

was at this odd moment that one of the amateurs (who spoke only QSO English) asked me why all the British amateurs he contacted were using a pair of 807's in parallel in the P.A. Apparently it seemed a shocking waste to him, when one can get so much more out of them in push-pull. I managed to make him understand that when one in three Styrian families looked-in to the signals from this very aerial, it would be a safe bet that he himself would be using 807's in parallel.

**TV On a Shoe-String**

On my return an acquaintance welcomed me more cordially than I would have expected. "I am glad you are back," he admitted, "there's something I want to ask you." (It is quite time I started to charge a consultation fee. After all, it is not fair to undercut Query Corner, and the clients never want anything to do with you until they are in trouble!)

metal tube tapped at both ends to take a bolt. Thus the nut can be bolted to a chassis by means of a bolt at one end and at the same time serve as a threaded metal socket to receive a fastening bolt at its other end for fastening the chassis in position. If these nuts cannot readily be bought, they can easily be made by tapping duralumin or brass tube of the appropriate bore to take the desired size of bolt. A 4BA bolt is a convenient size, as the overall outside diameter of the tube is then about 1/4 inch. The nuts may be made about 3/8 inch overall length, so that they will comfortably accommodate an inch of threaded bolt in each end.

Various modifications are possible to the "end-on" chassis both as to its shape and method of construction.

For example, the ends of the chassis may be omitted, in which case bracing struts may extend vertically between the top and bottom adjacent their free edges, and these struts may also serve as a support for the shelf.

Also, if desired, the platform can be cut right out from the chassis and bolted on by means of angle brackets along the upper edge of the aperture. This avoids bending and may be easier to do, though it is a slightly more lengthy method of construction.

Doubtless, individual constructors will think up all sorts of further modifications and variations which automatically spring to mind when designing a particular piece of equipment. The aim of this article has been to give the broad idea of this very useful and novel type of chassis layout, together with some practical examples and working instructions.

Apparently he had bought an old t.v. receiver which had been out of use for several years on account of a c.r.t. breakdown. He bought it cheap and managed to scrounge a tube with a scorch mark.

To his delight it worked perfectly—except for one thing. When he adjusted it so that the picture filled the picture area there was a certain amount of distortion. Would I look at it. Softened up by a bit of flattery, I weakly promised I would—some time.

Fortunately my brain (?) dulled by the holiday recovered by the next morning. As soon as I began to think the answer was obvious. As it was an old set it obviously had the old aspect ratio. He was trying to fit a four-by-three transmission into it! Now he's looking round for a cheap mask (current pattern).

P.S.—It seems to have cost him next to nothing so far. I'll bet he feels it would be a shame to have to pay out good money for a licence!

Compiled by E. G. BULLLEY

**PART 2**

**VIBRATOR DATA**

4258-12	ATR				4415-12	ATR				340	Turner				8542	Delco			
4258-32	4306-24				4415	4415				340	Turner				5043025	Delco			
4306-12	4313				4415	4415				340	Turner				866	Mallory			
4314	4314				4415	4415				340	Turner				866	Mallory			
4318	4318				4415	4415				340	Turner				866	Mallory			
4319	4319				4415	4415				340	Turner				866	Mallory			
4320	4320				4415	4415				340	Turner				866	Mallory			
4322	4322				4415	4415				340	Turner				866	Mallory			
4402	4402				4415	4415				340	Turner				866	Mallory			
4403	4403				4415	4415				340	Turner				866	Mallory			
4404	4404				4415	4415				340	Turner				866	Mallory			
4415	4415				4415	4415				340	Turner				866	Mallory			
4415-12	4415-12				4415	4415				340	Turner				866	Mallory			
4416	4416				4415	4415				340	Turner				866	Mallory			
4417	4417				4415	4415				340	Turner				866	Mallory			
4501	4501				4415	4415				340	Turner				866	Mallory			
4502	4502				4415	4415				340	Turner				866	Mallory			
4504	4504				4415	4415				340	Turner				866	Mallory			
4505	4505				4415	4415				340	Turner				866	Mallory			
4507	4507				4415	4415				340	Turner				866	Mallory			
4608	4608				4415	4415				340	Turner				866	Mallory			
4610	4610				4415	4415				340	Turner				866	Mallory			
4611	4611				4415	4415				340	Turner				866	Mallory			
4613	4613				4415	4415				340	Turner				866	Mallory			
4614	4614				4415	4415				340	Turner				866	Mallory			
5300-12	5300-12				4415	4415				340	Turner				866	Mallory			
5301	5301				4415	4415				340	Turner				866	Mallory			
5303	5303				4415	4415				340	Turner				866	Mallory			



# CLYNE RADIO LTD.

18 TOTTENHAM COURT RD LONDON W1  
 MUSEUM 5929/0095  
 (50 yards only from Tottenham Court Road Tube)

All Post orders please to—  
 24-26 HAMPSTEAD ROAD  
 LONDON NW1  
 EUSTON 5533/4/5  
 Monday-Friday 9-6 pm  
 Saturday 9-1 pm

A working T.V. receiver with this cover attached may be seen at our shop premises at 18 Tottenham Court Road.

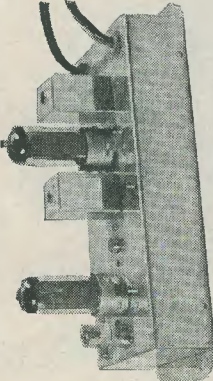

**AERIALS, etc.** We carry what is probably London's largest selection of Band III T.V. aerials. Price range from 7/6 upwards. Also filter boxes, and the very latest Aerolite Aerial (air-spaced co-ax) especially manufactured for Band III—Price 9d. per yard only plus p. & p. If unable to call your written enquiry will receive our usual prompt attention.

**POWER SUPPLY.** Should the receiver itself be unable to provide the necessary power we shall be pleased to supply a complete kit for a power pack at the special inclusive price of 22/6 only plus 1/6 p. & p. This includes our own wiring diagram, or alternatively, separate items as under.

Drilled Chassis: Input: 230V, Output: 200V	3	0
Transformer: 30mA, 6.3V at 5A	8	6
Miniature Contact Cooled Rectifier, 250V at 50A	7	6
Electrolytic 32-4-32mid 275V	3	6
5Watt Cement-coated Resistor	1	3
Tag Strip	...	...
Wiring Wire	...	...
Nuts and Screws	...	...
	<b>£1</b>	<b>4 11</b>

We can supply this power unit ready assembled and tested at 30/- plus 1/6 p. & p.

**MAINS TRANSFORMER BARGAINS!** Limited quantities. Manufacturers' Surplus 350-0-350, 80mA, 6.3V 3A., 5V 2A., Half shrouded, drop-through, 14/6 only, plus 1/6 p. & p. 110/210/240V Input, 250-0-250 120mA, 6.3V 4A., 5V 2A. Upright mounting, 21/- plus 2/- p. & p. 230V Input, 300-0-300 80mA, 6.3V 3A., 4V 2A. Tropicalised drop-through type, 9/6 only, plus 1/6 p. & p. Input 110/230V Auto load 230V 750mA, 350-0-350 130mA. Tapped filament winding 6V 3A., 15V 3A., 21.5V .6A, also 5V 2A. Tropicalised drop-through type, 21/- plus 2/6 p. & p. 270-0-270, 100mA, 6.3V 3A., 5V 2A, 200/250V Input universal mounting 16/6 plus 1/6 p. & p.

London's most comprehensive Component stocks, all under the same roof! Our fully-competent technical staff is at your service. Why not pay us a visit?

The chassis illustrated and described in this issue was designed and constructed by our Technical Staff. All items supplied and listed below are exactly to specification described herein.

### INDIVIDUAL COMPONENT LIST

Drilled chassis size 7" x 3" x 1 1/4"	3	9
Complete with bottom plate	15	0
Coil set and wiring diagram complete (Teletron)	1	0
2 Valves, type EF80. Brand new	1	9
Tax Paid at 10/6 each	6	0
7 1/2 watt resistors at 3d. each	1	6
1 1/2 watt Resistor	2	2
8 Ceramic Capacitors at 9d. each	1	6
2.2-8pf Phillips Trimmers at 9d. each	1	6
3 power Leads (each 2ft.)	1	6
1yd Wiring flex	1	6
Hardware bag (Nuts, Bolts, Tags)	1	6
Solder	1	4
Co-axial Socket	1	6
2 Amphphenol B9A V/holders at 9d. each	1	6
2ft. Co-axial Cable	1	6
	<b>£2</b>	<b>15 2</b>

We shall however, be pleased to supply the complete kit as itemised above at the special inclusive price of 48/6 plus 2/- p. & p.

If required we can supply this unit ready assembled and tested at 67/6 plus 2/- p. & p.

### VALVES

We have perhaps the most up-to-date valve stocks in the trade. A stamp will bring complete list but the following is a selection only of brand new imported valve types, fully guaranteed. Purchase Tax Paid.

EABC80	10/-	EL41	10/6	PY81	10/-
EB41	7/6	EL84	11/6	PY82	9/6
EB91	10/6	EM80	9/-	PY83	11/6
EBC41	10/6	EY51	11/-	UBC41	10/6
ECC81	9/6	(large)	11/-	UF41	10/6
ECC82	9/6	(small)	12/6	UL41	10/6
ECC83	9/6	EZ40	8/6	UY41	9/-
ECC84	10/6	EZ80	8/6	6AQ5	8/6
ECH42	11/6	PCF82	12/6	6AT6	8/6
ECH81	11/6	PCC84	12/6	6AU6	9/6
ECL80	10/6	PL81	13/6	6BE6	9/6
EF41	10/6	PL82	10/6	6BX6	8/6
EF85	10/6	PL83	11/6	6CX4	7/6
EF89	10/6	PY80	10/6	etc.	etc.

## Quality Equipment Designers Ltd. LONDON, N.4. Phone: STA. 3712

### BAND III CONVERTER KIT

We can supply a complete kit of parts including valves, ready-wound Teletron coils, drilled chassis, connecting wire, nuts and bolts. This kit is suitable for TRF or Superhet receivers. Price complete with wiring instructions **£2.15.0** plus 1/6 post/pkg.

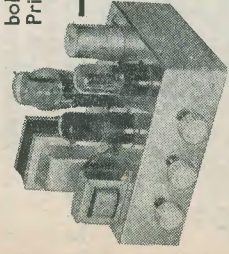

**THE 'ROFTON' FOUR — A HIGH QUALITY AMPLIFIER**  
 ★ Separate Treble ★ Separate Volume ★ Fully shrouded Mains Trans ★ Output 4 watts ★ Engraved Control Knob (Vory or Walnut) ★ Negative feedback ★ LS PU pliers and screen lead PU provided. L.U. 6SL7, 6V6, 5Z4, Mains 200/250V A.C. Can be supplied in KIT FORM at £4 15 0 plus 2/6 pkg. Instructional book, theoretical circuit, chassis layout, etc., 1/-.  
 Completely built and tested **£5. 12. 6** Plus 2/6 pkg., etc.

**BALL BEARING SLIDERS** Designed to give smooth silent movement with complete rigidity in any position. Cadmium plated steel captive ball carriage with brass spring. Suitable for extending radiogram motor boards, tape decks, cabinet drawers, etc. Length 1 1/2", runner extends 9/4" 10/- pair. Post free

**MAINS NOISE SUPPRESSOR UNIT** A simple and effective method of cutting out all mains noises. The kit consists of 2 specially designed chokes together with 3 condensers. The unit can be assembled in existing receivers or separately if so desired. **4/11 COMPLETE WITH CIRCUIT DIAGRAM (Plus 6d. post, etc.)**

**LIGHTWEIGHT UNIVERSAL MAGNETIC PICK-UPS** complete with rest and instructions, 27/6, plus 1/- postage and packing. Suitable for all makes of gram. units.

**TERMS:** Cash with order or C.O.D. All orders for small items totalling over £2 post free unless otherwise stated. (Write to Dept. R.C.) Personal shoppers welcomed—alight at Harringay Arena. Open 9-6 Mon.-Sat. (Early closing Wed.)

## PANEL-SIGNS TRANSFERS

**Set No. 1: Receivers and Amplifiers**  
 Five sheets 8 1/2" x 5 1/2" containing one Large scale, twelve control panels and wording. 3s. 6d.

**Set No. 2: Test Instruments**  
 Five Sheets 8 1/2" x 5 1/2" containing two Medium scales, twelve control panels and wording. 3s. 6d.

**Set No. 3: Wording**  
 Wording for Receivers, Amplifiers, Transmitters, Test Equipment and other Radio Apparatus. (4 Sheets, Approx. 400 Words 2s. 6d.)

Panel-Signs Transfer Fixing Varnish 1s. per bottle

Trade Enquiries Invited

Published by  
**DATA PUBLICATIONS**  
 57 Maida Vale London W9

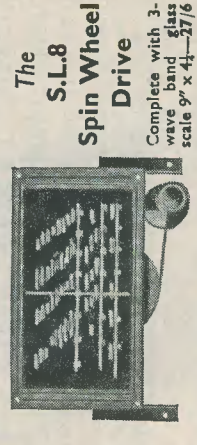

**The S.L.8 Spin Wheel Drive**  
 Complete with 3-wave band glass scale 9" x 4 1/2" 27/6

The S.L.8 Spin Wheel Drive gets easy control through a ratio 24:1. Fitted with constant velocity coupling, it eliminates strain on the Condenser, providing mechanical and electrical isolation from vibration and noise.

S.L.5, similar, but fitted with reverse vernier drive, gives ratios of 18:1 search and 50:1 reverse vernier. 26/6.

Please write for our list of Condensers and Drives

**JACKSON BROS.**  
 (London) Ltd.

KINGSWAY WADDON SURREY  
 Telephone CROYDON 2754-5  
 WALFICO, SOUPHON, LONDON  
 Telegrams

# LANES (RADIO) LTD

The Amateur's ... Paradise ...

11 GARDNER STREET · BRIGHTON · Telephone BRIGHTON 20773

**ALL LEADING MAKES OF STANDARD COMPONENTS FROM STOCK** ★ LET US QUOTE INCLUSIVE PRICE FOR YOUR FULL REQUIREMENTS

**FREE** To introduce our service to Radio Constructor readers a free copy of Denco's FM Feeder Unit booklet will be given with all orders of £1 or over.

**ALL BASIC COMPONENTS AVAILABLE—ALSO THIS FINE**

**SELECTION OF INEXPENSIVE CONSTRUCTORS TOOLS**

<b>RADIO SCREWDRIVERS 4" &amp; 6"</b>	1/- each
<b>SCREWDRIVER MAINS TESTER</b>	6/9 "
<b>UNIVERSAL TOOL SETS</b> with 3 screwdrivers, Phillips tools, etc.	12/- "
<b>BOX SPANNER TOOL SETS</b>	25/- "
2, 4, 6, BA & 3 sizes Screwdrivers	1/3 "
1 1/2" Square	1/3 "
3" and 3 1/2" .. 11/6	KEY 10d.
3" .. 12/6	10d.
1 1/2" .. 14/9	1/3
1 1/4" .. 16/6	1/3
1 1/2" .. 18/6	1/3
1" Square .. 23/-	1/3

<b>BIB WIRE STRIPPERS 3/6</b> each	<b>15/9</b> "
<b>TEST PRODS.</b> Bulgin. Red & Black	<b>5/-</b> "
<b>Radio Point NOSE PLIERS</b> and Wire Benders	<b>2/9</b> "
	<b>7/6</b> "

**HENLEYS SOLDERING IRONS**

25 watt .. 19/8  
65 .. £1.3.8  
125 .. £2.2.8  
ALL SPARES for the above on orders below £1. Over from stock. £1 POST FREE.

**ERSIN SOLDER Multicore 5 - 1/4 Pkt.**

**TERMS**—Cash with order or C.O.D. (over £1), packing add postage, and packing on orders below £1. Over £1 POST FREE.

## G2AK THIS MONTH'S BARGAINS G2AK

**Talking of TABLE TOPPERS**

The Ideal Power Transformer for the Table Top Rig. This Parmeko-made Transformer has the following conservative ratings: Primary 230V 50c Secondary 620V 550/375/10/375/10/550/620V. Rated at 275VA. It will give 620 or 550 volts at 200mA simultaneously with 375V at 250mA. All the HT you require for RF and Modulator. Also 2.5V 3A windings for suitable rectifiers such as 5R4CY, 5Z3, 83, 5U4, etc., weight 244lb. Size 6 1/2" x 6 1/2" x 5 1/2" high. Worth at least £7. Our price £3 only, ex post. C.W.O. Only. No C.O.D.

We regret that orders from EIRE or ABROAD cannot be accepted.

**METERS:** 2 1/2" Scale Flush Mounting 0-10mA, 0-30mA and 0-100mA 12/6 each. 2" Scale Square Flush 0-50mA, 0-150mA, 0-3A Thermo 0-20V d.c., and 20/0/20A d.c. 7/6 each. 2" Scale Round Flush 0-1A Thermo and 0-350mA ditto, 7/6 each. Carriage paid on all orders over £1 except where stated.

**PI CIRCUIT OUTPUT TUNING CONDENSERS.** Made by E.F. Johnson Co. U.S.A. Max. cap. 500pF 1.500V rating. Ceramic insulation size 5" long x 2 1/2" wide x 2 1/4" high excluding spindle projection. Our price only 15/- post free.

**PIRSPACED CO-AXIAL CABLE** 150 ohms (normal price 3/11 per ft.), 20-yd. coils only £1 per coil, post free.

**FOR THE New MOBILE** 12V Miniature rotary transformers. Output 360/310V, 30mA c.s. or 70mA, I.C.A.S. Only 4 1/2" x 2 1/2" overall. ONLY 17/6 each, or 30/- for 2. P. & p. 1/6.

**ABSORPTION WAVEMETERS:** 3.00 to 35.00Mc/s in 3 switched bands. 3.5, 7, 14, 21 and 28Mc/s. Ham Bands marked on scale. Complete with indicator bulb. A Must for any Ham Shack. Only 15/- each, p. and p. 1/-.

**RACK MOUNTING PANELS:** 19" x 5 1/2" 7" 8 1/2" or 10 1/2" black crackle finish. 5/9, 6/6, 7/6, 9/- respectively, postage and packing 1/6.

**PANL HOME CRACKLE.** Black, brown or green, 3/- tin, p. & p. 8d. post free.

**FISK SOLARISCOPE.** Complete with Charts, Free World Time, light and dark patches. Invaluable to the DX man. List 2/-. Our price 7/6 post free.

**COPPER WIRE:** 14G, H/D 140ft, 15/-; 70ft, 7/6, post and packing 2/-. Other lengths pro rata.

**TRANSFORMER** with voltage tapping strips. Primary 200/250V Output 275/275V, 100mA, 6.3V, 3A, 5V, 2A, 18/6 only, p. & p. 1/6.

## BAND 3 ! BAND 3 !! BAND 3 !!!

Our address may be in South Wales but that doesn't mean that we do not look after our friends in London. On the contrary, our London representative is one of the liveliest men in the Industry.

## THE TELETRON BAND 3 CONVERTER

Build this successful unit and enjoy Commercial Television now! This Converter is fully described in this month's *Radio Constructor*. We have the complete kit of coils available, together with fully-drilled chassis. So waste no time and order early for Commercial TV!

Here are our prices for these high-grade components:  
The Complete Coil Kit (Ref TBI) .. .. . 15/-  
The Chassis (complete with bottom screen) .. .. . 3/9  
Please add 10d. p.p. for coil kit, or coil kit and chassis.

## AND NOW — "THE UNIVERTER"

Ikopatents, the laboratory which gave you the Magna-View, the Super-Visor, and the Tele-King, now produce their latest masterpiece—The Univerter! This is the Band 3 Converter which has the background of a famous name with a constantly successful home-constructor television background. We have complete kits available for the Univerter, these including the instruction book. Valves are not supplied; you obtain these through the normal channels. Everything else is there.

Prices are as follows:  
The Kit, less valves and cabinet .. .. . £6 15 0  
The Kit, less valves but with beautifully-finished professional cabinet .. .. . £8 0 0  
Please add 1/6 p.p. to orders for these Kits.

## Home Constructor's Handbook

Published by RODING LABORATORIES

This famous handbook is now available in the NEW 1955 Edition. It contains 22 tested circuits, complete with descriptions, constructional details, full parts lists, etc. Also contains hints, formulae, data. Circuits include superhets, communications receiver, oscillator, signal tracer, tape recorder, amplifiers, beginner's receiver, and many more items of gear. And the book is backed by Roding Laboratories, who are so well known for their quality home constructor products. This 70-page book represents unbeatable value at 2s. 6d. (plus 3d. postage and packing). Order now and take immediate advantage of the wealth of information it affords.

## R. DAVIES 54 Newton Rd. Mumbles Swansea

MAIL ORDER ONLY—NO C.O.D.  
"The Customer and Courtesy Come First"

## "FM TUNER UNITS for FRINGE & LOCAL AREA RECEPTION"

This booklet, now in its Second Edition, includes a description of a Suitable Tuning Indicator and of The Ostram 912 High Fidelity Amplifier. 32 pages with art board cover, price 2s. 2d., post paid.

## DATA PUBLICATIONS LTD

57 MAIDA VALE · LONDON W9 Telephone CUNNINGHAM 6141 (2 lines)

## BAND III CONVERTER KIT

Complete kit of parts including valves, ready wound TELETRON coils, punched chassis, down to the last nut and bolt. Suitable T.R.F. or superhet receivers. PRICE £2 15s. 0d. Circuit details, 6d. post paid.

## FM TUNER

TELETRON BAND III COILS 15/- per set

We stock all parts for the Radio Constructor F.M. tuner including punched chassis and ready wound coils. Complete kit with valves. PRICE £6 15s. 0d. (post 1/-).

## FULL-TONE AMPLIFIER

All parts available from stock, s.a.e. for full list. We can now offer a suitable replacement for the OPT348 transformer. Type OPT7 17/6

## HOME RADIO of MITCHAM

187 LONDON ROAD MITCHAM SURREY  
Telephone MIT 3282

## GZACC offers you . . .

**ALUMINIUM PANELS**, 18 s.w.g. bright finish: 8" x 4" 1/-, 8" x 8" 1/10, 9" x 5" 1/3, 9" x 9" 2/3, 9" x 10" 2/6, 10" x 5" 1/5, 10" x 6" 1/8, 12" x 8" 2/8, 12" x 9" 3/-, 12" x 10" 3/4, 12" x 12" 4/-, 15" x 9" 3/9, 15" x 15" 6/3, 17" x 10" 4/9, 17" x 12" 5/8, 18" x 9" 4/6, 18" x 10" 5/-, 18" x 12" 6/-, 18" x 18" 9/-.

Other sizes to order. Please include sufficient for adequate packing to avoid damage in transit.

**ALUMINIUM**, 16 s.w.g.—See catalogue for prices.

**CATALOGUE No. 9.** Over 2,000 new items listed with over 100 photographic illustrations. All leading makes. Specialities—Transmitting and short wave components, TV, tape recording components and special items for the service engineer. Post free on request.

Established over 21 years

**Southern Radio and Electrical Supplies**  
SORAD WORKS  
REDLYNCH · SALISBURY  
Telephone Downton 207.

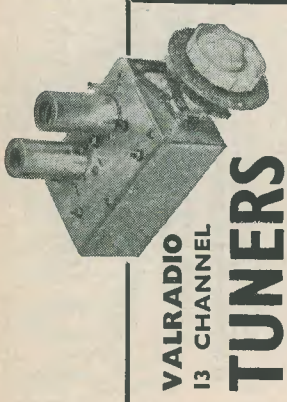

## VALRADIO 13 CHANNEL TUNERS

NOW AVAILABLE TO THE HOME TV CONSTRUCTOR

Adapt your set to receive the Commercial TV programmes. Valradio tuners are suitable for home constructed receivers including "The Wireless World," "Magnaview," "Teleking," "Premier," etc.

Complete with fitting instructions . . . £6

Bracket for fixing tuner to cabinet . . . 2/6



Valradio Limited, New Chapel Road, High Street, Feltham, Middlesex. Phone Feltham 4242 & 4837

## THE SIMPLEST WAY TO BUILD AN ALL-BAND EXCITER IS TO USE

the **Labgear** WIDE-BAND MULTIPLIER

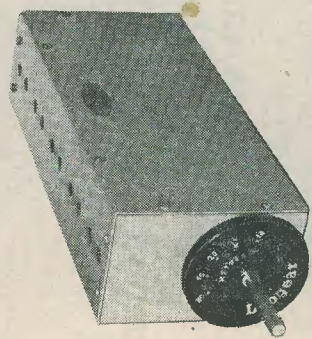

Covers 10, 15, 20, 40, 80m. at the turn of a switch.  
PRICE £5 ex-stock

Complete with circuit application information

**Labgear (Cambridge) Ltd**  
WILLOW PLACE · CAMBRIDGE · Telephone 2494-5



**Solder with LITE-SOLDER**

THE LIGHTWEIGHT CLAMPION

With the "PERMABIT" sent on request No. 58

● NO TRANSFORMER NECESSARY  
● FOR MAINS OR LOW VOLTAGES

Sole Manufacturers and Distributors  
**LIGHT SOLDERING DEVELOPMENTS LTD**  
106 GEORGE ST. CROYDON SURREY  
Telephone CROYDON 8589

NEW TESTED AND GUARANTEED	
1R5	7/6 6F8G
1S5	4/9 12K8GT
1T4	6/6 57
3V4	7/6 6K7G
504G	8/6 6K8G
5Y3GT	9/6 6L6G
5Z4G	8/6 6Q7G
6AG5	6/9 607GT
6AL5	7/6 6S37
6AT6	8/- 6SK7
6BE6	8/- 6SL7GT
6BW6	8/- 6U7G
6BD8	8/6 6V6G
6BB7	7/6 6U5G
6BA6	7/6 6X4
6BS7	8/6 6X5GT
6SA7	8/- 7H7
6F6G	8/6 12AH7
	8/6 12AX7
	8/6 12X8T
	8/6 12K8GT
	8/6 EF22
	8/6 EF36
	7/6 EF37A
	7/6 EF39
	7/6 EF80
	11/6 EF85
	11/6 EF91
	7/6 EF92
	4/6 EL32
	7/6 EY51
	12/6 EZ35
	8/- KT66
	11/6 U142
	9/6 U142
	12/6 PL81
	10/6 PL82
	8/6 U78
	11/6 UCH42
	11/6 PCC84
	11/6 UY41
	8/6 X65
	10/6 X65

Matched Pairs KT66, 25/-; 6V6G and GT, 17/- per pair. 6K8G, 6Q7G, 6V6G, 5Z4G, 6K7G, 6F6G, 34/6 per set. 1R5, 1T4, 1S5, 3V4, 27/6 per set.

**ELECTROLYTIC CONDENSERS**

Tubular Type Can Type

2/350V B.E.C. 1/3 8/500V Dubilier, 1/9

8/350V T.C.C. 1/6 8 x 8 450V B.E.C. 4/-

8/450V B.E.C. 2/- 8 x 16 450V B.E.C. 5/-

16/275V T.C.C. 2/- 16 x 16 450V B.E.C. 5/6

16/450V T.C.C. 3/3 4 x 4 x 4 450V 3/6

16/450V B.E.C. 3/- 32 x 32 450V B.E.C. 5/9

FM COILS Osamor QAFM, QJFM, 7/- each; QOOFM 7/6; QRFM 5/-; QICD (inc. 2 GEX34) 25/- each.

**Bias Condensers:** 12/50V T.C.C., 9d.; 25/25V, 1/3; 25/50V, 1/6; 50/25V, 1/6; 50/50V, 2/-; Small Mica: 25/0.005p, 6d.; .003p, 1mid, 500V Tubular, 8d.; 25-1mid, 500V, 1/-; Mica: 1,000V wkg. T.C.C., .0015, .002, .0025, .003, .004, .005, .006, .01, 1/-; Paper Block T.C.C. 2/5; 1,500V, 2/3; 2mid 100V, 1/3; 4/100V, 1/6; 2/350V, 2/6; 4/350V, 3/-; 2.5 x 2.5 x 1/400V, 3/6; Meters: 34-amp. Thermo. 0-2mA P.C. movement, 2in scale, with switch, 4/6. Potentiometers: all values, long spindle, s.p., 4/-; d.p., 4/9; less SW, 3/-; W.W. pre-set, 3W, 3/-; Resistors: 1W, 4d.; 1/2W, 6d.; 1W, 8d.; 2W, 10d.; 5W, 1/-; 10W, 1/3. Switches: midjet long spindle, 1P 12W, 2P 6W, 3P 4W, 4P 3W, 4/-; Co-axial Cable: stranded, 75 ohm, 7/7d. yard. B7G 7/7. Holders: ceramic with sng. can, 1/-; B9A, moulded, 2/-; I.O., moulded, 6d. Toggle Switches: Q.M.B., s.p., 2/-; s.p.d.t., 3/6; d.p.d.t., 4/6. O.P. Transformers: Pen. 60mA, 4/6; 45mA, 3/6; Chokes, 15h, 60mA, 4/9. Fil. Trans. 6.3V 2A, 7/6.

All goods new and guaranteed

Post 6d.

**R. COOPER**  
32 SOUTH END CROYDON SURREY  
CROYDON 9186

# What is a Silver Zinc Accumulator?



A Silver Zinc Accumulator is the smallest and lightest type of rechargeable accumulator in world-wide use. It has other advantages too — such as constant voltage and high rate of discharge — full particulars on request.



Write for Publication RC/A

**VANNER ACCUMULATORS LTD**  
KINGSTON-BY-PASS NEW MALDEN SURREY  
Telephone MALDEN 2442

Associated Cos. Vanner Limited — Vanner Electronics Ltd.

**★ "RF 26" F.M. CONVERTER UNIT—88/100 mc/s ★**  
 This well-known RF26 Unit is now adaptable for F.M. reception using 2—1.F. stages and separate local Oscillator and tuned by a Mu-Metal graduated vernier drive, and can be converted. Low cost, 92/6.  
 Send 2/— for 8-page Descriptive Booklet containing full wiring instructions, circuits and lay-out diagrams.  
**COMPONENTS OFFERED TO COMPLETE F.M. UNIT**  
 New RF26 UNIT WITH THREE VALVES—VR137, EF54, EF54. Chassis stamped out for easy conversion £15 0  
**COMPLETE SET OF ALL COMPONENTS FOR CONVERSION**, including 2-6BA6 and EB91, tuning condenser, I.F.T.'s and OSC coils, resistors and fixed condensers, plugs, wire and tag strips ... £4 12 6  
**INSTRUCTION BOOK** with technical circuit and complete lay-out diagrams ... 1 6  
**SPECIAL OFFER OF ALL ABOVE ITEMS, INCLUDING RF26 and book** ... £6 5 0  
**CHARGE FOR ALIGNMENT WHEN COMPLETED** 7 6  
**COMPLETE SET** as above and 6 valves—aligned and ready for use ... £8 10 0  
**N.B.—VOLTAGE REQUIRED:** 250V 50 M/A and 6.3V 2 amps.

**CATHODE-RAY TUBES**  
 VCR97. Guaranteed full TV picture (carr. 2/—), £2.  
 VCR517C full TV picture, £1 15s.  
 Mu-Metal Screens for above 10s.  
 VCR139A (ACR10). For TV or "scope", brand new and boxed £1 15s.  
 VCR97 Brand new, slight cut-off but suitable for "scopes". 15/—, Post and package, 2/—.  
 3PB1 Boxed, 30/—.

**R.F. UNITS** post free  
 RF24 20-30 Mc/s. ... 12/6  
 RF25 40-50 Mc/s. ... 15/—  
 RF26 50-65 Mc/s. ... 30/—  
 RF27 60-80 Mc/s. ... 35/—  
 All Brand New with Valves

**INDICATOR UNIT TYPE 1B2A**  
 Limited Quantity Available  
 Suitable for TV or Oscilloscope. "Radio Constructor" scope constructional circuit included.  
 Offered at 67/6 (plus 7/6 carr.).

**U.S.A. INDICATOR UNIT BC259A**  
 Complete with 3BP1 C/R Tube and Shield. 7 valves, 2-6SN7GT, 2-6H6 6G6, 2X2, 6X5G volume controls, etc. Black crackle case, 15 1/2" x 9" x 9". Ideal for portable scope. Brand new condition, 65/—, Carriage 5/—.

**CRYSTALS**  
 200 kc/s 2 pin U.S.A. 10/—  
 465 kc/s 2 pin U.S.A. 10/—  
 500 kc/s 2 pin British 15/—

SEND STAMPS FOR 28-PAGE CATALOGUE  
 Post Free unless otherwise stated

**WE HAVE OVER 50,000 VALVES IN STOCK AT VERY COMPETITIVE PRICES. SEND 3d. FOR 28 PAGE CATALOGUE**

**LATEST TYPES NOW IN STOCK**

EBC41	10/—	ECL80	12/6
EY51	12/—	50R5	10/6
EY41	11/—	PL81	12/6
EL41	11/—	PL82	10/—
EL40	10/—	PY81	10/—
EM34	10/—	PC82	12/6
UL41	11/—	PCC84	12/6
UY41	11/—	PCB82	12/6
UY41	11/—	50C5	10/—
UCH42	12/6	12AT7	8/—
UBC41	10/—	12AT7	9/—
DK40	10/—	12AU6	9/—
EF80	10/6	12BA6	9/—
EABC80	10/—	12BE6	10/—
ECC85	10/—	6X4	8/6
EL80	9/—	35W4	8/—

**RCA 931A PHOTO-ELECTRIC CELL AND MULTIPLIER**  
 For facsimile transmission, flying spot telecine transmission, and research involving low light-levels, 9-stage multiplier. Brand new and guaranteed, only £2 10s. Special 11-pin base. 2/— Data sheets supplied. Equivalent to Mazda 27Y1 and 27M2.

**U.S.A. PACKARD-BELL PRE-AMPLIFIER**  
 Complete with 6SL7GT and 28D7GT Relay Condensers and Resistors. Brand new with Instruction Book, 12/6

**BRAND NEW AMERICAN U.S.A. DYNAMOTORS**  
 Input 12V, output 250V 60 mA, 21/6  
 Input 12V, output 350V 180 mA, 45/—  
**AMERICAN OIL-FILLED CONDENSERS**  
 2 mid. 600V wkg. ... 3/6  
 4 mid. 600V wkg. ... 6/—  
 8+8+4 mid., 600V wkg. ... 12/6  
 ALSO  
 8+8 475V wkg, tub can ... 4/—  
 10 mid., 475V wkg, tub can ... 2/—  
 Co-Axial Conversion Plug. Converts U.S.A. to British  
 Pye-plug  
**HALLICRAFTER Mike Transformer** 2/—  
**HALLICRAFTER Output Transformer** 5/—  
**HALLICRAFTER Modulation Transformer** 5/—  
**JENSEN 5in. P.M. Speaker** ... 21/—  
**RELAY UNIT TYPE BC442** 17/6

**62A INDICATOR UNIT**  
 Containing VCR97 with Mu-metal Screen 21 valves: 12-EF50, 4-SP61, 3-EA50, 2-EB34, Plus Pots, Switches, S/V Cond., Resistors, Mu-metal S/M Dial, Double Deck Chassis  
**BRAND NEW ORIGINAL CASES** 67/6.  
 Carriage 7/6

**HENRY'S (RADIO LTD) SHOP HOURS**  
 Mon.-Sat. 9 a.m.-6 p.m. Thursday 1 p.m.  
 Telephone Paddington 1008/9 & 0401  
**5 HARROW RD. LONDON W2**

**SMALL ADVERTISEMENTS**  
 Readers' small advertisements will be accepted at 3d. per word, including address, minimum charge 2/—, Trade advertisements will be accepted at 9d. per word, minimum charge 6/—, If a Box Number is required, an additional charge of 1/— will be made. Terms: Cash with order. All copy must be in hand by the 8th of the month for insertion in the following month's issue.

**PRIVATE**

**FOR SALE.** Tx/Rx Type RT-7/APN-1, perfect, £10 o.n.o. Also many other items. Send for list to Button, 7 Upper Flowerfield Nunney, nr. Frome, Somerset.

**FOR QUICK SALE.** Any reasonable offer will secure the following, singly or otherwise. *Wireless World* 1943-1952, *Practical Wireless* 1950-54. All in new condition. W. Bodak, 20 Winthorpe Road, Newark, Notts.

**SURPLUS** to our requirements, all brand new. Two 12-inch electrostatic short-persistence cathode ray tubes ACR12, original crates, £7 each or £12 the two. Buyer collects. One 12 inch long-persistence 12EP7, £4. Four valves CV57, £3 10s. 0d. each or £12 the four, post paid. Hartley Turner 215 Speaker, £14 carriage paid. Fry, St. Briac, Main Street, Mayland, Chelmsford, Essex.

**TAPE DECK.** Truvox, Mark III, as new, hardly used, £12 10s. 0d. Box No. D.168.

**FOR SALE.** BSR Monarch 3 Speed Record Changer, £9 5s. 0d. English Electric T901 Tube, £10 10s. 0d. Allen DC-300 Deflector Coil, £1 10s. 0d. Frame Output Transformer, 12s. 6d. All above brand new and with unregistered guarantee. Box No. D.167

**FOR SALE.** VCR97 TV comprising 2-R1355's, 2-RF27's, 500-0-500 transformer, Metal Rectifiers HT and EHT. Enlarger, Oak Cabinet. Good picture. Offers and further particulars, W. Fleetwood, 26 Queensway, Wigan, Lancs.

**AMATEUR** selling Tx and Rx. Also TV spares. All perfect. Give away bargains, list for SAE. J. McManus, 79 Park Street, Thame, Oxfordshire.

**FOR SALE.** Homelab Type 10 Signal Generator, good condition, £5. D. Vaughan, 32 Lincoln Crescent, Enfield, Middx.

**OWNER EMIGRATING.** R1155E, £5, R1132A, 35s. Twin track tape recorder, amplifier, P.U., speaker, in case, £20. Foster, 2 Templeton Place, London, S.W.5.

**REAL BARGAIN.** Portable O.V.1 S.W. Battery Receiver, will cover all bands, fitted bandset, bandspread, calibrated, very economical, excellent condition, very cheap. SAE for particulars. Box No. D.161.

**MORSE OSCILLATOR.** Modified for mains (240v). Ex. Govt. type 2, 30s. Bound copies of *Radio Constructor*, Vols. 1-5, £4. *Short Wave Magazine*, Vols. 4-8, £4. Write P. Bysh, 86 Barrerengate Road, London, N.10.

**AMATEUR SELLING UP.** Re the advert in last month's issue. All the equipment advertised has been sold. So many people have written that it is impossible to reply to each one individually, so to those who have not already heard from me, please accept this as a reply. G. M. Croft, 16 Meriton Road, Hanborough, Wilmslow, Cheshire.

(Continued on page 127)

**JUST RELEASED**  
 Type 1392. Air Tested 15 Valve Superhet. Frequency 95-150 Mc/s (2 to 3 metres). Slow-motion tuning over 95-150 Mc/s or can be Crystal controlled. Power supply required: 240-250V at 80mA, 6.3V at 4A. Size: 19" x 10" x 10". Standard rack mounting. PRICE £6.19.6. Complete with valves and circuit diagram. Pkg. & Pstg. 17/6. 10/— returnable on packing case. Power Pack 234 for 1392 £3.10. 0. Pkg. & Pstg. 7/6.

**RECEIVER Type 1132. 11 Valve Superhet.** Frequency coverage 100/125 Mc/s Switchable A.G.C. and A.V.C. Variable B.F.O. Circuit diagrams with units. Easily convertible to cover Wrotham Band. No alteration to wiring required. Conversion Slugs and instructions 5/— extra. Size: 19" x 10" x 10". Standard rack mounting. PRICE £3.7.6. Pkg. & Pstg. 15/—, 10/— returnable on packing case.

Power Pack 3 for 1132. £2. 5. 0. Pkg. & Pstg. 7/6.

**INDICATORS Type 62a.** Ideal for conversion to Oscilloscopes, TV Units, etc. Containing V.C.R. 97, 12 VR91 (EF50), 2 VR54 (EB34), 3 VR92 (EA50), 4 CV118. Slow-motion dial, 13 pots and scores of useful components. Size: 8 1/2" x 11 1/2" x 18". New. In wooden packing case, PRICE £3.10.0. Crg. 7/6.

**F.L.8a FILTERS.** Splendid value. PRICE 10/6. Pkg. & Pstg. 1/6.

**The Walk-around Shop**  
 NOTE—Orders and Enquiries to Dept. "R"  
**PROOPS ROAD, W1** 52 Tottenham Court  
 Open all day Saturday  
 Hours 9-6 p.m. Thursday to 1 p.m. LAngham 0141

**T.V. 12in. CHASSIS, 97/6.**—Complete chassis by famous manufacturer (London or Birmingham) R.F., E.H.T. unit included. Drawing FREE. Easily fitted to Table or Console model. Owing to this chassis being in three separate units (Power—Sound and Vision—Timebase INTER-connected) THIS CHASSIS IS LESS VALVES AND TUBE, but see our catalogues for cheap valves by request. Carr. 5/—.

**T.V. TUBES.** 6 months guarantee on Mullard, 3 month's guarantee on Mazda. £5 plus 15/6 ins., Carr. C.W.O.

**RADIO-GRAM CHASSIS, 29/9.**—Incl. speaker. 5 valve 5/16t 3 W/band, AC mains, complete but less valves. All used, tested and guaranteed. Postage and packing 4/6.

**AMPLIFIER, 77/6.**—4 valve, 7 watts complete, ready for use with addition of speaker. Post 3/6.

**SPEAKERS, 10/9.**—8" Std., P.M. 3-5 ohms. Post 1/9.  
**TRANSFORMERS, 9/9.**—6V and 5V heaters, 200-250 Primary 350-0-350V. Post 2/—.

**TRANSFORMERS, 5/9.**—350-0-350V, 12V and 4V heaters, 100-250V Primary (ideal auto-trans.). Post 2/—.

**O.P. TRANSFORMERS, 1/9.**—Std. size, 2-5 ohms. Post 9d.

**DUKE & CO**  
 621 ROMFORD ROAD · LONDON · E12  
 Telephone GRA 6677



# REPANCO HIGH GAIN

\*\*\* COILS \*\*\*

Dual range miniature 2/6  
Crystal Set Coil with circuit, type DRX1 (Regd. Design)  
Dual range Coil with reaction with 2 mains and 2 battery circuits, 4/0  
Matched pair Dual Range T.R.F. Coils with reaction; with battery and mains circuits, type DRM3  
Standard I.F. Transformers, type SE, 1 1/2" x 2 1/2", pre-aligned 465 k/c.  
Miniature I.F. Transformers, type MSE, 1 1/2" x 1 1/2", pre-aligned 465 k/c  
Ferrite Rod Aerial, type FRI, long and medium wave, complete with fixing brackets 12/6

★ All Coils wound on low loss formers  
★ Individually tested and guaranteed  
★ Post 3d. on all orders ★ Trade supplied

Distributed by  
**RADIO EXPERIMENTAL PRODUCTS LTD**  
33 MUCH PARK STREET COVENTRY  
Telephone Coventry 62572

# F.M. TUNER

## POWER PACK AUDIO STAGE

**TUNER (KIT OF PARTS)**  
Chassis 6" x 4" 4/10  
Coils and Choke 9/-  
Tuning Condenser 4/6  
Resistor Kit 9/6  
Condenser Kit 16/9  
Tag Strips 2/4  
5 Valves—(2) 6AM6, (1) 6BE6, (1) EF80, (1) 6AL5, 34/10  
Complete Kit £6 2 0  
Circuit Diagram 1/- (Free with kit)

**POWER PACK KIT**  
Chassis 6" x 4" 4/10  
Transformer 28/6  
Choke 8/6  
(2) 4-pin Plugs and Sockets 2/-  
Complete Kit £3 1 2  
Circuit Diagram 1/- (Free with kit)

**AUDIO STAGE KIT**  
Chassis 6" x 4" 4/10  
(2) Valveholders 1/8  
I.M. Volume Control 3/6  
Output Transformer 7/6  
Complete Kit £1 18 9  
Circuit Diagram 1/- (Free with kit)

★ Also BAND III CONVERTER KIT £3 5 0 ★  
**TELEKIT SUPPLY**  
104 HIGH STREET BECKENHAM KENT  
BEC 3720

# HANNEY sells MAXI-Q by DENCO

DENCO General Catalogue, 1/- post free  
CHASSIS. Universal TV with brackets, 53/6; P.Tel. Supervisor, 31/6; Magnaview, 3-piece, 37/6; Mullard 310 with printed bronze panel, 21/-; Osram 912 with printed bronze panel, 21/-; P.W. New "Fury Four" with paxolin front panel, 19/6.

**WIDE ANGLE TV COMPONENTS.** Line line control, 7/6; width control, 7/6; frame block trans., 16/-; deflector coils, 43/-; focus coil, 31/-; line o.p. trans., 42/-; frame o.p. trans., 21/-; coil sets for Magnaview and Universal TV, complete with can and brass slugs, 42/9

**FM FEEDER UNIT.** Chassis set, 7/6; coil sets, 11/9; 10.7 Mc/s i.f.s., 6/- each; ratio discrim. trans., 12/6; phase discrim. trans., 9/-; technical bulletin giving point-to-point wiring, circuit and construction details, 1/9 post free

**IF TRANSFORMERS.** Midget IFT.11, 465 or 1.6 12/- pair; Standard IFT.6 465 or 1.6, 18/4 pair  
**COILS,** chassis mounting, miniature or standard, 3/11 each, Ae, H.F. or Osc. Coils with reaction, 4/9  
Type "C", TRF coils, 9/- pair  
**COILPACKS.** CP.3/370 and CP.3/500, 42/8 each; CP.4/L and CP.4/M, 33/4 each; CP.4/L/G and CP.4/M/G, 41/4 each

**MODULATED TEST OSCILLATOR,** MTO.1, with valve, 75/-  
**TELEVISION PRE-AMPLIFIER,** TPA.1, with valve, 29/6

Please add 2/- postage on orders under £3. Send S.A.E. for our General List

**L. F. HANNEY**  
77 LOWER BRISTOL ROAD BATH  
Telephone 3811

# SMALL ADVERTISEMENTS

continued from page 125J

## TRADE

**THE NEW ELECTROVOX GENERAL CATALOGUE** now available. Price 1s. post free. J. L. Robinson, Summer Lane Park, Knightcote, Westonsuper-Mare.

**FM DIPOLE,** comprising two rod elements complete with junction box, suitable indoor or outdoor aerial, suitable for outdoor erection, 2 element Yagi complete with junction box, 7s. 6d. carriage only. Cheapest aerials on the market. Complete range of television coils at list prices. All radio components stocked. Goods sent per return. Wireless Manufacturing Co. (Supplies), 29 Praed Street, London, W.2. Tel. PAD 1903.

**BLUEPRINTS.** High Gain 10 Metres Converter, with a de-tune circuit comprising EF91 P.F. stage, EC91 double triode mixer and oscillator, EF92 I.F. amp, or with stabilised voltage supply via a 7475, 1s. 8d. post free with full instructions. Data Publications, 57 Maeda Vale, London, W.9.

**KENDALL AND MOUSLEY LTD.** Manufacturers of Laboratory Equipment, chassis and instrument cases; also suppliers of B.V.A. valves. Radio and TV components. 18 Melville Road, Birmingham 16.

**COILS, COILS, COILS.** We can supply coils for all frequencies, RF Chokes, Filters, etc. Coils wound to specification—send details for estimate. Send SAE for circuits and data. The Teloron Co., 266 Nightingale Road, London, N.9.

**I.P.R.E. PUBLICATIONS.** 5,500 Alignment Peaks for superhets, 5s. 9d. Sample copy *The Practical Radio Engineer*, 2s. Membership examination particulars, 1s. Syllabus of TV and Radio Courses free and post free. Secretary, I.P.R.E., 20 Fairfield Road, London, N.8.

**F.M. TUNER UNIT.** Sept. issue. Fully wound Coil chassis with S.M. condensers, 17/6 p. & p. 1/- Punched settings 7/6 post paid. C.O.P.Y. Windings, Healey Lane, Batley, Yorks.

**GOVERNMENT SURPLUS ILLUSTRATED CATALOGUE** No. 12, containing over 400 items of electrical, mechanical and Radio equipment for experiments, etc., price 1/6, post free. Arthur Sallis, 93 North Road, Brighton, Sussex.

**OSMOR**—for efficient coils, coilpacks, etc. Send 5d. stamp for FREE circuits and lists. Dept. RCC, Osamor Radio Products, Ltd., 418 Brighton Road, South Croydon, Surrey. Telephone Croydon 5148/9.

**JOIN THE ISWL.** Free services to members including OSL Bureau, Translation, Technical and Identification dens, DX certificates, contests and activities for the SWL. Monthly magazine "MONITOR" duplicated, containing articles of general interest to the SWL and League members, 12s. 6d. per annum, post free. ISWL HQ., 86 Barringer Road, London, N.10.

**BUILD YOUR OWN TV** and learn about its operation maintenance and servicing. Qualified engineer-tutor available whilst you are learning and building. Free Brochure from E.M.I. Institutes, Department R.C. 58, London, W.4. (Associated with H.M.V.)

**LEARN AS YOU DO IT**—we provide practical equipment combined with instruction in Radio, Television, Electricity, Mechanics, Chemistry, Photography, etc. Write for full details to E.M.I. Institutes, Department R.C. 47, London, W.4.

# NEW SURPLUS..

OZ4A	6/-	666G	4/-	35Z4GT	9/6	EF80	10/-
IS5	7/6	616M	5/-	808	9/6	EF91	5/-
IT4	7/6	615GT	6/-	808	30/-	EF92	5/-
IT4	7/6	617G	6/-	813	60/-	EL35	9/-
IL4	4/6	616	5/-	807 (USA)	60/-	EL84	11/6
IL4	4/6	6K7G	5/-	832	30/-	EL91	6/6
ILN5	4/6	6K7GT	6/6	832	30/-	EY1	12/6
2A3	7/6	6K8M	6/6	866A	12/6	EZ40	9/6
2D21	8/6	6K8G	6/6	954	5/-	EZ80	8/6
2X2	3/6	617M	7/6	955	5/-	PCCB4	12/6
3A4	7/6	607G	8/6	955	5/-	PL82	9/6
305GT	8/6	6SA7M	8/6	9003	5/-	R12	12/6
354	9/6	6SG7M	7/6	9001	5/-	R19	12/6
5Y3GT	8/6	6SL7GT	7/6	CB11	10/-	SP61	3/-
5U4G	8/6	6SN7GT	6/6	CV286	6/6	U50	30/-
5Z4G	8/6	6SU7M	6/6	CV287	6/6	U50	7/6
6AB7M	7/6	6U5G	7/6	DL33	9/6	U50	10/-
6AC7M	9/-	6V6GT	6/6	E450	2/6	UY41	8/6
6AG7M	9/-	6X4	7/6	EB3	10/-	V5110A	4/6
6A5	6/6	6X5GT	7/6	EB91	5/-	VU120A	3/6
6AL5	5/-	6Z4	5/-	EC81	10/6	VR105/30	7/6
6AM6	5/-	6AU6	8/6	EC82	10/6	VR105/30	7/6
6AQ5	5/-	6B6	7/6	ECH35	10/6	VR105/30	7/6
6BE6	7/6	7C5	9/-	ECH42	11/6	VT62	10/-
6B6	7/6	7C6	9/-	EF37	7/6	W77	5/-
6B7	7/6	7S7	9/-	EF50	4/-	X66	5/-
6B7W	7/6	7Y4	9/-	EF57	4/-	X66	5/-
6C4	5/6	12A6M	7/6	EF6	10/-	Z77	5/-
6CH6	5/6	12B6M	7/6	EF6	10/-	Z77	5/-
6F6G	8/6	12AU7	9/-	EF50(SYL)	7/6		
6F7	8/6	15D2	4/6	EF54	5/-		
6F8G	5/-	25L6GT	10/-				

## DENCO FM RECEIVER

Drilled chassis, FM manual, all components, pins and bolts, etc., and 5 valves (for 2 IF stages), EB91, 6BA6(2), 12AH8, and EF91. £6 7 6, or with Denco dial and drive 9/- extra.

**Dinghy Transmitters** Type BC.778E, 500 k/c/s. with one each 12A6 and 12C7 valves. Reel of aerial wire. Hand generator 300V, 40m/A. Scores of components. Brand new, only 37/6 each, carriage paid.

**Switch Units** Type 274. In black stoved steel box, 8 1/2" x 6 1/2" x 2 1/2", with 10amp 250V 4 Pos. rotary switch and one each 30 watt vitreous resistors 3, 6, 9 ohms. Bargain. Brand new, 7/6 each, carriage paid.

**RCA Crystal Multipliers** Type M1-19-468. Fitted 0-10m/A meter, 80V valve and supplied in sealed makers cartons with spare 807, and manual. 45/- each carriage paid.

**Command Transmitters** Type T19/ARCS. Range 3-4 Mc/s. Fitted 1626 VFO, 1629 magic eye resonance indicator. Pair of 1625's in parallel. Gang tuned, 100 watts input. These units are supplied in good used condition, i.e., cases are slightly soiled and are a terrific bargain while they last at only 45/- each, carriage paid.

**Canadian Power Packs** Type 19-2. For 115V input. Comprises two identical packs on one chassis (transformers each give 300-0-300 volts, 70m/A, 6.3V, 3A, 5Y.2A) wired to supply two stabilised outputs of 150V, 30m/A. Fitted 4 shrouded 10H, 70m/A chokes, 4 10mfd 600V wkg. paper condensers. 2 5Y4G and 2 VR150/30 valves and one of each spare. Could be used for standard mains with inputs in series and outputs in parallel. Offered brand new in original sealed crates for only £3 19 6 each carriage paid.

Orders for the above cannot be accepted from Eire or Overseas customers.  
Post/packing—Under 10/- (6d.), 20/- (1/-), 40/- (1/6) Free over 40/-

**JOHN ANGLIN**  
160 CLEETHORPE ROAD GRIMSBY Lincs  
Telephone 56315

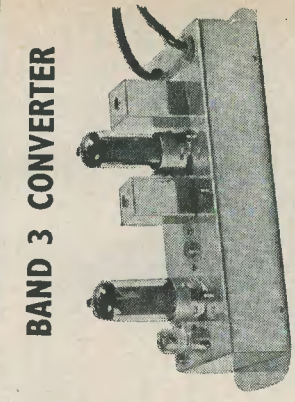

**BAND 3 CONVERTER**  
BUILD THIS UNIT AND RECEIVE COMMERCIAL TELEVISION NOW! Complete kit of parts, as illustrated above, including valves and bases, pre-punched chassis with bottom screen, all condensers, resistors, nuts, bolts, etc. Kit of parts, complete with Teletron Coil Kit Mk. 1, £2 15s. 0d. Post 6d.

**TELETRON BAND 3 COIL KIT, 15/-**, Post 3d. Chassis, pre-punched, 3/9, Post 3d. Valves 10/6 each, Post 6d.

**BAND 3 and FM AERIALS**—See small adv.—All items previously advertised still available.

**Wireless Marketing Co**  
29 Praed Street  
Established 1926  
London, W2  
Telephone PAD 1903

**ADCOLA**  
(Regd. Trade Mark)  
**SOLDERING INSTRUMENTS**



Reg. Design No. 860302 (British, U.S. and foreign Patents)  
Designed for wireless assembly and Maintenance  
Supplied for all volt ranges from 61V to 230/250V 3/16" Dia. Bit Standard Model, 25/6  
Sole Manufacturers **ADCOLA PRODUCTS LTD.**  
Sales Office and Works  
Gauden Road London SW4 (MAC 4272)

**AMAZING BARGAIN..**  
Huge assortment of Condensers ranging from 30pfd to .25mfd . 50 Mixed types 5/- 9/6 per 100  
★ GUARANTEED NON-LEAKERS  
MONEY REFUNDED IF DISSATISFIED  
**FRANK MOZER**  
5 Angel Corner Parade  
Edmonton N18 . EDM 2784

**OUR NEW**  
**GOVERNMENT SURPLUS**  
**CATALOGUE No. 12**  
containing over 400 items, price 1/6 post free  
2/6 overseas seairmail  
**ARTHUR T. SALLIS (R.C.)**  
93 NORTH ROAD BRIGHTON  
SUSSEX  
Telephone BRIGHTON 25806

**BRASS, COPPER, DURAL**  
**ALUMINIUM, BRONZE**  
ROD, BAR, SHEET, TUBE, STRIP, WIRE  
3,000 STANDARD STOCK SIZES  
No Quantity too Small List on application  
**H. ROLLET & CO. LTD**  
6 Chesham Place SW1 Telephone SLOane 3463  
also at Liverpool, Birmingham, Manchester, Leeds

**H.A.C. SHORT-WAVE EQUIPMENT**  
Supplies for over 18 years of Radio S.V. Receivers of Quality  
One-Valve Kit, price 25/-. Two-Valve Kit, price 50/-.  
Improved designs with Denco coils. All kits complete with all components, accessories and full instructions.  
Before ordering call and inspect a demonstration receiver, or send stamped addressed envelope for descriptive catalogue.  
**H.A.C. SHORT-WAVE PRODUCTS (DEPT. R)**  
11 OLD BOND STREET LONDON W1

**REPORT PADS**  
REPORT/REPLY RATIO LOW?  
Then send a report which contains all the information a station requires. Each pad contains 50 printed forms detailing the headings under which reports should be made. Your QSL returns will be much higher if you use these property prepared reports. Printed on a high quality paper suitable for airmail transfer they cost only 5/9 post paid.  
Orders with remittance to  
**DATA PUBLICATIONS LTD**  
57 MAIDA VALE LONDON W9

**HIGH FIDELITY**  
COMPONENTS IN STOCK FOR THE  
MULLARD 5-10 AMPLIFIER circuits 2/6  
OSRAM 912 AMPLIFIER circuits 3/6  
DENCO FM TUNER circuits 1/6  
RADIO CONSTRUCTOR FM TUNER circuits 2/-  
Price lists available on request  
**J. T. FILMER** MAYPOLE ESTATE  
BEXLEY KENT  
Telephone BEXLEYHEATH 7267

**GUARANTEED VALVES — Over 3,000 in Stock**  
6AM6, 6C4, EP92, 6AL5, EAC91, 616, 5/-  
12A1T, 12AX7, 6AK5, 6F33, EC91, EL91, 6SN7, 6SL7  
6SK7, 6SJ7, R10, 6BA6, 6F17, 6CH6, 6BW6, 7/6.  
12AU7, 2D21, 9/-.

**A. A. W. SKILLMAN**  
74 FRANCHISE STREET WYEMOUTH

**PANL**

Most of the nationally known mail order houses now stock this popular air-drying crackle finish as a regular line at 3/- per 4pt. can, in black, green and brown. If you have any difficulty in obtaining your supply, send 3/6 to G. A. MILLER, 8 Kenton Park Crescent, Kenton, Middx.

**20 CIRCUITS for 2/6 only**

- Our 1955 Super-Handbook "The Home Constructor" (76 pages) now incorporates...
- **AMPLIFIERS**—Superhet's, T.R.F. Sets, super-simplified layout and point-to-point wiring diagrams for building a variety of series.
- **COIL PACK**—Full constructional details for building a superhet coil pack.
- **CAR RADIO**—Full constructional details, including a CHEAP charger—Details for building a GEN. Pages of information, Re-knowledge, Code, Formulae, and list.
- **RADIO CONTROL**—General information and list.
- **CATALOGUE**—Constructors list.
- **SUPACOILS**—Profusely illustrated list of components including: price 800, 10-30, 16-50, 30-75, 75-200, 190-350 metres. Aerial H.F. or Osc 30/-.  
30/-.  
superhet pack—single hole fixing—recon. aligned 47/5.  
\*\*The most helpful book in the Trade.\*\*

**SUPACOILS (DEPT. RC9)**  
21 Markhouse Road London E17  
Telephone KEY 6896

**CONSTRUCTORS build these at low cost!**

**PERSONAL PORTABLE RADIO**  
30/-  
Post Free

This little set was designed to give you a real personal portable radio that you can enjoy anywhere without disturbing others. Ideal for the holiday, hiking, fishing, camping, cycling, etc. Use it at home, at the office, in the car, or just anywhere.

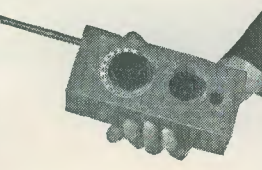

Send 2/- for layout, Wiring diagram and Components Price List.

**"METEOR" MINI-RECEIVER**  
30/-

COMPONENTS	
All Resistors	... 4/3
All Fixed Condensers	... 9/-
25pF Variable Condenser	... 2/6
100pF Variable Condenser	... 2/6
Panel & Chassis	... 3/6
Cabinet	... 7/-
50K Potentiometer	... 3/-
Phone Plug & Jack	... 5/-
Knob & Pointer	... 1/6
PVC Wire, nuts and Bolts	...
Solder Tags, Solder, Rubber Grommet, Aerial/Earth and 3 way Tag Strip	... 2/6

Ideal for the beginner or for those requiring a simple standby receiver.

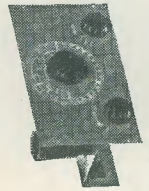

This 1 valve S.W. receiver can be built for 30/- from our list of components, which can be purchased separately. It includes valve and 1 coil covering 20-40 metres. Provision is made to increase to 2 or 3 valves if required, and all components are colour-coded so that the beginner can build this set quite easily. Send 2/- for specification, wiring diagram, layout and price list.

Send 2/- for layout, Wiring diagram and Components Price List.

**R.C.S. PRODUCTS (RADIO) LTD**  
11 OLIVER ROAD (Mail order only) LONDON E17

**YOU CAN RELY ON US**

We specialise ONLY in radio and electronic components, a comprehensive stock of which are held by us, to supply Government, educational and commercial laboratories. Can we be of some help to you, the experimenter and constructor? Here are a few of our many stock lines—

- Tapped Volume Controls, 1/2mg, 1mg, 1/6mg, 1/3mg, 1/4mg, 1/5mg, 1/6mg; Linear, 1/2mg, 1/3mg, 1/4mg, 1/5mg, 1/6mg; Surplus Stock Potentiometers, less switch, 2/3; with, 4/3; D/P, 5/-; midget, wirewound, preset, etc., in stock.
- All J.B. Scales and Gangs. Full vision, 13/9; SL8, 27/6; SL5, 26/-; 3-gangs in .0003 and .0005, 18/3; Single gang .0005, 9/-; Twin midget gang, covered, 11/-.
- Bulgin Plugs, Sockets, Panel Lights, etc. Belling-Lee Co-ax. Plugs, 1/3; Sockets, 1/2. Plugs, Sockets, etc. Resistors, 10 ohms to 15 meg in 1/4W, 1/2W, 4d.; 1W, 8d.; 2W, 1/4; midget 1/2W, T type, 6d.; High stability 2% 100-2 megs, 1/6 each; wirewound (green vitreous), 33 ohms to 10K, 10 watts Max., 2/- each.
- Over 200 T.C.C. types of Condenser. 189 types of Hunts. Electrolytics new and surplus. 10,000 surplus Valves plus large stock BVA Valves 515pF to 815pF, 1/6; 1,000pF to 5,000pF, 2/6.
- 1% Silver Micas, 1.5pF to 100pF, 1/-; 100pF to 280pF, 1/2; 300pF to 500pF, 1/4; 515pF to 815pF, 1/6; 1,000pF to 5,000pF, 2/6.
- COILS.—COMPLETE RANGE OF DENCO, WEYMOUTH, WEARITE, OSMOR, R.E.P., TELETRON; DENCO F.M. UNIT PARTS, '912' PARTS, MULLARD '510' PARTS—ALL TAYLOR, AVO INSTRUMENTS IN STOCK, CELESTION, ROLA, ELAC, W.B., WHARFEDALE, GOODMANS SPEAKERS.

Send now for our Supplementary Winter List with H.P. Terms—Quotes S.A.E. Please. Postage extra  
Next to South Ealing Tube Station 65 Bus.

**RADIO SERVICING CO**  
82 SOUTH EALING ROAD Telephone EAL 5737  
LONDON W5 Telephone EAL 5737