

# 'THE DAILY EXPRESS'

half page on October 6th

features—

## MODERN PRACTICAL RADIO & TELEVISION

This outstanding Caxton book is being included in an important half-page advertisement appearing in the October 6th issue of "The Daily Express." (From this issue you can obtain details of many other Caxton publications).

Caxton books are repeatedly advertised in this foremost National Newspaper, with the widest possible results. Thousands of "Daily Express" readers regularly enquire about the various Caxton technical publications.

Watch the columns of "The Daily Express" yourself for details of new technical publications that Caxton are shortly to publish.



### THE CONTENTS

Sound, Capacity, Reactance and Impedance, Tuned Circuits, Principles of the Thermionic Valve, Detection, H.F. of Tetrode and Pentode, High-frequency Amplification, Frequency-changing Valves, Design of the Superheterodyne, Low-frequency Amplification, The Output Stage, Automatic Controls, Frequency Modulation, Five Circuits Analysed, High Vacuum Cathode-ray Tube and its Application to Television, Television-receiver Design, Adjustments and Faults of a Television Receiver, Valve Testing, Fault-Finding Procedure, etc., etc.

### THE ILLUSTRATIONS

"Modern Practical Radio and Television" is profusely illustrated. It contains 16 full-page plates, over 400 diagrams in the text and 7 large folding insets. Each illustration has been specially selected for its practical utility.



## FREE PARTICULARS

To THE CAXTON PUBLISHING COMPANY LIMITED

73 MORLEY HALL, ST. GEORGE STREET, HANOVER SQUARE, LONDON, W.1.

Please send me, free of charge, particulars of "Modern Practical Radio & Television" together with your terms of easy payment.

Name.....  
(Send this form in unsealed envelope 1½d. stamp)

Address.....

RT14 .....

Published by Data Publications Ltd., 57 Maida Vale Paddington London W9  
Printed by A. Quick and Co. Ltd., Oxford House Clacton-on-Sea Essex



The

# RADIO CONSTRUCTOR

for the Radio and Television Enthusiast

Volume 7  
Number 1  
SEPTEMBER  
1953



IN THIS ISSUE ...

## THE SIMPLEX THREE GRAM AMPLIFIER

THE "INEXPENSIVE" CAR RADIO

THE "UNIVERSAL"

AC/DC LARGE SCREEN TV

A MODERN 3-WAVEBAND

SUPERHET RECEIVER

DESIGN FOR BATTERY/MAINS RECEIVER

Radio Snapshots Competition

Semi-Conductor Devices

Radio Control Equipment etc. etc.

# 16



## THE MODERN BOOK CO.

**The Radio Amateur's Handbook** by A.R.R.L. 1953. 30s 0d. Postage 1s 0d.

**Television Fault Finding** compiled by *Radio Constructor*. 5s 0d. Postage 6d.

**Receivers, Pre-Selectors and Converters**. 2s 6d. Postage 2d.

**The Oscilloscope Book** by E. N. Bradley 5s 0d. Postage 3d.

**Reference Data for Radio Engineers**. STC. 10s 6d. Postage 6d.

**Television Receiver Design I** by A. Uitjens. 21s 0d. Postage 9d.

**Amplifiers** by G. A. Briggs and H. H. Garner. 15s. 6d. Postage 6d.

**Radio Servicing Instrument** by E. N. Bradley. 4s 6d. Postage 3d.

**Constructors' Radio Receivers** by E. N. Bradley. 2s 6d. Postage 2d.

**Brimar Radio and Teletube Manual No. 5**. 5s 0d. Postage 6d.

**Radio Valve Data** compiled by *Wireless World*. 3s 6d. Postage 3d.

**P. H. Brans' Equivalent Radio Tube Vade-Mecum 1953**. 21s 0d. Postage 1s 0d.

**Basic Mathematics for Radio Students** by F. M. Colebrook. 10s 6d. Postage 6d.

**Foundations of Wireless** by M. G. Scroggie. 12s 6d. Postage 9d.

We have the finest selection of British and American Radio publications in the Country. Complete list on application.

**19-23 PRAED STREET (Dept. RC) LONDON W2**

PADdington 4185

**SCOTTISH INSURANCE CORPORATION LTD.**



**62-63 CHEAPSIDE LONDON, E.C.2.**

### TELEVISION SETS AND SHORT WAVE TRANSMITTERS

Television Sets and Short Wave Transmitters/Receivers are expensive to acquire and you no doubt highly prize your installation. Apart from the value of your Set, you might be held responsible should injury be caused by a fault in the Set, or injury or damage by your Aerial collapsing.

A "Scottish" special policy for Television Sets and Short Wave Transmitters/Receivers provides the following cover:—

- (a) Loss or damage to installation (including in the case of Television Sets the Cathode Ray Tube) by Fire, Explosion, Lightning, Theft or Accidental External Means at any private dwelling house.
- (b) (i) Legal Liability for bodily injury to Third Parties or damage to their property arising out of the breakage or collapse of the Aerial Fittings or Mast, or through any defect in the Set. Indemnity £10,000 any one accident.
- (ii) Damage to your property or that of your landlord arising out of the breakage or collapse of the Aerial Fittings or Mast, but not exceeding £500.

The cost of Cover (a) is 5/- a year for Sets worth £50 or less, and for Sets valued at more than £50 the cost is in proportion. Cover (b) (i) and (ii) costs only 2/6d. a year if taken with Cover (a), or 5/- if taken alone.

Why not BE PRUDENT AND INSURE your installation—it is well worth while AT THE VERY LOW COST INVOLVED. If you will complete and return this form to the Corporation's Office at the above address, a proposal will be submitted for completion.

NAME (Block Letters) .....

(If Lady, state Mrs. or Miss) .....

ADDRESS (Block Letters) .....

JB

**ALL-ROUND DEPENDABILITY**

VALVE CHARACTERISTIC METER

UNIVERSAL BRIDGE

THE D.C. AVO MINOR

HEAVY DUTY METER

UNIVERSAL MINOR

UNIVERSAL METER

ELECTRONIC TESTMETER

ELECTRONIC TEST UNIT

WIDE RANGE SIGNAL GENERATOR

**AVO Precision ELECTRICAL MEASURING INSTRUMENTS**

See the complete range of "AVO" Instruments at the

**RADIO SHOW** Stand No 15

**EARLS COURT** SEPT. 2-12

You can depend on "Avo." When choosing instruments, consult our complete catalogue, a copy of which may be had free on application.

**THE AUTOMATIC COIL WINDER & ELECTRICAL EQUIPMENT CO. LTD.**  
WINDER HOUSE • DOUGLAS STREET • LONDON S.W.1. Telephone: VIctoria 3404-9



**WIDE ANGLE TV**



ALLEN · DENCO · COLVERN · DUBILIER  
ELAC · MEMURDO · MORGAN  
STC · TCC

for the

**"TELEKING"**  
**"VIEWMASTER" CONVERSION**  
and **"MAGNA VIEW"**  
(Radio Constructor)

also **Tubes, Valves and Cabinets**  
etc. Price Lists on receipt of SAE

**H. L. SMITH & CO. LTD**

287/9 Edgware Road London W2

Telephone Paddington 5891

Hours 9 till 6 (Thursday 1 o'clock)

Nr. Edgware Road Stations, Metropolitan & Bakerloo

**ARTHURS HAVE IT!**

LONDON'S OLDEST RADIO DEALERS

**LARGE VALVE STOCKS**

**AVOMETERS IN STOCK**

Avo Test Meters and Signal Generators  
and Taylor Meters  
Leak Point One Amplifiers and Tuning  
Units.

Chapman Tuning Units.  
Crystal and Moving Coil Mics.  
Decca Replacement Heads and Pickups.  
Goodman's Axiom 150 Speakers.  
Partridge Output Transformers for  
Williamson Amplifier.

All Components for the Radio Constructor's 16" Televisor.

Weare & Wright Tape Deck £35.

**LATEST VALVE MANUALS**

Mullard, Osram & Brimar No. 4 5/- each  
Mazda 2/- each Postage 6d extra

**TELEVISION SETS, WIRE AND TAPE  
RECORDERS ALWAYS IN STOCK**  
Goods offered subject to price alterations  
and being unsold.

**Arthurs first** Est. 1919

Proprietors: ARTHUR GRAY LTD.

**OUR ONLY ADDRESS Gray House  
150-52 Charing Cross Road  
London, W.C.2.**

TEMple Bar 5833/4 and 4765 WRITE FOR LISTS

For  
**SUCCESSFUL**  
wide-angle  
scanning

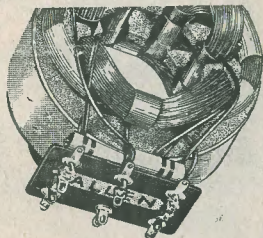

**ALLEN DEFLECTOR COILS**

70° Scan with minimum deflection  
defocusing High-efficiency castellated  
"FERROXCUBE" core. Suits any wide  
angle C.R.T. up to 27" double (d) Scan.  
**LARGE SCREEN TELEVISION**  
Can only be achieved by using high  
efficiency components throughout.  
ALLEN can supply the complete range.

For prices and details of  
the full range of ALLEN components — Write to  
For circuit diagram of  
Line and Time Base  
send 9d. and stamped  
addressed envelope to

**ALLEN**

**COMPONENTS LIMITED**

Crown Works, 197 Lower Richmond Rd  
Richmond Surrey Telephone Prospect 9013

**TELEVISION  
CABINETS**

All Sizes up to 16" Tube

Specially Designed for 'The Radio  
Constructor' 'MAGNAVIEW" TV.  
Receiver.

Price **£18:10** Carriage £1

SEND FOR ILLUSTRATED LEAFLET

**H. ASHDOWN**

98 HERTFORD ROAD

TOTtenham 2621 EDMONTON N9

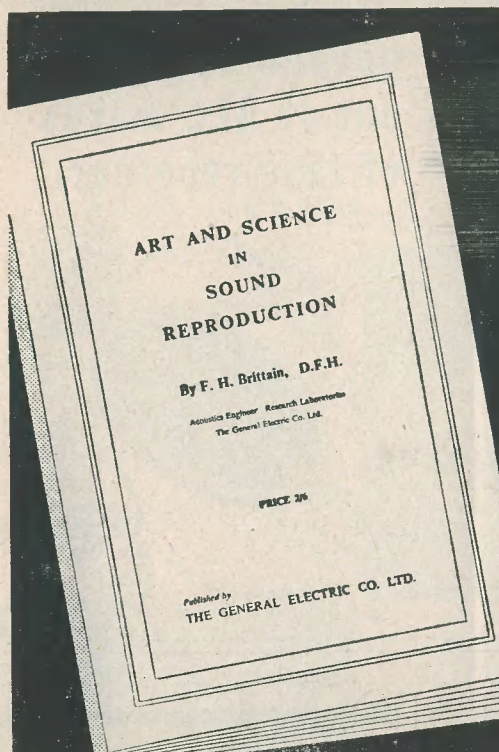

A new  
essential  
publication  
for your  
technical  
library

Published by The General Electric Co. Ltd.

**56** PAGES Reverberation and echo · The loud-  
speaker · Amplifiers for the high quality reproduction  
of sound · Design factors in high fidelity  
amplifiers · Notes on 6, 12, 14, 20 and 30 watt amplifiers ·  
The design of the pre-amplifier and tone control · Notes  
on the feeder units · Using the G.E.C. Metal Cone Loud-  
speaker · Circuits and full constructional details

**2/6**

from the G.E.C.

**DEMONSTRATION ROOM D9**  
at the National Radio and Television Exhibition

THE GENERAL ELECTRIC CO. LTD., MAGNET HOUSE, LONDON, W.C.2





get the best  
out of ALL makes  
of tape-recorder

'Scotch Boy' fits all makes of tape recorders. It brings new clarity, new fidelity, an all-round improvement to your own recordings. 'Scotch Boy' is a medium coercivity, plastic-backed tape with a frequency range of 50 c/s to 10 kc/s at a tape speed of 7 1/2" per second. It is available in six reel sizes from 300 ft. to 1000 metres, to provide a wide range of playing times. 'Scotch Boy' is used by the B.B.C. and most other big recording and broadcasting corporations. Ask your dealer for 'Scotch Boy' and hear the difference it makes on your own machine.

Another  Product

Write for further details to  
Minnesota Mining & Manufacturing Co. Ltd  
167 Strand, London W.C.2. Temple Bar 6363

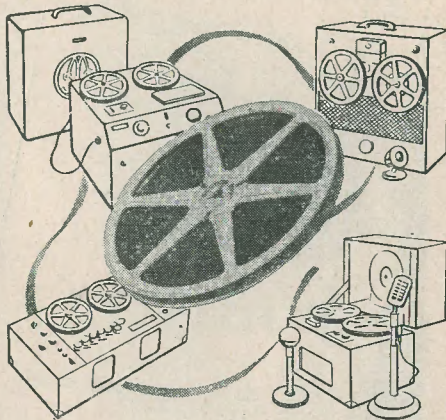

## Have your Copies Bound

VOLUMES OF RADIO CONSTRUCTOR  
AND RADIO AMATEUR FULLY BOUND  
IN IMITATION LEATHER, WITH GOLD  
LETTERING. 7s 6d POST FREE. PRICES  
FOR OTHER PUBLICATIONS ON APPLICATION



If not required to be bound in, remove  
covers before sending.

# JEROME ALCOCK

CHEADLE, STOKE-ON-TRENT

## IKOPATENTS

LTD.

Managing Director  
E. G. O. ANDERSON

### Consultants

- RADIO
- TELEVISION
- ELECTRONICS

17 CRISP ROAD W6  
RIVERSIDE 2678

## ELAC T/V COMPONENTS

as specified in

"THE UNIVERSAL"

LARGE SCREEN AC/DC TELEVISOR

### DUOMAG FOCALISER

incorporating two sintered oxide magnets of high electrical resistivity. The unit provides a "double lens" system and can be placed close to high efficiency scan coils without detracting from their performance.

Type FD12/4 (for Mullard  
MW.43/64)

37/6

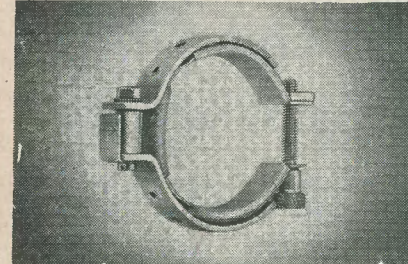
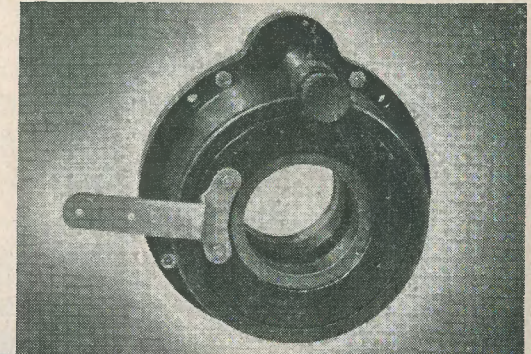

### "ELAC" ION TRAP

Each assembly is individually checked to ensure correct flux. The special clamping device obviates strain on the neck tube and the possibility of breakage with change of temperature. Type I.T.9. for Mullard  
MW.43/64

5/-

### 5" LOUDSPEAKER

(Series 5D)

This unit is one of the most sensitive small Loudspeakers in quantity production. The response is characterized by the crisp reproduction of speech and excellent rendering of orchestral items.

Type 5/45 (as specified)  
23/9 inc. P.T.

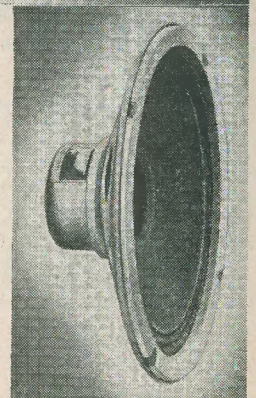

Matching  
Transformer  
Type T18009 6/6



ELECTRO ACOUSTIC INDUSTRIES LTD  
STAMFORD WORKS, BROAD LANE, LONDON, N.15



# BRIMAR VALVES

used in famous CAR RADIOS!

- ★ DELCO-REMY
- ★ MASTERADIO
- ★ MOTOROLA
- ★ PHILCO
- ★ PYE
- ★ ROMAC
- ★ VAUXHALL

**YOUR "Inexpensive" CAR RADIO  
needs these high-quality Valves too!**

BRIMAR VALVES are recommended in the *Radio Constructor* August issue, page 634.

6 Volt	12 Volt
6BA6	12BA6
12AH8	12AH8
6BA6	12BA6
6AT6	12AT6
6V6GT	12A6

The rugged construction and small size of Brimar Valves makes them most suitable for use in mobile equipment such as high performance Car Radios. Produced by an organisation with years of experience in the development and manufacture of "Trustworthy" special quality valves, the Brimar range is renowned for its reliability. To ensure that your time and money spent in careful construction is not wasted, it is recommended by the designer that Brimar Valves should be used in the "Inexpensive" Car Radio.

*Standard Telephones and Cables Limited*

BRIMAR VALVE WORKS · FOOTSCRAY · SIDCUP · KENT FOOTscray 3333

# FREE

**THIS  
FULLY  
INFORMATIVE  
BROCHURE**

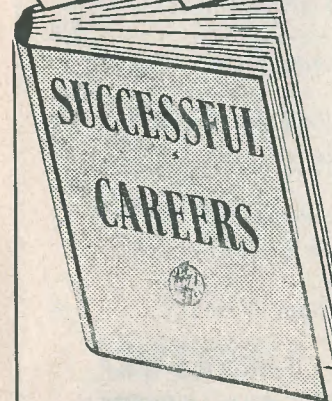

**NEW!**

**HOME EXPERIMENTAL  
KITS NOW AVAILABLE**  
Practical experimental kits form part of the following courses: **Radio & Electronics, Draughtsmanship, Carpentry, Chemistry, Photography and Commercial Art.**

describing the wide range of Engineering and Commercial Courses of modern training offered by E.M.I. Institutes — the only Postal College which is part of a world-wide Industrial Organisation.

Over 150 courses include:

- |                                |                                |
|--------------------------------|--------------------------------|
| General Radio & TV Engineering | Radio Amateurs Licence         |
| Radio & TV Servicing           | General Electrical Engineering |
| Radar                          | Installations & Wiring         |
| Sound Recording & Reproduction | I.E.E. Theory                  |
| Industrial Electronics         | High Frequency Electronics     |
| Advanced Radio                 | Radio Operating                |
| P.M.G. Certificate             | ... and many others.           |

Also Examination Courses for: General Certificate of Education, B.Sc. Eng., Common Preliminary, A.M.I.Mech.E., A.M.I.C.E., A.M.I.Struct.E., A.M.Brit.I.R.E., A.F.R.Ae.S., A.M.I.P.E., A.M.I.I.A., A.M.I.M.I., A.M.I.H. & V.E., M.R.San.I., A.M.I.San.E., A.M.I.Munic.E., A.M.I.E.D., A.M.S.E., L.I.O.B. Also CITY and GUILDS Certificates in Mechanical, Electrical, Aeronautical, Automobile, Telecommunications and Structural Engineering; Refrigeration, Heating & Ventilation. Courses also provided for all branches of Commerce and Business Management.

COURSES FROM £1 PER MONTH

**POST NOW**

Please send, without obligation, the above FREE book  
E.M.I. Institutes, Dept. 179k,  
43 Grove Park Road, Chiswick, London, W.4.

## EMI INSTITUTES

The only Postal College which is  
part of a world-wide industrial  
organisation.

Name.....

Address.....

IC.14E



## COMPONENTS FOR THE "INEXPENSIVE CAR RADIO" Described in this Issue

each	each
20 s.w.g. Steel Case finished in Black Cellulose complete with Front and Rear Panels, Screen and Potentiometer Mounting Bracket. . . . .	30/-
DTB.6—Constructor's Envelope giving full Assembly and Wiring Diagrams. . . . .	2/6
Dual Purpose Coils: Range 2 Blue, Range 2 Yellow and Range 2 Red . . . . .	3/11
I.F. Transformer, IFT.11. . . . .	6/-
Potentiometer, .5 M ohm. . . . .	3/6
Variable Condenser, 300 pF. 3 Gang . . . . .	18/3
Concentric Trimmers, 3/30 pF. . . . .	3/6
Valveholders, Octal, B7G, B9A . . . . .	1/-
Slow Motion Epicyclic Drive . . . . .	3/9
Lampholder . . . . .	6d
Knobs. . . . .	8d
Single Tag Posts . . . . .	2d
Extension Spindle and Coupling. . . . .	2/-
Scale, Medium Wave. . . . .	1/9

**DENCO (CLACTON) LIMITED**  
**357-9 OLD ROAD CLACTON-ON-SEA ESSEX**

*You're SURE to get it at*  
**STERN'S**  
 ESTABLISHED 25 YEARS

## CAR RADIO

THE "INEXPENSIVE" CAR RADIO RECEIVER DESCRIBED AND ILLUSTRATED IN THIS ISSUE

CAN BE COMPLETELY BUILT INCLUDING VIBRATOR PACK for THIS PRICE INCLUDES ALL VALVES, 5-INCH SPEAKER, DRILLED CHASSIS, AND ALL COMPONENTS DOWN TO THE LAST NUT AND BOLT **£12-19-6**

SEND 2/8 for the complete Set of Assembly Instructions, CIRCUITS, LAYOUTS, POINT-TO-POINT DIAGRAMS, together with the complete Component Price List  
 This is NOT AN EX-GOVT. RECEIVER, it is a new design employing new Components and Valves

### A GENUINE SPECIAL OFFER!

**PLESSEY 3 SPEED AUTO CHANGE UNITS £11-3-6** (NORMAL PRICE OVER £20)

- These units will auto-change on all three speeds, 7in 10in and 12in.
- They play MIXED 10in and 12in records.
- They have separate sapphires for L.P. and 78 r.p.m., which are moved into position by a simple switch.
- Minimum baseboard size required 16in x 12½in with height above 5½in and height below baseboard 2½in.

A bulk purchase enables us to offer these BRAND NEW UNITS at this exceptional price.

Please add 7/6 packing, carriage and insurance.

**STERN RADIO LTD.**

109 & 115 FLEET STREET LONDON E.C.4.  
 Telephone CENTRAL 5812-3-4

# The RADIO Constructor

Vol. 7. No. 1

Annual Subscription 18/-

September 1953

Editorial and Advertising Offices—57 Maida Vale London W9  
 Telephone CUNingham 6518

Editor: C. W. C. OVERLAND, G2ATV

Advertising Manager: F. A. BALDWIN

SUGGESTED CIRCUITS: A VOLTAGE DOUBLING DETECTOR, by G. A. French. . . . .	10
IN YOUR WORKSHOP, by J. R. D. . . . .	12
VALVES AND THEIR POWER SUPPLIES, PART 10, by F. L. Bayliss, A.M.I.E.T. . . . .	14
THE "INEXPENSIVE"—A CHEAP AND EFFICIENT CAR RADIO, Part 2, by A. Tiel . . . . .	18
RADIO MISCELLANY, by Centre Tap . . . . .	24
THE "UNIVERSAL" LARGE SCREEN AC/DC TELEVISOR, PART 4, described by A. S. Torrance, A.M.I.P.R.E., A.M.T.S. . . . .	26
THE G.E.C. GERMANIUM TRIODE GET1 . . . . .	30
SEMI-CONDUCTOR DEVICES, by A. L. Pardew . . . . .	32
TRADE NEWS . . . . .	36
THE "SIMPLEX" THREE—A SIMPLE GRAM AMPLIFIER FOR THE BEGINNER, by E. Govier . . . . .	38
RADIO CONTROL EQUIPMENT, PART 7, by Raymond F. Stock . . . . .	40
RADIO SNAPSHOTS—A COMPETITION . . . . .	43
A MODERN 3-WAVEBAND SUPERHET RECEIVER, by James S. Kendall, Assoc.Brit.I.R.E., M.I.P.R.E. . . . .	44
OSCILLOSCOPE TRACES, No. 3, by A. B. . . . .	48
LET'S GET STARTED—VALVES AS DETECTORS AND OSCILLATORS, by A. Blackburn . . . . .	49

### NOTICES

THE CONTENTS of this magazine are strictly copyright and may not be reproduced without obtaining prior permission from the Editor. Opinions expressed by contributors are not necessarily those of the Editor or proprietors.

THE EDITOR invites original contributions on construction of radio subjects. All material used will be paid for. Articles should be typewritten, and photographs should be clear and sharp. Diagrams need not be large or perfectly drawn, as our draughtsmen will redraw in most cases, but relevant information should be included. All Mss must be accompanied by a stamped addressed envelope for reply or return.

Each item must bear the sender's name and address. TRADE NEWS. Manufacturers, publishers, etc., are invited to submit samples or information of new products for review in this section.

ALL CORRESPONDENCE should be addressed to Radio Constructor, 57 Maida Vale, Paddington, London, W.9. Telephone CUN. 6518.

A COMPANION JOURNAL TO THE RADIO AMATEUR



# Suggested Circuits for the Experimenter

The circuits presented in this series have been designed by G. A. FRENCH specially for the enthusiast who needs only a circuit and the essential relevant data.

## No. 33: A VOLTAGE DOUBLING DETECTOR

THIS MONTH'S CIRCUIT illustrates an unconventional method of obtaining gain at the detector whilst using diodes. The circuit gives a theoretical voltage gain of two. Fidelity of detection should be equivalent to that offered by a conventional diode circuit.

### Operation

The circuit functions in the same manner, largely, as does a normal voltage doubler. When the AC voltage supplied by the IF

transformer secondary is positive with respect to chassis, V1 conducts. This causes C1 to charge to the peak value of the applied AC, its right-hand plate being negative and its left-hand plate positive. The voltage across C1 then acts in series with that supplied by the IF transformer secondary, with the result that the voltage applied to the cathode of V2 varies between zero and twice the peak value of the applied AC. V2 conducts and charges C2 to a similar voltage.

(continued at foot of next page)

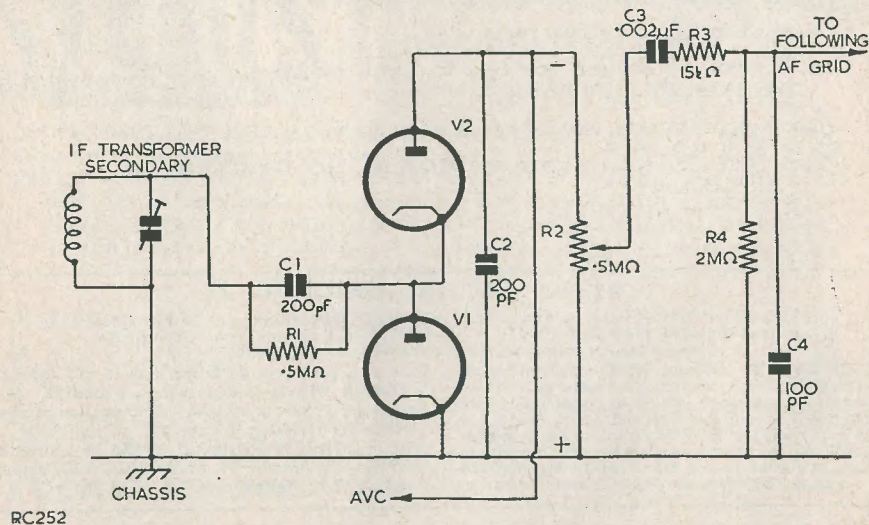

A Voltage Doubling Detector

## As Pretty as a Picture

THIS is an example of a picture which might have been taken by any of our readers. Why not go through your own snapshots?

Details of a new competition will be found on page 43—and the photographs need not have been specially taken for the purpose. Any picture of radio interest is eligible.

(Sorry—but we are as intrigued as you are about this particular picture. We just haven't any information about it at all. Any clues?)



(continued from preceding page)

R1 and R2 are connected across C1 and C2 respectively in order to allow these capacitors to discharge slightly between successive peaks and thus "follow" the modulation envelope of the received signal. R2 can be considered as the resistive diode load.

In accordance with conventional detector practice the following grid leak should have a value at least four times that of the resistive diode load. In this instance R2 is  $0.5M\Omega$  and R4 is  $2M\Omega$ . Either R2 or R4 may be a volume control, but it might be easier to use R2 for this purpose since volume controls of this value are more readily obtainable.

### Possibilities

As may be seen from the circuit, AVC is developed across R2; and it is here that the circuit will probably prove most useful. Whilst a voltage gain of two will give a noticeably increased audio output, with conventional receivers the effect will not be spectacular. On the other hand, a doubled AVC voltage should definitely give better control; as well as providing the incidental benefit of greater tuning indicator deflection.

Either V1, V2, or both, may be germanium diodes, if desired. Thus, when using conventional receiver design, V1 could be the

diode section of a diode-triode or diode-pentode whilst V2 could be a germanium diode.

## The Editor Invites

articles from readers, of a nature suitable for inclusion in this magazine.

Articles submitted for publication should preferably be typewritten, but ordinary writing is acceptable if clearly legible. In any case, double spacing should be used, to allow room for any necessary corrections.

Drawings need not be elaborately finished, as they will usually be redrawn by our draughtsmen, but details should be clear.

Photographs should preferably be large (half-plate) but in any case the focus must be good. Much useful advice to prospective writers is given in our *Hints for Article Writers*, which will be sent free on request.



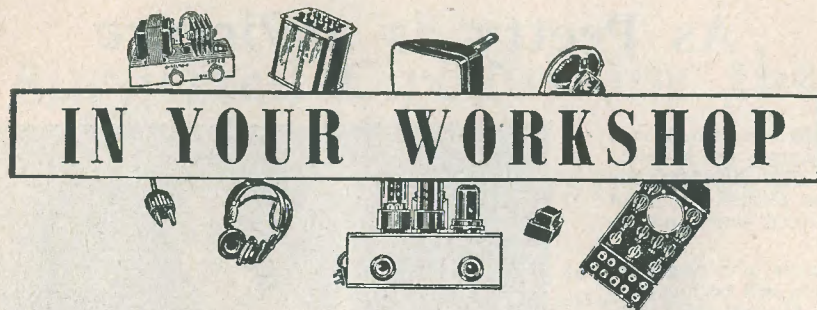

*In which J. R. D. discusses Problems and Points of Interest connected with the Workshop side of our Hobby based on Letters from Readers and his own experience.*

**R**EADERS MAY REMEMBER my mentioning some time ago that I was away from this country and that there were liable to be some unavoidable delays with regard to correspondence. I am happy to say that I have now returned. In fact, by the time this appears in print I shall have been in the U.K. for several months. I must thank all those who have been good enough to write to me during the last ten months or so for having put up so patiently with the annoying delays which occurred before I could reply. In order to keep in touch as well as I possibly could, I took the precaution of opening two Monomark addresses before leaving; one for air mail, and one for surface mail. It sounds a little complicated, but this system enabled letters to reach me much more quickly than would otherwise have been the case. I shall now, of course, be able to deal promptly with any letters I receive.

#### Impressions

Whilst I was away I spent some time in Singapore and Hong Kong and I was able to gain a few impressions of things out there from the radio angle.

Amongst other things I attended the radio exhibition held in the Happy World Stadium at Singapore last year. This contained several interesting exhibits, including a broadcasting studio in actual use; but the item which captured the Singapore imagination, almost to the exclusion of everything else, was a demonstration of closed circuit television. Pye equipment was used for this exhibit, the reproduced pictures being shown on normal domestic receivers. Singapore was most definitely impressed by this demonstration

and there has been some controversy since the exhibition over the erection of a television station for Singapore. Although it is claimed that a transmitter radiating sponsored programmes could be built fairly quickly, the Government has withheld permission. Whether a Government-run station is being planned or not is unknown; but it is doubtful whether such a station would appear for several years at the very least. To my mind this is rather a pity, because, apart from other considerations, television in Singapore would open a welcome overseas market to British manufacturers.

Without television, most radio interests are concerned with sound transmission and reception. So far as transmitted programmes are concerned, a large number of BBC recordings are used for English broadcasts both at Singapore and Hong Kong; these recordings consisting mainly of popular items such as "Take It From Here" and "P.C. 49." Radio Hong Kong caters for English and Chinese audiences, this being done fairly easily by using two separate wavelengths; but Singapore has to broadcast to a mixed audience of English, Chinese, Malays and Indians. Something of a headache!

There is a fair amount of interest both at Singapore and Hong Kong in high-fidelity reproduction but very little home-construction is attempted, listeners being satisfied with commercial units. LP records seem to sell quite well.

Apart from the peculiar factors raised by the very humid climate in Singapore, servicing seems to raise no unusual problems. Quite a lot of servicing work is carried out by Indians or Chinese, usually under European super-

vision, and this system works quite well in practice. I was interested to note that the old enemy — "tuning capacitor howl" on the short wave bands — hardly appeared at all; and, even when it did, only on the cheaper receivers. This trouble used to be a common complaint when I was in Southern Rhodesia five years ago. I was also a little intrigued at the comments of a friend in the trade at Singapore when he remarked that many Chinese are interested only in receivers which are simple to operate and give plenty of volume. They do not even want tone controls!

#### Aerials

One of the first things that caught my eye on returning to the U.K. was the vast array of TV aerials which have sprung up all over the country in the last year. Of course, TV aerials are going up continually all the time, but one needs to be away for a while to gain the full impression.

TV has now, fortunately, almost entirely overcome its early impression of being a "rich man's hobby." The initial cost of a commercial receiver is high; but to my mind such expenditure is an investment. Of course, the knowledgeable amateur can enjoy the best of both possible worlds, since he can gain pleasure from building his own receiver as well as saving money in the process.

I do honestly think, however, that the quality of the programmes transmitted could still be considerably improved. So far as vision is concerned the entertainment value of a talk, for instance, is only slightly higher than that of a test card. The BBC has always had a penchant towards educating us ignorant types; but I do wish they would suppress their zeal, especially in the evenings.

#### TV From Batteries

I seem to remember describing, several years ago, a radio set I fixed up for some relatives who live in the country. The point of interest in this particular set was given by the fact that the only available supply was given by a 24-volt battery system. This receiver has been relegated to the background because my relatives now have TV — also supplied from 24-volt batteries!

The set-up they use is as follows: a small ex-W.D. dynamo driven by a paraffin engine gives a floating charge of approximately

10 Amps to four twelve-volt accumulators connected in series-parallel and having a total capacity of 200 Amp hours at 24 volts; these accumulators provide lighting in the house (lighting consumption varying between 2 and 10 Amps), and, in addition, feed a rotary converter (ex-W.D. as well) which gives a nominal 230 volts at 50 cycles. The TV receiver, a conventional commercial model, then runs from the converter output. The converter is, of course, only switched on for viewing.

This arrangement has, to date, given no trouble. The converter and dynamo are sited about fifty yards from the set and the aerial, and they cause no interference at all. Indeed, apart from the obvious measures of earthing the frames of the dynamo and converter, and of connecting a couple of 0.01  $\mu$ F capacitors between the brushes of the dynamo and earth, no precautions against interference from this source have been taken at all. TRS wire is used throughout for all connections and wiring. The converter is unregulated but, so long as the batteries are kept fairly well charged, the voltage supplied to the receiver remains quite stable enough for satisfactory viewing.

The only fault I have noticed on the equipment is a small frame "wobble" at the centre of the picture. The wobble occurs at a slow speed and is mainly noticeable on stills. The effect usually clears after half-an-hour or so.

This trouble is, of course, most probably caused by the frequency of the converter output varying from 50 cycles, with the result that the frame time base output is distorted at the "difference frequency," as it were. If this is the case it is quite fortunate that the converter settles down to a reasonably steady 50 cycles after half-an-hour's running!

For the sake of the record, I had better mention that probably the best method of running a TV set from battery supplies consists of using a converter with a DC output feeding an AC/DC receiver; and that converters of this type, designed for 50 or 110 volt DC inputs, are available commercially.

However, if any reader wishes to have more specific information on the particular 24-volt installation I have just described, I shall be only too pleased to pass on any facts I know. I would also be interested to hear of any other power supply problems which have been solved by similar means.

#### CAN ANYONE HELP?

Mr. E. C. Newstead, c/o G.P.O., Hunstanton, Norfolk, would be particularly interested to hear from readers who have converted ex-W.D. units to 'scopes using VCR/97 or VCR138. Information about such units which are still available on the surplus market will also be welcome.



# Valves and their Power Supplies

PART 10

BY F. L. BAYLISS, A.M.I.E.T.

## Trouble Free Service

SO POPULAR is the mains-battery super-heterodyne and so convenient and satisfying the facilities that it offers as a general purpose receiver, that, in discussing these receivers again, the writer can only offer this popularity as his excuse.

Moreover, at the present time, the supply of inexpensive metal rectifiers shows little signs of diminishing in the ex-WD markets.

Many of these rectifiers are highly suitable—almost ideal—for use in the power supply circuit of a mains battery superhet, and render the cost of the power pack so low as to tempt even those who require only a battery portable to go the whole hog, for a few extra shillings, and include the mains facility for possible future use.

To those contemplating the inclusion of such a power pack, then, the metal rectifier has much to offer. Simplicity of wiring, robust construction and a lifetime's trouble-free service place it in a class by itself. Even at double the cost it would be worth quadruple in usefulness.

## The Circuit

The circuit of Fig. 32 is offered as an arrangement to meet the demands of the most exacting of constructors.

A high degree of smoothing, low power dissipation, maximum safeguard of the valves, ease of switching and accuracy of supply voltages and current, all combine with the inherent simplicity to form a most suitable arrangement.

The 4-pole, 3-way switch gives "MAINS," "OFF" and "BATTERY" positions. The "OFF" position is central so that when switching from "MAINS" to "BATTERY" capacitors C<sub>2</sub> and C<sub>3</sub> are short-circuited to chassis in the central position, thus preventing high surge voltages from damaging the valves.

The switching arrangement has the slight disadvantage that the choke and capacitors C<sub>4</sub> and C<sub>5</sub> remain at mains potential in the "OFF" and "BATTERY" positions, but, in the writer's opinion, this is no more

inconvenient than the usual arrangement where S<sub>2</sub> is placed directly in the upper mains lead. As it is, S<sub>2</sub> performs the very useful function of disconnecting the large value electrolytics C<sub>4</sub> and C<sub>5</sub> when running off batteries, and prevents possible battery leakage.

HT smoothing is effected by the smoothing choke, C<sub>4</sub> and C<sub>5</sub>. It is desirable to prevent too great a voltage rise when running off AC mains—to keep the voltage about equal to the input voltage, in fact, if at all possible. To this end the values of C<sub>4</sub> and C<sub>5</sub> should each not exceed 8.0μF, the necessary degree of smoothing being catered for by a good quality choke having an inductance of not less than 20 henrys.

As the components used by constructors will doubtless vary, however, adjusting resistors R<sub>2</sub> and R<sub>3</sub> have been included to prevent too high a voltage being supplied to the valve filaments. A millimeter may be inserted between pin 1 of V<sub>4</sub> and chassis, and, with the receiver switched on, the adjusting plug inserted to give a reading of approximately 50mA through the valve filament chain. Alternatively, of course, a 500Ω preset type wirewound potentiometer may be used in place of R<sub>2</sub> and R<sub>3</sub>.

The HT voltage is dropped to 90 volts by resistor R<sub>1</sub>, whilst capacitor C<sub>3</sub> gives some additional smoothing to the mains HT voltage, but acts primarily as an HT battery bypass capacitor.

Resistor R<sub>6</sub> is used to by-pass the combined anode currents of V<sub>1</sub> and V<sub>2</sub> and to prevent this current adding to the normal filament current of V<sub>3</sub> and V<sub>4</sub>.

Resistor R<sub>7</sub> performs a similar function in respect of by-passing the cathode current of the half of V<sub>4</sub> between pins 5 and 7, i.e. of preventing this current from flowing through the other half of V<sub>4</sub> filament.

Final smoothing of the filament current, mains working, is provided by C<sub>2</sub>.

The correct value of bias resistor with this valve arrangement is 820Ω, but, on mains, the filament chain current also flows through this resistor on its way to the return side of the mains.

An additional resistor, for mains working only, is connected in parallel with the 820Ω resistor R<sub>5</sub>. This resistor, R<sub>8</sub>, keeps the bias potential at its previous (battery) voltage.

## Automatic Bias Voltages

By virtue of the series filament arrangement

of the valves, the filaments of valves in the upper part of the chain will be positive with respect to chassis by the voltage across filaments of valves below them.

Thus, instead of returning valve grid leads to chassis, as usually, the grid return may be made to an appropriate point in the filament

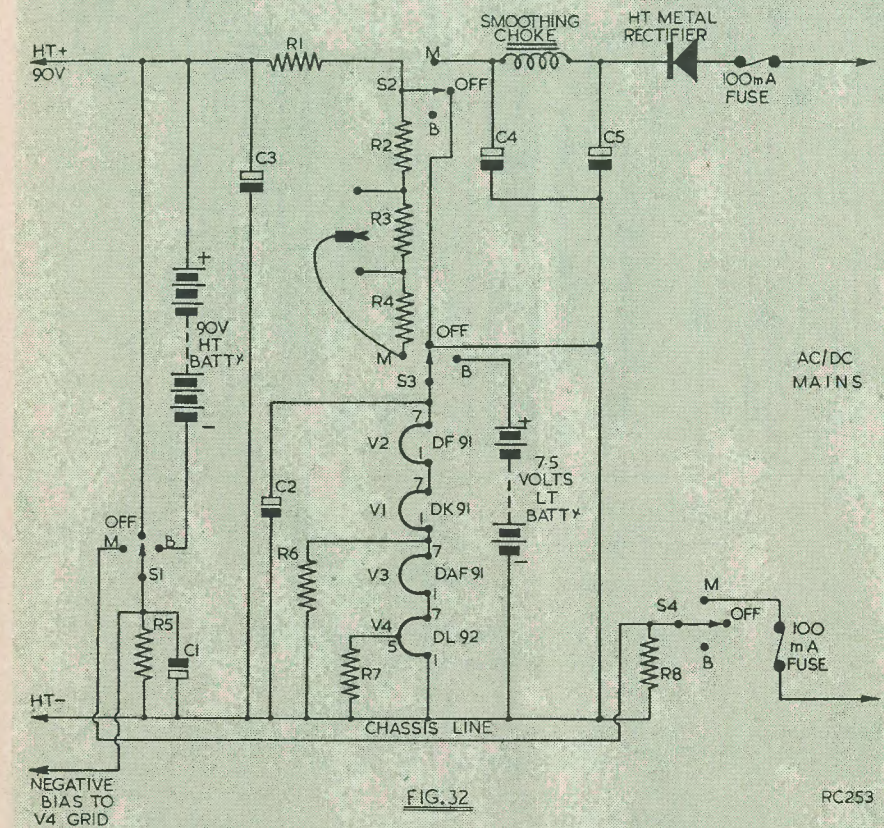

List of Components for Fig. 32

R <sub>1</sub>	— 10kΩ, 3 Watts	2	— 100mA Fuses and Fuseholder.
R <sub>2</sub> , R <sub>3</sub>	— 390Ω, 1 Watt	C <sub>1</sub> , C <sub>2</sub>	— 25μF, 25 Volts Electrolytic
R <sub>4</sub>	— 4.7kΩ, 10 Watts	C <sub>3</sub>	— 2.0μF Electrolytic, 360 Volts Wkg.
R <sub>5</sub>	— 820Ω, ½ Watt	C <sub>4</sub> , C <sub>5</sub>	— 8.0μF plus 8.0μF Electrolytic — 450 Volts Wkg.
R <sub>6</sub>	— 560Ω, ½ Watt	V <sub>1</sub>	— Mullard DK91 (1R5)
R <sub>7</sub>	— 270Ω, ½ Watt	V <sub>2</sub>	— Mullard DF91 (1T4)
R <sub>8</sub>	— 150Ω, ½ Watt	V <sub>3</sub>	— Mullard DAF91 (1S5)
1	— 4 pole, 3-way, Miniature Rotary Switch	V <sub>4</sub>	— Mullard DL92 (3S4)
1	— 20 Henrys, 60mA Smoothing Choke		
1	— Metal or Selenium Rectifier, — 250 volts, 60mA		



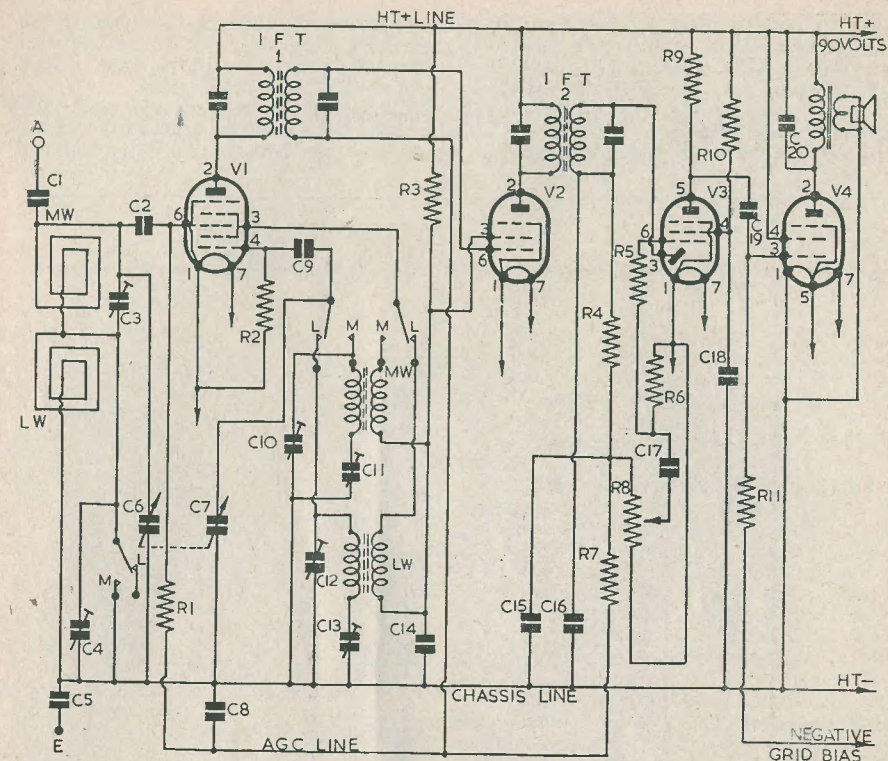

FIG. 33

Circuit of a receiver suitable for use with the power supply shown in Fig. 32

List of Components for Fig. 33

- |                  |                              |              |                      |
|------------------|------------------------------|--------------|----------------------|
| R1, R11          | — 1.0MΩ, ½ Watt              | C8, C14, C18 | — 0.1μF, Tub., Paper |
| R2               | — 100kΩ, ½ Watt              | C11          | — 500pF, Preset      |
| R3               | — 27kΩ, ½ Watt               | C13          | — 200pF, Preset      |
| R4               | — 47kΩ, ½ Watt               | C17, C20     | — 0.005μF, Mica      |
| R5               | — 22kΩ, ½ Watt               | C19          | — 0.01μF, Mica.      |
| R6               | — 6.8MΩ, ½ Watt              |              |                      |
| R7, R10          | — 2.2MΩ, ½ Watt              |              |                      |
| R8               | — 1.0MΩ Carbon Potentiometer |              |                      |
| R9               | — 470kΩ, ½ Watt              |              |                      |
| C1               | — 0.002μF, Mica              |              |                      |
| C2, C9, C15, C16 | — 100pF, Mica                |              |                      |
| C3, C4, C10, C12 | — 100pF, Preset              |              |                      |
| C5               | — 0.1μF, 1,000 Volts Wkg.    |              |                      |
| C6, C7           | — 500pF Two-Gang Tuner       |              |                      |
- MW and LW Frame Aerial } Or Osmor  
 MW and LW Oscillator Coils } Type "B"  
 } Coilpack
- One pair 465kc/s IF Transformers (RSGB, Semi-Midget)  
 One Output Transformer Ratio 50:1  
 One 3Ω, M/C Loudspeaker.  
 One 2-socket "A" and "E" Socket Strip Valves and Batteries as for Fig. 32.  
 One 4-pole, 2-way Rotary Wavechange Switch (Not required with Osmor Coilpack).

chain to give an automatic negative bias to the valve grid concerned.

This is an important point, and should be made clear by reference to Fig. 33.

The grids of V1 and V2 are connected together by R7 and R8. By connecting the lower end of the volume control R8 to V3 pin 1 instead of to chassis, V1 will be given a bias of -1.4 volts—that due to the voltage across the V3 filament—whilst V2, the first valve in the chain, becomes biased by -2.8 volts due to V1 and V3 filament voltages.

V3 itself, which normally requires no bias voltage, has its grid resistor R6 returned to its own negative filament-pin and thus remains unbiased.

V4 derives its bias from R5 and R8 (Fig. 32) as stated previously.

One further point: the diode anode of V3 is located, inside the valve, at the negative end of the filament. To maintain equivalent diode anode and filament potentials, therefore, the anode return lead, via R4 and R8, must be connected to its own negative filament, and, in Fig. 33, this is effected.

A Superheterodyne Circuit

Although strictly not within the scope of this series of articles, the power supply circuit of a mains-battery receiver is so tied up with the signal circuits that it is perhaps best to give the arrangement in its entirety.

The complete circuit of a 1.4 volt valves receiver is therefore shown in Fig. 33 and a list of components is appended.

Constructors possessing suitable coils and frame aerial will, no doubt, want to use these, and for these constructors the coil arrangement of Fig. 33 is intended.

Constructors wishing to buy new coils for this circuit, however, cannot do better than buy the Osmor type "B" coil pack for short, medium and long waves. This pack incorporates a medium wave frame aerial and long wave loading coil: the connecting data is given in the Osmor leaflets, and the

padding and trimming components of Fig. 33 will not be needed. (C3, C4, C10, C11, C12 and C13).

Note upon R4

The value of R4, 4.7kΩ, together with the 150Ω resistance of the valve filaments in series, allows a filament current of 0.05A to flow through the filament chain when the HT plus potential at C4 is 240 volts.

Resistors R2 and R3 each cause a voltage drop of approximately 20 volts, when in circuit, and there is thus provision for an HT plus rise in potential (due to half wave rectification) to 280 volts.

In the writer's opinion, it is unlikely that the smoothed voltage will exceed this figure, even with higher values of capacitors C4 and C5. The circuit is thus safe, on AC.

Used on DC mains, however, it would probably be wise to reduce R4 to 4kΩ—to substitute this value for the value 4.7kΩ quoted.

There will thus be a voltage drop of 200 volts across the new value of R4, that may be raised to 240 volts by the inclusion of R2 and R3.

Constructors "on" freak mains voltages—and there are not a few, these days—may calculate the required value of R4 from the simple formula:

$$R4 = \frac{\text{Mains Volts} - 150}{0.05}$$

For instance, with a mains voltage of 190 volts:

$$R4 = \frac{190 - 150}{0.05} = \frac{40}{0.05} = 800 \Omega$$

The nearest commercial values obtainable will probably be 3,500Ω and 150Ω, and these two, of 10W and ½W rating respectively, may be used in series.

FOOTNOTE

The power supply circuit, as shown in Fig. 32 on page 15, allows some 220V to appear at the valve anodes in the event of one of the valve filaments breaking down.

By taking the HT+ lead from a two-resistor potentiometer, as shown in the accompanying illustration, the HT voltage rise is considerably limited should there be valve failure. The mains bias resistor is reduced to 100Ω, to allow for the additional potentiometer current.

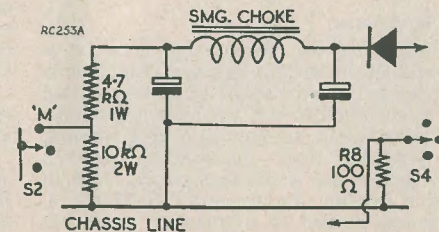



# The INEXPENSIVE

## A CHEAP and EFFICIENT CAR RADIO

By A. Tiel

PART 2, continued from p.635. Aug. '53

The red indicator lamp holder was then wired up with a twisted pair from the heater connections of the RF stage. The white indicator holder should have one side earthed to the chassis and a long flexible lead soldered to the other pole, this lead being brought out at the rear with the other external connections. This lamp takes the place of the green dash lamp which indicates when the car side lamps are switched on, and is not part of the set, and can be dispensed with if the car is of a different make, or if the set is mounted elsewhere than in the Morris 8 dash. This completes the wiring and the set is then ready for alignment.

As mentioned earlier in this article, it is essential to have the use of a signal generator to align a superhet receiver. The 465 kc/s IF coils are accurately set up by the makers before dispatch, but need trimming when in position owing to additional capacity added by the various wires and components. If a signal generator is available, the technical bulletin from Denco (Clacton) Ltd. gives ample detail on the alignment of the coils. If the constructor has no access to one of these, then it is advisable for him to take the set to the local radio shop where this work can be undertaken for a small charge. The "hit and miss" method is most unsatisfactory and a great waste of time, besides giving disappointing results.

### Car Compression

Before fitting any receiver into a car, it is essential that the various electrical components be suppressed, otherwise the noise transmitted from them would make listening impossible. The devices to be suppressed are as follows: each sparking plug, distributor, dynamo, electric pump and windscreen wiper. Not all will give trouble. In my series E Morris 8, the dynamo needed no suppression at all, but

the wiper did. In this present car it is the reverse. The wiper gave no trouble, but the dynamo produced a whine which ruined the programme.

To start with, a complete set of plug suppressors are required. These, together with the distributor suppressor, are available at nearly every garage or electrical shop at a cost of around 12/6 a set. Fitting instructions are invariably included, and the fitting of these will also remove television interference.

Next the electric pump. Various values of condensers can be fitted to eliminate the "click" as the points make and break. A  $1\mu\text{F}$  low voltage condenser is suitable, and same can be purchased for around 1/- from any shop selling surplus material. First secure the condenser by means of a clip or screw as close as possible to the pump, and take as short a lead as convenient from one terminal to a near point on the chassis, having first thoroughly cleaned the surface to which the lead is being secured. Take another lead from the other terminal and screw under the live terminal of the pump.

To suppress the dynamo, again fix as close as possible to it a  $0.01\mu\text{F}$  condenser, preferably mica (this stands up better to the heat). As before, keep the leads short, fix one to an earth point, and the other to the live insulated terminal of the dynamo. Make sure this is the one connected to the brushes and not to the field. The brush terminal is always the larger or heavier one.

In the case of the wiper, if noisy, follow the same procedure as for the dynamo; a  $0.01\mu\text{F}$  condenser usually being satisfactory.

It is also advisable to earth the engine back to the chassis by means of a piece of heavy flexible copper braid. Secure one end under the cylinder head bolt and the other to a point on

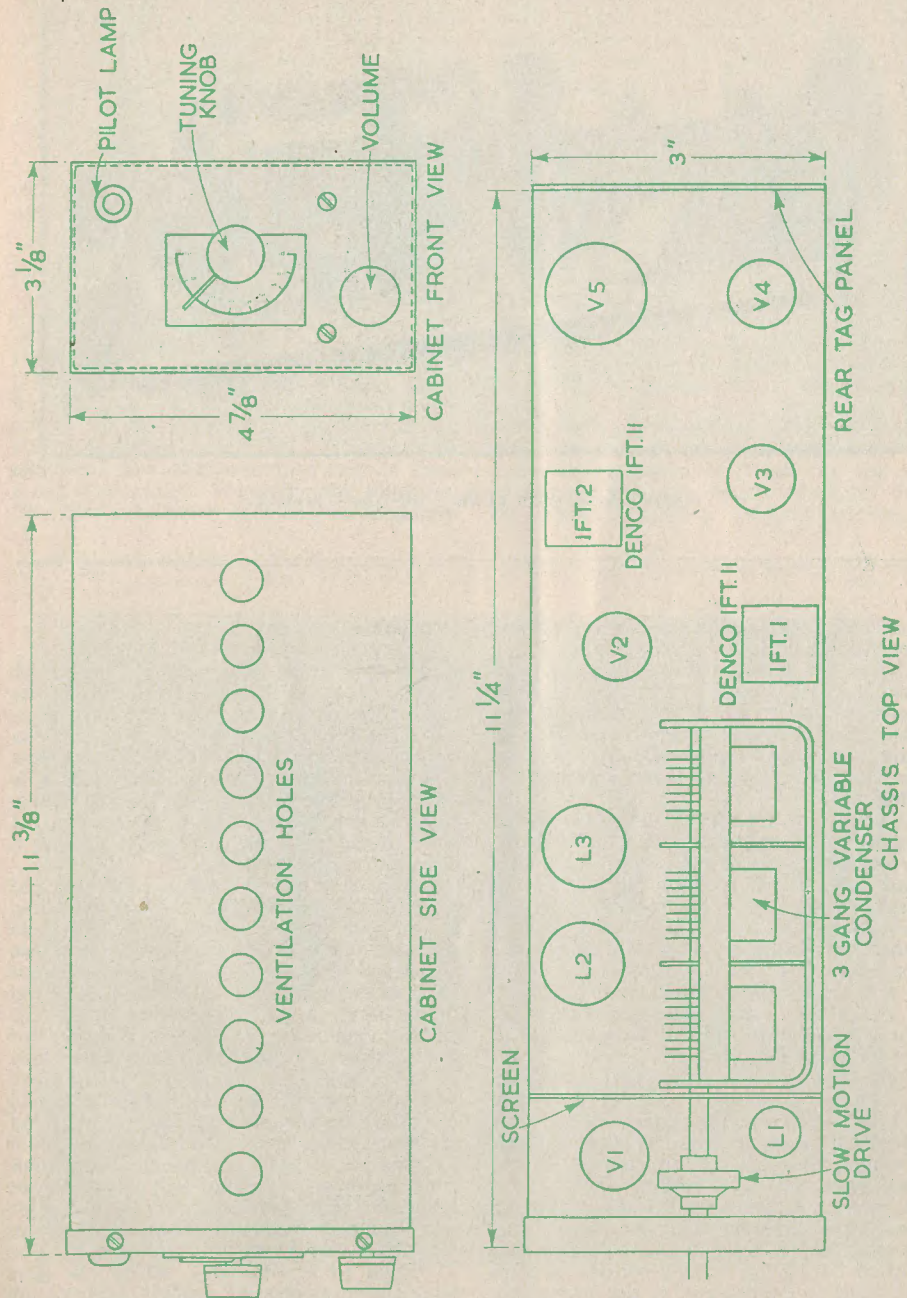



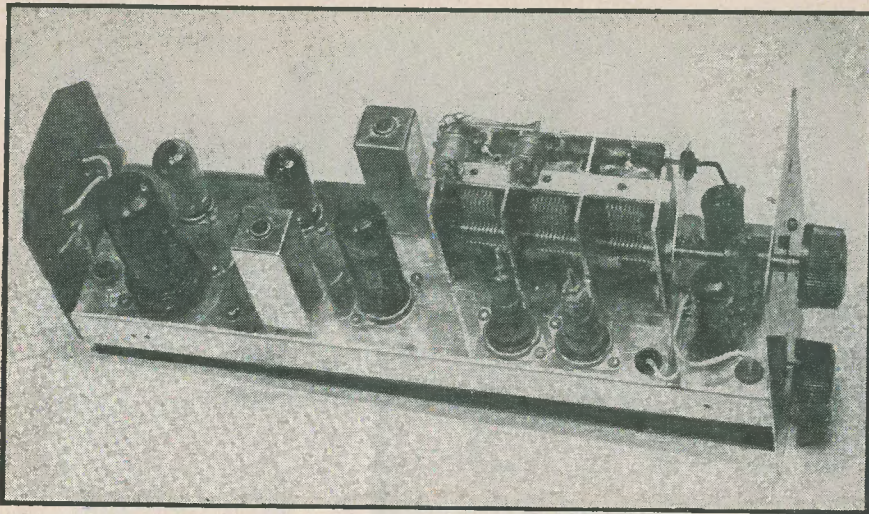

Above-Chassis View of the "All-New" version

the chassis, keeping the lead as short as possible. Allow sufficient slack for engine rock.

Always remember to thoroughly clean the chassis, i.e. scrape away any paint or oil from around the hole to which you are bolting the leads. This is essential, otherwise you may be wasting your time as suppression will not take place. Also keep all leads as short as possible.

#### Aerials

There are two types of aerials available, the metal rod pattern (whip) which fits either to the roof or chassis of the car, or the under-board aerial which is fitted beneath the car chassis. In the case of the former, it may be necessary to screen the lead down to the set; earth the screening braid as close as possible to a point near where the aerial enters the car, and again adjacent to where it plugs into the set. M.B.C. screen plugs and sockets are ideal as connectors and can be purchased at most Radio Dealers.

Quite a satisfactory underboard aerial can be made by using about 20-ft. of VIR cable fixed by means of clips around the boards underneath the car, or as in my particular case by winding them around the hydraulic copper tubes connected to the brakes. It was, however, noticed that interference was picked up when braking due to static electricity being generated at the brake drums. As this only occurred during the braking periods no steps were taken to eradicate it, as the interference was not sufficient to warrant it.

#### Installation

This applies to the 1949/52 Morris 8.

First remove the grille which, in the earlier models, is secured by three small nuts at the rear of the dash. The later type have pegs, which are held in position by spring clips, so by gently pulling, the grille slides out. Next remove the dash indicator lamp which is secured by the locking nut on the choke control. It may be necessary to lengthen the leads to the wiper switch in order to have a clean entry into the dash.

Gently slide the case through the hole and fix panel in position by two self-threading screws and brace if necessary to the cross members of the scuttle below. Join the wire which was removed from the green indicator lamp to the lead connected to the white lamp on the panel, so that it lights when the car side and head lamps are switched on. Choose your own position for the loudspeaker, which may be in the hole under the dash or in the glove box, after removing the medallion, or mounted as in my own case under the lower tray behind the gear change lever. Do not use the small 2½" speaker, it will not handle the output comfortably and distortion will result. It was found that the 5" speaker gave good volume and quality. The writer uses a Goodman T27/470 Elliptical P.M. Loudspeaker 4" x 7" which sits comfortably behind the gear lever and gives pleasing quality. Connect the lead from the plate of the 12A6 to one side of

the Transformer. The other side of the transformer joins to the HT lead from the set (see connection diagram). From the power supply, whether rotary or vibrator, take the positive HT to the HT side of the speaker transformer and the negative HT to the frame of the set. Heaters are connected across the battery. Finally connect the aerial, which may be the roof or underboard type. The set is then ready for operation. Do not run the receiver with the speaker transformer disconnected, or damage will be done to the output valve.

#### GENERAL

##### Power Supplies

Either small Rotary Converters or Vibrator Packs with an input of 12 volts and an output of 250 volts 50mA. will be satisfactory as an HT supply.

For the 12 volt car, a surplus rotary transformer type 104 Ref. 10K/238 gives ample output for the satisfactory operation of the set. It is rather a large unit, as there is an additional low tension output from a third 6 volt commutator. This is the unit which has been used consistently over the past 12 months

with the prototype. The approximate current drain when running under load with a 12 volt supply is 3½ Amps, plus ¾ Amps for the heater supply, giving a total drain of approximately 4¼ amps. There are available much smaller rotary converters with an output of 250 volts at 50mA, which draw just over 2 Amps from the battery.

For 6 volt car owners, the dinghy rotary transformer type 1, Ref. 10K/13043, will be suitable. It is advisable to remove the handle and gear wheels from this machine. If 6 volts are fed into the low tension end an output of about 220 volts will be obtainable. Do not forget to close the shunt circuit, i.e. join LT "A" negative to the terminal marked "F" in the centre of the frame. Another useful rotary is the type 57 6 volt, Ref. 10K/706. All these units can at present be obtained from Messrs. Jobstocks, 91 Beulah Road, Walthamstow, E.17.

For further information, the total HT draw from the rotaries using the surplus 12 volt valves is approximately 47mA. In the case of the two 6 volt units already mentioned, these are without smoothing. Invariably, a 0.01µF

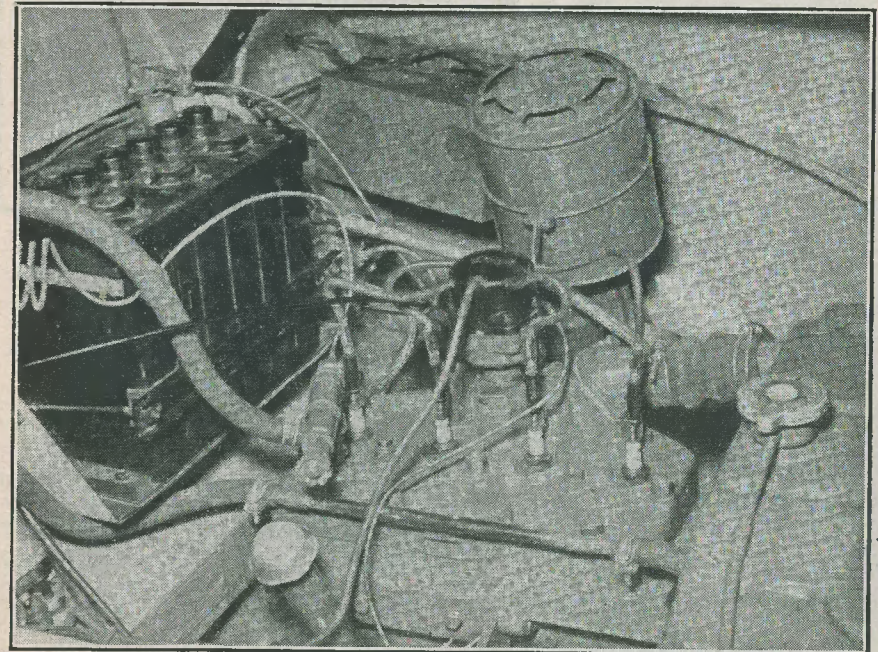

Under-Bonnet view of Author's car, showing Converter mounted to the left of the Air Filter, also Plug and Distributor Suppressors in foreground.



## FOR BEGINNERS—Resistor Colour Code

Resistors are valued in ohms ( $\Omega$ ), and to denote this value each is painted in colours which conform to a standard code. There are three arrangements, the first of which employs a body colour, a coloured end, and a coloured spot superimposed on the body colour. In the second method this spot is replaced by a coloured band. Where either the spot or end colour, or both is not apparent, then the appropriate colour is the same as that of the body. In the third method of marking, four bands of colours are used, grouped towards one end of the resistor. The innermost band of these, and any silver or gold band which may appear in the other two methods, are used to indicate the tolerance percentage and for the purposes of this article may be ignored.

The body colour, or outermost band, indicates the first significant figure of the value. The end colour, or second band, gives the second significant figure. The colour of the dot or band superimposed on the body, or that of the third band in the other method, gives the number of "noughts" to follow these two significant figures.

Colour	Figure	Colour	Figure
Black .. .. .	0	Green .. .. .	5
Brown .. .. .	1	Blue .. .. .	6
Red .. .. .	2	Violet .. .. .	7
Orange .. .. .	3	Grey .. .. .	8
Yellow .. .. .	4	White .. .. .	9

### Examples

First, in the parts list it will be noticed that some values are given in  $\Omega$  (ohms), whilst others are in  $k\Omega$  and  $M\Omega$ . k and M are, respectively, abbreviations commonly used to denote thousands (kilo) and millions (Mega). Thus, R2, 33  $k\Omega$ , is 33,000 ohms, and R12, 2  $M\Omega$ , is 2,000,000 ohms—which is more often called 2 Megohms.

Taking the colour code given above, R2 will in the first two methods be totally orange in colour (with perhaps a silver or gold marking to denote the tolerance) and with the third method will have orange for the three outermost bands. R18, on the other hand, will have an orange body and end with a brown spot or band superimposed on the body, or alternatively the outer two bands will be orange, and the third band brown. It also has a 1 Watt rating as against the  $\frac{1}{2}$  Watt for R2, and will thus be larger physically.

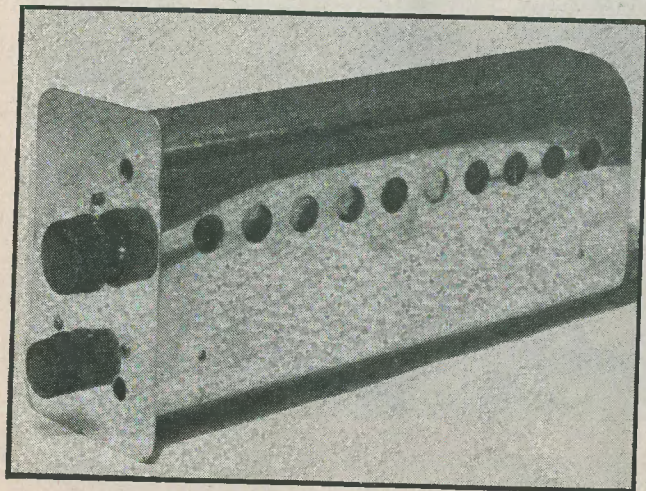

The "Inexpensive" Car Radio Receiver Cabinet, which may be mounted either vertically or horizontally, according to the space available.

condenser sweated from each brush box to a point on the rotary frame will considerably reduce interference. In some cases, however, it may be necessary to insert chokes. These units can be fitted quite satisfactorily under the bonnet or car chassis. Don't forget to mount them on a piece of rubber if possible, so as to stop mechanical noise transmission and vibration, and earth the frame to the car chassis.

In some cases it may be necessary to screen all leads where interference is noticed, but invariably if the car electrical equipment and rotary transformer is efficiently suppressed no screening of the leads is at all necessary.

When a larger rotary is used with an output of 250V at 125 or 200mA, a dropping resistor may be necessary in the HT feed. This is because the machine having only 50mA drawn from it has, in consequence, a higher voltage output, which, in some cases, may cause instability, or oscillation. The set will give very satisfactory results with an HT applied voltage of from 200 to 250 volts, drawing approximately 50mA dependent upon the supply.

A constructor's envelope containing the wiring diagram and layout can be obtained

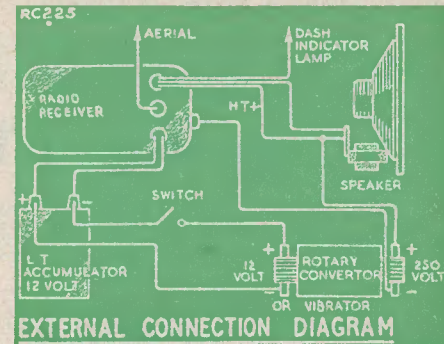

from Denco (Clacton) Ltd., Old Road, Clacton-on-Sea, Essex, price 2/6.

The writer would like to take this opportunity of thanking Mr. Fred Ruth, of Ilford, for his help in the mechanical construction and aligning of the set.

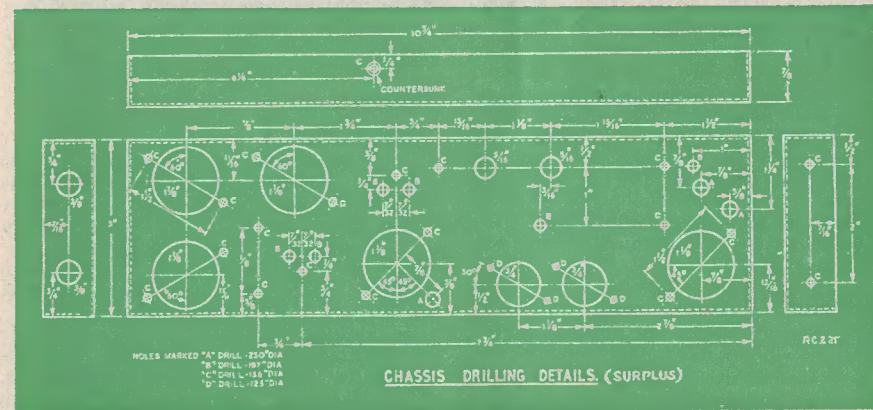

## Experimental Transmitter for Television Students

The Television Society has built an experimental 405-line transmitter to operate on 427 Mc/s with a peak power of 12 watts. The equipment is being installed at the Norwood Technical College, and in addition to providing a test signal for members interested in U.H.F. reception it will serve as a demonstration for students attending the television training classes in the College.

The call sign is G3CTS/T, and it is expected to put a signal on the air by the end of July.

The Society also has under consideration a 625-line transmitter, which will be designed and operated in collaboration with the radio industry. This will enable commercial receivers built to continental standard to be tested under working conditions.

It is not intended that either transmitter shall be operated as a commercial station, and their construction has been undertaken as part of the Society's policy of aiding the development of television technique.



# Radio Miscellany

WHEN THAT MIGHTY MIDGET, the transistor, was first announced in 1948, many constructors began to look forward to a real breakaway in contemporary radio design. With the big American corporations eagerly competing to put it into harness few guessed that to-day, five years later, transistors would still be beyond our practical experience. For us they are "just around the corner" and it seems it will be a year or two yet before we can use them in our circuitry.

It is doubtful that, even in its perfected form, the transistor will supersede the thermionic valve. There are a lot of jobs the germanium wonder cannot do, for the uses of the valve have now become legion. Even in its present state of development there are many production snags to be ironed out before the manufacture of transistors on a large scale can be achieved, and Defence and National services rightly have priority. Germanium itself is plentiful enough but its refinement to a meticulous degree of purity has to be made before it is fit for use. Then impurities have to be introduced, with equally meticulous care!

## Possibilities

The lack of access by British constructors has given rise to some doubt whether the transistor is all that it is cracked up to be. Early reports are invariably over-enthusiastic. Most of the apparatus described which incorporates them has come from American sources, and over there they are still in short supply and very expensive. The general impression in Europe is that, as a substitute for the valve, they are not yet the valve's equal, and this seems (at present) to fairly summarise the position. Thus interest in them is not so great as it might be if the transistor was as revolutionary as the early enthusiasts claimed. It is natural that constructors should ask themselves why pay a high price for a substitute of doubtful efficiency.

True, they require very little power — it is claimed that some of the later types will oscillate or amplify with a total power as

low as 10 microvolts — but modern valves are economical and, after all, for most radio purposes we are able to draw our power from the mains supply. Their advantages for portable use are obvious. The power supply is the bulkiest, and by far the heaviest part of portable equipment. A little reflection, however, suggests a wide extension of many existing radio uses as well as new applications.

The transistor might easily make the battery TV receiver an everyday affair. We cannot have a germanium CRT, but a battery CRT combined with an all-transistor receiver, is a readily conceivable probability. When that becomes cheaply possible our present TV system may have become old-fashioned, but doubtless the transistor, once established, will keep pace with other developments.

## Problems

Since the introduction of transistors it has seemed that as soon as the production of one type gets going, a new model that greatly out-performs earlier patterns emerges from the laboratory. Thus we can console ourselves that our lateness in having them available has some silver lining, however small.

On the practical side they still have a few disadvantages. In operation they are noisier than valves, particularly at audio frequencies. At RF, however, the noise lessens, decreasing inversely with the frequency. In the Megacycle range (that is for those types which can get there) operational noise is claimed to be low. The types that do work on the higher frequencies are liable to be erratic in behaviour, and much remains to be done to overcome their "stop-and-go" tendencies.

## Also in the Picture

The American periodicals have widely publicised the transistor and given much prominence to the development work carried out by their big radio corporations. The result has tended to produce an impression that it is an all-American device.

This is far from the truth. The extraction of germanium (from chimney soot) was a

discovery of British scientists made before World War II — in 1937 in fact. We still produce all the pure germanium we need. Should they run short of raw material I can let them have a few bags of soot to go on with and no doubt many others will oblige in a like manner. In exploring its possibilities a whole lot of other experimental work has been done in Great Britain, too.

One very useful feature of the transistor is the absence of a warming-up period, and while this is of only minor importance for broadcast and communication uses, it is of great advantage in many electronic applications.

The economy in size, weight and power drain, are of paramount importance for many uses, and on these points it will score heavily over the valve. Its employment for deaf-aids, etc. are obvious. Less apparent are uses such as those in miniature transmitters and receivers. Such a transmitter attached to a roving microphone and fed back to the main transmitter or recording point would enable commentators, or actors on screen or TV studio sets, to roam about freely without the need for long wires to trip over, or microphone booms to keep clear of the top edge of the frame.

## Centre Tap *talks about*

## TRANSISTORS—TVI— QSL MANNERS

### Wot! No D.F.?

The interference which marred TV reception over much of south-eastern England during the week or so prior to the Coronation fortunately stopped in time for the telecast of that ceremony. It appears that the B.B.C. were inundated with complaints and enquiries. In fact they had to appeal to viewers to desist from 'phoning them.

It was astonishing to hear the announcer, even after a week of the interference, refer to it as an "unidentified" signal being the cause of the trouble. Surely someone has some D.F. equipment? Even without, one might make a pretty accurate guess.

In my own locality it greatly varied from house to house, depending on the aerial siting. At home, signals from A.P. are quite adequate with an indoor dipole stood on the floor at ground level, at the back of the house. At the front, the dipole has to be at least twelve feet clear of the ground to pick-up a comparable signal.

At the time of the trouble the only other band I was equipped to check on was around 145 Mc/s. There the conditions were on the

poor side and no DX at all was to be heard. So sporadic-E seemed the answer.

When the full number of transmissions between 40 and 60 Mc/s get in their stride, what fun and games we are going to have each time similar conditions occur.

### No Names, No Pack Drill

Thinking of 145 Mc/s reminds me of a complaint by a reader regarding the failure of certain amateur users of this band to QSL. Presenting a new angle, he says those most lacking in courtesy seem to rank in inverse proportion to their prominence in the hobby. QSLing on the VHF bands has some additional importance in qualifying for awards, etc., apart from the question of good manners. This reader complains particularly of a number of prominent amateurs who had either requested a card from him or promised one and subsequently failed to respond. A check with a few others shows that they had not only been guilty of letting this reader down.

This column cannot normally concern itself with specialised interests, especially as there are periodicals primarily devoted to transmitting affairs. As he points out, one of these has on several occasions vaguely

threatened to "black-list" such offenders, but he believes they dare not do it. Perhaps the recently formed International V.H.F. Society will take a more courageous line in this matter through the columns of their lively paper *The Upper Spectrum*.

Among the absentees common to several lists appear two members of the R.S.G.B. Council, a regular writer of the VHF commentary, and one or two others well known in amateur circles. It is a rather perturbing state of affairs when the chief offenders appear to be the very people who might be expected to best exemplify the amateur spirit.

### K.1., P.2., Tog.3.

Last month's problem. No. 3 size referred to knitting needles which happen to be  $\frac{1}{4}$ " diameter. As they are available in a wide range of plastics and similar insulating materials of all colours, they make excellent and cheap extension rods, etc. For those who didn't guess, please look back at the clue to check if it really helped to make it as easy as I thought.



# The "UNIVERSAL" Large Screen

## AC/DC Televisor

Part 4. Described by A. S. Torrance, A.M.I.P.R.E., A.M.T.S.  
(by kind permission of IKOPATENTS LTD.)

### Wiring of Components

PREVIOUS SKETCHES AND THE TEXT have explained the procedure for voltage selection, but the actual mechanical connections require special treatment. These should not be soldered to the tapping points anywhere. The wire-ends must be made into ringed shapes and tapping connections effected by nuts and bolts.

It sometimes happens that considerable heat is generated or dissipated in these components, and your writer has known soldered joints to melt. Subsequent damage can be caused by the solder falling on other parts.

Readers residing in AC areas may be dubious about building a receiver employing series-heater technique. Without discussing

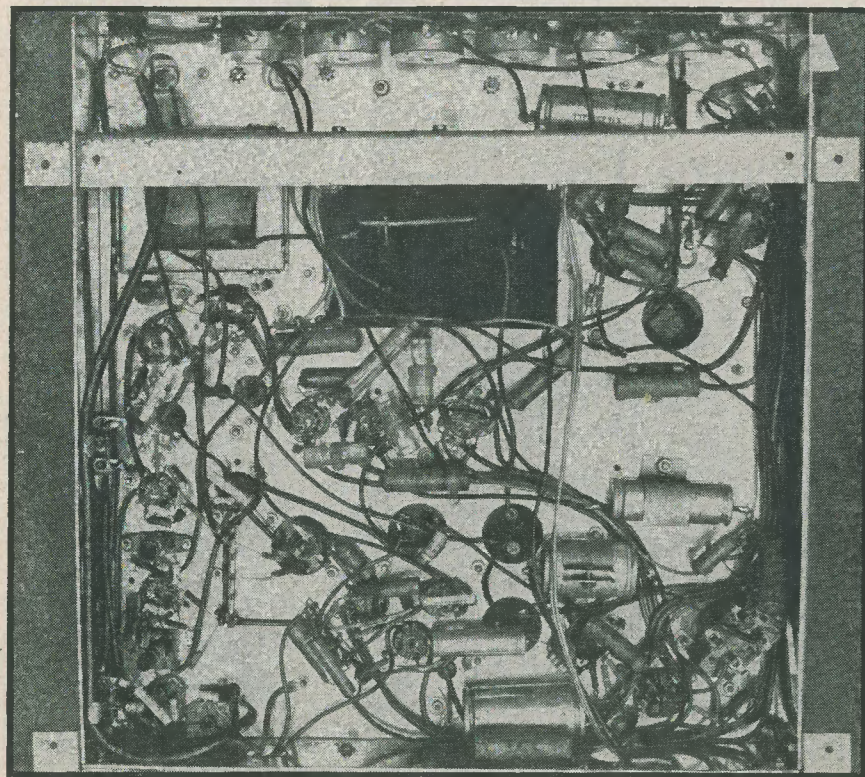

Under-Chassis View—Compare with the sketch on opposite page.

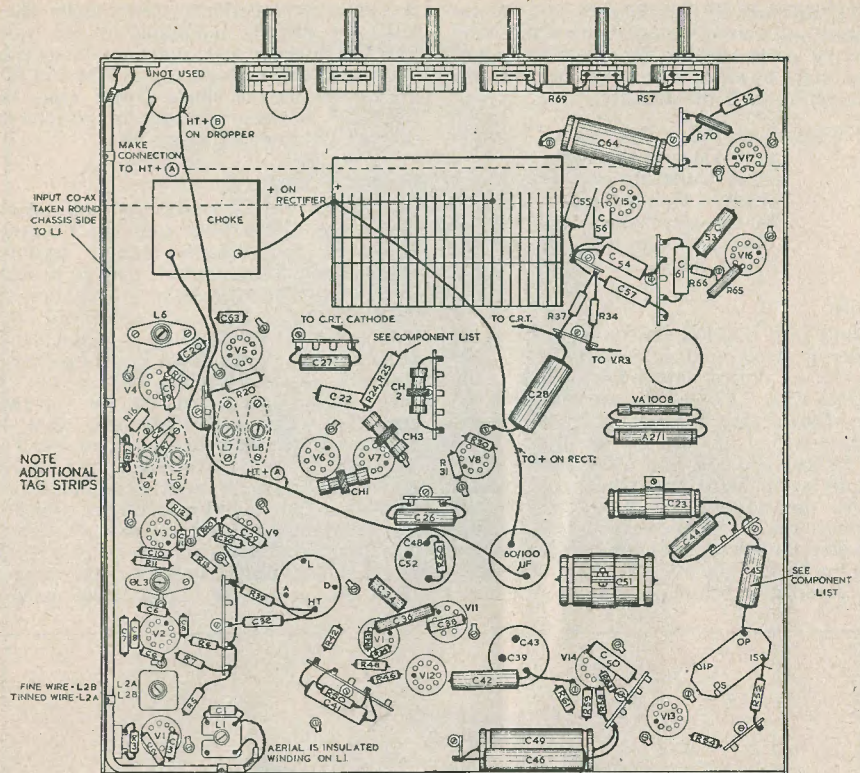

Note: Components shown not to scale but mainly emphasised for clarity  
For heater chain wiring see appropriate drawing

UNDERSIDE OF CHASSIS SHOWING LOCATION OF MAIN COMPONENTS

TV 1712

matters of economy, although quite a considerable saving is made in this TV, it is a fact that with a properly designed series arrangement the stability, regulation, and life factors of the heaters, both in the valves and CRT, are very high indeed.

In a parallel heater line-up, a considerable surge is experienced due to the transformer employed. In the series system this is easily controlled; in this case by the VA1800, and the A2/1 (750Ω resistor). Evidence of this is given by the fact that the warming-up period of the "Universal" is approximately Two Minutes Before the Picture Appears. Readers should make a note of this lest they experience any apprehensions when switching on for the first time.

### Photographs and Sketches

The "Universal" TV has been well illustrated and it was felt that with a point-to-point heater wiring diagram, and by showing the disposition of a reasonable number of resistors, condensers etc., adequate direction was available. Where a group of resistors shown are numbered, say, R3, R6, R7, quite obviously in that stage R4, R5 etc. would be present in the actual receiver, but perhaps not visible in the illustrations.

One such example: R4 and similar resistors throughout the receiver.

R4 is soldered directly to pin 8 and to pin 7 of V1. Then from pin 8, R5 is soldered to the tag-strip where connection is made to the HT+B supply. The constructor, by



cross reference to the sketches and photographs and careful recognition of the valve internal parts seen in the valve base chart may, stage by stage, wire in the components, completing each in sequence.

**NOTE**—The Black Dot shown beneath each valve in the valve drawings is, of course, the equivalent of the recessed or missing pin hole seen in the valveholders. The CRT base is wired with the key or slot as guide.

### Coils

Bolt into position the tuning coils in the order as shown and note carefully the coils shown in dotted lines, L4, L5—L7, L8. These, with L12A/L12B, are mounted on top of the chassis, the remainder underneath. Before wiring up, test L1 aerial coil (Red PVC) and grid-coil, and make sure no continuity is possible to chassis before proceeding.

At the completion of the first stage connect the HT+ circuit and bring a connection to the tag-strip of this supply for joining to R5. In this way, each stage may be completed before moving to the next.

It should be possible to have really short leads by directly mounting to the valve pins the resistors and condensers associated with each valve. Notice that R24 and R25 are shown as the single 2-watt type, but this may be two resistors in parallel as described in the component list.

### General Wiring

A solder tag is placed for convenience under one of the bolts near the Contrast, Brilliance, and Volume variable resistors. The leads for these controls may be brought through the two large holes provided on the chassis front. It is recommended that coloured PVC or sleeving be employed in the wiring-up. Thus, Black could be chassis, Red—HT, Green—Heaters, and so on. In this way final checking is greatly simplified. Coloured leads may now be attached to the deflection coils, to 4-6-1-3. These are brought down beside the Linearity and Width coils for subsequent attachment to Line-output and Frame-output transformers. (Make a note of the colours selected). The Deflection coils can now be placed into position and lightly bolted to the support (Part D). A washer of insulating material

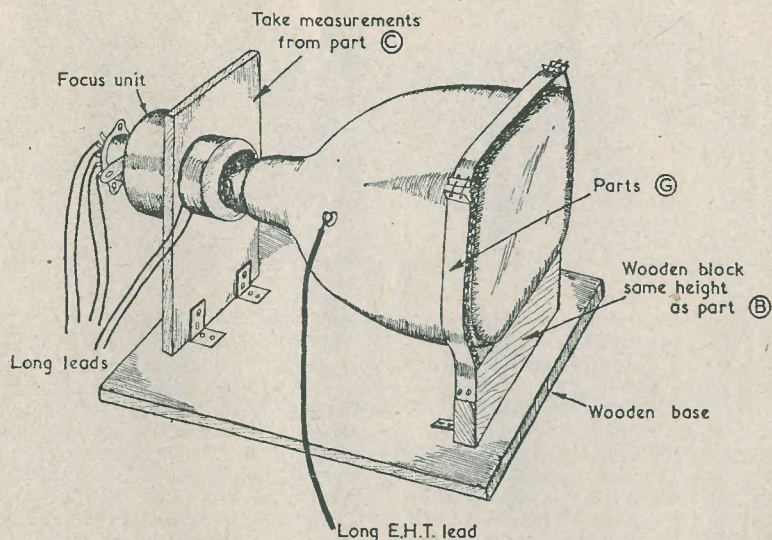

TEMPORARY MOUNTING OF TUBE ASSEMBLY

TV17/13

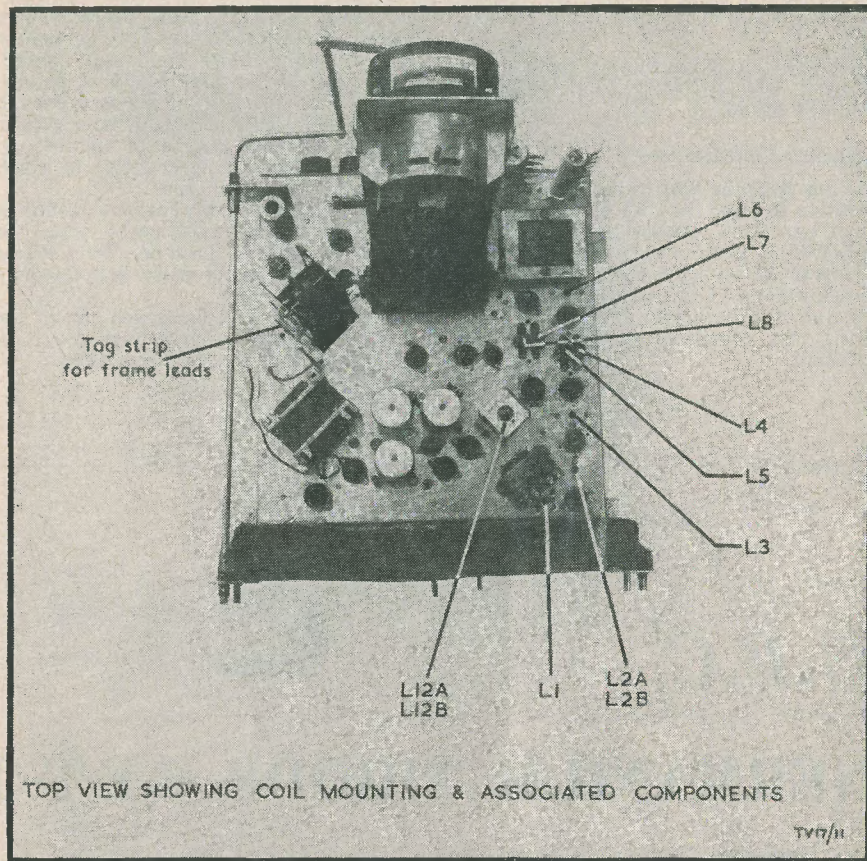

TOP VIEW SHOWING COIL MOUNTING & ASSOCIATED COMPONENTS

TV17/11

is placed between the coils and focus unit to prevent shorting the deflection connections. The Line-output transformer may now be installed. This is drilled especially for small Parker-Kalon self-threading screws. The EHT rectifier is carefully soldered into position as shown in the sketch. The greatest consideration must be given to the soldering—sharp points should be avoided. The EHT lead is attached as shown.

**Note** Orientation of transformers on chassis. The frame transformer is positioned by the side with black-white leads. These are adjacent to the Line-output transformer.

### Mains Connections

These are made directly to the two fuses (2A) and from there direct to one side of the double-pole switch. Check the switch

with continuity meter to ascertain the correct contacts, thus avoiding a short when first switching on. Take a connection from the other side of switch to chassis on the adjacent solder-tag. The remaining contact is taken to "Negative" on the rectifier, which provides an excellent anchorage for connection to the Heater Dropper.

**Note** The power supply sketch has shown the switch in the wrong position. It should be after the fuse.

### Testing Circuits

Make sure that the cans for L4—L5 and L7—L8 are not fouling the coils and condensers. Check the heater-chain again as outlined before. Ascertain that the voltage droppers are tapped to suit the local mains supply.

Test mains input connections to make certain there are no dead shorts.



Test HT circuit to chassis to detect possible shorts.

(Readers not possessing a meter may improvise with a battery and bulb for continuity testing).

### Installation Considerations

At this stage the constructor is virtually in a position to instal the CRT and valves, and switch on. This requires carefully sliding the MW43-64 in from the front and bolting up parts G. When tightly bolted, it is possible to work with the "Universal" in any position. However, it is recognised that a great many readers may experience misgivings at this procedure.

A simple and easily made answer to this situation would be the creation of a temporary CRT mounting away from the chassis. Longer leads to the tube would, of course, be required. With such an arrangement the constructor would undoubtedly have greater access to the entire chassis, or alternatively may be planning a cabinet design in which this would be a permanency.

Measurements for this auxiliary mounting are taken from the chassis parts. When the receiver is properly lined-up, the CRT is restored to its proper place and the base connection shortened.

**Note** A temporary connection from the tube-coating is also required to chassis, to be made a permanency later.

(To be continued)

# G.E.C.

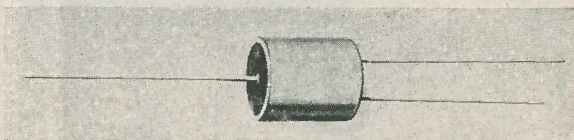

## GERMANIUM TRIODE GET 1

**A** GERMANIUM triode of the point contact type which has for some time past been exhibited by the Research Laboratories of the General Electric Co. Ltd. at the Physical Society and similar exhibitions, is now in pilot plan production in the Company's works and is available to equipment makers in sufficient quantities for experimental work and prototype equipment. The triode uses single crystal germanium, and the unit is hermetically sealed

in a metal can insulated from all electrodes. Flexible leads are provided for the connections.

The triode is suitable for use in amplifiers, oscillators and for electronic switching applications. Its low power consumption and electrical characteristics make it idea for digital computer work.

### Technical Details

The accompanying diagrams illustrate a

The most reliable arrangement for the amplification of small signals incorporating G.E.C. point-contact germanium triode. A power gain greater than 17. dB can be obtained.

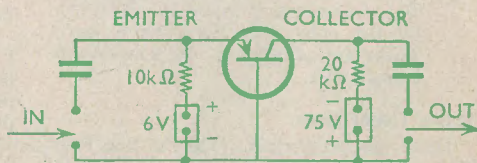
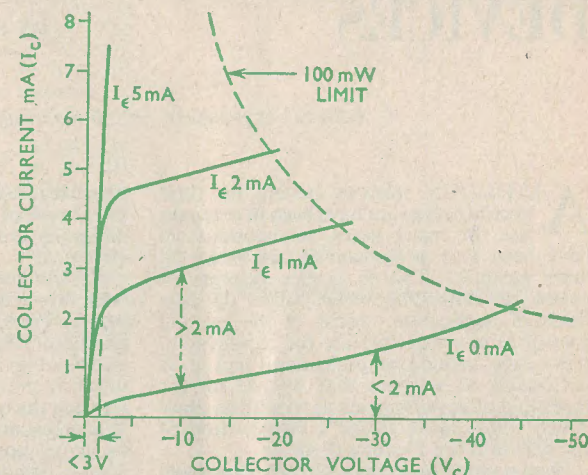

Fig. 2.

typical circuit employing the new transistor (Fig. 2) and also characteristic curves of the device (Fig. 3). From these the reader can see that the current gain is greater than 2, that the "knee" voltage is less than 3, and that the collector current at -30V for zero

emitter bias is less than 2 mA. The maximum D.C. collector voltage is -50V, but normal operation is with much lower voltage, supplies of 22½V being typical. Whatever the collector voltage used the dissipation should be kept below 100 mW.



Static characteristics of G.E.C. point-contact germanium triode.

Fig. 3.

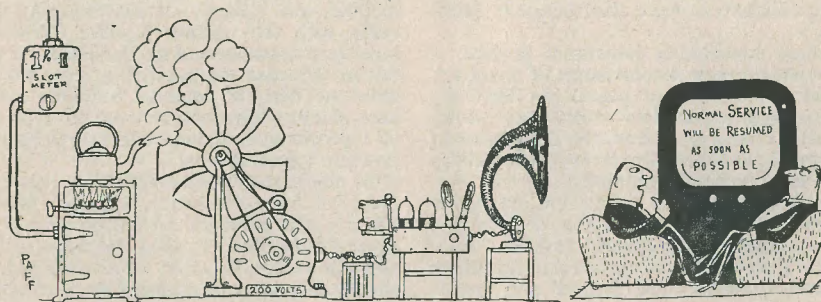

"There's a lot to be said for Steam Radio"

### ERRATA

On Data Publications Order Form, page 53, under Miscellaneous Books, the third line should read Receivers (R.S.G.B.) 3/6 postage 2d, and the fourth line Simple TX Equipment (R.S.G.B.) 2/- postage 2d.



# SEMI-CONDUCTOR DEVICES

by A. L. PARDEW

*A Survey of rectifiers, crystal diodes and transistors*

**A**LTHOUGH DEVICES relying on their special properties have been in common use for many years, semi-conductors have been very prominent in the technical news recently. This is largely because of recent developments which open up new fields of application. Most of the existing uses of semi-conductors are for rectification. New uses include amplification, and it is reasonable to suppose that we are on the threshold of developments as fruitful as those which followed de Forest's introduction of the grid into the Fleming diode.

Semi-conductor devices already developed can do many of the jobs which were hitherto the exclusive prerogative of thermionic valves, and their advantages over the latter are due to the elimination of two features, namely, the hot emitter and the vacuum which, whilst essential to the operation of thermionic valves, were also the main weakness.

Before considering individual devices, a few notes on their general mode of operation would not be out of place, but anything approaching a complete explanation would require a highly advanced mathematical treatment, so the information which follows is necessarily highly simplified.

Semi-conductors as a class are crystalline in structure, which means that their atoms are arranged in an orderly fashion. In a perfectly pure state the electrons in the atoms of semi-conductors are 'bound' and unable to move from one atom to the next under the influence of an electric field; in other words, they are insulators. The presence of minute quantities of suitable impurities, however, gives a few 'free' electrons which allow conduction. This conductance is much poorer than that of common metals (about a million times poorer) because of the small number of current carriers, hence the term semi-conductors. Such a semi-conductor is called 'n'

type because the current carriers are negative. In the case of germanium, traces of arsenic or antimony are typical providers of the excess electrons.

Certain other elements as impurities give what are called positive holes. These can best be described as gaps lacking an electron and into which electrons easily move. An electron moving into a hole leaves a gap from which it moved, so that the hole appears to move in the opposite direction to the electron. It is convenient to regard these positive holes as actual positive charges when considering semi-conductors.

When a metal whisker is put in contact with an 'n' type semi-conductor a potential barrier appears which makes it much more difficult for electrons to move from the metal into the semi-conductor than in the opposite direction, hence the combination forms a rectifier, the polarity of easy current flow being with the whisker positive. With 'p' type semi-conductors a similar effect occurs, but in this case the polarity of easy flow is with the whisker negative. Similar effects take place at junctions between 'p' type and 'n' type material, and this effect is the basis of junction type rectifiers.

By placing two whiskers closely spaced on a piece of semi-conductor, current in one whisker will influence current flowing to the other. This effect is called transistor action, and allows amplification to be obtained. A similar effect may be achieved by sandwiching a thin layer of 'p' type material between two of 'n' type material, or vice versa, and this is the basis of n-p-n and p-n-p junction transistors.

## Rectifiers

Before considering semi-conductor rectifiers in particular, a few general words on rectifiers will be a useful preparation. Although no such thing exists, a perfect rectifier would have zero resistance in one direction and infinite resistance in the other, i.e. its curve would be a right angle, and since there would be no voltage drop in the forward

direction and no current in the reverse direction, there would be no dissipation to cause heat and infinitely large powers could be handled. In practice, all rectifiers are imperfect to some extent, and the purpose for which they can be used and their ratings depend on the degree of imperfection. A detailed study of rectifiers, therefore, is chiefly a study of their limitations. The thermionic valve is included below for comparison since it is probably the type of rectifier most familiar to the majority of readers.

**Vacuum Valve.** Because of the vacuum between its electrodes this type of rectifier will withstand high reverse voltage. Receiving types will work at over 1,000 volts and the largest X-ray types go up to 250,000 volts. In the forward direction there is appreciable impedance, giving rise to voltage drop which not only lowers the rectification efficiency but also results in heating which means that a current limit must be set. The total amount of emission from the cathode also affects the rating.

**Gas Valve.** By introducing a suitable gas at low pressure, the thermionic valve can be given a much lower forward impedance by allowing gas ions to carry the current instead of electrons. This advantage is gained at the expense of certain other properties such as response to high frequency.

**Copper Oxide.** The first semi-conductor power rectifier to come into general use was the copper oxide rectifier. It has a low forward resistance, but compared with thermionic valves its back resistance is also low, and in addition it will only handle a limited reverse voltage without breaking down. To rectify mains voltage, a considerable number of elements have to be put in series. As in all semi-conductor rectifiers the back resistance falls with increasing temperature, so that cooling fins are necessary for efficient operation. The greatest advantage of this type of rectifier is its robustness and long life. Owing to the high self capacitance the frequency response is limited, and even with small rectifiers about one Mc/s is the extreme top limit. The main uses of this type of rectifier have been for power rectifiers, meter rectifiers and telephony modulators.

**Selenium.** Selenium rectifiers have largely replaced copper oxide in the power rectifier field. Their forward resistance is higher for each element, but because they withstand a higher back voltage, a smaller total number of elements is needed, so that the total resistance is less than that of copper oxide, and higher efficiency is obtained. Where low voltages are involved and only a single element is required they give in general a poorer

performance than copper oxide and, therefore, the latter is still used in preference for meters and telephone modulators.

**Silicon Crystal.** The present day silicon crystal is a direct descendant of the crystal detector used in the early days of wireless. The most common material used in those

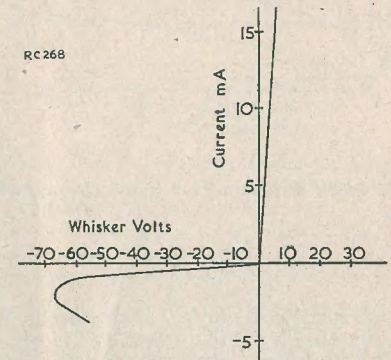

FIG. 1. Static characteristics of typical germanium crystal diode

days was galena or lead sulphide, but silicon itself was not unknown. It was reinstated after its eclipse by the thermionic valve because of the need for an efficient mixer at centimetric wavelengths, and for this purpose it is still paramount. The silicon used for this purpose contains an impurity, usually boron, to give 'p' type conduction, and a tungsten whisker is used. Good efficiency and low noise can be obtained at frequencies in excess of 30,000 Mc/s. It has a forward resistance lower than that of a small thermionic diode, coupled with a moderate back resistance. It will only withstand a few volts in the reverse direction, but this is of no importance for mixer use. It is easily burnt out by overload and special precautions have to be taken in Radar equipment to prevent pulses from the transmitter reaching the crystal.

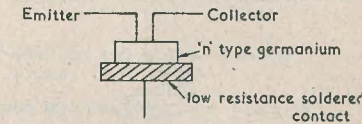

FIG. 2. DIAGRAM OF POINT CONTACT TRANSISTOR

**Germanium Crystals.** In the search for a suitable Radar mixer, germanium was con-

EDITOR'S NOTE—Practical applications in preparation.



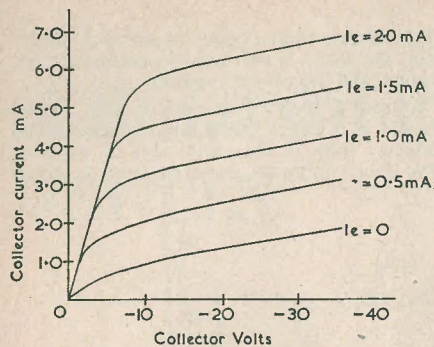

FIG. 3. Static characteristics of typical point contact transistor  
RC276

sidered but rejected in favour of silicon. It was, however, noted that it was able to withstand surprisingly high back voltage, and after the war the germanium crystal was developed for radio and television applications in competition with the thermionic diode, and is now coming into wide use. Its special advantages include small size, low capacitance, good high frequency performance, very long life and absence of a heater. Its back resistance is, in present production, often less than a Megohm and exhibits a considerable variation. Selection is, therefore, carried out into various types, graded according to back resistance, and in general the higher the back resistance the higher the price. In selecting a crystal for a particular purpose it is usual to select the grade with the lowest back resistance that the circuit will tolerate. The exact properties depend on the impurity content, and as improved techniques are introduced high back resistance and high back voltage types tend to fall in price.

The characteristic curve of a typical germanium crystal is shown in Fig. 1. This is a general purpose type such as the GEX45/1

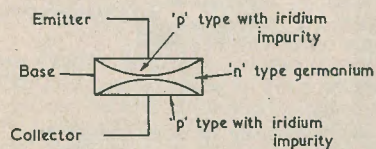

FIG. 4. Diagram of p-n-p junction transistor  
RC271

or the American IN34. Its reverse current is measured at -50 volts, and has to be less than  $800 \mu\text{A}$ . No measurements of back current or limits are imposed at other values of voltage, but the back resistance will tend to increase with decreasing voltage, reaching a maximum at about -3 volts. This variation in back resistance with applied volts is sometimes overlooked, but it is very important to take the effect into account when designing circuits around crystals. At very small values of applied voltage the forward impedance rises and the back impedance falls, so that the front to back ratio falls to a lowish figure.

The most widespread use of germanium diodes at the present moment is probably in the sound and vision detector stages of T.V. sets, but their small size and other convenient features have resulted in large numbers of miscellaneous applications in electronic equipment.

**Junction Diodes.** The rectifier formed by a junction between 'p' and 'n' type material gives a power rectifier which is superior to either copper oxide or selenium. Efficiency is so high that size can be enormously reduced. Germanium junction rectifiers are in production in U.S.A. but are not yet available in this country. Silicon can also be used for this purpose, and has the advantage of giving better performance than germanium at higher temperatures.

**Point Contact Transistors.** The action of the current in one whisker affecting that in the adjacent one is best explained by regarding the first whisker as injecting positive holes into the semi-conductor and making it more conductive. The whisker used for this purpose is known as the emitter, whilst the other whisker is called the collector. The 'n' type germanium which is the usual semi-conductor material employed in these devices is called the base. The device is shown diagrammatically in Fig. 2. Its family of curves shown in Fig. 3 bears some similarity to that of a thermionic pentode but this similarity does not extend very far. It will be noted that the collector current is plotted against collector voltage for various values of emitter current instead of voltage. The input impedance of a transistor is low and usually below  $500 \Omega$ . The output impedance is in the region of  $20,000 \Omega$ . Circuits to use them have to be different in many respects from those which are familiar for thermionic valves, and a new approach is needed. It is better to regard the devices as current amplifiers rather than voltage amplifiers. No attempt will be made here to go into detailed applications, but it is thought that the most fruitful fields will be in computers and in Services equipment where space and ruggedness are at a premium. It will be noted that a negative H.T. supply is needed for point contact transistors, and that positive

bias is applied. Input and output signals are in phase and, since there is a current gain within the device, negative resistance effects are readily obtained. The upper frequency limit of transistors at present in production is in the neighbourhood of  $2 \text{ Mc/s}$ , but by special techniques operation up to hundreds of Megacycles has been achieved. Two rather severe limitations of the point contact transistor are its high noise factor and its limited power dissipation. These devices are now available in limited quantities in this country at a price which at present is high but will fall as production builds up. More complex transistors using additional contacts are the subject of experiment.

**Junction Transistors.** The junction type transistor is more recent than the point contact type, and in some directions has distinct advantages over it. It is, however, not necessarily better in every case and does not render it obsolete. It can handle higher power, but has a lower limit of frequency. Its noise factor is appreciably lower. One method of producing the necessary junctions is by diffusing a metal called indium from both sides into a piece of 'n' type germanium. If properly controlled this produces two zones of 'p' type germanium separated by a thin layer of the original 'n' type material. The device is shown diagrammatically in Fig. 4. The junction transistor is capable of giving good amplification at extremely low values of applied voltage, as can be seen from the curves in Fig. 5, and amplifiers can be made with a high tension supply of 1.5 volts or less. Obvious applications for this device are in deaf aid amplifiers and local telephone amplifiers. A truly enormous field of application is available when these devices can be produced in quantity at a reasonable price. At present there is limited production in America, but none in Great Britain. Here

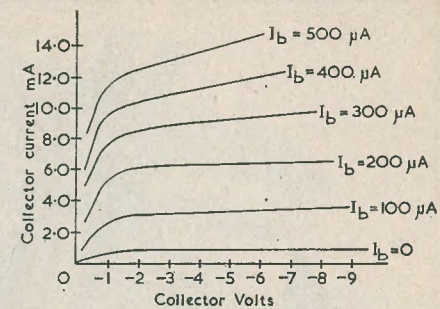

FIG. 5. Collector characteristic of typical p-n-p junction transistor  
RC272

again more complex devices with additional junctions are being explored.

**Photo Transistors.** The reverse current in a point contact germanium diode can be increased by shining light on it. This is the basis of the photo transistor which gives a photo cell of extremely high sensitivity and excellent frequency response coupled with minute size. These devices are not yet in production, but an obvious application would appear to be in calculating machines using punched cards.

An enormous amount of effort is being expended all over the world on the study of semi-conductors, and it is reasonable to suppose that the future holds the development of devices which will make those at present available just as crude, in comparison, as the early bright emitter valves now seem compared with modern button based miniature valves. There seems no doubt that semi-conductors will remain in the news for many years to come.

## THE RADIO AMATEUR

### August Issue—Contents

Radio Equipment for Everest  
Experimental Oscillator  
An Audio Filter Unit  
The ZU-LS Fourteen Mc/s "Minibeam"  
Making your own Miniature Soldering Iron  
Talks about V.H.F.  
Moonbeams and Moonshine

Broadcast Bands Review  
World on the Air—Jamaica  
Amateur Bands Commentary  
On the Higher Frequencies  
Around the Shacks  
New Hammarlund Communications Receiver  
SW Broadcast Station List



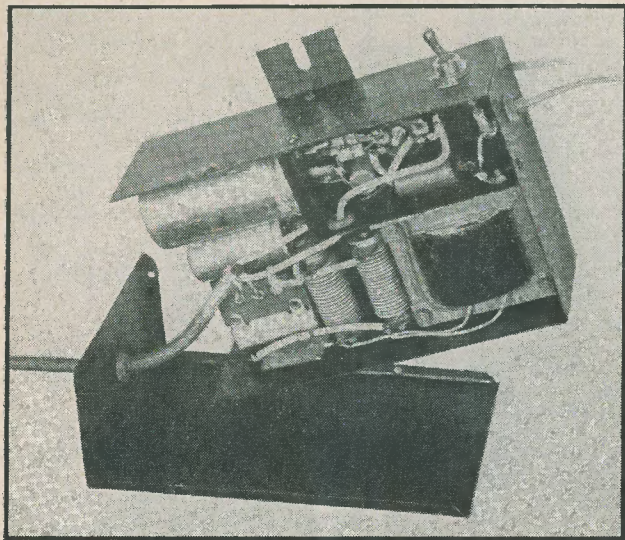

## TRADE NEWS

Stern Radio Ltd., of 109 and 115 Fleet Street, London E.C.4., have designed a Vibrator Power Pack which, apart from its other uses, is eminently suitable for the "Inexpensive" car radio receiver currently being described in this magazine.

The power pack is completely self-contained in its own metal case, and may thus be fixed in any suitable position, the input and output leads being screened to prevent any interference.

The accompanying illustration clearly shows that economy of space has been achieved without any undue cramping, and that the construction should present no difficulty at all to any reader.

The pack may be used with either 6V or 12V input, depending upon the type of vibrator and transformer which is employed. Either series or shunt types of vibrator may be used. The output is 220V at 50 mA.

A complete outfit of components, case, sleeving, wire, screws and everything necessary to build the power pack costs £3, but components can also be supplied separately. This is a useful point where the constructor may already possess some suitable items. There is also available, at 1s, a set of instructions with circuit and wiring/layout diagrams, and component price list.

Messrs. A. T. Sallis, of 93 North Road, Brighton, Sussex, have sent us a copy of their latest list, No. 10. This contains over 400 items of ex-WD gear, many of them useful types which are not normally adver-

tised. Amongst them we spotted a gun firing switch, comprising a bakelite pistol grip holder with thumb switch, which has many uses. Your writer recently used one of these in the construction of a solder gun. A bargain at 2s 6d. Another useful item, at 6d, are coils which are wound just right for the 27 Mc/s radio control band. This list is well worth the 6d charged for it.

Messrs. Radio Servicing Co., now of 82 South Ealing Road, London, W.5., have forwarded to us their latest catalogue No. 12.

This is a very well produced publication indeed; on art paper, and with a very durable cover, it will "last" well in the shack—and we can foresee it being used quite often for reference purposes. One useful item not always incorporated in catalogues is an index, but this has one which is also comprehensive.

All the items listed, by the way, are currently manufactured, not ex-WD, and they are well illustrated with, in many cases, such useful information as dimensions included. There are 70 pages and 250 illustrations—and the price is only 1s.

John Bell and Croyden, 117 High Street, Oxford, have sent us the following information on two of the miniature transformers which they are manufacturing and which are now available.



This illustration shows as near as possible the exact size of the 'O' type unit, which is, we believe, the smallest transformer at present in production in this country.

Its measurements are  $\frac{3}{8}'' \times \frac{3}{8}'' \times \frac{1}{4}''$  and it is an inter-stage transistor transformer or general coupling transformer. The inductance is 4H at 0.4 milliamps over the normal A.F. frequency band. The step-down ratio is 4.5:1 with a D.C. resistance of 870 ohms primary and 170 ohms secondary. This transformer has a mumetal core, and can be supplied with a screening can if required.



This illustration, again to size, shows the 'A' type unit, measuring  $\frac{3}{4}'' \times 9/16'' \times 7/16''$  across the bobbin.

It is an interstage transformer for matching a high gain pentode to a transistor, and has a primary of 12.5H at 50 microamps. The step-down ratio is

30:1; the D.C. primary resistance is 6,000 ohms; the secondary resistance is 80 ohms.

The Edison Swan Electric Co., Ltd., are now producing a Cathode Ray Tube with a 14" round bulb. Designated type CRM.141 this tube is fitted with an ion trap tetrode gun assembly and has an aluminised screen. The face plate is of clear glass and the tube has a B12A duodecal base. List price of this tube is £14 15s 0d plus £5 15s 1d Purchase Tax.

A further addition to the Ediswan/Mazda range is the 20P4, a new line time base output tetrode. This valve has a re-designed screen (G2) the dissipation of which has been greatly reduced, thereby enabling the valve to handle considerably higher current pulses on the active portion of the operating cycle. Owing to the improved mutual conductance figure the power sensitivity of the valve has also been increased. List price of the 20P4 is 17/6d plus 5/9d Purchase Tax.

Now available . . . . .

Data Book Series No. 8

## TAPE AND WIRE RECORDING

containing reprints of a selected series of articles which have appeared at various times in the pages of this magazine and its companion journal, *The Radio Amateur*.

Covers both theory and practice

48 pages ★ Price 2/6 ★ Postage 2d.

TRADE ENQUIRIES INVITED

available from your local supplier or direct from

**DATA PUBLICATIONS LTD**

57 MAIDA VALE LONDON W9

Telephone CUNingham 6518



# THE "SIMPLEX" THREE

## A Simple Gram Amplifier for the Beginner

by E. GOVIER

**M**ANY BEGINNERS, at some time or another, have probably felt the need for a simple yet inexpensive amplifier for use with a gramophone pick-up, or even a one or two valve receiver. To judge from readers' letters in "Mailbag," many of them beginners in the art of radio construction, it would appear that the following specification would be most popular:— Output 4 watts approximately, few component parts, cheapness, simplicity of construction and last but not least, availability of parts. All of these considerations have been complied with in the circuit presented herewith. No attempt has been made to

provide negative feedback, and, being a simple amplifier, the only refinement incorporated is a simple top-cut tone control.

A good idea of the layout, both above and below chassis, will be obtained from the photographs and these, together with the circuit diagram, should present intending constructors with a clear picture of the unit—both theoretically and physically.

### Circuit

This is shown in Fig. 1, from which it will be seen that it is a two stage amplifier with built-in power pack. The first stage comprises a 6J7 pentode with variable input circuit

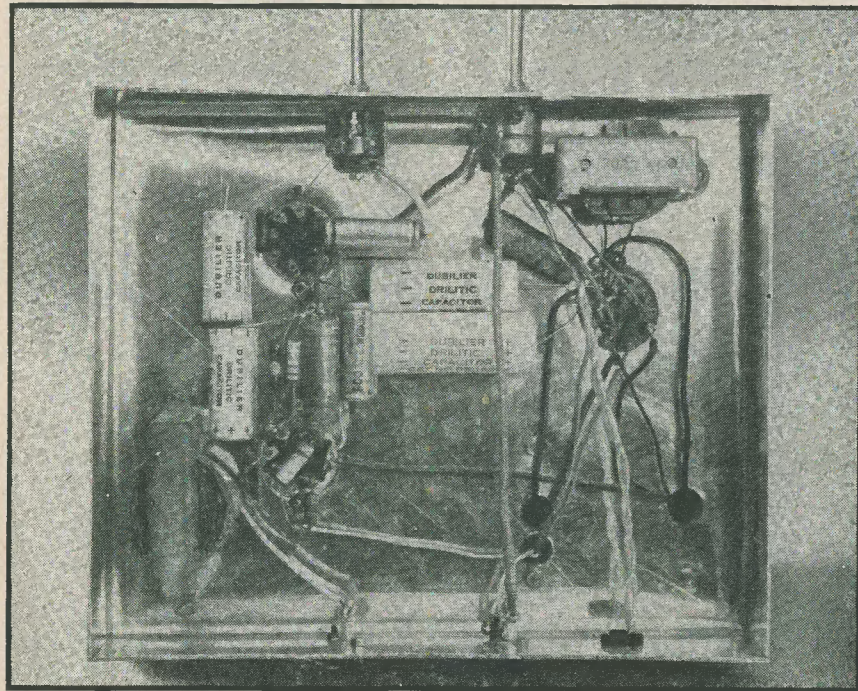

Showing that the "Simplex" is well named!

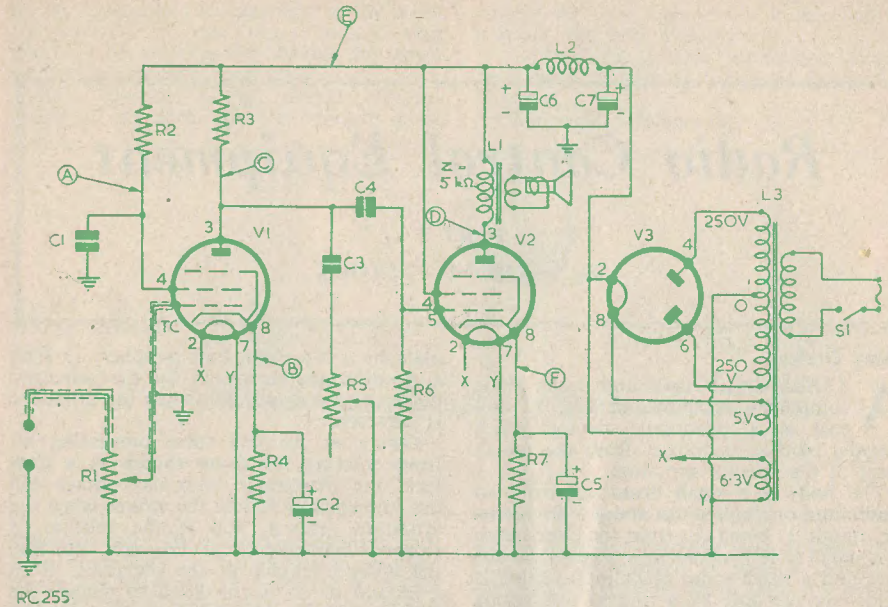

### Component Values

R1	250k $\Omega$ pot.	C2	25 $\mu$ F 25v wkg. Dubilier
R2	100k $\Omega$ , $\frac{1}{2}$ watt	C3	.05 $\mu$ F 350v wkg.
R3	22k $\Omega$ , $\frac{1}{2}$ watt	C4	.02 $\mu$ F 350v wkg.
R4	1k $\Omega$ , $\frac{1}{2}$ watt	C5	25 $\mu$ F 25v wkg. Dubilier
R5	250k $\Omega$ pot. with switch	C6	16 $\mu$ F electrolytic 350v wkg.
R6	470k $\Omega$ , $\frac{1}{2}$ watt	C7	8 $\mu$ F electrolytic 350v wkg.
R7	270 ohms $\frac{1}{2}$ watt	T1	Output transformer 350v
V1	6J7	L1	Smoothing Choke, 20H
V2	6V6	T2	Mains transformer. See text.
V3	5Y3		
C1	.05 $\mu$ F 350v wkg.		

suitable for any high impedance moving iron pick-up. Should a low impedance pick-up be used, a matching transformer will be required—in which case the manufacturers will advise the type of transformer and input impedance required. For those that have the valves at hand, the 6J7 could be replaced without circuit alterations by an EF36 or an ex-Government VR56. A simple top-cut tone control is incorporated in the anode circuit (C3 and R5) and this has been found to perform satisfactorily in the final design.

The output from V1 is fed into the grid of V2 via C4. This stage, comprising a 6V6 output pentode, is entirely conventional and should present no difficulty to the beginner. Provided the circuit values given are adhered to, and a similar layout used as shown in the prototype photographs, no

trouble should be encountered. Again, for those with a stock of valves, most other pentode output valves could be utilised here, although the value of the bias resistor R7 may require modification in order to obtain the correct bias voltage.

The power pack is also conventional and any mains transformer capable of supplying 250—0—250 volts at 60mA may be used. The one shown in the photograph is an Ellison Type M.T. 162 (see component list). The rectifier valve is a 5Y3 although any similar type could be employed. No hum trouble was experienced in the original model, and the power pack layout should be closely followed in order to obviate any 50 c/s mains ripple being induced into the circuit. S1 is incorporated in the potentiometer R5.

(continued on page 43)



# Radio Control Equipment

PART 7

By RAYMOND F. STOCK

## Delay Device

A COMMONLY USED and easily made component is shown in Fig. 32 and this is a pneumatic device which actually receives its power from the movement of the selector armature.

The body is a small drum cut from an aluminium or tinplate can about 1" in diameter, about  $\frac{1}{4}$ " being cut from the closed end.

A small hole is made with a needle in the end, and a small scrap of balloon rubber is held over the hole by a ring of draughting tape as shown. This forms a non-return valve.

A piece of rubber is then stretched lightly over the open end and secured by rubber solution smeared on the edge of the can and by a thread binding. A small circle of copper (no sharp edges here) is cemented to the centre of the rubber diaphragm. Opposite this is bent a thin contact so that the two connections touch when the diaphragm is flat. The contact strip is retained by being trapped under the thread binding, as shown, and the contact stuck to the diaphragm has a thin flexible lead soldered to it.

These contacts form a delayed connection. The complete unit is clamped to the selector

plate by a clip around its periphery in such a position that a striker on the armature depresses the diaphragm when the armature is attracted.

Owing to the flap valve preventing air from entering the drum except as a slow leak, the diaphragm with its contact will not immediately follow the striker when the armature returns, and if the selector is stepped immediately to the next position the delayed circuit is not energised. If a  $\frac{1}{4}$  second or so is permitted to elapse, the contacts close and operate the delayed circuit.

This device can be used in 'reverse' in one special case.

Where a three-way steering selector is used (as in Fig. 23) it may be very desirable to avoid adding a separate motor control position (as explained in the next section). In this case the delay device can be used from the other side of the armature so that the contacts are held permanently open by the armature at rest.

When normal short steering pulses are sent, the delayed contacts never close; but if a long pulse is sent they operate the motor selector. Admittedly this long pulse will introduce a spurious steering step, but

it can immediately be cancelled by the quick transmission of two short pulses, thus restoring the steering (but leaving the motor selector advanced by one step).

Since selectors always operate on the return of the armature, the spurious pulse

rotated 90° at a time; its knob can then be marked out with 4 positions.

In either case a 'click' mechanism should be fitted, accurately to locate the knob after its travel.

Clockwork pulsing units (as in Fig. 17)

Fig. 33 Spring loading of control lever.

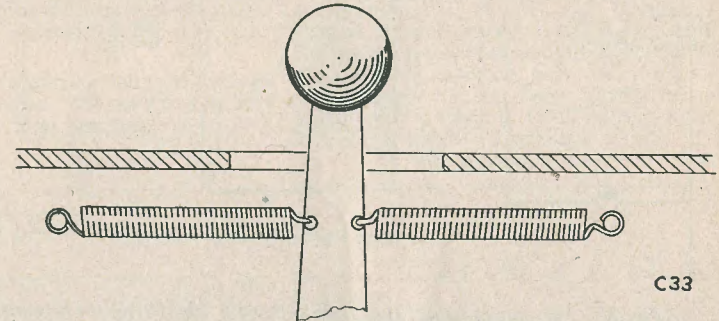

C33

does not take effect on the steering until it ends, and thus can be effectively cancelled by the two short signals following it. Selectors are made to operate on the return stroke largely because the power then comes from the tension spring and is not subject to variation as the batteries run down.

## Control Box for Selector Systems

All selector systems may be controlled by a simple rotary switch as described for escapements, and when the steps are limited to 3 the device shown in Fig. 18 can be used and is very effective. In this application, since the port and starboard positions of the control lever represent port- and starboard-*going* positions rather than definite angles, the control lever should be spring-loaded to the central position as shown in Fig. 33. This will be found more natural in use, since the knob is pressed over in the correct direction and when released springs back to central; this central position now means 'Hold' (whatever rudder angle is applied) and not necessarily 'Amidships.'

To operate the motor control in this system involves the transmission of one long and two short pulses. These can be sent by the manual microswitch, but more realism is obtained by fitting a separate knob having on the inside of the control box a wiper arm moving over three contacts, one long and two short. Fig. 34 shows the rear view, and it will be seen that by 360° rotation a suitable signal is sent for stepping the motor selector on.

To avoid having to remember the motor sequence, the wiper shaft can be driven by 4:1 gearing from another shaft which is

can be used for stepping steering selectors, and may be adapted as already described for manual pulsing units: but no simple mechanical device can code signals from more than one control knob (e.g. steering-wheel and engine 'telegraph').

The general way in which movements of more than one control may be coded is indicated by the circuit of Fig. 35. This assumes that the selector in the model has a sequence of 6 steering positions, a motor selector position and one other (for control of a hooter, etc.) all these to be controlled by the appropriate knob or lever at the control box.

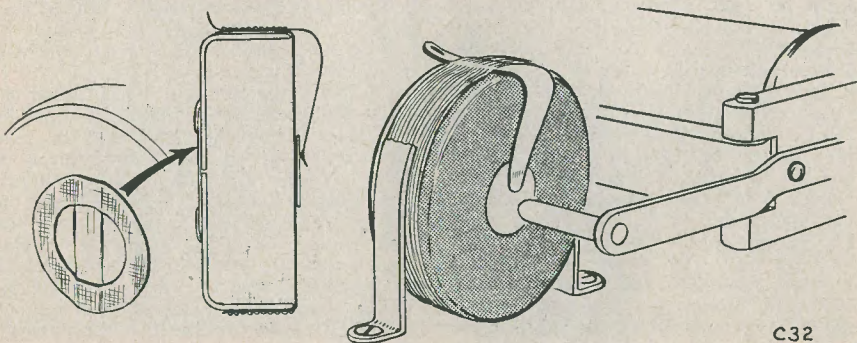

C32

Fig. 32. Construction of pneumatic delay.

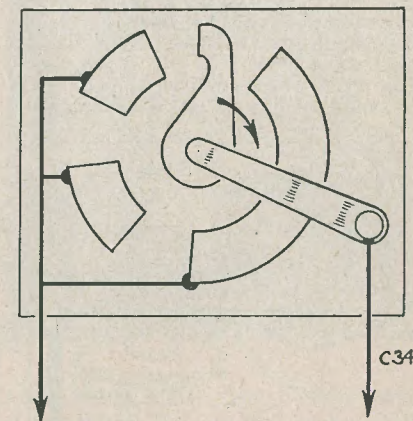

C34

Fig. 34. Motor control switch



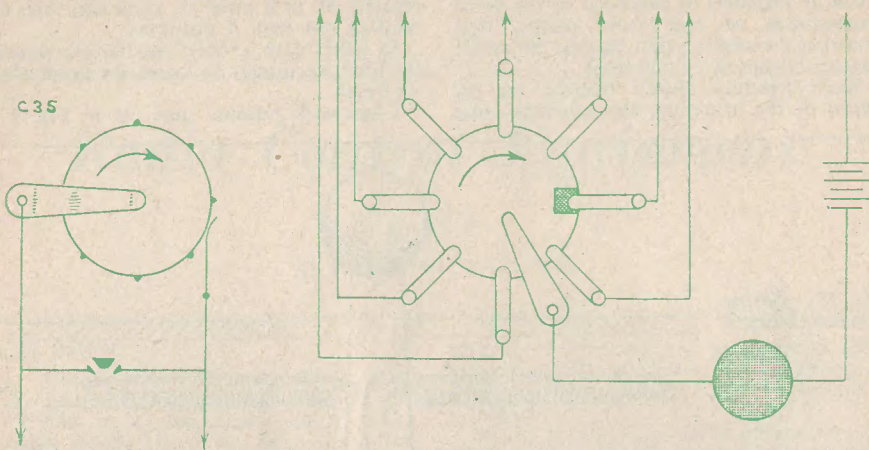

Fig. 35. The pulsing wheel (left) and follow-up wheel (right) are mounted on one shaft geared down from the motor

The apparatus is divided into two parts. On the left is shown a pulsing disc having 8 contacts around the edge, working against a fixed contact. One keying lead goes to the latter and the other to a light brush bearing against the wheel to preserve continuity. A micro switch is in parallel with the contacts, for manual keying.

Rotation of the disc sends pulses, and the selector in the model follows the movements of the disc.

The disc is mounted on a shaft geared down from an electric motor, and current goes to the latter via a metal wheel on the pulsing disc shaft and one of 8 brushes. These brushes are connected to the various positions of the control switches and knobs which may be press buttons, Yaxley switches etc. as required.

The metal wheel has one insulating segment and, when a brush is energised by

moving one of the controls, the wheel rotates until the insulation is under the brush (and thus cuts off the supply from the motor). This part of the device is, in fact, another homing mechanism, though the wheel always follows up in one direction rather than by the shortest route. Provided the leads from the brushes to switches are connected in the right order to correspond with the set sequence, any movement of the controls will cause the correct number of pulses to be sent.

In practice the pulsing disc and contact wheel are combined in one, and Fig. 36 is a drawing of the main parts of this unit.

The disc is of brass, about  $1\frac{1}{2}$ " diameter, and is soldered to a shaft supported by a brass bush. A light copper foil brush is arranged to bear on the disc near the centre to make connection (earth) for both the keying and operating circuits.

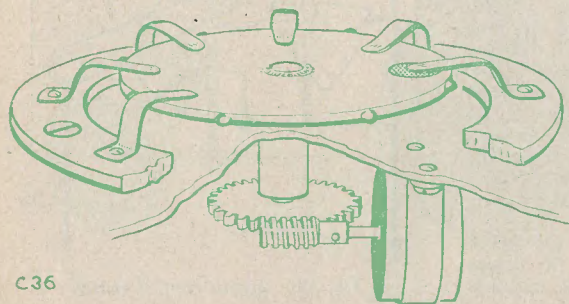

Fig. 36. Construction of a motor-driven coding switch. Keying brushes are not shown

8 small silver or copper rivets are soldered to the edge of the disc, and the static keying contact is supported on a perspex block which forms the base of the unit. 8 copper brushes are riveted to the base and press lightly on the disc near the edge. The insulating segment can be a simple cut-out in the disc, or a hole filled with some thermo-plastic insulation filed off flush with the surface.

It is necessary to arrange that the keying contacts 'make' about halfway through the travel of the disc from one position to the next.

The shaft supporting the disc carries a worm wheel driven by a worm on the motor shaft, but a simple gear train from a clock can be used. The ratio should be such that the keying is carried out as fast as possible within the capabilities of the selector to follow signals.

Any number of separate control switches and buttons can, in this way, be used to transmit their orders through a single channel, and there is no theoretical limit to the number of complete sequence positions. A local power supply for the motor is required, of course, and a separate torch battery within the control box is a convenient source.

(to be continued)

## THE "SIMPLEX" THREE—continued from page 39.

Voltage measurements as made with an AVO Model 40 are given for those with such an instrument or similar type. Measurements A, C and D were made on the 480 volt range and were as follows:—A, 75 volts; C, 115 volts; D, 190 volts and E, 200 volts. Cathode measurements were made

on range 12 and were—B, 2.5 volts and F, 8 volts.

The output obtained is approximately 3 watts with good quality. With this inexpensive and easy to construct amplifier, the reader will find it comparatively easy to add further refinements at a later date as finances and time permit.

## Radio Snapshots

THERE can be but few readers who neither own, nor have access to, a camera, and to encourage an increase of readers' photographs in our columns we have devised a simple contest.

Readers with inexpensive cameras will stand an equal chance with those possessing "all the gadgets," for the subject of the photograph—so long as it will reproduce satisfactorily—will be the deciding factor, and not the pictorial merit.

Many subjects suggest themselves; Ham Shacks, Listening Dens, home built equipment, novel tools and gadgets, field days, workshops—these are but a few.

There is but one simple condition. The photograph(s) must be the copyright of the entrant.

An award of three guineas will be made to the sender of the picture which, in the opinion of the Editor, is the best submitted. A reproduction fee of 10s 6d will be paid to the sender of each photograph published.

In order to allow overseas readers to participate, the latest date for receipt of entries has been fixed at November 5th (easily remembered!)

A short description should accompany each photograph submitted.



VHF Amateurs leave their "calling cards" at Chessington Zoo, on the occasion of their annual outing, June '53



# A MODERN 3-WAVEBAND SUPERHET RECEIVER

By JAMES S. KENDALL Assoc. Brit. I.R.E., M.I.P.R.E.

*An article on the construction of a receiver of conventional design using modern B8A valves. The construction of both AC and AC/DC circuits is described. There is nothing outstanding claimed over the performance but it is as good as most sets of the same type when properly aligned.*

THE BASIC CIRCUITRY of the superhet receiver has changed little over the last ten to fifteen years, but in this time there have been many changes in the valves. To-day on the market there are some very efficient valves with all glass bases, the B8A base as it is known. It is around these British types of valves that this circuit is designed. The valves chosen are the ECH42, EF41 or 6F15, EBC41, EL41 and EZ40. These are all 6.3 valves, including the rectifier which is run off the same heater chain as the other valves. After the AC version had been made, an AC/DC version was devised on the same circuit.

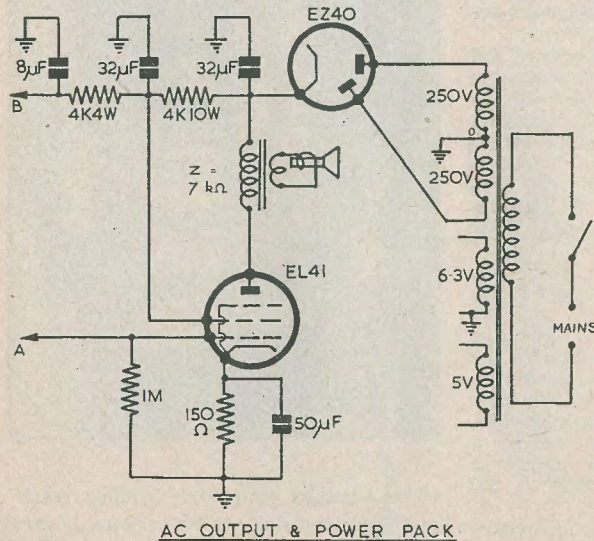

AC OUTPUT & POWER PACK

RC 257

The original chassis used was 11"×7"×2" deep, but an extra 1/2" on the depth would allow an easier mounting of the trimmers on the coils. An "L" layout was devised, with the frequency changer, 1st IF transformer and the IF valve forming the short arm, whilst the long was formed by the IF valve, 2nd IF transformer, and double-diode-triode followed by the output valve. At the extreme end of the chassis was placed the 32-32µF smoothing condenser.

The power unit or section consists of an Elstone SR/250 transformer, which gives 250-0-250V at 80mA, 6.3V and 5V. The 5-volt winding was used for the dial lights with 6.3 volt bulbs; this ensures that the winding is not left unused and that the life of the dial bulbs is kept at a maximum. It might be mentioned here that the designer ran into quite a queer noise fault whilst constructing the set; this was traced to one of the two dial bulbs.

The transformer can be mounted one of three ways; in the prototype a hole was cut and the transformer dropped through. The home constructor, however, does not always have the tools to cut such holes, and can bolt

the transformer to the top of the chassis. If this is done two holes should be made either side, and grommets fitted so that the sharp edges of the chassis do not chafe the wiring. The rectifier valveholder was mounted at the side of the transformer. A hole 7/8" diam. was cut with the aid of a "Q-Max" cutter, and two suitably placed 1/8" holes drilled to take the fixing screws for the holder. The 32-32µF condenser was mounted over a 1 1/8" diam. hole made with the aid of a cutter for octal holders; this allowed the tags to be dropped through the hole without letting the can follow, a much neater job than if the hole is cut too large and the condenser dropped half-way through.

Next the holes were made for the other valves and the IF transformer. The way the IF holes were made may seem at first a little crude, but the holes, although an odd shape, are symmetrical, and leave enough metal under the coil to act as a support. Four 3/8" holes were made so that the four projecting wires can be passed through with a good clearance, then a 3/8" hole drilled in the centre to take the bolt of the chassis cutter and a further 1 1/8" taken out. This allows the tuning slug to be got at easily.

The tuning condenser was left until last as the coils had to be mounted under it. The coils chosen, although not a new type, were the Wearight "P" coils. The writer has used these coils on many occasions with great success. The ones used are PA1, PO1, PA2, PO2, PA3 and PO3, which cover the long, medium and short wavebands. Coils in this series are arranged so that the constructor can make a receiver that has a continuous coverage from 7 to 2,000 meters. It is only a matter of altering the switching of the wavebands to do this. If the chassis is 2 1/2" or more in depth it is a simple matter to mount the 40pF trimmer direct on the tags of the coils, with a saving of chassis space. This system has the further advantage that one can see the coil to which the trimmer is attached.

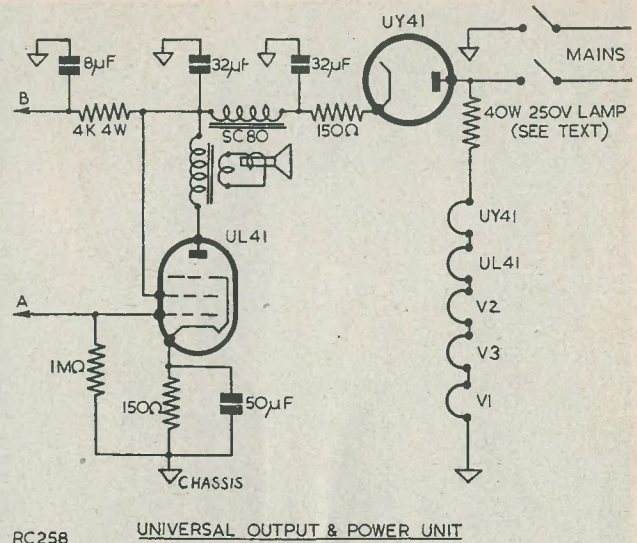

UNIVERSAL OUTPUT & POWER UNIT

RC 258

The position of the tuning condenser was then chosen, and two suitable 3/8" holes made at equal spacing from its spindle to take the volume control and the wavechange switch. The dial drive used was one of the W.B. range. It covers the correct bands, has a good slow-motion action and is low in price, the latter being a consideration these days.

If, as was the case in the prototype, the chassis is not deep enough to take the trimmers mounted directly on the coils, then they will have to be mounted on the side of the chassis. Be careful here as the stray capacities can lead to instability. A fixed padder was used for the shortwave band, but a double variable was used for the medium and long bands.

The smoothing is simple. The anode of the output valve is fed via the output transformer direct from the reservoir condenser. This does not result in hum, as might at first be thought, as it is the amount of hum on the screen that causes the hum to appear in the output. The reduced current through the smoothing resistor allows one of 4,000Ω to be used; this is a value as high as the impedance of a quite good smoothing choke and at a very much lower cost. The smoothing condenser is the other 32µF, and the screen is taken direct from this. The remainder of the circuit is decoupled with the aid of a 4,000Ω resistor of lower wattage rating and an 8µF condenser. This extra smoothing removes all trace of hum from the RF side of the receiver.



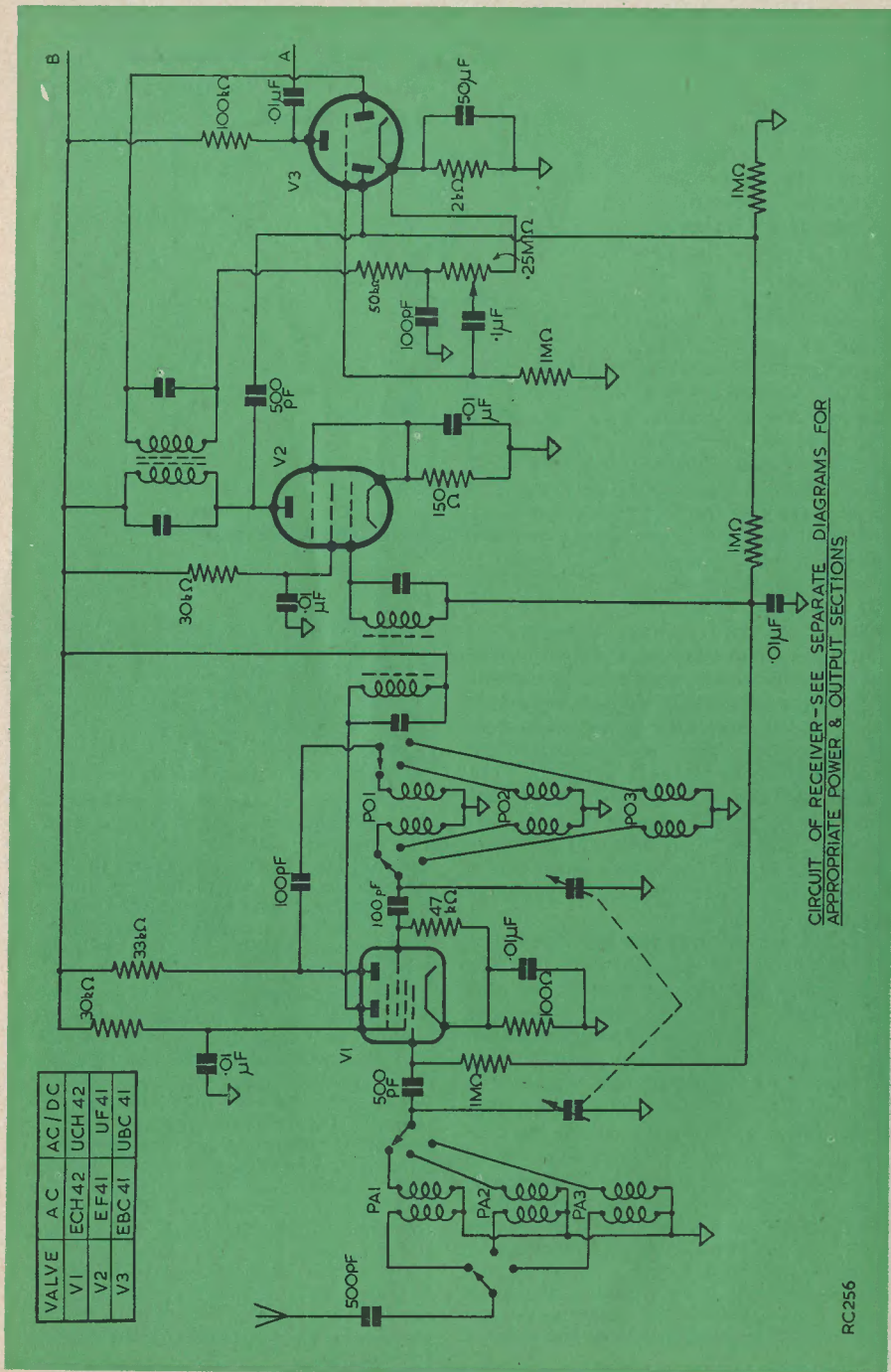

Full use should be made during the wiring of "Tag" strips, which can be obtained at the cost of a few coppers each and very greatly improve the standard of construction. This ensures that there are no bundles of poorly soldered wires suspended in space, ready to sag and short out on to some component that won't like the extra volts!

If a little thought is applied there should be no trouble with the wiring. A good solder of the 60/40 type is recommended, also the cleaning of the wires of all resistors and condensers with the aid of fine emery cloth. Emery cloth lasts longer than glasspaper.

Next the alignment has to be done. Here a signal generator is indispensable; suitable circuits have from time to time appeared in the pages of this journal, a particularly good one being described in the December 1952 issue. The method of alignment is to turn the volume control of the set to "full on," and with the signal generator joined to the grid of the IF valve, and tuned to 465kc/s (as low a signal as possible should be used), a maximum should be tuned for on both windings of the second IF transformer. As there is usually some interaction between windings it is advisable to repeat the process several times to ensure that correct tuning is obtained. The trimmers can then be sealed, or if slugs are used a mixture of candle wax and vaseline melted together can be smeared on. This mixture gives the necessary amount of "bind" whilst allowing enough ease of turning to facilitate tuning.

The first IF transformer is tuned at 470 and 460kc/s so that a good bandwidth can be obtained for broadcast listening. The short wave enthusiast will no doubt prefer to sacrifice fidelity for selectivity, and will tune to 465kc/s on both windings. The tuning is effected by moving the signal generator from the grid of the IF valve to that of the frequency changer, then setting the receiver tuning knob so that there is no "beat" from the oscillator section of the frequency changer, and with the signal generator set to the required frequency trimming the appropriate winding. Then set again, and trim the other to the correct frequency. Repeat several times until there is no change required to be made.

The various wavebands are aligned by setting the generator to a frequency at the high end of the scale and adjusting the trimmers on both the grid and oscillator coils, then repeating several times to get good tracking. This should be done for each waveband in turn. The signal should, of course, be fed into the aerial terminal.

No mention has been made of the tone control, but then there are so many and nearly every constructor has his own favourite circuit.

The AC/DC version is, in the main, the same, the difference being in the types of valve used. Again these are the B8A type, and of the 100mA type that are now so popular. A dropping resistor is placed where the transformer was in the AC version. If the receiver is to be used on 230 volt mains, the dropper can quite well be in the form of a 250 volt 40W electric light bulb. This will give a circuit that will ensure that the current through the valves does not rise to too high a value during the warming up period. If a lamp is not used it is advisable to insert a BRIMISTOR in series with the mains dropper resistor. The valves used are the UCH42, UF41, UBC41, UL41 and the UY41. These require a total drop of 117 volts, at a current of 100mA. It is therefore quite a simple matter to work out the value of the dropping resistor that will be required. The wattage required will be, in this case, one tenth of the voltage drop.

As the circuit is being fed direct from the mains, a resistor of 150Ω 1W should be joined from the cathode of the rectifier to the reservoir condenser. With the very few volts to spare, it is recommended that a good smoothing choke such as the Elstone SC/80 be used, and the anode and screen both fed from the smoothing condenser. The reason for this change in the circuit is that the UL41 is made to work with a lower anode voltage than the EL41.

The remainder of the circuit is the same as for the AC version, but this does not mean that the heaters are joined in parallel. As in all universal circuits they must be joined in series. Dial lamps should be of a max. current of 150mA—this prevents them from blowing during the current surge before the valves are properly warmed up.

As the chassis is live, both the aerial and the earth should be fed via condensers of suitable capacity and of at least 750 volts DC working. The user should be protected by placing the chassis in a wood or bakelite cabinet, so that it cannot be touched. Care should be taken that the tuning dial frame, if of metal, does not make contact with the chassis. The same precaution should be taken if a metal speaker grille is employed. It is also wise to fill the holes in the control knobs with a little wax so that it is impossible to get a shock off the grub screws.



# OSCILLOSCOPE TRACES

BY A.B.



## No. 3 AMPLIFIER PARASITICS

HIGH GAIN AF AMPLIFIERS — such as those used for tape recording — sometimes suffer from parasitic oscillation. The frequency of this oscillation is often very high — well out of the audio range. Although it cannot be heard, it makes itself felt by a general deterioration in performance, a fault which normally takes one of two forms: (i) it only occurs when an input voltage is applied to the amplifier; (ii) it is independent of input.

The shape of the input waveform is not critical but its amplitude should be kept small to avoid any overloading. A shows a sine wave input.

The type of parasitic oscillations which depend upon input appear as thick blobs on a part of each cycle, as shown in B. If the amplifier input is reduced they may disappear, only to reappear again as the input is increased.

The other type appears as shown in C. No input is applied, and if no parasitics are present the timebase line should remain undisturbed as each point in the amplifier is checked.

A third and rather remote possibility is that oscillation is occurring constantly and not in spurts as in B and C. This would appear as a thick bright line on the screen.

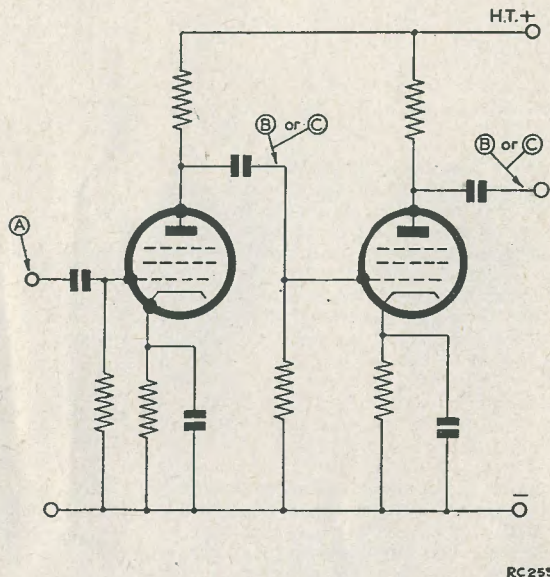

Your Copy of the Index to Volume 6 will be sent on receipt of your self-addressed stamped envelope.

Let's Get Started . . .

# 4: Valves as Detectors and Oscillators

BY A. BLACKBURN

Because there are some fundamental principles of radio which, although they have to be learned, do not make particularly interesting reading, I have ventured to talk first of those techniques which appeal more to the reader's curiosity.

But the hard graft has to be tackled sometime—it is no good leaving things in mid-air purely because it is a dull subject. However, knowing as you now do, some of the more advanced aspects of radio theory, you should be sufficiently interested in the ultimate effect to want to know more of the cause.

In our last article we spoke of how we can select signals, but we did not explain how these selected signals are detected, which is the process coming between selection and amplification. Detection simply means translating a selected carrier into an audio signal.

Suppose you were blindfolded, handed an object and asked to describe it. You could either feel its shape, and so say whether it were a cube, a globe, a cone, etc., and give an approximate idea of its size. Or you could take the bandage from your eyes and describe it more fully.

In either case you are using a sense as a means of detection in order that that sense may transmit its observations to your brain.

That virtually is what happens in radio. Once a signal has been selected, the detector picks it up and converts it into a form which can eventually become a recognisable sound.

Now the valve has been put to many uses, some of which we have discussed. Two more applications of 'the most important technique in radio' as we called the valve in our first article, are as a detector and an oscillator. There are other types of detectors and oscillators, of course, but we shall be dealing with these later.

### The Diode Detector

The diode valve was the first type we described at the beginning of this series. If we have appeared to ignore it, it is only because its function is rather different from the other types with which we have dealt.

You will remember that the diode has only two electrodes—the filament and the anode. Current will only flow in the valve if the

anode is positive with respect to the filament. Therefore, if an AC voltage were applied between anode and filament, current would only flow on positive half-cycles, as can be seen from Figs. 1a and 1b.

If the waveform shown in Fig. 1c in last month's article were applied to the diode in Fig. 1 below, the diode would remove one half of this waveform either above or below a horizontal line drawn through the middle of the waveform, leaving the waveforms shown in Fig. 1c.

The modulation has now been effectively separated except for the half-cycles of carrier which can easily be removed by connecting, between points A and B in Fig. 1a, a capacitor of such a value that they would be by-passed. Remember that the carrier frequency is very much higher than the modulation frequency. Therefore, a condenser of, say, 100 pF will have a very low reactance at carrier frequency and a very high reactance at modulation frequency.

This process of separating the modulation from the carrier is known as *demodulation*, *detection* or *rectification* of the signal, and is a very important application of the diode valve. If we were to reverse the diode connections, that is to say apply the input at the filament of the diode and take the rectified output from the anode, the waveform shown in Fig. 1c would be upside down. The reason for this is that the diode would then conduct on negative half-cycles.

You might ask, why go to all this trouble when the audio-modulation still has some carrier associated with it even after detection? The point to realise is that (referring to Fig. 1c last month) the waveform is symmetrical and if we were to apply it to headphones direct, the "bumps" on top of the waveform and the "bumps" underneath would cancel one another out. What the diode really does is to make this waveform asymmetrical.

However, the diode is not the only device which will detect a signal in this way. In fact, the cat's whisker and crystal so much beloved by the early amateur were amongst the first detectors in radio chronology. A crystal-cat's whisker combination produces the same effect



as the diode in that it tends only to pass current in one direction. In the last war the crystal detector returned to popularity with the advent of radar and it is now obtainable commercially.

Physically very small—it is normally about  $\frac{1}{8}$  in long and  $\frac{1}{16}$  in in diameter—the crystal detector is very efficient. Fig. 2 shows a circuit of a crystal set, incorporating one of the principles we discussed last month of coupling the aerial to the tuned circuit. The crystal detects the selected signal operating the headphones, across which the 0.001  $\mu$ F capacitor by-passes the carrier as described above.

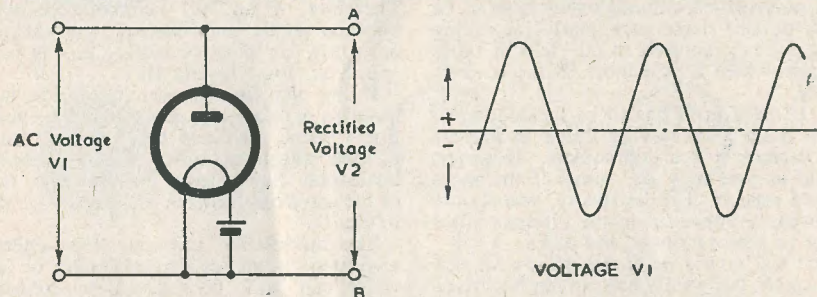

FIG. 1 (a)

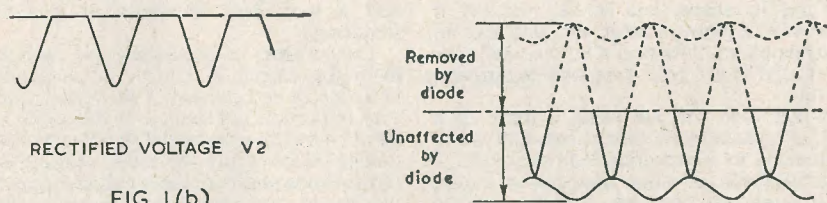

FIG 1 (b)

FIG 1 (c)

ILLUSTRATING THE EFFECT OF A DIODE UPON AN APPLIED AC VOLTAGE

Fig 1(c) is a "detected" modulated carrier wave

RC.246.

### The Valve as an Oscillator

Basically, the oscillator is a device which produces a continuous train of waves. The simplest electric oscillator is the electric bell which, provided a battery is connected, will continue "oscillating" indefinitely. Obviously, the highest frequency at which such a system could operate is limited by the weight of the moving parts. In radio work, oscillations of

millions of cycles per second have to be produced, and this is where the valve comes into its own.

As we already know, any small voltage change at the grid of a valve produces a magnified voltage change at the anode. If this magnified voltage were fed back to the grid an even larger signal would appear at the anode which in turn would be fed back. With the grid signals being supplied from the anode, the voltages at the grid and anode would, therefore, go on increasing until a limiting condition were reached, when continuous oscillation would occur. The other condition for maintained oscillation is that the

As the grid voltage becomes more positive, more current flows in the valve and in the anode load, resulting in an increased voltage drop across the load. The anode voltage falls, therefore, at the same time as the grid voltage rises. (Readers who are familiar with AC theory will recognise these voltages as being 180° out of phase). So, if the anode signal voltage were fed back to the grid without changing its phase, it would be in opposition to the grid signal voltage, which produced it, and no oscillation would occur. One common method of ensuring correct phase between anode and grid is by coupling them with two coils as shown in Fig. 3.

Very often an oscillator is required to operate over a wide range of frequencies, and the best way of achieving this is to use a variable tuning circuit. Fig. 3 shows an oscillator using a triode valve, inductive feedback coupling and a tuned circuit to determine the frequency. We will assume that, upon switching on, a small disturbance occurs in the grid circuit which will cause a similar but larger disturbance to occur in the anode circuit.

The feedback coil, or reaction coil as it is sometimes called, will induce this larger disturbance back into the grid circuit in the correct phase. Oscillation builds up as we already know, and frequency will be determined by the tuned circuit. Thus we have an oscillator which, like the electric bell, will continue to run for as long as we require it, at frequencies suitable for radio applications.

The conclusions we have reached on the necessity for signals at the anode and grid to be in phase may be easily verified. Supposing that you have built the oscillator in Fig. 3, connected it to suitable power supplies and switched on, and also that the coil and condenser are suitable for tuning in the medium waveband.

There are three methods of discovering whether or not the oscillator is working. By placing a milliammeter in the anode circuit at the point marked X in Fig. 3, an indication of the current flowing in the valve will be obtained. If the circuit is oscillating, shorting the grid to earth will cause a rise in the reading on this meter. However, if the oscillator is not working no change will be observed.

Another method is to remove the grid leak from earth and connect a micro-ammeter between the free end of the grid leak and earth, the negative terminal of the micro-ammeter being connected to the grid leak. The meter will only give a reading if the oscillator is operating correctly.

The third method involves no meters, but an ordinary radio set only is used. For this system to be effective, the oscillator must be in close proximity to the aerial of the radio set.

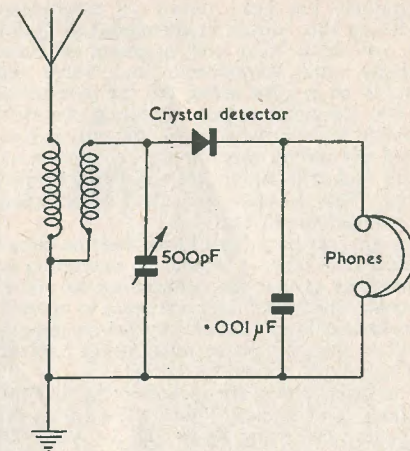

FIG. 2. THE CRYSTAL DETECTOR

RC.247.

The set is tuned just off the station, somewhere in the medium waveband, so that the station can still be heard but the reproduction is distorted. Switch on the oscillator and with the tuning condenser ( $C_1$  in Fig. 3) tune slowly over the band. If the oscillator is working a whistle will be heard superimposed on the station at one setting of the tuning condenser. Some readers may remember how a selected

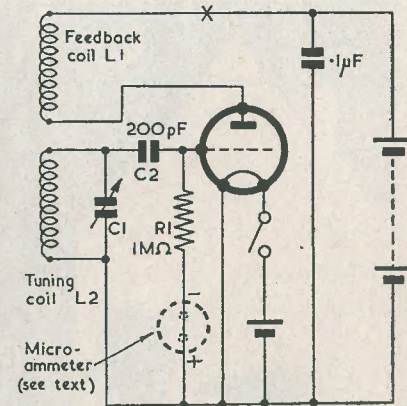

FIG. 3. A SIMPLE OSCILLATOR

RC.248.



programme has been ruined by neighbours producing this whistle in their sets.

If you have tried one or more of these methods, and components and valve are found to be in good order, but the indications are that the circuit is not oscillating, the most probable fault is that one of the coils is connected the wrong way round, i.e., the anode circuit and grid circuit are not in the correct phase. This is easily remedied by reversing the connections of one coil.

Should you have been lucky and the circuit worked first time, it would be interesting to deliberately reverse the connections to one of the coils, when the circuit will cease to operate. This demonstrates most effectively how important it is that the phase relationship between anode and grid should be correct.

The behaviour of the meters in the first two methods is of interest. Both these effects are a function of  $C_2$  and  $R_1$  in Fig. 3. When the oscillator is first switched on, we know that oscillation builds up until a limiting value is reached. Each half-cycle charges  $C_2$ , but, because  $R_1$  is of too high a resistance to allow it to leak away completely before the next half-cycle arrives, the charge becomes greater with the increasing amplitude of oscillation, until the grid of the valve becomes so negative, i.e. has such a high grid bias value, that any further increase of oscillation would completely cut off the current in the valve.

Should the amplitude of oscillation try to increase further, the bias it produces will increase and tend to limit the amplitude.

Therefore, the circuit will settle down automatically and produce a constant amplitude voltage.

When the meter is connected to the anode circuit, shorting the grid to earth has four related effects: oscillation stops; negative bias is removed; more current flows in the valve; and the reading on the meter rises. With the meter connected between the grid leak and earth, an indication is given of current flowing through the grid leak. No current will flow, however, if no signal, i.e. no oscillation, is present at the grid. Therefore, if current is flowing, the circuit must be oscillating.

#### Uses of Oscillators

Because it is possible to use a radio set to detect signals from an oscillator, it can be seen that the oscillator may be used as a transmitter.

An oscillator of some sort is used in every transmitter to produce the carrier, and in high powered transmitters the oscillator output is amplified before being fed to the aerial.

You have all seen those advertisements which, with discreet claims to supremacy, offer expensive "superhet" radio sets? Eye-catching word — superhet, although its actual implication may be lost on most people. But an oscillator is used in every superhet set.

Oscillators also find many applications outside the field of radio for producing high frequency voltages in many sciences, including medicine, metallurgy and atomic physics.

Further references to their uses will be made in subsequent articles.

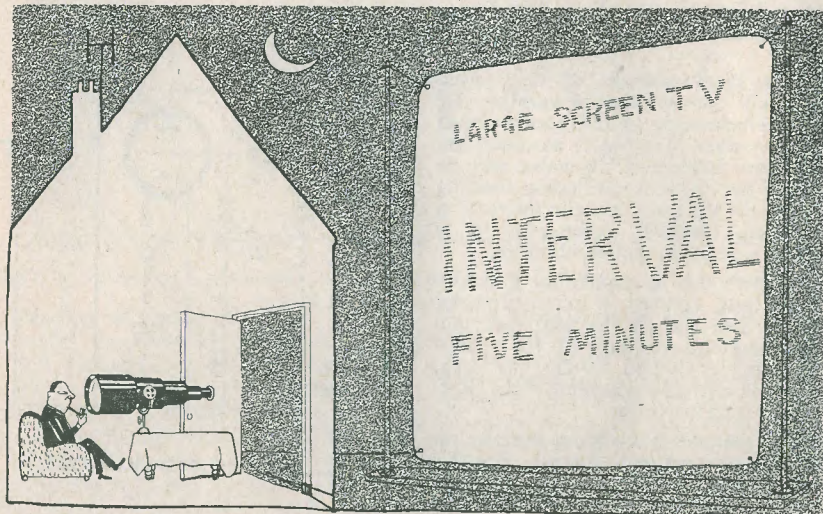

# DATA publications

LIMITED

57 MAIDA VALE LONDON W9

Telephone CUNningham 6518

## ORDER FORM

Please supply the following

	Price	Postage	No.
<b>DATA BOOK SERIES</b>			
D.B.4. INEXPENSIVE TELEVISION . . . . .	2/6	2d	<input type="checkbox"/>
D.B.5. T.V. FAULT FINDING . . . . .	5/-	3d	<input type="checkbox"/>
D.B.6. THE RADIO AMATEUR OPERATOR'S HANDBOOK . . . . .	2/6	2d	<input type="checkbox"/>
D.B.7. RECEIVERS, PRESELECTORS AND CONVERTERS. . . . .	2/6	2d	<input type="checkbox"/>
D.B.8. TAPE AND WIRE RECORDING . . . . .	2/6	2d	<input type="checkbox"/>
<b>MISCELLANEOUS BOOKS</b>			
WORLD RADIO HANDBOOK . . . . . (Johansen)	8/6	3d	<input type="checkbox"/>
HOW TO LISTEN TO THE WORLD . . . . . (Johansen)	1/9	3d	<input type="checkbox"/>
RECEIVING . . . . . (R.S.G.B.)	2/6	2d	<input type="checkbox"/>
SIMPLE TV. EQUIPMENT . . . . . (R.S.G.B.)	2/6	2d	<input type="checkbox"/>
T.V. PICTURE FAULTS . . . . . (T.V. Times)	3/6	3d	<input type="checkbox"/>
THE RADIO AMATEUR'S REPORT PAD (Data Publications)	3/6	3d	<input type="checkbox"/>
<b>MAGAZINES</b>			
THE RADIO CONSTRUCTOR . . . monthly . . . . .	1/6	2d	<input type="checkbox"/>
"   "   "   "   6 months sub. . . . .	9/-	paid	<input type="checkbox"/>
"   "   "   "   12 months " . . . . .	18/-	paid	<input type="checkbox"/>
THE RADIO AMATEUR . . . monthly . . . . .	1/6	2d	<input type="checkbox"/>
"   "   "   "   6 months sub. . . . .	9/-	paid	<input type="checkbox"/>
"   "   "   "   12 months " . . . . .	18/-	paid	<input type="checkbox"/>

PLEASE CUT HERE

PLEASE TICK SUBSCRIPTIONS REQUIRED AND STATE FIRST ISSUE BELOW

Enclosed find Cheque/Postal Order/International Money Order £.....

NAME ..... PLEASE  
 ADDRESS ..... USE  
 BLOCK  
 CAPITALS

ALL OUR PUBLICATIONS ARE AVAILABLE THROUGH  
 YOUR LOCAL NEWSAGENT

TRADE TERMS AVAILABLE ON REQUEST



## TELE-RADIO (1943) LTD.

We stock a full range of the Specified Components for the "Universal" Large Screen AC/DC Televisor

Please send S.A.E. for price list C.O.D. or C.W.O. Packing and Postage extra

Telephone Shop Hours  
PAD 4455/6 Mon.-Sat. 9 a.m.-6 p.m.  
Thursday 9 a.m.-1 p.m.

189 EDGWARE ROAD, LONDON W.2

## SOLIDAS LTD

4 PRAED STREET  
LONDON W2

**DEFINITELY  
THE CHEAPEST RADIO SHOP IN  
TOWN**

Telephone **AMB 4670**

32+32 mfd 275V 4/-, 16 mfd 425V-wet-screw fitting, 4/-, 8 mfd 500 screw, 1/6, 8 mfd 600 V/W, screw 2/-, 8 mfd 450 midget, 2/6, 30+30 350, 2/6, 10 mfd paper 600V, 4/-, 4-way Fuse holder, 6d. Continuity tester in nicely polished box can also be used for Morse practice, 5/-; 10 watt push-pull output Trans., 15/-; 4 gang .0005, 2/6; Slow motion drive with 2" drum, 1/6. L.T. Trans., 6.3, 2 amps, 7/6. Polythene stand-off insulators, 9d. WX6 W.I. detectors, 1/-; L.T. Trans., 3V, 1A, 2/6; Box of 10, 3.2, 0.2 pilot bulbs, 2/6. Tube neck support fits 9", 12", 15", 2/- Wire wound pots. 1000Ω, 500Ω, 2/- Miniature 2 amp plug and socket, 1/- pair. L.T. Trans., input 110-250V, output 2.0-2V, 3.3A, or 4V, 6.6A, 12/6. Bush All Wave chassis, 5 valve S/Het., less speaker, reconditioned, £6.10.0, has gram. sockets; 5.5 KV EHT Trans. with U22

**ACCUMULATORS.** 6 volt 16 amp hour. 3 separate 2 volt cells. Contained in wood case with carrying handle. 7"x5"x9" deep. Brand new. Uncharged. 22/6. Post 2/6.

**AMERICAN HEADPHONES.** Light weight type headphones, complete with matching transformer, plug and lead. 8/6 per pair. Post 1/3.

**INDICATOR LAMP HOLDERS.** Nickel plated. Approximately 3/4 diameter bezel. Takes ordinary screw-in type lamps. Illuminated numbers. Set of 10 separate lamp holders with number '0' to '9'. 12/6. Post 1/6.

**AMP METERS MOVING COIL.** 5" scale. Pressed steel black enamel cases. Range 0 to 14 amps with fitted external shunts. Basic meter movement 75 milli volt f.s.d. Brand new and boxes. 30/- Post 1/9. This is one of the best 5" meters we have handled for some time.

**TELESCOPIC MASTS.** 4 section, each 3ft long, 7/8-3/8" dia. 2 aerials in 3ft canister. 7/6. Carr. 3/6.

**I.F.F. CHASSIS,** less dynamotor, but containing voltage regulators, split stator condenser, 9 valve holders, large 1 ohm vitreous resistor, coax connectors, and dozens of small resistances and condensers, all contained on two chassis bolted together. Price 8/6. Post 2/6.

**THERMAL RELAYS,** for delaying application of HT voltages. 2/6. Post 10d.

**LF. CHOKES.** P.O. type in grey metal case. Type AR4400-3. New condition. 2/6 Post 1/3.

**RF. CHOKES.** Small round type 1 1/4" dia. 3/- per doz. Post 1/-.

**OUR NEW LIST NO. 10 NOW AVAILABLE**  
Price 6d Inland 2/- Overseas Airmail

**A. T. SALLIS**

93 NORTH ROAD BRIGHTON SUSSEX  
Telephone BRIGHTON 25806

Rectifier, 45/-, MV4=MH4 4/-; 878A 10/-; Z62 10/-; 807 10/-; Z77 10/-; EF22=7H7 6/-; 3D6 2/6; 1LD5 4/-; APR12 2/6; VU111-VU133 2/6; 6SS7=6SJ7 5/-; 12Y4 0.3 Rect. 5/-; 6L6M 10/-; VT25 5/-; H30 5/-; HHLD6=6Q7 A.C. 6/-; 6SL7 10/-; 6SN7 10/-; M4 5/-; TP25 7/6; VR55=EBC33 8/-; VP41 10/-; SU4G=US2 10/-; 6F6G 8/6; 6C6=6D6 5/-; 12C8 10/-; Y63 7/6; 6G6 6/-; 7DA 10/-; 12SH7 5/-; 12SK7 7/-; 117L7 10/-; VR56=EF36 6/6; 6AG5 6/-; CU188 V/Regulator 6/-; VR137, EC52 4/6; 9D2 4/-; VR116 4/6; KTZ73=Z66 10/-; 6AK5 10/-; 6SK7 7/-; VR126=VP4B 10/-; MS/PEN 6/-; SZ4 8/6. Special offer AZ31 less locating pin 6/-; CY31 less locating pin 6/-; KT44 7/6; AC6PEN 6/-; 12SA7 10/-; 5Y5 6/6.

## URGENTLY WANTED

COMMUNICATIONS RECEIVERS.

TEST EQUIPMENT.

RADIOS—and TELEVISION SETS.

TAPE RECORDERS.

**BEST PRICES GIVEN**

Phone or Call

## ELECTROLYTIC CONDENSERS

8 mfd. 450 v.w. . . . .	2/3	16+16 mfd. 500 v.w. . . . .	4/6
8 mfd. 500 v.w. . . . .	2/11	16+32 mfd. 450 v.w. . . . .	5/11
16 mfd. 350 v.w. . . . .	2/6	32+100 mfd. 450 v.w. . . . .	7/6
16 mfd. 500 v.w. . . . .	3/6	60+100 mfd. 350 v.w. . . . .	9/6
32 mfd. 500 v.w. . . . .	4/11	BIAS	
50 mfd. 350 v.w. . . . .	3/11	25 mfd. 25 v.w. . . . .	1/6
60 mfd. 350 v.w. . . . .	3/11	50 mfd. 12 v.w. . . . .	1/6
250 mfd. 350 v.w. . . . .	4/11	50 mfd. 50 v.w. . . . .	1/6
8+8 mfd. 450 v.w. . . . .	4/6	8+16 mfd. 500 v.w. . . . .	1/-
8+16 mfd. 500 v.w. . . . .	4/11	12+12 mfd. 350 v.w. . . . .	3/6

ALL BRAND NEW AND GUARANTEED (NOT EX-GOVT.)

All other types, Paper, Tubular, Waxed, etc., in stock

### SPECIAL C.R.T. OFFER

Brand new and unused 12in ion trap cathode ray tubes. 6.3 volt heater, 7-9 Kv. E.H.T. 35 mm neck. Black and white picture. By Famous

Manufacturer  
**PERFECT £12/19/6**  
Carriage and insurance 15/- per tube extra.

### GERMANIUM CRYSTAL DIODES

2/3 each

### ANTENNA ROD SECTIONS

Steel, sprayed khaki. Each rod 12in long, 1/4in diam. Any number can be fitted together. 2/6 per doz. 6/- three doz. POST FREE.

### VCR97 C.R. TUBES

New unused. 35/- Carriage 5/-.

### EHT Transformer

For VCR97. 45/-.

### SCREEN ENLARGER

For VCR97. Filter type. 17/6. Postage 2/6.

### E.H.T. Condensers

.1 mfd. 3Kv. . . . . 3/6  
.1 mfd. 2.5 Kv. . . . . 2/6

### MICROPHONE STANDS

Table model. 2-section chrome plated. Crackle finish base . . . 17/6  
Floor model. 2-section. Brass, heavily chrome plated. . . . . 69/6  
Carriage 2/6 extra

### SOLO SOLDERING IRONS

220-250 volts. Latest model instrument iron . . . 19/8  
Standard model . . . 19/-

### SPECIAL BRAND NEW T.C.C. T.V. CONDENSERS

32+100 mfd. 450 v.w. Type CE15PE . . . . . Price 7/6  
.04 mfd. 12.5Kv. Type CP59VO. . . . . Price 7/6

### LARGE SCREEN T.V.

Every component in stock for the Magnaview, Television, Viewmaster and Universal television receivers, including all cathode ray tubes and valves.

### 9 INCH TABLE T.V. CABINETS

Medium shade mahogany finish. Complete with back, safety glass, speaker-free. Internal dimensions: 19 1/2in high, 16in wide, 14in deep. LASKY'S PRICE 39/6. Carriage 7/6 extra. Adaptor frame available for 6in c.r. tubes. The aperture can easily be enlarged for 12 or 14in c.r. tubes.

### A.C. MAINS GRAM MOTORS—Synchronous

For use on 200-250 volts. 50 c.p.s. Rim and belt drive type. 9/6 each. MANY USES.

### PORTABLE TAPE RECORDER CABINETS

Strong wood construction, finished in attractive cream covering, with carrying handle and two chrome plated locks. Hinged lid. Internal dimensions: 15in long, 10in wide, 7in high. Soiled condition. LASKY'S PRICE 25/- Carriage 5/- extra.

### DINGHY AERIALS WITH REFLECTORS

Umbrella type, with wire mesh reflector. Complete with setting up instructions. Mast not supplied. LASKY'S PRICE 7/6. Post 1/6.

### TANNOY PRESSURE UNITS

10 watts 7.5-ohms impedance. Last few only. Price Reduced to 59/6. Carriage 3/6 extra.

### I.F. TRANSFORMERS

Midget. 465Kc/s. Iron dust cores. In can size: 1 x 1 1/2 x 2 1/4in. high. 9/6 pair. Wearite type 500. 450-470 Kc/s. Dust cored compression trimmer tuned. In can size: 1 1/2 in square x 3 1/2in high. 12/6 pair. Wearite type 550. 445-520 Kc/s. Permeability tuned. In can size as for 500 type. 12/6 pair.

### C.R.T. Rear neck protectors.

2/6.

### R.I132A RECEIVERS

With all valves. Brand New . . . 79/6  
Store Soiled . . . 50/-  
Carriage 10/- extra.

### AMPLIFIERS

4-Watt Model. Ex-Government. Complete with 10 valves: 2 2SL6, 1 6H6, 1 4Z5, 6 6SK7. For operation on 110 volts A.C./D.C. Balance and push-pull. High, medium and low impedance inputs, A.G.C., etc. LASKY'S PRICE £5/19/6 complete. No circuits available. Carriage 10/- per unit extra.

### RECORD PLAYING DESKS

Sloping steel table, grey crackle finish, size:—10" high, 15" deep, 19" wide. Complete with pick-up and centre spindle drive Collaro motor, adjustable speed, also 10" turntable. For use on 200-250 volt 50 c.p.s. mains. BRAND NEW. LASKY'S price 79/6d. Carriage 7/6 extra.

### CATHODE RAY TUBES MASKS

New aspect ratio.

9in cream . . . . .	7/-
10in Double D . . . . .	7/6
12in . . . . .	15/-
12in Flat face . . . . .	15/-
12in Old ratio . . . . .	9/6
14in Rect. . . . .	21/-
16in Double D . . . . .	31/6
17in Rect. . . . .	25/-
12in Soiled . . . . .	7/6
12in Soiled, Cream, with safety glass . . . . .	11/6
12in Soiled, Black, with safety glass . . . . .	8/6

### 15 INCH CATHODE RAY TUBE MASKS

No. 1. Cream rubber. Latest aspect ratio. Overall dimensions: 17in wide, 13in high. Price 17/6. Postage 2/- extra.

No. 2. Plastic, incorporating gold finish tube escutcheon, and dark screen filter. Latest aspect ratio. Overall dimensions 15in wide, 12in high. Price 21/- Postage 2/- extra.

### ARMOUR PLATE GLASS

15in Actual size, 18 1/2in x 19 1/2in x 3/4in 7/11. 12in Actual size, 13in x 10 1/2in x 1/2in 4/-. 9in Actual size, 9in x 8in x 3/4in 3/-.

### DARK SCREEN FILTERS (LATEST TINT)

18 x 14 1/2in . . . . . 25/-  
14 1/2 x 12 1/2in . . . . . 19/6  
13 1/2 x 11in . . . . . 14/11

### PERSPEX

13 1/2in x 10 1/2in x 1/2in. Natural shade, slightly marked. 4/11 per piece.



## LASKY'S RADIO

Lasky's (Harrow Road) Ltd. 370 HARROW RD  
PADDINGTON LONDON W9

(Opposite Paddington Hospital) Telephones CUNningham 1979 and 7214. All Departments.

Hours Mon. to Sat. 9.30 a.m. to 6 p.m., Thurs. half day 1 p.m.

MAIN ORDER & DESPATCH DEPARTMENTS 485/487 Harrow Road Paddington London W 10

Terms Pro Forma, Cash with Order, or C.O.D. on post items only. Postage and packing on orders value £1—1/- extra, £5—2/- extra, £10—3/6 extra. Over £10 carriage free. All goods fully insured in transit.



# NEW! RADIO, TELEVISION AND ELECTRONICS

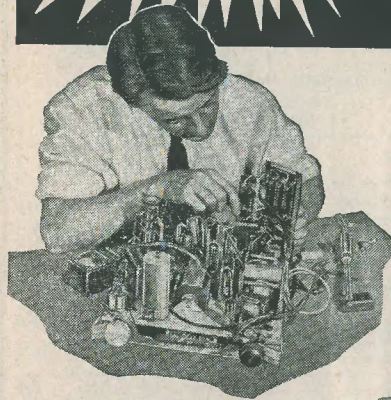

## LEARN THE PRACTICAL WAY Instruction and Equipment

Here at last is the only real way of making home study really successful. Actual equipment is supplied thus combining theory and practice in the correct educational sequence. Whether your need be for career, hobby or general interest, here is the ideal method for acquiring the knowledge in the most efficient way possible.

### QUICKER - BETTER - MORE INTERESTING

This equipment specially prepared and designed remains your property and it provides thoroughly sound basic sets which can easily be expanded to meet your growing knowledge.

**PRACTICAL COURSES IN MANY OTHER SUBJECTS INCLUDING:**  
Draughtsmanship, Carpentry, Chemistry, Photography, Commercial Art



### POST THIS COUPON TODAY

Please send me your FREE book on *Practical Courses*  
To: E.M.I. INSTITUTES, Dept. 179x,  
43 Grove Park Road, Chiswick, W.4.

NAME .....

ADDRESS .....

We will not worry you with personal visits.

# EMI INSTITUTES

The only Postal College  
which is part of a world-wide  
Industrial Organisation.

IC20

## SMALL ADVERTISEMENTS

Readers' small advertisements will be accepted at 2d per word, minimum charge 2/- . Trade advertisements will be accepted at 6d per word, minimum charge 6/- . If a Box Number is required, an additional charge of 1/- will be made. Terms: Cash with order. All copy must be in hand by the 12th of the month for insertion in the following month's issue.

### PRIVATE

RADIOVISION V55R receiver AC mains £10. CR100 not in working order £10. E. Filmer, 22 Batteries Close, Lynsted, Sittingbourne, Kent.

EDDYSTONE speaker and S Meter, both in perfect condition £5. Box No. C134.

DOUBLE SUPERHET, 15 valves, appearance as Denco DCR19, Turret coils 36 Mcs to 200 Kcs, Bandsread all Ham bands, mechanical calibrated every control, Xtal second frequency changer, PP, 6V6s, £20 or exchanges. Wanted Premier TV complete, or Hallicrafter S27 or ? SAE please. MCR1 with coils and circuit, slight fault, tubes OK, £3, Windsor 65B Generator £9. Delivery in London. Taylor, 41 High Street, Lake Sandown, I.O.W. Phone SanDOWN 746.

VALVES for sale. 807, ECC35, KTW61, 6L6, KTW63, 6U7, 6V6, 12AT7, 6A7, TH41, 12BA6 at 8/- each. ECC31, 6J7, HL42DD, 6K7, EB91, ML4, 6L7 at 6/- each. PP225, 220HPT, 220P, Z21, 210SPT, 210VPT, W21, TDD2A, PM12M, L63, 6J5 at 4/- each. Box No. C133.

VCR97 for £1, 131 12" £4, 97 Magnifier 15/-, 1115 £4, 194 IF Strip (London) modified with valve. 30/- . Emmerson, 85 Frimley Road, Hook, Surrey

1082 RECEIVER for sale, complete set of coils, offers. No. 68 Receiver 3 to 5 Mcs. No. 18 Receiver, modified for Long, Medium, Short and Trawler Bands, all need slight attention, also 14 copies *Radio Constructor*, 20 copies *Wireless World*, 42 copies *Practical Wireless*—offers. R. C. Smith, 10 Carlton Hill, Princes Park, Liverpool 8.

ALLEN FOCUS COIL, new, Corona Ring, Rubber mask with plate glass for 16" "Teleking," 65/- . Hall, 89 Preston Old Road, Blackpool.

CAXTON *Practical Radio and Television*, 2 books. 50/- . EHT transformer 1500v—2.0-2—4v, new, £1. S. Petts, 7 Chedworth House, Geldeston Road, Clapton, E.5.

WANTED Circuit and information for BC454. L. C. Dalby, 3 Bank Street, Herne Bay, Kent.

# HENRY'S

5 HARROW ROAD LONDON W2  
Open Mon. to Sat. 9—5.30 (Thurs. 1 p.m.)  
Telephone PAD 1008/9 and 0401

### SPECIAL VALVE OFFER

Ten EF50 Brand New (Ex-Units) 55/- set or 6/- each  
**SET OF 5 MAINS VALVES**  
6K8CT, 6K7GT, 6Q7G, 5Z4, 6V6G or KT61 at 42/6 Set.  
**SET 5 AC/DC VALVES**  
6K8GT, 6K7G, 6Q7G, 25A6G, 25Z6G at 42/6 Set.  
**SET 5 AC/DC VALVES**  
6A7G, 6D6, 6C6, 43, 25Z5 at 42/6 Set.  
**SET 5 AC/DC VALVES**  
12K8GT, 12K7GT, 12Q7GT, 35Z4GT, 35L6GT or 50L6GT at 42/6 Set.  
**SET 5 AC/DC VALVES**  
12SA7GT, 12SK7GT, 12SO7GT, or 12SR7GT, 35Z4GT, 35L6GT or 50L6GT at 42/6 Set.  
**SET OF 4 BATTERY MINIATURE 1.4v. VALVES**  
1R5, 1S5, 1T4, 1S4 or (3S4 or 3V4) at 32/6 Set.  
**SET OF BATTERY VALVES 2 volt MAZDA TYPES**  
TP25, HL23/DD, VP23, PEN25 or QP25 at 27/6 Set.  
**WE HAVE OVER 10,000 EX-GOVT. AND BVA VALVES IN STOCK AT VERY LOW PRICES. LET US HAVE YOUR REQUIREMENTS.**

L.T. RECT'S.	
6v. 1 amp G.E.C. ....	4/-
12v. 2½ amp. Westinghouse ....	12/6
12v. 4 amp. S.T.C. ....	17/6
12v. 8 amp. S.T.C. ....	32/6
S.T.C. RECT'S. E.H.T.	
K3/25 650v. 1 m/a. ....	4/7
K3/40 1000v. 1 m/a. ....	6/-
K3/100 8,500v. 1 m/a. ....	14/8
K3/200 10,500v. 1 m/a. ....	26/-
H.T. RECT'S.	
S.T.C. 150v. 120 m/a. ....	4/6
S.T.C. 250v. 250 m/a. ....	18/-
G.E.C. 1 m/a Meter Rect. ....	11/6

RECEIVER R1355. As specified for *Inexpensive Television*. Complete with 8 Valves VR65 and 1 each 5U4G, VU120, VR92. Only 55/- carriage 7/6. Brand new in original case.  
RF24 25/-, RF25 25/-, RF26 59/6, RF27 59/6.

**CATHODE RAY TUBES**  
VCR97, Guaranteed full picture 40/-, carriage 2/-.  
VCR517, Guaranteed full picture 40/-, with Mu-Metal 3BP1 Suitable for 'scopes 25/-, carriage 3/- . Screen. Mu-Metal Screens 10/-, 6" Enlargers 17/6.

**PYE 45 Mc/s STRIP.** Type 3583 Units. Size 15"x8"x2". Complete with 45 mc/s Pye Strip, 12 valves 10 EF50, EB34 and EA50, volume controls and hosts of Resistors and Condensers. Sound and vision can be incorporated on this chassis with minimum space. New condition. Modification data supplied. Price £5, carriage paid.

**INDICATOR UNIT TYPE 182A.** This unit contains VCR517 Cathode Ray 6" Tube, complete with Mu-Metal Screen, 3 EF50, 4 SP61 and 1 5U4G valves, 9 wire-wound volume controls and quantity of Resistors and Condensers. Suitable either for basis of Television (full picture guaranteed) or Oscilloscope. Offered BRAND NEW (less relay) in original packing case at 79/6. Plus 7/6 carriage.

**VCR517C BLUE AND WHITE 6½in. TUBE**  
This Tube replaces the VCR97 and VCR517 without alteration and gives a full Blue and White picture. BRAND NEW in original crates, 45/-, plus 2/- carriage.

**"WEYMOUTH" 3-WAVE BAND COIL PACKS**  
Short, Med. and Long with Gram. Switch, Brand New Miniature type complete with circuit, 19/6. P.P. 1/6 Absolute bargain.

SEND 3d. FOR 28-PAGE CATALOGUE

continued on page 59



## Kendall and Mousley

Electronic Engineers and  
Laboratory Equipment Manufacturers

99 DUDLEY PORT, TIPTON, STAFFS.

Instrument cases in 18G steel, complete with light alloy front panel Colours Black (Red and Green 10 per cent extra). Back punched for ventilation. 8"x9"x8" at 18/-, 10½"x12"x10½" at 21/-, Chassis to suit 7" square by 2½" deep (16G Light alloy, four sides) 7/6. Chassis to suit 10" square by 2½" deep (16G Light alloy, four sides) 10/6. Heavier steel case in 20G steel complete with 18G alloy front panel, finished in Black (Red or Green 10 per cent extra). Back punched for ventilation, 9"x12"x9" at 30/-, chassis for same 10"x8"x2½" (reinforced corners) at 10/6 each. Case complete with chassis and panel £2.0.0. Meter stands, ends only, 2/6 per pair, panel for same 6" square at 1/9, 9"x6" at 2/6 and 12"x6" at 3/3. Meters can be mounted at extra cost if required. A full range of components, by well known manufacturers, are stocked, Mullard, Brimar, Cossor, T.C.C., Dubilier, Erie, R.E.P., Wearite, Elstone, Morganite, etc. High stability 1, 2 and 5 per cent resistors available from stock or to order.

**Metal Rectifiers.** 250V 60mA H/W 6/6; 250V 250mA H/W 12/6; 12-24V 3A H/W 4/6; 12/24V 3A F/W 12/-; 12-24V 4A F/W 14/-.  
**Polystyrene B7G Holder** with Can, set of 4, 6/-.  
**Earphones.** 4000Ω 12/6 per pair.  
IT4, IR5, IS5, 3S4, set of 4, 32/-.  
**Linecord.** 3A. 3-way 60-70Ωp. foot, 1/9 per yard.  
**Co-Ax Cable.** 70-80Ω per foot, 1/- per yard.  
**Radio Cabinet.** Size 12x7x5 inch in Walnut (wood) or brown (Bakelite) complete with punched chassis, Dial (Med. and Longwave) backplate, drum drive and pointer, £1/7/6.  
**Cable & Wire Stripper.** Ideal Tool for home and Workshop. Price 5/6.  
Hundreds of Bargains in Radio and TV Components.

Send for List. Callers Welcome. Please add Postage.

JACKSON'S RADIO SUPPLIES  
163 EDGWARE ROAD LONDON W.2

## ADCOLA

(Regd. Trade Mark)

### SOLDERING INSTRUMENTS



Reg. Design No. 860302 (British, U.S. and Foreign Patents)

Designed for wireless assembly and Maintenance

Supplied for all volt ranges from 6/7v to 230/250v 3/16" Dia. Bit Standard Model 25/6

Sole Manufacturers ADCOLA PRODUCTS LTD.

Sales Office and Works Cranmer Court, Clapham High St. London SW4 (MAC 4272)

**CORONATION QSL'S**  
why not send a distinctive QSL this year?  
Special designs to celebrate Coronation Year,  
available from G6MN who has supplied 'special'  
QSL's for discriminating users all over the world.  
Attractive "Coronation-1953 designs now available  
from  
G6MN Castlemount Worksoop Notts.

### VALVES—OVER 3,000 IN STOCK

12AT7, 6BW6 6CH6, 6SN7, 807, 6V6, 9/-, EF91,  
6AM6, EC91, EL91, 6J6, 6S17, 12AX7, 7/6, 6C4,  
6J5, 6N7, 6J7, EF92, EAC91 6/-.

SKILLMAN  
FRANCHISE STREET WEYMOUTH

### ★ 1953 EDITION

## The Radio Amateur's Handbook

Published by the A.R.R.L.

Price 30/- postage 1/-

THE MODERN BOOK CO.  
19/21 Praed Street London W.2.

Telephone PADDington 4185

Dept. RC

## REP

HIGH GAIN  
DUAL RANGE  
COIL WITH  
REACTION

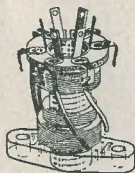

COMPLETE  
WITH  
2 BATTERY  
AND  
2 MAINS  
CIRCUITS

PRICE 4/- POST 3d.  
(Trade Supplied)

Radio Experimental Products Ltd  
33 MUCH PARK STREET  
COVENTRY

### VALVES NEW TESTED AND GUARANTEED

IR5	7/9	6F6g	8/6	6SA7	7/6	6V6g	8/6
IS5	7/9	6F12	7/6	6SG7	6/6	6V6gt	8/6
IT4	7/9	6G6	5/9	6SK7	6/9	8D3	7/6
IS4	7/9	6J5g	4/6	6SN7	8/6	12AT7	7/9
3S4	7/9	6K7g	4/6	6SQ7	7/6	12AX7	5/9
3V4	7/9	6K7	6/6	6X4	8/6	57	6/9
5U4g	8/6	6K8gt	8/6	6X5	7/6	954	2/-
5Z4g	8/9	6K8g	8/9	7C7	7/9	2C34	2/-
6AM6	7/6	6Q7g	8/9	7H7	6/9	EB91	6/6

MATCHED PAIRS 6V6g and gt 17/-; 6F6G 17/-;  
KT66 21/-; 807 15/6; 6G6 12/-; 6J5g 9/6 per pair  
P. and P. 6d per valve

### R. COOPER

32 SOUTH END CROYDON SURREY  
Telephone CROYdon 9186

## SMALL ADVERTISEMENTS

continued from page 57

### PRIVATE

**FOR SALE.** Sensitive Relays, similar Siemens Type 73, 2000 ohms, s.p.d.t. Suitable R/C, 10/- Also with 3400 ohms coil, 10/- E.C.C. Miniature Relay. Type 5A, £1. Miniature Accumulators Exide Type 2—SP1, 4v 3 A.H. L3½"×W1½"×H3" 10/-, 2 mfd 1000 V.D.C. condensers 2/- Packard Bell Pre-amplifier Model K, 10/- Denco IF's Type IFT7/1.6, 5/6. BFO 1.6, 7/6. Laboratory type milliammeter 25-0-25×4×10, 10/6. Selection three transformers, unidentified, from surplus, 5/- Muirhead Slow Motion Drive, ratio 48:1, 5/6. Midget 2 gang tuning condensers, max, 50 pf per section, 2/6. Ditto 500 pf, 3/6. VALVES. T.20, 5/- Four German RL12.P35's, transmitting pentodes, with two bases, £2 the lot. VT136, 12E1, EF50, VR136, VR56, VR53, VR99 all at 3/6. 6F6G 7/6. Wireless World 1952, Apl. May, June, Sept, Oct., Dec., at 1/- copy. Cathode Ray Oscillographs J.H. Reyner, 10/- Radio Control for Models Honnest-Redlich, 7/6. Short Wave Magazines 1952 March, April, May, Oct., Nov., 6d copy. WANTED. Old bug key—paddle and contacts, several 8000 ohm sensitive relays. "East Keal," Romany Road, Oulton Broad, Suffolk.

### TRADE

**JOIN THE ISWL.** Free services to members including QSL Bureau, Translation, Technical and Identification depts. Dx certificates, contests and activities for the SWL. Monthly magazine 'MONITOR' duplicated, containing articles of general interest to the SWL and League member, 10/6 per annum, post free. ISWL HQ, 86 Barrenger Road, London, N.10.

**BLUEPRINTS.** High Gain 10 Metre Converter, with a de-luxe circuit comprising EF91 RF stage, ECC91 double triode mixer and oscillator, EF92 IF amplifier, with stabilised voltage supply via a 7475. Is 8d post free with full instructions. A.S.W.P., 57 Maida Vale, London, W.9.

**FREE!** Brochure giving details of Home Study Training in Radio, Television, and all branches of Electronics. Courses for the Hobby Enthusiast or for those aiming at the A.M.Brit.I.R.E. City and Guilds Telecommunications R.T.E.B., and other professional examinations. Train with the College operated by Britain's largest Electronic Organisation. Moderate fees. Write to E.M.I. INSTITUTES, Postal Division, Dept. RC28, 43 Grove Park Road, London, W.4. (Associated with H.M.V.).

**METALWORK.** All types cabinets, chassis, racks, etc. to your own specification. Philpott's Metalworks Ltd. (Dept. R.C.), Chapman Street, Loughborough.

**KENDALL AND MOUSLEY.** Manufacturers of Laboratory Equipment, chassis and instrument cases, also suppliers of B.V.A. valves, Radio and T.V. components. 99 Dudley Port, Tipton, Staffs.

**TRANSFORMERS.**—Manufactured to our specification and fully guaranteed. Normal Primaries. 425 v. -0-425v. 200 ma., 6.3 v. 6 a., 6.3 v. 6 a., 5 v. 3a., 0-2-4-6.3 v. 3 a., ONLY 72/6. 425 v. -0-425 v. 200 ma., 6.3 v. 4 a., 6.3 v. 4 a., 5 v. 3 a. ONLY 50/- 350 v. -0-350 v. 160 ma., 6.3 v. 6 a., 6.3 v. 3 a., 5 v. 3 a. ONLY 42/6. 250 v. -0-250 v. 100 ma., 6.3 v. 6 a., 5 v. 3 a. ONLY 32/6. The above are fully shrouded, upright mounting. Universal Mounting 350 v. -0-350 v. 80 ma., 0-4-6.3 v. 4 a., -0-4-5 v. 2 a. ONLY 18/6. Top shrouded, drop through 260 v. -0-260 v. 70 ma., 6.3 v. 3 a., 5 v. 2 a. ONLY 16/6. The following are upright mounting. EHT for VC97 Tube 2,500 v. 5 ma., 2. -0-2 v. 1.1 a., 2 v. -0-2 v. -0-2 v. 2 a. ONLY 37/6. EHT 5,500 v. 5 ma., 2 v. 1 a., 2 v. 1 a. ONLY 72/6. EHT 7,000 v. 5 ma., 4 v. 1 a. ONLY 82/6. PLEASE ADD 1/6 PER TRANSFORMER POSTAGE. **TRANSFORMER**, for use on trains, models, etc., giving outputs of 3 v., 4 v., 5 v., 6 v., 8 v., 9 v., 10 v., 12 v., 15 v., 18 v., 20 v., 24 v., 30 v., at 2 amps from normal mains input. ONLY 17/6 (postage 1/-). **TRANSFORMERS.**—Ex. W.D. and Admiralty, built to more than 50 per cent. safety factor, with normal A.C. Mains Primaries. All Brand New and Unused. 300 v. -0-300 v. 200 ma., 5 v. 3 a., 6.3 v. 5 a., C.T., 20 v. 750 ma., 70 v. 100 ma. Weight 12 lb. ONLY 42/6 (postage, etc., 2/6). 330 v. -0-330 v. 100 ma., 4 v. 3 a. Weight 7 lb. ONLY 22/6 (postage 1/6). L.T. 5 v. -0-5 v. 5 a., 5 v. -0-5 v. 5 a., 5 v. -0-5 v. 5 a. By using combination of windings will give various voltages at high current. Weight 11 lb. ONLY 35/- (postage etc., 2/6). L.T. 6.3 v. 7.7 a., 4.2 v. 2.5 a., 4 v. 1 a. ONLY 19/6 (postage 1/6). EHT 1,400 v. 2 ma., 520 v. 10 ma., 300 v. 10 ma., 2 v. 1.5 a. ONLY 21/- (postage, 1/6). Cash with order, please, and print name and address clearly. Amounts given for carriage refer to inland only.

### U.E.I. CORPORATION

The Radio Corner

138 Gray's Inn Rd. LONDON WC1  
Open until 1 p.m. Saturdays. We are 2 mins. from High Holborn (Chancery Lane Stn.) and 5 mins. by bus from King's Cross.

### 6 VALVE SUPERHET V.H.F. RECEIVER.

Six channel switching, tuning 30.5 to 40 mc/s. Receives TV, Fire, Taxis, many British and Continental amateurs, etc. Components include 30 ceramic trimmers, 6 ceramic v/holders, 32 small condensers, 30 resistance, valve cans and covers, etc. All for 7/6. Post 2/6. Also supplied complete with valves at 17/6. Post 2/6. Drawings available for conversion to A.C. or A.C./D.C. operation.

**LOUD HAILER.** Powerful P.A. system. No valves to break or damage. Metal-clad and weather-proof. Consists of microphone and combined amplifier/speaker. Works off 12 or 24 volts D.C. OUR PRICE £8.17/6, carriage 5/6.

**RADIO-GRAM CHASSIS.** Three models available. Six wave band at £15.15.0, and two three wave band types, one at £12.12.0, and one at £10.17.6. All are brand new, and have latest valve line-up, gram switch, flywheel tuning and negative feed-back. Carriage 4/6.

**RADIO TELEPHONES.** Brand new American made walkie-talkie sets. 53-75 mc/s. Visual range. Complete with G.P.O. type handset. Operates either from set of internal batteries, or from a vibrator pack from 12 volt accumulator. PRICE £9.17.6, less vibrator. OR £18.17.6 a pair. Vibrators 27/6 each. SPECIAL OFFER of £21 for a pair, and two vibrators. Carriage 10/-.

**FIXED CONDENSERS.** Various values—0.05 mfd, 350 VDC; .15 mfd, 350 VDC; .01 mfd, 450 VDC; .001 mfd, 500 VDC; .25 mfd, 350 VDC. Stamp for complete catalogue C.W.O. or C.O.D.

### DUKE & CO.

621 Romford Road LONDON E12  
Money back guarantee GRA 6677

continued on page 60



## CLYDESDALE

Bargains in  
Ex-Services Radio and Electronic Equipment

**TI154B TRANSMITTER UNIT**  
Medium/High powered, for C.W.-M.C.W.-R/T. 3 Ranges 10-5.5 mcs, 5.5-3 mcs, 500-200 kcs. Complete with 4 valves etc., in metal case 14x16½x8½ins. External Power Supply required.

ASK FOR **39/6** Each CARRIAGE  
B/E5A Circuit 2/3 7/6 EXTRA

**RI155 RECEIVER UNIT**  
Communications, D.F. and "Ham" 20, 40, 80. 5 Ranges 18-7.5 mcs, 7.5-3 mcs, 1500-600 kcs, 500-200 kcs and 200-75 kcs. Complete with 10 valves, SM Drive, ME tuning, BFO etc., in metal case 16½x9x9ins. External Power Supply required.

ASK FOR **£9 19s 6d** Each CARRIAGE  
B/E6 Appearance As New PAID

ASK FOR **£8 19s 6d** Each CARRIAGE  
B/H916 Appearance Good PAID

ASK FOR **£5 19s 6d** Each CARRIAGE  
B/H898 Appearance Rough 7/6 EXTRA  
Circuit 1/3

New List No. 8D. Price 1/6  
(Credited on first purchase of 10/- or over)

Order direct from: Telephone SOUTH 2706/9

**CLYDESDALE** SUPPLY CO. LTD.  
2 BRIDGE STREET GLASGOW C.5

Branches in Scotland England and North Ireland

## We are Sorry . . .

that we cannot repeat our December publicity offer, but as we are continually being asked for the L.M.S.2 coil-pack together with the specially matched pair of I.F. transformers we are now offering a parcel comprising these items. The price is surprisingly low at

**£2 . 7 . 6** post paid

**L.M.S.2. Miniature Coil-Pack**  
38/6 Post & Pkg. 1/6

- \* 3 wave band.
- \* High quality—outstanding performance.
- \* Only 5 wires to solder—  
one nut to tighten.

**Miniature 465Kc. I.F. Transformers**  
12/- Post & Pkg. 1/-  
\* Specially matched to L.M.S.2. Coil unit.

Supplied Separately or in bargain parcel.

**5" Loud speakers** brand new nearly all sold  
last few 11/6 post paid

## Deal Component Co

105 Evering Road N16

## SMALL ADVERTISEMENTS

continued from page 59

### TRADE

Announcement

New Service for the Amateur and Experimenter

A stamped addressed envelope will bring you details of the new series of blue-prints of aerial tested circuits, from single valve to six and seven valve superhets. In the near future, kits of parts will be offered, both for the home constructor and the Amateur Transmitter and Receiver. Coming off the drawing board shortly is a Simple Communications Receiver Circuit. Further announcements will be made shortly concerning equipment for the T/V home constructor, including wide band pre-amplifiers, etc., at prices which will be right for your pocket. Get your name and address on the files NOW by sending your S.A.E. to J.H.G. Box No. C107.

Miller's "PANL"—the air drying black crackle enamel. From dealers 3s 6d jar or direct 4s 6d including postage.—8 Kenton Park Crescent, Kenton, Middx.

OSMOR—for efficient coils, coilpacks, etc. Send 5d stamp for FREE circuits and lists. Dept. RCC. Osmor Radio Products Ltd., Borough Hill, Croydon, Surrey. Tel. Croydon 5148/9.

"GLOBE KING" (Regd.) Miniature Single Valve Receiver gets real Dx. Amateur Radio enthusiasts, should send for free copy of interesting literature and catalogue (enclose stamp for postage). Write to makers: Johnsons (Radio), 46 Friar Street, Worcester.

BOOKBINDING. Volumes of *Radio Constructor* and *Radio Amateur* fully bound, imitation leather, gold lettering, 7s 6d post free. Prices for other publications on application. Jerome Alcock; CHEADLE, Stoke-on-Trent.

I.P.R.E. PUBLICATIONS. 5,500 Alignment Peaks for superhets 5/9. Sample copy *The Practical Radio Engineer* 2/-. Membership examination particulars 1/-. Syllabus of TV and radio courses free and post free. Secretary, I.P.R.E., 20 Fairfield Road, London, N. 8.

OAK SWITCH SERVICE. Multi-way switches made to specification. Approx. cost:—Ceramic Wafer 5/-, Paxolin Wafer 2/-, Clicker Plate 2/6. Box No. C117.

ARE YOU STUCK? PRE-WAR VALVES from 6/- each. WAVEMETERS, VOLT and MILLIAMMETERS from 15/- S.A.E. for list. LAWRENCE, 134 Cranley Gardens, London, N.10.

BOOKS! Any radio book in print supplied Cash on Delivery. "Handbooks," 80 Eastern Esplanade, Southend, Essex.

TAPE RECORDING. Truvox, Lane, Motek Tape Tables (definitely in stock). R/P Amplifiers, kits or complete Microphones, Cabinets and all components. Complete recorders. Expert advice. R.M.C. Radio, 99 Shacklewell Lane, London, E.8. Clissold 2362.

## "YOU CAN RELY ON US"

**COILS**  
Wearite "P" Coils. All types in stock including AF.I, RF.I. Price 3/-.

Midget I.F. Transformers Type 800. 21/- per pair. Standard Type 500/501 (465Kc/s) 20/- pair

**HIGH IMPEDANCE HEADPHONES**  
New Ex-Government Price 12/6 per pair.

**SCOTCHBOY TAPE**  
1200ft Reels 35/-  
Spare Reels 4/3

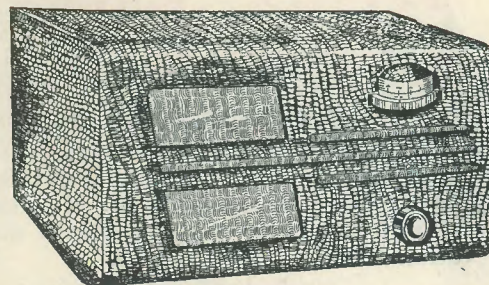

**COILS**  
Osmor Midget iron-cored "Q" Coils 4/- each. Leaflet on request.

Coilpacks Type H.O. 52/- LM 43/4, MTS 54/2, TRF 43/4, all including Tax.

**TRIMMERS**  
All new Postage Stamp Ceramic. 4-70pf 8d, 40-100pf 10d, 20-150pf 1/- 100-550pf 1/3.

**LINECORD**  
3-way .3a at 60 ohms, per foot 6d ft., .2a at 100 ohms per ft. 8d ft.

The "MAXIMITE" AC/DC SUPERMIDGET SUPERHET — Full Plans 1/-

CATALOGUE No. 12 now available

70 pages 250 illustrations Price 1/-

NOTE OUR NEW ADDRESS

**RADIO SERVICING COMPANY**

DEPT. K 82 SOUTH EALING ROAD LONDON W.5

Telephone EALing 5737

## EDDYSTONE FINE COMMUNICATION RECEIVERS

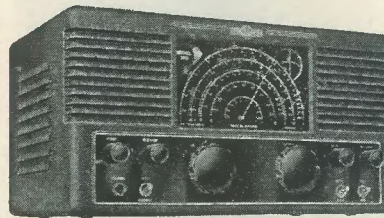

MODEL '740'

- Sound design
- Eight valves
- High performance
- Geared Drive
- Mechanical bandspread

£42 : 15 : 0 (exempt from Purchase Tax)

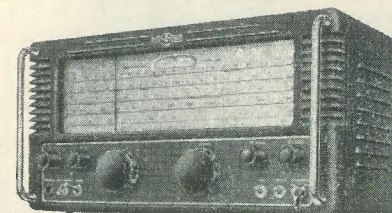

MODEL '750'

- Double superheterodyne
- Eleven valves
- Variable selectivity
- Long linear scales
- Chrome handles

£68 : 0 : 0 (exempt from Purchase Tax)

For full specifications, please apply to your local Eddystone Distributor or to:—  
**STRATTON & CO. LTD., EDDYSTONE WORKS, BIRMINGHAM, 31**



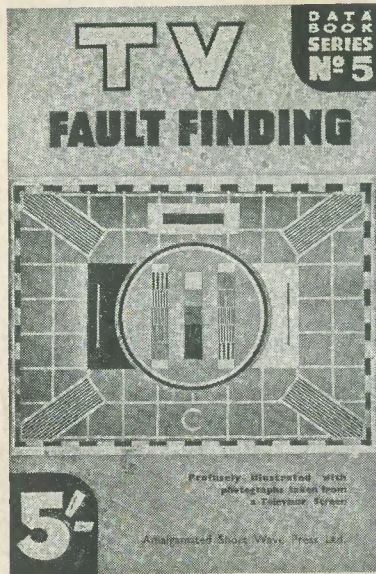

## TV FAULT FINDING

*Data Book Series No. 5*

This is a completely new production—not a reprint—and is unique in that it is lavishly illustrated by photographs taken from the screen of a television exhibiting the faults under discussion. A handy fault-finding guide is incorporated, and this is cross-referenced to the book itself.

**100**  
*Illustrations and Diagrams*

**80**  
*pages, high quality paper with heavy art board cover*

PRICE 5 SHILLINGS, Postage 3d.

Available from your usual supplier, or direct  
(Trade enquiries invited)

AMALGAMATED SHORT WAVE PRESS LTD.  
57 MAIDA VALE LONDON W9

Telephone CUN 6518

Published by Data Publications Ltd, 57 Maida Vale Paddington London W9  
Printed by A. Quick and Co. Ltd., Oxford House Clacton-on-Sea Essex



“ . . . . A book that should be in every television dealers service workshop, and in every home-constructor's, for that matter.”

*Journal of the Television Society*

“ . . . . The book will undoubtedly be of value to TV service engineers, particularly those who are not fully experienced in translating the appearance of faulty pictures into the necessary adjustments or receiver fault location.”

*Wireless and Electrical Trader*

# The RADIO CONSTRUCTOR

*for the Radio and Television Enthusiast*

Volume 7  
Number 2  
SHOW  
NUMBER

## THE 'UNIVERSAL'

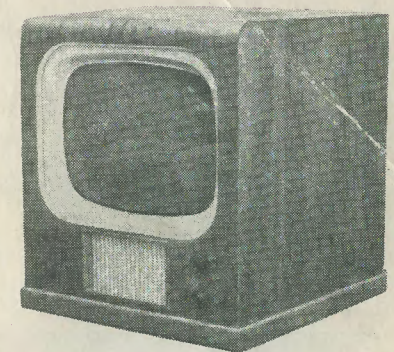
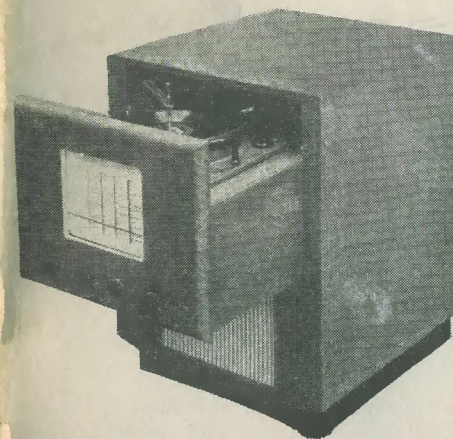

## Large Screen AC/DC TELEVISOR

ALSO IN THIS ISSUE

### A PORTABLE OSCILLOSCOPE

NATIONAL RADIO SHOW • INEXPENSIVE 3-VALVE DOMESTIC RECEIVER • THE "UNIVERSAL" AC/DC LARGE SCREEN TELEVISOR • PHOTOCCELL RELAY UNIT • TV PRE-AMPLIFIER Black Spotter • Battery Set Power Pack • Radio Control Equipment • etc. etc.

# 16



## THE MODERN BOOK CO.

**The Radio Amateur's Handbook** by A.R.R.L. 1953. 30s 0d. Postage 1s 0d.

**Television Fault Finding** compiled by Radio Constructor. 5s 0d. Postage 5d.

**Receivers, Pre-Selectors and Converters.** 2s 6d. Postage 2d.

**The Oscilloscope Book** by E. N. Bradley 5s 0d. Postage 3d.

**Reference Data for Radio Engineers.** STC. 10s 6d. Postage 6d.

**Television Receiver Design I** by A. Uitjens. 21s 0d. Postage 9d.

**Amplifiers** by G. A. Briggs and H. H. Garner. 15s. 6d. Postage 6d.

**Radio Servicing Instrument** by E. N. Bradley. 4s 6d. Postage 3d.

**Constructors' Radio Receivers** by E. N. Bradley. 2s 6d. Postage 2d.

**Brimar Radio and Teletube Manual No. 5.** 5s 0d. Postage 6d.

**Radio Valve Data** compiled by Wireless World. 3s 6d. Postage 3d.

**P. H. Brans' Equivalent Radio Tube Vade-Mecum** 1953. 21s 0d. Postage 1s 0d.

**Basic Mathematics for Radio Students** by F. M. Colebrook. 10s 6d. Postage 6d.

**Foundations of Wireless** by M. G. Scroggie. 12s 6d. Postage 9d.

We have the finest selection of British and American Radio publications in the Country. Complete list on application.

**19-23 PRAED STREET (Dept. RC) LONDON W2**

PADdington 4185

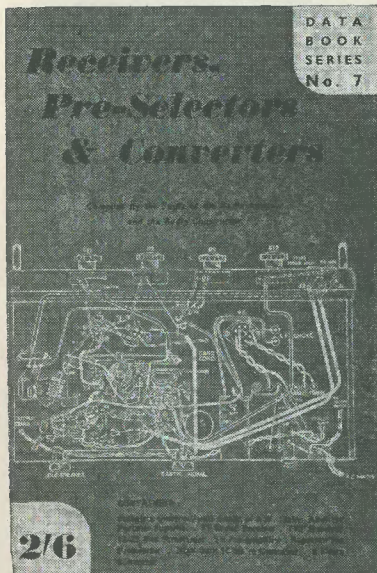

DATA BOOK SERIES No. 7

Just published — Data Book No. 7

### "Receivers, Pre-Selectors & Converters"

The book for which you have been waiting!

Containing complete constructional details of:

S.W. Mains Receiver . Portable Superhet  
TV Sound Receiver . TRF Receiver  
13-31 Mcs Pre-selector . TV Pre-amplifier  
Regenerative Pre-selector . High Gain  
10 Metre Converter . 2 Metre Converter

PRICE 2/6 Postage 2d

Available immediately from:

**Data Publications Ltd.**  
57 Maida Vale . London . W.9



**POST THE COUPON TODAY FOR OUR BROCHURE ON THE LATEST METHODS OF HOME TRAINING FOR OVER 150 CAREERS & HOBBIES**

**PRIVATE AND INDIVIDUAL TUITION IN YOUR OWN HOME**

### NEW! LEARN THE PRACTICAL WAY

With many courses we supply actual equipment thus combining theory and practice in the correct educational sequence. This equipment, specially prepared and designed remains your property. Courses include: Radio, Television, Electronics, Draughtsmanship, Carpentry, Photography, Commercial Art, Amateur S.W. Radio Electricity, Languages, Mechanics, etc.

Accountancy  
Advertising  
Aeronautical Engineering  
Automobile Engineering  
Banking  
Book-keeping  
Building  
Business Management  
Carpentry  
Chemistry  
Civil Service  
Civil Engineering  
Commercial Subjects  
Commercial Art & Drawing  
Customs & Excise Officer  
Draughtsmanship  
Dressmaking  
Economics  
Electrical Engineering

Electronics  
Fashion Drawing  
Heating & Ventilating Eng.  
Industrial Administration  
Journalism  
Languages  
Marine Engineering  
Mathematics  
M.C.A. Licences  
Mechanical Engineering  
Motor Engineering  
Photography  
P.M.G. Licences  
Police  
Production Engineering  
Public Speaking  
Radar  
Radio & Television Servicing

Radio Engineering  
Refrigeration  
Retail Shop Management  
Salesmanship  
Sanitation  
Secretaryship  
Sheet Metal Work  
Shorthand & Typing  
Sound Recording  
Structural Eng.  
Telecommunications  
Television  
Time & Motion Study  
Tracing  
Welding  
Writing  
Works Management  
Workshop Practice  
and many others.

Also courses for University Degrees, General Certificate of Education, B.Sc. Eng., A.M.I. Mech.E., L.I.O.B., A.C.C.A., A.C.I.S., A.M. Brit. I.R.E., A.M.I.I.A., City & Guilds Examinations, R.S.A. Certificates, etc.

### THE ADVANTAGES OF E.M.I. TRAINING

- ★ The teaching methods are planned to meet modern industrial requirements.
- ★ We offer training in all subjects which provide lucrative jobs or interesting hobbies.
- ★ A tutor is personally allotted by name to ensure private and individual tuition.

- ★ Free advice covering all aspects of training is given to students before and after enrolment with us.

**COURSES FROM £1 PER MONTH**

# EMI INSTITUTES

The only Postal College which is part of a world-wide Industrial Organisation

### POST THIS COUPON TODAY

Please send without obligation your FREE book.  
**E.M.I. INSTITUTES** (Dept. 179K)  
43 Grove Park Road, London, W.4. Phone: Chiswick 4417/8

NAME .....

ADDRESS .....

SUBJECT(S) OF INTEREST .....

ICL



WIDE ANGLE TV

*Smith's*  
of  
EDGWARE ROAD

ALLEN · DENCO · COLVERN · DUBILIER  
ELAC · McMURDO · MORGAN  
STC · TCC

for the

"TELEKING"  
"VIEWMASTER" CONVERSION  
and "MAGNA VIEW"  
(Radio Constructor)

also Tubes, Valves and Cabinets  
etc. Price Lists on receipt of SAE

**H. L. SMITH & CO. LTD**

287/9 Edgware Road London W2  
Telephone Paddington 5891  
Hours 9 till 6 (Thursday 1 o'clock)  
Nr. Edgware Road Stations, Metropolitan & Bakerloo

**ARTHURS HAVE IT!**

LONDON'S OLDEST RADIO DEALERS

**LARGE VALVE STOCKS**

AVOMETERS IN STOCK

Avo Test Meters and Signal Generators  
and Taylor Meters  
Leak Point One Amplifiers and Tuning  
Units.

Chapman Tuning Units.  
Crystal and Moving Coil Mics.  
Decca Replacement Heads and Pickups.  
Goodman's Axiom 150 Speakers.  
Partridge Output Transformers for  
Williamson Amplifier.

All Components for the Radio Construc-  
tor's 16" Televisor.

Weare & Wright Tape Deck £35.

LATEST VALVE MANUALS

Mullard, Osram & Brimar No. 4 5/- each  
Mazda 2/- each Postage 6d extra

TELEVISION SETS, WIRE AND TAPE  
RECORDERS ALWAYS IN STOCK  
Goods offered subject to price alterations  
and being unsold.

*Arthurs first* Est.  
1919

Proprietors: ARTHUR GRAY LTD.

OUR ONLY ADDRESS Gray House  
150-52 Charing Cross Road  
London, W.C.2.

TEmple Bar 5833/4 and 4765 WRITE FOR LISTS

INFORMATION

for the Home Constructor

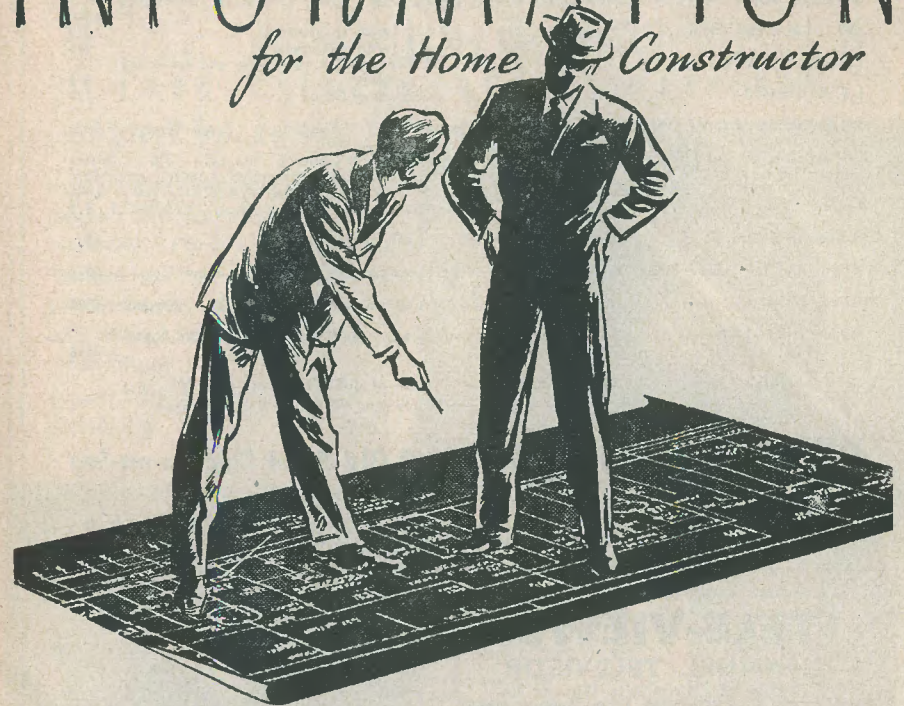

THIS year at Earls Court the Mullard stand is of especial interest to the Home Constructor. There you will find an information centre where you can discuss your problems with representatives of the Mullard Technical Service Department. You can inspect a selection of radio and television receiver and sound amplifier chassis by well-known designers. And, of course, there is the comprehensive range of Mullard receiving valves and "Long-life" picture tubes. We look forward to seeing you.

**Mullard**  
STAND 91

On show will be the "Universal", the new AC/DC televisor, which has been the subject of a recent series of articles in the "Radio Constructor".



MULLARD LTD., CENTURY HOUSE, SHAFTESBURY AVENUE, LONDON, W.C.2

MVM 236A

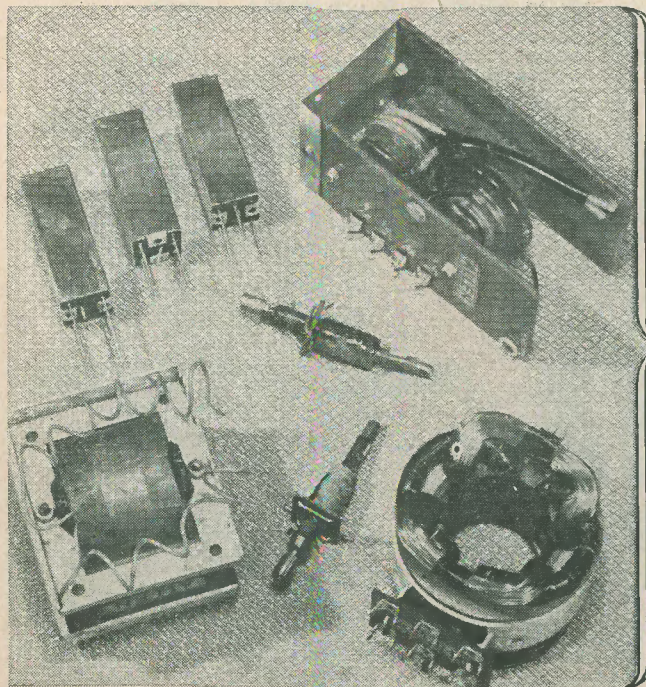

THESE STANDARD  
WIDE ANGLE  
COMPONENTS ARE  
USED IN THE  
"TELEKING"  
AND  
"SUPERVISOR"

Also for the conversion  
to 14" or 17" C/R Tube  
of all popular home-built  
televisors.



From all leading stockists.

**ALLEN**  
COMPONENTS  
LIMITED

Crown Works  
Lower Richmond Road  
Richmond Surrey

Telephone Prospect 9013

Send address and stamped  
envelope for  
Circuit Diagram.



## WIDE ANGLE TELEVISION COMPONENTS

**SOUND AND VISION COILS** suitable for "Magna-View" and "Universal" Televisors

CH.1, CH.2 and CH.3 . . . . .	each 2/6	L.5 (with condenser) . . . . .	each 3/9
L.1 . . . . .	4/6	L.7 (with condenser) . . . . .	3/6
L.2A/B . . . . .	2/9	L.12A/B (with condenser and screening can) . . . . .	8/6
L.3, 4, 6 and 8 . . . . .	2/6	Screening Cans . . . . .	1/7

**SCANNING COMPONENTS** suitable for "Magna-View," "Teleking," "Super-Visor," "Universal" and "Viewmaster Conversion."

Deflection Coil Assembly, WA/DCA.1...43/- Line Linearity Control, WA/LC.1...7/6 Frame Output Trans. WA/FMA.1...21/- Frame Blocking Osc., WA/FBT.1 (Not required on Super-Visor)...16/- Focus Coil (Not required on Universal) WA/FCA.1...31/- Width Control, WA/WC.1...7/6 Line Output Trans. WA/LOT.1...42/- Flywheel Adjustment used on "Super-Visor," WA/WC.1...7/6

- Smoothing Choke, WA/SC.1, suitable for "Universal" television . . . . . 19/-
- Ready Drilled 3-piece Chassis complete with all Brackets suitable for "Magna-View" . . . . . 37/6
- Ready Drilled Chassis complete with all Mechanical Parts suitable for the "Universal" television 43/6
- Ready Drilled Chassis complete with all Brackets suitable for the "Practical Television Super-Visor" . . . . . 41/6

Obtainable from all reputable stockists or in case of difficulty direct from Works  
For complete details of these and other products send 9d for General Catalogue

**DENCO (Clacton) Ltd** 357/9 Old Road Clacton-on-Sea

## ELAC T/V COMPONENTS

as specified in

**"THE UNIVERSAL"**

**LARGE SCREEN AC/DC TELEVISOR**

### DUOMAG FOCALISER

incorporating two sintered oxide magnets of high electrical resistivity. The unit provides a "double lens" system and can be placed close to high efficiency scan coils without detracting from their performance.

Type FD12/4 (for Mullard MW.43/64)

37/6

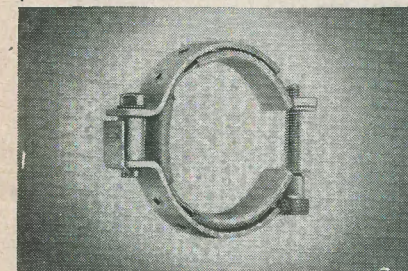
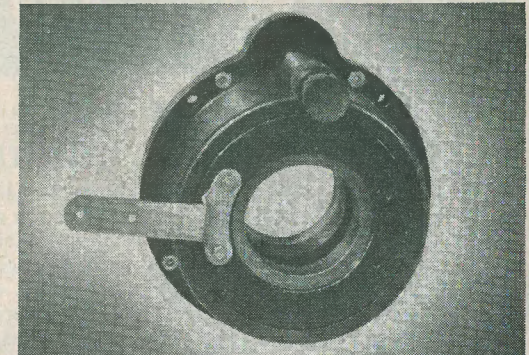

### 5" LOUDSPEAKER

(Series 5D)

This unit is one of the most sensitive small Loudspeakers in quantity production. The response is characterized by the crisp reproduction of speech and excellent rendering of orchestral items.

Type 5/45 (as specified)  
23/9 inc. P.T.

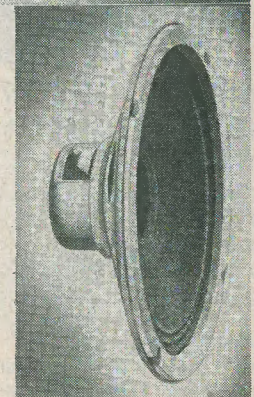

Matching Transformer  
Type T18009 6/6

### "ELAC" ION TRAP

Each assembly is individually checked to ensure correct flux. The special clamping device obviates strain on the neck tube and the possibility of breakage with change of temperature.  
Type I.T.9. for Mullard MW.43/64

5/-



**ELECTRO ACOUSTIC INDUSTRIES LTD**  
STAMFORD WORKS, BROAD LANE, LONDON, N.15

## THE 'TELE-VIEWER'

### 5 CHANNEL TELEVISOR

A Design of a Complete 12in. or 9in. SUPERHET T.V. RECEIVER FOR THE HOME CONSTRUCTOR

This receiver has been developed after most careful research and affords a high standard of Television entertainment by producing a picture of really outstanding quality.

Successful construction, even by the most inexperienced is assured by the step by step wiring detail and diagrams provided, and at about half the cost of the nearest comparable commercial receiver.

Here are some of the features which combine to make this such a fine receiver:

- The Superhet circuit easily tuned to any of the five channels, e.i. LONDON, SUTTON COLDFIELD, HOLME MOSS, WENVOE and KIRK-O'SHOTT. (The extreme ease of tuning is accomplished by the provision of pre-aligned I.F.T's).
- A lifelike, almost stereoscopic, picture quality made possible by the following factors: (a) Excellent band width of I.F. circuits. (b) A really efficient video amplifier. (c) C.R.T. Grid modulated from low impedance source. (d) High E.H.T. voltage (approx. 10 kV).

The picture brilliance is also much above the average and enables comfortable viewing with normal room lighting or daylight.

- FIRM picture "HOLD" circuits (Frame-Line).
- Negative feedback is used in the audio frequency circuits which provide 2/3 watts of High Quality Sound.
- Entire receiver built on two chassis units, each measuring 14 1/4 x 6 1/2 x 3 1/2 in.
- Rigid C.R.T. mounting enables entire receiver to be safely handled.

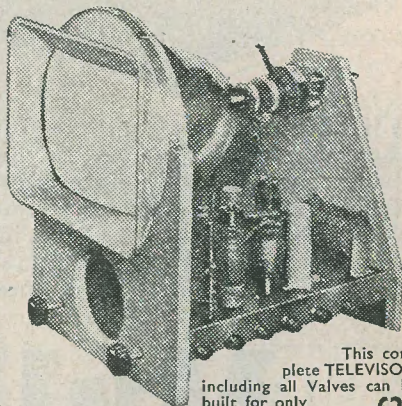

This complete TELEVISOR, including all Valves can be built for only £28 (plus cost of C.R.T.)

- All presets accessible from front. All parts available separately or as complete stages (1-5).

Complete set of ASSEMBLY INSTRUCTIONS are now available, price 5/- (refunded against first order). The instructions include really detailed PRACTICAL LAYOUTS, WIRING DATA AND COMPONENT PRICE LIST.

### STERN RADIO LTD

109 & 115 FLEET STREET, E.C.4.  
Telephone CENTRAL 5812-3-4



# NEW! RADIO, TELEVISION AND ELECTRONICS

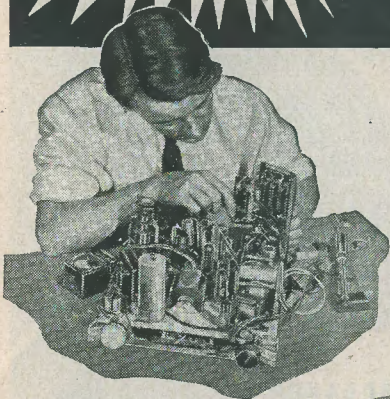

## LEARN THE PRACTICAL WAY Instruction and Equipment

Here at last is the only real way of making home study really successful. Actual equipment is supplied thus combining theory and practice in the correct educational sequence. Whether your need be for career, hobby or general interest, here is the ideal method for acquiring the knowledge in the most efficient way possible.

### QUICKER - BETTER - MORE INTERESTING

This equipment specially prepared and designed remains your property and it provides thoroughly sound basic sets which can easily be expanded to meet your growing knowledge.

PRACTICAL COURSES IN MANY OTHER SUBJECTS INCLUDING: Draughtsmanship, Carpentry, Chemistry, Photography, Commercial Art

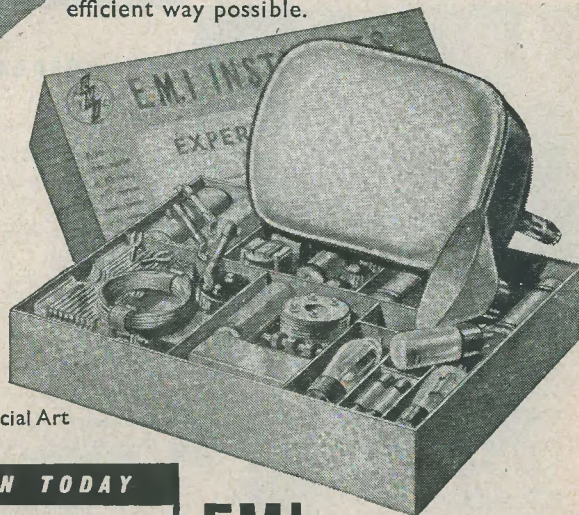

## EMI INSTITUTES

The only Postal College  
which is part of a world-wide  
Industrial Organisation.

### POST THIS COUPON TODAY

Please send me your FREE book on *Practical Courses*  
To: E.M.I. INSTITUTES, Dept. 179x,  
43 Grove Park Road, Chiswick, W.4.

NAME .....

ADDRESS .....

We will not worry you with personal visits.

IC20



## CONDENSERS

The abbreviated ranges of two popular types given here are representative of the wide variety of T.C.C. Condensers available

WAX PROTECTED TUBULARS  
(Temperature Range 60°C. Max.)

Cap. $\mu$ F.	Wkg.	Dimensions		Type
		length	Dia.	
.0005	500	$\frac{3}{4}$ in.	$\frac{3}{16}$ in.	543
.002	500	$\frac{3}{4}$ in.	$\frac{3}{16}$ in.	543
.01	500	$\frac{3}{4}$ in.	$\frac{3}{16}$ in.	543
.05	750	$1\frac{1}{2}$ in.	$\frac{3}{16}$ in.	743
.1	350	$1\frac{1}{2}$ in.	$\frac{3}{16}$ in.	343
.25	350	$1\frac{1}{2}$ in.	$\frac{3}{16}$ in.	343
.5	350	2 in.	$\frac{3}{16}$ in.	343

SUPER TROPICAL "METALMITES"  
(In Aluminium Tubes)

Cap. $\mu$ F.	Wkg. Volts D.C.		Dimensions		Type No.
	at 71°C.	at 100°C.	Length	Dia.	
.001	1000	750	$1\frac{1}{2}$ in.	$\frac{1}{8}$ in.	CP49W
.002	1000	750	$1\frac{1}{2}$ in.	$\frac{1}{8}$ in.	CP49W
.005	500	350	1 in.	.25 in.	CP32S
.05	500	350	$1\frac{1}{2}$ in.	$\frac{7}{16}$ in.	CP37S
.01	350	200	1 in.	.25 in.	CP32N
.1	350	200	$1\frac{1}{2}$ in.	$\frac{7}{16}$ in.	CP37N
.1	200	120	$1\frac{1}{2}$ in.	$\frac{7}{16}$ in.	CP36H

THE TELEGRAPH CONDENSER Co. Ltd.  
Radio Division: North Acton, London, W3 Tel: Acorn 0061

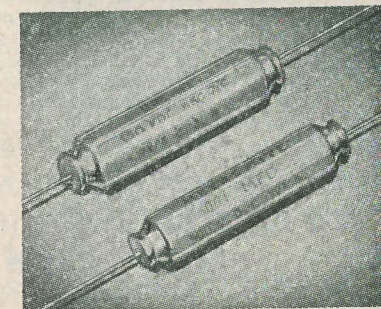
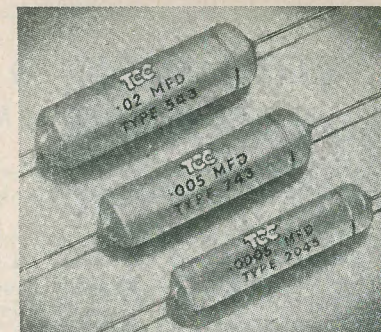

## TELE-RADIO (1943) LIMITED

WALCHRIS GUITAR PICK-UPS WITH VOLUME CONTROL 30/-  
TRANSFORMERS 0-230v. 6.3v. 1A. UPRIGHT 350-0-350v. 70mA. 5v. 2A. 6.3v. 8/6.  
UNIVERSAL MOUNTING, 12/6. 350-0-350v. 60mA. 5v. 2A. 6.3v. 3A. DROP THROUGH 13/6.  
METAL RECTIFIERS BRIDGE TYPE. 6.3v. 3A., 10/6. 12v. 1A., 6/6. 12v. 1.5A., 8/9. 12v. 3A., 12/6. 12v. 4A., 15/- 12v. 10A., 35/-  
RONETTE CRYSTAL MIKES 50/- (LIST  $\pounds$ 4.10.0). TABLE STAND, 15/6. COLLAPSIBLE FLOOR STAND,  $\pounds$ 3.12.6.  
ELAC LOUDSPEAKERS 5" 13/-. 8" 21/-  
GOODMANS PENTODE OUTPUT TRANSFORMERS 5/-  
ALUMINIUM CHASSIS 18G. REINFORCED CORNERS. 8" x 6" x 2 1/2" 7/6. 10" x 6" x 2 1/2" 8/3. 12" x 6" x 2 1/2" 8/6. 12" x 8" x 2 1/2" 9/6. 14" x 8" x 2 1/2" 10/6. 14" x 10" x 2 1/2" 11/- 17" x 10" x 2 1/2" 12/6.  
ELLISON TRANSFORMERS Pri. 200/250v. UPRIGHT. MT162 250-0-250v. 60mA. 5v. 2A. 6.3v. 3A., 23/3. MT137 250-0-250v. 120mA. 5v. 3A. 6.3v. 7A., 33/9. MT121 350-0-350v. 80mA. 5v. 2A. 6.3v. 3A., 27/9. MT190 350-0-350v. 120mA. 5v. 5A. 6.3v. 5A., 39/9. T68 6.3v. 4A., 19/6. FT51 6.3v. 1.5A., 9/- SP70 0-6-12v. 3A. 21/-  
POSTAGE & PACKING EXTRA. C.W.O. OR C.O.D.

189 EDGWARE ROAD LONDON W2  
Telephone PAD. 4455/6  
Shop Hours Mon.-Sat. 9 a.m.-6 p.m. Thursday 9 a.m.-1 p.m.

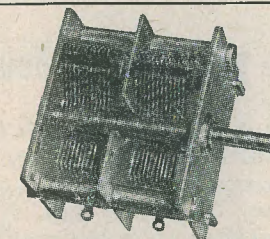

### M.G. GANG CONDENSER

M.G. Gang Condenser available as 1, 2 or 3 gang, 490 p.F. nominal capacity with Cadmium plated steel frame, aluminium vanes; matched and standardised to close limits. Low loss non-hygroscopic insulation. Supplied with trimmers if required. Other capacities available. Write for further details. Prices 9/3, 14/-, 18/3

Please write for our list of condensers and drives

## JACKSON BROS.

(London) LTD.  
KINGSWAY, WADDON CROYDON Surrey  
Telephone: CROYDON 2754-5  
Telegrams: WALFILCO, SOUPHONE, LONDON



## PETTER RADIO & ELECTRICAL SUPPLIES

205 FOREST ROAD WALTHAMSTOW E17

Telephone LARKSWOOD 7575-6

Telegrams Acsmart Walt-Ldn.

You may be wanting goods from several of the undermentioned manufacturers?

If so, why not place **ONE ORDER** for the lot? We have everything in stock, ready for immediate despatch

**B.V.A. VALVES and CATHODE RAY TUBES**, big stocks. We are authorised Wholesalers.

**ERIE RESISTORS**,  $\frac{1}{2}$ ,  $\frac{1}{4}$ , 1 and 2 watt, over 80 different values of each type.

**VOLUME CONTROLS**, Standard or Midget, less, S.P. or D.P. Switch. All makes.

**ELECTROLYTICS**, etc., T.C.C., Hunts, Dubilier, 75 different types.

**TELEVISION AERIALS and Components**. Belling Lee and Aerialite. A large range.

**GRAMOPHONE MOTORS, AUTO-CHANGERS**, etc. Collaro, B.S.R.

**PICK-UPS, PICK-UP HEADS, CARTRIDGES, NEEDLES**, Collaro, Acos, Rothermel, Decca, Etc.

**METERS, SIGNAL GENERATORS**, Advance, Avo, Taylors, Radar, Cossor, etc., stocked.

**RECTIFIERS, BRIMISTORS**, etc. Westinghouse, Brimar.

**TRANSFORMERS, CHOKES**, etc. Elstone, Weymouth, Wearite, Ellison, etc.

**TAPE DECKS and ACCESSORIES**, Wearite, Truvox. Scotch Boy Tape.

**WIRES**, Co-axial, Tinned Copper, D.C.C., D.S.C., Enam., Push Back, Screened Wire, Line Cord.

**TELE-KING, VIEWMASTER, SOUNDMASTER**, and **ELECTRONIC ENG.** Components—Large stocks.

**ELECTRICAL GOODS and BAKELITE FITTINGS.**

**VISIT OUR STAND No. 223 (First Floor) Radio Show Earls Court**

TRADE ONLY SUPPLIED

## Have your Copies Bound

VOLUMES OF RADIO CONSTRUCTOR AND RADIO AMATEUR FULLY BOUND IN IMITATION LEATHER, WITH GOLD LETTERING. 7s 6d POST FREE. PRICES FOR OTHER PUBLICATIONS ON APPLICATION



If not required to be bound in, remove covers before sending.

# JEROME ALCOCK

CHEADLE, STOKE-ON-TRENT

## IKOPATENTS

LTD.

Managing Director

E. G. O. ANDERSON

## Consultants

- RADIO
- TELEVISION
- ELECTRONICS

17 CRISP ROAD W6

RIVERSIDE 2678

# The RADIO Constructor

Vol. 7. No. 2

Annual Subscription 18/-

Show Number 1953

Editorial and Advertising Offices—57 Maida Vale London W9

Telephone CUNINGHAM 6518

Editor: C. W. C. OVERLAND, G2ATV

Advertising Manager: F. A. BALDWIN

## Contents

SUGGESTED CIRCUITS: A METHOD OF ALTERING EFFECTIVE REVERBERATION, by G. A. French . . . . .	70
IN YOUR WORKSHOP, by J. R. D. . . . .	71
VALVES AND THEIR POWER SUPPLIES, PART 11, by F. L. Bayliss, A.M.I.E.T.	74
OSCILLOSCOPE TRACES No. 4, by A.B. . . . .	77
A PORTABLE OSCILLOSCOPE, by L. F. Sinfield, A.M.I.P.R.E. . . . .	78
AN INEXPENSIVE THREE VALVE DOMESTIC RECEIVER, by E. Govier . . . . .	82
THE "UNIVERSAL" LARGE SCREEN AC/DC TELEVISOR, PART 5, described by A. S. Torrance, A.M.I.P.R.E., A.M.T.S. . . . .	83
THE "MAGNA-VIEW"—MODIFICATIONS . . . . .	88
QUERY CORNER—A RADIO CONSTRUCTOR SERVICE FOR READERS . . . . .	89
RADIO MISCELLANY, by Centre Tap . . . . .	92
A PHOTOCCELL RELAY UNIT, by J. W. Bagnall . . . . .	94
A NOISE LIMITER, by R. G. Young . . . . .	95
RADIO CONTROL EQUIPMENT, PART 8, by Raymond F. Stock . . . . .	96
POWER PACK FOR A BATTERY SET, by B. B. Fisher . . . . .	101
LET'S GET STARTED—THE SINE WAVE, by A. Blackburn . . . . .	105
THE 20TH NATIONAL RADIO SHOW, 1953 . . . . .	108

## NOTICES

THE CONTENTS of this magazine are strictly copyright and may not be reproduced without obtaining prior permission from the Editor. Opinions expressed by contributors are not necessarily those of the Editor or proprietors.

THE EDITOR invites original contributions on construction of radio subjects. All material used will be paid for. Articles should be typewritten, and photographs should be clear and sharp. Diagrams need not be large or perfectly drawn, as our draughtsmen will redraw in most cases, but relevant information should be included. All Mss must be accompanied by a stamped addressed envelope for reply or return.

Each item must bear the sender's name and address. TRADE NEWS. Manufacturers, publishers, etc., are invited to submit samples or information of new products for review in this section.

ALL CORRESPONDENCE should be addressed to *Radio Constructor*, 57 Maida Vale, Paddington, London, W.9. Telephone CUN. 6518.

A COMPANION JOURNAL TO THE RADIO AMATEUR



# Suggested Circuits for the Experimenter

The circuits presented in this series have been designed by G. A. FRENCH specially for the enthusiast who needs only a circuit and the essential relevant data.

## No. 34: A method of altering effective reverberation

IT IS WELL KNOWN that the acoustic properties of a room in which sound-reproducing equipment is installed have a considerable effect on the impression received by the listener. Thus, a room which is heavily carpeted and contains a large amount of sound-absorbent furniture can give an apparent "deadening" effect to the reproduced sound. On the other

hand, a large bare room with few furnishings can cause multiple echoes which may detract from the quality of the reproduced sound and cause loss of "presence."

This month's circuit shows an experimental method of increasing the apparent reverberation of a room or hall. Sound from the reproducing loudspeaker is picked up by a remote microphone and fed back to the

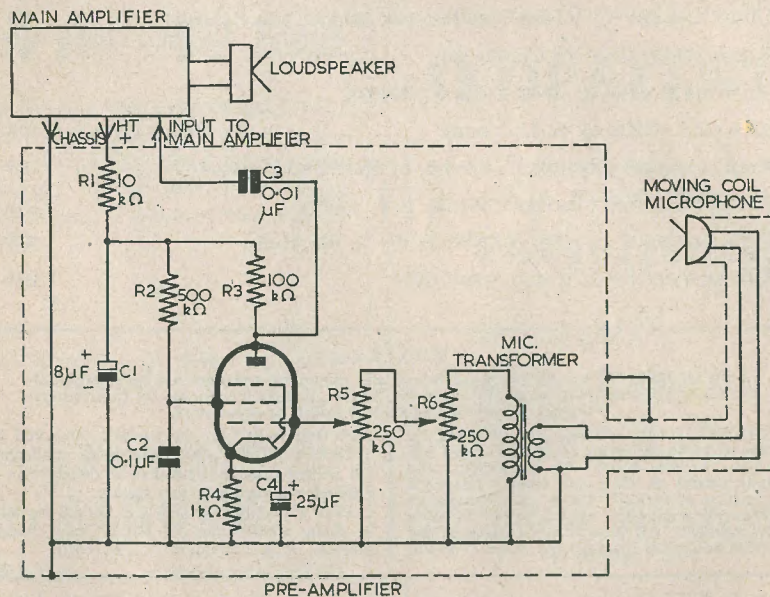

RC273

amplifier, whereupon it is once more reproduced. The effectiveness of such an arrangement depends mainly upon the time spent by the original sound in reaching the microphone; and it may be found that best results are obtained when the microphone is mounted as far away from the loudspeaker as space limitations allow.

As may be seen, the effect given is, roughly, that of a "fixed echo." Whether an apparent improvement in reproduction results depends entirely upon the local conditions of the room in which the amplifier, loudspeaker and microphone are installed; the particular recording being played (or programme being received); and, finally, upon the tastes of the listener.

### Practical Points

The circuit shown here depicts a pentode pre-amplifier which obtains its power supplies from the receiver or amplifier already installed. A moving-coil microphone is illustrated. This should give adequate results, although any other type of microphone with a reasonably good response should cope just as well.

The volume level of the sound picked up by the microphone is adjusted manually by R6. R5 is a pre-set component and should be adjusted so that feedback howl between the loudspeaker and microphone cannot occur even when R6 is set to "full". The output from the pre-amplifier is fed to the most convenient grid after the volume control in the main amplifier. The valve used in the pre-amplifier may consist of any straight pentode of the 6J7 class. In some instances, sufficient gain may be obtained if the pentode is replaced by a triode; in which instance, R2 and C2 will not, of course, be needed.

As was mentioned above, best results will probably be obtained when the microphone is an appreciable distance from the loudspeaker. The effective distance may be increased by mounting the microphone behind furnishings so that it receives only those sound waves which are reflected from walls or ceiling. Such a course will also allow R5 to be set to a higher position before feedback occurs than would otherwise be the case.

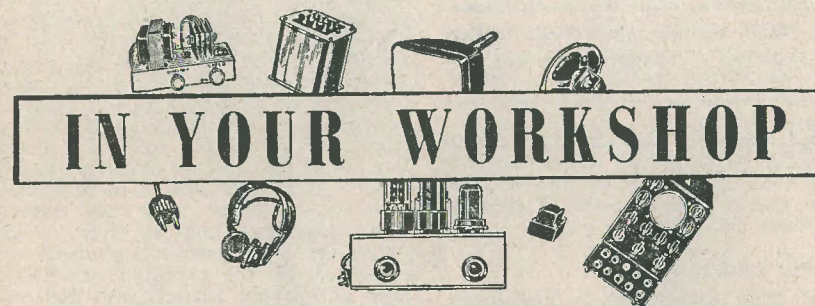

In which J. R. D. discusses Problems and Points of Interest connected with the Workshop side of our Hobby based on Letters from Readers and his own experience

ON SEVERAL OCCASIONS during the past few months I have heard rumours that government surplus wireless gear is at last beginning to run out. How true this I don't know, but it is quite possible that many of the chassis which were most readily adaptable to civilian purposes have by now been snapped up. A short visit to Lisle Street some time ago showed me that plenty of business was taking place so far as components were concerned; but there were not many complete items of equipment on display. Less saleable items such as

motor-generators and similar electrical gear also took up a lot of window space.

Nevertheless, so far as components were concerned, trade was definitely brisk. A typical price was given by paper 0.01μF capacitors being sold at a penny each.

In my own case, most of the purchases of surplus equipment I have made since the market came into being have consisted of small components, or of units bought expressly for stripping down. I have been lucky in my purchases and have been able to use to good purpose almost every item



Charge-holding time (seconds) for min. leakage res. of:-					
Capacitor Value (μF)	100 kΩ	1 MΩ	10 MΩ	100 MΩ	500 MΩ
.002*	—	—	—	—	1
.005*	—	—	—	—	2.5
.01*	—	—	—	1	5
.02*	—	—	—	2	10
.05*	—	—	—	5	25
.1*	—	—	1	10	50
.2†	—	—	2	20	100
.5†	—	—	5	50	250
1†	—	1	10	100	500
2†	—	2	20	200	1,000
5†	—	5	50	500	—
8†	—	8	80	800	—
10†	1	10	100	1,000	—
16†	1.6	16	160	—	—
32†	3.2	32	320	—	—
50†	5	50	500	—	—

\*Check by "Spark Test."  
† Check by Meter Deflection.

Fig. 1 Table showing approximate leakage resistance of various capacitors

obtained. Resistors, especially, have proved to be most reliable indeed. Capacitors have been a little more doubtful, however, and I have always made a point of checking these before use.

#### Capacitor Testing

Apart from open-circuits or breakdowns, the fault most likely to occur with surplus capacitors, especially the waxed paper type, is leakiness. A quick check of such capacitors can often be made by measuring the length of time over which they can hold a charge. This test can, of course, be applied to all types of capacitor which are suspected of being leaky.

If a capacitor whose value lies between 0.002 and 0.1μF is charged up to 150 volts or so, it will give a noticeable spark when it is discharged again. The spark is especially noticeable if the wire ends of the capacitor are touched against a shiny metal surface. One may gain a rough idea of the leakage resistance of a capacitor so discharged by seeing how long it will hold a charge, the presence of the charge being checked by the spark which occurs on discharge.

The time taken for a resistor and capacitor in parallel to discharge to 37 per cent of the original charging voltage is the time constant of the combination. Thus, by assuming that the capacitor will give no spark, or a noticeably weak spark, when the voltage across its plates has dropped to 37 per cent of its original value, we may gain a rough idea of its leakage resistance by working out the time constant offered by the capacitor and its leakage resistance in parallel.

The time constant, in seconds, of such a combination is given by multiplying the capacitance in microfarads by the resistance in Megohms. Thus, if a 0.1μF capacitor is found by the "spark test" to be capable of holding its charge for ten seconds, its leakage resistance should be greater than 100 Megohms. Similarly, a 0.01μF capacitor which holds its charge for five seconds will have a leakage resistance of at least 500 Megohms. Although the test is very rough and ready, it gives an approximate idea of minimum leakage resistance up to a surprisingly high value.

Electrolytic capacitors, and paper capacitors, having values higher than 0.1μF, may also be tested by checking the time constant. With these components, however, the "spark test" is not recommended, since it can harm the capacitor. Instead, a test for presence of charge can be carried out by connecting a voltmeter across the capacitor after the requisite number of seconds has passed. Assuming a reasonably high-resistance meter, capacitors up to 1μF or so will cause the needle to give a noticeable kick, whilst larger values will deflect the needle for a short time whilst the capacitor discharges into the meter. An idea of what is to be expected with the particular meter and capacitor value being tested may be given by comparing the effect given by the meter when connected to the capacitor immediately after it has been charged with that given after the checking time has elapsed. (Be careful! Your Editor once ruined a meter movement when checking the HT+ line for leakage to chassis. The set used 32μF condensers for smoothing and, though it had been unused for some 15 minutes or so, there was sufficient charge to convert the pointer into a "hairspring!")

A table of time constants for individual capacitors is given in Fig. 1. As was mentioned earlier, the results given by the test are approximate only, although they do give a good idea of the minimum leakage resistance of the capacitor. The figures in the horizontal columns give the time constant in seconds for each individual value of capacitance against the leakage resistances, which are shown at the heads of the columns. Thus, a 5μF capacitor will have a minimum leakage

resistance of 10 Megohms if it can hold its charge for 50 seconds. Time constants longer than 1,000 seconds (16 minutes) are not given as they will probably not be required.

What is the difference between the two regulator valves shown in Figs. 3 (a) and (b)? It is usually safe to assume that the regulator shown in Fig. 3 (a) is one having a definite cathode and anode (such as the

Fig. 2 (a) An incorrect method of depicting a metal rectifier.  
(b) The correct method.

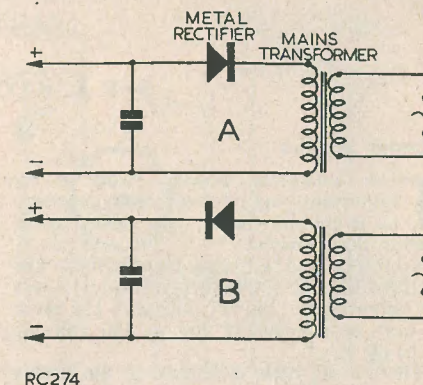

#### Circuit Symbols

The Editor, like the sergeant-major, has a Neye like a Neagle, and he quickly spotted a mistake I made in a circuit diagram which I submitted to him some time ago. In this circuit I had accidentally drawn a half-wave metal rectifier in the manner shown in Fig. 2 (a). The correct method should, of course, have been that shown in Fig. 2 (b). It is sometimes a little difficult to visualise the direction of current when a metal

VR150/30), in which it is important that the cathode (depicted by the circle), be connected to the negative side of the voltage source whilst the anode is connected to the positive side. The stabiliser shown in Fig. 3 (b) would, in most cases, consist of a valve which has no definite anode or cathode and which may be connected either way round. This latter type is met fairly often and usually consists of a miniature bulb

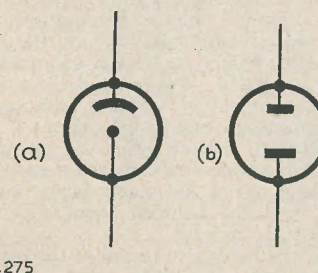

Fig. 3 (a) and (b) Two different types of voltage regulator

rectifier (or germanium diode) appears in a complicated circuit. It is often stated that the "arrow" represented by the symbol indicates the flow of "conventional" current; i.e. current from positive to negative. Alternatively, one may state that the straight-line part of the symbol represents the cathode of a diode.

into which are introduced two similar wires or two similarly-shaped electrodes. Fig. 3 (b) should not be confused with a similar symbol in which the "anodes" are shown in outline only. This latter symbol is occasionally met in circuit diagrams to depict an outlet socket.



# Valves and their Power Supplies

## PART 11

By F. L. BAYLISS A.M.I.E.T.

### Vibrator Supplies

THE VIBRATOR POWER PACK is an important part of a car radio receiver, as it enables mains type valves to be used in that receiver.

Vibrators and vibrator transformers are readily available for both 6-volt and 12-volt car batteries, and the HT output is the same in both cases—usually 200 to 250 volts at 70 to 80 mA.

There is no basic difference in the circuit arrangement for the two voltages, the change being confined to the vibrator coil and transformer windings.

It is essential, however, that the correct voltage rating of these two components should be chosen to suit the car battery voltage, 6V types are not suitable for 12V batteries, nor *vice versa*.

In each voltage group there are two distinct types of vibrator pack, (a) the rectifier type, in which a full-wave or bi-phase rectifying valve is used to supply the HT voltage, and (b) the "self-rectifying" or synchronous type, in which a valve or other rectifier is not used.

Perhaps the more popular type, in this country, is the rectifier type, whilst in America—if ex-WD surplus is any pointer—the synchronous type appears to hold considerable sway.

In the latter type, the saving effected by not using a valve is thrust back upon the vibrator in the form of extra contacts and more complex construction of that component, so it would seem that there is little saving and little to choose.

### The Rectifier Type

The circuit arrangements for both types have become largely standardised, and are governed to a great extent by the components used.

In Fig. 36 the circuit for the rectifier type is shown. Briefly, the operation is that closing the on/off switch allows battery current to flow through the vibrator coil, through the contacts shown closed, and via the armature to chassis, thus completing the circuit.

The armature is attracted to the core, makes contact with the upper of the open contacts, and allows battery current to flow through the top half of the transformer primary via the centre tap: this current also flows to chassis via the armature.

When the armature is attracted, however, the circuit for operation of the vibrator coil is broken, and, after a brief period, the armature falls away toward normal. It is spring loaded, however, and the spring tension carries it past the normal position to make contact with the lower open contact point.

Thus, current again flows through the transformer primary via the centre tap, but this time through the lower half, and via the armature to chassis. At the same time the vibrator coil contact is again closed, and the armature is attracted to the core once more.

The action repeats continuously and rapidly, whilst the on/off switch remains closed.

The transformer has a step-up ratio of about 1:40—sometimes higher—for a 6V component. 12V transformers are approximately one half of this ratio.

The primary voltage fluctuations are transferred to the secondary by induction, and, with the secondary centre tap connected to chassis, some 250 Volts is available at each end of the secondary winding, although in phase opposition one to the other.

The ends of the secondary are connected to the two anodes of a bi-phase rectifying valve, as in usual AC mains power supply circuits, and the rectified output is taken from the valve cathode.

By far the best valve to use as the rectifier is the American type OZ4, a valve specially developed as a car radio rectifier. It is a cold cathode type, i.e., there is no heater element, and it gives the great advantage that stray vibrator pulses on the LT line—the car battery—cannot be fed via the rectifier heater to the cathode, and thus become common to all receiver valve anodes via the HT+ line. With this type of valve, stability and noise reduction are most marked.

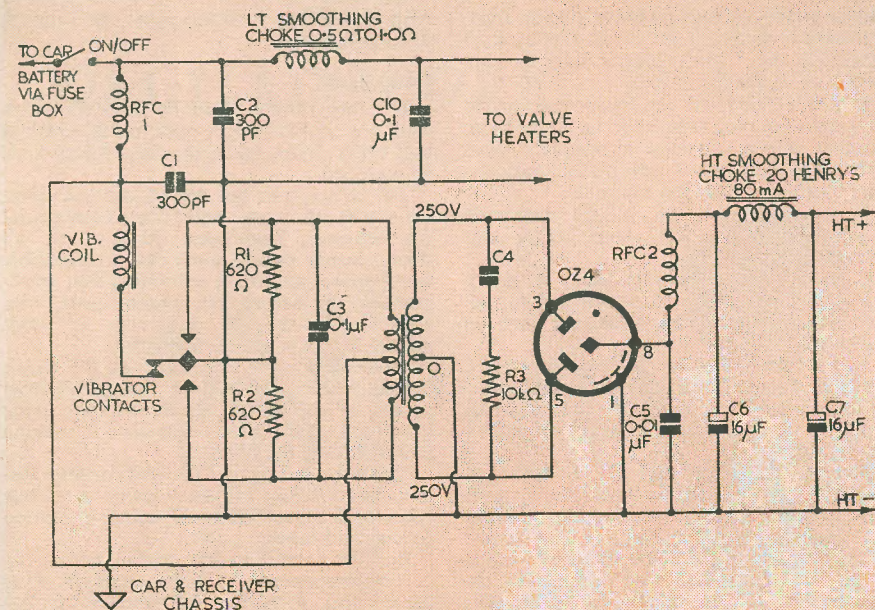

FIG. 36  
RECEIVER TYPE VIBRATOR POWER PACK

RC276

The danger of pulse feedback via the receiver valve heaters—and then to the cathodes—is still there, however, and will be until a complete set of cold cathode valves for car radio are marketed.

### Smoothing

Notwithstanding the facilities offered by the use of the OZ4, good smoothing is an undeniable asset in a car radio power pack. A high inductance choke—20 Henrys, or even higher—will do much to iron out stray and unwanted pulses, and to flatten the rather steep-sided curve of the ripple voltage. Such a choke, with C6 and C7, forms the HT smoothing.

The LT smoothing choke in the valve heater lead is helpful in keeping the heaters free of vibrator pulses. The resistance must be kept low, however, and the wire used of ample gauge to carry the total heater current.

Assuming a total heater current of 2.0A, 20 swg enamelled copper wire would be suitable, and, since 1.0 Volt may conveniently be dropped across this choke, 200 turns of this wire wound on to a standard type output transformer bobbin and core would form a useful component. (The battery, on charge, normally gives 7.5 volts, and would thus allow a volt or so drop to 6.3 volts.)

### Quenching.

The heavy current—5.0A is not an unusual figure for a car radio—and the inductance of the vibrator coil and transformer primary would naturally cause considerable arcing at the vibrator contacts.

R1 and R2, together with C3, however, are inserted to counteract such arcing, and their values may be varied to suit the vibrator and transformer used. For instance, C3 may safely be increased to 0.25µF, in marked cases.

The abrupt nature of the primary voltage alternations induces very high back-EMF voltage pulses in the secondary, and to prevent damage to the rectifying valve these pulses must be absorbed. C4, 0.01µF, carries out this absorption, and to prevent a direct short circuit on the transformer secondary—and consequent burn-out—should this capacitor break down, R3, 10kΩ, is included to limit the current to 50mA.

It is essential that C4 should have a working voltage rating of at least 2,000 volts, and it should be a mica component.

### Ignition Filters

Whilst ignition radiation is usually dealt with by adequate screening of the receiver



and its aerial, chassis and battery leads, there is always a tendency for direct feedback to occur via the battery, particularly in cars using coil ignition systems.

The fitting of 15kΩ suppressor resistors in each sparking plug lead, close up to the plug, together with a capacitor of adequate value across the distributor interruptor contacts, does much to lessen the nuisance.

Further filtering in the vibrator pack itself is effected by the RF choke RFC<sub>1</sub> and capacitors C<sub>1</sub> and C<sub>2</sub>.

This choke will have to carry a heavy current—some 3.0A or so—therefore, as with the LT choke, the resistance must be kept low.

Again, 200 turns of 20 swg enamelled wire may be used, but, this time, wound on to an air-cored bobbin; an old wire-reel would be very suitable. No iron laminations are required.

The use of RFC<sub>2</sub> and C<sub>5</sub>, however, is optional and may depend upon the type of valve rectifier used. Their inclusion would be nothing but beneficial, in any case; RFC<sub>2</sub> may consist of 3,000 turns of 36 swg or 38 swg enamelled wire, wound in six slightly spaced piles of 500 turns per pile, upon a ½" diameter air-cored coil former, some 2" long.

Looking at the circuit of Fig. 36, the constructor may consider it a little complex

with the rather intricate filter and quench arrangements.

#### Interaction

If a programme is to be received which does not consist of 50% hum, mush, crackles and other noise, however, these filters must be included.

The writer, who has delved into the vibrator packs of many high class commercial car receivers, has found them to be all there—neatly packed away into an incredibly small space, and often exhibiting fine workmanship in wiring and manufacture, and considerable thought and care in component layout to avoid interaction.

This last point is important; an RF choke placed within the field of the transformer or one of the smoothing chokes may bring to naught all the good work done in making and including the filters.

Similarly, interaction between transformer and choke (LT or HT) may set up a vicious circle of feedback that will reduce reception to rags and tatters.

But, be careful in the layout, with iron-cored components at right angle to each other, and with the RF chokes, if not screened, then at a reasonable distance from iron laminations, and there is no reason why car radio should not equal the home mains receiver at its very best.

# OSCILLOSCOPE TRACES

by A.B.

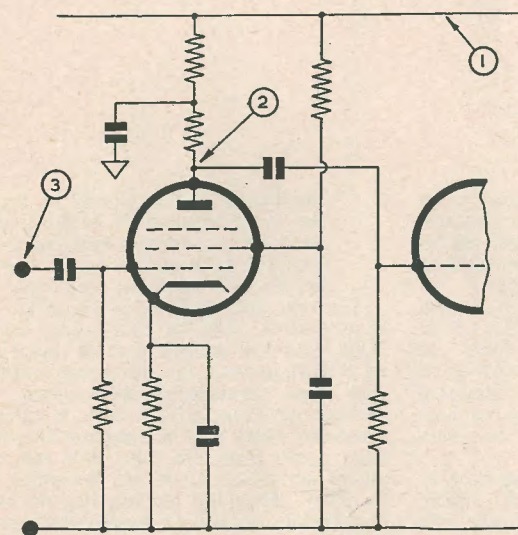

RC289



A

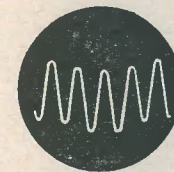

B



C

No. 4: Hum Tracing

Hum is generally introduced from one or both of two sources, i.e. pick up in high impedance circuits, or the HT line.

Trace A shows a hum-free audio signal, which is applied at point 3. If hum is present at the anode, point 2, the trace will take a form similar to that shown by B. If hum is present when the oscilloscope is connected to the HT the trace will look like C. Connection must be made via a condenser if one is not included in the oscilloscope input circuit. It is possible that the hum voltage

shown in C may be considerably less than that superimposed on the audio (trace B), in which case the HT line can be exonerated.

A combination of pick up and HT ripple will give waveforms of unpredictable shape, particularly if the rectifier is full wave. In this case, pick up will be 50 c/s and the HT ripple 100 c/s.

To prevent hum voltages being induced in them, the oscilloscope leads should be kept as short as possible.

**Have you entered our 'Radio Snapshots' Competition?  
If not, Remember that the Closing Date is November 5th**

FULL DETAILS WERE GIVEN IN THE SEPTEMBER ISSUE

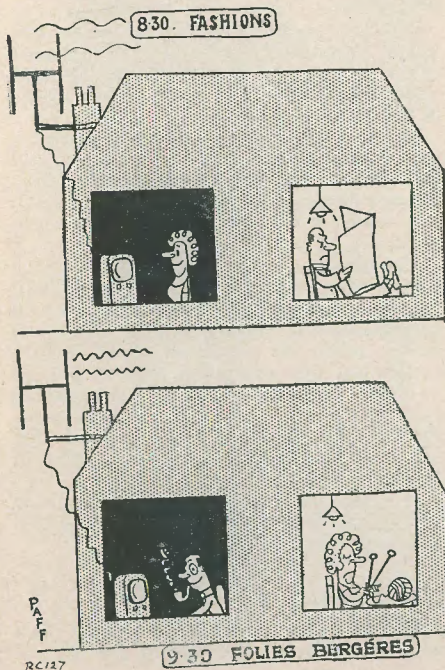

RC127

## Can Anyone Help?

Dear Sir,

Can anyone assist me to obtain information on, or an instruction manual for, an ex-Govt. Trawler Wireless Set CNY2?—J. N. HOLDER, "Green Trees," Forest Road, East Horsley, Surrey.

Dear Sir,

In removing one of the Jones plugs from my R1155 I unfortunately broke one of the shorting switch wafers of the master switch, the wafer being nearest the front panel, and although I have tried locally and at shops in London to obtain a spare wafer or switch, have been unable to do so. Can anyone help, please?—E. J. WALTERS, 25 Fullerton Road, East Croydon, Surrey.







timebase waveform feeding back looks back into a low impedance. After passing through the isolating resistor (270kΩ) into this impedance, the amount of feedback is negligible even with sync at maximum.

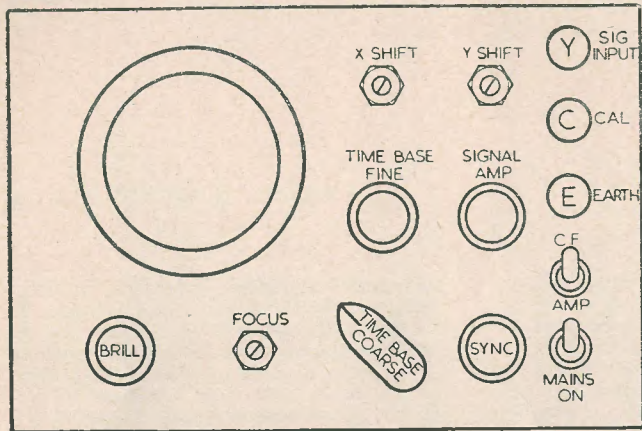

FIG. 2 PORTABLE OSCILLOSCOPE - FRONT PANEL LAYOUT

This arrangement eliminates the necessity of a separate isolating amplifier purely for sync. The actual amount of sync injected is very small, but it is sufficient to hold a signal of constant amplitude in a fixed position. (It is, of course, not possible to lock a signal of varying amplitude, such as actual audio, but this stipulation applies to all sync as normally used on scopes, and for this use the sync should be set to minimum).

The timebase itself consists of a self-running Miller-transitron. Both the grid and the suppressor condensers are switched in order to obtain optimum amplitude and short flyback time. Five ranges are provided, giving an overall range of 11.5 c/s to 54 kc/s with plenty of overlap.

Actual measured ranges are:

1. 11.5 — 130 c/s
2. 65 — 650 c/s
3. 270 — 2,800 c/s
4. 1,300 — 13,000 c/s
5. 5,500 — 54,000 c/s.

These will be found ample for normal use, as inputs in the region of 500 kc/s will only produce some 9 or 10 cycles, which is still easily discriminated. No amplitude control is fitted to the timebase, as the amplitude has been arranged to be constant on all ranges and to fully scan the tube. Silvered mica

capacitors should be used where possible on the timebase ranges, as they are the most stable.

The CRT network derives its supply mostly from a S.T.C. K3/40 rectifier to give a negative supply for the tube. In addition to this, anodes and the X2 and Y2 plates are returned to a positive voltage via a network across the HT supply. This gives extra voltage to the tube and simplifies the shift networks. If the tube is mounted with the spigot upward and the connections made as numbered, then the deflection will be correct. The 0.5μF EHT smoothing condensers are of 600V working 'bathtub' type.

All potentiometers are the bakelite-cased carbon type. The Focus, X shift and Y Shift controls are all of the screwdriver adjustment type, as they seldom require altering and this prevents the small front panel being cluttered up with unused knobs.

The mains transformer is a standard 250-0-250V with two 4V windings. Instead of connecting the centre of the HT winding to earth, however, one end is earthed and the centre unused. This makes it 500V overall, which is rectified negatively by the pencil rectifier for the tube and positively by two 250V 60mA series-connected selenium rectifiers. The reservoir is a 2μF 600V working oil-filled paper block condenser. A 1,000Ω relay and a 32μF 500V working electrolytic completes the HT smoothing. Due to the metal rectifier, the HT comes on before the valves warm up and before the load is effective, so that the HT is then very high and would break down the electrolytic. This condenser is therefore connected in circuit via a switched contact on the relay. The relay energises when the valves warm up and start to take current, so that the electrolytic is not in circuit until a load is on the HT line to keep the voltage down. A resistor across the switch contacts allows the condenser to charge to a certain extent before the switch closes, so that there is less surge and sparking at the contacts. The relay may need slight adjustment in order that it energises only when the valves draw current and not when the scope is first switched on.

The decoupling condensers in the CRT network are the usual 350V working, but

all the other 0.1μF condensers should be selected low-leakage types of at least 500V working (T.C.C. metal-cased tubulars are ideal). This applies particularly to the blocking condenser in the Y1 plate lead, as if any leakage is present the trace will shift according to whether the amplifier switch is in the "cathode follower" or the "amplifier" position. The 0.05μF and the 0.02μF condensers in the timebase should also be low-leakage types.

#### Layout

Fig. 2 shows the layout of controls on the front panel. Much of the circuit wiring is directly across the back of the potentiometers at the rear of the front panel, in order to keep the wiring as direct as possible. The leads to the grid of the amplifier are kept short and away from other wiring, as at this point the input signal is still at a high impedance. The input 0.1μF and the 1MΩ leak are mounted close to the rear of the Y input terminal, and a short lead taken to the top clip, which also holds the grid stopper.

Fig. 3 shows the plan layout. There should be little trouble from electrostatic pick-up, due to design precautions, but if a very compact construction is required then it is necessary to take steps to prevent hum on the trace due to magnetic induction from the mains transformer. The tube itself should be enclosed in a mu-metal shield (several spaced mu-metal shields, if available) and the mains transformer kept to the rear of the tube as much as possible. It is advisable not to secure the mains transformer until it has been orientated to give the least hum deflection on the trace.

The voltages are high in the unit, and it is best to run all the HT and EHT wiring in heavily insulated wire to avoid breakdown trouble.

#### Notes

The timebase is quite linear except for

slight non-linearity below 25 c/s on the lowest frequency range. This is a characteristic of this type of timebase and, as the amount and range of the non-linearity is so small, it is not worth the bother of

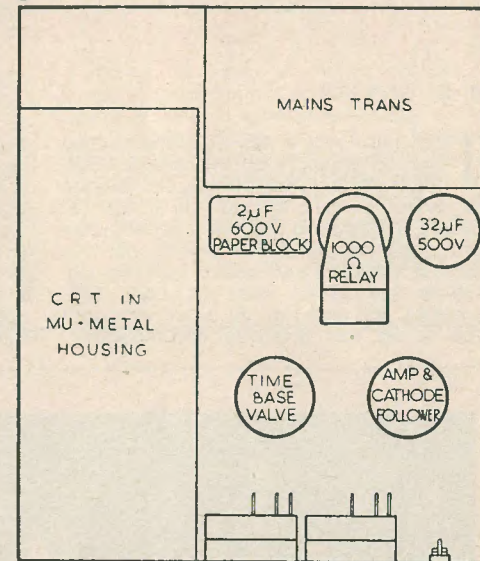

FIG. 3 PORTABLE OSCILLOSCOPE - UPPER CHASSIS LAYOUT

additional circuit complications to try to cure it.

The amplifier is flat to beyond 100,000 c/s and is adequate for television timebase and sync analysis, and for the testing of audio amplifiers (including square wave response) and is therefore suitable for testing high fidelity equipment. Greater gain can be obtained from the amplifier by increasing the anode load, but the maximum frequency response is reduced proportionately. The limits chosen should give the maximum adaptability.

## SECOND NATIONAL HANDICRAFTS & HOBBIES EXHIBITION

Central Hall, Westminster, London S.W.1.

SEPTEMBER 17 to 30

ADMISSION 1/-



## AN INEXPENSIVE THREE VALVE DOMESTIC RECEIVER

By E. GOVIER

THE NEED FOR A new domestic receiver having arisen, and the present high price of those on the market, decided the writer to cast around for a suitable cheaply constructed circuit. In common with many others, it was found that our listening pleasure was shared between two stations—the Home and the Light Programmes, and therefore the three waveband type of set was definitely not required—

both from the considerations of cost and non-usage.

Having decided on the foregoing, the next step was to draw up a circuit using as few parts as possible, and one which would give sufficient audio gain for the average living room. As a matter of interest, several circuits were hastily knocked together and tried out, but the most suitable was that shown in the circuit diagram. From this,

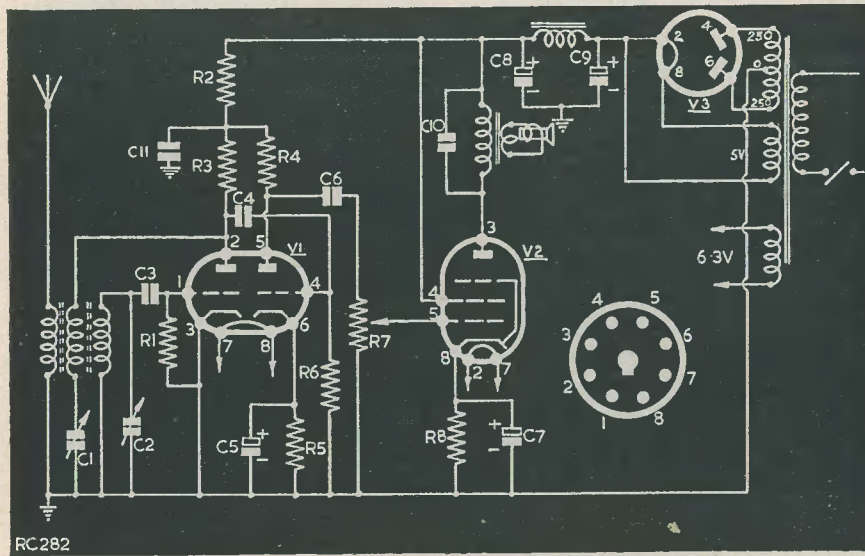

### Component List

R1 1MΩ ½W  
R2 100kΩ 1 watt  
R3 50kΩ ½ watt  
R4 50kΩ ½ watt  
R5 1kΩ ½ watt  
R6 500kΩ pot. with switch  
R7 270Ω 1 watt  
Coil—Osmor type QR11  
Mains transformer—Ellison MT 162

C1 500pF Mica variable  
C2 500pF Mica variable  
C3 150pF Mica  
C4 0.01μF 350V  
C5 25μF 12V wkg Electrolytic  
C6 0.01μF 350V  
C7 25μF 12V wkg Electrolytic  
C8 16μF 350V wkg Electrolytic  
C9 8μF 350V wkg Electrolytic  
C10 0.002μF paper 500V.  
C11 8μF 350V wkg Electrolytic

it will be seen that use is made of the 6SN7 both as a leaky grid detector and as a triode first AF amplifier—a function which this valve performs extremely well. It has always been of some amazement to the writer that more use is not made of this type of valve in this country—at least in published circuits. In the U.S.A. much greater use of the 6SN7 is made than here.

The detector stage is entirely conventional—as is the whole receiver for that matter, and it is therefore capable of being constructed by the veriest beginner with little or no trouble. The coil used is the Osmor type QR11, which has proved to be eminently suitable for such a circuit. Output from the detector portion of the triode is fed into the grid of the following portion via C4, and thence from the anode of this half via C6

and R7 into the grid of the output stage, a 6V6 valve.

The output stage and the power pack (using a 5Y3 rectifier), needs little or no explanation, being entirely basic in design and with no frills. The whole receiver when completed may be fitted into a small cabinet to match the surrounding furnishings. The audio output in the writer's case was sufficient to work an 8-inch speaker at some 2½ watts approx., although in the final set-up a 5½-inch speaker was used. Selectivity using an aerial some 25 feet long was found to be adequate, with no breakthrough noticeable. Any reader constructing this receiver will find that it conforms to the specifications as stated in the opening paragraph. Simple and cheap to build, it will give good service and performance to the user.

## The "UNIVERSAL" Large Screen AC/DC Televisor

Part 5: Described by A. S. Torrance, A.M.I.P.R.E., A.M.T.S.

(By kind permission of IKOPATENTS LTD.)

### Tube Handling

Readers are warned that the CRT is highly evacuated, and must be handled at all times with the greatest care. Never hold by the neck. Safeguard the EHT anode connector from accidental contact. Goggles should always be worn when working on exposed cathode-ray tubes.

### Switching On

When all these tests are completed, the constructor may now prepare to switch on for the first time.

### A WARNING MUST BE GIVEN

Do not work at any time on a bare concrete or cement floor. A well-covered lino or carpeted wooden floor constitutes the highest safety margin. This is even more important where D.C. is to be employed.

Place all knobs in position and ensure that grub-screws are below the surface.

When the set is completed, the screw holes should be filled with wax.

### The Ion-Trap Magnet

Two alternative brilliance networks have been described, and the method finally adopted by the individual reader should be recalled to mind. Remember, in one system full brilliance is achieved with the control in the fully clockwise position, and in the other with the control anti-clockwise.

Commence with the Brilliance low.

Locate the ion-trap magnet on the line provided on the neck of the CRT. This will be found in line with pin 3 of the tube base.

Increase Brilliance, and at the same time slide the ion-trap magnet backwards and forwards along the neck until maximum brilliance is achieved.

Note that it may be found necessary to switch off and reverse this component. The CRT must not be run for long without a raster being visible on the screen, if the ion-trap magnet is wrongly sited. At any setting of the Brilliance control, the magnet should be set for maximum brilliance and tightened permanently. On no account should



brightness be sacrificed by a wrong setting of the magnet to overcome shadowing. This should be cured by ascertaining that the deflection-coils are as far up the neck of the tube as possible, and by careful adjustment of the focus unit.

#### Raster

In general, if the EHT rectifier heater lights up it is almost certain that EHT is present.

Set the raster by the controls at the rear.

Turn the line drive control up until white upright lines are visible in the centre of the raster, and then turn the control back until these just disappear. Set "Height" and Focus unit for both focus and centring.

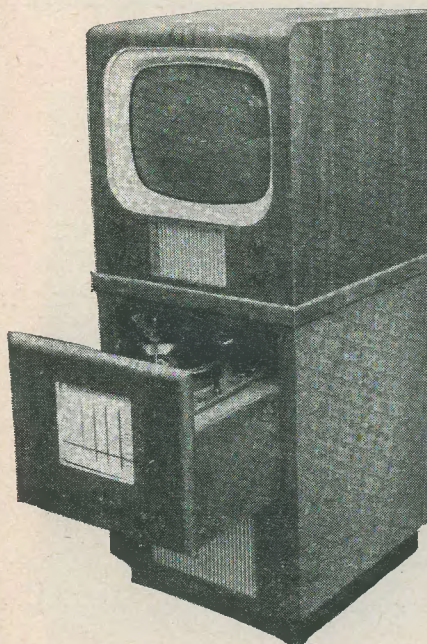

Complete instrument as it will appear when finished.

#### Lining-Up Receiver

Secure a plastic knitting needle and file this to a screwdriver end which will fit the slots in the cores of the coils. This improvised tool makes a most excellent trimmer. On no account should a metal screwdriver be used for lining-up. Study the chart and ascertain that the cores are as laid down for the local transmitter. Thus, for example,

readers desirous of tuning to Sutton Coldfield will use:—Iron-core for L1, Brass core for L2A, Iron core for L2B, and change C9 to 10pF (Silver Mica). All other cores would be iron.

The most important item, as mentioned before, is undoubtedly L12A/L12B. This transformer is pre-set and forms the entire basis of the tuning procedure. Quite obviously, with the sound IF set at the correct frequency of 23.25 Mc/s a datum-line is available for the entire lining-up. The component must not be interfered with. If the reader has accessibility to a signal generator, this transformer and the sound section may be checked by injection of 23.25 Mc/s into the grid of V9. With the Sensitivity, Contrast, and Volume controls at maximum, a crude setting of L1, L2A and L2B should make the sound signal audible. L2B should always be set for maximum sound. Adjust L4 and L5 for maximum sound. Varying the sensitivity control, adjust L1, L2A, L3, L4, L6 and L8 for the brightest picture.

(Note that the picture may not be synchronised at this stage, and constant adjustment should be made to the frame hold, and line hold. It is always possible that this fortunate condition may be arrived at very quickly). Readjust L5 until sound on picture is at minimum. Temporarily short to chassis the grid of V9 and adjust L7 until sound on picture disappears. (This symptom is recognisable by the picture jumping in step with the spoken word or musical notes). Minor inter-action would show horizontal black bars moving up the screen.

Readjust L1, L2A, L3, L6, and L8 until a picture is obtained at the lowest setting of the sensitivity control. If possible, utilise Test Card 'C' for the above. Last of all, but not until the test card is fully resolved, L12A/L12B may be given slight adjustment for maximum volume.

#### Notes

Readers tuning to the Alexandra Palace transmitter may experience difficulty in obtaining synchronisation. This is due to the fact that the Universal is a single-sideband receiver, and it is possible to be misaligned so that, although the picture and sound content may be good, no frame synchronisation is achieved. The remedy is to retune with the cores tending to be at the top end of the formers. The best resolution will be found by final and delicate setting of L1, L4, L6 and L8.

#### Linearity

At this stage, the picture may be badly out of linearity. Once again increase the line drive control and repeat earlier procedure, slacking off any contraction or white lines

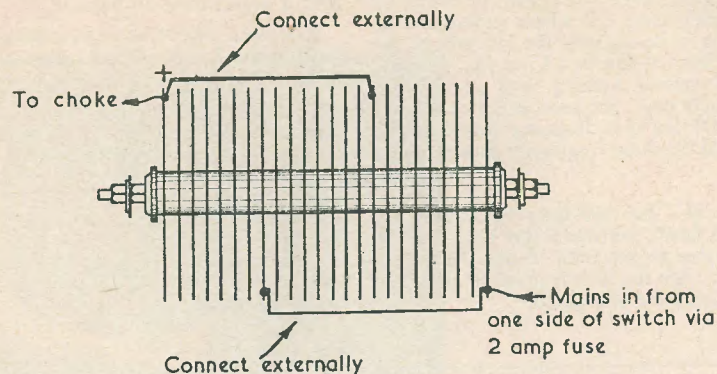

#### CONNECTIONS FOR WESTINGHOUSE RECTIFIER 14A/342

(Seen from underside of chassis)

TV17/10

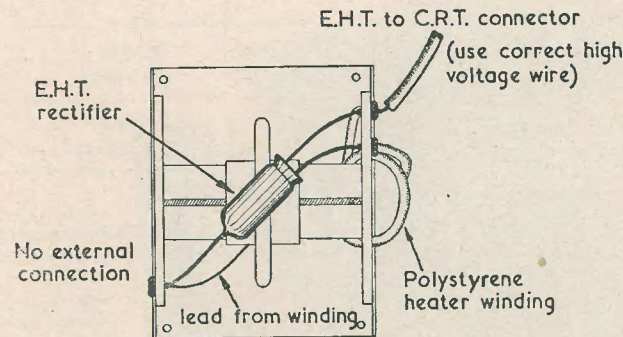

Important note: Avoid sharp points when soldering and do not overheat. See text on soldering in of rectifier

#### E.H.T. RECTIFIER CONNECTION

TV17/14



seen in the centre. Adjust the Width coil and Linearity coil. Find the centre of swing of the Linearity coil, i.e. where movement of core brings in or expands the left side of the picture. Now obtain best Linearity with the line-drive control, making final setting with the Linearity coil. Set vertical Linearity and Height. Obtain best focusing (incidentally, this should be done frequently during lining up).

*Note.* If the auxiliary mounting is employed, black perpendicular bars may be observed due to the long leads. These will disappear when the tube is properly mounted and the leads are shortened.

Increase values to increase EHT. These may take a wide variety of values.

*Remember, this receiver takes approximately two minutes for the picture to appear, and one minute for sound.*

The following changes in values to those given in the Component List have resulted in greatly improved performance.

R59 changed to 6.8kΩ results in better frame form. Excessive line scan may be obviated by reduction of C58 to 2000pF. Similarly, excessive EHT was experienced with the original values of the EHT peaking condensers C60-C61. These are now reduced to 47 pF each.

CHANNELS	L1	L2A	L2B	AERIAL POLARISATION
1 Alexandra Palace Glen Cairn *	Iron core do	Iron core do	Iron core do	Vertical Horizontal
2 Holme Moss South Devon	Iron core	Iron core	Iron core	Vertical do
3 Kirk o'shotts Brighton *	Aerial end iron core Grid end brass core	do	do	do
4 Sutton Coldfield Aberdeen	do	brass core	Iron core C9 - 10pF	Vertical Horizontal
5 Wenvoe Pontop Pike	do	do	do	Vertical Horizontal

\* Names likely to be changed

NOTES: Channels 3/4/5, L1 requires both iron & brass cores. Remaining cores L3/4/5/6/7/8 all iron. Aerial must be obtained to match local transmitter and mounted to suit polarisation.

RECEIVER TUNING CHART INCLUDING PROPOSED TRANSMITTERS

TV17/16

#### Component Effects

Severe non-linearity of the vertical time-base may be cured by varying the values of R59 (affects top of raster) and increasing R61. Readjust V. Linearity control at the same time. Variation of C58 will affect the picture width. C60 and C61 will vary the EHT.

#### Mounting Escutcheon and Perspex with Dust-Proofing Method

Study the photographs, and with long countersunk bolts secure the escutcheon and perspex to parts F. Hold in position at top with springs to the top bolts on parts G. With sticky tape, go all around the edge of

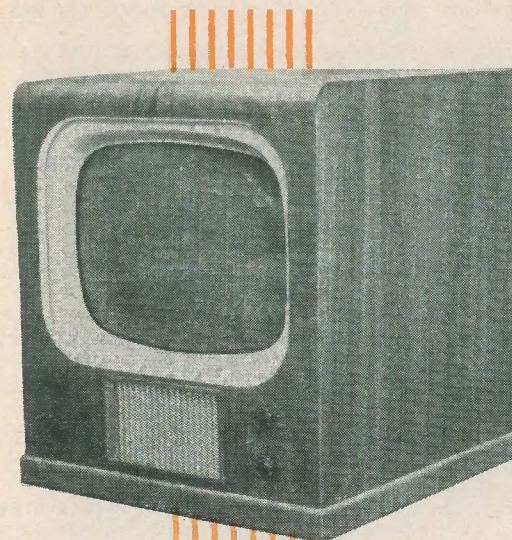

The "Universal" Large Screen AC/DC Televisor as described so far in this series.

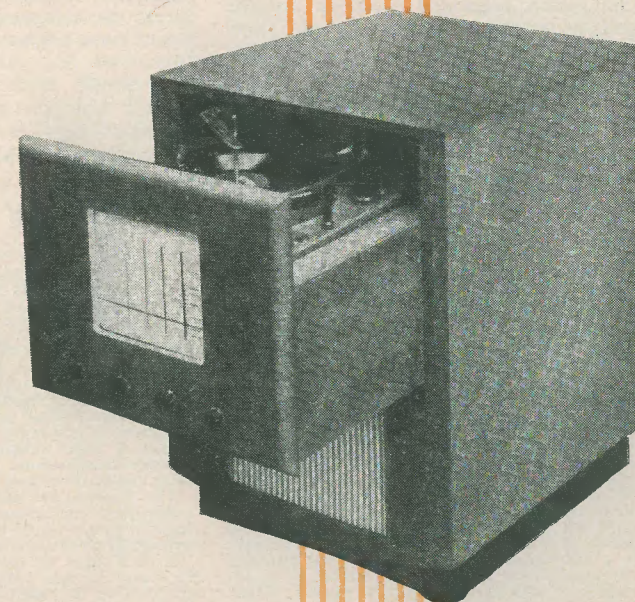

The "Universal" Radiogram Unit to be described later in this series. Both units are complete in themselves, and may be built independently as desired. If amalgamated, they result in the striking instrument illustrated on p. 84.



the escutcheon and CRT, thus forming a dust-proof joint. Similarly, tape the perspex to the escutcheon.

*Note.* Remember to clean the tube screen and perspex before sealing up.

#### Precautions

The greatest caution must be observed at all times when operating DC or AC/DC equipment. The entire chassis is alive to one side of the mains and requires constant care. If possible, it is recommended that a neon tester be obtained and the set operated with the chassis connected to the negative side of the mains. The mains plug and socket should then be marked to ensure correct polarity, or preferably use should be made of a three-pin type. Once set, any removal of this latter type plug will be assured of proper replacement. Instal the receiver into the cabinet as

soon as possible after completion, and fill the grub-screw holes in all knobs with wax or shellac.

Do not use a metal grille for the speaker opening; fabric is highly recommended, for safety reasons.

The cabinet has been specially made by Lasky's (Harrow Road) Ltd. to take this set and no difficulty in installation should be experienced.

It is not intended to alarm constructors by the warnings given—in point of fact, all electrical apparatus under certain conditions may be dangerous. But we do implore readers to make a study of the contents and obtain a complete understanding of the points raised.

This receiver will finalise, as mentioned previously, in a complete TV—Radio-Gram, and articles on this will appear in future issues of *The Radio Constructor*.

## THE "MAGNA-VIEW"

FURTHER LABORATORY TESTS have been conducted on this now popular television, and two modifications have emerged, both of them well worthy of inclusion.

The first concerns the video stage (N78) anode load resistor. This has been reduced in value to  $3k\Omega$  2W, with a subsequent improvement of HF response. The result is that clearer edges are noticeable, and the highlights become more pronounced. There is, however, a slight loss of amplification, and readers in fringe areas must decide for themselves whether or not they are in a position to forego some gain for an increase in quality. In areas of good field strength the modification is undoubtedly beneficial.

The second modification applies to any television, and will therefore be effective on both the "Magna-View" and the "Universal."

One annoying feature of TV programmes during the course of transmissions is the occasional appearance of flyback lines. These may often be seen during a film change-over; reduction of brilliance only means that this control must be set again to the original position when the original level is restored.

A simple method of overcoming this trouble is to connect a  $0.002\mu F$  silver mica condenser between the anode of the frame output stage and the cathode of the CRT.

## BOOK REVIEW

A FIRST COURSE IN WIRELESS, by "Decibel." Third Edition. 231 pages, 93 illustrations. Price 12/6. Published by Sir Isaac Pitman and Sons Ltd., Parker Street, Kingsway, London W.C.2.

Nearly 20 years ago a series of articles appeared in *World Radio* entitled *The Radio Circle: For Beginners Only*. Due to their popularity at the time there were many requests for the series to be made available in book form. The author, 'Decibel', produced the book and Messrs. Pitman published it. As a result of the author's lucid style and the usual high quality of production on the part of the publishers, the book soon became established as a standard primer for the novice.

This present new edition is based mainly on the previous ones and the re-prints, but it has also been brought up to date, and now includes additional material. It is eminently suitable for those who have only a little knowledge of radio and the electrical theory appertaining to it, for it is written in an encouraging as well as an instructive manner. There are not many parts where mathematics are used to a great extent, but where they are resorted to it is essential for this form of explanation to be given in order to

make things clear. Even so, the standard of mathematics does not demand anything more than an elementary knowledge of simple formula and their manipulation.

The book follows the usual pattern of such primers, taking the reader from simple electricity into alternating currents, capacitors, inductors, resonant circuits, electromagnetic waves, aerials and receivers. Other chapters deal with high frequency and low frequency amplifiers, decoupling circuits and push-pull output arrangements. The principles of superheterodyne receivers are discussed, and the last two chapters provide a useful insight into circuits for resistance capacity combinations, tone control, negative feedback, automatic volume control, etc.

The diagrams are particularly clear, and free from unnecessary components which might confuse the reader, but several of them would perhaps be more complete if component values had been given.

A snap check on the Index revealed that it refers the reader to page 188 for a reference to automatic grid bias, yet the page contains only a passing mention of the subject. Far more is found on pages 190 and 191, where the principle is discussed and a typical example worked out mathematically.

NORMAN CASTLE

## Query Corner

### A Radio Constructor service for Readers

#### Black Spotter

*I am particularly troubled by car ignition interference in my locality, and although a reasonably efficient noise limiter is employed I find the everlasting procession of white spots across the picture most distracting. Do you think a black spotter could be employed to some advantage, and if so could you recommend a circuit for such a device?*

E. Pedder, Enfield

There must be many viewers whose enjoyment of a television programme is marred by ignition interference from passing traffic. There is quite a lot of relief to be obtained from this annoying trouble by the erection of a carefully positioned highly directional aerial system, and much has already been written about this matter. Also, it is important that a really good noise limiter is used, and in this connection perhaps

the best of these is the one in which the clipping level is manually set by means of a preset control. However, no matter how efficient this type of limiter is made, it can only reduce the interference to the intensity of the peak white part of the picture, and particularly on receivers which tend to defocus on highlights the effect of interference pulses is most troublesome. It would, of course, be advantageous if the white interference spots or blobs could be converted into black spots, as these would be far less obvious and distracting to the viewer, and this is the function of the device known as a "black spotter." There are many different types of black spotter, and some are very complicated and difficult to set up; however, we believe that the circuit which we are recommending constitutes the best compromise between operating efficiency and complexity.

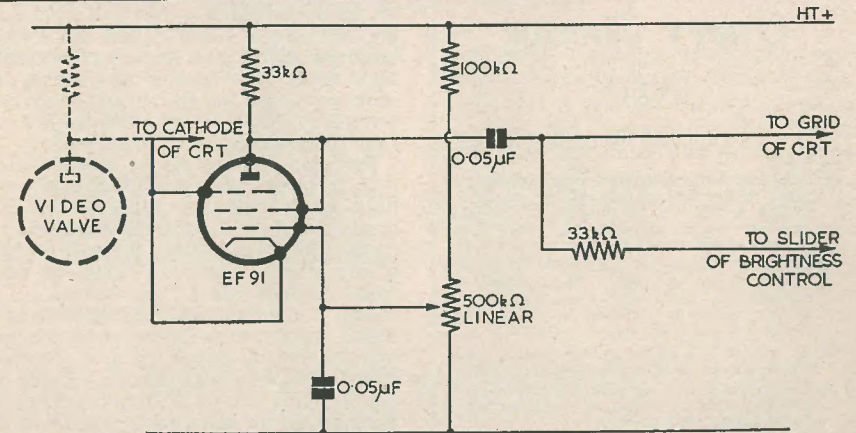

RC 266

Fig. 1. Circuit of black spotter. If a 6.3V CR tube is used, the heater of the additional valve may be fed from the same winding as is the tube



The arrangement is very simple, and is shown in Fig. 1, the additional components being indicated by heavy lines. The video stage shown is a typical one such as is used to drive the cathode of the C.R. tube. This black spotter, for reasons which will be obvious after the following description, is only suitable for use where the video signal is fed to the cathode of the picture tube. The mode of operation is as follows:

An interference pulse whose amplitude exceeds that of the video signal drives the cathode of the spotter valve negative, causing a negative-going pulse to appear at the anode. This pulse is fed to the grid of the picture tube, causing the beam current to be cut off for the duration of the noise pulse. It will be appreciated that the effect of this interference suppressor is not to remove the unwanted pulses from the C.R. tube cathode, but to apply to the tube grid an amplified version of the pulse in the same phase. As the pulse on the grid is larger than that on the cathode, the tube is biased back causing a black spot to appear on the screen. Because the spotter valve is required to amplify the pulse without reversing its phase, the input is applied to the cathode of the valve whilst the output is taken from the anode. The bias on the valve is set so that under normal working conditions no anode current flows until the video signal exceeds the peak white level. This adjustment is made by means of the potentiometer whilst viewing the picture. The control is gradually advanced until the highlights in the picture start to darken;

it is then slackened back just enough to restore the highlights. In this position the circuit will function most efficiently as a black spotter.

#### TV Pre-amplifier

*A friend of mine has a commercial TV receiver which, in this locality where the signal level is low, has insufficient sensitivity to provide a well contrasted picture. I have in mind fitting a pre-amplifier to boost the signal before it is fed to the receiver, and I would be grateful if you would recommend me a suitable circuit.*

G. Kempson, Salisbury

This type of request arises from time to time from different parts of the country, and we feel that it is time to modernise a circuit of a TV pre-amplifier which was first published in the August 1950 issue of the *Radio Constructor*. The original circuit has proved to be very satisfactory, and we do not hesitate to present it again using a more modern miniature valve and providing coil winding details for each of the channels which are now in use. The revised circuit is shown in Fig. 2, and it will be seen that use is now made of the miniature low noise high slope pentode type 6AK5, which is also known as the Mullard EF95. The use of this type of valve enables the complete unit to be assembled on a small metal chassis 3x2x2 inches, which can be conveniently accommodated on the back panel of the receiver. No provision can be made on a chassis of this size for a power pack, and indeed there are few receivers where one would be necessary. The supplies required by the pre-amplifier are 6.3V at 0.175 Amps and 200 volts at 10mA. These can normally be tapped off the main receiver power supply. If, however, the valves in the receiver have series-connected heaters it would be advisable to feed the heater of the pre-amplifier valve from an additional 6.3V transformer.

Reference to the circuit diagram shows that a shunt resistance-capacitance combination is included between the outer conductor of the co-axial input cable and the chassis; these components are only necessary when the pre-amplifier is employed with a receiver which has a 'live' chassis. If the chassis is not connected to one side of the mains supply, then the outer of the co-ax may be directly connected to it. Both the input and output impedances of the unit are 80 ohms, so that the output socket may be linked to the aerial socket on the receiver by means of a short length of feeder cable. The gain is pre-set by means of a wirewound variable resistor in the cathode circuit of the valve.

The tuning coils are wound on standard Aladdin formers, and are fitted with dust iron cores. The coils should be mounted on either side of the valve, and each is fitted with a screening can. The table below indicates the number of turns required on the coils to tune to any of the B.B.C. TV channels.

The coils are wound with 32 swg enamelled copper wire, the two which are wound on the same former being separated by a piece of thin card, one being wound directly above the other. The heater choke is of the self-supporting type and consists of 10 turns of 22 swg PVC-covered wire wound on a

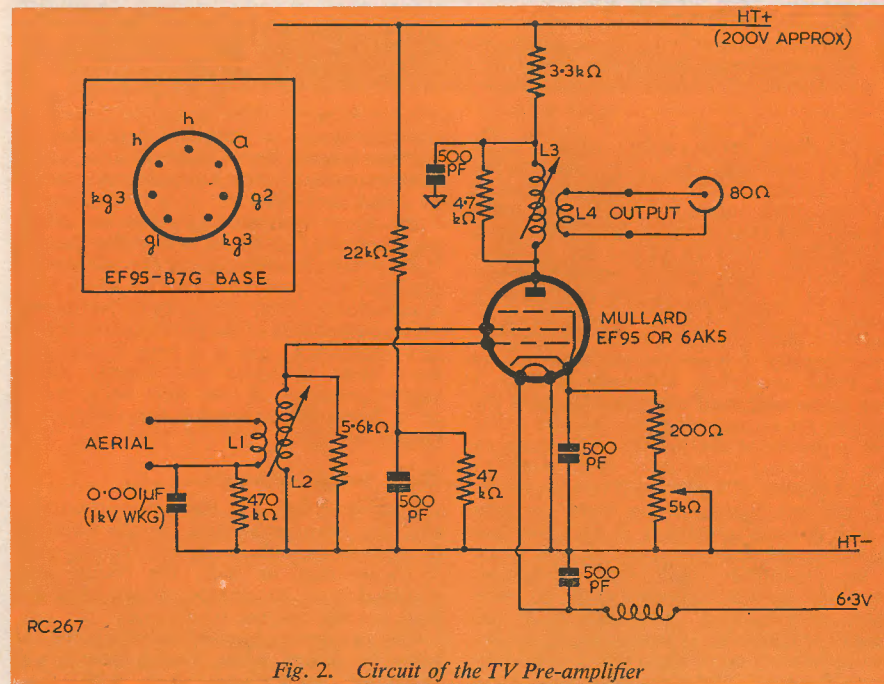

Fig. 2. Circuit of the TV Pre-amplifier

Channel	L1	L2	L3	L4	1/4 inch diameter mandrel. Decoupling capacitors should be of the mica dielectric type.
No. 1 London	1 1/2	8	8 1/2	1 1/2	The unit is very simply trimmed by turning the coil core until maximum picture brightness is obtained, then whilst viewing Test Card "C" some slight improvement in definition may be obtained by very slightly detuning each core.
Glencairn	1 1/2	7	7 1/2	1 1/2	
No. 2 Holme Moss	1 1/4	6 1/2	6 3/4	1 1/4	
No. 3 Kirk o'Shotts	1 1/4	6 1/2	6 3/4	1 1/4	
Brighton	1 1/4	6	6 1/2	1 1/4	
No. 4 Sutton Coldfield	1 1/4	5	5 1/2	1 1/4	
No. 5 Wenvoe	1 1/4	5	5 1/2	1 1/4	
Pontop Pike	1 1/4	5	5 1/2	1 1/4	

Commencing next month

## THE "PATTERN-MASTER"

By D. Allenden, Grad.I.E.E.

A versatile TV Pattern Generator for serious work, covering 40-70 Mc/s.

## Query Corner

### RULES

- (1) A nominal fee of 2/6 will be made for each query.
- (2) Queries on any subject relating to technical radio or electrical matters will be accepted, though it will not be possible to provide complete circuit diagrams, for the more complex receivers, transmitters and the like.
- (3) Complete circuits of equipment may be submitted to us before construction is commenced. This will ensure that component values are correct and that the circuit is theoretically sound.
- (4) All queries will receive critical scrutiny and replies will be as comprehensive as possible.
- (5) Correspondence to be addressed to "Query Corner," Radio Constructor 57 Maida Vale, Paddington, London, W.9.
- (6) A selection of those queries with a more general interest will be reproduced in these pages each month.



## Radio Miscellany

NO doubt many readers make a point of watching the TV programme "Inventors' Club." Such a programme promises much interest in itself, and there is always the chance that a good idea for a radio gadget might be picked up, or some little point might inspire another bright notion. This column has previously drawn attention to what I have considered commendable ideas presented in this programme. Unfortunately, I have not yet seen any of the items marketed, although perhaps I have under-estimated the probable time for them to get into production. Maybe it has been a matter of the publicity. It seems to take something more than sheer merit to make a success of a good idea nowadays!

In the recent programmes there has been no lack of ideas submitted. In fact, the time allotted could well be expanded, and many of the prototypes could, with advantage, even from the entertainment angle, be more amply demonstrated. The fullness of the present programmes is something of a contrast to its early days, when only a few items were submitted. The ideas, too, seem more technical. I remember one of the early items particularly—an expanding collar stud to safeguard the wearer of shrunken-necked shirts from being choked. Nowadays they are of a much more serious nature.

I was rather fascinated with the cable stripper recently shown. Cable strippers are, of course, no new idea, and most of us have already tried out a number of types. Many of them seem to require pretty careful handling, particularly when used on multi-stranded wires, and most especially if they are encased in a tough covering. Even the best of them seem to be restricted to a limited range of cable sizes for really efficient working.

The new pattern recently sent in by Mr. N. E. J. HALEY of Cambridge showed great promise, and made a quick and neat job of the two "strips" demonstrated in front of the TV camera. It was claimed to be capable of equally effectively dealing with a wide range of sizes. Unfortunately,

the time given to both the demonstration and the description was all too brief, and I felt disappointed their action was not shown as a real close-up.

By their treatment of this and other programmes, I always have a feeling that the B.B.C. sadly underestimate the number of practical men among viewers. Most men, whether as cyclists, motorists or handymen, pick up some idea of the principles of elementary mechanics, and it is very irritating to have ideas of which one eagerly awaits details treated as if they were being shown as a form of amusement for infants and elderly ladies.

### Those Naughty Sponsors

Sponsored TV, if it has achieved nothing else, has been responsible for the utterance of some of the silliest nonsense imaginable. It seems that, as ever, the people least qualified to air an opinion on any debatable issue are the readiest to do so.

On this question Lord Mancroft quoted one eminent divine who, having denounced sponsored programmes, was asked how many of them he had seen. It transpired that he hadn't seen *any* TV at all. Perhaps, after all, that sort of thing is only what is to be expected. Busybodies always seize on the opportunity to prevent anybody else from doing anything.

The press generally, however hostile they secretly felt at this threatened intrusion on their advertising revenue, generally refrained from partisanship, although much of the drivel talked and written by those who, either from self-interest, bigotry or sincere belief, opposed it was fully quoted. To be on the safe side more than one newspaper long since applied for licenses. One of them in its Company Report warns the shareholder of the impact which sponsored TV will have on its advertising. It goes on to hastily assure them that they themselves intend to be in on the ground floor if and when it is permitted.

The entertainment world, already faced with diminishing receipts due to the rising

popularity of TV, has long been in a state of jitters. The threat of alternative and lively quality programmes has given them fresh cause for panic.

### Don't Mention It!

Much has been made of the advertising aspect. It seems that everybody overlooks the simple answer that if you don't like the "ads." you can simply switch off or look at what the BBC have got to offer. That is undoubtedly just what will happen if there is too much plugging or the advertising is put over in bad taste.

No-one objects to advertisements in newspapers and periodicals—in fact most people seem to like them, or at least they read them. Women, particularly, give as much attention to the advertisement pages of the glossy covered magazines as they do to the rest of the contents. You, gentle reader, can hardly derive any feeling of masculine superiority from that. How many hobbyists have you heard admit they only bought a certain radio periodical for the sake of the

of the earliest days of broadcasting. At that time the vast majority of receivers in use were crystal sets, and one occasionally saw some brazen claims for crystals with wonderful names. In fact, the names were the most wonderful part about them, and to give them just the right touch they were invariably suffixed with "-ite" or "-tone." One firm claimed that Birmingham (5IT) transmitter was regularly heard in their London show-room on a set using one of their crystals. In those happy days broadcast stations were on what we should now regard as flea-power, and it would be quite a feat. I imagine most of the time 5IT was on the air it would be after shop hours, and in any case it wouldn't be easy to prove the weak signals in the headphones were not from Birmingham.

Another get-rich-quick back-street firm boasted that New York could be heard with their crystals. Beautiful tone, too! Optimists sent in their half-crowns for the wonderful new crystal in the expectation of hearing real DX with it. In due course they received

## Centre Tap *talks about* INVENTORS' CLUB— —SPONSORED TV

advertisements? If you are quite honest, you will probably admit that in your early days as a constructor you did the same thing yourself.

I have never heard of anyone switching off when the BBC allow a few "ads." to creep in, and the TV side offends particularly in this way. The naming of plays, films, theatres, cinemas etc., has become almost a regular part of interviews. Writers plug their books, and even the Zoo man tells you what books to buy and holds up copies to make sure you buy the right ones. Film stars especially are asked by the interviewer for the name of their latest picture and even the date of release. Mr. and Madam Celebrity from *What's my Line* are given the fullest opportunity of telling viewers "this is my last two weeks at the Palladium. Next week I am appearing in Manchester after which I go on to Bristol."

It is curious that those who swallow this sort of advertising without protest should profess such horror that someone might mention the name of a brand of soap or toothpaste.

It just doesn't add up, but then human nature's like that.

### Delayed Action

Thinking of advertisements reminds me

a shiny bit of silica that looked very much like any other crystal. In fact, it behaved very much like any other crystal; no worse but certainly no better.

When they complained to the advertiser they received a polite note saying that New York could most certainly be heard—if they took the set to New York!

Naturally the victims very nearly burst with indignation upon receipt of this. As this reaction subsided they generally had a wry laugh over it—those with the keenest sense of humour getting over it soonest. When their resentment at being cheekily defrauded wore off, they re-read the advertisement and checked through the carefully worded claim. As the silly side of the whole business became more and more apparent it seemed to them almost funny. In fact, it seemed to become funnier and funnier as the days passed, especially when they thought of all the other people who had also been so impudently swindled. As it occurred to them how comic some of their pals' faces would look when they discovered that they, too, had been stung for half-a-dollar, they'd begin to do their best to induce them also to send up for one of these wonderful crystals!

But then, as I have already said, human nature's like that.



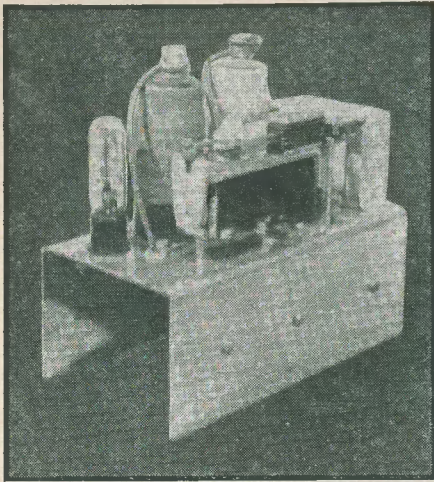

## A PHOTO-CELL RELAY UNIT

By J. W. BAGNALL

**M**OST of the photocell Units that the writer has seen previously have used Thyatron valves, but not having one available it was decided to see what could be done using components from the "Junk" box.

The following circuit was evolved using two SP61 valves. These were chosen as they have a steep slope, which is desirable for this purpose, and they are also readily available at low prices.

The HT supply is of the AC-DC type, but as there is no direct connection to the chassis the unit is quite safe to handle; for this reason the metalising of the valves was left unconnected. A transformer was used to supply the heaters, as the SP61 draws 0.6A, and a dropping resistor was not considered practicable as it would need to dissipate 130 watts. The relay was a Post Office type with a resistance of 6.2k $\Omega$ , but any type could be used providing it will close when a current of 3 to 4 mA passes through the energising coil. To operate the external appliance, two sets of contacts are used, one make and one break, so that one pair are made in either position of the relay. The photocell used is a caesium silver type, and it needs a polarising potential of 60 to 70 volts on its anode.

### The Circuit

The polarising voltage for the photocell is derived from the chain R1 and R2. This voltage is also used to supply the screen and anode of V1 which is DC coupled to the grid of V2. This valve is normally held at cut-off point by virtue of the potential

applied to the cathode, which can be adjusted by VR1.

When the beam of light on to the photocell is interrupted it causes the cell to cease conducting, the grid voltage on V1 falls and the current flowing through the valve decreases. This causes the voltage at the anode to increase, which makes the grid of V2 less negative. The current which now flows through V2 closes the relay, which is held closed until light falls on to the photocell again. The purpose of C1 is to bypass to ground any AC that appears at the anode of V1.

With the unit in operation, the valves should not be removed without first switching off. It will be seen that if V1 is removed the grid of V2 will have a large positive voltage on it, and the valve will pass excessive current.

### Construction

No special precautions are necessary in the construction of the unit, apart from short leads to the photocell and a screened grid lead to V1; a screened grid cap was not found necessary.

To set up the device, it only needs to set VR1 so that the relay is open when there is light on the cell. This position will be found to vary according to the amount of light that falls on to the cell.

One last word of caution regarding the photocell. Too high a voltage across it will result in ionisation or "blue glow," which if allowed to continue would ruin the cathode. Should this occur when switching on the completed unit, the resistor R1 should be increased in value.

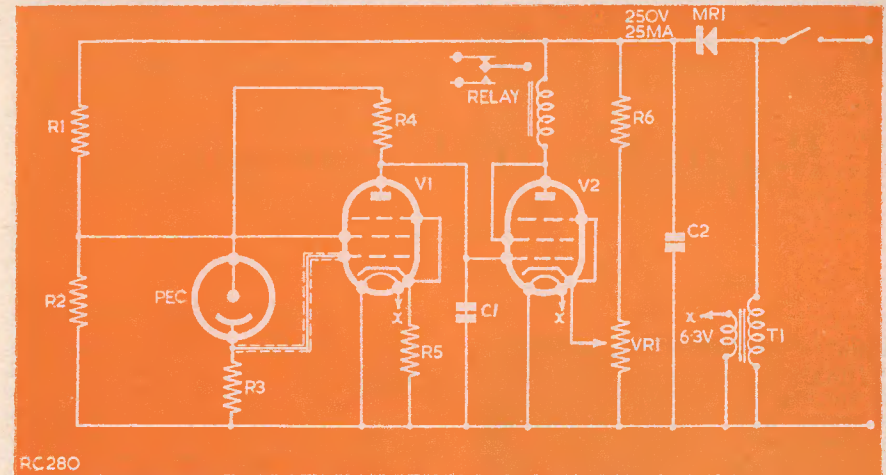

Photocell Relay Unit

### Parts List

R1	33 k $\Omega$ 1W
R2	22 k $\Omega$ 1W
R3	4.7 M $\Omega$ ¼W
R4	22 k $\Omega$ ¼W
R5	2.2 k $\Omega$ ¼W
R6	22 k $\Omega$ 1W

VR1	10 k $\Omega$ wirewound
C1	0.1 $\mu$ F 150V wkg.
C2	4 $\mu$ F 350V wkg.
MR1	40 mA metal rectifier
T1	6.3V 2A heater transformer
V1, V2	SP61
PEC	Caesium silver photo-electric cell.

## A Noise Limiter By R. G. YOUNG

**T**HIS circuit is equally suitable for BC, SW and TV, and can even be used as a PA Limiter with success. It may preserve the ears of some of your long-suffering readers!

The distortion produced, even at "maximum clip level" (minimum pass) is remarkably low. The circuit is, as far as I know, completely novel and has never been published elsewhere.

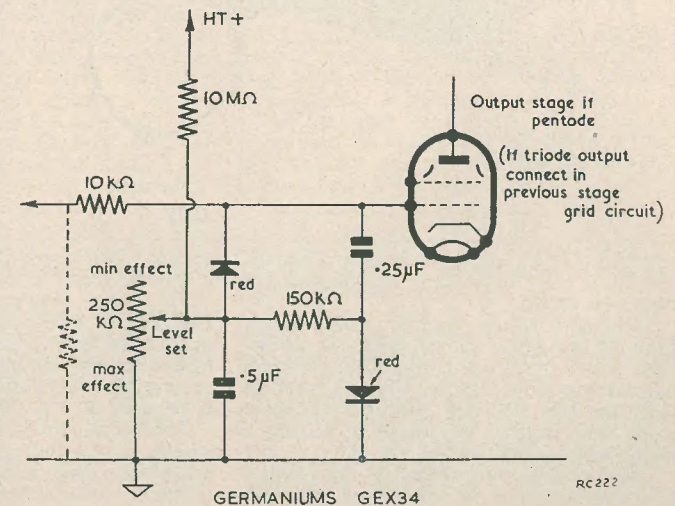



# Radio Control Equipment

## PART 8

By RAYMOND F. STOCK

### Control for Non-Electric Propulsion Systems

STEAM AND INTERNAL COMBUSTION engines are less easy to control than electric motors and usually require auxiliary equipment such as clutches, gearboxes etc., which are outside the scope of this article.

It is worth bearing in mind that such items as steam control valves, reversing levers and the ignition levers of petrol engines are all susceptible to control by an electric motor and gear train.

The actuators used for these purposes are similar to those described for steering, and may either be arranged for continuous

cut-out is usually fitted by the makers for stopping. This can easily be controlled by radio, and a small electromagnet or solenoid can be coupled to the lever (which requires only a light pull). When this is worked from a 'stop' position mixed in with a steering sequence, on either a selector or escapement, it requires no artificial delay, since the control does not generally respond inside a half second or more.

### Non Sequential Systems

A very well known control system depends upon the transmission of a continuous

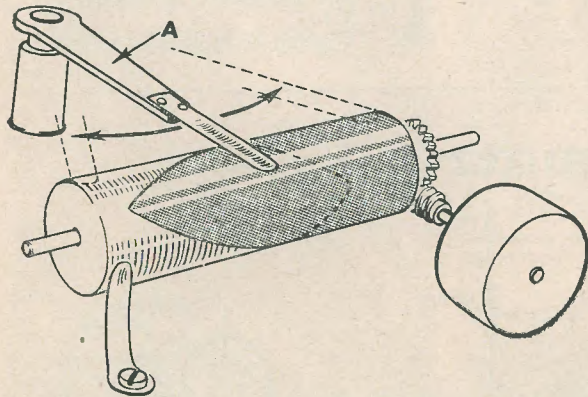

Fig. 37.  
Pulse Generator

rotation (using a crank to apply a push-pull effort) or may have limit switches and a reversible action.

Although electric motors have always been the standby of the newcomer to modelling, many miniature compression ignition engines are now used in first ventures as they are very tractable and reliable, apart from their obvious advantage of having a good power weight ratio.

These engines, unfortunately, are practically uncontrollable for speed, but a simple

train of pulses, at a fixed frequency but with a variable length of pulse.

The pulse length is infinitely variable from 0% to 100% and is controlled by the position of the steering wheel in the control box. Several methods are available for generating these pulses, but the easiest one is depicted in Fig. 37.

The electric motor, fed from a local power supply, drives the contact drum through a step-down gear train. The drum is of insulating material but has on, or let into,

its surface a conducting area which varies linearly from 360° at one end to 0° at the other. A light brush makes one keying connection to the conducting layer.

A second brush is moved along the surface of the drum by the steering control, and this is shown as being on the end of the lever A which moves with the control wheel (outside the control box).

When the wheel is centred, the brush is receiving current from the drum over 180° (or 50% of the time). It will be evident how the percentage pulse changes as the wheel is moved.

The operating gear for the model is often that shown in Fig. 38. In this diagram, back and front contacts of the receiver relay are wired to opposite poles of the battery and thus supply current to the motor in either direction.

When pulses are being received of 50% length, the motor is continuously caused to rotate back and forth an equal amount; the frequency of pulses is several per second and the final shaft of the motor reduction gear which carries the rudder moves only imperceptibly (if indeed at all, in view of the probable backlash in the gearings).

When the pulse length is changed, however, the motor moves more in one direction than in another and the rudder creeps over.

It should be stressed that this system is not a strictly proportional one, since the movement of the wheel is related to the *speed* at which the rudder alters, not to its *position*.

The construction of the operating gear and the control box is obvious in this case, except perhaps for the pulsing cylinder. This should really have a truly flush surface, best obtained by mounting together on one shaft a half-cylinder of insulating plastic and a half-cylinder of metal both split diagonally. These, however, would have to be skimmed up on a lathe when assembled; a fair solution is to use a length of plastic rod, about  $\frac{3}{8}$ " diameter, mounted on a shaft, and to wrap around it a diagonally-cut half-cylinder of copper foil bent from a triangular shape. This can be secured by soldering it to the heads of countersunk 8-BA brass screws in the plastic.

The operating gear described has its limitations, but using the same control box a similar system can be employed in a truly proportional device.

Fig. 39 shows a circuit where the receiver relay A applies a voltage (15 or 20) to a resistor and condenser (and thus charges the latter) whenever a pulse is received.

This voltage is applied to the grid of a pentode and biases it to cut-off point, if sufficient.

Included in the grid line is the potentiometer B across a source of EMF which

opposes the other voltage. The voltage on the grid, therefore, depends upon the difference between the two opposite voltages. In the anode circuit is a relay switching the steering motor C across two batteries to reverse its direction; the motor is geared down to the rudder and to the shaft of the potentiometer.

It will be seen that whatever pulse length is being transmitted, a certain balance will be achieved between the potentiometer-controlled source of EMF and the voltage across the condenser.

Whenever the pulse length is changed the charging period of the condenser will vary—and thus its voltage—and a state of unbalance is created which can be restored only by rotation of the potentiometer; this is done by the motor which carries the rudder with it.

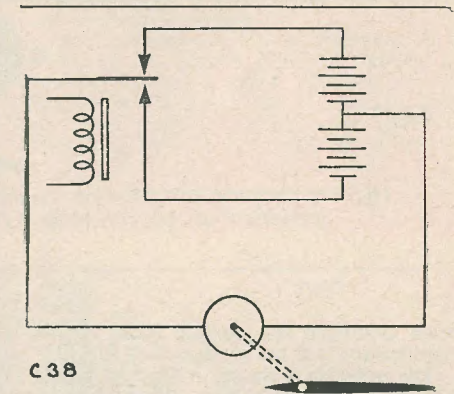

Fig. 38. Typical pulse operating gear

It is found that the armature of a suitable relay in the anode circuit can be made to float between the contacts during a state of unbalance: a Siemens relay is ideal.

The frequency of the pulses is increased to perhaps 50 or 100 per second with this gear, and the receiver relay must be capable of operation at this speed.

The values of the charging condenser and resistors are best found by experiment, since they will vary with several factors. The valve can be an output pentode such as a 3S4 in the miniature range.

A different type of equipment is also capable of giving proportional results, and with less expenditure of energy since continuous signals are unnecessary.

I originally developed this idea for use in a cabin cruiser, but have used it extensively since in other applications, and it has much to commend it; it requires, however, a more complicated mechanical side dependent



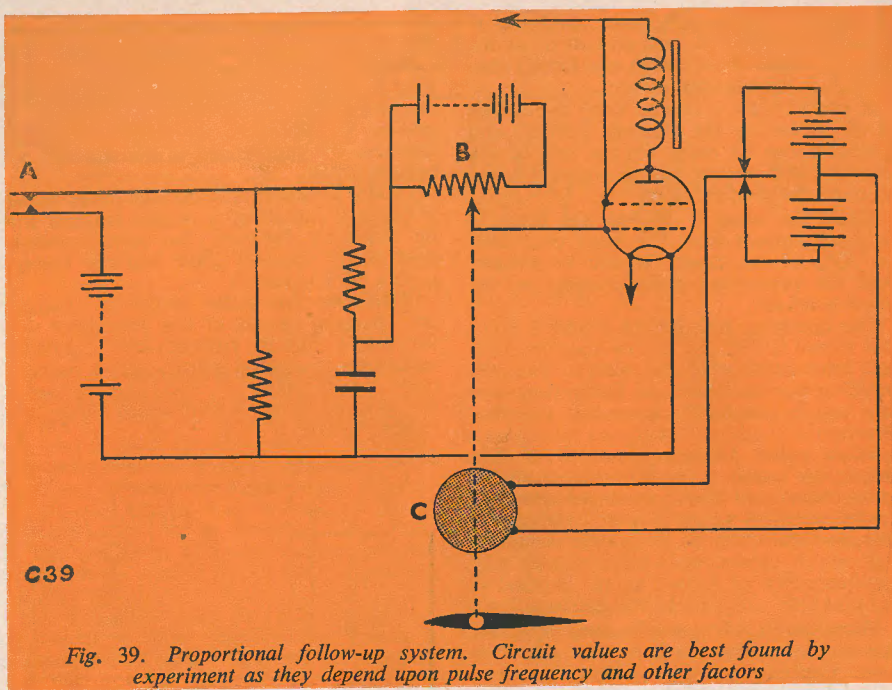

Fig. 39. Proportional follow-up system. Circuit values are best found by experiment as they depend upon pulse frequency and other factors

upon obtaining the correct gears, so the construction will not be described fully.

The principle is shown in Figs. 40 and 41. Fig. 40 is the control box. When the knob A is turned, one or other of the two contact pairs close under mechanical pressure and further movement, transmitted through them, rotates the pulsing wheel B through a 40:1 gear train. The latter (B) carries a brush which rotates against two conducting segments, one short and one long. One or other of these is brought into circuit according to which contact pair was originally closed. The brush as it rotates keys the transmitter; the number of pulses sent depends directly on how many times the brush rotates, i.e. how far the knob is turned. The type of pulse sent (long or short) depends on the way the knob is turned (to port or starboard).

The operating gear is shown in Fig. 41. The receiver relay energises electromagnets A (directly) and B (through a delay device C). A and B each have a pivoted armature and pawl, and these work upon two ratchet wheels; the latter are integral with the two bevel wheels of a differential, and the pinions turning between them rotate the output shaft in a way which represents the

algebraic sum of their two movements. Thus the output shaft moves in direction and extent exactly in phase with the control knob.

It will be realised that a long pulse will operate both A and B, but this is overcome by making the teeth of the delayed magnet's ratchet twice as large (in an angular sense) as those used on the non-delayed gear. When a delayed pulse is used, therefore, one wheel moves forward by  $X^\circ$  and the other backward by  $2X^\circ$ , the final result being  $X^\circ$  backward.

The pulses used are in a ratio of 4:1, and to prevent too much variation the control box gear train is fitted with a centrifugal governor to limit the maximum speed of turning.

With this system a very long pulse can be used to control an engine selector; it will introduce a spurious 'delayed' pulse, but this can be cancelled by adding a short pulse immediately after.

#### Multi-Channel Systems

Most of the interest in these systems lies in the electronic gear and is thus outside the limits of this article. Briefly, the transmitter is modulated by either (a) a single

power oscillator whose audio frequency can be varied or (b) a number of master oscillators on various audio frequencies which drive a power amplifier for modulation.

Generally the former system is used, as some of the signals to be transmitted are mutually exclusive (e.g. Port and Starboard) and therefore not required simultaneously.

The receiver, after detection and 2 stages of valve amplification, RC coupled, uses the signals to feed a discriminating device; this can be a purely electronic phase change circuit, but is more usually a multi-reed unit responsive to certain audio frequencies. The vibration of the reeds when resonating is used to make a physical contact and operate a relay. The receiver, therefore, terminates in 2 or more relays instead of one, and the operating gear following each relay is of simple electro-mechanical type such as has been described for a single channel.

One system peculiarly adapted to two-channel working is the last one described, and the short and long pulses are replaced by signals of one or the other frequency.

The carrier current may or may not be continuous when audio channels are used.

Better reception is afforded by the former case, but it should not be overlooked that a third 'channel' can be obtained by using the carrier in the normal way. Similarly, if two channels of audio are simultaneously available, yet another 'channel' is obtained by keying them together.

Tuned reed units are interesting to make, and they can also be obtained commercially.

#### Models for Radio Control

Model aircraft are sufficiently difficult to fly satisfactorily without control equipment, and the fitting of the latter does not, as might be thought, simplify the problem. Some little experience in the hobby is therefore essential before radio control is attempted, and in most cases there is sufficient complication to warrant a 'team' approach by an established aeromodeller and a radio enthusiast.

Land vehicles are less troublesome, as a failure of the control system is unlikely to produce expensive antics. Space is usually limited for the use of fast car models, and the most suitable prototype is therefore something like an armoured car or heavy

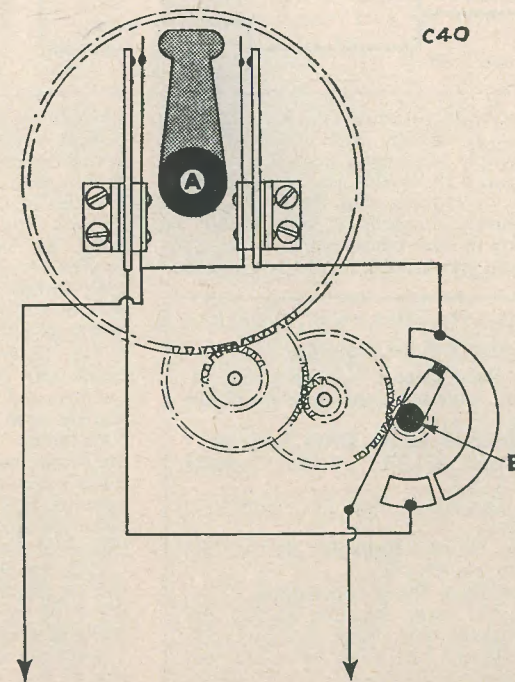

Fig. 40. The large gear wheel is mounted loosely on the shaft of A.



lorry (plenty of room in the back for equipment!) or a tank, if the tracks can be managed. The most suitable power supply is an electric motor and secondary cells, and the torque of a series-wound motor makes it ideal for traction. Such models will not require much room for working, and can accept (if low geared) poor ground. Great fun can be had in one's garden, and the transmitter can then be mains supplied, which cuts the cost.

ced. With modern miniature components, quite orthodox models no more than 18" long can be controlled, while a 40" cargo vessel would take any amount of operating gear and batteries. The most popular type of hull is the V-bottomed boat (motor cruiser, M.T.B., etc.), and this is easy to make, and has plenty of beam for stowing equipment.

Secondary cells and an electric motor are ideal for propelling the slower prototypes,

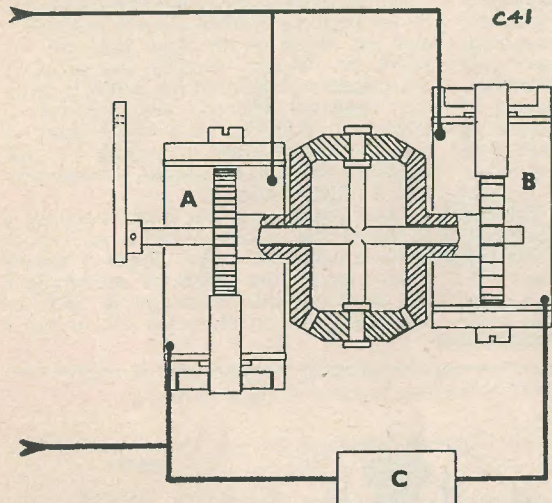

Fig. 41. C is another small relay whose natural time lag provides the very short delay period required

Any selector system giving fine control is suitable for vehicles, and electric traction lends itself to full engine control.

Ship and boat models are by far the most popular for control, and rightly so. They are relatively inexpensive and require no machining in their construction, while many kits of parts are available for the less experien-

and suitable cells are available cheaply from surplus stores. Local power for operating gear is no problem where electric propulsion is used, and complicated selector systems are in order here (with no damage done if they do miss a pulse once in a while!)

On the other hand, one of the most entertaining models is a fast 'diesel' powered hull; unless a clutch can be contrived no control will be possible over the speed, but this is offset by the excitement of controlling a fast model. Fortunately a commercial engine can nowadays be acquired, with no qualms and at little expense, and built straight into a hull (perhaps also from a commercial kit) in the knowledge that the combination is bound to succeed; and if radio is installed with an effective range of, perhaps, half a mile, a great deal of entertainment can be derived from trying different classes of control gear.

Even the simple three-position escapement will be found to work surprisingly well, and some of the more complex gear can be really precise in action.

Why not try a model? You might even like it!

## THE RADIO AMATEUR

Contents of the September Issue:

The "Band Hopper"—a switched, all-band, table top transmitter for phone and CW.

Modifications to the HRO Receiver. On Being an XYL Radio Operator—CTIYA.

VFO Discussion—new ideas for VFO design.

Strictly for the Beginner—Buffers and Doublers, Part 3.

Narrow Band Phase Modulation. and the usual Amateur Bands, SW Broadcast and VHF features, SW BC Station List, Club News, etc., etc.

# POWER PACK for a BATTERY SET

by B. B. FISHER

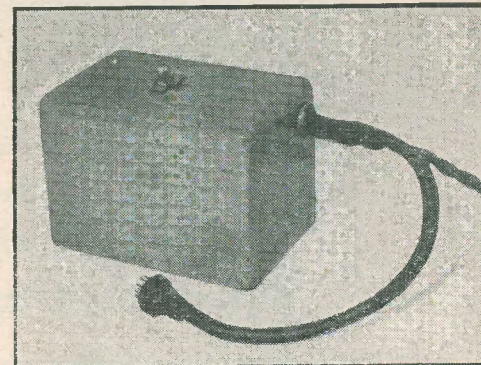

THE FOLLOWING ARTICLE describes a mains power pack made for a Marconi portable battery wireless set. Details are given of the power pack built by the author together with general considerations and suggested circuits for power packs which will meet the requirements of most portable battery sets. The power pack still permits the set to be run with its battery.

One of the main differences between a battery set and a mains operated set is that the former uses directly heated valves. The effect of applying alternating potential to the directly heated cathode is the same as applying a similar signal to the grid. Since this would result in an overpowering 50 cycles hum, the heater supply for battery sets must be rectified and efficiently smoothed. Experiments with AC heater supply and a humdinger were found to be unsuccessful. Four possible circuits of a power pack are given. They all use metal rectifiers, since these elements are more robust and allow of a more compact construction than valve rectifiers.

The first circuit shown in Fig. 1 uses a transformer with two separate windings for the HT and LT supplies. Fig. 2 shows a circuit using a transformer for the heater supply only, the required drop of voltage being obtained by means of resistance R<sub>3</sub>. These two circuits are suitable for sets operating with heater voltages of 1.4V. With sets having an LT supply of 7.5V it is, in general, more economical to bleed the HT supply. The circuits for such sets corresponding to those of Figs. 1 and 2 are shown in Figs. 3 and 4. It will be seen that the circuits of Figs. 1 and 3 use a trans-

former giving a complete electrical isolation of the set from the mains. The use of a transformer is better suited for tap changing, and has the advantage over a dropping resistor in that it dissipates only a negligible amount of power. It allows of a construction uncramped by the necessity of keeping hot components (resistors R<sub>8</sub> and R<sub>10</sub> in Fig. 4) away from other parts and providing adequate ventilation. The disadvantages of a transformer are its higher cost, size and weight. It should be noted that in Figs. 3 and 4 the LT and HT supplies have one common lead. Care should therefore be taken to connect the positive LT lead to the correct output terminal of the power pack. If it is found that the valves are not glowing, the LT leads from the set should merely be reversed.

The approximate values of the components are given under each diagram, but these should merely be regarded as approximate values. Below is outlined a procedure for determining component values suitable for the particular set and for the transformer and rectifiers available.

To determine the best values of components, connect equivalent HT and LT resistances of the set across the corresponding output terminals of the chosen circuit. The smoothing and dropping resistors (R<sub>3</sub>, R<sub>4</sub> and R<sub>5</sub> in Fig. 2) can then be adjusted to give the rated voltages. The equivalent HT and LT resistances of the set can be obtained by dividing the two voltages by the corresponding currents taken. These currents can be obtained from the valve data, or measured directly by connecting the set to the battery. It can, however, be taken as a



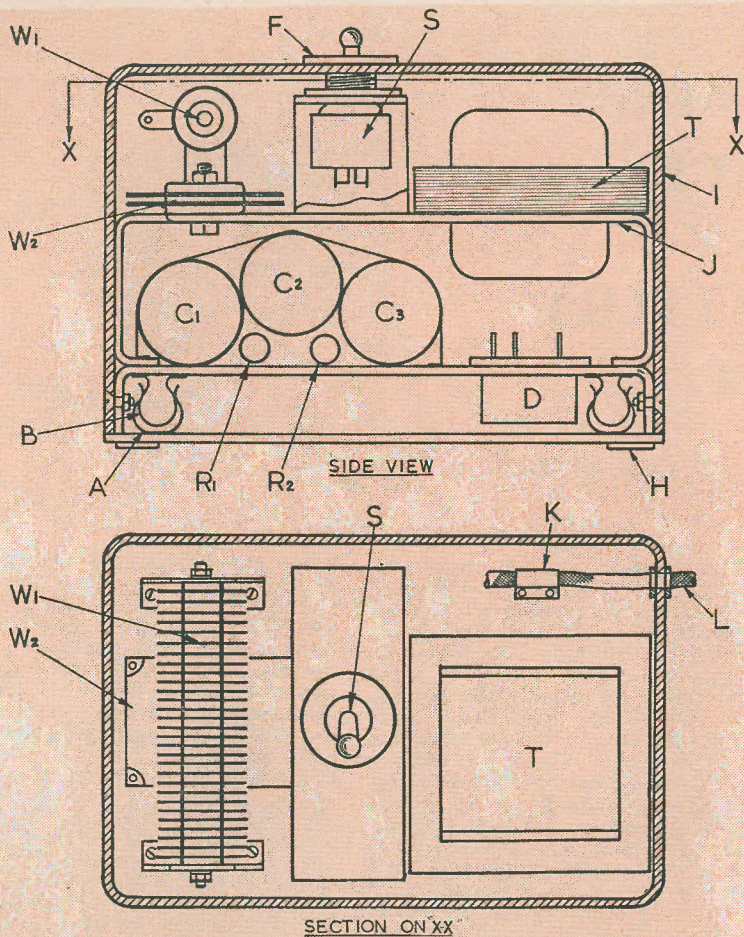

RC287

List of Components referring to Fig. 5

- A Terry Clips
- B Brass Supports
- C1 C3 2000 $\mu$ F electrolytic condensers
- C2 20-30 $\mu$ F electrolytic condenser
- D Tap Changer
- F Switch fixing nut
- S Switch
- W1 HT rectifier
- W2 LT rectifier
- T Transformer
- K Cable Clip
- L Input and output cable
- R1 R2 Smoothing resistors
- I Steel box
- J Aluminium chassis
- H Rubber feet
- G Chromium plated countersunk screws.

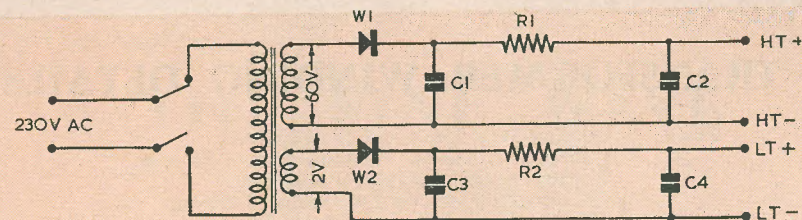

FIG. 1

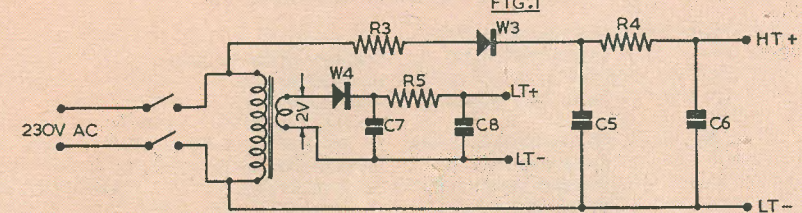

FIG. 2

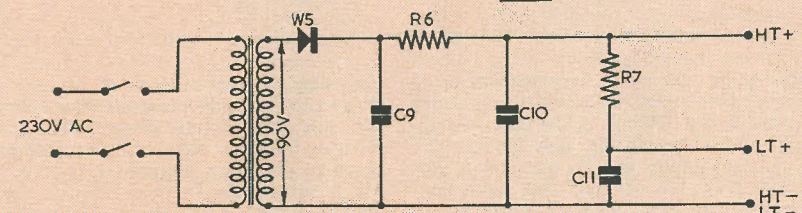

FIG. 3

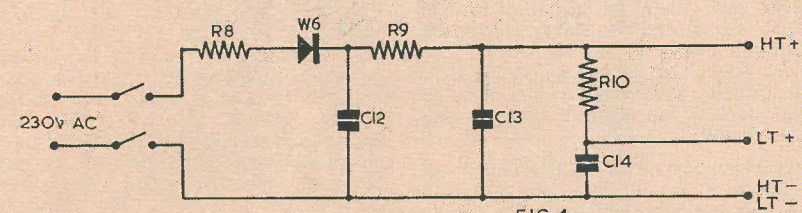

FIG. 4

RC286

Typical Components Values for Fig. 1

- R1 5k $\Omega$  1/2W  $\pm$ 20%
- R2 6 $\Omega$  1/2W  $\pm$ 20%
- C1, C2 20-30 $\mu$ F 150V Elect.
- C3, C4 2000 $\mu$ F 3V Elect.
- W1 15mA 150V Rectifier
- W2 0.5A 3V Rectifier

Typical Component Values for Fig. 2

- R3 15k $\Omega$  2W  $\pm$ 20%
- R4 5k $\Omega$  1/2W  $\pm$ 20%
- R5 6 $\Omega$  1/2W  $\pm$ 20%
- C5, C6 16-16 $\mu$ F 150V Elect.
- C7, C8 2000 $\mu$ F 3V Elect.
- W3 15mA 150V Rectifier
- W4 0.5A 3V Rectifier

Typical Components for Fig. 3

- R6 470 $\Omega$  2W  $\pm$ 20%
- R7 1.5k $\Omega$  5W  $\pm$ 20%
- C9, C10 16-16 $\mu$ F 150V Elect.
- C11 500 $\mu$ F 12V Elect.
- W5 70mA 150V Rectifier

Typical Components for Fig. 4

- R8 2k $\Omega$  10W  $\pm$ 20%
- R9 470 $\Omega$  2W  $\pm$ 20%
- R10 1.5k $\Omega$  5W  $\pm$ 20%
- C12, C13 16-16 $\mu$ F 150V Elect.
- C14 500 $\mu$ F 12V Elect.
- W6 70mA 150V Rectifier



## TRANSFORMER WINDING DETAILS

- FIG. 1 Output 60V at 15mA and 2V at 250mA.  
Core area=0.2sq. in. Window Area=0.65sq. in.  
Primary winding 6,900 turns of 40 swg.  
HT secondary winding 1,980 turns of 40 swg.  
LT secondary winding 66 turns of 28 swg.
- FIG. 2 Output 2V at 250mA.  
Core area=0.2sq. in. Window area=0.6sq. in.  
Primary winding 7,800 turns of 40 swg.  
Secondary winding 72 turns of 28 swg.
- FIG. 3 Output 90V at 65mA.  
Core area=0.45sq. in. Window area=0.7sq. in.  
Primary winding 3,450 turns of 38 swg.  
Secondary winding 1,480 turns of 35 swg.

general guide that a battery set takes an HT current of approximately 10 mA and a heater current of 250 mA in the case of 1.4V LT sets and 50 mA in the case of 7.5V LT sets. For example, in the case of a 90V HT and 1.4V LT set the two equivalent resistances are 9000 ohms (1 watt) and 6 ohms ( $\frac{1}{2}$  watt). In this procedure, considerable care should be taken not to overrun the rectifiers and electrolytic condensers. Thus if condensers C1 and C2 in Fig. 1 are rated at 100V, the voltage across either of them must not exceed this value. Also the voltage across C1 must not exceed the rated rectifier output.

The power pack built by the author was that shown in Fig. 1, and the components quoted are those actually used. That circuit was chosen in preference to others due to the fact that the power pack was built for a regular traveller and had to be suitable for operation on 110V as well as 230V AC. A transformer supplying both HT and LT with a simple tap changer was considered to be a much simpler way of changing the operating voltage than a system of resistors with a complicated switching arrangement, especially as a heater transformer had in any case to be provided. The physical arrangement of components is shown in Fig. 5. Only overall dimensions are given as the particular detail arrangement will depend in each case on the components available.

The box was built of  $\frac{1}{16}$ " steel. All the joints were welded and the edges neatly rounded off with a file. The box has the advantage of allowing an easy access to the tap changer D, and at the same time not

exposing the tap changer to an easy interference by outside persons. The bottom of the box carries four Terry clips A which fit over four specially bent pieces of brass B fixed to the lower aluminium chassis. Thus the bottom of the box can be easily removed and replaced. The bottom also carries four rubber feet fixed by glue. The whole box can be easily removed for servicing by removing the switch nut F and unscrewing four countersunk screws at G. C1 and C2 were a double electrolytic condenser. The resistors R1 and R2 were suspended by the wiring. It has been found that although the transformer has been designed for 230V, no change in performance of the set has been detected with the mains voltage varying between 200 and 250V. The author, therefore, does not consider it essential to provide taps for the normal variations in mains voltage. Those constructors wishing to wind their own transformer will find winding details at the end of this article.

To deliver the power into the radio, the case containing the set has been drilled for a 7BG valve base which was fixed in position by two countersunk screws. Contrary to expectations this did not spoil the appearance of the case. A four-pin socket identical with the one used in the battery was fixed inside the set, and connected to the base. Care should be taken at this stage to fix the socket in such a way as not to interfere with the space normally taken by the battery. The lead from the power pack was terminated by a 7BG plug. The set could thus be connected to the mains by inserting the 7BG plug into its base, and removing the radio plug from the battery and plugging it into the internal socket.

Let's Get Started

## 5 THE SINE WAVE

by A. Blackburn

AS YOU GAIN EXPERIENCE in radio, the time will come when you will start to build instruments to test faulty or newly-designed circuits. Guess work and trial-and-error techniques have their limitations: besides, test equipment provides an efficient and economic method of locating and diagnosing any trouble.

At some time, then, you may have an audio signal generator under construction, and in all probability you will use a circuit already tried successfully by someone else.

To avoid an embarrassed silence or an admission of lamentable ignorance when told: 'Of course, the output is pretty nearly sinusoidal,' I am going to briefly outline why it needs to be treated with respect.

brated in angles of degrees, 45°, 90°, and so on.

With the vector lying horizontally and pointing to the right, imagine the vector rotated until it is at an angle of 45° with the horizontal, that is, in the position shown. Projecting from the point C to the right until it meets a vertical line from the corresponding angle on the graph will give us the point D. Rotating the vector a further 45° to the vertical position and projecting again will enable us to plot another point E. When the vector has rotated through 360° and is in its original position, we will have plotted a number of points on the graph. By joining up these points we will have drawn the curve shown, which you will recognise as the sine wave.

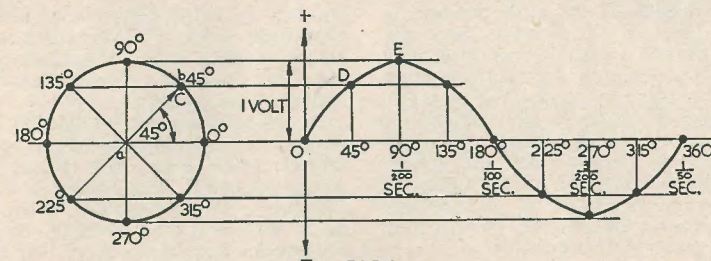

FIG. 1  
GEOMETRICAL PRODUCTION OF THE  
SINE WAVE

RC283

I am taking it for granted that the memory of maths, learned at school has degenerated into nothing more useful than a resolve to instil your sons with a more industrious attitude to the subject. At any rate, it is for this section of my readers that this article is intended.

On the right-hand side of Fig. 1 you will recognise a shape which has appeared many times before in this series. In almost any radio textbook it will crop up, or be referred to as the 'sine wave,' the author assuming that his readers know of what he is speaking.

The line AB in Fig. 1 is called a vector, and its length represents to some scale a current or voltage of, let's say, one volt. The base line on the right-hand side is cali-

### Why It is Important

At first sight the connection between radio and all this geometry and graph drawing may not be very obvious, but suppose we replace the vector by a coil of wire rotating in a magnetic field as shown in Fig. 2? As the coil rotates it will be cut by the magnetic lines of force existing between the poles, and a voltage will be induced into the coil. This voltage will not be constant for every position of the coil in the gap, however.

If we assume the lines of force to be parallel as in Fig. 2B, the coil will cut less lines of force per degree of rotation when it approaches the vertical position than when it approaches the horizontal. In our figure



it will only cut two lines for 30° of rotation as it approaches the vertical, but 6 lines for 30° of rotation as it approaches the horizontal. I want you to notice particularly that, as one side of the coil moves from proximity with one pole to the other, the induced voltage

768 c/s (two octaves above), and so on. It is the presence of these harmonics in varying proportions which give an instrument or voice its particular character; in fact, if all instruments produced pure sine waves they would be indistinguishable from one

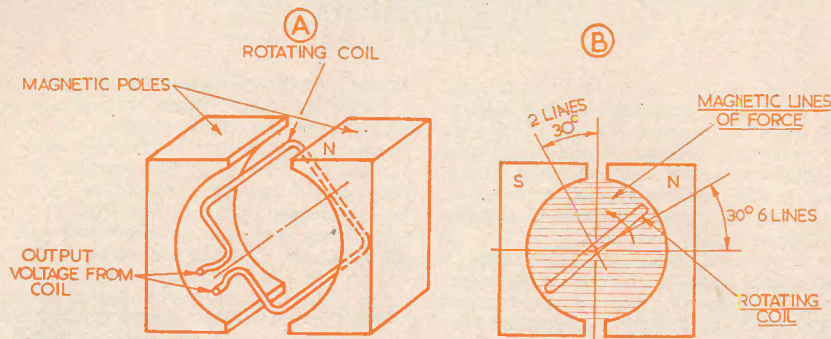

FIG. 2  
SIMPLE AC GENERATOR

RC284

will be reversed—from, say, positive to negative. Now, if the voltage from this coil were plotted vertically against angular movement on a graph, the resultant curve would be the same as the one in Fig. 1.

Fig. 2 is, of course, a very simple AC generator, complicated versions of which produce for us electric light and power. The engineers responsible for the design of these huge machines go to considerable trouble to ensure that the AC voltage from them is as sinusoidal as possible.

It is not merely a question of petty exactitude which gives this particular waveform such importance in scientific engineering. The reason is that the sine wave is the only waveform containing only one frequency. If our elementary coil of wire were rotated at 50 revs/sec, the frequency of the alternating current output would be 50 c/s because one complete wave would be produced by every revolution. This explains the other markings on the base line of Fig. 1. The degrees of rotation have been replaced by the time the vector has taken to rotate to any particular point, assuming that the rotational speed of the vector is constant. Now it can be shown that any waveform which departs from sine wave or sinusoidal shape contains harmonics. These are frequencies which are multiples of the main or fundamental frequency. For example, middle C in the musical scale has a frequency of 256 c/s and its second harmonic is  $2 \times 256 = 512$  c/s (an octave above middle C), and its third

another. In sound, therefore, non-sinusoidal waveforms are very important, and they are of interest in radio because amplifiers must be designed to reproduce them as accurately as possible.

In transmitters and oscillators, however, the story is very different. Consider a transmitter carrier tuned to 1 Mc/s. If some second harmonic were present in the carrier waveform, the transmitter would radiate on 1 Mc/s and (less strongly) on 2 Mc/s. This means that some of its power would be wasted in radiating an unwanted frequency, and one which would probably interfere with another transmitter.

Summing up, two apparently conflicting requirements must be met in radio. One, that amplifiers must be capable of handling non-sinusoidal waveforms without distortion, and two, that oscillators—except in special cases—must produce as nearly as possible a sinusoidal waveform. Incidentally, the oscillator described last month produces a very close approximation to the sine wave.

#### Measuring AC

We all know that measuring DC is a comparatively simple matter. We connect our meter and as the voltage or current being measured remains steady, the needle of the meter takes up a fixed position on the dial and stays there. But with AC, when we are measuring under different conditions, the subject becomes more complicated.

As we can see from Fig. 3, the voltage—

or current—is continually varying, so that, if the frequency were, say, 5 c/s, the needle of the meter would also vary five times a second. As the frequency is increased, however, the needle would not have time to follow rapid changes in the voltage or current.

We have assumed in the above remarks that we are always using a moving coil meter. However, if we were to use a rectifier to change AC to DC, and then apply it to a moving coil meter or, alternatively if we were to use a moving iron meter, the needle would take up a fixed position when the meter is connected to an alternating current or voltage.

I do not intend to go deeply into the subject of meters here, as it has been dealt with in an article by Mr. T. H. Robinson in the April number of the *Radio Constructor*.

The question we ask ourselves now is, what part of the alternating current waveform is the meter reading? Is it indicating the points A, B, C or D in Fig. 3? Obviously it cannot be A or C, as these are at zero. As was pointed out in Mr. Robinson's article, some meters read RMS values, some read average, and additionally some measure peak. The meaning of these terms may possibly be unknown to you.

We will start with the simplest—the peak value. As you might expect, in Fig. 3 this is 100V (point B), i.e. the maximum value to which the voltage rises from the datum line. The voltage then changes direction and begins to go negative, until it becomes -100V (point D) with respect to the datum line. So the actual voltage from the maximum at B to the minimum at D is 200V. This is called the peak to peak value. Peak values are important when considering insulation, as it is the maximum value to which the voltage rises.

Possibly the most mystifying term is RMS. Written in full this means root mean square. We will certainly not embark on an explanation of this peculiar term, as its derivation is mainly mathematical. Its significance is that, if an AC voltage of 100V peak is applied to a resistance of, say, 100 ohms, the power dissipated in the resistor would be the same as if a DC voltage of 70.7V were applied to the resistor of 100 ohms. In other words, the peak value of an alternating

current or voltage must be multiplied by .707 to give the RMS value, and the RMS value must be multiplied by 1.414 to give the peak value. In actual fact, .707 is equal to

$$\frac{1}{\sqrt{2}}$$

and 1.414 is equal to  $\sqrt{2}$ . The significance of RMS values can be realised by the fact that the mains voltage is always stated in RMS. Therefore, the peak value is 1.414 times this. So if your mains are 240V, the peak value is approximately 340V.

So far we have not mentioned the average value. The average value is .637 of the peak—so the average value of our 100V peak sine wave is 63.7V. Unfortunately, these figures—.707, 1.414 and .637—only apply to a truly sinusoidal waveform.

Normally voltmeters are calibrated in RMS. However, in some cases they actually read peak or average. To take a case in point, imagine that we are measuring the output voltage of an amplifier with a valve voltmeter, which actually measures peak but which is calibrated in RMS. If the output voltages were purely sinusoidal, the readings would be correct, but if distortion were occurring in the amplifier the peak value may not change very much but, due to the distortion, the RMS value may be quite different. The meter, therefore, would not be reading the true RMS value, and would not be giving a correct estimation of the amplifier performance. This is, of course, the advantage of an oscilloscope,

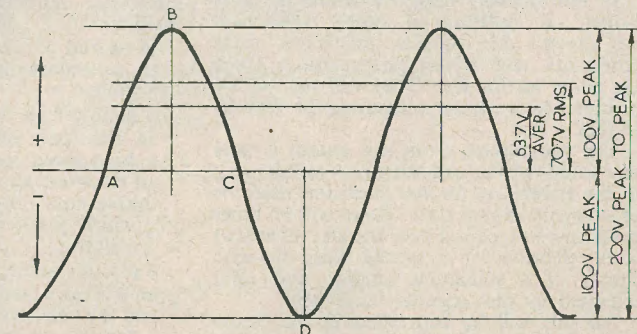

FIG. 3  
SINE WAVE VALUES

RC285

which draws a picture of the waveform, and if it is clearly non-sinusoidal, errors in measurement with meters can be detected.

Having briefly outlined this theoretical aspect of radio, we return next time to a more practical footing, and have a look at a TRF receiver.



# THE 20th NATIONAL RADIO SHOW

EARLS COURT - LONDON

September 1st—12th 1953

FOLLOWING THE VERY SUCCESSFUL television broadcasts of the Coronation which were seen "live" in four Continental countries and in the form of tele-recordings in many others, the British radio industry and the B.B.C. are intending to give, at the 20th National Radio Show, Earls Court, London, September 1 to 12, their best demonstration yet of how television programmes are rehearsed, photographed, transmitted and received. This will be of particular interest to visitors from countries starting or considering having a television service.

In the specially built TV studio at Earls Court, an audience of nearly 1,000 will see camera and lighting rehearsals, dress rehearsals, and actual performances which are going on the air. They will see the TV pictures on a screen measuring 21 feet by 16 feet.

The programme from this studio is only one source of the pictures which will be seen in the Exhibition on 400 television receivers of every make and size. There will be other programmes received over the air; interviews with celebrities on a special dais; one-man shows in a miniature studio; and films televised by film scanner equipment.

All this will be controlled in the Radio Industry Council Control Room—an exhibit in itself of considerable technical interest and entirely visible to visitors through its glass walls.

Television receivers, now made to any standard for export, will be seen on 36 manufacturers' stands and about 200 models will also be seen working side by side in what is known as "Television Avenue." Underwater TV will be demonstrated. There will be over 100 exhibitors in all, including manufacturers of components, valves and

batteries. Projection television receivers will be seen in the making. The Army and the Royal Air Force will stage large exhibits to show some of their latest equipment and the Ministry of Supply will show components of a guided missile. Other exhibits of technical as well as public interest, are the training display by five leading bodies, including King's College, University of London, and the B.B.C. Engineering Establishment.

A central feature of the Show will be a large three-face clock controlled by radio pulses from Rugby, and specially arranged electronic attractions in operation will include:

- Industrial X-ray equipment;
- an auscultoscope for testing heart and lungs;
- a large screen microscope;
- an electronic office message-sender;
- a high-speed sorter of beans by colour;
- an electronically controlled oxygen cutter;
- the National Physical Laboratory's machine which plays noughts and crosses with visitors;
- a plastics welder;
- an electronic stencil cutter;
- and the "electronic commissioner" which for the second year will greet foreign visitors in their own languages and give information about locations and times of demonstrations.

There will also be radio-controlled models of an army tank and an amphibious vehicle.

Tuesday, September 1, is preview day and is reserved for overseas visitors and other special guests, including Press. The Exhibition will be opened to the public on the following day, by Field Marshal Lord Montgomery.

## Alphabetical List of Exhibitors

	Stand No.
Aerialite Ltd. Castle Works, Stalybridge, Cheshire	79
AIR MINISTRY. Information Div., Whitehall Gardens, S.W.1	205
ALLEN RADIO LTD., RICHARD. Caledonia Road, Batley, Yorks.	85
AMBASSADOR RADIO (R. N. FITTON LTD.). Princess Works, Brighouse, Yorks	5
ANTIFERRENT LTD. 67 Bryanston Street, Marble Arch, W.1	53
ARGOSY RADIOVISION LTD. Argosy Works, Hertford Road, Barking, Essex	3
ASSOCIATION OF RADIO BATTERY MANUFACTURERS. 41 Gordon Square, London, W.C.1	99
AUTOMATIC COIL WINDER AND ELECTRICAL EQUIPMENT CO. LTD. Winder House, Douglas Street, S.W.1	15
Baird Television Ltd. Lancelot Road, Wembley, Middlesex	59
BALCOMBE LTD., A. J. 52 Tabernacle Street, London, E.C.2	101
BELLING AND LEE LTD. Cambridge Arterial Road, Enfield, Middlesex	202
BERNARDS (PUBLISHERS) LTD. The Grampians, Western Gate, W.6	232
BOOSEY AND HAWKES LTD. Electronics Division, Deansbrook Road, Edgware, Middlesex	209
BOWMAKER LTD. Bowmaker House, Lansdowne, Bournemouth	210
BRITISH BROADCASTING CORPORATION. Broadcasting House, London, W.1	200
BRITISH IRON AND STEEL FEDERATION. Steel House, Tothill Street, S.W.1	12
BRITISH RADIO AND TELEVISION. 92 Fleet Street, E.C.4	25
BRITISH RAILWAYS. Railway Executive, 222 Marylebone Road, London, N.W.1	2
BROWN BROS. LTD. Browns Buildings, Great Eastern Street, London, E.C.2	70
BULGIN AND CO. LTD., A. F. Bye-Pass Road, Barking, Essex	1
BUSH RADIO LTD. Power Road, Chiswick, W.4	74 & 97
Champion Elec. Corporation. Champion Works, Newhaven, Sussex	71
COLE LTD., E. K. Ekco Works, Southend-on-Sea, Essex	100
COLLARO LTD. Ripple Works, Bye-Pass Road, Barking, Essex	35
CO-OPERATIVE WHOLESALE SOCIETY LTD. Publicity Department, 99 Leman Street, London, F.1	6
COSMOCORD LTD. 700 Great Cambridge Road, Enfield, Middlesex	234
COSSOR LTD., A. C. Cossor House, Highbury Grove, N.5	90
Decca Record Co. Ltd. 1/3 Brixton Road, London, S.W.9	48
DOMAIN PRODUCTS LTD. Domain Works, Barnaby Street, N.W.1	13
DUUBLIER CONDENSER CO. (1925) LTD. Ducon Works, Victoria Road, North Acton, W.3	98
DYNATRON RADIO LTD. Perfecta Works, Ray Lea Road, Maidenhead, Berks	112
Econasign Co. Ltd. 92 Victoria Street, London, S.W.1	20
EDISON SWAN ELECTRIC CO. LTD. 155 Charing Cross Road, W.C.2	51
ELECTRICAL TRADES UNION. Hayes Court, West Common Road, Bromley, Kent	202
E.M.I. SALES AND SERVICE LTD. Head Office, Hayes, Middlesex	93 & 104
ELECTRONIC PRECISION EQUIPMENT LTD. Elpreq House, High Street, Wealdstone, Middlesex	222
ENGLISH ELECTRIC CO. LTD. Queens House, Kingsway, W.C.2	52
EVER READY CO. (G.B.) LTD. Hercules Place, Holloway, N.7	30
Ferguson Radio Corporation Ltd. 105 Judd Street, London, W.C.1	57
FERRANTI LTD. Hollinwood, Lancs.	49
Garrard Engineering and Manufacturing Co. Ltd. Newcastle Street, Swindon, Wilts.	103
GENERAL ELECTRIC CO. LTD. Magnet House, Kingsway, W.C.2	89
GOODMANS INDUSTRIES LTD. Axiom Works, Wembley, Middlesex	37
GRAMOPHONE CO. LTD. Head Office, Hayes, Middlesex	92
Hobday Bros. Ltd. 21/27 Great Eastern Street, E.C.2	96
HUNT (CAPACITORS) LTD., A. H. Bendon Valley, Garratt Lane, Wandsworth, S.W.18	88
Iliffe and Sons, Ltd. Dorset House, Stamford Street, S.E.1	45
IMHOF LTD., ALFRED. 112/116 New Oxford Street, W.C.1	211
INVICTA RADIO LTD. Parkhurst Road, Holloway, N.7	47
J. B. Manufacturing Co. (Cabinets) Ltd. 86 Palmerston Road, Walthamstow, E.17	27
J. G. PUBLICATIONS LTD. 56(a) Rochester Row, S.W.1	24
Keith Prowse and Co. Ltd. 159 New Bond Street, London, W.1	114
KERRY'S (GREAT BRITAIN) LTD. Warton Road, Stratford, E.15	38
KOLSTER-BRANDES LTD. Footscray, Sidcup, Kent	32
Linguaphone Institute Ltd. Linguaphone House, 207/209 Regent Street, W.1	19
LLOYDS BANK LTD. Premises Dept., 71 Lombard Street, E.C.3	84
LUGTON AND CO. LTD. 209/212 Tottenham Court Road, W.1	204
McMichael Radio Ltd. 190 Strand, London, W.C.2	34
MARCONIPHONE CO. LTD. Hayes, Middlesex	58
MASTERADIO LTD. 10/20 Fitzroy Place, N.W.1	46
MIDLAND BANK LTD. Premises Dept., Poultry, E.C.2	39
MULLARD LTD. Century House, Shaftesbury Avenue, W.C.2	91
MULTICORE SOLDERS LTD. Maylands Avenue, Hemel Hempstead, Herts.	111
MURPHY RADIO LTD. Welwyn Garden City, Herts.	31



	Stand No.
National Provincial Bank Ltd. Premises Dept., 15 Bishopsgate, E.C.2	23
NEWNES LTD., GEORGE. Tower House, Southampton Street, W.C.2	87
Odhams Press Ltd. Sales Promotion and Service Dept., 96 Long Acre, London, W.C.2	86
Pamphonic Sales Ltd. 400 Holloway Road, London, N.7	108
PETO SCOTT ELECTRICAL INSTRUMENTS LTD. Adlestone Road, Weybridge, Surrey	77
PETTER RADIO AND ELECTRICAL SUPPLIES. 201/209 Forest Road, Walthamstow, E.17	223
PHILCO (OVERSEAS) LTD. Romford Road, Chigwell, Essex	50
PHILIPS ELECTRICAL LTD. Century House, Shaftesbury Avenue, W.C.2	33
PILOT RADIO LTD. 31/37 Park Royal Road, N.W.10	56
PLESSEY CO. LTD. Vicarage Lane, Ilford, Essex	113
PORTOGRAM RADIO ELECTRICAL INDUSTRIES LTD. Priel Works, St. Rule Street, S.W.8	36
PYE LIMITED. Radio Works, Cambridge	76
Radio Gramophone Dev. Co. Ltd. Eastern Avenue West, Mawneys, Romford, Essex	94
REGENTONE RADIO AND TELEVISION LTD. Eastern Avenue West, Mawneys, Romford, Essex	60
REPRODUCERS (ELECTRONIC) LTD. 82 Great Portland Street, W.1	233
ROBERTS' RADIO CO. LTD. Creek Road, East Molesey, Surrey	11
ROLA CELESTION LTD. Ferry Works, Summer Road, Thames Ditton	8
RUDMAN, DARLINGTON (ELECTRONICS) LTD. Wednesfield, Staffs.	208
Simon Sound Service Ltd. 48 George Street, Portman Square, W.1	95
SLINGSBY LTD., H. C. 89/97 Kingsway, W.C.2	62
SOBELL INDUSTRIES LTD. Langley Park, Slough, Bucks.	55
STANDARD TELEPHONES AND CABLES LTD. Connaught House, Aldwych, W.C.2	81
STANDARD TELEPHONES AND CABLES LTD. (BRIMAR). Footscray, Sidcup, Kent	9
"THE STAR". 12/22 Bouverie Street, E.C.4	221
STELLA RADIO AND TELEVISION CO. LTD. Oxford House, 9/15 Oxford Street, W.1	72
Taylor Electrical Instruments Ltd. 419 Montrose Avenue, Slough, Bucks.	105
TELEGRAPH CONDENSER CO. LTD. Wales Farm Road, North Acton, W.3	107
TELEQUIPMENT LTD. 1319A, High Road, Whetstone, N.20	28
TELERECTION LTD. Antenna Works, St. Pauls, Cheltenham, Glos.	220
TELEVISION SOCIETY. 164 Shaftesbury Avenue, W.C.2	78
THOMPSON, DIAMOND AND BUTCHER LTD. 34 Farringdon Road, London, E.C.1	7
TRADER PUBLISHING CO. LTD. Dorset House, Stamford Street, S.E.1	63
TRIX ELECTRICAL CO. LTD. 1/5 Maple Place, Tottenham Court Road, W.1	16
TRUVOX LTD. Exhibition Grounds, Wembley, Middlesex	106
Ultra Electric Ltd. Western Avenue, Acton, W.3	73
UNITED APPEAL FOR THE BLIND. 204/206 Great Portland Street, W.1	201
Valradio Ltd. New Chapel Road, Feltham, Middlesex	207
VIDOR LTD. West Street, Erith, Kent	75
War Office. Directorate of Public Relations, War Office, Whitehall, S.W.1	206
WESTINGHOUSE BRAKE AND SIGNAL CO. LTD. 82 York Way, Kings Cross, N.1	54
WESTMINSTER BANK LTD. Premises Dept., 51 Threadneedle Street, E.C.2	10
WHITLEY ELECTRICAL RADIO CO. LTD. 109 Kingsway, W.C.2	109
WOLSEY TELEVISION LTD. 75 Gresham Road, Brixton, S.W.9	61
WRIGHT AND WEARE LTD. 138 Sloane Street, London, S.W.1	110
WAVEFORMS LIMITED. Radar Works, Truro Road, N.22	26
WHITE IBBOTSON LTD. 205 Station Road, Harrow	4
Demonstration Rooms and Offices	
COLE LTD., E. K.	D.14
COLLARO LTD.	D.6
CO-OPERATIVE WHOLESALE SOCIETY LTD.	D.28
COSSOR LTD., A. C.	D.13
DECCA RECORD CO. LTD.	D.26 and D.27
EDISON SWAN ELECTRIC CO. LTD.	D.8
E.M.I. SALES AND SERVICE LTD.	D.24
FERGUSON RADIO CORPORATION LTD.	D.3 and D.4
FERRANTI LTD.	D.25
GENERAL ELECTRIC CO. LTD.	D.9
GRAMOPHONE CO. LTD.	D.10
MARCONIPHONE CO. LTD.	D.23
MULLARD LTD.	D.7 and D.11
MULTICORE SOLDERS LTD.	D.16
MURPHY RADIO LTD.	D.1
PETO SCOTT ELECTRICAL INSTRUMENTS LTD.	D.5
PHILIPS ELECTRICAL LTD.	D.21
PLESSEY CO. LTD.	D.19
PYE LIMITED	D.29
TELEGRAPH CONDENSER CO. LTD.	D.12
TRUVOX LTD.	D.17
VIDOR LTD.	D.18
WHITLEY ELECTRICAL RADIO CO. LTD.	D.15

## PRE-SHOW NEWS

### PETTER RADIO and ELECTRICAL SUPPLIES

This firm has specialised in Radio Components and Accessories for the past twenty-five years, and hold stocks to fulfil almost every requirement of the trade. Included on their stand are the following:—  
Erie Resistors, Volume Controls (all makes), Electrolytics (over 70 different types), Aerials (including Television), all Belling-Lee components, Chokes, Coils, Condensers all types, Dials and Slow Motion Drives, Chassis, Earth Rods, Loudspeaker fabric, Fuses, Gramophone Motors, and Auto Changers, Amplifiers, Microphones, Pick-ups, Knobs, Meters, Signal Generators, Speakers, Spades, Plugs and Sockets, Screws and Nuts, Washers, Soldering Tags, Westinghouse Rectifiers, Sleeving, Solder, Solon Irons, Car suppressors, Toggle Switches, Transformers, B.V.A. Valves, and a host of other items too numerous to mention. *Wholesale only.*

### TELERECTION Ltd.

A fully comprehensive range of aerials, to meet the requirements of the most discriminating dealer and viewer alike, in any area of the United Kingdom, is exhibited by Telerection on their Stand No. 7, of almost 1,000 square feet, at the National Radio Show, September 1st to 12th 1953.

From the simple single dipole, with its ancillary equipment, to the absolute fringe aerial or horizontally polarised unit, the accent is on a substantially built and well-designed series to meet localised conditions coupled with a price range of particular interest.

The latest Telerection introduction, the "Paravex", the vertical counterpart developed from their "Paravex" horizontal aerial, which has met with such marked success in both the Pontop Pike and Belfast areas, brings British Television aerial design to a most advanced stage and proves that *British technical knowledge and inventiveness in this direction is unsurpassed anywhere else in the world.* This new aerial has a similar polar diagram in the vertical plane as that of the "Paravex" Horizontal in the horizontal plane and its acceptance angle is also 35° of the central line, with two null points either side which are very sharply defined. Forward gain is exceptional and signal to noise ratio shows a marked improvement on the conventional "H" or "X". This unique aerial has been specifically designed to counteract reflections from the side to the very highest degree, and matching is inherent in the design of the crossarm, thus maintaining the impedance of the aerial at 80 ohms.

The 4-element "Multimus" aerial has established itself as of outstanding design and construction for absolute fringe reception, its adjustable delta matching device enabling impedance to be varied to suit the special circumstances of location and receiver. This aerial operates perfectly with either co-axial or twin balanced feeder and, as with all Telerection aerials, no dissimilar metals are used in manufacture, thus eliminating all possible corrosion due to electrolytic action.

In near-fringe areas, the 3-element "8DBD" is ideal. This aerial also embodies delta matching to ensure maximum interference suppression and greatly improved signal to noise ratio.

For hilly or mountainous districts, the Telerection "Anti-Ghost" aerial has been specially produced to eliminate troublesome reflections. Of "double H" design, this aerial met with immediate success on its introduction at the 1952 Radio Show and now fulfils a consistent demand in both South Wales and Scotland. The standard  $\frac{1}{2}$  and  $\frac{1}{4}$  wave H Type aerials and single dipoles are designed and produced to the same high standards as the multi-array models. Equal importance is also attached to all Telerection fixings and mountings, each being specifically designed to give maximum serviceability under all conditions. Half-inch aluminium alloy elements are utilised for all aerials. Quality is therefore such that it meets the demand of the most critical and a planned production ensures a price range which is most competitive.

### DUBILIER CONDENSER Co. Ltd. (1925)

The DUBILIER Exhibits on Stand No. 98 are classified under the following headings:—  
Mica Capacitors

For use in Television, Radio, Radar and Electronic equipment, including moulded mica and silvered mica types.

#### Paper Capacitors

For all purposes connected with Television, Radio, Radar and Electronic equipment, including high voltage types and those specially designed for tropical applications.

#### Trimmer Capacitors

Ceramic dielectric.

#### Electrolytic Capacitors

An extensive range of high and low voltage types to meet every requirement, including the new miniature "Drilitic".

#### Fixed Resistors

A comprehensive selection suitable for Television, Radio, Radar and Electronic equipment, including the smallest insulated  $\frac{1}{2}$  watt resistor type BTS, Power Wire Wound, High Voltage, High Frequency, High Stability and Precision Wire Wound types.

#### Variable Resistors

Potentiometers, Volume Controls and Tone Controls in non-tropical, tropical and miniature types.

#### Television and Radio Interference Suppressors

Capacitors and filter units for use with domestic appliances, including 3-pin mains suppressor plugs. Filter units designed for tropical applications. A full range of Suppressor Chokes for industrial applications, including electric lift installations. Miniature capacitors and chokes in kit form specially designed for Television interference suppression.

### GOODMANS INDUSTRIES, Ltd.

The main feature of Stand No. 37, which will be of interest to the high fidelity enthusiast is the demonstration theatre that forms the centre section of the Goodmans display. In this theatre the General Public will be able to listen to selected recordings that serve to demonstrate the lead that the Goodmans Axiom and Audiom range of loudspeakers have in the world of good quality and high fidelity reproduction.

A popular theme that Goodmans Industries wish to express at this year's Radio Show is, should you have friends who may be interested in high fidelity reproduction then bring them along to the demonstration theatre. Alternatively, if your friends have a special recording they wish to hear, then bring it along to Stand No. 37 and subject to time available it will be recorded via the Axiom, Audiom range of loudspeakers.

Tickets for the demonstration theatre will be issued from Stand No. 37 during the period of the show, and for those interested, application to Goodmans Industries prior to the exhibition will enable a seat to be reserved at a particular demonstration.

The static display of Stand No. 37 will include:—  
Loudspeakers

A range of Permanent Magnet loudspeakers that includes the well known Audiom and Axiom series.

The registered trade name Audiom is applied to the wide range quality loudspeakers such as those that may be installed in high class Radiograms, P.A. Installations or Electronic Organs. Under this heading is the Audiom 60 (12"–15 watt), Audiom 70 (12"–20 watt), Audiom 80 (15"–25 watt) and Audiom 90 (18"–50 watt).

The high fidelity range—designated Axiom—includes the Axioms 150 Mk. II (12"–15 watt), Axiom 22 Mk. II (12"–20 watt), Axiom 101 (8"–6 watt), Axiom 102 (8"–6 watt).

#### Microphones

A recently developed low impedance moving coil microphone, Type Z/33, will have its debut at the Radio Show and will be on display for the first time.

The Z/33 has four main characteristics; namely the ability to be used as a hand microphone, desk,



pocket attachment (that leaves the hands free for control adjustments), or as a stand microphone by virtue of having a tapped hole ( $\frac{1}{2} \times 26$  T.P.I.) that will fit the majority of present day microphone stands.

The microphone can be used for general Public Address work, Sound dubbing on Cine Projectors, or for use with tape recorders. Its superior output and overall sensitivity compares favourably with crystal microphones without the disadvantages usually associated with that type of unit.

The general design of the Z/33 allows provision for an internal transformer for direct to Grid operation. Television (Permanent Magnet) Focusing Units;

A new type of Permanent Magnet Focusing Unit will also be displayed for the first time. This unit, which employs new features in picture focus and shift, is being used by all the leading British Television Manufacturers and is now available to the home constructor.

There are three constructions applicable to this design, Type 12/44, 14/44 and 16/44; all of which utilise the new Ferroxdure magnetic material that has the advantage of high resistivity, enabling the units to be positioned close to the deflector coil without affecting the performance of the set.

#### Transformers

Amongst the loudspeakers displayed will be a representative range of output transformers which will include the well known H6. The H6 is an outstanding 30 watt unit specially recommended for use with the Axiom 150 Mk. II and 22 Mk. II. This transformer can be wound to customers' specification.

#### Vibration Generators

A range of Permanent Magnet Vibration Generators will be on show amongst which will be:—

Model V/47 Force factor 0.9lbs/amp.

Model 390A Force factor 4.7lbs/amp.

Max. continuous current rating = 4 amps (with air cooling).

Model 790 Force factor 9.5lbs/amp.

Max. continuous current rating = 4 amps (with air cooling).

Model 8/600 Force factor 60lbs/amp on high impedance.

20lbs/amp on low impedance.

Max. continuous current rating with air cooling on high impedance = 4.2 amps.

On low impedance = 12.6 amps.

These instruments have a widening application in the field of Scientific Instruments for the investigation of Vibration Phenomena.

#### Public Address Equipment

Under this heading Goodmans Industries will be showing an Omni-directional Sound Diffuser Model CD/77. This unit houses a high flux P.M. 10" loudspeaker and has provision for an internal line transformer.

A smaller version of the CD/77, Type CD/66, has just been developed and will also be on show. This unit houses a high flux P.M. 6" loudspeaker. Also included in this section will be a 15 watt Pressure Unit Type T52.

#### BOOSEY and HAWKES Ltd.

A tape recorder of unique design is making its first appearance this year on the stand of Boosey and Hawkes Ltd., Electronics Division. It is called the Reporter and, as its name implies it was originally intended for journalists, but its small size and weight and complete independence of electric mains give it a very much wider range of application.

There is a choice of tape speeds—7 $\frac{1}{2}$ " per second for quality recordings (15 minutes spool duration) or 3 $\frac{3}{4}$ " for long-duration speech recordings (30 minutes). In both versions one winding of the spring motor gives a recording time of eight minutes.

The standard model with headphone playback weighs only twelve pounds but there is a de luxe model (thirteen pounds) with a small built-in loudspeaker (available in both 7 $\frac{1}{2}$ " and 3 $\frac{3}{4}$ " versions).

All models use standard torch cells for LT and 67 $\frac{1}{2}$  Volt HT batteries and the actual battery consumption cost is only about 4d an hour.

To do full justice to the inherent high quality of recordings, the tape can be played back on a con-

ventional mains-operated tape recorder; for example, the Boosey and Hawkes *Magnograph* which is also being exhibited.

#### WESTINGHOUSE BRAKE and SIGNAL Co. Ltd.

At this year's Radio Show, Westinghouse Brake and Signal Co. Ltd., will once again be showing a large number of Metal Rectifier units, representative of the many thousands of types this company markets.

Prominent in the display will be selenium rectifiers suitable for use in power supply circuits for radio and television, and these will be divided into two general categories. The first will be typical of those already in use in commercial sets, and designed to suit manufacturers requirements, whilst the second will be general types of interest to amateur and professional alike. The latter group includes popular units used in such circuits as "The View-Master," "The Universal" etc.

Also displayed will be the pencil type of extra high tension rectifiers, now familiar from their wide usage in television circuits, where they provide a cheap and reliable EHT supply. These pencil types are made in two ranges, offering maximum outputs of some 8KV at 2 or 8 mA according to type. In addition, a newly developed miniature range will be on view, having comparable performance at lower current ratings, and providing greater ease for wiring into circuit.

Rectifiers specially designed for use in high ambient temperatures, including those developed for Power Amplifier circuits, will be on view, along with the Type Approved units that have met the stringent requirements laid down by the Ministries. Copper-Oxide rectifiers for use with measuring instruments and the complete range of Germanium Crystal Diodes will be displayed, many of the latter being included in a demonstration television receiver showing how metal rectifiers can perform any normal valve-diode function. Two battery chargers and a wide selection of technical literature will complete the display, whilst qualified technicians will be in attendance to advise on the many and varied applications of metal rectification.

#### MULLARD Ltd.

Of particular interest to the public at the National Radio Show to be held at Earls Court, from September 1st to 12th will be the Information Centres that Mullard Ltd., are providing on Stand 91. Here expert advice on a wide variety of viewing and listening problems will be available free of charge. Mullard Ltd., are providing this service to meet the need for technical advice for the layman and the home constructor which has become apparent at the last few Radio Shows.

There will be three of these Information Centres. One will specialise in helping the prospective buyer in his choice of a set. Here he will be able to judge for himself the comparative merits of the various television picture sizes available and obtain useful guidance on such problems as correct viewing conditions and aerial installations.

Another Information Centre offers advice on the maintenance of receivers. The need for regular valve testing is given special emphasis, and the Mullard Electronic Valve Tester is there to demonstrate the efficient service now available in many radio stores and service departments throughout the country. The Valve Tester will be demonstrated to the Trade in Demonstration Room No. D7. On another part of the stand will be an amusing display designed to show with the aid of distorting mirrors the way in which worn-out valves can affect reproduction.

A third Information Centre is devoted to the problems of the Home Constructor. Several radio and television chassis incorporating Mullard valves and tubes are given prominent display. Information about designs suitable for home construction will be available on request.

Special features on the Mullard Stand will offer visitors a glimpse of the intricate precision work involved in the manufacture of valves and cathode ray tubes. Operators from one of the seven Mullard factories are to be seen assembling the electron gun for television tubes, while the assembly of a modern television valve is depicted in a specially produced filmlet which will be shown continuously.

A major exhibit on Stand 91 will be a selection from the comprehensive Mullard Range of domestic receiving valves and television picture tubes. Mullard "Long-life" picture tubes will be shown, which together with their associated range of "World Series" valves are incorporated in many of this season's television models. Valves for use in mains and battery-operated receivers, car radio, public address equipment, sound-on-film equipment, and hearing aids will also be shown.

#### THE TELEVISION SOCIETY—Stand No. 220

The Television Society will exhibit their 405-line experimental transmitter which is being installed at the Norwood Technical College later this year for educational purposes and for the use of members wishing to gain experience on ultra-short-wave reception. The vision carrier is 427 Mc/s and the sound carrier 423.5 Mc/s. An adapter for reception on standard television receivers will also be shown.

In addition a number of reprints and booklets on television engineering will be available, with copies of the Society's *Journal*.

Membership of the Society is open to all interested in television engineering, and full particulars can be obtained from the members and staff in attendance.

Hon. Secretary: G. Parr, M.I.E.E., 164 Shaftesbury Avenue, W.C.2.

#### T.C.C. Co. Ltd.

Although the T.C.C. exhibit on Stand 107 will display many familiar ranges of paper, mica, ceramic, plastic and electrolytic condensers, the emphasis will be on the progress made during the past year, the results of which are summarised here.

In the Paper Dielectric class, the new High Voltage Smoothing Condensers Types 561-3 will be of especial interest to television designers. Their unique construction is exemplified by the absence of metal parts at the high potential end. Improved performance and reliability at high temperatures are the benefits gained by using "Visconol-X" Impregnation for "Metalpack" and "Metalmit" Tubulars, which will now operate at 100°C. without voltage de-rating.

In the Electrolytic class interest will certainly focus on the new range of Sub-Miniature Tubulars, which are believed to be the smallest of their kind ever made. These condensers are a noteworthy step forward in the design of miniature components for use in hearing aids and with transistors. Higher ratings and improved performance have also been achieved in the new "Picopack" Tubulars to which has been added a new range for operation at 85°C. The Type 928 Chassis Mounting Electrolytic is outstanding in that here for the first time is an 800V electrolytic condenser which can be used instead of a paper condenser at this voltage, in rectifier units.

In the Ceramic class, three new types have been added: the High Voltage Tubulars for use in line timebase circuits for large screen TV receivers, the Small Capacity Close Tolerance Tubulars for top end coupling in band-pass filters, and the Close Controlled Temperature Co-efficient Tubulars set in "Plimoseal" for use in oscillator and IF circuits.

Once again T.C.C. are featuring one of their highly specialised machines, an Automatic Mica Laying Machine. Designed and made at the Acton Factory, this machine will lay-up stacked mica plates of all sizes from 1" x 11/16" to 2 $\frac{1}{2}$ " x 2" at the extraordinary rate of 4500 micas per hour. The number of micas required for each plate is pre-set mechanically, and the largest number that can be laid-up in one plate is 50. These plates are used in the Transmitter Type H.F. Condensers. In order that visitors may follow the sequence of actions more easily, and so appreciate the ingenuity of this machine, the running speed has been reduced to one-fifth of normal.

#### MULTICORE SOLDERS

On Stand 111 in the centre section of the National Radio and Television Show, Earls Court, in conjunction with Philips Mitcham Works, Multicore Solders will be displaying what is claimed to be the first ever public demonstration of the wiring and soldering of sub-assemblies used in the Philips Projection Television Receiver.

# SEE . . .

## The "Orpheus" Tape Recorder

to be described in future issues of this magazine, which will be on display at

THE GENERAL ELECTRIC CO.'s DEMONSTRATION STAND, D9.

## The "Universal" Large Screen AC/DC Televisor

now being described, which can be seen on the main

MULLARD STAND, 91

The units being constructed by the skilled operatives from Philips works will be returned each evening to Mitcham Works for tests and will be later incorporated in the Philips model 6027A Receiver.

It is estimated that more than 25,000 soldered joints will be made during the run of the Show, using standard factory size 7lb reels of Ersin Multicore.

Seen for the first time at a National Radio Exhibition will be the new Multicore Tape Solder which melts with the aid of an ordinary match.

Of particular interest will be the Ersin Multicore T.L.C. alloy, a special low melting point alloy used for certain defence contracts. The melting point is 145°C., more than 40° below that of the conventional tin/lead alloys and not many degrees above the melting point of the flux which is contained in the three cores. At the reverse end of the scale is Ersin Multicore Comsol alloy incorporating silver, with the comparatively high melting point of 296°C., shown for the first time at a National Radio Exhibition. Other new special types of Ersin Multicore Solder will be exhibited for technical engineers and research chemists of Electronic Manufacturers.

For workshops, and servicing organisations where a larger or more economical quantity of solder is required, the R5018 is recommended. This is a 1lb reel containing approximately 167 feet of 18 s.w.g. 50/50 alloy and retails at 15/-. This pack was specially designed in response to numerous requests from dealers and smaller engineering concerns.

Service Engineers will also be interested in the various Size 1 cartons of Ersin Multicore Solder available in 4 specifications, retailing at 5/- each.

Ersin Liquid Flux, for dipping purposes and other processes where it is not convenient to use Ersin Multicore Solder, is shown in 10oz tins. It is also supplied in 1gallon cans and 5gallon drums.

Ersin and Arax Solder Slugs and Pellets, rings and preforms, in a wide range of sizes and in standard tin/lead alloys are included on the Multicore Stand. Claimed to be more economical in certain soldering operations, the "shapes" are available with or without flux cores.

Arax Multicore, a cored solder wire with a washable flux residue, is also displayed on the Stand in similar specifications to Ersin Multicore.



# DATA publications

LIMITED

57 MAIDA VALE LONDON W9

Telephone CUNningham 6518

## ORDER FORM

Please supply the following

	Price	Postage	No.
<b>DATA BOOK SERIES</b>			
D.B.4. INEXPENSIVE TELEVISION . . . . .	2/6	2d	<input type="checkbox"/>
D.B.5. T.V. FAULT FINDING . . . . .	5/-	3d	<input type="checkbox"/>
D.B.6. THE RADIO AMATEUR OPERATOR'S HANDBOOK . . . . .	2/6	2d	<input type="checkbox"/>
D.B.7. RECEIVERS, PRESELECTORS AND CONVERTERS. . . . .	2/6	2d	<input type="checkbox"/>
D.B.8. TAPE AND WIRE RECORDING . . . . .	2/6	2d	<input type="checkbox"/>
<b>MISCELLANEOUS BOOKS</b>			
WORLD RADIO HANDBOOK . . . . . (Johansen)	8/6	3d	<input type="checkbox"/>
HOW TO LISTEN TO THE WORLD RECEIVERS . . . . . (Johansen)	1/9	3d	<input type="checkbox"/>
RECEIVERS . . . . . (R.S.G.B.)	3/6	2d	<input type="checkbox"/>
SIMPLE T X EQUIPMENT . . . . . (R.S.G.B.)	2/-	2d	<input type="checkbox"/>
T.V. PICTURE FAULTS . . . . . (T.V. Times)	3/6	3d	<input type="checkbox"/>
THE RADIO AMATEUR'S REPORT PAD (Data Publications)	3/6	3d	<input type="checkbox"/>
<b>MAGAZINES</b>			
THE RADIO CONSTRUCTOR . . . monthly . . . . .	1/6	2d	<input type="checkbox"/>
" " " " 6 months sub. . . . .	9/-	paid	<input type="checkbox"/>
" " " " 12 months " . . . . .	18/-	paid	<input type="checkbox"/>
THE RADIO AMATEUR . . . monthly . . . . .	1/6	2d	<input type="checkbox"/>
" " " " 6 months sub. . . . .	9/-	paid	<input type="checkbox"/>
" " " " 12 months " . . . . .	18/-	paid	<input type="checkbox"/>

PLEASE TICK SUBSCRIPTIONS REQUIRED AND STATE FIRST ISSUE BELOW

Enclosed find Cheque/Postal Order/International Money Order £.....

NAME ..... PLEASE  
USE  
ADDRESS ..... BLOCK  
CAPITALS

ALL OUR PUBLICATIONS ARE AVAILABLE THROUGH  
YOUR LOCAL NEWSAGENT

TRADE TERMS AVAILABLE ON REQUEST

PLEASE CUT HERE

## SCOTTISH INSURANCE CORPORATION LTD.



62-63 CHEAPSIDE  
LONDON, E.C.2.

### TELEVISION SETS AND SHORT WAVE TRANSMITTERS

Television Sets and Short Wave Transmitters/Receivers are expensive to acquire and you no doubt highly prize your installation. Apart from the value of your Set, you might be held responsible should injury be caused by a fault in the Set, or injury or damage by your Aerial collapsing.

A "Scottish" special policy for Television Sets and Short Wave Transmitters/Receivers provides the following cover:—

- (a) Loss or damage to installation (including in the case of Television Sets the Cathode Ray Tube) by Fire, Explosion, Lightning, Theft or Accidental External Means at any private dwelling house.
- (b) (i) Legal Liability for bodily injury to Third Parties or damage to their property arising out of the breakage or collapse of the Aerial Fittings or Mast, or through any defect in the Set. Indemnity £10,000 any one accident.
- (ii) Damage to your property or that of your landlord arising out of the breakage or collapse of the Aerial Fittings or Mast, but not exceeding £500.

The cost of Cover (a) is 5/- a year for Sets worth £50 or less, and for Sets valued at more than £50 the cost is in proportion. Cover (b) (i) and (ii) costs only 2/6d. a year if taken with Cover (a), or 5/- if taken alone.

Why not BE PRUDENT AND INSURE your installation—it is well worth while AT THE VERY LOW COST INVOLVED. If you will complete and return this form to the Corporation's Office at the above address, a proposal will be submitted for completion.

NAME (Block Letters) .....  
(If Lady, state Mrs. or Miss) .....  
ADDRESS (Block Letters) ...../JB

**UNISELECTORS.** Minor type. 2 banks of 10 contacts will operate from 24v or 12v with slight adjustment, has electro-magnetic release when wipers reach end of the bank. Resistance of drive coil 50 ohms, release coil 70 ohms. These are ideal for sequence switching, model radio control, telephone exchanges, etc. Used but new condition. 25/- Post 1/6.

**ADMIRALTY TYPE SWITCHES** Containing heavy duty terminal strip two resistances. P.O. type indicator lamp holder with red glass and 10 amp 2 pole on/off switch. Contained in metal box approx. 4½"x2" deep. 3/- each, postage 1/3. New and boxed.

**ROTARY CONVERTER.** 11 volt input, 250 volt at 150 m/amps D.C. output, fitted with chokes, condensers for smoothing, and contained in a sound-proof metal case, 18"x1"x8" deep, including lid, case black crackle, similar to an attache case, with controls and plugs brought out to side of case. New condition. Price 50/-, carriage 7/6.

**PRESSURE HEADS.** 12 volt. Suitable for use as immersion heaters. Will operate off car battery. New and boxed 3/- Postage 1/3.

**INDICATOR LAMP HOLDERS.** Nickel plated. Approximately ¾" diameter bezel. Takes ordinary screw-in type lamps. Illuminated numbers. Set of 10 separate lamp holders with numbers '0' to '9' 12/6. Postage 1/6.

**SMALL CHASSIS** 4½"x8½"x1½". Drilled for 3 valves. Volume control switch, etc. Price 2/6. Post 11d.

26 Page List No. 10 now available. Price 6d. inland. 2/- overseas air-mail.

**A. T. SALLIS**

93 NORTH ROAD BRIGHTON SUSSEX

### THE COMMANDER

The complete kit to build a 3-valve plus rect. TRF. receiver, housed in an attractive walnut cabinet size 12"x5"x7". Medium and Long Waveband coverage, with illuminated dial, and for use on 200/250v AC mains. Price £5-19-6. P & P 2/6. Supplied completely built and tested. Price £7-3-6. Carr. & Packing 4/-.

Cabinet as above, or Bakelite (Walnut or Ivory) complete with—Dial, Backplate, Drum and Drive Spindle, Cord, Spring, Punched Chassis and 2 Chassis Brackets. Price 28/6. P & P 2/6.

### THE BAFFLETTE

Receiver as above, but in a superior table baffle cabinet, beautifully grained and polished. Baffle area size 17"x11½". Illuminated dial 7"x2" with transverse pointer. THIS IS A REALLY OUTSTANDING CABINET. Complete kit—Price £7-3-6. P & P 4/-.

Supplied completely built and tested. Price £8-7-6. Carr. & Packing 4/-.

Baffle cabinet complete with—Chassis, 2 Chassis Brackets, Scale, Scale Pan, Drive Spindle, Drive Drum and Spring, Transverse Pointer, 3 Idler Pulleys (with rivets), 5 Back Screws and Cup Washers and 2 P.K. Chassis Screws. Price 48/6. P & P 2/6.

Component price list available—S.A.E.

Post orders only to

**J. L. ROBINSON**

CARAVAN SITE  
COMPTON BASSETT, CALNE, WILTS.



## ELECTROLYTIC CONDENSERS

8 mfd. 450 v.v. . . . .	1/9	16+16 mfd. 500 v.v. . . . .	4/6
8 mfd. 500 v.v. . . . .	2/3	16+32 mfd. 450 v.v. . . . .	4/9
16 mfd. 350 v.v. . . . .	2/3	32+100 mfd. 450 v.v. . . . .	7/6
16 mfd. 500 v.v. . . . .	3/3	60+100 mfd. 350 v.v. . . . .	7/6
32 mfd. 500 v.v. . . . .	5/11		
50 mfd. 350 v.v. . . . .	4/6		BIAS
50 mfd. 500 v.v. . . . .	3/6	25 mfd. 25 v.v. . . . .	1/6
60 mfd. 350 v.v. . . . .	4/11	50 mfd. 12 v.v. . . . .	1/3
250 mfd. 350 v.v. . . . .	3/11	50 mfd. 50 v.v. . . . .	1/9
8+8 mfd. 450 v.v. . . . .	4/6	75 mfd. 12 v.v. . . . .	1/-
8+16 mfd. 500 v.v. . . . .	2/6		
12+12 mfd. 350 v.v. . . . .			

ALL BRAND NEW AND GUARANTEED (NOT EX-GOVT.)  
All other types, Paper, Tubular, Waxed, etc., in stock

### SPECIAL C.R.T. OFFER

Brand new and unused 12in ion trap cathode ray tubes. 6.3 volt heater, 7-9 Kv. E.H.T. 35 mm neck. Black and white picture.  
By Famous Manufacturer

PERFECT £12/19/6  
Carriage and insurance 15/- per tube extra.

### GERMANIUM CRYSTAL DIODES

2/3 each

### ANTENNA ROD SECTIONS

Steel, sprayed khaki. Each rod 12in long, 3/4in diam. Any number can be fitted together. 2/6 per doz. 6/- three doz. POST FREE.

### VCR97 C.R. TUBES

New unused. 35/- Carriage 5/-.

### EHT Transformer

For VCR97. 45/-.

### SCREEN ENLARGER

For VCR97. Filter type, 17/6. Postage 2/6.

### E.H.T. Condensers

.1 mfd. 3Kv. . . . . 3/6  
.1 mfd. 2.5 Kv. . . . . 2/6

### MICROPHONE STANDS

Table model. 2-section chrome plated. Crackle finish base. . . . . 17/6  
Floor model. 2-section. Brass, heavily chrome plated. . . . . 69/6  
Carriage 2/6 extra

### SOLO SOLDERING IRONS

220-250 volts. Latest model instrument iron. . . . . 19/8  
Standard model. . . . . 19/-

### SPECIAL BRAND NEW T.C.C. T.V. CONDENSERS

32+100 mfd. 450 v.v. Type CE15PE . . . . . Price 7/6  
.04 mfd. 12.5Kv. Type CP59VO. . . . . Price 7/6

### LARGE SCREEN T.V.

Every component in stock for the Magnaview, Tele-King, Viewmaster and Universal television receivers, including all cathode ray tubes and valves.

### 9 INCH TABLE T.V. CABINETS

Medium shade mahogany finish. Complete with back, safety glass, speaker-fret. Internal dimensions: 19 1/2in high, 16in wide, 14in deep. LASKY'S PRICE 39/6. Carriage 7/6 extra. Adapter frame available for 6in c.r. tubes. The aperture can easily be enlarged for 12 or 14in c.r. tubes.

### A.C. MAINS GRAM MOTORS — Synchronous

For use on 200-250 volts, 50 c.p.s. Rim and belt drive type. 9/6 each. MANY USES.

### PORTABLE TAPE RECORDER CABINETS

Strong wood construction, finished in attractive cream covering, with carrying handle and two chrome plated locks. Hinged lid. Internal dimensions: 15in long, 10in wide, 7in high. Soiled condition. LASKY'S PRICE 25/- Carriage 5/- extra.

### DINGHY AERIALS WITH REFLECTORS

Umbrella type, with wire mesh reflector. Complete with setting up instructions. Mast not supplied. LASKY'S PRICE 7/6. Post 1/6.

### TANNOY PRESSURE UNITS

10 watts. 7.5-ohms impedance. Last few only. Price Reduced to 59/6. Carriage 3/6 extra.

Lasky's (Harrow Road) Ltd. 370 HARROW RD  
PADDINGTON LONDON W9

(Opposite Paddington Hospital) Telephones CUNningham 1979 and 7214. All Departments.  
Hours Mon. to Sat. 9.30 a.m. to 6 p.m., Thurs. half day 1 p.m.

MAIN ORDER & DESPATCH DEPARTMENTS 485/487 Harrow Road Paddington London W9  
Terms Pro Forma, Cash with Order, or C.O.D. on post items only. Postage and packing on orders value £1—1/- extra, £5—2/- extra, £10—3/6 extra. Over £10 carriage free. All goods fully insured in transit.



## SMALL ADVERTISEMENTS

Readers' small advertisements will be accepted at 2d per word, minimum charge 2/-. Trade advertisements will be accepted at 6d per word, minimum charge 6/-. If a Box Number is required, an additional charge of 1/- will be made. Terms: Cash with order. All copy must be in hand by the 12th of the month for insertion in the following month's issue.

### PRIVATE

FOR SALE—Qualtape Deck fitted with three motors and two Audigraph High Impedance Heads, £9. Ex. A.M. 3" Oscilloscope (not conversion) £15. Hilliard, 16 Sharnan Avenue, Lytham St. Annes, Lancs.

FOR SALE—Four VCR97, £1 each. Two Magnifiers, 12/6 each. Mask 3/6. Valves—2 at 6AC7, 10/-; 2 at 6SN7, 10/-; 5 at SP61, 15/-, all unused. EHT Transformer 2.5 kV, 27/6. Two 0.1 ufd 2.5 kV, 4/6. Caxtons Modern Radio and Television 3 Vols., Data Book as new 50/-. Whitehead, 92 Seymour Road, Trowbridge, Wilts.

FOR SALE—VCR97, new, picture tested. Magnifier, Mask and Base. 14 at J50's, 0.1-0.02 High Voltage capacitors. Offers—HAR 5096. P. Connell, 37 Toorack Road, Wealdstone, Middx.

FOR SALE—Rx R208, fine trim £10. Indicator Unit in good order, 25/-. Lots of really friendly junk for disposal, callers welcomed. G2AWJ, Coldwaltham Vicarage, Pulborough, Sussex.

MCR1—Miniature Communications Superhet, 19-2000 metres, AC/DC, Power Pack, Coils, IS4 Output, perfect £7 10s 0d. WS18—Tx/Rx—with accessories, Mk. III, perfect £4. Brigham, Farneth, Catisfield, Fareham, Hants.

TV BARGAIN—Two R1355 Vision/Sound Receivers. RF25 and RF26 Units, converted to channels 2 and 4. VCR97 tube, power pack and time bases. All in perfect working order, offered, together with partly completed cabinet, for £17. Free delivery, under 50 miles, by car. Maloney, 33 Balfour Road, Preston.

VIEWMASTER COMPONENTS Holme Moss £10, cost £15. AVO Valve Tester £9. All Wave Signal Generator £6 10s 0d. Williams, 7 Chapel Street, Portmadoc, Caerns.

### CATHODE RAY TUBES MASKS

New aspect ratio.

9in cream . . . . .	7/-
10in Double D. . . . .	7/6
12in . . . . .	15/-
12in Flat face . . . . .	15/-
12in Old ratio . . . . .	9/6
14in Rect. . . . .	21/-
16in Double D. . . . .	25/-
17in Rect. . . . .	21/-
12in Soiled . . . . .	7/6
12in Soiled, Cream, with safety glass . . . . .	11/6
12in Soiled, Black, with safety glass . . . . .	8/6

### 15 INCH CATHODE RAY TUBE MASKS

No. 1. Cream rubber. Latest aspect ratio. Overall dimensions: 17in wide, 13in high. Price 17/6. Postage 2/- extra.

No. 2. Plastic, incorporating gold finish tube escutcheon, and dark screen filter. Latest aspect ratio. Overall dimensions 15in wide, 12in high. Price 21/-. Postage 2/- extra.

### ARMOUR PLATE GLASS

15in Actual size, 18 1/2in x 19 1/2in x 3/8in. 12in Actual size, 13in x 10 1/2in x 1/2in. 9in Actual size, 9in x 8in x 1/2in. 3/-.

### DARK SCREEN FILTERS (LATEST TINT)

18 x 14 1/2in . . . . . 25/-  
14 1/2 x 12 1/2in . . . . . 19/6  
13 1/2 x 11in . . . . . 14/11

### RECORD PLAYING DESKS

Sloping steel table, grey crackle finish, size—10" high, 15" deep, 19" wide. Complete with pick-up and centre spindle drive Collaro motor, adjustable speed, also 10" turntable. For use on 200-250 volt 50 c.p.s. mains. BRAND NEW. LASKY'S price 79/6d. Carriage 7/6 extra.

### PERSPEX

13 1/2in x 10 1/2in x 1/2in. Natural shade, slightly marked. 4/11 per piece.

# HENRY'S

5 HARROW ROAD LONDON W2

Open Mon. to Sat. 9—5.30 (Thurs. 1 p.m.)  
Telephone PAD 1008/9 and 0401

### SPECIAL VALVE OFFER

Ten EF50 Brand New (Ex-Units) 55/- set or 6/- each  
SET OF 5 MAINS VALVES  
6K8CT, 6K7GT, 6Q7G, 5Z4, 6V6G or KT61 at 42/6 Set  
SET 5 AC/DC VALVES  
6K8GT, 6K7G, 6Q7G, 25A6G, 25Z6G at 42/6 Set.  
SET 5 AC/DC VALVES  
6A7G, 6D6, 6C6, 43, 25Z5 at 42/6 Set.  
SET 5 AC/DC VALVES  
12K8GT, 12K7GT, 12Q7GT, 35Z4GT, 35L6GT or 50L6GT at 42/6 Set.  
SET 5 AC/DC VALVES  
12SA7GT, 12SK7GT, 12SO7GT, or 12SR7GT, 35Z4GT, 35L6GT or 50L6GT at 42/6 Set.  
SET OF 4 BATTERY MINIATURE 1.4v. VALVES  
IR5, IS5, IT4, IS4 or (3S4 or 3V4) at 32/6 Set.  
SET OF BATTERY VALVES 2 volt MAZDA TYPES  
TP25, HL23/DD, VP23, PEN25 or QP25 at 27/6 Set.  
WE HAVE OVER 10,000 EX-GOVT. AND BVA VALVES IN STOCK AT VERY LOW PRICES  
LET US HAVE YOUR REQUIREMENTS.

L.T. RECT'S.  
6v. 1 amp G.E.C. . . . . 4/-  
12v. 2 1/2 amp. Westinghouse . . . . . 12/6  
12v. 4 amp. S.T.C. . . . . 17/6  
12v. 8 amp. S.T.C. . . . . 32/6

S.T.C. RECT'S. E.H.T.  
K3/25 650v. 1 m/a. . . . . 4/7  
K3/40 1000v. 1 m/a. . . . . 6/-  
K3/100 8,500v. 1 m/a. . . . . 14/8  
K3/200 10,500v. 1 m/a. . . . . 26/-

H.T. RECT'S.  
S.T.C. 150v. 120 m/a. . . . . 4/6  
S.T.C. 250v. 250 m/a. . . . . 18/6  
G.E.C. 1 m/a Meter Rect. . . . . 11/-

RECEIVER R1355. As specified for Inexpensive Television. Complete with 8 Valves VR65 and 1 each 5U4G, VUI120, VR92. Only 55/- carriage 7/6. Brand new in original case.  
RF24 25/-, RF25 25/-, RF26 59/6, RF27 59/6.

CATHODE RAY TUBES  
VCR97. Guaranteed full picture 40/-, carriage 2/-.  
VCR517. Guaranteed full picture 40/-, with Mu-Metal 3BP1 Suitable for scopes 25/-, carriage 3/- Screen. Mu-Metal Screens 10/-, 6" Enlargers 17/6.

PYE 45 Mc/s STRIP. Type 3583 Units. Size 15"x8"x2". Complete with 45 mc/s Pye Strip, 12 valves 10 EF50, EB34 and EA50, volume controls and hosts of Resistors and Condensers. Sound and vision can be incorporated on this chassis with minimum space. New condition. Modification data supplied. Price £5, carriage paid.

INDICATOR UNIT TYPE 182A. This unit contains VCR517 Cathode Ray 6" Tube, complete with Mu-Metal Screen, 3 EF50, 4 SP61 and 1 5U4G valves, 9 wire-wound volume controls and quantity of Resistors and Condensers. Suitable either for basis of Television (full picture guaranteed) or Oscilloscope. Offered BRAND NEW (less relay) in original packing case at 79/6. Plus 7/6 carriage.

VCR517C BLUE AND WHITE 6 1/2in. TUBE  
This Tube replaces the VCR97 and VCR517 without alteration and gives a full Blue and White picture. BRAND NEW in original crating, 45/-, plus 2/- carriage.

"WEYMOUTH" 3-WAVE BAND COIL PACKS  
Short, Med. and Long with Gram. Switch. Brand New Miniature type complete with circuit, 19/6. P.P. 1/6 Absolute bargain.

SEND 3d. FOR 28-PAGE CATALOGUE

continued on page 119



## Kendall and Mousley

Electronic Engineers and  
Laboratory Equipment Manufacturers

99 DUDLEY PORT, TIPTON, STAFFS.

Instrument cases in 18G steel, complete with light alloy front panel Colours Black (Red and Green 10 per cent extra). Back punched for ventilation. 8"x9"x8" at 18/-, 10 1/2"x12"x10 1/2" at 21/- Chassis to suit 7" square by 2 1/2" deep (16G Light alloy, four sides) 7/6. Chassis to suit 10" square by 2 1/2" deep (16G Light alloy, four sides) 10/6. Heavier steel case in 20G steel complete with 18G alloy front panel, finished in Black (Red or Green 10 per cent extra). Back punched for ventilation, 9"x12"x9" at 30/-, chassis for same 10"x8"x2 1/2" (reinforced corners) at 10/6 each. Case complete with chassis and panel £2.0.0. Meter stands, ends only, 2/6 per pair, panel for same 6" square at 1/9, 9"x6" at 2/6 and 12"x6" at 3/3. Meters can be mounted at extra cost if required. A full range of components, by well known manufacturers, are stocked, Mullard, Brimar, Cossor, T.C.C., Dubilier, Erie, R.E.P., Wearite, Elstone, Morganite, etc. High stability 1, 2 and 5 per cent resistors available from stock or to order.

**Metal Rectifiers.** 250V 60mA H/W 6/6; 250V 250mA H/W 12/6; 12-24V 3A H/W 4/6; 12/24V 3A F/W 12/-; 12-24V 4A F/W 14/-.  
**Polystyrene B7G Holder** with Can, set of 4, 6/-.  
**Earphones.** 4000Ω 12/6 per pair.  
IT4, IR5, IS5, 354, set of 4, 32/-.  
**Linecord.** .3A. 3-way 60-70Ω 2p. foot, 1/9 per yard.  
**Co-Ax Cable.** 70-80Ω per foot, 1/- per yard.  
**Radio Cabinet.** Size 12x7x5 inch in Walnut (wood) or brown (Bakelite) complete with punched chassis, Dial (Med. and Longwave) backplate, drum drive and pointer, £17/6.  
**Cable & Wire Stripper.** Ideal Tool for home and Workshop, Price 5/6.  
**Hundreds of Bargains in Radio and TV Components.**

Send for List. Callers Welcome. Please add Postage.  
**JACKSON'S RADIO SUPPLIES**  
163 EDGWARE ROAD LONDON W.2

## ADCOLA (Regd. Trade Mark) SOLDERING INSTRUMENTS



Reg. Design No. 860302 (British, U.S. and Foreign Patents)

Designed for wireless assembly and  
Maintenance

Supplied for all volt ranges from 6/7v to 230/250v  
3/16" Dia. Bit Standard Model 25/6

Sole Manufacturers  
**ADCOLA PRODUCTS LTD.**

Sales Office and Works Cranmer Court,  
Clapham High St. London SW4 (MAC 4272)

**CORONATION QSL'S**  
why not send a distinctive QSL this year?  
Special designs to celebrate Coronation Year,  
available from G6MN who has supplied 'special'  
QSL's for discriminating users all over the world.  
Attractive "Coronation-1953 designs now available  
from  
**G6MN Castlemount Workshop Notts.**

**VALVES—OVER 3,000 IN STOCK**  
12AU7, 12AT7, 6BW6, 6CH6, 6BE6, 6SN7, 807,  
6V6, 9/, EF91, EC91, EL91, 6J6, 6SJ7, 12AX7 7/6.  
6C4, 6J5, 6N7, 6J7, EF92, EAC91 6/-.  
**A. A. W. SKILLMAN**  
74 FRANCHISE STREET WEYMOUTH

**ASTOUNDING BARGAINS!**  
**VIBRATOR PACKS 6V to 230V 100mA £3.0.0.**  
**"TELE" ROTARY CONVERTER DC 230V**  
to AC 230V £12.10.0  
**R132 Receiver 90-140 MC with Valves £4.10.0.**  
**10 WATT P-A Amplifier 4 Valves £7.0.0.**  
**6 WATT P-A Amplifier 4 Valves £5.0.0.**  
**EDDYSTONE PREWAR 14 MC to £10.0.0.**  
600 KC  
**MARCONI MARINE Receiver 6-9 MC 6**  
Valves 4" LS £7.10.0.  
S.A.E. for LIST including Valves, Meters, Rectifiers,  
difficult to get.  
**LAWRENCE FRANKEL MAIL ORDER**  
134 Cranley Gardens London N.10.  
Telephone - - CLIssold 6641 and TUDor 1404

## REP

HIGH GAIN  
DUAL RANGE  
COIL WITH  
REACTION

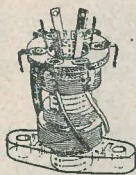

COMPLETE  
WITH  
2 BATTERY  
AND  
2 MAINS  
CIRCUITS

PRICE 4/- POST 3d.  
(Trade Supplied)

**Radio Experimental Products Ltd**  
33 MUCH PARK STREET  
COVENTRY

## VALVES NEW TESTED AND GUARANTEED

1R5	7/9	6F6g	8/6	6SA7	7/6	6V6g	8/6
1S5	7/9	6F12	7/6	6SG7	6/6	6V6gt	8/6
1T4	7/9	6G6	5/9	6SK7	6/9	8D3	7/6
1S4	7/9	6J5g	4/6	6SN7	8/6	12AT7	7/9
354	7/9	6K7g	4/6	6SQ7	7/6	12AX7	5/9
3V4	7/9	6K7	6/6	6X4	8/6	57	6/9
5U4g	8/6	6K8gt	8/6	6X5	7/6	954	2/-
5Z4g	8/9	6K8g	8/9	7C7	7/9	2C34	2/-
6AM6	7/6	6Q7g	8/9	7H7	6/9	EB91	6/6

**MATCHED PAIRS 6V6g and 6J7/-; 6F6G 17/-;**  
KT66 21/-; 807 15/6; 6G6 12/-; 6J5g 9/6 per pair  
P. and P. 6d per valve

**R. COOPER**  
32 SOUTH END CROYDON SURREY  
Telephone CROYdon 9186

## SMALL ADVERTISEMENTS

continued from page 117

**R116A Battery Communications Rx.** double superhet, seven wavebands covering 142 mc to 20 mcs, complete with transit case, £8. Moore, 33 Jackson Road, Clacton-on-Sea, Essex.

**PYE A39JH—11 waveband.** 9 Watts push-pull output, £30, spot on. Sussex. Box No. C135.

**WANTED—Denco Coil Turret with RF Stage, IF 1.6 mcs.** State price. Taylor, 37 Lulworth Avenue, Blackpool.

**WANTED—Unused Eddystone Cat. No. 787 Cabinet Assembly, complete.** Must be in perfect condition. Price to Robinson, 15 Holly Walk, Enfield, Middx.

**WANTED—QST, April 1945. Practical Wireless, March 1943.** G3IDG, 95 Ramsden Road, London, S.W.12.

## TRADE

Announcement

New Service for the Amateur and Experimenter

A stamped addressed envelope will bring you details of the new series of blue-prints of aerial tested circuits, from single valve to six and seven valve superhets. In the near future, kits of parts will be offered, both for the home constructor and the Amateur Transmitter and Receiver. Coming off the drawing board shortly is a Simple Communications Receiver Circuit. Further announcements will be made shortly concerning equipment for the TV home constructor, including wide band pre-amplifiers, etc., at prices which will be right for your pocket. Get your name and address on the files NOW by sending your S.A.E. to J.H.G. Box No. C107.

**NO WORKSHOP** is complete without a jar of PANL (the air-drying black crackle) handy. From Dealers 3/6 or 4/6 (includes postage) from L. Miller, 8, Kenton Park Crescent, Kenton, Middx.

**OSMOR**—for efficient coils, coilpacks, etc. Send 5d stamp for FREE circuits and lists. Dept. RCC, Osmor Radio Products Ltd., Borough Hill, Croydon, Surrey. Tel. Croydon 5148/9.

**"GLOBE KING"** (Regd.) Miniature Single Valve Receiver gets real Dx. Amateur Radio enthusiasts, should send for free copy of interesting literature and catalogue (enclose stamp for postage). Write to makers: Johnsons (Radio), 46 Friar Street, Worcester.

**BOOKBINDING.** Volumes of *Radio Constructor* and *Radio Amateur* fully bound, imitation leather, gold lettering, 7s 6d post free. Prices for other publications on application. Jerome Alcock; CHEADLE, Stoke-on-Trent.

**TRANSFORMERS.**—Manufactured to our specification and fully guaranteed. Normal Primaries. 425 v. -0-425v. 200 ma., 6.3 v. 6 a., 6.3 v. 6 a., 5 v. 3a., 0-2-4-6.3 v. 3 a., ONLY 72/6. 425 v. -0-425 v. 200 ma., 6.3 v. 4 a., 6.3 v. 4 a., 5 v. 3 a. ONLY 50/-, 350 v. -0-350 v. 160 ma., 6.3 v. 6 a., 6.3 v. 3 a., 5 v. 3 a. ONLY 42/6. 250 v. -0-250 v. 100 ma., 6.3 v. 6 a., 5 v. 3 a. ONLY 32/6. The above are fully shrouded, upright mounting. Universal Mounting 350 v. -0-350 v. 80 ma., 0-4-6.3 v. 4 a., -0-4-5 v. 2 a. ONLY 18/6. Top shrouded, drop through 260 v. -0-260 v. 70 ma., 6.3 v. 3 a., 5 v. 2 a. ONLY 16/6. The following are upright mounting. EHT for VC97 Tube 2,500 v. 5 ma., 2. -0-2 v. 1 l a., 2 v. -0-2 v. 2 a. ONLY 37/6. EHT 5,500 v. 5 ma., 2 v. 1 a., 2 v. 1 a. ONLY 72/6. EHT 7,000 v. 5 ma., 4 v. 1 a. ONLY 82/6. PLEASE ADD 1/6 PER TRANSFORMER POSTAGE. **TRANSFORMER**, for use on trains, models, etc., giving outputs of 3 v., 4 v., 5 v., 6 v., 8 v., 9 v., 10 v., 12 v., 15 v., 18 v., 20 v., 24 v., 30 v., at 2 amps from normal mains input. ONLY 17/6 (postage 1/-).

**TRANSFORMERS.**—Ex. W.D. and Admiralty, built to more than 50 per cent. safety factor, with normal A.C. Mains Primaries. All Brand New and Unused. 300 v. -0-300 v. 200 ma., 5 v. 3 a., 6.3 v. 5 a., C.T., 20 v. 750 ma., 70 v. 100 ma. Weight 12 lb. ONLY 42/6 (postage, etc. 2/6). 330 v. -0-330 v. 100 ma., 4 v. 3 a. Weight 7 lb. ONLY 22/6 (postage 1/6). L.T. 5 v. -0-5 v. 5 a., 5 v. -0-5 v. 5 a., 5 v. -0-5 v. 5 a. By using combination of windings will give various voltages at high current. Weight 11 lb. ONLY 35/- (postage etc., 2/6). L.T. 6.3 v. 7.7 a., 4.2 v. 2.5 a., 4 v. 1 a. ONLY 19/6 (postage 1/6). EHT 1,400 v. 2 ma., 520 v. 10 ma., 300 v. 10 ma., 2 v. 1.5 a. ONLY 21/- (postage, 1/6).

Cash with order, please, and print name and address clearly. Amounts given for carriage refer to inland only

**U.E.I. CORPORATION**  
The Radio Corner

138 Gray's Inn Rd. LONDON WC1  
Open until 1 p.m. Saturdays. We are 2 mins. from High Holborn (Chancery Lane Stn.) and 5 mins. by bus from King's Cross.

## 6 VALVE SUPERHET V.H.F. RECEIVER.

Six channel switching, tuning 30.5 to 40 mc/s. Receives TV, Fire, Taxis, many British and Continental amateurs, etc. Components include 30 ceramic trimmers, 6 ceramic v/holders, 32 small condensers, 30 resistance, valve cans and covers, etc. All for 7/6. Post 2/6. Also supplied complete with valves at 17/6. Post 2/6. Drawings available for conversion to A.C. or A.C./D.C. operation.

**LOUD HAILER.** Powerful P.A. system. No valves to break or damage. Metal-clad and weather-proof. Consists of microphone and combined amplifier/speaker. Works off 12 or 24 volts D.C. OUR PRICE £8.17.6, carriage 5/6.

**RADIO-GRAM CHASSIS.** Three models available. Six wave band at £15.15.0, and two three wave band types, one at £12.12.0, and one at £10.17.6. All are brand new, and have latest valve line-up, gram switch, flywheel tuning and negative feed-back. Carriage 4/6.

**RADIO TELEPHONES.** Brand new American made walkie-talkie sets. 53-75 mc/s. Visual range. Complete with G.P.O. type handset. Operates either from set of internal batteries, or from a vibrator pack from 12 volt accumulator. PRICE £9.17.6, less vibrator. OR £18.17.6 a pair. Vibrators 27/6 each. SPECIAL OFFER of £21 for a pair, and two vibrators. Carriage 10/-.

**FIXED CONDENSERS.** Various values—.005 mfd, 350 VDC; .15 mfd, 350 VDC; .01 mfd, 450 VDC; .001 mfd, 500 VDC; .25 mfd, 350 VDC. Stamp for complete catalogue C.W.O. or C.O.D.

## DUKE & CO.

621 Romford Road LONDON E12  
Money back guarantee GRA 6677

continued on page 120



## CLYDESDALE

Bargains in  
Ex-Services Radio and Electronic Equipment

### MOVING COIL METERS

In Original Cartons

**Microammeter** Range 500-0-500 mA int. res. 500 ohms. 2 1/2 in. round mld. case, plug-in-type.

ASK FOR **15/-** Each POST PAID  
B/E304

**Milliammeter** Range 0/1 mA 2in. round mld. case, drilled flange mtg.

ASK FOR **15/-** Each POST PAID  
B/E305

**Milliammeter** Range 0/5 mA. 2in. square mld. case drilled flange mtg.

ASK FOR **12/6** Each POST PAID  
B/H537

**Milliammeter** 2 Ranges 0/40 mA Int. res. 175 ohms and 0/120 mA. Int. res. 42 ohms. 2in. square mld. case, drilled flange mtg.

ASK FOR **12/6** Each POST PAID  
B/E312

**Milliammeter** Range 0/100 mA shunted (Int.) from 10 mA. Scale marked 0/300 mA, 2in. square mld. case, drilled flange mtg.

ASK FOR **7/6** Each POST PAID  
B/E309

Illustrated Catalogue No. 8D. Price 1/6 (credited on first purchase of 10/- or over)

Order direct from: Telephone SOUTH 2706/9

**CLYDESDALE** SUPPLY CO. LTD.

2 BRIDGE STREET GLASGOW C.5

Branches in Scotland England and North Ireland

## TELEVISION CABINETS

All Sizes up to 16" Tube

Specially Designed for 'The Radio Constructor' 'MAGNAVIEW' TV Receiver.

Price **£18:10** Carriage £1

SEND FOR ILLUSTRATED LEAFLET

**H. ASHDOWN**

98 HERTFORD ROAD

TOTtenham 2621 EDMONTON N9

## SMALL ADVERTISEMENTS

continued from page 119

**J.P.R.E. PUBLICATIONS.** 5,500 Alignment Peaks for superhets 5/9. Sample copy *The Practical Radio Engineer* 2/-. Membership examination particulars 1/-. Syllabus of TV and radio courses free and post free. Secretary, J.P.R.E., 20 Fairfield Road, London, N.8.

**OAK SWITCH SERVICE.** Multi-way switches made to specification. Approx. cost:—Ceramic Wafer 5/-. Paxolin Wafer 2/-. Clicker Plate 2/6. Box No. C117.

**BOOKS!** Any radio book in print supplied Cash on Delivery. "Handibooks," 80 Eastern Esplanade, Southend, Essex.

**HR EARPIECES** 1/6. 2 volt 7p. Vibrators 7/6, Carbon Mike Inserts 1/-. 2 gang .0003 Condrs. 2/6 Valves from 1/6. Under 15/- add 9d p.p. 2 1/2 stamp for clearance bargains list. Pimble, 66 Liverpool Road, Newcastle, Staffs.

**JOIN THE ISWL.** Free services to members including QSL Bureau, Translation, Technical and Identification depts. Dx certificates, contests and activities for the SWL. Monthly magazine 'MONITOR' duplicated, containing articles of general interest to the SWL and League member, 10/6 per annum, post free. ISWL HQ, 86 Barrenger Road, London, N.10.

**BLUEPRINTS.** High Gain 10 Meter Converter, with a de-luxe circuit comprising EF91 RF stage, ECC91 double triode mixer and oscillator, EF92 IF amplifier, with stabilised voltage supply via a 7475. 1s 8d post free with full instructions. A.S.W.P., 57 Maida Vale, London, W.9.

**FREE!** Brochure giving details of Home Study Training in Radio, Television, and all branches of Electronics. Courses for the Hobby Enthusiast or for those aiming at the A.M.Brit.I.R.E. City and Guilds Telecommunications R.T.E.B. and other professional examinations. Train with the College operated by Britain's largest Electronic Organisation. Moderate fees. Write to E.M.I. INSTITUTES, Postal Division, Dept. RC28, 43 Grove Park Road, London, W.4. (Associated with H.M.V.)

**METALWORK.** All types cabinets, chassis, racks, etc. to your own specification. Philpott's Metalworks Ltd. (Dept. R.C.), Chapman Street, Loughborough.

**KENDAL AND MOUSLEY.** Manufacturers of Laboratory Equipment, chassis and instrument cases, also suppliers of B.V.A. valves, Radio and T.V. components. 99 Dudley Port, Tipton, Staffs.

**RADIO** Control that Model. Practical circuits, simple, cheap, easy to construct. Applications—Boats, A/C, Trams and Domestic Radios. Handbook 3/6 post free with unlimited advice. Carter, A.M.I.E.T. 101, High Street, Harlesden, N.W. 16.

## "YOU CAN RELY ON US"

**COILS**  
Wearite "P" Coils.  
All types in stock  
including A.F.I., R.F.I.

Price 3/-  
Midget I.F. Trans-  
formers Type 800.  
21/- per pair. Stand-  
ard Type 500/501  
(465Kc/s) 20/- pair

**HIGH  
IMPEDANCE  
HEADPHONES**  
New Ex-Government  
Price 12/6 per pair.  
**SCOTCHBOY**

**TAPE**  
1200ft Reels 35/-  
Spare Reels 4/3

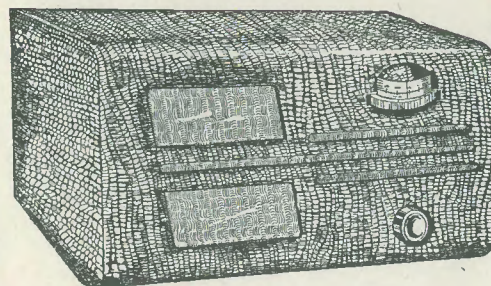

**COILS**  
Osamor Midget iron-  
cored "Q" Coils 4/-  
each. Leaflet on re-  
quest.

Coilpacks Type H.O.  
52/-, LM 43/4, MTS  
54/2, TRF 43/4, all  
including Tax.

**TRIMMERS**  
All new Postage  
Stamp Ceramic.  
4-70pf 8d, 40-100pf  
10d, 20-150pf 1/-  
100-550pf 1/3.

**LINECORD**  
3-way .3a at 60 ohms,  
per foot 6d ft., .2a at  
100 ohms per ft. 8d ft.

The "MAXIMITE" AC/DC SUPERMIDGET SUPERHET — Full Plans 1/-

CATALOGUE No. 12 now available

70 pages 250 illustrations Price 1/-

NOTE OUR NEW ADDRESS

**RADIO SERVICING COMPANY**

DEPT. K 82 SOUTH EALING ROAD LONDON W.5

Telephone EALing 5737

## SOLIDAS LTD.

4 PRAED STREET  
LONDON W2

DEFINITELY

THE CHEAPEST RADIO SHOP IN  
TOWN

Telephone AMB 4670

32+32 mfd 275V 4/-, 16 mfd 425V-wet-screw fit-  
ting, 4/-, 8 mfd 500 screw, 1/6, 8 mfd 600 V/W,  
screw 2/-, 8 mfd 450 midget, 2/6, 30+30 350, 2/6,  
10 mfd paper 600V, 4/-, 4-way Fuse holder, 6d.  
Continuity tester in nicely polished box can also be  
used for Morse practice, 5/-; 10 watt push-pull  
output Trans., 15/-; 4 gang .0005, 2/6; Slow motion  
drive with 2" drum, 1/6. L.T. Trans., 6.3, 2 amps,  
7/6. Polythene stand-off insulators, 9d. WX6 W.1  
detectors, 1/-; L.T. Trans., 3V, 1A, 2/6; Box of 10,  
3.2, 0.2 pilot bulbs, 2/6. Tube neck support fits 9",  
12", 15", 2/-, Wire wound pots. 1000Ω, 500Ω, 2/-  
Miniature 2 amp plug and socket, 1/- pair. L.T.  
Trans., input 110-250V, output 2-0-2V, 3.3A, or  
4V, 6.6A, 12/6. Bush All Wave chassis, 5 valve  
S/Het., less speaker, reconditioned, £6.10.0, has  
gram. sockets; 5.5 KV EHT Trans. with U22

Rectifier, 45/-, MV4=MH4 4/-; 878A 10/-; Z62  
10/-; 807 10/-; Z77 10/-; EF22=7H7 6/-; 3D6  
2/6; 1LD5 4/-; APR12 2/6; VU111-VU133 2/6;  
6SS7=6SJ7 5/-; 12Y4 0.3 Rect. 5/-; 6L6M 10/-;  
VT25 5/-; H30 5/-; HHLD6=6Q7 A.C. 6/-;  
6SL7 10/-; 6SN7 10/-; ML4 5/-; TP25 7/6;  
VR55=EBC33 8/-; VP41 10/-; SU4G=US2 10/-;  
6F6G 8/6; 6C6-6D6 5/-; 12C8 10/-, Y63 7/6;  
6G6 6/-; 7DA 10/-; 12SH7 5/-; 12SK7  
7/-; 117L7 10/-; VR56=EF36 6/6; 6AG5 6/-;  
CU188 V/Regulator 6/-; VR137, EC52 4/6; 9D2  
4/-; VR116 4/6; KTZ73=Z66 10/-; 6AK5 10/-;  
6SK7 7/-; VR126=VP4B 10/-; MS/PEN 6/-; SZ4  
8/6. Special offer AZ31 less locating pin 6/-; CY31  
less locating pin 6/-; KT44 7/6; AC6PEN 6/-;  
12SA7 10/-; 5Y5 6/6.

## URGENTLY WANTED

COMMUNICATIONS RECEIVERS.

TEST EQUIPMENT.

RADIOS—and TELEVISION SETS.

TAPE RECORDERS.

**BEST PRICES GIVEN**

Phone or Call