

RADIO CONSTRUCTOR

1/3

Vol. 2 No. 10

MAY
1949

For Every Radio Enthusiast



Contents

Radio at the British Industries
Fair

Circuit Reading

Radio Constructor Quiz

A "Surplus" Superhet

AN IMPROVED VISION
UNIT

Using ex-Government
components

Query Corner

Bench Measuring Instrument

Logical Fault Finding

Inexpensive Television—Queries

Mailbag

Trade Notes



AN AMALGAMATED SHORT WAVE PRESS PUBLICATION

COULPHONE RADIO

"The Return of Post Mail Order Service"

Phone:—
ORMSKIRK
987

53 Burscough Street, Ormskirk, Lancs

Grams:—
COULPHONE
ORMSKIRK

Proprietor:— C. Coulborn G3AJM

COULPHONE RADIO, apart from being the fastest **MAIL ORDER SERVICE** with **SOUND GOODS** is a **PERSONAL SERVICE** well appreciated by over 20,000 clients in all parts of the world—including America. **ALL ORDERS ARE POST FREE.** Terms C.W.O. or C.O.D.

MAINS TRANSFORMERS
from 16/6 post paid

Standard size, drop through chassis type with top shroud. Screened, primary tapped 200/230/250v. Interleaved and impregnated windings.

- (a) 250-0-250v 60ma 6.3v 3a, 5v 2a ... 16/6
- (b) 250-0-250v 60ma 4v 4a, 4v 2a ... 16/6

Following types have **UNIVERSAL LT WINDINGS 0-4-6.3v 4a CT** and **0-4-5v 2a** enabling either 4v or 6.3v valves and 4v or 5v rectifier to be used.

- (c) 250-0-250v 80mA ... 19/-
- (d) 300-0-300v 80mA ... 19/-
- (e) 350-0-350v 80mA ... 19/-
- (f) 250-0-250v 100mA ... 22/-
- (g) 300-0-300v 100mA ... 22/-
- (h) 350-0-350v 100mA ... 22/-
- (i) 350-0-350v 150mA 0-4-6.3v 6a, 0-4-5v 3a ... 39/-
- (j) 425-0-425v 180mA 6.3v 4a, C.T., 6.3v 4a, C.T., 5v 3a ... 44/6

Types (i) and (j) are upright type, fully shrouded.

20,000 VALVES IN STOCK—NEW AND EX-GOV'T.

Send 2½d stamp for 48 page Catalogue and valve list. If interested in EX-GOV'T. SURPLUS, please include extra 2½d stamp for illustrated surplus catalogue, it will save you £s.

SELECTED EX-GOV'T. SURPLUS GEAR.

RII55 RECEIVERS, Complete with valves £10 10 0

ROTHERMEL "TORPEDO" CRYSTAL MICROPHONES. Brand new in maker's boxes. List price £18/18/0. My Price £3/18/6. Post paid.
RECEIVER TYPE 1124, Complete with 6 valves. Ideal Conversion Television Sound £17/6.

PACKARD-BELL PRE-AMPS TYPE K1, less valves. A Super Bargain 4/6.

BALLOONS 5ft. diameter in cannisters 3/11.
AIRCRAFT COMPASS 6" in wood boxes 15/-.

BC454 COMMAND RECEIVERS ideal conversion for car radios, 6 valves £1/15/0.

TI154 TUNING PANELS. Two single and one 2-gang condensers with reduction drives. Three coloured knobs. Only 4/6. Post paid.

TU5B Tuning Units. Brand New. 19/6. Carr. Paid.
Type BC454 40 Watt MODULATOR UNITS with 1625, 12J5 valves and VT150 stabiliser. 19/6. Post paid.

LASKY'S RADIO

TRANSFORMER SPECIALS

All 200/250v 50 c.p.s., input.

New goods and fully guaranteed.

TYPE P/Z. Output 325-0-325v, 80 m/a. Also 6.3 v, 3 amps; 5v, 2 amps; Semi-shrouded, drop through chassis fixing. **LASKY'S PRICE 18/-.** Post 1/6 extra.

E.H.T. TRANSFORMERS FOR THE VCR97 CATHODE RAY TUBE

Secondary: 2,500v, 4 m/a.; 4v, 1.1 amps; and 4v (C.T.) 1.5 amps. **LASKY'S PRICE 35/-.** Post 1/6 extra.

SPECIAL MAINS TRANSFORMER FOR THE 1355 RECEIVER

(As specified in the Inexpensive Television data book No. 2). Output 250-0-250v, 80 m/a. Filament windings: 6.3v, 6 amps; and 5v, 3 amps. **LASKY'S PRICE 27/6.** Post 1/6 extra.

TYPE P/12

Output 350-0-350v, 80 m/a. Also 6.3v, 3 amps; 5v, 2 amps. This transformer is fully shrouded with fixing feet. **LASKY'S PRICE 23/6.** Post 1/6 extra.

MAINS TRANSFORMER TYPE P/16

Input 200/250 volts, 50 c.p.s. Output 350-0-350 volts at 120 m/a. Filament windings: 6.3 volts, 5 amps (C.T.); 4 volts, 3.5 amps; 5 volts, 3.5 amps. A voltage control panel on the secondary side will give almost any combination of filament windings from this excellent multi-purpose transformer. **LASKY'S PRICE 37/6.** Post 1/6 extra.

EX A.M. RECEIVER UNIT TYPE 71

Contains 9 valves: 4 EF50, 1 EL32, 1 EA50, 2 EF39, 1 EBC33. This is a superhet unit with an R.F. stage and 3 I.F. stages. Overall dimensions: 10½in. wide, 7½in. deep, 5½in. high. **IDEAL FOR CONVERSION TO AN ORDINARY RE-**

CEIVER. The breaking up value is well over £3. **LASKY'S PRICE 25/-.** Carriage 3/6 extra. Brand New and Unused, in maker's original carton's

EX R.A.F. UNITS TYPE W.F.G.34

Containing 13 brand new valves: 7 SP61, 2 EB34, 3 VR56, 1 VR55. Hundreds of components, resistances, condensers, 2 relays, potentiometers, Pye plugs, etc. Built on strong chassis, size: 11½in wide, 10in. long, 3in. high. Totally enclosed in metal case, size: 11½in. wide, 10in. long, 7½in. high. Weight when packed 35 lbs. **LASKY'S PRICE 29/6.** Carriage 4/6 extra. **AS ABOVE BUT USED.**

LASKY'S PRICE 19/6. Carriage 4/6 extra. **EX-A.M. RECEIVER, TYPE 3084A**

BRAND NEW, in maker's original wood transit case

This radar receiver contains 14 new valves: 7 EF50, 2 VR136, 1 VR137, 1 HVR2, 1 R3, 1 V1507, 1 EA50. A 5-stage I.F., strip, small motor, dozens of useful components, resistances, condensers, switches, plugs, etc. Totally enclosed in metal case, size 19 x 8½ x 7½in. Weight when packed 40lbs. **EASILY CONVERTED TO TELEVISION.** **LASKY'S PRICE 75/-.** Carriage in wood transit case 10/- extra (case included). Send 2½d. stamp with your name and address (in block letters please) for a copy of our current monthly list of Ex. Government bargains, The Lasky's Radio Bulletin, by return.

LASKY'S RADIO,

370, Harrow Rd., Paddington, London, W.9
(Opposite Paddington Hospital)

Telephone: CUNningham 1979
Hours: Mon. to Sat. 9.30 a.m. to 6 p.m., Thurs. half day.



Radio Constructor

Vol. 2, No. 10

Annual Subscription 16/-
(Waiting List)

May, 1949

Editors:

ARTHUR C. GEE, G2UK

W. NORMAN STEVENS, G3AKA

Technical Editor:

LIONEL E. HOWES, G3AYA

Advertisement & Business Manager:

C. W. C. OVERLAND, G2ATV

Editorial

THOSE CIRCUIT DIAGRAMS

THERE is one type of letter which turns up fairly regularly in our mail and that is from the reader who wishes us to print point-to-point wiring diagrams.

We have expressed our views before on this subject in these pages, and our contributor "Centre Tap" discourses further on this topic in this number on page 566. We should like to give editorial support to the views he has expressed.

Whilst we realise that the usual theoretical diagram is confusing to the beginner, we feel that to construct radio gear by simply putting components and wire together like the parts of a constructional mechanical toy is not the proper way of learning the principles of our hobby.

What happens should the receiver not function immediately? Some knowledge of the theory

behind the receiver is clearly necessary and a point-to-point wiring diagram is of no use here. In the latter case, the diagram simply shows the shape and location of the components. It gives no indication of the functions of those components. A circuit diagram, on the other hand, shows the function of each part of the receiver. A resistor or capacitor shown in a point-to-point wiring diagram may appear much the same, whilst in a circuit diagram one is shown as consisting of two plates with no path for direct current whilst the other, the resistor, can conduct direct current through the shape—a zigzag line—indicating that it does so with reluctance. Admitted that the theoretical diagram does not show the position of the components and that this is sometimes of importance; in such a case it should be mentioned in the text or a layout given. We feel that the subject is of considerable interest to beginners and we hope shortly to publish some articles on translating theoretical circuit diagrams into practical layouts. C.O.

NOTICES

THE EDITORS invite original contributions on construction of radio subjects. All material used will be paid for. Articles should be clearly written, preferably typewritten, and photographs should be clear and sharp. Diagrams need not be large or perfectly drawn, as our draughtsman will redraw in most cases, but relevant information should be included. All MSS must be accompanied by a stamped addressed envelope for reply or

return. Each item must bear the sender's name and address.

COMPONENT REVIEW. Manufacturers, publishers, etc., are invited to submit samples or information of new products for review in this section.

ALL CORRESPONDENCE should be addressed to *Radio Constructor*, 57, Maida Vale, Paddington, London, W.9. Telephone: CUN. 6579.

AUTHENTIC AND UP-TO-THE-MINUTE INFORMATION ON VHF, BROADCAST BAND AND AMATEUR ACTIVITIES IS GIVEN IN OUR MONTHLY PUBLICATION "SHORT WAVE NEWS."
TELEVISION FANS — READ "TELEVISION NEWS" MONTHLY

RADIO

at the British Industries Fair

TELEVISION, ELECTRONICS AND SOUND RECORDING ARC FEATURES

The most up-to-date equipment used in television transmitting and receiving, radio communications, aids to navigation, sound reproducing and other branches of the radio and electronic engineering industries was shown at the British Industries Fair in London and Birmingham from May 2 to May 13.

Television Receivers

At Olympia, London, there were several combined television and radio receivers. **E. K. Cole Ltd.** exhibited a combined console model with a high definition picture 10" x 8" viewed indirectly on a specially processed mirror in the lid set at the correct viewing angle. The viewing surface is shielded from conflicting light or reflections. The radio has instantaneous tuning to five chosen stations obviating the need for a tuning scale.

R. N. Fitton Ltd. featured an 18-valve console model designed to fit into the corner of a room, believed to be the only one of its type manufactured in this country.

Also shown was a new communal amplifier, developed to cover the television frequencies, for use in blocks of flats or similar buildings enabling up to 20 television receivers to be fed from one normal aerial. The total power consumption is approximately 50 watts.

Radio Receivers

A new radio receiver was shown at Olympia by **Mullard Electronic Products Ltd.** Claimed to be the first domestic radio to incorporate the special double superheterodyne circuit, it has band-spread tuning on the eight important short wave bands. The design of the magic-eye enables tuning to be carried out with the volume control at the minimum setting.

A new type of nine-valve receiver by **R. N. Fitton Ltd.**, has been designed exclusively for export, based on refinements requested by overseas agents. By employing an advanced technique and using miniature valves it has been possible to build a nine-valve receiver in a cabinet of the size normally used for five-valve types.

An all-wave superhet exhibited by **A. J. Balcombe Ltd.** is claimed to be the smallest in the world.

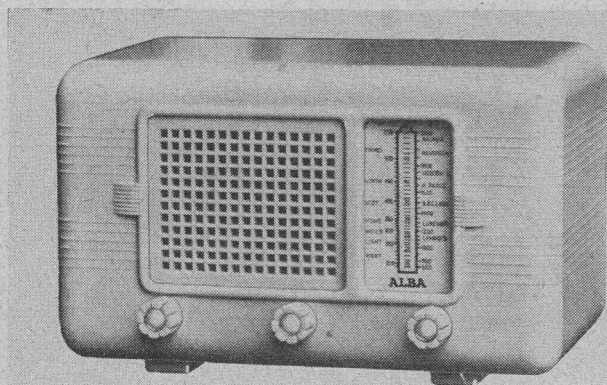

The Alba all-wave superhet, which is claimed to be the smallest of its kind in the world.

Television Aerials

Re-designed television aerials by **Belling and Lee Ltd.**, shown at Birmingham. Complete aerial systems in three individual kits comprised: dipole, reflector and cross-arm for different frequencies, eight or twelve foot masts, and different lashing kits and chimney brackets for the masts. A new high tensile light alloy is now being used in the manufacture of the elements and masts, reducing the weight of the aerial system by roughly one-third.

Radar

The cloud and collision warning radar equipment at Olympia by **E. K. Cole Ltd.** was designed to enable pilots of aircraft to detect certain types of clouds associated with storm areas at a distance of 40 miles. Other uses for the equipment include map pointing facilities, detecting other aircraft in the vicinity, and for selecting a route through dangerous cloud formations at night, or in poor visibility.

Again with the accent on portability, here is the Trix portable battery-operated PA system. With an output of five watts this unit measures just under a foot cube.



Communications

Also shown at Olympia by E. K. Cole Ltd. was light aircraft communications equipment, including a crystal-controlled aircraft VHF transmitter/receiver, with selector switch control, weighing only 12 lbs.

The same firm also had a "walkie-talkie" transmitter/receiver developed for use during the war, but now having many uses in civilian life. The set, employing miniature valves and components, is strapped to the back of the operator who can continue his normal job without inconvenience.

Sound Re-producing

A portable battery-operated public address system less than a foot cube, weighing only 25½ lbs. with an output of approximately five watts, manufactured by Trix Electrical Co. Ltd. They also featured a portable electric gramophone, fitted with an automatic record changer, operating from the mains supply. It has a complete amplifier unit and loudspeaker of the high efficiency permanent magnet type.

A distinctive feature of the automatic record changer shown by Plessey International Ltd. was the centre spindle on which the records are stacked. It incorporates a tiny collapsible shelf and expanding ring which operates automatically and releases the records as required. Eight records of either size, or mixed, can be repeated or rejected by a pre-selecting button. The changing time is approximately four seconds. Another exhibit was a single record player for 10" or 12" records operated by a press button which automatically places the pick-up on the record and starts and stops the turntable.

Garrard Engineering and Manufacturing Co. exhibited for the first time at the Fair, a marine version of the "V" radiogram unit. It was shown playing a record while undergoing a rolling

motion as if at sea. All Garrard pick-ups have now been designed to plug into the new pick-up arm and take only a few seconds to change over. The advantage is a high fidelity pick-up head to play the better records and a more robust type for general family use. Among new models on show for the first time were the AC/DC and 6 or 12 volt battery-operated versions of the model RC70 record changer and the model "S" radiogram unit.

(continued on page 567)

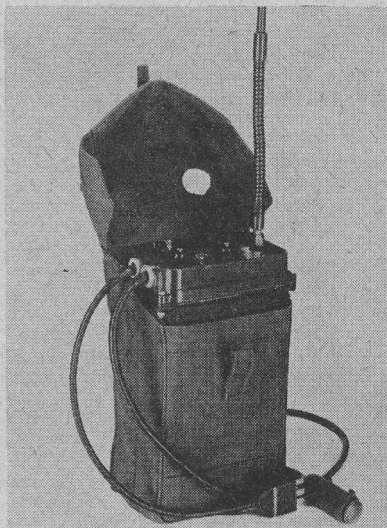

The walkie-talkie transmitter receiver exhibited by E. K. Cole Ltd. It can be strapped to the back of the operator.

THE old saying "It's an ill-wind that blows no one any good" has been borne out as far as the radio beginner is concerned. He has simply *had* to move on from the point to point wiring stage.

Restrictions on paper supplies have cut down many desirable features in radio journalism, they have also been responsible for greatly reducing the practise of using pictorial wiring diagrams which in pre-war years invariably accompanied constructional articles. That, in my opinion, is the solitary piece of good brought about by the ill-wind, and, strangely enough, it is the beginner who benefits most!

Admittedly a wiring diagram may help him in planning his layout, but this can be adequately met by a well positioned photograph. A drawing of the wiring can only have the opposite effect when it comes to understanding the circuit, while the wasted space merely irritates the more serious constructor. The beginner who merely copies a wiring plan learns nothing and can get no permanent satisfaction from the resulting equipment, and he is completely unable to carry out the simplest experiment with it or to add any of the many possible refinements which will improve the performance or operation, of the foundation design.

All the wiring plans in the world will never help the beginner to understand a circuit, let alone learn anything about radio, and personally I should deplore the re-introduction of the general use of pictorial wiring plans in modern radio journalism.

Prove it Yourself

I hope that those who feel the circuit diagram too complicated for them will take heart from the foregoing and hope that they will try this simple method of proving the case for themselves.

Firstly, find a circuit of a two-valve receiver. Draw out the components on a piece of paper in their respective positions on the chassis. Then fill in the lines to represent the wiring. Simple really, isn't it?

From that, move on progressively to more complicated multi-valve sets. You will soon become convinced of the enormous saving of time effected by radio "shorthand" and surprise yourself at just how much you take in at the first quick glance of the next circuit you see.

International Use

It has, at various times, been pointed out that when foreign radio books and magazines come into one's hands, how little the descriptions matter as long as the circuits are there. Together with a

CIRCUIT READING

discussed by

CENTRE TAP

Schematics

Circuit diagrams, more picturesquely described by our American friends as "Schematics," have been called the shorthand of radio and they certainly do enable a complicated maze of wiring to be taken in at a glance.

Should you happen to be one of the beginners who shy at the conventional circuit design, try to depict any wiring or switching arrangement you can devise in a more simple and straightforward manner. When you have finally decided on the best form you will most certainly find the result practically identical to the circuit symbolism you have sought to dodge. All that is required to "read" a circuit is a little practice, and from that stage you will find it easily possible to take in the main form of a receiver or transmitter with a few seconds automatically tracing out the details mentally. Schematics provide the only quick way of doing this, and with a little more experience, the layout, which is based on a quickly acquired convention that soon becomes almost instinctive a mental image of the finished product can be formed simply by examining the circuit. The sense of layout is developed by familiarity with constructional photographs of similar gear and by observation of ex-W.D. or ordinary broadcast receiver design.

photograph they will give you all the information you need.

This is true for the more experienced amateur, but beginners are often perplexed by slight variations of the conventional symbols. There can hardly be many readers who have not at some time or the other perused one or more of the many U.S. radio books and magazines. Their system of circuit depiction is a little strange at first, particularly the valves themselves, but once the minor differences are appreciated no difficulty is experienced. There is certainly room for greater uniformity in circuitry—not only on an international basis but within individual countries.

Standardisation

Actually, most of the divergences are in detail and relatively unimportant where the technician or the experienced amateur is concerned. They already know, or can quickly visualise the point which might be clarified for the less experienced, if the universal acceptance of certain points were observed.

Among these points the following come readily to mind. Firstly, the need for a more definite distinction in the use of the symbol used for "Earth" or "Chassis," especially in AC/DC circuits. This is of particular importance having

regard to the growing popularity of the AC/DC principle in television receivers.

Capacitors, too, could for the beginner be more clearly indicated. They would best be illustrated by using parallel "bars" for mica capacitors, one straight bar and one curved to depict a paper dielectric capacitor—the curved bar representing the outer foil. A "hollow bar" would be used to indicate the positive side of an electrolytic.

These points, as I have already said, are unimportant to the old hand: he will already know them. To the beginner they would help, particularly in establishing his confidence.

Component Values

In concluding there are one or two points worth mentioning as they may help to clear any remaining doubts in the minds of newcomers.

K following the figure beside a resistor means "kilo" or 1,000. Thus 50K becomes 50,000 ohms.

(B.I.F.—continued from page 565.)

A pick-up of novel design was shown by Erwin Scharf. It is provided with three interchangeable plug-in pick-up heads each fitted with a different sapphire stylus suitable for different types of recordings. There is also a special head to play the new American long-playing microgroove records requiring a sapphire stylus tip of one thousandth of an inch radius.

E.M.I. had a high fidelity magnetic tape recorder, one reel recording for over 20 minutes.

Electronics

The industrial applications of electronics are increasing and developments on show at Birmingham included devices for measurement, control and selection. Among the demonstrations staged by E.M.I. was the treatment and drying of grasses to ensure full nutritive value for livestock consumption. A method of heating and soldering small metal parts combined with the use of a hydraulic press makes it possible to apply heat and pressure simultaneously, ensuring a perfectly air-tight joint.

British Thompson-Houston Co. Ltd. had a working model of an electronic speed control for electric motors, and also showed a voltage regulator.

Exhibits of Mullard Electronic Products Ltd. included a photometric tube for the accurate measurement of light quantity; a directly heated tetrode for use in mobile equipment; a high frequency double tetrode for use in fixed stations; an accelerometer tube which can be used as a low mass pick-up for measuring and recording the acceleration and vibration of high velocity elements without using a special high gain amplifier, and a moisture meter for measuring the moisture content of grain.

The only controlled neon discharge lamp manufactured in England was shown by Ferranti Ltd. The lamp forms the basis of their "Synchrolite" stroboscopic equipment.

M used in a similar manner means megohm (a million ohms) and 2M simply means 2,000,000 ohms.

m means "milli" and is "one thousandth part of."

100 μ F is a simpler way of saying .0001 microfarads.

With the tiny capacities used in SW and USW work smaller and smaller capacities are becoming more common. 5 micro-microfarad—or 5 picofarad—would look a very awkward figure written as .000005 microfarad.

The control grid of a valve is always shown nearest the cathode, and gas-filled valves (and neon tubes) are always shown shaded-in.

The symbol for crystal or metal rectifiers is a solid triangle pointing to a straight line. The straight line is the positive side, the "arrow" indicating the direction of current flow.

**"RADIO CONSTRUCTOR"
QUIZ**

Conducted by W. Groome

The Quiz has become accepted as not only a source of amusement but also as an easy method of learning facts. It is with this dual purpose in mind that we are installing the "Radio Constructor" Quiz as an experiment. If you like it, write and tell us. If you don't like it, still let us know.

The questions have, and will be, selected with a view to avoiding the discouragement of those readers who are not yet advanced. Here are this month's questions . . .

- (1) Some parts of a set may remain "live" after disconnection from the mains. Right or wrong?
- (2) Is any harm likely to be caused by disconnecting the loudspeaker when the set is operating?
- (3) What valve constant is represented by μ ?
- (4) The attainment of very high selectivity results in poor audio fidelity. Why?
- (5) Which of the following screw sizes is the larger: 4BA or 6BA?
- (6) The diode detector is distortionless at all signal levels. Right or wrong?

(Answers on page 577)

ARE WE TOO Highbrow ?

" It is rather too advanced in technical descriptions so far as my limited knowledge of radio is concerned.

Yours sincerely,

J. S. Bollard (Chester)."

(We would appreciate reader's views on this matter.—Ed.)

A "SURPLUS" SUPERHET

Low cost, high efficiency, DX receiver

By C. SUMMERFORD

WITH the large amount of "surplus" radio gear now available, a golden opportunity presents itself to the enthusiastic constructor and short wave DXer to build a high-class receiver at very low cost; one, moreover, that compares favourably in the important matter of efficiency with those used by many active transmitting "hams."

Apart from the question of cost, however, there are several other factors to be taken into account if the receiver is to be really worth while; such things as sensitivity, selectivity, noise-level, image-rejection, and so on. A decision has also to be made as to whether the receiver is to be used for headphone or loudspeaker reception. With regard to this last point, there is this to be said for headphones, they *do* effectively shut out, or drastically reduce, the extraneous noises that can be so annoying when one is trying to "resolve" a weak signal. It is worth noting here that headphone users among the "hams" are still in the majority. At the same time, when designing a short wave headphone receiver it is always worth while to do this in such a way as to make modification for loudspeaker reception relatively simple. Another point worth noting is that to obtain the utmost from a small number of valves one must be generous in the matter of panel controls. Not that this will be a disadvantage, for most enthusiasts like plenty of "knobs."

The Circuit

The diagram (Fig. 1) gives circuit details of a receiver which, to be precise, has four valves in a physical sense and five electrically—the last valve has two in one envelope. These valves are used as mixer, oscillator, intermediate-frequency amplifier, detector and output.

As the mixer stage of an ordinary dual-purpose frequency changer has radio-frequency amplifying properties that compare unfavourably with a good RF pentode, it was decided to use separate valves for mixer and oscillator. Furthermore, the use of two valves makes aerial regeneration simpler. This regeneration is made possible by using a third winding on the aerial coil former placed close to the grid winding and wired in series with V1 anode and the first IF transformer primary, actual regeneration being controlled by VR1. It should, however, be pointed out that the receiver should first be built without the regeneration circuit and then, when everything else has been found to be satisfactory, it may be

added. One further point about this circuit is that if "Eddystone" 6-pin or similar type coils are used, the third winding will have to have some of its turns removed. Actually, one turn appears to be sufficient on all ranges.

The valve chosen for RF amplifier-mixer is one of the popular EF50's and, in making the choice, it was taken into consideration that apart from the fact that it is cheaply obtained it is also one of the best RF valves procurable.

There is nothing out of the ordinary about the oscillator valve or circuit, and all that need be said is that the valve is a 6J5 and the coils standard 4-pin.

Separate band-set capacitors are shown in the diagram with ganged band-spreaders, and both band-setters and band-spreaders have reduction drives, but the band-spreaders have the difference that they are fitted with a full-vision dial. This arrangement is, of course, a matter of taste and, should there be a preference for mechanical band-spreading, this can easily be arranged. In such a case VC1 and VC2 would be ganged, VC4 would not be required, and VC3 would then have a reduction drive and be used as an aerial trimmer.

Choice of IF

An IF of 1.6 megacycles has certain attractions, chief of which is that it makes image suppression easier, but its disadvantages are: lower selectivity, lower gain, and greater difficulty in obtaining accurate tracking of signal and oscillator tuned circuits. The latter point, however, does not create quite so much of a problem in a receiver designed purely for "ham" band reception; but even so, it entails the winding of special coils. This being so it was decided to make the IF 465 kcs as this frequency allows one to obtain quite good selectivity with reasonably good image rejection (much improved by regeneration), plus greater ease in signal-oscillator tracking. The actual IF transformers used are Wearite Type M400B which are dust-iron cored and permeability tuned.

An EF39 is used for the IF amplifier and, although this is a metallized valve, it should be covered with a valve screen. No variable resistance is included in the cathode circuit of this valve although one may be added if desired. The EF39, incidentally, is the octal base version of the EF9.

An article submitted for our Surplus Gear Contest

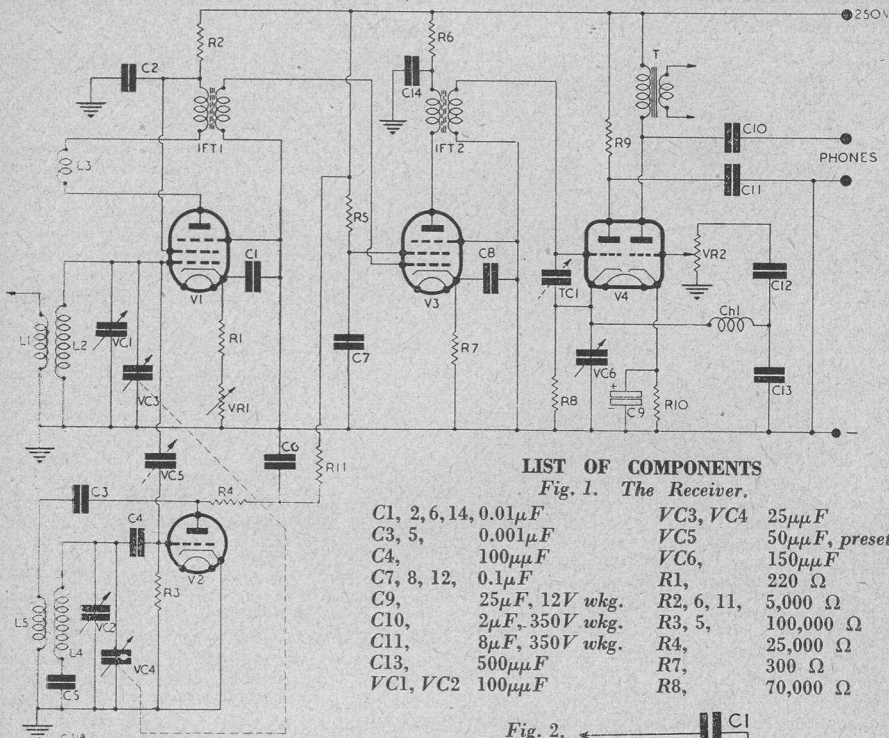

LIST OF COMPONENTS

Fig. 1. The Receiver.

- | | |
|----------------------------|---------------------------|
| C1, 2, 6, 14, 0.01 μ F | VC3, VC4 25 μ F |
| C3, 5, 0.001 μ F | VC5 50 μ F, preset |
| C4, 100 μ F | VC6, 150 μ F |
| C7, 8, 12, 0.1 μ F | R1, 220 Ω |
| C9, 25 μ F, 12V wkg. | R2, 6, 11, 5,000 Ω |
| C10, 2 μ F, 350V wkg. | R3, 5, 100,000 Ω |
| C11, 8 μ F, 350V wkg. | R4, 25,000 Ω |
| C13, 500 μ F | R7, 300 Ω |
| VC1, VC2 100 μ F | R8, 70,000 Ω |

- | |
|--|
| R9, 20,000 Ω |
| R10, 1,000 Ω |
| VR1, 2,000 Ω |
| VR2, 500,000 Ω |
| L1, 2, 3, Eddystone 6-pin coils (modified) |
| L4, 5, Eddystone 4-pin |
| IFT1, 2, Wearite M-400B |
| T, Small output transformer |
| Ch 1, M/L wave RF choke |
| V1, EF50 |
| V2, 6J5 |
| V3, EF39 |
| V4, 6SN7 |

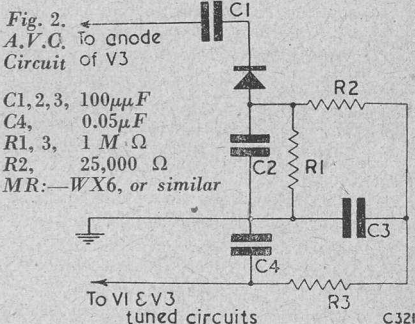
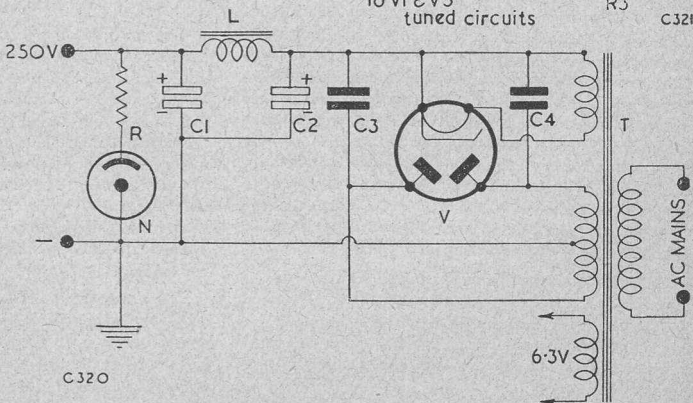

Fig. 3. The Power Pack

- | |
|---|
| C1, 8 μ F, 350V wkg. |
| C2, 16 μ F, 350V wkg. |
| C3, 4, 0.01 μ F, 700V wkg. |
| R, 5,000 Ω , 20 watt (adjustable) |
| L, 30H, 60mA choke. Approx. 300 Ω |
| N, Cossor S130 |
| V, 5Z4G |
| T, Secondaries: 250-0-250V 60mA, 5V 2A and 6.3V 2A. |

N.B.:—One side of 6.3v winding should be earthed.



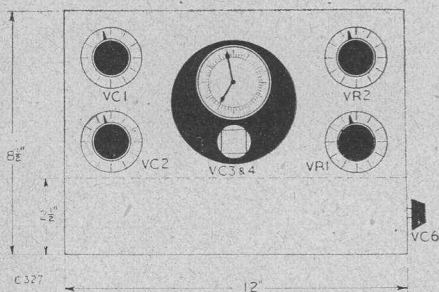

Fig. 4. Panel arrangement and dimensions.

The Detector

The detector is an anode-bend-negative-feed-back detector or, as it is generally called, the infinite-impedance detector. Like the diode, this type of detector gives no gain at audio-frequencies but, *unlike* the diode, it imposes almost no damping on the tuned circuit. What little damping there is may be neutralized by an adjustment of VC6. In fact, if VC6 is fitted with a reduction drive the circuit can be made to gently oscillate and so provide an audible note without the need to employ a separate BFO valve and circuit. The note thus produced is completely under the control of the operator and may be chosen according to the frequency desired.

Trimmer TC1 is inserted to reinforce the grid-cathode capacity of the detector thus ensuring that regeneration shall be adequate.

Before concluding this brief description of the detector it should perhaps be pointed out for the sake of the uninitiated that it is almost impossible to overload it to the point at which distortion becomes apparent.

Output is taken from the cathode circuit of the detector and fed to the grid of the output valve via the usual RF filter, coupling capacitor and volume control. Incidentally, the dual detector and output valve is a 6SN7.

It will be noticed that the primary winding of an output transformer is used as a choke for energizing the headphones. This is done so that the receiver may be used for loudspeaker reception when required without the need to make any circuit alteration. Naturally, the volume at loudspeaker strength will not be so great as one normally expects from a mains receiver. Nevertheless, it will be found to be entirely adequate and will in fact, be about the same as that given by a battery pentode output stage, but with rather better quality of reproduction.

No provisions has been made for AVC in Fig. 1, but this may easily be added if required as shown in Fig. 2. As will be seen, this entails the use of a metal rectifier and a few extra resistors and capacitors, the whole of which should only cost a few shillings.

Mains Unit

Fig. 3 shows the circuit of a suitable semi-stabilized mains unit which may be built quite cheaply.

The words "semi-stabilized" are meant to imply that regulation will not be quite so good as if two stabilizer tubes were series-connected across the output, but will be better than if a simple bleeder resistor were used. In the case of the fully stabilized mains unit a 300 or 350 volt secondary winding on the mains transformer would be needed, whereas with the modified version used here, a 250 volt secondary will be satisfactory.

Layout and Construction

As this receiver has been designed primarily to make use of "surplus" equipment, no rigid rules are laid down as to the choice of components. In the model constructed by the writer, described herewith, all fixed resistors and capacitors (except for C9 and C10), valves and bases, and VR1 are "surplus," and the remaining components are mostly taken from the "junk box."

RF and oscillator circuits have their own separate compartments, and coils are horizontally mounted so as to give short grid-circuit wiring. This horizontal coil mounting has the further advantage of keeping most of the tuned circuit wiring above the chassis, so making sub-chassis screening unnecessary. All variable controls, with the exception of VC6, are also mounted above chassis.

The chassis itself is constructed from $\frac{1}{16}$ " aluminium sheet, as also are the panel, screens and coil brackets. Both screens are cut and bent at one end to form a bracket arrangement similar to that shown for the coil brackets. The panel is held rigid by two 4" metal brackets.

A glance at Fig. 4 shows the symmetrical arrangement of the panel controls. This has been made possible by (1) mounting the auxiliary control VC6 at the side of the chassis, and (2) drilling the mounting bracket for VC1 with a $\frac{5}{16}$ " hole so as to allow the connecting rod spindle to VC2 to pass through it.

The main tuning dial is an old dual-ratio Lissen model, now, unfortunately, unobtainable, which was used only because it happened to be the only suitable one available. In any case, a dual ratio drive is not really necessary with electrical bandspread. Constructors who possess dials of a different type will find that there is ample room on the panel to accommodate these; actually, the space between the smaller controls in a horizontal direction is 6", and this allows a large amount of latitude without disturbing the general symmetry of the panel.

The mains-unit layout, like that of the receiver, also allows considerable latitude in the choice of components, provided the values are adhered to. Connection between mains-unit and receiver is made by a 4-pin plug and socket.

For the Television Enthusiast

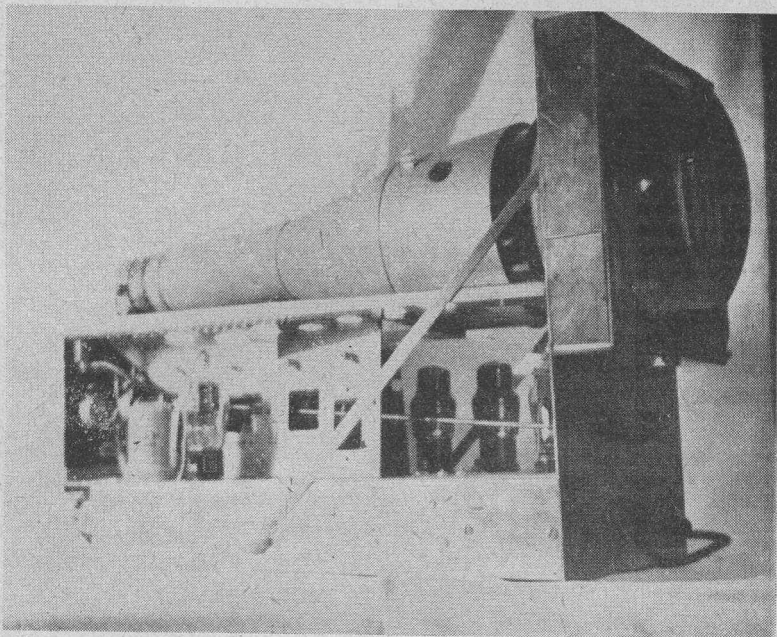

AN IMPROVED

VISION UNIT

USING EX-GOVERNMENT COMPONENTS
constructed and described by R. A. SEAL

TO date there have appeared in the technical press quite a number of articles relating to the conversion of Ex.-Government Radio and Radar equipment into Television equipment, and from the author's experience this new venture has become quite the rage for the radio-minded fraternity.

Having tried out quite a number of the various circuits that are available, all of which produced quite good pictures, the author decided that there was room for improvement in both receiver and vision unit design. However, we are only concerned with the vision unit in this article.

The first consideration was that of a suitable tube and the choice lay between four types, the VCR97, VCR517, 5CP1 and 5BP1. However, as availability was of prime importance the VCR517 and 5BP1 were ruled out leaving a choice between the 5CP1 and VCR97, and having taken into consideration the questions of cost, technical preference and a number of minor factors, it was finally decided to build the unit around a 5CP1, as this in conjunction with one of the new magnifiers will give an excellent picture.

Having decided on a tube, the next step was to find a suitable unit containing the tube and if possible suitable valves and components. However, there does not appear to be any Radar Unit available with suitable valves as well as the 5CP1 tube, so the author was forced to purchase the Loran indicatorless valves and purchase the valves as separate items. Due to these being available as surplus there was very little increase in cost.

The time bases were the next problem and it was here that it was decided to revert from the usual surplus television design. All the circuits that the author has previously tried have used Transitron time base generators and these have usually necessitated quite an amount of experimental work before they could be persuaded to operate satisfactorily, the main snag being that if one varies one circuit constant it affects all other constants and consequently if one varied the anode load it not only affected the amplitude, but the repetition frequency and linearity as well. Therefore, it was decided to choose a time base that was much more stable in operation, namely a Blocking Oscillator. This time base has the great

advantage that the actual charging circuit bears very little relation to the circuit controlling the repetition frequency, thus making it possible to lock the picture on the screen and observe the effects of varying such things as charging capacitor, anode load, or HT volts.

Circuit Description

The output from the vision receiver is fed via a coaxial lead to the grid of V2 (EF50) with V1 acting as a DC restorer. It should be noted that an isolating capacitor of 0.1 μ F must be connected between the anode of the video amplifier and the coaxial line otherwise the HT volts from the receiver will be fed to the grid of the EF50.

V2 is a conventional phase inverter giving the positive going picture signals at the cathode and positive going sync. pulses at the anode. The cathode of V2 is connected via a 0.03 μ F (3kV) capacitor to the grid of the CRT. The positive going sync. pulses from the anode of V2 are fed via a fairly long time constant circuit to the grid of V3 which is the sync. separator. It is most important that the circuit constants given in the diagram are strictly adhered to otherwise poor separation will result giving very erratic lock to the picture.

Frame pulses are taken via a capacity dividing network to the screen of V4. This valve with its

associated components forms the frame generator. The repetition frequency is controlled by the time constant of the grid circuit, whilst the linearity is mainly affected by R10 and C18 and these components have been chosen to give as linear an output as possible, combined with suitable amplitude. VR6 controls the anode voltage and provides a suitable means of varying sawtooth amplitude which in turn controls the height of the picture.

V5/V6 combine to form the push-pull frame output stage and both valves are fitted with grid stoppers which should be connected directly to the valves. VR3 is used to balance the output to the two deflector plates and should be adjusted to give equal and opposite voltages at the anodes, although in the case of the circuit shown the waveforms are not quite identical due to the combination of VR2 and C21 which form a variable linearity control, allowing a wide change in linearity from the complete spreading out of the top of the picture to a fold over of nearly 33 per cent. The use of this control in conjunction with VR6 enables a perfectly linear frame scan to be obtained.

Returning to V3, line pulses are taken through a very small capacity C3 of 20 μ μ F to the screen of V7 which acts as the line generator. The only

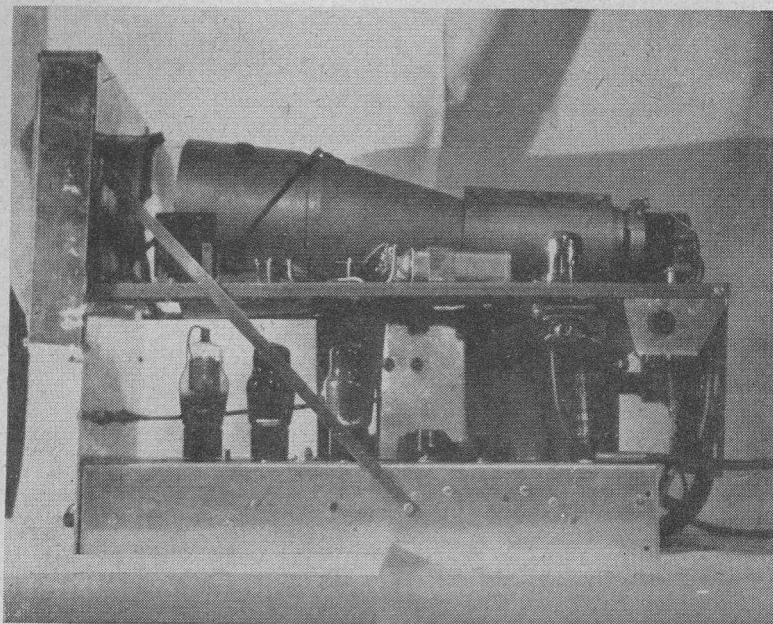

Side view of the unit. The three valves on the left are, respectively, V4, V5 and V6. Between V4 and V5 can be seen the spindle of VR6 and between V5 and V6 is VR2. To the right of V6 are the controls VR5 and VR7. The socket on the right (just below the top "deck") is for the EHT 1.5kV supply.

COMPONENTS LIST

Capacitors

Ref.	Capacity	Volts Working
C 1	0.5 μ F	350
C 2	0.1 μ F	350
C 3	50 μ F	350
C 4	0.5 μ F	350
C 5	0.05 μ F	350
C 6	1.0 μ F	350
C 7	0.001 μ F	350
C 8	0.1 μ F	350
C 9	50.0 μ F	50
C10	0.1 μ F	500
C11	0.1 μ F	600
C12	0.1 μ F	600
C13	500 μ F	350
C14	0.1 μ F	350
C15	0.002 μ F	350
C16	0.002 μ F	350
C17	0.1 μ F	350
C18	0.35 μ F	350
C19	0.01 μ F	600
C20	20 μ F	350
C21	2.0 μ F	400
C22	0.02 μ F	350
C23	0.01 μ F	600
C25	0.1 μ F	350
C26	8.0 μ F	550
C29	8.0 μ F	500

Variable Capacitors

V C1 3-10 μ F air dielectric.

Transformers

T1. Line Oscillator transformer

T2. Frame Oscillator transformer

Values

Ref.	Type	Function
V1	EA50	DC Restorer
V2	EF50	Phase inverter
V3	6J7	Sync. separator
V4	6J7	Frame generator
V5	6J5	Frame amplifier
V6	6J5	" "
V7	6J7	Line generator
V8	6J5	Line amplifier
V9	6J5	" "

CRT. 5CP1

Resistors

Ref.	Value	Rating
R 1	1M Ω	$\frac{1}{4}$ w
R 2	3.3K Ω	$\frac{1}{4}$ w
R 3	3.3K Ω	$\frac{1}{4}$ w
R 4	2.2M Ω	$\frac{1}{4}$ w
R 5	1M Ω	$\frac{1}{4}$ w
R 6	15K Ω	$\frac{1}{4}$ w

Potentiometers

Ref.	Function	Value
VR1	Frame hold	330K
VR2	Frame linearity	1M
VR3	Frame amp. balance	500K
VR5	Line amplitude (width)	1M
VR6	Frame amplitude (height)	1M
VR7	Line linearity	200K
VR8	Line Hold	50K

R 7	15K Ω	$\frac{1}{2}$ w	R20	47K Ω	$\frac{1}{4}$ w
R 8	5K Ω	$\frac{1}{2}$ w	R21	470K Ω	$\frac{1}{4}$ w
R 9	100K Ω	$\frac{1}{4}$ w	R22	100K Ω	$\frac{1}{4}$ w
R10	1M Ω	$\frac{1}{4}$ w	R23	1M Ω	$\frac{1}{4}$ w
R11	100K Ω	$\frac{1}{4}$ w	R24	500 Ω	$\frac{1}{4}$ w
R12	1M Ω	$\frac{1}{4}$ w	R25	1M Ω	$\frac{1}{4}$ w
R13	500 Ω	$\frac{1}{4}$ w	R26	100K Ω	1w
R14	125K Ω	1w	R27	100K Ω	1w
R15	4.7M Ω	$\frac{1}{4}$ w	R28	5K Ω	$\frac{1}{2}$ w
R16	500 Ω	$\frac{1}{4}$ w	R29	500 Ω	$\frac{1}{4}$ w
R17	5K Ω	$\frac{1}{2}$ w	R30	5K Ω	$\frac{1}{2}$ w
R18	125K Ω	1w	R46	10K Ω	1w
R19	2.2K Ω	$\frac{1}{4}$ w	R47	4.7K Ω	1w

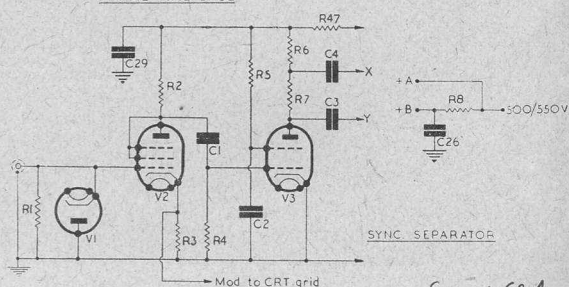
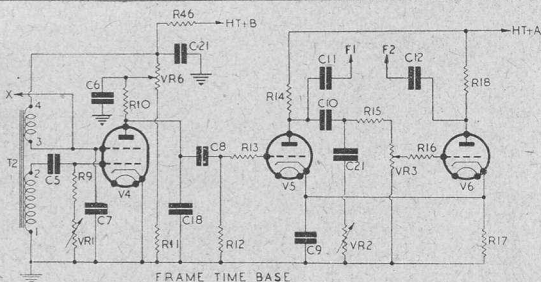

See p 94

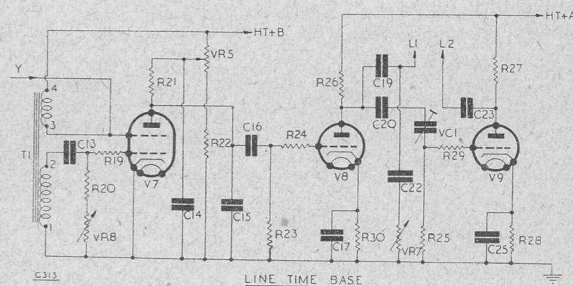

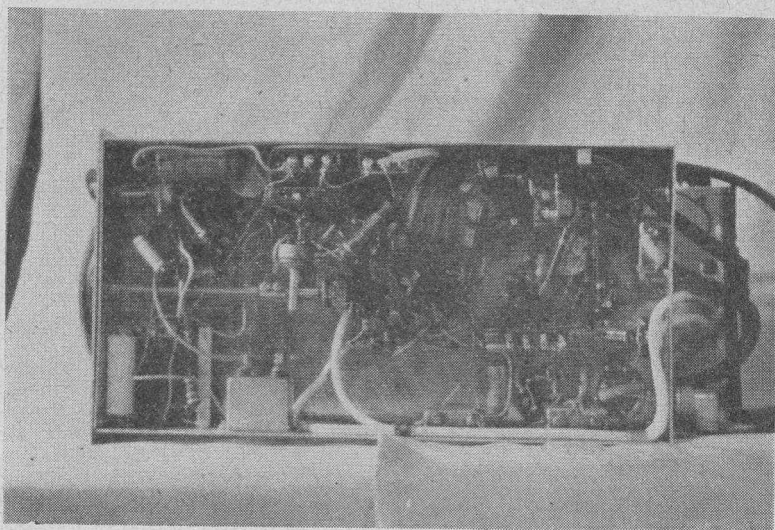

Underchassis view of the vision unit.

difference between the line time base and the frame time base, apart from circuit constants, is the method of coupling V8 and V9.

Owing to the fact that to obtain sharp flyback it is necessary for the amplifiers to handle up to at least the 10th harmonic of the sawtooth in question, the use of a resistive network is unsuitable, therefore a potential divider consisting of VC1 and the grid cathode impedance of the valve

(V9) is used, R25 forming the DC return for the grid.

Linearity of the line time base is affected in the same way as the frame linearity, and picture width can be conveniently set up by using VR7 in conjunction with the amplitude control VR5.

The CRT network may appear to be rather unorthodox but this circuit was adopted to overcome the necessity for using high voltage cap-

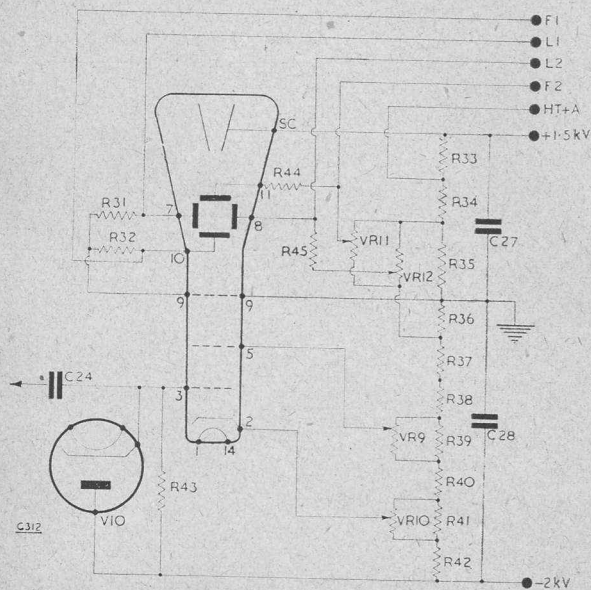

The CRT Network

Component Values

C24, 0.03 μ F, 2,500V wkg.

C27, 0.5 μ F, 2,000V wkg.

C28, 0.1 μ F, 2,500V wkg.

R31, 1 M Ω , $\frac{1}{4}$ watt.

R32, 1 M Ω , $\frac{1}{4}$ watt.

R33, 1 M Ω , 1 watt.

R34, 470,000 Ω , $\frac{1}{2}$ watt.

R35, 220,000 Ω , $\frac{1}{2}$ watt.

R36, 220,000 Ω , $\frac{1}{2}$ watt.

R37, 500,000 Ω , $\frac{1}{2}$ watt.

R38, 500,000 Ω , $\frac{1}{2}$ watt.

R39, 680,000 Ω , $\frac{1}{4}$ watt.

R40, 220,000 Ω , $\frac{1}{2}$ watt.

R41, 680,000 Ω , $\frac{1}{4}$ watt.

R42, 20,000 Ω , $\frac{1}{4}$ watt.

R43, 1 M Ω , $\frac{1}{4}$ watt.

R44, 1 M Ω , $\frac{1}{4}$ watt.

R45, 1 M Ω , $\frac{1}{4}$ watt.

VR9 Focus 1 M Ω , with insulating mounting.

VR10 Brilliance 1 M Ω , with insulating mounting.

VR11 Vertical centering 1 M Ω , Preset

VR12 Horizontal centering 1 M Ω , Preset.

V10 6H6 DC Restorer.

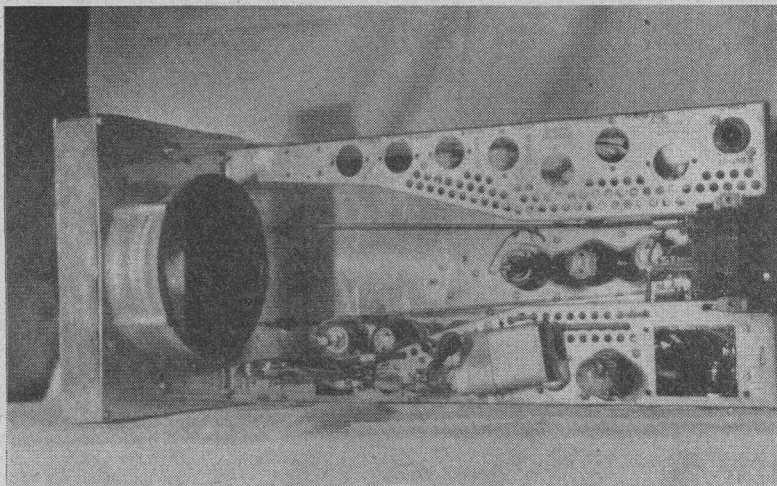

Top view of the unit. The three valves along the centre (right) are V7, V8 and V9 respectively. The valve below V8 is V10, to the left of which can be seen C27. In the top right-hand corner can be seen the EHT 2kV socket.

acitors for the deflector plate coupling. The author uses 600V Sprague capacitors for this purpose and they are quite satisfactory. C24 can be much higher capacity if required but must not be less than 2.5 kV working. It will be noticed that the normal 500 V HT line is connected to the CRT network at the junction of R33, R34. The object of this was to enable the circuit to operate with only the -2 kV line connected. This was included with the object that some constructors may have on hand a 2,000 V supply and would not wish to go to the expense of obtaining a higher voltage power pack. The 6H6 DC restorer V10 should be mounted on an insulated panel. If the constructor uses the Loran indicator the socket for this valve is already mounted but it must be remembered that the heater supply for this valve and the CRT must have sufficient insulation to withstand the full EHT voltage.

Practical Layout

Although the author does not intend to go fully into the actual mechanical construction of his unit, because usually constructors prefer to use such chassis and panels as they may have on hand, it might perhaps be of assistance to those contemplating building their units from scratch to have some ideas on layout.

A standard 14" x 8" x 2 1/4" aluminium chassis with a 16 swg 14" x 9" panel bolted upright on the end is used as the basis of the design.

Mounted on the panel by means of four 1 1/2" x 3/8" bushes is a small sub panel of 8" x 9", this has a square cut in the centre and forms the mounting for the magnifier. A 5" dia. hole is cut into the main panel and in this is fitted the CRT mask

removed from the Loran unit. The complete upper decks from the Loran are also removed and fitted to the chassis to form the remainder of the tube mounting structure, they are also used to mount the DC restorer diode V10 and the CRT network. The Brilliance and Focus controls are mounted on a small bracket at the back of the unit and the controls extended by means of flexible drives to the front panel. The whole of the EHT circuits are mounted at the back of the unit and are protected by a paxolin panel affixed to the rear of the upper deck structure and supported at the base by a small aluminium bracket. This paxolin panel forms a convenient mounting medium for the shift networks and the CRT grid coupling capacitors.

This equipment can be used quite satisfactorily in conjunction with a modified R1355 receiver and is capable of giving pictures of excellent definition. It is entirely constructed of Government surplus components with the exception of the chassis panel, magnifier and the Blocking Oscillator transformers.* However, those who do not wish to go to the trouble of drilling and punching a new chassis, can quite conveniently use the original Loran unit chassis with practically no structural alterations.

*The transformers finally used in this unit for the time base oscillators are the "counting down" transformers which are mounted down one side of the upper deck support on the "Loran" Indicator chassis. These were found to be vastly superior to the ordinary LF types formally used. Any two of the four transformers may be used. Connections are shown on the circuit diagrams.

Query Corner

A "Radio Constructor" service for readers

Pick-Up with R1155

"I have an R1155 receiver to which I have added an output stage and power supply. Can you please tell me the best method of connecting a gramophone pick-up to this modified receiver?"

A. G. Dunnett, S.E.6.

A gramophone pick-up may be satisfactorily employed with this receiver and in order to obtain sufficient amplification its output should be fed into the grid circuit of the VR101, the triode section of which is used for audio amplification. The conversion is a simple one as its only a matter of locating the volume control and connecting the gramophone switch to it as shown in Fig. 1. The volume control may be located by tracing the lead from the top cap of the VR101 to its sliding contact. Having found the volume control it is then necessary to remove the lead from its left hand contact (when viewed from the front) and take this lead to the gramophone switch. Reference to the circuit diagram should make the remainder of the connections quite clear.

Satisfactory results may be obtained when using the receiver in the manner suggested with any standard type of high impedance moving iron pick-up. Connection to the pick-up should be made by means of a length of screened cable, the screen of which is used for the earth connection. If trouble is experienced due to interference generated by the electric gramophone motor this may generally be cured by earthing the motor casing to the screen of the connecting cable.

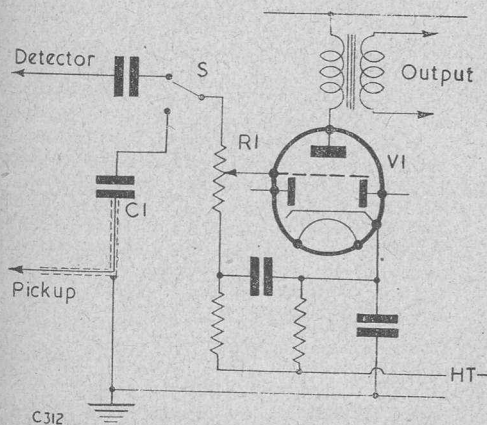

Fig. 1. Pick-up with R1155. The only additional components are the switch and C1 (0.2 μ F). R1 is the 0.5 M Ω volume control and V1 is the VR101 (DL63).

CRT for Television

"Would you please tell me whether or not the VCR517 is suitable for use in place of the VCR97 in the Inexpensive Television Receiver?"

K. A. Wilson, S.W.15.

There are a large number of surplus cathode ray tubes of the type VCR517 on the market at present, and a number of readers have written to ask if they are suitable for use in a television receiver. The electrical characteristics of this tube are similar to those of the VCR97, but unlike the VCR97, the VCR517 has a long persistence type of screen. This means that after the electron beam has been switched off, the trace remains visible upon the screen for several seconds. This persistence will obviously cause an appreciable loss of definition when moving objects appear on the television screen. The VCR517 was manufactured during the war years with different types of screens, the type being indicated by an additional letter A, B, etc., after the type number. Of the two tubes readily obtainable at present, the VCR517A gives very poor television definition, but the VCR517B provides a passably good picture. We strongly recommend, however, that in order to take full advantage of the definition obtainable from the "Inexpensive Television" receiver, a VCR97 should be employed.

Barretters

"It has become necessary to replace the barretter in my AC/DC receiver but the original type is no longer procurable. Will any barretter having the same filament current rating be suitable, or would you suggest that I use a voltage dropping resistor?"

J. Litch, Caithness.

A barretter is a form of ballast lamp used for the purpose of dropping the excess voltage in the heater circuits of AC/DC receivers. By careful choice of the type of wire used for the barretter filament, it is possible to obtain a current/voltage characteristic which is substantially flat over the working voltage range. Fig. 2 shows a typical barretter characteristic curve in which the working voltage range is between 80 and 170 volts at 0.3 amp. If the voltage across this particular barretter exceeds 170 volts the filament current will increase and the filament will most probably fracture. On the other hand if the voltage falls below 80 volts the

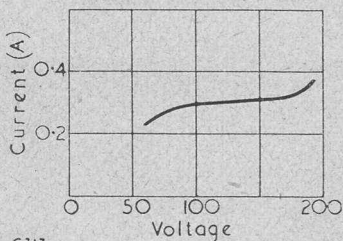

Fig. 2. Typical barretter characteristic curve.

filament current will fall below 0.3 amps with consequential under running of the valve heaters.

It will be appreciated from the foregoing that when replacing a barretter by one of a different type the working voltage range as well as the current must be considered. The voltage across a barretter will be the difference between the main supply voltage and the total of the valve heater voltages, and should be somewhere near the centre of the working voltage range of the barretter. In the example chosen this will be between 100 and 150 volts, which allows about 20 volts on either end of the voltage range for fluctuations in mains voltage which might otherwise result in the over-running or under-running of the barretter.

Of recent years the use of the barretter has become less popular in receivers. This fact may be largely contributed to its relatively high cost when compared with that of a dropping resistor. However, a dropping resistor has not the same stabilising effect upon the valve heater current as has a barretter. Thus it is necessary when using a resistor to provide a number of tapping points on it in order that the heater current of the valves may be kept within reasonable bounds over a range of main supply voltages. For receivers designed to work on mains voltages of between 200 and 250 volts it is sufficient to provide three tapping points on the resistor for voltages between 200 to 215 V, 215 to 230 V, and 230 to 250 V. This means that as the first tap is provided for voltages between 200 and 215 the total resistance

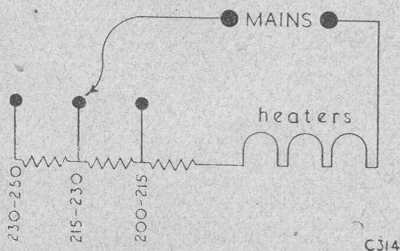

Fig. 3. Mains dropping resistor in circuit, showing suitable tapping points.

“Query Corner” Rules

- (1) A nominal fee of 1/- will be made for each query.
- (2) Queries on any subject relating to technical radio or electrical matters will be accepted, though it will not be possible to provide complete circuit diagrams for the more complex receivers, transmitters and the like.
- (3) Complete circuits of equipment may be submitted to us before construction is commenced. This will ensure that component values are correct and that the circuit is theoretically sound.
- (4) All queries will receive critical scrutiny and replies will be as comprehensive as possible.
- (5) Correspondence to be addressed to “Query Corner,” Radio Constructor, 57, Maida Vale, Paddington, London, W.9.
- (6) A selection of those queries with the more general interest will be reproduced in these pages each month.

in circuit between this tap and the valve heaters should be such that the correct heater current will flow when a voltage of 207.5 V is applied to the tap. This voltage is, of course, midway between 200 and 215 V. A similar procedure should be adopted when calculating the position of the other taps. No trouble should be experienced in calculating the actual value of resistance as our old friend Ohms Law

$$R = \frac{V}{I}$$

may be called to our assistance.

One final point, which is not always apparent by those who are making their first AC/DC receiver, and that is, all the valves must have the same heater current unless it is intended to make use of shunting resistors.

ANSWERS TO QUIZ

- (1) Right. Large capacitors in the power pack and decoupling circuits may retain a charge for some time after switching off.
- (2) Yes. Without the “reflected” impedance of the speaker, the primary of the output transformer presents hardly any load to the valve which will be seriously damaged, or destroyed.
- (3) Amplification Factor, or rate of change of anode voltage for a given change in grid voltage.
- (4) Highly selective tuned circuits pass only a narrow band of frequencies and result in loss of sidebands representing the higher audio frequencies. Consequently reproduction lacks “top,” essential for high fidelity.
- (5) 4BA.
- (6) Wrong. The diode is frequently guilty of distortion, particularly at low signal levels.

Bench Measuring Instrument

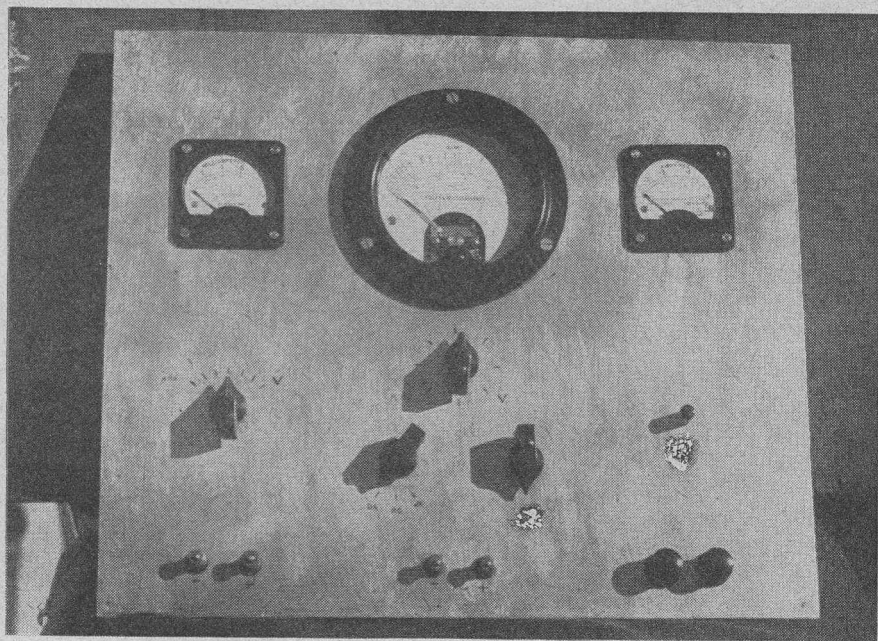

By EDWIN N. BRADLEY, A.I.P.R.E.

DURING recent design work on a series of new amateur transmitters the writer soon found that a single analyser or multimeter required considerable supplementary gear in order that voltage and current measurements might be made concurrently, and since a second multimeter was not to hand an ordinary 0—1 mA instrument, fitted with a suitable shunt or multiplier, was employed. At the same time it was necessary to keep a check on the output power into a dummy load, a thermo-ammeter being used for this purpose, and the resulting array of instruments, wires and spare shunts and multipliers soon became both formidable and dangerous. It was considered wise to stop work sufficiently long to build up a three-way bench meter which would contain three measuring instruments capable of covering ranges and applications useful not only in transmitter design work but of service also in receiver design and repair applications and for general experimental work, and the three-part circuit shown in Fig. 1 was the result.

The first circuit is a fairly comprehensive multimeter with a basic sensitivity of 1,000 ohms per volt. Over 11 ranges the meter covers full-scale readings of 1, 10, 100 and 1,000 mA's DC: 1, 10,

100 and 1,000 volts DC, and 10, 100 and 1,000 volts AC. By the use of precision resistors accuracies of 1 per cent on DC and 2 to 3 per cent on AC are easily attained.

The second circuit is a more sensitive though simplified version of the first. A moving coil instrument with a sensitivity of 10,000 ohms per volt (a 100 microamps instrument) is fitted with switched shunts and multipliers to give, over 9 ranges, full scale readings of 0.1, 1, 10 and 100 mA's DC, and 0.1, 1, 10, 100 and 1,000 volts DC. No AC volts ranges are needed on this circuit.

It will be noted that the first meter circuit provides no facilities for measuring alternating current, although AC volts are catered for. This is for the reason that a current transformer is awkward to make and not easy to obtain, whilst it is of use only on the frequency for which it is designed—i.e., for the mains frequency of 50 cps in the vast majority of cases. Alternating currents at all frequencies are measured with far greater convenience by the third meter circuit which utilises a thermo-ammeter with a basic range of 0.5 amp, such meters being in wide supply.

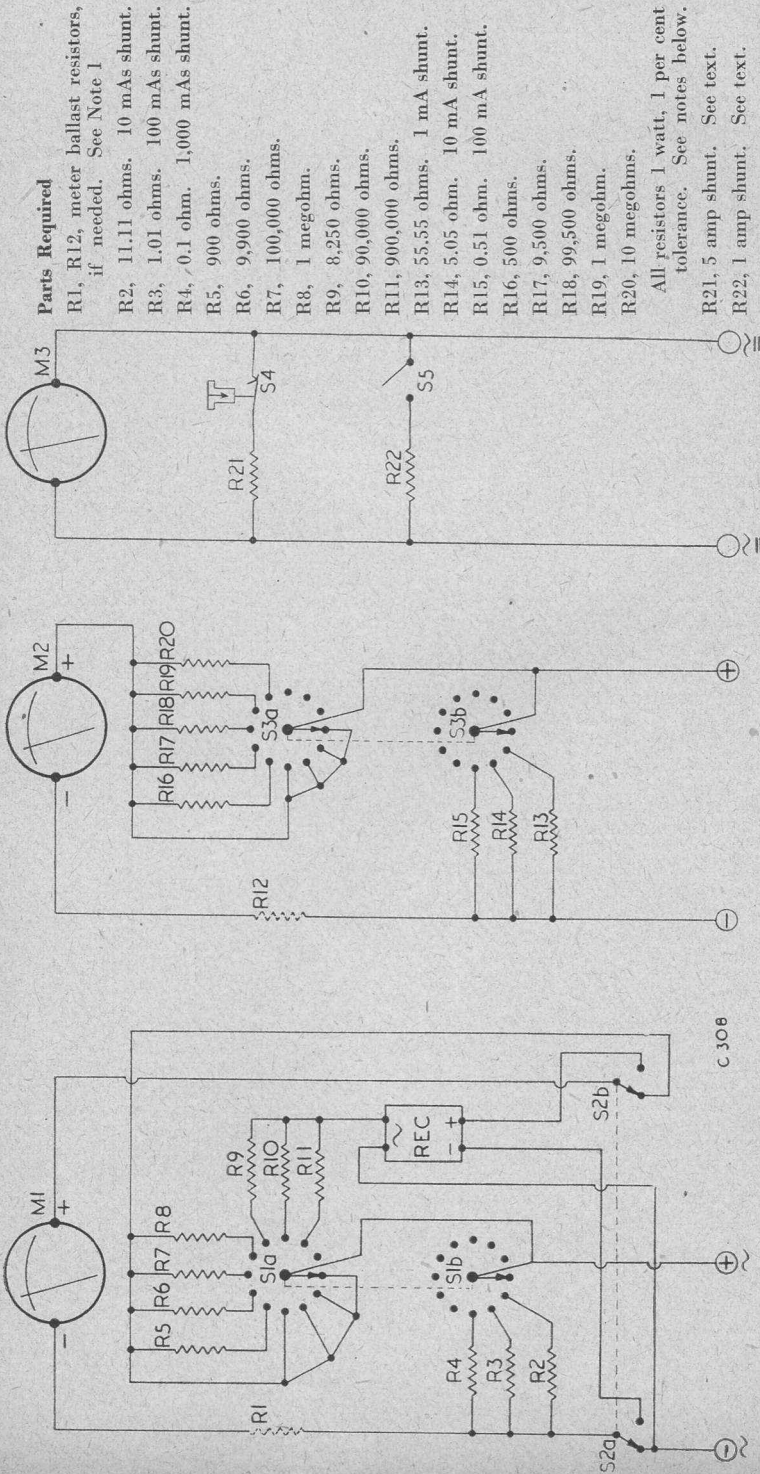

Parts Required

- R1, R12, meter ballast resistors, if needed. See Note 1
- R2, 11.11 ohms. 10 mAs shunt.
- R3, 1.01 ohms. 100 mAs shunt.
- R4, 0.1 ohm. 1,000 mAs shunt.
- R5, 900 ohms.
- R6, 9,900 ohms.
- R7, 100,000 ohms.
- R8, 1 megohm.
- R9, 8,250 ohms.
- R10, 90,000 ohms.
- R11, 900,000 ohms.
- R13, 55.55 ohms. 1 mA shunt.
- R14, 5.05 ohm. 10 mA shunt.
- R15, 0.51 ohm. 100 mA shunt.
- R16, 500 ohms.
- R17, 9,500 ohms.
- R18, 99,500 ohms.
- R19, 1 megohm.
- R20, 10 megohms.

All resistors 1 watt, 1 per cent tolerance. See notes below.

- R21, 5 amp shunt. See text.
- R22, 1 amp shunt. See text.

- Rec, 1 mA instrument rectifier, Westinghouse.
- 6 Input terminals.
- Aluminium mounting panel, 12" x 12" with back supporting frame of wood.
- Wire, sleeving, etc.
- 3 control knobs.

M1, 0-1 mA, 100 ohms moving coil instrument.

M2, 100 microamps, 500 ohms moving coil instrument.

M3, 0-0.5 amp thermo-ammeter.

S1a, b, 2 pole 12 way rotary selector switch.

S2a, b, 2 pole 2 way rotary selector switch.

S3a, b, 2 pole 12 way rotary selector switch.

S4, Press-to-break switch. See text.

S5, On-off toggle switch.

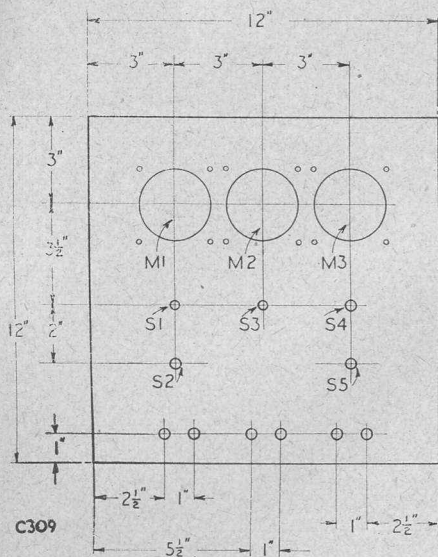

Fig. 2. Sketch showing panel drilling dimensions. The layout is a suggestion, arising from the original model.

Many constructors can fit such a meter as it stands without any shunting or protective devices, for their test requirements will be no more than checking 0.2 and 0.3 amp heater circuits on AC/DC receivers, but where a thermo-ammeter is to be used over a wide range of applications, especially where the magnitude of the current is not easily assessable, a thermo-ammeter should be protected by a shunt. This is particularly so when, as in the writer's case, the meter is to be used for RF output measurements, when the current will depend both on the transmitter output and the characteristics of the loading circuit. The thermo-ammeter is therefore fitted, in the original instrument, with two shunts, one connected in via spring contacts so that the shunt is only removed from circuit, and full instrument sensitivity attained, by depressing a plunger. This shunt is made to give a 10 times multiplication to the ammeter range, so that until the plunger is depressed the meter reads 5 amps full scale.

Besides this shunt, which is both protective and a range extending device, a 2 times shunt is provided with a shunt switch of the normal type. The thermo-ammeter thus reads over the ranges 0-0.5 amp, 0-1 amp and 0-5 amps. The readings are substantially correct for frequencies from 50 cps up to amateur frequencies; the tendency is for the reading to increase as frequency is increased but at very high frequencies the error is no more than about 20 per cent, whilst at normal amateur frequencies the reading may be taken as accurate.

Some constructors may be misled by the scale marking on many surplus thermo-ammeters, "For Use on RF Only." It can be said that practically every thermo-ammeter of the 0.5 amp type was checked and calibrated, during manufacture, on a frequency of 50 cps and the scale legend can be ignored.

Remember, too, that thermo-ammeters will read direct current over the same ranges with equal accuracy. The heating effects of DC and sinusoidal AC are equal.

Applications

With the three instruments and their associated circuits mounted side by side on a portable bench rack in the manner to be described, making readings and measurements on all types of apparatus becomes pleasantly simplified. When only single readings are needed the first circuit is brought into action; this section of the whole instrument is ideally suited for measurements on faulty receivers, checking, battery testing, maintenance work and all the normal applications of circuit analysers and multimeters.

Circuit 2, with its higher sensitivity, is ideal for voltage measuring at the anodes of audio-frequency pentodes and for similar applications where low power demands are of great importance, but when sections 1 and 2 of the instrument are used together it is possible to make voltage and current checks concurrently. As one example of the possibilities of the unit it may be pointed out that resistors can be measured in circuit by using section 1 of the meter to measure current through the resistor whilst section 2, connected across the resistor, measures the voltage drop across the component. By Ohm's Law the resistance is then given as:—

$$R = \frac{1,000V}{I}$$

where R is in ohms, V is the voltage measured by section 2 and I is the current indicated by section 1.

Many other applications will come immediately to mind.

Note 1. R1 and R12 may or may not be needed, depending on the internal resistances of M1 and M2. The shunt values given in the parts list above are calculated for an internal resistance of M1 of 100 ohms and an internal resistance of M2 of 500 ohms. Instruments with such resistances are quite widely obtainable, and, although the supply fluctuates a great deal, it is often possible to obtain shunts of the prescribed values from retailers advertising in this magazine. If instruments with internal resistances lower than those quoted are used the instrument resistance can be brought up to the required values of 100 and 500 ohms. The values of R1 and R12 are obtained by measuring the meter resistances by one of the several methods recently described in these pages, subtracting this from the

Fig. 3. Showing the method of calibrating the 10 Volts AC range.

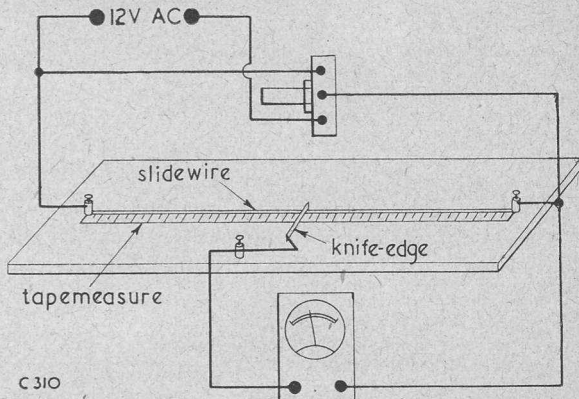

required value, and then making R1 and R12 equal to the difference in values. Adding R1 and R12 to the circuits does not, of course, alter the basic sensitivity of the respective moving coil instruments. What is changed is the voltage drop across the instrument together with its series resistor.

When M1 and M2 respectively have the correct values of 100 ohms and 500 ohms internal resistances, R1 and R12 are deleted from the circuits, and the connections are carried straight through. The use of instruments of higher internal resistance is not recommended, but if this course has to be taken, new shunt values for the various shunting resistors may be calculated from the formula:

$$S = \frac{M}{(X-1)}$$

where X is the factor by which the basic instrument range is to be multiplied, S is the required shunt resistance and M is the internal resistance of the instrument used.

Note 2. As with the shunt resistors, the various multiplier resistors may be obtained from advertisers. The values given in the parts list are the final requirements and in some cases it may be necessary to build up these values from two resistors in series. A wide variety of 1 per cent resistor values is obtainable, however, and the constructor is advised to contact a retailer who specialises in high accuracy components.

Note 3. The constructor who requires accuracies of less than 1 per cent can make a very useful measuring instrument using 5 per cent resistors which at present are in very wide supply, and are found even in cheap lots of new surplus resistors. Resistors of 5 per cent accuracy are coded with a gold band, tip or dot, and little trouble should be found in making up a set of resistances, accurate to within 5 per cent, corresponding with the values quoted above.

Note 4. R21 and R22 are made from resistance wire of heavy gauge by trial and error. A normal thermo-ammeter has an internal resistance of less than 1 ohm, so that the shunt resistors will be of the order of 0.1 ohm for R21 and 0.4 or 0.5 ohm for R22. To make R21, connect the thermo-ammeter in series with a suitable rheostat and accumulator battery, and adjust the meter reading to full scale, 0.5 amp. (Ensure, before switching on, that there is sufficient resistance in the circuit to prevent the instrument's being overloaded and burnt-out.) With the ammeter at full scale, connect a short length of stout resistance wire across the terminals; the reading will fall. Adjust the length of the wire so that the reading falls to 0.05 amp; the meter scale is then multiplied by 10 and the length of wire required makes the 10 times shunt.

The 2 times shunt is made in the same manner, the wire length in this case being adjusted to bring the meter reading from 0.5 amp to 0.25 amp.

These two shunts should not be wound into spirals, but should be left as straight wires. A spiral, at the higher frequencies, would present sufficient inductance to cause considerable error in the readings.

Note 5. The press-to-break switch was made, in the prototype, from the contacts of a heavy duty relay. These were mounted behind the panel so that normally they assumed the on position, a simple plunger taken from a press button switch breaking the contacts when depressed. No details are shown since there are several ready-made switches capable of performing this function.

All the switches used in the apparatus must be of high quality with sound, heavy contacts. Poor contact in the shunt circuits would introduce a variable switch resistance, and the accuracy of the current readings would suffer very considerably. A toggle switch for S5 may be used since a relatively heavy current flows through this shunt and good contact under heavy current conditions is more readily obtained than in light current circuits.

Construction

The panel size and drilling is shown in Fig. 2, where the instrument holes suit the normal $2\frac{1}{2}''$ type of instrument. Larger instruments will call for larger panel holes. The holes are cut with a tank cutter.

For convenience in reading the panel slopes back at an angle of 45° although constructors should check this angle before making the wooden framework as they may find a different angle more suited both to the height of their benches and to their own size. For protection and to exclude dust, the framework should be enclosed with plywood; if desired, of course, the whole casing may be made from sheet aluminium and the wooden framework discarded.

Resistors are mounted directly across switch contacts with a tie-point where necessary. When soldering 1 per cent resistors keep the component wires sufficiently long in order that they may be gripped between the soldered joint and the body of the resistor by a pair of broad-nosed pliers. This keeps heat away from the resistor itself.

Handle the rectifier with care, and mount it by a long 6 or 8BA bolt to the rear of the panel. Avoid straining the flex leads from the rectifier; should one of these leads be broken off it must on no account be sweated back to its lug as the application of heat would ruin the rectifier. A reading would still be obtained on AC but the accuracy of the instrument would be gravely impaired. A broken wire must be wrapped on to its lug.

Calibration

Only one range of the whole instrument needs calibration; the 10 volts AC range of section 1. With the specified resistance of 8,250 ohms the meter will read 10 volts at full-scale deflection, but as the reading falls down the scale linearity is lost. A conversion chart, showing AC readings in terms of the DC scale markings is easily made, however, employing the method shown in Fig. 3.

Two 6 volt windings on a normal mains transformer (or the 6 and 5 volt windings on a small transformer) are connected in series to give 11 or 12 volts AC output. The voltage should be checked with a 12 volt lamp to ensure that the windings are connected in the correct sense. A potentiometer, slide wire and the instrument switched to the 10 volts AC range are then connected up as shown in Fig. 3. The slide wire is held between two terminals screwed into a length of board and should be made of exactly 60 inches of resistance wire. The final resistance of the wire is of little importance provided that it can carry the current due to 10 volts across its ends; the length of the wire is the important factor. A wire resistance of between 10 and 20 ohms is satisfactory.

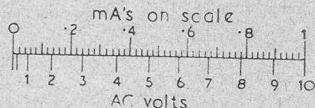

Fig. 4. Specimen conversion chart for 10 Volts AC range.

Beside the resistance wire is mounted a tape measure so that the wire can be measured accurately along its length. A third terminal carries a stout flex lead with a knife-edge at its end—a razor blade is suitable as the knife-edge—and the instrument to be calibrated is connected between one end of the wire and the knife-edge.

First connect the instrument right across the resistance wire and, by rotating the potentiometer (which should be of the 30 ohms high current type found in most junk boxes), set the instrument to its full-scale reading. The value of R9 is chosen to make this reading 10 volts with fair accuracy.

Now slide the knife-edge down the wire; the voltage reading will fall and, since there are 10 volts across the 60 inches of wire, the fall in voltage will be 1 volt per each 6". The instrument may thus be calibrated as 9 volts at 6", 8 volts at 12", 7 volts at 18" and so on, with further smaller divisions as required. ($\frac{1}{2}$ volt per 3", $\frac{1}{4}$ volt per 1½", etc.)

Note the actual scale reading for each applied voltage, and draw up a conversion chart as shown in Fig. 4. (This chart is a specimen only, and should not be used for actual measurements; each instrument will require its own chart made to suit its own characteristics.)

The make measurements on the 10 volts AC range, once the chart is made, it is only necessary to note the scale reading on the instrument and to convert this to volts AC, on the chart.

The 100 volts AC and 1,000 volts AC ranges of section 1 may be taken as linear, and AC voltages on these ranges read directly from the instrument scale.

Using the Instrument

One or two precautions are necessary concerning the use of the instrument.

Never apply AC to section 1 unless S1 is in positions 9, 10 or 11, with S2 in the AC position. Failure to observe this ruling may result in damage to the instrument or rectifier.

Use great care when measuring with section 2 when S3 is in positions 1 and 5. The basic current and voltage ranges on this instrument are highly sensitive.

After using sections 1 and 2, always return the selector switches to the OFF positions and set S2 to the AC position. This safeguards the instruments and rectifier should the leads fall on to live lines or be connected into circuit before the correct ranges have been selected.

Always set for the correct range before connecting up.

Switch Codings

The ranges and switch positions for the whole instrument are as follows:—

S1a, b.			
Position 1.	0-1 mA	DC	
Position 2.	0-10 mA	"	
Position 3.	0-100 mA	"	
Position 4.	0-1,000 mA	"	S2 a, b.
Position 5.	0-1 Volt	"	Code:—
Position 6.	0-10 Volts	"	
Position 7.	0-100 Volts	"	DC. AC.
Position 8.	0-1,000 Volts	"	
Position 9.	0-10 Volts	AC	
Position 10.	0-100 Volts	"	
Position 11.	0-1,000 Volts	"	
Position 12.	OFF.		

S3a, b.

Position 1.	0-0.1 mA	DC
Position 2.	0-1 mA	"
Position 3.	0-10 mA	"
Position 4.	0-100 mA	"
Position 5.	0-0.1 Volt	"
Position 6.	0-1 Volt	"
Position 7.	0-10 Volts	"
Position 8.	0-100 Volts	"
Position 9.	0-1,000 Volts	"

Positions 10, 11, are available for further volts ranges if required.

Position 12. OFF.

S4. Code:— Depress for 0.5 amp. Normal. 5 amps.

S5. Code:— 1 amp with S4 depressed.

Trade Notes

TAYLOR PRICE REDUCTIONS

Following increased efficiency of production methods, Taylor Electrical Instruments Ltd., have made a series of price reductions of some of their most popular models of radio test equipment, the instruments affected being as set out below:—

Model	Old Price	New Price
70A	£11.11.0	£10.10.0
75A	£14.14.0	£14. 0.0
85A/P	£19.19.0	£18.10.0
85A/S	£18.18.0	£17.10.0
110B	£12.12.0	£11. 0.0

The above reductions came into force on April 1st.

THE MULLARD NEWS LETTER

The Transmitting and Industrial Valve Department of Mullard Electronic Products Ltd. have just issued the first of a series of "News-Letters" designed for the information of valve users.

The News Letter is intended to provide a service of advance information in tabloid form pending the availability of more comprehensive literature. A further object is to enable valve users to select what current Mullard Technical Publications are of real interest to them.

Technical information, and news about new valve types for transmitting and industrial purposes will form the major contents of the sheet which will issue quarterly to begin with. Frequency of publication will increase if warranted by demand, supply of information, etc.

THE 200ft. COMMUNICATIONS TOWER AT G.E.C. RESEARCH LABORATORIES, WEMBLEY

The Research Laboratories of The General Electric Company, Ltd., are actively engaged on research and development in connection with long-distance VHF point-to-point communications. This has grown naturally from their leading part, during the war, in the development of valves and radar systems in the centimetric waveband. Present commitments include the London to Birmingham Radio Link for Television, on behalf of the G.P.O., and radio communications systems for the export market.

VHF waves are essentially optical in character and travel in straight lines resembling a searchlight. It is therefore necessary to avoid obstruction of the line of sight of the linkage path by hills, buildings or trees.

In order to provide such an optical path from the Wembley Research Laboratories a tower, 200 feet high, is being erected which will be suitable as the Wembley terminal of experimental radio links, enabling a large amount of apparatus there to form an essential part of such schemes. It will also be suitable for work on many other projects at very short radio wavelengths.

The tower is being designed and installed by Pirelli-General Cable Works, Ltd., to the requirements of the Research Laboratories. It is a lattice steel tower standing on a base 45 feet square, each corner leg being set in a reinforced concrete foundation ten feet square and eleven feet deep.

A passenger lift will give access to two cabins situated one above the other at the top of the tower. Each cabin will be octagonal, about eleven feet wide and will have an external balcony on which the very directional short wave aerials will be mounted. The cavity walls of the cabins will be thermally insulated and electrically screened. The external surfaces of the cabin walls will be galvanised and the windows in them will be of the ship's side-light type.

When completed the tower will provide a very valuable extension to the telecommunications facilities of the Wembley Laboratories.

LOGICAL FAULT FINDING

The fourth in a series of articles to assist the home constructor in tracing and curing faults

By J. R. DAVIES

4: INSTABILITY

WHAT do we mean by "instability"? If an oscillator does not remain oscillating reliably on one frequency it is said to be unstable. Also, if an amplifier has tendencies towards self-oscillation, that, as well, is a case of instability. In this section we shall take the second definition and treat the various cases in which instability in a receiver shows itself as self-oscillation (or near self-oscillation) in one or more of the amplifying stages. As we are looking for the causes of this oscillation, the whole problem boils down to the fact that somewhere in the receiver there is unwanted feedback. The problem is to find where that feedback is occurring and, of course, to eradicate it.

Before we start, we find that we can class the various types of instability under the following headings:—

1. **Instability in the RF or IF stages.** This applies to superhets. or to straight sets using one or more RF stages.
2. **Instability in the AF stages.** This may show up as howling, motor-boating, hissing or as any continuous note. In the case of near-oscillation it may be noticeable as distortion; in which case, a certain note or a certain volume of sound may cause the AF section of the receiver to burst into damped oscillations for a short space of time, so causing distortion. ("Threshold Howl" is discussed also in this section.)
3. **Instability wherein the feedback is maintained via an acoustic-mechanical path.**

1. Instability in the RF or IF stages

Instability occurring in the IF or RF stages of a receiver is quite easy to diagnose. It occurs as a whistle when each station is tuned in; the whistle exactly resembling that of a regenerative detector with the regeneration too far advanced. It must not be confused with second channel whistles in a superhet which only show on certain stations in the band. In the case of RF instability, whistles may only appear on part of a band, but *all* those stations in that part of the band will have a whistle to them. Also, if the set is unstable on only one part of a band, it will be possible to hear the oscillation commence (in the form of a "plop" or a hiss) as the tuning capacitors travels over its range.

In addition, the note of a second-channel whistle changes twice as fast as that of an un-

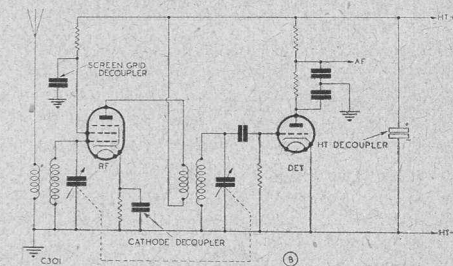
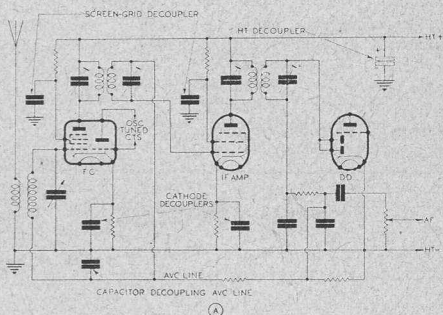

Fig. 8(a). RF and IF stages of a typical commercial superhet.

Fig. 8(b). RF and detector stage of a normal straight receiver.

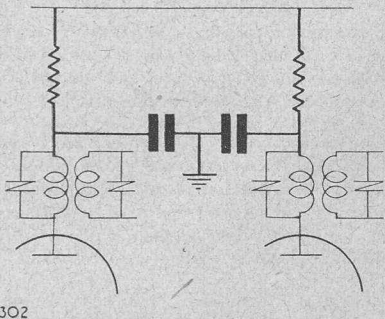

Fig. 8(c). Showing how additional anode decoupling components are fitted in some receivers (see text).

stable RF or IF amplifier, in proportion to the movement of the tuning capacitor.

The other main forms of whistle, "adjacent channel" and "IF harmonic," are treated in a later article under the heading of "Lack of Selectivity," and do not concern us here.

As was mentioned before, our job is to find out where and how the unwanted feedback is occurring. There are several paths through which the trouble may appear, and the order of probability of these paths is as follows:—

- (a) The case where feedback is carried by a common connection. By this is meant a connection common to various successive stages in an amplifier, such as an HT line; and which should be connected directly, or adequately by-passed to earth.
- (b) The case where feedback is capacitive,
- (c) The case where feedback is inductive,
- (d) The case of a badly-designed receiver where several compromises have to be reached to obtain stable working. These shall be considered under the heading—"Miscellaneous Causes."

(a) Feedback via a common connection (RF and IF)

Let us now treat the first case where feedback is due to a "common connection." Fig. 8 (a) and (b) show two typical circuits; Fig. 8 (a) that of the RF, IF and detector stages of the usual four-valve (plus rectifier) superhet as far as the AF stages, Fig. 8 (b) shows the RF and detector stages of a normal straight set. A reaction circuit is not shown in Fig. 8 (b); assuming that one is fitted to the receiver under test, the reaction control should be set to minimum. (When the cause of instability is discovered the reaction should then work quite normally.)

It will be seen, in the case of the superhet, that there are two main paths along which feedback may travel. They are the HT line and the AVC line. In the case of the straight set in Fig. 8 (b) there is only the HT line. In addition, insofar as the screen-grids of the IF and RF amplifier valves are common to both halves of an amplifying stage, then these also are to be considered as common links liable to cause trouble if not adequately decoupled. So also the cathodes¹. Our job, then, consists mainly of checking decoupling capacitors.

It is very common practise to allow one electrolytic capacitor across the HT supply to decouple

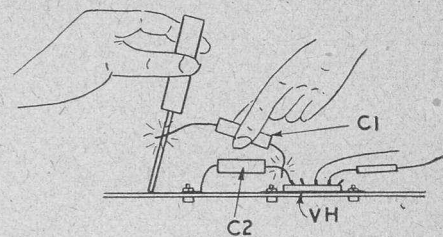

Fig. 9. A quick method of ascertaining whether or not a decoupling capacitor is open-circuit. C1 is the testing capacitor, C2 is the suspected capacitor, VH is the valveholder. (The metal-ended screwdriver makes contact with the metal chassis.)

all anode circuits in the receiver, and this should be the first component to be checked. Another capacitor of similar value should be connected across it to do this, using short leads. If the original electrolytic capacitor is proved serviceable, then all screen-grid and cathode by-pass capacitors should be tested by connecting an 0.1μF capacitor across each of them in turn. If the receiver is of a more expensive type, and especially if it is a "communications" model, it will almost certainly have individual anode decoupling as shown in Fig. 8 (c). These additional decoupling capacitors should be tested. Do not forget that, even if the trouble is IF instability, it is possible for the RF stage (if fitted) to pick up and amplify the IF frequency, injecting it into the frequency-changer. Therefore, it is best to play safe and check all decoupling capacitors, whether IF or RF.

The final capacitor to test (in the case of the superhet) is that decoupling the AVC line. (See Fig. 8 (a).) If, of course, more than one AVC capacitor is fitted, then those additional capacitors should also be checked.

The simplest and quickest way of checking a decoupling capacitor is shown in Fig. 9. This shows the chassis upside down. One side of the testing capacitor (an ordinary wire-ended component), is touched against that end of the capacitor under test which is away from the earthing tag on the chassis. The other end of the testing capacitor is then touched against the metal shaft of an ordinary small insulated screwdriver, the blade of which is pressed against the chassis at the nearest convenient point. If the chassis is plated or varnished it may be necessary to turn the screwdriver blade a little so as to scratch a good connection for itself.

The whole operation takes only a second or two, and, even in a complicated communications receiver, the isolation of a faulty decoupling capacitor should never take more than a quarter of an hour, unless the layout of the set is very crowded.

¹So also the cathodes." Although an un-by-passed cathode should give negative feedback and degeneration (thereby assisting stability); in practise, an un-by-passed RF or IF cathode may quite often cause oscillation. This is mainly due to phase shift in the amplifier and at the detector, and also because the cathode is liable to pick up stray RF voltages capacitively.

The above tests should be carried out with the set switched on and tuned to a station, the discovery of the faulty capacitor causing the cessation of the whistle and proper reception.

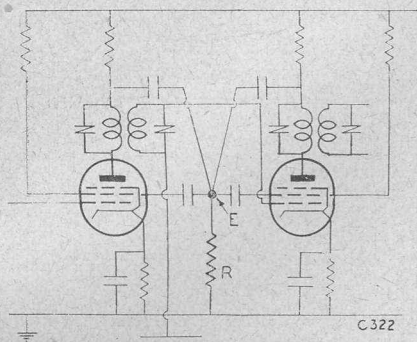

Fig. 10(a). Indicating how a badly connected earthing return, if for several circuits, may actually assist feedback. The feedback voltages, at different stages of amplification, are built up across the resistance "R," which represents the resistance of the joint. (E is the earth tag with high resistance joint.)

It will be realised that these checks on the decoupling capacitors are to ascertain whether or not they have lost their capacity or become open-circuit. If they were leaky or short-circuited, this could be found by means of the test-meter, but the symptoms in the set would be those of silence or weak reception, and not instability.

Another case where a common path for feedback may exist between two circuits happens when one earthing connection holds the decoupling returns for several circuits. See Fig. 10(a). If a bad connection to chassis exists at the common earthing point, it will be seen that, instead of decoupling the circuit, the common connection is actually assisting feedback. Another example of this trouble may occur when the

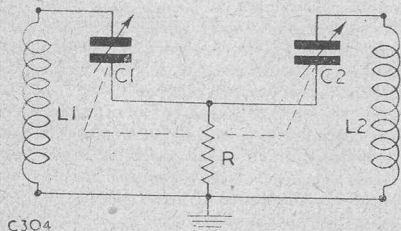

Fig. 10(b). The state of affairs that may exist if the rotor vanes are making bad contact to earth; the resistance "R" representing the bad connection. If the signals across L1 and C1 are amplified before being applied to L2 and C2, it can be seen that R provides a common impedance to the two circuits, thereby assisting oscillation.

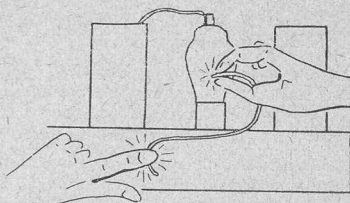

Fig. 11. A quick and reliable check of the effectiveness of the metalising of a valve (see text).

moving vanes of a tuning capacitor are not making a good connection to the frame. Fig. 10(b) shows the state of affairs that can occur if the rotor vanes of the tuning capacitor make bad contact to earth; the resistance "R" representing the bad connection. If the signals across L1 C1 are amplified before being applied to L2 C2, it can be seen that "R" provides a common impedance to the two circuits, thereby assisting oscillation.

(b) Capacitive Feedback (RF and IF)

Let us now consider the case in which feedback is capacitive. This will almost always infer that some part of the screening in the set has become defective. If the valves in the set are of the metallised type, the connection of the metallising to earth should be checked. This should not be done with a resistance meter, but whilst the set is working, using the following method. Fig. 11 gives the general idea. One end of a short length of wire is held to the chassis, ensuring that a good connection is made. With the other end the metallising of each individual valve is rubbed. If the metallising is not adequately connected to earth, the touch of the earthing wire will indicate this because the instability will then disappear. This test is quicker and more reliable than a simple continuity test between metallising and chassis. The rubbing contact is necessary because it may be difficult to make a good connection to the valve metallising, especially if the latter is a little oxydised and dirty. There is one word of warning, however. In the case of certain 2 volt battery valves, with which the metallising is taken to a filament leg, the screening of the valve may have a potential with respect to chassis. This point should be checked before the test is carried out.

If the valve metallising is not at fault, all the other screening cans and screened leads should be checked for good connections to earth. Wires carrying currents at RF potentials should not be allowed to run close to each other; and if they have become bent out of place they should be repositioned.

(c). Inductive Feedback (RF and IF)

Inductive feedback should never occur in a commercial receiver. This form of feedback is due to two or more tuned circuits coupling back to

(continued on next page)

INEXPENSIVE TELEVISION

Readers' Queries

As may be expected we receive various letters concerning our televisor. We are selecting a few for comment herewith which have a general interest.

P. Branham of Bradford suggests one or two modifications which may be more convenient in certain individual cases. He suggests that the VCR97 may be used with a positively earthed EHT supply, thus making it possible to couple the deflector plates via normal 350V working capacitors. In this case only the modulator (grid) will require a high voltage capacitor.

Positively earthed EHT supply allows the rectifier heater winding to be connected directly to the "hot" end of the EHT winding, thus removing the peak inverse stress from the transformer and reducing the risk of breakdown.

Coupling the modulator grid through a capacitor loses the DC level, but this can be restored by a diode inserted at the tube grid—the heater of which is fed from the CRT heater winding. The Brilliance and Focus controls will be at a high potential with respect to chassis and should therefore be well insulated.

G. F. Green of Leicester comments on the method of coupling two R1355 receivers to a common dipole. This aerial is fed with 80 Ω screen co-ax and the screening being earthed to each chassis. One feeder is taken to the sound receiver aerial terminal and the other to the vision receiver. The RF units are then aligned with the equipment in operation.

Sgt. Gray of R.E.M.E., Plymouth, whose home is in East Sheen, Surrey, is unfortunately on DC mains and wonders if it is possible to adapt the televisor to suit this supply. One point of interest is that by using SP61 (VR65) valves throughout in conjunction with 6X5 rectifier and 5CP1 CRT, and wiring the heaters in series, it should be possible to make an AC/DC version of the televisor. All the valves mentioned have a 0.6 amp heater. For the EHT, an RF oscillator supply may be used, (we will describe one in an early issue.) With AC/DC apparatus caution should be taken as the chassis will probably be "live."

E. Smith of Cleveland, Yorks., suffers from the effect of receiving 7 Mcs signals on the television sound and vision channels. We suggest that the offending signals may be local amateur transmitters operating on the 7 Mcs band (this frequency, of course, being approx. the IF of the R1355). Signals may also be entering via the RF stage due to local "blanketting." If the cause is definitely proved to be from amateur transmitters, a friendly visit should be paid to

the station (or stations) and we are sure that the operators will co-operate in every way.

We would also like to mention that it is possible to pick up B.B.C. signals in the 7 Mcs band if the receiver is operated minus the metal case as all the top caps of the valves in the IF stages are unscreened.

(FAULT FINDING—continued)

each other by means of mutual inductance. If the set has been designed to account for this feedback, it should never occur once the set has left the factory. However, if the screening on any of the coils has become broken or badly connected to chassis, inductive feedback may occur. The cure, of course, is simply to check all screening cans and partitions.

Nevertheless, on home constructed apparatus, inductive feedback may occur due to bad design. This form of instability can be reduced by judicious screening, by mounting coils with their axes at right angles to each other, or by mounting them further apart from each other.

OUR READERS WRITE—

I have an Idea, Sir . . .

Like me, you probably remember the gear that Noah had in the shack in the Ark. Unwieldy, and he got his best DX by a form of carrier-pigeon, but that gear had at least one artful, space-saving contrivance about it. Remember it? Yes, that's right, the old .001 capacitor, with a hollow shaft through which went a small shaft to the single rotor strung along at the back as an early bandspread device.

It saved space, and nowadays with small components we could do with some space-saving from the tuning-gear side. Can you drive it into some enterprising manufacturer's noddle that it would be a Murdoch idea (and it wouldn't Costa lot—ow!) to give us some similar up-to-date instrument. Why on earth should we have to put up with TWO dials when One could do? Two capacitors, bandspread and bandset, O.K., but let the two of 'em connect up to ONE dial, with hour-and-minute hands arrangement. I haven't seen such on sale, and I do look in the suppliers' windows and I have got Two eyes on my ONE dial.

Trusting you will let your readers know which manufacturer ONE DIALS to get this sort of gear, when said manufacturer has done his stuff and turned out the space-saver.

Yours cordially,

Malcolm Mackenzie
(London, W.2)

For Your Reading

MAGAZINES.

"Radio Constructor."

Published monthly and designed to cater for the home constructor, giving details of receivers, transmitters, test gear and other radio equipment. Price 1/3 monthly.

"Television News."

Published monthly for the viewer. *Television News* gives details of forthcoming programmes, criticisms of past features, articles on stars and personalities of television and details of the latest developments both at home and overseas. Essential to the keen viewer. Price 1/- monthly.

"Short Wave News."

The third of our magazines, catering for the "DX" fan. Up-to-date news of VHF, broadcast band and amateur activity are published in each issue in addition to constructional articles, exclusive news of the International Short Wave League, "visits" to ham shacks and other features of interest to the short wave enthusiast.

Price 1/3 monthly

These magazines are distributed through local book-sellers. A limited number of annual subscriptions can be accepted, but please write first for confirmation. Sample copies will be sent on request.

OTHER PUBLICATIONS.

The World Radio Handbook.

This beautifully produced handbook gives extensive information of interest to broadcasting station listeners. It includes details of all the chief broadcasting stations in the world, such as frequencies, call-signs, times of transmission, type of programme, the postal address, hints on identification and the stations attitude to listener reports. This veritable mine of information is a "must" for broadcast listeners.

Price 6/9 post paid.

"These You Can Hear."

This booklet, well illustrated and printed on art paper throughout, was published to afford an opportunity to those who had just decided to take up the hobby of SW listening. Containing information of how to tune in stations, when to listen, and details of many internationally known stations this booklet is ideal for those just starting the hobby and of great interest to those who have already been bitten by the bug.

Price 2/3 post paid

Data Booklet No. 1.

The first in this series, this booklet deals with the now famous "Basic Superhet." It describes the construction of the basic receiver and various "add-on" units which may be added when the basic receiver has been built. Full coil and valve details are given. Price 1/2 post paid

Data Booklet No. 2.

Now in its fifth printing *Inexpensive Television* needs little introduction to readers of this magazine. Have you had your copy yet?

Price 1/8 post paid.

AMALGAMATED SHORT WAVE PRESS LIMITED.

57, Maida Vale, Paddington, London, W.9.

Telephone: CUNningham 6579.

The Radio & Electrical Mart

(G3BSW) of 253B Portobello Road, London, W.11

PHONE : PARK 6026

Take pleasure in offering the following:

Type 22 Transmitter Receiver. 2 to 8 Mcs. We have a few left of this 13-valve ex-R.A.F. crystal controlled T/R. The sets are as new—tested—in canvas holdalls with 12V. Power Pack—Mike and Headphone Set. Price £15, and 10/- for wood case. Returnable.

Type BC605 U.S. Signals Amplifiers. These 15-watt sets are complete except for power supply in handsome duralumin cases—olive green finished and contain two 1619 metal valves—input and output tapped transformers—Carbon and Magnetic Mike Jacks. Price 50/-.

T17 Mikro for use with above. 10/-.
12V. Vibrator Power Pack, complete with pentode Audio Amplifier—in self-contained case. Bargain Price of 30/-.

R.A.F. Test Set Type 46. New Battery-operated Frequency Meter, 2 to 23.5 Mcs. Made by Marconi Instruments. Can be made all-wave by inclusion of MW and LW coils. 40/- each.

Mains Transformers. Input 110/250V. Output 400-0-400V. at 150 mils.. 6.3V. at 4 amps, 6.3V. at 2 amps, 5V. at 4 amps. 35/- and 2/6 carriage.

Mains Power Supply Unit. This neat and handy unit in black enamelled case, 9 x 6 x 6 in., contains heavy-duty transformer, rectifier valve, smoothing choke, condensers, panel light switch and fuses. Input 200/260V. A.C. Output 6.3V. at 3.5 amps. H.T. 350V. at 80 ma. Larger output available by changing rectifier valve. Price £3/5/-.

250-watt Double-Wound Transformers. 230V. 110V. Made by G.E.C. With steel shroud. New. £2/7/6 each.
R1132A. This grand 10-valve superhet, covering from 100 to 126 Mcs., is easily adapted to 144 Mcs. band by simply moving connections on tuning coils. Large slow-motion dials, "S" meter, etc. Case measures 20 x 12 x 12 in. Price £4/19/6 plus 10/- carriage and packing.

S
R
E
S

Southern Radio and Electrical Supplies,

85, Fisherton Street, Salisbury, Wilts
Telephone: Salisbury 2108

BRAND NEW EX-GOVT.

TELESCOPIC ROD AERIALS. Size 14½ x ¾ in. diam. extending to 7ft. 6in. Only 7½ oz. Ideal for car radio and beam aerials 6/9.
Coppered Rods. 12 x ¼ in. Any number may be joined. 3d. each.

CO-AXIAL CABLE. Heavy duty. 45in. diam. 80 ohms, 10d. yard. Any length supplied.

CO-AXIAL CONNECTORS. Pyetype plug and skt. Takes up to ¼ in. diam. cable 2/-.

Heavy duty to take up to ¼ in. diam. 3/-.

SW VARIABLE CONDENSERS. 20pF 2/6.
100pF 2/9. 18pF twin-gang 5/-.

100pF twin-gang, double-spaced vanes 9/6.

MORSE KEYS. Type 2 Mk 2 1/6 each.

KEY-FILTERS. Fit in each key lead 6d. each.

POTENTIOMETERS. Pre-set panel mounting, 250,000 ohms. Size 1 in. diam. x ¼ in. 1/6 each.

FREQUENCY METER. B.C. 906. 23.5 to 14.5 Mcs. Worth pounds. Only £2 each.

R.F. CHOKE UNITS. Heavy duty SW choke, .001mfd, 2,200V. test mica condenser. 10 meg, ¼ watt resistor 1/6.

VIBRATOR UNIT. 12V. input, 210V. 70ma output. Ideal for car radio, etc. 35/-.

Please include postage on orders under £2.

Our usual guarantee applies. Any item may be returned in seven days if not suitable.

Bargain List 3d. post free.

These are in Stock . . .

- INTRODUCTION TO TELEVISION** By A. Folwell 9s. 6d. postage 5d.
TELEVISION SIMPLY EXPLAINED By R. W. Hallows 9s. 6d. postage 5d.
TELEVISION RECEIVING EQUIPMENT By W. T. Cocking
 12s. 6d. postage 5d.
MODERN HOME-BUILT TELIVISOR By W. A. Flach and N. H. Bentley
 2s. 6d. postage 2d.
NEWNES TELEVISION MANUAL By F. J. Camm 7s. 6d. postage 6d.
TELEVISION EXPLAINED By W. E. Miller 3s. 6d. postage 2d.
PROBLEMS IN RADIO ENGINEERING By E. T. A. Rapson
 5s. 0d. postage 3d.
RADIO UPKEEP AND REPAIRS By A. T. Witts 7s. 6d. postage 5d.

We have the finest selection of British and American radio books. COMPLETE LISTS ON APPLICATION

THE MODERN BOOK CO.
 (Dept. R.C.) 19-23 PRAED STREET, LONDON, W.2

Ex-Govt. Valves from 3/6. Electrolytics 8 plus 16 Mfd 450 VDC 3/6, 16 plus 16 Mfd 450 VDC 3/6, 8 plus 16 plus 16 Mfd 450 VDC 3/6, 8 Mfd 500 VDC Dubilier 2/6, 16 plus 16 tubular 350 VDC 3/6. Speakers 2½ in. Philips 10/6, 6 in. R & A, less transformer 13/-, with transformer 15/-, 8 in. Truvox less transformer 16/6, 8 in. R & A with transformer 18/-, 10 in. Goodmans less transformer 19/6.

Trade enquiries welcomed, send stamp please for detailed bargain list, Money refunded immediately if not satisfied.

DUKE & CO.

(Dept. RCI)

219, ILFORD LANE,
 ILFORD 0295, ESSEX

METAL WORK

with a Difference !

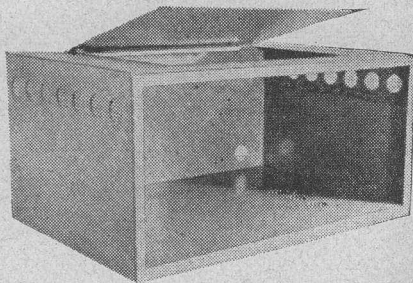

This is an example of gear which can be made to YOUR OWN dimensions and layout.

For full details and address of nearest agent, contact—

L. J. PHILPOTT (G4BI)
 (E. J. PHILPOTT)

Chapman St., Loughborough Tel.2864
 Leics.

SMALL ADVERTISEMENTS

Readers' small advertisements will be accepted at 2d. per word, minimum charge 2/-. Trade advertisements will be accepted at 6d. per word, minimum charge 6/-. If a Box Number is required, an additional charge of 1/- will be made. Terms: Cash with order. All copy must be in hand by the 10th of the month for insertion in the following month's issue.

PRIVATE

WANTED. The following valves required: Types KTW62, X66, DH63 and KT63.—Stonehaven, Horncastle Road, Boston, Lincs.

TAYLOR MODEL 47 A/P combined valve tester and universal test meter, in oak case, £16 nearest.—Pollock, Halebourne House, Chobham, Surrey.

MARCONI 10in. mains energised loudspeaker, complete with power pack, in strong wooden cabinet, for 240v AC input. Excellent quality and guaranteed O.K. 30/-. Rothermel senior model crystal pick-up, recently overhauled by makers. Excellent condition. 30/-.—Box 129.

WANTED URGENTLY. Wire Recorder.—Full details and price to G2DUV, 51, Kingscourt Road, London, S.W.16.

FOR SALE. 3.5 and 7 mcs. crystals, both $\frac{1}{2}$ in. and $\frac{3}{4}$ in. holders, certificated. 10/- each.—Box 131.

"S.W.N.'s" required urgently. January to August 1948, inclusive. State price.—Goddard, 11, Handcross Grove, Greenlane, Coventry.

NEW RCA TE149 WAVEMETER. Uses 1.5 volt battery valves. Crystal controlled. Complete, but less batteries. £4/10/-.—Box 132.

TRADE

"GENERAL ENGRAVING" neat and accurate work to specification. "Panels," "Circuit" and "Switch Plates," "Call Sign Plates," "Escutcheon Plates," "Indicators," "Metal," "Plastic" or "Wood." Service and satisfaction guaranteed.—Engraving & Metal Craft Production, 4 Mansfield Terrace, Taunton, Somerset.

COMPONENTS for all circuits. Stamp for list. Smith, 98, West End Road, Morecambe, Eddystone, Raymart, etc.

CHASSIS, Panels, Racks and Metal Cabinets stock sizes or made to specification in steel or aluminium: Wrinkle finishes available.—Reosound Engineering & Electrical Company, Colleshill Road, Sutton Coldfield.

QSL's and G.P.O. approved log books. Samples free.—Atkinson Bros., Printers, Elland, Yorks.

G6MN for the "best" QSL's and approved log books, send for samples: G6MN, Bridge Street, Workson, Notts.

DUKE & CO. CLIENTS. Stamps only please when sending for lists of valves, from 3-6, and receivers.—219, Ilford Lane, Ilford, Essex.

LOOK! New Components Only. Everything for the Home Constructor. Send 2½d. stamp for List.—Electro Radio Co., Llwyngwril, Merioneth.

ONE-VALVE LOUDSPEAKER SET. The "Economo" AC mains.—Send 2/6 for Diagram and Constructional Notes to Drew, 126, Sidwell Street, Exeter.

Our complete list of government surplus and new components is now ready. Those whose names are already on our books will be sent copies without further request. All other readers' are recommended to send us a S.A.E. for same.

GARLAND RADIO (Dept. R.C.)
4, Deptford Bridge, London, S.E.4

Phone: TIDeway 3965.

Henry's Radio Component Specialists

We have the most comprehensive range of Radio Components of every nature.

Our reputation is your guarantee.

If unable to call, please send stamp for current price list.

(Dept. RC)

5 HARROW ROAD, W.2

(Opposite Edgware Road Tube)

PADddington
1008/9

TELEVISION CONSTRUCTION FROM EX-GOVT. GEAR. We have had a tremendous response for the Constructional Details advertised last month. These show how to modify Radar Units for TV reception, and are supplied gratis with the units, which cost £6/10/0. Alternatively, they will be supplied on receipt of 7/6, which will be allowed against the purchase of the units within 14 days. A combined HT and EHT Mains Transformer is factory built, and costs £5/10/0, but if purchased with the Radar Units the total cost is £11/10/0, showing an additional saving of 10/-. The stock of units are holding out, but please bear with us if there is a few days' delay in delivery. Please add 12/6 carriage plus 10/- deposit on returnable packing case.

MAGNIFYING LENS FOR SIX-INCH TUBES. Just what is wanted to bring up the size and definition of the TV set using a six-inch tube or of a 'scope. A new manufactured item, not Govt. surplus. ONLY 29/6, postage 1/6.

INDICATOR UNIT 62A. Contains 12 valves EF50, two of EB34, four of SP61, three of EA50, and six-inch tube VCR97, and shoals of condensers, resistors, potentiometers, etc. A marvellous buy for breakdown, or conversion to a super CRO. ONLY 89/6. Carriage 12/6 plus 10/- on case.

INDICATOR UNIT 162B. Contains six-inch tube VCR517 and three-inch tube VCR139, three valves SP61, four of EA50, and CV67 Klystron, in addition to the usual mass of small components. ONLY 67/6. Carriage as above.

TEST SET TYPE 74. This is an Oscilloscope used by the R.A.F. for VHF work. The time base only requires slight alteration for normal use. Has a three-inch CRT Type VCR139, three valves SP61, one of 6J5G, one of 6Q7, one of 5Z4, one of SU2150A, one of E1148. Has built-in power pack in addition. First come, first served at £5/10/0, while they last. A few only available. Carriage and case charge as above.

S.A.E. for list.

U.E.I. CORP.

The Radio Corner, 138 Gears Inn Road, London, W.C.1
(Phone: TRerninus 7937)
(Open until 1 p.m. Saturdays, we are 2 mins. from Chancery Lane Station, High Holborn, 5 mins. from King's Cross.)

INSTRUMENT CO.

244, Harrow Rd., London, W.2.

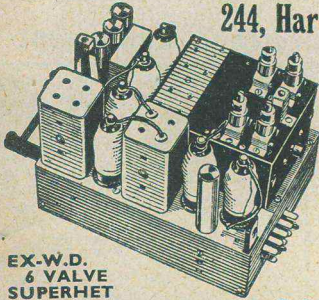

**EX-W.D.
6 VALVE
SUPERHET**

Complete less valves and crystal **8/6**
Can be adapted for Broadcast Receiver. Full of useful components. Plus 1/6 postage

Above set can be supplied with valves. Plus 2/6 post and Packing **29/6**

Circuits and Modification details 2/3

EX-RAF CLOCK UNIT. This can be modified for use as clock or automatic timing device. Packed in Casket of strong bakelite or solid oak with sponge padding. Size of actual motor—diameter 3 1/2" x 1" deep. Casket 6"x6"x5" **12/6**
Post free, complete

Write for list of bargains to Dept. R.C.

INSTRUMENT CO., 244, Harrow Road, W.2.

Telephone—CUNningham 0508

EX-R.A.F. AMPLIFIER 1134

Ideal for use with a microphone, or can be used as an amplifier without modification. Complete with wooden transit case. **16/9**
Post free

12 ASSORTED RELAYS for experimental purposes. Post free **12/9**

NUTS, BOLTS, WASHERS small sizes for model making. 3 gross asstd. **7/6**

Brand New MOVING IRON AMMETER 0—25 apps. **7/6**
Post free

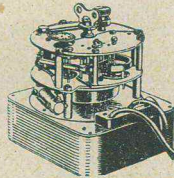

The Inexpensive Televisor

costs you less than any other if you buy now

R1355 RECEIVER as recommended by this magazine for the construction of inexpensive television. Complete with RF unit type 25, 42/6 plus 5/- carriage.

TYPE 6 INDICATOR (new) also specified £3/19/6, plus 15/- carriage in wooden case. 7/6 refund allowed on return of case.

MAINS TRANSFORMER giving 350-0-350, 6.3 and 5v. Post free £1.

E.H.T. TRANSFORMER to give 2500 volts and two 4 volt Secondaries. Very well insulated. Post free £2/8/0.

E.H.T. RECTIFIER (post free) 8/-
SMOOTHING CONDENSERS 8mfd. 450 volts working. Each 1/9.

DATA BOOK giving full modification instructions and parts required for the Inexpensive Televisor. Post free 1/8.

Benson's Better Bargains

T.V. RF UNITS. 24, 25 15/-; 26 31/6. Modified unit 45/61 mcs, 5 spot frequencies 20/-.

PP-2/APO5 AMPLIFIER, with valves, 4 6Y6, 2 5U4G, 1 6X5, 1 6SL7, 400 cps 37/6. BC453/4/5. Set 3 coils 5/-; set 3 IFTs 7/6; all other spares available. **MAINS UNITS** for above, plug-on, 230v input, 250v DC and 12v AC output 45/- complete, CR100 **ROTARY CONVERTERS**, Input 6v DC, output 190v 80 ma and 6v smoothed. Cased, with input and output leads. Brand new 22/6.

XTALS. Frequencies 5.1 to 6.78, 7.55 to 8.9 mcs 5/6, 8090 7/6, 100 kes 15/-. Few only. **XTAL DIODES** 1N21, 1N22, 1N23 2/9 each.

TOROIDAL POTENTIOMETERS. Ceramic. 200 ohms 1/2a 6/-; 460 ohms 1/2a 4/-. Resistance mats, 350 ohms 1/6. **VITREOUS RESISTORS.** 35k 35w, 30k 25w, 25k 15w, 400 ohms 20w, each 1/- . Pots, w/w 20k 4w 5/-.

MAINS TRANSFORMERS. RCA. Fully shrouded. Input 190/250v. Output 400-350-0-350-400 200 ma, 6.3v 6a, 5v 3a. Boxed 37/6. For R1355: 300-0-300 100 ma, 6v 6a, 5v 2a. Input 230v 27/6. EHT Trans. 1,100v 20 ma 4v 2a CT, 230v input 21/-; 2,000v 10 ma, 2 x 4v 1 1/2a CT, 6.3v 1 1/2a tapped at 4v. Can be used for voltage doubling, or straight, either specified CRTs. Input 230v 45/- . Transformers wound to your specification, quotation by return. SAE. 230v to 20v 4a 8/6; 230v to 12.6v CT 2 1/2a 7/6.

OIL FILLED CONDENSERS. 4mfd 1,000v 4/6; 1mfd 1,500v 2/9; .01mfd 1,000v 9d; 12mfd 330v AC 5/6; 30mfd 100v Electrolytic 1/-.

METAL RECTIFIERS. 600v 30ma, 230v 80ma, HW each 5/6; 280v 100ma CT 7/6; 120v 500ma FW 7/6; 48v 2 1/2a FW 15/6; 15v 5a 20/-; 12v 6a 22/6; 12v 1 1/2a 8/6.

CHOKES. 300 ohms 100ma 4/6; 100 ohms 200ma 7/6; 20 ohms 100ma AC 4/6.

HEADPHONES (S. G. Brown) 4k boxed 7/6. **BULGIN.** Twin fuseholders 1/-; Ruby Indicators 1/9; Toggles SP 2/-; Mains input plug and socket, 2-pin 5a chassis fitting 1/6.

SPINDLE COUPLERS. Standard 1/2in., Concertina 1/-; Disc 9d.; Epicyclic Drives 1/3.

VARIABLE CONDENSERS. Miniature 100pf Ceramic 2/-; standard .0005, isolated rotor 3/6; 3-gang 160pf 5/6.

MUIRHEAD VERNIER DRIVES S.M. AS RF26/27 6/-. Sloydlock Fuses, 5a, 1/3.

YAXLEYS. 3-pole, 3-way, 3-bank 3/6; 2-pole, 11-way 2/6; 4-pole, 2-way 1/6; 3-pole, 3-way, 2-bank (linked poles) 1/6.

FERRANTI push-pull driver trans. Twin secs. each 2 1/2 7/6.

RCA DRIVER/MOD. TRANS. CT Primary, Twin Secs. each 1.1/74. Impedance P500/Ss3,000, 2kv insulation 12/6.

PYE PLUGS (2) on 1 yd. co-ax. 1/6.

ROD AERIAL HOLDERS, ceramic base (threaded), brass head, 1/2in. hole with thumbscrew 1/3; BC434A Control Box, new 8/6; Flexible drives to suit 8/-.

CREED Highspeed Relays 500microA 12/6; No. 19 Set Supply Units 12v 10/- (Carr. Forward).

METERS. 2 1/2in. MC 50microA 15/-; 0/50mA 7/6; 0/200microA 8/6; 0/2 1/2a 7/6; 2in. 0/1a 5/6.

VALVES at 5/6—5R4GY, 6SN7, 6SL7, EF50, 12SK7, 12SR7, EF36, 6K7M, 6N7M. At 3/6—6SH7, SP61, SP41, 12J5. At 3/-—6H6, EA50, EB34, 7193, CV6, 2051. At 6/6—6Y6G, 5U4G, 5Z4M, 12K8. At 7/6—6V6, ECH35, 6K8M, 6X5, 6AC7. Most other types stocked at keen prices.

Terms: C.W.O. NO C.O.D. Carr. Paid. S.A.E. enquiries please.

Benson's, 308 Rathbone Rd., Liverpool 13.

STONEYCROFT
1604

Largest Stocks, Best Selection and Bargains in Ex-Services Radio and Electronic Equipment

BRAND NEW RECEIVER and UNITS of SCR-269-G RADIO COMPASS By Bendix Aviation Corp.

Comprising:—
BC-433-G, 15 valve s/het rcvr Covers Med & Long Wave, 172-1500 metres, in 3 switched bands. Power input 115V. 400 c/s. (if converted to 200/250V. 50 cs. power requirements would be 350-0-350V. 150 ma. 6.3V. 6A. 5V. 3A.,) in metal case 8½ x 21 x 12in.

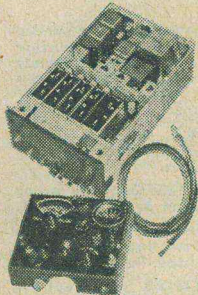

Plus,
BC-434-A Control Box, with "S" Meter, etc., in metal case 7½ x 4 x 7½in.

Plus,
Flexible Tuning Drive, MC214.

Plus,
Indicators 1-81-A and 1-82-A.

Plus,
Service Instruction Book, for SCR-269-G. Radio Compass equipment.

CLYDESDALE'S **£6/15** CARRIAGE PAID
PRICE ONLY

Per set

Set of 'Radio Compass' (SCR-269-G) Circuits available at 2/6 per set. Post Paid.
Flexible Tuning Drive MC214 available at 7/6 each. Length 12in. or 120in. Specify when ordering.

BRAND NEW, in maker's carton Ex. U.S.A.S.C.

Master Oscillator Type M1-19467-A. A "ready-made" V.F.O. Unit, ranges 1-5 mcs and 2-10 mcs. 807 and spare (2 valves). Grid current meter. E.C.O. circuit, variable inductances, calibrated micrometer controls, etc., in metal case 12 x 10 x 6in. With Instruction Books.

£5/15 each

For those 144 mcs. experiments BRAND NEW, RACK MTG. VHF. R/T RECEIVER UNITS R1481 Frequency 65-86 mcs. R1132 Frequency 100-124 mcs. Each a 10 valve (plus stabilizer) superhet with 4/VR53's (EF39), 2/VR65's (SP61), VR54 (EF34), VR57 (EK32), VR66 (P61), VS70 (7475) plus precision S.M. tuning dial assy. "S" meter, screened R.F. Unit, 4 tuned circuits, 3 I.F. trans. (12 mcs.) B.F.O. etc., etc. Present range covered by air spaced inductances and variable ganged microdensers, could be changed to suit personal requirements. Rack-mtg enclosed chassis 19 x 10½ x 11in. Finish: (R1481) dark grey R1132) light grey. Circuit supplied, all units tested and guaranteed working before despatch.

CLYDESDALE'S PRICE ONLY

£4/19/6 (either)

CARRIAGE PAID

Power requirements are H.T. 210V. 55 ma. smoothed D.C. L.T. 6.3V 3.5A. provision to just plug in.

Ex. R.A.F. R1155

As a 9-valve communications receiver for 200/250V. A.C. mains. Receiver Unit with 7 valves: VR99 (X65), 3/VR100 (KTW61), 2/VR101 (DH63), VR103 (Y63ME), 5 switched bands:—

18-7.5 mcs.	(17-40 metres)
7.5-3 mcs.	(40-100 metres)
1,500-600 kcs.	(200-500 metres)
500-200 kcs.	(600-1,500 metres)
200-75 kcs.	(1,500-4,000 metres)

S.M. drive, BFO, AVC, MVC, etc., metal case 6½ x 9 x 9in.

Power/Output Pack with 2 valves: EL35, U50, 8in. mains energized speaker, mains trans, output trans. Tone control and ON/OFF switch, metal case 14 x 14 x 7in. Complete with circuits and linking cables, plugs, etc.

CLYDESDALE'S **£18/10**
PRICE ONLY

CARRIAGE PAID both Units

BRAND NEW (U.S.A. made) TRANSFORMERS

THERMADOR POTTED TYPE E536 Modulation Transformer With ceramic stand-off terminals. Pri. 6,700 ohms. C.T. Sec. 4,500, 5,000 and 5,500 ohms. max op. + 470db. freq. +—10db. 400-4,000 cs. Test 5,000V. suits TZ40, T35, 813, etc., size 7 x 6½ x 5½in., weight 22lbs. CLYDESDALE'S **57/6** each
PRICE ONLY

CARRIAGE PAID

E533 Filament Transformer Pri. 0-210-230-250V. 50 cs. Sec. 6.3V. C.T. 6A. 5V. C.T. 6A. Test 2,000V. Size 4½ x 4 x 5½in. Wgt. 8lbs. CLYDESDALE'S **27/6** each
PRICE ONLY

POST PAID

E534 Filament Transformer Pri. 0-210-230-250V. 50 cs. Sec. 2.5V. C.T. 10A. 2.5V. C.T. 10A. Test 7,500V. ceramic S.O. terminals. Size 4½ x 4 x 5½in. Weight 8lbs. CLYDESDALE'S **21/0** each
PRICE ONLY

POST PAID

E535 Power Transformer Pri. 0-210-230-250V. 50 cs. Sec. 1,360V. C.T. 225 ma. Test 2,500V. Size 4½ x 4½ x 6½in. Weight 16lbs. CLYDESDALE'S **35/0** each
PRICE ONLY

CARRIAGE PAID

BRAND NEW

E537 Filter Reactor Choke Thermador potted type (U.S.A. made), 10 henries, 225 ma. Res. 84 ohms. Test voltage 2,500V. Size 4½ x 4 x 5½in. Weight 10½lbs. CLYDESDALE'S **21/0** each
PRICE ONLY

POST PAID

Transmitter Tuning Units

For VFO conversion. TUSB. 1,500-3,000 kcs. Black crackle case 17½ x 7½ x 8in. Unused but scratched and dented.

19/6 each

ALL GOODS CARRIAGE OR POST AND PACKING PAID.

BRAND NEW, in maker's cartons BC-456 Speech Modulator A Unit of the SCR-274-N (Command) Equipment

Employing screen modulation, complete with valves, 1625, 12J5, and stabilizer VR150/30. Transformers, chokes, etc. less Dynamotor). In metal case 10½ x 7½ x 4½in.

CLYDESDALE'S **19/6** each
PRICE ONLY

POST PAID
Circuit of BC-456 available at 1/3 each

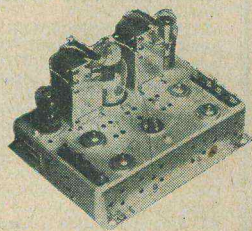

All goods advertised or in our list can be ordered from any of our branches, in England, Scotland, Northern Ireland, or direct from:—

CLYDESDALE SUPPLY CO LTD

2 BRIDGE STREET • GLASGOW • C.5
Phone: SOUTH 2706/9

Send now for new Illustrated 112 page List No. 5. Please print Name and Address