

Practical

JULY 1988 £1.20

ISSN 0141-0857

Wireless

The Radio Magazine

**Amateur Radio
Stateside - Part 1**

**PW "Portland"
RF Voltmeter**

**Jaybeam VR3
Antenna Review**

**Apartment HF
Antennas- Part 1**

**"Making Waves"
Concluded**

and you thought you had planning problems...

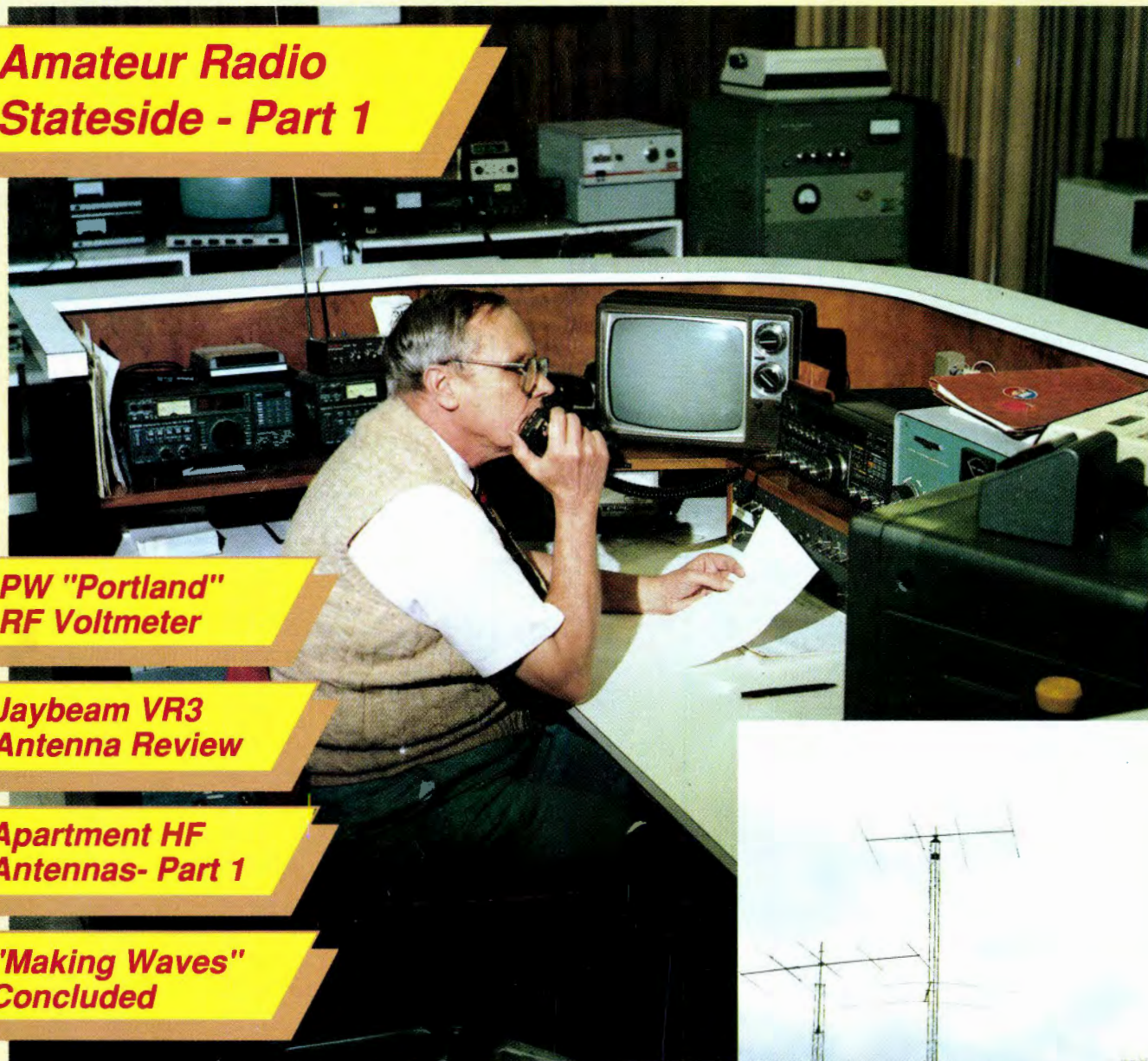

"They said I couldn't work DX with just 100 watts. Especially with a radio that has less than 1000 switches on the front panel.

But the truth is, I'm working lots of DX, more than some of these blockbuster types, thanks to my Yaesu FT-747GX.

You see, my no-nonsense FT-747GX was designed with me in mind, so I can hop around the band fast to nail those DX stations. While the other hams are warming up their amplifiers, I'm working the new country!

My FT-747GX has a super receiver, with a directly-driven mixer for great overload protection. And, Yaesu included the CW filter in the purchase price

(I used the money I saved on postage for the QSL cards!).

And my FT-747GX is loaded with other features. The receiver works from 100kHz straight through 30MHz, and it's a fantastic shortwave broadcast receiver. I can use all twenty memories for that alone! Plus it's got dual VFOs. A noise blanker. Split frequency operation for the pile-ups. And scanning up the band helps me check out openings as they happen.

I just put in the optional crystal oven, and next month I'm going to pick up the FM board.

And with the money I saved when I bought my FT-747GX, I got a second ten-metre antenna for satellite work on the high end of the band. I use my personal

computer to tell me what satellites are going by, and the computer even sets the frequencies on the radio for me.

Now my friends are getting FT-747GX rigs, too. I knew they'd figure out my secret weapon sooner or later. But now I'm setting the pace!

Thanks, Yaesu. You've made a rig that makes sense, at a price I can afford."

South Midlands Communications Ltd
S.M. House, School Close,
Chandlers Ford Industrial Estate,
Eastleigh, Hants SO5 3BY
Tel: (0703) 255111
UK Sole Distributor

YAESU

"They laughed when they saw my radio. Then they saw my logbook."



Practical Wireless

The Radio Magazine

JULY 1988 (ON SALE 9 JUN 1988)

VOL. 64 NO. 7 ISSUE 976

NEXT MONTH

Build our
Multi-purpose
Zener Diode
Tester

A Low-Cost
Indoor Antenna
for 144MHz

PW REVIEW
of the
Yaesu FT-212RH
VHF Mobile
Transceiver

and
All the usual
features

Don't miss
it—place
your order with
your
newsagent now!

On sale July 14

Contents subject to last-minute revision

- 18 DXpedition North Sea '87**
F. Jul-Christensen OZ1EVA/G4MJC
- 20 Wither Bandplans?**
Peter Chadwick G3RZP
- 21 Practically Yours**
Glen Ross G8MWR
- 22 The Micro's Secret Code**
Joan Ham
- 24 Amateur Radio Stateside—1**
David Jardine G0FDV
- 54 Making Waves—A Guide to Propagation—8**
A. J. Harwood G4HHZ
- 32 Valved Communications Receivers**
*The Collins TCS
Chas E. Miller*
- 36 PW "Portland" RF Voltmeter**
Robert & David Crone
- 39 Apartment HF Transmitting Antennas—1**
Richard Q. Marris G2BZQ
- 46 Understanding Circuit Diagrams—5**
R. F. Fautley G3ASG
- 50 Mobile Practice Morse Key**
Mason Jay
- 52 PW Review**
*Jaybeam VR3 Vertical HF Antenna
Paul Essery GW3KFE*

Regular Features

- | | | |
|------------------------|-------------------------------|-------------------------|
| 71 Advert Index | 54 On the Air | 51 Subscriptions |
| 48 Binders | 53 PCB Service | 26 Swap Spot |
| 30 Bookshelf | 13 PW Services | 12 Write On |
| 42 Book Service | 35 Short Wave Magazine | |
| 14 Newsdesk | | |

Editor

Geoff Arnold T.Eng FSERT G3GSR

Assistant Editor

Dick Ganderton C.Eng MIERE G8VFN

Art Editor

Steve Hunt

Technical Features Editor

Elaine Richards G4LFM

Technical Projects Sub-Editor

Richard Ayley G6AKG

Editorial Assistant

Sharon George

Technical Artist

Rob Mackie

Administration Manager

Kathy Moore

Clerical Assistant

Claire Jackson

Accounts

Alan Burgess

Editorial and

Advertisement Offices:

Practical Wireless

Enefco House

The Quay

Poole, Dorset BH15 1PP

☎ Poole (0202) 678558

(Out-of-hours service by answering machine)

FAX Poole (0202) 666244

Prestel 20267 1191

Advertisement Manager

Roger Hall G4TNT

PO Box 948

London SW6 2DS

☎ 01-731 6222

Cellphone 0860 511382

Advert Copy and Make-up

☎ Poole (0202) 676033

COPYRIGHT © PW Publishing Limited 1988. Copyright in all drawings, photographs, and articles published in *Practical Wireless* is fully protected and reproduction or imitation in whole or in part is expressly forbidden. All reasonable precautions are taken by *Practical Wireless* to ensure that the advice and data given to our readers are reliable. We cannot however guarantee it and we cannot accept legal responsibility for it. Prices are those current as we go to press.

Practical Wireless, July 1988

A.R.E. COMMUNICATIONS

TS-680S HF and SIX Metre Transceiver

Since our introduction of this remarkable transceiver last year, many of them are now in use throughout the U.K. Top-Band to Ten, including SIX Metres, plus a GENERAL COVERAGE RECEIVER thrown in!

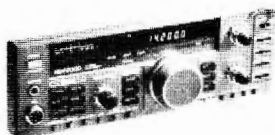

N.E.C. Exhibition Price
£899.00

FT47GX HF "Economy" Transceiver

An HF transceiver with built in General Coverage Receiver, All Mode including FM — for less than the price of a 2M multimode?



N.E.C. Exhibition Price
£659.00 + Free FM BOARD
and Microphone

FT767GXM HF +2M +6M +70CM

A complete Ham station in one package. All band, all Mode, built-in auto Aerial Tuner, 240V Power-supply, General Coverage Receiver, Digital Power/SWR meter 100W o/p (HF) Optional 2M/6/70CM modules just plug in.



N.E.C. Exhibition Price
Ask at the show!!

Yaesu FT690R mk II

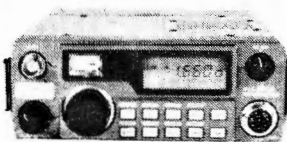

If you are not on SIX METRES yet, you certainly should be. What better way than to buy the new FT690R complete with a 15 watt output linear amplifier? And at the special N.E.C. Price!

N.E.C. Exhibition Price
£375.00 including Linear
(£349.00 without Linear)

Standard C500 Dual Band Handie



You must have read our AD's by now, we've sold hundreds! 2M & 70CM, full Duplex, 138-170 MHz + 420-469 MHz. Many additional features. Take a look at our Exhibition price. . .

N.E.C. Exhibition Price
£339.00

Yaesu FT736R Quad-Band Multimode



The KING of VHF/UHF Base stations, the FT736R has all the facilities any discerning user may need, plus the two most important features: Uncompromised receive performance and a clean transmitted signal.

Our special offer available on the first 10 sets purchased during February was so popular, we have decided to re-introduce it for the N.E.C!

N.E.C. Exhibition Price
Ask at the Show!!

Yaesu FT23R 2M HANDIE



Due to A.R.E. importing direct and cutting out the middle man, we really have slashed the price of this one!

Offered to full U.K. spec., with FBA9 battery case, helical antenna and strap.

N.E.C. Exhibition Price
£195.00

N.E.C. is here again and as usual A.R.E. Communications will be offering incredible part-exchange deals. Bring along any clean, working Amateur Radio equipment that we can take in part-exchange or SELL IT FOR YOU at the show. Remember! Bernie and Brenda are infrequently beaten on price OR customer service. With H.P. facilities available at NEC, you can literally walk away with your new purchase the same day!

Look forward to seeing you there. 73's Martin G4HKS.

STOP PRESS! Rumour has it that Brenda's special coffee will be available at the show!

Opening Hours Mon/Fri 9.30 to 5.30
Saturday by appointment Tel: 01-997 4476



A.R.E. Communications Limited, 6 Royal Parade,
Hanger Lane, Ealing, London W5A 1ET, England

Professional Tel: 01-997 4476 Fax: 01-991 2565 Telex: 94016185 AREC G

STAND B2 + C3
AT THE NEC

Come and see
us at Birmingham
15th, 16th & 17th JULY

AT LAST

A HIGH PERFORMANCE TRANSVERTER THAT'S USER FRIENDLY

This sophisticated, but simple to use range of transverters has performance characteristics and features previously not available. The output stage uses well rated PA devices and advanced filtering techniques which guarantee a low harmonic output while the ALC circuits

ensure a remarkably clean output signal. The receive section uses highly regarded MOS-FET's in an innovative active feedback configuration. Variable receive gain gives total control and allows the optimum signal to noise ratio to be achieved within the system.

Features:

- ★ Independent RX Output
- ★ Internal & External ALC
- ★ LED Bar Graph
- ★ Push Button Switches
- ★ Overdrive Protection
- ★ Low Harmonic Output
- ★ Rugged PA Section

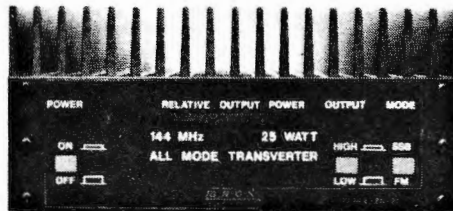

- Accessory socket with:-
- 8Vdc (ICOM TX/RX Drive Switching)
- R.F. Switching
- External PTT Output
- PTT Input
- +12V
- Ground

SPECIFICATIONS	TL50-28-25	TL50-144-25	TL70-28-25	TL70-144-25	TL144-28-25
Frequency Range	50--52MHz		70-72MHz		144-146MHz
Input Frequency	28-30MHz	144-146MHz	28-30MHz	144-146MHz	28-30MHz
*Output Power high	25W		25W		25W
low	5W		5W		5W
Input power (adjustable)	100uW-500mW	1mW-1W	100uW-500mW	1mW-1W	100uW-500mW
Supply	(-10+27dBm)		(-10+27dBm)		(-10+27dBm)
Switching	13.8Vdc @5A +/-15%		13.8Vdc @5A +/-15%		13.8V @5A +/-15%
RX Gain	RF Vox & "hard wired" PTT				
ALC Range Input	9-26dB Variable				
Output	0 - -4Vdc				
	0 - -12Vdc				

*Fully adjustable from 1 to 25 Watts.

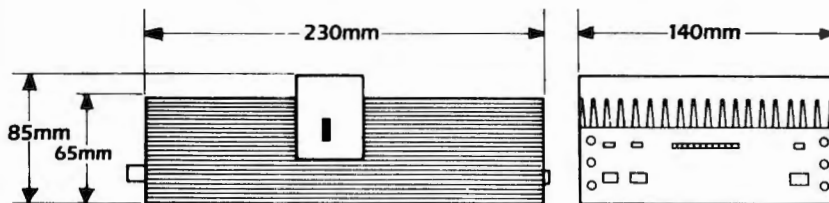

TL-50-28-25 £316.25
TL50-144-25 £299.00

TL70-28-25 £316.25
TL70-144-25 £299.00

TL144-28-25 £345.00

HOW TO ORDER

By phone: using your Access or Visa/Barclaycard
By mail: Cheque, Postal Order or Credit Card
Or from your local BNOS Authorized Dealer
Or see us on stand B2 & C3 at the NEC

Post, Packaging and Insurance should be added to all orders
3 Working day delivery service

Orders with a total value less than £50 add £2.50 to total
Orders with a total value more than £50 add £5.00 to total
Orders with a total value more than £250 add £7.50 to total

Next day delivery service.
Orders any value add £15 to total.



B.N.O.S.
ELECTRONICS

Mill Lane, Stebbing, Dunmow, Essex, CM6 3SL.
Tel: 0371-86681 Tlx: 817763 BNOS G

E&OE

ICOM

NEW! IC-228E 2 Meter FM Transceiver

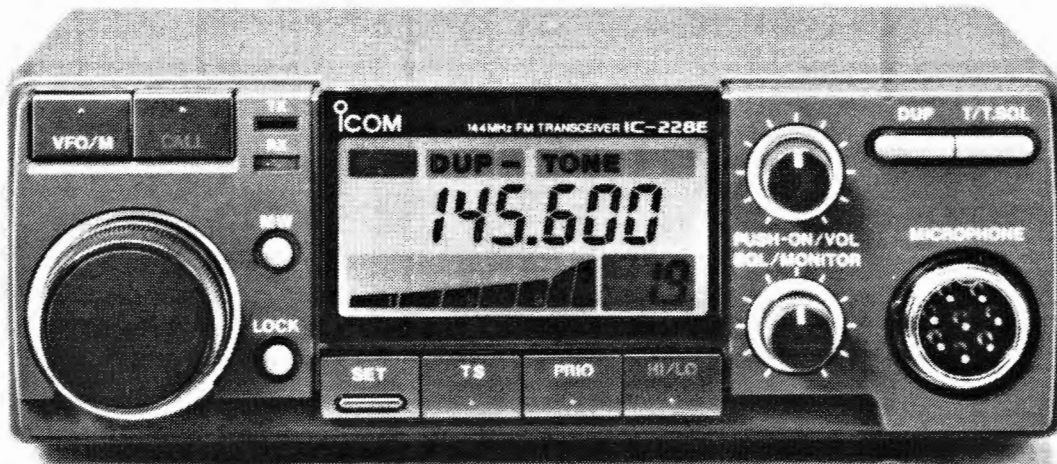

Actual
size

Features:

- Multicolour Liquid Crystal Display.
- 25 Watt output.
- 20 Memory channels.
- Scanning.
- Call and priority function.
- Compact size.
- HM15 microphone supplied.

Take a close look at this easy to use and compact VHF Mobile Transceiver. It's unique orange, red and green LCD highlights the numbers and letters for easy viewing. With a 25 watt output from a custom designed power module and a extra large heatsink, this transceiver does not get too hot under your dashboard.

Each of the 20 memory channels can store frequency, offset and direction, in fact all the information to work simplex or a repeater. The memory scan function will scan the memory channels and with the skip

function miss those you choose. The program scan will scan all frequencies between two programmable limits. The call channel ensures that your favourite frequency is within easy reach, and with the priority watch the call channel or memory channels can be monitored every five seconds.

This transceiver provides you with so many features, its small compact size and simple front panel design make it a superb mobile transceiver. See the IC-228E or the IC-228H 45 watt high power version at your local ICOM dealer.

Icom (UK) Ltd.

Dept PW, Sea Street, Herne Bay, Kent CT6 8LD. Tel: 0227 363859. 24 Hour.

Count on us!

NEW! IC-32E Dual Band VHF/UHF FM handportable

Features:

- Full cross band duplex operation.
- 5 Watt output with IC-BP7 nicad.
- 20 Dual band memories. • Small size.
- Scanning. • Power saver circuit.
- Compatible with ICOM accessories.

When are ICOM going to produce a dual band handportable? This has been the most asked question about new ICOM products for a long time. The IC-32E is the answer.

This exciting new handportable offers full crossband duplex operation, and with a built in duplexer allows single antenna operation. 3 Watt output is standard but with the BP7 high power nicad pack or external 13.8v, 5 Watts can be achieved on both bands. The IC-32E comes packed with features, such as the 20 memory channels which can store both a VHF and UHF frequency in one memory and also simplex duplex condition, offset direction and frequency.

There is a choice of five scanning functions, full programmed memory, memory band and priority. The die-cast frame gives a solid construction featuring rubber gaskets for splash-proof operation. The IC-32E is supplied with VHF/UHF a dual band antenna, BP3 battery pack and wall charger. OK, when are ICOM going to produce a new dual band mobile with full cross band duplex? The IC-3210E will be the answer.

NEW! IC-2GE 2 Meter FM handportable

Features:

- Rugged and compact. • High power option.
- Power saver circuit.
- 20 memories. • Scanning.
- Compatible with ICOM accessories.

What's new on 2? ICOM's latest 144MHz FM handportable. The ICOM IC-2GE fulfils the most important criteria for a handheld transceiver, it is small, rugged and easy to operate.

The 3 Watt RF output is a compromise on battery life against power output, but for those who require extra punch, the set can deliver 7 Watts when used with the BP7 or external 13.8v DC. On receive the power saver circuit reduces current drain automatically, but can be overridden for packet operation.

The 20 memory channels can store all your favourite simplex and repeater frequencies, and with the programmed scan and memory scan functions, there is no need to manually search for activity. The IC-2GE utilises most existing ICOM handheld accessories plus a new line of carrying cases. If you are expecting to be outdoors this summer or looking for your first handportable transceiver, the ICOM IC-2GE will take a lot of beating.

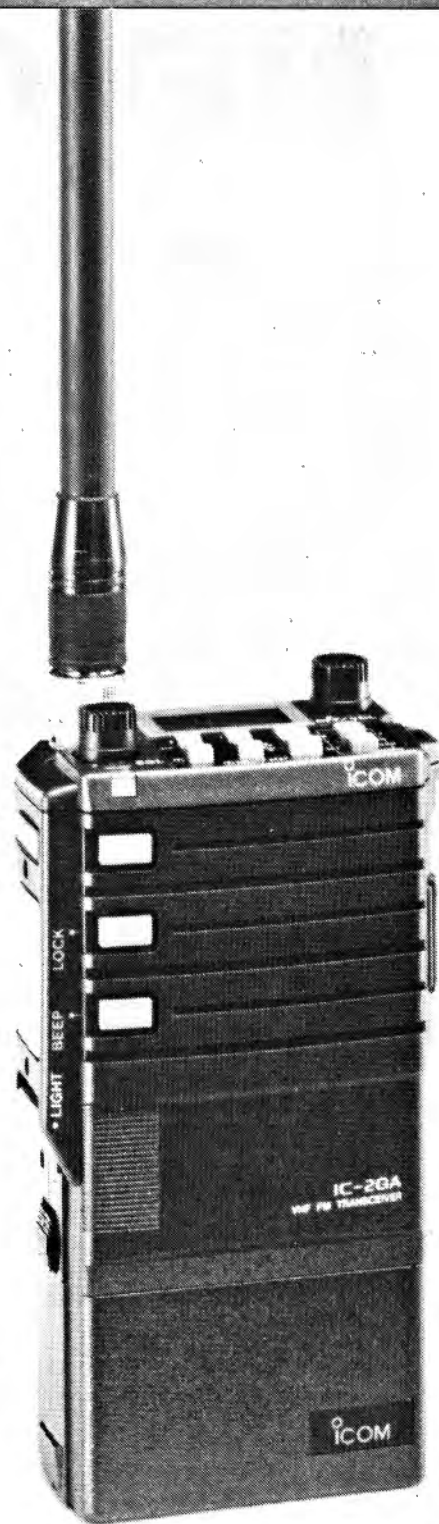

Helpline: Telephone us free-of-charge on 0800 521145. Mon-Fri 09.00-13.00 and 14.00-17.30. This service is strictly for obtaining information about or ordering Icom equipment. We regret this cannot be used by dealers or for repair enquiries and parts orders, thank you.

Datapost: Despatch on same day whenever possible.

Access & Barclaycard: Telephone orders taken by our mail order dept, instant credit & interest-free H.P.





FANTASTIC PERFORMANCE, FANTASTIC PRICE



- ★ 160-10M HF TRANSCEIVER
- ★ GENERAL COVERAGE RECEIVER
- ★ ALL MODE (FM OPTIONAL)
- ★ 0-100W OUTPUT (25W AM CARR.)
- ★ CW NARROW (500Hz) STANDARD
- ★ LARGE CLEAR LCD DISPLAY
- ★ SIMPLE OPERATION (see pic below)

The FT-747GX is a compact SSB/CW/Am and (optionally) FM transceiver providing 100 watts of PEP output on all hf amateur bands, and general coverage reception continuously from 100kHz to 30MHz. A front panel mounted loudspeaker and clear, unobstructed display and control layout make this set a real joy to use. Convenient features include operator selectable coarse and fine tuning steps optimized for each mode, dual (A/B) vfos, along with twenty memory channels which store mode and skip-scan status for auto resume scanning of selectable memories. Eighteen of the memories can also store independent transmit and receive frequencies for easy recall of split-frequency operations. Wideband (6kHz) AM and narrowband (500Hz) CW IF filters are included as standard, along with a clarifier, switchable 20dB receiver attenuator and noise blander. User programming for more advanced control by an external computer is possible through the CAT (Computer Aided Transceiver) System. The transmitter power amplifier is enclosed in its own diecast aluminum heat-sink chamber inside the transceiver, with forced-air cooling by an internal fan allowing full power FM and packet, RTTY, SSTV and AMTOR operation when used with a heavy duty power supply.

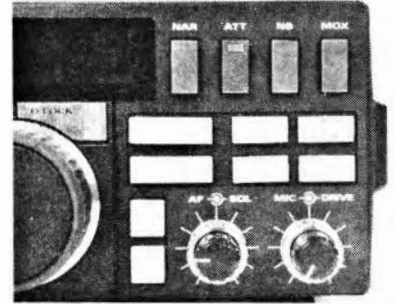

All major controls are grouped together for convenience and ease of operation.

MD-1B8 Base Mic	£79.00	MH-1B8 Hand Mic	£21.00	FRB757 Relay Box	£10.50
MMB38 Mobile Mount	£22.00	FIF232C Interface	£75.00	FP757HD Heavy Duty P.S.U.	£239.00
D3000568 FM unit	£39.99	FC757AT Automatic ATU	£349.00	FL7000 500W P.E.P. Linear	£1600.00
FP700 Standard P.S.U.	£195.50	FAS14R Remote Ant. SW	£80.00	SP767 Ext. Spkr	£69.95
		TXCO 747	£28.95		

FT747GX TRANSCEIVER RRP £659.00 inc VAT

'HIGH POWER' by TOKYO HY-POWER

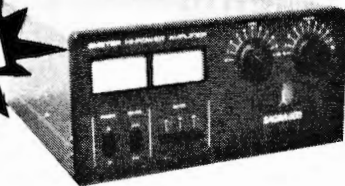

New from TOKYO HY-POWER, the SAGRA 600 is a ruggedly constructed 2m linear amplifier, designed around a pair of efficient, yet reliable 4CX 250 valves, giving an output of 500W+ and requiring a nominal 10W drive. Also available the HL-1KGx all band HF linear amplifier also using a pair of 4CX 250B and giving an output of up to 1kW PEP for 70-120W input.

SAGRA 600 £795 HL-1KGx £945.00

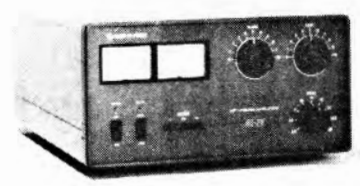

Also introducing the HL-2K, a finely engineered HF all band linear, including WARC, utilising a pair of 3-500Z to give an output of up to 2kW from an input between 70-120W. Designed to meet the exacting standards of operation on the HF amateur bands whilst remaining easy to operate and install.

HL-2K £1425

Also available a range of VHF/UHF linears at very competitive prices.

HL30V 2m 2W in/30W out	£54.00	HL110V 2m 2/10W in/110W out	£215.00
HL37V 2m 3W in/35W out	£89.00	HL20U 70cms 2W in/20W out	£82.00
HL62V 2m 10W in/60W out max	£119.00	HL60U 70cms 10W in/50W out	£179.00
HL66V 6m 10W in/50W out	£119.00		

LEEDS
SMC (Northern)
Nowell Lane
Industrial Estate
Leeds LS9 6JE
Leeds (0532) 350606
9-5.30 Mon-Sat

CHESTERFIELD
SMC (Midlands)
102 High Street
New Whittington,
Chesterfield
Chest. (0246) 453340
9.30-5.30 Tues-Sat

BUCKLEY
SMC (TMP)
Unit 27, Pinfold Lane
Buckley, Clwyd
Buckley (0244) 549563
10-5 Tues, Weds, Fri
10-4 Sat

JERSEY
SMC (Jersey)
1 Belmont Gardens
St. Helier, Jersey
Jersey (0534) 77067
9-5 pm Mon-Sat
Closed Wed

N. IRELAND
SMC N. Ireland
10 Ward Avenue
Bangor
County Down
0247 271875

BIRMINGHAM
SMC (Birmingham)
504 Alum Rock Road
Alum Rock
Birmingham B8 3HX
(021-327) 1497/6313
9.00-5.00 Tues-Fri
9.00-4.00 Sat

AXMINSTER
Reg Ward & Co Ltd
1 Western Parade
West Street,
Axminster
Devon EX13 5NY
Axminster (0297) 34918
9-5.30 Tues-Sat



Southampton Showroom open 9.00-5.00 Monday to Friday, 9.00-1.00 Saturday. Service Dept open Mon-Fri 9.00-5.00.
AGENTS: JOHN DOYLE, TRANSWORLD COMMS, NEATH (0639) 52374 DAY (0639) 2942 EVE

DAVID STENNING, G4JA, LOUTH 0507 604967

ommunications Ltd. YAESU

WIMBORNE, HANTS. SO5 3BY TEL: 0703 255111 FAX: 0703 263507 TLX: 477351

Serious about VHF/UHF? Then the FT736R is for YOU!



- ★ Up to four band capability
- ★ LSB/USB, CW & FM
- ★ Full Duplex crossband operation
- ★ Memory storage of up to 230 frequencies
- ★ Keypad frequency entry
- ★ Fourteen VFO's
- ★ Global call channel
- ★ Programmable channel steps
- ★ Electronic keyer option
- ★ Remote preamplifier switching
- ★ TXCO high stability reference oscillator

The FT-736R is a frequency-synthesized amateur transceiver incorporating up to four band modules covering the 50, 144, 430, and 1200 MHz amateur bands. The standard model provides 25 watts RF power output on the 144 and 430 MHz amateur bands in SSB, CW, and FM modes. (10 watts output on the 50 and 1200MHz bands). Operating conveniences usually found only on HF transceivers, such as front panel adjustable IF shift and IF notch, a noise blanker, all-mode VOX and three-speed selectable AGC are included. GaAs FET receiver RF amplifiers are provided in the 430 and 1200 MHz band modules. The innovative memory system includes one hundred general purpose memories plus ten full duplex cross-band memories, one global call channel memory that can be recalled from any band or mode and up to four band-specific call channel memories, all of which store mode and receive and transmit frequencies independently. In addition, fourteen vfos are provided, two general purpose plus one PMS (Programmable Memory limit Scanning) on each band, two special-purpose full duplex vfos, and up to four clarifier memories, one per band. Each of the two full duplex vfos can be selected so that its receive and transmit frequencies and modes can be displayed and tuned independently, or linked to tune synchronously in opposite directions for satellite operation. You can retain twelve satellite uplink/downlink modes in the special vfos and ten full duplex memories at all times. Naturally, with FM the predominant mode on the VHF and UHF bands, the FT-736R includes all manner of convenient features for both FM simplex and repeater operation, like a discriminator center tuning meter, special narrow FM mode (to cut adjacent channel interference in crowded areas) and Automatic Repeater Shift when tuned to 2-meter repeater subbands. The FT736R also includes a tr-switched DC supply line for masthead preamplifiers, activated from the front panel, and digital input connection directly to the modulator for high performance packet radio tnc interfacing (preamps, personal computers and packet tncs not supplied by Yaesu).

OPTIONAL ACCESSORIES

FEX 736/50	50MHz module	£239.00	XF455MC	600Hz CW Filter	£60.00
FEX 736/1.2	1.2GHz module	£425.00	SP767	External Spkr c/w Audio Filters	£69.95
FMP-1	AQS Message Processor c/w display	£189.00	MD-1B8	Desktop Microphone	£79.00
FTS-8	CTCSS Tone Squealch Unit	£45.00	MH-1B8	Hand Scanning Microphone	£21.00
FVS-1	Voice Synthesiser Unit	£33.00	FIF232Cvan	CAT/INC Interface for Packet & CAT	£68.95
Keyer Unit B	Internal Iambic Keyer Unit	£15.95	FIF232C	CAT Interface for RS232 O/P	£75.00
TV-736	Fast Scan TV (ATV) Mod/Demod Unit	£159.00	FIF65A	CAT Interface for Apple II series	£60.00

FT736R R.R.P. £1450.00 C/W 2M & 70cms.

★ SPECIAL SHOW OFFERS ★

ON STAND No. D14 & E15

HANDHELDS



FT709R(4)
£199
FT703R(3)
£199
FT703R(4)
£199

MOBILES



FT770RH
£279 inc.

FT790R
£299 inc.

BASE



FT726R(2) £699
SAT/726 £59
50/726 £249
21/24/28 £249

YD844A BASE MIC £19.99 78B 7/8 2M ANT £15.00
MMB11 MOBILE MOUNT £29.95 GP233 x 5/8 2M BASE ANTENNA £45.00
FL2010 10W 2M LINEAR £39.00

Prices & availability subject to change without prior notice.

FREE FINANCE . . .

On many regular priced items SMC offers free finance (on invoice balances over £120) 20% down and the balance over 6 months or 50% down and the balance over a year. You pay no more than the RRP price!

Details of eligible items available on request.

FREE S.M.C. SERVICE INTERLINK DELIVERY . . .

Free Interlink delivery on major equipment. Small items, Plugs, Sockets, etc. by post £1.75. Antennas, Cables, Wire & larger items, Lynx up to £5.00. Interlink delivery available, upon request, for items other than radios, from £7.30 depending on weight. Same day despatch whenever possible.

GUARANTEE

Importer warranty on Yaesu Musen products. Ably staffed and equipped Service Department. Daily contact with the Yaesu Musen factory. Tens of thousands of spares and test equipment. Twenty-five years of professional experience.

DEWSBURY

ELECTRONICS

G4CLX

From the makers of the world renowned STAR MASTERKEY a new MORSE KEYBOARD.



Send perfect morse as easily as typing a letter. It has never been as easy to send morse.

Variable transmission. Speed 1-99 wpm or up to 400 wpm.



CQ

CQ

Indication of speed on 7 segment display.

Type ahead buffer with status leds transmission of stored messages.

Indication of operating mode on leds. Sidetone and relay output for all types of transmitter.

Full QWERTY keyboard with real keys.

Metal cased for RF immunity.

For Full Details Send S.A.E. To:

Dewsbury Electronics, 176 Lower High Street, Stourbridge, West Midlands.

Telephone: Stourbridge (0384) 390063/371228

Telex: 336712 SHEL TN G. Ref. D2850



Instant finance available subject to status. Written details on request.

TX - 3 RTTY/CW/ASCII TRANSCIVE

Split-screen, type-ahead operation, 24 memories, clock, review store, callsign capture, RTTY auto CR/LF, CW software filtering and much more. Needs interface or TU. **BBC-B/Master** and **CBM64** tape £20, disc £22. **SPECTRUM** tape £35, +3 disc £37 inc. adapter board (needs interface/TU also).

Also **VIC20** RTTY/CW transceive program, tape £20.

RX - 4 RTTY/CW/AMTOR/SSTV RECEIVE

This is still a best-selling program and it's easy to see why. Superb performance on all 4 modes, switch modes at a keypress to catch all the action. Text and picture store with dump to screen, printer or tape/disc. The essential software for the SWL. Needs interface. **BBC-B/Master**, **CBM64** tape £25, disc £27. **VIC20** tape £25. **SPECTRUM** tape £40, +3 disc £42 inc. adapter board (needs interface also). The **SPECTRUM** software-only version is still available £25, +3 disc £27.

TIF1 INTERFACE for TX-3 and RX-4. RTTY and CW filters, computer noise isolation for excellent reception. Transmit outputs for MIC, PTT and KEY. Kit £20 (assembled PCB + cables, connectors), ready-made £40 state rig. Available only with TX-3 or RX-4 software.

Also **MORSE TUTOR** £6, **LOGBOOK** £8, **RAE MATHS** £9 for BBC and CBM64 (disc £2 extra), **SPECTRUM**, **ELECTRON**, **VIC20**.

Prices include VAT and p&p, 1st Class inland, airmail overseas, normally by return. Eire, C.I., BFPO deduct 13%.

technical software (P.W.)

Fron, Upper Llandwrog, Caernarfon LL54 7RF.

Tel. 0286 881886



SEE THESE PROGRAMS DEMONSTRATED AT THE NEC



LAKE ELECTRONICS

QRP KITS AT QRP PRICES!

DTR3 CW TRANSCIVE KIT FOR 80 METRES

This compact and lightweight TX/RX is an ideal QRP rig for 3.5 MHz CW operation. Great for portable and holiday operation!

A COMPLETE kit! — Comprises ALL hardware, VFO, Audio Filter, RIT, Sidetone etc. and fully detailed building instructions.

£74.25 plus £2.00 postage and packing.

"CARLTON" 3 BAND RECEIVER KIT

A "Direct Conversion" Receiver for 80m, 40m and 20m. Suitable for both SSB and CW. The kit is ABSOLUTELY COMPLETE — case, slow-motion drive, knobs and all hardware: even wire for coils and PCB interconnections.

Fully detailed instructions and modular construction. A pleasure to build and use. You will need only a 12Vdc battery or power supply, low impedance headphones, or speaker, and an aerial.

Price: £61.00 plus £2.00 post/packing

The Instruction Manuals, together with the basic PCB's (i.e. boards only), can be supplied for just £20.00 (DTR3) or £16.50 (CARLTON), including postage.

For further details of these and other kits in our range, send SAE to:

LAKE ELECTRONICS, 7 MIDDLETON CLOSE, NUTHALL, NOTTINGHAM NG16 1BX.

or ring Alan, G4DVW on (0602) 382509

RADIOSONDES later version of M.60 as crystal controlled Tx on 27.95 Megs sends data in morse via drum swt of Press. Temp & R.H. reqs 3v DC only new cond **£16.50**. **ARMY SIG GEN No. 2** provides AM/FM signals in range 20/80 Megs two bands with var deviation to 40Kc carrier meter var O/P to 1 Uv small unit for 240v or 12v DC operation new cond **£45.00**. **SPEAKERS** Army AFV type 3 ohm in metal case size 5 x 3" dia new cond **£8.50**. **HAND GENYS** Army type o/p 12/14v DC stab & adjustable at 1 amp tested **£24.50**. **DURIMY LOAD RES** non inductive type 150 ohm approx 40 watt ea price 3 for **£11.58**. **VARIACS** panel mt 240v LP o/p 0/270v at 2 amps **£18.50** also 8 amp at **£35.00**. **ARMY MAST KIT** 30ft 10 section 1" dia with accs in carry bag new cond **£38.00**. **WAVEMETER HEADS** absorption type 1.9 to 5Gz with cal charts provides det O/P to work 100 Ua meter **£24.50**. **TAPE REC** Ferrograph type with Ser 6 deck two chan replay only with two heads, 3 speed, two chan transis amps for 240v in metal case with lid **£65.00**. **PYE 24** to 12v DC at 3a power converters with fittings for Westminster new. **£17.50**. **TUNER HEAD** tunes 88/108Mc/s with 10.7 Megs IF o/p reqs 12v DC supply new **£7.50**. **OIL LEVEL SENSORS** we have no info on these (made by Brymar Elec) but comprise sensor probe, connec cables, die cast box size 6 x 3 x 2" this contains electronic circ board, for use on 12v DC new cond **£13.50**. **EHT RECT STACKS** special purpose 36Kv PIV see list **£23.00**. **POWER UNIT** for 240v general purpose provides HT at 250/300v DC at 250 Ma & 6.3v AC at 5 amps fused & swt in neat case 10 x 10 x 10" tested **£26.50**. **AERIAL SWT.** type J for use with R1155/54 Inst new cond **£16.50**. **BELLS** for 24v DC 6" dia new **£7.50**. **RACAL RXs** RA17 & Mk11 500Kc/30 Megs **£188.00** also RA17L **£235.00** with book etc.

Above prices include Cart/Postage & VAT. Goods ex equipment unless stated new. SAE with enquiry or 2x 10p stamps for List 42, closed Mon/Thurs.

A.H. SUPPLIES

Unit 12, Bankside Works, Darnall Road, Sheffield S9 5HA

Phone: 444278 (0742)

YOUR ONE SOURCE FOR RADIO

ARROW

ELECTRONICS LIMITED
 5, The Street,
 Hatfield Peverel,
 Chelmsford, Essex
 0245 (Chelmsford) 381673 or 381626
 Telex 995801 (ref. A5)

ALL THE
 TOP BRANDS
 AT
 UNBEATABLE
 PRICES

IT WILL
 PAY YOU
 TO PAY
 US A
 VISIT!

THE NAME YOU CAN TRUST FOR PRICE & AFTER SALES SERVICE

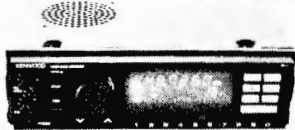

NEW!! The Amazing KENWOOD RZ-1

Covers 500kHz to 950MHz in a CAR-RADIO format!! Send SAE for details — see it at ARROW'S Rally stand. £469.00.

TS140S £862.00

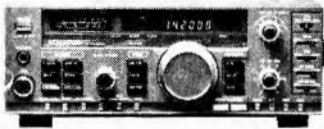

KENWOOD's New HF Transceiver has all fibre-glass PCB's & opens like a book for easy servicing — our service Dept. love it — so will you!



NOW AVAILABLE

KENWOOD's NEW MINI's for 2m & 70cms FM. East of use & full size battery are excellent features.

TH25E £258 TH45E £296

STOP PRESS . . . Send SAE for details of the IP-100 Mini Fax — Facsimile transceiver for mobile — even portable use!



NEW MODEL FT747-TX

Superb HF Mini at a staggering price
ONLY £599.00

FT736R



NEW VHF/UHF Base Station has Full Duplex and comes with 2M & 70cms as standard. Options: 6M & 1296MHz! TV module etc. etc . . .

BASIC MODEL £1499

The best selling 2M handy World-Wide! These super transceivers are available from stock.

FT23R £223.50 (+ Batts)

FT73R £243.50 (+ Batts)

NEW FROM YAESU ROTATORS
 G400RC, G600RC, G800SDX
 NOW IN — DETAILS SEND SAE



R7000



This superb receiver — far more than a scanner will really complement your shack.

£869.00 FOR CASH/COLLECTED

Full range of Active Antennas available from stock, Discones, etc. incl. AH7000 **£82.00**

IC-735

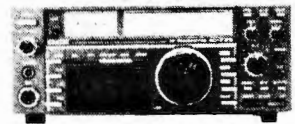

Best selling HF Mini transceiver in the UK.
SUPERB VALUE AT £859 for Cash/Collected.

IC-28E



A truly excellent 2M FM mobile transceiver, with receive capability 138-174MHz
GREAT VALUE AT £329.00



Cash/Collected

COMPLETE RANGES STOCKED OF ALL MAJOR BRANDS

PLEASE SEND S.A.E. WITH ALL ENQUIRIES

BUTTERNUT (USA) ANTENNAS

- HF2V 80M + 40M Vertical £139.95
- HF6V 6 Band Vertical £154.65
- TBR160 Top Band Coil £55.24
- STR2 Radial Kit £45.00

NEW HF5B
 5 Band Mini Beam
 only 12'6 W x 6'
£235
 NOW IN STOCK

SCOTTISH CUSTOMERS
 PLEASE NOTE OUR
 NEW GLASGOW ADDRESS

ARROW ELECTRONICS (SCOTLAND)
 UNIT 17, 6 HARMONY ROW,
 GOVAN, GLASGOW, G51 3AD
 Tel: Jim McIaverty
 041 445 3060
 Monday to Friday 8.30 – 5.30
 Saturday AM by appointment

CASH PRICES??

This Advert is prepared two months before you read it. If anybody else is selling cheaper — just give ARROW a ring (any branch) for our LATEST price!!!



DAIWA RANGE

- MR750E Multitorque Rotator £245.00
- MR750PE ditto + preset cont £278.00
- MR300E High Speed VHF rotator £243.00
- LMC Lower Mast Clamps £18.00
- MR750U Motor unit £75.00
- MR300U Fast motor unit £75.00
- KS065 Mast Bearing £35.00
- (Meters are Crossed needle type)
- CN410M 3.5-150MHz SWR/PWR £58.00
- CN460M 140-450MHz SWR/PWR £62.00
- NS448 900-1300MHz SWR/PWR £86.00
- NS660PA 1.8-150MHz SWR PEP + RMS & Averaging meter £115.00
- 30-300 3 kW £55.00
- UB6VN 140-525MHz (NS660P) £110.00
- CN4727 Dual Band Aerial Tuner Meter £199.00
- CN4419 HF ATU-Meter £199.00
- PS130M 30 Amp PSU Var. Volts £199.00
- PS120XM 3.15v Var. 12 Amp. PSU £99.00
- CL680 Antenna Tuner £99.95
- CS401 4 way Antenna Switch £59.50
- CS201 2 way Antenna Switch £21.90
- CS201G 2 way Antenna "N" Switch £35.00
- CS4 4 Way Ant. Sw. BNC £30.00

SAGANT

- SA450 2 way Antenna Switch SO-239 £21.00
- Super Rod 2 for 2M BNC £12.95
- Super Rod for FT290R £12.95
- Super Rod 7 70cms BNC £12.95
- BL40X HF Balun £19.50

ALINCO

- ELH230D(II) 2M Linear 3 in 30 outw. pre-amp £89.95
- ELH260D 1.5w in up to 60W out with pre-amp £109.00



FT767GX BARGAIN!!

SPECIAL PURCHASE OF YAESU'S SUPERB H.F. TRANSCEIVERS & MODULES LIMITED QUANTITIES ONLY AT THESE AMAZING PRICES.

- FT767GX £1359.00!!
 - 70 CMS £177.00!!
 - 6 METRES £139.00!!
 - 2 METRES £149.00!!
- FIRST COME FIRST SERVED - CASH ONLY

NEW RANGE COMET AERIALS

- CA1243E Dual Band Base ant. 70 & 23cm £39.83
- CA207TMA Mini Heavy duty mobile 2+70 £30.20
- CA285E 5/8 wave 2m mobile £15.00
- CA2x4FX 2+70 fibreglass Base ant. £52.50
- CA2x4JR 2+70cm mini mobile ant. £24.22
- CA2x4SDP Ultra mini 2+70 mobile ant. £14.40
- CA2x4SUP Hi-gain Dualbander 2+70 Base £69.00
- CA2x4WX Dual Band Base ant. 2+70 Hi-G £74.00
- CA2x4Z Ultra Hi Gain 2+70 Base ant. £91.90
- CA412NN Duplexer for 23cm + 70cm £31.74
- CAABC21 5/8 Wave ground plane Base 2M ant. £24.50
- CAABC22A 5/8 + 5/8 2M Base ant. Ally £36.00
- CA ABC23 3 x 5/8 Wave 2M Base ant. £59.50
- CASUS22A Stainless Steel 2M 2x5/8 Base £52.50
- CAABC71 70cm ground plane Base ant. £21.56
- CAABC72 2 x 5/8 wave 70cm Base ant. £33.00
- CAMS58 Magnetic mount PL259 type £18.20
- CA2x4Mini 2M + 70cm Mini Mobile ant. £15.89
- CARS2 Gutter Mount De-Luxe £10.65

For detailed spec. sheets on COMET send SAE please.

PACKET RADIO

- Kantronics KAM £298
 - Kantronics KPC1 £159
- Now available from stock.
 Details on "Packet" (article) send 2 x 18p stamps.

INTEREST FREE FINANCE

Many major items at Recommended Retail Price + carriage, are available on our FREE credit scheme. List of eligible items on request.
 20% down Balance over 6 months.
 1/3rd down Balance over 9 months.
 50% down Balance over 12 months.
 Competitive Finance available with 10% deposit/Part exchange as deposit — balance over up to four years. Written details on request.



ALL MAIL ORDERS TO CHELMSFORD OFFICE
 0245 381673

Our normal despatch is one or two days (as thousands of satisfied customers will tell you). Subject to manufacturers supplies being available. Access and Barclaycard accepted. Save time — phone over your order with your Access or Barclaycard number.



Only a few showrooms in the U.K. can offer ALL MAJOR BRANDS as FRANCHISED DEALERS. Our main showrooms are only 10 minutes from the M25 Outer London Motorway (Take the A12 dual carriageway — just past Chelmsford) (British Rail Hatfield Peverel 3 mins.) Free car parking. Monday to Saturday 9-5pm. Closed all day Thursday.

GLASGOW SHOP
 041 445 3060
North West Agent — Jim Cook
 (Wigan) 0942 214969

Leicester Agent — Alan Faint
 (Market Harborough) 0858 62827

North Wales Agent — John Lewis
 (Anglesey) 0248 714657

dressler

COMMUNICATIONS LTD.

**191 FRANCIS ROAD
LEYTON · E10 6NQ · LONDON**
TELEX 8953609 LEXTON G
PHONE 01-558 0854 01-556 1415
FAX 01-558 1298
OPEN MON - SAT 9AM - 5.30PM
INTEREST FREE HP FACILITIES AVAILABLE
ON MANY ITEMS PROMPT MAIL ORDER



**dressler - ara 30 -
active antenna**
50 kHz . . . 40 MHz
WITH LIMITED PERFORMANCE
UP TO 100MHz

Professional electronic circuitry with very wide dynamic range. Meets professional demands both in electronics and mechanical ruggedness. 1.2m long glass fibre rod. Circuit is built into waterproof 2.5 mm thick aluminium tube. Ideal for commercial and swl-receiving systems. £129. See Review in August 1985 Issue p.35

NEW

**DRESSLER
ARA 900
ACTIVE ANTENNA**
50MHz to 1300MHz
Gain 17dB Typical
TECHNICAL SPECIFICATIONS
FOR ARA 900

Gain 17dB Typical (14-17dB)
Frequency Range 50-1300MHz
Noise Figure 1dB at 50-180MHz
1.5dB below 300MHz
2.0dB below 350MHz
2.7dB below 400MHz
3.0dB below 500MHz
3.8dB below 650MHz
4.6dB below 1300MHz
Intercept Point 3rd Order +18dBm at Input
Post £3.00 or Securicor £7.00 extra

£139.00

Both antennas come complete with 7 metres of cable, interface, power supply and brackets.



YAESU FRG-9600
£475
60-905MHz
AM · FM · SSB
FREE SECURICOR

YAESU FRG-8800
£575 + OPTIONAL
FRV 8800
CONVERTER
118-174MHz **£100**



FREE
SECURICOR

ICOM RZ1
General Coverage Receiver
£825



FIRST CLASS SHORT WAVE RECEIVER. BUY THIS FOR £825 AND RECEIVE AN ARA 30 FREE.

NOW AVAILABLE

Kenwood RZ1
Mobile Scanning
Receiver

**WHY GO ALL
THE WAY TO THE
NEC WHEN THE
BEST BARGAINS ARE
STILL HERE IN
LONDON!**

ICOM R7000 25MHz-200MHz
SPECIAL OFFER!! (Cash or cheque sales only)



FREE
ARA 900.
ACTIVE ANTENNA
WORTH £139.00
£969

ALL SONY PRODUCTS UK SUPPLIED

SONY ICF 2001D
76-108 MHz
116-136 AIRBAND
153kHz-29.995MHz
FM · AM · SSB 32 MEMORIES
INC PSU, CARRY STRAP
& EARPHONE

£325

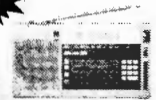

NOW AVAILABLE ALSO IN PRESENTATION BOX COMPLETE WITH AN ACTIVE ANTENNA **£378.00** INCLUDING FREQUENCY LIST'S BOOKS

SONY ICF 7600DS
76-108MHz

76-108MHz
153kHz-29.995MHz
Complete with case,
mains power supply,
earphone and
frequency list.

£169

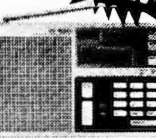

SONY PRO-80
150kHz-108MHz
115.15MHz-223MHz
AM + FM + SSB
40 MEMORIES
£329



**NEW SONY SW.1
MICRO-SW-RECEIVER
INC. ACTIVE
ANTENNA etc.**
£249

**ALL SONY FREE
SECURICOR DELIVERY**

MERLIN

MERLIN WAY, BOWERHILL,
MELKSHAM, WILTSHIRE SN12 6TJ.
Tel: 0225 706886.

SYSTEMS

Look out for Merlin Systems at the following rallies and exhibitions, RAFARS, at RAF Halton, Aylesbury, Bucks on June 18, the Longleaf Rally on June 26, the NEC Exhibition on the 15, 16, 17 July and the Scarborough Amateur Radio Society Rally on 31 July. You may also call at the Warehouse but please ring first.

NEW SYSTEM

MERLIN SYSTEMS PC Turbo 256K Ram, 8088 CPU, 1 Diskdrive, Hires Mono Monitor, 84 Keyboard, Fax printer port, Radio and MSdos software and Merlin Systems backup. £450.00 + £15.00 P&P.

COMPUTER DESK

Up Market desk L 102cm x W 74cm x H 74cm with keyboard recess and cabling trunking. New only £50.00 + £16.00 P&P.

POWER SUPPLIES AND TRANSFORMERS

Bench mains input PSU in a blue case with switched input and HT output 6.3vac lamp for valve heaters 250Vdc HT stabilised. H 115mm W 185mm D 125mm £8.00.

2nd USER SYSTEMS

BBC B with DFS one 40 track SS drive. £250.00. BBC + 128K 1770 DFS, S way rom, one 40 track DS drive. £350.00. IOTEC IONA 64K CPM 2.2.2 40 track DS drives. £160.00. Apple II+ with one disk drive and software. £150.00. FRANKLIN ACE 1000 with disk drive and software this is a Apple compatible. £150.00. P&P £10.00.

COMPUTER PARTS

APPLE cards, S100 cards, PSUs, NEW 12 inch green screen composi input Hires open frame monitor. only needs 12 volts DC. £30.00. P&P £5.00.

NEW

Made by well known Japanese manufacturer, twin cassette mechanism, complete with stereo heads, counter doors and leads only £6.00 P&P £1.00. Complete working LW, MW, FM, stereo music center PCB (the cassette plugs in) only £5.00 P&P £1.50.

RADIAL ELECTROLYTICS

10 x 4.7uf 25v	30p	5 x 3300uf 25v	1.30
10 x 22uf 10v	30p	2 x 340uf 40v	75p
10 x 22uf 25v	35p	MISCELLANEOUS	
10 x 47uf 25v	35p	1 x I.E.C. 1amp mains filter socket	1.25
10 x 47uf 35v	40p	1 x I.E.C. 3amp mains filter socket	1.50
5 x 47uf 250v	60p	1 x I.E.C. 6amp mains filter socket	1.75
10 x 100uf 10v	35p	5 x push latching pcb switches	70p
10 x 220uf 10v	35p	5 x slide pcb switches	70p
10 x 220uf 16v	35p	10 x phono plugs	50p
10 x 220uf 25v	40p	5 x 240v panel neons	70p
10 x 220uf 40v	45p	5 x 24v panel lamps	70p
10 x 220uf 50v	45p	5 x MES lamp holders	50p
10 x 470uf 25v	35p	5 x 2way 3pole switches with knobs	1.20
10 x 470uf 50v	50p	4 x 4way dill switches	30p
10 x 1000uf 25v	35p	5 x 1.7amp 200v bridge rectifiers	1.20
		3 x 1amp 50v bridge rectifiers	50p
POWER ELECTROLYTICS		10 x 5mm x 2mm red leds	1.00
5 x 50uf x 50 of 200v	60p	3 x 5mm x 2mm green leds	1.00
2 x 220uf 315v	1.75	MERLINS KIT PACKS	
2 x 220uf 400v	2.00	1 x mixed power capacitors	1.75
2 x 470uf 200v	1.50	1 x mixed pf capacitors	1.50
2 x 1500uf 25v	1.75	1 x mixed axial electrolytics	1.50
2 x 2200uf 25v	2.00	1 x mixed wire wound resistors	2.20

PAYMENT: Credit card, cheque, PO, cash. Post and Packing, up to £10.00 add £1.50. £10.00 to £20.00 add £1.00. Please add VAT to total.

CRICKLEWOOD ELECTRONICS LTD

It's no secret!



... that there is a real difference at Cricklewood Electronics. That's why you should never be without the FREE CRICKLEWOOD ELECTRONICS COMPONENTS CATALOGUE, for sheer variety, competitive prices and service from the U.K.'s number one 100% component shop. No gimmicks, no gadgets or computers, just components, millions of them, all easily available by mail order, calling or credit card telephone orders. Just pick up the phone (for a pen) to get your FREE copy now (no SAE required). You have nothing to lose.

CRICKLEWOOD ELECTRONICS LTD.

40 Cricklewood Broadway NW2 3ET.

01-450 0995 & 01-452 0161

ALL MAJOR CREDIT CARDS ACCEPTED

Telex 914977 Phone or write today

R.A.S. (Nottingham)

G6XBH
G1RAS
G8UUS

Radio Amateur Supplies
Tel: 0602 280267



Visit your Local Emporium

Large selection of New/Used Equipment on Show

AGENTS FOR:

F.D.K.
AZDEN
ICOM
YAESU
ALINCO
KEMPRO

ACCESSORIES:

Welz Range
Microwave Modules
Adonis Mics
Mutek Pre-Amps
Barenco Mast Supports
DRAE Products
BNOS Linears & P.S.U.'s

AGENTS FOR CELLNET AND VODAFONE RADIOS
AERIALS, Tonna, Halbar, New Diamond Range of Mobile Whips, Jaybeam
BRING YOUR S/H EQUIPMENT IN FOR SALE
JUST GIVE US A RING

Monday: CLOSED Tuesday-Saturday: 10.00am to 5.00pm

3 Fardon Green, Wollaton Park, Nottingham NG8 10U
Off Ring Rd., between A52 (Derby Road) & A609 (Ilkeston Road)

Lee Electronics



For

SR STANDARD COMMUNICATIONS

C500

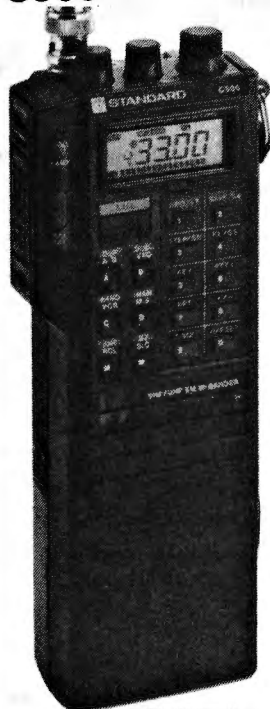

£375

★ Frequency coverage 144-146 & 430-440MHz with Full Duplex available. ★ Extended receive capability:- 130-169.995 & 410-470MHz. ★ 2.5 to 5 Watts output (depending on battery pack). ★ High or Low switchable RF output. ★ Step sizes:- 5/10/12.5/25/50kHz (user programmable). ★ Keyboard programmable repeater offset (0-39.9MHz). ★ Reverse repeater mode. ★ Priority Channels available on both bands. ★ Each band has 10 memories for frequency and repeater offset. ★ Dual synthesised VFO's. ★ User programmable CALL button (instant QSY to your favourite channel - either band). ★ Numerous scanning modes (Pause or Busy - memories - band etc.). ★ Auto Power Off - with Alarm (4mA current drain on standby). ★ Battery Save on receive - 9 user programmable Rx/Off ratios. ★ Vacant Channel Search - for easier QSYing. ★ Lock - disables keypad and/or PTT. ★ Squelch Off button (saves twiddling the knob). ★ Low Battery indicator. ★ Easy to read Liquid Crystal Display with backlight. ★ LCD S/Power output meter. ★ Can be powered directly from a car's cigar lighter (5W output). ★ Keypad or Rotary Knob frequency selection. ★ Dimensions:- 173mm H x 60mm W x 34mm D.

C5200

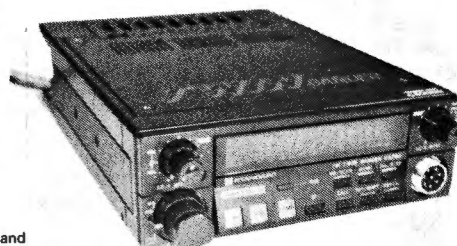

£599.00
(Special Show Price)

The new Standard C5200 leads the way into a new generation of dual band mobile transceivers. It is virtually two radios in one box. There are two individual bright green LED displays - one for 70cms and one for 2m - each with a separate frequency indicator, S meter and Busy indicator. Both bands can be received simultaneously and the powerful 2W of audio from each band can be heard from the built-in speaker. If this gets a little confusing, there are two separate external speaker outputs on the back of the set - one for each band - or one external speaker can be used for both bands. Each band has its own separate Volume and Squelch controls and there is also an Automatic Mute control that can be set to mute the audio from one band while the other one is being received.

The C5200 can also be used for full duplex communications with either band being used for transmit or receive. An unusual feature of this set is that when it is being used in the duplex mode for crossband working, the received frequency (either 70cms or 2m, whichever you have chosen) can be tuned while you are transmitting on the other frequency. Thanks to the well-designed fan cooled PA stage, 45 Watts of RF is available on each band.

There are 4 different Scan modes which are available independently on each band and each band has 10 memory channels. Five step sizes are provided and different ones can be set for each band so it is easy to have, for instance, 12.5kHz spacing on 2m and 25kHz on 70cms.

Remote control of some of the many functions is possible with the supplied microphone and a tone squelch unit (CTN500) and an AQS Controller are available as optional extras.

This radio really is different to the run-of-the-mill dual banders that you may have seen before so come into the shop and try it for yourself or see it on our stand at the NEC where it will be on sale at the special show price of £599.

AS THE SOLE IMPORTER OF STANDARD EQUIPMENT IN THE UK,
WE ARE ABLE TO OFFER A FULL BACKUP SERVICE AND CURRENT SPARES FROM STOCK.

SWR METERS

		P+P
SWR3	3.5-30MHz 200 Watts/50-150MHz 50 watts.....	34.00 (1.50)
SWR50	3.5-150MHz 1KW PEP with back light facility.....	34.00 (1.50)
FSS00H	This peak reading meter has RMS/PEP with follow/hold facility in the range 1.8 to 60MHz-20/200/2KW.....	75.00 (2.00)
SWR15	Single meter SWR/Field Strength 3.5-150MHz.....	9.77 (1.50)
SWR50B	Twin meter SWR/Field Strength 3.5-150MHz.....	19.00 (1.50)
T435	VHF/UHF Twin Meter 2/20/120W.....	52.50 (1.50)

WELZ PRODUCTS

SP330	1.8-500MHz 200W Dash Mount.....	95.00 (1.50)
SP430	Mobile SWR/PWR/Volt Meter 140-150/420-450 MHz 60 watts.....	49.50 (2.00)
SP600	1.6-500MHz 20/200/2KW.....	169.00 (1.50)
SP825	1.8-1.3GHz 2/15/150W.....	169.00 (1.50)
SP10X	1.8-500MHz 200W Pocket Size.....	42.50 (1.00)
AC38	3.5-30MHz Coax ATU 200CW/400C PEP.....	95.00 (1.00)

MORSE KEYS

HK707	Straight Up/Down Keyer.....	19.25 (1.00)
HK702	As HK707 only with a Heavy Marble Base.....	34.75 (1.50)
HK704	Squeeze Keyer.....	24.50 (1.50)
MK705	Squeeze Keyer.....	31.50 (1.00)
MK702	Manipulator Key on Marble Base.....	40.50 (1.00)
BK100	Semi Automatic Bug Key.....	32.95 (1.00)
EKM-1A	Morse Code Practice Oscillator with variable Tone.....	10.25 (1.00)

ROTATORS

AR1002	Automatic Antenna Rotator.....	45.00 (3.25)
AR2200	Heavy Duty Antenna Rotator.....	89.95 (3.50)
KR400C	Mid to heavy Vertical Load 200KG 6 core cable.....	189.00 (5.00)
KR600C	Heavy-vertical load 200KG Brake Torque 400KG/CM.....	219.00 (5.00)

ANTENNAS

TA285D	2M Colinear Base Antenna.....	35.00 (7.50)
TA285D	2M 70cm Colinear.....	35.00 (7.50)
X50	Base Antenna 70/2.....	60.00 (7.50)
DPCP5	Base Antenna 80-10m.....	198.00 (7.50)
DPL EL77MH	Mobile Antenna 70/2.....	29.95 (7.50)

POWER SUPPLIES

EPL40	4.2 Amps.....	39.95 (4.00)
EPL70	6.5 Amps.....	69.00 (4.00)
EPL122	12 Amps.....	95.00 (5.00)
EP2510	25A Continuous 30A Max 13.8VDC Fully Stabilized.....	155.00 (6.50)
DRAE	13.8VDC 12 Amps.....	86.50 (5.00)
DRAE	13.8VDC 6 Amps.....	65.00 (4.00)

METERED UNITS AVAILABLE AT EXTRA COST PLEASE PHONE

ADONIS MICS

AM303	Base Mic SSB/FM Switch.....	49.50
AM503	Desk Compressor Mic as 803 with One Output. Two levels of compression.....	59.00 (1.15)
AM803	As 503 with Meter & 3 Outputs.....	89.50
FX1	Swan Neck Fet Mic with Control Box.....	49.00 (1.15)
202S	Flexible Neck Clip Mic with Control Box.....	37.50 (1.15)
HW7	Head Set Boom Mic For Yaesu/Icom/Trio.....	27.50 (1.15)

COAX SWITCHES

SA450	Diecast 2 Way SD239 3.5-500MHz.....	13.65 (1.50)
Toggle Type	CT1 3x SD329/CT2 2x SP239 1x PL259 3.5-150MHz.....	7.50 (1.00)

★ SPECIAL OFFERS ★

TA285D	2m Colinear Base Antenna or 70cm Colinear.....	29.95 each (3.00)
Toggle Switch	6.00 (7.50)
SWR15	7.50 (2.00)
LPF120	Low Pass Filter (up to 55MHz).....	3.75 (1.50)
2 x CPB 78-70cms 1W in 10W out amplifier.....		£49.50 each
FV707DM M&M/Scan Unit.....		£75.00
YR901 RTTY/CW Decoder.....		£185.00 New but bought as seen
2 x C7900 70cms 10W Mobile Ex Demo.....		£235.00
C110 and CNB110 Nicad Pack. Was £35.....		NOW £25.00
CSA10 Rapid Base Charger. Was £52.....		NOW £35.00
C120 Package Deal:- 2M H/H Cell Case, Nicad Pack and Wall Charger.....		£269.00

SEE THESE NEW MODELS, AND MORE
ON OUR STAND AT THE NEC.
WE CANNOT GUARANTEE TO HOLD THESE
BARGAIN PRICES AFTER THE SHOW.

400 EDGWARE ROAD,
LONDON W2
01-723 5521 Tlx 298765



Normally 24hr despatch
but please allow 7 days
for delivery.

NEAREST TUBE:
EDGWARE ROAD
PADDINGTON

OPENING TIMES:
9.30am-5.30pm Mon-Fri.
10am-4.30pm Sat.



Plastics

Can anyone enlighten me as to why the word "plastics" appears in *PW/SWM* but never anywhere else? The only reference to the word that I can find is as the plural of plastic.

I can understand that it may be to make a distinction between plastic in its original sense—pliable, flexible, etc.—and the oil-based material with which we are all familiar, but if I went into a builders' merchant and asked for some "plastics drainpipe", I would suggest I would get a peculiar look, and probably an even more peculiar reply.

I realise that this query may be seen as "nitpicking", but as well as

finding it irritating I am genuinely puzzled by the use of the word. Can anyone provide me with an explanation?

**N. Richardson
Aylesbury**

In the days when I was taught about such things, I was told very firmly that "plastic" was an adjective, used to describe things that deformed under pressure, and "plastics" was a noun describing materials that are man-made from oil.

I suspect that in the petrochemical industry, they will still stick to these definitions, but in ordinary dictionaries the meanings of the words have gradually changed over the years, and in recent editions "plastic" is given both as an adjective and as a noun meaning those oil-based substances. More proof, I suppose, that English is a living language.

I guess that we should make the change too, though I must confess to being still worried about the possibility of having to describe an item as being made from rigid plastic—somewhat of a nonsense!—Ed.

934MHz Reallocation

Although the Personal Radio Club of Great Britain were consulted on the withdrawal of the MPT1321 934MHz CB Specification, they made it clear they were not in agreement. The views expressed by the club were met by the statement "The DTI awaits the choice of the new system from CEPT (Conference of European Posts and Telecommunications)".

However, the PMR press state that the EEA (Electronic Engineering Association) and the DTI have been working on a system to present to CEPT. If this proves to be correct, then it would seem to contradict a statement made in a letter dated June 1986, addressed to the PRCGB: "The DTI will ensure that any future system, if and when introduced, will be compatible with this service." (i.e. 934MHz CB).

The proposed service being presented to CEPT has no CQ call, no scan, and a one-minute timer. Even if you overlook that it is not

compatible, these specifications will not benefit the hobby user. The PRCGB would have liked the DTI to have backed the Swiss system of PRS (Personal Radio Service). This is a mixture of Japanese PRS and CB type radio, having 40 auto-channels in 933-934MHz and 40 manual channels in 934-935MHz. This system would benefit both the small business and the hobby user. Being compatible with existing equipment also, it is available now and it's affordable. The DTI has stated to the PRCGB that although they are considering an early withdrawal of Specification MPT1321, they are not withdrawing 934MHz CB, and continue to be concerned to protect the interests of 934MHz CB licensees in CEPT discussions. We are waiting to see if this is so.

**J. R. Smith
Midland Area Rep
PRCGB 581
Chasetown, Staffs**

Novice or Student

Recent correspondence critical of the proposed Novice/Student Licence has both surprised and saddened this writer. I am astonished at the antipathy aroused by the proposals in some quarters and get the impression that there are those amongst us who would rather see amateur radio die a slow death, than give their support to measures directed at broadening entrance to our hobby. Are we really so insular that we cannot learn from the experience of amateurs in other countries?

The USA and Australia, to quote but two examples, have had Novice Class Licences for many years and it is my understanding that their amateur radio is thriving. Limited to low power c.w. operation on the band sectors allocated to them, these enthusiasts can be heard regularly in the UK and I am sure that, like myself, many c.w. operators have sensed the pleasure

which they feel in establishing communication with stations in Britain.

I have given instruction for the RAE at the local Adult Education Centre for a number of years, and I recognised at an early stage that the theoretical aspects of the Examination were a deterrent to those whose mathematics had become "rusty" or was non-existent. Simple transposition of formulae, scientific notation and the basic trigonometry essential to the understanding of a.c. theory are "closed books" to many genuinely keen students. It is difficult in a 22-week course (reduced from 26 as a result of "cuts") to give the detailed instruction necessary in this area, without sacrificing time which has to be spent on other aspects of the syllabus. The consequence is that some lose interest, the "magic piece of paper" seems unattainable, and students who know their Licence Regulations and Operating Practices like the backs of their hands, fall by

the wayside. Give these students the opportunity to operate and they will be encouraged to persevere with these difficulties. I believe that the influx to our hobby, which all of us in the older generation are trying to encourage, would then be forthcoming.

Should a Novice/Student Licence become part of the UK Regulations, it could bring an added advantage. The impact of commercialism on our hobby has created an impression that without a couple of thousand pounds to spend on an "all-singing, all-dancing" black box, coupled with a magic "Thundertonne" beam antenna, no-one can expect to work DX on today's busy bands. Perhaps the Novice/Student operator, limited to low power on the key, will come to realise that "only" 559 from VK does not detract from the enjoyment of the hobby!

**C. J. Teece, TEng, FIElectE,
G4DBR
Rugeley,
Staffs**



More Pipesmoke?

Further to my article in March *PW* on coil formers from waste-pipe, and the letter from G4BYV in the May issue, he is of course quite correct that an r.f. voltage must be reached, sooner or later, where such a coil former will be useless.

The piping I use is what is known as $\frac{3}{4}$ in waste pipe, and enquiries at the DIY store where I buy it produced the information, for what it's worth, that it is rigid ABS. If so then it is similar to the stuff used to make the multitude of plastics boxes which we use in our hobby.

However, like most materials and components used in electronics, there is a breakdown voltage. Any winding or transformer which gets hot during operation must be investigated. The cause could be the wire gauge, voltages involved, current ratings, insulation and—most important—ventilation.

On reflection, perhaps I should have stated in my article that the coil formers could be used for low to medium power rigs. I have used them for p.a. coils, in a.t.u.s and in antennas running up to 100 watts of c.w. r.f., and have never had any problems.

I was interested to see GW2DDX apparently using the self-same tubing in his intriguing Mini-beam for 14/21MHz in May *PW*. I wonder what r.f. power he is pumping into this antenna. Of course, he does have the slight advantage of having built-in water cooling in our typical UK weather, i.e. the rain!

*Richard Q. Marris G2BZQ
Slough*

Data Symposium

The following lectures have been confirmed for the first RSGB Data Symposium at Harrow School, NW London on July 22-23.

The Other Side of the Coin by Gwyn Reedy W1BEL
Packet Radio Developments in France by Remy Jentges F6ABJ

Send your letter to the Editorial Offices in Poole, the address is on our Contents page. Writer of the Star Letter each month will receive a voucher worth £10, to spend on items from our PCB or Book Services, or on *PW* back numbers, binders, reprints or computer program cassettes. And there's a £6 voucher for every other letter published.

Letters must be original, and not duplicated to other magazines. We reserve the right to edit or shorten any letter. Brief letters may be filed via our Prestel Mailbox number 202671191. The views expressed in letters are not necessarily those of *Practical Wireless*.

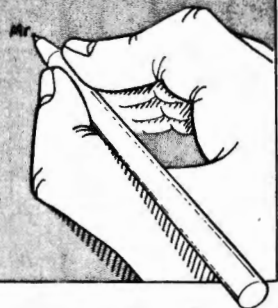

Keeping in Touch by John Kirk G4LPO

High Speed Linking in the Amateur Packet Network & Packet Systems, Which Way Now? by Ed Harland G3VPF

RTTY Night Owl Theatre (RTTY Pictures) by Lindsay Rohrlach VK3KAF/G1XPG

A Short History of Telegraphy by Alan Hobbs G8GOJ and Sam Hallas G8EXV presented by G6GJW

The Irish Packet Scene by E15CI
Commercial Aspects of Data Transmissions by John Coll of Xon Software

UK Data Networking Strategy by Mike Dennison G3XDV

The Application of AMTOR in the Amateur Radio Global Message Handling Network

by Peter Martinez G3PLX presented by G3XDV
Rail Block Signalling by Mr Giles of British Rail
The Trials and Tribulations of Being a Mailbox by Andy Witt G1DIL

Reconciling Legislation with Experimentation by G3XDV
Overture & Beginners plus a Packet Video by Phil Bridges G6DLJ

9600 Baud Packet Radio
Modem Design by James Miller G3RUH
Satellite Digital Communications by Jeff Ward G0/K8KA
AMPRNET by Gareth Howie G6KVL

Registration starts at 8.45am each day. Booking forms can be obtained by sending a large s.a.e. to: **Membership Services Department, RSGB HQ.**

OUR SERVICES

QUERIES

We will always try to help readers having difficulties with a *Practical Wireless* project, but please observe the following simple rules:

1. We cannot give advice on modifications to our designs, nor on commercial radio, TV or electronic equipment.
2. We cannot deal with technical queries over the telephone.
3. All letters asking for advice must be accompanied by a stamped, self-addressed envelope (or envelope plus International Reply Coupons for overseas readers).
4. Write to the Editor, "Practical Wireless", Enefco House, The Quay, Poole, Dorset BH15 1PP, giving a clear description of your problem.
5. Only one project per letter, please.

COMPONENTS, KITS AND PCBs

Components for our projects are usually available from advertisers. For more difficult items, a source will be suggested in the article. Kits for our more recent projects are available from CPL Electronics, and from FJP Kits (see advertisements). The printed circuit boards are available from our PCB SERVICE (see page 53 of this issue).

CONSTRUCTION RATING

Each constructional project is given a rating, to guide readers as to its complexity:

Beginner

A project that can be tackled by a beginner who is able to identify components and handle a soldering iron fairly competently.

Intermediate

A fair degree of experience in building electronic or radio projects is assumed, but only basic test equipment is needed to complete any tests and adjustments.

Advanced

A project likely to appeal to an experienced constructor, and often requiring access to workshop facilities and test equipment for construction, testing and alignment. Definitely not recommended for a beginner to tackle on his own.

BACK NUMBERS AND BINDERS

Limited stocks of most issues of *PW* for the past 18 years (plus a few from earlier years) are available at £1.30 each, including post and packing to addresses at home and overseas (by surface mail).

Binders, each taking one volume of *PW* are available Price £3.95 to UK addresses, or overseas, including post and packing. Prices include VAT where appropriate

CLUB NEWS

If you want news of radio club activities, please send a stamped, self-addressed envelope to **Club News, "Practical Wireless", Enefco House, The Quay, Poole, Dorset BH15 1PP**, stating the county or counties you're interested in.

ORDERING

Orders for p.c.b.s, back numbers and binders, *PW* computer program cassettes and items from our Book Service, should be sent to **PW Publishing Ltd., FREE-POST, Post Sales Department, Enefco House, The Quay, Poole, Dorset BH15 1PP**, with details of your credit card or a cheque or postal order payable to *PW Publishing Ltd.* Cheques with overseas orders must be drawn on a London Clearing Bank.

Credit card orders (Access, Mastercard, Eurocard or Visa) are also welcome by telephone to Poole (0202) 678558. An answering machine will accept your order out of office hours.

SUBSCRIPTIONS

Subscriptions are available at £14 per annum to UK addresses and £18.50 overseas. For further details, see the announcement on page 51 of this issue. Airmail rates for overseas subscriptions can be quoted on request.

Rotators

More and more amateurs, s.w.l.s and TVDXers are investing in rotators these days. South Midlands communications have sent us details of some of their Yaesu antenna rotators.

Detailed here are three that may interest readers as they are for light and medium duty work. Obviously there are some very "beefy" rotators also available including ones that can provide azimuth elevation too.

The first one is the G-250, it is for small and medium v.h.f., u.h.f. f.m. radio and television antennas. The power consumption is 37VA, the 360° rotation time is 43 seconds, the maximum vertical load is 50kg and the mast diameter is 25-38mm.

The G-400 and G-400RC have the same specification but have different control units. They are designed for

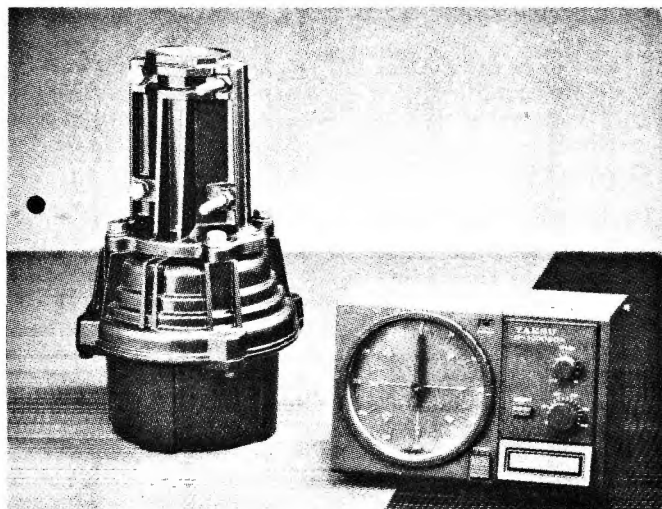

small h.f. and medium to large u.h.f., v.h.f., f.m. radio and television antenna arrays. Power consumption is 40VA, 360° rotation time is 50 seconds, the maximum vertical load is 200kg and the mast diameter is 36-63mm.

For details of these and all the other Yaesu rotators, contact:

**South Midlands Communications Ltd.,
School Close,
Chandlers Ford Ind. Est.,
Eastleigh,
Hants. SO5 3BY.**

RAE Courses

Stockport: The Avondale Evening Centre will be holding both RAE and Morse classes starting in September. Morse classes are Mondays at 7pm and the RAE classes are Tuesdays at 7pm. Enrolment takes place during the week commencing Monday September 19. Further information is available from **Avondale School. Tel: 061-477 2382.**

Mullard Name Change

Mullard has changed its name to Philips Components. Founded in 1920 by Stanley Mullard, the Company has traded under the Mullard name ever since, even though it became part of Philips in 1927.

The company believes it should be seen as a manufacturer and supplier with world-wide resources. They feel that, as Philips Components Ltd., it will signify to customers that it has direct access to the latest developments in component technology throughout the Philips concern.

RadioGram

The RadioGram magazine is published bi-monthly for all valve radio enthusiasts. It costs £6.50 in the UK and Ireland for six issues, that's not always a calendar year.

Issue No. 15, which recently arrived on my desk, contains features about the Barker 88 receiver, The EMI Story, constructing an

antenna tuning unit as well as general features on vintage music and a wireless set in a glass bulb.

If you would like to know more about RadioGram, then contact:

**The RadioGram,
Larkhill,
Newport Road,
Woodseaves,
Stafford ST20 0NP.**

Cermet Potentiometers

West Hyde Ltd., usually better known for their enclosures, have introduced a new range of p.c.b. mounted cermet potentiometers.

They are designed by Leonhardy in Germany. The range is part of a modular component system based on a 5.08mm grid. It has a rectangular body with a square front measuring 10.16mm along each side. Small tongues and grooves on the body assist alignment when two or more components are mounted side by side.

The devices are suitable for flow soldering as they are sealed to provide protection from flux, solder vapour or cleaning agents. The maximum power rating

is 0.5W at 75°C and the resistance values range from 10Ω to 1MΩ in standardised steps.

More details on these and other ranges, contact:

**West Hyde Developments Ltd.
9-10 Park Street Ind Est.,
Aylesbury,
Bucks. HP20 1ET.
Tel: 0296 20441.**

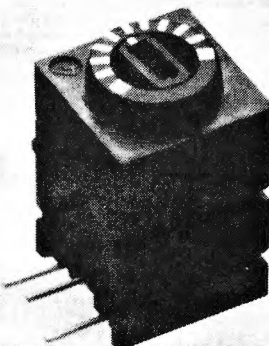

Free Software

We have heard from Peter Fawcett G0FBK and he would like us to pass on that free software is available in the form of a cassette to enable the EG2000 Colour Genie computer to run packet. The Colour Genie has been used for quite some time now as a dedicated RTTY terminal. It has been used successfully with the TNC220, but it is thought that it should be possible to use it with other TNCs.

If you send one pound, that covers the cost of the cassette and postage, you will receive a cassette and four-pages of useful data.

It's not known just how many Colour Genie EG2000 were sold, but they were retailed by Lowe Electronics for RTTY use. Now it is hoped that RTTY enthusiasts can get going on packet too — without too much extra expense.

For more details of where to obtain your software from, write to:

**Peter L. Fawcett G0FBK,
7 Albert Hill,
Bishop Auckland,
Co. Durham DL14 6EH.**

Portable Soldering

A new addition to the range of soldering and desoldering equipment offered by STC Electronic Services is the Steinel GL1000 portable butane gas powered soldering tool.

It provides up to three hours soldering time and can be refuelled quickly. Three attachments allow soldering, hot air nozzle heat-shrinking, and, with torch attachment, open-flame hard-soldering or brazing capability, up to 1300°C.

Fuel is burnt in a catalyst—ensuring flame-free temperature controlled soldering by the use of adjustment rings. The tool comes complete with protection cap, soldering tip, hot air nozzle, butane gas and lighter. For further details, contact:

**The Tool Group,
STC Electronic Services,
Edinburgh Way,
Harlow,
Essex CM20 2DF.**

Audio/Video Care

When you have spent many hours waiting for that elusive TV or radio signal, you don't want to find that the tape or video recorder you have been using to preserve the moment with is dirty and the results ruined.

We have been given details of a range of six audio/video care systems launched by Bib. Each care system is packaged in a strong, handy, "luggage" type case with a clear, hinged lid, snap lock closure and handle.

We've only space here to describe three of the care packages for you, but you should be able to find the whole range in the shops.

The Video Care System CS1 includes a push button VHS cleaner, anti-static screen cleaning fluid, VHS title labels and re-useable record safety tabs.

The Audio Care System CS3 includes a carbon fibre anti-static record brush, a stylus brush with inspection mirror, cleaning fluid, cassette head cleaner, head cleaning fluid, tape splicer complete with splicing tape and tape cutter.

The Audio Cassette Care System CS5 includes an electronic tape head demagnetiser, audio cassette tape head cleaner and fluid, audio tape head cleaning tools, a pocket sized inspection light and 10 audio cassette title cards.



The price you can expect to pay for these kits is £12.99 each. So does anyone have birthday in the near future? . . .

Many apologies to those who tried to go to the Science Museum rally and found it was the wrong day. Unfortunately the date was changed and no-one told the Newsdesk!



Icom IC-781

The Icom IC-781 is an h.f. all band transceiver, the functions of which are far too numerous to mention here. It's best to contact Icom (UK) Ltd., for the brochure.

The receive section of the rig covers 0.1-30MHz and the transmit side has the WARC bands fitted. A few of the features are that it has a multi-function c.r.t.

display. This 5in display shows the frequencies of VFO A and VFO B, the contents of the memory, two menu screens, fifteen operational screens and packet and AMTOR data. There are 99 memory channels available, fortunately the contents of these can be displayed on the c.r.t.

The frequencies are

derived digitally so each frequency step is 10Hz. There are also six different scan functions available. So you can see it is a very complex transceiver. The eight-page brochure explains the functions much more fully. That is available from: **Icom (UK) Ltd. Sea Street, Herne Bay, Kent CT6 8LD.**

Attention Cybernet Users

Nevada have recently written to us saying that the Kyocera Corporation of Japan will be ceasing production of 27MHz CB radios. Kyocera were responsible for producing the famous Cybernet and Ham International brand names.

Nevada have managed to purchase a large quantity of spare parts for all the Cybernet models, including the Cybernet Beta 3000, Beta 2000 and Beta 1000. They also have a limited quantity of Ham International spares.

For details of availability and cost of various spares, contact:

Nevada, 189 London Road, North End, Portsmouth, Hants. PO2 9AE.

Piracy

We have been sent details regarding a pirated callsign on the 3.5MHz band. Not surprisingly the owner of this callsign is not overly impressed.

The culprit is believed to be on the Isle of Anglesey using GW8WJ on 3.5MHz c.w. He gives the QTH location as "near Mold" or just "N. Wales".

The real owner of the callsign, J. P. Evans, is located at Prestatyn. So if you hear the pirated call, steer well clear.

The RNARS

The Royal Naval Amateur Radio Society was founded in October 1960, for the purpose of gathering together all radio amateurs who had any connection with the service, or allied services, at home and abroad. Since its formation, membership has been extended to members of Merchant Navies. Membership now covers all continents with representatives from most Commonwealth areas. The society is recognised by the Ministry of Defence (Navy) and is affiliated to the RSGB.

The Australian branch was formed in 1979 and is recognised by the Australian Department of Defence (Navy) and is affiliated to the Wireless Institute of Australia.

Society Headquarters are situated at the School of Maritime Operations, HMS Mercury, Nr Petersfield, Hampshire.

There are three classes of membership.

Corporate—Open to serving

or past members of the RN, RM, WRNS, Reserves, Commonwealth Navies, RNXS, RFA service, Sea Cadet Corps or those connected with these services in a civilian capacity, and serving or past members of UK or Commonwealth Merchant Navies. **Associate**—Open to serving or past members of Foreign Navies or those connected with these services in a civilian capacity, or serving or past members of Foreign Merchant Navies. **Clubs**—The society supports the formation of RN clubs at home and overseas and these clubs can become affiliated to the society and benefit from such affiliation.

If you would like to know more about the Royal Naval Amateur Radio Society, whose subs are £5 per year, then send an s.a.e. to: **The Secretary, RNARS, HMS Mercury, Leydene, Petersfield, Hants.**

TF3SIX on the Air

Jonas Bjarnason TF3JB of Hljodtaekni Radio Supply and Richard Diamond G4CVI of South Midlands Communications have worked together in order to obtain the licence for a 50MHz Icelandic beacon.

SMC have donated the beacon, built by Mike Walters G3JVL, along with a

vertical unity gain antenna. The Yaesu power unit has been donated by Hljodtaekni Radio Supply, who have also organised the site near Reykjavik.

The beacon has the callsign TF3SIX and uses 50.057MHz running 50W e.r.p. The locator is HP94CC.

Security

A subject close to all amateurs who have spent a lot of money on their station is security.

A firm called Security International Ltd., have sent us information of some of their products launched recently.

The Teleguard VP4 and VP3 are volumetric security systems which use passive infra red movement detectors. The VP3 is a self contained unit comprising one infra red movement detector, siren and power supply. The VP4 is a modified version of this offering protection of up to three additional areas by means of radio linked passive infra red detectors. As an extra deterrent, the optional VP2 Telesound unit can be positioned outside

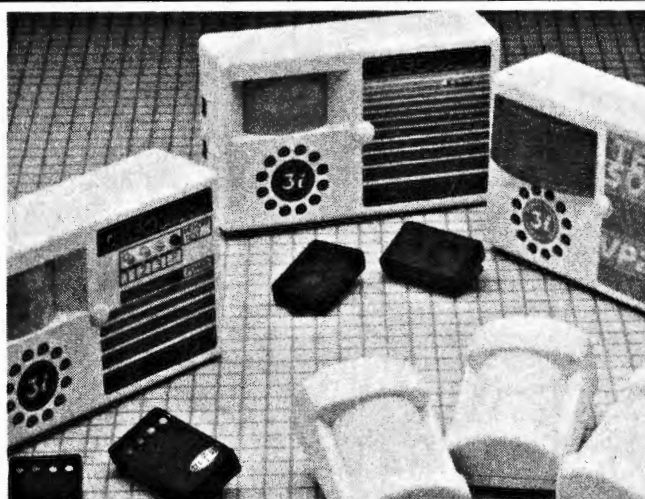

the protected area to give audible and visual warning.

The units are armed and disarmed by a small hand held remote transmitter which can be used up to 30m away from the unit. The built-in siren has a 115dB noise level too, so

it's likely to be heard!

If you would like more details on these units, then contact:

Security Int. Ltd.
Cornwallis House,
Howard Chase,
Basildon,
Essex SS14 3BB.

The 934MHz Club UK

The 934MHz Club UK is a nationwide organisation that brings together users of 934MHz and represents their interests. The magazine they produce comes out four times a year and gives round-ups of what's happening in all the different areas around the UK.

For your year's subscription, you get 4 magazines, updated membership lists, organised contests and rallies. So if you are a 934MHz user, or potential user, and would like to know more about the group's activities, then contact them at:
The 934MHz Club UK.
PO Box 424,
Althorne,
Chemsford,
Essex CM3 6UP.

Special Event Stations

GB75RPP: Trowbridge & District ARC will be operating this station between June 18-19. They will be operating from North Townsend Farm, Melksham, Wilts using 144 and 432MHz. They are being sponsored to raise money for Rotary Polio Plus. This is a two-year worldwide program to eliminate polio and five other children's diseases. Special QSL cards will be issued and further details are available from: **Jan GOGRI. Tel: 0380 830383.**

GB75MAL: This callsign will be used by the Scarborough Special Event Group on July 3 and 9. It's to celebrate the 50th Anniversary of the steam locomotive Mallard's world

record breaking 126 m.p.h. run. On these two days, the famous engine will run from London to Scarborough. Operation will be around 3.725MHz, 7.055MHz and 144MHz band. Special QSL cards will be available. Enquiries to: **Roy Clayton G4SSH. QTHR.**

GB2ACO: Between July 2 and 8, this special event will be established at an International Girl Guide Camp at Aikerness, Evie, Orkney. Operation will be on h.f. s.s.b. using 3.5, 7, 14 and hopeful 21MHz primarily in the evening when the girls will be in the camp. There will be QSL cards available and the WAB is HY32. More details from: **Anne GM6WPA or Bill GM3IBU. QTHR.**

Icom IC-228H

The Icom IC-228H is a 144MHz f.m. transceiver capable of 45W output. It has a multi-coloured liquid crystal display, orange, red and green highlight the numbers and letters displayed in black. To cope with the 45W output there is an extra large heatsink on the back of the rig.

There are twenty memory channels available, which

should be enough to plan your 144MHz activity on any journey. There is also a programmed and memory scan facility as well as a priority watch operation.

For full specification details on this new transceiver, contact:
Icom (UK) Ltd.
Sea Street,
Herne Bay,
Kent CT6 8LD.
Tel: 0227 363859.

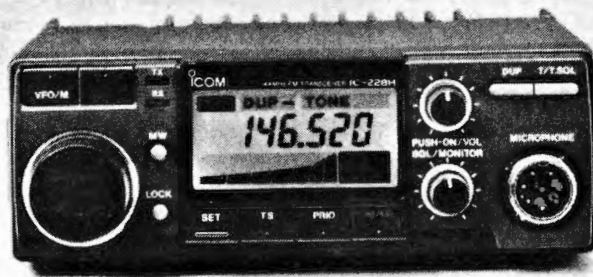

Can You Help

A reader rescued a book called *Wireless Coils-Chokes and Transformers* by F. J. Camm, 8th edition, published in 1949. He's had quite a bit of success with designs from the book, but would like to read the missing pages. These are 89-94 and 169-170. If anyone can help with photocopies of these pages, write to: **Bob Stone. 357 St Levan Road, Keyham, Plymouth PL2 1JR.**

Worked Scandinavia on CW Award

This new award has been so popular that the Scandinavian c.w. Activity Group has had to revise the rules. The number of awards available is no longer limited and s.w.l.s are welcome to apply.

European stations need to work 75 c.w. stations from five of the following countries: LA, OH, OY, OZ,

TF and SM. At least five of these stations should be SCAG members and you must obtain their membership number during the QSO.

Only QSOs made after 1 January 1988 are valid for this award. Applicants should send a list, confirmed by two other amateurs, of calls worked showing date, band, QTH, name and SCAG number where appropriate. No QSL cards are required.

The fee for the award is US \$7, DKK50 sent by

postal Giro to DK-7192185 or 171RCs.

Short Wave Listeners should send a self-addressed envelope, plus one IRC, to obtain a copy of the SCAG membership list to assist in identifying members. Their applications should be confirmed by two local amateurs or registered s.w.l.s.

All applications to:
R. Meilstrup OZ5RM.
Bavnestien 6,
DK-2850 Naerum,
Denmark.

Switches

ITW Switches has launched the Series 39, right-angle mount, push-button switch. This range of switches comprises two parts. The lower half of the switch is automatically loaded onto the p.c.b., which is then flow soldered in the normal way and process cleaned using fluorinated, chlorinated or aqueous methods to remove flux.

The top half of the switch is then snapped onto the base where it is securely retained giving a

contaminated-free switch.

The Series 39 is available in many options including 2-pole change-over as standard, momentary or alternative action as well as choice of lens styles, colours and illumination methods.

The right-angle mount means that the switch has dimensions of 12.4 x 9.6mm, when viewed by the operator.

For more information, contact:

**ITW Switches,
Norway Road,
Portsmouth PO3 5HT.
Tel: 0705 694971.**

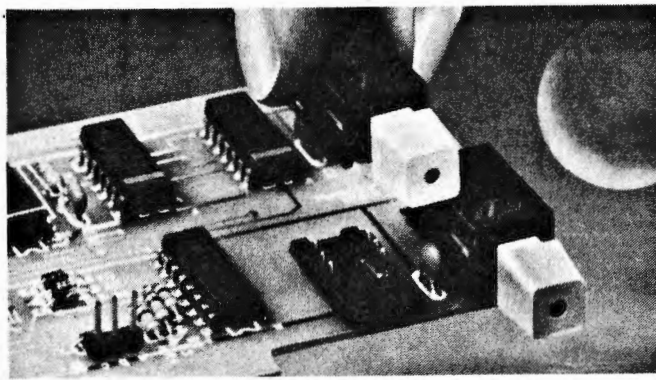

DXpedition

The Five Bells Contest Group will be going to St Kilda (VR18f) for their 1988 DXpedition.

St Kilda is located some 160km west of the Scottish mainland. The indigenous population was evacuated in 1930 and so public facilities are extremely meagre. Anyone who charts a boat to visit the Island must first seek permission from the Scottish National Trust. In the case of radio operations permission must be obtained from the Ministry of Defence who maintain radar and missile guidance installations.

Only 12 visitors are

permitted on the island at any one time, and these are required to be totally self-sufficient.

Due to the limitations of transport and the unpredictability of the weather, no sked can be made in advance. Interested parties should monitor the European v.h.f. net on 14.345MHz.

The relevant details for the DXpedition are:

Date: August 1-6.

Callsign: GB4VR.

QRG: 144.215 & 432.215MHz (tropo).
144.028MHz (ms).

Operators: G4ODA,
G4DHF, G4NPH, G8JJC.

QSL: via bureau. Direct via G4DHF QTHR.

Uniden Crystals

Cirkit have been appointed as a distributor for Uniden crystals, crystal filters and clock oscillators.

Apparently, Uniden are one of the few manufacturers in the world that grows its own crystal so that quality can be controlled right from the raw material stage. They say that special frequencies and tolerances can be

accommodated from 1MHz up to 130MHz in a variety of can sizes and mounting styles.

Crystal filters are available in 2, 4, 6 and 8 pole configurations in a variety of centre frequencies and band widths.

For further information, contact:

**Cirkit Distribution Ltd.
Park Lane,
Broxbourne,
Herts. EN10 7NQ.**

Rally Calendar

***July 15-17:** The RSGB 75th Anniversary National Convention will take place at the National Exhibition Centre, Birmingham. RSGB HQ can supply you with more details.

***July 24:** The Cornish Amateur Radio Club are holding their rally at the Village Hall, Perranwell. This is about 8km south-west of Truro.

July 24: The Burnham Beeches, Maidenhead and Chiltern ARC will be holding the 6th McMichael Rally at Haymill Centre, Burnham, near Slough. Doors open at 10.30am, 10.15am for the disabled. All the usual attractions will be there and the car boot sale will again be held. More details from: **Bob Hearn G0BTY. 70 Herbert Road, High Wycombe, Bucks.**

July 28-31: The AMSAT-UK Colloquium will again be held in the University of Surrey, Guildford. More from: **G3AAJ. Tel: 01-989 6741.**

***July 31:** The Scarborough ARS Rally will be held at The Spa, Scarborough. Doors open at 11am. Talk-in will be on S22 and SU8 as well as GB3NY. More details

from: **Ian Hunter G4UQP. QTHR. Tel: 0723 376847.**

***August 14:** The Flight Refuelling ARS and Bournemouth RAIBC Rally will be held at the FRARS Sports & Social Club, Merley, Near Wimborne, Dorset. All the usual attractions will be there for all the family. Entrance is 50p (children free). Gates are open from 10am to 5pm. More details from: **John Fell. Tel: 0202 691649.**

August 14: The 1988 Derby Mobile Rally will take place at the usual venue of Lower Bemrose School, St Albans Road, Derby. Doors open at 11am. More details from: **G3KQT. QTHR.**

August 28: The Annual Rally of the British Amateur Radio Teleprinter Group (BARTG) will again take place at Sandown Park Racecourse, Portsmouth Road, Esher. More details from: **Peter Nicol G8VXY. Tel: 021 453 2676.**

August 28: The Galashiels & District ARS are holding their Open Day at the Focus Centre, Livingstone Place, Galashiels. There will be trade stands, a bring & buy as well as catering facilities. More from: **John Campbell GMOAMB. Tel: 0835 22686.**

Amateur Madness

Everyone knows that radio amateurs are mad and a story that reached the news desk recently proves it!

Roy Andreang, using the callsign GB4CMT, jumped out of an aeroplane at 14 200 feet on Easter Saturday. He had hoped to be able to send Morse on the way down, but unfortunately the Morse key didn't work properly.

Still, he did manage to put out a call using the FT-290 Mk II loaned by SMC (Northern) Ltd. Four days after the jump, Roy celebrated his 64th birthday, but he has promised his family that this was the last time.

Over the years, whilst working in association with the Haltemprice District Scout Fellowship, Roy has acquired many awards. He was the first to transmit



from the top of the north tower of the Humber Bridge in 1974, was the first amateur to talk to others whilst making a parachute jump when he was 55 and the claim this time was the first to brew a cup of tea on the way down.

DXpedition North Sea '87

Having crossed the North Sea for many years, F. Jul-Christensen OZ1EVA/G4MJC wondered what it would be like to make a dedicated trip to work a few "wet" squares.

Everyone else seems to prefer good solid ground under their mast. As I have worked several /MM over the years, I thought there would be a good possibility in making such a trip worthwhile. So, I decided that during my holiday in 1986, I would take some equipment with me to try to ascertain the outcome of a possible trip. The equipment consisted of an FT-290R to a HB9CV at about 24m onboard MS *Tor Scandinavia*.

I had previously made a few skeds and in the hour I was "allowed" I was pleased to have worked 32 Gs and PAs which included some local stations. I could have carried on longer but my XYL's arm, being the support for the HB9, got tired. That was all the "proof" I needed (if proof is ever needed to go on the radio).

The rest of 1986 was spent toiling with ideas on how to put such a trip together! I asked Jan G4XNL (PA3EVP) who conveniently is also a navigator, Shaun G4MDZ and Simon G6VYH what they thought of the idea. Fortunately they liked it. I then had to get some letters written to DFDS, the owners of the ship, to the magazines all over Europe and to the trade for sponsors. Then bad luck struck—after having written the first letter I was taken into hospital so had to pass it all over to Jan. I am very grateful for all the work he did with the correspondence, both before and after the event.

Now, organising a trip like this means checking and double checking everything, so I made checklists which covered everything from rig to pens and spare lightbulbs. Although it was very similar to a contest site, this one moves and if any item is forgotten you can't just send someone down the hill to collect it.

Having sorted out the dates of the trip and had it advertised in many magazines all over Europe, confusion struck as we were informed by DFDS that there was to be no sailing on October 9 due to circumstances beyond their control. So, we asked to go on October 16/17/18. Now this time luck was on our side, the ship was fully booked due to half-term—which was just as well as you all no doubt remember 16 October 1987!

We subsequently settled for October 8, which meant we had to try to get the correction republished and at the same time spread it over the air as much as possible including GB2RS. I had previously been informed by DJ0XR



(OZ1FKR) that he, plus DD2KE and DF8VK, would be setting up /P in the mountains (DJ), so I had to write him a letter to stop him taking the wrong day off work!

The day finally arrived. With a sharp eye on the weather, some of our party had made enquiries as to "what will the sea be like?" "Oh, no problem," I said, "this is not your average cross-channel ferry." I'm not sure I succeeded in calming them down.

We loaded all the gear up having gone through the dreaded list again.

We were met by the ship's CRO who showed us to what was to be our shack for the next three days. The paint-locker turned out to be the ship's Conference Room on the upper deck. Our surprise must have shown as the CRO said "Thought you would be more comfortable here." He was right!

We started to erect the antennas as it would soon be dark, looking at the sky very heavy with rain. In fact, it never stopped raining while we were assembling the antennas. By then it was really blowing quite well and it took four of us to get the mast up. The ship is fully air-conditioned so the windows and portholes don't open. We had thought of that as we had allowed enough cable to go down the side of the sun deck and via two water-tight doors.

When we tested the station everything worked alright, the rotator even turned 180°—then it stopped. It wouldn't move, as we were underway and the wind was picking up it had to stay there. We tried out a few contacts, everything seemed to work fine so we went off to dinner.

The first call was put out at 1907UTC, G1VGJ and about a hundred others answered—we were in BM square. It was a pile-up the likes we had never heard before. Shaun and I took the first watch to 0200, then Jan

and Simon took over. We reversed the order on the way back.

The pile-ups continued to 0150 when we arrived in CN. There weren't many takers there, but in CO at 0439 it started all over again until 1206 when we entered EP. We did wonder why we hadn't worked many OZs, the answer was evident on the way back when we didn't work any Gs. The screening effect of a 18 x 9m funnel had not been fully appreciated.

We stopped transmission at 1213 to have a look at the rotator, but it was too dangerous to get the mast down as we had a storm on our hands. Some of the party were not too amused, we had a job to stay on our feet!

At 1705 on the return journey we made our first QSO with OZ1ELF. I worked the first ten or so, then Jan and Simon took over. I went to get some sleep, despite the ship rising and falling by 9 or 12m or so. I was called at 0200 and worked stations in CN square, actually they kept me awake to ensure there was someone to talk to in BN square.

The worst job was the packing up of the station and getting the antennas down, but nothing got broken so it all ended well.

Having made about 800 contacts in all, I thought the trip was very worthwhile—despite the weather. I will be doing it again one day, especially if there was more sponsorship available. I couldn't write an account like this without thanking those who made the trip possible, so in alphabetical order: Blount Aerials, Eastbourne; Bourne Wholesale Electrics, Eastbourne; DFDS, Copenhagen; Icom UK; Randam Electronics, Oxon.; Robann Technique, Seaford; Southdown ARS, Eastbourne; Southdown Communications, Eastbourne; and not least the Captain, Officers and crew of M/S *Dana Anglia*.

Practical Wireless, July 1988

SOLDERLESS WIRING

EASIWIRE



Construct your electronic circuits the new, quick and easy-to-learn way, **WITHOUT** solder: with Circuigraph Easiwire from BICC-VERO

With Easiwire all you do is wind the circuit wire tightly around the component pins. No soldering, no chemicals, no extras, simplicity itself. Circuits can be changed easily, and components re-used.

Easiwire comes in kit form. It contains all you need to construct circuits: a high-quality wiring pen with integral wire cutter, 2 reels of wire, a tool for component positioning and removal, a flexible injection moulded wiring board, double-sided adhesive sheets, spring-loaded terminals and jacks for power connections and an instruction book. Of course, all these components are available separately too.

To take advantage of the special introductory offer, complete the coupon on the right and send it to:

BICC-VERO ELECTRONICS LIMITED,
Flanders Road,
Hedge End,
Southampton, SO3 3LG



Please rush me.....Easiwire kits, retail price £18.-;
special introductory offer £15.-. (includes p & p and VAT).

I enclose cheque/postal order for....., made payable to
BICC-VERO Electronics Limited

Please debit my credit card as follows:



Card Number

Expiry Date

Name

Address

Signature

or phone 04892 88774 now with your credit card number
(24-hour answering service).

Wither Bandplans?

Bandplans, like modern languages, are living things which must develop and change. Usually the changes are orderly and well planned, but that's not always so. In this article, Peter E. Chadwick G3RZP discusses some recent developments which he finds worrying.

Nearly everyone has heard of bandplans. They're an attempt to put some sort of order into the chaos that results from a free-for-all on the amateur bands—say, mixing 'phone, c.w., RTTY and SSTV. In some parts of the world, such as the USA, bandplans are mandatory, and the areas of the bands in which 'phone, c.w., etc., can be used are strictly regulated. Additionally, the incentive licensing programme restricts access to certain portions of the bands to certain grades of licence holder.

Now bandplans are not written on tablets of stone, handed down from ages past as being totally irrevocable. Indeed, before WW2, the c.w. portions of the h.f. bands tended to be at the h.f. end, as opposed to today. Bandplans are discussed by the IARU (International Amateur Radio Union) at their various international meetings, and it is from these meetings that modifications to the bandplans come.

Bandplans apply to all the amateur bands: some of them are either purely local, as in the case of the 70MHz band, which is allocated to very few countries, or are generally local, except under lift conditions. In the latter case, we find the Scandinavian 430MHz (70cm) repeaters, which are "reverse" to the UK ones. However, it is only under anomalous propagation that any problem exists, while normally we find a well-organised system.

The same applies to most of the h.f. bands, with some attempt made to keep the beacon frequencies in the 14, 21 and 28MHz (20, 15 and 10m) bands clear. However, the proposed beacons on 21.150MHz are likely to have a hard time unless some changes take place!

Below 21.150MHz, the allowed modes are data (at certain points) and c.w. From about 21.100 to 21.150MHz is used by Novices, especially in the USA but in some other countries as well, and the use of s.s.b. in this portion of the band is against the bandplan. It's not a very good example to set to a new operator, either, is it? And yet, you can still hear a number of s.s.b. QSOs going on in this section of the band.

Even worse is to listen to these QSOs. Comments such as "I'm licensed for all modes from 21MHz up, so I'm going to use them" can be heard. "They're only Novices, what have they got to complain about?" "They're only Novices and I've had a licence since 1937, so I've got priority". All these comments, and more, have been heard relatively recently from UK and Canadian operators. I don't speak German, French, Russian or Spanish, so I don't know what has been said in those languages!

Bandplans are gentlemen's agreements. That means that they are kept by gentlemen, and the corollary to that is that those who break them . . .

Top Band

Another area when the bandplan has difficulties is on 1.8MHz (160m). Here, the JA's have a narrow slot (1.907 to 1.912MHz), and it is therefore good manners to keep out of this slot—at least in the hours when this window may be open. By open, we mean "open to anyone in range of your transmission", which could be most of Europe. But you can hear "We've been on this channel every night for 20 years, and we're not moving now". Maybe so, the bandplan allows this, as it does DXing, but to ignore the QRM it causes to the DXers is selfish. Working the other way, the insistence of certain DL stations in holding local s.s.b. QSOs in the c.w. end of the band is just as bad.

On 3.5MHz (80m), an s.s.b. QSO on 3.730MHz may well be told to move "because this is the SSTV frequency". Does this mean that only SSTV is allowed here? The answer is a resounding "NO"—the bandplan merely says that 3.730MHz (and 14.230) are meeting frequencies for this mode. However, the comments from some of the SSTV protagonists have to be heard to be believed! More insidious on this band is the use of frequencies within the DX portions for local QSOs during daylight.

Daylight

The difficulty is in defining daylight—and no, I'm not off my rocker! Northern Sweden, beyond the Arctic Circle, gets no daylight in winter. Certainly northern Scandinavia is in an l.f. band DX condition for most of the day, and the UK station with a reasonable signal can be providing a QRM level which is wiping out DX for the Scandinavians. Bear in mind that h.f. propagation is better in the south than in the north, so they deserve a break in Scandinavia. So it is that operating in the DX portions of 80m during what appears to you to be daylight can be causing real trouble for someone in SM, OH or LA.

Generally speaking, national radio societies such as the RSGB and ARRL support bandplans. After all, it is they, through IARU, who formulate them. Recently, however, we've seen ARRL deliberately break the bandplan for h.f., with the introduction of packet radio.

Until recently, it was accepted that "data" modes, such as RTTY, should have their own bit of band and on 20m this was from 14.070 to 14.099MHz (14.100MHz is reserved for the International Beacon Project). From 14.101MHz up is filled with s.s.b. stations, many of them from the Pacific in the early morning, and with French-speaking stations during the day, including the rarer French colonies. The packet radio operators discovered that packet and RTTY didn't co-exist very well: for some of them, the ability to switch to s.s.b. when technical difficulties arose was useful. Thus it was that packet radio "grew up" in this area—STRICTLY AGAINST THE BANDPLAN! The ARRL proceeded to make packet radio above 14.100MHz "official"—but bear in mind that in the USA, this segment was only available for c.w. by the licence conditions. Thus it is that we now have the situation that 14.100 to about 14.106MHz has become "the packet frequencies"—not by agreement but by hijacking! And ARRL has approved it, without a word of discontent having been publicly uttered by the member societies of IARU. If you listen to 20m on a busy weekend, you can hear packet up to 14.112MHz, and if you call CQ on s.s.b. on 14.103MHz not only may you work some very good DX, you'll also get a lot of rude comments from people saying "This is the packet frequency—QSY!" and that's the politest of the comments. Yet, as we have seen, packet has no more right there than Radio Tirana has on 40m—perhaps less, since Albania hasn't signed the ITU agreement.

It may be argued that the development of new modes that don't fit into existing bandplans requires changes.

Practical Wireless, July 1988

Certainly, there is some truth in this argument, but to carry it to its logical conclusion, there is no reason why spread spectrum shouldn't start up on 14.104MHz—or elsewhere. After all, it's a technically advanced new system! Ignoring the bandplan "because it's new technology" is like changing the law by ignoring it, and that way lies chaos and anarchy.

Bandplans are gentlemen's agreements. That means that they are kept by gentlemen, and the corollary to that is that those who break them . . .

What Next?

With the increasing usage of the bands, bandplans are essential if anyone is to have a satisfactory QSO, especially those who aren't running high power and big beams. The incursion of packet into 14MHz, and the ARRL "stamp of approval" on the breaking of the internationally agreed bandplan are the start of the breakdown, unless other operators do something about it.

What can you do? First, You can

stay within the bandplan, regardless of what others do. Second, you can tell your national society to support the bandplans, regardless of political pressure. Third, you tell your national society how you want the bandplans to evolve to meet changing technologies. If you adopt the attitude of "This technology needs this bit of band, so we'll take it and be damned to the rest of you", it won't be long before you won't get a QSO either.

So you see, the title of this article isn't a spelling mistake—"Wither bandplans"—what then? **PW**

Feature

Practically Yours

By Glen Ross G8MWR

A thing which many amateurs would find useful around the shack is a frequency counter. Unfortunately these do not come cheap but, provided you are not looking for extreme accuracy, it is possible to construct a useful indicator at very little cost. The unit to be described was built to check the frequency of audio oscillators running at frequencies from near d.c. up to about 20kHz, but by changing a single component the high frequency and can be extended upwards to around 2MHz.

The Theory

By understanding how the meter works you can easily adapt it to your own requirements. The basis of the unit is a frequency discriminator, the essentials of which are shown in Fig. 1. When the input signal goes positive, capacitor Ca charges through resistor Ra and diode Da in series with the source impedance of the input signal. At this point in the operation, Da is in forward conduction and the emitter-base junction of transistor Tra is reverse-biased. As long as the time constant CaRa is short compared to the input frequency then Ca stores a charge equal to $C \times V$, where C is the value of the capacitor and V is the amplitude of the input signal.

When the input signal drops to zero or reverses polarity, Ca discharges through the base-emitter junction of Tra, and a pulse of current flows in the emitter circuit. A similar current, but multiplied by the gain of the transistor, flows in the collector circuit and the average value of this current is directly proportional to the input frequency and the value of Ca. The frequency range over which the meter will operate is influenced by the value of Ca, and the listing in Table 1 shows the value required for various ranges of input frequency.

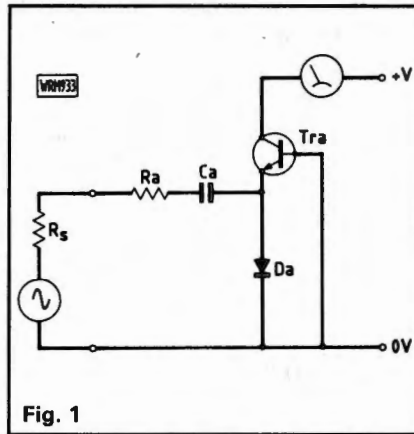

Fig. 1

The Circuit

A practical circuit is shown in Fig. 2, and is based around three BC107 transistors. Of these, Tr1 is used as an input amplifier and allows the indicator to work with input levels down to 50 millivolts. The signal then passes to Tr2, a buffer/limiter whose output, regardless of input waveform, is a squarewave of constant amplitude as required by the following stage, Tr3 which functions as the discriminator and meter driver in the manner already described. A pre-set resistor is included in the meter circuit, and this is the only adjustment needed to calibrate the instrument.

Build and Set-up

The unit can be constructed in any small enclosure, and there is nothing tricky in the layout of the components. The circuit in Fig. 2 shows switching for two ranges, but more could be incorporated if desired. The values for C1, C2 and C3 are correct for ranges from around 200Hz to 200kHz, but if inputs outside this range are to be measured then the values of these components should be changed by the same factor as the range extension.

If you are going up in frequency by a factor of 10 then reduce the capacitor values to a tenth of those shown. Setting up simply entails applying a signal at a known frequency and then adjusting the appropriate range pre-set to give the correct reading on the meter. **PW**

TABLE 1

Value for Ca in Fig. 1, C4 and C5 in Fig. 2	
Max. Freq.	C
200Hz	0.47μF
2kHz	47nF
20kHz	4.7nF
200kHz	470pF
2MHz	47pF

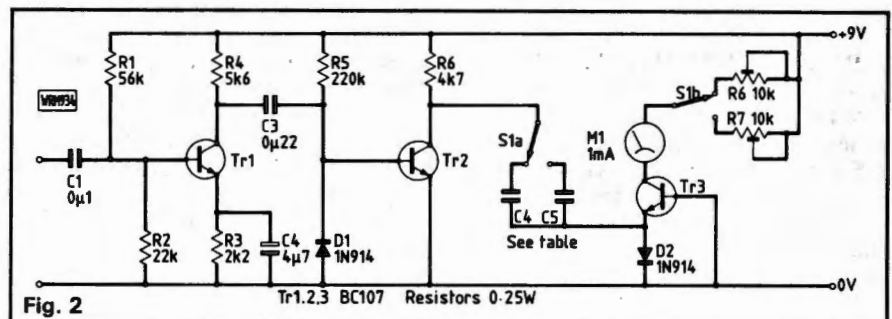

Fig. 2

You might be forgiven for thinking that the binary code is an invention of the 20th century. This article by Joan Ham shows how the binary system kept our state secrets from prying eyes long before the invention of the computer.

The Micro's Secret Code

An Example of Accommodation.

F V G F
a ababb aa bbaa bbaaa baa.
Manere te volo donec venero

An Example of a Bi-formed Alphabet.

a. b.a.b. a.b. a.b.a b.a.b.a. b.a.b.
{ A A aa B B bb C C.c.c D D.d.d.

a b.a.b. a. b.a.b.a. b. a.b. a. b.a.b.
{ E E.e.e F F.f.f G G.g.g H H.h.h.

a. b.a.b.a. b.a.b.a.b. a.b. a. b.a.b
{ I I.i.i K K.k.k L L.l.l M M.m.m.

a. b. a.b.a.b.a.b.a. b.a.b.a. b. a.b.a.
{ N N.n.n O O.o.o P P.p.p Q Q.q.q R

b. a.b.a.b.ab. a. b.a.b.a. b.a.b.a.b.
{ R r.r S S.s.s T T.t.t V V.v.v u.u.

a. b. a.b. a. b. a.b. a.b.ab.ab.a.b.
{ W W.w.w X X.x.x Y Y.y.y Z Z.z.z

Fig. 1: A short excerpt of the original Bi-formed code together with an example of a Bi-formed alphabet

That most contemporary and ubiquitous invention, the microcomputer, would not have been possible without the binary scale—but the system of counting with a radix of 2 is over 400 years old.

In 1576 a 16-year-old boy, who had left Cambridge 3 years previously declaring that they could teach him nothing more, was gaining experience with the diplomatic service in Paris. It was a time of international tension and danger for England; the secret service was coming into its own, and ambassadors were "sent to lye abroad for their country". This brilliant young man was appalled by the clumsy ciphers used in letters, the unskilled cipher clerks and the ease with which a stolen dispatch could be read by those for whom it was not intended. He devised a totally secure method of expressing the 24-letter Elizabethan alphabet in 2 characters, so that by making 2 different alphabets with small differences in the formation of the letters, each letter of hidden text was represented by 5 letters of plaintext (similar to a group of Morse dots and dashes representing individual letters now). The beauty of the system was that the only requirement of the "open letter" was that it should be five times longer than the enciphered message. The plaintext could, of course, be anything—a family letter, local gossip, poetry, etc.—the point being that the text, clear for all to read, had *no connection* at all with the real message it contained.

The towering intellect which invented this "bi-literary alphabet" was that of Francis Bacon: statesman, philosopher, father of inductive science and Lord Chancellor to James I. He called his revolutionary cipher "Omnia per Omnia", but for obvious reasons did

▶ 48

aaaa = A	00000 = 0	abaaa = I/J	01000 = 8	baaaa = R	10000 = 16
aaaab = B	00001 = 1	abaab = K	01001 = 9	baaab = S	10001 = 17
aaaba = C	00010 = 2	ababa = L	01010 = 10	baaba = T	10010 = 18
aaabb = D	00011 = 3	ababb = M	01011 = 11	baabb = U/V	10011 = 19
aabaa = E	00100 = 4	abbaa = N	01100 = 12	babaa = W	10100 = 20
aabab = F	00101 = 5	abbab = O	01101 = 13	babab = X	10101 = 21
aabba = G	00110 = 6	abbba = P	01110 = 14	babba = Y	10110 = 22
aabbb = H	00111 = 7	abbbb = Q	01111 = 15	babbb = Z	10111 = 23



RAYCOM GIVES YOU MORE PURCHASING POWER

FOR FAST SERVICE PHONE IN YOUR ORDER WITH ANY MAJOR CREDIT CARD OR IN MOST CASES WE CAN OFFER YOU INSTANT CREDIT OF UP TO £1,000.00 (SUBJECT TO STATUS) RAYCOM ARE LICENCED CREDIT BROKERS. APR 29.8% SUBJECT TO VARIATION. FREE CREDIT ON CERTAIN PRODUCTS AT LIST PRICES. 50% DEPOSIT AND SIX MONTHLY PAYMENTS. PLEASE TELEPHONE FOR MORE DETAILS AND APPLICATION FORMS.

NEW HELPLINE 0836 282228 (until 9pm Daily)

THROUGH YOUR CONTINUOUS AND VALUED CUSTOM, RAY WITHERS COMMUNICATIONS LTD. HAS MOVED AND EXPANDED TO ENABLE US TO OFFER YOU EVEN BETTER SERVICE AND PRICES - STILL WITH THE RAYCOM GUARANTEE, BEST EQUIPMENT, BEST SERVICE, BEST PRICES, BEST BACK UP. PLENTY OF PARKING FACILITIES AND EASIER TO GET TO! WE NOW BOAST THE BEST CENTRAL FACILITIES IN THE COUNTRY, WHY NOT POP ALONG AND SEE THE LATEST TRANSCEIVERS, SHORTWAVE/SCANNING RECEIVERS AND ACCESSORIES? MOST OTHER PRODUCTS ADVERTISED IN THIS MAGAZINE ARE AVAILABLE AT RAYCOM, AND DON'T FORGET OUR EXCLUSIVE PRODUCTS AND MODIFICATIONS!



ORDERING INFORMATION

ALL PRODUCTS WE ADVERTISE ARE NORMAL STOCK ITEMS OUR NEW MAIL ORDER DEPARTMENT CAN NOW DESPATCH MANY LINES SAME DAY, BUT PLEASE ALLOW UP TO 14 DAYS DELIVERY TIME IS SUBJECT TO CARRIAGE METHOD. IF ORDERING BY MAIL PLEASE INCLUDE CARRIAGE AND STATE YOUR DAYTIME TELEPHONE NUMBER. ALL PRODUCTS OVER £750.00 CARRIAGE FREE. PLEASE ALLOW TIME FOR PERSONAL CHEQUES TO CLEAR. PLEASE CALL BEFORE ORDERING AND FOR MORE DETAILS.

Telephone 021-544 6767

A new Concept in Amateur Radio Uniden 2830 10Mtr Band Amateur Transceiver

Its here at last! a beautifully made processor controlled full feature 10w (20w PEP) multimode transceiver with LCD readout and all functions necessary to work DX with Sparadic E and in the forthcoming sunspot maxima and also for transferring to the VHF and UHF bands! Work out the facts... how much is a Two Meter multimode? how much is the Uniden 2830 Ten Meter multimode and a 2 mtr transverter? With the Uniden 2830 you can have two bands for the price of one, with 10 watts on each band and all modes including CW.

Features: * All modes, AM/FM/USB/LSB/CW. * LCD Readout of frequency/functions. * CW with Sidetone. * FM bandwidth compatible with VHF/UHF. * 10 Watts continuously variable o/p AM and FM. * Scanning feature, up and down steps on Mic. * Selectable frequency steps, 10KHz, 1KHz, 100Hz. * Ten meter band selectable in 500KHz steps. * Built in VSWR Meter and protection circuit. * Superb receiver sensitivity < .3 uV FM.

Just ten of the many reasons for choosing the Uniden 2830. **Price £249.50** Inc. VAT. Insured post and packing £10.00. * A range of VHF-UHF of matching transverters available, please enquire for models currently in stock.

* This Product is Exclusive to Raycom



**10/2MTR VERSION
OUT SOON @ £399.00**

£249.50
£10.00 Post & Packing

ANTENNAS & ACCESSORIES

NOW AVAILABLE AT RAYCOM: CUSHCRAFT, BUTTERNUT, HY-GAIN ATENNAS, JAYBEAM, TONNA, MET, HAM-M ROTATORS. Call for full details, prices, availability and delivery costs.

- ICOM AH7000 SUPER 25-1300MHz DISCONE £79.50
 - G5RV HALF SIZE HF ANTENNA ready to use £16.50
 - G5RV FULL SIZE HF ANTENNA ready to use £18.50
 - G8KW-TYPE 7.1MHz TRAP DIPOLE KIT SO239 £24.50
 - G8KW-TYPE as above for use with 75 OHM £23.50
 - G8KW-TYPE 2X 7.1 TRAPS ONLY. LESS CABLE £9.95
 - RAYCOM AIRBAND-VHF SIX ELEMENT DISCONE £12.50
 - RAYCOM DISCONE VHF 60-600MHz 8E.50239 £29.50
 - SUN KG209 2M 5/8 MOBILE TILT-OVER 259 £14.50
 - HAYLUM CAST GUTTERMOUNT C/W SO239/COAX £8.50
 - GAMMA TWIN 2 METRE SLIM JIM KIT inc. instr. £14.50
 - RAYCOM/RWC HB9CV 2 METRE 2E MINI BEAM £12.50
 - RAYCOM/RWC HB9CV 70CM 2E MINI BEAM £8.95
- The above popular products POST FREE.
(UK mainland only)

SCANNERS

YAESU FRG9600 from the company who specialises in fitting extra options, as supplied to Government departments and professional bodies. We also upgrade existing models, please call for more details, prices, delivery and information.

- Yaesu FRG9600 Basic Model Improved 'S' Meter + Sens. £465.00
 - Yaesu FRG9600/RWC Mk2 60-950MHz 'N' Connector Fitted £495.00
 - Yaesu FRG9600/RWC MK3 HF 100KHz-950MHz plus Mk2 Spec. £595.00
 - Yaesu FRG9600/RWC Mk5 HF 50KHz-950MHz Active Mixer £625.00
- Package deal on above Mk3/5 FRG9600 c/w AH7000 discone, G5RV, PA4 AC PSU, complete receiving station HF-UHF including delivery UK mainland. Add £100.00 to above price.
- Icom ICR7000 25M-2GHz superb quality professional Rx £859.00
 - Icom ICR7000/AH7000 Receiver plus Matching Discone £937.50
 - KENWOOD RZ1 500KHz-950MHz POA
 - Wide & Narrow AM/FM
 - Fox VHF-UHF Multi Function Mobile Scanner FM only £139.00
 - UNDEN BEARCAT UBC 50XL VHF-UHF 10ch H/held Scanner £95.00
 - UNDEN BEARCAT UBC 70XL VHF-UHF 20ch Miniature H/held. £179.00
 - Uniden-Bearcat UBC 100XL VHF-UHF Airband H/held Scanner. £189.00
 - Uniden-Bearcat UBC 175XL VHF-UHF Airband Desk-Top £175.00
 - BJ200 Mk2 VHF-UHF-Airband-Military Airband H/held £220.00
 - AOR 2002 25-550, 800-1300MHz Desk-Top/Mobile AM/FM £469.00
 - Sony Air 7 Top Quality VHF-Airband Handheld Scanner £245.00
- PACKAGE DEAL AVAILABLE ON ALL MAKES

SHORT WAVE RECEIVERS

- Yaesu FRG8800 Short Wave 100KHz-30MHz all Mode + Mem. £589.00
 - Yaesu FRG8800/FRV8800 as above with VHF Conv. fitted £679.00
 - Icom ICR-71 Top Grade Communications Receiver £799.00
 - Sony PRO80 HF/VHF Handheld Scanner c/w accessories £345.00
 - Sony 2001D Short Wave/Airband DEI IIXF RX with ANI kit £395.00
- Many more makes and models in stock, PLEASE CALL FOR PRICES. DELIVERY COSTS and any advise or information, or send large SAE. (Insured post and packing £10.00. Carrier £12.50)

SONY. RAYCOM now appointed official Sony dealers, full range of both professional and domestic models available to order. Worth waiting for!

HANDHELDS

* = Extended Receiver coverage available, call for details.

- YAESU FT27R/FNB4A 2.5W (5W) DUAL BANDER. C/W CHRGR £395.00
 - *YAESU FT23R/FNB10 2.5W (5W) 2MTRS C/W CHARGER £249.00
 - *YAESU FT73R/FNB10 2.5W (5W) 70CMS C/W CHARGER £259.00
 - *ICOM MICRO 2E 2.5W 2MTR HANDHELD WITH CHARGER £209.00
 - CTE1600 (SAME AS ICOM IC2E) C/W NICAD CHARGER £179.00
- Many other types of handheld stocked, please enquire.

PORTABLES

- FT290RMK2 2.5W MULTIMODE STANDARD ACCESSORIES £399.00
- FT290RMK2 2.5 WATT M/M AS ABOVE C/W NICADS CHRGR £425.00
- FT 290RMK2/FL2025 (STD) WITH 25W LINEAR AMPLIFIER £489.00
- FT690RMK2 6MTR 2.5W MULTIMODE STANDARD ACCES. £399.00
- FT690RMK2 6MTR 2.5W M/M AS ABOVE C/W NICADS CH. £425.00
- FT790RMK2 NEW 70CM 2.5W MULTIMODE DUE OUT SOON ... £499.00

MOBILES

- YAESU FT211RH 45W 2MTR MOBILE WITH FREE 1/4 WAVE ANT £299.00
 - FT290RMK2 2.5 WATT M/M AS ABOVE C/W NICADS CHRGR £425.00
 - *ICOM IC28E 2MTR 25W MOBILE WITH FREE 5/8 ANTENNA ... £359.00
 - ALINCO Dual Bander ALD-24E £445.00
 - ICOM IC-48e 70cm 25W £429.00
 - ICOM IC-3200 Dual Band 25W £499.00
- Many other types and makes stocked, please enquire.

Opening hours 9am-5.30pm 6 days, late nights Thursday & Friday till 7pm.

SCANNERS

BEARCAT by Uniden



UBC 175XL



UBC 100XL

RAYCOM ARE TRADE AND RETAIL DISTRIBUTORS FOR THIS SUPERB RANGE OF QUALITY SCANNERS. THE POPULAR UBC 100XL HAND HELD HAS SOLD IN THOUSANDS, BUT IS NOW COMPLEMENTED BY THE UBC 70XCL POCKET SIZED HANDHELD. ALSO THE NEW COST EFFECTIVE UBC 50XL HANDHELD. SEE THE NEW MODELS IN OUR SHOWROOMS OR SEND A S.A.E. FOR DETAILS.

FROM £99.50

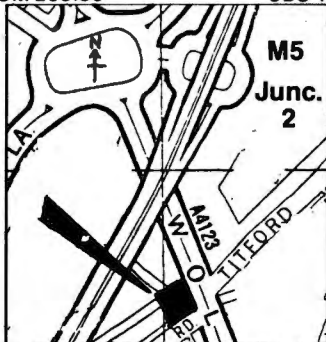

RAYCOM COMMUNICATIONS SYSTEMS LTD.
INTERNATIONAL HOUSE, 963 WOLVERHAMPTON ROAD
OLDBURY WEST MIDLANDS B69 4RJ
Telephone 021-544 6767. Fax 021-7124. Telex 336483 Identi-G



INTERNATIONAL HOUSE
GUARANTEE
BEST PRICES
BEST SERVICE
BEST PRODUCTS
BEST BACK-UP

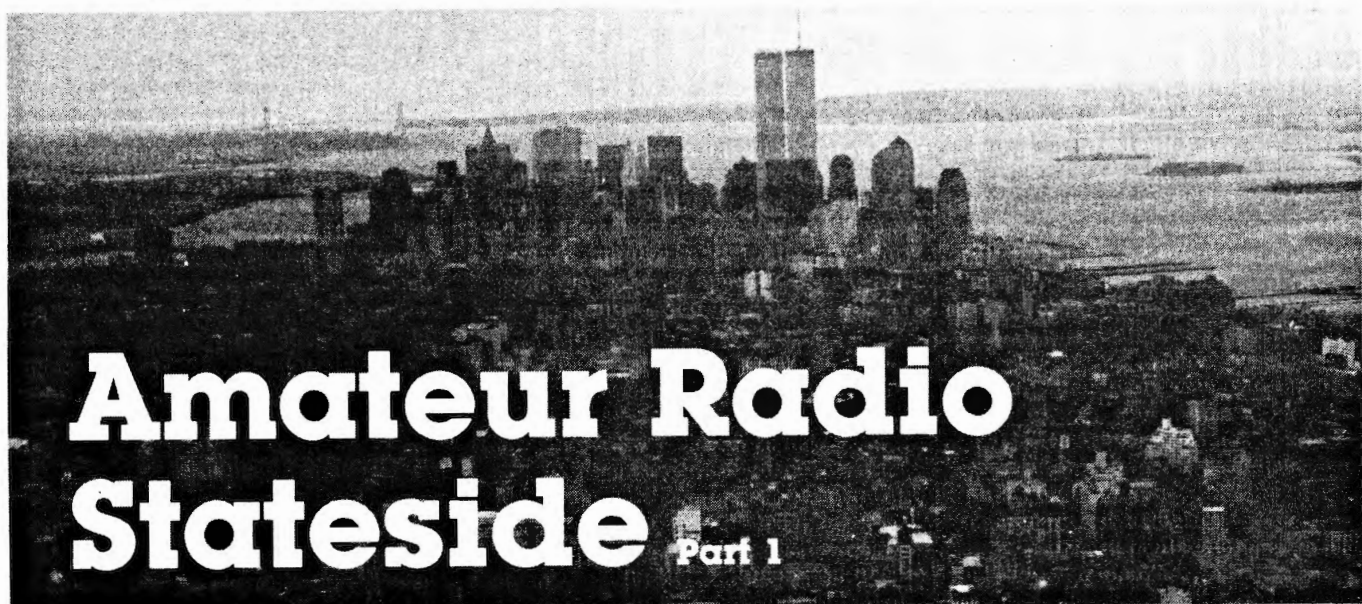

Amateur Radio Stateside

Part 1

★★
David Jardine G0FDV visited New York City, Chicago and the ARRL HQ (American Radio Relay League) at Newington, Connecticut while in the USA on business last winter. It was, he says, the most exciting trip he'd ever been on.
 ★★

My journey started in New York. For the historians, New York's original name was New Amsterdam formerly capital of New Netherlands. As the story goes, Manhattan Island (the main part of New York City) was "bought" from the Indians in 1626 for about \$24 worth of goods. When the English conquered New Netherlands, they named both city and province after the Duke of York (later James II).

Nowadays, there are twenty plus 144MHz repeaters covering Queens, Staten Island, Brooklyn, Bronx and Manhattan, with seven in the latter area alone. So in effect, you can walk or drive all over the centre of this incredible city with amateur radio contact all the time—very handy if you need a guided tour. Most repeaters are high in the city's skyscrapers so there's no real access problem, the biggest drawback is r.f. attenuation through buildings. Not once, day or night, including the early hours did I listen and not hear someone, somewhere out there talking. I found the ARRL *Repeater Directory*, a 130 x 75mm 400-page pocket book, invaluable. It lists all the repeaters, their input and output frequencies, access information, sponsors, etc. When I was there, last year, it only cost me \$4 too.

John K2VKA from New Jersey was my city guide. I told him I wanted to write an article about amateur radio in the US. He was more than helpful in fixing up meetings and giving advice, etc., especially Indian restaurants on the East Side.

As a radio amateur in New York, my first call was to Barry Electronics. It doesn't matter what day you want to go there, they're open seven days a week.

The shop is, believe it or not, on Broadway—fairly near the gigantic World Trade Center's twin towers. (If you've a head for heights, take a trip to the top. At 110 floors up you'll stand on the world's highest observation platform!)

The Barry Shop is run by Kitty WA2BAP. They stock Tentec, Trio, Icom and Yaesu plus an almost innumerable list of various brand names from around the world. This shop is rather like Dr Who's *Tardis*, quite modest and small on the outside, but inside it seems to spread out in all directions. They keep vast stocks of all makes as they are the main distributor/retailer for the entire New York Metropolitan area.

The staff in the shop are all amateurs too, there's Emil N2EZZ, Lew W2BIE, Jan KB2RV and Peter KB2BTQ. I met some very interesting people whilst in the store. I'd only been there a couple of hours when I met Brook Allen N2BA, also known as 8P6/MBarbados, HI8/P Dominican Republic and 6Y5/P Jamaica—and that's in his spare time! Brook reckoned he doesn't get much spare time as he's a Senior Strategist for Merrill Lynch at the World Financial Center, New York City. Like many other "2" call stations, he runs one kilowatt with a beam from Sullivan County!

Another regular at the shop is Andy Funk KB7UV, he's editor of *Digiplex News* in New York. At the time I met him, he was heavily involved in the imminent New York marathon (co-ordinated by WA2DHF). Andy told me that the New York Police Department had said unless amateur radio operators were involved in co-ordinat-

ing it, no marathon. I counted more than forty licensed senior officials/radio operators with the marathon. There were some 22 000 runners with 400 radio amateurs over the course.

You often hear tales of how it isn't safe to walk around New York at night. My own experience showed you just need commonsense. The respectable business and shopping areas are no more dangerous than Oxford Street. If you walk through the West Side with an expensive camera and an FT-727R on show, in some areas you may well meet someone who'll take them off your hands. Generally, I found most central parts in the big cities trouble-free. Trying to walk from Times Square to Grand Central Station in the rush hour is a real experience though.

Whilst at Barry Electronics, I spent some time talking on the FT-209 with commuters travelling in and around the city—a most fascinating experience. I directed John K2VKA in to the shop from the Holland Tunnel which joins the West Side to New Jersey across the world famous Hudson River.

During our conversation, John told me that with the pilot's permission apparently you can use a hand-held while airborne on a scheduled flight. In fact, some TWA captains are licensed amateurs and John has had QSOs with them entering and leaving JFK Airport. With that kind of height, of course, you can talk "line of sight", so 190km is not uncommon on 144 or 430MHz. Apparently US military transport planes can also be heard on the amateur airwaves.

Unfortunately, abuse of the amateur bands, especially 144MHz, is also a

Practical Wireless, July 1988

TABLE 1

<i>Class</i>	<i>Code Test</i>	<i>Written Examination</i>	<i>Privileges</i>
Novice	5 WPM (Element 1A)	Elementary theory and regulations. (Element 2)	Telegraphy in 3700-3750 kHz (5167.5 kHz Alaska only, emergency communications using single sideband), telegraphy in 7100-7150 kHz, 21,100-21,200 kHz, telegraphy and RTTY in 28,100-28,300 kHz, telegraphy and single-sideband voice on 28,300-28,500 kHz, all amateur privileges authorized on 222.1 to 223.91 kHz and 1270 to 1295 MHz.
Technician	5 WPM (Element 1A)	Elementary theory and regulations, general theory and regulations. (Elements 2 and 3A)	All amateur privileges above 50.0 MHz plus Novice privileges.
General	13 WPM (Element 1B)	Elementary theory and regulations, general theory and regulations (Elements 2, 3A and 3B)	All amateur privileges except those reserved for Advanced and Amateur Extra Class. 1500-watts PEP output maximum.
Advanced	13 WPM (Element 1B)	General theory and regulations, plus intermediate theory (Elements 2, 3A, 3B and 4A)	All amateur privileges except those reserved for Amateur Extra Class. 1500-watts PEP output maximum.
Amateur Extra	20 WPM (Element 1C)	General theory and regulations, intermediate theory, plus advanced techniques (Elements 2, 3A, 3B, 4A and 4B)	All amateur privileges. 1500-watts PEP output maximum.

*A licensed radio amateur will be required to pass only those elements that are not included in the examination for the amateur license currently held. In other words, if you hold a Novice license, you need not take another 5-WPM code test to qualify for a Technician class license.

problem in the USA. Usually repeaters are switched off if it becomes a real problem. It seems that there are large groups of children and many cab drivers who buy (and use) 144MHz equipment by mail order—this doesn't help the spectrum abuse.

The "phone-patch" system they use in the USA is something I'd like to see in operation here. If you have a 144MHz band rig in the car that can contact your base station at home, you can make and receive telephone calls as though you were at home. Trouble is, you need two rigs, plus a special access tone to activate your base station.

Many companies manufacture high-quality ancillary units that enable a.m., f.m. or s.s.b. base stations to be used in conjunction with the US 'phone system. This means that individuals can both initiate and receive telephone calls from mobile or handheld radio without any outside assistance. These units are fully compatible with all dial pulse telephone systems and can be used manually too. At the "flick of a switch", someone at the base station can patch any mobile channel into the 'phone system for a fully automatic conversation. You can even work via repeaters!

In general, the US amateurs take their hobby quite seriously. There are over twice as many amateurs per head of population there as in the UK. That means that they can lobby effectively too! The total number of licensed operators, at the time I was there, was apparently 442 136 (that includes those in Puerto Rico and other US Possessions).

Practical Wireless, July 1988

Licence Classifications

The US licensing classifications sometimes cause confusion. The ARRL set it out as:

To communicate via amateur radio in the US, you must be licensed by the Federal Communications Commission (FCC). As you can see from Table 1, there are five different licence classes. The basic licence class is Novice and this allows you to use Morse code, voice, teletype and digital modes on the 3.5, 7, 21, 28, 223 and 1296MHz bands.

The next class is Technician. With this licence you have all privileges of the Novice, plus all v.h.f. and u.h.f. amateur bands (this includes the popular 144MHz band). The General licence allows the use of h.f. 'phone bands as well. The Advanced and Extra class licences allow even more frequency privileges.

To obtain your Novice licence, you must be able to copy Morse code at 5 w.p.m. and pass a 30 question written test on radio theory. The Technician class licence requires a 25 question written test on rules and radio theory (no additional

The photographs for this series, including our front cover this month, were provided by Jardine Advertising Mobile Photographic Unit.

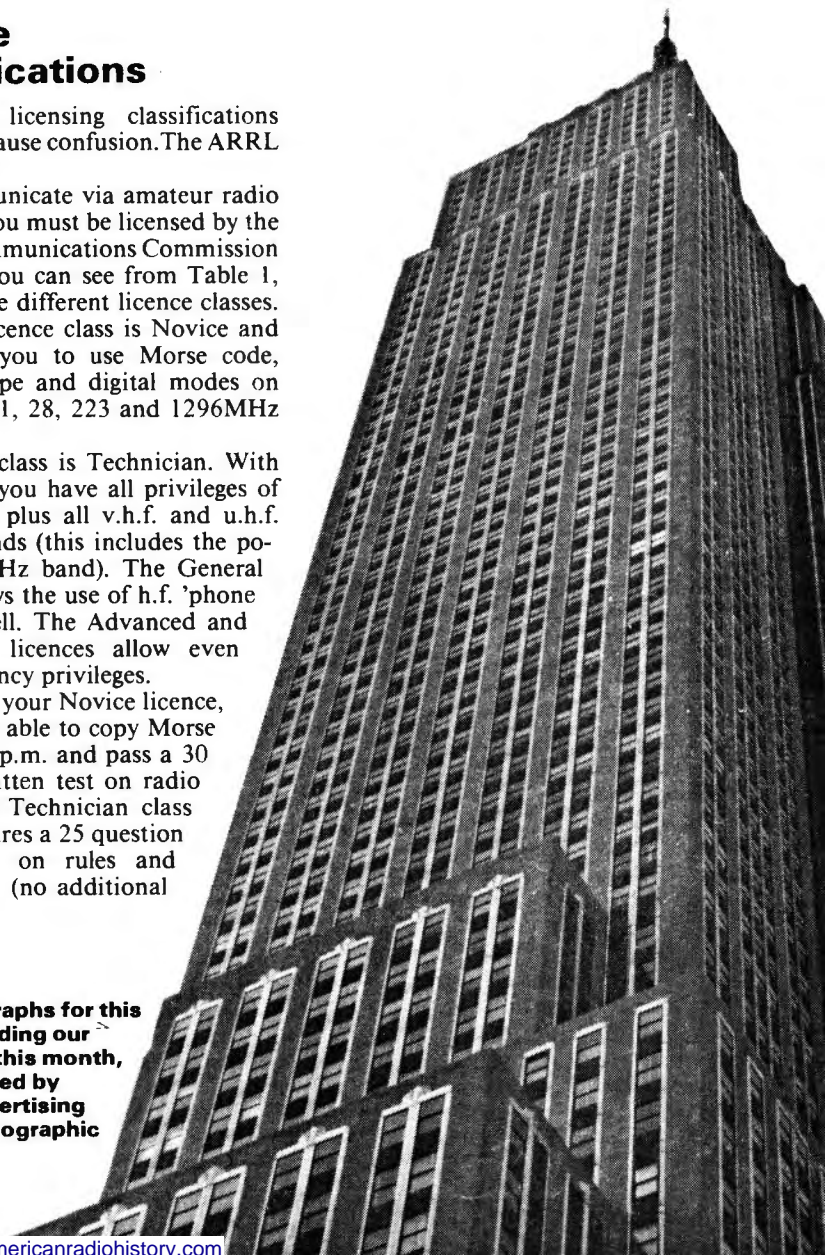

code test). The General class licence requires a 25 question written test and you must copy Morse code at 13 w.p.m. You may not skip any of the licence classes, but you may take more than one test at the same time (e.g. Novice and Technician). There is no age limit to being an amateur in the US, there are some as young as 6 years old!

The Advanced licence is earned by passing a 50 question written test on radio theory. The Extra class exam consists of 40 written questions and a 20 w.p.m. code test.

The Novice licence exam must be given by two licensed radio amateurs who are at least 18 years of age. They must hold a General or higher class licence, they can't be related to the person being tested either. All other licence grades must be tested by a team

of at least three qualified Volunteer Examiners. The test sessions are organised by radio clubs in hundreds of locations all over the country.

Novice Enhancement

On 28 January 1987, the FCC announced approval of the American Radio Relay League's Novice Enhancement proposal. All rules and regulations became effective 0001UTC 21 March 1987.

The Commission amended its rules to allow Novices and Technicians to operate 28.1-28.5MHz, using Morse code, as well as digital modes from 28.1-28.3MHz, then Morse code and voice modes from 28.3-28.5MHz. Novice and Technician control operators are limited to 200 watts output in this band, but other licensees are not similarly limited.

Novices may use up to 25 watts in the 222.1-223.91MHz band, with all authorised emissions, as well as up to 5 watts in the 1270-1295MHz band.

The ARRL

The highlight of this visit was the trip to the ARRL HQ at Newington, Connecticut. This small town nestles peacefully in rural New England, about 110-130km north from the hustle and bustle of New York City. Probably the best way to get there from New York City is by train from Penn Station. Unfortunately, I was given duff information and ended up at Grand Central Station, so I missed the train.

I ended up going by bus, which wasn't as unpleasant as I had expected. We had a friendly driver who took us through Central Park and on through the Bronx. As we went through the Connecticut turnpike and on to Hartford we passed some magnificent countryside.

In the next part, we'll look at what I found at the ARRL HQ.

SWAP SPOT

Have Eddystone 840A communications receiver. Would exchange for 144MHz rig, i.e. FDK-700E or FT-208R. Receiver must be collected. Mr J. Williams, 97 Gilmorton Close, Gilmorton Estate, Leicester LE2 9GX. *E285*

Have 16K ZX81 computer with p.s.u., Scarab interface plus terminal unit for RTTY. Would exchange for KR400 rotator or w.h.y? Tel: 0437 781265 (Haverfordwest). *E286*

Have Chinon Memotron 35mm camera, auto/manual, Vivitar zoom lens 75-150mm plus X2 adaptor, filters screw type and Cokin in addition to flash, tripod, broly and 150 Super 8 movie camera. Would exchange for good 144MHz multimode. Gillies, Bradford, West Yorkshire. Tel: 390237 *E298*

Have G4BMK AX25 packet modem, packet, RTTY and c.w. cartridge, plus Dragon 32 computer and FT-207R dedicated for packet. Would exchange for FT-101 transceiver or similar in good condition. Ron GW0FYF. Tel: 06333 64446. QTHR. *E299*

Have Eddystone S680X, 490kHz-30.4MHz receiver, Quad amp, a.t.u., antennas, Spectrum+ computer plus datacorder and many other items. Would exchange for six man tent and camping equipment or 934MHz set up, swapper collects. Trevor. Tel: 0980 630652. *E316*

Have lots of components, panel meters, valves and manuals, clearing out, s.a.e. for list. Would exchange for useful items photographic or marine. Meek, 92 Stopples Lane, Hordel, Lymington, Hants SO41 0JA. Tel: 0425 610669. *E322*

Have approximately 110 J.T.E. DS6N paperback books. Would exchange for Datong Morse tutor and instructions. J. Harrison, 43 Churchfield Court, Walton, Peterborough PE46 6GB. *E329*

Have spark transmitter type 52M made by Creed & Co. Croydon, circa 1917, similar to models in Science and War Museums. Would exchange for new Sony ICF-7600DS with AN1 and Sony Air-7 Mac. Tel: 08045 3826 (Brixham). *E341*

Have Racal RA17L 0-30MHz receiver in superb condition. Would exchange for active antenna or 35mm wide angle lens camera outfit. Dave. Tel: 0543 75640 (Staffs.). *E348*

Have Yaesu FRG-7700 communications receiver with memory in mint condition. Would exchange for Sinclair Z88 computer. Mr Keen, 34 Unwin Road, Isleworth, Middlesex. Tel: 560 8195. *E350*

Have CBM 64 computer with music expansion system. Would exchange for either scanner, 144MHz hand-held or heavy duty p.s.u. cash adjustments considered. B. Mulleady, 9 Elizabeth Crescent, Falkirk FK1 4JF. *E353*

Got a camera, want a receiver? Got a v.h.f. rig, want some h.f. gear to go with your new G-zero? In fact, have you got anything to trade radio-wise?

If so, why not advertise it FREE here. Send details, including what equipment you're looking for, to "SWAP SPOT", Practical Wireless, Enefc House, The Quay, Poole, Dorset BH15 1PP, for inclusion in the first available issues of the magazine.

A FEW SIMPLE RULES: Your ad. should follow the format of those appearing below, it must be typed or written in block letters; it must be not more than 40 words long including name and address/telephone number. Swaps only—no items for sale—and one of the items MUST be radio related. Advert for ILLEGAL CB equipment will not be accepted.

The appropriate licence must be held by anyone installing or operating a radio transmitter.

Have one hand held Harvard 020 two-channel CB with squelch. Excellent condition, hardly ever used. Would exchange for good short wave receiver with antenna (5-18MHz) etc. Codar or similar quality considered. Tel: Nuneaton (0203) 344870. *E357*

Have Yaesu FT-260B 50MHz base rig, s.s.b., a.m., c.w. mint condition, very rare. Exchange for FDK Multi with expander or w.h.y? Philip. Tel: 01 405-6079 weekdays 10am to 5pm. *E362*

Have Sommerkamp FT-767DX (FT-707) with mic, owner's manual, workshop manual, plus 4 spare crystals (27MHz), together with all parts for 1.8MHz band. Would exchange for any of the following: IC-271E, TS-251E or FL-2100Z. G4XPP. QTHR. *E378*

Have Shimizu SS-105S 5 band h.f. rig with modified TL-120 (200 watt p.e.p. linear), plus 48K Spectrum computer with Micro Drive and Interface 1. Would exchange for 50MHz TX/RX plus 25 amp p.s.u. or Belcom LS-102 plus p.s.u. or TAU SPC-3000S a.t.u. G4XPP. QTHR. *E378a*

Have Canon T90 camera, F3.5-4.5 and 35-70 Canon zoom lens. As new, boxed, cost £500. Would exchange for Lowe HF-125 or similar h.f. receiver or w.h.y? Tel: Walsall 641665 after 6 p.m. *E365*

Have Amstrad PCW8256. Would exchange for radio equipment or good selection of components, or interesting w.h.y? But definitely no oriental black boxes. B. Edwards G3WCE, 232 Earlham Road, Norwich, Norfolk NR2 3RH. No callers without appointment. *E384*

Have Realistic DX-440 receiver, 1.5MHz to 30MHz a.m., s.s.b. plus f.m. stereo, 2 months old. Would exchange for a hand-held scanner of the following type: PRO-32, BT-200 or Bearcat 100XL. Tel: 0443 755876. *E385*

Have Rolex Oyster Perpetual Chronometer Explorer I, waterproof to 100 metres, cost £681 one year ago. Would exchange for Sony ICF-2001D or PRO-80, or CRF230, with cash adjustment up to £400. K. Miller, 15 The Rise, Green Lane, Whitby, Yorkshire YO22 4ES. *E389*

IC-505 50MHz s.s.b., c.w., f.m. option, 500mW, 3W and 10W output. Would exchange for h.f. transceiver in good working order, FT-707, FT-77 or FT-101 or similar. Tel: 0934 65614. *E390*



**MAIL ORDER
IS OUR
SPECIALITY**

58 High Street, Newport Pagnell, Bucks. MK16 8AQ.

Kenwood

SPECIAL OFFERS WHILE STOCKS LAST		
		P&P
TW4100E	2M/70CMs Dual Band Transceiver	ONLY 499.00 (5.00)
TS440S	NEW Amateur band transceiver	
	General coverage RX	1138.81 (7.00)
PS50	Heavy Duty PSU for TS440S	222.49 (5.00)
AT440	Auto ATU for TS440S	144.82 (3.00)
TS940S	9 Band TX General Cov RX	1995.00 (7.00)
AT940	Auto ATU for TS940S	244.88 (4.00)
TS930S	9 Band TX General Cov RX	1695.00 (7.00)
TS830S	160-10m Transceiver 9 Bands	1098.00 (7.00)
AT230	All Band ATU/Power Meter	208.67 (5.00)
SP230	External Speaker Unit	66.49 (5.00)
PS430	Matching Power Supply	173.78 (5.00)
SP430	Matching Speaker	40.81 (3.00)
MB430	Mobile Mounting Bracket	15.80 (2.50)
FM430	FM Board for TS430	48.05 (1.50)
LF30A	HF Low Pass Filter 1kW	32.26 (2.50)
YK68A	60kHz AM filter for TS430S/440S	49.37 (1.50)
YK68C	500Hz CW filter for TS430/440/830/530	46.08 (1.50)
YK68CN	270Hz CW filter for TS430/440/830/530	54.64 (1.50)
YK68SN	1.8kHz SSB filter for TS430/440/830/530	46.71 (1.50)
YK455C1	500Hz CW filter for TS140S	54.05 (1.50)
MC50	Dual Impedance Desk Microphone	46.08 (2.50)
MC35S	Fist Microphone 50K ohm IMP	21.72 (1.50)
MC8S	Deluxe Desk Mic with Audio Compensator	107.59 (3.00)
MC43S	Up-Down Hand Mic 8-Pin 500 Ohm	22.22 (1.50)
MC40S	Up-Down Hand Mic 6-Pin 500 Ohm	19.07 (1.50)
MC60A	Desk Mic with built-in Pre-amp	88.22 (3.00)
MC5S	Mobile Microphone with control box (up/down etc.) 6 or 8 pin	52.67 (2.50)
TR751E	2M Multimode (mobile)	599.00 (5.00)
MU1	DCL option for TR751E	30.95 (1.00)
TS711E	2M Base Stations	898.00 (7.00)
HS5	Deluxe Headphones	37.54 (2.50)
SP40	Mobile External Speaker	21.06 (2.00)
TS140S	HF General coverage RX/Amat Band TX	862.00 (7.00)
NEW		
TH25E	2M FM Compact handheld transceiver	258.00 (4.00)
TH205E	2M Handheld Transceiver	215.26 (4.00)
TH215E	2M Handheld with Keypad Entry	252.13 (4.00)
PG2V	DC Power Cable for TH205E/215E	3.96 (1.50)
SMC31	Speaker Mic for TH21E/41E/2600/3600E	29.80 (2.00)
TM221E	2M FM Mobile Transceiver 45W	317.30 (5.00)
TM421E	70cms FM Mobile Transceiver 35W	372.08 (5.00)
TH405E	70cms Handheld Transceiver	273.18 (4.00)
TH415E	70cms Handheld with Keypad Entry	298.85 (4.00)
TR851E	70cms All Mode Transceiver	699.00 (5.00)

Yaesu

PA3	Car Adaptor/Charger	21.85 (2.00)
MD18B	Hand 600 8pin mic	21.00 (2.00)
MD108	Desk 600 8pin mic	79.00 (3.00)
MF1A3B	Boom mobile mic	25.00 (2.50)
YH77	Lightweight phones	19.99 (2.50)
YH55	Padded phones	19.99 (2.50)
YH1	L/wght Mobile H/set-Boom mic	19.99 (2.00)
YH2	L/wght Mobile H/set-Boom mic	19.95 (2.00)
SB1	PTT Switch Box 208/708	22.00 (2.00)
SB2	PTT Switch Box 290/790	22.00 (2.00)
SB10	PTT Switch Box 270/2700	22.00 (2.00)
FT690RMKII	2.5W 6M multimode portable/mobile/base	399.00 (4.00)
FT767GX	HF Gen. Coverage trans. with optional VHF/UHF/6M modules	1550.00 (—)
FT767-2	2m module for FT767	169.00 (3.00)
FT767-7(B)	70cms module for FT767	215.00 (3.00)
FT767-6	6m module for FT767	169.00 (3.00)
PL7000	Solid State linear with built in auto ATU	1600.00 (—)
FT727R	Dual Band handheld transceiver 144-146MHz, 430-440MHz up to 5W on each band	425.00 (3.00)
FT290RMK II	2M multimode portable/mobile/base	429.00 (4.00)
FT73R/RN10	2M mini handheld with LCD display 5W	286.28 (3.00)
FT73R/RN10	70cms mini handheld with LCD display 5W	286.28 (3.00)
NEW		
FT747GX	Gen coverage receiver, Ham Bands Transceiver	659.00 (7.00)
FT736R	Multimode VHF/UHF Base CW 2M, 70 cms & Duplex	1450.00 (7.00)
FT212RH	2M Transceiver, FM, 45W	349.00 (5.00)
DVS1	Voice Memory Unit for FT212RH/FT12RH	79.00 (3.00)
FT12RH	70cms Transceiver, FM, 35W	375.00 (5.00)
FT790RMK II	70cms Multimode, Portable, 2.5W	499.00 (5.00)

Aerial Rotators

DAIWA MR750E	Heavy Duty rotator. Can have up to 4 motors	254.10 (5.00)
KR400	Med/H Duty	139.00 (5.00)
KR500	6 core Elevation	149.95 (5.00)
KR400RC	5 core Medium Duty	169.00 (5.00)
KR600RC	6 core Heavy Duty	219.00 (5.00)
KC038	lower mast clamps	17.45 (2.00)
KS065	Rotary Bearing	29.95 (2.50)
AR1002	Lightweight VHF Rotator	47.00 (4.00)

Second Hand List

	P&P
ICOM IC-251A 2M Multimode Base Station 10W. Excellent condition, untested	499.00 (5.00)
SONY-PRO 80 Handheld Receiver. 150KHz-108MHz & 115-150MHz-223MHz. (As new)	259.00 (4.00)
SONY-PRO 80 Handheld Receiver. 150KHz-108MHz & 115-150-223MHz. (As new)	259.00 (4.00)
SONY-ICF 7600D Shortwave Receiver. (As new)	119.00 (3.00)
SONY-ICF 2001D Shortwave Receiver + Airband. (Demo model)	299.00 (4.00)
CD660 Communications Decoder. Decodes RTTY/CW/AMTOR/SACII	199.00 (4.00)
YAESU FT230R 2M FM Handheld C/W Base Charger. 2x FN64 Nicads. 1x FN83 Nicads. Leather case & 2 Vinyl cases	267.00 (4.00)
ICOM IC-290A 2M Multimode iOw. C/W Mobile mount. Mic & manual.	225.00 (4.00)
YAESU FT720R 2M High iOw C/W Detachable 70cms unit. (Excellent cond)	255.00 (4.00)
FDK 750X 2M Multimode 10W	225.00 (4.00)
ICOM IC-735 160-10M Amat. Band Trans. Gen. Cover RX	750.00 (7.00)
YAESU FT299RH 2m Handheld Demo model	205.00 (3.00)
GPI-Computer Patch card GEM4 software Capable of TX/RX of RTTY/AMTOR/CW/ASCII	189.00 (4.00)
IC-471A 70cms Multimode Base Station 25W. As new and complete	750.00 (7.00)
TR751E 2m Multimode 25w VGC. Probably the best 2m Multimode on the market	499.00 (5.00)
ALINCO ALM-203E 2m Handheld c/w 30w ampifier, spare nicad pack, DC converter, charger & case	205.00 (3.00)

Receivers

Trio R2000 HF general coverage receiver	595.00 (7.00)
Trio VC10 VHF converter for R2000 118-174MHz	161.94 (3.00)
Trio R5000 NEW HF general coverage receiver	875.00 (7.00)
Trio VC20 VHF converter for R5000 108-174MHz	187.21 (3.00)
Yaesu FRG8800 HF general coverage receiver	639.00 (7.00)
Yaesu FRV8800 VHF converter for FRG8800 118-175MHz	100.00 (3.00)
Icom R71E HF general coverage receiver	825.00 (7.00)
Icom R71 remote control unit for ICR71E	82.00 (2.00)
AR2002 VHF-UHF scanner 25-550MHz and 800-1300MHz	487.00 (5.00)
FRG9600 VHF-UHF scanner 25-950MHz	509.00 (5.00)
Icom R7000 VHF-UHF scanner. all modes 25-2000MHz	957.00 (7.00)
Icom R7012 remote control unit for R7000	62.00 (3.00)
RS37S Air band portable. Tunable 118-136MHz	69.51 (3.00)

NEW		
RS35 VHF-UHF Airband Receiver 60 memory channels, memory scan, programmable scan with RS232 interface	249.00 (3.00)	
Black Jaguar B200 MKII Handheld VHF-UHF Scanner	158.00 (4.00)	
HF125 HF general coverage receiver 30KHz-30MHz (Made in Britain)	375.00 (5.00)	
WIN-108 Synthesised Airband Handheld Receiver 108-136 MHz	175.00 (3.00)	
Kenwood RZ-1 Wideband Receiver. 500KHz-950MHz Car Radio size.	465.00 (4.00)	
AOR800 Handheld VHF/UHF Scanner C/W Nicad pack, charger & two aeras. Covers 75-105/118-136/140-174/406.495-830-950MHz.	199.00 (4.00)	
Only Handheld that covers all frequency ranges.		

Icom

IC751A	HF Transceiver	1465.00 (—)
IC735	New HF Transceiver	949.00 (—)
PS15	P.S. Unit	158.00 (4.00)
PS30	Systems p.s.u. 25A	343.85 (—)
SM6	Base microphone for 751/745	46.00 (1.00)
IC2900	2m 25w M/Mode	542.00 (—)
IC505	10W/3W 6M multimode, portable/base	459.00 (5.00)
IC02E	2m Hi-Held	269.00 (—)
IC04E	70cm handheld	299.00 (—)
BC35	Base Charger	70.15 (1.50)
HM9	Speaker mic	21.85 (1.50)
BP3	Std Battery Pack	29.90 (1.50)
BP4	Empty Battery Pack	9.20 (1.50)
BP5	High Power Battery Pack	90.95 (1.50)
CP1	Car Charging Lead	6.00 (1.50)
DC1	12v Adaptor	17.25 (1.50)
IC-Micro	2 mini hand portable LCO display 1W	238.00 (3.00)
NEW		
IC-275E	2M Multimode Base Station inc. PSU. 25W	1839.00 (7.00)
IC-475E	70cms Multimode Base Station inc. PSU. 25W	1125.00 (7.00)
IC-1200	23cm FM Mobile. 10W output, style similar to 28E	559.00 (4.00)
ICOM 761	HF general coverage transceiver with internal PSU and auto ATU	2459.00 (7.00)
ICOM IC575	6/10 metre Base Station	999.00 (10.00)
ICOM IC781	HF general coverage trans. C/W internal psu, auto AW, built in VDU. (Send for details)	4580.00 (10.00)

Power Supplies

	4 amp	6 amp	12 amp	24 amp	80MS	6 amp	12 amp	25 amp	40 amp
DRAE	48.30	71.53	95.16	137.54	78.20	129.95	192.20	423.20	
	(3.00)	(3.00)	(3.00)	(5.00)	(3.00)	(3.00)	(3.00)	(7.00)	
BMS NEW 'E' SERIES POWER SUPPLIES									
	12.5E 5amp PSU	12.10E 10amp PSU	12.20E 20amp PSU	12.30E 30amp PSU	57.50	97.75	132.25	195.50	
					(3.00)	(4.00)	(5.00)	(5.00)	

Switches

Sigma	2 way S0239	26.20	(1.50)
Sigma	2 way 'n' Skts	22.95	(1.50)
Welz CH20A	2 way S0239	30.75	(1.50)
Welz CH20B	2 way 'n' Skts	54.00	(1.50)
Drae	3 way S0239	17.00	(1.50)
Drae	3 way 'n' Skts	21.95	(1.50)

CW/RTTY/Equipment

	P&P	
BY1	Squeeze Key, Black base	67.42 (3.00)
BY2	Squeeze Key, Chrome base	76.97 (3.00)
HI-MOUND MORSE KEYS		
HK708	Straight key	21.50 (2.50)
HK702	Deluxe version of above on Marble Base	42.50 (3.00)
HK706	Straight key	23.00 (2.50)
HK707	Straight key	22.25 (2.50)
MK704	Squeeze paddle	20.00 (2.50)
MK705	Squeeze paddle on Marble Base	32.20 (3.00)

NEW

RTTY-EQUIPMENT		
PK-232	Packet, AmTOR, RTTY, CW, ASCII, FAX transceiver in one unit. Works with any computer equipped with an RS232 interface. 12V operated	269.95 (4.00)
NEW PK-88 Budget packet radio TNC.		
NEW FAX option for existing PK232 users (includes new manual)		109.95 (4.00)
NEW PK-87 1200 Baud AmTOR Packet Radio TNC		148.50 (4.00)
NEW PK-90 Commercial Packet Radio TNC		368.40 (4.00)

SOFTWARE PACKAGES		
PK232/CGA-128 Cartridge, overlays, cable, handbook		69.00 (1.50)
PK232/BBC-B & Master E-PRIME, overlay, cable, handbook		35.00 (1.50)
PK232/IBM-C & Compilables, Disc, handbook		39.00 (2.50)
P87/CGA-128 Cartridge, overlays, cable, handbook		69.00 (1.50)
PK87/BBC-B & Master E-PRIME, overlay, cable, handbook		35.00 (1.50)

NEW FAX-1 Radio Facsimile Weather Map demodulator with double screened printer cable. Includes mounting bracket and NEW RTTY receive facility.		279.95 (4.00)
--	--	---------------

CD660	Data Receiver for CW/RTTY/TOR/AMTOR/ASCII	264.97 (5.00)
CD670	As above but with built in LCD display	327.77 (5.00)

KEYERS & ACCESSORIES		
Star Master Key	Electronic Keyer	54.70 (3.00)
Star Memory	MasterKey electronic CMOS memory	95.00 (3.00)
TRX3	Morse Oscillator	13.65 (1.50)
Datung	D70 Morse Tutor	56.50 (3.00)

Howes Kits

SWB30	SWR Meter Kit	12.50 (1.50)
CV220	2M Receive Converter, for use with 20M RX	17.50 (1.50)
CV620	6M Receive Converter, for use with 20M RX	17.50 (1.50)
DCRX20	20M Amateur Band Receiver	15.00 (1.50)
DCRX40	40M Amateur Band Receiver	15.00 (1.50)
DCRX80	80M Amateur Band Receiver	15.00 (1.50)
DCRX160	160M Amateur Band Receiver	15.00 (1.50)
MS2	'S' Meter Kit	8.60 (1.50)
CSL4	Dual Bandwidth Filter. Improves selectivity. Internal use.	9.90 (1.50)
ASL5	External Filter Unit. Improves selectivity on your receiver	14.90 (1.50)
TRF3	Shortwave Broadcast Receiver. 5-7 to 12.8MHz	14.80 (1.50)
TRF20	10W 20M CW Transmitter. Crystal Controlled	22.00 (1.50)
CTX40	3W 40M CW Transmitter. Crystal Controlled	13.80 (1.50)
CTX80	3W 80M CW Transmitter. Crystal Controlled	13.80 (1.50)
CVF	20, 40 or 80M VFO's. Fully featured VFO units for use with the MTX or CTX range of transmitters, or a DCRX receiver for transceive operation	10.40 (1.50)
CTU30	Antenna Tuning Unit. 1.8 to 30MHz. Up to 30W RF	27.90 (1.50)
AP3	Automatic Speech Processor	15.90 (1.50)
ST2	CW Side Tone or Practice Oscillator	8.80 (1.50)
XM1	Crystal Calibrator	16.60 (1.50)
NEW		
HC266	2M to 6M Transverter, fully assembled and tested. 10W RF output	179.95 (3.00)

Aerials

6M HB9CV 2 ele beam		12.95 (4.00)
6M 3 ele Beam		25.00 (12.00)
6M 5 ele Beam		39.00 (12.00)
AH-7000	Wideband Discone Antenna. 25-1300 MHz	82.00 (4.00)
Revocone	Wideband Discone Antenna. 25-500 MHz	31.50 (4.00)
G5RV	Full size 102'	18.75 (3.00)
G5RV	Half size 51'	14.25 (3.00)
HB9CV	2 metres	3.95 (3.00)
HB9CV	70cms	3.95 (2.00)
2 metre	Slim Jim	8.95 (3.00)
7 ele ZL Special 2M		14.25 (5.00)
12 ele ZL Special 2		

Theory

In this, the final episode, A.J. Harwood C Eng MIERE G4HHZ talks not so much about propagation as the way a knowledge of the subject allows services which use radio transmission to be planned in a manner that enables communication without chaos.

Making Waves—A Guide to Propagation

Part 8—According to Plan

The one commodity which all such services use is radio frequency spectrum and, since this is much sought after, it must be used economically and in a way which permits many users to share the spectrum without causing undue interference to one another. To this end the use of radio transmission is regulated by international agreement, and users are allocated set frequencies which they have a right to use and on which they can expect a degree of freedom from interference caused by other users. The one exception to this is the amateur radio service where the users are simply confined to certain frequency bands and powers, and are self-regulating in the use of individual frequencies within these bands. As an example of how a service is planned I will use the u.h.f. television service within the United Kingdom, although the broad principles apply to the planning of any service.

Television at u.h.f. is transmitted on frequencies in Bands IV and V between 470 and 850MHz. The bands are internationally agreed and divided into 44 channels, each of which is 8MHz wide which gives sufficient bandwidth to contain the vision and sound signals forming a television transmission. As we frequently talk of the television service we need to be clear as to what we mean when we say someone is served by television. Obviously part of the answer is that they can easily receive a signal which provides them with a satisfactory picture (and of course sound, although generally if reception of the picture is good then so is the sound.) When planning the television service, we must therefore take into account the ability of the receiver to produce pictures, and the level of signal it requires to do so. The planning is therefore dependent on both the transmission and reception equipment available.

At the same time the u.h.f. service was planned, the broadcasters aimed to provide a service which does not fall below a minimum level referred to as Grade 3. This is defined as having impairments that are definitely perceptible but that the average viewer does not find disturbing. In an ideal

world each transmission would operate on a unique channel and the principal impairment would be the inherent noise produced in the front end of the receiver. The level of this noise is easily calculated and the noise power generated by the receiver is given by:

$$N = F \times K \times T \times B \text{ watts}$$

where F is the noise factor of the receiver, T is the temperature in kelvin (degrees above absolute zero) and B the bandwidth of the receiver in hertz. K is a constant known as Boltzman's constant and has the value 1.372×10^{-23} joules per degree. For a television transmission the bandwidth of the receiver i.f. is about 5.5MHz and T is usually taken as 290. In the 1960s manufacturers felt that receivers would have a noise factor of about 8dB

(a power ratio of 6.3 to 1) giving a total noise power of:

$$N = 6.31 \times 290 \times 1.372 \times 10^{-23} \times 5.5 \times 10^6 = 1.38 \times 10^{-13} \text{ watts.}$$

If the front end of the receiver has a purely resistive input impedance of 75 ohms then the noise voltage producing this power is:

$$V = \sqrt{75 \times N} = 3.22 \times 10^{-6} \text{ volts or } 3.22 \text{ microvolts } (\mu\text{V}).$$

A Grade 3 picture is obtained with a video signal to noise ratio of about 34dB and, because television is transmitted as amplitude modulation with a vestigial sideband and the modulated signal also contains the synchronising pulses, the r.f. carrier to noise ratio required to give a 34dB video signal to noise ratio is about 8dB higher or 42dB, a voltage ratio of 126 to 1. The input signal to the receiver therefore needs to be $3.22 \times 126 = 406\mu\text{V}$. A level of $500\mu\text{V}$ input is a practical figure to work with.

Thus in order to serve an area the broadcasters need to provide field strengths which allow an average antenna installation to deliver a minimum signal level of half a millivolt (mV) to the receiver input. Some assumptions have to be made about this installation, as the broadcasters cannot specify what equipment viewers use, and this assumption is that an external antenna with a gain of about 14dB (over a half-wavelength dipole) is the norm with a feeder having a loss of about 3dB. The feeder loss is equivalent to a voltage ratio of 1.414 to 1 so to produce 0.5mV at the receiver requires 0.707mV at the antenna output. In Part Two of this series, I showed how to calculate the field strength required to produce a given voltage from an antenna of known gain and at a given frequency. To get our half millivolt with 14dB of antenna gain (a power ratio of 25 to 1 and so a voltage ratio of 5 to 1) at a frequency of 500MHz (which is Channel 24 in band IV) where the wavelength is 0.6 metres, the sum is:

$$E = V \times 2 \times \pi / G \times \lambda$$

Practical Wireless, July 1988

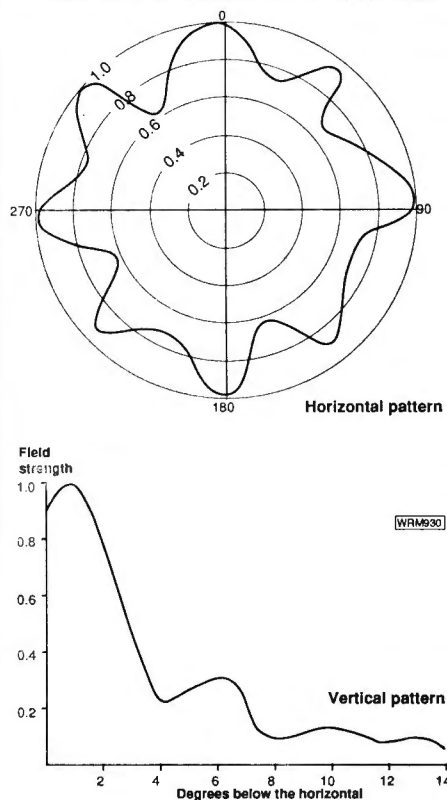

Fig. 8.1: Radiation patterns for a u.h.f. high-power main station. The horizontal pattern is omnidirectional, and the vertical pattern is tailored to minimise field strength variations within the service area

$$= 0.707 \times 2 \times \pi / 5 \times 0.6$$

which comes to 1.48 millivolts per metre (mV/m). This is usually quoted in decibels above 1 microvolt per metre which in this case is 63.4dB ($\mu\text{V/m}$).

If we repeat the sum for Channel 62 where the frequency is 800MHz and the wavelength correspondingly shorter at 0.375m we find that the field strength required to produce 0.707mV out of the antenna is:

$$E = 0.707 \times 2 \times \pi / 5 \times 0.375 \\ = 2.37\text{mV/m}$$

or almost 68dB ($\mu\text{V/m}$) and since the feeder losses tend to be somewhat greater at the higher frequencies the field strength needs to be some 2dB higher than this. The actual values used by the broadcasters in deciding if an area is served is 64dB($\mu\text{V/m}$) in Band IV and 70dB($\mu\text{V/m}$) in Band V. Viewers beyond the service area defined by these levels can also get good pictures by using higher gain antennas and pre-amplifiers with a low noise figure. There may however be other factors which affect them, such as the presence of co-channel interference.

A total of 44 transmission channels are available in Bands IV and V and, since each transmitting station radiates four television services (ITV, Channel 4, BBC1 and BBC2) these channels must be re-used many times if maximum coverage of the country is to be achieved. Each transmitter is a potential source of interference to others on the same channel. Planning must take this into account and it is necessary to know what level of interfering signal can be tolerated before the visual effect produced by the average receiver becomes unacceptable. If the carrier frequencies of co-channel transmitters are kept stable to within 500Hz of one another then it has been found that an interfering signal at the receiver input needs to be 45dB lower than the wanted signal for the visual impairment to be Grade 3. If however the carrier frequencies are offset by a multiple of one third of the picture line frequency ($15.625/3 = 5.21\text{kHz}$) then with the same carrier frequency stability of 500Hz a level of unwanted signal only 30dB below the wanted produces Grade 3 interference.

The ratio of the unwanted signal to the wanted for an acceptable level of interference is known as the protection ratio and in this case is 30dB for offset working and 45dB for the non-offset case. In practice, offsets of plus or minus five thirds of line frequency are necessary to avoid the audible beat a one third offset would cause. This technique of offset carrier working is widely used as it permits closer spacing of co-channel transmitters and thus allows more efficient use of the spectrum. The levels of the wanted and unwanted signals at the receiver depend on the radiation pattern of the receiving antenna, and the relative positions and levels of the two signals.

Practical Wireless, July 1988

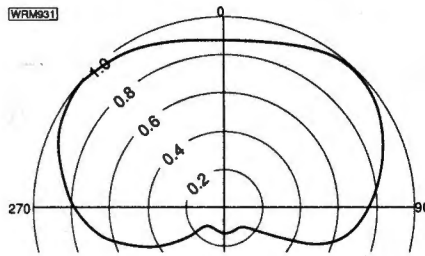

Fig. 8.2: Horizontal radiation pattern for a relay station. The power is directed mainly into the service area and radiation is reduced behind the antenna, allowing the channel to be re-used at other relays

For a given level of interfering signal, the level of the wanted signal required to give a receiver input, where the wanted-to-unwanted level equals the protection ratio, is known as the protected field strength.

The service planner thus has two main objectives, both of which require a knowledge of propagation. First, he must specify the combination of frequency, transmitter power, antenna location, height, radiation pattern and effective radiated power which provides the level of field strength needed throughout the service area. Secondly he must calculate the levels of signals from co-channel stations likely to be encountered in the service area and ensure that, when the directivity of the receiving antenna is taken into account, the level of the interfering signal at the receiver inputs results in an impairment which is acceptable, in this case Grade 3. For main stations which are fairly well separated geographically, the interference is usually due to tropospheric propagation during anticyclonic meteorological conditions and thus varies with time. In the United Kingdom the aim is to try to ensure that co-channel interference does not cause pictures to be worse than Grade 3 for more than 5 per cent of the time. Since continental and Irish stations are also sources of interference, service planning and frequency allocation involves a great deal of international co-operation.

There are 51 high-power main stations in the United Kingdom and these provide a service to about 90 per cent of the population. To serve as much as possible of the remainder, a large number of relay stations with effective radiated powers of between 1 watt and

1 kilowatt are used. There are currently over 820 relays and all are fitted in using channels from the same 44 as are used for the main stations. Again, interference has to be avoided and, since the relay may be much closer to its co-channel partner than is the case for the main stations, the levels of the interfering signal is much more constant since the propagation mechanism is no longer tropospheric. To reduce the effect to the viewer of virtually continuous interfering signals, a protection ratio some 10dB higher is applied, which results in just perceptible interference.

Re-use of frequencies is facilitated by careful choice of radiation patterns and station siting. Main stations are sited at high locations, where they give maximum coverage consistent with the need to keep the levels of co-channel interference to the minimum. Horizontal polarisation is used and in general the horizontal radiation pattern is omnidirectional except in the case of a few main stations where the antenna pattern is tailored to reduce interference levels in a specific direction. The vertical radiation pattern is designed to radiate less power towards the ground close in to the station and the maximum power is directed towards the outer parts of the service area, the aim being to keep the variations in field strength across the service area to within reasonable limits.

Relay stations are designed to have the smallest effective radiated power consistent with serving as much of the unserved area as possible. Antenna patterns are usually directional and the majority of relays use vertical polarisation. Siting is often fairly critical and antenna heights are kept to the minimum possible consistent with obtaining the desired coverage. In most cases the relay needs to be positioned so that viewers' antennas point away from the principle source of co-channel interference. Even so there may still be locations where the field strengths are above the level needed for a service but the co-channel interference levels are high enough to impair reception.

Choice of frequencies is limited by a number of factors in addition to the co-channel requirement. If a channel is already in use in the vicinity of a relay station then certain channels are precluded from use at the relay. Working with the upper and lower adjacent channels is not easy (though it is not

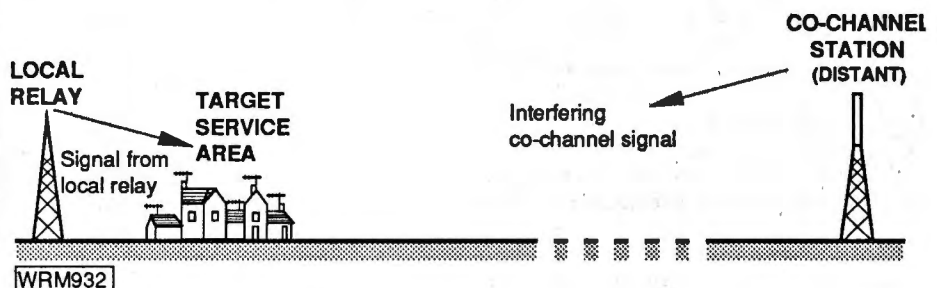

Fig. 8.3: Correct siting of a relay station reduces the effects of co-channel interference by making use of the radiation pattern of the receiving antenna

impossible). Use of the channels which are 5 and 9 higher is also not possible since the +5 channel is liable to interference from the local oscillators of receivers tuned to the existing channel, whilst to allocate the +9 channel would put the relay on the image channel of the existing receivers and cause them interference. Similarly the relay cannot use the -5 and -9 channels.

These then are the principles upon which any service is planned. The required level of communication is

defined taking into account the performance of the transmission and reception equipment available and the service planned using the appropriate propagation methods for the frequency band and path. Care is taken to ensure that the interference levels are kept to a minimum and for the least time allowed by propagation conditions. All this is conditional on the siting available (not to mention the complexities of obtaining planning permission) and usually entails a degree of compromise.

It is a task which requires skill and one which the service planning engineer finds challenging.

This brings me to the end of the series which I for one have enjoyed writing. I do thank those who have been kind enough to contact me with their (mainly useful) comments and hope that I have enabled at least a few to obtain an insight into an aspect of radio engineering without which the science (or art?) would be impossible. I must also thank my cat, Maxwell. **PW**

BOOKSHELF

INTERFERENCE HANDBOOK

Edited by William I. Orr W6SAI

Published by Radio Publications Inc

Available from the Practical Wireless Book Service
137 x 207mm, 253 pages. Price £6.75 plus 75p P&P
ISBN 0 933616 01 5

The purpose of this handbook is to help the reader locate and resolve interference problems of every type. Sources of interference are described along with the methods used to locate them. Suppression circuits for interfering devices are discussed in detail as well as protection techniques for home entertainment equipment.

The book covers all aspects of interference to TV, stereo, radio telephone, radio amateur and CB equipment. There are helpful facts about power line interference, how to locate

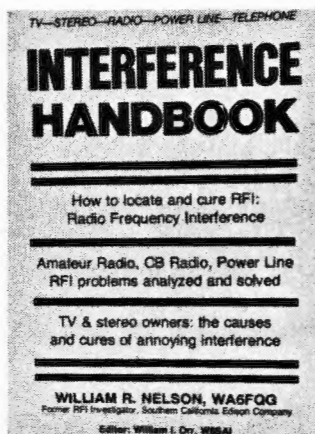

it, how to cure it, how to work with the public, do's and don'ts, safety precautions and how to train an r.f.i. investigator.

PRACTICAL ELECTRONICS CALCULATIONS AND FORMULAE (BP144)

by F.A. Wilson

Published by Bernard Babani (publishing) Ltd

Available from Practical Wireless Book Service
110 x 178mm, 249 pages. Price £3.95 plus 75p P&P
ISBN 0 900162 70 8

This book has been written not for the family bookshelf but as a workshop manual for the electronics enthusiast. Its aim is to bridge the gap between complicated technical theory, which sometimes seems to have little relevance to practical work, and the "cut and try" methods which may bring success in design but leave the experimenter a little confused.

There is a strong practical bias, but tedious and higher mathematics have been avoided where possible. Many tables have been included, partly to save calculation and partly because actual figures bring a greater intimacy with the

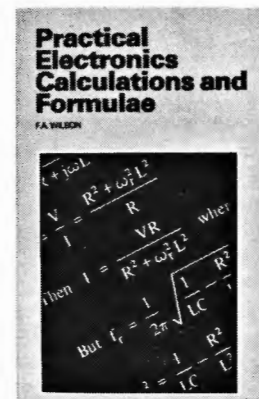

design process.

There are six chapters: Units and Constants; Direct Current Circuits; Passive Components; Alternating Current Circuits; Networks and Theorems; Measurements.

AMATEUR RADIO SATELLITES THE FIRST 25 YEARS

by Arthur C. Gee G2UK Chairman AMSAT-UK

Published by AMSAT-UK

Available from the Practical Wireless Book Service
146 x 210mm, 34 pages. Price £2.25 plus 75p P&P

Amateur radio satellites haven't always been so many and so successful. Things have moved so fast in this field that the 25 years have simply flown by unnoticed. Development has progressed at such a pace that it has been difficult to keep up with it. New satellites have been launched at such a rate that one seems to have hardly got used to the characteristics of one, before another has appeared with its new technology, to which users have to become accustomed.

The material in this souvenir publication is drawn from the records of

the author, AMSAT-UK's chairman. The story starts recalling a conversation with G2BVN after the Sputnik launch when the idea of amateur radio one day being involved in spacecraft was mentioned. Then came the birth of Project Oscar, Orbital Satellite Carrying Amateur Radio. The book follows the Oscar story through to Oscar 8. It also recounts some of the RS story too. The University of Surrey aren't missed out either, as a great deal of the booklet is devoted to their part in amateur radio satellite history. Even our own info in Orbit author Pat Gowen G3IOR gets a mention!

THE HISTORY OF ROBERTS RADIO

Published by Roberts Radio Co. Ltd.

Available from: Bob Burt, Roberts Dynatron & Co. Ltd., Molesey Avenue, West Molesey, Surrey
KT8 0RL.

154 x 219mm, 45 pages hardcover. Price £5.95
ISBN 0 9512590 0 8

The royal radio-makers, named after the East End boy who co-founded the firm, are publishing their history after 55 years in the business.

Roberts Radio hold three Royal warrants and are a British survivor of the radio industry battered by the Far East competition. They started business in 1933, partly financed by the sale of a motorbike, and Harrods (yes, the Harrods) became their first customer.

Over the years they have been asked to supply radios for special events, like the Queen's Royal Tour in 1953, equipped expeditions on their journeys into no-man's land and supplied sets to prisons and the blind.

The book has plenty of illustrations, including a mink

coated radio circa 1959! The history of the company is charted carefully and makes interesting reading. In these days of few British radio manufacturers, it is reassuring to read books like this—if only to remind ourselves that British radio equipment still exists.

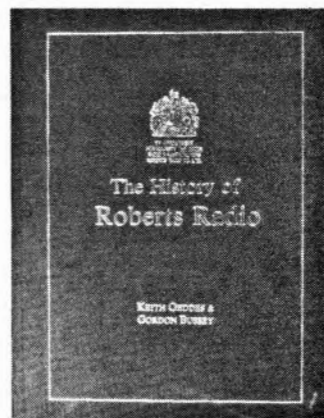



Bredhurst electronics



SITUATED AT SOUTHERN END OF M23 — EASY ACCESS TO M25 AND SOUTH LONDON

HF RECEIVERS	£	(c&p)
Icom ICR71	825.00	(-)
Kenwood RT2000	595.00	(-)
Kenwood VC10 V.H.F. Converter	161.94	(2.00)
Kenwood RS000	875.00	(-)
Yaesu FRG8800	639.00	(-)
Yaesu FRV8800 V.H.F. Converter	100.00	(2.00)
Lowie HF125	375.00	(-)

HF TRANSCEIVERS	£	(c&p)
Kenwood TS940S	1995.00	(-)
Kenwood TS930S	1695.00	(-)
Kenwood TS440S	1138.81	(-)
Kenwood TS140S	862.00	(-)
Yaesu FT980	1785.00	(-)
Yaesu FT757GXII	969.00	(-)
Yaesu FT767GX	1550.00	(-)
Yaesu FT747GX	659.00	(-)
Icom IC735	949.00	(-)
Icom IC751A	1465.00	(-)

V.H.F. SCANNING RECEIVERS	£	(c&p)
Icom ICR7000	957.00	(-)
Yaesu FRG9600M 60-950MHz	509.00	(-)
A.O.R. AR2002	487.30	(-)
Signal R535 "Airband"	249.00	(-)
Sony Air 7 handheld	249.00	(-)
Sony PRO 80 New Sony Receiver	349.00	(-)
WIN 108 Airband Receiver	175.00	(2.00)

V.H.F. SCANNER ACCESSORIES	£	(c&p)
A.K.D. HFC1 HF Converter	49.00	(1.00)
Revcone Discone Antenna 30-500MHz	32.16	(3.00)
Icom AH7000 Antenna 25-1300MHz	82.00	(3.00)

ANTENNA TUNER UNITS	£	(c&p)
Yaesu FRT7700 Short wave listening	59.00	(2.00)
Yaesu FC757AT	349.00	(-)
Kenwood AT230	208.67	(2.50)
Kenwood AT250 auto	366.00	(-)

2.M. TRANSCEIVERS	£	(c&p)
Kenwood TH21E Handheld	189.00	(-)
Kenwood TR751E 25W multimode	599.00	(-)
Kenwood TS711E base station	898.00	(-)
Kenwood TH205E Handheld	215.26	(-)
Kenwood TH215E Handheld	252.13	(-)
Kenwood TW41000E 2m/70cm FM Mobile	499.00	(-)
Kenwood TM221ES 45W Mobile	317.00	(-)
Kenwood TH25E Handheld	258.00	(-)
Yaesu FT290II Portable multimode	429.00	(-)
Yaesu FT23R + FNB10 Handheld	255.70	(-)
Yaesu FT736R Multimode VHF/UHF Base complete with 2m, 70cm and duplex	1450.00	(-)
Icom IC2E Handheld	225.00	(-)
Icom IC02E Handheld	299.00	(-)
Icom IC28E 25W mobile	359.00	(-)
Icom IC275E base station inc PSU	1039.00	(-)
Icom IC3200E 2m/70cm FM mobile	556.00	(-)
Icom IC Micro II Handheld	239.00	(-)

70cm TRANSCEIVERS	£	(c&p)
Kenwood TH41E Handheld	218.00	(-)
Kenwood TS811E base station	998.00	(-)
Kenwood TH405E Handheld	273.18	(-)
Kenwood TH415E Handheld	298.85	(-)
Kenwood TM421ES 35W Mobile	352.84	(-)
Yaesu FT73R + FNB10 Handheld	275.70	(-)
Icom IC4E Handheld	285.00	(-)
Icom IC04E Handheld	299.00	(-)
Icom IC451E base station inc PSU	1125.00	(-)
Icom IC Micro 4 Handheld	279.00	(-)

STATION ACCESSORIES	£	(c&p)
MC 50 Desk Microphone	46.08	(2.00)
MC 60A Desk Microphone with Pre-amp	88.22	(2.00)
MC 55 Mobile Microphone with Control Box	52.67	(1.00)
MC 35S Hand Microphone 4 pin	21.72	(1.00)
MC 43S Up/down Hand Microphone 8 pin	22.22	(1.00)
MD18B Base Microphone	79.00	(2.00)
LF 30A Low Pass Filter 1kW	32.26	(2.00)
SP 40 Mobile Speaker	21.06	(1.00)
HS 7 Miniature Headphones	15.80	(1.00)
HY 77 Light Deluxe Headphones	19.99	(1.00)
HS 5 Deluxe Headphones	37.54	(1.00)
CS 100 Mobile Speaker	13.50	(1.00)
VS 1 Voice Synthesizer Module	32.26	(1.00)
VS 2 Voice Synthesizer Module	32.26	(1.00)
GC5 Icom World Clock	43.00	(2.00)
CD600 CW/RTTY Decoder	215.14	(2.50)
KPC2 Kantronics Packet Communicator	159.00	(2.50)
Kent Morse Key Kits	29.50	(2.50)
Kent Twin-Paddle Morse Key Kits	38.50	(2.50)

ANTENNA BITS	£	(c&p)
HI-Q Balun 1:1 5kW P.E.P.	13.95	(1.50)
Bricom Balun 4:1 1kW	13.80	(1.50)
Bricom 7.1MHz Epoxy Traps (pair)	10.95	(1.50)
Self Amalgamating Tape 10m x 25mm	4.25	(0.75)
T-piece polyprop Dipole centre	1.60	(0.25)
Small ceramic egg insulators	0.65	(0.20)
Large ceramic egg insulators	0.85	(0.20)

CABLES ETC.	£	(c&p)
URM67 low loss coax 50 ohm	per metre	0.75 (0.25)
UR76 50 ohm coax dia. 5mm	per metre	0.30 (0.10)
UR70 70 ohm coax	per metre	0.35 (0.10)
UR95 50 ohm coax dia. 2.3mm	per metre	0.40 (0.10)
4mm Polyester Guy Rope (400kg)	per metre	0.25 (0.10)
50mtrs. 16 swg hard drawn copper wire		6.95 (1.50)
75ohm Twin feeder light duty	per metre	0.20 (0.10)
300ohm Slotted ribbon cable	per metre	0.32 (0.10)

VISIT OUR STAND AT THE SUSSEX MOBILE RALLY, BRIGHTON ON SUNDAY 10th JULY

GOODS NORMALLY DESPATCHED WITHIN 24 HRS - PRICES CORRECT AT TIME OF GOING TO PRESS - E&OE - MAIL ORDER AND RETAIL

BREDHURST ELECTRONICS LTD HIGH ST, HANDCROSS, W. SX. RH17 6BW (0444) 400786

COMMUNICATION CENTRE OF THE NORTH

The largest range of communications equipment available in the North. Full range of receivers, transceivers, antennas, power supplies, meters. All tubing - wall brackets - rotators - insulators.

ANTENNA RANGE

BUTTERNUT	£	(c&p)
HF2V 40-80m vertical	£142.00	(-)
20 MRK 20m add on kit	£33.49	(-)
HF6VX 6 band vertical	£159.00	(-)
TBR160S 160m Add on kit	£53.99	(-)
HF4B Triband Mini Beam	£236.00	(-)

CUSHCRAFT	£	(c&p)
A3 3 element Tribander	£262.00	(-)
A4 4 element Tribander	£350.00	(-)
10-3CD 3 element 10m	£115.00	(-)
15-3CD 3 element 15m	£139.75	(-)
20-3C2 3 element 20m	£238.00	(-)
AP8 8 band 25ft vertical	£164.00	(-)
AV5 5 band 25ft vertical	£123.00	(-)
18 element 2m Boomer	£106.00	(-)
15 element 2m Boomer	£85.00	(-)

ANTENNA TUNERS

Kenwood AT230	£208.00	(-)
CAPCO SPC 3000	£225.00	(-)
CAPCO SPC 3000D	£325.00	(-)
MFJ 962B 1.5k Tuner	£241.00	(-)
MFJ 949C 300W Versatuner	£157.00	(-)
MFJ 941D watt Basic	£105.00	(-)
MFJ 1601 Random Wire Tuner	£42.02	(-)
Kenwood AT250 Automatic	£366.00	(-)

G5RV full size £165.00, half size £145.00 Full range of Antenna - Accessories plus full range of VHF - UHF - HF mobile Antennas

Full range of RSGB and ARRL publications in stock. Part Exchanges welcome. Second hand lists daily. Send S.A.E. for details of any equipment.

HP terms. Access/Barclaycard facilities.

Open 6 days a week. 24 Hour Mail Order Service.

Goods normally despatched by return of post.

WELZ	£	(c&p)
DCP5 5 band vertical with radial kit	£195.00	(-)
DCP4 40-20-15-10 vertical with radial kit	£147.00	(-)

JAYBEAM	£	(c&p)
VR3 3 band vertical	£73.60	(-)
TB1 Rotary Dipole	£105.80	(-)
Minmax Triband Mini Beam	£327.00	(-)
TB2 2 element Tribander	£202.00	(-)
TB3 3 element Tribander	£316.00	(-)

SWR/POWER METERS

MFJ 815 HF 2kw SWR/PWR	£57.32	(-)
SWR Twin Meter 1.8-50MHz	£25.00	(-)
DIAWA CN410M 35-150MHz	£51.72	(-)
DIAWA CN460M 140-450MHz	£85.40	(-)
NS660P 1.8-150MHz + PEP	£115.00	(-)
Wetz SP10X	£37.00	(-)
Wetz SP220	£67.95	(-)
Wetz SP420	£59.95	(-)

DUMMY LOADS

DL60 60 watt	£10.96	(-)
DL600 600 watt	£62.75	(-)
CTS30 500 watt	£59.00	(-)
MFJ2600 300 watt	£28.35	(-)

HYGAIN

TH2 MK3 2 ele Tribander £249.00

18 AVT 5 band trapped vertical £146.00

EXP14 4 element 20-15-10 m £449.00

Phone 0942-676790.

STEPHENS JAMES LTD.

47 WARRINGTON ROAD, LEIGH, LANCs. WN7 3EA.

RST

RST MAIL ORDER CO.
LANGREX SUPPLIES LTD,
1 MAYO ROAD,
CROYDON,
SURREY CR0 2QP.

SPECIAL EXPRESS MAIL ORDER SERVICE

AZ31	£p	EM81	2.50	PL519	6.00	6AK5	5.99	6KD6	8.00
CL33	4.00	EM87	2.50	PL802	6.00	6AL5	1.50	6LG6	5.00
DY867	1.50	EN91	6.50	PY33	2.50	6AM6	6.02	6L6CC	7.50
DY802	12.00	EY86	1.75	PY81	1.50	6AN5	4.75	6L7	2.50
EB88C	10.33	EY86	1.75	PY82	1.50	6AN8A	3.50	6L6	7.50
E180F	1.95	EY88	1.75	PY82	1.50	6A05	3.25	60T	3.75
E810F	35.48	EY500A	3.00	PY83	1.25	6AR5	25.00	6RH8BKNB	
EAB30	1.25	DZ80	1.50	PY88	2.00	6AS6	8.66	6SA7	3.00
EB91	1.50	EZ81	1.50	PY800A	4.00	6AS7G	8.75	6S4T	3.00
EBF80	1.50	EN91	6.50	PY801	1.50	6AS7G	8.75	6S6T	2.75
EBF89	1.50	GZ32	4.00	PY801	1.50	6AUSGT	5.00	6SG7M	2.50
EC91	8.00	GZ33	4.75	QV02-6	38.00	6AU6	2.50	6SJ7	3.25
ECC33	4.50	GZ34	5.00	QV03-10	26.25	6AV8A	3.75	6SK7	3.50
ECC35	4.50	GZ37	4.75	QV03-20A		6B7	3.25	6SL7GT	3.00
ECC81	1.75	KT61	5.00	QV06-40A	48.38	6B8	3.25	6SN7GT	3.00
ECC82	1.75	KT66	15.00			6BA6	1.50	6SS7	2.75
ECC83	1.75	KT77 Gold Lion	12.00	QV03-12	6.80	6B4T	5.00	6UBA	2.25
ECC85	1.75			R18	3.00	6BE6	1.50	6V6GT	4.25
ECC88	3.50	KT88	15.00	R19	9.24	6BH6	2.50	6X4	3.00
ECC91	8.90	N78	15.00	R19	9.24	6BJ6	2.25	6X5GT	1.75
ECF80	1.50	OA2	3.25	SP41	6.00	6BN6	2.00	12AX7	1.75
ECH35	3.00	OB2	4.35	SP61	4.00	6B7A	3.50	12BA6	2.50
ECH42	3.50	OC3	2.50	U19	13.75	6BR7	6.00	12BE6	2.50
ECH81	3.00	OD3	2.50	U25	2.50	6BR8A	3.50	12BY7A	3.00
ECL80	1.50	PC86	2.50	U26	2.50	6BS7	6.00	12E1	20.00
ECL82	1.50	PC88	2.50	U37	12.00	6BW6	6.00	12HG7	4.50
ECL83	3.00	PC92	1.75	UAB30	1.25	6BW7	1.50	30L12	1.38
ECL96	1.75	PC97	1.75	UBF89	1.50	6BZ6	2.75	30P4	2.50
EF37A	5.00	PC900	1.75	UCH42	2.50	6C4	1.25	30P19	2.50
EF39	2.75	PCF80	2.00	UCH81	2.50	6C6	3.50	30PL13	1.80
EF41	3.50	PCF82	1.50	UCL82	1.75	6CB6A	2.50	30PL14	1.80
EF42	4.50	PCF86	2.50	UCL83	2.75	6CD6GA	5.00	372B	65.00
EF50	2.50	PCF81	2.50	UF89	2.00	6CL6	3.75	805	45.00
EF54	5.00	PCF82	2.50	UL41	5.00	6CH6	13.00	807	3.75
EF56	3.50	PCF85	1.70	UL84	1.75	6CWA	8.00	811A	18.33
EF80	1.75	PCF88	1.70	UY41	4.00	6D6	3.50	812A	65.00
EF86	5.00	PCH200	3.00	UY85	2.25	6DQ5	7.50	813	52.50
EF91	2.95	PCL82	2.00	VR105/30	2.50	6DQ6B	4.75	866A	35.00
EF92	6.37	PCL83	3.00	VR150/30	2.50	6E49	3.00	872A	20.00
EF183	2.00	PCL84	2.00	Z759	25.00	6E6	1.85	931A	18.50
EF184	2.00	PCL85	2.50	Z803U	25.00	6F6	3.00	2050	7.50
EH90	1.75	PCL86	2.50	ZD21	3.25	6GK6	2.75	5763	4.50
EL32	2.50	PCL805	2.50	ZB28	50.00	6H6	3.00	5814A	4.00
EL33	5.00	PD500	6.00	4C250B	58.00	6H56	3.77	5842	12.00
EL34	5.00	PE500	5.50	SPAGY	5.50	6J5	4.50	6980	14.00
EL36	2.50	PL36	2.50	U44G	3.00	6J6	8.93	6146A	12.00
EL80	25.00	PL81	1.75	5V4G	2.50	6J7	4.75	6146B	12.00
EL81	5.25	PL82	1.50	5Y3GT	2.50	6JB6A	6.50	6550	12.50
EL84	2.25								

Valved Communications Receivers

The Collins TCS

The compact size and rugged construction of the TCS made it suitable for use in motor vehicles (including tanks) and small vessels, where space was at a premium and vibration an ever-present hazard. Both main units are of the same size, 297 × 349 × 300mm (11.69 × 13.75 × 11.81in), and might be mounted side-by-side or one above the other. The transmitter weighs just under 23kg (50lb) and the receiver, with which we shall be concerned here, around 18kg (40lb). Both are housed in steel cabinets, whilst the chassis are of unitary construction based on die-cast main frames of immense strength. In military service, all power supplies were derived from external power supply units, including motor-generators for use with storage batteries, typically 12V vehicle types. For economy reasons, the sets used 12.6V heater valves throughout.

The frequency coverage of the TCS receiver is not as wide as that of many contemporaries, being 1.5-12MHz, but it is nevertheless very useful and provides excellent reception facilities for the lower amateur bands, and for general short wave listening up to the 11.7MHz (25m) band. The three ranges are well divided into 1.5-3MHz, 3-6MHz and 6-12MHz, with a clearly calibrated dial having a smoothly-gearred slow-motion drive. In addition to the direct frequency markings, there is a good vernier scale which operates in conjunction with divisions marked on the tuning knob. The latter has a locking device for use in mobile service, etc., when vibration may be troublesome.

General Description

The TCS receiver is a 7-valve superhet having one r.f. amplifier stage, mixer with separate oscillator, two i.f. amplifier stages, detector/a.g.c./b.f.o./a.f. amplifier, and power output stage. The r.f. amplifier, mixer and local oscillator valves, together with the tuning coil box and the main tuning capacitor, are mounted on a sub-chassis which takes up about two-thirds of the internal space of the receiver. This chassis also housed the relays used for switching power supplies, etc., during transmitter opera-

This month, Chas E. Miller looks at the Collins TCS, a compact transmitter and receiver assembly built for the US Government in the mid-1940s by the Collins Radio Company, of Cedar Rapids, Iowa, and the Stewart-Warner Corporation of Chicago, Illinois.

tion, but it is unlikely that any "civilianised" set will now retain these. The i.f. amplifiers, detector, etc., and the a.f. output stages each have their own small sub-chassis bolted to webs cast into the left-hand side of the frame. Most of the small components are mounted on strong tag-panels fitted below the small sub-chassis, or behind the larger one. The coil box and tuning capacitor are mounted transversely, one above the other, at the front of the receiver; all r.f. and oscillator adjustments are carried out through slots cast into the frame and cut into the front panel. The latter is of thick aluminium, and carries all the controls and the dial aperture.

The controls are, from top to bottom, left to right: b.f.o. on/off, power on/off; b.f.o. pitch, a.f. gain, tuning; r.f. gain/a.g.c. on/off, band switch. The r.f. gain control switches off the a.g.c. when it is turned back from its maximum setting, and the a.g.c. is also disabled when the b.f.o. is brought into operation. There was, in original receivers, a third knob set about centrally on the front panel which operated a switch selecting either normal free tuning or one of four crystal-controlled channels. This switch, too, is unlikely to have survived civilian ownership. All valve-holders are of the highest quality ceramic low-loss type.

The Circuit in Detail

The antenna input goes via the band-switch to one of the three primaries of r.f. transformers L201, L202, L203. Other sections of the switch connect the appropriate secondary winding to the tuning capacitor and simultaneously short out unused secondaries. Signals are passed via coupling capacitor C206 (100pF) to the control grid of the r.f. amplifier valve (V201, VT131/12SK7). Note—"VT" here is the old US military type code meaning "Vacuum Tube", not to be confused with the old British military type code, where it would indicate "Valve, Transmitting"—Ed. Shunt-fed a.g.c. is applied via R202 (100kΩ). Manual bias from the r.f. gain control is also applied via the cathode of V201 (and also that of the 1st i.f. amplifier valve). The screen grid is supplied from a fixed potential divider consisting of R231, R217 and R213, providing 62V (at 225V h.t. input). This voltage is also taken to the screen grid of the 1st i.f. amplifier. Amplified r.f. signals are coupled to the control grid of the mixer (V202, VT161/12SA7) via tapped tuning coils L204, L205, L206. A similar switching arrangement to that of the r.f. coils is used to select the desired inductor and to short out those not used. Capacitive coupling (C220, 100pF) and shunt-fed a.g.c. (R209, 100kΩ) are again employed to the control grid of the mixer, which in this particular valve is G3. The oscillator grid, G1, was originally taken to the manual/crystal tuning switch, but will now almost certainly be found to be coupled directly to the local oscillator V203. The valve chosen for this job is an extraordinary selection, being a VT134/12A6 output beam tetrode. It operates in a Hartley mode with three tapped coils selected as for the r.f. amplifier anode. The anode of the VT134/12A6 is taken directly to the h.t. line, whilst its screen grid is fed via a 4.7kΩ resistor. The output is taken from the cathode via C223 (100pF). Despite the unlikely choice of valve, the local oscillator works very well and appears to reach thermal stability in a commendably short time.

Grids 2 and 4 of the mixer are supplied with voltage via R205 (22kΩ)

Practical Wireless, July 1988

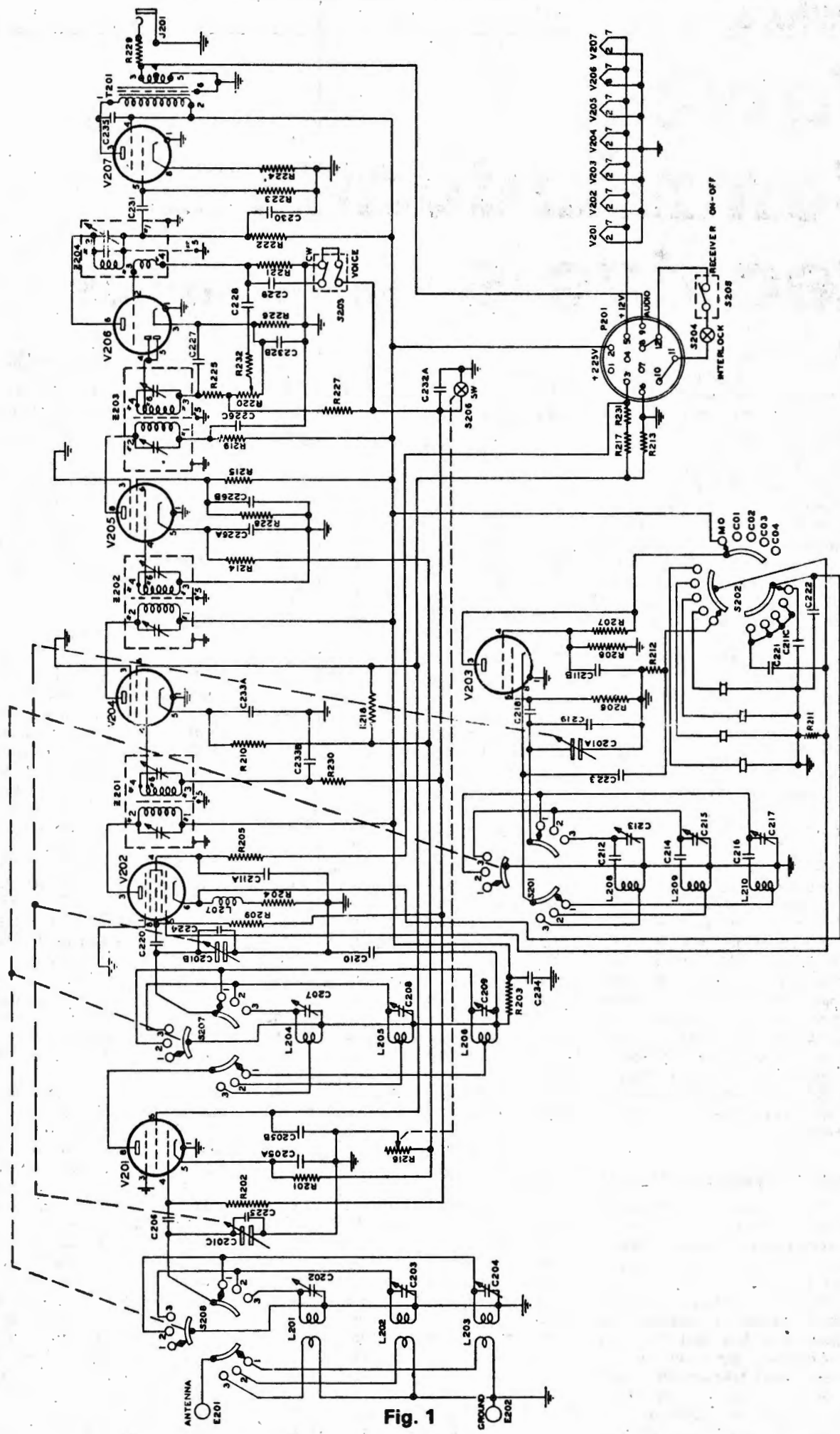

Fig. 1

and originally a muting switch opened when the transmitter was operated. The i.f. signals at 455kHz appearing at the anode are applied to the primary of the first i.f. transformer, and thence via a tapped secondary winding to the control grid of the 1st i.f. amplifier (V204, VT131/12SK7), with series-fed a.g.c. A similar second i.f. transformer passes the signals on to the 2nd i.f. amplifier (V205, VT131/12SK7), which is operated at fixed bias. This is a good arrangement, as the valve then acts as a virtual a.g.c. amplifier, and the a.g.c. action as a whole is enhanced. However, this worthy feature was negated by the use of a rather crude a.g.c. circuit in the next stage, as we shall see.

The third i.f. transformer has its tapped secondary connected to the strapped diodes of V206 (VT104/12SQ7), the resultant a.f. being filtered by C227 (200pF) and R225 (47kΩ) before being passed to the a.f. gain control, R220 (100kΩ). The negative voltage appearing at the junction of R225 and R220 is further filtered by R227 (1MΩ) and C232A (0.1μF), then used for a.g.c. purposes. In order to prevent the detector diodes from being biased (and having a "squelch" effect) the bottom end of the a.f. gain control is returned to the cathode, which is normally 1.1V above chassis. Thus the a.g.c. line is also biased positively in the absence of signals, which may enhance the r.f. and i.f. sensitivity a little, but is hardly to be recommended. At the same time, with the absence of a proper a.g.c. delay system, any signal producing over 1.1V will start to reduce the sensitivity, possibly too low a starting point for effective control combined with proper loading of the a.f. stages. It has to be remembered, of course, that the receiver was designed for military operation under conditions vastly different from those experienced in civilian general-purpose work.

The next unusual aspect of this part of the set is the way in which the b.f.o. works. Another coil set, which looks physically just like another i.f. transformer, is connected into the anode and grid circuits of the triode section of V206, in a "tuned anode, untuned grid" configuration. When the receiver is switched for normal unmodulated signal reception, the circuit remains stable and the two coils act more or less as r.f. chokes. The a.f. signals pass through the anode winding to its junction with R222 (220kΩ), the load resistor, and are passed via C231 (10nF) to the output stage. When the c.w. mode is selected an extra capacitor (C229, 2nF) is switched into the grid circuit, altering its impedance and triggering it into oscillation, producing an audible note on c.w. signals. It has to be noted that, as with so many of the military receivers described in this series, the purpose of the b.f.o. was simply to make Morse code signals audible, and was not connected with single-sideband work. In these circumstances it was felt that this particular

b.f.o. might not be effective for s.s.b., but happily this is not the case. Resolution is effected without undue difficulty, and long-term stability of the b.f.o. is good. The anode coil is provided with a tuning capacitor (the "pitch" control) and there is also an adjustable core to provide pre-setting of the oscillator frequency.

The output stage is conventional in design, employing another VT134/12A6 (V207) in its more accustomed role. The cathode bias resistor for this valve is un-bypassed, providing a degree of negative feedback at the grid. The maximum a.f. output is stated as 1.5W. At 1W the distortion is less than 5 per cent.

External Power Supply Requirements

The nominal h.t. voltage, as stated earlier, is 225V. The receiver will consume about 100mA under these conditions. It will operate successfully down to around 200V, the h.t. current being proportionately lower. The 1.t. voltage is 12.6V, with a drain of 1.15A. This voltage should be maintained within fairly close limits.

There is no loudspeaker built into the TCS; the power pack may conveniently be combined with a loudspeaker cabinet. For mobile work a surplus car-radio vibrator pack could be pressed into service for the h.t. supply, with the heaters fed directly from a 12V battery.

For the receiver which provided the basis for this article, a mains transformer from a redundant tape-recorder was used to provide 250-0-250V a.c. and 6.3V a.c. for an EZ81 rectifier. Smoothing was taken care of by a 32 + 32μF electrolytic capacitor and a small choke. An output of 225V was thus obtained after smoothing, and at full load. A separate small transformer was found which could deliver the heater voltage for the receiver valves. The whole unit fits comfortably into a cabinet that is roughly a 200mm (8in) cube, together with a 127mm (5in) round loudspeaker.

I.F. Alignment

Two types of i.f. transformer were fitted to the TCS as alternatives, one having iron-dust core adjustments, the other having trimming capacitors. Identification is simple; the core type has a single hole at the top of the can, the capacitor type two. Note that the core type may be fully adjusted from the top, access to the lower core being obtained concentrically through the top adjuster. **It is absolutely vital that a non-metallic screwdriver be used.** If such a tool is not available, it may be possible to use the alternative adjuster at the bottom of each can, but care must still be taken to avoid h.t. short circuits. The traditional thin plastics

knitting needle through the top is much to be preferred!

If only minor maladjustment is suspected, the signal generator may be connected to G3 of V202, but should there be serious errors it may be necessary to connect to the grid of the 2nd i.f. amplifier, then the 1st, and then back to the mixer. An output meter must be used; The AVO8 on its 1A a.c. range is suitable.

For capacitor-tuned i.f.t.s, inject 455kHz and tune each transformer for maximum on the meter, working back from the last. The procedure for the core-tuned i.f.t.s is rather more complicated. A 10kΩ damping resistor has to be connected across the secondary of the last i.f.t. whilst both cores are adjusted for maximum output on the meter. The damper is then transferred to the primary and the top core re-adjusted for maximum. This has then to be repeated for the other two i.f.t.s, working back to the first.

As ever, if a wobulator and oscilloscope are available, an actual display of the i.f. response curve is much to be preferred. Ideally, the curve should be 9kHz wide at 6dB down, 18kHz wide at 20dB down and 30kHz wide at 40dB down.

Radio Frequency Alignment

Remove the tuning chart from the front panel of the receiver (four captive screws) to obtain access to the trimmers and cores. Inject signals directly into the antenna socket and chassis, if the generator is provided with a dummy antenna output. If not, insert a 10Ω carbon resistor in series with a 100pF capacitor between the antenna socket and the generator lead. Use the output meter as before. Note that the r.f. trimmers and cores are fitted with locking nuts which must be released with a 2BA box spanner prior to adjustment.

Band 1: Tune receiver and generator to 1.5MHz and adjust L203, L206, L210 for maximum output. Retune to 3MHz and adjust C204, C209, C217. Repeat until no further improvement is possible.

Band 2: Adjust L202, L205, L209 at 3MHz. Adjust C203, C208, C215 at 6MHz. Repeat as necessary.

Band 3: Adjust L201, L204, L208 at 6MHz. Adjust C202, C207, C213 at 12MHz. Repeat as necessary.

Finally, re-lock all adjustments, taking care not to disturb the actual trimmers or cores in the process.

B.F.O. Pre-set Tuning: Tune to a station providing steady s.s.b. signals, such as RAF Volmet on 4.7MHz. Resolve this (if possible) with judicious use of the c.w. pitch, main tuning and r.f. gain controls. If the point of resolution is off the "pitch" scale, or indeed unattainable, set the knob to the centre-scale point and adjust the trimmer at the top of the b.f.o. can for maximum intelligibility.

Suggested Modifications

It is the stated aim of this series to discourage gratuitous modifications to vintage equipment, and to recommend alterations only when these will result in genuinely worthwhile improvements in performance and no detraction from the appearance of the receiver in question. It is considered that the foregoing apply to certain aspects of the TCS, especially the a.g.c. system, to which reference has already been made. Alteration to an effectively delayed system is easily achieved without a great deal of disturbance to the original circuitry, as follows.

1. Remove the strap from pins 4 and 5, V206. Ensure that the lead from the secondary of the third i.f. transformer goes only to pin 4.
2. Connect a 100pF capacitor from the anode terminal of the third i.f. transformer to pin 5. Connect an additional 1MΩ 0.25W resistor from pin 5 to chassis.
3. Disconnect R227 (1MΩ) from the junction to R225 (47kΩ) and R220 (a.f. gain control). Connect its free end to pin 5.
4. Disconnect R226 (2.2kΩ) from chassis and insert an additional 8.2kΩ 0.25W resistor between it and chassis.
5. Disconnect R221 (220kΩ) from chassis and take the free end to the junction of R226 and the new 8.2kΩ resistor.
6. Connect a new 25μF 12V capacitor across C232B (i.e., from V206 cathode to chassis).

The result of these changes will be that the cathode voltage of V206 will rise from 1.1V to 3.6V. Since the a.g.c. diode is returned to chassis via the new 1MΩ resistor, it will be biased to the 3.6V and will not conduct until signals providing in excess of that voltage are received. This represents an acceptable delay to the a.g.c. system. At the same time, the removal of R227 from the diode load circuit will improve the latter's performance. Because R221 is connected to the top of the new 8.2kΩ

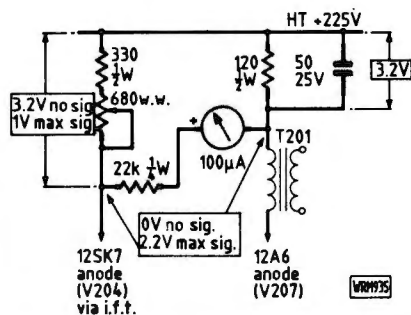

Fig. 2: Adding an S-meter to the Collins TCS receiver

resistor, the grid of V206 will continue to receive only the original 1.1V bias. The extra bias capacitor assists in reducing output to near zero when the volume control is at its minimum setting.

Extensive tests both with instruments and on actual signals indicate that a very significant improvement in the a.g.c. action is derived from this modification. If an S-meter is added (see later) the excellent stability of output level compared with fluctuation of signal strength is graphically displayed.

For certain types of reception it was felt that the automatic disablement of the a.g.c. when the b.f.o. was switched in was a disadvantage, and consequently this feature was removed by cutting the link from the a.g.c. line to the b.f.o. switch.

In the receiver used in the preparation of this article, the front panel has been cut at some time to accommodate a meter having a dial calibrated 1-5 and the legend "AVC Volts". However, it had not been connected into circuit in any way, doubtless because when tested it was found to be open-circuit! Rather than have a useless dial, or a blank hole, a replacement meter acting as S-meter was considered appropriate. The 100μA type used was marginally larger in girth than the one it replaced, necessitating the filing out of the hole. The hard work involved in gaining an extra fraction of an inch

commanded respect for the person who had hacked out the original aperture, but at the same time invoked great wonder as to why, after all that effort, he had not completed the job!

The type of S-meter circuit used was that described in the "Versatile Valve Monitor and S-meter" article which appeared in the May, 1986 issue of *Practical Wireless*, so only the general outline will be discussed here. For the reference voltage, a 120Ω resistor was inserted into the h.t. feed to the output transformer, producing 3.2V under no-signal conditions. This was found to alter very little even at full volume on a strong station. The anode current of the 1st i.f. amplifier was measured at 4.7mA with no signal, indicating that a series resistor of 680Ω would produce a similar 3.2V drop. By one of those (very occasional) fortunate coincidences, a 680Ω potentiometer came at once to hand, and was put into service with a 330Ω series resistor to allow some leeway on the adjustment. The hole in the front panel sometime occupied by the oscillator switch had been filled by the fitting of an unconnected potentiometer (presumably by the meter man), which was ripe for removal in favour of the 680Ω potentiometer as meter-zeroing control. The strongest signal to be found reduced the anode current to 1.5mA, and thus the drop across the potentiometer to 1.2V, making a differential of 2.2V across the bridge (see Fig. 2) from zero to maximum signal. Thus a 22kΩ resistor in series with the 100μA meter gave it a 2.2V f.s.d. and the ability to indicate all expected signal strengths with some accuracy. As mentioned earlier, it is fascinating to watch just how much variation there can be on the dial without serious alteration to the output of the loudspeaker.

Finally, as a tribute to the reliability of the TCS, in this particular example, which is now some 40 years old, only one faulty component (a leaky capacitor) was discovered whilst it was being restored to useful service—a truly enviable record. **PW**

Short Wave
Magazine

Short Wave
Magazine

THE SHUTTLE & NOAA-11

When Peter Rouse was in the USA recently he visited NASA and came away with the latest on the progress of the Shuttle programme and weather satellite NOAA - 11.

TRADING POST

This new feature allows readers to advertise their Sales & Wants.

REGULARS

Airband, Scanning, Seen & Heard, Grassroots, What Receiver?

.....JUNE ISSUE OUT NOW.....JUNE ISSUE OUT NOW.....

Constructional

The accurate measurement of r.f. power is very important to anyone who operates transmitters, whether he or she be an amateur with an experimental interest or a broadcaster with a professional involvement. This versatile design by Robert and David Crone should easily meet most requirements.

PW "Portland" Radio Frequency Voltmeter

Nowadays, the 50ohm standard is almost universally in use—transmitters are matched into 50Ω antennas via lengths of 50Ω coaxial cable—so to determine the power in our system all we have to do is to measure the voltage at the required point and work out the power from the very simple formula:

$$P = \frac{V^2}{50}$$

Obviously a voltage of 7.1V corresponds to a power of 1 watt. Power levels below this value are generally regarded as "low power" and are usually measured directly on a voltmeter, i.e., the antenna cable is disconnected and fed to a voltmeter which is designed to have a 50Ω input impedance. Powers greater than a watt are usually measured by means of a directional coupler and a voltmeter. The directional coupler taps a known fraction of the power out of the system and feeds it to the voltmeter. The 20dB coupler is very popular for this purpose because the calculations are easy—one hundredth of the power or one tenth of the voltage.

Diode Detectors

The diode detector is widely used to measure r.f. voltages and the characteristic curve of a typical r.f. diode is shown in Fig. 1. Note that the diode just starts to conduct at around 0.2V. In Fig. 2, the diode is shown connected up in a real circuit and with an applied r.f. voltage of 1V r.m.s. or 1.4V peak at point A. At point B, the r.f. has been clamped to -0.2V by the action of the

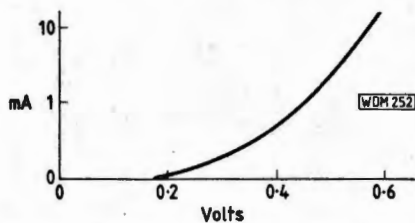
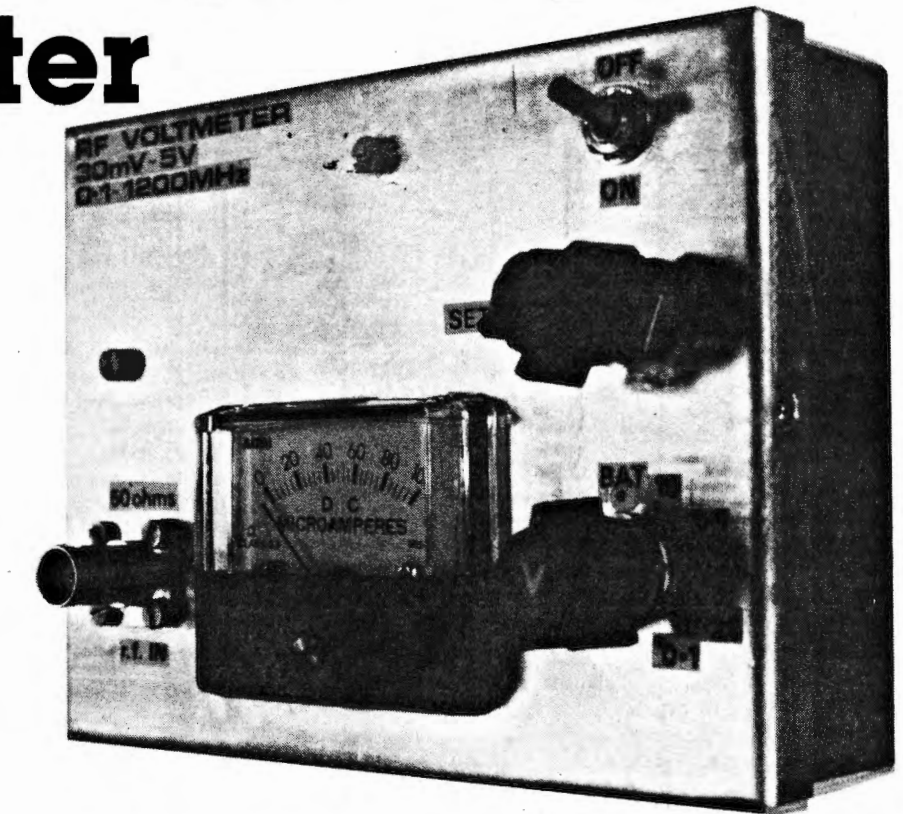

Fig. 1: Characteristic curve of typical r.f. diode



diode, adding a d.c. component to the signal. At point C, the r.f. has been filtered out leaving a d.c. of 1.2V, and the circuit is clearly a peak voltage detector.

The thoughtful reader will note that 0.2V of the incoming waveform has been wasted in the forward voltage drop across the diode, thus an incoming voltage of less than 0.2V peak value will not switch on the diode at all, and there will be no detected output at point C. What we have to do is to apply a permanent forward bias to the diode, which is derived from the -5V stabilised supply rail via resistor R2 (see

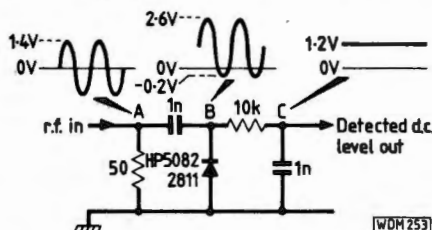

Fig. 2: Simple but inefficient r.f. detector circuit

Fig. 7). Only a very small bias current is required for the HP5082-2811. The no-signal standing bias of -0.2V might appear to be a problem, but it is easily offset or nulled out in the following op-amp buffer stage.

RF Head

The circuitry contained within the broken-line box on Fig. 7 is known as the detector head, and all the components in it are built around a 4-hole fixing, 50Ω BNC panel socket (e.g. Greenpar type GE35007H). The 50Ω input match is very important, and the load R1 is constructed as follows.

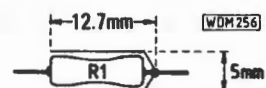

Fig. 3: Shows dimensions of copper tubing used to screen input load resistor R1

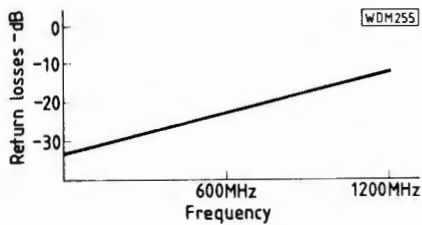

Fig. 4

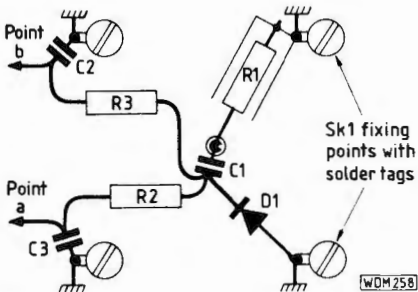

Fig. 5

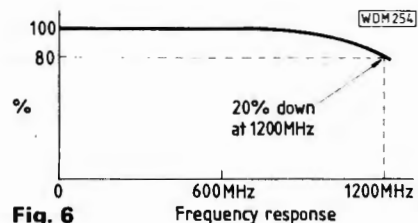

Fig. 6

Obtain some 5mm ($\frac{3}{16}$ in) outside diameter model makers' copper tubing and a 51Ω 2% $\frac{1}{2}$ W metal oxide resistor. Cut exactly a 12.7mm ($\frac{1}{2}$ in) length of tubing and insert the 51Ω resistor into it, then with pliers carefully crimp one end of the tube and trap the resistor lead. Solder the lead to the crimped tube, as shown in Fig. 3.

On its own, this very simple load gives a surprisingly good match, ranging from 34dB return loss (2 per cent reflection) at 100MHz to around 26dB (5 per cent reflection) at 1200MHz (Fig. 4). The next step is to drill the holes for the BNC connector and bolt it to the meter box, remembering to include a solder tag under each of the fixing nuts. The first solder tag is used to earth the tubing of R1, the second one earths one end of diode D1, the third holds disc ceramic capacitor C2, and the fourth holds disc ceramic C3. Capacitor C1 is soldered directly on to the pin of the BNC connector. This should be made clear by Fig. 5.

As one would expect, the self-capacitance of D1 affects the input match, and Fig. 4 shows how the match gradually deteriorates from about 32dB return loss at 100MHz to around 14dB (20 per cent reflection) at 1200MHz. We have now finished the most difficult part of the project and the rest is plain sailing. The measured frequency response of the prototype is shown in Fig. 6.

Internal view of authors' prototype
Practical Wireless, July 1988

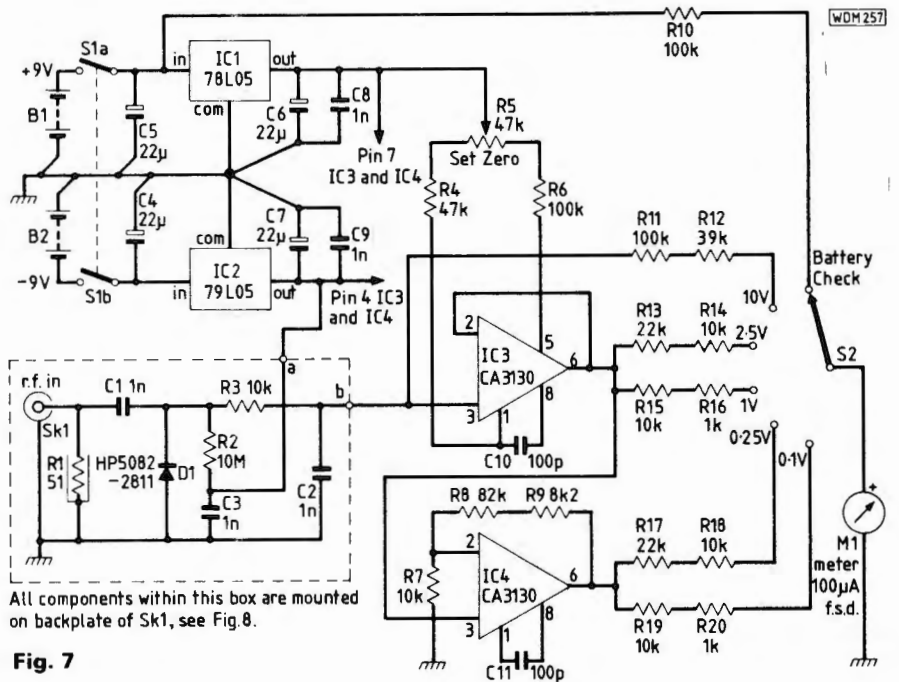

Fig. 7

Fig. 4: The graph shows a gradually deteriorating input mismatch caused by the self capacitance of D1

Fig. 5: Constructional details of off-board r.f. detector, built around standard 50Ω BNC type socket

Fig. 6: Graphic representation of the prototype detector's frequency response showing a 20% drop in output at 1200MHz

Fig. 7: Circuit diagram of r.f. voltmeter

Meter Circuit

The meter driver circuit forms the right-hand half of Fig. 7. Note that the multiplier resistors for the meter are made up of the nearest combination of standard values and take into account the internal resistance of the meter. Remember that the detector responds to the peak value of the input signal, and the multiplier values are selected to make the meter read r.m.s. (for a sine wave signal). The 10V range is

unbuffered as the diode bias of -0.16 V is negligible here.

The CA3130 is used because of its low current consumption. The upper amplifier, IC3, is a simple unity-gain buffer driving the 2.5V and 1V ranges, and the lower amplifier, IC4, has a gain of 10 and drives the two lower ranges. You will find that the meter reads true down to 30mV, below this value the linearity starts to deteriorate and an input voltage of 20mV r.m.s. will only produce a meter reading of 12. Diode

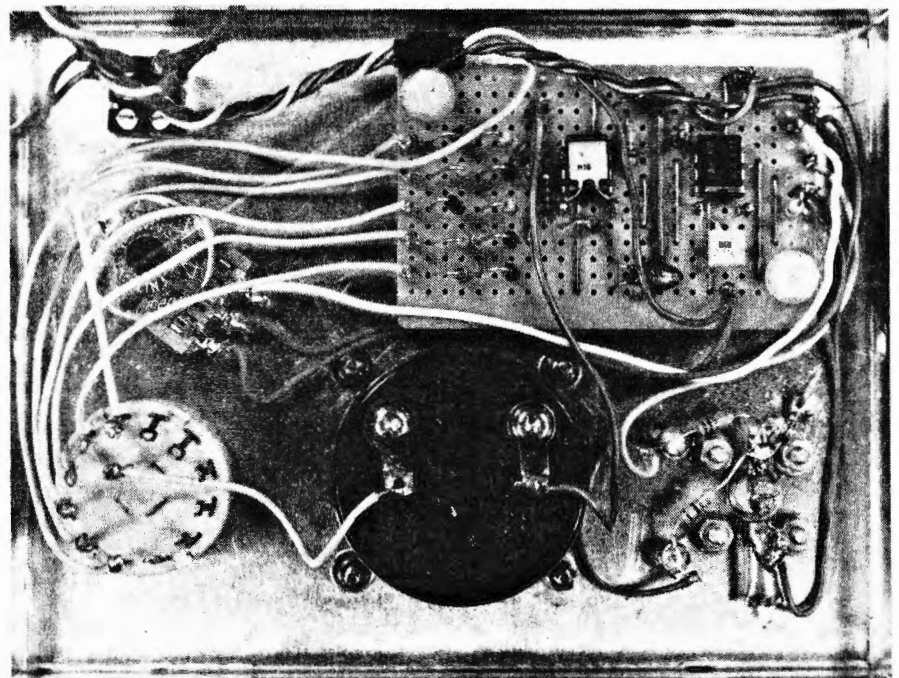

temperature drift of about 1mV per degree celsius is just noticeable on the 100mV range, this may be corrected with the SET ZERO control.

Balanced, stabilised supply rails are required for the two op-amps. These are produced from two 9V batteries by two 3-terminal regulators, IC1 for the +5V rail and IC2 for the -5V rail (see Fig. 7).

Finally, going back to the meter circuit, why not provide more amplification and add on a 25mV and a 10mV range? One can in fact do this, but two problems crop up. The first is diode temperature drift, and the second is non-linearity between the input r.f. voltage and the meter reading. The first of these may be solved by using an additional 2811 diode as a temperature sensor, and the second by constructing simple non-linearity correctors made up of op-amps and diodes. Steam radio really, but a lot of it. Hopefully it may be described in a future article. **PW**

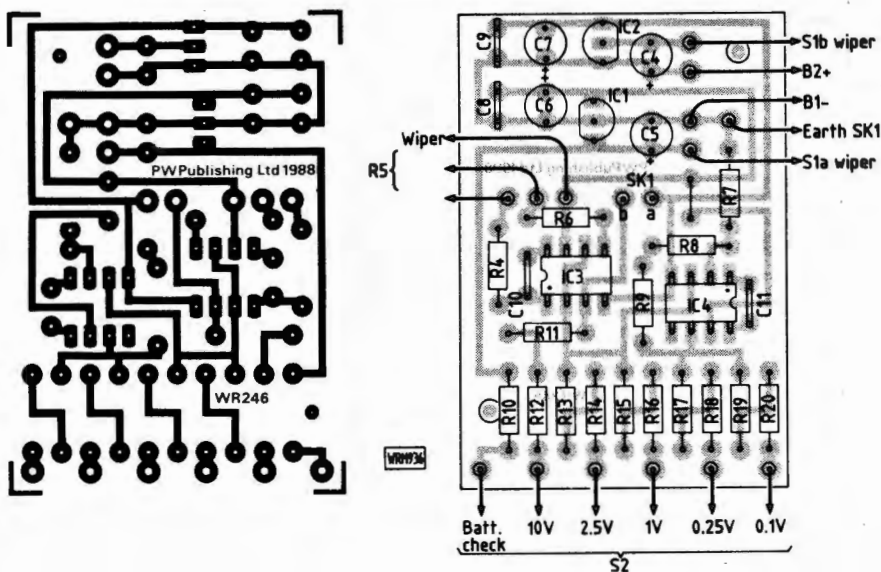
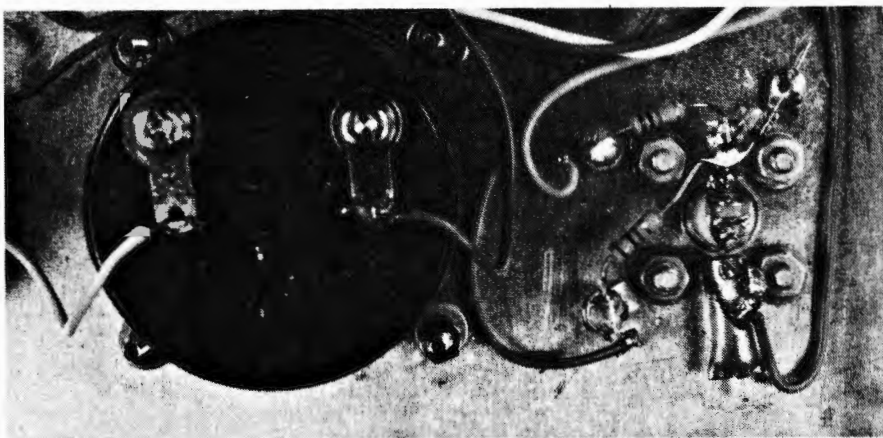

Fig. 8: Full size single-sided track pattern and component placement diagram of r.f. voltmeter

Internal close-up view of SK1 showing load resistor R1 and diode D1



SHOPPING LIST

Resistors

0.25W 1% Metal film

1kΩ	2	R16, 20
8.2kΩ	1	R9
10kΩ	6	R3, 7, 14, 15, 18, 19
22kΩ	2	R13, 17
39kΩ	1	R12
47kΩ	1	R4
82kΩ	1	R8
100kΩ	3	R6, 10, 11
10MΩ	1	R2

0.5W 2% Metal oxide TR5 type

51Ω	1	R1 ⁽⁵⁾
-----	---	-------------------

Midget linear potentiometer

47kΩ	1	R5
------	---	----

Capacitors

Monolithic ceramic

1nF	2	C8, 9
-----	---	-------

Leadless ceramic

1nF	3	C1-3 ⁽⁴⁾
-----	---	---------------------

Sub miniature plate ceramic

100pF	2	C10, 11
-------	---	---------

Solid tantalum bead 16V

22μF	4	C4-7
------	---	------

Semiconductors

Diode

HP5082-2811 (RS. No. 271-729) ⁽¹⁾	1	D1
--	---	----

Integrated circuits

CA3130	2	IC3, 4
78L05	1	IC1
79L05	1	IC2

Miscellaneous

M1 100μA f.s.d. 3kΩ internal resistance⁽²⁾; S1 sub-miniature d.p.d.t. toggle switch; S2 1-pole 6-way rotary switch; BNC square chassis socket; 6-F22 (PP3) battery connectors (2); 6-F22 type batteries (2); Control

knobs (2); p.c.b.; A48 type two-part aluminium project box⁽³⁾; Connecting wire; 5mm ($\frac{1}{16}$ in) o.d. copper or brass tubing; 6BA nuts, bolt, washers and solder tags.

(1) RS Electromail, PO Box 33, Corby, Northants NN17 9EL. Tel: 0536 204555

(2) T.K. Electronics, 13 Boston Road, London W7 3SJ

(3) Minffordd Engineering, Sun Street, Ffestiniog, Gwynedd. Tel: 076-676 2572

(4) Cirkit Distribution Ltd, Park Lane, Broxbourne, Herts EN10 7NQ. Tel: (0992) 444111

(5) Greenweld Electronics Ltd, 443 Millbrook Road, Southampton SO1 0HX. Tel: (0703) 772501

**How Much?
&
How Difficult?**

£22

Intermediate

Apartment HF TX Antennas

Part 1

Imagine you've got a full amateur licence, or maybe you're studying like mad to get one, and for some reason you have to move into, or you're already living in, an apartment or flat.

You cannot or must not erect or dangle any form of outdoor antenna, and there's no loft or attic. Looks grim doesn't it? On the surface of things it looks like you're all finished with this hobby, maybe even before you got started.

So what are your options? Trade in the licence! Flog the gear! All hope has gone! You have now joined many many others in your despair. Unfortunately, an ever increasing number of amateur or potential amateurs are faced with this problem. Take heart, because believe it or not, there are lots of ways to overcome problems of this nature and some real fun can be had in the process. So read on!

Necessity is the Mother . . .

Twenty-five years ago, or more, it so happened that for occupational reasons I had to move QTH quite often, in fact all around the UK and the USA. It meant that I was living for the most part out of apartments and flats, invariably there were no outdoor antennas, no attics or lofts.

Despite all this, transmitting was continued on the h.f. bands and eventually techniques were evolved using "in-room" transmitting antennas, which the textbooks and "experts" said were just not on.

A set of essential rules and design ethics were cooked up to get maximum radiation from "in-room" antennas into the great wide world outside. That is after a shaky start. These days, TX power is limited by choice to 10/15

Living in modern accommodation and having a hobby like amateur radio is not really conducive to a harmonious existence with either neighbours or local planning authorities. If you've already fallen foul of both, then this article by Richard Q Marris G2BZQ could be just what you're looking for.

watts of c.w., which is more than enough to allow me to carry on researching "in-room" compacted antennas. These antennas are often of a somewhat sacrilegious profile and design, in the always-held belief that the simplest answer to a not-so-simple problem, is invariably the best. Maybe that's what amateur radio should be all about again; whatever the difficulties are, an answer can and must be found. It's a lot of fun trying, anyway.

Food for Thought

Before examining further the ins and outs of this topic, it is perhaps pertinent to look at three contrasting, personally experienced, transmitting situations and lessons that can be learned from them:

1. Kilowatts in the sky. Once upon a time instructions were received to proceed to a trans-world h.f. beam station, in the back of beyond. The station was reputed to have 25 kilowatts of c.w.

power at its disposal. This was fed into an enormous antenna, supported by several huge girder masts; each several hundreds of feet high, the tops of which were usually obscured by low cloud.

From a technical viewpoint it was extremely impressive, but from an operational one it was incredibly boring. Obviously not an amateur inspired design.

2. Things that go "Bump-in-the-Night". While living, working and operating in the USA for a number of years. I had the good fortune to meet a fellow radio amateur, living as it happened, not more than a 30 metres away from me in the same apartment complex—absolutely no outdoor antennas, or TVI type complex!

This guy had cooked up a sort of "in-room", outdoor antenna system. It consisted of a mobile whip (with 15/20/80 metre loading coils) poked horizontally out of a very large metal frame window, in the dead of night, or during snowstorms or blizzards, which were a regular winter event.

A sort of horizontal whip with a vertical window frame groundplane. The radiation pattern was anybody's guess! The whip was painted matt black and was completely invisible from the ground in spite of high security illumination surrounding the building.

This antenna was borrowed, poked out of the window of the 1st-floor apartment, and fastened to the window frame with its home constructed fixing/clamping wizardry. The first QSO, using about 12 watts of c.w., had a QRB of nearly 9000km, and this was from a first floor apartment remember. The one just above ground level. Maybe tower block radio amateurs might like to ponder on this a while?

3. Indoor QRP—versus—outdoor QRO tests. Over the winter of 1986/1987 tests were conducted on 80 metres c.w. with a very experienced DK in Stuttgart, between 0500/0600GMT. The set-ups were: The writer used 10 watts and 2 alternative "in-room" antennas. The DK used 100 watts and a high outdoor dipole.

Some days, one or other gave a RST 599 report, and some days signals were very weak and barely audible. That is pre-dawn 80 metres. A point of interest is that if one party was receiving loud and clear then the other party was receiving much weaker signals and vice versa.

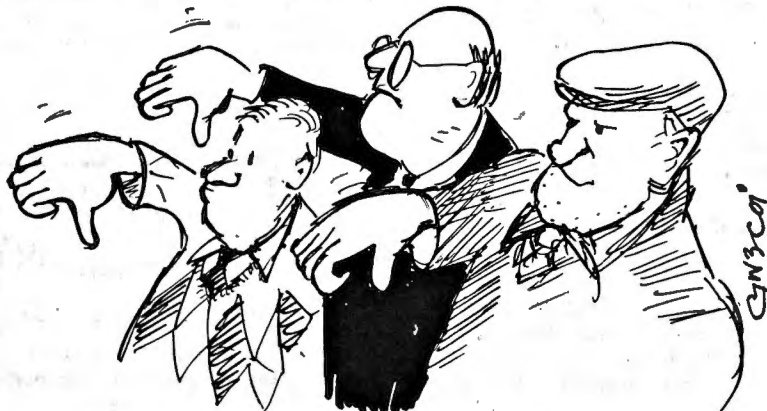

"... EXPERTS SAID WERE JUST NOT ON . . ."

The real point of interest is the average of the two way RST reports over 22 QSOs:

Average RST SENT was 559!

Average RST RECEIVED was 459!

These figures are very, very close, even with completely diverse power and antenna systems.

It Makes You Think!

Again some years ago, in the USA, a quantity of underhand tests were made on 20 metres. A transceiver was being used with an "in-room" antenna. The TX power was throttled back to 100 watts. There was also a 10 watt transmitter available and with suitable switching, the two transmitters were alternated between, without informing the party on the receiving end. It may seem strange that no comment on signal strength change was received, even when asking for a new RST late in the QSOs. Again, it makes you think! The definition of an "in-room" transmitting amateur, is a person who for family, personal economic or occupational reasons, has to move into an apartment. Which according to the dictionary means "a suite of rooms forming a complete dwelling". Which also of course describes a flat.

It is assumed that this radio amateur is unable, or probably not allowed, to erect an outdoor antenna and does not have access to a loft, attic, or rooms above living room level. This situation, in fact, covers a rapidly increasing number of radio amateurs and short-wave listeners.

Some Golden Rules

These are rules which should be observed, as far as possible, when moving into a "no outdoor antenna" residence:

1. Survey the residence to locate all visible and invisible wiring, pipes and structural metalwork, including metal window frames, etc.

2. Carefully measure the dimensions of the room that will house your transmitting gear, not forgetting the diagonal corner to corner measurement. Using this information draw a simple map and plot the locations of the items listed in rule one.
3. Decide where the transmitter will be located on your plan of the room. A corner would be preferable.
4. Concentrate on one band to start with, until you get the absolute best out of the installation on the band chosen.
5. Bear in mind that the higher the band chosen, the smaller the antenna, and the easiest to accommodate. Unfortunately the higher the band the more chance there is of causing TVI problems, and the lower the band used then the larger and more difficult the antenna installation becomes.
6. If an a.t.u. is necessary, use a separate tailor-made unit for each band. This means you can optimise each antenna and its matching unit, making for easy band changing and as few compromises as possible. The object is to get every last milliwatt of

power "up the spout" and into the world outside.

7. Try to stick to c.w. (no, this is not a c.w. versus s.s.b. morality point), because of its communications efficiency you are more likely to get contacts much further afield by using low power c.w. than s.s.b. of the same power. The lower the power used, the less chance there is of causing TVI.

8. When low power c.w. is used, you will have to adopt the following operating procedure; using your receiver, study the band in question at the anticipated time of operation, and note the regular and frequent band areas of QRM. Avoid band edges and the usual multitude of amateurs calling for DX, and if there's an East European contest in progress, move h.f. in the band, where the "CQ Test" stations are thinner on the ground, or in the air!

9. Contrary to what is often written and advocated, avoid long lengths of wire pinned to walls, wandering from room to room. These pick up man-made interference galore on receive, and conversely, due to their close proximity to mains wiring and other services, they will increase your chances of causing TVI. In addition to the mains wiring, girders, water pipes, etc., will all soak up that precious r.f. you are trying to radiate into the world outside.

10. Avoid the temptation to push out more and more power, in an attempt to increase the distance worked. It will certainly increase your TVI potential and probably not much else. Concentrate on the antenna! Remember the object after all is to get as much power out of the building, and the less r.f. power used in the process, the better.

Advantages

Your "in-room" antenna is always to hand, it can be pruned on the spot and in situ. If the antenna isn't performing as expected it can quickly be replaced by Mk2, Mk3 or even Mk4, etc. With this kind of antenna installa-



"TWO TRANSMITTERS . . . WITH SUITABLE SWITCHING . . ."

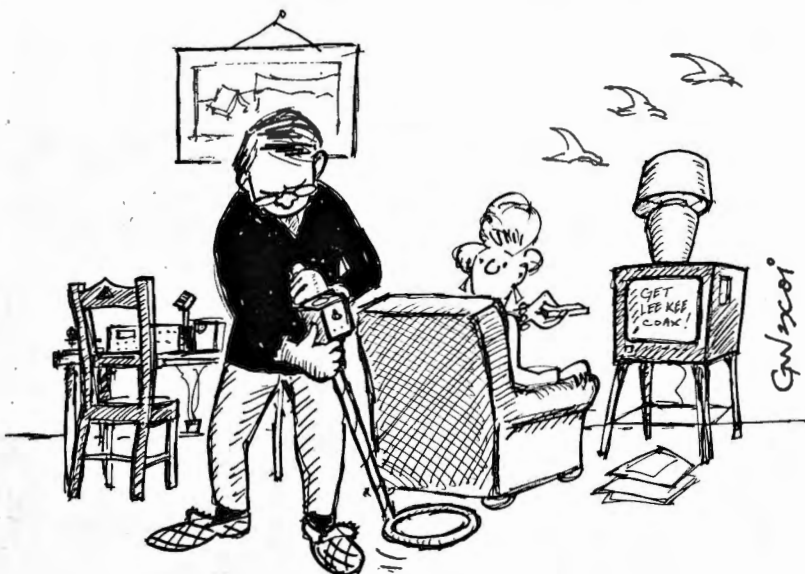

"LOCATE . . . ALL INVISIBLE WIRING . . ."

ALINCO - THE NAME THAT MEANS VALUE!

FM MICRO HANDHELD

- ★ 3 Watts FM
- ★ Memory Channel
- ★ Battery Save
- ★ Smallest in World

£189!

ALX-2E



The ALX-2E is a truly pocket transceiver. Capable of 3 watts output it covers the full 140-150MHz using the familiar thumbwheel dial. Features include memory channel, scanning, priority, battery saver, tone-burst, 600kHz shift etc. Supplied complete with nicad pack, AC charger, 12v DC charger, and helical. Accessories available include case, car cigar adaptor, headphone/mic, various batt. packs etc.

ALD-24E

DUAL BANDER

- ★ 2M/70cm
- ★ 25 Watts
- ★ Full Duplex
- ★ Built-in Diplexer/Dual VFO
- ★ Small size/21 memories

£449!

What can you say about this transceiver other than praise? The new ALINCO ALD-24E has brought the cost of dual banders down to a price that makes it a serious option to the 2 metre only rig. Just think of the pleasure of being able to select 2m or 70cm at the press of a button. No aerial switching (duplexer built in) and full duplex operation. The ALINCO actually has two completely separate transceivers built into its small case measuring 5.5" x 2" x 6.5". It has all the features of the ALR-22E (see below) at a huge saving over its competitors. We could mention the optional extended receiver coverage of 138-174MHz & 420-454MHz at no extra charge, but then everybody would want one! So we thought that we'd simply invite you to send for the full colour brochure instead.

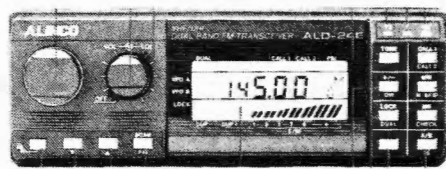

ALR-22E 2M FM MOBILE



THE RADIO COSTS £249

THE SCANNER COMES FREE!

- ★ 25 Watts FM
- ★ 21 Memories
- ★ Rx 138-174MHz
- ★ Mini-size

ALINCO products are hitting the market in a big way. And the ALR-22E must rank as today's best buy. When you buy the ALR-22E you don't just purchase a 2 metre mobile, you purchase a vhf scanner as well. For no extra cost we will extend the frequency coverage to 138-174MHz on request. All this for a price that puts the competition in the shade! Features include 21 memory channels, programmable scan, priority channel options, programmable splits, reverse repeater button, dual speed scanning, optional delay, back-lighted LCD display, dual vfo, lithium battery back-up, 25/12.5kHz steps, mini size measuring 5.5" x 1.5" x 6.5", up/down microphone control, quick release mobile bracket plus mounting hardware, superb sensitivity, 5 watt low power position, manual or electronic tuning, 12 months parts and labour warranty etc. With a specification like this we suggest you phone for colour brochure, today.

BOOKS BOOKS BOOKS!

HF OCEANIC AIRBAND COMMUNICATIONS
Published December, 1987

Tune into the exciting World of long distance airband communications. Hear aircraft navigating the world's oceans; air and sea rescue in action; flight crews talking back to base; instant weather broadcasts from all corners of the world. It's exciting, and this book will tell you exactly where and when it all happens.
£3.50 plus 80p post.

UK LISTENERS CONFIDENTIAL FREQUENCY LIST
New 5th edition. Available April 1988

Everything you have ever wanted to know about the short wave services. Who uses them, their frequencies, call signs and times. It's all in this book. 150 pages and some 7,000 entries plus editorial covering aerials, receivers, RTTY, FAX, TOR etc. A genuine UK publication based on the very latest information and monitoring. **NOT AN AMERICAN COPY!** Includes civil & military aircraft, press and meteo., embassies, maritime, emergency, broadcast, weather, beacons etc. Available April 1988. **£6.95 plus £1 postage.**

HF AERIALS AND ROTATORS

C4 6-10-15-20m Mini vertical89.00
CP5 5 band vertical + radials189.00
CP4 4 band vertical + rigid radials149.00
CP3 6/10/15m vertical + radials49.00
MM3 Minimax 3 el minibeam325.00
TB3MK3 3 band 3 el 2kW315.00
TB2MK3 3 band 2 el 2kW210.00
TB1MK3 3 band 1 el 2kW105.00
VR3 3 band vertical 1kW73.00
EL40X Sagant 70ft 80/40m dipole +balun	59.95
MT240X Sagant 70ft 80-10m dipole system	78.00
BL40X 1 : 1 50 Ohm balun 1kW	19.50
G-400S Yaesu rotator for hf beams	139.00
G-400RC As above but with round controller	169.00
GC038 Lower mast clamps for "400" series	16.95
GS065 Alignment bearing for 2" masts	29.95
AR 200XL Lightweight rotator for medium VHF	49.95

NEW! 50-1300MHz

CLP 5130-1 50-130Hz

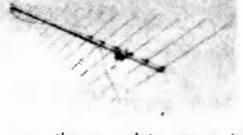

CLP 5130-2 105-1300Hz

These antennas cover the complete range to 1300MHz with a VSWR better than 2:1. They can be mounted vertically or horizontally with the hardware provided. And with a power handling capability of 500 watts they are equally at home transmitting or receiving. Forward gain up to 12dBi & 13dBi and front to back ratios of 15dB are achieved respectively. Model 1 £179.00. Model 2 £89.00. Carriage £3.00.

THE COMPLETE GUIDE TO VHF/UHF FREQUENCIES

Covering the range 26 to 47000MHz, this new edition provides full details of frequencies used within the UK. Covering emergency services, aviation, marine, PMR, beacons and repeaters, weather, space etc. The pages are full of all the information that you need in order to operate your scanning receiver. 90 pages crammed with frequencies, both simplex and duplex, plus editorial on all that you should know about VHF/UHF monitoring. **£5.95 plus £1 post.**

VHF/UHF AIRBAND FREQUENCY GUIDE

A complete list of all the aviation frequencies for both the military and the civil services. Frequencies are listed under airport/airfield headings and includes details of airways and company frequencies. Also supplied with the book is a list of all the recent changes to UHF and VHF frequencies that have taken place. Includes editorial and photographs etc. A must for the aircraft enthusiast. **£5.95 plus £1 post.**

HF & VHF RECEIVERS

R-2000 Trio receiver & VHF option595.00
R-5000 Trio deluxe receiver875.00
ICF7600DS Sony rx AM/SSB/CW to 30MHz169.00
ICF7600DA Analogue version of above159.00
ICF2001D 150kHz-30MHz rx + Air-band329.00
ICFSW1S Micro HF receiver kit249.00
ICFPRO-80 150kHz-225MHz portable all mode329.00
FRG8800 Yaesu 150kHz to 30MHz639.00
IC-R71 Icom hf receiver825.00
HF125 Lowe hf receiver375.00
WIN 108 Airband scanner 108-136MHz175.00
SONY AIR-7 Monitor 108-174MHz + AM/FM249.00
SONY PRO-80 As above but 150KHz-225MHz329.00
R537S Tunable plus 2 xtal positions69.50
R535 VHF/UHF Airband Monitor249.00
LCBP Nicad pack & case42.75
R7000 ICOM All-mode rx 25MHz-2gHz957.00
AOR2002 25-550/800-1300MHz scanner487.00
AOR2001 25-550MHz scanner325.00
IF323C Computer interface for 2002255.00
MB2001 Mobile mount for 2001/200211.50
SONY-AIR-7 108-174MHz + AM/FM249.00
SONY PRO-80 150KHz-225MHz handheld329.00
FRG9600m 60-950MHz 12v DC509.00

SEE US AT NEC!

We'll be taking huge stocks and have some very special offers! Come early and look at our s/h gear.

We'll have all the latest products and some new items.

NEW NEW!

Diamond base station aerial 2m & 70cm with huge gain and fibre glass encapsulation. 8.3dB & 11.7dB! Phone for details.

THE SECRET OF LEARNING MORSE CODE

Here's a book that takes the problem of learning Morse by the scruff of the neck and exposes the myths and mysteries that surround this most valuable skill. The author, Mark Francis, takes you simply but thoroughly through the whole learning process and shows that with his method you will quickly be able to read Morse code. Long overdue, the book is written in a non technical language which makes it a joy to read. Mark Francis covers all aspects of the subject and provides some very valuable tips on the best ways to learn and improve your code. And once you have learnt the code you can test yourself with the sample tests at the back of the book. There is even a chapter that tell you exactly what you should expect when you take your seat in the examination room for your RAE Morse test. As one readers said, "it's the most comprehensive book available on the subject today." **£4.95 plus £1 post.**



RETAIL & MAIL ORDER:- 18-20, Main Road, Hockley, Essex SS5 4QS.
Tel: (0702) 206835, 204965

RETAIL ONLY:- 12, North Street, Hornchurch, Essex RM11 1QX.
Tel: (04024) 44765

Visa and Access by telephone. 24hr. Answerphone.

BOOK SERVICE

The books listed have been selected as being of special interest to our readers. They are supplied from our editorial address direct to your door. Some titles are overseas in origin.

HOW TO ORDER

Add 75p per order postage (overseas readers add £1.50 for surface mail postage) and send a postal order, cheque or international money order with your order (quoting book titles and quantities) to **PW Publishing Limited, FREEPOST, Enefco House, The Quay, Poole, Dorset BH15 1PP**. Payment by Access, Mastercard, Eurocard or Visa also accepted on telephone orders to Poole (0202) 678558. Books normally despatched by return of post but please allow 28 days for delivery.

★ A recent addition to our Book Service. O/P = Out of print, O/S = Out of stock.

RADIO

★ AIR & METEO CODE MANUAL

Joerg Klingenfuss
Contains detailed description of the World Meteorological Organisation Global Telecommunication System operating FAX and RTTY meteo stations, and of its message format with decoding examples. Also contains detailed description of the Aeronautical Fixed Telecommunication Network amongst others. 289 pages £14.00

BETTER RADIO/TV RECEPTION

A. Nallawalla, A. T. Cushen and B. D. Clark
An Australian publication giving guidance and advice both to listeners seeking reliable reception of some distant radio station, and to DX listening hobbyists. 134 pages £9.95

BETTER SHORTWAVE RECEPTION (USA)

W. S. Orr W6SAI & S. D. Cowan W2LX
Receivers, antennas, propagation, DX listening techniques for the short waves and v.h.f. 158 pages £5.50

RECEIVING STATION LOGBOOK (RSGB)

Standard logbook for the s.w.l. in horizontal A4 format. 32 lines per page. 50 pages O/S

SCANNERS

Peter Rouse GU1DKD

A guide for users of scanning receivers, covering hardware, antennas, accessories, frequency allocations and operating procedure. 177 pages £7.95

SCANNERS 2

Peter Rouse GU1DKD

The companion to Scanners, this provides even more information on the use of v.h.f. and u.h.f. communications band and gives constructional details for accessories to improve the performance of scanning equipment. 216 pages £9.95

★ SHORT WAVE RADIO LISTENERS' HANDBOOK

Arthur Miller

In easy-to-read and non-technical language, the author guides the reader through the mysteries of amateur, broadcast and CB transmissions. 207 pages £6.99

★ RADIOTELETYPE CODE MANUAL

10th Edition

Joerg Klingenfuss

This book provides detailed descriptions of the characteristics of telegraph transmission on short waves, with all commercial modulation types including voice frequency telephony. It provides comprehensive information on all RTTY systems and c.w. alphabets. 96 pages £8.00

THE SATELLITE EXPERIMENTER'S HANDBOOK (USA)

A guide to understanding and using amateur radio, weather and TV broadcast satellites. 207 pages £9.25

BEGINNERS

AN INTRODUCTION TO RADIO DXING (BP91)

R. A. Penfold

How to find a particular station, country or type of broadcast and to receive it as clearly as possible. 112 pages £1.95

BEGINNER'S GUIDE TO RADIO (9th Edition)

Gordon J. King

Radio signals, transmitters, receivers, antennas, components, valves and semiconductors, CB and amateur radio are all dealt with here. 266 pages £6.95

BEGINNER'S GUIDE TO ELECTRONICS

Owen Bishop

For youngsters thinking of a career in electronics; theory and applications in computers, radio, TV, recording, medical and industrial electronics. 240 pages £4.95

★ ELECTRONICS SIMPLIFIED—CRYSTAL SET CONSTRUCTION (BP192)

F. A. Wilson

This is a book especially written for those who wish to take part in basic radio building. All the crystal sets in the book are from old designs but updated to take account of modern components. 72 pages, £1.75

QUESTIONS & ANSWERS

RADIO

Eugene Trundle

Basics of electrical theory, radio and semiconductors, receivers, amateur and CB radio, and test equipment. 110 pages £2.95

THE SIMPLE ELECTRONIC CIRCUIT AND COMPONENTS Book 1 (BP62)

The aim of this book is to provide an in expensive but comprehensive introduction to modern electronics. 209 pages £3.50

TELEVISION

★ AN INTRODUCTION TO SATELLITE TELEVISION (BP195)

F. A. Wilson

Answers all kinds of questions about satellite television. For the beginner thinking about hiring or purchasing a satellite TV system there are details to help you along. For the engineer there are technical details including calculations, formulae and tables. Plenty of advice for the d.i.y. enthusiast. 104 pages. £5.95

A TV-DXERS HANDBOOK (BP176)

R. Bunney

Information on transmission standards, propagation, receivers including multi-standard, colour, satellites, antennas, photography, station identification, interference, etc. Revised and updated 1986. 87 pages £5.95

SATELLITE TELEVISION

Peter S. Pearson

How satellite TV works, setting up your own TVRO terminal, the costs, the programmes available. 72 pages £4.95

GUIDE TO WORLD-WIDE TELEVISION TEST CARDS

Edition 2

Keith Hamer and Garry Smith

The main purpose of this book is to assist long distance television enthusiasts (TV DXers) around the world with signal identification. There are 240 test cards, identification slides and clock captions pictured. It is in "semi-alphabetical" order, that is the stations are in alphabetical order in their geographical sections. 52 pages £2.95

THEORY

AMATEUR RADIO & ELECTRONICS STUDY GUIDE

3rd Edition

Ian Ridpath ZL1BCG

This book aims to fill the gap between high level amateur radio handbooks and over-simplified beginners manuals. It is written in a "students own notes" format that hopes to put the reader more at ease than formally written text books do. 216 pages £7.00

COMMUNICATION (BP89)

(Elements of Electronics—Book 5)

F. A. Wilson

Fundamentals of line, microwave, submarine, satellite, digital multiplex, radio and telegraphy systems are covered, without the more complicated theory or mathematics. 256 pages £2.95

FOUNDATIONS OF WIRELESS AND ELECTRONICS (10th Edition)

M. G. Scroggie and S. W. Amos

Covering d.c. and a.c. circuits, L, C, tuned circuits and selectivity, valves, semiconductors, transmission lines, antennas, radiation, oscillation, modulation, detection, amplification, superhet receivers, c.r.t.s, waveform generators and switches, computers and power supplies. 551 pages £8.95

LEVEL II RADIO & ELECTRONICS THEORY

Ian Ridpath ZL1BCG

A sequel to Amateur Radio & Electronics Study Course, this book covers advanced theory up to a level needed on most technician courses. The handwritten format is designed to make the student feel as though the pages are his own notes. 169 pages £6.70

PRACTICAL ELECTRONICS CALCULATIONS AND FORMULAE (BP53)

F. A. Wilson

This has been written as a workshop manual for the electronics enthusiast. There is a strong practical bias and higher mathematics have been avoided where possible. 249 pages £3.95

LISTENING GUIDES

AIR BAND RADIO HANDBOOK

David J. Smith

With air band radio you can eavesdrop on the conversations between aircraft and those on the ground who control them. The author, an air traffic controller, explains more about this listening hobby. 174 pages £5.99.

DIAL SEARCH (5th Edition 1988/89)

George Wilcox

The listener's check list and guide to European broadcasting. Covers medium wave, long wave, v.h.f. and short wave, including two special maps, making the most of your portable and many more. 46 pages £3.25

GUIDE TO BROADCASTING STATIONS

19th Edition (1987/88)

Philip Darrington

Frequency and station data, receivers, antennas, Latin American DXing, reporting, computers in radio, etc. 240 pages £6.95

★ GUIDE TO FACSIMILE STATIONS

7th Edition

Joerg Klingenfuss

This manual is the basic reference book for everyone interested in FAX. Frequency, call sign, name of the station, ITU country/geographical symbol, technical parameters of the emission are all listed. All frequencies have been measured to the nearest 100Hz. 252 pages £12.00

★ GUIDE TO FORMER UTILITY TRANSMISSIONS

3rd Edition

Joerg Klingenfuss

This manual is built on continuous monitoring of the radio spectrum from the sixties until the recent past. It is a useful summary of former activities of utility stations and provides information to the active radio monitor in the classification and identification of radio signals. 126 pages £8.00

★ GUIDE TO UTILITY STATIONS

6th Edition

Joerg Klingenfuss

This book covers the complete short wave range from 3 to 30MHz plus the adjacent frequency bands from 0 to 150kHz and from 1.6 to 3MHz. It includes details on all types of utility stations including FAX and RTTY. There are 15802 entries in the frequency list and 3123 in the alphabetical call sign list plus press services and meteorological stations. 494 pages £19.00

HF OCEANIC AIRBAND COMMUNICATIONS (3rd Edn.)

Bill Laver

Aircraft channels by frequency and band, main ground radio stations, European R/T networks, North Atlantic control frequencies. 29 pages £3.50

INTERNATIONAL RADIO STATIONS GUIDE (BP155)

Revised and updated in 1985, this book shows the site, country, frequency/wavelength and power of stations in Europe, the Near East and N. Africa, North and Latin America and the Caribbean, plus short-wave stations worldwide. 128 pages O/P

THE COMPLETE VHF/UHF FREQUENCY GUIDE

Updated 1988

This book gives details of frequencies from 26–2250MHz with no gaps and who uses what. Recently updated, there are chapters on equipment requirements as well as antennas, etc. 88 pages £5.95

★ THE INTERNATIONAL VHF FM GUIDE

7th Edition

Julian Baldwin G3UHK & Kris Partridge G8AAU

The latest edition of this useful book gives concise details of repeaters and beacons worldwide plus coverage maps and further information on UK repeaters. 70 pages £2.85

UK LISTENERS CONFIDENTIAL FREQUENCY LIST (5th Edition)

Bill Laver

Covering the services and transmission modes that can be heard on the bands between 1.635 and 29.7MHz. 147 pages £6.95

VHF/UHF AIRBAND FREQUENCY GUIDE

A complete guide to the airband frequencies including how to receive the signals, the frequencies and services, VOLMET and much more about the interesting subject of airband radio. 74 pages. £5.95

WORLD RADIO TV HANDBOOK 1988

Country-by-country listings of long, medium and short wave broadcasters and TV stations. Receiver test reports. English language broadcasts. The a.w.l.'s "bible". 576 pages £17.95

INTERFERENCE

INTERFERENCE HANDBOOK (USA) William R. Nelson WA6FQG

How to locate and cure r.f.i. for radio amateurs, CBers and TV and stereo owners. 253 pages £6.75

RADIO FREQUENCY INTERFERENCE (USA)

What causes r.f.i.? Are all r.f.i. problems difficult, expensive and time-consuming to cure? These questions and many more are answered in this book. 84 pages £4.30

TELEVISION INTERFERENCE MANUAL (RSGB)

B. Priestley
TV channels and systems, spurious-radiation TVI, strong-signal TVI, audio breakthrough, transmitter design. 78 pages £2.94

AMATEUR RADIO

A GUIDE TO AMATEUR RADIO (RSGB)

Amateur Radio—the hobby, the equipment, workshop practice, the licence, the RAE (including sample questions). 154 pages 0/P

AMATEUR RADIO CALL BOOK (RSGB)

Winter 87/88 Edition
This useful work now incorporates a 48-page reference section of useful information for amateur radio enthusiasts. 310 pages £6.47

AMATEUR RADIO LOGBOOK

Standard logbook for the transmitting amateur in horizontal A4 format. 25 lines per page. 96 pages £2.30

AMATEUR RADIO OPERATING MANUAL (RSGB)

A mine of information on just about every aspect of amateur operating, including international call sign series holders, prefix lists, DXCC countries list, etc. 204 pages £6.16

AMATEUR RADIO SATELLITES the first 25 years

Arthur C. Gee G2UK
The material in this souvenir publication is drawn from the author's archives. It is mainly a pictorial account on the pattern of developments which have occurred over the last 25 years. 34 pages £2.25

CARE AND FEEDING OF POWER GRID TUBES (USA)

This handbook analyses the operation of EIMAC power grid valves and provides design and application information to assist the user of these valves. 156 pages £6.75

HOW TO PASS THE RADIO AMATEURS' EXAMINATION (RSGB)

G. L. Benbow GJHB
The background to multiple choice exams and how to study for them with nine sample RAE papers for practice, plus maths revision. 91 pages £3.15

PASSPORT TO AMATEUR RADIO

Reprinted from PW 1981-1982
The famous series by GW3JGA, used by thousands of successful RAE candidates as an aid to their studies. Plus other useful articles for students of amateur radio. 96 pages £1.50

QUESTIONS & ANSWERS AMATEUR RADIO

F. C. Judd G2BCX
What is amateur radio? The Radio Amateurs' Exam and Licence. The technology, equipment, antennas, operating procedure and codes used by amateurs. 122 pages £2.95

RADIO AMATEUR'S GUIDE RADIO WAVE PROPAGATION (HF Bands)

F. C. Judd G2BCX
The how and why of the mechanism and variations of propagation in the h.f. bands. 144 pages £8.95

RADIO AMATEUR'S MAP OF NORTH AMERICA (USA)

Shows radio amateurs prefix boundaries, continental boundaries and zone boundaries. 760 x 636mm £2.25

★ RADIO AMATEUR'S PREFIX MAP OF THE WORLD (USA)

Showing prefixes and countries, plus listings by order of country and of prefix. 1014 x 711mm £2.50

★ RADIO AMATEUR'S WORLD ATLAS (USA)

17 pages of maps, including the world-polar projection. Also includes the table of allocation of international call sign series. £2.95

★ THE RADIO AMATEUR'S DX GUIDE (USA)

15th Edition
The guide contains information not easily obtained elsewhere and is intended as an aid and quick reference for all radio amateurs interested in DX. 38 pages. £2.95

THE RADIO AMATEUR'S QUESTIONS & ANSWER REFERENCE MANUAL 3rd Edition

R.E.G. Petri GBCCJ
This book has been compiled especially for students of the City and Guilds of London Institute RAE. It is structured, with carefully selected multiple choice questions, to progress with any recognised course of instruction, although it is not intended as a text book. 258 pages £6.95

THE 1988 ARRL HANDBOOK FOR THE RADIO AMATEUR

This, the sixty-fifth edition is available only in hardback, the first time the ARRL have done this. New construction projects are the theme of this edition, there is a deluxe memory keyer, receiver projects, a linear QSK converter, a low-powered balanced Transmatch and a d.t.m.f. decoder. Updated every year, this provides useful reference material for the radio amateur. It also includes 18 pages of p.c.b. track pattern for you to build your own boards. 1157 pages £19.25 (hardback)

VHF HANDBOOK FOR RADIO AMATEURS (USA)

H. S. Brier W9EGQ & W. I. Orr W6SAI
VHF/UHF propagation, including moonbounce and satellites, equipment and antennas. 335 pages £7.95

VHF/UHF MANUAL (RSGB)

G. R. Jessop G6JP
Theory and practice of amateur radio reception and transmission, between 30MHz and 24GHz. 520 pages £12.92

DATA & REFERENCE

DIGITAL IC EQUIVALENTS AND PIN CONNECTIONS (BP140)

A. Michaels
Equivalents and pin connections of a popular selection of European, American and Japanese digital i.c.s. 256 pages £5.95

INTERNATIONAL DIODE EQUIVALENTS GUIDE (BP108)

A. Michaels
Possible substitutes for a large selection of many different types of semiconductor diodes. 144 pages £2.25

INTERNATIONAL TRANSISTOR EQUIVALENTS GUIDE (BP85)

A. Michaels
Possible substitutes for a popular selection of European, American and Japanese transistors. 320 pages £3.50

LINEAR IC EQUIVALENTS AND PIN CONNECTIONS (BP141)

A. Michaels
Equivalents and pin connections of a popular selection of European, American and Japanese linear i.c.s. 320 pages £5.95

NEWNES AUDIO & HI-FI ENGINEER'S POCKET BOOK

Vivian Capel
The is a concise collection of practical and relevant data for anyone working on sound systems. The topics covered include microphones, gramophones, CDs to name a few. 190 pages Hardback £9.95

NEWNES COMPUTER ENGINEER'S POCKET BOOK

This is an invaluable compendium of facts, figures, circuits and data and is indispensable to the designer, student, service engineer and all those interested in computer and microprocessor systems. 203 pages Hardback £8.95

NEWNES ELECTRONICS POCKET BOOK

5th Edition
Presenting all aspects of electronics in a readable and largely non-mathematical form for both the enthusiast and the professional engineer. 315 pages Hardback £8.95

NEWNES RADIO AMATEUR AND LISTENER'S POCKET BOOK

Steve Money G3FZX
This book is a collection of useful and intriguing data for the traditional and modern radio amateur as well as the short wave listener. Topics such as AMTOR, packet radio, SSTV, computer communications, airband and maritime communications are all covered. 160 pages Hardback £8.95

NEWNES RADIO AND ELECTRONICS ENGINEER'S POCKET BOOK

(17th Edition)
Keith Brindley
Useful data covering maths, abbreviations, codes, symbols, frequency bands/allocations, UK broadcasting stations, semiconductors, components, etc. 201 pages Hardback £8.95

★ NEWNES TELEVISION AND VIDEO ENGINEER'S POCKET BOOK

Eugene Trundle
This is a valuable reference source for practitioners in "entertainment" electronic equipment. It covers TV reception from v.h.f. to s.h.f., display tubes, colour camera technology, video recorder and video disc equipment, video text and hi-fi sound. 323 pages Hardback £9.95

POWER SELECTOR GUIDE (BP235)

J. C. J. Van de Ven
This guide has the information on all kinds of power devices in useful categories (other than the usual alpha numeric sort) such as voltage and power properties making selection of replacements easier. 160 pages £4.95

RSGB RADIO DATA REFERENCE BOOK

G. R. Jessop G6JP
The 5th Edition of an essential book for the radio amateur's or experimenter's workbench. 244 pages Hardback £8.56

SEMICONDUCTOR DATA BOOK

A. M. Ball
Characteristics of about 10 000 transistors, f.e.t.s, u.i.t.s, diodes, rectifiers, triacs and s.c.r.s. 175 pages £7.50

TRANSISTOR SELECTOR GUIDE (BP234)

J. C. J. Van de Ven
This guide has the information on all kinds of transistors in useful categories (other than the usual alpha numeric sort) such as voltage and power properties making selection of replacements easier. 192 pages £4.95

FAULT-FINDING

ARE THE VOLTAGES CORRECT?

Reprinted from PW 1982-1983
How to use a multimeter to fault-find on electronic and radio equipment, from simple resistive dividers through circuits using diodes, transistors, i.c.s and valves. 44 pages £1.50

★ GETTING THE MOST FROM YOUR MULTIMETER (BP239)

R. A. Penfold
This book is primarily aimed at beginners. It covers both analogue and digital multimeters and their respective limitations. All kinds of testing is explained too. No previous knowledge is required or assumed. 102 pages. £2.95

OSCILLOSCOPES, HOW TO USE THEM, HOW THEY WORK (Revised 2nd Edition)

Ian Hickman
This book describes oscilloscopes ranging from basic to advanced models and the accessories to go with them. 133 pages £6.95

PRACTICAL HANDBOOK OF VALVE RADIO REPAIR

Chas E Miller
The definitive work on repairing and restoring valved broadcast receivers dating from the 1930s to the 60s. Appendices giving intermediate frequencies, valve characteristic data and base connections. 230 pages Hardback £17.50

QUESTIONS & ANSWERS RADIO REPAIR

Les Lawry-Johns
How to fault-find and repair valved and transistorised receivers, car radios and unit audio equipment. Suggested lists of tools and spare parts. 106 pages £2.95

SERVICING RADIO, HI-FI AND TV EQUIPMENT

Gordon J King
A very practical book looking at semiconductor characteristics, d.c. and signal tests, fault-finding techniques for audio, video, r.f. and oscillator stages, and their application to transistor radios and hi-fi. 205 pages £5.95

TEST EQUIPMENT FOR THE RADIO AMATEUR (RSGB)

H. L. Gibson G2BUP
Techniques and equipment for tests and measurements on devices, systems and antennas. 142 pages Hardback 0/P

TRANSISTOR RADIO FAULT FINDING CHART (BP70)

C. E. Miller
Used properly, should enable most common faults to be traced reasonably quickly. Selecting the appropriate fault description at the head of the chart, the reader is led through a sequence of suggested checks until the fault is cleared. 635 x 455mm (approx) £0.95

PROJECT CONSTRUCTION

HOW TO BUILD ADVANCED SHORT WAVE RECEIVERS (BP226)

R. A. Penfold
Greater satisfaction can be gained from the hobby of shortwave listening when using home constructed equipment. This book gives full practical constructional details of a number of receivers as well as some add-on circuits like S-meters and noise limiters. 118 pages £2.95

HOW TO DESIGN AND MAKE YOUR OWN P.C.B.s (BP121)

R. A. Penfold
Designing or copying printed circuit board designs from magazines, including photographic methods. 80 pages £1.95

INTRODUCING QRP

Collected Articles from PW 1983-1985
An introduction to low-power transmission, including constructional details of designs by Rev. George Dobbs G3RJV for transmitters and transceivers from Top Band to 14MHz, and test equipment by Tony Smith G4FAL. 64 pages £1.50

MORE ADVANCED POWER SUPPLY PROJECTS (BP192)

R. A. Penfold
The practical and theoretical aspects of the circuits are covered in some detail. Topics include switched mode power supplies, precision regulators, dual tracking regulators and computer controlled power supplies, etc. 92 pages £2.95

POWER SUPPLY PROJECTS BP76

R. A. Penfold
This book gives a number of power supply designs including simple unregulated types, fixed voltage regulated types and variable voltage stabilised designs. 91 pages £2.50

PRACTICAL POWER SUPPLIES

Collected Articles from PW 1978-1985
Characteristics of batteries, transformers, rectifiers, fuses and heatsinks, plus designs for a variety of mains-driven power supplies, including the PW "Marchwood" giving a fully stabilised and protected 12V 30A d.c. 48 pages £1.25

PROJECTS IN AMATEUR RADIO AND SHORT WAVE LISTENING

F. G. Rayer G3OGR
Full constructional details are given for all projects, including housing the units in a suitable case. All the projects are either on p.c.b. or matrix board. 90 pages £4.95

SOLID STATE SHORT WAVE RECEIVERS FOR BEGINNERS (BP222)

R. A. Penfold
There is a strange fascination in listening to a broadcast which has been transmitted over many thousands of kilometres. This is even more the case when you've built the receiver yourself. This book contains several designs that will give a fairly high level of performance. 93 pages £2.95

AUDIO FREQUENCIES

AUDIO (BP111)
(Elements of Electronics—Book 6)

F. A. Wilson
This book studies sound and hearing, and the operation of microphones, loudspeakers, amplifiers, oscillators, and both disc and magnetic recording. 320 pages £3.50

ANTENNAS (AERIALS)

AERIAL PROJECTS (BP105)

R. A. Penfold
Practical designs including active, loop and ferrite aerials plus accessory units. 96 pages £1.95

ALL ABOUT CUBICAL QUAD ANTENNAS (USA)

W. I. Orr W6SAI & S. D. Cowan W2LX
Theory, design, construction, adjustment and operation of quads. Quads vs. Yagis. Gain figures. 109 pages £5.50

ALL ABOUT VERTICAL ANTENNAS (USA)

W. I. Orr W6SAI & S. D. Cowan W2LX
Theory, design, construction, operation, the secrets of making vertical work. 191 pages £7.50

AN INTRODUCTION TO ANTENNA THEORY (BP198)

H. C. Wright
This book deals with the basic concepts relevant to receiving and transmitting antennas. Lots of diagrams reduce the amount of mathematics involved. 86 pages £2.95

BEAM ANTENNA HANDBOOK (USA)

W. I. Orr W6SAI & S. D. Cowan W2LX
Design, construction, adjustment and installation of h.f. beam antennas. 198 pages £6.75

HF ANTENNAS FOR ALL LOCATIONS (RSGB)

L. A. Moxon G6XN
Taking a new look at how h.f. antennas work, and putting theory into practice. 260 pages £7.94

OUT OF THIN AIR

Collected Antenna Articles from PW 1977-1980
Including such favourites as the ZL Special and '2BCX' 16-element beams for 2m, and the famous 'Slim Jim', designed by Fred Judd G2BCX. Also features systems for Top Band, medium wave/long wave loop designs and a v.h.f. direction finding loop. Plus items on propagation, accessories and antenna design. 80 pages £1.80

SIMPLE, LOW-COST WIRE ANTENNAS FOR RADIO AMATEURS (USA)

W. I. Orr W6SAI and S. D. Cowan W2LX
Efficient antennas for Top Band to 2m, including 'invisible' antennas for difficult station locations. 191 pages £6.75

THE ARRL ANTENNA BOOK

14th Edition (USA)
A station is only as effective as its antenna system. This book covers propagation, practical constructional details of almost every type of antenna, test equipment and formulas and programs for beam heading calculations. 327 pages. £9.10

THE ARRL ANTENNA COMPENDIUM Volume 1 (USA)

This book makes fascinating reading of hitherto unpublished material. Among topics discussed are quads and loops, log periodic arrays, beam and multi-band antennas, verticals and reduced size antennas. 175 pages £9.25

TWO-METRE ANTENNA HANDBOOK

F. C. Judd wrote this book for radio amateurs new to the 144-146MHz band. The range of antennas described will cater for most situations, particularly those where space is a problem. 157 pages £5.95

WIRES & WAVES

Collected Antenna Articles from PW 1980-1984
Antenna and propagation theory, including NBS Yagi design data. Practical designs for antennas from medium waves to microwaves, plus accessories such as a.t.u.s, s.w.r. and power meters, and a noise bridge. Dealing with TVI. 160 pages £3.00

25 SIMPLE AMATEUR BAND AERIALS (BP125)

E. M. Noll
How to build 25 simple and inexpensive aerials, from a simple dipole through beam and triangle designs to a mini-rhombic. Dimensions for specific spot frequencies, including the WARC bands. 80 pages £1.95

25 SIMPLE INDOOR AND WINDOW AERIALS (BP136)

E. M. Noll
Designs for people who live in flats or have no gardens, etc., giving surprisingly good results considering their limited dimensions. 64 pages £1.75

25 SIMPLE SHORT WAVE BROADCAST BAND AERIALS (BP132)

E. M. Noll
Designs for 25 different aerials, from a simple dipole through helical designs to a multi-band umbrella. 80 pages £1.95

25 SIMPLE TROPICAL AND MW BAND AERIALS (BP148)

E. M. Noll
Simple and inexpensive aerials for the broadcast bands from medium wave to 49m. 64 pages £1.75

COMPUTING

AMATEUR RADIO SOFTWARE (RSGB)

John Morris GM4ANB
Using a computer for c.w., RTTY, data, plus calculations for antennas, distance, bearing, locators, satellites, sun, moon and circuit design. 328 pages Hardback £9.41

AN INTRODUCTION TO COMPUTER COMMUNICATIONS (BP177)

R. A. Penfold
Details of various types of modem and their applications, plus how to interconnect computers, modems, and the telephone system. Also networking systems and RTTY. 96 pages £2.95

AN INTRODUCTION TO COMPUTER PERIPHERALS (BP170)

J. W. Penfold
Covers monitors, printers, disk drives, cassette recorders, modems, etc., explaining what they are, how to use them and the various types of standards. 80 pages £2.50

MICROPROCESSING SYSTEMS AND CIRCUITS (BP77)

(Elements of Electronics—Book 4)
F. A. Wilson
A comprehensive guide to the elements of microprocessing systems, which are becoming ever more involved in radio systems and equipment. 256 pages £2.95

MORSE

INTRODUCING MORSE

Collected Articles from PW 1982-1985
Ways of learning the Morse Code, followed by constructional details of a variety of keys including lambic, Triambic, and an Electronic Bug with a 528-bit memory. 48 pages £1.25

THE MORSE CODE FOR RADIO AMATEURS (RSGB)

Margaret Mills G3ACC
A guide to learning to send and receive Morse code signals up to the 12 w.p.m. required for the RAE. 19 pages £2.88

THE SECRET OF LEARNING MORSE CODE

Mark Francis
Designed to make you proficient in Morse code in the shortest possible time, this book points out many of the pitfalls that beset the student. 87 pages £4.95

40▶

tion there are no masts, or nasty guy systems to maintain or worry about, particularly in high winds. The antenna is also saved from the rigours of atmospheric corrosion and consequently a fall-off in performance.

While on the subject of performance, seeing that the antenna is so available, you can use old fashioned methods of detecting maximum r.f. current points. This is done by holding a neon lamp close to the transmitting antenna, and as it is moved down the length of the antenna the maximum r.f. voltage points will cause the neon to strike. The non-striking points along the antenna's length are the maximum current points, and these radiate the majority of the power.

Another positive aspect of the "in-room" antenna is that with its close proximity to your own domestic appliances, you will be the first to know about any TVI. Just leave the television on while initially tuning up your antenna, and if there are any problems you should immediately see them.

Some of the advice given in this article may seem horrific to those who can push a few hundred watts into a beam antenna or full size dipole hooked on to a mast or chimney. Good luck to them, but I am afraid they are now becoming a minority, the rest of us have to put up with postage stamp size gardens, and at worst no external antennas at all, in addition to low power restriction.

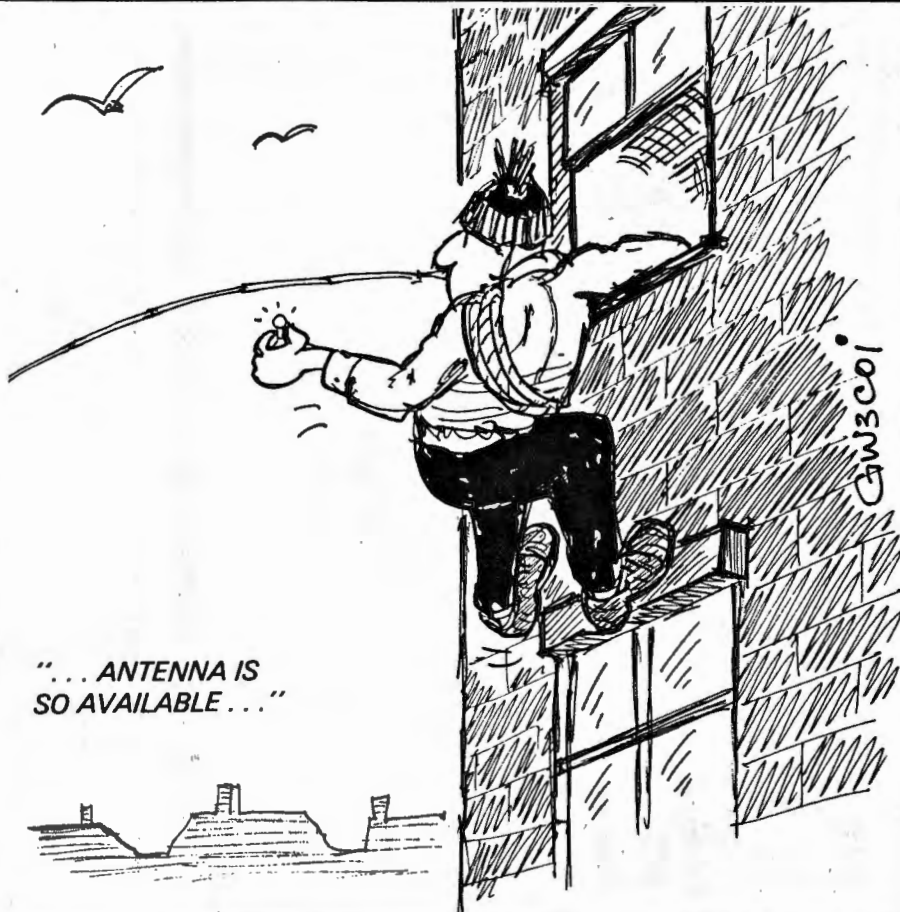

In Part Two of this three-part series we will look at some practical designs of "in-room" antennas.

READ ALL ABOUT IT!

IN THE SUMMER '88
Cirkit CATALOGUE

TOOLS [173]

PCBs & MATERIALS [95]

CONNECTORS [51]

KITS & MODULES [131]

HARDWARE [73]

BOOKS [17]

TEST EQUIPMENT [153]

SEMICONDUCTORS [109]

SMALL SIGNAL LOW FREQUENCY DEVICES

SMALL SIGNAL RADIO FREQUENCY DEVICES

SMALL SIGNAL HIGH FREQUENCY DEVICES

FREE!
Digital clock with
orders over £50.00

competition prizes
despatch from
free

Discount vouchers, competition, free gift and,
of course, the latest new products.
Available at your newsagent or direct from
Cirkit at the address below.

PRICE £1.30

Cirkit



Cirkit Distribution Ltd.
Park Lane, Broxbourne, Herts EN10 7NQ
Telephone (0992) 444111 Telex: 22478

ALTRON COMMUNICATION EQUIPMENT

ALWAYS CHOSEN BY PROFESSIONALS
AND DISCERNING RADIO AMATEURS.

COMPACT LATTICE TOWERS
SLIMLINE TUBULAR MASTS

Telescopic—Tiltover, Fixed—Mobile from 3M to
60M. Over 50 Models, suitable for a wide range of
civil and military applications such as:

- Radio Communications
- Amateur Radio
- CCTV and Surveillance
- Meteorological Monitoring
- Aero & Marine Nav Aids
- Flood Lighting etc.

Purpose designed using 4.5m and 3m
section modules for low retracted
heights and cost effective shipping.
Engineered to B.S.I. standards and hot
dip galvanised to BS729 for protection.
Wind loads are based on BS CP3
CHAP V PT 2 1972 for wind speeds up to
100mph/160kph. (BS8100)

ANTENNAS

AQ6-20 "SPACE SAVER", THE
COMPACT 4 BANDER THAT IS
DIFFERENT. 2, 3 OR 4 ELEMENTS
6, 10, 15 AND 20M.

Unique Fully Sealed Coils.
Hi'Q'—Close
Coupled capacity
hat loaded Yagi with
optimized
performance. Ideal
for small spaces.
Send for full Spec.
sheet. NOW!

SEE NEW AT
STAND ETC

QUALITY
RELIABILITY
KNOW HOW

WE DESIGN—WE MAKE—WE SELL—DIRECT.
At manufacturers prices—you get best value.

SEND S.A.E. FOR FURTHER DETAILS
AND PRICES OF ALTRON PRODUCTS.

H.P. TERMS



ALLWELD ENGINEERING

Factory 6, 232 Seisdon Road,
South Croydon, Surrey, CR2 6PL.
Tel: 01-680 2995 (24 hr) 01-681 6734

Reading & Understanding

(with a bit of theory thrown in)

In Part 5 of this series, R. F. Fautley G3ASG takes a look at power supplies.

When we amateurs refer to power supplies, what we're usually talking about are devices for changing our domestic alternating current (a.c) electrical supply of 240 volts r.m.s. at a frequency of 50Hz into direct current (d.c.) supplies of, usually, quite different voltages. The term r.m.s. will be dealt with later, so don't worry about it now. In the US, the voltages will probably be 110 volts and 60Hz.

An example of what we may want is a supply of 14V d.c. to provide a load current of about 10A to power a semiconductor 144MHz linear amplifier. Another case could be that we want 2000V at 250mA for a valve amplifier.

What do power supply circuit diagrams look like? Well they come in several different forms, but to help us recognise them we will look for a few components that always appear, i.e.:

- (a) mains transformers
- (b) diode rectifiers
- (c) capacitors (having fairly high capacitance values)

The only new component symbol to illustrate is that for the mains transformer. This symbol, in Fig. 5.1, is used for all iron-cored transformers. That is for transformers with laminated, interleaved cores which are made of a silicon-steel alloy.



Fig. 5.1: Symbol for an iron-cored transformer

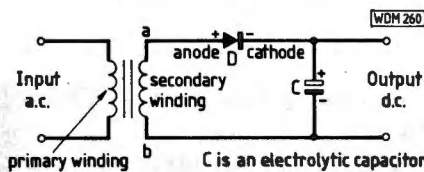

Fig. 5.2: Half wave rectifier

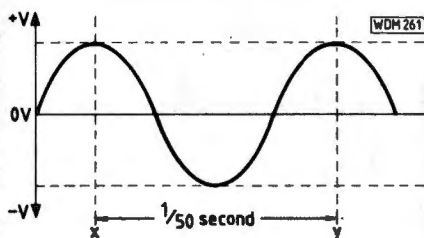

Fig. 5.3: Mains supply voltage waveform

Half Wave Rectifier Circuit

The simplest rectifier circuit is called the half wave rectifier and is shown in Fig. 5.2. Can you see the resemblance to the circuit of the crystal set in Fig. 2.6? If you can, it's because the crystal set is a half wave rectifier circuit!

The action of the circuit is as follows: The "rectified" voltage from the diode D "charges" the "reservoir" capacitor C during the half cycle when the voltage at "a" on the mains transformer secondary winding (Fig. 5.2) is positive with respect to the other end of the winding "b". There are a few terms here that need explanation!

(1). What does "rectified" mean? An alternating current (a.c.) varies periodically from positive to negative, then back to positive and so on. The ordinary domestic electricity supply varies from + to - sinusoidally, i.e. if the voltage is plotted against time, the resulting waveform is a sine wave, as in Fig. 5.3. The time period for a complete cycle (from "x" to "y") is 1/50 of a second. So, in one second there would be exactly 50 complete cycles. The frequency of the supply is then said to be 50Hz, or 50 cycles per second.

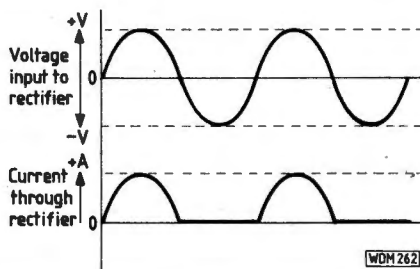

Fig. 5.4: Voltage supply to, and current flowing through, the rectifier diode



Fig. 5.5: Ripple voltage across the reservoir capacitor for a half wave rectifier

If a device can be found that will only pass current (conduct) when the alternating voltage supply is positive at "a" with respect to "b" (Fig. 5.2), but will effectively switch off the supply when "a" is negative with respect to "b", then the voltage across capacitor C will always have the same polarity (even though it will vary in amplitude).

Such a device is called a rectifier, and a diode performs this function because only during the time that its anode connection is positive with respect to its cathode connection will it pass current. This happens in the circuit of Fig. 5.2 during the positive half cycle ("a" positive to "b"). During the following negative half cycle, whilst the voltage applied to the diode's anode is negative with respect to that at its cathode, the diode acts as an open switch and no current flows.

The wave forms of both the a.c. voltage applied to the diode and of the current flowing through it are shown in Fig. 5.4.

(2). The next term is "charges". At the instant the power supply is switched on, the capacitor C behaves exactly as a short circuit, so connecting the diode D directly across the mains transformer secondary winding "a-b". This is because before switch-on, there is no voltage across the capacitor and thus no energy is stored in it.

When the supply is switched on, energy rushes into the capacitor at an alarming rate for a short time to start to charge it. The capacitor is "charged" when the voltage across it reaches the maximum voltage from the diode D. Any resistive load across the d.c. output terminals will try to discharge the capacitor during the half cycle when there is no output from diode D. This occurs when "a" on the transformer secondary is negative with respect to "b". During this period (half cycle), the diode behaves as an open circuit and so passes no current.

Capacitor C is then similar to a battery, maintaining the d.c. supply to the load until "a" again becomes positive with respect to "b" allowing diode D to conduct and further recharge the capacitor.

(3). It is called a "reservoir" capacitor because it acts as a "reservoir" of energy during the diode "switch-off" period. Because of this cycle of capacitor charging, partly discharging through the load, then charging again; the d.c. voltage across the load (that is the output voltage) is not absolutely

Circuit Diagrams

constant. This small change of voltage across the reservoir capacitor C, which is rising and falling as in Fig. 5.5 is called the "ripple voltage" and is referred to either as so many volts (or milli-volts) "r.m.s." or "peak-to-peak". This ripple voltage is the cause of the "hum" heard in loudspeakers and headphones.

What is r.m.s. then? Well, the domestic mains voltage, as we all know is 240V, and this is the supply's r.m.s. value. The term r.m.s. is an abbreviation for "root-mean-square", which it is not necessary to mathematically analyse here. (Did I hear "thank goodness" from somewhere?) It is the most common way in which a.c. (either voltage or current) quantities are expressed. Thus, an alternating voltage of 240V means 240V r.m.s. The other expression "peak-to-peak" may be derived in the case of a sine wave from the relationship:

$$V_{\text{peak to peak}} = 2(\sqrt{2} \times V_{\text{rms}})$$

So, for the 240V mains supply:

$$V_{\text{peak to peak}} = 2 \times 1.414 \times 240 = 679V_{\text{peak to peak}}$$

As by now you may have gathered, the circuit is called a "half wave" rectifier because only one half cycle of the applied a.c. wave form is used to provide the d.c. output, the other half cycle having no effect. The diode is inoperative during one half cycle (see Fig. 5.4).

If the diode D is reversed, connecting its cathode to "a" on the transformer secondary and its anode to capacitor C, the operation is the same, but the d.c. output will be negative instead of

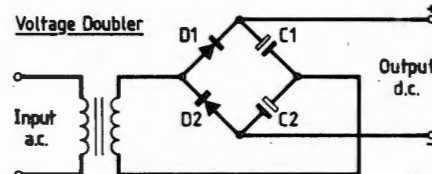
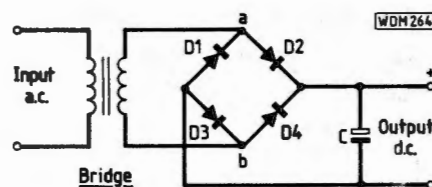
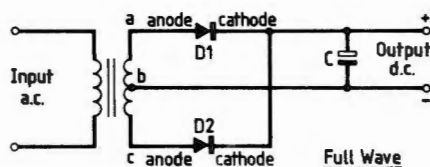

Fig. 5.6: Full wave, bridge and voltage doubler rectifier circuits

positive. (If C is an electrolytic capacitor, and it will be in most cases, its connections must also be reversed.)

We must not lose sight of the basic idea prompting these articles, i.e. helping to understand and read circuit diagrams. So, having described the half wave rectifier, the other rectifier circuits in common use will be shown diagrammatically in Fig. 5.6. They will be described only briefly.

They are:

- (a) the full wave rectifier
- (b) the bridge rectifier
- (c) the voltage doubler rectifier

Full Wave Rectifier

The full wave circuit operates like two half wave rectifiers with each operating during alternate half cycles. The secondary winding of the mains transformer can be considered as two windings in series, with one winding "a" to "b" supplying diode D1 and the other "b" to "c" supplying diode D2. Taking D1 with winding "a" to "b" first. Compare it with the half wave circuit in Fig. 5.2. It behaves in exactly the same way. So also does the other diode D2, with winding "b" to "c",

operate in the same way. Note that it is then D2 that is conducting (passing current) just at that time and D1 is not conducting. This can be shown to be a more efficient rectifier.

Bridge Rectifier

The bridge circuit behaves like two full wave rectifiers in parallel. During the half cycle that point "a" is positive with respect to "b", diodes D2 and D3 are conducting. When the alternating supply reverses, point "b" becomes positive with respect to "a" and diodes D1 and D4 conduct. The advantage of the bridge circuit over the full wave circuit is that the transformer secondary winding needs only half the number of turns to provide the same d.c. voltage output.

Voltage Doubler

The voltage doubler is in fact two half wave rectifiers each with its own reservoir capacitor, supplied from a common alternating source winding "a" to "b". Their outputs are effectively connected in series, thus providing about twice the voltage obtainable from a single half wave circuit.

HAVING DIFFICULTY GETTING YOUR COPY OF PRACTICAL WIRELESS?

Then place a regular order with your newsagent **NOW!**



Dear Newsagent, please reserve/deliver my monthly copy of PRACTICAL WIRELESS

Distributed by Comag

Name _____
Address _____

Signed _____

not publish it until nearly the end of his life in 1623, when he included it in a chapter on ciphers in his book *De Augmentis Scientiarum* (The Advancement of Learning), where it was illustrated (see Fig. 1) for the very first time.

The table on page 22 shows the bi-literary alphabet, and also what happens when the letters of the cipher alphabet are replaced by numbers in the same sequence ("a" and "b" replaced by "0" and "1"):

The secret alphabet is a perfect binary code. To demonstrate in an exaggerated way how the system works, suppose you are visiting a country with postal censorship and you run into trouble and need to ask for help from outside. You could send a postcard, which anyone can read, using upper case for the a-alphabet and lower case for the b-alphabet; the card might read thus:

WEathER iS LOvEIY. ScenERY ab-
SOLuTEIY FaNTaStiC. FoOD Out Of
tHiS woRLd. I WiSh wE CoUID Stay
FOr ANoTHER MoNtH.

The recipient of the card would totally disregard what it actually said and go through it letter by letter assigning "a" to the upper case letters and "b" to lower case, as follows:

aabbbbaa ba aababa abbbbaaa
bbaaabaaba abaababba abaa abb ab
baab bbaab a abba ba ababa abbb aab
aabaaaa aabaa

Next, your friend back home would ignore word spacings and punctuation and divide the "ab" assignments into groups of five:

aabbb aabaa ababa abbbba aabba aabaa
baaba ababb aabaa abbab baabb
baaba abbab aabab aabbb aabaa baaaa
aabaa

Now, each 5-letter group of "abs" is a letter of the secret message and is decoded from the bi-literary (binary) table, so the first one is aabbb = H; the next group is aabaa = E and so on. The message is therefore:

H E L P G E T M E
O U T O F H E R E

So your "having a lovely time" postcard is really a desperate plea for help!

Bacon realised the enormous potential of his alphabet, and says in his book *"Neither is it a small matter these Cypher-Characters have, and may performe. For by this Art a way is opened, whereby a man may expresse and signifie the intentions of his mind, at any distance of place, by objects which may be presented to the eye and accommo-*

dated to the ear, provided those objects be capable of a two-fold difference only; as by Bells, by Trumpets, by Lights and Torches, by the reports of Muskets, and by any instrument of like nature".

In 1988 he would have continued, "... or switches on or off, negative and positive current, and/or gates, etc."

Towards the end of his life, Bacon wrote a Utopian story, *The New Atlantis*, listing discoveries, inventions and developments unknown to his contemporaries, which he claimed were already in use in his imaginary commonwealth and college. Among his predictions of radio and television, the telephone, microscopes, telescopes, engines, refrigeration, weapons of war which sound frighteningly familiar today, submarines, aircraft and hundreds of other things, he included a perfect model of the Royal Society (not instituted until 36 years after his death) declaring, *"We have also a Mathematical House, where are represented all Instruments, as well of Geometry as Astronomy, exquisitely made."*

I have always wondered what great men of the past would have thought of recent inventions, but in presenting Francis Bacon with the wonders of the microcomputer I feel sure he would say rather wearily, "What took you so long? I left instructions for this 400 years ago!"

PW

Tidy up your shack

PW BINDERS

Only £3.95 each (Including Post, Packing and VAT)

Are you tired of sifting through cardboard boxes and carrier bags to find that useful item in PW?

Our **smart new style** binders, covered in blue plastics, are a must for your library, keeping your radio magazines in good condition and easily accessible.



New!

Tidy up those other mags too. Plain binders to take any A4 size magazines—no names, no pack drill!

HOW TO ORDER

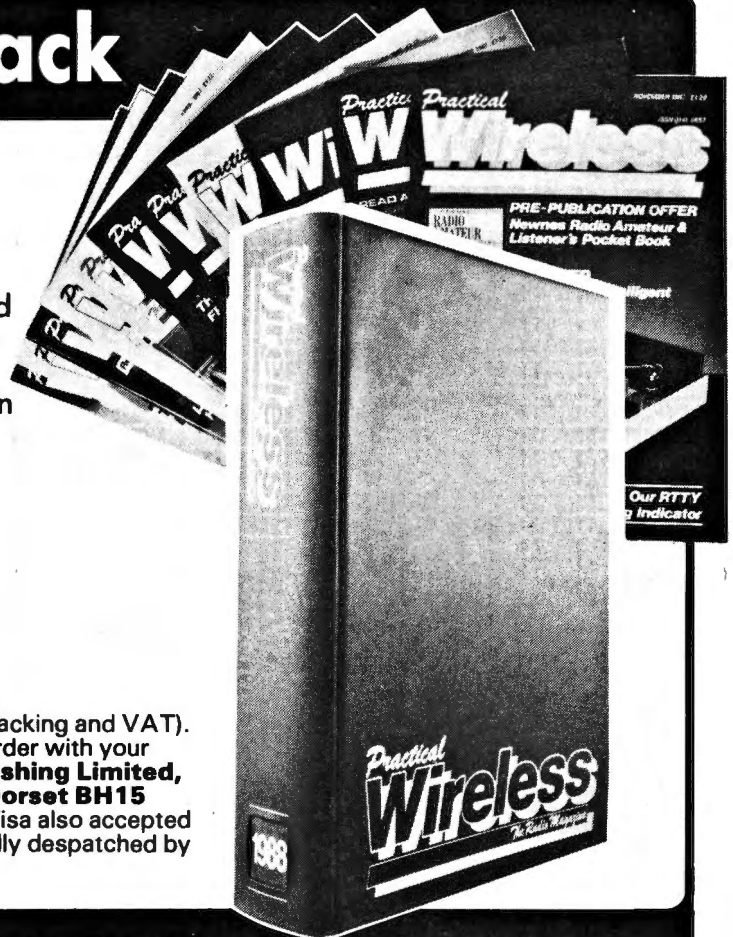
PW or plain Binders are £3.95 each (including Post, Packing and VAT). Send a postal order, cheque or international money order with your order, stating number and type required to **PW Publishing Limited, FREEPOST, Enefco House, The Quay, Poole, Dorset BH15 1PP**. Payment by Access, Mastercard, Eurocard or Visa also accepted on telephone orders to Poole (0202) 678558. Normally despatched by return of post but please allow 28 days for delivery.



0202 678558   (24 hour Answer Service)



TONNA F9FT THE VHF/UHF ANTENNA SPECIALIST

50MHz		435MHz	
20505 5 element	£41.69(a)	20909N 9 element	£28.62(a)
		20919N 19 element	£34.35(a)
144MHz		20438 19 element crossed	£39.66(a)
20804N 4 element	£27.60(a)	20921N 21 element 432TV	£44.57(a)
20808N 4 element crossed	£34.96(a)	20922N 21 element 4TV	£44.57(a)
20809N 9 element fixed	£30.87(a)		
20809N 9 element portable	£33.12(a)	1296MHz	
20818N 9 element crossed	£57.86(a)	20623 23 element	£30.36(b)
20813N 13 element portable	£46.00(a)	20696 4 x 23 element - power splitter - stacking frame	£160.00(a)
20817N 17 element	£61.54(a)	20656 56 element	£46.20(a)
144/435MHz		20666 4 x 55 element - power splitter - stacking frame	£230.00(a)
20899N 9 & 19 element Oscar	£57.86(a)		

All prices include VAT. Please add carriage (a) £5.00, (b) £2.20.
ACCESS or VISA cardholders telephone your order - immediate despatch.
Callers welcome but by telephone appointment only please.
SEND 50p FOR OUR CATALOGUE WHICH CONTAINS FULL SPECIFICATION OF ALL OUR ANTENNAS, POWER SPLITTERS, STACKING FRAMES, COAXIAL CABLES ETC.

SOLE UK DISTRIBUTOR 12 Conduit Road, Abingdon, Oxon. OX14 1DB.
RANDAM ELECTRONICS (P) Tel: (0235) 23080 (24 hours)

VALVES

	High Quality	Very High Quality	Prices correct as at 9/5/1988 but may fluctuate. 15% VAT incl.						
A1065	1.40	EBF89	0.80	EF89	1.80	PF1200*	2.80	UCC24	0.85
A2231	1.80	EC51	0.85	EF91	1.80	EF86/87	0.75	PL3	1.00
A2900	12.75	EC91	4.80	EF92	2.15	EF98	0.85	PL81	1.30
AR8	1.15	EC92	1.85	EF96	1.80	EZ20	0.80	PL82	0.70
AR3	1.15	ECC11	1.25	EF96	0.80	EZ21	0.80	PL83	0.90
AR26	1.15	ECC22	0.85	EF180	0.75	GM4	0.80	PL84	0.90
ATP4	0.90	ECC23	1.10	EF184	0.75	GM4	0.80	PL504	1.25
B12H	6.50	ECC24	0.80	EF212	0.75	GM4	0.80	PL508	2.00
CY31	2.40	ECC25	0.75	ELF200	1.85	G222	1.80	PL509	5.95
DA70	1.75	ECC28	1.10	EL60	0.85	G222	1.80	PL519	5.85
DAF96	0.90	ECC189	1.20	EL32	0.85	G233	4.20	UM80*	2.30
DET22	32.80	ECC204	0.85	EL34	3.25	G234	2.45	PR20	0.70
DF82	0.85	ECF80	1.25	EL34*	5.95	G234*	4.60	PR18/800	0.85
DF86	1.15	EL82	0.70	EL82	0.70	G237	3.95	PR182	0.75
DH76	1.15	ECF80	1.80	EL84	1.30	G237	3.95	PR188	2.10
DL32	1.45	ECM42	1.85	EL86	1.45	KT77**	14.00	PR200A	0.80
DY86/87	0.85	ECM42	0.90	EL90	1.75	ML4	35.00	QVW370	5.95
DY882	0.70	ECL30	0.85	EL91	0.90	ML4	35.00	QVW310*	7.50
E32CC	2.80	EL32	0.75	EL95	1.80	ML6	3.20	QVW320A	27.50
E180CC	11.50	ECL26	0.75	EL504	2.70	MX12001	28.50	QVW640A	28.50
E1148	0.75	ECL36	1.10	EL509	5.95	N78	5.10	QVW640*	54.10
EA76	1.80	EL39	3.50	EL519	2.70	OB2	1.80	QVW912	0.75
EB34	1.15	EF22	3.90	EL821	0.85	PCL82	0.85	SP61	2.50
EB91	6.50	EF37A	2.15	EL822	0.85	PCL84	0.85	TT21	45.00
EB33	2.20	EF80	0.85	EL805SE	4.50	PCL86	0.85	TT22	45.00
EB30	0.80	EF83	0.90	EL805SE	4.50	PCL86/85	0.85	UAB30	0.75
EB31	0.80	EF86	0.80	EM87	3.80	PD500/510	4.30	UBF80	0.70
EB90	0.85	EF86	1.45	EY51	0.80	PF220	1.10	UBF85	0.70

VALVES AND TRANSISTORS Telephone enquiries for valves, transistors, etc. Retail 749 3934, trade and export 743 0899. POSTAGE: £1-£3 50p; £3-£5 65p; £5-£10 85p; £10-£15 £1.05; £15-£20 £1.60. Minimum order £1.00. Delivery by return.

COLOMOR (ELECTRONICS LTD.) 170 Goldhawk Rd, London W12 8HN
Tel: 01-743 0899 or 01-749 3934. Open Monday to Friday 9 a.m.-5.30 p.m.



STAY TUNED FOREVER WITH A CAP.CO.ATU - ONCE BOUGHT - NEVER REPLACED

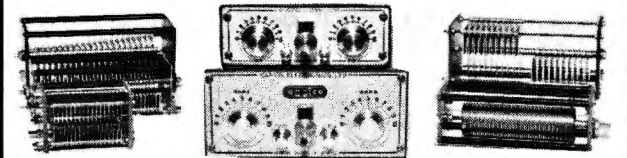

ANTENNA TUNING UNITS

SPC-300 D 1Kw p.e.p.	£225.00
SPC-3000D 1Kw p.e.p.	£325.00

ADD £5.00 p&p

CAPACITORS

CAP-25S S GANG 250 pfd	£15.50
CAP-25T T GANG 250 pfd	£18.95
CAP-10S S GANG 500 pfd	£21.95
CAP-25D DIFF 500 pfd	£18.95
ABOVE CAPS HAVE 2.5mm plate spacing rated at 8Kv. ADD £2.00 p&p	
CAP 31S S GANG 250 pfd	£17.95
CAP 31T T GANG 250 pfd	£22.95
CAP 12S S GANG 1200 pfd	£25.95
ABOVE CAPS HAVE 4.5mm plate spacing rated at 12Kv. ADD £2.50 p&p	
ROLLER COASTER + £2.00 p&p	£22.95
BALUNS 4:1, 1:1 + £2.00 p&p	£16.50
AERIAL KIT + £1.00 p&p	£5.30
URNS COUNTER - £1.00 p&p	£25.50

THE GENUINE MAGNETIC LOOP ANTENNA A RARE TECHNOLOGICAL BREAKTHROUGH

The Magnetic Loop Aerial is totally different from any other aerial. It relies solely on the magnetic portion of the electromagnetic wave to operate. It filters out all unwanted noise via 180° phase shift between the magnetic and the electrical wave, exactly what is required from 1 to 14MHz where the electrical noise is virtually unbearable.

Depending on the model used and within the bounds of the frequency designated for that model, the Control Box enables the user to operate the antenna from the lowest to the highest part of the frequency with no gaps. There are various models of loops - typically 2 antennas and 1 Control Box is required to cover the whole HF frequency range from 1 to 30 mcs. A reduction of £50.00 is allowed for two aerials. Prices range from £79.95 for the receive Loop to £456.00. Power ratings for these versions are from 100-200 watts.

The Commercial versions, power rating 500 and 1000 watts come complete with Automatic Controller which selects the frequency you require.

- It has a very high Q
- A radiation resistance of an ohm, never more than 800 milli ohms
- Has a bandwidth from 3KHz to 50KHz
- It has an SWR of 1.4 to 1 at the very least, 1.1 to 1 on most bands
- Will operate at virtually ground level
- The loop has a vertically polarised radiation pattern containing both very high and very low angle radiation (ideal as a DX antenna)
- Does not require an Antenna Tuning Unit
- Depending on the model used it only occupies from 80cm to 4mt of space
- It is ultra compact, light and waterproof
- Planning permission is not necessary

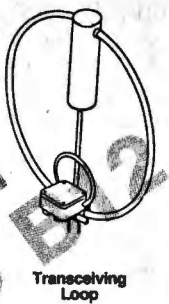

Transceiving Loop

PLEASE WRITE INCLUDING SAE FOR FURTHER DETAILED INFORMATION

Our equipment is guaranteed, unique and as such protected by registered designs and copyright. Our policy is one of continual research and improvement therefore current specifications are subject to change without notice.

63, Hallcroft, Birch Green, Lancs WN8 6QB. Telephone: 0695 27948

DATONG ELECTRONICS LIMITED

AUDIO FILTERS MODELS FL2, FL3, FL2/A

Model FL3 represents the ultimate in audio filters for SSB and CW. Connected in series with the loudspeaker, it gives variable extra selectivity better than a whole bank of expensive crystal filters. In addition it contains an automatic notch filter which can remove a "tuner-upper" all by itself. Model FL2 is exactly the same but without the auto-notch. Any existing or new FL2 can be up-graded to an FL3 by adding Model FL2/A conversion kit, which is a stand-alone auto-notch unit. Datong filters frequently allow continued copy when otherwise a QSO would have to be abandoned.



FL2 £89.70 FL3 £189.37 FL2/A £39.87

ACTIVE RECEIVING ANTENNA

Datong active antennas are ideal for modern broadband communications receivers - especially where space is limited.

- highly sensitive (comparable to full-size dipoles)
- Broadband coverage (below 200 kHz to over 30 MHz)
- needs no tuning, matching or other adjustments
- two versions AD270 for indoor mounting or AD370 (illustrated) for outdoor use.
- very compact, only 3 metres overall length.
- professional performance standards.
- both include mains power unit.



MORSE TUTOR

The uniquely effective method of improving and maintaining Morse Code proficiency. Effectiveness proven by thousands of users world-wide.

- Practice anywhere, anytime at your convenience.
- Generate a random stream of perfect Morse in five character groups.
- D70 unique "DELAY" control allows you to learn each character with its correct high speed sound. Start with a long delay between each character and as you improve reduce the delay. The speed within each character always remains as set on the independent "SPEED" control.
- Features long life battery operation, compact size, built-in loudspeaker plus personal earpiece.



AD270 £51.75 AD370 £89.00

Our full catalogue plus further details of any product are available free on request. Dealers in most countries, please send for list. Credit cards accepted. Goods normally despatched within 3 days subject to availability. All prices include V.A.T. P+P.



Datong Electronics Limited, Department PW, Clayton Wood Close, West Park, LEEDS, LS16 6QE. Tel: (0532) 744822 (2 lines)

Mobile Practice Morse Key

Unfortunately, today's pace of life rarely leaves time for the practice of any language, excepting our native tongue. Mason Jay, realising this fact, has designed this go anywhere Morse training key. Just right for use while travelling to work on public transport.

The problem with Morse is the fact that practice makes for perfection, trouble is for some there never seems to be enough time to acquire that perfection. Rushing around like I do drives the point home, but where there's a will there's usually a way.

My first thoughts on this matter were to carry my Morse key on my person, and thus use up any free time with a bit of practice; alas this proved disastrous as the key tore the lining of my jacket pocket! So for all those "fisters" out there walking around with a hole in your jacket pocket, here is a better idea by far . . . an actual portable practice key!

The Circuit

The circuit isn't new, it is one of those found lying around the shack scribbled on a piece of paper, like many variations on a theme. The one described here is another in that category. The circuit uses a 555 or c.m.o.s. 7555 timer i.c. (Surprise! Surprise!) in conjunction with some bits from the "I might need that later!" box; the Morse tones are heard via a set of earphones, I used the pair I got with my personal cassette player.

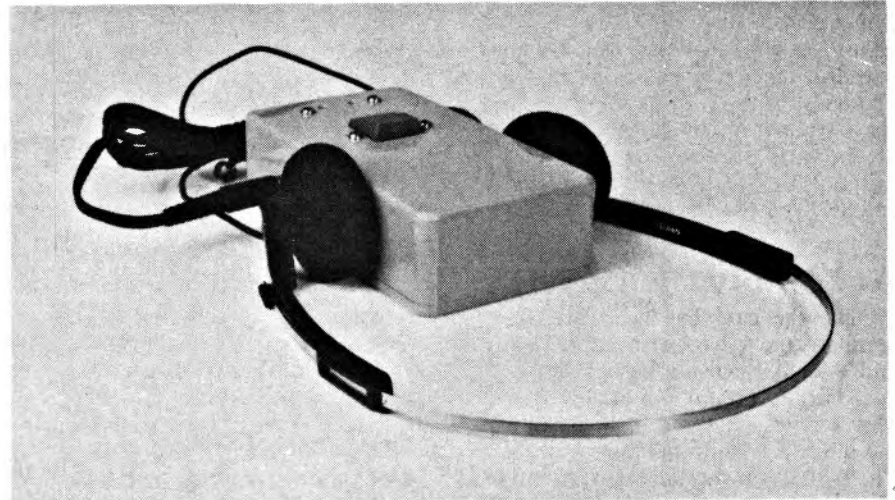

Completed PW prototype

The Unit

The Morse key is formed by an RS keyboard switch (Part No. 337-368), that company has now opened a mail order service for us mortals!⁽¹⁾ The Morse oscillator p.c.b. fits snugly into a small plastics box, the dimensions of which are left to the discretion of the constructor; I used a cuff-link box, a present from my daughter who hadn't noticed I never wear shirts!

The motive behind this simple unit

is to allow the beginner a sneaky bit of practice while travelling on the bus or train to work!, or even on horseback if that should be desired! Back in the shack with the prized brass key plugged into SK1 and an 8Ω speaker into SK2, the little unit is transformed into a full blown practice oscillator.

There is no intention here to assume that a keyboard switch duplicates the action of a Morse key, but because the

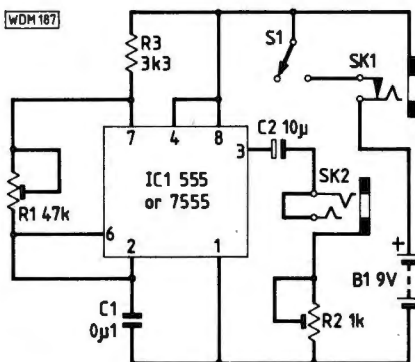

Fig. 1: Circuit diagram

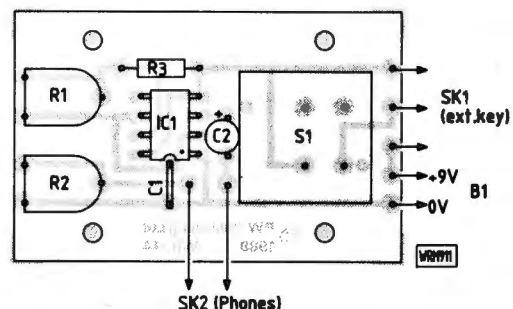
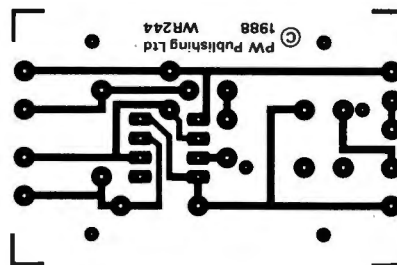

Fig. 2: Single-sided p.c.b. track pattern and component placement diagram shown full size.

switch has, manufacturers quote "tactile feedback", it simulates the key action and is useful for that bit of extra practice when a big key isn't at hand. (Please excuse the pun!) An alternative to this type of switch could be one of the many types of micro switch now in existence.

Construction

When the p.c.b. is made and drilled, and before any components are soldered in, place it track-side up against the underside of the lid and mark the position of the three guide holes and fixing holes. Drill out two holes just large enough to accept a small screwdriver; enabling external adjustment of tone (R1) and volume (R2) potentiometers. Next make the square hole to take the switch pad, using a suitable size drill bit and a square needle file. To complete work on the lid, drill four p.c.b. fixing holes, large enough to accept 6BA screws. Lastly drill two suitably sized holes for mounting SK1 and SK2, positioned for ease of access.

Assembly

Once the case has been prepared, populate the p.c.b. with components and any flying leads needed for off-board connections. Then, taking four 6BA screws, nuts and spacers mount the p.c.b. on the underside of the lid. The switch pad should be just proud of

SHOPPING LIST

Resistors		
<i>0.25W Carbon film 2%</i>		
3.3kΩ	1	R3
<i>Miniature horizontal presets</i>		
1kΩ	1	R2
47kΩ	1	R1
Capacitors		
<i>Monolithic ceramic</i>		
0.1μF	1	C1
<i>Tantalum bead 16V</i>		
10μF	1	C2
Semiconductors		
<i>Integrated circuits</i>		
555 or 7555	1	IC1

Miscellaneous
 S1 keyboard rocker switch, momentary action (RS No 337-368); Plastics box 80 x 60 x 35mm; 6BA nuts and screws (4); 6BA x 6mm spacers (4); 3.5mm stereo chassis socket; 3.5mm chassis socket, closed circuit contacts; 6-F22 (PP3) battery and connector; Sticky Fixer; Connecting wire; p.c.b.

**How Much?
& Difficult?**
£10.00
Intermediate

the top of the lid, and the trimming screws of R1 and R2 should be in line with their adjustment holes. Next fit and connect SK1 and SK2, in addition to B1, using sticky fixers to secure the battery to the case.

Finally, close the box, plug a pair of

earphones into SK2, and with the switch pad of S1 used as the Morse key you can sit down and practice anywhere . . . and may the fist be with you!

PW
 (1) Electromail, PO Box 33, Corby, Northants NN17 9EL.

SUBSCRIPTION OFFER

One Year — £14.00
Two Years — £26.00
Three Years — £36.00

Wherever you live, a Postal Subscription will ensure that you receive your copies of PRACTICAL WIRELESS and/or SHORT WAVE MAGAZINE regularly, through your own letterbox, before it gets onto your newsagent's shelf. Order a Joint Subscription and you will qualify for the Special Discount.

Fill in the Order Form below and post it to: PW Publishing Ltd., FREEPOST, Subscriptions Dept., Enefco House, The Quay, Poole, Dorset BH15 1PP (no stamp required). Credit Card Orders taken on (0202) 678558.

Overseas subscriptions outside Europe are now despatched by Accelerated Surface Post for faster delivery.

Please indicate the type of subscription required:

Special Joint Subscription



- See above (UK)
 See SWM (April)
 £27.00 (UK)
 £18.50 (Overseas) for offer details
 £30.00 (Overseas)

(Prices correct at February 1988)

To commence with issue dated

To: PW Publishing Ltd., FREEPOST, Subscriptions Dept., Enefco House, The Quay, Poole, Dorset BH15 1PP (no stamp required).

Name

Address

I enclose cheque/PO (Payable to PW Publishing Ltd) £

Charge to my Access/Visa Card the amount of £

Card No.

Valid from to

Signature

PW REVIEW

Jaybeam VR3 Vertical Tri-band Antenna

PW HF Bands columnist Paul Essery GW3KFE recently installed a Jaybeam VR3 vertical tri-band antenna at his home QTH. Here he relates his impressions of the antenna and its performance.

The packaging of an antenna is an important consideration for a buyer. The author collected his VR3 from GW3TMP at SMC(TMP) in Buckley, Clwyd, and was pleased to note that the package slipped neatly into the back of a Metro, whereas the equivalent Hy-Gain antenna was in a longer package and would have been a problem to transport home.

Instructions

First impressions are of a nicely covered pamphlet, until I found that the internal pages are a copy of some pages on the equivalent tri-band beam, incompletely amended. I had visions of some poor character endeavouring to reconcile references to directors and reflectors and failing miserably! There were several obvious spelling errors also. Overall, not a credit to the makers. It would seem sensible also to give dimensions in inches as well as metric, for the benefit of older buyers!

Assembly

I just followed the instructions, with the bits laid out along the hall of the house, and checked all measurements. Jaybeam give dimensions for low-band operation (c.w.- biased), high-band operation (for s.s.b.-only types) and a mid-band set for those who like both modes. They state that you cannot mix modes between bands. In fact, if you are prepared to spend a lot of time fiddling and measuring v.s.w.r. you can bend the rules a little. Obviously, though, if you do this you may reduce the physical overlaps in the tubes below what the makers would regard as an acceptable safety margin.

The only problem experienced was

the the smallest size Jubilee-clips used to clamp the very top section both failed with stripped threads: hardly J-Beam's fault, in fairness, since they supply very obviously high-quality clips. Luckily I had a couple of spare ones in the tool-box, so the delay was quite minimal.

Mechanical

Unusually, J-Beam make the lower piece, which clamps to the mast, from extrusion rather than the bent and joggled sheet material used by the other makers. I think this is a plus point for Jaybeam, in terms of strength, and of a neat appearance at the top of the mast. Against that, the SO239 connector and the potted shunt inductor are both bolted to the extrusion and are therefore out in the rain. However, this design has the advantage that it is very easy for any moisture which might find its way into the main assembly to drain to the bottom and drip straight out. The radials are attached to specified places on the base extrusion, and odd lengths are called up for them to balance this out.

Getting it up

The erection party comprised just two people, both active pensioners. It is essential though, to have a clear plan of campaign; spend more time planning the erection than working. Don't forget that an antenna falling while being erected could be dangerous to life and limb. My garden is about 7.5m (25ft) square; at the end of the garden there is a road. Thus we had to use some care in erection, since we had the antenna mounted atop a 7.5m two-section mast. We were able to persuade

it to an upright position without too much difficulty, with one member of the party hauling on a line taken from the top of the mast up to a convenient bedroom window. There are three guys at the top of the mast, and four guys running from the 4.3m level.

As it was, we had a problem once the system was in the air, as the radials had done a fine "weaving" job. Putting it up on a future occasion. I would try to find some way of keeping the radials apart and away from the guys of the mast while the mast and antenna is being raised.

Results

When the antenna was first erected, I returned indoors to find an infinity v.s.w.r.! The moral to this is: check the coaxial cable from end to end with a d.c. meter BEFORE you raise the whole show. It goes without saying that the short was inside the PL259 plug at the antenna end! Once the short-circuit in the coaxial connector had been rectified, the antenna proved very good in terms of contacts. Radiate it certainly did, and very satisfactorily. The v.s.w.r. measurements turned out to be just the same as the claimed graphs shown in the instructions. I set the antenna up for mid-band, which gives coverage of all of 14, 21 and 28MHz with acceptable v.s.w.r.; those who have a solid-state p.a. rig may need to use an a.t.u. at the band-edges.

Although nothing is said about it in the manufacturer's instructions, there can be no doubt that the v.s.w.r. degrades in wet weather; a 1.5:1 s.w.r. will rise to about 2.5:1. On the other hand, after drying naturally, the s.w.r. reverted to normal, and the antenna showed no sign of distress when fed

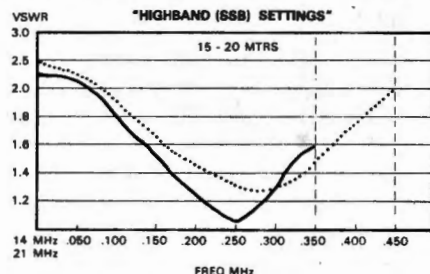
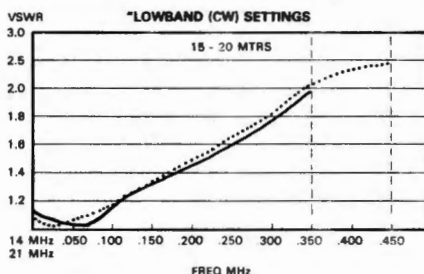
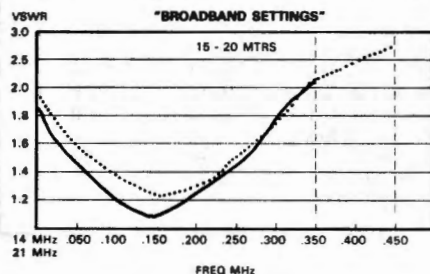

with key-down full power from the FL-2100Z linear. As a primarily c.w. operator, I have not yet poked a "full gallon" of s.s.b. up it in wet weather. Wet or dry, it yields the signals in the receiver, and it doesn't seem to become lossy.

However, noting the way the v.s.w.r. worsens in bad weather I can't help but wonder whether I shall have trouble at some future date. Mechanically it has stood up against some mighty gales without complaint. All continents have been worked on 14, 21 and 28MHz without difficulty, and I seem to have got rid of my previous problem of inability to radiate to the west, possibly by virtue of the bit of extra height as well as the vertical polarisation.

The radials specified for ground-plane style operation at the top of a mast are two to each band. The dimen-

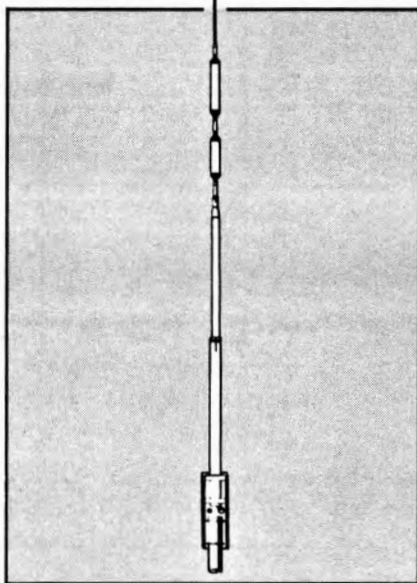

sions are given, and it is important to note that both radials for the band be the SAME length; if one is short and the other long you may have an unexpected amount of upwards radiation, though this isn't mentioned in the manufacturer's data. Also, ideally each pair of radials should be opposite each other e.g. one north, one south.

Ground Mounting

The idea of ground-mounting a vertical is attractive. However, for success you need a good take-off, and a good earth system. In practice, a vertical at ground level seems to radiate well enough but all the r.f. is absorbed in surrounding objects—something for which the antenna cannot be blamed. Get it up in the air is my motto! **PW**

**REVISED SERVICE!
LOWER PRICES!**

Practical Wireless



0202 678558



PCB SERVICE

Printed circuit boards for *Practical Wireless* constructional projects are available from the PW PCB SERVICE. The boards are made in 1.5mm glass-fibre, and are fully drilled and tinned. All prices include postage, packing and VAT for UK orders. Please add £2.00 per order for despatch to overseas addresses.

Orders and remittances should be sent to: **PW Publishing Limited, FREEPOST, Eneco House, The Quay, Poole, Dorset BH15 1PP**, marking your envelope **PCB SERVICE**. Cheques should be crossed and made payable to PW Publishing Ltd.

When ordering, please state the Article Title and Issue Date as well as the Board Number. Please print your name and address clearly in block letters, and do not send any other correspondence with your order. You may telephone your order using Access or Visa. A telephone answering machine will accept your order outside office hours.

Please allow 28 days for delivery. Always check the latest issue of PW for the current details of price and availability. Please enquire for p.c.b.s not listed here.

Board Number	Title of Article	Issue Dated	Price (£)
WR068	AF Speech Processor	Jan 80	5.20
WR095	Transceiver Power Supply	Sep 80	3.85
WR126	"Exe" 10GHz Transceiver	Aug 81	7.70
WR144	Iambic Keyer	Mar 82	6.50
WR143	ATV Converter	Apr 82	7.10
WR156	Repeater Time-out Alarm	Nov 82	5.20
WR160	LMS Regenerative Receiver	Feb 83	5.20
WR167	RTTY Terminal Unit for ZX81	June 83	7.80
WR165	"Severn" (VFO)	June 83	5.20
WR166	"Severn" (Receiver/Audio)	Jun 83	6.50
WR168	"Severn" (Ch. over/Sidetone)	Jul 83	6.50
WR169	"Severn" (Transmitter)	Jul 83	6.50
WR165 etc set	"Severn"	—	14.90
WR161	"Marchwood"	Jul 83	2.40
WR179	Transceiver VOX Unit	Mar 84	6.50
WR183	Top-band DF Receiver	Apr 84	6.50
WR184	Simple Top-band Receiver	Jun 84	6.50
WR185	Auto-notch Filter	Jun 84	6.50
WR187	Morse Sending Trainer	Jul 84	4.50
WR190	Mod FRG-7 (Switching)	Oct 84	4.50
WR189/192 pr	Bug Key with 528-bit memory	Oct 84	8.50
WR194	Mod FRG-7 (FM/squelch)	Nov 84	4.50
WR195	Stable Toneburst	Nov 84	2.60
WR196	"Teme" (Transmitter)	Nov 84	3.70
WAD246	"Dart" Follow-up	Dec 84	4.00
WA001	"Teme" (VFO/Doubler)	Dec 84	2.80
WA002	"Teme" (Receiver)	Jan 85	4.30
WAD280**	Triambic Keyer	Feb 85	7.10
WAD249	Mod FRG-7 (BFO)	Feb 85	3.00

Board Number	Title of Article	Issue Dated	Price (£)
A004	"Colne" (RF Amp)	Apr 85	3.10
A005	"Colne" (VFO)	Apr 85	3.10
WR198	"Colne" (Product Det/Audio)	May 85	3.90
WR197	"Colne" (Oscill/Converter)	Jun 85	3.90
WAD302	Battery Charger Controller	Jun 85	3.00
WR200	Low-cost Crystal Tester	Jul 85	2.50
WR201	Add-on BFO	Aug 85	2.50
WR202	Economy UHF Pre-scaler	Sep 85	3.70
WR199	"Meon" 50MHz Transverter	Oct 85	6.70
WR203	Simple Capacitance Meter	Oct 85	2.80
WR204	WQ Medium Wave Loop	Nov 85	3.00
WR205	RTTY/Morse Modem	Jan 86	5.40
WR206	RTTY/Morse Modem (plug-in)	Jan 86	2.80
WR207	Crystal Calibrator	Jan 86	2.10
WR208	RF Speech Processor	Mar 86	4.10
WR209	Simple Audio Oscillator	Mar 86	4.30
WR211	"Meon" Filter	Apr 86	3.10
WR210	"Arun" Parametric Filter	May 86	8.10
WR213	Mod FRG-7 (Carrier Osc)	Jun 86	2.70
WR215	Simple 50MHz Converter	Sep 86	3.60
WR217	Automatic NiCad Charger	Oct 86	2.40
WR220	Get Started Low-cost Converter	Oct 86	2.40
WR216	LF Bands Active Antenna	Nov 86	2.40
WR222	"Taw" VLF Converter	Nov 86	2.80
WR223	High-imp MOSFET Voltmeter	Dec 86	2.90
WR214	Mod SRX-30D (Audio)	Dec 86	3.00
WR224	"Westbury" Basic Wobbulator	Jan 87	3.50
WR218	Masthead Pre-amp for 144MHz	Feb 87	4.20
WR219	Masthead Pre-amp PSU	Feb 87	2.50
WR225	"Woodstock" SW Converter	Mar 87	4.10
WR298	"Itchen" LCR Bridge	Apr 87	3.40
WR226-8 set	"Blandford" Rcvr Converter	Apr 87	9.70
WR230-2 set	"Axe" Signal Tracer	May 87	9.20
WR233	"Downton" F-V Converter	Jun 87	3.90
WR234	Side-tone Oscillator	Jun 87	2.70
WR235	Mains on/off for Batt Radios	Sep 87	3.00
WR236	"Blenheim" VHF Converter	Sep 87	4.50
KANGA	High Stability VFO (see issue)	Oct 87	—
WR237	RTTY Tuning Indicator	Nov 87	5.20
WR238	"Otter" 50MHz Receiver	Jan 88	7.10
WR239-241 set	"Orwell" Medium Wave Recvr	Mar 88	9.10
WR242	"Orwell" Varicap Tune Option	Mar 88	2.90
WR243	VHF Monitor Receiver (Audio)	Apr 88	2.30
WR245	Stopband filter for PW Blenheim	Jun 88	2.90
WR244	Practice Morse Key	Jul 88	2.96
WR246	"Portland" RF Voltmeter	Jul 88	3.59

On The Air

On The HF Bands

Reports to Paul Essery G3KFE
287 Heol-y-Coleg, Vaynor, Newtown, Powys SY16 1AR.

DXpeditions & Contests

Revilla Gigedo activity, from Clarion Island, by XE2HUM/XF4 is slated to go on into the autumn, with QSLs via W6RQ. However, W6RQ is merely collecting up the mail, operator N6OND will bring the logs back home with him when the research project is over and then handle all the QSL chores himself.

A couple of interesting ones, BTOLS on Mount Everest and BTOZMS in Lhasa, both favouring 14.180 and 14.280MHz.

On to October, K8JRK will be on from Tuvalu, with FO0 to follow. The T2 activity will be timed to correspond to the CQ WW SSB contest dates.

Congo, TN, is likely to be available at weekends thanks to an effort by N4NW and 9Q5DA. They are setting up regular weekend visits to Brazzaville from their base in Zaire. They cross the river on Friday evening, operate until Sunday lunch-time and return to 9Q5 later on Sunday. The frequencies to note are: on c.w. 25kHz up from the bottom of each band and on s.s.b. 7.043, 14.145, 14.180, 21.250, and 28.495MHz, all split-frequency operation.

Apparently, Tom is asking for donations for this one as it costs \$150 for the river crossing each time and the licence costs some \$700 dollars. QSLs either direct to AL7EL or via the Bureau. It should be noted that the Bureau cards will not be answered by AL7EL, they will be handled by N4NW on his return in October and should therefore be addressed to his home call N4NW.

There has been a tightening-up of Solomon Is, H44, licensing recently, so there are now only five operators available on h.f. H44X will be operational between June and August to celebrate the tenth anniversary of their independence.

Rumour has it that there will be another Mount Athos expedition in September; in addition it is said that the monk Apollo passed his test and at the time of writing was waiting the allocation of the call SY2A.

Glorioso Is, FR/G, will be activated by Bruno FROEH between June 22 and July 31.

Rumours of an operation from Vietnam abound, the main aim seems to be a major effort by the Russians to coincide with the CQ WW SSB contest in October, some ten operators being mentioned. On the other hand it is also noted that another rumour says they are aiming for 1989...

Thanks to friends, the DX Bulletin and RSGB's DX News Sheet for the above information.

On the contest front there is the AGCW-DL QRP CW contest over the weekend July 16-17. There is also a QRP ARCI CW Sprint on July 10, the s.s.b. leg being on August 14. That leaves July 9-10 for the IARU HF World Championship.

The 1.8MHz Band

Not much in the way of reports this month. G3BRD (Seaford) notes two-way s.s.b. contacts with HH7PW, D44BC, J56AS, SV1DO, OY9JD, T18CBT, YV3AZC, YV3AGT, FY5YE, PJ2FR, T12CC, VP2MU, 4U1UN, P40V and TG9NX. The c.w. brought VK5BC (the

opening lasted nine minutes at Seaford), RF6FIN, U18BWE, UG6GCK, UC2SD, RA9SSN, UD6DBN, RV9CFU, UA9CVK, UA0YO (Zone 23), J52US, PZ1DT, W6LTA, K5XX, WB5HKY, W0CD, W0FIH and about twenty assorted Europeans. The score over the past year is 114 countries and 29 Zones.

G2HKU (Sheppey) reckons the bands have improved and so he seems to have spent more time on h.f. However, Top Band produced contacts with ON4CW using c.w. and ON7BW using s.s.b.

The 3.5MHz Band

This band seems largely to have been ignored by most. G2HKU operated c.w. to work GI3VJ/CT3 and YU3AG/MM, who was aboard a 30 000 ton bulk carrier *MV Bovec*, off EA8.

For the moment, GM0FUW (Beith) has 20m of wire nailed to the barge-boards around the house, fed against ground, and an HW8. Steve has some 2 watts of c.w. and says he worked G4WUS and GM3MXN.

The 7MHz Band

GM0FUW kicks us off with his QRP and wire antenna bent around the eaves. The first trials on weekday mornings proved the proposition viable, with DL3BAH worked on c.w., but UF6DZ was a Gotaway.

Now we turn to G2HKU. He offers c.w. with K01C, W7WA, YV4OY, KA9UOM, W2BA, VE2GFE, CO1RH and K4HZ.

GM3JDR (Wick) is quite active on this band and I would guess Don picks his homes for a quiet environment. Whatever it is, his c.w. connected with W6FGD, WK6E, OX3LX, VK2ARZ, AX6RZ, VK3XU, VK2KM, VK3MJ, AX6SA, VK1DO, JA6QCK, JA6PK, JA4DND, JA3BRB, JA5RH, JF1PJK, JA8DNW, JA8ZO, JA7AGO, JA3BCT, 5K7U (HK), FJ5BL, VU2JCE, VU2PTT, VU2GRM, VU2VWN, PY5RT, PY2NE, PY1DNL, PY2ATL, PY2LEE, UA0YO, RH8BA, U18F, UA0AAS, U18IZ, PZ1DV, ZL2AFH, YN3CC, KC3RE/TA3, WA2IUO/TI2, LU6XPA, ZS6BSZ, ZS6QU, ZS2HZ, T77F, T22VU, FT5ZB, Y88POL, 8R1J, YB3AS, 4Z4OI, 9V1VS, VE6UX, FK8FF and SY88AE.

Next we have a new reporter. Oene PA3CWN, Terschelling Is, uses what he describes as "an old Swan 500C" with about 100 watts, initially into a vertical, more recently to a Delta Loop which is proving the best so far. Three months activity has yielded contacts with over 130 countries. On the c.w. front, Oene offers 9V1XE, 9V1TJ, KL7XX, FY4EE, ZF2KZ, PZ1DV, ZS6QU, 6Y5JH, CN2AQ, PY0FNI, 9N7YDY, VP8LX, 3B8CF, PA3XAU/SU, OX1XC/JT, J37AE, 9Y4JJA, FG5BM, W4UXI/J8, W4UXI/VP5, KP4NL, J56AS, OH0MB/OJ0, VK9YA, 7X3DA, OD5LX, 4J1J, 4K0E, HC1ATG, VS6UW, HI3JH, 4S7WP, 8P9HR, FM5WD, C56/DJ1RL, N4RP/C6A, V31OX, ZL7TZ, T18LGM, 5H1HK, WB1AUW/V47, KH6LE, VP2MET, XE3AAF, YN3CC, VK9LC, KOKJ/HP1, CE6NOT, SY88AM, NG1V/FG, PJ2AM, YV410, lots of PY, JA, ZL and Ws, plus, on phone PJ7/W3BTX and CP6RS.

For GOJBA (Sittingbourne), the band was mainly a question of Europeans worked, though Phil managed to hear ZLs, VKs, ZSs, YVs and other goodies.

Now G3BDQ (Hastings). On s.s.b., John mentions 4X6UK, JA2BAY, JT0TJ (Ulan Bator, Zone 23), TF5BW, RL8PYL and UL8LYA. The main activity on c.w. produced contacts with 4S7WP, 4X4OR, AX6RZ, JE8PFJ, KP4TIN, OX3LX, VU2GRM, VU2JCE, VU2ASH, UL7CSAD, UL8GWB, U8MCC, RWOAW, UA0ABB, UA0QO (Yakutsk) and UA1OT (Franz Josef Land).

The 10MHz Band

Rather more reports this time. Nice to hear from G3PJT (Cambridge). He found HB0/HB9BFN, JA6HW, JA8AAM/1, JA1ADN, JA1QXY, JA6WGE, JH2CLV/2, KP4TIN, W7EXR, UA0FN (Sakhalin), VK3NC and N6QR. The JAs seem to be best around 1830-2100, along with UA0, W6, W7, VE7 between 0500-0700 on the short path and the VKs between 0600-0800 on the long path. As for the antenna, Bob uses a two-element quad. Bob says I should try to persuade more people to try this band, trouble is you must have a receiver able to cope with QRM.

The 14MHz Band

GM3JDR seems to have stuck to c.w. and his bag includes UA0IDX, VK2APD, ZL3AGI, JA7ARH, VS6DO, TPOCE, VS6UO, YB2FEA, 9M2FK, VK5TL, AX5BGL, ZL1BSG, ZL1FZ, FK8AH, TI2LK, K8TVO/KL7, EX0DR, CM7UW, VK9LC, KL7PJ, CX5RV, ZLOAAC, T3OMA, T22VU, 4K0E, Y88POL, VU2OIC, ZL2PV, VK7CW, BV2FA, HL5AP, JTONP and 8Q7VG.

Turning to the letter from G2HKU, we find Ted sticking to c.w., with such as 9Y4AJC, WOSA (Minn), NODDP, KA4IVQ, HK7UL, VK4DU, 9Y4BK, AX4XA, JWOB (QSL to SP5EVN), PZ1AV, VE3NOT, K2LE, N1FES, PY1BVY, LU3ARA/MM off Puerto Belgrano, VK3BXN, W4DGJ, W3VT, KL7PJ, K4FU and WA4SNI. The QSO with VK4DU started at 70 watts and was steadily reduced to 12 watts while still maintaining solid Q5 copy all the way.

G3NOF (Yeovil) says the band has been opening with signals over the North Pole from 0600, to KL7, KH6, ZL and the Pacific, changing to long-path for VK/ZL about 0700 up to 1000, the short path has been opening as early as 0900, with some signals holding up till 1800Z. West Coast Ws were good around 0630 and again around 1700. QSOs using s.s.b. were entered in the log from AL7FQ, AX2HD, AX4BLE, AX5ANC/M, BY1QH, C18C, C18JH, C18XN, CT3EU, FK8FI, FY0EK, HL4CCM, I8CZW/VP2M, J6LRG, JA4KFA, JA7HMZ, JG4AKL, JT0TJ, JX8KY, K9AJ/KH5K for country number 316 on phone, KC6HA, KH6J, KL7JA, KL7KN, KL7RA, NO1Z/KH1, OY9A, P40V, UA9TX, UA9YE, UA0KBO, (Zone 19), UA0KK, UZ0KWO, (Zone 19), UZ0OWA, UZ0QWJ, V44KAR, V47NXX (Nevis Is), many VKs, VO1SA/UA0 (the ski trek), VR6YL, VU2DK, XE2NNZ, XX9JN, Y14KRD, YJ8PE, WB3KBZ/VP9, ZK1DD, ZK1XG, ZL5BKM (Antarctica),

3D2MP, 4S7NMR, 4S7RO, 4U1UN, 4X6TT/W6, 5TORIM, 5W1TT and 9M2TR.

The list of stations heard from G1HEW includes a couple of VKs, VK4NE and VK5IT, April 13 and 14 respectively.

For G1MOFUW the QRP c.w. tests on his new wire showed the way with SP3NNE and IK0IHA both raised; lots of Yanks were about during the evenings, including the ARRL slow c.w. Pick of the Gotaways was probably YV2DDD who went back to a DL8.

G3BDQ says most of the real DX this time was on 21MHz, but on 14MHz he used s.s.b. to raise 7X2EB, 7X5AV, 7X5VRK, 4S7NMR, 4S7RO, IH9JKY (Pantelleria), VK7EK and ZL2APW. On the c.w. front there were 3B8FQ, UA0KB, UT9MGO/UA9K (Arctic), UZ0LWA (Vladivostok), TA1F, VU2HSM, VU2TTC and VE7HDX.

The 18MHz Band

G3EKP (Belthorn) says that he put up a dipole for 10.1MHz and after trying it out, decided to see whether it would accept r.f. on 18MHz. It did, and what is more there were signals, so G3EKP was able to work W5RK, KXOV and N2CUF in succession, at a time when his ears were telling him the band was probably just fading out.

Turning to GM3JDR, we find Don worked VK3NC, FG5XC, JA6BSM and UW9TB. There was also a brief list from G2HKU; Ted offered VK200 and W5ZF.

The 21MHz Band

G3NOF found the long path opening in the mornings good to JA/VK/ZL/Asia, changing over at about 0900 to the short path. Africans were noted morning and afternoons, South Americans 1100-2200, North Americans noon until band closure. Contacts using s.s.b. were made with CM5DD, DU6RCR, CP8CB, FM4DN, FM5FA, FY0EK, H2HH, HK6ISX, HL2BQE, HL9OB, HLOAFE, J45JG, many JAs, JT1KAI, RA0AIL, S83H, S79KO, SORASD, TI2CC, TU4BR/5U7, TX0A, UA0CT, UA0ICC, UA0QCA, UA0WAA, UW0LAP, VK9NKG (Cocos Is), VP2EC, VS6BL, VU2XX, W7IHI (Utah), VK4XY, ZPOY, 4Z5UZ, 5N0WRE, 5Z4ET, 8Q7MT, 9J0A and 9V1TJ.

Again an all c.w. operation by GM3JDR. Don made it to P29KD, JAs, ZS2RL, 8Q7XF, 8Q7VG, BV20A and U0AL.

Now G3BDQ, who reckoned this was the place to find the DX; for him, s.s.b. was the main mode, to A22CL, AX4KRP, AX6AI, 4X40A, 4Z4OI, 5H1HK, 4X4FF/5N4, 8P9EQ, 7X5AV, 7X5BY, 9X5AA, CN8EK, CU3GD, H22H, HL2INX, HR3JJR, JAs, J37XD, JY5EC, EL8BS, P40V, VE7DGI, VI88WA, VP8BP, VU1KT, TU3QOC, ZS3GB, YC0JIV, YC0JBE, YC1JZZ, YC3OSE, YC7JK, YC7URY, YC8KAR, RL7ABK and RA0AIL. There was c.w. with 5N0ELT, 8Q7XI, CP8XA, HK7UL, VS6VC and YB0DPO.

G1HEA's R1000 receiver seems to have stuck to the phone end of the band, resulting in 5B4US, YC0EAQ, YB0TL, JL1WPQ, JL1HE, JH2HYN, JG7REV, JI3BHE and JK1YGQ.

Next we turn to the report from G0FEH (Chesterfield). Dave uses a TS-830S, plus a pair of 813s as a linear, a 3.5MHz band dipole and an a.t.u. for all bands. Dave notes that he has worked C53FU, DU1DZA, EL2BA, HL5BAJ, JF2BAN, many JAs, JT1BG, KX6LJ, TG9NX, UW0LAP, VK8NHM, YC4VH and 3B8FU. As an aside, Dave asked about Russian awards ... not sure, but the obvious starting point for an enquiry would be Box 88 Moscow.

Now we turn to G0GMS (Horsham) who uses a FT-101ZD and a 21MHz delta loop, facing east and west, with the bottom length a mere 2.5m above ground. This produced J28EV, OK7XC/JT, all W call areas, FR5AG, ZC4NC, PJ2GG, PY5TM, F2JD/A6, VE6GJD, YJ8NYS, AP2MQ, 9V1MP, JAs, VE3, 4X6TV, UI, UF, an assortment of European Russians, UA9s and 4X4JU. The Gotaways included VK9NKG, VK9YT, JT0NP, 5H3BH, 5H3BR, VU2DPQ and KP2AP.

On a different tack, Tony wants a QSL address for 5A0A, I would think the SP Bureau might be a good place to start, but if anyone has anything better I would be pleased to pass it on.

Finally on this band, it gives me great pleasure to record that G1MOFUW, plus his two watts of c.w. and barge-board mounted antenna, has made it across the Pond; W1PMR, 1835, on April 20 — which must have made G1MOFUW's day.

The 28MHz Band

G0JBA starts us off. He uses an Icom 735 into either a half-size G5RV or, for 28MHz, a close-spaced three-element beam at 15 metres above ground. Phil

says he still has a lot to learn about c.w. operating, but he made it to UB5MHN and UA5HQA. On phone, using the beam, there were QSOs with EA8AGK, R3AUC, PA3AXU/SU (about whose status there have been some mutterings), 4X6DK, VK6AEA who is ex G0APG, VU2SMN, J28DN, RW9WZ, VI88NSW, UF6, UL7, FR5ZN, ZC4EE, LU9DM, PY1ZFO/P/O (Fernado do Noronha, QSL via W9VA), K4VFD, VU2GUY, TA2AO, TU2QQ, 5B4SA, HB9CUZ/P/5N9 (QSL to Box 8426 Kaduna), PYs, GB75DXN, KA1MVB, 9Y4DR, 8P6OV, VP8FIR, YI1BGD, YC6KHZ, OD5PL, JY5CI, ZS4AE, NG1WRM/M, N3EMY, V47NXX (QSL via AA4FS), 4Z4OI, CX2AAL, CE8DQS, and of course the usual crop of Gotaways and small fry.

G4QCQ (Brighton) uses 28MHz in particular at the weekends when he travels back home to Farnham. He uses the calling frequencies of 29.6MHz for f.m. and 28.5MHz for c.w. Early one morning, VK6LK was raised on s.s.b. Others have been OD5MWA, ZY5EG, LS1E, EA8VV, 3B8CF, all on s.s.b., N4JTZ on c.w. and a couple of 4X4s on f.m., plus a Gotaway AX6RO on the same mode.

Turning to G3NOF, Don notes that on the good days it has been very good, but on poorer days there have only been South America or the Middle East. The band has been open from 0700 to 2200Z on the best days. Contacts using s.s.b. were made with A4XKB, AX4NHF, AY6D, CE3NR, CP2DP/6, CP8HD, DJ6SI/TY, FH8CB, FM4DN, FT5ZB, FY5EM, FY0EK, H2HH, J28EV, JY1, KV4AD, KH6FOO, LU1E, LU4FM, NR5M, PY1VOY, PY0FF, PP5UI, RL9PYL, TA2AO, TA3C, TJ1DL, VK9NKG (Cocos Is), VP8BGA, VP8BKO, VP8BLD, WOQEV, XX9JN, YC0FEX, YI10BGD, ZP5MSC, ZS1IC, ZS3/DL8ZBL, 3B9FR, 3DA0BW, many 4Xs, 5B4TI, 5H3RB, 5N0WRE, 5TORIM, 7P8DP, 8P6OV, 9J2WS and 9Y4VU.

April 13 saw Patrick Travers G1HEW tuning around the band. He found 4Z4AB on this band, using his R1000 and 21MHz dipole.

**The next deadlines for
your letters are: June 29,
July 27 & August 24**

VHF Up

With one-third of the year gone there is still no good tropospheric life to report. Looking back, not since November 1987 has there been a decent opening. To offset this though, several readers have mentioned E-layer propagation on the lower v.h.f.s during April, and Auroral activity has continued.

Awards News

Congratulations to Paul Pasquet G4RRA (ZL67h) from Upper Hale, Farnham in Surrey. He is member number 86 of the 144MHz QTH Squares Century Club. The basic certificate has stickers for 125, 150, 175 and 200 added and Paul's confirmed total is 208, with a handful of cards for QSOs made under his previous call G8PVB.

Cards from 36 DXCC countries were submitted, plus IT9 (Sicily). 153 QSOs

Practical Wireless, July 1988

were by tropo, 32 via Es, 18 by Ar and five by meteor scatter modes. 151 contacts were on s.s.b., 52 c.w. and the rest on f.m.

Many QSOs were really choice DX and I would pick out IW9AJZ/IH9 (GW) via Es in July 1983 which is Zone 33 and Africa, IJ7ET (IA) via Es in June 1982 in the Cheradi Islands, UA2WJ (KO) on tropo in Oct 1985, SV8JE (KY) via Es in June 1987, SV10E (LX) via Es in June 1985 and RA3YCR (RN) via Es in July 1986.

Paul's QTH is very good to Europe and his present station comprises an Icom IC-730 transceiver and 28/144MHz transverter by MuTek, the antenna a 9-el Yagi by Tonna.

The 1988 Annual Table

The inclusion of 50MHz in the Annual Table seems to be popular as over 60 per

Reports to Norman Filch G3FPK
40 Eskdale Gardens, Purley, Surrey CR2 1EZ.

Annual c.w. ladder

Station	Band (MHz)				Points
	50	70	144	430	
G4ZEC	—	—	303	—	303
G0HGA	—	—	189	—	189
G4OUT	—	—	163	—	163
G0HLT	9	—	117	—	126
G4WHZ	8	—	106	—	112
G4ZVS	—	—	80	—	80
G3FPK	—	—	62	—	62
G2DHV	10	23	22	—	55
G0DJA	6	—	48	—	54
G0GKN	—	—	52	—	52
G4AGQ	—	11	27	2	40
G4VOZ	8	22	—	9	39
G1SMD	8	—	13	—	21
GW4HBK	5	14	—	—	19
GU4HUY	—	—	3	—	3

Number of different stations worked since January 1.

cent of participants are using this band. One reader queried cross-band QSOs but these cannot be included. All countries and countries must be in-band QSOs. Things would rapidly get out of hand otherwise.

For the benefit of new readers, the scores are based on unconfirmed QSOs so please only include counties and countries you are certain you have worked. In a hectic Es opening, with signals fading from S9-plus to nothing in seconds, you cannot be certain that the contact was complete; i.e. exchange of both call signs and reports. QTH locator information is not required for a valid QSO, by the way.

The same comments apply to random m.s. contacts and frankly I am rather sceptical when I hear someone claiming to have completed dozens of such QSOs in, say, the Perseids. I have monitored a great deal in major showers and there is such confusion that it is often impossible to be sure the "rogers" you receive are for you and not someone else. Such ambiguous QSOs ought not to be claimed until confirmed on the 14MHz v.h.f. net or by QSL.

DXpedition News

Nigel Wilson G4VVZ, Secretary of the Derbyshire Hills Contest Group, has sent further information about their proposed operation from the Isles of Scilly this summer. The dates are Aug 4-14 and it will be their seventh such operation.

The operators will include G6ABU and G6HKS as well as G4VVZ but fewer personnel than in previous years due to other members' prior commitments. Three v.h.f. bands will be used as follows:

70.220MHz using an Icom IC-202, Microwave Modules transverter, 4CX250B amplifier and 5-ele MET Yagi at 14m a.g.l. 144MHz using an IC-251E with MuTek mod., 400W amplifier, MGF1202 pre-amp and two 19-ele MET Yagis at 14m. 432.220MHz using an IC-471E, 400W amplifier, MGF1202 pre-amp and four 23-ele Cue-Dee Yagis.

On 70MHz the call will be G4VVZ/P, on 144MHz G4ZAP/P and on 430MHz, G6APZ/P. The 144MHz QRGs will be .220 for tropo, .144 for c.w. m.s. and .444 for s.s.b. m.s. The locators are WJ09e or IN69UV. Contact G4VVZ (QTHR) for m.s. skeds.

Another VHF Net

John Eden G4VEXN (HLD) passes along the information that a 3.5MHz band v.h.f. net has been proposed with a particular emphasis on Auroral events. It was due to begin on April 12 but it was not stated if it is to be a daily affair.

The time is from 1900UTC on 3.678MHz and the instigators are LA5SAA and PA3CWN. Please let me know if this idea catches on. It makes sense to have an alternative to the v.h.f. net around 14.345MHz which is often difficult at times for inter-Europe QSOs and frequently suffers strong QRM from North American nets.

Contest Notes

First a reminder about the 432MHz f.m. contest on June 12; see the June VHF Up for details. Next a note that the third and fourth legs of the 10GHz Cumulatives are on June 19 and July 10, 0900-2100UTC.

VHF NFD occupies the weekend July 2/3 and is the usual 24-hours event starting at 1400UTC. Up to four separate stations allowed in the 70, 144, 432 and 1296/2320MHz bands. As previously, on 70MHz c.w. only from 1400-2200 and

Annual v.h.f./u.h.f. table January to December 1988

Station	50MHz		70MHz		144MHz		430MHz		1296MHz		Total Points
	Counties	Countries	Counties	Countries	Counties	Countries	Counties	Countries	Counties	Countries	
G4XEN	33	3	—	—	58	13	39	7	—	—	153
G1KDF	6	3	—	—	62	10	44	6	9	3	143
G6HKM	—	—	—	—	62	10	37	6	7	4	126
G1IMM	19	2	—	—	50	9	28	2	—	—	110
G1SWH	13	3	—	—	52	7	29	5	—	—	109
GMOEWX	41	7	—	—	44	11	—	—	—	—	103
GOIMG	25	3	16	1	38	6	5	1	—	—	95
G8LHT	5	1	—	—	47	10	27	2	—	—	92
GW6VZW	24	3	—	—	56	9	—	—	—	—	92
G3FPK	—	—	—	—	64	14	—	—	—	—	78
G1EZF	—	—	2	1	56	18	—	—	—	—	77
GMOHBK	12	6	—	—	44	13	—	—	—	—	75
G6MGL	11	1	—	—	49	8	—	—	3	2	74
G6MXL	14	3	8	2	31	4	9	2	—	—	73
GW4FRX	—	—	—	—	49	16	—	—	—	—	65
G2DHV	5	1	12	1	28	6	7	1	—	—	61
G4VOZ	12	3	25	3	—	—	13	3	—	—	59
G8PYP	6	3	1	1	34	6	4	1	—	—	56
GW4HBK	17	4	29	3	—	—	—	—	—	—	53
G3EKP	12	3	16	4	7	4	5	1	—	—	52
G8XTJ	—	—	—	—	47	5	—	—	—	—	52
G4WHZ	3	2	—	—	31	12	—	—	—	—	48
G4AGO	—	—	9	1	25	3	6	1	—	—	45
G1SMD	12	3	—	—	20	4	—	—	—	—	39
G4ZVS	—	—	—	—	34	5	—	—	—	—	39
ON1CDO	—	—	—	—	26	10	—	—	—	—	36
G8BDFX	—	—	—	—	27	9	—	—	—	—	36
ON1CAK	—	—	—	—	27	8	—	—	—	—	35
GOHGA	—	—	—	—	30	5	—	—	—	—	35
GOHDZ	—	—	—	—	30	5	—	—	—	—	35
GJ6TMM	1	1	—	—	13	7	—	—	—	—	22

phone only 0600-1400 with a shut down between 2200 and 0600.

There are two sections in NFD. The Open (O) is as per the licence conditions and the Restricted (R) limits the TX output to 25W p.e.p., antenna height 10m a.g.l. or less using one antenna per band; i.e. no stacked or bayed Yagis, collinear arrays or switching between different antennas allowed. The 2.3GHz band is excluded from the R section.

Inspectors will be on the prowl visiting sites on a random basis. Entries will be disallowed if an inspector cannot find the site due to inadequate or incorrect information.

The VHF Worldwide WPX Contest is a marathon 48-hour stint starting at 0000UTC on July 16. It is sponsored by *CQ Magazine*. European participants can do very well in this event as there are so many prefixes to work in the numerous countries. Unfortunately, I have not seen a copy of the rules for 1988 but assume they follow the pattern of previous years.

PA3BIX and PE1AAP have written to say that a group of Dutch amateurs will be operating in this event from JO22RC on 144MHz, a good location in the centre of Holland. The normal call, PI4AMF, will be replaced by the special one PA6VHF.

Moonbounce Matters

Geert Stams PA3CSG has written to me about a proposed international meeting of 432MHz moonbounce enthusiasts on September 10. The venue is Geert's home town of Thorn which is situated near the German border, 40km from Eindhoven and about the same distance from Aachen.

A lecture programme is planned with DL9KR dealing with weak signal reception and DJ9BV talking about ultra low noise 432MHz pre-amps. Geert will be showing a video tape made at his QTH during part of the REF-EME contest. If possible some videos of US Moonbounce stations will be shown provided he can accommodate the conversion from NTSC to European PAL system.

For further details contact Geert at Iftervoortweg 60, NL-6017 BZ Thorn, Netherlands or by telephone after 1900 local time on 04756-5502 preceded by the

appropriate dialling code, of course. All lectures will be in English, by the way.

The 50MHz Band

Clive Penna G3POI (LDN) will be operating from Orkney (YS07g) from the beginning of July but the exact dates cannot be confirmed. The call will be GM3POI/A and he will be on 50.122MHz using the legal limit and a 5-ele Yagi.

In a recent edition of Hal Lund's *ZS6WB VHF News* I read that Mike Barry ZD8MB has applied to operate 50MHz and 28MHz beacons from St Helena. These would be in the care of ZD7CW. He is also keen to do the same from Gough Island and has contacted ZD9BV on the matter. Donations of cash and equipment would be welcomed. Anyone interested may contact ZS6WB at PO Box 27746, Sunnyside 0132, Republic of South Africa.

Hal also mentioned the SMIRK Six Metre Party Contest over the June 18/19 weekend but gave no further details. This is the 13th such annual event so I imagine the rules will be much the same as previously.

In a 50MHz DX News Special Hal reports an excellent opening between southern Africa and the Mediterranean on March 9 when the 9H1SIX and 5B4CY beacons were copied. By 1630UTC 5B4CY was peaking S9 + 30dB in Pretoria. 9H1BT was worked by ZS6s WB, XJ and XL.

On March 12, SZ2DH (Athens) was worked by three ZS6s. On the evening of the 14th 9H1SIX and CT0WW beacons were copied by ZS3E (JG89) and again on the 21st.

At 1552 on March 31, ZS6WZ/M and ZS6IO were in contact via an f.m. repeater on 145.725MHz. During a pause, a station signing IOCCDO (Rome) was heard calling CQ and a short QSO resulted until fluttery QSB set in at 1557 and he disappeared. Hal asks for comments.

In his Southern Africa Six Metre Station Directory, Hal lists 44 stations recently active on the band running at least 50W to a Yagi antenna. 17 squares were represented in the list.

Dave Cater G4WHZ (ESX) uses a Yaesu FT-620B with 10W to a 5-ele Yagi. He sent a list from PA3EUI of all 30 active Dutch 50MHz stations who are: PA0s CIS,

Yaesu

FT167	HF Transceiver	1550.00	(—)
FTX767(2)	2m Module (767)	169.00	(3.00)
FTX767(70)	70cm Module (767)	215.00	(3.00)
FTX767(16)	6m Module (767)	169.00	(3.00)
SP767	Speaker	69.95	(2.50)
FT290	Mini New Super 290	429.00	(—)
MMB11	Mobile Bracket	SPECIAL 199.00	(2.00)
NC11C	Charger	10.50	(2.00)
CS1A	Carrying Case	6.50	(2.00)
YH41E	2m Helical	7.50	(2.00)
YH444D	70cm 1/2wave	12.50	(2.00)
YMA9	Speaker Mike	23.00	(2.00)
MMB15	Mobile Bracket	19.50	(2.00)
FT23R	2m Mini HH	223.50	(3.00)
FT23R	70cm Mini HH	243.50	(3.00)
FN89	Nicad Battery Pack (23/73)	57.50	(2.00)
FN10	Nicad Battery Pack (23/73)	32.80	(2.00)
FN11	Nicad Battery Pack (23/73)	50.60	(2.00)
NC.18C	Charger (23/73)	12.35	(2.00)
SMC28	Charger (23/73) 13A Plug	15.40	(2.00)
NC.28	Charger (23/73)	17.71	(2.00)
NC.29	Basic Charger (23/73)	67.50	(3.00)
PA6	Car Adapto.Charger (23/73)	18.40	(2.00)
MH12A2B	Speaker Mic	29.75	(2.00)
MH18A2B	Speaker/Mic Miniature (23/73/77)	27.00	(2.00)
FT27R	2m/70cm H/H	425.00	(3.00)
FN83	Spare Battery Pack	41.00	(2.00)
FN84	Spare Battery Pack	46.00	(2.00)
FN85	Empty Cell Case	10.00	(2.00)
FRG9800M	90-950MHz Scanning RX	509.00	(—)
PA4C	Power Supply for 9800	21.00	(2.00)
MMB10	Mobile Bracket	10.00	(2.00)
NC3C	Charger	11.50	(2.00)
PA3	Car Adapter/Charger	21.85	(2.00)
YM24A	Speaker/Mic	21.05	(2.00)
FRG800	HF Receiver	639.00	(—)
FRV800	Converter 118-175 for above	150.00	(2.50)
FR17700	RX ATU	18.00	(2.50)
MH18B	Hand 600 Spin mic	21.00	(2.00)
MD18B	Desk 600 Spin mic	79.90	(2.00)
MF1A3B	Boom mobile mic	25.00	(2.00)
YH55	Padded phones	19.99	(2.00)
YH77	Lightweight phones	19.99	(2.00)
SB1	Lightweight Mobile H/est-Boom mic	18.99	(2.00)
YH1	PTT Switch Box 208/708	22.00	(2.00)
SB2	PTT Switch Box 208/750	22.00	(2.00)
SB10	PTT Switch Box 270/2700	22.00	(2.00)
FT236 NEW	27/20cm 25W Base Stn.	1,450.00	(—)
FT747CX	160-10 All mode TX Gen. Cov.	653.00	(—)
FT2311R	23cm FM Transceiver	475.00	(—)

Datong Products

PC1	Gen. Cov. Con.	137.40	(2.50)
VLF	Very low frequency conv.	34.90	(2.50)
FL2	Multi-mode audio filter	99.70	(2.50)
RL3	Audio filter for receivers	129.00	(2.50)
ASPB	r.f. speech clipper for Trio	82.80	(2.50)
ASPB	r.f. speech clipper for Yaesu	82.80	(2.50)
ASB	As above with 8 pin conn	89.70	(2.50)
D75	Manual RF speech clipper	56.35	(2.50)
D70	Mouse Tutor	56.35	(2.50)
RFA	RF switched pre-amp	36.00	(2.50)
AD270-MPU	Active dipole with mains p.a.u.	51.75	(2.50)
AD370-MPU	Active dipole with mains p.a.u.	69.00	(2.50)
DC14A/28	2m converter	39.67	(2.50)
ANF	Automatic notch filter	67.85	(2.50)
SRB2	Auto Woodpecker blanker	86.25	(2.50)
RFA	RF switched pre-amp	36.00	(2.50)

K761	New Super HF Transceiver	1465.00	(—)
K751A	HF Transceiver	948.00	(—)
K735	New HF Transceiver	395.00	(3.50)
AT100	100W ATU (751/745)	315.00	(3.50)
AT150	150W ATU (735)	185.00	(3.50)
PS55	50MHz multi-mode portable	459.00	(—)
K2900	2m 25W M/Mode	542.00	(—)
K2BE	25W FM	359.00	(—)
K29H	2m 45W FM	399.00	(3.00)
K2 Micro	2E New Mini HH	239.00	(3.00)
K2L	2m The Original HH	225.00	(3.00)
K29H	2m 45W FM	399.00	(3.00)
K275E	New 2m 25W Base Stn	1039.00	(—)
K4E	70cm FHU	295.00	(3.00)
K29E	70cm FHU	295.00	(3.00)
IC48E	70cm 25W FM Mobile	449.00	(3.00)
K490	70cm 10W M/Mode	617.00	(—)
K2900	2m/70 Dual Band FM Mobile	556.00	(—)
K12E	23cm H/H	428.00	(3.00)
KR71	Gen Cov RX	825.00	(—)
VHF/UHF Scanner		987.00	(—)
25-1300MHz Discone		82.00	(3.00)
SP3	Battery Pack 8.4V (24E/02/04E)	29.90	(2.50)
K7000	Empty Battery Case (24E/02/04E)	9.20	(2.00)
EC257	Battery Pack 10.8V	80.95	(2.50)
GC5	Battery Pack 13.2V (02/04E only)	74.75	(2.50)
AD2	Battery Pack 8.4V	71.30	(2.50)
CP1	12V Charge Lead BP3/7/8	6.90	(2.00)
DC1	DC/DC converter operate from 12V	17.25	(2.00)
H7000	2m Helical BNC	9.20	(2.00)
FA3	70cm Flexible 1/4 wave Antenna (BNC)	3.20	(2.00)
FA2	Speaker/Mic	21.85	(2.50)
M3	Head set Boom Mike	20.70	(2.00)
HS10SA	Vox Unit HS10 (02/04E only)	26.30	(2.00)
HS10SB	PTT SW Box HS10	20.70	(2.00)
LC1	Leatherette Case 2E/4E+BP5	6.90	(2.00)
LC2	Leatherette Case 2E/4E+BP3	6.90	(2.00)
LC14	Leatherette Case 02E/04E+BP3/7/8	9.20	(2.00)
SS1	Shoulder Strap	10.35	(2.00)
SM6	600ohm 8P Base Mic	46.00	(2.50)
SM8	1.3uA/800 8P Base Mic	82.00	(2.50)
SM10	Comp/Graphic Mic	116.00	(3.00)

— CW Keyers —

VIBROPLEX	Imbic Standard	63.33	(3.00)
	Imbic Deluxe	78.09	(3.00)
	Vibroplex Standard	63.98	(3.00)
	Vibroplex Deluxe	78.09	(3.00)
	The Original Standard	73.54	(3.00)
	The Original Deluxe	82.74	(3.00)
BENCHER			
BY1	Squeeze Key, Black base	67.42	(3.00)
BY2	Squeeze Key, Chrome base	76.97	(3.00)
KENPRO			
Kenro	Electronic Keyer Unij (No Paddle)	54.70	(3.00)
Kenpro	Electronic Memory Keyer (No Paddle)	95.90	(3.00)
Kenpro	Squeeze QMG S Keyer	82.00	(2.50)
KP200	Memory Squeeze Keyer	234.55	(3.00)

ICOM

P.O.A.			
TS340S	9 Band TX General Cov RX	1895.00	(—)
AT340	Auto/ATU	244.88	(3.00)
SP340	Ext Speaker	87.55	(3.00)
TS330S	9 Band TX General Cov RX	1685.00	(—)
AT330	Auto/ATU	206.03	(3.00)
SP330	Ext Speaker	115.23	(3.00)
TS320	9 Band TX General Cov RX	144.82	(3.00)
Auto/ATU		222.45	(3.00)
PS50	HDUTY PSU	1086.00	(7.00)
TS300S	160-10m Transceiver 9 Bands	206.67	(3.00)
AT330	All Band ATU/Power Meter	85.49	(3.00)
SP330	External Speaker Unit	215.28	(3.00)
SP430	Matching Power Supply	40.81	(3.00)
MP430	Mobile Mounting Bracket	15.86	(3.00)
FM430	FM Board for 1300	343.62	(3.50)
SM220	Station Monitor	77.00	(3.00)
BS2	Band Scope Unit (830/940)	1465.00	(7.00)
TL522	10/160 2kW Linear	189.00	(3.00)
TH21	2M Mini HH	218.00	(3.00)
TH41	70cm Mini HH	215.28	(3.00)
TH206	2M HH	252.13	(3.00)
TH215	2M HH Keyboard	599.00	(—)
TR761	2M 25W M/M Mobile	895.00	(—)
TS111	2M 25W Base Stn (New Low Price)	396.00	(—)
TS811	70cm 25W Base Stn (New Low Price)	599.00	(—)
R2000	Gen Coverage HFRX	161.94	(2.50)
VC10	118-174MHz Converter (R2000)	875.00	(—)
R5000	General Coverage HFRX	167.21	(2.50)
VC20	118-174MHz Converter (R5000)	11.86	(2.00)
BT2	Empty Battery Case TH2141	25.00	(2.00)
DC21	DC Power Supply TH2141	8.77	(2.00)
EB2	Ext. Battery Case TH2141	32.91	(2.00)
HNC1	Headset with Vox TH2141	24.36	(2.00)
BP21	Nicad Pack TH2141	98.00	(2.50)
BC8	Desk Charger TH2141	11.86	(2.00)
SC2	Soft Case TH2141	28.31	(2.00)
SMC30	Speaker/Mic TH2142/2600	65.26	(3.00)
MC30	4P Desk Mic	22.22	(2.00)
MC30A	8P Desk Mic	33.96	(3.00)
MC30B	Electronic Desk Mic	99.00	(3.00)
MC35	Desk Mic Audio Level Comp	22.22	(2.00)
MC43	8P Frit Mic	21.72	(2.00)
MC35	4P Frit Mic	32.67	(3.00)
MC55	Mobile Mic (8br 8p)	13.26	(2.50)
LF30	HF Low Pass Filter	67.28	(3.00)
IC33	Receiver ATU (Mizuh)	24.36	(2.50)
HS6	Lightweight H/phones	37.54	(2.50)
HS5	Deluxe H/phones	862.00	(—)
TS140	HF 9 Band Gen. Cov. TX/RX	499.00	(5.00)
TS4100	270cm FM Dual band model SPECIAL		

KENWOOD

TS340S	9 Band TX General Cov RX	1895.00	(—)
AT340	Auto/ATU	244.88	(3.00)
SP340	Ext Speaker	87.55	(3.00)
TS330S	9 Band TX General Cov RX	1685.00	(—)
AT330	Auto/ATU	206.03	(3.00)
SP330	Ext Speaker	115.23	(3.00)
TS320	9 Band TX General Cov RX	144.82	(3.00)
Auto/ATU		222.45	(3.00)
PS50	HDUTY PSU	1086.00	(7.00)
TS300S	160-10m Transceiver 9 Bands	206.67	(3.00)
AT330	All Band ATU/Power Meter	85.49	(3.00)
SP330	External Speaker Unit	215.28	(3.00)
SP430	Matching Power Supply	40.81	(3.00)
MP430	Mobile Mounting Bracket	15.86	(3.00)
FM430	FM Board for 1300	343.62	(3.50)
SM220	Station Monitor	77.00	(3.00)
BS2	Band Scope Unit (830/940)	1465.00	(7.00)
TL522	10/160 2kW Linear	189.00	(3.00)
TH21	2M Mini HH	218.00	(3.00)
TH41	70cm Mini HH	215.28	(3.00)
TH206	2M HH	252.13	(3.00)
TH215	2M HH Keyboard	599.00	(—)
TR761	2M 25W M/M Mobile	895.00	(—)
TS111	2M 25W Base Stn (New Low Price)	396.00	(—)
TS811	70cm 25W Base Stn (New Low Price)	599.00	(—)
R2000	Gen Coverage HFRX	161.94	(2.50)
VC10	118-174MHz Converter (R2000)	875.00	(—)
R5000	General Coverage HFRX	167.21	(2.50)
VC20	118-174MHz Converter (R5000)	11.86	(2.00)
BT2	Empty Battery Case TH2141	25.00	(2.00)
DC21	DC Power Supply TH2141	8.77	(2.00)
EB2	Ext. Battery Case TH2141	32.91	(2.00)
HNC1	Headset with Vox TH2141	24.36	(2.00)
BP21	Nicad Pack TH2141	98.00	(2.50)
BC8	Desk Charger TH2141	11.86	(2.00)
SC2	Soft Case TH2141	28.31	(2.00)
SMC30	Speaker/Mic TH2142/2600	65.26	(3.00)
MC30	4P Desk Mic	22.22	(2.00)
MC30A	8P Desk Mic	33.96	(3.00)
MC30B	Electronic Desk Mic	99.00	(3.00)
MC35	Desk Mic Audio Level Comp	22.22	(2.00)
MC43	8P Frit Mic	21.72	(2.00)
MC35	4P Frit Mic	32.67	(3.00)
MC55	Mobile Mic (8br 8p)	13.26	(2.50)
LF30	HF Low Pass Filter	67.28	(3.00)
IC33	Receiver ATU (Mizuh)	24.36	(2.50)
HS6	Lightweight H/phones	37.54	(2.50)
HS5	Deluxe H/phones	862.00	(—)
TS140	HF 9 Band Gen. Cov. TX/RX	499.00	(5.00)
TS4100	270cm FM Dual band model SPECIAL		

SWR/PWR Meters

WEL2	1.8-150MHz PWR/SWR	37.00	(3.00)
SP10X	1.8-200MHz PWR/SWR/PEP	99.95	(3.00)
SP225	140-525MHz PWR/SWR/PEP	119.95	(3.00)
SP225	140-525MHz PWR/SWR/PEP	119.95	(3.00)
SP225	1.8-200-430-800-1240MHz	189.95	(3.00)
HANSEN			
FS25	130/440 MHz 20/200W	62.75	(2.50)
FS5E	3.5-150MHz 20/200W	42.75	(2.50)

Miscellaneous

SMCS 2U	2 Way S023B Switch	18.95	(2.50)
SMCS 2N	2 way 'n' S145 Switch	23.50	(2.50)
Drae	3 way S023B Switch	18.96	(2.50)

CLN, ERA, OOM, OOS, PKD, RDY, WFO and XMA: PA1s HXK and KKY: PA2s HJS and UST: PA3s, AKM, ALB, BAS, BFM, CNN, DOL, DTM, DYS, DYY, EJE, EKG, EON, EQK and EVZ: PE1s LCH, LVU and EVX. PA3DOL lives in CM square and also operates -/P from CN.

Adrian Gee G11MM (CBE) caught the Aurora on April 4 but found it difficult to work anything with only 2.5W. He did manage GM3BQA (LTH) eventually though and has since added a Spectrum 20W amplifier to make it a little easier.

Jim Whittle G3EKP (LNH) has just put up some new v.h.f. antennas and his 50MHz one is a 3-ele Yagi. Using 0.3W he enters the Annual Table and has worked down to G1MEJ (CBE). Paul Thompson G6MEN (SPE) worked his first EI on April 11, EI9Q (Waterford) on c.w.

John Jennings G4VOZ (LEC) complains of long periods of silence on the band when CQ calls go unanswered because others only seem to want to work DX or their own friends. "Just like two metres f.m." he reckons. When the band does open up, QSOs last about half-a-minute, "... just like on h.f."

John asks if he can count cross-mode QSOs for the c.w. ladder as he has often worked 'phone stations using the key himself. No, I really started this table for c.w. to c.w. QSOs to encourage more use of the mode.

John Palfrey G4XEN (NHM) took part in the April 2 contest and his 57 QSOs provided six more 1988 counties. Best DX was G4KUX (DHM) but he wrote, "This band is really poor for tropo." He first noticed the Ar on April 4 when the TV carrier on 53.757MHz appeared with an "A" tone. He now has this QRG in a memory on his transceiver.

G8PYP (DOR) heard GM3WYL at RST 53A on March 26 for a quarter hour from 2247 but Steve could not get through from the coast. No other stations were heard via Ar on s.s.b. First Jersey QSO in 1988 was with G4ICD on April 17.

Calum Macpherson GMOEWX (HLD) last wrote on April 5 and reports Ar events on March 26-29 and April 3-5, the best this year being on April 4. That one lasted from 1300 to 2000 or later and he worked 25 stations in G, GM and GW on s.s.b. and c.w. I make your county tally 41 now, Calum.

Dave Lewis GW4HBK (GWT) is back on the band having overhauled his antennas and rotator. In the April 4 Ar he worked GM4DGT (YQ) and GM8COX (YP). More ambitiously he is looking for ZS and KH6 stations.

Paul Baker GW6VZW (GWT) added four more annual counties in the contest—G3XBY (WKS), G4BLX (SXE), G3OGP (SXW) and G0AFH (KNT). G4UJC (HWR) and GW6BRC (GNS) were new at other times. He has heard EI9Q many times but has yet to attract Dick's attention.

The 70MHz Band

Roger Banks G4WND (WKS) has sent me a copy of his new *QSB The Newsletter for Four Metres* which is a very neat and informative A4 size publication. Issued quarterly, the annual subscription is £4.00. Further details from Roger at "Rivendell," Kiln Way, Polesworth, Tamworth B78 1JF.

G3EKP runs 12W and uses a 4-ele Yagi. Jim has 16 counties so far (you counted Shropshire twice OM) including G3RRA (DOR) GM4HAM (LTH) and GW4HBK (GWT). Pat Billingham G4AGO (SRY)

QTH Locator Squares Table

Station	Band (MHz)			
	1296	430	144	Total
G3IMV	35	119	405	559
G8GXP	45	151	331	527
G74ICD	59	119	253	431
G4KUX	—	80	345	425
G3UVR	75	125	224	424
G4RGK	38	106	260	404
G3XDY	81	137	185	403
G3JXN	87	133	175	395
G8DER	76	110	183	369
G1EZF	32	93	241	366
G4XEN	—	106	252	358
G8XVJ	18	88	236	342
G3COJ	44	103	186	333
G4DEZ	44	38	246	328
G4OHF	—	—	307	307
G6HKM	27	101	178	306
G8XVV	25	64	211	300
G4TIF	—	107	187	294
G4SWX	—	—	293	293
G8PNN	62	97	128	287
G6MGL	59	89	138	286
G8HHI	31	106	148	285
G4FRE	63	136	84	283
HB9AOF	55	80	141	276
G0DAZ	—	91	183	274
G4SSD	—	78	195	273
G1KOF	32	91	149	272
I4YND	—	—	270	270
G8ATK	42	89	138	269
G4NBS	59	103	102	264
G4MUT	28	90	145	263
G1LSB	—	126	125	251
G1EGC	—	77	172	249
G6DZH	—	87	149	236
G3NAQ	—	75	154	229
G1GEY	—	68	158	226
G3FPK	—	—	224	224
G4IGO	—	—	223	223
G4SFY	—	—	222	222
G4MJC	—	33	184	217

Starting data January 1 1975.

reckons activity is mostly confined to contests and Class A operators. He hopes to have bought a portable mast at the Convention and wonders if anyone makes a commercial HB9CV antenna for the band?

By contrast, G4VOZ mentions, "lots of new stations in the past month. In one week I worked five all-time newcomers." Writing on April 22, John mentioned hearing east European f.m. broadcasters heralding Es propagation.

John advises that G4VCJ operates from the rare county of Cleveland and puts a reasonable signal into the Midlands yet never seems to get much back. G4VOZs c.w. ladder figure includes three B licensees and he has worked 61 different stations on various modes between April 1 and 22.

GW4HBK needed CVE and DHM to complete working all the English counties. Dave did not complete with G4KUX (DHM) in the April 3 contest but did contact Nick the next day in the Air. He heard G4VCJ but did not attract his reply. Other Ar QSOs that day were with G3UKV, G4WND, G4SEU, G6DER, G3APY and EI9FK, the last signal being heard at 1753.

The 144MHz Band

Best DX in April for G11MM were GMOFRT (GRN), GD4UFB, GUODXX (GUR), GW3KJW (GDD), GW4WRR/P (PWS) and DF7DJ. G3EKP has opened his account on the band this year and Jim uses 30W to a dual band vertical antenna.

Ian Cornes G4OUT (SFD) wonders why, with the current level of c.w. activity most evenings, people religiously stick to

Station	Band (MHz)			
	1296	430	144	Total
GM4CXP	—	31	184	215
G4MEJ	—	—	211	211
G6STI	21	58	124	203
G8LFB	—	—	202	202
G8MKD	—	49	137	186
GM0BPP	—	57	129	186
G4XEK	—	—	178	178
EI5FK	—	35	137	172
G8ZDS	—	43	129	172
G400L	—	—	172	172
ON1CAK	—	—	172	172
GJ6TMM	—	38	133	171
G8LHT	2	58	103	163
G6AJE	5	57	95	157
G4CQM	—	52	100	152
GW4FRX	—	—	152	152
GW8VHI	—	48	102	150
G11JUS	—	—	149	149
G4AGQ	1	41	103	145
G4FVK	20	46	75	141
G4TGK	—	—	118	118
G10DX	28	34	53	115
G6MXL	10	36	66	112
GW6VZW	—	6	106	112
G11MM	—	13	94	107
G8XTJ	—	—	107	107
G4ZTR	29	29	37	95
G0FEH	—	18	70	88
G14OWA	—	—	78	78
G1SMD	—	—	77	77
PA3EUS	—	18	57	75
GMOHBK	—	—	74	74
GMOGDL	—	17	54	71
G1CRH	—	—	62	62
G0HDZ	—	—	61	61
G8PYP	—	5	53	58
G1VTR	—	23	32	55
GU4HUY	—	—	54	54
G1NVB	—	—	49	49
G2DHW	2	6	31	39
GM8DFX	—	—	20	20

No satellite or repeater QSOs.

calling CQ on 144.050MHz? He points out that in an opening operators spread out and that there are no calling frequencies on the v.h.f. bands. He suggests that 144.050MHz be a "centre of activity" so once a reply to a CQ has been heard, there is no need for this time-wasting QSY-ing phenomenon.

From G3FPK, I often hear a distant station call CQ only to be obliterated by a more local station starting to call and who has not inquired first if the frequency is in use. This applies equally to the s.s.b. calling frequency. Surely it is time we abandoned this archaic practice? What do you think?

G4XEN's only recent m.s. completed QSO was on April 3 with "regular" SM2CEW (LZ). A couple of skeds with HG7WJ/5 (JN97) were incomplete as reflexions were "abysmal." John's only QSO in the March 27 Ar was SM4GVF (JO79). He worked GMOITA (IO67) in the April 4 Ar but has yet to contact GMOEWX.

Ela Martyr G6HKM (ESX) worked two stations in YS square in the March 26 Ar and GMOITA for a new one. The April 4 event brought 17 QSOs, seven GMs, five GIs, OZ1JVX (EQ) and DD7LO (EO) among them. In the April 9/10 contest, Ela made her highest yet total of 451 QSOs working all English counties except CVE and DHM.

G6MENs log for April 4 shows five Ar contacts at a QTE of 35° and Paul worked GM0DRU (WS), GM1TBW (ZR) and GMOEWX (WR) all new squares, plus GM3TSL (YR) and GM8DPV. On the 9th he had a tropo QSO with GMOFRT (YR) who is always good into the Shrewsbury area.

Practical Wireless, July 1988

Philip Ruder's G6MGL (LDN) best DX was on April 21 to DK0BF (EJ) at 2056. G6MXL enjoyed the April 9/10 contest which brought Colin G4NOK (YSW) for an all-time new county. However, G6MFR was a "gotaway," as he was for other locals in the Dorset area.

G8LHT caught the April 4 Ar and Ian worked into GI, GM, EI, PE and OZ as well as G. Best DX was the first ever Shetland QSO with G6OILB (IP80). He thought tropo conditions in the contest disappointing but did find XM for a new square.

GBYP answered other stations' CQ calls in the contest and this resulted in 21 counties for Steve. Best DX were G4APA/P (YSN) and G0CLP/P (CBA) in IOB4, a new square.

John Fitzgerald G8XTJ (BKS) added G1SGB/P (YSN), G6OWX/P (DVN), G6ZUQ/M (HBS) and GW6JNE/M (GNM) to this year's county tally. He did not think there was much on at all in the contest, though.

Mervyn Rodgers G6OGDL (CTR) reports little activity from his home QTH which is unsatisfactory for Ar events. On April 24 he, with G6OGDL, G6OGRL and G6VVB were out portable from the 983m Ben Vorlich mountain (TYS) but could only take QRP equipment.

They intend to use the site for the *PW* contest. With 2.5W and a 9-ele Yagi they worked G1KDF and G1SMI (LNH), G1OWA (LDR) and GW1SXN and quite a number of others in northern England. 14 stations were worked in just half an hour at the summit.

G6EWX works most all his counties and countries via Ar openings and has accumulated 44 so far this year; not bad from his remote QTH on Skye (HLD). Calum included long lists of stations worked in several such recent events.

Mar. 26, 1842-0152 he worked a couple of GMs, OZ2ST (EP) on c.w. and EI5FK (Cork) but spent most of the time on 50MHz. On Apr 3 he contacted G6OPEO at 1830 on c.w. The major event was on Apr 4 when he lists 64 QSOs. 20 were on c.w. with G, GM and EI stations.

Using s.s.b. there were some continental contacts with D, ON and PE stations plus the local British Isles prefixes. Squares worked included BK, CK, CL and CN. The QSOs were made between 1404 and 1910UTC when he switched off. The event was still on at 2000 but nothing more was worked.

Welcome to **Denny Morrison GM1BAN** from Castletown in Caithness (HLD) who wrote for the first time. He uses an Icom IC-260E, Datong Automatic Speech Processor and Microwave Modules MML 144/100LS amplifier, the antenna being a 6-ele Yagi by MET.

On Mar 26 at 1700 he copied Ar signals from GB3LER (ZU) and SK4MPI (HU) and had his first QSO at 1736 with G6OITA (XR). Over the next six hours he worked another 32 stations, mostly Gs, plus a PE1 and ON1.

On the following day Denny worked five stations between 1609 and 1754 in a weak event. On Apr 3 G6HCV was worked at 1813 in a very weak Ar but the big event the next day brought 37 QSOs between 1306 and 1747. Pick of the bunch were OZ1JOH (JO46), SM6BCD (JO58), LA2CAB (JO54), DD7LO (JO44), DD1BR (JO32) and DC1JP (JO31).

GM4ILS (GRN) is reported to have made 125 QSOs in the April 4 affair. Ron worked 15 countries between 1235 and 2015, the last being OY9JD. QTEs ranged from 20-90°. At 1730 he thinks he heard an

EA1 station at 100° in the QRM. Has anyone a report of northern Spanish stations getting into this Ar?

John Lincoln GM8DFX (HLD) reports mainly on the Apr 4 Ar and from 1400 he could detect the GB3LER, DLOPR and SK4MPI beacons. 15 stations were worked in an hour from 1600, mostly Gs, but PE1KDV (JO21) and DL8HCV (JO53) also. G7AOT (AL) was his first G7 QSO. All QTEs were 35°.

John Edens G6OEXN (HLD) notes came via GM8DFX and he copied Ar signals from 1200 from SK4MPI, GB3LER, DLOPR and Y41B (FN). GB3VHF was detectable and later reached S6A with a stronger signal with the beam northwest. Yet another Ar was discovered for 20 minutes from 1950 on Apr 5 with SK4MPI detected beaming NE. Later GB3VHF came up, again best at a NW heading.

GW6VZW added EI4EY (Limerick/VM27e) but did not mention the date or propagation mode. Apart from the April contest, Paul has found conditions quite poor but has added another seven 1988 counties.

Reg Woolley GW8VHI was in on the Apr 4 Ar using his DA4RG call but from CL37e in Holland. He worked GW2HIY (XN) on c.w. and heard Y22ME, GM, PA and SM6 stations. He hopes to be active on v.h.f. more this year after his stint on the h.f. bands as VP8BPZ in the Falkland Is.

The 430MHz Band

David Thickett G6FEH (DYS) now has his amplifier working and it is producing 300W from 3W of drive. He has also installed a masthead pre-amp. To mid-April, only four countries had been worked, DL, G, ON and PA with nothing heard from GM and GW.

G6HKM sums it all up I think, "Contacts on this band are few and far between." On Mar 30 Ela worked GD4UFB operated by Dieter DG8SAB for the first IOM QSO this year. A CQ call on Apr 7 to the NW brought a reply from G1OGDP (ATM) for another 1988 country while G6OHOL provided GNS.

From the far north of Scotland **GM8DFX** is QRV on the band. Denny has a Yaesu FT-790R and MML 432/30 amplifier. His antenna is a 17-ele crossed Yagi but he is poorly sited. This means he never knows whether there is a lift on so would appreciate someone telephoning him so that he might provide and work some DX. His number is Castletown (084 782) 241.

The Microwave Bands

The only 1.3GHz report this time was from **G6HKM** who discovered the continental beacons were up on the morning of Apr 3. However, Ela found very few people about but did work ON5NY (BK) and DF7KB (DK). In the monthly Dutch contest on Apr 12 she contacted PE1EWR (BL).

G6MEN was out portable on Apr 17 in the first leg of the 10GHz Cumulatives. Paul operated solo as G1GHZ/P at the Ordnance Survey trig point, NGR SO 415944 which I make YM36c or IO82NN. He completed nine QSOs from nine attempts using wideband f.m. from the Long Mynd site, 516m a.s.l.

Best DX was to G3NKL/P (IO83QW) which I make 156km. He tried a new path to G8KQW/P (IO92IR) over 108km. All the gear was "motorcycle portable" using a 400mm dish. Paul would like to arrange skeds on 10GHz from the Long Mynd to

operators on high spots in XL, XN, ZL and ZN squares. He can be reached at PO Box 32 Shrewsbury SY1 1ZZ.

Worked All Britain News

From **G8XTJ** news that the very rare **OV00 (YSN)** operation by **GB10VA** duly took place on Apr 2/3 from the foot of the high cliffs near Ravenscar. Plans to use weather balloons to raise the antenna had to be abandoned. The station comprised a Yaesu FT-290R and 100W amplifier, the antenna being a 13-ele Yagi at 4.6m. Best DX were G6HCV (SFD), G8MFV (KNT), ON1CAK, ON1CDQ and PE1LVU.

A reminder about forthcoming **WAB** contests. The 144MHz High Power s.s.b. event is on June 19, 0900-1600UTC. The 144MHz QRP s.s.b. one is on July 10, 0900-1300, followed by the 432MHz contest from 1400 to 1800. Log sheets and information from **G6XLL (QTHR)** and send a 9 x 4in s.a.s.e. plus three first-class stamps.

Quality versus Width

In any contest there are usually some signals which are far from reasonably linear. While most responsible operators do take the trouble to emit as clean a signal as possible, a few seem oblivious to criticism, blaming complainants for having inadequate receivers.

There is one sure way to deal with such anti-social behaviour and that is for the adjudicators to disqualify the entrant. If you are quite certain that a signal really is bad, e.g. it is 20kHz wide at S9 with your beam sideways on, then note it in your log, tell the person you are so doing and make a note in the comments column when you submit your own entry.

General Rule 13 states; "Any complaints received or made about signals must be recorded in the comments column." Therefore, when the adjudicator cross-checks, and does not find the comment in the offending station's log, that would be grounds for disqualification.

Obviously a single complaint from someone with a poor transceiver a couple of miles away will be viewed with suspicion. But several similar complaints from more distant stations must surely be taken seriously.

Meteoric Notes

There are several minor showers in the last week of June and the second week in July which could provide reasonable results on a random basis. The next major shower is the Perseids around August 12 and I will give the data next month.

John Hunter G3IMV (BKS) mentioned that the April Lyrids shower was poor this year and nobody has listed anything worked in it. Perhaps it came too close to the deadline so if you did have any successes, let me know for the August issue.

**The deadlines
for the next
three issues
are June 29,
July 27 &
August 24**

FAX

Yet another first Monday in the month has passed with me being miles away from the radio. So I've missed yet another amateur FAX activity night, I hope my predicament isn't too wide-spread otherwise there will be no activity at all. Is there anyone active on the first Monday of the month?

I still find the best day to pick up amateur FAX is Sundays, in the late morning. This is when the German enthusiasts seem to be on the air. My best results have been received just above 14.1MHz, packet stations willing.

The latest Datacom from BARTG includes some FAX schedules which may be of interest. First of all there is the European FAX net on 3.605MHz with FAX at 1900UTC followed by s.s.b. at 2015UTC. The other schedule covers the FAX roundtable which operates on the second, third and fourth weekends of each month. The frequencies used are 3.602MHz at 1700UTC on Saturdays and 14.102MHz at 1200UTC on Sundays. All the transmissions use the normal amateur FAX mode of 120 r.p.m. and an i.o.c. of 288.

One station I did log was Vlad SP4KM (Poland) on 14MHz. Although I copied his transmission with no particular problems it was unusual in that he was using a speed of 240 r.p.m. Fortunately I was using the ICS Electronics FAX-1 which automatically selects the correct speed and i.o.c. The transmission from this station included the correct start and stop tones which is another unusual point as most amateur stations don't seem to bother with these tones.

Beginners

Chris Norfolk (Scunthorpe) has written with a few tips for beginners. He seems to have all sorts of problems at home, he lives next door to a garage. You can imagine the QRM (noise) on the bands when they are testing a car, running welding gear, etc., but he still manages decent results.

When asked for advice from those starting out in the hobby, Chris maintains that you don't necessarily have to trade in your old radio for a much more expensive one—there are ways to run data modes quite cheaply. If your receiver is of reasonable quality with a b.f.o. then it's possible to resolve RTTY signals with very little extra equipment.

If you're not sure whether the data modes are for you, then there are two main routes to follow. You either try one of the computer programs that doesn't require a terminal unit, or you try one of the systems that does require a terminal—simple isn't it. Well, the decision as to whether you need a terminal unit depends very much on who you have been talking with recently. If your friend is happy with his terminal-less programs, that's the one he'll recommend. If on the other hand he's been using a terminal and associated software with success, then that's where his preference will lie.

So how does the newcomer know which to choose? There isn't really a simple answer to that, a lot depends on the type of receiver and computer you have as well as your budget. Generally the terminal-less programs are cheaper, but not always as effective as a good, dedi-

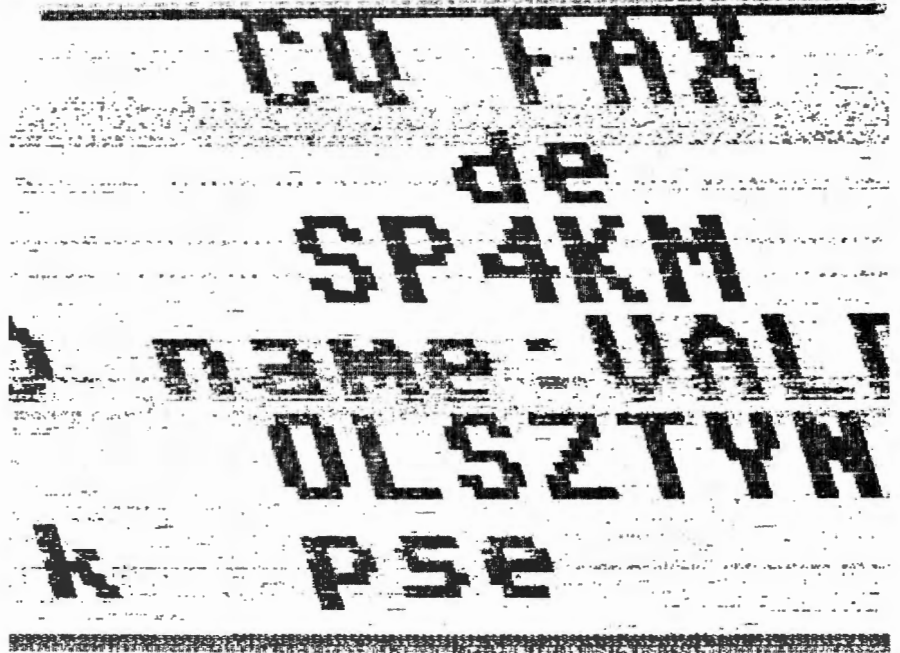

240 r.p.m. IOC 288. Received 8/5/88

cated terminal unit, some are better than others. Obviously there are good and bad programs and terminals. This is where it often pays to talk to others, perhaps at the local radio club, about what systems they are using.

The most important point to remember is that it doesn't have to cost a fortune. Don't believe those who say things like, "the first thing you must do is buy a much more expensive receiver", or "it'll cost you at least £500 to get going".

You can get by with quite simple receivers and a lot of patience. An example of this is Chris, he uses a Realistic DX302 receiver, I also know of other readers using the Matsui MR-4099.

If you are using a simple system with good results, then I would like to hear from you. Your trials and successes can help others as they step out along the data communications path.

Readers Letters

From the letters I have been receiving it would seem that there are quite a few of you who would like to use the Atari 800XL computer for RTTY. The latest offer of advice comes from Pete Lewis G3EMF. He points out that Maplin Electronics used to supply a print-out for an Atari RTTY program with their TU-1000 terminal unit kit. It's not too clear whether the program was specifically for the 800XL but it may be worth enquiring.

Although I have not had a chance to test the Maplin TU-1000, Pete is very pleased with his and gives it a strong recommendation. His best DX whilst using the TU-1000 with his Commodore 64 has been PT7WA (Brazil) which is very respectable.

Don't forget if you have any suggestions for utilising the Atari 800XL, or any other computer for that matter, then please drop me a line.

My next letter is from Bruce Marshall VK7MB (Tasmania), that's some pretty good DX to start with! Seriously though, Bruce has managed to capture a stray BBC-B computer and is looking for a source of public domain amateur radio

software. The ideal would be an Australian source, but he is quite happy to deal direct with the UK if necessary. If you know of any sources then please let me know and I will pass all information on to Bruce.

The final plea for computer information comes from Ivar Markussen LA5XX (Hesseng, Norway). Ivar is situated in the extreme north of Norway about 6km from the USSR border and has acquired a Sharp MZ-700 computer which he would very much like to use for RTTY. Unfortunately he has been unable to find any RTTY programs for this computer, so help is required.

Around The Bands

As I seem to have been a bit short on logs this month I've spent more time than usual in the shack logging.

One of my favourite times for searching out DX is early in the morning before I leave for work, about 0600-0700UTC. The best band at the moment seems to be 14MHz but it's worth keeping an eye on the other bands. The most common DX at this time in the morning is VK (Australia) and I have logged several VKs during the past month. When listening in the early morning you will generally find that the band sounds completely flat with a very low noise level. Most of the DX stations that I have copied have actually been very weak but because of the low noise are perfectly readable. Another common phenomena is that there may be quite severe and sometimes rapid QSB. The following is a selection of some of my early morning RTTY success: VK2KM, 3C1MB (Equatorial Guinea), ZS6CDJ (South Africa) and VK2BQS.

VK2KM (Karl) was using a Yaesu FT-101 transceiver with a home-brew p.a. feeding into a three element mono-band antenna. When I logged him he was working Fabio I2MJB in Gallarate, Northern Italy and they were exchanging signal reports of 599, though I could only hear the VK station which was quite weak with me.

Another band to remember is 28MHz. I think that many amateurs tend to ignore

this band as it is often completely dead. With the summer months ahead there are usually plenty of sporadic E openings to take advantage of. One tip I have is rather than to just listen on 28MHz for RTTY, try checking the beacons to get an idea of the state of the band. If it looks good then start calling CQ even if there are no other RTTY stations to be heard, you may be the first to discover the opening!

Whilst on the subject of 28MHz I recently copied part of an interesting QSO between G3DZW and HG5AEZ (Hungary). The Hungarian station appeared to be using a very simple set-up which included a Sinclair ZX-81 computer. The antenna in use was a straight forward 40m long wire but despite this simplicity he was putting out a very good signal. This just goes to demonstrate that you don't need to spend a fortune to achieve success.

I would obviously be very interested to hear about your favourite bands and times for searching out that illusive DX.

On May 7 I logged LZ2FX (Bulgaria) on 21MHz at 0900UTC. The significant point about this station was that he was using a mechanical teleprinter rather than the more common computer. I wonder how many of you still enjoy the magic of working with these wonderful electro-mechanical devices. If you have any stories to tell then please drop me a line, you never know we might be able to start a revival which would be great for all those who hate computers.

Regular readers of this column will remember that in the May issue I mentioned that John Barber G4SKA had heard

A15AC but didn't know where the call was located. Well, fortunately Andy McClelland G0KKN/PA3EVB has come to the rescue. Apparently the Dutch Amateur Radio Society included the details in their magazine. According to this source the A15 prefix is used by the territory of Abu Ail and was activated by a German DXpedition earlier this year. The actual calls used and the operators own calls are shown here:

A15AA DJ6SI using c.w.

A15AB DK8CM using s.s.b.

A15AC DJ6JC using RTTY.

If you managed to contact any of these stations then you have captured some rare DX! If you want to QSL then the address is: Baldu Drobnica (DJ6SI), Zedernweg 6, 5010 Berheim, West Germany.

Whilst on the subject of unusual calls, I have just logged SB67 on 14MHz RTTY at 0851UTC. This station was calling CQ and describing itself as a UK mobile in southern Italy. The station appeared to be trying to contact some other English SB stations as their names were mentioned in the call. I did try calling the station to find out more details, but unfortunately he could not hear me. Can someone out there put me out of my misery and explain this call?

Packet

The activity on this mode still seems to be increasing with more and more mailboxes appearing. The list that follows shows the prefixes heard during a few hours of monitoring on 14MHz at a weekend

C30 (Andorra)
CT (Portugal)
DA-DL (West Germany)
EA (Spain)
EX (USSR)
F (France)
I (Italy)
G (England)
GI (Northern Ireland)
HA (Hungary)
HB (Switzerland)
LA (Norway)
LX (Luxembourg)
OE (Austria)
OH (Finland)
ON (Belgium)
OZ (Denmark)
PA (Netherlands)
SM (Sweden)
TF (Iceland)
W (USA)
YU (Yugoslavia)
4X (Israel)
5B4 (Cyprus)

As you can see from this list there is a very good spread of international activity on Packet.

That's it for this month but don't forget to send in your reports and comments either to the address at the head of the column or to my Prestel mailbox 425470071.

June 29, July 27 & August 24 are your deadlines

Amateur Satellites

Reports to Pat Gowen G3IOR
17 Heath Crescent, Hellesdon, Norwich, Norfolk NR6 6XD.

Phase III-c

OSCAR-13 should be in orbit by the time this issue reaches you, as all looks set for a launch from the ESA pad at Kourou, the jungle clearing in French Guiana. (see Fig. 1, courtesy Ariospace)

Werner Haas DJ5KQ, on behalf of the AMSAT-DL team finalising the integration, said as FY0EK in a recent 14.280MHz QSO "... we confidently expect a good launch on or about the 1 June, but it could be up to four or five days later, or even a day or two earlier ... it really all depends upon the success of the inserted V-23 lift off carrying Intelsat-5". Werner has his video-camera active and within the restrictions imposed on the actual launch, hopes to make another film as he did with the launch of OSCAR-10.

The launch windows of June 1 are from 1110 to 1146 and again from 1300 to 1440, which fits the time for world wide network coverage of the event well. If it is postponed, then we could have a launch around midnight, when communications may be difficult.

Do not expect immediate communications via the OSCAR-13 transponders, as it could take up to six weeks to finally position and test out the satellite systems. Other than unspecified test periods, the beacons only will be on until the new spacecraft is open for general amateur radio communications.

Phase III-c Frequencies

In the finishing stages of checking out the forthcoming OSCAR-13 satellite, AMSAT-DL carefully measured the frequencies of all the uplink and downlink passbands and the beacons. Whilst it is

possible that launch vibration and the dielectric changes brought about by vacuum may cause a very marginal movement, the following tables gives the measured status.

MODE "S"

Uplink: 435.601 to 435.637MHz.

Downlink: 2400.711 to 2400.797MHz.

Beacon: 2400.325MHz.

The passband is linear and non-inverting, e.g. an upward QSY on the uplink will result in a similar upward frequency movement on the downlink, and u.s.b. input will result in u.s.b. output.

"RUDAK"

(Digital packet radio store and forward)

Uplink: 1269.710MHz

Downlink: 435.677MHz

MODE "B"

Uplink: 435.567 to 435.422MHz

Downlink: 145.823 to 145.968MHz

General Beacon: 145.812MHz

Engineering Beacon: 145.985MHz

The passband is linear and inverted, e.g. signals at the top of the uplink passband will give a downlink at the bottom of the downlink passband, and l.s.b. up will produce u.s.b. down.

MODE "L"

Uplink: 1269.620 to 1269.330MHz

Downlink: 435.715 to 436.005MHz

General Beacon: 435.651MHz

Engineering Beacon: 435.677MHz

The passband is linear and inverting.

MODE "JL"

(50kHz of parallel operation into the Mode "L" downlink provided for the benefit of eastern block countries that do not normally have availability of the 1269MHz

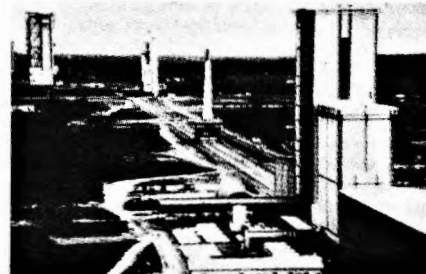

Fig. 1

spectrum for amateur radio use)
Uplink: 144.425 to 144.475MHz
Downlink: 435.990 to 435.940MHz.
This downlink also is inverting.

Project "HAART"

The schematic circuit of the "HAART" (High Altitude Amateur Radio Transponder) project designed (originally on the back of the menu at the Birmingham RSGB dinner) and since built by G3RWL and G4CUO is shown in Fig. 2.

The 435MHz received signals are passed via a helical filter to a pair of BFR90s forming the r.f. amplifier. Double conversion is employed to obtain good image rejection using i.f. frequencies of 29.050 and 10.7MHz, chosen because of ease of availability and the bandwidth. The local oscillators, fed from 10V regulated lines, operate on the low side of the received signals, 101.5MHz x 4 giving 435.045 to 29.045MHz, and 18.345 for 29.045 and 10.7MHz. Thus, harmonics from 18.345MHz are out of the passband, i.e. 18.345 x 24=440.280MHz.

The second i.f. bandwidth is limited to 10kHz by two crystal filters at 10.7MHz

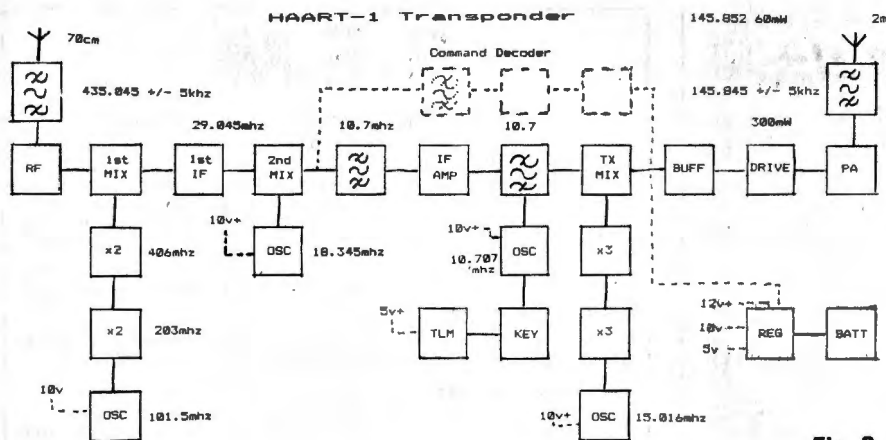

Fig. 2

and amplified by some 60dB. The second filter is used to suppress noise to a level that will not interfere with the transmitter mixer. This output is then converted to 145.875MHz by the transmitter oscillator injection on 135.145MHz. A balanced mixer using two BF245s provides suppression of the oscillator harmonics, and the bandpass filter ensures that the only output is at 145.845MHz +/- 5kHz.

The 145.852MHz beacon is derived by injecting a 10.707MHz oscillator frequency into the transmitter mixer, e.g. $135.145 + 10.707 = 145.852\text{MHz}$, which is keyed by the on-board miniature computer, with a sequence such as "HI HI TEST DE GB5AUK GB5AUK (if indeed this is the call given) 001" followed by a 60 second pause. The "001" will increase by one each time the call is sent, thus indicating the number of minutes into the flight. A two stage linear amplifier improves the selectivity and amplifies the two metre signal plus the beacon to 300mW and 60mW respectively before passing through a helical filter to the antenna. The frequencies chosen have been selected so as to be in the exclusive 145.800-146.000MHz space band, but not to clash with any existing satellites or any proposed, other than an intrusion into a small part of the OSCAR-10 c.w. section. Current thoughts are that the bandwidth may be widened, and that a mode "A" transponder may be included to give access to the stations who are already equipped for providing a 145MHz uplink and a 29MHz downlink as for the "RS" satellites.

It is hoped to fly the transponder in the ladies high flying balloon altitude record attempts to be made later this year. The whole system is now built, tested, and finalised, and only the licence is awaited to permit the unit to fly for the balloon flights that will occur as soon as the weather is suitable. It would appear that the Ministry of Aviation, for a reason known only to them, is not in favour of the experiment. The required permit seems to be an awfully long time coming, but, the months waited may seem small compared with the long QRX suffered by G3HUL and G3IOR, who applied for a special 430MHz e.m.e. licence over ten years ago, and still awaits attention. "All good things are worth waiting for" goes the ancient adage. "Take Heart" is another.

As offers have come from several overseas AMSAT groups to fly the transponder, whose countries offer no impediments, it might be necessary to take it to one of the nearer European countries if things are not seen to move soon. This may well not restrict communications over the UK, as the radio coverage can be calculated by first multiplying the square root of the height in feet by 1.42, the result

being the horizon path. Twice this figure will give the station to station contact maximum distance, with a little tropospheric ducting adding to help even further.

PY-SAT "Peacemaker"

AMSAT-Brazil ("BRAMSAT") will soon be starting work with AMSAT in USA on building an amateur radio educational satellite. It will carry a new and advanced voice synthesiser, speaking many languages, e.g. Russian, Portuguese and English, with other languages capable of being added, giving spacecraft operating conditions on the telemetry and greetings messages to other nations using space for peaceful purposes. The format and message content would be controlled by ground command under the control of the international authorities.

It is hoped to place the satellite into a 800km orbit in early 1989 ready for use in International Space Year planned for 1992. It will be designed and constructed as to be easily received by simple inexpensive equipment and omni-directional antennas by schools and amateurs who may wish to study the telemetry content to explore the space sciences.

The final and exact details of the parameters intended are awaited, and will be published in full in this column when available. It is to be called "The Peacemaker". If it were G3RWL and G4CUO's "HAART" project under discussion, we might aptly name this "The Pacemaker" in more senses than one! (Please note triple entendre!)

MIR-Sat

Negotiations are now almost complete to lead to a launch of an AMSAT/VITA packet radio satellite from the orbiting "MIR" space station between April and June next year. Two small obstacles remain in the path of fruition.

First, non-amateur radio frequencies will need to be employed by the VITA (Volunteers in Technical Assistance) store and forward package for the purposes of exchanging error free scientific and medical content between various world institutes and the remote stations in the developing countries. This could be a slight headache, as cost free launches are normally provided to the amateur radio community, but not necessarily to those who would employ what might be termed 'commercial' frequencies. This should be overcome when the social and international aid value is fully evidenced.

The second and a much bigger snag is that a Presidential decision has recently been made in the USA prohibiting the launch of any satellites by the USSR that

contain any USA manufactured parts. Ostensibly, this is to protect the western technology which is claimed to be advanced over and above that of the USSR. In real terms, it is far more likely to be intended to protect vested launch interests and limit assistive international agreements.

With the increasing drag factors created by atmospheric expansion in the rapidly elevating solar flux, such a satellite is unlikely to stay in orbit for more than a few months (if not weeks) unless agreement could be made to place a kick-motor aboard to boost the package to a higher orbit. This is felt to be unlikely, as the manned mission has overriding protective safety factors that could well negate such a selection. Even so, if the barriers can be lowered, it will prove to be a further step in mutual co-operation between amateur radio, aid and launch agencies and further international co-operation that will undoubtedly lead to further advances in the near future.

RS-1

This aged satellite has been heard by many again over the past month, still sending out its 20w.p.m. c.w. "55 5015 . . ." corrupted telemetry on 29.401MHz. It is not always on when in sunlight, and the current general opinion seems to believe that it also depends upon its temperature, and also the actual attitude of the satellites still functioning solar cell(s) to the sun to provide a sufficiency of power to activate the oscillator. For certain, the battery has long decayed, this being its salvation, as an open circuit battery imposes no load upon the power regulation.

RS-11

The elevating 21MHz QRM from increasing numbers of stations using the 15m uplink passband for terrestrial QSOs has led to a new operational schedule being put into operation by control station RS3A.

For the past few months, the satellite has been on Mode "KA", i.e. 21 + 145MHz combined uplinks to provide a single 29MHz downlink. Whilst the propagational information has been valuable, and the deployment by non v.h.f. stations welcome, the powerful inputs of the users of the rapidly improving 21MHz band have been a source of considerable attenuation and QRM to the satellite users. Until further notice, RS-11 (and undoubtedly RS-10 also when it is again activated) will be on the above mode during weekdays, but will be switched to Mode "A", i.e. 145MHz uplink only, for 29MHz down, during week-ends when things are very busy on the fifteen metre band.

If the accompanying COSMOS 1861 NAVSAT is placed on, as it was during some early morning passes in late March and early April, giving blocking of the 145MHz input by its powerful adjacent 150MHz RTTY like signal, then it may be that "T" or "KT" may be commanded in for these periods. In this way, the best of all possible uses will be supplied.

The photograph in Fig. 3 is from DJ6ZL and DL1CF of AMSAT-DL of the BRTK-10 module that went into the COSMOS 1861 package to give us RS-10 and 11.

FO-12

Dave Rowan G4CUO advances an interesting theory as to why the JARL and JAMSAT seem reluctant to issue the

AERIAL TECHNIQUES

VIEW OUR COMPLETE RANGE OF PRODUCTS

Send for our 22 page illustrated catalogue, priced 75p.

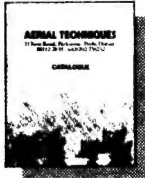

INSIDE OUR CATALOGUE Multi-standard Televisions/ Monitors, Aerial Rotators and many more items. Our extensive listings cover domestic, fringe and DXing installations within Bands 1 to 5 inclusive. Aerial Techniques provide a complete and comprehensive consultancy service for ALL reception queries and problems. Would you like to receive an extra ITV Channel at little extra cost? Why not send for our catalogue including an SAE together with details of present ITV region received. ACCESS and VISA Mail and Telephone orders may be placed for any product listed in our Catalogue. We are active TV/FM DXing specialists - your guarantee of honest and knowledgeable advice.

11, KENT ROAD, PARKSTONE, POOLE, DORSET BH12 2EH
Tel: 0202 738232

S.E.M.

UNIT P, UNION MILLS, ISLE OF MAN
Telephone: (0624) 851277

S.E.M. QRM ELIMINATOR. Unique design gets rid of any local interference. Connect in your aerial lead and removes QRM before it gets to your receiver (you can transmit through it). Any sort of interference, it can be next to your rx (your computer) or several miles away, e.g. power lines. £69.50 ex stock. As the P.W. review says "Does it work? Yes it does."

S.E.M. TRANZMATCH MKIII. The only Aerial Matcher with UNBALANCED and TRUE BALANCED OUTPUTS. 1 kW 1.8-30 MHz, £120. Built-in EZITUNE (see below), £39.50. Built-in Dummy Load, £9.90. Ex stock.

EZITUNE. Allows you to TUNE UP on receive instead of transmit. FANTASTIC CONVENIENCE. Boxed unit, £45.00. P.C.B. and fitting instructions to fit in any ATU, £39.50.

FREQUENCY CONVERTERS. V.H.F. to H.F. gives you 118 to 146 MHz on your H.F. receiver, Tune Rx. 2-30MHz, £49.50 ex stock.
H.F. to V.H.F. gives you 100 kHz to 60 MHz on your V.H.F. scanner, £49.50 ex stock. Plug in aerial lead of any receiver.

TWO-METRE TRANSMATCH. 1kW, will match anything, £32.00 ex stock.

DUMMY LOAD. 100 W. THROUGH/LOAD switch, £24.00 ex stock.

VERY WIDE BAND PRE-AMPLIFIERS. 3-500 MHz. Excellent performance. £32.00 or straight through when OFF, £37.00 ex stock.

R.F. NOISE BRIDGE. 1-170 MHz. Very useful for aerial work. £45.00 ex stock.

IAMBIC MORSE KEYS. 8-50 w.p.m. auto squeeze keyer. Ex stock. Ours is the easiest to use. £45.00. First class twin paddle key, £20.00 ex stock.

TWO-METRE LINEAR/PRE-AMP. Sentinel 40: 14x power gain, e.g. 3 W - 40 W (ideal FT290 and Handhelds), £85.00. Sentinel 60: 6x power, e.g. 10 W in, 60 W out, £95.00. Sentinel 100: 10 W in, 100 W out, £135.00. All ex stock.

H.F. ABSORPTION WAVEMETER. 1.5-30 MHz, £39.50 ex stock.

MULTIFILTER. The most versatile audio filter. BANDPASS Hi Pass, Lo Pass and two notches. Frequency and Bandwidth adjustable 2.5 kHz-20 Hz, £75.00 ex stock.

HIGH PASS FILTER/BRAID BREAKER. Cures T.V.I., £7.50 ex stock.

CO-AX SWITCH. Three-way + earth position. D.C.-150 MHz, 1kW, £25.00 ex stock.

12 MONTHS COMPLETE GUARANTEE INCLUDING TRANSISTORS

Prices include VAT and delivery. C.W.O. or phone your CREDITCARD NO. Ring or write for further data or catalogue. Orders or information requests can be put on our Ansaphone at cheap rate times. Remember we are as near as your phone or post box.

J & M (Amateur Radio) G4GKU

36, WESTGATE, ELLAND,
W. YORKS HX5 0BB.
PHONE: (0422) 78485
Ask for John G4GKU

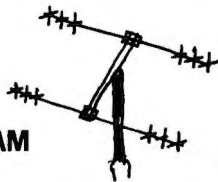

NOW A TRI-BAND MINI BEAM
AT A SENSIBLE PRICE

£69.95

10m, 15m, 20m

(TRADE ENQUIRIES WELCOME)

Direct from the manufacturer at a money saving £69.95 complete. Or in kit form or as spare parts. Ask for a quote.

Do you have a Camera/Hi-Fi/Radio/Binoculars or any technical item that you would like to part exchange for this antenna? If so just call and we will consider it.



SPECTRUM COMMUNICATIONS

MANUFACTURERS OF RADIO EQUIPMENT AND KITS

4 and 6m EQUIPMENT

RECEIVE CONVERTERS 4 or 6m antenna input, 10 or 2m i.f., variable gain 0-26dB, n.f. less than 3.5dB. Buffered local oscillator output, types RC4-10, RC4-2, RC6-10 and RC6-2. PCB kit £17.25, PCB built and tested £24.50, boxed kit £29.25, boxed, built and tested £41.00.

TRANSCEIVE CONVERTERS Single board version of receive converter and 500mW transmit converter. 10m drive 25mW to 500mW. Types TRC4-10 and TRC6-10. PCB kit £39.00, PCB built and tested £54.00, boxed kit £54.00, boxed, built and tested £83.25.

TRANSCEIVE CONVERTERS Separate receive converter and 2.5W transmit converter in a single boxed unit, 2m or 10m drive 10mW to 100mW only, requires r.f. sensing switch and attenuator for use with 2.5W 2m rigs. Types TRX4-10H, TRX4-2H, TRX6-10H and TRX6-2H. Boxed kit £60.00, boxed and built £99.50.

TRANSCEIVE CONVERTERS As above but including an interface providing RF sensing attenuation and PTT switching. 1/2W-5W 2M drive. Types TRX4-2I and TRX6-2I. Boxed kit £67.00, boxed and built £115.00.

RECEIVE PREAMPS

2, 4, 6, or 10 metres RF switched and DC sensing, 100W transmit handling power, gain 0-20dB adjustable by panel control, NF 1dB on 2M, 2dB on 4 & 6M, 3.5dB on 10M, 13.5V negative ground operation. Excellent performance at a reasonable price. Well made attractive boxed unit 77x70x39mm, an asset to any Ham shack. Types RP2S, RP4S, RP6S, & RP10S. PCB KIT £12, PCB BUILT £16.75, BOXED KIT £20.25, BOXED BUILT & TESTED £27.

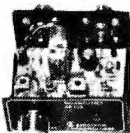

FM CONVERSIONS

FOR YAESU & KENWOOD TRANSCEIVERS

FD311X & FM2000 for FT101, 101B, 101E, 101Z, 101ZD, 901, 902, 107, 107M, 77S, 77, 707, 200, 250, 7B, all £71.

FD311X & FM3000 for TS120V, 120S, 130V, 130S, 520, 520SE, 530, 830, 930, all £81.

State rig type when ordering.

CB to 10m

CB TO 10 FM CONVERSION BOARDS - THE FIRST COMMERCIALY AVAILABLE, suits all UK FM CB rigs to give 29.31 to 29.70MHz. Size only 63 x 40 x 13mm. Built and aligned board SC29 £18.50. Or send your rig and we'll fit it. £31.50 inc. return P&P for mobiles. £35 inc. for base rigs.

MULTIMODE CB CONVERSIONS, send your 120 channel rig and we'll convert it to give 28.01 to 29.70MHz in straight sequences without gaps. Colt 1200DX, Cobra 148, Hy Gain 5, Multimode 2, Major M360, Tristar 747 & 777, Super Star 360, Concorde, etc., £62 inc. return P&P. Jumbo or Colt Excalibur 1200, £65. 80 Channel rigs such as Stalker 9 or Major M588 are modified to give 28.31 to 29.70MHz in straight sequence without gaps, £55.00 inc. return P&P. 200 Channel in 4 bands of 50 are converted to give 28.00 to 30.00MHz or 28.00 to 29.70MHz as required. Super Hy Gain 5, Lafayette 1800, Super Star 2000. £45.00 inc. return P&P. Nato 2000 £52.50, Super Star 2000-5 x 40CH £70. Colt 1600, 4 x 40CH, £65.50



VAT & P&P INC PRICES
Delivery within 14 days if available.
24 hr answering.

SEE YOU AT THE
NEC 15, 16, 17 JULY

SHOP TIMES: 9am-1pm & 2pm-5pm TUES-FRI
9am-1pm & 2pm-4pm SAT
CLOSED SUNDAY & MONDAY

UNIT B6 MARABOUT INDUSTRIAL ESTATE, DORCHESTER, DORSET. TEL: 0305 62250

operating schedule of their satellite more than some five weeks ahead of implementation, an insufficient time for us to meet the deadline for this column. "The useage of JO-12 is very low," says Dave, "and hence the battery depletion is slight, permitting a reasonably reliability of maintaining the planned transponder on time". "If the transponder 'on' times were made more widely available, then the increase of use which would result would mean that the battery storage would be depleted sooner, and thus the very schedule planned could not be met".

In other words, a form of negative feedback is effected, as due to the limitation of solar cells on such a little satellite, the more use it has, the less use it is likely to have, and vice versa, an interesting concept! Your scribe recently took two passes of the satellite, and found only two stations on s.s.b. and none (other than himself) on c.w. At other times of pre-advertised activity, it has been found to be silent, which rather proved the point.

Space Antennas

In our last month's column on e.m.e. communications possibilities for the more modestly equipped station, we made mention of some of the "big" signals that were workable, by using their transmit and receive gains to make QSO's possible over the vast attenuating path.

Several readers have asked what these other stations use, so here is a short list of some of those well equipped 144MHz moonbounce stations that you may be able to work, particularly when the moon is at perigee, the path fairly transparent as in quiet sun periods, and the Faraday rotation is not set at 90 degrees. If you have a clear and noise free horizon to the rising or setting moon, this too will help with the ground gain, and further not require antenna elevation.

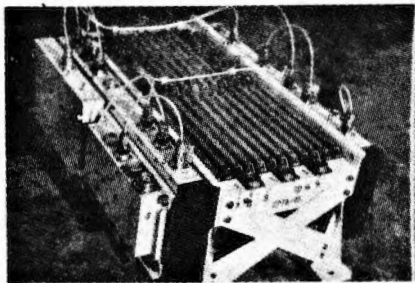

Fig. 3

W5UN uses 32 KLM 17LBX Yagis, and is currently considering upgrading this to 48! He is quite a signal on 144MHz e.m.e. KB8RQ has 32 Cushcraft 32-19, which are presently being taken down to replace them with 16 of K6MYC's new 5-wave-length "M2" Yagis. VE7BQH employs a 224-element collinear array with "Z" axis rotation as well as "X" and "Y" thus permitting overcoming the Faraday rotation. SM7BAE uses sixteen 3.2 wave-length CueDees, whilst N5BLZ utilises twelve KLM 16LBX Yagis. All of the above have some 1.5kW of r.f. output into the antenna and very good low noise front ends.

Some equally large arrays in size, and hence greater in gain, are used on 432MHz, and even more on 1296MHz. One station in France in the e.m.e. activity week-end of March 26/27 was using a dish with 61dB of gain, which turns 1 watt of r.f. output into an airp of exactly 1.25893254 megawatts!

Polar Bridge

The tough group of Canadian and Russian skiers reached the north pole at 0720UTC on April 26, to be met by an international group of Canadian and USSR

ministers, dignitaries, press, TV, assisting radio-amateurs, etc. all flown in via the North-Pole 28 polar ice station, and transported by helicopter.

For the occasion, the UoSAT-11 Digi-talker was placed on with the position continuously, with a short greetings and congratulatory message on the digital bulletin board. This was to provide a demonstration to the visitors on the effectiveness of amateur radio and satellites in providing a useful and reliable function for such ventures. Leonid Labutin UA3CR, came up as promised as EXOVE from the north pole exactly, and made many contacts including your columnist via RS-11, with an excellent signal on both s.s.b. and c.w. On h.f. both the calls EXOVE and C18UA were used by many operators including Michael G0/PA3BHF of the University of Surrey and many thousands of stations were worked. (Would anybody like to work out the QRA locator for the precise North Pole?)

This combination of amateur radio expertise in tracking, communications, satellite technology and international co-operation has done an enormous amount for the prestige of our mutual hobby, and has been the major content of the world wide amateur radio media, packet radio and news broadcasts. In South Africa alone, over one hundred schools are involved in tracking and environmental projects using both satellite and HF sources for information. The general media has also covered the event well, but in the UK hardly a mention (other than our columns) has come about in our press, radio, TV, GB2RS, etc.

The moving group are now on the way to Resolute Bay in Canada, a further 750km, added to by the polar ice drift and any diversions caused by the melting ice-cap. The progress will be reported daily by OSCAR-11 until the final destination is reached.

Propagation

Reports to Ron Ham
Faraday, Greyfriars, Storrington, West Sussex R20 4HE.

My interest in atmospheric disturbances dates back to 1946/7. This was when pictures from the then limited BBC television service, on 45MHz, were frequently obliterated, during the mid-summer months, by a natural event called Sporadic-E. My interest was further stimulated when I read the *Radio Handbook Supplement*, published by the RSGB in 1942. I learnt about the structure of the ionosphere, its dependence on the sun and the influence that each layer has on the paths of terrestrial radio signals.

Towards the end of the 1940s, articles were appearing in technical magazines about radio waves being generated by active areas on the sun's surface. Furthermore, these waves were detectable on earth with large antennas and receivers operating in the v.h.f. part of the spectrum. The thought of receiving radio waves from a natural source, 150 million kilometres away, fascinated me especially as the solar system was among my interests as an "armchair" astronomer.

I spent most of the 1950s and early 60s doing a variety of jobs in the domestic radio industry. I often had to explain to customers why their favourite programme on their "interference free" v.h.f. radio was being overpowered by foreign voices and why their normally crisp television pictures were covered with fluctuating patterns. Many times I witnessed the effect of a hefty Sporadic-E on BBC television in Band

I and a tropospheric opening on the ITV signals in Band III. Sometimes, in June and July, continental stations are heard in Band II via tropospheric opening and at the same time from the Mediterranean area and the USSR due to Sporadic-E. Believe me, that takes some explaining to satisfy a lay-man.

Over the years, I have followed the activities of radio amateurs, especially in the world of v.h.f. where the 70 and 144MHz bands are subject to the same disturbances as their commercial neighbours in Bands I, II and III. Because of this, enthusiastic amateurs with great patience have looked for the best DX while an event was in progress and proved that signals will travel far beyond their normal range during the lifetime of an aurora, sporadic ionisation in the E layer or ducting in the troposphere.

During the first 20 years, I gathered a great deal of practical information about propagation by looking for beacon signals in the 28, 70 and 144MHz bands, monitoring the East European broadcast band (68-73MHz), taking part in a few RSGB v.h.f. contests and keeping records of atmospheric pressure and disturbances to the domestic radio and television networks. However, one important factor was still missing, I didn't know when the sun was active. So, early in 1968, I decided to build a solar radio telescope and made reference to the book *Solar Radio Astronomy* by Kundu. From other literature, I already

knew that when sunspots are present, the sun is a very powerful transmitter of radio waves. A chart in Kundu's book showed that noise from large bursts and storms can be received on earth in the 100-200MHz region with a peak around 150MHz. Fortunately, I had previously heard solar noise on a communications receiver and knew that descriptions of it sounding like "hissing", "the sea rolling across the shore", "whoOOoshing" and "varying background noise" over a wide band were correct.

Obviously I had to select an observational frequency that was clear of local signals and after many prolonged tests with a converter and dipole, I decided on 135.95MHz, just outside the satellite band. The next job was to find a suitable south facing site on which to build the antenna, seen with a 20-year younger yours truly in Fig. 1. The main frame which supported the 4 Yagis was 3 x 2m, made with 2in rough sawn batten, held together with about 120 No. 10 wood screws and covered with 0.5in wire mesh as the reflector. Following a chat with the late Vic Hartopp, a director of Jaybeams, they duly supplied all the parts I needed to make the Yagis and the coaxial matching harness.

The site I selected had a clear view of the midday sun for about 3 hours and was well away from sources of man-made electrical interference. This was ideal because the

SEE US AT NEC STAND K

GAREX THE SCANNER SPECIALISTS

SEE US AT NEC STAND K

★ ★ ★ 25th ANNIVERSARY YEAR 1963-1988 ★ ★ ★ ★ ★ 25th ANNIVERSARY YEAR 1963-1988 ★ ★ ★

★ ★ ★ 25th ANNIVERSARY YEAR 1963-1988 ★ ★ ★ ★ ★ 25th ANNIVERSARY YEAR 1963-1988 ★ ★ ★

JIL SX-400
THE PROFESSIONAL SCANNER



- Basic coverage 26-520MHz
- AM, NFM & WFM
- Expandable from 100kHz to 1.4GHz with SSB and CW
- Computer control options
- IF output terminals
- Specifications set by professionals

£649

AOR 2002
THE WIDE RANGE SCANNER



- Covers: 25-550MHz, 800MHz-1.3GHz
- AM & NFM & WFM on all bands
- Computer interface socket
- 20 memories
- Compact size
- 12V dc operation
- Up/down step control knob

£487

REVCO RS-3000
THE COMPACT SCANNER



- Size only 6"×2"×8"
- Covers: 26-32MHz, 60-90MHz, 118-180MHz, 380-512MHz
- AM & FM all bands
- Liquid crystal display
- 50 memories
- Scan, search, priority

£199

AOR 800E
THE SMALLER HANDY-SCANNER



- Covers: 75-106MHz, 118-175MHz, 406-496MHz, 830-950MHz
- AM & NFM programmable on all bands
- Full scan & search functions are available
- 20 memories
- Measures only 2.5"×5.5"×2"
- Nicads, charger & BNC whip antenna included in the price

£199

JIL SX-200N
THE SUPERIOR SCANNER



- The choice of the professionals
- Proven reliability
- Covers: 26-88MHz, 108-180MHz, 380-514MHz
- AM & NFM on all bands
- Positive action keyboard
- 16 memories
- 12V dc & 240V ac

£325

NEW IMPROVED REVCON E

The British made REVCON E already renowned throughout the world has now been improved with a new exclusive feature. The addition of a vertical element to a discorne has been shown to improve the performance on a selected band.

Now the REVCON E offers YOU the choice of band

All new REVCON ES supplied by us now incorporate a mounting stud for an optional vertical whip for the band of YOUR choice. Whips may be chosen for any frequency from 27 to 950MHz from the standard REVCON range.

Basic REVCON E, excellent value at **£33.75**

Add-on whips from **£3.90 to £10.75**

Remember this British product carries no overseas freight or import Duty!

BROADBAND PREAMPLIFIERS

REVCO PA3 inline masthead model, with special mains psu. DC-1GHz min. 13dB gain **£49.95**

PA3I instrument or back-dial-set version for 12V DC operation, BNC connectors (S0239 or N-type options) **£38.50**

GAREX ELECTRONICS

HARROW HOUSE, AKEMAN STREET, TRING HP23 6AA. Phone Tring (044282) 8580 & Cheddington (0296) 668684. Callers by appointment only.

MAIN DISTRIBUTOR OF REVCO PRODUCTS. PRICES INCLUDE UK P&P and 15% VAT. Ask for details of our interest free credit.

Extensive range of PYE radiotelephone spares — S.A.E. for list. Ask for our secondhand scanner bargain list.

Books for radio amateurs

FDK

THE 'HAM SHACK'

ELLIOTT ELECTRONICS

for the Radio Enthusiast

MICROWAVE MODULES

INSTANT HP AVAILABLE

OSY OLD MAN TO

AERIAL ACCESSORIES AND MASTS

JAYBEAM AMATEUR ANTENNAS

APPOINTED DISTRIBUTOR

RIGS, ANTENNAS, SWR BRIDGES, POWER SUPPLIES, TEST GEAR, COMPONENTS, MORSE KEYS, COAXIAL CABLES, ROTATORS, MICS, PLUGS AND SOCKETS, SWITCHES

Call us on (0533) 553293

OR COME AND LOOK AROUND AT

26/28 Braunstone Gate, Leicester

SMC NORTHERN

South Midlands Communications Limited

Open Day and Stocktaking Clearance

Sunday June 26th 1988

Have *you* visited our new premises in Leeds?

Having moved just over a year ago we have gone from strength to strength, with our range of equipment and services expanding daily.

As part of the biggest importer of YAESU in Europe and Africa, we can offer *you* all the usual services that you expect from a dynamic and rapidly expanding company.

Come and visit us on Sunday June 26th and sample our hospitality and pick up one of our bargains, many at special prices only for our open day.

Closed for stocktaking Thursday June 30th

OPEN 9.00 a.m. - 5.30 p.m. Monday to Saturday

NOWELL LANE INDUSTRIAL ESTATE, LEEDS LS9 6JE

Telephone: (0532) 350606 Fax: (0532) 350155

J. BIRKETT

RADIO COMPONENT SUPPLIERS

25 The Strait Lincoln, Tel. 20767 (LN2 1JF) Partners J.H.Birkett, J.L.Birkett.

SEI CRYSTAL FILTERS Type QC1246MIB 10.7MHz 7.5KHz @ **£2.95**, Type QC1121A 10.7MHz 7.5KHz @ **£3.00**.

CRYSTAL FILTERS 1.4MHz BW 2.4KHz Upper and Lower Sideband @ **£11.95** Pair.

MULLARD X BAND GUNN OSCILLATOR MODULE CL8630 @ **£9.95**.

X BAND GUNN DIODES @ **£1.65**, X BAND TUNING VARACTORS 3p.f. or 4p.f. @ **£1.65** each.

X BAND DIODES LIKE 1N23 @ 45p, SIM 2 @ 45p, 1501E @ **£1.65**.

TUBULAR TRIMMERS 0.5p.f. to 3p.f. @ 30p, 15p.f. @ 25p.

COMPRESSION TRIMMERS 30p.f. 50p.f. 100p.f. @ 20p each, 500p.f. @ 25p.

RECTANGULAR LEADS 15 for **£1.00**, 25 Assorted Colours 0.2" for **£1.00**.

AIR SPACED VARIABLE CAPACITORS 200+350p.f. with Slow Motion Drive @ **£2.50**, 125+125p.f. Direct Drive @ **£1.95**, 10+10+20p.f. Direct Drive @ **£1.50**.

SOLDER-IN FEED THRU 5p.f., 27p.f., 300p.f. @ 25p Doz, 1000p.f. @ 5p each.

RF POWER TRANSISTORS PT9787 8W, 30MHz @ **£7.95**, PT9788 20W, 30MHz @ **£9.95**, BLX92A 8W, 470MHz @ **£8.95**, TPV593 UHF No Details @ **£3.95**, 2N3866 @ 85p, BFW16A @ 75p.

AIR SPACED TRIMMERS Mullard 809 36p.f. @ 30p, 22p.f. @ 55p, 35p.f. @ 60p, 57p.f. @ 85p, 100p.f. @ 95p, Differential Type 10×10p.f. @ 50p, 30×30p.f. @ 85p.

TRANSMIT-RECEIVE PIN DIODES VHF 5 for 60p, UHF 5 for 75p.

80 ASSORTED VARI-CAP DIODES @ 60p, 300p.f. Type 5 for 50p, 100p.f. 5 for 50p.

HIGH VOLTAGE SILVER MICA CAPACITORS 750v 10, 18, 27, 36, 82, 100, 150, 200, 270, 330, 500p.f. All @ 20p each.

JACKSON TYPE 00 GANG VARIABLE CAPACITOR 200+220p.f. @ **£2.50**.

WOOD AND DOUGLAS AND C.M.HOWES KITS AVAILABLE BY POST AND FOR CALLERS. ACCESS AND BARCLAY CARDS ACCEPTED, P.P. 60p UNDER £5. OVER FREE.

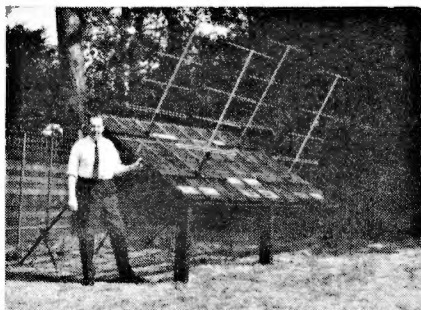

Fig. 1

rotation of the earth would move the antenna across the sun in the horizontal plane. All I had to do was adjust its angle about 5 times a year to keep the sun within its vertical beamwidth. This could be done by hinging the reflector on its bottom rail and supporting the back with a couple of 3.6m x 38mm aluminium poles and a simple arrangement of universal clamps. This weighty assembly was supported by three, 2m lengths of 9 x 3in timber, evenly spaced with approximately 0.6m of each protruding above the ground. The bases of the log reflector hinges were bolted to a plank which, in turn, was secured to the uprights with coach screws.

Next month, I'll continue with my story but now, back to 1988 and the latest observations.

Solar

Varying numbers of sunspots were observed on many days by **Patrick Moore** (Selsey) between March 25 and April 26. A fair sample can be seen from the drawings he made at 0820 on March 27 (Fig. 2), 0805 on April 13 (Fig. 3) and 0925 on the 20th (Fig. 4).

From Edinburgh, **Ron Livesey** located three sunspot groups almost daily from March 17 to 25 and four groups from the 27th to 31st inclusive. In Bristol, **Ted Waring** counted 30 sunspots on March 27, 21 on April 3, 15 on the 11th and 22 on the 20th.

At his observatory in Sevenoaks, **Cmdr Henry Hatfield** uses a spectrohelioscope for visual observations of the sun and a 136MHz radio telescope for advanced warning of sunspot activity. Far too often overcast skies prevent astronomers from using their optical gear however, Henry logged three sunspot groups and 11 filaments at 1455 on March 25, two groups and 14 filaments at 0912 on April 1, one group, 24 filaments and a small flare between 0946 and 1013 on the 3rd and two groups, 14 filaments and two small flares in the early afternoon of the 13th.

Henry recorded large individual bursts of radio noise, lasting about 10 minutes on April 3, 7, 14 and 17 and continual noise, with additional bursts on days 1, 2, 13, 17, 18 and 19. "Things are definitely waking up—though still quite slowly," said Henry.

"March was the first month with every day above 100 solar flux units," wrote **Neil Clarke GOCAS** (Ferrybridge). The general increase in solar flux between the 10th and 31st is clearly seen on Neil's computer print out, Fig. 5. He tells me that the sunspot number at the beginning of March was in the 80s, but fell to 59 on the 15th. Then, apart from the 23rd, it stayed above 100 and climbed to a peak of 146 at the end of the month.

Magnetic

Neil also reports that magnetic conditions became stormy on March 25 with an



Fig. 2

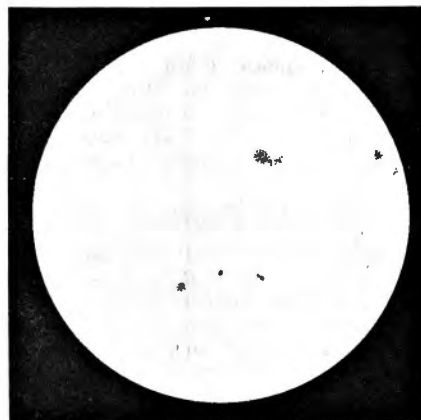

Fig. 3



Fig. 4

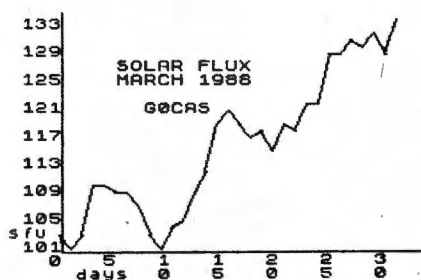
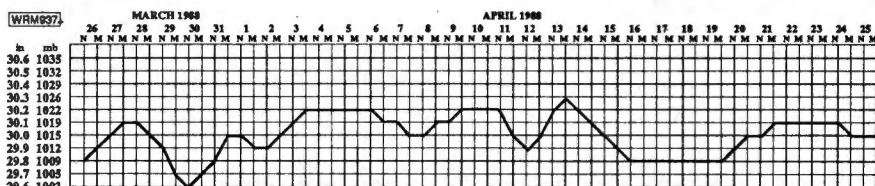

Fig. 5

Fig. 5

Beacon	March 88											April 88																			
	25	27	28	29	30	31	1	2	3	4	5	6	7	8	9	10	11	12	13	14	15	16	17	18	19	20	21	22	23	24	25
AK2RSY									X				X																		
QAQAB																															
OLQIGI	X			X	X	X	X	X	X	X	X	X	X	X	X	X	X	X	X	X	X	X	X	X	X	X	X	X	X		
EA3IA	X				X											X													X		
IY4M									X	X																					
LW1DZ					X										X																
LW1UG	X		X	X	X	X	X	X	X	X	X	X	X	X	X	X	X	X	X	X	X	X	X	X	X	X	X	X	X		
LU4XS					X											X												X	X		
OH1ZAA															X													X	X		
OH2TEN									X																						
PT7AAC	X	X	X	X	X	X	X	X	X	X	X	X	X	X	X	X	X	X	X	X	X	X	X	X	X	X	X	X	X		
PY2AMT	X	X	X	X	X	X	X	X	X	X	X	X	X	X	X	X	X	X	X	X	X	X	X	X	X	X	X	X	X		
PY2G08	X	X	X	X	X	X	X	X	X	X	X	X	X	X	X	X	X	X	X	X	X	X	X	X	X	X	X	X	X		
VK4RTL									X																						
VK5WI																								X							
VK6ZT																								X				X			
VK6RWA						X							X			X															
VP8ADE	X		X	X	X	X	X	X	X	X	X	X	X	X	X	X	X	X	X	X	X	X	X	X	X	X	X	X	X		
VB4DJS																X															
VB4IHS																							X								
VB8ICY																							X								
ZS1LA	X	X	X	X	X	X	X	X	X	X	X	X	X	X	X	X	X	X	X	X	X	X	X	X	X	X	X	X	X		
ZS5VHF	X	X	X	X	X	X	X	X	X	X	X	X	X	X	X	X	X	X	X	X	X	X	X	X	X	X	X	X	X		
ZS6PV	X	X	X	X	X	X	X	X	X	X	X	X	X	X	X	X	X	X	X	X	X	X	X	X	X	X	X	X	X		
Z21ANB	X	X	X	X	X	X	X	X	X	X	X	X	X	X	X	X	X	X	X	X	X	X	X	X	X	X	X	X	X		
SB4CY	X	X	X	X	X	X	X	X	X	X	X	X	X	X	X	X	X	X	X	X	X	X	X	X	X	X	X	X	X		

Fig. 6



Ap index of 56 which reached 61 on the 26th and then remained stormy for the rest of the month. The magnetometer used by **Karl Lewis** (Saltash) was very unsettled on March 7, 26, 29 and 30 and indicating storm periods on days 4 and 26 to 30.

Auroral

Ron Livesey is the auroral co-ordinator for the British Astronomical Association. He received reports of "active aurora" from observers in Ireland and Scotland for

the night of March 26/27, "corona overhead" and "active rays" from south Scotland for 27/28 and 30/31 respectively.

Greg Lovelock G3III (Shipston-on-Stour) found that his beam heading between 320 and 025 degrees made little difference when he worked a few stations on s.s.b. during the aurora on April 4.

The 28MHz Band

John Levesley G0HJL (Bishopscote), using a Yaesu FT-747GX plus High Gain 18V-S vertical antenna, heard stations from South and North America, South Africa and the USSR on March 19 as well as Argentina, Canada, Cyprus and the USSR on the 20th. John also made his first contact into Uhta in Asiatic Russia, using about 20W, on the 20th. He heard signals from both Americas on the 23rd, Canary Is, Chile and Israel on the 26th. John also worked W3FYT/P/4X, a UL7 and an unusual call, TY4BR/P/5U7, on the 26th. Some of the countries heard by John in April are both Americas on the 1st; Australia, South Africa and Uruguay on the 2nd; Brazil, the Mediterranean area and the USSR on the 3rd; Argentina, Japan, Mediterranean area and South Africa on the 10th; Brazil, Israel and South Africa plus some short skip producing signals from France and northern Ireland on the 12th; Puerto Rico, Spain and South Africa on the 15th; Brazil, South Africa, Sweden and the USSR on the 16th; Israel and South Africa on the 17th; Japan on the 18th and Brazil and both sides of a QSO between a JY5 and SORASD on the 19th. In addition he worked UL8GWB in Alma Ata City and 4X4JU on the 3rd and K4XS in Florida on the 16th.

John Coulter (Winchester) heard a VK6 working a station in Bournemouth at 1215 on April 21. **Fred Pallant G3RNM** (Storrington) logged ZD8HF at 59 on the 25th.

Propagation Beacons

First, my thanks are due to **Chris van den Berg** (The Hague), **John Coulter**, **Henry Hatfield**, **Don Hodgkinson G0EZL** (Hanworth), **John Levesley**, **Greg Lovelock**, **Ted Owen** (Maldon), **Fred Pallant** and **Ted Waring** for their dedication to 28MHz beacon monitoring. These reports enable me to prepare the monthly chart, Fig. 6, of beacons heard, however if you see a blank square at a time when you heard that beacon's signal, then why not ask me for a log sheet and join the band of regular beacon watchers.

Chris van den Berg, heard WB4DJS (28.295MHz) in Florida at 599 on April 9 and WB9VMY (28.217MHz) in Oklahoma City on March 24. Also on this day, **Don Hodgkinson** heard KB4UPI/B (28.266MHz) and WC8E/BCN (28.295MHz) for the first time. **Don** received a QSL card from **Mick Lindley KB4UBI** (Birmingham, Alabama) showing a transmitter power of 20W to a 0.25λ dipole. **John Coulter** and **Fred Pallant** logged WB4JHS/B (28.250MHz) and WB8IGY (28.293MHz) on April 16. **Don Hodgkinson** and **Fred Pallant** found another first timer, **LU4XS** (28.220MHz) on the days listed in Fig. 6. **Greg Lovelock** logged LU1DZ (28.215MHz) on March 30 and April 9.

Ted Owen, reports hearing VK6ZT (28.270MHz) testing at 0859 on April 7 and the signal "TESTING IN KPOIRO" on the 17th and 22nd.

Tropospheric

The slightly rounded atmospheric pressure readings at noon and midnight for the period March 26 to April 25, Fig. 7, were taken from the barograph at my home in Sussex. In Maldon, **Ted Owen's** barometer indicating a low of 1000mb (29.55in) on

March 30 and highs of around 1028mb (30.35in) on April 5, 13 and 14. Although the average noon pressure for the period was 30.0in (1015mb) mild tropospheric openings did occur, following the higher pressure, around April 3/4, 10/14 and 23/24. So far I have reports that these events increased the range of signals in the broadcast Bands II (88-108MHz) and III (175-230MHz) and the 934MHz Citizens Band.

934MHz

At 2115 on April 2, **John Raleigh DW-04** (Bedford) heard several east coast stations and realised a slight lift was in progress. A few hours later at 0145 on the 3rd, he made contact with stations in Kent, Southampton and Suffolk. **John**, Secretary of The Four County 32cm Club, learnt that **Fred** and **Dora Mills TL-01** (Kempston) made several contacts in Leicestershire around 0700 on the 3rd.

"Local stations tell me that the band has been open over about a 160km path between Dorset and Sussex on a few afternoons in mid-April," wrote **John Levesley UK-627**. He worked **GY-186** in Guernsey on the 8th, heard him again on the 9th and **JY77** in Jersey on the 10th.

The deadlines for the next three issues are: June 29, July 27 & August 24

Peter Shore

Broadcast Round-up

It has been the time of major frequency changes in the past few days—the start of the May to September period, and stations have been moving to higher frequencies. Whilst most stations made their schedule alterations on Sunday May 1, Moscow delayed implementing theirs until 0000UTC on Wednesday May 4, as it would have caused major problems in the Soviet Union to change all domestic and external channels on one of the most important holidays of the year: May Day, and it would have affected coverage for audiences at home and abroad of the famous May Day parade. Once again, domestic radio in the Soviet Union linked to broadcast uninterrupted commentary, and Radio Moscow World Service—the English language external service—and Radio Moscou International—the French language service—also provided coverage from around 0600UTC.

Tuning around a few days before compiling this month's column, I was surprised at how poor conditions were on 21MHz during the morning here in the United Kingdom. Perhaps things will improve in the coming weeks, as I am sure that more stations will be utilising frequencies in this band during the summer period. However, conditions for worldwide listening did seem to be quite good on slightly lower channels, and perhaps this augurs well for the summer.

All India Radio is to get a powerful new short wave transmitter soon, according to

a report carried on the station. AIR claimed that the new transmitter will be the most powerful in Asia, so it may be that a 500kW sender is on order. The new equipment will be used for programmes beamed to Africa, Australia and South East Asia.

Meanwhile, Radio Japan's re-engineering at the Yamata site has recently been completed, with new 100 and 300kW transmitters and antenna arrays. These are designed to improve reception in Asia and the West Coast of North America where reception has been poor until now. Yamata is an inland site, 60km north-east of Tokyo and was built in 1941, but remained almost unchanged until work started on renewing the station in 1984. There are eight transmitters in total, four each of 100 and 300kW power. There are 17 antennas—four log periodic and thirteen curtain arrays. Radio Japan has offered relay facilities to other broadcasters—there is already an arrangement between Radio Canada and the Japanese broadcaster, and it will be interesting to see if any other stations take advantage.

Jordan also has new facilities which will start tests in the late summer. Three 500kW transmitters have been installed at the Kharanah site, along with a 1000kW medium wave transmitter and two long wave transmitters with a total output of 1200kW.

Controversy affected the BBC and Voice of America in April when the Liberian

authorities ordered Liberian Radio to cease relaying *Focus on Africa* from London and Washington's *African Panorama*.

Algeria has now caught up with the long wave changes which should have been completed in February, and moved from 200kHz to 198kHz, Morocco, allocated to 207kHz, continues on 209kHz.

Europe

All times UTC (=GMT)

Listeners to ORF Austria during April on 6.155MHz may have been surprised to hear what could have been a crude sort of jamming between 0900 and 1300. Tuning around the bands would have revealed similar noises on 9.915 and 12.04MHz, both BBC and VoA UK relay frequencies. In fact, these were tests of a new propagation prediction evaluation system using tones and pulses which was to be demonstrated by the BBC to an ITU CCIR Study Group in Switzerland. Transmitters of 250kW on a 70 degree beam at Woofferton were used for these tests, which were monitored in Hull prior to the tests for the Geneva Study Group. It seems rather strange that the BBC should have chosen to use an occupied frequency in the 49 metre band—6.01MHz is clear during the morning period which was wanted for the tests and would have saved any embarrassment for the British and Austrian authorities.

Radio Finland International has begun

announcements in Japanese during its broadcasts to Asia at 0830. This may be a precursor to the introduction of a fully-fledged Japanese service which was hinted at by Juhani Niinisto, Head of External Broadcasting at YLE last June.

Radio France International has altered the name of its 1600 English broadcast. Previously *Paris Calling Africa*, the name has changed, in line with the station's policy of adopting a broader and more global view of its audience, to *Paris Calling the World*. English news may also be heard at 0315 on 9.79, 11.67 and 11.70MHz and at 1245 on 21.645, 15.155 and 11.67MHz. The Arabic news broadcasts which I mentioned briefly last month can be heard at 1100 on 21.52 and 11.845MHz.

Radio Berlin International from 2 May:
0500 on 5.965 and 6.115MHz
0745 on 6.115 (not Sat & Sun), 6.04, 7.185 and 9.73MHz
0945 on 6.115MHz
1100 on 6.115 and 9.665MHz
1300 on 6.115MHz
1345 on 9.73MHz
1545 on 7.295 and 9.73MHz
1715 on 7.26, 7.295 and 9.73MHz
1945 on 6.115 and 1.359MHz
2145 on 5.965MHz

The 6.115 channel has until now been used by the German domestic service. 13.61MHz is also used by RBI's African Service.

Radio Budapest's schedules from 2 May for English:
1830 and 2000 to Europe on 15.16, 11.91, 9.835, 9.585, 7.22, 6.11MHz
2330 (Mon-Sat) and 0030 to North America on 15.16, 11.91, 9.835, 9.585, 9.52, 6.11MHz

Radio Polonia in Warsaw changed its schedule too, at the beginning of May. The 1730 and 2030 transmissions in English have been dropped, and replaced by a 50 minute programme starting at 2305, replacing the concert programme which was broadcast at that time. There is still a broadcast at 2230 for thirty-minutes, meaning that there will be almost 90 minutes in English starting at 2230, with a five minute break at 2300.

Spanish newscasts from REE can be heard at 1000, 1130 and 1500 on 21.575, 17.77, 17.845 and 15.395, with additional frequencies at 1130 of 12.035, 11.92, 9.875 and 9.57MHz.

Swiss Radio International's new schedule from 1 May runs through until 5 October. The European service may be heard on 3.985 between 0500-1000 and 1230-1945, on 6.165 and 9.535 between 0500-1945 and on 12.03 between 1000 and 1230, with English at 0630, 1200 and 1700, with a programme at 2130 on 6.19MHz. Music is on the air at 1000-1030 daily, 1600-1630 Mon-Sat and 1630-1700 on Sunday. The Intercontinental English service is heard at:

0200 on 5.965, 6.135, 9.725, 9.885 and 12.035MHz
0400 on 6.135, 9.725, 9.885 and 12.035MHz
0630 on 15.43, 17.57 and 12.03MHz
0830 and 1000 on 9.56, 13.685, 17.83 and 21.695MHz
1100 on 11.935, 13.685, 15.57 and 17.83MHz
1330 on 11.695 (via Beijing), 13.685, 15.135 (Beijing), 15.57 and 17.83MHz
1530 on 13.685, 15.43, 17.83 and 21.63MHz
1830 on 9.885 and 11.955MHz
2100 on 9.885, 12.035 and 15.57MHz

Some new feeders for USSR domestic channels were noted on the air just before the May changes: 18.87, 18.65 and 18.285MHz, all u.s.b., and noted during daylight hours. Other feeders include 14.41, l.s.b. and 14.85MHz u.s.b. Moscow's World Service can be heard during the day on 13.68 and 13.71 during the daytime, although the latter does opt out to the German language service. A reliable feeder for the domestic Moscow Second programme, or Mayak (Lighthouse) service, is 13.735MHz u.s.b. Moscow seems to have started listening to other international broadcasters, for its German service is now using music which Radio Netherlands has been playing as theme music for many months, and in a recent feature on *Focus on Asia and the Pacific* on Moscow World Service, part of an interview credited to the BBC was played...

Radio Caroline's h.f. transmitter has moved from 6.205 to 6.215MHz, and is now carrying programmes from World Missionary Radio with a mailing address in California, USA.

Africa

Algeria has three services on the air between 1100 and 1200:

French on 15.205, 15.16MHz and 254kHz
Spanish on 15.215, 9.64MHz and 981kHz
Arabic on 11.715, 9.545, 9.510, 7.246MHz and 891kHz

Kenya's Domestic service is providing good listening here in the UK: the National Service is heard on 4.885 until 2110, in parallel with a weak 6.15MHz. The General Service is also on the air until 2110 on 4.915 and 4.934MHz.

The Libyan Radio feeder channels have been active once again, heard in the morning from around 1015 on 13.50, 13.70 and 18.0MHz all u.s.b., in parallel with the established a.m. channels on 15.235, 15.415 and 15.45MHz, and in the evening on 5.705, 4.50, 4.20 (all u.s.b.) and 4.155MHz l.s.b.

Mali can be heard at around 0700 and 1900 on 4.835MHz, and English from Mozambique is on 9.617 variable at 1800.

Tunisian Radio has been heard from 0800 on 7.31, in parallel with 12.004 and 11.55 continuing well in to the afternoon.

The South African Broadcasting Corporation has published a list of all stations heard between 3.20 and 17.775MHz in southern Africa. Called *QTH Africa* it is available from Radio: RSA's *DX Corner* programme for \$2.00. Write to SABC, PO Box 6, Honeydew 2040, South Africa. The new English schedule for Radio RSA is:

1100 on 7.27, 15.365, 17.89 and 21.59MHz
1400 on 7.27, 15.365, 17.755, 21.535 and 21.59MHz
1800 and 11.875 and 15.365MHz
1900 on 5.98, 7.27 and 9.61MHz

Middle East

At 1600, Dubai is heard on new 15.30MHz, in parallel with 11.955, 11.73 and 9.64MHz. Abu Dhabi, also in the United Arab Emirates, is heard on 17.81 and 17.82 in the morning from before

1000, and after 1400 on 15.51, 15.395 and 11.815MHz.

Israel was heard with a jamming free Russian service on 15.155 at 1530. There is to be a possible restructuring of the Kol Israel External Service soon, although no further details are available at present.

Asia and the Pacific

Radio Afghanistan's language services are heard at 1230-1430 in Urdu on 11.985, 9.765 with Pashto continuing between 1430 and 1700.

Radio Australia has been heard in the morning with good reception on higher frequencies:

0800 on 17.715, 11.72 (poor), 9.655 and 9.58MHz
0900 on 15.415, 17.72, 9.76, 9.655 and 9.58MHz (poor)

Indonesia's RRI National Service is audible on 9.68MHz variable at around 1500.

New Zealand has changed frequency for its broadcast at 1830-2105—now on 12.045MHz.

North and South America

Some schedules for North American private short wave broadcasters:

KSDA 0200-0700 on 11.70 and 17.865MHz
0700-0900 on 11.70 and 17.855MHz
0900-1100 on 11.98 and 17.855MHz
1100-1200 on 11.83 and 11.98MHz
1200-1400 on 9.465 and 11.98MHz
1400-1500 on 11.70 and 11.98MHz
1600-1700 on 11.70MHz
2000-2200 on 9.465 and 15.225MHz
2200-0200 on 11.75 and 15.125MHz

KUSW 0100-0300 on 11.695MHz
1900-2200 on 15.40MHz

WCNS 0000-0400 on 9.85MHz
0400-0600 on 9.87MHz
0600-0800 on 9.495MHz
1600-1800 on 21.64MHz
1800-2000 on 15.39MHz
2200-2400 on 15.30MHz

WHRI 0000-0300 on 9.87 and 7.40MHz
0300-0400 on 7.40 and 7.355MHz
0400-0600 on 7.40MHz
0600-0800 on 9.62MHz
0800-1100 on 9.51 and 7.355MHz
1500-1700 on 21.655 and 15.105MHz

WMLK 1600-2400 on 9.465MHz

Radio Canada International broadcasts in English to Europe:

Mon-Fri 0515-0530 and 0545-0600 on 6.05, 6.14, 7.295 and 9.75MHz
1830-1900 on 9.555, 7.235, 11.945, 15.325 and 17.875MHz
2000-2030 on 6.03, 9.555, 11.945, 15.325, 17.82 and 17.875MHz
2100-2200 on 11.945 and 15.325MHz
Sat&Sun 2000-2100 on 6.03, 9.555, 11.945, 15.325, 17.82 and 17.875MHz

Any reports or comments for this column should be sent to the Poole Offices

ICOM

Count on us!

IC-290D/490E Mobiles

These SSB, CW, FM transceivers are ideal for mobile or base station operation. The IC-290D for 2 metres produces 25 watts/5 watts low power. The IC-490E for 70 centimetres produces 10 watts/1 watt low power. Both transceivers have a range of operating features, these include 5 memory channels, dual V.F.O.'s and a priority channel to automatically check your most used frequency. Squelch on FM and SSB to allow silent scanning whilst searching for signals, slow or fast AGC for SSB and CW and a noise blanker to suppress pulse type QRM. Sidetone is provided on CW. Memory and full or



Credit facilities available

programmable band scan with internal switches to stop on busy or empty channels. Programmable offsets are included for odd frequency splits. For further information regarding the IC-290D/490E please contact your authorised ICOM dealer or contact us direct.



Icom (UK) Ltd
Unit 8/9 Sea Street Industrial Estate, Herne Bay, Kent CT6 8LD. Telephone: (0227) 369464.
Open: 9-5.30, Lunch 1-2pm. Mondays to Saturdays.



PLEASE MENTION PRACTICAL WIRELESS WHEN REPLYING TO ADVERTISEMENTS

ANTENNA TUNER

FOR outside or **INDOOR** antennas, end-fed LONG WIRES or dipoles, **BOOST DX** and reduce interference 100KHz-30MHz in 6 overlapping ranges, IDEAL for FRG7700 etc or 10W tx, BANDPASS design, ALSO adapts to WAVEMETER, field strength meter etc, **only £29.90**, hear **FAINT DX**.
ANTENNA FAULT? Poor reports? Not getting out? CHECK FAST with an **ANTENNA NOISE BRIDGE**, measure RESONANCE 1-160MHz and RADIATION RESISTANCE 2-1000 ohms, simply null the noise, **only £26.20**, get **ANSWERS** and **MORE DX**.

Each fun-to-build kit (ready-made to order) includes all parts, case, pre-wound coils, instructions, by-return postage (Europe same, Giro 21.923.4000) etc. and list of other kits.

CAMBRIDGE KITS

45 (PG) Old School Lane, Milton, Cambridge.

SPECIAL NOTICE TO READERS

Although the proprietors and staff of *PRACTICAL WIRELESS* take reasonable precautions to protect the interests of readers by ensuring as far as practicable that advertisements in *PRACTICAL WIRELESS* are bona fide, the magazine and its Publishers cannot give any undertakings in respect of claims made by advertisers, whether these advertisements are printed as part of the magazine, or are in the form of inserts.

While the Publishers will give whatever assistance they can to readers having complaints, under no circumstances will the magazine accept liability for non-receipt of goods ordered, or for late delivery, or for faults in manufacture. Legal remedies are available in respect of some of these circumstances, and readers who have complaints should address them to the advertiser or should consult a local Tradings Standards Office, or a Citizen's Advice Bureau, or their own solicitor.

MAKE YOUR INTERESTS PAY!

More than 8 million students throughout the world have found it worth their while! An ICS home-study course can help you get a better job, make more money and have more fun out of life! ICS has over 90 years experience in home-study courses and is the largest correspondence school in the world. You learn at your own pace, when and where you want under the guidance of expert 'personal' tutors. Find out how we can help YOU. Post or phone today for your **FREE INFORMATION PACK** on the course of your choice. (Tick one box only!)

Electronics <input type="checkbox"/>	Radio, Audio and TV Servicing <input type="checkbox"/>
Basic Electronic Engineering (City & Guilds) <input type="checkbox"/>	Radio Amateur Licence Exam (City & Guilds) <input type="checkbox"/>
Electrical Engineering <input type="checkbox"/>	Car Mechanics <input type="checkbox"/>
Electrical Contracting/Installation <input type="checkbox"/>	Computer Programming <input type="checkbox"/>
GCE over 40 'O' and 'A' level subjects <input type="checkbox"/>	

ICS Name _____ P. Code _____
 Address _____
 International Correspondence Schools Dept EES 78, 312/314 High St., Sutton, Surrey SM1 1PR. Tel: 01-643 9598 or 041-221 2926 (24hrs).

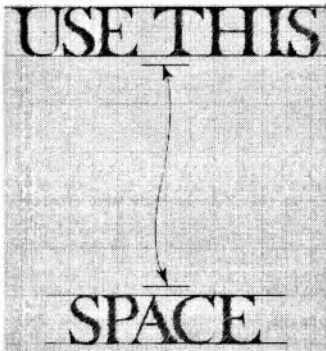

SMALL ADS

The prepaid rate for classified advertisements is 40 pence per word (minimum 12 words), box number 60p extra. Semi-display setting £13.24 per single column centimetre (minimum 2.5 cm). Please add 15% VAT to total. All cheques, postal orders etc., to be made payable to Practical Wireless. Treasury notes should always be sent registered post. Advertisements, together with remittance should be sent to the Classified Advertisement Dept., Practical Wireless, Enefco House, The Quay, Poole, Dorset BH15 1PP. Telephone (0202) 678558.

Whilst prices of goods shown in advertisements are correct at the time of closing for press, readers are advised to check with the advertiser both prices and availability of goods before ordering from non-current issues of the magazine.

For Sale

RCS VARIABLE VOLTAGE D.C. BENCH POWER SUPPLY
0 to 20 volts up to 1.5 amps D.C. Fully stabilised. Twin panel meters for instant voltage and current readings. Overload protection. Fully variable. Operates from 240V A.C. Compact Unit: size 9x5 1/2 x 3 ins. £36 + Post £2.



RADIO COMPONENT SPECIALISTS

ACCESS 337 WHITEHORSE ROAD, CROYDON SURREY, U.K. Tel: 01-684 1665 VISA
List, Large S.A.E. Delivery 7 days Callers Welcome Closed Wednesday

"GRUNDIG" INFRA-RED REMOTE CONTROL "VIF-K1" consists of Transmitter TPV355 & VIF-E1 brand new & boxed £4.99. P&P £2. Box of 10 VIF-E1 £9.99p P&P £3. VIDEO HEADS (GRUNDIG 2x4 Super) with head assembly £29 P&P £2. 2x4 SUPER panels - DTF, SERVO, VIDEO, CROMA, STEREO-TON, MOTOR-BOARD, MODULATOR & TUNER all £5.99 each P&P £1. VIDEO TAPES VCC360 £6.99, VCC480 £7.99 P&P £1. REMOTE CONTROLS suitable for use with FERGUSON, JVC, PHILIPS, SONY, GRUNDIG, ITT brand new boxed £19.95, P&P £1. GRUNDIG 2x4 SUPER STEREO £79 & £89 (callers only). SURPLUS STOCK WANTED. STAN WILLETTTS, (PW), 37 High St., West Bromwich, West Midlands B70 6PB. 021 553 0186.

Situations Vacant

EXPERIENCED SERVICE ENGINEER

Experienced RF Service Engineer required for bench servicing of Marine/Land Mobile and Amateur radio equipment. Candidates must have at least 2 years experience. Salary negotiable.

Contact:

C. Webster, 01-450 9755.
Communique UK Ltd.,
Communications House,
Purley Avenue, London. NW2 1SB.

Service Sheets

TECHNICAL INFO SERVICES (PW)

76 CHURCH STREET, LARKHALL, LANARKSHIRE ML9 1HE

Phone: 0698-884585 Mon.-Fri., 9-5, any other time: 0698-883334, for Fast Quotes

WORLD'S LARGEST COLLECTION SERVICE MANUALS - Most unobtainable elsewhere.

Prices range from only £4.50 - large s.a.e. any quotation, no obligation to buy.

WORLD'S SOLE Suppliers of TV & Video Repair Manuals, etc. from TV TECHNIC

also such publishers as Heinemann, Newnes, TV Technic, Thorn, etc.

Every published service sheet in stock, supplied full size, not bits and pieces.

CTV's or any combination £3.50 + I.s.a.e.; any other single item £2.50 + I.s.a.e.

Complete Circuit Sets for most Videorecorders only £7 set (No service sheets made).

L.S.A.E. for QUOTATIONS plus GIANT CATALOGUE - NEWSLETTERS - BARGAINS -

FREE S/Sheet as available.

Comprehensive TV Repair Manual £9.50. Complete Radio Service and Repair Course £9.50.

Complete Repair & Service Manuals - Mono TV £12.50; CTV £17.00; Video £19.50.

Complete Repair Data with Circuit - Mono TV £ 9.50; CTV £12.50; Video £10.50.

£3.00 + L.S.A.E. BRINGS THE ONLY COMPREHENSIVE SERVICE SHEETS & MANUALS

CATALOGUES plus FREE CHASSIS GUIDE and £4.00 OF VOUCHERS.

SERVICE MANUALS

Most Makes, Models, Types, Audio, TV, Video, Test, Amateur Radio, Vintage etc.

LSAE Enquiries and FREE CATALOGUE

Unique Repair/Data guides, valve books etc.

MAURITRON (PW), 8 Cherry Tree Road, Chinnor, Oxfordshire OX9 4QY.

TECHNICAL MANUALS AR88, CR100, R210, SX28. £4 each. Thousands s.a.e. lists. Bentley, 27 De Vere Gardens, Ilford, Essex IG1 3EB. Phone 01-554 6631.

Educational

COURSE FOR CITY & GUILDS, Radio Amateurs Examination. Pass this important examination and obtain your licence, with an RCC Home Study Course. For details of this and other courses (GCE, GCSE, Career and professional examinations, etc.) write or phone: THE RAPID RESULTS COLLEGE, Dept. JX22, Tuition House, London, SW19 4DS. Tel. 01-947 7272 (9am-5pm) or use our 24hr Recordcall Service: 01-946 1102 quoting Dept. JX22.

Rally

SUSSEX MOBILE RALLY, Brighton Racecourse, Sunday 10th July, Family Fun Day starts 10.30. (04446) 3757 Evenings.

Receivers and Components

VHF ACTION RECEIVERS. Hand-compact 54-176MHz/80Ch 11m for aircraft, marine, public-service, ham-radio, utilities, local 2-way etc, squelch and VFO functions. European origin: £32.50 all inclusive, unbeatable value. Taylor D/T, 8 Emmerson Street, Crook, Co Durham, UK, COD/enquiries 0388 763323 (see details).

QUARTZ CRYSTALS and FILTERS

Large numbers of standard frequencies in stock for amateur, CB, professional and industrial applications. Stock crystals £5.00 each (inc. VAT and UK post). Any frequency or type made-to-order from £6.50. Phone or SAE for lists.

GOLLEDGE ELECTRONICS
Merriott, Somerset, TA16 5NS.
Tel: (0460) 73718.

RADIO CANADA. Peking, Australia, Voice of America. A Vega 206 (MW/LW/6 x SW) pulls these and dozens more £24.49. Vega Selina 215 (MW/FM/LW/5 x SW) £35.95. Steepleton FM/MW/AIR band pocket radio £9.95. B.F.O. kit resolves SSB signals on nearly any radio £9.95. Year's guarantee. Return despatch. CORRIGAN-RADIOWATCH, Building 109, Prestwick Airport KA9 2RT.

LARGE QUANTITY of used 2732. EPROMS. All tested and erased. £1.00 each. Telephone 0279 503568 evenings.

SCANNER OWNERS. For those of you who wish to hear more, we offer extensive frequency listings and many scanner modifications. For full details send a large S.A.E. to S.S.C. PO Box 71, Bournemouth, Dorset BH9 1DL.

ORDER FORM PLEASE WRITE IN BLOCK CAPITALS

Please insert the advertisement below in the next available issue of Practical Wireless for
insertions. I enclose Cheque/P.O. for £ CAT. heading

NAME

ADDRESS

PRACTICAL WIRELESS
Classified Advertisement Department,
Enefco House, The Quay, Poole,
Dorset BH15 1PP. Telephone (0202) 678558
Rate 40p per word, minimum 12 words.
Box No. 60p extra.
PLEASE ADD 15% VAT TO TOTAL

Company registered in England. Registered No. 1980539. Registered Office: Towngate House, 2 Parkstone Road, Poole, Dorset, BH15 2PJ.

7/88

Valves

BILLINGTON VALVES

39 Highlands Road, Horsham, Sussex RH13 5LS
Tel: 0403 864086 Fax: 0403 210108 Telex: 87271

- * Rarities our speciality - huge stocks held *
- * Competitive prices *
- * Overseas enquiries welcome *

VALVES - NEW, BOXED, GOOD QUALITY BRANDS

4CX250B Eimac £58.00, 6F33STC £9.00, 6JE6C £7.20, 6JS6C £7.20, 813 Philips £34.00, 572B (USA) £59.00, 5763 £7.50, EF91 Mullard £1.40, EL34 £2.75, M8162/CV4024, Mullard £5.00, QOV03-20A Mullard £23.00, QOV06-40A Mullard £38.00. (Gvt. Surplus £24.00.)

ENQUIRE FOR ANY TYPE NOT LISTED

Add 15% VAT to all prices, and £1.00 P&P per order.

TRANSISTORS AND ICs - BULK SUPPLIES ONLY

(Minimum transistor order £20). Please phone for a quotation on your requirements.

WE WILL BUY VALVES, TRANSISTORS AND ICs (in large quantities only). Please post or facsimile your lists to us. We still wish to purchase a small quantity of valve type PX4 (PX25/PP3-250/PPS-400) also KT66 + KT88.

Kits

(F.J.P. KITS) COMPONENTS

P.W. kits all post paid with reprints.

P.W. Meon Transvt 6-4 Mtrs 28 mhz IF	Kit £42.00	Semiconductors
P.W. Meon 2Mtrs IF 6Mtrs only	Kit £43.50	8C107 12p
P.W. Orwell Varicap Version 4 P.C.Bs	Kit £55.00	8C108 12p
with all Box £60.00		J309 55p
P.W. Ichen L.C.R. Bridge	Kit £25.50	MPFLO2 45p
P.W. Westbury, Basic MW Wobulator	Kit £15.00	2N3619 30p
P.W. Mostel Hi voltmeter	Kit £25.00	8F224 15p
P.W. Auto Notch Filter	Kit £22.50	BFY50 25p
P.W. FET dip oscillator	Kit £18.50	BFX88 25p
F.J.P. 6-4-2 Mtrs 15 watt 12db linear	Kit £27.50	2N3866 £1.25p
F.J.P. P.W. Orwell P.SU 12v & 9v Stabilised	Kit £5.00	741 x 8 19p
		SEL1 £8.45p
		S042P £2.40p

A4 Sae Brings list of components-testmeters.
ICS Plessey, etc all are full spec.

Terms: CHEQUES, ACCESS, VISA, P.O.'s

Delivery by return, on plastic. Other seven days max.

F.J.P. Kits, 63 Princess Street, Chadmore, Cannock, Staffs. WS11 2JT.
Tel: 05435 6486, 6 days.

MINIATURE TRANSMITTER V.F.O., covers 4M/2M amateur bands. Size 33x15mm plus microphone (included). Kit only £4.50. ACE(PW), 99 Greenheath, Hednesford, Staffs WS12 4AU.

Software

FAX FOR YOUR SPECTRUM

RECEIVE FAX PICTURES ON YOUR SPECTRUM. WEATHER MAPS ETC.

REAL TIME CLOCK. CONTRAST CONTROL. WIDTH CONTROL. SCREEN STORE ETC.

SAVE RECEIVED DATA TO TAPE OR DUMP TO YOUR PRINTER.

THE PROGRAMME NEEDS AN EXTERNAL DRUM SPEED GENERATOR.

PROGRAMME ONLY £9.00

DRUM SPEED GENERATOR £24.00

S.A.E. for details of all our products



J.B.P. ELECTRONICS LTD.

New Road Complex, New Road, Kidderminster, DY10 1AL. Tel: (0562) 753893

COMMODORE COMPUTERS (+4, C16, 64, 128). "MICROCOM" cw/rty tx/rx with superb Morse tutor. "TURBO LOG" ultimate high speed station log. "MICROCOM INTERFACE" ready built. S.A.E. to: Moray Micro Computing, Enzie Slackhead, Buckie, Moray, AB5 2BR. Tel. 0542 7384.

Q.S.L. Cards

QSL CARDS New 1988 Impact Designs. Single and multi-colours, personal designs and with American style raised print. For the best value around send s.a.e. to: CONTACT CARDS, 11 Winchcombe Road, Bispham, Blackpool FY5 3JH.

Masts & Antennas

DXTV? We have in stock a wide range of high gain aerials and low noise amplifiers. Send a large SAE to ARCC Aerials (DXTV) 52 Sandon Road, Cresswell, Stoke-on-Trent for details.

Miscellaneous

HEATHKIT U.K. Spares and Service Centre. CEDAR ELECTRONICS, Unit 12, Station Drive, Bredon, Tewkesbury, Glos. Tel. (0684) 73127.

62W LOOP ANTENNAS COMPLETE WITH ATU FOR HIGH FREQUENCY HAM BAND TRANSMISSION (SWR One to One 40, 15 and 10 and One Point Five to One 30 and 20) AND SWLs, AND LONG AND MEDIUM WAVE BANDS FOR BCL's. Loops 21 inches square or triangle. D.I.Y. projects. No special skills required. Circuits, Parts Lists with sources of supply and full assembly data. HIGH FREQUENCY LOOP 80 to 10 Metres £5. LONG AND MEDIUM WAVE LOOP FOR BCL's £3. LONG WAVE MEDIUM WAVE AND SHORT WAVE LOOP 1500 to 10 Metres FOR THE BCL AND SWL £8. SHORT WAVE ATU FOR USE WITH EITHER A LOOP OR LONG WAVE ANTENNA £4. FIELD STRENGTH METER £2. Morse Code Practice Unit £2. SAE for details. Photo Copy HRO Manual £4. F. G. Rylands, 39 Parkside Avenue, Millbrook, Southampton SO1 9AF. Tel. (0703) 773064

WAVEGUIDE, FLANGES & DISHES. All standard sizes & alloys (new material only) from stock. Special sizes to order. Call: EARTH STATION 01-228 7876. 22 Howie Street, London SW11 4AR.

MICROWAVE TRANSISTORS and Devices for Industrial use. Quotation sent on request. TSUTOM YOSHIHARA, C1-105, Deguchi-cho 34, Suita-shi, Osaka 564, Japan.

THE SCIENTIFIC WIRE COMPANY
811 Forest Road, London E17. Telephone 01-531 1588

ENAMELED COPPER WIRE

SWG	1 lb	8 oz	4 oz	2 oz
8 to 34	3.63	2.09	1.10	0.88
35 to 39	3.82	2.31	1.27	0.93
40 to 43	6.00	3.20	2.25	1.61
44 to 47	8.67	5.80	3.49	2.75
48	15.96	9.58	6.38	3.69

SILVER PLATED COPPER WIRE

14 to 30	10.10	5.20	2.93	1.97
----------	-------	------	------	------

TINNED COPPER WIRE

14 to 30	3.97	2.41	1.39	0.94
----------	------	------	------	------

Fluxcore
Solder 5.90 3.25 1.82 0.94
Post free, please add VAT @ 15%. Orders under £3.00 add 50p. SAE for list of copper and resistance wire. Dealer enquiries welcome.

USED AMATEUR EQUIPMENT?

I Buy, Sell & Exchange!

Whether SELLING or BUYING, if you're talking TOP QUALITY USED AMATEUR EQUIPMENT.

Phone G4TNY for the BEST deals around !!

Phone Dave on 04024 57722 or 0836 201530, 9am to 7pm, Mon to Sat

Ask about our new 'RIGSEARCH' services.

Send SAE for lists.

Personal callers by appointment, please.

G4TNY AMATEUR RADIO

132, Albany Road, Hornchurch, Essex RM12 4AQ

PART EXCHANGE

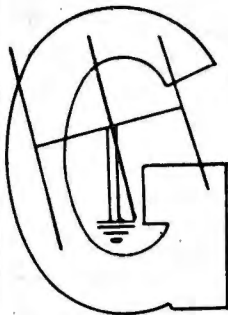

MAIL ORDER

INDEX TO ADVERTISERS

Aerial Techniques	63	Elliot Electronics	65	Radio Component Specialists	70
Allweld Engineering	45	FJP Kits	71	Radio Shack	72
AH Supplies	8	G4TNY	71	Random Electronics	49
ARE Communications	2	Garex	65	RAS Nottingham	10
Arrow Electronics	9	Golledge Electronics	70	Raycom Communications Systems	23
BNOS	3	Howes, CM Communications	57	RST Valve	31
Bicc Vero	19	Icom (UK) Ltd	4,5,6,9, Cover 3	Rylands F G	71
Billington Valves	71	ICS Intertext	69	Scientific Wire Company	71
Birkitt J	65	J & M Amateur Radio	63	SEM	63
Bredhurst	31	J & P Electronics Ltd	71	Short Wave Magazine	35
Cambridge Kits	69	Lake Electronics	8	South Midlands Communications	Cover
Capco	49	Lee Electronics	11		2,6,7,65
Cirkit	45	Maplin	Cover 4	Spectrum Communications	63
Colomor	49	Mauritron	70	Stephens James Ltd	31
Communique UK Ltd	70	Merlin Systems	10	Technical Info Services	70
Cricklewood Electronics	10	Photo Acoustic Ltd	27	Technical Software	8
Datong	49			Ward Reg & Co Ltd	57
Dewsbury Electronics	8			Waters & Stanton	41
Dressler Communications Ltd	10				

YOUR LOCAL DEALERS

STOKE ON TRENT
MRZ COMMUNICATIONS LTD
 ICOM - Amateur/PMR/Marine/Air. YAESU - Amateur MRZ Desk PSU for ICOM/YAESU Portables. UK and EXPORT
Tel: (0782) 619658

IRELAND
Radcom Electronics
 Icom, Yaesu and most Amateur Radio Accessories ex stock.
NEW PREMISES:-
Unit 4, Albert Quay, Cork City.
Tel: 021-632725 and 088 553947
(Mon-Fri 9-5 and Sat 9-3.45)

LONDON
Henry's
 27MHz/934MHz Rigs & accessories in stock. Lists - S.A.E. (A4) - 26p Full catalogue (TG/P) - large S.A.E. £1.00
404 Edgware Road, London W2 1ED
Tel: 01-724 0323
(Open 6 days a week)

ESSEX
Selectronic
 The UK's leading suppliers of 934MHz personal radio equipment
203 High Street, Canvey Island, Essex
Tel: 0268 691481
(Open Mon-Sat 9-5.30)
 Amateur radio equipment also in stock

HERNE BAY

ICOM (UK) LIMITED
 The Official Icom Importer
Unit 8, Sea Street Herne Bay, Kent CT6 8LD
Tel: 0227 369464
 Fax: 0227 360 155
 Open Mon-Sat 9-5.30, (Lunch 1-2.00 pm)

SOUTHAMPTON
South Midlands Communications
 Official Yaesu Importer
S.M. House, School Close, Chandlers Ford Industrial Estate, Eastleigh Hants SO5 3BY.
Tel: 0703 255111

PORTSMOUTH
Telecomms
 Importers of the Nevada range of 934MHz equipment
189, London Road, North End, Portsmouth, Hants, PO2 9AE
Tel: 0705 662145

DEVON
Reg. Ward & Co. Ltd.
 The South-West's largest amateur radio stockist. Approved dealer for Kenwood, Yaesu and Icom
1 Western Parade, West Street, Axminster, Devon, EX13 5NY
Tel: 0297 34918
(Closed 1:00-2:00 and all day Monday)

BUCKINGHAMSHIRE
Photo-Acoustics Ltd.
 Approved Kenwood, Yaesu and Icom dealer (part exchange always welcome)
58 High Street, Newport Pagnell, Buckinghamshire MK16 8AQ
Tel: 0908 610625
(Tues-Fri 9:30-5:30, Sat 9:30-4:30) Closed Mondays

SOUTH WALES
ELECTRO DISPOSALS
 2000 sq ft of surplus equipment and components
LONLAS WORKSHOPS SKEWEN, NEATH.
Tel: 0792 818451

LONDON
AMCOMM OF LONDON
 Approved dealer for Yaesu and Icom
373 Uxbridge Road, London W3 9RN
Tel: 01-992 5765
(Mail order a speciality)

DERBYSHIRE
Low Electronics
 The official importer of the Kenwood range of equipment (See main ad. for the full list of all our shops)
Chesterfield Road, Matlock, Derbyshire, DE4 5LE
Tel: 0629 2817/2430/4057

MERSEYSIDE
MGR SERVICES
 Wirral based communications
 ICOM - YAESU - M. MODULES - HOWES - CIRKIT - WOOD & DOUGLAS - PART-EX - AERIALS - PMR - MARINE - MET ANTENNAS - ALINCO - HEATHERLITE - SPECTRUM COMMS
48, Shrewsbury Road, Oulton, Birkenhead, L43 2NZ.
Tel: 051 653 3437
(Callers by appointment 9 am-9 pm, Mon-Sat)

PLEASE MENTION PRACTICAL WIRELESS WHEN REPLYING TO ADVERTISEMENTS

CHESHIRE
FLIGHTDECK THE AIRBAND SHOP
 Specialists in Airband and Shortwave receivers.
 Official agents for Sony, Signal, AOR, Revco, Lowe and Kenwood (rec's only)
FAIRBOTHAM & Co. Ltd. 58-62, Lower Hill Gate, Stockport, SK1 3AN.
Tel: 061 480 8080
(closed 1.00-2.15 & all day Thursdays)

WEST SUSSEX MAIL ORDER RETAIL
BREDHURST ELECTRONICS LTD.
 High St., Handcross, West Sussex
Tel: (0444) 400786
 Situated at the Southern end of M23. Easy access to M25 and South London.
 Open Mon-Fri 9am-5pm except Wed 9am-12.30pm. Sat 10am-4pm.

RADIO SHACK SAVES YOU MONEY ON SCANNERS!

THE FINEST EVER SCANNER AT AN UNBEATABLE PRICE 25-520, 760-1300 MHz, 300 MEMORIES ALL FOR £349.95



THE ONLY SCANNER WITH 10 PROGRAMMABLE SEARCH RANGES!!!

Continuous tuning from 25 to 520 MHz and 760 to 1300 MHz 300 permanent memories in ten banks of 30 plus an additional ten channels used for temporary storage when in search mode. Switchable audio squelch allows you to ignore blank carriers. Three reception modes, AM, FM (Wide) and FM (Narrow). Adjustable step size, 5 kHz, 12.5 kHz and 50 kHz. Sensitivity (NFM) 0.5uV for 20dB S/N up to 1100 MHz. Extremely attractive, information packed blue LCD display, Headphone jack socket, tape recorder socket, external speaker socket, attenuator switch, 240 Volt operation and 13.8 VDC with optional mobile power lead.

Also still available BC-200FB 16 CHANNEL SCANNER



£159.95



RADIO SHACK LTD

188 BROADHURST GARDENS, LONDON NW6 3AY

(Just around the corner from West Hampstead Station on the Jubilee Line)

Giro Account No. 588 7151 Telephone: 01-624 7174





ICOM

Count on us!

IC-R7000, 25-2000 MHz Commercial quality scanning receiver



With 99 programmable memories the IC-R7000 covers aircraft, Marine, FM Broadcast, Amateur Radio, television and weather satellite bands. For simplified operation and quick tuning the IC-R7000 features direct keyboard entry. Precise frequencies can be selected by pushing the digit keys in sequence of the frequency or by turning the main tuning knob. FM wide/FM narrow/AM upper and lower SSB modes with six tuning speeds: 0.1, 1.0, 5, 10, 12.5, 25KHz.

The IC-R7000 has 99 memories available to store your favourite frequencies including the operating mode. Memory channels can be called up by pressing the memory switch then rotating the

memory channel knob, or by direct keyboard entry. A sophisticated scanning system provides instant access to the most used frequencies. By depressing the Auto-M switch, the IC-R7000 automatically memorises frequencies that are in use whilst it is in the scan mode, this allows you to recall frequencies that were in use. The scanning speed is adjustable and the scanning system includes the memory selected frequency ranges or priority channels. All functions including the memory channel readout are clearly shown on a dual-colour fluorescent display. Other features include dial-lock, noise blanker, attenuator, display dimmer and S-meter and optional RC-12 infra-red remote controller, voice synthesizer and HP 1 headphones.

Icom (UK) Ltd.

Dept PW, Sea Street, Herne Bay, Kent CT6 8LD. Tel: 0227 363859. 24 Hour.

Helpline: Telephone us free-of-charge on 0800 521145, Mon-Fri 09.00-13.00 and 14.00-17.30. This service is strictly for obtaining information about or ordering Icom equipment. We regret this cannot be used by dealers or for repair enquiries and parts orders, thank you.

Datapost: Despatch on same day whenever possible.

Access & Barclaycard: Telephone orders taken by our mail order dept, instant credit & interest-free H.P.



**PROJECTS
GALORE FROM
Maplin**

SALES
0702 - 554161

A self-contained alarm system disguised as a video cassette. Gives audible alarm if machine moved or cassette ejected. Full details in Project Book 24 (XA24B) Price 85p.

KIT PRICE
ONLY **£11.95** ORDER CODE **LM27E**

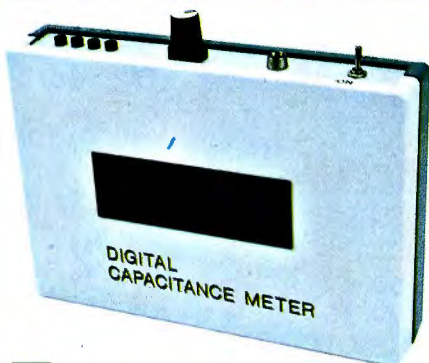

CHECK THOSE UNMARKED

capacitors with this versatile, low-cost, piece of test equipment. Full details in Project Book 23 (XA23A) Price 85p.

KIT PRICE
ONLY **£24.95** ORDER CODE **LM28F**

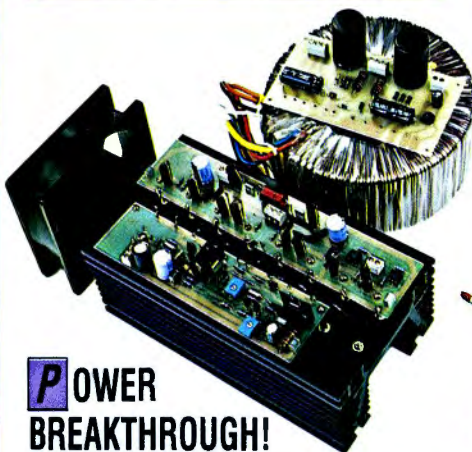

POWER BREAKTHROUGH!

A superb 1kW Mosfet amplifier, a major new source in sound! Full details in Project Book 26 (XA26D) Price 85p. This project is made up from 4 kits.

KIT PRICE	KIT PRICE	KIT PRICE	KIT PRICE
DRIVER KIT LM50E	OUTPUT KIT LM51F	MONITOR KIT LM52G	PSU KIT LM53H
£11.95	£99.95	£19.95	£89.95

PROTECT YOUR VHS VIDEO PLAYER WITH THIS VHS VIDEO ALARM PROJECT!

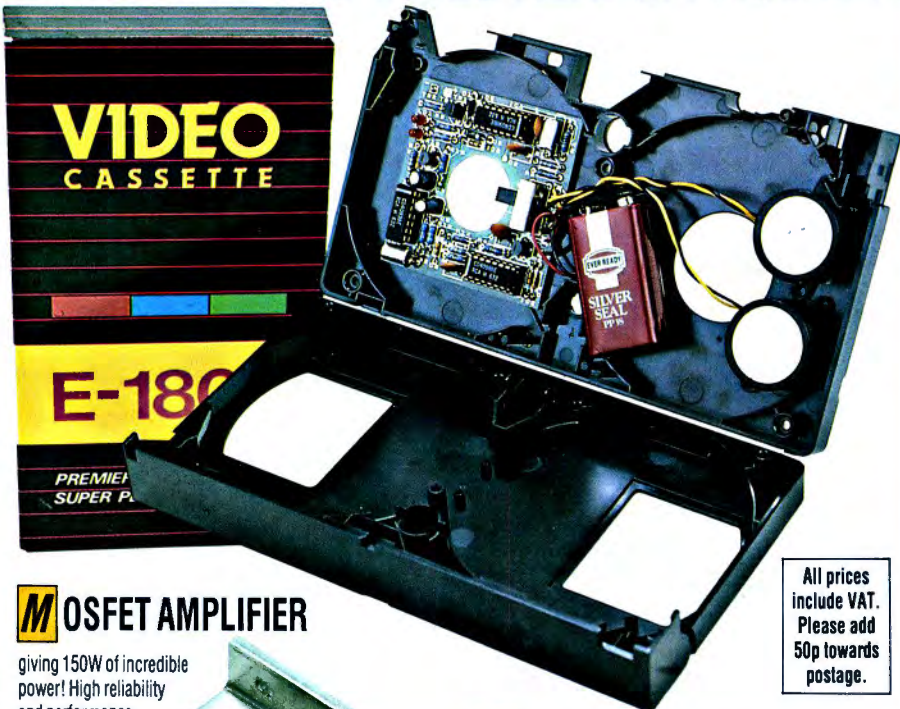

MOSFET AMPLIFIER

giving 150W of incredible power! High reliability and performance.

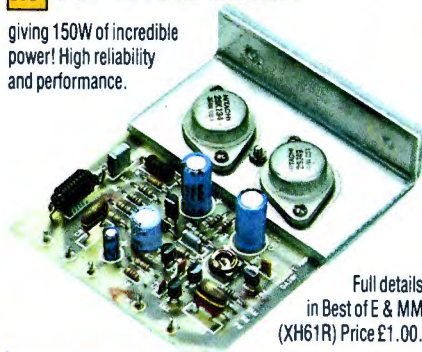

Full details in Best of E & MM (XH61R) Price £1.00.

KIT PRICE
ONLY **£19.95** ORDER CODE **LW51F**

NUCLEAR RADIATION MONITOR



capable of measuring the level of Alpha and Beta particles, and Gamma and X-Rays. Full details in Project Book 24 (XA24B) Price 85p.

KIT PRICE
ONLY **£99.95** ORDER CODE **LM24B**

All items subject to availability

All prices include VAT. Please add 50p towards postage.

MUSICAL DOORBELL

with 28 tunes and chimes with selectable piano to organ like sounds. Note: case and front panel not in kit. For full details see Project Book 13 (XA13P) Price 85p.



KIT PRICE
ONLY **£14.95** ORDER CODE **LK57M**

Maplin Electronics
P.O. Box 3, Rayleigh, Essex, SS6 8LR.

MANY MORE PROJECTS INSIDE!

Pick up a copy of our giant 512 page catalogue from WHSMITH for just £1.60.



Shops at: Sutton New Road, Erdington, Birmingham. 302 Gloucester Road, Bristol. 159-161 King Street, Hammersmith, London. 8 Oxford Road, Manchester. 46-48 Bevois Valley Road, Southampton. 282-284 London Road, Southend-on-Sea.