

Practical

JULY 1987 £1.10

ISSN 0141-0857

Wireless

The Radio Magazine

ANTENNA SPECIAL

Scaling Antennas For Other Bands

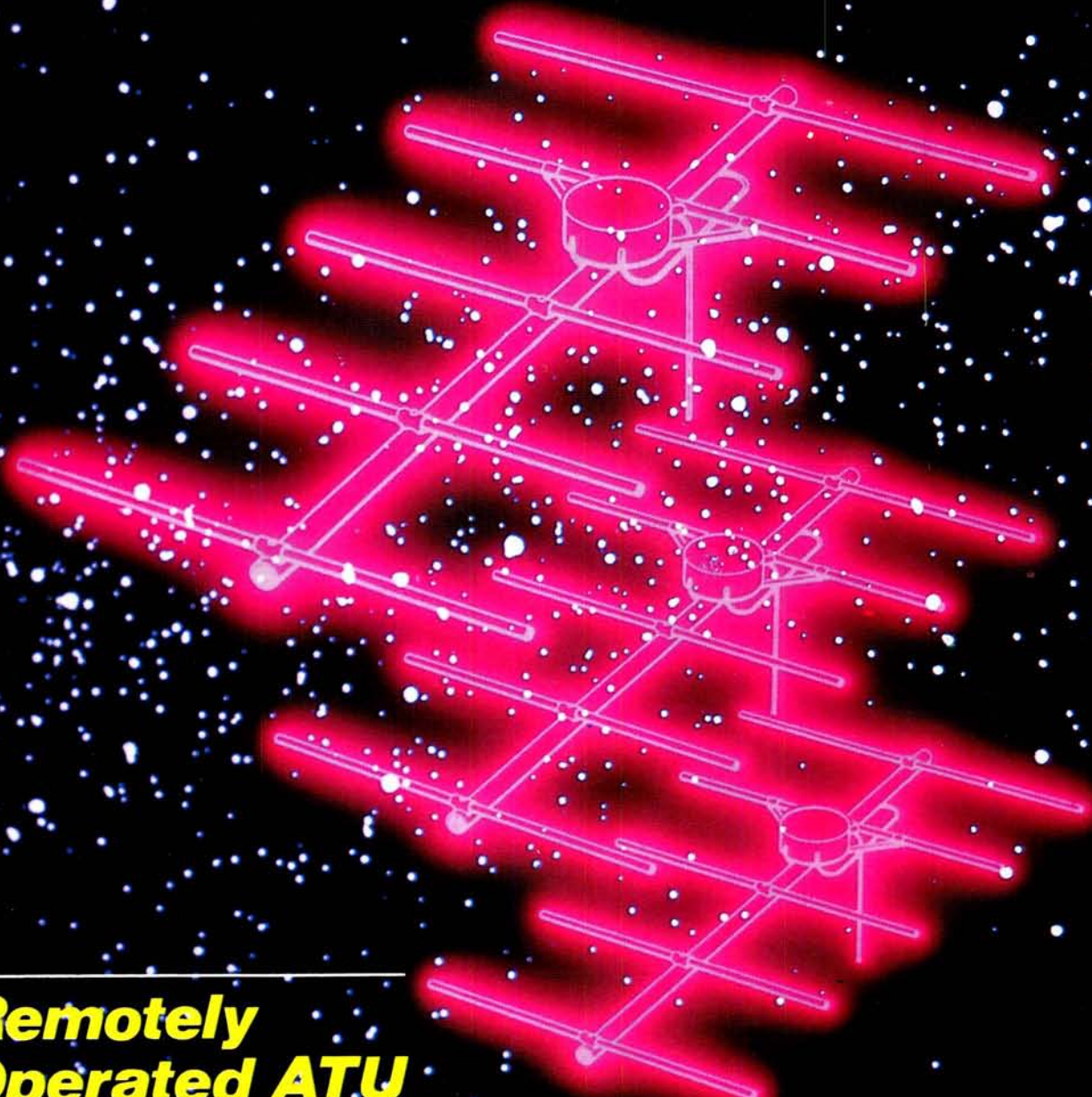

**Remotely
Operated ATU**

Counterpoise Systems

Build An External Ferrite Loop

Practical Wireless

The Radio Magazine

JULY 1987 (ON SALE 11 JUNE)

VOL. 63 NO. 7 ISSUE 964

NEXT MONTH

CIRCUITS &
COMPONENTS
SPECIAL
Covering
Passive Filters,
Capacitors,
MESFETs
and more!

PLUS
"Valved Comms
Receivers"
The AR-88D

and

What's New at the
1987
Dayton Hamfest

Don't miss
it—place
your order with
your
newsagent now!

On sale July 9

Contents subject to last-minute revision

- 20 Marconi's Bristol Channel Triumph**
Eric Westman
- 22 Packet Radio—3**
Roger J. Cooke G3LDI
- 26 Variations on the Vertical**
F. C. Smith GW2DDX
- 27 A Remotely Operated ATU**
Malcolm Kirk G4XMK
- 30 Counterpoise Systems**
J. R. D. Brown G4UBB
- 32 An External Ferrite Loop Antenna**
Richard Q. Marris G2BZQ
- 34 Scaling Antennas for Other Frequencies—1**
F. C. Judd G2BCX
- 38 Test Methods and Equipment—4**
Ray Steele
- 40 Practically Yours**
Glen Ross G8MWR
- 40 Errors & Updates**
PW "Axe" Signal Tracer, May 1987
- 42 PW Kit Review**
Circuit MSF Clock
- 44 Computing Corner**
Paul Newman
- 46 Confessions of a Radio Inspector**
Roger Lancaster

Regular Features

71 Advert Index	68 Past Gems	48 Subscriptions
52 Book Service	53 PCB Service	50 Swap Spot
39 Did You Know?	18 Products	14 Write On
16,51 News	15 PW Services	
54 On the Air	36 Short Wave Magazine	

Editorial and Advertisement Offices:

Practical Wireless
Enefco House
The Quay
Poole, Dorset BH15 1PP

☎ Poole (0202) 678558 (Out-of-hours service by answering machine)
Prestel 202671191

Editor Geoff Arnold T.Eng FSERT G3GSR
Assistant Editor Dick Ganderton C.Eng. MIERE G8VHF
Art Editor Steve Hunt
Technical Features Editor Elaine Richards G4LFM
Technical Projects Sub-Editor Richard Ayley G6AKG
Technical Artist Rob Mackie
Advertisement Manager Roger Hall G4TNT
☎ 01-731 6222
Administration Manager Kathy Moore
Clerical Assistant Claire Horton
Accounts Annette Martin

THIS MONTH

COPYRIGHT © PW Publishing Limited 1987. Copyright in all drawings, photographs, and articles published in *Practical Wireless* is fully protected and reproduction or imitation in whole or in part is expressly forbidden. All reasonable precautions are taken by *Practical Wireless* to ensure that the advice and data given to our readers are reliable. We cannot however guarantee it and we cannot accept legal responsibility for it. Prices are those current as we go to press.

LOWE SHOPS.

In Glasgow,

the shop manager is Sim, GM3SAN, the address, 4/5 Queen Margaret Road, off Queen Margaret Drive, Glasgow, telephone 041 945 2626.

In the North East,

the shop manager is Hank, G3ASM, the address, 56 North Road, Darlington, telephone 0325 486121.

In Cambridge,

the shop manager is Tony, G4NBS, the address, 162 High Street, Chesterton, Cambridge, telephone 0223 311230.

In Cardiff,

the shop manager is Carl, GWOCAB, the address, c/o South Wales Carpets, Clifton Street, Cardiff, telephone 0222 464154.

In London,

the address, 223/225 Field End Road, Eastcote, Middlesex, telephone 01-429 3256.

In Bournemouth,

the shop manager is Colin, G3XAS, the address, 27 Gillam Road, Northbourne, Bournemouth, telephone 0202 577760.

Although not a shop, there is on the South Coast a source of good advice and equipment, John, G3JYG. His address is Abbotsley, 14 Grovelands Road, Hailsham, East Sussex. An evening or weekend call will you put in touch with him. His telephone number 0323 848077.

Lowe Electronic Shops are open from 9.00 am to 5.30 pm, Tuesday to Friday and from 9.00 am to 5.00 pm on Saturday. Shop lunch hours vary and are timed to suit local needs. For exact details please telephone the shop manager.

AR2002 receiver



Frequency range of the AR2002 is from 25 to 550 and from 800 to 1300 MHz. Modes of operation are wide band FM, narrow band FM and AM. The receiver has 20 memories, memory scan and a search mode which checks frequencies between user designated limits.

The receiver has a push button keypad for easy frequency entry and operation.

A front panel knob allows the listener to quickly step up or down in either 5, 12.5 or 25 kHz steps from the frequency initially chosen.

The AR2002 has a front panel LED bar "S" meter.

There is a front panel 3.5 mm jack socket for headphone use.

A socket for the optional RS232 interface (RC PACK) is provided on the rear panel. The RC PACK consists of an 8 bit CPU with its own ROM and RAM and with your own computer acting as a dumb terminal many additional operating facilities become available. Of course, if you want to write your own programs using the RC PACK as an interface then "the sky's the limit".

AR2002 Receiver . . . £487.30 inc VAT, carriage £7.00

from TRIO, a **new** short wave receiver, the **R5000**.



The R5000 is a new general coverage receiver. It offers the dedicated short wave listener and radio amateur a receiver that will match the performance of the best transceivers available today.

The R5000's frequency range is continuous from 100 kHz to 30 MHz and its modes of operation are USB, LSB, CW, AM, FM and FSK. An optional VHF converter (VC20) extends the frequency range to include 108 to 174 MHz.

The R5000 uses 2SK 125 junction-type FETs in the high sensitivity direct

balanced first mixer resulting in outstanding two signal characteristics and a substantially improved noise floor level.

Operating from either 12 V DC or 240 V AC the receiver can be used both in the home or whilst out in car, caravan or boat.

The receiver has two rates of tuning for each mode selected by a front panel switch. The frequency increments for SSB/CW/FSK are 10 Hz and 100 Hz, for AM 100 Hz and 1kHz and for FM 2.5 kHz and 5 kHz.

Both low (50 ohms) and high (500 ohms)

aerial connections are provided on the rear panel of the R5000. The required aerial can be selected by means of a front panel switch. Information on which aerial to be used with a stored frequency can also be held in memory. **The R5000 has 100 memory channels** which store frequency, mode and which of the two aerial connections has been selected. Information is easily transferred from one VFO to the other, from memory to VFO and in order to quickly access your favourite station, from VFO to any of the memories. Both memory scan and frequency scan (between frequencies in memories 8 and 9) are included in the receiver. Halt on an occupied channel whilst scanning can either be timed or until the signal drops. The entire one hundred memories can also be quickly scrolled to check the data held and to find the location of an empty channel.

To enhance reception, IF shift and a tunable notch filter are part of the R5000 receiver. Filter selection according to mode is automatic when the front panel selectivity switch is set to AUTO. This automatic selection can, of course, be overridden. Additionally the introduction of optional SSB and CW filters (YK88SN for SSB and either YK88C or YK88CN for CW) will improve the already excellent signal to noise ratio and selectivity. The optional YK88A-1 AM filter will improve the shape factor and enhance reception even further.

The R5000 general coverage receiver also has keyboard frequency entry, dual mode noise blanker, two 24 hour clocks with timer, option VS1 voice synthesizer and CW tone mode indication for the blind operator, a large 100 mm diameter top mounted speaker, switchable AGC (fast or slow), RF attenuation (10, 20 or 30 dB steps) and a FLOCK switch which protects against frequency shift if the VFO knob is accidentally moved.

R5000 Receiver . . . £895 inc VAT, carriage £7.00

LOWE ELECTRONICS LTD.

Chesterfield Road, Matlock, Derbyshire DE4 5LE
Telephone 0629 2817, 2430, 4057, 4995.

send £1 for complete mail order catalogue.

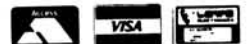

DAIWA meters

CN410M . . . Frequency range 3.5 to 150 MHz, forward power switchable 15/150 Watts, reflected 5/50 Watts, SO239 connectors.

CN460M . . . Frequency range 140 to 450 MHz, forward power switchable 15/150 Watts, reflected 5/50 Watts, SO239 connectors.

NS448 with remote head . . . Frequency range 900 to 1300 MHz, forward power switchable 5/20 Watts, reflected 1.6/6.6 Watts, N type connectors.

NS660P . . . switchable meter reading (average, normal PEP and hold PEP) and provision for optional remote head (U66V), frequency range 1.8 to 150 MHz, forward power switchable 15/150/1500 Watts, SO239 connectors.

U66V . . . remote head, frequency range 140/525 MHz, max 300 Watts, N type connectors.

SC20 . . . extension cable for U66V, approx 20 metres long.

CN410M . . . **£61.72 inc VAT**, carriage £1.50.

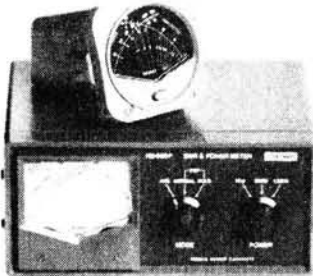

NS660P . . . **£118.00 inc VAT**, carriage £2.50.

CN460M . . . **£65.40 inc VAT**, carr £1.50.



NS448 . . . **£86.60 inc VAT**, carriage £2.50.

airband receivers

R537S . . . a tunable airband receiver covering 118 to 136 MHz plus the facility for two crystal controlled channels (crystals not included).

R537S . . . **£69.51 inc VAT**, carriage **£2.00**. Crystals **£4.60 each**.

R528 . . . an airband receiver scanning four out of six crystal controlled channels (crystals not included). The R528 also has a manual channel selection switch.

R528 . . . **£128.36 inc VAT**, carriage **£2.00**. Crystals **£4.60 each**.

R532 . . . not needing crystals, the R532 is a synthesized receiver covering the airbands from 110 to 136 MHz and having 100 programmable memory channels (ten banks of ten). Operating on 12 volts DC, the R532 can be used either mobile or at home with the optional mains power supply. Add a nicad battery pack and carrying case and the R532 is also ideal for portable use.

R532 . . . **£224.05 inc VAT**, carriage **£7.00**.

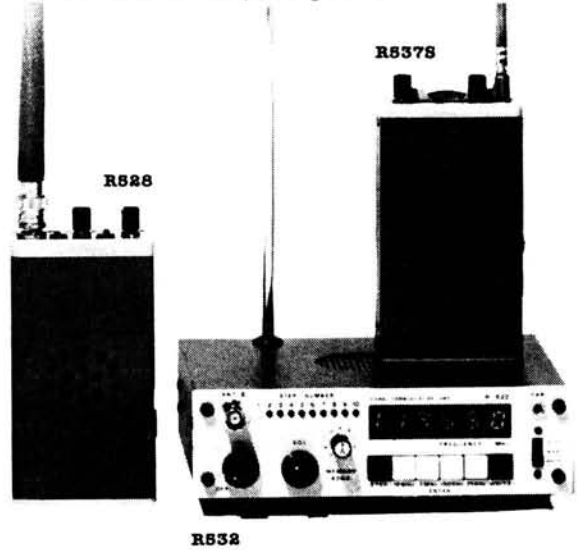

data equipment

CD600 . . . RTTY, CW, ASCII, TOR, AMTOR decoder, output for UHF television, monitor and printer, can also be used as morse tutor.

CD600 . . . **£215.14 inc VAT**, carriage £7.00.

CD670 . . . A higher specification RTTY, CW, ASCII, TOR and AMTOR decoder complete with liquid crystal dot matrix display, variable RTTY shift, normal/reverse mode switch, outputs for TV, monitor and printer and can also be used as morse tutor.

CD670 . . . **£327.77 inc VAT**, carriage £7.00.

CD660 . . . Similar in specification to the CD670 but without the built-in dot matrix display.

CD660 . . . **£264.97 inc VAT**, carriage £7.00.



HOKUSHIN aerials

Base station aerials

HP5 . . . 80 to 10 metre vertical, no radials are required when it is mounted at ground level. **£83.39 inc VAT**, carriage **£7.00**.

HP5R . . . Radial kit for use with the HP5 when it is mounted on a chimney or gable end. **£54.81 inc VAT**, carriage **£7.00**.

GPV5 . . . Two metre base station colinear, 6.5 dB gain, 3.1 metres high. **£54.92 inc VAT**, carriage **£7.00**.

GPV23 . . . as above but a 3 section version, 7.8 dB gain, 4.45 metres high. **£51.97 inc VAT**, carriage **£7.00**.

GPV7 . . . Seventy centimetre 5/8 over 5/8 over 5/8 base station colinear, 6.8 dB gain. **£45.89 inc VAT**, carriage **£7.00**.

GPV720 . . . Dual band (144/430 MHz) base station aerial. **£48.68 inc VAT**, carriage **£7.00**.

Mobile aerials

2E . . . Two metre 5/8 whip, 3.4 dB gain, foldover base. **£14.55 inc VAT**, carriage **£2.00**.

2NE . . . Two metre 7/8 whip, 4.5 dB gain, foldover base. **£24.23 inc VAT**, carriage **£2.00**.

OSCAR430 . . . Seventy centimetre 5/8 over 5/8 over 5/8 whip, 6.3 dB gain. **£27.72 inc VAT**, carriage **£2.00**.

OSCAR720 . . . Dual band (144/430 MHz) whip. **£24.59 inc VAT**, carriage **£2.00**.

HS770 . . . 144/430 MHz diplexer for use with OSCAR720. **£18.02 inc VAT**, carriage **£1.50**.

GSS . . . Gutter mount (requires RG4M cable assembly). **£6.26 inc VAT**, carriage **£1.25**.

RG4M . . . Cable assembly for GSS base, complete with SO239 and PL259 plug. **£6.25 inc VAT**, carriage **£1.00**.

12B . . . Car wing mount with SO239 top and bottom. **£5.73 inc VAT**, carriage **£1.00**.

HSTMB . . . Car boot mount including cable and PL259. **£15.42 inc VAT**, carriage **£1.50**.

MA200S . . . High quality mag mount with cable and strong protective cover to prevent paintwork damage. **£22.90 inc VAT**, carriage **£2.00**.

LOWE ELECTRONICS LTD.

Chesterfield Road, Matlock, Derbyshire DE4 5LE
Telephone 0629 2817, 2430, 4057, 4995.

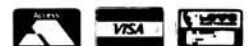

send £1 for complete mail order catalogue.

Thanet Electronics is dead

LONG LIVE ICOM (UK) LTD.

As from the 16th march 1987 Thanet Electronics Ltd have been trading under the new banner of ICOM (UK) LTD.

Nothing else has changed, still top quality ICOM equipment and service from one of the UK's leading Amateur radio importers.

The World System



To celebrate our name change we are offering to those persons who selected the following badge numbers at N.E.C. this year a gift from the ICOM range.

To claim your prize just send your winning badge to ICOM (UK) LTD and we will send you the fantastic ICOM Micro 2.2 metre handportable.

Naturally this does exclude those persons who already claimed their prize at the N.E.C. The numbers are 1271 2751 3200

This summer ICOM (UK) LTD will be one of the sponsors for Richard Branson's Transatlantic Balloon Challenge. They will be using ICOM communication equipment.



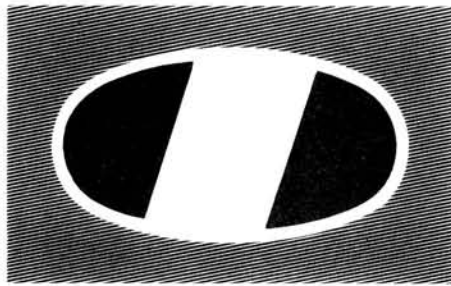

ICOM

Communications

THE HOTTEST ITEMS THIS SUMMER

VHF/UHF FM Handportables

If you want a handheld with exceptional features quality built to last and a wide variety of interchangeable accessories, take a look at the ICOM range of FM transceivers; all ICOM handportables come with a nicad battery pack, AC wall charger, flexible antenna and wrist strap.

Micro 2E/4E

These new micro-sized 2 metre and 70 centimetre handportables give the performance and reliability you've come to expect from ICOM.

Measuring only 148 x 50 x 30 the Micro fits in your pocket as easily as a cassette tape. The Micro 2E/4E features an up/down tuning system for quick frequency adjustments, 10 programmable memories, a top panel LCD readout, up to 2.5 watts of output (optional).

IC-2E 2 metre Thumbwheel Handportable

This popular handheld from ICOM is still available. For those amateurs who require a straightforward and effective FM transceiver the IC-2E takes some beating. Frequency selection is by means of thumbwheel switches (with 5KHz up switch) simplex or duplex facility. Power output is 1.5 watts or low 150 milliwatts (2.5 watts possible with BP5A battery pack).

IC-02E/04E 2 metre and 70cm Keypad Handportable

These direct entry CPU controlled handhelds utilise a 16 button keypad allowing easy access to frequencies, memories and scan functions. Ten memories store frequency and offset, these handhelds have an LCD readout and power output is 2.5 watts or low 0.5 watt. 5 watts is possible with the IC-BP7 battery pack or external 13.8v DC.

IC-12E 23cm Handportable

Similar in design and style to the 02E/04E this 1296Mhz handheld utilises ICOM's experience in GHz technology, gained by the excellent IC-1271E base station. Power output is 1 watt from the standard BP3 nicad pack; external 13.8v DC powering is available to the top panel jack. With the growing number of repeaters on 23cm, the IC-12E makes it an ideal band for rag chew contacts.

ALSO AVAILABLE FOR ICOM HANDPORTABLES ARE A LARGE RANGE OF OPTIONAL EXTRAS INCLUDING A VARIETY OF RECHARGEABLE NICAD POWER PACKS, DRY CELL BATTERY PACKS, DESK CHARGERS, HEADSET AND BOOM MIC, LEATHERETTE CASES AND MOBILE MOUNTING BRACKETS.



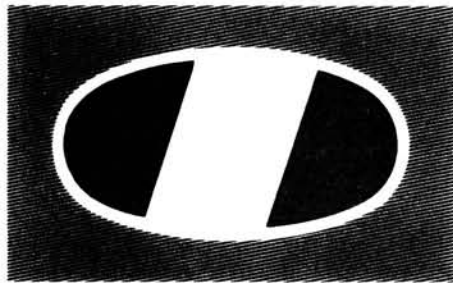

ICOM

Communications

IC-275E/475E 25 Watt 2 metre/70cm. Multimode Transceivers.



Tech Talk from ICOM: THE EXCITEMENT OF SATELLITE COMMUNICATIONS

An ever increasing number of radio amateurs are joining the excitement of Phase 111 - type satellite communications. This new medium combines the communications range of the 20 and 80 metre bands with the line-of-sight reliability of 2 metres. It's equivalent to a totally new band, and a vast technical background is not necessary for enjoying the action.

ICOM is able to help you enjoy the fascinating new capabilities of OSCAR and future amateur satellites. Its all mode 2 metre and 70cm base transceivers bring the operating conveniences of low band units to the VHF and UHF amateur bands. They can be used for local FM operations via repeaters or for SSB/CW communications via Phase 111 satellites. The IC-1271E all mode 23cm transceiver is in a class of its own, providing mode L satellite uplink capability (Mode L: 1269MHz uplink, 436 downlink) (Mode U: 435 uplink, 145 downlink).

Satellite relayed signals are somewhat weak in nature and the IC-275E's low noise/high sensitivity receiver gives the highest performance

for hearing everyone regardless of their uplink performance. The noise blanker prevents pulse type electrical interference from masking desired DX signals, the selectable AGC can follow fast fades associated with spin modulation. There are also the 99 mode memories which can be used for inter-mixed FM repeater and SSB/CW operators. When the IC-275E is equipped with the optional mast mounted AG25 GaAsFET pre-amp, it becomes a satellite operations dream come true.

ICOM's IC-475E 70cms transceiver has a front panel continuously adjustable power output to allow for daily signal variations. This overcomes the practice of overloading a satellite on board receiver. The IC-475E also includes 99 all mode memories for the ultimate in operation flexibility.

Using the ICOM CT16 satellite communications interface these base stations will track together via the ICOM CI-V system. If you are interested in joining today's most excitement era of amateur communications, i.e. OSCAR and future Phase 111 satellites, ICOM is the logical choice for top performance equipment.



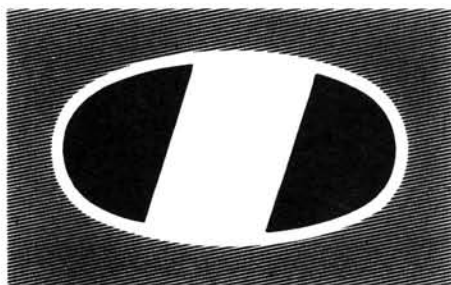

ICOM

Communications

CLASS B's and 6 metres.

During the R.S.G.B. National Amateur Radio Convention at the Birmingham N.E.C. Mr John Butcher MP, Parliamentary Under-secretary of State for Industry made reference to Class B licences operation on all bands above 30MHz. ICOM have available multimode equipment for the 6 metre band.



IC-505 50MHz Transceiver

This SSB, CW, FM (Optional) transceiver features dual V.F.O.'s and 6 channel memories with scanning facilities. The IC-505 accepts standard dry cell batteries, rechargeable nicad battery pack or 13.8v DC external P.S.U. Power output is 10 watts at 13.8v, 3 watts when used with internal batteries. 0.5 watts LOW. Options include EX248 FM unit.

IC-551/551D 50MHz Base Station

These multimode base stations cover 50-54MHz with 10 watt (80 watts IC-551D) R.F. power output. The IC-551 has an internal A.C. power supply unit and options include EX106 FM unit, EX107 Vox unit, EX108 Pass Band Tune unit.

The IC-551D requires an external power source such as the IC-PS15 20A P.S.U. the EX106 FM unit's optional. With this model the VOX and PBT units are installed as standard.

ICOM 70cm Promotion

Due to our new range of equipment we are able to offer the following equipment only while stocks last.

- ICOM IC-471E 25 watt Multimode Base Station £650.00
- ICOM IC-471H 75 watt Multimode Base Station £759.00
- ICOM IC-47E 25 watt FM Mobile £349.00
- ICOM IC-U12 12 Channel 450-460 MHz

Handportable, uses existing ICOM handheld accessories, details on how to get onto 70cms provided. Supplied as radio body only £115.00

For further information on these or any other ICOM products. Contact your local ICOM dealer or ICOM (UK) LIMITED.



Telephone us free-of-charge on:

HELPLINE 0800-521145.

— Mon-Fri 09 00-13 00 and 1400-17 30 —

This is strictly a helpline for obtaining information about or ordering ICOM equipment. We regret this service cannot be used by dealers or for repair enquiries and parts orders. Thank you

You can get what you want just by picking up the telephone. Our mail order department offers you free same day despatch whenever possible, instant credit, interest free H.P., Barclaycard and Access facility, 24 hour answerphone service.



Datapost



ICOM (UK) LIMITED
Dept PW, Sea Street,
Herne Bay, Kent CT6 8LD.
Tel: 0227 363859.



South Midlands

SCHOOL CLOSE, CHANDLERS FORD IND. EST., EASTLEIGH

NEW IMPROVED



NOW EVEN BETTER!

- ★ All Mode SSB (USB + LSB) CW, AM & FM
- ★ All Band Tx (General Coverage Rx)
- ★ 100% Duty Cycle (100w CW, FM 25w AM)
- ★ Pushbutton mode selection
- ★ Switchable VFO steps (all modes)
- ★ New Notch Filter
- ★ Dual VFO's and 10 Memories (Freq. & Mode)
- ★ Computer Compatability (with optional interface)

OPTIONAL ACCESSORIES

FP757HD	Heavy Duty P.S.U.	£239	FAS-1-4R	Remote Antenna SW	£80
FP757GX	Light Duty P.S.U.	£69	FC757AT	Automatic ATU	£349
	FL7000 500W Solid State Linear Amplifier	£1,600			

FT757GXII

£959 inc. VAT

NEW

BEST VALUE ON 2M ONLY £299

- ★ 45/10W Switchable RF Output
- ★ Easy 'one touch' push button operation
- ★ Reversible sloped front panel
- ★ Large green easy to read LCD
- ★ Ten memories (independent Tx & Rx)
- ★ Switchable 12.5/25kHz steps
- ★ Priority channel monitoring
- ★ C/w Hand mic and mobile mounting bracket

FT211RH

45W OUTPUT



OPTIONAL ACCESSORIES

SP55 External Speaker	£19.55	MH 10F8 Speaker/Mic	£22.00
YH1 Headset (C/W Mic)	£19.00	MH 14A8 Speaker/Mic (C/W Tone Burst)	£23.00
SB10 PTT Switch Unit	£21.00	MF 1A3B Boom Mic (Via SB10)	£25.00

'B' on 6!

CATCH THE LIFT AND MIX IT ON 6

FT690R

FT767GX

FT726R

FT690R2/A



All mode USB, CW, AM & FM. 2.5W FM, CW 0.8W AM (Carrier Only). Fully synthesised, dual VFO's & 10 memories. Large LCD display and separate S-PO meter. Programmable synthesiser steps. C/w Hand mic, carrying strap & telescopic antenna.

★ Specifications for VHF/UHF options. All mode LSB, USB, CW, AM and FM. 10W RF output all modes (AM 2.5W carrier)*. 4 Microprocessors. Dual VFO's and 10 memories. Push button selection of mode, freq. mem channel etc. Large Fluorescent 'Easy to Read' display. Computer & Packet radio compatability.

★ Specifications for VHF/UHF options. All modes LSB, USB, CW & FM. 10W RF output & $-0.25\mu V$ for 12dB sinad*. Synthesised dual VFO's & 11 memories. Switchable freq. steps and programmable RPT shift. Full duplex operation (with optional module). Packet radio compatability.

All mode FM, CW, LSB & USB. Fully synthesised, dual VFO's & 10 memories. 2.5W RF output & $-0.25\mu V$ for 12dB sinad. Large clear LCD and separate S-PO meter. Optional FL6020 10W linear amplifier c/w Hand mic, Battery Case, Antenna & strap.

ANTENNAS & ACCESSORIES

FT690R	50 MHz Multimode (as above)	£289.00	64B	4 element optimised 50MHz	£74.75	50-3	3 element yagi 50MHz	£39.95	£2.65 p&p
FT690R2 A	50 MHz Multimode (as above)	£429.00	UR43	Solid centre coax 5mm	£0.31	50-5	5 element yagi 50MHz	£59.90	£2.65 p&p
FL6020	10W linear for FT690R2 A	£109.00	UR76	Stranded centre coax 5mm	£0.32	DB4	4 element yagi 50/70MHz	£115.00	£4.00 p&p
50 726	6M Module for FT726R	£249.00	UR67	Low Loss 10.2mm	£0.79	4Y6M	4 element yagi 50MHz	£48.88	£2.85 p&p
50TV	6M Module for FTV series	£ 99.00	H100	in 25, 50, 100, 200m lengths	£0.79	4Y4M	4 element yagi 70MHz	£36.63	£2.85 p&p
50 767	6M Module for FT767GX	£169.00	IC505	50MHz 3:10W O-P Transceiver	£459.00	PH2 4M	Phasing Harness 2 way 70MHz	£19.90	£1.85 p&p

LEEDS
SMC (Northern)
Nowell Lane
Industrial Estate
Leeds LS9 6JE
Leeds (0532) 350606
9.5-30 Mon-Sat

CHESTERFIELD
SMC (Midlands)
102 High Street
New Whittington,
Chesterfield
Chest. (0246) 453340
9.30-5.30 Tues-Sat

BUCKLEY
SMC (TMP)
Unit 27, Pinfold Lane
Buckley, Clwyd
Buckley (0244) 549563
10-5 Tues, Weds, Fri
10-4 Sat

JERSEY
SMC (Jersey)
1 Belmont Gardens
St. Helier, Jersey
Jersey (0534) 77067
9-5 pm Mon-Sat
Closed Wed

N. IRELAND
SMC N. Ireland
10 Ward Avenue
Bangor
County Down
0247 271875



Southampton Showroom open 9.00-5.00 Monday to Friday, 9.00-1.00 Saturday. Service Dept open Mon-Fri 9.00-5.00.

AGENTS: JOHN DOYLE, TRANSWORLD COMMS, NEATH (0639) 52374 DAY (0639) 2942 EVE DAVID STENNING, G4JA, LOUTH 0507 604967
BOOTH HOLDINGS, SALTFORD, BRISTOL 02217 2402 JACK McVICAR, SCOTCOMMS, EDINBURGH 031 657 2430

SUPER SUMMER SALE

ONLY AVAILABLE WHILST STOCKS LAST

RIGS and MAJOR ITEMS

All these are new items at super discount

FT790R	FM/SSB Portable/mobile/base	£369.00
FT709R(4)	Keyboard 70CMS Handheld	£199.00
FT703R(4)	Thumbwheel 70CMS Handheld	£189.00
FT730R	10W 70CMS FM Mobile	£179.00
FM2033	2 Metre FM Mobile	£199.00
FM240	2 Metre FM Mobile	£269.00
FM740	70CMS FM Mobile	£269.00
FP757GX	20A switched mode 12V supply	£69.00
430-TV	70CMS 10W transverter module	£199.00
50-TV	6 Metre 10W transverter module	£99.00
LL1	Phone Patch Unit	£29.50
LR1	Auto answer for LL1	£29.50
FRV7700A	Converter 118-150 to 20-30MHz	£29.50
FRV7700D	Converter 70-80, 118-130, 140-150 to 20-30MHz	£29.50
FT757GX	* FP757GX HF Transceiver * PSU	£895.00
FTV107R(2)	Transverter with 2M fitted	£149.00
FTV107R(6)	Transverter with 6M fitted	£149.00

MUTEK EQUIPMENT

WHILE STOCKS LAST

SLNA50S	50MHz low noise pre-amp	£49.90
SLNA145SB	Pre-amp for FT290R	£31.90
GMFA144E	2 Metre Gasfet pre-amp	£119.95
TLNA432S	70CMS switched pre-amp	£74.90
TLNA432U	70CMS unswitched pre-amp	£29.90
TLNA432UB	70CMS unswitched unboxed	£22.40
XBPF700UB	TVI Filter	£4.40
LBPF50U	50MHz Bandpass filter	£29.90
TVHF230C	HF Multiband transverter	£299.90
TVVF50A	50MHz transverter 28MHz i.f. 10 Watt out, ALC controlled	£249.90
ACTS500	Sequential ctrlr for pre-amps	£33.90
SLNA144S	2 Metre switched pre-amp	£39.90
SLNA144U	2 Metre unswitched pre-amp	£22.40
GLN432E	70CMS Gasfet pre-amp 50 Watt through, c.w ACTS500 ctrlr	£159.90
BBBA500	20-500MHz broadband pre-amp	£34.90

DISCONTINUED ITEMS AND MOD KITS

FL2050	2 Metre Power Amp 50 Watts	£69.00
FL7010	70CMS Power Amp 10 Watts	£49.00
FCN2B	Telephone Handset spkr/mic	£35.00
MEMT107	Memory unit for FT107	£49.00
D3000337	Kit to use FT901 with FT980	£10.00
XF30B	AM Filter for FR101	£15.00
XF30D	FM Filter for FR101	£15.00
XF90C	CW Filter for FT301	£15.00
D3000071	Counter Unit for FT301	£49.00
WARC107	Warc Kit for FT107	£15.00
D3000055	DC Kit for FRG7700	£1.50
AMUT77	AM Unit for FT77	£12.50
D3000234	Marker Unit for FT77	£7.50
D3000031	Memory Unit for FT225	£59.00
FYG1	Xtal Checker 12-16MHz region	£9.50
D3000286	Curtis Keyer board for FTONE and FT980	£19.95
100WKIT107M	100 Watt PA for FT107	£69.00
100WKIT77S	100 Watt PA for FT77	£69.00
E72L	Extension Cable for FT720	£9.50
BHFRG7	Battery Holder for FRG7	£1.50
401B	Shure Fist Mic 600 ohms	£27.50
202	Shure Fist Mic Hi Z ceramic	£27.50
XF455.8MCN	300Hz CW filter for FT980	£39.00
D3000253	Noise Blanker mod kit FTONE	£7.50
D3000227	Fan mod kit for FTONE	£5.00
MMB7	Mobile bracket for FT7, FT7B	£10.00
SP4	Speech processor Unit	£29.00
FV707DM	Digital VFO for FT707/77	£99.00
RFP/B	Processor unit for FL101 after ser no 8001	£25.00
MODONE.901	Mod kit use FTV901 with FT1	£10.00
DIGKIT221	FT221 Digital disp. buffer kit	£2.50
DCRG7000	FRG700 DC kit	£2.00
D4000006	Cable FTONE to FL2100Z	£1.50
D4000007	Cable FTONE to FTV107	£1.50
D4000008	Cable FTONE to FC707	£1.00
D3000098	UHF Modulator for video output of YR901	£5.00
D3000034A	DC-DC Converter FT101	£19.99
WARC101Z	Warc kit	£15.00
FF5	M.F. filter for FRG7700	£2.50
S72	Switch box for FT720	£10.00

FOR THE FT901/2

D3000112	FT901 WARC Kit	£15.00
D3000286	Curtis Keyer board	£19.95
MMB1	Mobile mount for FT901/2 and all FT101 models	£12.50
DCT901	DC-DC Converter unit	£19.99
DIGT901	Counter Unit:digital display	£49.00
D3000105	Bandscope unit for Y0901	£18.50
XF8.9GF	12KHz FM filter	£19.00
XF8.9GA	6KHz AM filter	£19.00
XF8.9HC	600Hz CW filter	£19.00
MEMT901	Memory Unit	£49.00
FMUT901	F.M. Unit	£21.00
AFSK901	A.F.S.K. Unit for YR901	£15.00
LOOP901	50Ma loop unit for YR901	£15.00
AFR901	Alternative tone kit YR901	£17.50

AERIALS Suitable for 10 METRES

GP27	1/2 wave Base Aerial	£19.00
VA27	1/2 wave Base Aerial	£17.50
CBA11GP	Base c/w inclined radials	£21.00
11CE	1.2Mtr fold-over Whip	£6.90
11NE	1.5Mtr fold-over Whip	£17.50
11SE	The famous OSCAR	£17.50
11ZE	1.25Mtr fold-over Whip	£5.95
RSL28b	28MHz Yaesu Whip (Mobile)	£8.50

These aerials will need trimming to frequency.

S.M.C. OPEN DAY AT CHANDLERS FORD
 A day not to be missed.
 Special prices, bar and food, big prize raffle, stock clearance sale of discontinued items, talk in by G4SMC S22, free rig check, tours of factory, a chance to meet old friends and put the world to rights.
AUGUST 30th at 10.00

YAESU VHF/UHF AERIALS

RSL145MGP	2M 1/2 wave mobile with radials	£9.95
RSL435GP	70CMS 2 x 1/2 wave colinear with 'N' socket termination	£28.75

GOODIES FOR THE FT102

D2000029	XF82GA	AM Xtal Filter	£14.50
	XF82HC	CW 600Hz Filter	£14.50
	XF82HCN	CW 300Hz Filter	£12.50
D2000030	XF455C	CW 500Hz Filter	£39.00
	XF8.2HSN	Nar SSB Filter	£12.50
D2000028	XF455CN	CW 270Hz Filter	£39.00
AMFMUT102	AM, FM Unit for FT102		£39.00

All the above items are available only from Chandlers Ford Branch.

Carriage extra. Small items £1.50, Large items and Antennas £3.50.



SPECIAL OFFER – ONLY A FEW LEFT

FT757GX PLUS FP757GX LIST PRICE £1168

NOW ONLY £895 SAVE £273

GAREX THE SCANNER SPECIALISTS

JIL SX-400 THE PROFESSIONAL SCANNER



- * Basic coverage 26-520MHz
- * AM, NFM & WFM
- * Expandable from 100kHz to 1.4GHz with SSB and CW
- * Computer control options
- * IF output terminals
- * Specifications set by professionals

£649

REVCO RS-2000E THE VERSATILE SCANNER



- * Covers: 60-180MHz, 380-520MHz
- * AM & NFM on all bands
- * Search & store of active channels
- * Channel-activity counter
- * 70 memories
- * 12V dc & 240V ac

£279

JIL SX-200N THE SUPERIOR SCANNER



- * The choice of the professionals
- * Proven reliability
- * Covers: 26-88MHz, 108-180MHz, 380-514MHz
- * AM & NFM on all bands
- * Positive action keyboard
- * 16 memories
- * 12V dc & 240V ac

£325

AOR 2002

THE WIDER RANGE SCANNER

- * The receiver with the most Megahertz for your money
- * Covers: 25-550MHz, 800MHz-1.3GHz
- * AM & NFM & WFM on all bands
- * Computer interface socket
- * 20 memories
- * Compact size
- * 12V dc operation
- * Up/down step control knob



£487

REGENCY HX-850E THE SMALLER HANDY-SCANNER

- * Covers: 75-106MHz or 60-90MHz plus 118-175MHz, 406-496MHz
- * AM & NFM on all bands
- * Full scan & search functions
- * 20 memories
- * ONLY 2.5" x 5.5" x 2"
- * Nicads, charger & BNC whip antenna included



£279

DON'T FORGET THE ANTENNA!

All receivers need a good antenna and the ideal one for a scanner is the REVCONE, a 16 element disccone. Made in Britain by Revco, a company that has been manufacturing quality antennas for the last 25 years, the REVCONE covers 50-500MHz, is extremely well made and very good value at just £29.95. Also available - the RADAC dipole nest, 25-500MHz with extra performance designed for transmitting use. £89.95



PRE-AMPLIFIERS

Broadband antennas usually have no gain, so pre-amps are often desirable. One mounted at the masthead amplifies the weak signals but not the noise generated in the feeder cable.

- * New range of high performance broadband amplifiers from REVCO now available. ASK FOR DETAILS *



GAREX ELECTRONICS

MAIN DISTRIBUTOR OF REVCO PRODUCTS. PRICES INCLUDE UK P&P and 15% VAT. Ask for details of our interest free credit. Extensive range of PYE radiotelephone spares - S.A.E. for list.

7 NORVIC ROAD, MARSWORTH, TRING, HERTS. HP23 4LS. Phone 0296 668684. Callers by appointment only.



Ask for our secondhand scanner bargain list.

COMMUNICATION CENTRE OF THE NORTH

The largest range of communications equipment available in the North. Full range of receivers, transceivers, antennas, power supplies, meters. Ali tubing - wall brackets - rotators - insulators.

We are the original amateur radio suppliers in the North West with 20 years experience in all types of equipment. Wide range of Base, Mobile, Antennas for all applications. Full range of equipment on display. Guaranteed after sales service. Official Kenwood stockist for North. Also stockists for Tonna, Welz, G.Whips, Jaybeam, RSGB Publications, Diawa, Microwave Modules, Capco Antenna Tuners.

RECEIVERS

Full range of receivers for all modes and frequencies.

KENWOOD R5000 General Coverage Receiver	£895.00
VC20 VHF Converter for R5000	£171.94
KENWOOD R2000 General Coverage Receiver	£637.26
VC10 VHF Converter for R2000	£170.76
JRC NRD 525 General Coverage Receiver	£1,195.00
CMK165 VHF/UHF Converter for NRD525	£391.35
HF125 General Coverage Receiver	£375.00
AR2002 Wide Band Scanning Receiver	£487.00
R532 Synthesised 100 Channel Airband Receiver	£224.00
R537S Hand Held Airband Receiver	£69.50
AT1000 SWL Antenna Tuner	£69.00

Please send SAE for full information and up-to-date prices as these fluctuate to change in sterling rates. For the caller a wide range of Aluminium Tubing, Clamps, etc. at competitive prices, i.e. 12" x 2" Ali Tubing £10.95.

Full range of RSGB and ARRL publications in stock. Part Exchanges welcome. Second hand lists daily. Send S.A.E. for details of any equipment. HP terms. Access/Barclaycard facilities. Open 6 days a week. 24 Hour Mail Order Service. Goods normally despatched by return of post.

Phone 0942-676790.

STEPHENS JAMES LTD.
47 WARRINGTON ROAD,
LEIGH, LANCS. WN7 3EA.

AUDIO FILTERS MODELS FL2, FL3, FL2/A

Model FL3 represents the ultimate in audio filters for SSB and CW. Connected in series with the loudspeaker, it gives variable extra selectivity better than a whole bank of expensive crystal filters. In addition it contains an automatic notch filter which can remove a "tuner-upper" all by itself.



Model FL2 is exactly the same but without the auto-notch. Any existing or new FL2 can be up graded to an FL3 by adding Model FL2/A conversion kit, which is a stand-alone auto-notch unit. Datong filters frequently allow continued copy when otherwise a QSO would have to be abandoned.

Prices: FL2 £89.70, FL3 £129.37, FL2/A £39.67

ACTIVE RECEIVING ANTENNAS

Datong active antennas are ideal for modern broadband communications receiver - especially where space is limited.



- highly sensitive (comparable to full-size dipoles).
- Broad-band coverage (below 200 kHz to over 30 MHz).
- needs no tuning, matching or other adjustments.
- two versions AD270 for indoor mounting or AD370 (illustrated) for outdoor use
- very compact, only 3 metres overall length. • professional performance standards.

Prices: Model AD270 (indoor use only) £51.75 Both prices include mains power unit. Model AD370 (for outdoor use) £69.00

MORSE TUTOR

The uniquely effective method of improving and maintaining Morse Code proficiency. Effectiveness proven by thousands of users world-wide.



- Practise anywhere, anytime at your convenience.
- Generates a random stream of perfect Morse in five character groups.
- D70's unique "DELAY" control allows you to learn each character with its correct high speed sound. Start with a long delay between each character and as you improve reduce the delay. The speed within each character always remains as set on the independent "SPEED" control.
- Features: long life battery operation, compact size, built-in loudspeaker plus personal earpiece.

Price: £56.35

Our full catalogue plus further details of any product are available free on request. All prices include VAT and postage and packing. Goods normally despatched within 3 days subject to availability.

Barclaycard, Access Orders - Tel: (0532) 744822

DATONG ELECTRONICS LIMITED
write to dept. P.W.
Clayton Wood Close
West Park
LEEDS LS16 6QE
Tel: (0532) 744822 (2 lines)

THE LONDON AMATEUR EMPORIUM
FOR EVERYTHING RADIO

191 FRANCIS ROAD
LEYTON · E10 6NQ · LONDON
TELEX 8953609 LEXTON G

PHONE
01-558 0854
01-556 1415

dressler
FOR ICOM

OPEN MON -
SAT 9AM - 5.30PM
INTEREST FREE
HP FACILITIES AVAILABLE
ON MANY ITEMS
PROMPT MAIL ORDER



dressler
FOR YAESU

IC28E/IC48E

VERY LATEST MINI-MOBILE
25/45 watts. RX 138-174MHz
£££ unbelievable value.



ICOM R7000 25MHZ-2000MHZ
SPECIAL OFFER!!



FREE
ARA 500.
ACTIVE ANTENNA
WORTH £139.00
£969

ICOM MICRO 2
HANDHELD

ICOM IC-02E

ALSO
AVAILABLE
IC275E

ALL SONY UK SUPPLIED



£239 inc. NiCad
Charger & Case



£275



ICOM IC-735

£854

SPECIAL OFFER

BUY A
R71 FOR £825
& RECEIVE AN ARA 30
FREE
WORTH £129

WIDE RANGE OF YAESU/ICOM,
TRIO/KENWOOD, H.F., V.H.F., U.H.F.
SCANNING RECEIVERS AND
TRANSCIVERS IN STOCK ICOM ICA2 ALL
CHANNELS TX/RX 5 WATTS, 108-135 AND
175 MHz £450 — COMMERCIAL,
PROFESSIONAL, MARINE, CELLULAR
AND AMATEUR RADIO SALES AND
SERVICE.

SONY ICF 200ID

76-108 MHz
116-136 AIRBAND
153-29,995kHz
FM - AM - SSB 32 MEMORIES
INC PSU, CARRY STRAP
& EARPHONE

£325

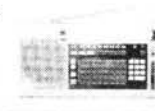

SONY ICF 7600D

76-108MHz

76-108MHz
153-29,995MHz
Complete with case,
mains power supply,
earphone and
frequency list.

£169



NEW

£425 - YAESU FT 290 MKII
A NEW
VERSION
OF THIS
POPULAR
PORTABLE
INC. NICAD
& CHARGER



DUAL BAND
FT727R
£P.O.A.



FT23/
FT73
£P.O.A.



FRG 8800 £575



NEW

FT767 YAESU



FRG 9600 £475



FULL HF GENERAL
COVERAGE TRANSCIVER

£1395

ACTIVE ANTENNAS

dressler - ara 30 -
active antenna

200 kHz . . . 40 MHz

Professional electronic circuitry with very wide
dynamic range. Meets professional demands
both in electronics and mechanical ruggedness.
120 cm long glass fibre rod. Circuit is built into
waterproof 2,5 mm thick aluminium tube. Ideal
for commercial and swl-receiving systems. £129.
See Review in August 1985 Issue p.15



**DRESSLER
ARA 500
ACTIVE ANTENNA**

50MHz to 1300MHz

Gain 17dB Typical

**TECHNICAL SPECIFICATIONS
FOR ARA 500**

Gain 17dB Typical (14-17dB)
Frequency Range 50-1300MHz
Noise Figure 1dB at 50-180MHz
1.5dB below 300MHz
2.0dB below 350MHz
2.7dB below 400MHz
3.0dB below 500MHz
3.8dB below 650MHz

£139.00

Operation is possible up to 1300MHz
with gain of 10dB

Noise 4-6dB
Intercept Point 3rd Order: +18dbm at Input
Post £3.00 or Securicor £7.00 extra

Both antennas come complete with 7 metres of cable, interface, power supply and brackets.

LINEARS

**SPECIAL OFFER
10 ONLY D200S £925**

D200 2 MTR 500W SSB

£858

D200S 2 MTR 750W SSB SEE PANEL ABOVE

D70 70 CMS 550W SSB

£1030

CARRIAGE FREE - SECURICOR



PRE-AMPS - NEW MODELS

MODEL	FREQ.	NOISE	GAIN	POWER	PRICE
EVV1296C	1.25-1.3GHz	0.9-1.2	16-18dB	100W	£162
EVV700SMD	430-440MHz	0.5-0.9	15-18dB	500W PEP	£124
EVV2000SMD	144-146	0.6-0.9	16-18dB	1KW PEP	£124
EVV200VOX	144-146	0.6-0.9	16-18dB	450W PEP	£112
EV2GAAS	144-146	0.6-0.9	15-18dB	100W PEP	£75
VV INTERFACE FOR ABOVE PRE-AMPS					£31

RECEIVE PRE-AMPS

MODEL	FREQUENCY	NOISE	GAIN	PRICE
EWPA 560	50-600-1GHz		16.5dB-1dB	£79
EWPA 560(N)	50-600-1GHz		16.5dB-1dB	£89
IP3 order			+18dBm	
ERPA 1296	1.25-1.30	0.8	17-18dB	£120
ERPA 435	430-440	0.5	15-18dB	£70
ERPA 144	144-146	0.7	16-18dB	£66
ASA 12	0-1GHz		Masthead Antenna Switch	£59

**IDEAL FOR VHF SCANNERS, CARAVANS,
AND BOATS. SUPERB TV RECEPTION.**

C.M.HOWES COMMUNICATIONS

139, Highview, Vigo,
Meopham, Kent,
DA13 0UT England.
Fairseat(0732)823129

ENHANCE YOUR RECEIVER!

There is hardly a receiver in existence that would not benefit from the addition of some extra filtering. Yet you can add this extra performance easily, and at a very reasonable price! The HOWES dual bandwidth filter kits enable you to add a narrow (300Hz at -6dB) CW filter and extra sharp SSB roll-off to your radio. We have had the results described to us as "spectacular" — we like comments like that!

If you have one of the popular general coverage receivers (FRG7, FRG7700, R600, R1000etc), you will find a big improvement in selectivity by adding the **HOWES ASL5**. Most popular transceivers are much improved too. Read the review in the April 87 Shortwave Magazine, and see the response curves plotted in the May '87 Rad. Com. article (Page 327). These filters are available in two versions, the ASL5 for external connection, and the CSL4 for wiring inside the radio (HOWES DcRx receiver etc). They are straightforward and enjoyable to build, with our usual high standard of parts and instructions. They offer the chance to improve your radio's performance, and provide an interesting constructional project into the bargain!

ASL5 External dual bandwidth filter kit: £14.90.

CSL4 Internal dual bandwidth filter kit: £9.90.

Assembled PCB: £22.50

Assembled PCB: £15.90

NEW PRODUCT!

Would you like an "S meter" for your HOWES DcRx, or other homebrew receiver project? The **DCS2** kit contains the parts to build a small two chip driver circuit and a nice little moving coil meter. Together they form a relative signal strength indicator, that will add a nice touch of class to your homebrew receiver project.

DCS2 Meter, and driver module kit: £6.30.

Meter and assembled PCB: £9.90

SOME OTHER HOWES KITS:

DcRx receiver, versions for 160, 80, 40, 30 or 20M bands, kit: £15.30

Tuning capacitors to suit all but 160M are £1.50 each (2 needed per DcRx).

CTX40 and CTX80 QRP CW Transmitters for 40 or 80M, kit: £13.40

MTX20 CW Transmitter for 20M with 10W RF output, kit: £21.90

CVF VFOs for above transmitters (will transceive with DcRx) kit: £9.90

CTU30ATU with balun, all HF bands up to 30W RF, kit: £24.90

PLEASE ADD 90p P&P to your total order value.



We can take telephone credit card orders during office hours, or you can order by post. Catalogues and product information sheets are free, but we do ask you to send an SAE for these.

If you would like some more information, or just our Summer Catalogue, why not drop us a line?

73 from Dave G4KQH, Technical Manager.

EASY TO BUILD KITS BY MAIL ORDER

AMATEUR ELECTRONICS UK

G6XBH
G1RAS
G8UUS

R.A.S. (Nottingham)
Radio Amateur Supplies
Tel: 0602 280267



Visit your Local Emporium

Large selection of New/Used Equipment on Show

AGENTS FOR:

F.D.K.
AZDEN
ICOM
YAESU
ALINCO
KEMPRO

ACCESSORIES:

Welz Range
Microwave Modules
Adonis Mics
Mutek Pre-Amps
Bareco Mast Supports
DRAE Products
BNOS Linears & P.S.U.'s

AGENTS FOR CELLNET and VODAFONE RADIOS

AERIALS, Tonna, Halbar, New Diamond Range of Mobile Whips, Jaybeam

BRING YOUR S/H EQUIPMENT IN FOR SALE

JUST GIVE US A RING

Monday: CLOSED Tuesday-Saturday: 10.00am to 5.00pm

3 Farndon Green, Wollaton Park, Nottingham NG8 1OU
Off Ring Rd., between A52 (Derby Road) & A609 (Ilkeston Road)

SEE WHAT YOU CAN HEAR WITH RADIO DATABASE INTERNATIONAL

NEW 1987 EDITION NOW IN STOCK

Turn on your radio, open your **RADIO DATABASE INTERNATIONAL** . . . and your set to conquer the world of shortwave listening!

This new expanded 1987 edition of **RADIO DATABASE INTERNATIONAL** features the world's most up-to-date Worldscan schedules presented in clear, easy-to-read graphics in handy frequency order. It's all world radio and it's all there at a glance without page-turning or thumbing through text!

Inconvenient frequency order from 2 to 26 MHz, **RADIO DATABASE INTERNATIONAL** displays station names, locations, frequencies, operating times, languages, jamming, intended reception areas and transmitter powers. It's all in one place, all at a glance. What were formerly separate International and Tropical Editions are now combined into one great book.

And there's more. **RDI** has added a number of new features and articles designed to help you make the most of your listening moments. Additionally, by popular request, major stations have been listed alphabetically, by country, with quick-access schedules.

The **1987 RADIO DATABASE INTERNATIONAL** also features a hard-hitting Buyer's Guide with ratings of dozens of models sold throughout the world. **RDI** veteran team of award-winning reviewers provides you with the world's most trusted advice on radios from portables to high-performance receivers.

With your radio and your **RDI**, you'll be ready to enjoy the wide world of shortwave listening as you never have before.

Price £12.50 + £1 post & packing in UK & Eire. Overseas: £6 airmail or £2 sea mail worldwide.

OTHER RADIO BOOKS

GUIDE TO UTILITY STATIONS 1986 New lists 15,083 SW frequencies Aero, CW, Fixed, Commercial RTTY, FAX, etc. stations, plus call signs and much more. The most comprehensive frequency listing book available. £16.00 + £1.45 p&p.

SCANNERS A VHF/UHF Listener's Guide with frequency lists £7.95 p&p FREE.

US MILITARY RADIO COMMUNICATIONS Full details of operations and frequencies used on HF bands. Part 1 £10.80 + 60p p&p. Parts 2 and 3 £9.85 + 60p p&p each. Parts 1, 2 and 3 together £26.50 p&p FREE.

COMMUNICATION SATELLITES New expanded 2nd edition covers: Ham, weather, navigation, DBS, Russian, US satellites plus much more. £13.25 + £1.55 p&p.

AIR TRAFFIC RADIO New edition. Guide to UK air traffic VHF & UHF frequencies. £2.25 + 35p p&p.

RADOTELETYPE PRESS BROADCASTS A comprehensive book on the world's Press Agencies including full details of their services, frequencies and transmission times. £11.85 + 60p p&p.

RADIO HACKER'S CODEBOOK Decoding codes and cyphers with home computers. £9.95 + 60p p&p.

Two or more books Post & Packing FREE (UK and Eire only). Ask for our NEW free catalogue of all books. Delivery normally from stock within 14 days.

INTERBOOKS, PWD23, Stanley, Perth, PH1 4QQ, Scotland. Tel: (0738) 828575

South Midlands Communications Ltd.

STOCK AND RECOMMEND

MICROWAVE MODULES LTD

		Prices Incl. VAT
MML28/100-S	100m 100W Linear, 10W input	129.95
MML144/20-LS	2m 30W Linear, 1 or 3W input	98.90
MML144/50-S	2m 50W Linear, 10W input	106.95
MML144/100-S	2m 100W Linear, 10W input	149.96
MML144/100-HS	2m 100W Linear, 25W input	159.85
MML144/100-LS	2m 100W Linear, 1 or 3W input	169.97
MML144/200-S	2m 200W Linear, 3, 10, 25W input	369.84
MML432/30-L	70cm 30W Linear, 1 or 3W input	169.05
MML432/50	70cm 50W Linear, 10W input	149.50
MML432/100	70cm 100W Linear, 10W input	334.65
MMC435/600	70cm ATV Converter, UHF output	35.65
MTV435	70cm ATV 20W Transmitter	197.80
MM2001	RTTY to TV Converter	188.83
MM4001-KB	RTTY Transceiver with keyboard	299.00
MMS1	The Morseltalker	129.95
MMS2	Advanced Morse Trainer	168.82
MMT50/28-S	10m to 6m Transverter	289.80
MMT50/144	2m to 6m Transverter	289.80
MMT144/28-R	2m Linear Transverter, 25W o/p	289.80
MMT144/28	2m Linear Transverter, 10W o/p	139.84
MMT220/28-S	220 MHz Transverter, 15W o/p	139.84
MMT432/28-S	70cm Linear Transverter	195.50
MMT1296/144-G	23cm Linear Transverter	258.75
MMX1268/144	1268 MHz Transmit Up-Converter	195.50
MMC50/28	6m down to 10m Converter	37.95
MMC144/28	2m down to 10m Converter	37.95
MMC144/28-HP	2m High Performance Converter	47.84
MMC432/28-S	70cm down to 10m Converter	44.85
MMC432/144-S	70cm down to 2m Converter	44.85
MMK1296/144	23cm down to 2m Converter	129.95
MMK1691/137.5	1690 MHz WX Satellite Converter	144.90
MMG144V	2m RF Switched GaAsFET Preamp	37.95
MMG1296	23cm GaAsFET Preamp/plier	74.98
MMG1691	1690 MHz GaAsFET Preamp	129.95
MMD1500P	1500 MHz Divide by 10 Prescaler	119.60
MMR/25	2dB 25 Watt Attenuator	19.78
MMR7/3	7 dB 3 Watt Attenuator	19.78
MMR15/10	15 dB 10 Watt Attenuator	19.78

Post & Packing FREE

SCHOOL CLOSE, CHANDLERS FORD IND. ESTATE
EASTLEIGH SO5 3BY. Tel: 0703 255111

AMCOMM'S SUPER SUMMER SALE!

A Super Summer Sale with terrific Guarantees . . .

★ **Low Prices** ★ **High Value After Sales Service** ★

*Phone for Prices and **really** marvel . . . as **we** say
– ‘Where a Good Deal More . . . Costs a Good Deal Less!’*

Amcomm's 1987 Top Twenty:



IC 761	HF TCVR	FT 767 GX	HF/UHF MULTIMODE
IC 751A	HF TCVR	FT 757 MK II	HF MULTIMODE
IC 735	COMPACT HF TCVR	FRG 8800	GEN COV RCVR
IC 275E	25W 2M MULTIMODE	FRG 9600	UHF/VHF SCANNER
IC 475	SOPHISTICATED UHF TCVR	FT 23	2M HANDIE
IC 02E	2M HANDIE	FT 73	70CM HANDIE
ICμ 2	MICRO 2M HANDIE	FT 211 RH	45W FM 2M TCVR
ICR 7000	UHF/VHF COMMUNICATIONS RCVR	FT 290 MK II	2M PORTABLE MULTIMODE
IC 290D	2M MULTIMODE MOBILE 25W	FT 690	6M PORTABLE MULTIMODE
IC 28E	2M MINI MOBILE TCVR	FT 727	VHF/UHF HANDIE

By the way, After Sales Service with AMCOMM means:

A FULL 100% 2 YEAR GUARANTEE!

Buy this month . . . It will never be a better time!

*Antenna bargains (VHF, UHF and HF)
up to 60%, yes **60% discount.***

*Hundred and hundreds more items at Sale Prices.
First come, first served!*



Amcomm of London



373 Uxbridge Road, London W3 9RN. Tel: 01-992 5765/6. Telex: 24263 Fax: 01-861 2591



QRM

Sir: I have read many letters regarding the RSGB and Morse tests and not taken much notice. (One never does when it doesn't apply to you!) But I recently sat the c.w. test at Belle Vue in Manchester where the noise level at times was shocking for an exam facility.

I went through the letters like no-one's business, and the first thirty numbers (this was on receive), but then came the noise from candidates and friends waiting outside the room, talking and using hand-helds, etc. Well, the distraction was such that I put my pen down, raised my hand in the air and declared, "The noise outside is putting me off!", this making me miss the last four groups, which gave me a fail on four uncorrected errors. I passed 100 per cent on transmit.

The examiners agreed after I had finished that the outside noise was a bit excessive but wouldn't send the last few groups again. I'm fluent at 14 w.p.m. and I enjoy c.w. as much as possible, but when I'm working c.w. I don't allow my kids to keep running in and out of the shack, so if I'm expected to produce 100 per cent I expect my examiners to give me 100 per cent test facilities. I take my hat off to the lads who passed, and to the fellows at the recent NEC convention who moved their test room because of the outside noise.

My test paper goes to RSGB HQ, to which I've written (no doubt there will be no reply; criticism is a sin!). Surely it will seem odd to them to find the passage correct, then 30 numbers all laid out neat and tidy, then a blank. Doesn't the RSGB give its examiners discretion to take account of the test environment, as the GPO and British Telecom used to? Please take over the Morse tests again, BT. You made a better job of it!

As someone devoted to the amateur radio hobby, I do like to see fair play.

**Steve Mayer G6KYO
Newcastle, Staffs**

Refraction

Sir: Following publication of the article on Ionospheric Refraction in the December issue of *PW*, there appears a little difficulty in some quarters in understanding that the upward velocity reduces to zero and then reverses, as shown in Fig. 5. This is no doubt due to the incorrect ideas having become entrenched. However, the following analogy may help.

As we know, a ball bounces back from a hard wall. If the same ball impinged on a spongy surface or net, it would gradually be retarded and then returned. In both instances, the velocity of the ball reduces to zero and then reverses in direction. What is the difference? With the hard wall, the velocity is reversed within a distance which is short compared

with the dimensions of the ball: with the spongy net the velocity is reversed in a distance which is large compared with those dimensions.

Reflection of electromagnetic waves occurs when the forward velocity reduces to zero and then reverses within a distance which is short compared with wavelength. Return by **refraction** occurs when the velocity reduces to zero and then reverses in a distance which is large compared with wavelength. To the observer on the ground the subjective effects are identical, as the article demonstrated.

The analogy is far from exact, but it may serve to illustrate the differences and the similarity of return by reflection and by refraction.

**L. W. Brown
Blackpool**

LAUGH WITH BARTHES



That Morse!

Sir: In answer to Mr Ian's letter (*PW* May 1987), what the RSGB has managed to do successfully is to create a lot of ill-feeling among radio amateurs, both Class A and Class B. Many feel that the Morse testing ought to have been left to the professionals; indeed, many amateurs feel a sense of betrayal.

What the RSGB has now introduced is a "sudden death" type of Morse test, where candidates are dealt with on a production line. Three candidates are processed in 30 minutes—of this time 3 minutes is used by the examiner to send plain language, 1½ minutes is used to send figures. Then candidates send plain language and figures on a one-to-one basis, taking at least 4½ minutes each. This leaves 12 minutes, during which time individuals are herded in and out of the room, credentials are checked, papers signed, etc. What time is allowed for the candidates to settle in? Gone are the days when the examiner could spend time putting candidates at their ease, and coaxing them to achieve their full potential. At £15 it was very good value for money.

Yes, there are more test centres, but often you are still faced with "expensive long-distance travelling" unless you are prepared to wait a couple of months for your appointment. Even if there is a test soon in your locality, there is a minimum delay in the RSGB system of a month between sending

for the application form and taking the test. Many coastal radio stations and marine surveyors were happy to accommodate a candidate within a couple of days in response to a telephone call, telling you to bring the application form down with you.

Even now, after running the Morse testing service for over twelve months, the RSGB is still talking about "eventually we will have ...": how long do we have to wait?

**M. D. Hiam G1FPJ
Tamworth, Staffs**

A Simple Wine

I must say how much I agree with L. Smart's letter in April 1987 *PW*. I, too, am a keen (unlicensed) s.w.l. and use mainly valved equipment and home-built add-ons. From time to time I become stuck for a solution to a problem, and it would be helpful for *PW* to run a monthly "practical" article on "Listening on the Cheap". After all, it is **Practical Wireless**.

At present I am unemployed, and high priced modern "known make" receivers are out of the question. So I haunt local market stalls and jumble sales, searching out defunct valved equipment—the results are surprising!

Finally, congratulations on the "Vin Plonk Special". It does work and bears more than a passing resemblance to some of my own experiments! More like this, please.

**D. Todd
Pencader, Dyfed**

Not Impressed!

Sir: I read with regret in the March issue of the new direction that *Practical Wireless* is to take. I have taken *PW* intermittently for over 20 years and continuously for the last 10. The change of direction in 1981 definitely did a lot to alienate those readers not dedicated to transmission. In the last couple of years there have, however, been some really excellent articles of interest to all sections of radio.

The series last year on sunspots was just as important to an s.w.l. as an amateur. Articles on antennas are just as useful to an s.w.l. After all, an antenna that transmits efficiently also receives well. The new policy will probably mean that articles such as those mentioned will appear in *PW*—what will appear in *Short Wave Magazine*?

I get the impression that the listener is going to be very much short-changed by this move, especially the listener with a technical interest. After all, what is the difference in propagation between 70cm and Band IV? Your policy will ensure part of the story appears in each magazine. I have seen the

editorial clarification in April's *PW* but I am not impressed.

I hope you will publish this letter, perhaps it will generate some response which will alter *PW*'s new policy.

**Paul Hardy
Caversham**

*We fully realised that the changes to *PW* and *SWM* would upset some established readers, but so far the comments received have been overwhelmingly in favour of the new formats. In planning the future development of both titles, we certainly shall be taking note of all the views expressed to us. Incidentally, that change in 1981 was from a publication dealing with electronic gadgets (burglar alarms, metal detectors, games, etc.) and hi-fi, plus some radio, to one totally for radio hobbyists, whatever their particular area of interest.—Ed.*

Listening

Sir: Reference the News item "Did You Know?" in *PW* May 1987, will you please explain to me how illegal reception can be a crime and how a person can be caught if he is listening in his home or on private property?

Send your letter to the Editorial Offices in Poole, the address is on our Contents page. Writer of the Star Letter each month will receive a voucher worth £10, to spend on items from our PCB or Book Services, or on *PW* back numbers, binders, reprints or computer program cassettes. And there's a £5 voucher for every other letter published.

Letters must be original, and not duplicated to other magazines. We reserve the right to edit or shorten any letter. Brief letters may be filed via our Prestel Mailbox number 202671191. The views expressed in letters are not necessarily those of *Practical Wireless*.

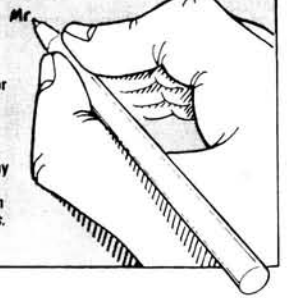

The radio airways are free for anyone to copy, so how can there be crime in listening to anything?

**W. Butcher
Leeds**

Use of radio equipment in the UK, whether for transmission or reception, is governed by the Wireless Telegraphy Acts. These basically forbid you to use any radio equipment unless you have the appropriate licence or you have some other form of permission. There is now a general dispensation within the Acts covering the reception of sound signals from "authorised broadcasting stations and licensed amateur stations". For the reception of "visual images" (in other words, television pictures) a TV licence is required. To receive radio signals in other services (even CB!) you need either the relevant licences, most of which are not issued to members of the general

public, or in some cases a letter of authority from a service-provider. Some RTTY, FAX and satellite TV services can be legally received under the latter arrangement.

As to how a person can be caught for illegal listening, the answer in general is that he will not be, unless he is foolish enough to advertise what he is doing. Using a handheld receiver to listen to public service transmissions in a public place could obviously be risky, but if you are really looking for trouble, show off yards of RTTY printout from a Press agency, Interpol net or similar, as one enthusiast is reputed to have done in his local pub in front of an alert off-duty policeman a few years ago!

As I have often commented before, the provisions of the Wireless Telegraphy Acts as they refer to reception are basically unenforceable in practical terms, and as such they are bad law.—Ed.

OUR SERVICES

QUERIES

We will always try to help readers having difficulties with a *Practical Wireless* project, but please observe the following simple rules:

1. We cannot give advice on modifications to our designs, nor on commercial radio, TV or electronic equipment.
2. We cannot deal with technical queries over the telephone.
3. All letters asking for advice **must** be accompanied by a stamped, self-addressed envelope (or envelope plus International Reply Coupons for overseas readers).
4. Write to the Editor, "Practical Wireless", Enefco House, The Quay, Poole, Dorset BH15 1PP, giving a clear description of your problem.
5. Only one project per letter, please.

COMPONENTS, KITS AND PCBs

Components for our projects are usually available from advertisers. For more difficult items, a source will be suggested in the article. Kits for our more recent projects are available from **CPL Electronics**, and from FJP Kits (see advertisements). The printed circuit boards are available from our **PCB SERVICE** (see page 1 of this issue).

Practical Wireless, July 1987

CONSTRUCTION RATING

Each constructional project is given a rating, to guide readers as to its complexity:

Beginner

A project that can be tackled by a beginner who is able to identify components and handle a soldering iron fairly competently.

Intermediate

A fair degree of experience in building electronic or radio projects is assumed, but only basic test equipment is needed to complete any tests and adjustments.

Advanced

A project likely to appeal to an experienced constructor, and often requiring access to workshop facilities and test equipment for construction, testing and alignment. Definitely not recommended for a beginner to tackle on his own.

BACK NUMBERS AND BINDERS

Limited stocks of most issues of *PW* for the past 18 years (plus a few from earlier years) are available at £1.25 each, including post and packing to addresses at home and overseas (by surface mail).

Binders, each taking one volume of *PW*, are available price £5.50 to UK addresses, £5.75 overseas, including post and packing. Please state the year and volume number for which the binder is required. Prices include VAT where appropriate.

CLUB NEWS

If you want news of radio club activities, please send a stamped, self-addressed envelope to **Club News**, "Practical Wireless", Enefco House, The Quay, Poole, Dorset BH15 1PP, stating the county or counties you're interested in.

ORDERING

Orders for p.c.b.s., back numbers and binders, *PW* computer program cassettes and items from our Book Service, should be sent to **Post Sales Department**, "Practical Wireless", Enefco House, The Quay, Poole, Dorset BH15 1PP, with details of your credit card or a cheque or postal order payable to Practical Wireless. Cheques with overseas orders must be drawn on a London Clearing Bank.

Credit card orders (Access, Mastercard, Eurocard or Visa) are also welcome by telephone to Poole (0202) 678558. An answering machine will accept your order out of office hours.

SUBSCRIPTIONS

Subscriptions are available at £13 per annum to UK addresses and £15 overseas, from "Practical Wireless" Subscription Department, Competition House, Farndon Road, Market Harborough, Leicestershire LE16 9NR. Tel: (0858) 34567. Airmail rates for overseas subscriptions can be quoted on request.

DRIP

The scenario so far ...
 "You are sailing off the coast of East Botsnavia in your 250 ton luxury motor cruiser and are suddenly hit by a freak storm. The force of the storm drove the cruiser onto the reef of a small island, at this point the upper lounge cabin (which you and your team were in) was torn off the top deck and washed ashore. The rest of the cruiser sank outside the reef in shark infested waters (don't worry it was well insured). This leaves you and your team a table, 3 chairs, the TV, a radio, the 'phone and a bag of bits.

Lucky for you the ship's carpenter and odd job man left his tools. It was he who

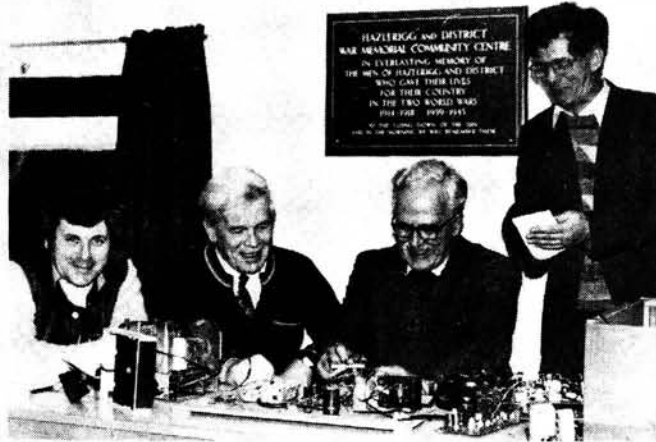

unbolted the upper cabin that you and your team were in at the time of the shipwreck (he was about to move it forward to make more room for the

swimming pool!).

Your task, should you accept the challenge is to construct and operate, within your licence parameters, a transmitter

and receiver, and to gain as many points as possible in the 24 hours you are allowed. In this time you also have 8 hours for rest (as the wreck was a very harrowing experience).

All contacts must be logged and confirmed by QSL card or official observer."

If this sounds like fun then you should contact the Hazlerigg and District RC as they are running the Desert Radio Islands Project. You can see from the photograph that they have been practising very hard, but will send any other club details of the various components and tools you can use to get on the air. Contact **M. Scott G8BGU**. Tel: 0661 32020.

Low Electronics Evening

On Wednesday June 17, meeting at 7.30pm, Lowe Electronics have booked the functions room of the Charlton Arms Hotel, Church Street, Wellington, Telford for a radio evening. Two talks are planned, John Wilson G3PCY (Technical Director of Lowes) will speak on "Reminiscences of a Radio Amateur" and John Thorpe on "The Design and Development of the HF125 Shortwave Receiver".

A cup of coffee and a biscuit will be available free of charge to the first 50 people to arrive and before, between and after the lectures a bar will be open. The latest models from Kenwood plus the HF125 receiver will also be on view.

In order to navigate the Wellington town centre one-way system a knowledgeable talk-in station has been arranged which will operate on S22 from 7pm.

MLARS Open Day

The following lectures and demonstrations have been arranged for the Mid-Lanark ARS Annual Open Day.

Satellite Working by John Branegan GM4IHJ.

Packet Radio by Vic Kusin GM4HCO.

Amateur Television by Adrian Beale GM1FML.

Morse tests will be

BAEC

The April '87 issue of the British Amateur Electronics Club has recently landed in the office. It contains a wide variety of articles including "The 555 Timer Chip", Part 18 of "Electronics A-Z" as well as Letters, News and Views and a Special Offer.

For more information contact the BAEC Secretary: **Mr J. G. Margetts**, 53 High Oaks Close, Locks Heath, Southampton SO3 6SX.

Leicester RS

As 1988 heralds the 75th Anniversary of the Leicester Radio Society they are trying to write a potted history of the Society.

Does anyone have any information to assist them, especially about the years between 1913 and 1934. Of course any mementoes of the past would be welcome.

If you can help then contact **Frank Elliott GAPDZ** on 0533 871086.

RAE Courses

Arnold & Carlton College of FE: Enrolment can be by post or at the college on Monday September 7 from 10am to 8pm and on Tuesday and Thursday September 8 and 9 between 2pm and 8pm. This college has six different classes you could join: The RAE class both full and short course; a

Construction Class; a Morse Practice Class; an Introduction to the RAE class; an After the RAE class and a class to cater for Foreign Languages for the Amateur. For further details contact:

R. G. Wilson G4NZU, Arnold & Carlton C of FE, Digby Avenue, Mapperley, Nottingham NG3 6DR.

Transformers

Clearing up after a break-in earlier this year, staff at Majestic Transformers in Bournemouth came across this proof copy of an advertisement placed in *Practical Wireless* by their company back in 1945.

Though their main business nowadays is in the production of small quantities of specialised transformers and power supplies for equipment manufacturers throughout the UK, they are still happy to tackle rewinds on those "difficult-to-replace" transformers whose failure is so often the cause of a still-useful piece of gear going to the scrap-yard.

You won't be quoted the sort of prices mentioned in that old ad, I'm afraid, but if you're in a fix with a burnt out transformer, give them a call. The **Majestic Transformer Co** is still at

180 Windham Road, Bournemouth.
Tel: 0202 34676.

MAJESTIC WINDING CO.

180, Windham Road, BOURNEMOUTH.
 A 24 HOUR SERVICE with 6 months guarantee, any transformer rewind; mains 1516, outputs, 4/- . All types of new equipment supplied to specification. Abridged list of standard new components.

MAINS TRANSFORMERS

TYPE 2A. 350-0-350v., 250 m.a. 4V4A, 4V4A, 4V2A, 4V2A, alternative L.T. 6.3V, 2A, 6.3V, 2A, 6.3V, 2A, 5V, 2A ... 55/-
TYPE 3A/B. 500-0-500v., 120 m.a. 4V4A, 4V2A, 4V2A, 4V2A ... 45/-
TYPE 4A/B. 350-0-350v., 120 m.a. 4V4A, 4V2A, 4V2A, 4V2A ... 40/-
TYPE SR327. 350-0-350v., 90 m.a. 4V4A, 4V2A, alternative L.T., 6.3V4A, 5V2A ... 33/-

OUTPUT TRANSFORMERS HIGH FIDELITY TYPE

TYPE AB2516. Suitable for 6L6's in Class AB1 Push-Pull to handle 25 watts speech ... 25/-
TYPE 12/4. Suitable for PX4's, etc., in Push-Pull Class A to handle 12 watts speech ... 17/6
 Also available, Intervalve Transformers, Chokes, etc. Standard lines, or to specification by order.

Special Event Stations

GB0KCK: This station will be on the air for the Kingston Bagpuize with Southmoor church fete. This will be held on June 27 in the recreation ground of the village of Kingston Bagpuize, which is situated 15km south west of the city of Oxford, in WAB Square SU49. This h.f. station will be operated by GOAOZ and GOGLB, with activity on both 14 and 3.5MHz s.s.b.

GB6HF: The Houghton-le-Spring ARC will run the

GB0KCF

Kingston Bagpuize - with - Southmoor Church Fete, Saturday 27th June 1987

To Station
 Confirming QSO MHz Mode
 Date Time GMT
 Report Tx/Rx
 Power Ant
 Remarks

Met Tex For Geo. Pse/Tnx Qsl Direct/Via Bureau.

special event station on 3.5 and 144MHz from October 2-October 11 to celebrate

Houghton Feast. It marks the dedication of the Church to St Michael.



The Church

The first Church and Chapel on the site was consecrated by Osmund, Bishop of Salisbury, between 1070-1100, and the Church remained here for nearly 300 years. The tower was rebuilt in 1565 and the 'Communion' (communion) in 1515. Kingston Bagpuize, like before the battle of Agincourt in 1415, the tower being a 'Cannon' in 1415, built in 1565. The present Church, built in the last years of the 18th century, was designed by John Field of Farnham and was completed in 1780. Alterations were undertaken in 1842 by E. Duffell when the gallery and high nave were removed and the beautiful organ case built. A careful examination of the south-west and north-west corners will reveal the places that the gallery was supported in the walls. The west door has 'Tessie' inscribed and above the west door an oval 'Tessie' style window.

Isle of Man Activity

On June 13 and 14 the Isle of Man ARS will operate a station from Peel Castle, St Patrick's Isle, Peel using the callsign GD4IOM.

They will also be setting up a station on the Calf of Man (a small island to the south of the IOM) from 1400 local time on July 4 to 1300 local time on July 6.

Callsigns will be GD4IOM and GD4FLH with activity on all h.f. bands plus 144 and 50MHz.

WAB enthusiasts please note that both Islands qualify separately for the WAB Islands Award. QSL via the GD Bureau or direct to GD4GWQ.

DTI Fact Sheets

The DTI have now printed their information sheets especially for those with 'partial sight'. The sheets are on yellow paper (to reduce glare) and they have increased the size of the print.

If they are a success they will repeat the process for the two new information

sheets due out soon.

If you would like a copy of the Radio Amateur Licensing Information Sheet 1-3 then write to:

**DTI,
 Radio Communications
 Division 2, Room 613,
 Waterloo Bridge House,
 Waterloo Road,
 London SE1 8UA.**

Club Changes

The **Eden Valley RS** have had a change of secretary, he is Martin J. Rigby G4FUI and you can contact him on 0768 66728. The club net takes place on 144MHz f.m.

on Sundays at 1100 on GB3EV (R4) or on S22 if the repeater is busy, as well as 3.5MHz s.s.b. on non-club Thursdays on 3.650MHz ± QRM at 1900 (clock times).

Rally Dates

June 14: The 18th Elvaston Castle mobile rally will be held at Elvaston Castle some 8km south-east of Derby on the B5010. There will be plenty to interest all the family such as an escapologist, stunt driving, mini motor bikes, bouncing castle, helter skelter and lots more, admission is free but the local authority charge 50p for car parking. This year they even have a craft marquee. For more information contact **John Robson G4PZY on Derby 767994.**

June 21: the Annual Rally organised by the Denby Dale & District ARC will be held at Shelley High School. Shelley is 8km south-east of Huddersfield on the B6116. Doors open at 11am (10.30 for the disabled). The usual trade stands will be there as

well as club stands and a bring and buy. There is free parking, a lucky draw, children's entertainments and 'the usual good food'. More details from **G3SDY. Tel: 0484 602905.**

July 12: The Worcester & District ARC are holding their Droitwich 'Strawberry' Rally at the High School Droitwich. Gates open at 11am and there is both free parking and entrance. All the usual trade stands will be there plus family entertainment and free transport to the local strawberry field (weather permitting). Morse tests by prior arrangement with the RSGB and talk-in on S22. For more details contact **Steve Colledge GOAOC, QTHR.**

***August 9:** Hamfest '87, organised by Flight Refuelling ARS, will again be holding their rally at FR

Sports & Social Club, Merley, Wimborne, Dorset. The gates will be open from 10am to 5pm and there will be the usual entertainment for all the family. Free parking is available to visitors and the entrance fee is 30p (children free).

August 31: The Doncaster & District RAYNET Group are holding their rally at the Bircotes Sports Centre, Bircotes, Doncaster (Grid Ref: SK630922). Doors open at 11am (10.30 for the disabled). Admission is 50p.

***September 13:** The Lincoln Short Wave Club also call their rally Hamfest '87 and this will be held at the Lincolnshire Showground and Exhibition Centre—6km north of the city on the A15. In addition to the usual stands of interest to the radio amateur they hope to have helicopter rides, model car racing, the

GB3AP

The Midlands AX25 Packet Radio Users Group have been operating a digipeater, GB3AP, located at Dudley in the West Midlands since November 22 last year.

Some of the operating parameters of the repeater are being changed and the group would find it extremely useful if they were able to map the current coverage area of the repeater both before and after the changes.

To this end they would be grateful if users would send reports of both signal strength and audio quality to the group as soon as possible. If you send a report you should state your location and brief details of your receiving equipment. Reports from listeners to 144.650MHz not equipped with packet radio terminals would also be useful, as for this exercise de-coding is not necessary.

Send your reports to:
**Andy Witts G1DIL,
 56 Stephenson Drive,
 Perton,
 Wolverhampton WV6 7YB.**

Can You Help?

Chas E. Miller has recently acquired a Canadian Type 250 receiver, made by VRL (Vancouver Radio Laboratories), and is looking for a circuit diagram, etc. Any information to Chas via the PW Editorial offices please.

police, the fire brigade and lots more. There is ample parking, caravans by arrangement, refreshments and a licensed bar with real ale! More details from **Pam Rose G4STO on Gainsborough 788356.**

September 20: The Trafford Rally and Components Fair will be held at Old Trafford Cricket Ground, Talbot Road, Stretford, Manchester. Doors open at 10.30am (10 for the disabled) and the rally closes at 5pm. There is free parking on site for over 700 cars and there will be a bar, tea, coffee and snacks available. Talk-in on S22.

***October 23/24:** The LARS Committee are holding the Leicester Amateur Radio Show at the Granby Halls again this year. As yet not many details, but contact **Frank G4PDZ on Leicester 553293.**

HF Coils

Oxley Developments have sent me information on their new series of inductors for use in applications requiring a high *Q* factor and maximum stability.

These inductors consist of a coil made from a highly conductive layer of precious metal fused to a high purity, high stability, alumina former.

Inductance values range from 45nH to 1.83µH with

an operating temperature range of -55 to +125°C.

Oxley expect these coils to find increasing use in front ends, instrumentation, digital communication systems and precision oscillators.

Further technical details from

**Oxley Developments
Company Ltd.,
Priory Park,
Ulverston,
Cumbria LA12 9QG.
Tel: (0229) 52621.**

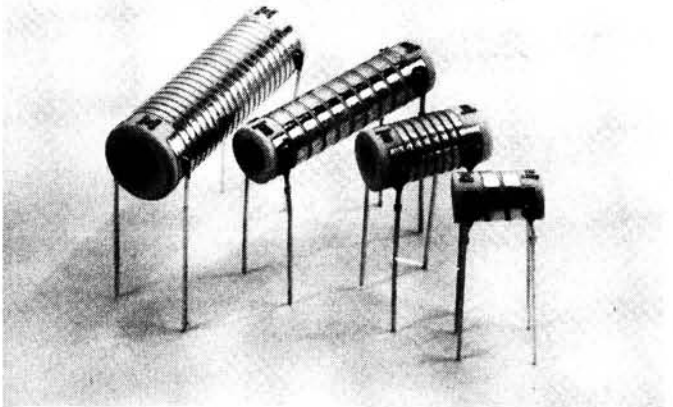

Telescopic Masts

Those of you who are into contesting from the tops of wild and inhospitable mountains, and I know from the entries for the PWQRP Contest that you do exist, will find these ultra-lightweight telescopic masts of interest.

Antenna Technologies have developed a range of telescopic masts made from advanced carbon-glass composite materials such as are used in aerospace applications. Up to 12m in height when extended these masts are much lighter than metal versions and can easily be carried by one person.

The design has evolved from a need for a mast light enough to be rapidly deployed by any unskilled person. The 12m mast weighs less than 8.5kg and retracts to 1.5m whilst the 8 and 6m versions are even lighter. The composite materials used also offer other benefits such as corrosion resistance and a long, maintenance-free life.

The masts are raised by extending the tubular sections manually and

locking them into position with the quick-release collars. No pneumatic seals or other complex equipment are used, and any number of the sections can be left unextended as required. When extended the sections cannot rotate within each other. Vehicle mounting brackets are available and a canvas carrying case complete with stays and stakes is supplied as standard.

Further details are available from
**Antenna Technologies,
Horace Road,
Kingston upon Thames,
Surrey KT1 2SN.
Tel: 01-546 7808.**



New Yaesu Transceivers

Yaesu have introduced two brand new transceivers. The FT-757 GX MkII combines the features of its predecessor with new technological developments in response, they say, to the most popular requests from serious h.f. operators.

This mobile/base unit now has an improved c.a.t. (computer aided transceiver) system for simplified programming and more advanced control from an external computer. Ten memory channels store mode and frequency together with auto-resume loop scanning between dual v.f.o.s and a special clarifier memory. Operator selectable mode-dependent tuning steps are also now a standard feature.

Power output is 10W p.e.p. Other features include a 40dB notch filter with adjustable i.f. shift;

wideband a.m. and narrowband c.w. i.f. filter; switchable r.f. amplifier and 20dB attenuator; adjustable noise blanking pulse width; full break-in QSK with custom integral keyer; a.f. speech processor and an interesting "duct flow" cooling system.

Yaesu have also just revealed the FT-211 RH synthesised 144MHz f.m. mobile/base transceiver.

This rig has a reversible sloped front panel to allow convenient mounting and includes soft green back lighting of keys and controls. The large liquid crystal display incorporates a bargraph power and S-meter.

Further information and prices are available from

**Amateur Electronics,
504 Alum Rock Road,
Alum Rock,
Birmingham
B8 3HX.
Tel: 021-327 1497.**

Turns Counter

The final piece in the a.t.u. components "jigsaw" has just been announced by Telecomms under their Nevada brand name.

The Nevada TC48 turns counter has been specially designed, by Ernie Quinell G4JEV of course, to drive their RC26 roller coaster coil (described in this column May 87). It could, of course, be used for any piece of equipment needing a multi-turn drive.

The drive is geared down 48 to 1 so that to obtain one turn of the outer dial and main drive shaft requires 48 turns of the control knob.

Selling at £12.95 inc. VAT the TC48 is available from

**Telecomms, 189 London Road, North End, Portsmouth,
Hants PO2 9AE. Tel: (0705) 698113.**



Any Ideas?

Telecomms tell me that they are always looking for new ideas and products and would like to hear from budding inventors with new items which they could help to finance and produce.

Battery Holders

If you want to be able to fit batteries with reliable connections and easy removal, this item will interest you.

It is a neat, panel mounting, drawer type holder to take four R6 (AA) size batteries.

**A.F. Bulgin & Co,
Bypass Road,
Barking,
Essex IG11 0AZ
Tel: 01-594 5588**

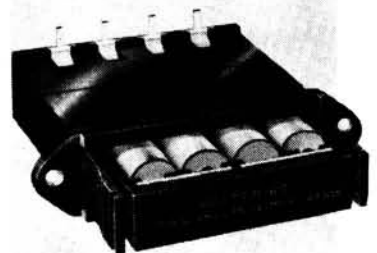

R. WITHERS COMMUNICATIONS LTD

Manufacturers, importers and suppliers of world famous communications products
 584 HAGLEY ROAD WEST OLDBURY, WARLEY, BIRMINGHAM B68 0BS
 021-421 8201/2/3. CELLNET 0860 323056. PRESTEL MBX 214218216 FAX 0215614074

Amateur Radio. Business Radio. Radio Telephones. Sales. Service Accessories and antenna systems.



YAESU



**THE TECHNICALLY ORIENTATED
 RADIO COMMUNICATIONS
 SPECIALISTS.**

RWC STOCKTAKING SALE

We've been told we have too much stock! So for ONE MONTH ONLY we are offering Hi-Tech Radios at the UK's Lowest Prices! **CALL IF THE RADIO YOU WANT IS NOT ON THIS LIST!**

SPECIAL THIS MONTH: FREE SO239 Moulded lead Guttermount assy. with 6 Mtrs of quality UR43 coaxial cable, with every 2Mtr transceiver purchased (normally £8.50).

★ HANDHELD TRANSCEIVERS ★

WE OFFER MORE TO CHOOSE FROM . . .

★ KENPRO KT220EE 2MTR 5W LCD H/H.....	£199.00	P/P £10.00
KENPRO KT400EE 70CM 2W H/H.....	£199.00	P/P £10.00
★ CTE 1600 2MTR 3W (SAME AS IC2E).....	£165.00	P/P £10.00
★ ICOM MICRO 2E 2MTR 2.5W EXT RX.....	£229.00	P/P £10.00
★ ICOM IC28E 25W MOBILE EXT.D. RX.....	£349.00	P/P £10.00
★ YAESU FT209R 2MTR FNB3 NICAD.....	£229.00	P/P £10.00
YAESU FT290R MK1 2MTR M/MODE.....	£319.00	P/P £10.00
YAESU FT290R MK1 C/W NICADS.....	£339.00	P/P £10.00
YAESU FT290R MK2 2MTR M/MODE.....	£399.00	P/P £10.00
YAESU FT690R MK1 6MTR M/MODE.....	£279.00	P/P £10.00
YAESU FT690R MK1 C/W NICADS.....	£299.00	P/P £10.00

NEW YAESU – *FT211E, FT757GX MK2, *FT23R/FT73R/FT727R

Subject to availability, price depending on version/nicad/charger. Several extended and special versions available. Please telephone and discuss your requirements. * = Extended RX available, TX for export only.

Very Special Offer – Yaesu FT726R with 2m £799.00. Free Carriage. Yaesu FT757GX Mk1 £699.00. Inc. Carriage.

FULL RANGE OF MATCHING ACCESSORIES IN STOCK

★ SCANNING RECEIVERS ★

WE OFFER THE LARGEST RANGE AND OPTIONS

YEASU FRG9600 MK1 60-905 MHZ.....	£459.00	P/P £10.00
YEASU FRG9600 MK2 60-950 MHZ.....	£499.00	P/P £10.00
YEASU FRG9600 MK3 100 KHZ-950 MHZ.....	£625.00	P/P £10.00

YAESU FRG9600 MK3 PACKAGE:

MK3 Receiver, ICOM AH7000 Super Discone Antenna, PA4C AC Adapter, 1/2 size G5RV. Complete H/F-UHF Broadcast/Amateur/PMR Receiving Station **£725.00 inc. carriage.** Options: PAL Video Unit (at **£27.50**, BBC CONTROLLER PROG, **£49.50 inc. post.** SAE or phone for more details.

ICOM ICR700E

25-1300MHZ SPECIAL PRICE **£862.50 carr. £10.00.** ICR700E with AH700 antenna at **£942.50, carr. £10.00.**

THE WORLD'S BEST KNOWN SCANNERS, DIRECT FROM THE DISTRIBUTORS

Bearcat Scanners are value for money and the most popular.

★ BEARCAT ★

UBC100XL LB/AIR BAND VHF/UHF Handheld.....	£229.00	POST FREE
UBC175XL as above, desk-top FREE DISCONE.....	£209.00	POST FREE
DX1000 SHORT WAVE RECEIVER.....	SORRY	SOLD OUT
FDK AIR BAND SYNTHESIZED H/H 118-136 MHZ.....	£139.00	POST £3.00
FDK VHF-FM SYNTH. H/HELD 139-174 MHZ.....	£145.00	POST £3.00
REGENCY HX850 AM-FM VHF-UHF H/H SCANNER.....	£235.00	POST £3.00

WE STOCK ALL CURRENTLY AVAILABLE MAKES OF SCANNING RECEIVERS

★ SPECIAL MOBILE ANTENNA OFFER ★

SUN KG309SE2 5/8 Ant c/w Moulded SO239 Lead and guttermount assy..... £20.00 inc post

Important. Please confirm your order before sending payment as we do not wish you to be disappointed if the model you require is sold out or the price has gone up! Special offers are subject to availability, we DO NOT advertise products or models that are NOT normal stock items. The above offers will be sold on a first come first served basis. Please DO NOT DELAY, as with previous offers we always get hundreds of enquiries when the offers are SOLD OUT! Instant Credit available Subject to Status.

Mail Order welcome, you may order by Access, Visa, Diners Club, Amex or CWO for immediate despatch. Please call for further details or brochures. Prices variable and are subject to change without prior notice.

ALL PRICES CORRECT AT TIME OF GOING TO PRESS.

E&OE.

Tel: 021 421 8201 (24hr answerphone)

Telex: 334303 G TXAGWM



Marconi's Bristol Channel Triumph

Eric Westman brings us an insight into the largest step made by man in the field of communications technology since the invention of the telephone.

May 1987 marked the 90th anniversary of a major Marconi achievement, namely the first radio transmission across the sea and the vindication of his system of communication.

When the 22-year-old Italian brought his invention to Britain in 1896, after failing to get it tested by the Italian navy, he obtained an introduction to William Preece, the Engineer-in-Chief of the British Post Office, which handled all matters of communications. Preece was also a member of the Royal Commission on Electrical Communication with Lighthouses and Lightships, which had expressed the need for an efficient system of communication without wires. Indeed, Preece himself had devised his own method of signalling without wires and had successfully worked it between the coast of South Wales and the small island of Flat Holm, 5.3km distant in the Bristol Channel.

After Marconi had successfully demonstrated his radio apparatus over a few kilometres on Salisbury Plain, Preece decided to have it tested over his own proving-ground in the Bristol Channel, and arrangements were made to compare the two systems in May, 1897. Besides Marconi, Preece and other Post Office officials, representatives of the Army and Navy and some famous scientists were to be present. These would be essentially Post Office tests, with Marconi demonstrating his own equipment.

As a Chief Assistant, Marconi was allotted George Kemp, a former Royal Navy petty officer, who at that time worked in the Post Office's research department in London. Kemp and

Marconi got along well together and the ex-sailor eventually left the Post Office to spend the rest of his life working for Marconi.

A Mr Williams, who was in charge of the Post Office workshop in Cardiff, erected two 35m high masts before the tests began. One was on an 18m high cliff at Lavernock Point, near Penarth, and the other on Flat Holm island. At the top of each mast he fixed a zinc cylinder 0.9m in diameter and 1.8m long; this formed the "capacity area"—the forerunner of the antenna. He also fitted an earth cable of six heavy bare copper wires which ran over the cliff and down into the sea.

On Thursday, May 6, Marconi and Kemp travelled to Cardiff and put their apparatus in store. At Lavernock, Kemp ran a cable consisting of 16 strands of aluminium wire, insulated by gutta-percha, from the zinc cylinder down the mast.

The next day the tug *May* transported Marconi's transmitter, and Preece's transmitter and receiver, to the island, where Kemp fixed an 18-strand aluminium wire down the pole from what was to be the transmitting antenna. For the duration of the tests Kemp and his nephew, Herbert, of Cardiff University College, remained on the island—which boasted a lighthouse but little else. During the next few days he fitted up both Marconi's and Preece's equipment in huts under the mast, attended by the tug which crossed to and from the island daily.

Marconi's transmitter consisted of a Rhumkorff induction coil connected to a Righi oscillator, an arrangement which is now known to be very unsuit-

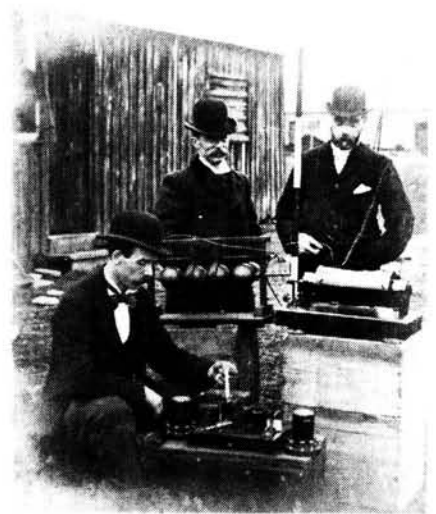

Post Office engineers inspecting Marconi's transmitter on Flat Holm Island (The Marconi Co. Ltd)

able for the frequencies Marconi was using. The oscillator comprised four brass spheres in line, two central ones about 100mm in diameter and 1–1.5mm apart, and two outer spheres about 25mm in diameter separated from the nearest inner ones by about 1.25mm. The secondary winding of the induction coil was connected to the two outer spheres, so that the spark discharge had to bridge the three gaps in the antenna-earth system. During the tests, three different induction coils were used: a powerful type bought by the Post Office, which gave a 508mm spark; a similar, but smaller, example giving a spark of 152mm; and Marconi's own coil of intermediate size, which broke down in early tests. The induction coil was powered by eight 2V cells in series.

On the Welsh mainland, Marconi's receiver consisted of a "coherer", a single cell and a telegraphic relay which operated a Morse inker. No



Antennas used for Flat Holm to Penarth test

(The Marconi Co. Ltd)



Antennas used to span the Bristol Channel

(The Marconi Co. Ltd)

means of tuning to a specific frequency was included, since no such device had then been invented. The coherer was a sealed glass tube containing two silver plugs about a millimetre apart; the gap between the plugs was filled with a loose mixture of fine nickel and silver filings. Connecting wires from the plugs led to the ends of the tube and were attached, respectively, to the antenna and earth leads, as well as to a single cell in series with a telegraphic relay. In its normal "decohered" state the coherer would not conduct direct current; but when a stream of radio signals was collected by the antenna, the tiny radio frequency currents caused the filings in the tube to stick together, or cohere, and so pass the direct current from the single cell to the relay. This in turn operated the Morse inker, which printed on a long paper strip. Since the coherer needed to be decohered, i.e. returned to a state in which it would not pass direct current, an electro-magnetic device was also activated to tap the coherer gently and so break up the chain of filings. The coherer was then ready for the next stream of radio-frequency currents.

The trials started on Monday, May 10, with Kemp transmitting from the island using Preece's parallel-wire system. Signals came through strongly. The next day he transmitted with Marconi's true radio, but no signals were received. Despite adjustments and alterations exactly the same results were obtained on the Wednesday. Marconi was in despair—it seemed that his great opportunity was to end in failure.

The next day, Thursday, May 13, someone suggested carrying the receiving apparatus to the beach 18m below, thereby adding that amount to the length of the antenna. The result was an instantaneous success. Professor Adolf Slaby, who was an observer at the request of the Kaiser, described the incident: *"I shall never forget how the five of us, crouching inside a big wooden box because of the high wind, our eyes and ears glued to the receiving instrument, suddenly, after the hoisting of a flag—the agreed signal—heard the first pips, the first Morse signs, carried soundless and invisible from that rocky coast of which we could perceive only the vague outline, through that unknown and mysterious medium, the ether, which formed the only bridge to the planets of the cosmos. It was the Morse sign for 'V' that came over as arranged."* Slaby posted the inked tape of the first message to his Kaiser.

During the following weekend preparations were made to extend the transmissions to 14km right across the Bristol Channel to Brean Down, a peninsula on the Somerset coast just south of Weston-super-Mare. Kemp transferred Marconi's transmitter from the island to the clifftop at Lavernock Point, and dismantled his receiving apparatus ready for transporting in the tug to Brean Down. For these transmissions kite-borne antennas of



MESSAGES SENT FROM FLAT HOLME TO LAVERNOCK MAY 13 1897
3 MILES

**Tapes of messages transmitted
across the Bristol Channel**
(The Marconi Co. Ltd)

*Johnstone,
Capt. R.R.*

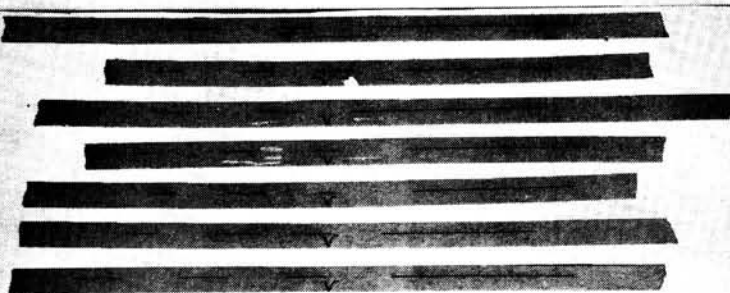

V. RECEIVED AT BREAN DOWN FROM LAVERNOCK MAY 13TH 1897
8 MILES

*Johnstone,
Capt. R.R.*

over 90m of 4-strand aluminium wire were to be used.

On Monday, May 12, Marconi and some Post Office officials set sail in the *May* for the peninsula, but the sea was too rough for them to land. The next day they not only landed, but set up the receiver, got the kite airborne and successfully received Kemp's transmissions from Lavernock Point. The messages were of a banal nature and often consisted of repetitions of the letter "V". In the late afternoon, a telegram was sent to the party in Wales telling of the success of the experiment. The original paper strip bearing the Morse symbols and signed by Marconi and Kemp now resides in the Welsh Industrial and Maritime Museum in Cardiff.

Preece, who had described Marconi's equipment as "home-made and somewhat crude" and had thought his

own method cheaper and more practical, now knew that his parallel-wire system was hopelessly outclassed. Marconi's invention was henceforth regarded seriously by the scientific community and no longer as a toy. To mark the occasion, Marconi sent a loyal message of greeting to Queen Victoria at Osborne, but sadly it has not survived in the Royal Archive.

Although that was the successful conclusion of the official trials, Marconi and Kemp continued their tests at Brean Down until Saturday, May 29, when they dismantled their equipment and took the train back to London. Even that was not the end of the radio experiments in the area, for in 1899 and 1900 the Post Office conducted trials there for the Schafer method of wireless signalling; it was found to be inferior to Marconi's system. And in 1932 the first ultra-short-wave telephone, as an extension of the land-line system, linked Cardiff and Weston-super-Mare over the same stretch of water that Marconi had conquered more than a third of a century earlier.

By way of a postscript, a plaque commemorating Marconi's feat erected on the wall of Weston-S-Mare's main post office, was unveiled in August '76 by Preece's grand-daughter, Mrs Geraldine Millington. In January '78, Marconi's widow, the Marchese Maria Cristina and his daughter Princess Elettra, came to view the plaque and to survey the vista of the Bristol Channel.

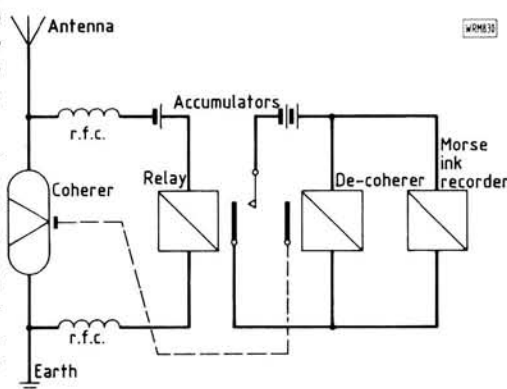

Circuit diagram of Marconi's test receiver

Packet Radio

In Part 3, Roger Cooke G3LDI looks at the WORLI Bulletin Board/Mailbox, one of the most common pieces of equipment used on the air in packet

There is still something quite exciting about receiving mail, with the exception of the brown envelopes with windows! This stems, I think, from our childhood when the only post we received was birthday and Christmas cards, no brown envelopes in those days. Using a Mailbox produces the same anticipation and usually pleasurable results. It can also be a very useful way of putting information about in a cheap and convenient way. The reverse is also true and one can glean lots of useful information by using mailboxes. This month will, therefore, be devoted to the description of and a discussion about the WORLI Bulletin Board/Mailbox, the most commonly used one on the air. Our thanks to Hank Oredson for developing this program.

Hardware

Refer to Fig. 3.1 and the photograph of the station of Jack Colson W3TMZ in Fig. 3.2. You will see that the heart of the system is the Xerox 820 computer board, together with its power supply and keyboard. These are available as surplus in the States and this is how I obtained mine at quite a reasonable cost. Jack W3TMZ was instrumental in both persuading me in the first instance to set up a system on h.f. and also getting the hardware and lots of support documentation to me. The system also requires two 8in disc drives and a monitor. Ideally, a printer is also nice to have, especially in the setting-up stage, because continual reference needs to be made to the files on the mailbox disc and a print-out of each is indeed an asset. I did not have one, but it would undoubtedly have saved me lots of head-scratching had I possessed one.

As the computer boards come as surplus, they may be faulty. Mine had been tested at W3TMZ for two weeks before it came to me, but it developed a dry joint. This took a lot of sorting and I ended up re-soldering the complete board. The system also pre-supposes a working knowledge of *CP/M Handbook* by Rodney Zaks and I am still learning! The computer board had to be modified for composite video for the monitor, together with several other modifications.

I was lucky enough to obtain a pair of Shugart 851 double-sided, double-density disk drives. These also had to be re-configured, wired into the disk port of the computer with about a dozen twisted pairs, power supplies

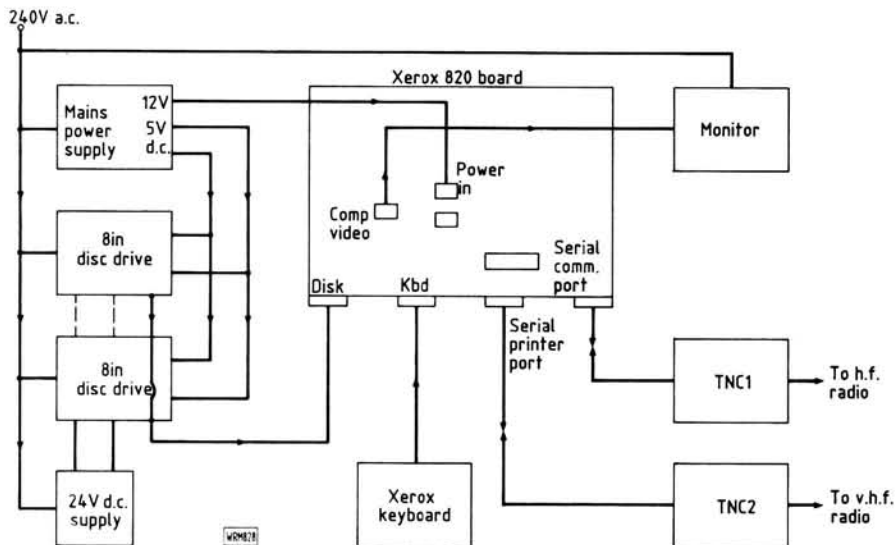

Fig. 1: The block diagram of the system. The heart of which is the Xerox 820 computer board with its power supply and keyboard. This was acquired from the States, kindly checked out by W3TMZ before being shipped to the UK

built, 5V and 24V d.c., completing the job with a logic switched mains supply for the motors so that the drives are not running until called upon.

The first TNC is wired into the serial communications port. In my case, this is the TNC-200. This is for h.f. use and connections are made using the RS232 connector on the TNC following the diagram in Fig. 3.3. The second TNC, in my case the original TAPR-1 board, is wired into the serial printer port using the RS232 connector but with a null modem cable as shown in Fig. 3.4. Outputs from the two TNCs go the h.f. and v.h.f. radios in the normal way.

Software

Having sorted out the hardware and wired it all up correctly (hopefully!), the software has to be installed. First the TNC parameters have to be set correctly. The communications parameters are:

Abaud —4800
Abit —1
Parity —4
Awlen —8

Setting these correctly will allow the TNC to communicate with the Xerox computer. Other parameters that have to be set are Autolf—off and Xflow—off. Setting Xflow correctly is important as this sets the TNC to operate in RTS/CTS mode instead of Xon/Xoff. When the TNC is ready to accept data it raises the RTS line (pin 4 on the RS232 line). This is sensed by the mailbox, which then knows it is OK to

send characters to the TNC. Unless RTS is high at the 820, CP/M will not boot, and the mailbox will hang-up. Bitter experience speaking! Debug has to be set to \$04, Dwait to 4, Echo off and Lfadd off. That takes care of the setting-up of the TNCs.

Two files are needed to make the mailbox operational, TNC.COM and CONFIG.TNC. The former is the program file which is executed and the latter is the file which contains all the information to be edited by the System Operator (SYSOP) to conform to his particular installation. Without going into too much detail, editing this file (I use Wordstar, very good word-processor) allows the Sysop to customise responses to prompts, enter his own station call and details, set beacon text and timing, allow or dis-allow the BBS on either TNC, allow or dis-allow the gateway, in other words make the mailbox work in just the way that is required depending on personal circumstances.

When the mailbox is working it creates its own mail data file as and when messages are entered. It also creates a file called Calls.TNC, which is like the MH list on the TNC-200, a list of the calls heard and the time in the period that the mailbox has been monitoring. Another file maintained by the mailbox is the Log file. This is quite complex and also can become quite large, depending on use, of course. At the end of each month I clear the Log file using a program written by Tom Hogan WB7DCH.

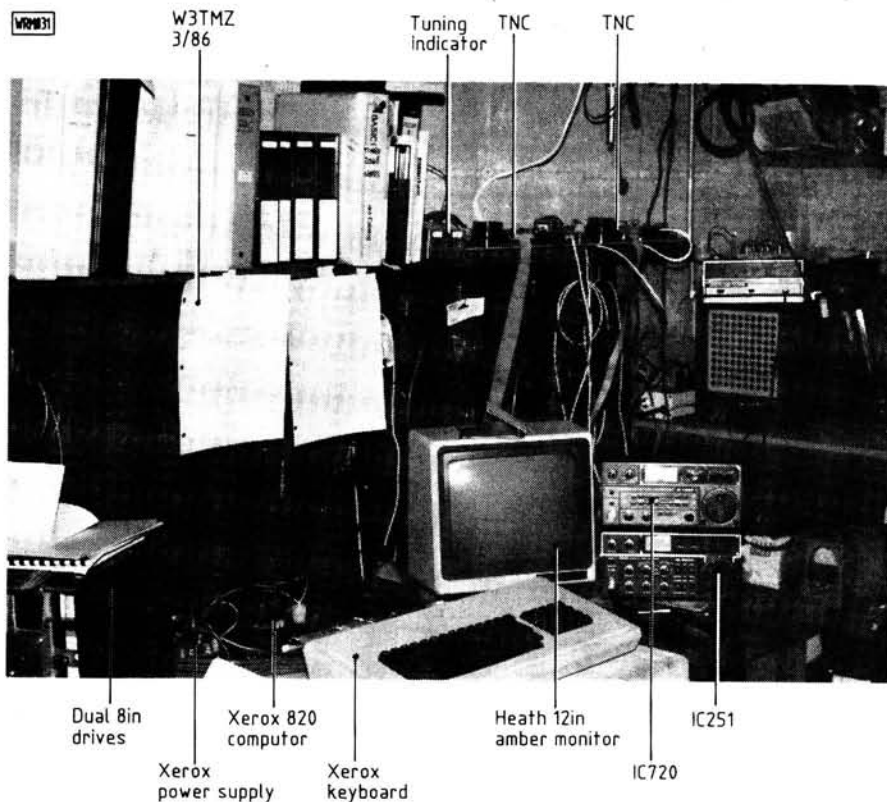

Fig. 2: The station of Jack Colsen W3TMZ where you can clearly see the Xerox 820 computer, keyboard and power supply. Radio amateurs the world over seem to have similar looking stations

This is a log analyser that gives a print-out of the month's activities, including details of who used the mailbox, the day, time and what the user did, how long he took, how many times in the month he used it, etc. The log as maintained by the mailbox is quite comprehensive and a lot can be deduced from this, as shown in Fig. 3.5. The log analysis is printed out and filed so that reference can be made retrospectively, if necessary.

Yet another file created by the mailbox is the User data. This contains all relevant details of each user, such as name, last time into mailbox, whether an expert user, remote Sysop, etc. The expert user designation means that the user knows how to use the mailbox and does not require a menu, so all he gets is the time and the number of messages. This saves a lot of menu-sending on the air. The mail and user data files can become quite large and from time to time they need "untangling". This prevents the files from becoming corrupted, something that has happened at G3LDI on several occasions.

I thought it was a control code character fouling things up until we carried out some checks locally. I now untangle once a week, a simple task with the W0RLI 11.5 software. On activating the mailbox, I type in "G" then sit back and watch the disc drives go bananas! It still pays to keep a backup copy. (Re-forming a mail data file with about 15K of bulletins is no fun!)

The forwarding file is quite innovative and it is fascinating to watch the mailbox when it is forwarding mail to see exactly what happens. Each Sysop, in co-ordination with others in other

areas, determines which mailbox should handle mail for which users. Assume, for example, that G8QR, G4VLS and G3PDH are to receive mail at G3LDI. Then, all other mailboxes would forward mail that they received for those stations to G3LDI for collection.

I have sent in the normal way but with the mailbox doing all the work from the original connection to the killing of the message if it was received OK. If it is not received the mailbox will try again one hour later.

Operation

Having basically described the system, let's assume you wish to use the mailbox. First of all, make the connect in the usual way. You will receive a "Welcome" message together with the last time you connected, the date and time and the number of active messages and a short menu. Having accessed the box and received the menu, you then have four minutes to make up your mind what command to give after which time the box will timeout and disconnect. The first command logically would be N space (your name). The box will then forever remember your name. To see what mail there is for you just type LM and return. The box will let you know if there is any mail for you. If there is, then type RM to read it or if there are several, type R space and the message number. When you have read the mail, kill it with KM. Remember to type in each command only once, there is never any need to repeat a command as your TNC will do that for you automatically if there was no acknowledgement from the box. Re-

RS232 connections for communications port of Xerox 820

820	TNC-200
Gnd 1	1 Gnd
TXD 2	2 RXD
RXD 3	3 TXD
RTS 4	4 CTS
CTS 5	5 RTS
DSR 6	20 DSR
DCD 8	6 DTR
DTR 20	8 DCD
Gnd 7	7 Gnd

Fig. 3.3

820	TNC 1
Gnd 1	1 Gnd
RXD 2	3 TXD
TXD 3	3 RXD
CTS 4	5 RTS
RTS 5	4 CTS
DSR 6	20 DSR
DTR 20	6 DTR
Gnd 7	7 Gnd

Null-modem RS232 connections as used on the serial printer port of the Xerox 820.

Fig. 3.4

peating a command merely causes the mailbox to repeat the reply and if that was a request for a menu, lots of time is wasted.

As you see from the list of commands, there are several general commands which allow the user to obtain various functions, for example the Help text, which is the list of commands given in Fig. 3.6. It might be a good idea to keep the list handy for reference. A longer menu can be shown instead of the short one, toggling between the two is done with the X command, or you can ask to talk to the Sysop with the T command.

To send a message the S command is used with SP if it is to be private. It is private to the extent that only the Sysop and the addressee can read it, as well as the person who sent it, of course. It is not posted in the "Mail for" beacon, but of course anybody can read it as it is being entered. These are the normal commands applicable to messages. The same L command is used when applied to bulletins, only it is followed by a B, hence LB would list all the general interest bulletins. To read one, simply type R followed by a space and the number of the bulletin to be read. These can be very interesting and informative and if you have an item which you think would be of interest to several people, post it as a bulletin with the SB command.

Files are longer and more permanent features which are on the disk drives and can be listed when you have accessed the box with the W command.

Example of Mailbox Log File

This file is maintained automatically by the Mailbox program. It contains all transactions of the connecting station. The format is as follows:

1. A letter, showing the type of transactions, as follows:

- C—a connection with the mailbox.
- M—a transaction involving a message.
- F—a transaction involving a file.
- X—a termination of the session.

2. The date and time of the transaction, starting with the year.

3. The command use.

4. The message number or file name, whichever is appropriate.

5. The call of the connecting station and the path used.

C8793281830A	a connect by
G4VLS via	G4VLS via
GB3NP	the repeater
N8703281831R 14	he read message 14
M8793281833K 14	he killed message 14
X8703281834B	he disconnected
C8703281845A	another connect
G4ZBA	
M8703281846S 18	he sent message 18
F8703281855W	a "W" command to list files
F8703281858D	a download of
DOC.TNC	DOC.TNC
M8703281906S 19	he sent message 19
X8703281914B	he disconnected

Fig. 3.5

If you want to read one of the files they have to be downloaded using the D command followed by the name of the file, exactly as given, using CP/M format. If, for example, you wanted a complete description on the mailbox, have your printer on the type D DOC.TNC. Files can be put onto disk in a similar manner using the U (unload) command.

Gateway

The gateway is the remaining feature to describe. This means that a station equipped for 144MHz only can access the mailbox and by typing G can be transferred through to the h.f. port. A connect can then be made in the usual way, but with the difference that the person making the connect will have "Linked to" instead of "Connected to" on the screen. By typing KM, any packet stations on h.f. can be monitored on 144MHz. Typing U allows the v.h.f. operator to call CQ on h.f. The converse is true, so that any h.f. operator can access and see what 144MHz is like.

- B—Bye, log out of Mailbox (forced if no response to Menu in 4 minutes).
- G—Activity the Gateway.
- H—Display the Help text.
- I—Display information about the system.
- J—Display the calls of station recently heard or connected.
- N (text)—Tell the mailbox your name. 12 characters maximum.
- P (call)—Show the path to that station from here.
- T—Talk to Roger. Rings the bell on the local terminal, gives up after one minute, or input from the TNC.
- X—Toggle between the short and long form of the Menu.

Commands That Apply to Messages

K—Kill a message:

Qualifier:

- F—Kill all forwards. (SYSOP ONLY).
 - M—"Kill Mine"—Kills all your Messages as read.
 - T—Used to kill traffic after it is taken.
- Argument—Message number.

L—List Message Headers:

Qualifier:

- None—list all messages entered since you last logged in.
- A—ARRL bulletins only.
- B—General interest bulletins.
- F—List messages forwarded, not yet killed.
- L—List the last N messages.
- M—List messages addressed to you only.
- T—List NTS traffic only.
- Y—List messages read, not yet killed.
- >—List messages to call given as argument.
- <—List messages from call given as argument.
- @—List messages @ call given as argument

Argument: Number of the oldest message to list.

For LL, the number of messages to list.

For L@, L<, and L>, the call.

Fig. 3.6

G3LDI Mailbox Description

General Description

Well, that's about it for this month; I hope some of you will have found this article useful. Perhaps it will encourage those who have not used a mailbox to have a go—it can be a lot of fun. I normally leave mine on 14.099MHz for forwarding or 14.105, depending on activity with the v.h.f. one on 144.60. Perhaps the actual bandplan-

R—Read a message:

Qualifier:

- None—Read one message.
- M—Read all messages addressed to you.

Argument: Message number to read.

S—Send a message:

Qualifier:

- None—A general message.
- B—A bulletin.
- P—A private message.
- S—A service message, generated by the mailbox.
- T—Traffic for the NTS.

Argument: Call of addressee.

The form: "S call 1 @ call 2" is also supported. Call 1 is the addressee, call 2 is the BBS to forward the message to.

Example: SP G3LDI @ G4RKL

Commands that apply to file transfers

The mailbox expert's standard CP/M filenames:

8 character maximum name, 3 character maximum extension.

Examples: DOC.TNC
HFCALLS.HRD CALLS.HRD

D—Download a file from the mailbox.

Argument: Name of file to transmit.

U—Upload a file to mailbox.

Argument: Name the file will have.

TERMINATE: the file with
^ Z (CTL-Z).

W—What files are available:

Argument: If present, Filespec to list.

Commands on Gateway Menu

B—Log out. Same as mailbox command.

C—Attempt a connection.

Argument: Call of station to connect to, may include digipeater routing, for example: C G3LDI via G4RKL-1, G4VLS-1.

J—Display the calls of stations recently heard or connected.

M—Monitor. You see what the other TNC sees. Type anything to return to menu.

U—Call CQ, whatever you transmit will be transmitted the other TNC in UNPROTOCOL mode.

R—Return to mailbox (Discontinue Gateway Operation).

ning for mailboxes will be more definite when we have proper allocations.

Next month will be the last in the series and will be a look at some of the accessories, together with an update of countries on the air and possibly countries worked (have you kept a list?), so until then, I wish you 73 and happy packeting.



RTTY TO TV CONVERTER

FEATURES:

- COMPREHENSIVE RANGE OF RTTY & ASCII SPEEDS AND SHIFTS
- SWITCHABLE INPUT FILTERS ALLOWS RECEPTION OF 170, 425, 850 & 1200 HZ SHIFTS
- COMPLETE TERMINAL UNIT/TV INTERFACE
- INCLUDES MODULATOR TO ENABLE DIRECT CONNECTION TO A STANDARD UHF TV SET
- PRINTER OUTPUT FACILITY
- SUITABLE FOR UOSAT TELEMETRY DATA
- LATEST STATE OF THE ART MICROPROCESSOR SYSTEM

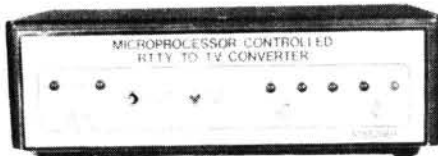

MM2001 PRICE: £188.83 inc VAT

SPECIFICATION:

Modes of reception	: Murray Coded RTTY - 45.5, 50, 75, 100 baud
	: Amateur standard ASCII - 110, 300, 600, 1200 baud
Printer output	: Centronics compatible, DB25 socket
Audio input socket	: Phono
TV (UHF output) socket	: Phono (CH 35)
Video output level	: 1V peak to peak composite video
Video output socket	: Phono
External T.U. socket	: 8 pin DIN socket
Power connector	: 5 pin DIN socket
Power requirements	: 10-14V DC at 700mA
Size	: 187 x 120 x 53mm
Weight	: 1 Kg

DESCRIPTION:

This converter contains a terminal unit and a microprocessor controlled TV interface, and requires only an audio input from a receiver and a 12V DC power supply to enable a live display of 'off-air' RTTY and ASCII on a standard domestic UHF TV set. The display format is 16 lines of text, each 64 characters wide. This may be displayed on the screen as black on white or white on black, and is switch selectable on the rear panel.

When receiving ASCII, upper and lower case text is displayed. A composite video output is also provided for use with a video monitor. The inclusion of internal buffering allows compatibility with an inexpensive dot matrix printer, thereby providing hard copy. The printer output is intended to interface directly with a standard parallel ASCII printer (centronics compatible) via the 25 way socket (DB25) located on the rear panel.

The input stage of the converter is a digital frequency discriminator having switchable centre frequencies, which allows reception of standard frequency shift transmissions of 170, 425, 859 Hz as well as 1200 Hz (Kansas City).

The incorporation of a comprehensive range of speeds and shifts makes the converter highly versatile and fully compatible with most amateur and commercial transmissions. The inclusion of 600 and 1200 baud ASCII makes the unit ideal for decoding telemetry data from the UOSAT satellite.

LED status lights provide a visual indication of correct centre-tuning and the RTTY or ASCII speed being received. The inclusion of automatic software routines eliminates the possibility of information being corrupted or over-written, by the incorporation of automatic carriage return line feed.

After 15 different characters in figure shift have elapsed, the converter will automatically return to letter shift. This feature alleviates the problem caused by a corrupt character forcing figure shift, but allows for repetitive underline characters. This facility may be overridden when the rear panel mounted 'case control' switch is in the off position. This enables reception of continuous figure shift characters, e.g. Oscar prediction tables (RTTY signals only).

A direct TTL input to the converter can be fed into the 8 pin DIN socket, located on the rear panel. In this way, the internal digital frequency discriminator is bypassed and an external terminal unit may be used, if so desired. However, under normal circumstances the supplied 8 pin DIN plug should be fitted to enable the internal terminal unit.

The converter utilises 2 microprocessors and 23 other integrated circuits. All circuitry is constructed on two high quality glass-fibre printed circuit boards. The unit is housed in a highly durable diecast enclosure and all necessary plugs are supplied.

FOR FULL DETAILS OF THIS PRODUCT CONTACT THE FACTORY FOR A FREE CATALOGUE



WELCOME

MICROWAVE MODULES Ltd

BROOKFIELD DRIVE, AINTREE, LIVERPOOL L9 7AN, ENGLAND

Telephone: 051-523 4011 Telex: 628608 MICRO G

CALLERS ARE WELCOME, PLEASE TELEPHONE FIRST

HOURS:
MONDAY-FRIDAY
9-12.30, 1-5.00
E. & O. E.

NEW! from Cirkuit

SUMMER 1987 ELECTRONIC CONSTRUCTORS CATALOGUE



6
MULTIMETERS
TO BE WON

PRICE ONLY
£1.20

- Many new lines
- Extended range of test equipment

- £11 worth of discount vouchers
- 6 Multimeters to be won in easy to enter competition.
- Available at your local newsagent or direct from address below.

Cirkuit



(0992) 444111

Cirkuit Distribution Ltd Park Lane, Broxbourne, Herts EN10 7NQ
 Telephone: (0992) 444111 Telex: 22478

BILLINGTON VALVES

VALVES, TRANSISTORS + COMPONENT BARGAINS

NEW VALVES + TRANSISTORS. Huge range stocked. Rareities our speciality. Competitive prices. Phone for immediate quotation on any type. SAE for catalogue.

USED VALVES. Tested, working & clean. 28 day guarantee. KT66 GEC **£6**. 6CH6 (Mazda CV4055) **£3**. 12E1 **£6.90**. CV4024 Mullard (special quality ECC81) **80p**. CV4003 Mullard (special quality ECC82) **70p**.

WE WILL BUY VALVES. Certain types only are required e.g. PX4, PX25, PP3/250, PP5/400, DA30, DA60, DA100, M22-200, but complete shop clearance, etc., considered.

USED GOVT SURPLUS TEST EQUIP. Repaired Avo 8 multimeters **£75** delivered. Leather case **£5**. Tektronix 465 dual trace 'scope 100MHz as new condition, works perfectly, with probes + lid **£750** delivered.

COMPONENTS. Please add VAT @ 15% to all prices. NEW Gould electrolytic capacitor 10,000uF @ 50V, 18.7A discharge, special quality for computer use, etc. 4in tall, usually **£8-£12**. Our price **£4** delivered.

China "egg insulators. White ceramic, old style **75p** delivered.

MORSE KEYS. Beautiful quality, as used by UK army, etc. Bakelite base, professional use not a practice set. Incredible bargain @ **£7** delivered.

NEW VARIAC. In case with 13A mains socket for output. Mains in 0-270V @ 3A out, 47-400MHz. Bargain @ **£40** delivered.

BLACK WAYRAD TRANSFORMER (NEW). 1/2 duty cycle rated (5 mins on, 10 mins off). Weighs 20lbs. Primary = 0-10-20 and 0-105-110-200-230. Output = 1185-0-1185 @ 360mA d.c. **£25** delivered.

CONSTANT VOLTAGE TRANSFORMERS. All famous brands. 5kVA, weighs 700lbs approx. Will control input mains fluctuations -40V or +20V. Output is 230V ±0.1%. Price **£200** delivered.

2.5A ISOLATING TRANSFORMER. Potted Parmeco, black, oil filled. In = 0-10-210-230 twice. Out = 0-180-220 @ 2.5A. **£20** delivered.

AUTO TRANSFORMERS. (Brown laminated). In = 0-115-200-210-220-230-240-250. Out = 115V @ 13.05A or 200-250V @ 7.5A. **£25** delivered.

Many other new transformers in stock. Listing should be finished during July.

1000 resistors or 1000 capacitors **£3.50** delivered.

INCREDIBLE BARGAIN PACKS

2.5kg of mixed i.c.s, transistors, relays, capacitors, resistors, potentiometers, switches **£5** delivered (+VAT). Or 10kg = **£10** delivered (+VAT).

TO ORDER. Please add VAT @ 15% to all orders. Postage is specified on each item. We accept Barclaycard. Usually same day despatch, possible delays during staff holidays June 12-20. Govt + export orders welcome.

BILLINGTON VALVES, 39 Highlands Road, Horsham, West Sussex RH13 5LS

Tel: 0403 210729. FAX 0403 210108. Telex: 87271 PRODSS G.

If visiting in person, please 'phone first to check that office is attended.

Variations on the Vertical

Antenna design is one of the last areas in which radio amateurs can still perform useful and original experimentation. F. C. Smith GW2DDX has been busy evaluating different designs of vertical antenna on his small plot and judging by his results it would seem that this has paid dividends.

It depends on your location as to whether you use horizontal or vertical antennas for chasing the elusive DX. If as in the author's case your garden plot is a little on the small side, the only antenna one can seriously entertain is the vertical. Most amateurs consider the vertical antenna as a poor relation when it comes to working DX. The author's experience of such antennas has modified his opinions to contrast with this line of thinking.

Most antennas like the $\lambda/4$ vertical require as many as a 100 ground plane radials, in order to bring down their angle of radiation. This unfortunately requires quite a large area of ground space, even for an h.f. antenna. The author looked at all the practical types of vertical antenna and made a list of the attributes. The $\lambda/4$ came bottom of the list for reasons already explained. The $5\lambda/8$ vertical came top with its

extra gain and the $\lambda/2$ came next with its base voltage and top current maxima. The vertical $5\lambda/8$ antenna seemed to be favourite, so this was the line taken by the author in his experimentation. The base of $5\lambda/8$ vertical was placed 3m above the ground, using six radials, excellent results were achieved with regards to DX, with contacts into Brazil, Argentina, the USSR, USA and Australasia. The secret behind making this antenna work, is in getting the base of the antenna well above the ground. The constructional details are shown in Fig. 1. The dimensions can of course be scaled up for the 14MHz band. The main vertical element consists of a length of Bofa ribbon feeder, shorted both top and bottom.

The second well known antenna tried was the "Bob-tail", or rather half of it. This antenna as opposed to the standard $\lambda/4$ vertical, is voltage fed at the bottom and has a current maxima at the top. It also has good DXing potential, with low angle radiation and a gain of 4dB over a dipole. The author obtained a 57 report while in QSO with a YB Indonesian station. This was with the antenna spaced across the width of two bedrooms. The other useful aspect is that it needs no radials. Details of the "Bob-tail" antenna are shown in Fig. 2.

The other DX antenna that does not require an earth system is the "J-match" antenna. The angle of radi-

ation on this type of antenna is governed by its height above the ground, so to obtain best results it should be mounted as high above the ground as possible. These antennas are then known as "long-haul" verticals, i.e. 6000km plus, working capability.

The "Bob-tail" can be inductively loaded, if space requires, as this shortens the top length. The top horizontal portion can be considered as a phasing line, to bring the top part of the vertical sections into maximum current. This is the best way to obtain DX, try and bring the current maximum as high up your vertical antenna as possible.

There are, of course, other configurations, such as phased verticals, but these are at ground level and they do require radial earth systems. These designs have not been included, as the examples given stand up well as excellent DX antennas, with the least complications in their erection. **PW**

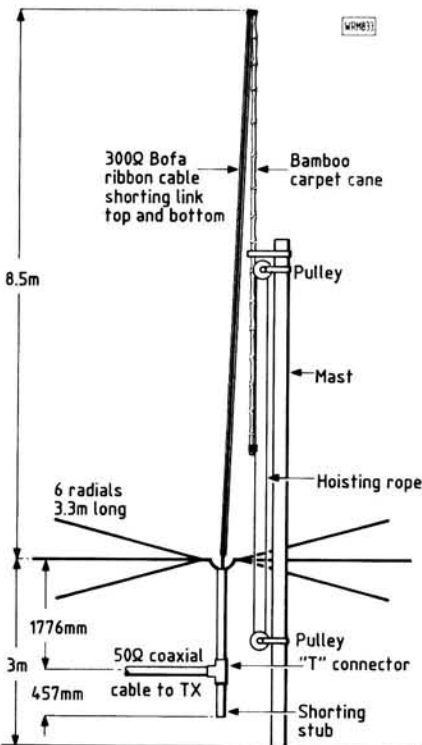

Fig. 1: Practical dimensions for 21MHz band $5\lambda/8$ vertical antenna

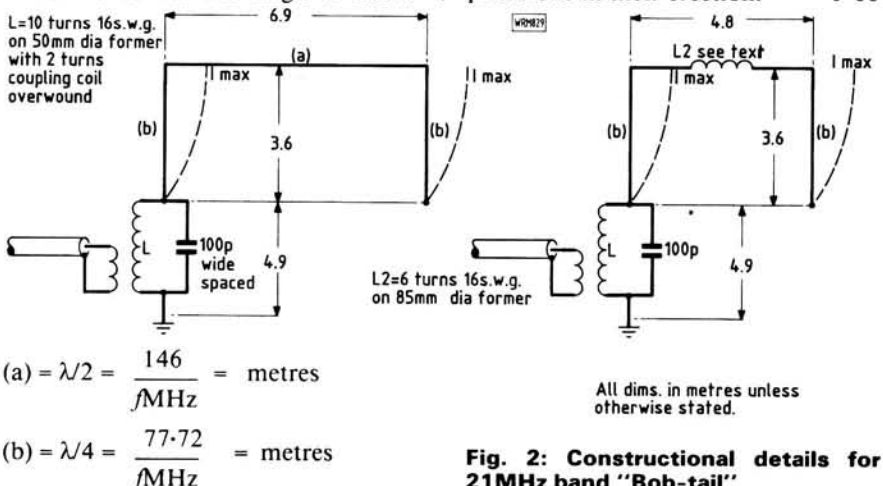

Fig. 2: Constructional details for 21MHz band "Bob-tail"

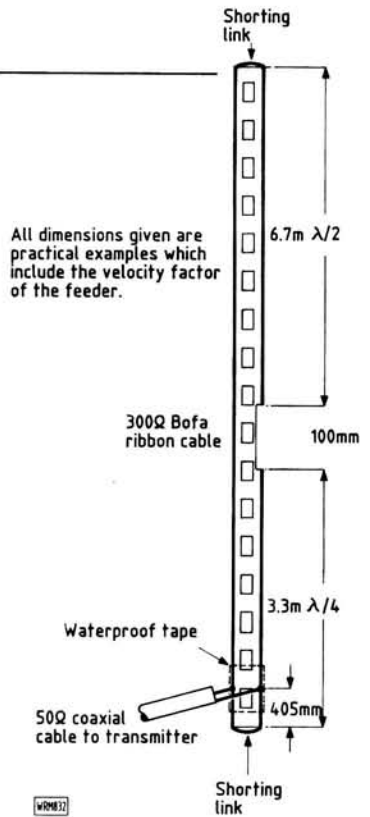

Fig. 3: "J-match" vertical for 21MHz band. Antenna can be supported in the same manner as $5\lambda/8$ antenna

Remotely Operated Antenna Tuning Unit

Malcolm Kirk G4XMK set about taming his long wire antenna; in doing so he developed this useful and novel matching system.

My basic requirement for an antenna is to give general purpose operation on the h.f. bands. Many antenna books conclude that a strong contender for the role is a long wire. This fact sharply contrasts with the "on-air" image of long wire antennas, which is one of difficult matching, TVI and hot spots. On balance I concluded that much of the abuse is mis-directed and that a properly configured long wire should work very well.

Two guiding principles were adopted to fit such an antenna to my site. First, there must be a clear distinction between feeder and antenna. Secondly, the earthing arrangements must not be compromised. The resultant antenna, which performs well on all bands, is shown in Fig. 1. It is possible to drive the antenna using an antenna tuning unit (a.t.u.), in my case an SPC Transmatch, situated at point A. The consequence of siting the a.t.u. at this point is an uncontrollable standing wave on the coaxial feeder. During the autumn and winter of 1985 I became conscious of losses in the feeder, particularly on the 3.5MHz band; this meant the difference between success and failure for marginal transatlantic contacts.

Placing the a.t.u. outside at point B yielded noticeably better reports under marginal conditions. A few experiments confirmed that the standing wave ratio (s.w.r.) and feeder losses were still quite high, this mismatch was confirmed by the disparity in reports. An unexpected result of placing the a.t.u. outside was a considerably broader range of tolerable s.w.r. This was particularly encouraging after having the a.t.u. at point A where the tuning characteristics of the a.t.u. were

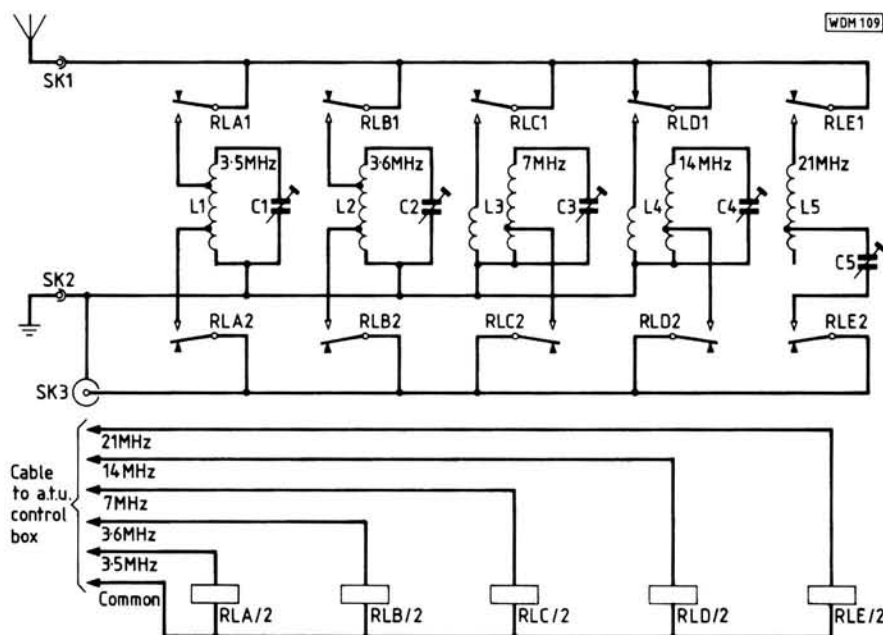

Fig. 2: Circuit diagram of remote antenna tuning unit

very sharp. Following the earlier reference made to the necessary discrimination between feeder and antenna, results obtained at point B actually suggest that the matching unit was positioned at this junction. Out of my experiences was born the need for a remotely operated a.t.u.

For some time I toyed with the idea of building a general-purpose automatic a.t.u. The concept seemed quite straightforward and I am now surprised at the dearth of literature on the subject. Eventually I decided on a course which was not such a busman's holiday and more in keeping with my meagre mechanical abilities. This

course led me to a simple relay-switched matching network. This was further prompted by the acquisition of a dozen two-pole changeover relays at a junk sale. These were actually "BR" octal base relays, but similar high current relays are very common and available from several sources.

For some time I had been using an SPC Transmatch outside in order to estimate the likely bandwidth of satisfactory s.w.r. This experience suggested that two tuned circuits would cover the s.s.b. portion of 3.5MHz band and a single tuned circuit should cover any of the higher frequency bands.

Currently my equipment is only capable of covering the 3.5, 7, 14 and 21MHz bands. I decided, therefore, to limit the operation of my a.t.u. to these frequencies. The final circuit of my design is shown in Fig 2. It should be stated that no two antennas are the same, and although the principles for matching are similar, the actual circuit values will have to be developed independently in a way which is to be described.

Feed Point Matching

The sequence of operations is dictated by opportunity, i.e. weather. I tended to do the indoor tasks when the

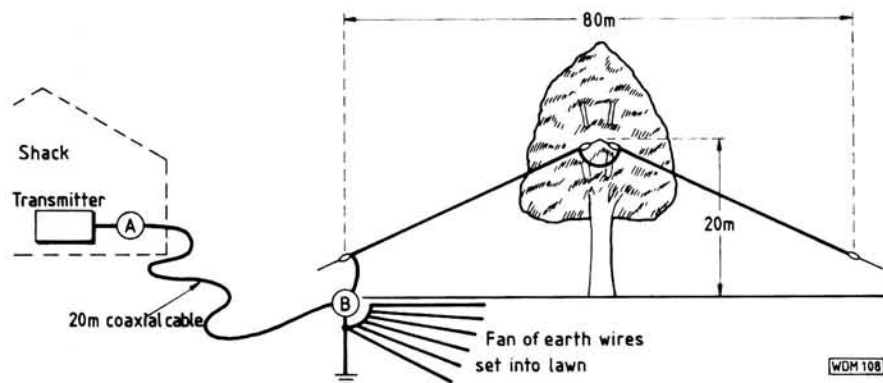

Fig. 1: Layout of author's all band long wire antenna

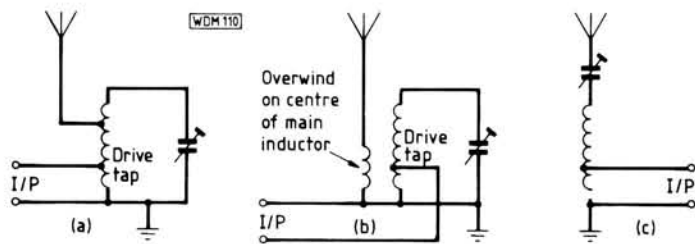

Fig. 3: Three basic tuning networks used by antenna tuning unit

weather was inclement and do the actual matching on fine evenings, when my harmonics were in their beds and not around to poke their fingers into the bare a.t.u.

It happens that the feed point impedance of my antenna is very high on the 3.5MHz band, i.e. thousands of ohms, but very low on the other bands in question. Other antenna lengths will be different and consequently the approach has to accommodate pretty well any impedance. The first operation is to install the noise bridge outside at the antenna feed point and establish the feed impedance at the desired frequency. It is sufficient to decide whether the real part is low, e.g. 50Ω, or high 500Ω, or even higher, thousands of ohms and off the scale of my bridge! The reactive part of the impedance in this connection is irrelevant.

After reading up on some theory and a little experimenting, I settled on two basic matching sections and later added a third series arrangement, all of which are shown in Fig. 3. High impedances are catered for by (a) and low impedances by networks (b) and (c).

In the first two cases the drive tap was located, assuming a loaded Q of around 10 which is easily realised, provided that the antenna doesn't exhibit a very high impedance, i.e. $>2k\Omega$. This high impedance will result in a much reduced bandwidth, but this should only cause problems on the 3.5MHz band. A drive impedance of 75/50Ω can be accommodated at approximately five turns from the earthy end of the inductance shown in Fig. 3 network (a). This point seemed a good place to start, connections were made and with a temporary air-spaced variable capacitor across the inductor, I checked the resonance of each tuned circuit using a g.d.o. It is also possible to load the circuit with a 2kΩ non-inductive resistor and check the drive tap impedance using a noise bridge.

The antenna tap is not so easy to

locate and has to be done outside, but with care and some simple arithmetic it can be done with a minimum of fuss.

1. With the noise bridge at the antenna, establish the feed point impedance.
2. Choose network section (a), (b) or (c) and calculate the tap position or overwind size appropriate to the antenna impedance.
3. With the aid of croc clips, attach the coil and air spaced capacitor network between the antenna and feeder.
4. With a noise bridge, tune the air-spaced capacitor for a null relative to 75/50Ω. To do this I ran 20m of wire from the transceiver's phone socket to headphones in the garden.

The final result should be a reasonable match, but a few QSOs watching the s.w.r. and manipulation of the noise bridge should serve to gain the correct antenna tap.

I tackled each frequency band in turn until I had five suitably tapped inductors for the chosen frequencies. In the case of 21MHz I found the series network (c) more convenient.

Cheap Capacitors

Finding one decent wide-spaced capacitor for my linear was not easy or cheap. The prospect of seeking five with the intention of immediately putting them outside was quite off-putting. Eventually I decided on home constructed capacitors made from double-sided epoxy glass laminate. This was after some abortive attempts at laminating aluminium and thin polystyrene sheet. I constructed two styles of capacitor, one of 128pF, the other 256pF. From which you might deduce that computing has some influence on my thought processes. By subdividing the one surface, as shown in Fig. 4, and then shorting islands together it is possible to realise any value of capacitance up to the maximum.

The matching process was then re-

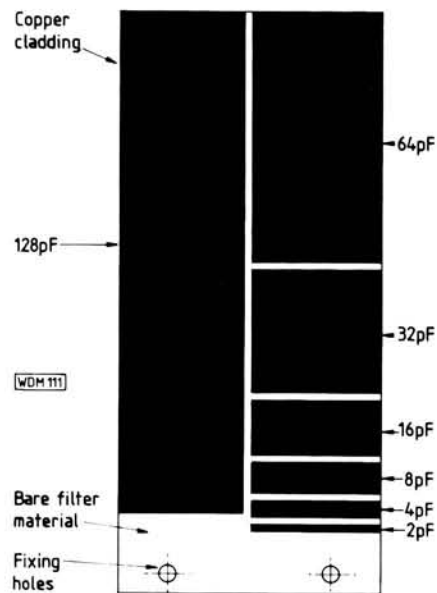

Fig. 4: Suggested layout of laminated p.c.b. capacitors

peated, replacing the air-spaced capacitor by laminated types. There are several ways that this may be neatly done, and I cheated and used a capacitance bridge to produce equivalent values directly. I found it paid to deliberately err on the side of too little capacitance and make the final adjustments after a few test transmissions.

Integration

The final step is to install all of these individually prepared matching sections in some enclosure. A metal enclosure is not necessary, indeed it might introduce problems with stray capacitance. For me the enclosure was a large plastics seed tray, the type with a propagator lid, recycled from the garden. This may seem a little strange to some people, but this type of enclosure will keep the weather out and little fingers away from the r.f.

The inductors for 3.5, 7 and 14MHz were all close-wound on 44mm plastics waste pipe, using 1mm solid conductor pvc covered wire. The 21MHz inductor was wound with 16 s.w.g. tinned copper wire, using the same diameter pipe as a mandrel. This inductor is essentially self-supporting, being threaded through two narrow strips of Perspex. The Perspex was marked out using a piece of scrap 0.15in pitch Veroboard as a drilling template. Table 1 gives winding details.

Layout

An aluminium plate was fastened to one of the short sides of the tray to take the input and output connectors. Another sheet was cut and bent to hold the five relay bases, this was then fastened along the length of the tray. The inductors and capacitors were positioned in the base of the tray adjacent to their respective relays; I decided to stagger the two 3.5MHz coils to minimise any coupling. The

Practical Wireless, July 1987

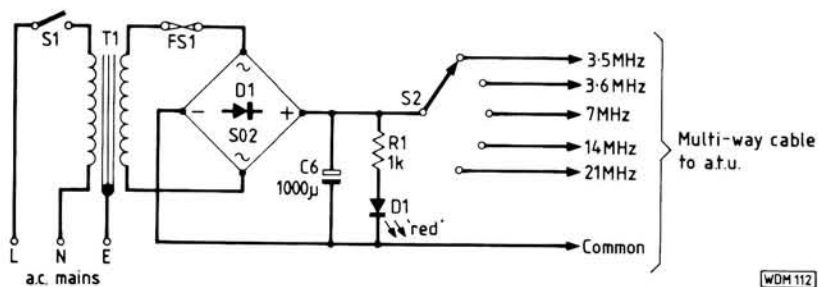

Fig. 5: Circuit diagram of power supply and control switch

TABLE 1: COIL WINDING DATA

Band	Coil	Turns	Wire Gauge (mm) copper	Coil form Dia (mm)	Remarks
3.5MHz	L1/2	25	1 pvc	44	close wound on former drive tap at 5 turns
7MHz	L3	12	1 pvc	44	close wound on former drive tap at 3 turns
14MHz	L4	7	1 pvc	44	close wound on former drive tap at 1.5 turns
21 MHz	L5	7	1.5 tinned	44	self-supported spaced at 3.81mm (0.15in)

All coils are tapped according to individual needs, see text.

relay power and indoor switching systems were housed in a diecast box. The very elementary power supply consisted of a small 12 volt mains transformer, a bridge rectifier and smoothing capacitor, as shown in Fig. 5.

Conclusion

Building an a.t.u. such as this doesn't require much expenditure but it does require a considerable amount of time and also access to at least a noise bridge and preferably a g.d.o. After succeeding with your own drive arrangements you will certainly understand considerably more about the subject of impedance matching. Band changing is instant on the a.t.u., unlike my equipment which has a valve p.a. and a Pi output network. What I might lose in tune-up convenience is more than offset by the wider range of impedances that I can drive with no real loss of output.

My a.t.u. has worked successfully for six months and has been flooded twice, since I failed to put in any drain holes. Presently it sits on a paving slab and is covered with heavy gauge polythene sheet. This in turn is held down with two house bricks, especially since "the goals are at this end of the garden". Since its installation there has been no drift in the components, no failures and, most importantly, no TVI.

Noise Bridge

A noise bridge is the most essential piece of test equipment for antenna matching. The general layout of a noise bridge is shown in Fig. 6. The bridge uses the station receiver (tuned to the frequency of interest) as a null detector. Bridge excitation is obtained from a wide band noise source, such as a Zener diode, see *PW* Noise Bridge, *Wires & Waves*.

I use my noise bridge for two distinct tasks. The first and most obvious is the measurement of unknown complex impedances, usually antennas. The second and much more common use is as a tuning aid, as described in the following procedure. Assuming the transceiver has a fixed input and output impedance, normally 50Ω, set the noise bridge to null at this impedance and place it in the coaxial line between the transceiver and a.t.u. Next, tune *Practical Wireless*, July 1987

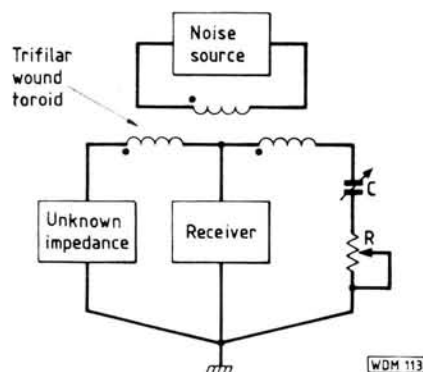

Fig. 6: Theoretical diagram of the noise bridge.

SHOPPING LIST

Resistors

0.5W 5% Carbon film
1kΩ 1 R1

Capacitors

Laminated p.c.b. type
C1-5 see text

Electrolytic 40V

1000μF 1 C6

Semiconductors

Red l.e.d. 1 D2
0.2in
SO2 1 D1

Miscellaneous

S1 s.p.s.t. mains type toggle

switch; S2 2p.6w. rotary switch; Relays 12V, 10A 2p. c.o (5) (e.g. RS 348-835) £2.85 + VAT each; Multi-core cable; SK1,2 terminal post 4mm; SK3 SO239; 20 x 20mm aluminium angle; G10 double sided p.c.b. material; 44mm dia. plastic waste water pipe; Perspex strip; Large plastics seed tray with propagator cover; Alloy project box; T1 12V 2A mains transformer chassis mounting type; Aluminium sheet; Wire for coils

**How Much?
& How Difficult?**

£47

Advanced

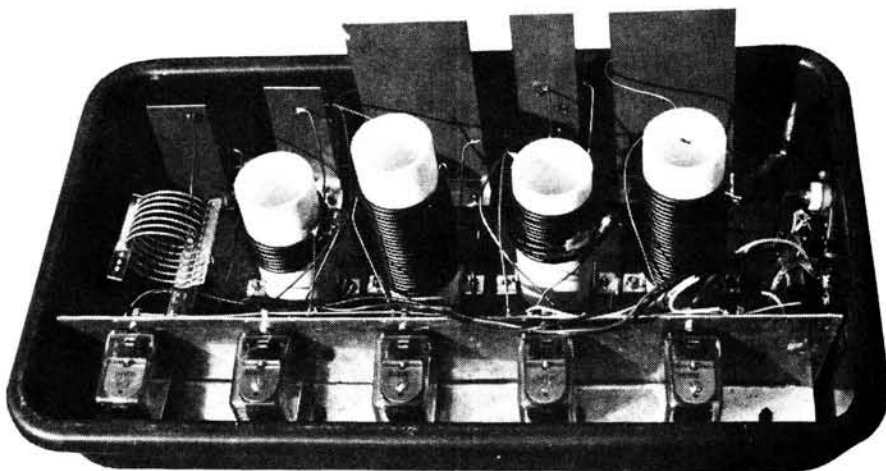

Author's working prototype

the transceiver to the desired operating frequency and adjust the controls of the a.t.u. until a dip in the receiver noise is heard. Finally, remove the noise bridge from the circuit and re-connect the transceiver directly to the a.t.u. If, however, you own a transmitter and receiver system of the early type, possessing transmitter loading

controls, the equipment will need to be matched into a 50Ω non-inductive dummy load before using the previously described matching procedure. This method of matching ensures an almost perfect match first time, without causing any of those annoying tuning signals one hears on the h.f. bands.

Counterpoise Systems

This article, by J. Brown, concerns the grounding system for use with end fed antenna wires, with particular reference to the difficulty of working from an upstairs shack.

The problem with the upstairs shack is that whether we ground via the electricity main earthing system, the plumbing, an earthing spike or any combination of these, it is likely that the length of grounding lead from the antenna matching unit or transmitter down to perfect ground will often exceed 0.05 of a wavelength. This is the maximum tolerable length of grounding lead, otherwise we are into problems with radio frequency impedance in the grounding system. These problems can manifest themselves in bad s.w.r., "hot" transmitters, r.f. burns and interference with other equipment via the mains wiring. Also the radiated signal is reduced by consumption in the grounding impedance. The problem is summarised in Fig. 1.

In practice the 8m for top band will

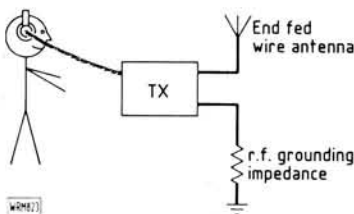

Fig. 1

not be exceeded if your mains earthing and plumbing system are interconnected and your house is fed by an underground electricity service cable. For the 14MHz band and shorter wavelengths, most amateurs use either balanced antennas or quarter wave/trapped verticals and radial earthing systems, not end fed wires. The effects of r.f. grounding impedance are likely to be encountered when working end-

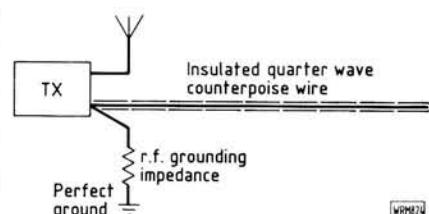

Fig. 2

fed wire antennas on the 3.5 and 7MHz bands.

The text book solution is to connect a quarter wave insulated wire to the shack earthing terminal. This wire is called a counterpoise. In reality this counterpoise acts in parallel with the domestic electricity earthing system, as shown in Fig. 2.

However carefully we may have cut our antenna and counterpoise we are

Fig. 3: Measurement of dip resonance

<p>Measured Dip Resonance 3.553</p> <p>Electrical Halfwave (150/MHz) 42.218</p> <p>So $a + g =$ 42.218m</p> <p>Fig. 3 (i): Antenna plus ground</p>	<p>Measured Dip Resonance 3.618</p> <p>Electrical Halfwave (150/MHz) 41.459</p> <p>So $c + g =$ 41.459m</p> <p>Fig. 3 (ii): Counterpoise plus ground</p>	<p>Measured Dip Resonance 3.613</p> <p>Electrical Halfwave (150/MHz) 41.517</p> <p>So $c + a =$ 41.517m</p> <p>Fig. 3 (iii): Counterpoise plus antenna</p>	<p>Measured Dip Resonance 3.580</p> <p>Electrical Halfwave (150/MHz) 41.899</p> <p>So $a + R =$ 41.899m</p> <p>Fig. 3 (iv): Antenna plus combined effect of ground and counterpoise</p>
<p>Key: a—Antenna g—Grounding c—Counterpoise R—Combined effect of grounding & counterpoise</p>		<p>Solving these equations by substitution we can obtain the following electrical lengths:</p> <p style="text-align: center;"> $c = 20.379m$ $a = 21.138m$ $g = 21.080m$ $R = 20.761m$ </p>	

TABLE 1

Band (MHz)	Max length of earthing lead for image grounding
1.8	8m
3.5	4m
7	2m
14	1m

really interested in the electrical length of the antenna, and the electrical length of the combined counterpoise and grounding system so that we can adjust them to resonance at the frequency we choose. The resonant frequency of an antenna system is measured using a dip meter and read from the digital readout of the transceiver switched to receive with an odd length of wire connected to the antenna socket to pick up the dip meter signal radiated from the antenna under test. Two or three turns of the antenna down lead, wound over the dip meter coil, are usually sufficient to couple the signal from the dip meter to the antenna.

At resonance the electrical length of a half wave antenna system is given by

$$\frac{150}{\text{MHz}}$$

and to measure the electrical lengths of antenna, counterpoise, ground image, and combined system we can proceed to take four dip readings as shown in Fig. 3.

In Fig. 3, we are looking at an end-fed wire and counterpoise grounding system for the 3.5MHz (80m) band. The band centre is 3.65MHz so a quarter wave will be $75/3.65 = 20.548\text{m}$. You must have the antenna at working height for all the measurements of this test.

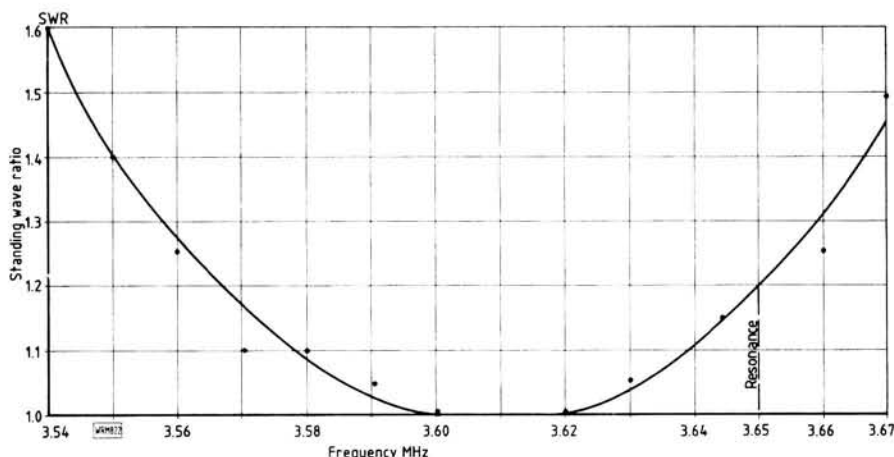

Fig. 4: An example curve for quarter wave end-fed wire and counterpoise grounding system after resonating the antenna and combined grounding system at 3.65MHz

From Fig. 3, the measured electrical length of the antenna is 21.138m. So we need to shorten the antenna "a" by $21.138 - 20.548$, i.e. 0.590 metres.

In practical terms I suggest only trim about 0.2m from the antenna at a time, then repeat the tests and calculations because the image length "g" will vary with frequency. Our calculation assumed "g" constant and is therefore approximate. Once "a" has been reduced to electrical length of 20.548 then the counterpoise can be trimmed, a little at a time until R is also the same figure. Resonance of antenna, ground and counterpoise system will then be 3.65MHz.

To keep life simple, do not connect more than one counterpoise to the shack earth terminal at any one time.

So what have we achieved? We have adjusted our antenna and the combined grounding system for the centre frequency of the band in which we are interested.

Note: s.w.r. =
$$\frac{\text{Radiation Resistance } (Z_0)}{\text{Transmitter (ohms)}}$$

at resonance
(no transmission line)

In this case, at resonance of 3.65MHz, we have s.w.r. = 1.2 (from graph). So:

$$1.2 = \frac{Z_0}{50}$$

Our radiation resistance is 60Ω —caused by limited height above ground

A resultant graph of standing wave ratio against frequency is given in Fig. 4, from which it can be seen that further adjustment of the resonant frequency to, say, 3.69MHz would move the curve to the right to make the standing wave ratio unity at 3.65MHz.

► 29

Laminate Capacitors

The formula for working out the value of a p.c.b. laminate capacitor is as follows:

$$C_pF = \frac{0.0096KA}{d}$$

where K = dielectric constant (5.4 for G10), A = Area in mm^2 and d = Plate separation in millimetres (1.5875mm for G10).

For common epoxy glass board, of which G10 is typical, this equation gives a foil to foil capacitance of 3.3pF per 10mm^2 . I measured several pieces of p.c.b. material and arrived at an average value of 3pF per 10mm^2 . My capacitors were made accordingly and outlined in Fig. 4. One side of the board was lightly marked with a scribe and then the copper was carefully cut away using a sharp scalpel. The 2mm

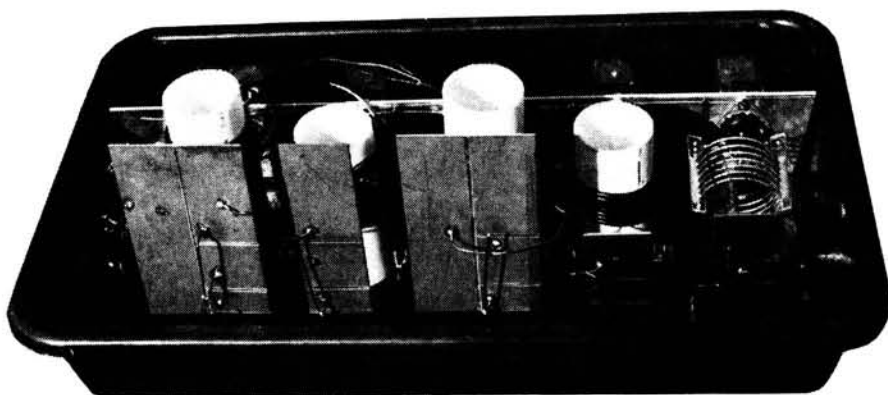

strips were removed using tweezers and a soldering iron.

For G10 the breakdown voltage is enormous at approximately 30kV, and consequently the air path around the edges is the limiting factor. I considered it sufficient to round and clean

the edges with fine glass-paper. Epoxy glass board is rather lossy for this purpose but it is very cheap and readily available. Laminates using ptfе would be better in this respect, but, at a few hundred watts p.e.p., the capacitors should and do survive.

PW

External Ferrite Loop Antenna MkII

Richard Q Marris G2BZQ stirred up a great deal of interest, amongst the medium wave DX fraternity, with his first ferrite antenna design. Now, the MkII version looks all set to do the same, with its increased selectivity and depth of null making it comparable in performance to that of a large frame antenna.

The author's design for a medium and long wave external ferrite loop antenna was published in *PW* February 1986. It was designed for use with communications receivers and older valved broadcast radios requiring external antennas. There are still many medium wave DXers and short wave listeners using this type of receiver for their hobby.

The original antenna has been in everyday use for two years, with a Pye Export receiver type 3017A, a first-class valved RX (circa 1950s). Also, from time to time, the antenna has been used with a communications receiver having m.w. facilities.

The original article produced a compact substitute for a longish outdoor antenna, the m.w. DXing potential never being realised. The MkII version has been designed with the medium wave DXer in mind, it has continuous coverage from 150-1620kHz (185-2000m) combined with sharp and effective nulling properties, making it ideal for winking out that elusive transatlantic DX.

This latest antenna design is a result of coming home, in the early hours of one morning, and switching on my Pye receiver with its external ferrite antenna connected. I tuned it across the medium wave band and quite unexpectedly heard two North American East Coast stations, which previously had been the prerogative of a more conventional frame antenna of much larger dimensions. Their signals were quite weak, with QRM, but they were there! When the ferrite antenna was changed for the frame loop, it "brought up" the signal strength, and the QRM could then be reduced, almost eliminated with its sharper nulling properties. The frame loop made it possible to identify that the QRM was being re-

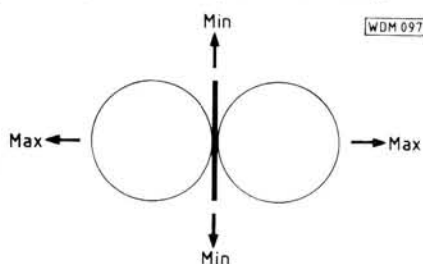

Fig. 1: Typical Polar Diagram of Ferrite Rod Antenna

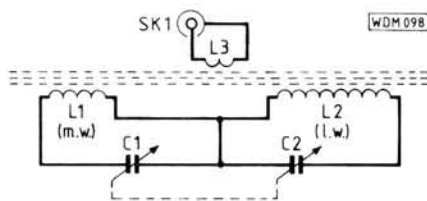

Fig. 2: Circuit diagram of antenna

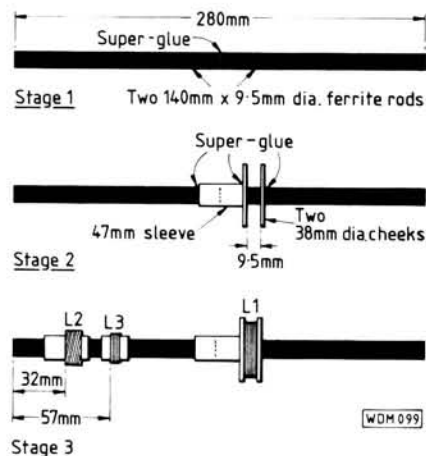

Fig. 3: Rod and coil assembly

ceived from European stations some degrees off the direct reciprocal bearing. The ferrite loop could not be used to identify this source of interference as its null point was not as pronounced as the frame antenna.

The polar diagram of a typical ferrite rod antenna is shown in Fig. 1. Introduction of a pre-amplifier only made things worse by bringing up the QRM and noise level.

Development

Research was conducted to look into a possible long-range version of the original ferrite loop, to give much better nulling and to greatly improve sensitivity, i.e. signal strength and operational range. The following points were established:

1. Sensitivity increases with relation to the length of ferrite rod, rods up to 600mm were tried!
2. As a given coil is moved from the end of a ferrite rod, towards the centre, its inductance and *Q* increases.
3. A narrow width multi-layer m.w. coil gives much higher *Q* than the normal width single-layer coil usually found in portable transistor radios. The depth of the coil should not be less than the width.
4. The answer to the new proposed design appeared to be in facts 1, 2 and 3.

Super-long ferrite rods cannot be obtained commercially. The maximum available length in the UK seems to be 200mm, though longer rods can

be obtained in the USA, at a high cost. However, they can be manufactured at home by taking two standard length ferrite rods and cementing them together end to end. In fact, the author has an experimental l.f. antenna using a rod some 480mm long, which may come as a bit of a shock to many readers.

For this new design of ferrite antenna two 140 x 9.5mm diameter rods are used, they are catalogue quoted as 9.5mm but are actually $\frac{3}{8}$ in diameter.

The MkII design is shown in Fig. 2. It consists of a 280mm ferrite rod with a m.w. coil (L1); a l.w. coil (L2); and a coupling coil (L3) which is connected via SK1 to about 1m of coaxial cable to the receiver's antenna socket.

Inductors L1 and L2 are resonated with C1, 2, a 2-gang 500pF per section, good quality air-spaced variable capacitor. Continuous coverage of 1620 to 150kHz can be obtained without band switching, by a novel arrangement. This will interest those readers who have a receiver capable of tuning over that "bit" between the m.w. and l.w. bands. Inductor L1 is a specially designed coil, while L2 and 3 are commercially wound types.

The final configuration of the antenna is shown in Fig. 3; the ferrite rod is supported on a long, wooden platform that is attached to the top of the plastics box housing C1, 2 and SK1. As shown in Fig. 3, inductor L1 (m.w.) is very narrow in width but large in diameter. This coil is mounted towards the centre of the rod, for maximum

inductance and Q , which amount to high sensitivity and excellent nulling. Inductor L2 (l.w.) is mounted down the other end of the rod, with L3 close by. The position of these coils is very important and has been arrived at to gain maximum performance from this antenna.

Construction

The rod and coil assembly is shown in Fig. 3, stages 1, 2 and 3.

1. Two F14 grade ferrite rods with the following dimensions, 140 × 9.5mm, are cemented together, end to end. To obtain maximum adhesion the two ends should be thoroughly cleaned by rubbing them gently on fine glass paper sat on a flat surface. Both ends should be given a light covering of Super-Glue, next **quickly, firmly and squarely** butt the ends together. It only takes a few moments for maximum adhesion to take place, and the result is a 280mm long ferrite rod. It is a good idea to wear rubber "kitchen" gloves, when using Super-Glue, as this prevents your fingers from being bonded as well. Super-Glue sets immediately on contact with two skin surfaces and should be treated with the utmost respect. You would look a little silly arriving at the local hospital casualty ward with two ferrite rods attached to your fingers!

2. Next, a Paxolin sleeve 47mm long with an i.d. of 9.5 and an o.d. of 11mm is slipped over the joint in the rod. This may be difficult to obtain so an alternative is to form a central reinforcing sleeve by winding a length of gummed paper parcel tape, 47mm wide, over the joint, making sure that the gum on the tape is moist enough. Besides the sleeve acting as a reinforcer, bearing in mind the length to weight ratio of the rod, it forms a useful marker to locate the bobbin of L1 against. The bobbin for L1 consists of two 38mm plastics discs, with 9.5mm dia centre holes. The author scrounged two plastics pill boxes from a friendly chemist and used the lids. With the lips cut away they measured 38mm in diameter. The discs could alternatively be cut from unclad s.r.b.p. or could, in fact, be 38 × 38mm squares with centre holes.

One cheek is slipped over the rod and Super-Glued hard up against the end of the reinforcing sleeve as shown in Fig. 4, stage 2. When the glue has set, the second cheek may be glued exactly 9.5mm away from the first. A piece of

SHOPPING LIST

Capacitors

Air-spaced variable
500 + 500pF 1 C1, 2⁽¹⁾

Wound Components

Coils

See text	1 L1
LWC1	1 L2
	(Circuit 35-00108)
FRCC	1 L3* see text

Ferrite Rod	F14 grade
FRA	2
	(Circuit 35-14147)
140 × 9.5mm dia	

Miscellaneous

Plastics box 76 × 127 × 89mm (see text); TV type coaxial socket; Wood (see text); 18 s.w.g. alumin-

ium sheet; Grommets $\frac{3}{16}$ in dia hole; Wire 7/0.2mm pvc covered; Knob; 6BA nuts, screws, washers; Super-Glue; Contact adhesive.

⁽¹⁾ Maxi-Q
G&P Powles
Unit 8, Brunel Road
Gorse Lane Industrial Estate
Clacton-on-Sea,
Essex CO15 4LU
Tel: (0255) 424152

⁽²⁾ Cirket Holdings PLC
Park Lane, Broxbourne
Hertfordshire EN10 7NQ
Tel: (0992) 444111



wood 9.5mm thick was used as a spacer and quickly extracted before the glue had set completely.

3. Inductor L1 is 70 layered close-wound turns of stranded 7/0.2mm pvc covered wire which has an outside diameter of 1.2mm. Because of the pvc insulation on the wire, it can be wound directly onto the ferrite rod, between the bobbin cheeks. The winding should be terminated in two 150mm long tails and a couple of layers of pvc tape.

The coupling coil L3 is a Cirket type FRCC and is fitted 57mm from coil edge to rod end. The long wave coil L2 is a Cirket type LWC1 and is positioned 32mm from the rod end, as shown in Fig. 3, stage 3. Both L3 and L2 coil former are fixed to the rod with blobs of contact adhesive.

The rod support frame is shown in Fig. 4. It consists of a wooden platform measuring 9.5 × 264 × 22mm painted black. Two slotted aluminium brackets, made to the dimension in Fig. 4, are bolted to the wooden platform using 6BA nuts and bolts. Two rubber grommets are located in the slots and are finally held in position with a spot of Super-Glue, these are best added to the rod just before its location on the platform, grommets should have a 9.5mm dia. hole.

As a base mounting, and protection

for the variable capacitor, a plastics box 76 × 127 × 89mm is used. The dimensions are not critical, any similar size could be used. The writer used a Fridge-O-Seal Freezer Box from Woolworth. The body is of rigid cream colour plastics, and the lid is soft tight-fitting polythene. With the box inverted, and all external fittings black, the whole thing looks very professional and nothing like a freezer box. The soft polythene lid seals the box against dust and also acts as a non-scratching base when put on a polished surface.

The variable capacitor, and coaxial socket, should be fitted as in Fig. 5. The rod mounting platform is fitted to the box with two small bolts. Next, fix the rod assembly into the aluminium support brackets, making sure the grommets sit evenly in the slot provided.

Connecting leads from L1-3 are dropped through the top of the hard plastics box, using holes carefully made with a small screwdriver. Inductors L1 and 2 are connected to the two sections of the variable capacitor, and L3 to the coaxial socket SK1, as shown in Fig. 2.

Inductor L3 is a modified MWC2 coil, available from Cirket (35-00268). This coil will need 80 per cent of its turns removed. It must be positioned as shown in Fig. 3, connection details given in the text still apply. Note, please ignore the small over-winding on the MWC2.

Testing and Operation

Firstly, C1, 2 should be resonated for maximum signal, on a weak station, at either end of the m.w. band. Rotation of the loop through 90 degrees will produce a maximum signal point and a

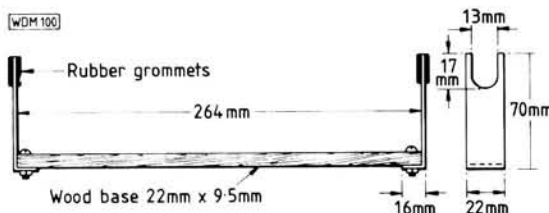

Fig. 4: Rod support frame showing bracket dimensions

Theory

This series, by F. C. Judd G2BCX, stems from letters sent in by readers of PW requesting details concerned with constructing an antenna of some particular design for use on a frequency band other than that for which the antenna was originally intended.

Scaling Antennas for Other Frequencies-1

An example is the re-construction of the 144MHz band (2m) 12-element ZL Special beam antenna for use on the 430MHz (70cm) band. Also the 144MHz band Slim Jim antenna re-dimensioned for operation on the 28MHz (10m) bands (actual details for this in the PW publication *Waves and Wires*). The Slim Jim has also been re-designed for 432MHz (details for a mobile version in *Waves and Wires*).

In addition the same antenna has been adopted by the Broadcasting Authority of Greece and re-dimensioned for v.h.f. broadcast stations transmitting on 101.8MHz. Another application has been for transmitting and receiving on the 156MHz v.h.f. marine radio band.

Frequency Ratio

The term **scaling up** can mean for a frequency **higher** than that intended for the original design and **scaling down** for a frequency **lower** than the original, e.g. 145MHz to 70MHz. There is a limit to this procedure but with other factors taken into account it can be applied to some types of h.f. and v.h.f. antennas.

The first step is to determine the "frequency ratio", to obtain a multiplying or dividing factor for ascertaining the new dimensions required. To take a simple case; a reader who already had constructional details and dimensions for a 144MHz band crossed dipole system wanted to produce a similar antenna for 29MHz. He wrote asking "how long would the elements have to be for 29MHz?". This can be done by finding the "frequency ratio", in this case $145/29 = 5$.

Assuming the original length for each of the dipoles for 145MHz was 990mm (with conductor velocity factor taken into account), then the length of each dipole for 29MHz would be $990 \times 5 = 4950\text{mm}$ or 4.95m.

The alternative in this case would be to forget "frequency ratio" and simply find the dipole length for 29MHz from

$$150 \times k/f(\text{MHz})$$

where k is an allowance for the velocity factor of the conductor material used for the elements.

If one assumed the use of aluminium

tube of, says, 12 to 19mm diameter then k would be about 0.96. The element length would be $150 \times 0.96/29 = 4.965\text{m}$. At this frequency the very small dimensional difference between the two examples would be of little or no consequence.

Scaling the Dimensions

Scaling the operational frequency up, or down, may seem a little confusing since the **dimensions** for constructing an antenna for a frequency higher than that for which it is intended are **scaled down** and **scaled up** for a lower frequency. If we reverse the previous example, i.e. scale up (frequency) from 29MHz to 145MHz then the factor for scaling down "dimensions" would be $29/145 = 0.2$. Therefore the 4.965m would become

$$4.965 \times 0.2 = 0.993\text{m}.$$

The simple formula for scaling one way or the other is:

Original Operating Frequency

New Operating Frequency

= Dimension Ratio

Other Parameters to be Considered

The first is the method used to obtain matching between the antenna and its feed cable from the transmitter. Secondly, and aside from spacing between all elements, driven and parasitic, the thickness of these elements

may have to be changed. Phasing links between driven elements (if any) may have to be modified. Each of the foregoing may prove to be more critical if the operational frequency is made higher and the physical size of the antenna becomes reduced. This was one of the problems the author soon discovered when producing test "models" of antennas to be operated at ultra high frequencies.

It is difficult to lay down hard and fast rules concerned with the above, particularly when a substantial decrease in physical size and increase in the frequency of operation is involved. It is, in fact, possible to completely ruin the performance of some antenna designs when attempting to change the dimensions for operation on another frequency band, particularly one that is higher.

Element Diameters

These will normally depend on the physical size of the antenna system and for beams designed to operate on h.f. bands, e.g. 14, 21 and 28MHz, the diameter of the various elements may be considerable in order to provide strength to the system. The elements used for v.h.f. antenna systems will generally be thinner, possibly even thinner still if scaled down by frequency ratio for u.h.f. This may result in the element diameter to wavelength ratio becoming quite high which means a higher radiation resistance as can be seen from the graph in Fig. 1.1.

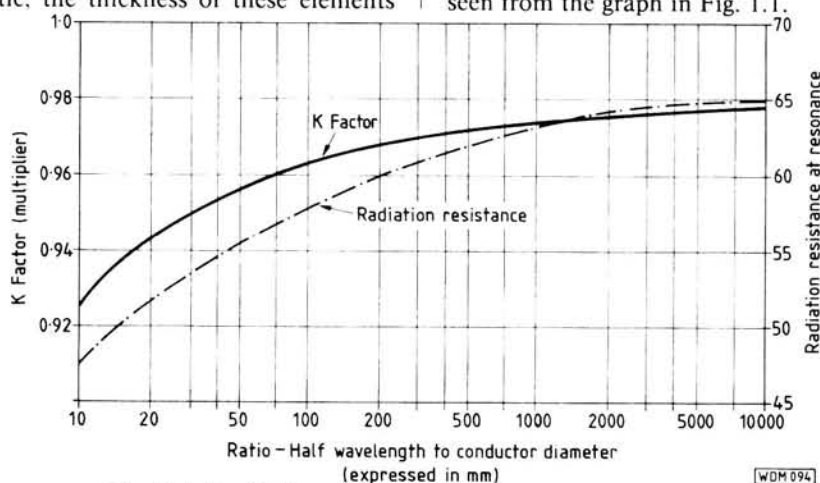

Fig. 1.1: Radiation resistance vs element diameter

Considerable thought must be given to this aspect, especially with the multi-element parasitic beam antennas. Incidentally, it is not practicable to re-dimension inductively loaded multi-band antennas on the basis outlined in this article.

Problems may also arise when an attempt is made to re-dimension a v.h.f. antenna for use on one of the higher h.f. bands. Scaled up dimensions may prove to be impracticable, particularly for individual element diameters and folded element spacing, as well as some types of matching systems, e.g. the "gamma match". Whilst the "Theory of Similar Antennas" can often be applied, it is not simply a case of using the "frequency ratio" method alone to ascertain ALL dimension changes (ref. 1).

A Practical Example

This embraces just a few of the problems mentioned above. Let us take the original construction and dimensions for the 144MHz band "Slim Jim" (centre frequency 145MHz) as in Fig. 1.2 and scale up ALL the dimensions for the top segment of the 28MHz band strictly according to the "frequency ratio". The voltage and current distribution shown in Fig. 1.2 (a) will be the same for whatever frequency this antenna is constructed. The frequency ratio with centre frequency of the band as 29.35MHz is $145/29.35 = 4.94$.

The minimum element material diameter for the 144MHz band version, Fig. 1.2 (b), is taken as 6mm. This gives an element material diameter of $6 \times 4.95 = 30\text{mm}$ for the 28MHz band. Next the spacing between the left and right hand sides of the whole folded element for the 144MHz band taken as 32mm. For the 28MHz band this will be just over 158mm.

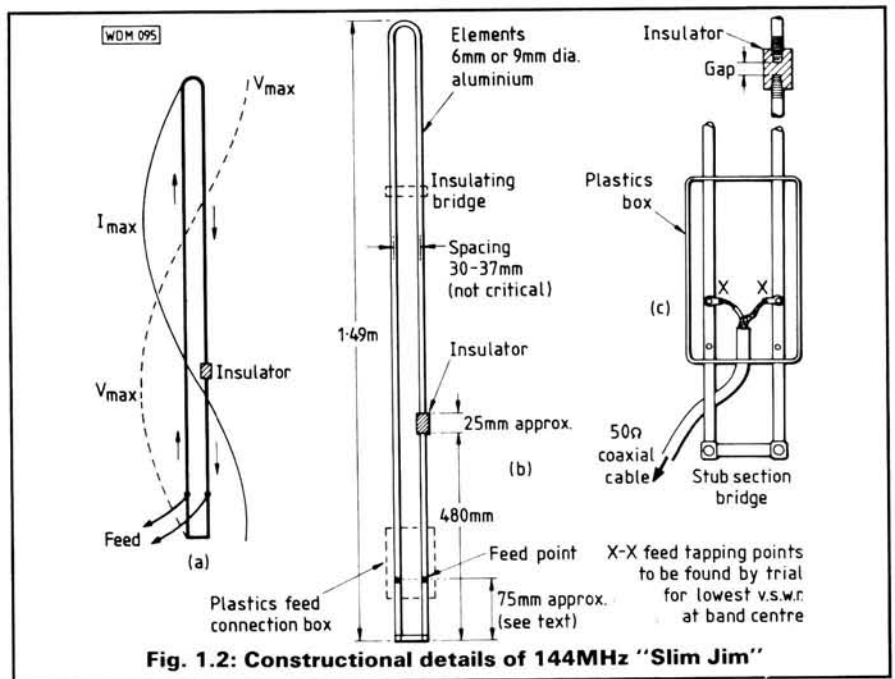

Fig. 1.2: Constructional details of 144MHz "Slim Jim"

Unlike a "Slim Jim" for the 144MHz band, a strictly "frequency scaled" version for 28MHz, as above, would NOT be self supporting unless firmly secured to some form of base mount, preferably a quarter-wavelength above ground (at 28MHz) and then held vertical with insulating guy lines (polypropylene rope). The alternative is the thin wire version as in *Wires and Waves*.

Effect on Bandwidth

The Slim Jim was originally designed for the 144MHz band (144 to 146MHz) and element material thickness and spacing, etc., were chosen to provide the widest bandwidth consistent with an acceptably low v.s.w.r. across the band. Using a thinner material for the element affects its velocity factor, and this means some small

changes in dimensions. In addition the bandwidth is narrowed and the v.s.w.r. becomes a little higher at each end of the band, assuming approximately 1 to 1 at centre frequency.

Slim Jim for the VHF Marine Radio Band

If the change in dimensions for another frequency band are not too great, i.e. the frequency change itself is not more than a few MHz and the demand for bandwidth is not excessive, then the "frequency ratio" method may be used with reasonable confidence. For example, a 144MHz Ultra Slim Jim (page 76, *Out of Thin Air*, PW publication) re-dimensioned for the 156MHz v.h.f. marine radio band. The frequency ratio for respective band centres will be $159/145 = 1.09$. One need only multiply all the dimensions

Fig. 1.3: Close up of Marine band "Slim Jim". The split metal sleeve a third of the way up the antenna, serves as an adjustable matching capacitor

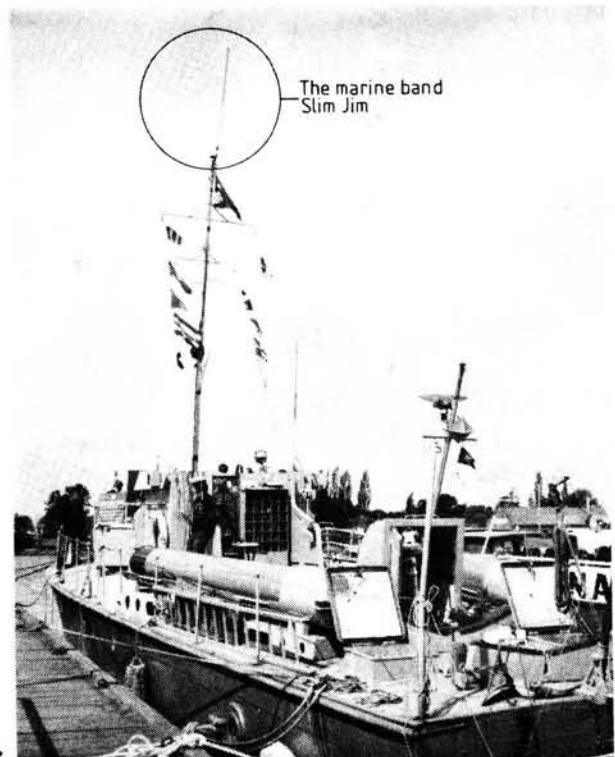

Fig. 1.4: Marine band "Slim Jim" mounted at the mast top of a renovated ex-WWII Motor Torpedo Boat



and carry out the final v.s.w.r. adjustment as necessary. Whilst the overall bandwidth will be limited a little and v.s.w.r. higher (2 to 1) at the extreme ends of the band, radiation loss will not amount to more than a dB or so. A marine band version of Ultra Slim Jim, constructed by the author and used with an Ocean Star 25W v.h.f. marine band transceiver, proved very successful during sea trials with a renovated wartime motor torpedo boat, see Figs. 1.3 and 4. The finished antenna was completely waterproofed by housing and sealing within a plastics tube. (Brown or white tube. NOT grey, which has a carbon content.)

A More Difficult Case

This from a PW reader in Zimbabwe, a s.w.l. keen on picking up aircraft transmissions and the like and who wished to convert a Slim Jim to cover a frequency range of 118 to 125MHz, a

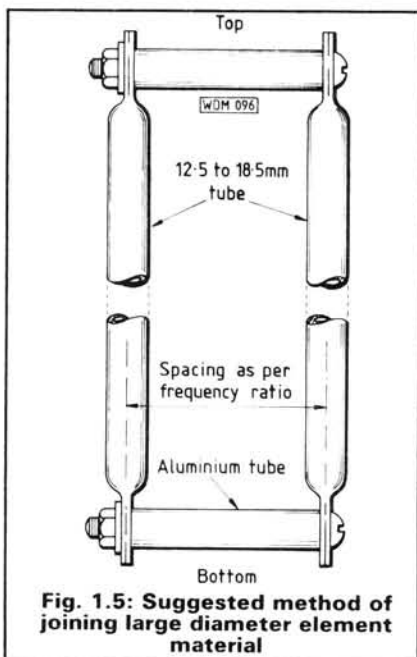

bandwidth of 7MHz. No problem to re-dimension since the frequency ratio, band centre to band centre, is about 1.2. The problem was the wide overall bandwidth. However, since the antenna would be used only for receiving, some loss over the higher and lower portions of the total bandwidths could be tolerated. In this case all the constructional dimensions could be increased in accordance with the frequency ratio but it was recommended that larger diameter element material be used (12.5 to 18.5mm) to help reduce bandwidth loss. To avoid having to bend the element sections top and bottom it was suggested that they be joined at each end as in Fig. 1.5, in the same way as the original Slim Jim (*Out of Thin Air*, PW publication, or *The Two Metre Antenna Handbook*, F. C. Judd).

1: *Practical Aerial Measurements*, F. C. Judd, *Wireless World*, December 1960.

...CALLING ALL LISTENERS...CALLING ALL LISTENERS...

JUNE issue OUT NOW



THE GREY-LINE DX PATH

*Improve your chances
of catching that elusive station*

SEEN & HEARD

*What's been heard
on the bands recently*

BANDSCAN

*Latest news on
the broadcast bands*

PLACE A REGULAR ORDER WITH YOUR NEWSAGENT

SITUATED AT SOUTHERN END OF M23 — EASY ACCESS TO M25 AND SOUTH LONDON

HF RECEIVERS	£ (c&p)	2.M. TRANSCEIVERS	£ (c&p)	KENWOOD ACCESSORIES	£ (c&p)
Icom ICR71	825.00 (—)	Kenwood TH21E Handheld	228.00 (—)	MC 50 Desk Microphone	48.59 (2.00)
Kenwood R2000	637.00 (—)	Kenwood TM201A 25w F.M. mobile	269.00 (—)	MC 60A Desk Microphone with Pre-amp	93.02 (2.00)
Kenwood VC10 V.H.F. Converter	170.76 (2.00)	Kenwood TR751E 25w multimode	649.00 (—)	MC 55 Mobile Microphone with Control Box	55.53 (1.00)
Kenwood RS000	895.00 (—)	Kenwood TS711E base station	991.00 (—)	MC 35S Hand Microphone 4 pin	22.91 (1.00)
Yaesu FRG8800	639.00 (—)	Kenwood TH205E Handheld	218.00 (—)	MC 40S Up/down Hand Microphone 6 pin	19.07 (1.00)
Yaesu FRV8800 V.H.F. Converter	100.00 (2.00)	Kenwood TH215E Handheld	258.00 (—)	MC 42S Up/down Hand Microphone 8 pin	22.22 (1.00)
		Yaesu FT290II Portable multimode	429.00 (—)	SMC 30 Speaker Microphone TH21	29.85 (1.00)
		Yaesu FT203R + FNB3 Handheld	255.00 (—)	LF 30A Low Pass Filter 1KW	34.02 (2.00)
		Yaesu FT209RH + FNB3 Handheld	309.00 (—)	SP 40 Mobile Speaker	22.22 (1.00)
		Yaesu FT270RH 45w F.M. mobile	469.00 (—)	HS 7 Miniature Headphones	16.66 (1.00)
		Yaesu FT726R base station (70cm optional)	999.00 (—)	HS 6 Ultra Light Deluxe Headphones	25.68 (1.00)
		Yaesu FT23R Handheld	249.00 (—)	HS 5 Deluxe Headphones	39.57 (1.00)
		Icom IC2E Handheld	225.00 (—)	HMC 1 Headset with Vox TH21 etc.	34.71 (1.00)
		Icom IC02E Handheld	299.00 (—)	VS 1 Voice Synthesizer Module	34.02 (1.00)
		Icom IC285 25w mobile	359.00 (—)	AD 1 Screwed Phone to BNC	
		Icom IC271E base station	835.00 (—)	Adaptor TH21E/41E	3.85 (0.50)
		Icom IC3200E 2m/70cm F.M. mobile	556.00 (—)	IF 232C RS232 Interface TS711/811E/940/440/R5000	72.89 (1.00)
		Icom Micro II Handheld	239.00 (—)		

V.H.F. SCANNING RECEIVERS	70cm TRANSCEIVERS	ANTENNA BITS
Icom IGR7000	Kenwood TH41E Handheld	Hi-Q Balun 1:1 5kW P.E.P.
Yaesu FRG9600	Kenwood TR3600E Handheld	Bricomm Balun 4:1 1kW
A.O.R. AR202	Kenwood TS811E base station	Bricomm 7.1MHz Epoxy Traps (pair)
Signal R532 "Airband"	Yaesu FT703R + FNB3 Handheld	Self Almagamating Tape 10M
	Yaesu FT709R + FNB3 Handheld	T-piece polyprop Dipole centre
	Yaesu 70cm module for FT726R	Small ceramic egg insulators
	Yaesu FT73R Handheld	Large ceramic egg insulators
	Yaesu IC4E Handheld	
	Icom IC04E Handheld	
	Icom IC471E base station	

V.H.F. SCANNER ACCESSORIES	ANTENNA TUNER UNITS
A.K.D. HFC1 HF Converter	Yaesu FRT7700 Short wave listening
Revcone Discone Antenna 30-500MHz	Yaesu FC757AT
Icom AH7000 Antenna 25-1300MHz	Kenwood AT230
	Kenwood AT250 auto



GOODS NORMALLY DESPATCHED WITHIN 24 HRS - PRICES CORRECT AT TIME OF GOING TO PRESS - E&OE - MAIL ORDER AND RETAIL

BREDHURST ELECTRONICS LTD HIGH ST, HANDCROSS, W. SX. RH17 6BW (0444) 400786

VALVES

*High Quality
**Very High Quality

Prices correct as at 7/4/1987 but may fluctuate. 15% VAT incl.

A1065 1.40	EBF89 0.80	E186 1.25	EY51 0.90	PF200 1.10	UBF89 0.70
A2293 7.00	EC52 0.65	F189 1.60	EY81 0.75	PF200* 2.20	UCB84 0.85
A2900 12.75	EC91 4.40	F191 1.60	EY86/87 0.60	PL36 1.10	UCB85 0.78
AR8 1.15	EC92 1.85	F192 2.15	EY88 0.65	PL81 0.85	UCH42 2.50
ARP3 1.15	EC81 0.95	F195 0.95	EZ80 0.70	PL82 0.70	UCH81 0.75
ARP35 0.70	EC82 0.95	F196 0.90	EZ91 0.70	PL83 0.60	UCH82 1.60
AT14 0.90	EC83 0.75	F183 0.75	GM4 0.90	PL84 0.90	UF41 1.35
B12H 6.90	EC84 0.60	F184 0.75	GY501 1.30	PL504 1.25	UF80 1.50
CY31 1.40	EC85 0.75	F1812 0.75	GZ32 1.40	PL508 2.00	UF80 1.50
DAF70 1.75	EC88 0.80	F1200 1.85	GZ33 4.20	PL509 5.65	UF85 1.20
DAF96 0.75	ECC189 0.95	F1950 0.85	GZ34 1.40	PL519 5.85	UL84 0.95
DF122 32.80	ECC804 0.65	EL32 0.85	GZ34* 3.80	PL802SE 3.45	UM80* 1.60
DF92 0.65	ECF80 0.95	EL34 2.10	GZ37 3.95	PY80 0.70	UM84 0.70
DF96 0.70	ECF82 0.95	EL34* 4.55	K196* 15.50	PY81/800 0.85	UR22 0.70
DH16 0.75	ECF82 1.80	EL62 0.70	K171** 14.00	PY82 0.75	UR85 0.85
DL92 1.10	EC42 1.20	EL84 0.95	K188 17.00	PY88 0.60	VR105/30 1.45
DY86/87 0.65	EC81 0.70	EL86 0.95	K188** 25.00	PY500A 2.10	VR150/30 1.80
DY902 0.70	EC84 0.80	EL90 1.75	ML4 3.20	QDV03/10 5.95	XG1M 1.70
E20CC 2.80	ECL80 0.65	EL91 6.50	ML5 3.20	QDV03/10* 7.50	X56 1.80
E180CC 11.50	EL82 0.75	EL95 1.25	MX120/01 29.50	QDV03/20A 27.50	Z749 0.75
E1148 0.58	ECL85 0.75	EL504 2.70	N78 9.90	QDV06 40A 28.50	Z758 19.00
E1476 1.80	ECL86 0.90	EL509 5.85	O42 0.70	QDV06 40A* 49.50	Z800U 3.45
E834 0.70	EF9 3.50	EL519 7.70	OB2 0.80	QV32/12 5.75	Z801U 3.75
EB91 0.60	EF22 3.90	EL821 8.45	PCL82 0.95	SP61 1.80	Z803U 18.50
EB33 1.85	EF29 1.10	EL822 9.95	PCL84 0.85	TT21 37.50	Z9001 2.45
EB30 0.90	EF80 0.65	EL180SE 4.50	PCL86 0.80	TT22 37.50	Z13 2.75
EB31 0.90	EF83 3.90	EM90 0.90	PCL89/95 0.95	UABC80 0.75	Z14 0.65
EB80 0.95	EF85 0.80	EM87 2.50	PD500 510 4.30	UBF80 0.70	Z185 0.80

VALVES AND TRANSISTORS Telephone enquiries for valves, transistors, etc. Retail 749 3934, trade and export 743 0899. POSTAGE: £1.63 5p, £3.25 6p, £5.10 8p, £10.15 10p, £15.20 11p, £20.15 12p. Minimum order £1.00. Delivery by return.

COLOMOR (ELECTRONICS LTD.) 170 Goldhawk Rd, London W12
Tel: 01-743 0899 or 01-749 3934. Open Monday to Friday 9 a.m.-5.30 p.m.

CRICKLEWOOD ELECTRONICS LTD

It's no secret!

that there is a real difference at Cricklewood Electronics. That's why you should never be without the FREE CRICKLEWOOD ELECTRONICS COMPONENTS CATALOGUE, for sheer variety, competitive prices and service from the U.K.'s number one 100% component shop. No gimmicks, no gadgets or computers, just components, millions of them, all easily available by mail order, calling or credit card telephone orders. Just pick up the phone (or a pen) to get your FREE copy now (no SAE required). You have nothing to lose.

CRICKLEWOOD ELECTRONICS LTD.
40 Cricklewood Broadway NW2 3ET.
01-450 0995 & 01-452 0161
ALL MAJOR CREDIT CARDS ACCEPTED
Telex 914977 Phone or write today

USED AMATEUR EQUIPMENT?

I Buy, Sell & Exchange!

Whether SELLING or BUYING, if you're talking TOP QUALITY USED AMATEUR EQUIPMENT.

Phone G4TNY for the BEST deals around !!
Phone Dave on 04024 57722 or 0836 201530, 9am to 7pm, Mon to Sat

Ask about our new 'RIGSEARCH' services.
Send SAE for lists. Personal callers by appointment, please.

G4TNY AMATEUR RADIO

132, Albany Road, Hornchurch, Essex RM12 4AQ PART EXCHANGE

EXTRA

Orkney Activity

Orkney is a relatively rare part of the UK. The Callbook shows 34 licences (14 Class A and 20 Class B), but not all are active. With a view to stimulating some interest and to provide others with the chance to work Orkney, the Orkney Group of Radio Amateurs have decided to consider June as an "Activity Month", during which as many as can, will make a special effort to be on the various bands.

The suggested frequencies for operation are (all in MHz and \pm): 1.973, 3.753, 7.023, 7.053, 14.033, 14.253, 21.253, 28.8, 29.6, 70.26, 144.033, 144.353. Modes: c.w., s.s.b., f.m. and possibly RTTY.

More details can be obtained from **Bill GM3IBU, QTHR**.

BARTG

The British Amateurs Radio Teleprinter Group (BARTG) exists to encourage and promote interest in teleprinting and similar activities and is the only group in the UK dedicated to all aspects of amateur data communications. BARTG is affiliated to the Radio Society of Great Britain and through the RSGB to the International Amateur Radio Union.

Membership is open to all persons, or clubs worldwide, who are interested in RTTY, machines, computers, constructional projects, AMTOR, packet radio, digital data transmissions, FAX, contests, awards and other related activities.

New members may join BARTG by sending a sterling cheque or bankers draft for the amount shown here. The subscription rates for 1987, which include the mailing of

AMRAC

The Amateur Radio and Computer Club has revised its membership subscriptions. As from May 1 the subscriptions are:

UK	£8.00
Europe	£10.00
Rest of the World	£12.00

AMRAC produce a bi-monthly 40-page newsletter **AMRAC USER** which covers all the latest news, ideas and technical items on packet radio, as well as AMTOR and RTTY. In addition to the newsletter the club also produce a "Hot-news sheet" in alternate months to ensure members are kept

right up to date.

AMRAC is keen to encourage the formation of local AMRAC groups which hold regular meetings and promote digital communications at a "grassroots" level. Such groups have already been formed in Hampshire, Thames Valley and Essex. It is hoped that more will be formed around the country.

Further details of AMRAC may be obtained by sending an s.a.e. to **Phil Bridges G6DLJ, 9 Hollydene Villas, Hyther, Hants SO4 5HU**. Or Prestel mailbox 703847754.

DATACOM magazine are:

UK	£7.00
Europe & Eire	£10.00
Overseas surface mail	£10.00
Overseas by airmail	£16.00

DATACOM is the official journal of the group, and is sent free to all BARTG members. It is published at the end of March, June,

September and December 1987.

For availability of back issues, general introductory information on the hobby and general membership enquiries please write to: **Mrs Pat Beedie GW6MOJ, Ffynnonlas, Salem, Llandelilo, Wales SA19 7NP**.

PW RADIO PROGRAMS CASSETTES

Each cassette costs **£3.75** (including p & p and VAT)

FOR THE SINCLAIR SPECTRUM (16/48K)

Cassette 3

QRA Locator/Contest Score Calculator
Distance & Bearing Calculator
Spurious Mixing Product Calculator
Callsearch File
Radio Logbook
Orbits Calculator (RS3-RS8 and OSCAR 8)
TV Colour Test-pattern Generator

Cassette 5

Antenna & Feeder Calculator
Radio Range Calculator
Single-layer Coil & Resonance Calculator
QSL Card Printer
Meter Shunt & Multiplier Calculator
Reactance/Impedance Calculator

FOR THE BBC Model B

Cassette 6

Transmission Lines Calculator
Tuned Output Stage Design

Cassette 7

Universal Locator/Contest Score Calculator
Bearing & Distance Calculator
ATV Test Card Generator
Logbook
Satellite Tracking

FOR THE SINCLAIR ZX81

Cassette 1

Morse Tutor*
QRA Locator/Contest Score Calculator*
Distance & Bearing Calculator*
Spurious Mixing Product Calculator*
Morse Tutor
Callsearch File
Radio Logbook
Orbits Calculator (RS3-RS8 and OSCAR 8)

Cassette 2

Structured Morse Learning Course

Cassette 4

Antenna & Feeder Calculator
Radio Range Calculator
Single-layer Coil & Resonance Calculator
QSL Card Printer
Meter Shunt & Multiplier Calculator
Reactance/Impedance Calculator

* These programs will run in 1K
Remainder require 16K of RAM

FOR THE DRAGON 32

Cassette 6

Transmission Lines Calculator
Tuned Output Stage Design

Send your order, asking for **PW Radio Program No.** (followed by the cassette number as quoted above) to:

Practical Wireless
Enefco House,
The Quay, Poole,
Dorset BH15 1PP

Telephone 0202 678558
(24 hours) for credit
card orders



Please make cheques payable to **Practical Wireless**

Practical Wireless, July 1987

Test Measurements and Equipment Part 4

The word potentiometer conjures up pictures of small variable resistors, used in radio equipment, in many people's minds. In Part 4 of this series, Ray Steele describes a different type of potentiometer, the sort used in test measurements. This instrument measures electrical quantities by balancing an unknown potential difference against a known one

One of the best ways of measuring any quantity is to measure it against a known standard. A potentiometer is a wire of fixed length and employing a standard cell. This produces a fixed voltage drop per unit length of wire. Therefore any other cell can be measured.

The method is as follows. With reference to Fig. 4.1, the 1V standard cell is connected to the slide wire via the movable contact, which is set at 1 metre. The rheostat is then adjusted for a null on the galvanometer.

The instrument is now calibrated to read 1 volt per metre and any other voltage below 1 volt can be measured. Obviously this instrument is useful for measuring low voltages but not much good for voltages much higher than 1 volt. The range can be extended slightly using shunt and volt boxes to read higher currents and voltages respectively.

An instrument over a metre long is like carrying a grandfather clock in order to tell the time, and Fig. 4.2 shows how the potentiometer can be reduced in size. Most of the wire resistance is lumped into resistor steps R1 and a slide wire R2 provides the fine adjustment. A further resistor chain R3 and R4 provide a lower range, depending on the ratio of R3 to R4.

The slide wire potentiometer provides a good accuracy since the detector is only required to sense a null and not actually indicate the reading.

Although, basically, a voltage comparison device, the potentiometer can

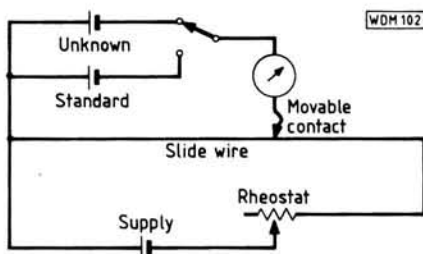

Fig. 4.1

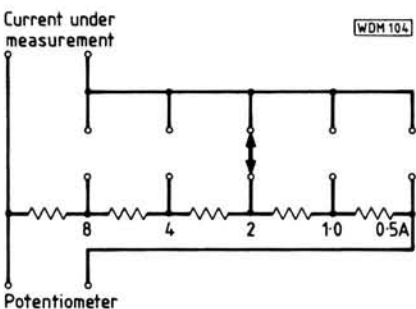

Fig. 4.3

be used to calculate the value of an unknown current if the unit resistance of the slide wire is known. The current reading capability can be extended by the use of a shunt box, Fig. 4.3. The shunt box acts as a current divider, bypassing the current that the potentiometer cannot handle. The contacts are made of silver and the resistors of manganin, giving an overall accuracy of about 99.98 per cent.

The voltage range can also be increased by using a volt box, Fig. 4.4. In this instance the switch selects a value

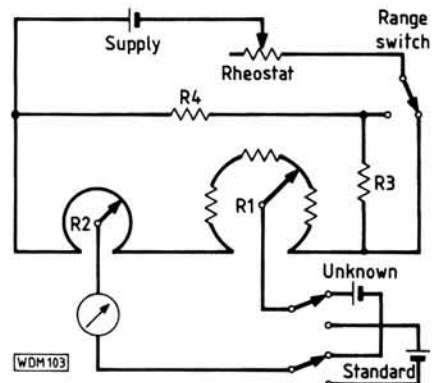

Fig. 4.2

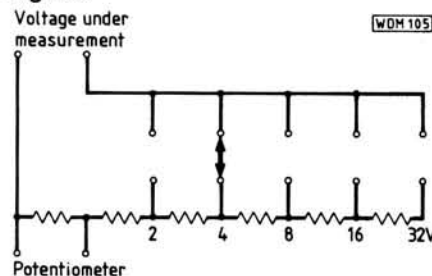

Fig. 4.4

of limiting resistor, i.e. a series resistor to drop the extra voltage that the potentiometer cannot handle. Silver contacts and manganin resistors are also employed in the volt box and because of the good accuracy, these instruments are used to calibrate d.c. wattmeters and ammeters.

The voltage divider chain of the volt box is a compromise. If a high resistance divider is used to keep the current drain low, then the galvanometer is not as sensitive. Also, low value resistors are more stable.

DID YOU KNOW?

That Marconi celebrated his first successful British demonstration by buying a bicycle?

After a not encouraging entry into Britain, during which some of his apparatus was broken by over-zealous customs officials, Marconi was, in 1896, invited to demonstrate his system before chief engineers and other experts of the British Post Office, including Sir William Preece who had

already done successful work in this field. The twenty-two-year-old Italian set up one transmitter and one receiver on the roof of the Post Office in St. Martins-le-Grand, London, and another transmitter and receiver on the roof of the Savings Bank Department building in Queen Victoria Street, a few hundred yards away. Sir William quickly wrote a few sentences on a sheet of paper and handed it to

Marconi, who thereupon tapped them out in Morse in bursts of sparks on his transmitter. Almost immediately his receiver began to repeat Sir William's message in Morse: it had been transmitted and received in both directions faultlessly. The demonstration was a complete success, and Marconi celebrated by buying something he had wanted for a long time—a bicycle.

Eric Westman

Practically Yours

by Glen Ross G8MWR

In last month's article we looked into the problems of antenna gain versus boom length and the number of elements involved and found that things were not very straightforward. This month we are going to look into some of the problems which have to be sorted out when we come to try and get more gain by stacking antennas for the same band or, much more commonly, when you stack two or more antennas for different bands.

You may perhaps have a sneaking suspicion that there is rather more to it than just bolting the antennas onto the mast and hoping for the best, and you would be right. We will assume that you are going to stack the antennas one above the other and that the antennas are set for horizontal polarisation. Although reference is made to v.h.f. beams in the examples, all the information is just as valid on the h.f. bands.

The Simple Way

The most common problem is probably that of stacking beams for two bands, perhaps 144MHz and 430MHz, on the same mast; what should the spacing be? Most people will tell you to put them as far apart as you possibly can and provided you can get them a few metres apart this is good basic advice, although it does ignore a lot of technical points that really should be taken into consideration. The usual practical problem, though, is the fact that you have, perhaps, only a short stub mast available to mount the beams on and really wide spacing is therefore not possible.

Getting Started

As a rule of thumb it can be stated that if the antennas are on the same band then the minimum spacing between them should be one half the boom length of the array. If the antennas are on different bands then the spacing may be half the boom length of the higher frequency antenna. There is, however, rather more to it than this oversimplified rule of thumb would appear to indicate.

In a stacked array for two bands the

larger lower frequency array will tend to appear to the higher frequency antenna as a ground or earth plane. We all know that the impedance of any antenna varies with height above ground and that it passes through its free space value at a quarter wavelength above ground and at multiples of that height. Multiples of quarter wavelengths as spacing distances would, therefore, seem about right to keep the feed impedance correct and the s.w.r. at a low value.

Radiation Angle

Things are rarely so simple and we still have another problem to look at. When the antenna is mounted at a quarter wavelength or ODD multiples of quarter wave above ground then the ground acts as a reflector, so causing a lot of your precious r.f. to depart at high radiation angles which is not at all what we want. This effect is at a minimum when the antenna is at the EVEN multiples of quarter wavelength above ground, or effectively the larger antenna, which is also the point where it passes through the free space impedance. The effect of spacing on the larger array is usually negligible and if very narrow spacings have to be used then the thing to watch for is a variation in the feed impedance of the smaller antenna.

Rematching

If you have an antenna with a built-in matching section of some sort then this can be adjusted to bring the s.w.r. down, unfortunately few commercial antennas have this facility built in. Even if this adjustment is made, remember you may still be getting your r.f. squirted rather uphill; there is no alternative to correct spacing if you want the optimum results from the array.

If you are stacking antennas for the same band then the spacing required varies with the gain of the antenna. Up to four or five elements, the spacing should not be less than a half wavelength but five eighth spacing is better. By the time you get up to ten or twelve

element Yagis then the required spacing goes up to around two wavelengths.

This means that using two ten-element Yagis on 144MHz you would need a spacing between them of at least 3.9m and 4.5m would be better.

Baying

This is the system where arrays are mounted side by side, and usually consist of two pairs of two Yagis made up into a box configuration. The important point here is the spacing between the ends of the elements rather than between the booms, although the end result is the same. To obtain the best gain in this configuration the spacing between the element ends should be at least five eighths of a wavelength, something like 2.4m at 144MHz. Assuming you are stacking four 8-element 144MHz antennas into a box array this would mean that you need boom to boom spacing of about 3.6m in the horizontal direction and 4.5m in the vertical if you want full gain.

Side Lobes

As the bay spacing is increased the main lobe, and hence the gain, becomes sharper but there is also an increase in the side lobe content. This can result in some misleading directivity patterns. Two 4-element Yagis spaced at a halfwave horizontally will have a beautifully clean pattern with virtually no side lobes. This can give the impression that all the radiation is going forward, in fact there will be only a small gain from this baying. What you have really done is to set the baying so as to minimise the side lobe radiation rather than optimise gain.

Conclusion

From all this it can be seen that if you want really high gain you end up with some really impressive dimensions and a lot of problems in keeping the beast up in the gales. You are also going to need a heavy-weight rotator with a good braking system to control the whole thing. Not something to be embarked on without a lot of thought.

ERRORS & UPDATES

PW "Axe" Signal Tracer May 1987

The track-side pattern of the probe p.c.b. shown in Fig. 3 is incorrect. The pad associated with the collector of Tr1 should be connected to the positive supply track. The solution is to

connect a link between pin 3 +V and the collector of Tr1. All p.c.b.s marked WR230a*, bought from the *Practical Wireless* p.c.b. service are correct and need no further modification. The board WR230a* cost £5.07 including VAT and p&p for the UK. Add £2.00 per order for despatch to overseas addresses. See page 53 for more details.

MAIL ORDER IS OUR SPECIALITY

58 High Street, Newport Pagnell, Bucks. MK16 8AQ.

Kenwood

Table listing Kenwood products and prices. Includes 'SPECIAL OFFERS WHILE STOCKS LAST' and a 'P&P' column.

Royal Blue



Photo Acoustics have pleasure in presenting the ROYAL BLUE — a Short Wave Listeners folded dipole antenna...

To buy this superb new antenna, just send us £25, plus £3 for postage and packing and we will rush one to you.

Receivers

Table listing various receiver models (Trio R2000, Trio VC10, etc.) and their prices.

Icom

Table listing Icom products such as IC751A HF Transceiver, IC275E 2M Multimode Base Station, etc.

Power Supplies

Table listing power supply models (DRAE, BNOS) and their specifications.

Aerial Rotators

Table listing aerial rotator models (DAIWA MR750E, KR400, etc.) and their prices.

Switches

Table listing switch models (Sigma, Welz CH20A, DRAE) and their prices.

CW/RTTY/Equipment

Table listing CW/RTTY equipment including Hi-Mound Morse Keys and various squeeze keys.

CW/RTTY/Equipment (cont.)

Table listing CW/RTTY equipment including Packet, Amort, RTTY, CW, ASCII transceiver, and various software.

Heatherlite

Table listing Heatherlite products like HF Explorer amplifier and Yaesu mobile safety microphones.

Table listing Trio mobile safety microphones.

Table listing Icom mobile safety microphones.

Table listing KOK mobile safety microphones.

Table listing FDK mobile safety microphones.

Table listing Standard mobile safety microphones.

Table listing For Hand Portables like IC2E, IC4E, IC02, IC04.

Aerials

Table listing various aerial models (GSRV, HB9CV, etc.) and their prices.

Table listing Special Offer products like Alnico ALM-203E and Alnico ALR206E.

NORTH LONDON AGENT: JIM SMITH G3HJF, 64 Galley Lane, Arkley, Barnet, Herts. EN5 4AL.

SPEND UP TO £1,200 INSTANTLY WITH A PHOTO ACOUSTICS LTD. CREDITCARD CARD — APPLY FOR DETAILS PART EXCHANGE WELCOME, ASK FOR KERRY G6IZF OR ANDY G4YOW RETAIL SHOWROOM OPEN TUESDAY-FRIDAY 9.30-5.30, SATURDAY 9.30-4.30

PW REVIEW

How about an accurate clock for the shack? It could certainly make logging much easier for both amateurs and s.w.l.s. Mike Richards G4WNC looks at the Cirkit MSF receiver and REWBICHRON 2 kits.

MSF Rugby

MSF is the callsign of the standard frequency station at Rugby which radiates a very accurate 60kHz carrier. This carrier is keyed every second with variable width pulses which contain the data for establishing the time and date. The reference for these transmissions is the Caesium Beam Standard at the National Physical Laboratory, so the accuracy is excellent. The data transmission rate is a sedentary 1 bit per second and is known as Slow Code. To determine the value of each data bit the pulse width must be examined, with a 100ms pulse indicating a binary 0 and 200ms a binary 1. This is known as first level data.

Data is sent as b.c.d. (binary coded decimal), which requires 4 bits per digit. To validate the data at the end of each minute, parity bits are sent as second level data. This is added after the first level data described earlier. The timing details for first and second level data bits are shown in Fig. 1.

Circuit Description

The 60kHz receiver is required to produce a t.t.l. compatible output which follows the carrier interruptions of the MSF signal. The reception of 60kHz presents several problems, not the least of which is the high level of QRM from television timebases. If using a 455kHz i.f., as in this case, the powerful medium wave broadcast signals present image problems for the receiver to further complicate the situation.

To maintain as high a *Q* as possible, and hence achieve maximum selectivity, the ferrite rod antenna is fed to the gate of a 2SK55 f.e.t. source follower. The output of this stage is fed via an adjustable attenuator to a low pass filter to overcome any image problems. The filtered 60kHz signal is applied to the input of a ULN3859 f.m. receiver chip which produces both audio and logic output. The logic output is actually produced by utilising the noise muting section of the ULN3859 which gives added noise immunity. In order to obtain good overall selectivity the receiver uses an 8kHz bandwidth ceramic filter for the 455kHz i.f.

The logic board uses 8 i.c.s to decode the MSF data and provide multiplexed outputs for the l.e.d. display and an external port. The heart of the logic

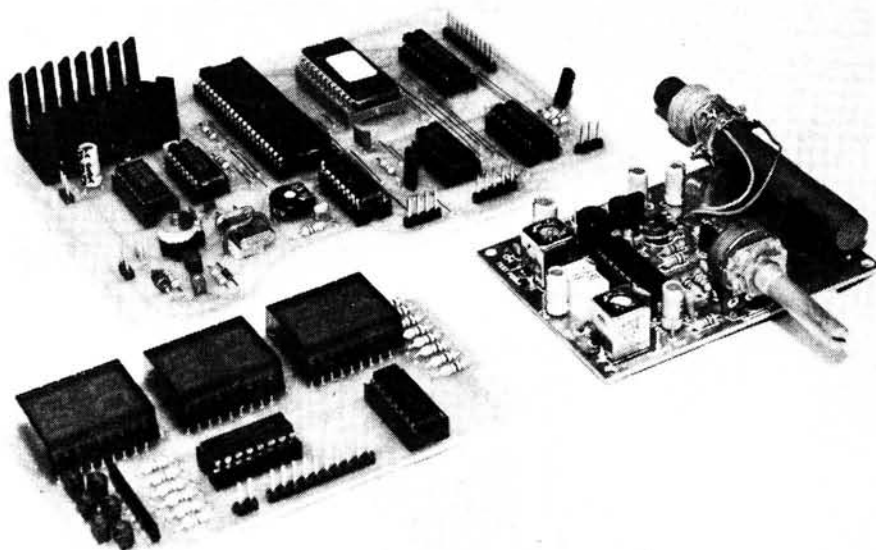

board is a standard Z-80 c.p.u. with its software in e.p.r.o.m. and the data output bus buffered by a 74LS373 octal latch. A crystal oscillator running at 3.2768MHz feeds a 4060 divider to supply the 1.638MHz c.p.u. clock and an accurate 100Hz interrupt pulse for the clock. All data is output on the data bus under the control of strobe lines, one set for the display and one for external use. Both the strobe lines are supplied erect and inverted to give maximum flexibility. The software for the external port sends 7 bytes of parallel data, containing the full data and time information, every second. All the output data from this board is in b.c.d. format as is normal for display drivers. In order to adjust the display brightness the strobe pulse width is made adjustable with a pre-set potentiometer on the logic board. Finally to ensure proper starting a circuit is included to reset the Z-80 when the power is first applied.

The display board accepts the multiplexed output from the logic board and converts it into a form suitable for driving the display. Of the 8 data bits

sent from the logic board, the lower 4 contain the digit to be displayed in b.c.d. format, and the upper 4 contain information to show which device should display the digit. Conversion from b.c.d. to seven segment is achieved using a 7447 i.c., the output of which is commoned to all 6 display devices. To derive the address information in the upper 4 bits a 74LS138 3- to 8-line decoder is used. The final demultiplexing is achieved using buffer transistors connected to the output of the 74LS138.

Construction

The complete clock requires the construction of three modules, the receiver, processor and display. As a clean demodulated MSF signal is required to check the other modules, the receiver should be tackled first. It would seem that there have been problems with this kit in the past as there is a new p.c.b. layout and the instructions warn that the p.c.b. overlay printing is wrong. There are also some discrepancies in the supplied circuit description. But all that aside, if the kit is constructed as per the new layout all is well.

The supplied components were good quality and the p.c.b. was double sided with the top side forming a ground plane. The constructional information supplied with the kit was minimal and assumed the constructor would be well experienced. As with the construction, alignment was fairly straight forward but virtually no guidance was given.

The procedure used for the review
Practical Wireless, July 1987

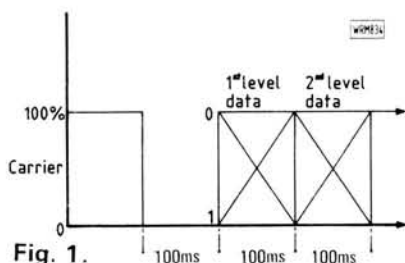

Fig. 1.

kit was to set the local oscillator frequency first, this should be 515kHz and can be measured at the test point. The output level at this test point is only a few millivolts and may be too low for use with a frequency counter, if this is the case then a good quality communications receiver tuned to 515kHz can be used.

Next stage is to set up L3 for symmetrical limiting at the audio output. The final r.f. adjustment is to position the coil on the ferrite rod antenna for maximum signal strength. The potentiometer RV1 sets the Schmitt trigger threshold and should be adjusted for clean data pulses.

Logic Board

This logic board is constructed on a single sided glass fibre p.c.b. which was supplied drilled and plated. As with most logic kits using single sided p.c.b.s, a fairly large number of wire links are required, 20 in this case. All the i.c.s were supplied with sockets and all components were again of good quality;

The supplied instructions, although giving good detail on the operation of the unit, offered very little constructional help, but the experienced constructor should have no problems.

Display Board

The display board supplied was a new design utilising AEG high efficiency l.e.d.s as there had been supply problems with the previous type. As with the previous units minimal constructional information was supplied. The construction presented no problems except that yours truly managed to insert one i.c. backwards, still nobody's perfect!

Testing

The first task is to ensure that the receiver is working properly before attempting to test the complete clock. Both the position of the ferrite rod coil and the rod direction are very critical so some experimentation is required to achieve success. In order to obtain clean signals you may have to move the receiver away from the logic board as this board outputs a lot of QRM.

Once the receiver has been set up to output clean pulses, the logic board and display board can be connected up for testing. If all is working, you will see the left hand two digits alternating between 0 and 1 at the same rate as the l.e.d. on the receiver flashes on and off. After about a minute of clean signals the display should burst into life showing HM:MM:SS, (Hours, Minutes, Seconds). If the control pins have been left open circuit every 15 seconds the display will blank for 1 second, show the date for 2 seconds, blank for 1 second, then resume showing the time.

Having achieved success we can move on to examine the other features of this clock. As with all microprocessor based items the heart of the unit is

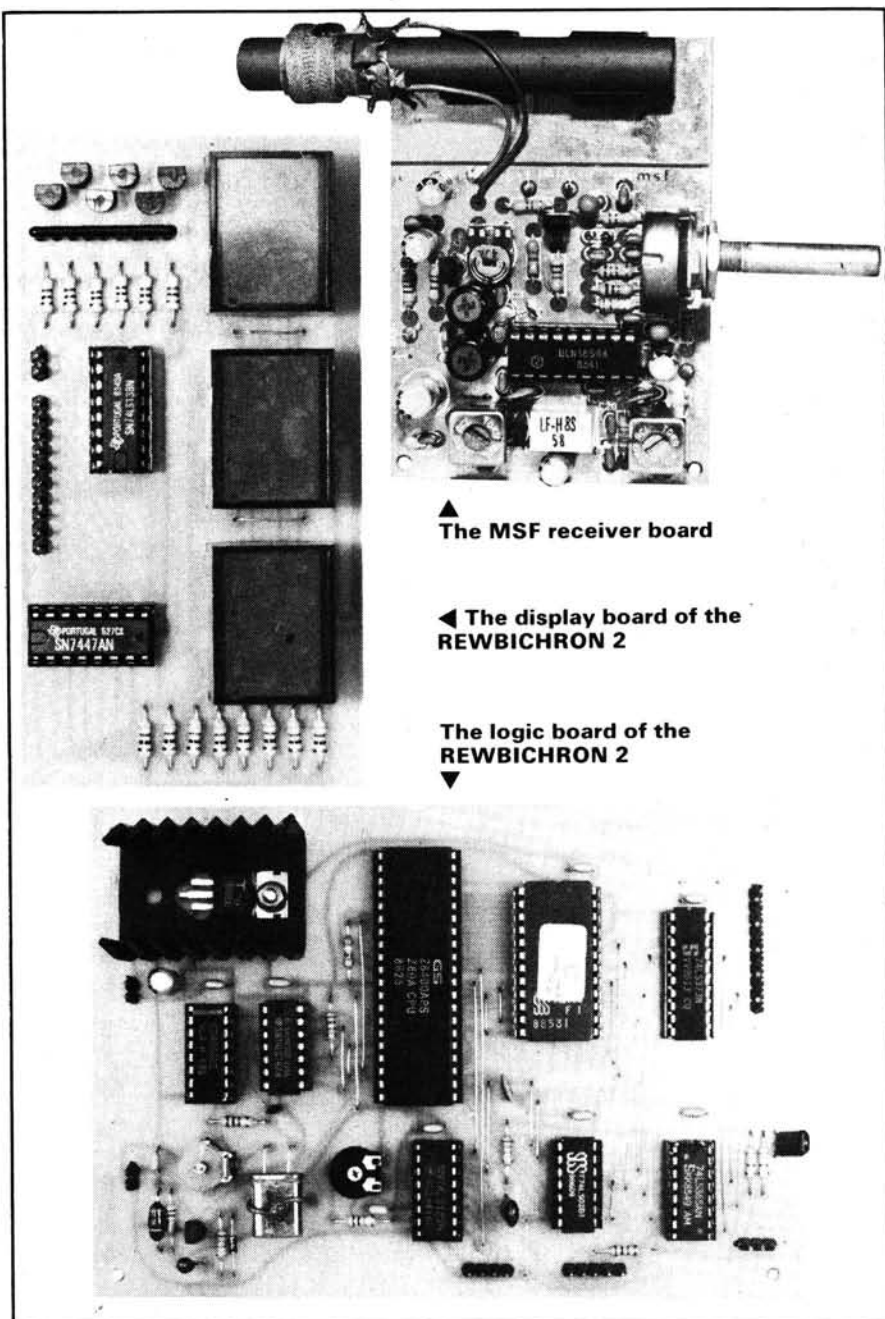

▲ The MSF receiver board

◀ The display board of the REWBICHRON 2

▼ The logic board of the REWBICHRON 2

the software, which in this case is in its second version. Although the format used for sending the data has a parity check it is still possible to receive errors and these must be trapped by the software. In this clock all data is checked before display and ignored if considered wrong, i.e. 31 November. In the event of corrupt data the clock displays the last correct date it received and reverts to its own internal clock for time details. So even if the Rugby transmission disappears completely the clock will continue to run and then lock onto Rugby as soon as the transmission resumes. To indicate to the user that either corrupted data, or no data at all, has been received the seconds display (the last two digits) is blanked for 1 second on the minute. The display format can also be changed to 12 hour, or time only, by grounding the appropriate control pins. One very useful feature is the general purpose output which sends 7 bytes of data, containing all the date and time information, every second.

Summary

This is definitely a kit for the experienced constructor, as the supplied instructions included only brief constructional notes. The clocks' ability to continue working during periods of signal loss can prove particularly useful in the shack. This is because the relatively high r.f. levels found during transmission may obliterate the Rugby signal.

In its present form, the clock displays local time. I personally would like to have the option of a UTC (GMT) display, saving the log keeping calculations during the summer. Overall then, a useful kit for the shack which will provide a very accurate show piece.

The MSF receiver kit costs £10.51 and the REWBICHRON 2 kit costs £32.49. Both are available from **Cirkit, Park Lane, Broxbourne, Herts. Tel: 0992 444111** — many thanks for the review kit.

Computing Corner

I am sure that many will have already expressed good wishes to *PW* and *SWM* under the new arrangements but I should like to add my support to these. I hope that through these pages I shall be able to provide information of use to users of the wide variety of micros available today.

I should like to say a brief word to those thinking about buying a micro for the first time. I get many letters asking me about the availability of radio-orientated software for a very wide range of micros. For some, I have to answer along the lines that at present there is none or at best very little. In a number of cases I know that micros have been re-sold for the sole reason that no software could be purchased at the time.

If you are buying a micro and especially if you are a non-programmer, remember that it takes a lot of time and effort to write worthwhile software especially for c.w./RTTY, etc.

Remember that the more expensive the micro generally, the fewer the users and consequently the fewer likely sources of commercial-quality software. If the micro is a new model then there will be few users and fewer experienced programmers able to write software.

If the machine uses a lesser-known processor (like the 68008 in the Sinclair QL) then there will be very few experienced machine-coders available to write the complex programs required. Indeed, I am convinced that this is the reason why we still have little professional software for this machine.

Finally on this subject remember that "public domain" software writers have their limits. It is unlikely that they can continue to expand their support indefinitely on a growing range of machines. If you buy a new model or a "minority" micro then be prepared for a long wait for those complex applications.

If your micro uses some of the well-known processors then the Public Domain Software Library may be of use. They have programs available for a wide variety of machines. Send an s.a.e. to PD Software Library, Winscombe House, Beacon Road, Crowborough, Sussex TN6 1UL for more details.—Ed.

On a more positive note, your new micro need not be totally idle in the ham-shack. Almost all micros will have a database application readily available and these make an excellent log-keeping facility!

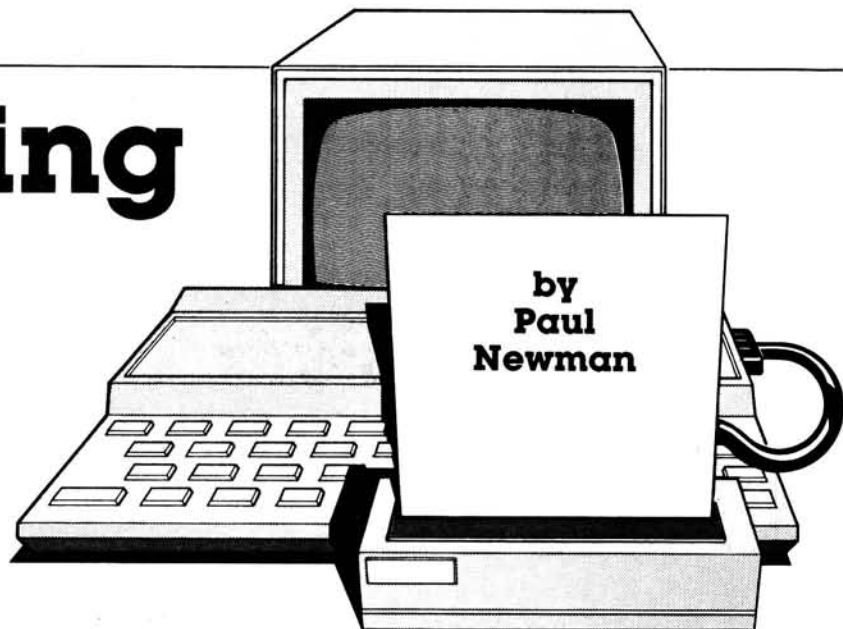

C64 DATABASE —some minor corrections

Alan Morris sent in a few minor corrections to his database program published with my last article in *SWM*.

The control characters appeared to cause some people trouble; they are:

Square symbol in lines 110, 1540, etc., = print cursor black

reverse heart symbol = print clear screen

reverse Q symbol = print cursor down

symbols on lines 160, 490, 670, etc., reverse vertical line = 3 times cursor-left

reverse R = reverse on symbol after reverse on in lines 180, 190, etc., = reverse off

reverse uparrow in 1540 = print cursor in green

The word SAVE in line 1420 should be SHOW. The word NAME in 1650 should be CALLSIGN.

This program seems to have been well received and I look forward to including others from time to time. Any contributions or ideas are of course welcome—but please—NO "locators" programs.

Manuel CTICO writes that there is practically no software available for his C64 in Portugal. The pages of *QST* and *73* magazines are, in my experience, a good source of software and I know that the C64 has featured prominently over the past few years. Issues going back to 1975 (and earlier) can provide useful information. Perhaps this may help both Manuel and others. The pages of *PW*, *RadCom* and *SWM* also provide the addresses of companies who will send their radio programs for the C64 anywhere.—Ed.

References (iii), (iv), (v) and (ix) might be of use to C64/C128 users.

The pages of foreign amateur radio magazines in general can be a useful source of supply of ideas and programs and although the language problem

obviously is a snag, many applications are self-evident either from circuit diagrams or programs. I've added a few references which might interest users of other micros (vi, vii and viii).

I remind you that GM4ANB maintains a register of radio computer software in both the public and commercial domains and that this is available from him in return for a stamped envelope.

Compilers on the Spectrum

I know that some will be both interested and amused by my having to "eat my words" with respect to the use of BASIC compilers on the Sinclair Spectrum. I have attempted to use several and found them to be laughable at best. Well now I have to eat my words because HISOFT (i) have brought out HiBasic which is indeed a full-scale compiler for the Spectrum. And it really works!

With only very minor limitations, HiBasic compiles all of Spectrum BASIC into code requiring a minimum of run-time routines. As an illustration, I compiled RUSCON—the RS5, 7 and 8 orbit predictor program by GM4IHJ and the AOS (acquisition of satellite) table took three minutes to print as against almost 15 minutes uncompiled! Bearing in mind that this program is very heavily maths-bound this speed-increase is no mean achievement especially when I made no attempt to rewrite the BASIC into a form which will compile into faster code.

Conversion of most BASIC programs to the compilable form is a very simple matter indeed and compilation is rapid.

Nearly all the GM4IHJ range of satellite programs should be available in compiled form by now. For other radio applications in BASIC, the compiler is a very worthwhile utility.

Practical Wireless, July 1987

Rotor-control by Computer

I am sure that many micro users who access satellites for any reason will be interested to know that full computer-control of antenna rotors in azimuth and elevation is now possible for a wide range of computers.

The "Spectrum West" (ii) autotrack interface is designed for use with the C64, Vic 20, TS1000/2000, TS2068 (Spectrum?), ZX81 (16K) plus any standard addressable model like the IBM, Apple, Digital and Radio-Shack PC's.

Any potentiometer type rotor may be used (such as the Kenpro KR400 or KR500) and no extra outside wiring is required—it's all done in the shack. Full control is available from the computer keyboard or through the "autotrack" mode; in fact it can be left unattended and still maintain full tracking in azimuth and elevation.

All Low Earth orbit satellites are in the program which can be user updated for others as they come along.

I am informed that a complete interface and program costs about £110 although this does not allow for Customs Charges, VAT or postal costs. If you are interested in the system I suggest you contact Spectrum West Direct for export-order details. My thanks to Bob WA6DLI for this information.

Amstrad CPC-range users who require satellite predictor programs are invited to contact the author (x) since authorisation to convert his excellent range of software has been obtained from John GM4IHJ. The h.f. predictor WOTSON is also being converted. Conversion of most programs should be completed by the time you read this.

This is in line with the decision to extend support to the Amstrad range of micros (CPC only at present) since correspondence indicates that material for these micros is in relatively short supply.

Two new Spectrum predictor programs are available: TENSAT incor-

porates prediction for NOAAs and Meteosats, and EQXER takes one day's EQX (equatorial crossing time) and can turn it into another's (plus/minus 10 days); all the usual daily increments are also given. Since both these programs use EQX data you might find ELIPRS more suited to prediction of Meteosats since this uses Keplerian element data only. Details as (x).

The promised NOAA satellite picture-system on the Spectrum will, sadly, never see the light of day. Although developed to a high degree it has been decided not to release it generally on the grounds that the company concerned cannot support it. It is a specialised system requiring for example, a very stable, 50kHz i.f.-bandwidth receiver of which there are only two kits available commercially. Producing this as a finished system is out of the question due to pressure of other commitments.

Having had a part in encouraging its development I am naturally disappointed to see the loss of this system but have to agree with the decision.

I encourage those interested in weather-fax and such like transmissions to explore the v.l.f. and h.f. bands with a good receiver and the G4IDE WEFAX system for the Spectrum. It can give superb results and several stations retransmit NOAA and Meteosat pictures after computer enhancement. The infra-red cloud-cover im-

ages can be particularly impressive at times.

And finally for this issue, Spectrum Plus-2 users will find help in installing an EAR socket and r.f. screening in recent SARUG newsletters—see reference (x). These appear in issues 26 and 27.

References

- (i) HiSoft, The Old School, Greenfield, Bedford MK45 5DE.
- (ii) Spectrum West, 5717 N E 56th Street, Seattle WA 98105 USA. Tel: (206) 523 6167.
- (iii) KA9GLB, 4880 N 49th Street, Milwaukee WI 53218 USA; a catalogue is available for return postage (use IRCs).
- (iv) C64/C128 Software, Box 387 Chillicothe, OH 45601 USA again with return post.
- (v) CW tutor for C64 *Megahertz*, January 1986.
- (vi) Apple-II Morse decoder *Megahertz* May/June 1986 pp 40-44.
- (vii) Contest with IBM-PC *Megahertz* April/May 1986 pp 42-49.
- (viii) FAX on Oric *Megahertz* November/December 1984.
- (ix) ANARC Computer Committee, 670J 153rd Lane NW, Anoka MN55303 USA. Enclose some valid IRCs for information.
- (x) Paul Newman G4INP, 3 Red House Lane, Leiston, Suffolk IP16 4JZ. S.a.e. essential in all cases.

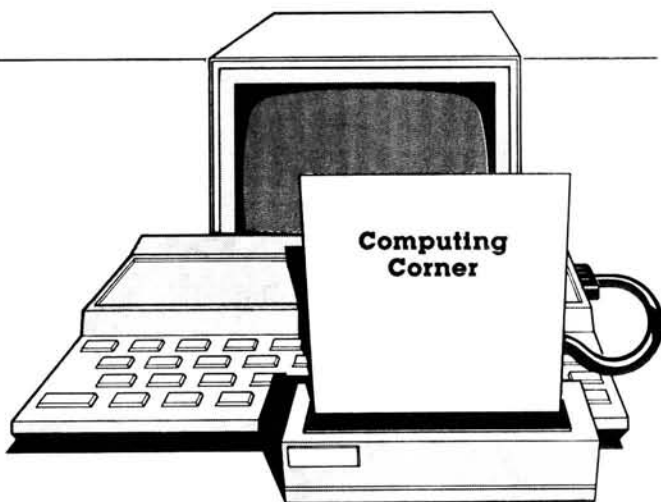

HAVING DIFFICULTY GETTING YOUR COPY OF PRACTICAL WIRELESS ?

Then place a regular order with your newsagent **NOW!**

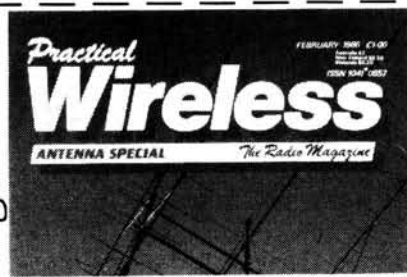

Dear Newsagent, please reserve/deliver my monthly copy of PRACTICAL WIRELESS

Distributed by Comag

Name _____
Address _____

Signed _____

Confessions of a Radio Inspector

Roger Lancaster looks back on a brief period of his life spent in New Zealand's South Island

During the latter half of the year 1960, fate had decreed that I should be radio officer aboard a tiny tramp ship plying the stormy seas around the Australian and New Zealand coasts.

The radio gear was minimal: an ancient two-valve main transmitter (410–512kHz only), a 2MHz short-range radiotelephone set, basic super-het receiver, electromechanical automatic alarm, clockwork autokey and a direction finder whose loop had to be cranked around by hand. There was no radar or echo sounder.

Eighteen months before this I had sailed aboard large passenger liners, bristling with the latest equipment. Now my spirits were very low.

Technically, the job held no challenge and I began to think in terms of a career ashore. At the height of a particularly bad storm one evening, the sight of a plateful of the cook's pork stew finally decided the matter.

I was very fortunate to land a job as a Trainee Radio Inspector, based at the main post office of Christchurch in New Zealand's South Island. The salary was a handsome £750 a year and my title sounded very impressive provided the word trainee was discreetly dropped.

I was the junior member of a team of four and we carried out a wide variety of work. We conducted radio amateur examinations and inspections, ship radio inspections at the port of Lyttelton nearby and aircraft radio inspections at Christchurch International Airport, yet we spent very little time in these activities.

Sledge Hammer

Ninety-five per cent of our work consisted of investigating complaints of interference to broadcast radio reception. Television had not yet reached the peaceful shores of the Land of the Long White Cloud: people had to pay a licence fee for broadcast radio reception and they were entitled to enjoy this free of interference. Our area covered the whole of the Canterbury Plains, from Hanmer Springs in the north to Ashburton in the south, from the Pacific Ocean in the east to the Southern Alps in the west.

The national network of overhead power lines afforded a common source



of interference. A damaged insulator would encourage arcing and the r.f. noise generated could travel for miles along the power lines, re-radiating and causing a nasty crackling sound in receivers over a wide area. It was our job to trace the offending pole and report it to the electricity department.

The method of pole detection was only partly scientific. We had a Standard Vanguard estate car fitted out with sensitive receivers, signal strength meters and direction-finding loop on the roof. Using the signal strength meters we could narrow the noise source down to within four or five poles. From there we employed a most useful tool which we always carried in the back of the car—an enormous sledge hammer. A hefty whack with this on each suspect pole would soon reveal the culprit—the noise would vary tremendously. On one occasion I bashed a pole and the noise ceased altogether and no matter how much more I hammered, the noise would not start again—a truly macro version of the “knowing where to hit” method of fault-finding.

The opening of thermostats and subsequent arcing could cause interference which often spread to several neighbouring houses. The noise sound-

ded like somebody blowing an enormous “raspberry” every few minutes. A certain popular model of refrigerator at the time contained a thermostatically-controlled butter conditioner which was particularly notorious for this.

An elderly couple in Ashburton once demonstrated this noise on their radio. Confidently, I asked to see their refrigerator, fully expecting to be led to the familiar model. After giving me long, quizzical looks, they took me out of the back door of the house, round a little path behind a bush, and there they unrolled a stone covering a brick-lined hole in the ground, at the bottom of which lay a joint of lamb, a bottle of milk and some cheese and eggs!

The general method of locating thermostat noise was simply to go around turning off all likely appliances until the noise stopped. But it was possible to be deceived.

Telephone Receiver

We had a case of such a noise in the main street of a small town. This interference was much less regular in its occurrence than normal. Several times we thought we had found the source but the noise kept reappearing.

Practical Wireless, July 1987

It was still there after three weeks of investigations. Finally one day we were sitting in the car listening for it, when we suddenly noticed that it coincided with the raising and lowering of a hydraulic car hoist at the local garage. On inspection, the wiring of the hoist controller was in an appalling state, and this proved to be the cause.

One lady complained that her radio reception was very poor except when she answered the telephone, whereupon the volume would rise as if to compete with her telephone conversation. The prospect of discovering such a demonic radio set intrigued me, but my more experienced colleague had heard it all before. At this time, ferrite rod components were rare and most receivers still had to rely on a good wire (preferably outdoor) antenna and a good earth. This lady had run her antenna around the living room, parallel to the telephone cable. It was a poor antenna but its performance was greatly enhanced by capacitive coupling to anyone who picked up the telephone receiver.

Plumbing Problems

Another common antenna-related complaint rejoiced in the title of "vent-pipe static". Many of the houses were wooden, with corrugated iron roofs. Often a vent or overflow pipe connected to the hot water cistern would pass through the tin roof. If the pipe made intermittent contact with the roof, this could cause a crackling noise on the radio which became worse in windy conditions. The remedy was either to bond the pipe and roof together electrically or to make sure they were well insulated from each other. Bonding was usually the easier method. But first, vent-pipe static had to be proved to be the cause. The procedure was to gently shake the hot water cistern and note whether this produced the crackling noise.

I went through this operation at one lady's home, but the result was inconclusive, so I gave the cistern a more vigorous shake. I still wasn't convinced, so I heaved the cistern to and fro with all my might and finally decided it was a mild case of vent-pipe static. I left details of how to effect the cure and went on my way to pay more calls before returning to the office. There, my boss, with a pained expression on his face, informed me that the lady had telephoned to complain bitterly that her house had been flooded by a leaky hot water cistern shortly after my departure.

I had to return the next morning to apologise. Fortunately for me, the lady had calmed down overnight and could see the funny side of it. No charges were brought.

Great excitement followed a series of

reports of a pirate ham operating somewhere in the area. This was a splendid opportunity to put in some lucrative overtime work in the evenings, when the pirate was active, and also a chance to do some real sleuthing work with the direction finder in the car. We took bearings from different parts of the city and the surrounding hills, seizing the opportunity whenever the phoney callsign was heard. We felt like the Gestapo tracking down a resistance spy: "Ve haf vays of listening to your talk!"

Finally, the plotted lines on the map were seen to intersect at the dormitory of a boys' boarding school in the city. We resisted the temptation to burst in at the dead of night to uncover the transmitter. Instead, we paid a discreet visit to the headmaster's office in the afternoon. Judging by the head's demeanour during our interview, I suspect the offender suffered much more from his head's wrath than from any penalty the New Zealand Post Office could inflict. We never heard the pirate again.

Another episode involving a schoolboy (the same one, perhaps?) arose when a nine-year-old boy entered the office one day seeking a licence to operate a two-way radio link between an earth station and a satellite which he and some of his school friends were planning to send into orbit. This was a

mere three years after the launch of *Sputnik One*.

The Head of Department, a man of infinite patience and kindness, talked to the lad for over an hour, encouraging him to go on learning all he could about radio but at the same time declining his application gently, on the grounds that a licensee had to be over a certain age. The boy left disappointed but certainly not downhearted. I often shuddered afterwards at the thought of him and some of his school mates putting a lighted match to a dustbin of explosives in some Christchurch back garden, but nothing of that nature hit the headlines while I was there.

Testing . . .

In order to carry out routine tests and maintenance, we occasionally visited the emergency radio station. This consisted of a hut in a field which contained basic battery-operated radio equipment and a landline telegraphy unit — one of those clackety-clack machines seen only in cowboy films. Although I was used to Morse, I could never have read it without the aid of a note-producing oscillator. Just what kind of local emergency would render the whole of the Canterbury Plains cut-off from civilisation yet leave this little shed unscathed I never could visualise.



The occasional trip to Lyttelton docks to help conduct a ship radio survey made a welcome change, but there could be problems in this as well. One of the requirements was for the transmitter/antenna system to generate a certain minimum number of "metre-amps". Basically, this was the product of antenna height in metres and current at the base of the antenna on full power, c.w. Unfortunately the regulations were open to various different interpretations.

There was a certain coaster which we always failed on these grounds, but which our colleagues in Auckland always passed. By the time the poor Master had become used to heightening the antenna by a couple of metres every time his ship entered Lyttelton harbour, he was given another ship and the new Master ran into the same difficulties soon after taking command.

Old Scores

Sometimes, people would try to use our interference service to settle an old score with a neighbour. "That blighter at number 23 keeps using a noisy battery charger which plays havoc with my reception," would be a typical cry. (For some reason, battery chargers and vacuum cleaners were often cited as suspected causes of interference, yet in our experience they were never trou-

blesome). Standard procedure in these cases was to visit the accused party, make a routine check on his licence, then return to the complainant and tell him we'd given his neighbour a severe telling off and that there'd be no more radio interference from that quarter. This always seemed to give satisfaction.

Re-radiation

One of the worst types of interference was a rare phenomenon which we called "cross-modulation". I don't think it was correct to apply the term in this case, but we had no other word for it. Reception would be perfectly all right for hours or days on end, but at very irregular intervals the sound would become distorted on local stations—slight at first then slowly getting worse and worse until it became a horrible screech, then gradually it would return to normal, all over a period of a few minutes.

The effect was produced by corrosion between a junction of metals somewhere in close proximity to the antenna, i.e. in the user's own home. It was usually between a pipe and the tin roof, or at a pipe union. Some kind of re-radiation which changed in phase was thought to give rise to the trouble. The remedy was to bond the two metals firmly together, of course. But first, to find the exact joint!

One poor chap was plagued by this for months. We spent days and evenings at his farmhouse in the country, listening for distortion and trying different remedies. We checked all the water-pipes and drain-pipes—on the roof, in the roof space, under the floorboards, all round the outdoor tanks. We tried different antennas, earths and receivers, all to no avail. We desperately wanted to cure the trouble for him but when I left the job he was still suffering. It bothered him so much that he seriously considered selling up and moving. I often wondered about the eventual outcome.

But by this time, after six months in the job, I was impatient to move on again. The bright lights of the passenger ships were beckoning me to return and I longed to see my family in England once more.

I arrived back in Britain in the spring of 1961. I rejoined my employers of two years previously, the P&O Line. They sent me as a junior radio officer aboard their newest and biggest liner, packed with the very latest radio, radar, navigational aids, electronics and television, and just about to sail on her maiden voyage. She was called the *Canberra*.

After my sojourn in the tranquil Canterbury Plains, how very different my life was to be aboard this bustling floating hotel, full of people seeking new adventures.

But that's another story.

PW

TAKE ADVANTAGE OF THIS GREAT SUBSCRIPTION OFFER

Wherever you live, a Postal Subscription will ensure that you receive your copies of PRACTICAL WIRELESS and/or SHORT WAVE MAGAZINE regularly, through your own letterbox, before it gets onto your newsagent's shelf. Order a Joint Subscription and you will qualify for the Special Discount.

Fill in the Order Form below and post it to: PW Publishing Ltd., Subscriptions Dept., Enefco House, The Quay, Poole, Dorset BH1 5 1PP. Credit Card Orders taken on (0202) 678558.



Please indicate the type of subscription required:



£13.00 (UK)

£15.00 (Overseas)

(Prices correct at May 1987)



£17.00 (UK)

£17.00 (Overseas)



£27.00

£27.00

To: PW Publishing Ltd., Subscriptions Dept., Enefco House, The Quay, Poole, Dorset BH1 5 1PP.

Name

Address

I enclose cheque/PO (Payable to PW Publishing Ltd) £

Charge to my Access/Visa Card the amount of £

Card No.

Valid from to

Signature

YOUR ONE STOP LISTENER SERVICE!

HUGE STOCKS — BEST PRICES — GOOD BACKUP — FREE SECURICOR*

*AVAILABLE ON MOST MAIN ITEMS

WE STOCK MOST PRODUCTS
ADVERTISED IN THIS MAGAZINE

SONY ICF7600D PORTABLE COMMUNICATIONS!

Not a toy, but a serious communications receiver 150KHz-30MHz AM/SSB plus FM 76-108MHz Digital readout, memories, clock and provision for external antenna Listen to the DX at work! Mains or battery.

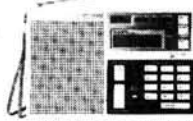

£169 FREE SECURICOR

SONY ICF2001D RECEIVER SUPER PORTABLE + BASE HF + AIR BAND COVERAGE

Described as "the best portable on the market" by a reviewer, it covers 150KHz-30MHz plus FM air band Memories scanning, etc., at a bargain price. External aerial socket and a host of other features. 230V AC or battery



£329 FREE SECURICOR

SONY AIR-7 HAND-HELD AM/FM 108-176MHz + LW/MW/FM UNBEATABLE VALUE

The best VHF monitor there is. That's a fact! 108-176MHz plus LW/MW/FM broadcast Covers air, marine, PMR, etc LCD display, memories, scanning, lockout, priority, etc. Supplies are short but we are the UK's largest stockist. So check with us!



£247 FREE SECURICOR

TR10 R5000 JUST ARRIVED! TOP SPECIFICATION RECEIVER

The newest and best receiver so far from Trio. A high specification covering 100KHz-30MHz AM/FM/SSB/CW Comprehensive facilities include memories and scanning, etc. Send today for full specification. PX welcome!



£895 FREE SECURICOR

ICOM R71 PROFESSIONAL "RECEIVER" A SUPERB PERFORMER

The flagship from ICOM. A high performance receiver that many regard as the best available at anywhere near the price. Covers 100KHz-30MHz and has a host of features. Send for specification sheet.



£815 FREE SECURICOR

ICOM R7000 VHF/UHF MONITOR COMPLETE COVERAGE TO 2GHz

The best VHF/UHF monitor on the market! 26-2000MHz and highly sensitive. It's not cheap but it really is a superb monitor for the serious user. Every possible facility you will ever need!



£939 FREE SECURICOR

TRIO R2000 HF RECEIVER POPULAR BASE MONITOR

Well respected, it covers 150KHz-30MHz AM/SSB/CW plus memories, scanning, digital readout and optional VHF module 118-174MHz. Like all Trio equipment it has a super specification



£637 FREE SECURICOR

GLOBAL AT1000 AERIAL TUNER

The AT1000 is a receiver aerial tuner designed to give you maximum performance from your receiver. Covering the frequency range 150KHz to 30MHz it matches all the modern receivers produced in recent years. Ideal for matching long wire, dipoles or balanced feeder.

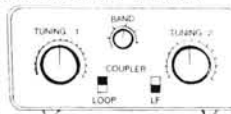

£69.00 POST FREE

AMSTRAD COMPUTERS IN STOCK

Part Exchange Ham Gear Welcome!

We can now supply the complete range of AMSTRAD computers from stock plus accessories and software. So now you can buy your computer equipment from your reliable ham radio store. We are approved stockists and can offer on site service contracts if required. You can also save £'s by part exchanging your ham gear. Prices below INCLUDE VAT and Securicor to your door.

PC8526	Single disc Word Processor	£425.00
PC8512	Dual disc Word Processor	£573.00
PC1512DM	Dual drive PC mono	£840.00
PC1512DC	Dual drive PC colour	£835.00
PC1512HDM	20Mb PC mono	£1030.00
PC1512HDC	20Mb PC colour	£1219.00
DMP3	Printer	£195.00
DMP4	Printer	£395.00
CPS8256	RS232 Interface for PCW	£62.95

SOFTWARE

Wordstar 1512	£65.00	Supercalc 2 PCW	£49.00
Supercalc 1512	£65.00	Locospell PCW	£39.00
Reflex 1512	£65.00	LocoMail PCW	£39.00
Sidekick 1512	£29.00	Ability 1512	£89.00
Sage Bookkeeper PC	£89.00	Sage Accountant PC	£139.00
Sage Accountant +	£179.00	PC Promise	£65.00
Gemdraw	£79.00	Flight Simulator	£44.00

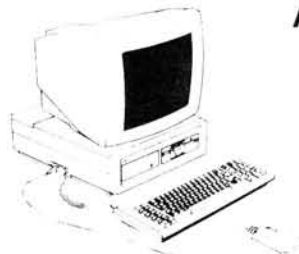

AMSTRAD OFFER!

COMPLETE BUSINESS PACKAGE

Save over £150 on a complete business package. Comprises the PC1512 with dual disk, mono monitor, interface lead and the DMP3000 dot matrix printer. Plus free software comprising Wordstar 1512 and Supercalc-3 spread sheet.

~~£976.00~~

£799.00

BOOKS SPECIALLY FOR YOU!

**COMPLETE
VHF/UHF
FREQUENCY GUIDE
26-2250MHz**
£4.95 + 80p p&p

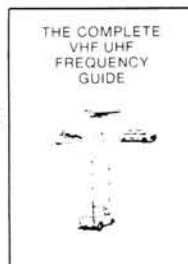

This guide has sold over 4,000 copies since its publication last August and is still selling well. Mainly because it is recognised as being of tremendous value and unique in radio literature. If you are one of the many who are curious to know who transmits where, in the wide VHF/UHF spectrum, then this is a guide that you should not be without. This book gives comprehensive details of all the main users of this part of the radio spectrum. The frequency range is subdivided into sections under appropriate headings for the type of services using the particular sub-divisions. All kinds of service are covered including land, sea, air and space. Full details are included of duplex splits for bases and mobiles plus some useful editorial. If you are at all interested in this part of the radio spectrum, you will find this a most valuable and absorbing book.

**UK LISTENERS
CONFIDENTIAL
FREQUENCY LIST
1.6-30MHz**
£5.95 + 80p p&p



NEW FOURTH EDITION

1978 EDITION This famous listing is now in its fourth edition. Completely updated for 1987 and a lot thicker. Yet the price is the same as the 1986 edition! Many additional frequencies have been added and of course some have been deleted where the service is known to no longer exist. Packed full of information on all that happens between 1.6 and 30MHz you will find this fascinating reading. Covering all aspects of the shortwave service, here is just a selection of the listings included: AVIATION, BROADCAST, MARINE, EMBASSY, MILITARY, RTTY, FAX, PRESS, and much more. Not only frequencies and stations, but in many cases times of transmissions as well. This is not an American import, but a UK printed manual specially for UK listeners. If you are one of the few people that haven't purchased one of these yet, then you really don't know what you have been missing. If on the other hand you have our previous editions, we know that you will want to get the latest edition. Available end of March. Order your copy today.

**VHF/UHF AIRBAND
FREQUENCY GUIDE
+ FREE UPDATE
SERVICE**
£5.95 + 80p p&p



Just published, this is the UK's foremost list of military and civil radio frequencies. Nearly three times as large as the 1986 edition and bang up-to-date. Every conceivable airfield is listed from the smallest grass field to the largest of our international airports. We have now included full airways listings plus helipads and off-shore rigs. In addition, there are listings of company frequencies, VOLMETs and miscellaneous air-to-air frequencies. Don't confuse this with other guides you may have seen. This one is REALLY comprehensive and packed with information. For the newcomer there is some interesting editorial plus photographs, and a very useful telephony designation list. Full colour semi-stiff covered in large format style makes this one of the best presented guides yet. Undoubtedly the best manual there is available to the enthusiast today. There is also a free up-date service to purchasers so you won't need to worry about the information becoming out of date. That's real service!

Better Short Wave Reception **£6.00 + £1.00 p&p**
Oceanic HF Airband Frequency Guide **£2.95 + £0.60 p&p**
World Radio HF Teletype Frequency List **£3.95 + £0.60 p&p**
World Radio & TV Handbook (1987) **£17.95 + £1.75 p&p**

Air Traffic Control by David Adair **£6.99 + £1.00 p&p**
Air Traffic Control by Ian Allan **£3.50 + £0.70 p&p**
Air Band Radio Handbook **£4.99 + £1.00 p&p**
Scanners: A VHF/UHF Listeners Guide **£7.95 + £1.00 p&p**

WATERS & STANTON

RETAIL & MAIL ORDER:- 18-20, Main Road, Hockley, Essex SS5 4QS.
Tel: (0702) 206835, 204965
RETAIL ONLY:- 12, North Street, Hornchurch, Essex RM11 1QX.
Tel: (04024) 44765
Visa and Access by telephone. 24hr. Answerphone.

SWAP SPOT

Have Sinclair ZX81 16K plus p.s.u. Would exchange for a.t.u. Also have Sony CRF320, f.m./m.w./l.w./s.w., 32 band digital RX. Excellent condition. Would exchange for Panasonic RF-8000 onward model RX. Tel: 061-743 1570. C702

Have 24GHz slotted line s.w.r. meter by Rank Precision Industries Ltd., type WQ802 complete with dial gauge etc., and spares. Cost over £700. Would exchange for a Cambridge Z88, G4FFO. Tel: Cambridge 860150. C720

Have piano accordion 48 base. In mint condition, cost £200. Would exchange for 430MHz rig in working order. G8LBW. Tel: 0707 872948. C726

Have Sommerkamp FT-290, NiCads, charger and case, 5/8λ whip, Gamma twin, 13-element Tonna, Toyo s.w.r. meter. Would exchange for suitable 934MHz equipment, Cybernet, Delta 1, NPR and any accessories. Also have FRG-7, Trio 9R59DS. Ian. Tel: 0676 40744 after 6pm weekdays, anytime Saturdays. C727

Have hi-fi system, Hitachi record deck, Eagle International stereo amplifier 20 + 20 watts power output, Ferguson stereo cassette deck, two Solavox each with 3 speakers as 35 watts per channel. All transistorised. Would exchange for AX25 packet radio unit or w.h.y.? Tel: 0704 892088. C733

Have Eddystone 750, dual conversion, variable selectivity. Very good condition, heavy! Would exchange for Eddystone EC10 Mk2 unmodified. Tel: 01-647 6157. C740

Have Apple II+/E software, mainly printer/graphic orientated with manuals, ideal for producing posters, club newsletters etc. Printshop, Newsroom, Clip Art, Fontrix plus many others. Would exchange part or all for suitable 144MHz linear or SSTV equipment. D. Bull, 103 Hawthorn Hill, Middle Wallop, Nr Stockbridge, Hants SO20 8NG. C742

Have FV101 v.f.o. and MHIB8 scanning mic. Would exchange for digital frequency meter and desk mic. Tel: 0723 366360. C743

Have FDK725X multi f.m. 144-148MHz, Heatherlite safety mic, 5/8 and 8/8 whips, Drae v.h.f. wavemeter, Titan 5/7 amp p.s.u., Baildon overvoltage protector unit (10 amp max), Slim Jim for the house. All v.g.c. Would exchange for FT-707, FT-77 or FT-7B with digi meter. Tel: 01-247 6097 daytime only. C745

Have CV2116 Klystron and some data also EMI Vidicon Tube No. 9677C. Would exchange for Ex Gov. valve receiver e.g. CR100/B28 or similar. Dave. Tel: 055934 697 (West Wales). C755

Have modern amateur photographers collection, Pentax ME, super 35mm camera—15 months old, two zoom lenses, host of accessories. Would exchange for 934MHz transceiver, matched base collinear antenna, cable. Kevin. Tel: Stoke-on-Trent 314383 C760

Have Trio/Kenwood SM220 station monitor scope with optional BS8, panoramic adaptor list £443. Would exchange for good portable multi mode i.e. FT-290R etc. Terry. Tel: 0462 35248 after 6pm. C756

Have Quad II stereo valve amps; Leak Point One stereo valves; RCA mono valves with tuner, all with pre-amps. Also Thorens TD124 deck. All good condition. Would exchange for early 1920s wireless sets, crystal sets, early books, horn speakers, components. Jim Taylor. Tel: 0202 510400. C757

Have Tandy PC6 pocket 8K computer, Trio TH21E 144MHz hand portable plus DC21, VOX headset, Thandar TC200, TP600 600MHz frequency counter, TRS80 Model 100 32K lap computer with 3.5in disc drive plus few discs, one on packet radio. Would exchange for any part(s) for AR2002 scanner. Tel: 04738 5526. C758

Have 4in reflector telescope and tripod, value £250. Would exchange for 430MHz or 144MHz transceiver or small communications receiver tuning up to 30MHz or higher. G8BSK, 290 Priory Road, St Denys, Southampton SO2 1LS. C766

Have KW77 1.8—29.7MHz s.s.b., c.w. pre-selector crystal calibrator, 11 valve receiver and Avo transistor tester. Would exchange for 1155 receiver or w.h.y.? Tel: Warrington 62410. C771

Have Yaesu FT-980, Trio-751, AR2002 scanner plus other good miscellaneous radio items. Bored with radio. Would exchange for car over 1100cc in good order. Tel: 085 883 210 anytime. C788

Got a camera, want a receiver? Got a v.h.f. rig, want some h.f. gear to go with your new G-zero? In fact, have you got anything to trade radio-wise?
If so, why not advertise it FREE here. Send details, including what equipment you're looking for, to "SWAP SPOT", Practical Wireless, Enetto House, The Quay, Poole, Dorset BH15 1PP, for inclusion in the first available issues of the magazine.
A FEW SIMPLE RULES: Your ad. should follow the format of those appearing below, it must be typed or written in block letters; it must be not more than 40 words long including name and address/telephone number. Swaps only—no items for sale—and one of the items MUST be radio related. Adverts for ILLEGAL CB equipment will not be accepted.
The appropriate licence must be held by anyone installing or operating a radio transmitter.

Have 1987 PRO 32 handheld scanner, 20 memory banks, 200 frequencies plus NiCads, mains adapter/charger plus all band Archer indoor antenna. Would exchange for Yaesu or Trio 430MHz handheld or portable preferably with accessories. Tel: 0603 867005. C803

Have Aiwa F350 tape deck and Pioneer SA-560 amp both 6 months old v.g.c. Would exchange for s.w.l. equipment a.t.u. or w.h.y.? Mr R. Mason, 53 Sanderson Ave, Irvine, Ayrshire, Scotland KA12 8DU. C806

Have Sharp C-1855E 18in v.h.f. colour TV Bands I and III, six tunable presets plus auto contrast. Ideal for TVDX. Would exchange for 144MHz equipment, base, portable or handheld or w.h.y.? S. Bishop, 22 John Street, Brightlingsea, Essex CO7 0NA. C815

Have inland waters boat outfit, Yamaha 2 h.p. outboard motor, Tabur Yak II dinghy, Moorland trailer plus lighting board, oars, life jackets all mint condition cost £790. Would exchange for AR-2002 scanner, must be in mint condition. Tel: 0204 852786. C822

Have AR88D with literature and factory fitted S-meter, insensitive CR100, CR300 with manual but no valves, plus R1155N with p.s.u. Would exchange for amateur radio gear, camera or microscope. No toys please. Tel: Medway 537471 anytime. C823

Have two Spectrum computers, datacoders, speech synth, lightpen, Centronics GLP printer, loads of software inc SSTV, Sony ICF 7600D radio, Yaesu FRT-7700, Datong AD370, cine camera and projector. Would exchange for Commodore disk drive, printer, MODEM, Yaesu NC15 charger. Tony G6RBK. Tel: 0923 662817. C837

Have Racal 1218 RX digital (GC) readout cost £600. Would exchange for Delta 934 or similar with all accessories. Mr D. Harvey, 93 Lochend Road, Gartcosh, Nr Glasgow G69 8AR. C845

Have Sharp GF-780D double tape deck hi-fi, with five-band graphic equaliser, search system, Dolby plus detachable speakers. As new, boxed worth £200. Would exchange for Trio Kenwood R600 receiver, must be in good condition. Tel: 08357 314. C850

Have JVC Radio-TV-Cassette recorder with f.m., m.w., s.w., v.h.f. TV, u.h.f. TV, in good condition, suitable for TVDX. Would exchange for Trio 9R-59D receiver, or CWR610E RTTY, c.w. decoder. Must be in good condition with no mods to receiver. Tel: 08537 314. C851

Have miniature valves. Would exchange for instruction manual for Hitachi TRK 8600E/E2 portable stereo radio cassette recorder. Cash adjustment available if necessary. Tel: 0246 75881. C852

Have Marconi 264 (circa 1935) and Ekco PB515 (circa 1938). Would exchange for post-war valve radios, equipment or literature. Tel: 0905 56818. C854

Have Nashua 180 photocopier, paper and fluid. Would exchange for general coverage receiver or w.h.y.? Tel: 0467 24623. C855

Have professional computer controlled darkroom, as new worth £800 plus all extras. Would exchange for FT-290R with NiCads, charger and linear, or FT-790R in new condition, or TR-751E. Mr P. Joynson, 10 Rothesay Gardens, Prenton, Birkenhead, Merseyside L43 3DW. C867

Have 1930s loud speaker, 18in balanced armature type made in USA. Would exchange for portable radio with short wave bands. G4FFO. Tel: Cambridge 860150. C877

Have Sony CRF320 32-band digital h.f. receiver, excellent condition. Would exchange for Sony CRF230 or onward with built-in b.f.o. Must be in pristine condition. Swapper collect or pay carriage. Tel: 061-743 1570. C913

Kanga Adsheet

You may have heard of the *Yellow Sheet* which is circulated amongst radio clubs in America, it is composed completely of adverts. Well, Kanga thought it was such a good idea that they have given it a try in the UK.

The adsheet is sent on the 1st and 3rd Saturdays of each month free of charge to all the clubs that they know of in the South East of England. They aim to cover a radius of 160km from Dover (excluding the Channel 'cos it's too wet!).

The cost of advertising is small, just 50p per item up to a maximum of £2 (10 items) and there is no restriction on the length of an advert.

The list of club contacts was taken from the latest call book (Spring '87 Edition), so if the club is in the call book and not seeing the adsheet, then someone is hogging it.

Any clubs that do not receive the adsheet and would like to do so then contact:

R. A. Pascoe,
Kanga Products,
3 Limes Road,
Folkestone,
Kent CT19 4AU.

Surprise Presentation

Tom Douglas G3BA thought he was visiting the Midland ARS to give a talk on "Getting the Best from VHF". Little did he know that they had a surprise in store for him.

He was presented with an illuminated scroll to commemorate 50 years in amateur radio. He successfully blew out the five candles on the cake—without help, but received plenty of help eating the cake!



Holiday '88?

Subject to there being enough interest, Peter Crosland G6JNS proposes organising a couple of trips to foreign amateur radio events in 1988. The two events he has in mind are Radio 88 are Freidrichshafen and the Dayton Hamfest.

If you are interested please send an s.a.e. to **Peter Crosland G6JNS,** **Red Lion Cottage,** **Holt Heath,** **Worcester WR6 6LZ.**

Airwaves

Airwaves is the title of the IBA's quarterly journal and the Spring 1987 issue was full of very interesting items.

One of the most interesting articles was one called "The Future of UK Radio", and is the IBA's views. It basically outlines their ideas for future development of national, local and "community" radio services in the UK.

Another article is called "To 2001 and Beyond" and is about the technology race in television and radio. Dr John Forrest, the IBA's Director of Engineering speculates on likely developments.

Airwaves is available free from the **Information Office,** **Independent Broadcasting Authority,** **70 Brompton Road,** **London SW3 1EY.**

Grampian ACS

The Grampian Amateur Computer Society was formed about ten years ago. Its members possess a variety of machines. Although an amateur society, great stress is placed on the more serious applications of the computer and upon the computer itself, as opposed to games.

They meet regularly on Monday evenings, and aim to provide organised talks, demonstrations and visits whenever possible. There is a bimonthly newsletter which gives details of forthcoming events.

If you would like more details then contact **Paul Cuthbertson on 0467 24030.**

33 ▶

point where the signal is removed or greatly reduced, see Fig. 1. Next, a similar test should be carried out for the l.w. band.

It will be found that the nulling is very sharp, and a movement of a few degrees will reduce or eradicate interference from other stations, except where an interfering station is on the exact bearing, or reciprocal bearing, of the required station. In a similar way it is often possible to eliminate or reduce directionally radiated interference generated by household electrical appliances. This nulling of in-house electrical noise can only be taken advantage of if the ferrite antenna is kept away from walls which may contain hidden wiring.

The frequency range of the MkII is continuous from 1620–150kHz (185–2000m). The l.f. end of the band appears when C1 is approaching maximum capacity and resonates L1 (m.w. coil) to 545kHz (550m). The same frequency of 545kHz (550m) can also

Practical Wireless, July 1987

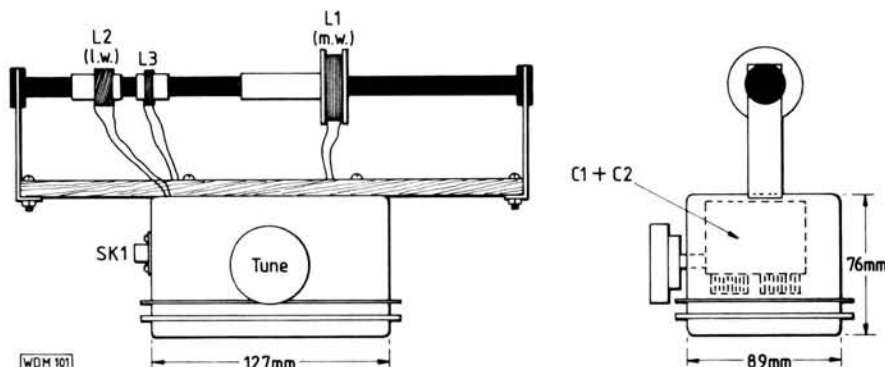

Fig. 5: Completed antenna assembly

be covered when C2 is nearing minimum capacitance and resonates with L2 (l.w. coil).

By using this novel arrangement it has been possible to cover the whole l.w. and m.w. bands without switching.

By using a good receiver, the need for additional pre-amplification has been found unnecessary, although this could be considered by anyone having a receiver short on front end gain.

High Performance Antenna

The MkII is a very convenient high performance antenna of much smaller dimensions than the usual 20 to 40 inch square frame loop or an outside longwire antenna. The pick-up range and nulling are excellent for such a small device.

PW

BOOK SERVICE

The books listed have been selected as being of special interest to our readers. They are supplied from our editorial address direct to your door. Some titles are American in origin. A number of new titles have been added to the service. Watch out for further additions in the months to come.

DATA & REFERENCE

DIGITAL IC EQUIVALENTS AND PIN CONNECTIONS (BP140)

A. Michaels
Equivalents and pin connections of a popular selection of European, American and Japanese digital i.c.s. 256 pages £5.95

LINEAR IC EQUIVALENTS AND PIN CONNECTIONS (BP141)

A. Michaels
Equivalents and pin connections of a popular selection of European, American and Japanese linear i.c.s. 320 pages £5.95

INTERNATIONAL TRANSISTOR EQUIVALENTS GUIDE (BP85)

A. Michaels
Possible substitutes for a popular selection of European, American and Japanese transistors. 320 pages £3.50

INTERNATIONAL DIODE EQUIVALENTS GUIDE (BP108)

A. Michaels
Possible substitutes for a large selection of many different types of semiconductor diodes. 144 pages £2.25

RSGB RADIO DATA REFERENCE BOOK

G. R. Jessop G6JP
The 5th Edition of an essential book for the radio amateur's or experimenter's workbench. 244 pages Hardback £8.56

SEMICONDUCTOR DATA BOOK

A. M. Ball
Characteristics of about 10 000 transistors, f.e.t.s, u.j.t.s, diodes, rectifiers, triacs and s.c.r.s. 175 pages o/s

PROJECT CONSTRUCTION

HOW TO DESIGN AND MAKE YOUR OWN P.C.B.s (BP121)

R. A. Penfold
Designing or copying printed circuit board designs from magazines, including photographic methods. 80 pages £1.95

INTRODUCING QRP Collected Articles from PW 1983-1985

An introduction to low-power transmission, including constructional details of designs by Rev. George Dobbs G3RJV for transmitters and transceivers from Top Band to 14MHz, and test equipment by Tony Smith G4FAI. 64 pages £1.50

PRACTICAL POWER SUPPLIES Collected Articles from PW 1978-1985

Characteristics of batteries, transformers, rectifiers, fuses and heatsinks, plus designs for a variety of mains-driven power supplies, including the PW "Marchwood" giving a fully stabilised and protected 12V 30A d.c. 48 pages £1.25

RADIO

COMMUNICATION (BP89) (Elements of Electronics—Book 5)

F. A. Wilson
Fundamentals of line, microwave, submarine, satellite, digital multiplex, radio and telegraphy systems are covered, without the more complicated theory or mathematics. 256 pages £2.95

AN INTRODUCTION TO RADIO DXING (BP91)

R. A. Penfold
How to find a particular station, country or type of broadcast and to receive it as clearly as possible. 112 pages £1.95

AMATEUR RADIO CALL BOOK (RSGB) Spring 1987 Edition

This useful work now incorporates a 48-page reference section of useful information for amateur radio enthusiasts. 310 pages £4.73

INTERNATIONAL RADIO STATIONS GUIDE (BP155)

Revised and updated in 1985, this book shows the site, country, frequency/wavelength and power of stations in Europe, the Near East and N. Africa, North and Latin America and the Caribbean, plus short-wave stations worldwide. 128 pages £2.95

BETTER SHORTWAVE RECEPTION (USA)

W. S. Orr W6SAI & S. D. Cowan W2LX
Receivers, antennas, propagation, DX listening techniques for the short waves and v.h.f. 158 pages £7.32

VHF HANDBOOK FOR RADIO AMATEURS (USA)

H. S. Brier W9EGQ & W. I. Orr W6SAI
VHF/UHF propagation, including moonbounce and satellites, equipment and antennas. 335 pages £13.37

WORLD RADIO TV HANDBOOK (1987)

Country-by-country listings of long, medium and short wave broadcasters and TV stations. Receiver test reports. English language broadcasts. The s.w.f.'s "bibliography". 576 pages £17.95

A TV-DXERS HANDBOOK (BP176)

R. Bunney
Information on transmission standards, propagation, receivers including multi-standard, colour, satellites, antennas, photography, station identification, interference, etc. Revised and updated 1986. 87 pages £5.95

QUESTIONS & ANSWERS AMATEUR RADIO

F. C. Judd G2BCX
What is amateur radio? The Radio Amateurs' Exam and Licence. The technology, equipment, antennas, operating procedure and codes used by amateurs. 122 pages £2.95

QUESTIONS & ANSWERS RADIO

Eugene Trundle
Basics of electrical theory, radio and semiconductors, receivers, amateur and CB radio, and test equipment. 110 pages £2.95

AMATEUR RADIO OPERATING MANUAL (RSGB)

A mine of information on just about every aspect of amateur operating, including international callsign series holders, prefix lists, DXCC countries list, etc. 204 pages £6.16

VHF/UHF MANUAL (RSGB)

G. R. Jessop G6JP
Theory and practice of amateur radio reception and transmission between 30MHz and 24GHz. 520 pages Hardback £9.86

FOUNDATIONS OF WIRELESS AND ELECTRONICS (10th Edition)

M. G. Scroggie and S. W. Amos
Covering d.c. and a.c. circuits, L, C, tuned circuits and selectivity, valves, semiconductors, transmission lines, antennas, radiation, oscillation, modulation, detection, amplification, superhet receivers, c.r.t.s, waveform generators and switches, computers and power supplies. 551 pages £8.95

THE COMPLETE DX'ER (USA)

Bob Locher W9KNI
Equipment and operating techniques for the DX chaser, from beginner to advanced. 187 pages £8.21

UNDERSTANDING AMATEUR RADIO (ARRL)

Understanding and building transmitters, receivers, antennas, power supplies and accessories. 222 pages £4.20

RADIO AMATEUR'S GUIDE RADIO WAVE PROPAGATION (HF Bands)

F. C. Judd G2BCX
The how and why of the mechanism and variations of propagation in the h.f. bands. 144 pages £8.95

AMATEUR RADIO LOGBOOK (RSGB)

Standard logbook for the transmitting amateur in horizontal A4 format. 25 lines per page. 96 pages o/s

RECEIVING STATION LOGBOOK (RSGB)

Standard logbook for the s.w.f. in horizontal A4 format. 32 lines per page. 50 pages £2.35

MOBILE LOGBOOK (RSGB)

Pocket-sized for the mobile operator. £1.00

PASSPORT TO AMATEUR RADIO Reprinted from PW 1981-1982

The famous series by GW3JGA, used by thousands of successful RAE candidates as an aid to their studies. Plus other useful articles for students of amateur radio. 96 pages £1.50

BEGINNER'S GUIDE TO RADIO (9th Edition)

Gordon J. King
Radio signals, transmitters, receivers, antennas, components, valves and semiconductors, CB and amateur radio are all dealt with here. 266 pages o/s

INTRODUCING MORSE Collected Articles from PW 1982-1985

Ways of learning the Morse Code, followed by constructional details of a variety of keys including Iambic, Triambic, and an Electronic Bug with a 528-bit memory. 48 pages £1.25

INTRODUCING RTTY Collected Articles from PW 1980-1983

Basics of RTTY, ways of generating and decoding it. A simple and inexpensive way of trying out RTTY using a Sinclair 16K ZX81. 33 pages £1.00

SWM GREAT CIRCLE MAP OF THE WORLD

Showing Great Circle bearings and distances, callsign prefixes, time zones and DX Zones. 1018 x 634mm £4.00

RADIO AMATEURS PREFIX MAP OF THE WORLD

Showing prefixes and countries, plus listings by order of country and of prefix. 1014 x 711mm £1.60

RADIO COMMUNICATION HANDBOOK (RSGB)

A comprehensive reference work on the theory and practice of amateur radio experimentation and practice. 794 pages o/s

A GUIDE TO AMATEUR RADIO (RSGB)

Amateur Radio—the hobby, the equipment, workshop practice, the licence, the RAE (including sample questions). 154 pages £3.62

RADIO AMATEURS EXAMINATION MANUAL (RSGB)

G. L. Benbow G3HB
A standard aid to studying for the Radio Amateurs Examination, covering the whole of the 1986-88 syllabus. 155 pages £3.62

HOW TO PASS THE RADIO AMATEURS' EXAMINATION (RSGB)

G. L. Benbow G3HB
The background to multiple choice exams and how to study for them with nine sample RAE papers for practice, plus maths revision. 91 pages £3.15

GUIDE TO BROADCASTING STATIONS 19th Edition (1987/88)

Philip Darrington
Frequency and station data, receivers, antennas, Latin American DXing, reporting, computers in radio, etc. 240 pages £6.95

ANTENNAS (AERIALS)

AERIAL PROJECTS (BP105)

R. A. Penfold
Practical designs including active, loop and ferrite aerials plus accessory units. 96 pages £1.95

SIMPLE AMATEUR BAND AERIALS (BP125)

E. M. Noll
How to build 25 simple and inexpensive aerials, from a simple dipole through beam and triangle designs to a mini-rhombic. Dimensions for specific spot frequencies, including the WARC bands. 80 pages £1.95

25 SIMPLE SHORT WAVE BROADCAST BAND AERIALS (BP132)

E. M. Noll

Designs for 25 different aerials, from a simple dipole through helical designs to a multi-band umbrella. 80 pages £1.95

25 SIMPLE INDOOR AND WINDOW AERIALS (BP136)

E. M. Noll

Designs for people who live in flats or have no gardens, etc., giving surprisingly good results considering their limited dimensions. 64 pages £1.75

25 SIMPLE TROPICAL AND MW BAND AERIALS (BP145)

E. M. Noll

Simple and inexpensive aerials for the broadcast bands from medium wave to 49m. 64 pages £1.75

BEAM ANTENNA HANDBOOK (USA)

W. I. Orr W6SAI & S. D. Cowan W2LX

Design, construction, adjustment and installation of h.f. beam antennas. 198 pages £8.00

ALL ABOUT CUBICAL QUAD ANTENNAS (USA)

W. I. Orr W6SAI & S. D. Cowan W2LX

Theory, design, construction, adjustment and operation of quads. Quads vs. Yagis. Gain figures. 109 pages £7.63

HF ANTENNAS FOR ALL LOCATIONS (RSGB)

L. A. Moxon G6XN

Taking a new look at how h.f. antennas work, and putting theory into practice. 260 pages £6.17

WIRES & WAVES

Collected Antenna Articles from PW 1980-1984. Antenna and propagation theory, including NBS Yagi design data. Practical designs for antennas from medium waves to microwaves, plus accessories such as a t.u.s. s.w.r. and power meters, and a noise bridge. Dealing with TVI. 160 pages £3.00

AUDIO FREQUENCIES

AUDIO (BP111)

(Elements of Electronics—Book 6)

F. A. Wilson

This book studies sound and hearing, and the operation of microphones, loudspeakers, amplifiers, oscillators, and both disc and magnetic recording. 320 pages £3.50

THEORY & CALCULATIONS

PRACTICAL ELECTRONICS CALCULATIONS AND FORMULAE (BP53)

F. A. Wilson

A book for the workbench, with a strong practical bias, covering units and constants, d.c. and a.c. theory, passive components, networks, theorems and measurements. Higher mathematics have been avoided where possible. 256 pages £2.95

BEGINNER'S GUIDE TO ELECTRONICS

Owen Bishop

For youngsters thinking of a career in electronics; theory and applications in computers, radio, TV, recording, medical and industrial electronics. 240 pages £4.95

COMPUTING

MICROPROCESSING SYSTEMS AND CIRCUITS (BP77)

(Elements of Electronics—Book 4)

F. A. Wilson

A comprehensive guide to the elements of microprocessing systems, which are becoming ever more involved in radio systems and equipment. 256 pages £2.95

AN INTRODUCTION TO COMPUTER PERIPHERALS (BP170)

J. W. Penfold

Covers monitors, printers, disk drives, cassette recorders, modems, etc., explaining what they are, how to use them and the various types of standards. 80 pages £2.50

AN INTRODUCTION TO COMPUTER COMMUNICATIONS (BP177)

R. A. Penfold

Details of various types of modem and their applications, plus how to interconnect computers, modems, and the telephone system. Also networking systems and RTTY. 96 pages £2.95

AMATEUR RADIO SOFTWARE (RSGB)

John Morris GM4ANB

Using a computer for c.w., RTTY, data, plus calculations for antennas, distance, bearing, locators, satellites, sun, moon and circuit design. 328 pages Hardback £7.29

FAULT-FINDING

TRANSISTOR RADIO FAULT-FINDING CHART (BP70)

C. E. Miller

Selecting the appropriate fault description at the head of the chart, the reader is led through a sequence of suggested checks until the fault is cleared. 635 x 455mm approx. £0.95

TELEVISION INTERFERENCE MANUAL (RSGB)

B. Priestley

TV channels and systems, spurious-radiation TVI, strong-signal TVI, audio breakthrough, transmitter design. 78 pages £2.02

TEST EQUIPMENT FOR THE RADIO AMATEUR (RSGB)

H. L. Gibson G2BUP

Techniques and equipment for tests and measurements on devices, systems and antennas. 142 pages Hardback £5.76

ARE THE VOLTAGES CORRECT?

Reprinted from PW 1982-1983

How to use a multimeter to fault-find on electronic and radio equipment, from simple resistive dividers through circuits using diodes, transistors, i.c.s and valves. 44 pages £1.50

QUESTIONS & ANSWERS

RADIO REPAIR

Les Lawry-Johns

How to fault-find and repair valved and transistorised receivers, car radios and unit audio equipment. Suggested lists of tools and spare parts. 106 pages £2.95

SERVICING RADIO, HI-FI AND TV EQUIPMENT

Gordon J King

A very practical book looking at semiconductor characteristics, d.c. and signal tests, fault-finding techniques for audio, video, r.f. and oscillator stages and their application to transistor radios and hi-fi. 205 pages o/s

PRACTICAL HANDBOOK OF VALVE RADIO REPAIR

Chas E Miller

The definitive work on repairing and restoring valved broadcast receivers dating from the 1930s to the 60s. Appendices giving intermediate frequencies, valve characteristic data and base connections. 230 pages Hardback £15.95

HOW TO ORDER

O/P = Out of print
O/S = Out of Stock



International Radio Stations Guide

An Introduction to Computer Communications

NEWNES
RADIO and ELECTRONICS
ENGINEER'S POCKET BOOK

Audio

Digital IC Equivalents and Pin Connections

Add 75p per order postage (overseas readers add £1.50 for surface mail postage) and send a postal order, cheque or international money order with your order (quoting book titles and quantities) to **PW Publishing Limited, Enefco House, The Quay, Poole, Dorset BH15 1PP**. Payment by Access, Mastercard, Eurocard or Visa also accepted on telephone orders to Poole (0202) 678558. Books normally despatched by return of post but please allow 28 days for delivery.



0202 678558

Practical Wireless

0202 678558



PCB SERVICE

Printed circuit boards for recent PW constructional projects are now available from the PW PCB SERVICE. The boards are fabricated in 1.5mm glass-fibre, and are fully drilled and roller tinned. All prices include VAT and postage and packing for UK orders. Add £2.00 per order for despatch to overseas addresses. Orders and remittances should be sent to: **PCB Service, Practical Wireless, Enefco House, The Quay, Poole, Dorset BH15 1PP. Cheques should be crossed and made payable to Practical Wireless.**

When ordering, please state the Project Title and Issue Month as well as the Order Code. Please print your name and address clearly in block capitals, and do not send any other correspondence with your order. You may phone your order using Access

or Visa. A telephone answering machine will accept your order outside office hours.

Please allow 28 days for delivery. Check the last issue of PW for more details of price and availability. Please enquire for earlier p.c.b.s.

PW "Itchen" (4/87)	WR298	£4.49
PW "Axe" (5/87)	WR230a	£5.07
	WR231	£4.24
	WR232	£3.82
PW "Downton" (6/87)	WR233	£5.04
Side-tone Oscillator (6/87)	WR234	£3.65

On The Air

On The HF Bands

Reports to Paul Essery G3KFE
Practical Wireless, Enefco House, The Quay, Poole, Dorset BH15 1PP

As far as the author is concerned, the month in retrospect has been notable for the changed weather; at the start, overcoats, then spring, then summer, and today back to spring again—so the best of the weather made the shack an unwelcome thought.

We continue bumping along the bottom of the sunspot cycle; when you read this we will be almost exactly eleven years since the last cycle bottomed out: we need spots; think spots!

History

The Mount Athos expedition by DL7FT is still, we understand under scrutiny by the ARRL HQ. The story is that DL7FT provided a copy of the licence which appeared to be the same as previous ones seen and accepted; but they also had a letter from the monks which is supposed to have cast doubt on the validity of the licence. We understand DL7FT was then asked for the original licence, but that this was lost in the post. ARRL are now trying to "establish the validity of the monk's letter" (!). In among all this is the implication that some previous operations from Mount Athos were less than perfect; and of course readers will recall the hoo-ha being kicked up at the time by the SVs who seemed to want Mount Athos to be a private covert for themselves.

The columnar opinion, for what it's worth, is that Mount Athos hardly rated country status in the first place and what has happened since justifies its deletion from the countries list. The monks have in the past made it clear they don't like it—what justification is there for accepting it as a DXCC country in the prevailing climate of opinion?

The Andaman and Nicobar expedition by the VUs seems to have ended up with some 40 000 QSOs in the book; records have been computerised and the QSLs are to be ready around June 1. Miss Bharathi is rumoured to be preparing for a four-week bash from May 1 once again from Nicobar, but this time the activity will not be round-the-clock.

It is interesting to note that Tom Christian VR6TC is now back on Pitcairn after his medical treatment in ZL and a visit to Norfolk Is. Tom seems to have missed the boat from Norfolk, so he hitched a lift from the *Aurora* which boat was heavily involved in the recent 3Y expedition. Wonderful, these conditions.

Coming

A possible new DXCC country is mentioned by *DX News Sheet*, in the form of the Saharan Arab Democratic Republic—this was once the southern half of Rio de Oro, EA9, the other half having been taken by Morocco. A group of EAs are trying to set this one up in terms of DXCC approval, and if it all comes together properly, the first couple of weeks in August will see it all happen; c.w. and s.s.b. operation promised, and ten days of activity with four operators.

Another EA group is planning an Andorra, C33A, operation for the period August 5–31.

54

If you are looking for a China contact, *DXNS* had a list of the active ones; BX1BC is VE7BC, while others are BY1PK, BY1QH, BY1SK all in Beijing, BY4AA, BY4AOM, BY4CZ, BY4RB, BY4RN, BY4SZ, BY5HZ, BY5RA, BY5RF, BY5QH, BY7HL, BY7KT, BY8AA, BY8AC, BY9GA, BY0AA, and BY5QA, with more and more appearing. Often the contest operation of these Chinese stations is by foreigners who deal with QSLs to their home addresses. Thus, for all Chinese stations, it is sense to check the QSL address at the time of the QSO.

If you are interested in Auckland and Campbell Is, ZL9, then you will be pleased to note that ZL1AMO is planning a session from there next Spring.

From our old friends Stephens-James in Leigh we have a note from Harry G3MCN, to say that he, plus G3TZO, G4JMH, and G6IFA (all from Chester Club), will be operating from the Faeroes for seven days from July 7. All the sevens—makes it easy to remember!

DXCC Revision

From *The DX Bulletin* we have a note of the proposals for a rehashing of the DXCC countries criteria. Basically, the problem is with Rules 2 and 3, defining separation by water and separation by foreign land respectively. Eric Scace K3NA has proposed revisions which would remove ambiguity in these rules, based on the UN Convention on the Law of the Sea definitions. His proposals do not address the problems of "separate administration" under which, for example Mount Athos, 1A0KM, and 4U1VIC are proposed, nor does it look at what constitutes proper amateur radio operation from a country, nor suggest whether a complete re-start of DXCC should occur. However, it does, in addition to bringing DXCC into line with an accepted international standard, also propose a system for use in effecting the change-over. The main effect of the proposal would be, it seems to the author, to stop all the arguments and consequent rule-bendings which have resulted in unjustified new countries on the one hand, or rejection of countries (for example, the Pribiloffs) on the other. More details and cross references on a very clearly-thought out paper from K3NA, QTHR.

The Bands

Like the curate's egg. We think it might be wide open at the moment, but the rig is switched off until the thunder fades away! Seriously, while there have been good times, they are relative things—similar conditions four years ago would have been dubbed "plain lousy" by everyone. So—let's see what is being reported.

Top Band

G2HKU (Isle of Sheppey) noted his s.s.b. contact with ON7BW who was using his 3.5MHz band quad for an antenna (!), while the c.w. made it two-way with SM6OID.

G3BDQ (Hastings) says he has more or less given up Top Band for the summer

season, and turned his attention to the higher bands. We can't say that we can blame John for this, knowing the static levels experienced in summer for ourselves—but we notice more and more that new ones appear on the band in what was once the close season for DX.

We hear that the TF3PS swanning around Top Band recently was a pirate; Icelandic stations retain the suffix part of their calls when they change call area.

Rumour is going round that HB9AMO has in fact completed a WAZ on the band, his last one being Zone 27 (KC6), but Pierre has not confirmed the report to the time of writing.

CE3DPD/XQ3DPD is anxiously searching out European contacts on Top Band; 0400-0500Z each morning, around 1835-1845kHz, and hoping to be the first CE to a Top Band DXCC.

Finally on Top Band, we note G3BRD has installed a "patent earth return wire" in his neighbour's garden, to "assure perfect TV reception"—and no doubt it has improved the effectiveness of the G3BRD transmissions too!

The 3.5MHz Band

This is an odd band. Very definitely there is DX to be worked on 3.5MHz, both c.w. and phone, but you need to have a good receiver and know how to drive it on the one hand, and on the other, know where to hunt for your prey. The biggest problem is that it has always been a chat channel, right back to before WWII, and many of the chat types don't know or care about others looking for DX. Many of them have never asked for or received a critical report so don't know they are spluttering for umpteen kHz either side of their transmit frequency, and that when they are working an S9 QSO. Let us hope that the licence revision will put some teeth into clauses designed to ensure better operating standards. Perhaps the RAE should have a section on operating practice too.

The best part of the band is probably the l.f. end, where the c.w. addicts play—not so much QRM, and always the odd QRP signal to be found; one we noted was GM4OSS, heard at lunchtime on Easter Monday at 579 here.

G3NOF (Yeovil) hasn't been very active on 3.5MHz for a long time, due to lack of room for an antenna. However, Don was recently urged to try a half trap dipole against earth, with part vertical and part horizontal. It had only been up for a few days when he wrote but was showing itself better than the trap dipole; s.s.b. contacts with EA6BZ, EA6KQ, GD0/DL2SCQ, GJ4ZFM, K2RIH, PA6IARU, TR8JLD, VO2WL and 4U1ITU back it up.

QRP was the route for G2HKU on this band, with HA6QR, HB9DAX, and 4N3DSA all booked in on c.w. at four watts input.

The 7MHz Band

Again a band on which few people report, but where lots of DX can be found if you have an r.f. attenuator in the receiver front-end. G2HKU used c.w. to raise W3NZ.

Practical Wireless, July 1987

We are pleased to introduce a new range of antennas shown thus (N). The dipoles have been redesigned and now include a fully sealed 'N' socket supplied complete with 'N' plug for coaxial cable. Absolutely NO matching or tuning required. Also a new 1296MHz 55 element yagi. Send for details.

ANTENNAS TONNA (F9FT)

435MHz	
9 element (N)	£28.62 (a)
19 element (N)	£34.35 (a)
19 element crossed	£39.66 (a)
21 element 432MHz (N)	£44.57 (a)
21 element ATV (N)	£44.57 (a)

144/435MHz	
9 & 19 element Oscar	£39.66 (a)

1296MHz also 1250MHz	
23 element	£30.26 (b)
4 x 23 element - power splitter	
- stacking frame	£160.00 (a)
55 element	£46.20 (a)

POWER SPLITTERS - STACKING FRAMES
PORTABLE ALUMINIUM TELESCOPIC MASTS

50MHz	
5 element	£41.69(a)
144MHz	
4 element (N)	£26.60 (a)
4 element crossed (N)	£34.96 (a)
9 element fixed (N)	£30.87 (a)
9 element portable (N)	£33.12 (a)
9 element crossed (N)	£57.86 (a)
13 element portable (N)	£46.00 (a)
17 element fixed (N)	£61.54 (a)

PLEASE ADD CARRIAGE AS SHOWN (a) £5.00. (b) £2.20. ALL PRICES INCLUDE VAT AT 15%

ACCESS - VISA - Just telephone your card number for immediate despatch

FOR FULL SPECIFICATIONS SEND 40p FOR CATALOGUE

Callers welcome, but by telephone appointment only please.

Goods by return.

RANDAM ELECTRONICS (P)

12 Conduit Road, Abingdon, Oxon OX14 1DB. Tel: (0235) 23080 (24 hours)

SPECTRUM COMMUNICATIONS

MANUFACTURERS OF RADIO EQUIPMENT AND KITS

4 and 6m EQUIPMENT

RECEIVE CONVERTERS 4 or 6m antenna input, 10 or 2m i.f., variable gain 0-26dB, n.f. less than 3.5dB. Buffered local oscillator output, types RC4-10, RC4-2, RC6-10 and RC6-2. PCB kit £17.25, PCB built and tested £24.50, boxed kit £29.25, boxed, built and tested £41.00.

TRANSMIT CONVERTERS 4 or 6m 500mW output, 10m drive 25mW to 500mW. Local oscillator input matches receive converters. Types TC4-10 and TC6-10. PCB kit £16.50, PCB built and tested £25.75, boxed kit £28.50, boxed built and tested £41.00.

TRANSMIT CONVERTERS 4 or 6m variable power 80mW to 2.5W, 2m or 10m drive 10mW to 100mW. Local oscillator input matches receive converters. Types TC4-10H, TC4-2H, TC6-10H, TC6-2H. PCB kit £27.50, PCB built and tested £37.75, boxed kit £39.50, boxed built and tested £53.00.

TRANSCIVE CONVERTERS Single board version of receive converter and 500mW transmit converter. 10m drive 25mW to 500mW. Types TRC4-10 and TRC6-10. PCB kit £39.00, PCB built and tested £54.00, boxed kit £54.00, boxed, built and tested £83.25.

TRANSCIVE CONVERTERS Separate receive converter and 2.5W transmit converter in a single boxed unit, 2m or 10m drive 10mW to 100mW only, requires r.f. sensing switch and attenuator for use with 2.5W 2m rigs. Types TRX4-10H, TRX4-2H, TRX6-10H and TRX6-2H. Boxed kit £60.00, boxed and built £99.50.

CB to 10m

CB TO 10 FM CONVERSION BOARDS - THE FIRST COMMERCIALY AVAILABLE, suits all UK FM CB rigs to give 29.31 to 29.70MHz. Size only 63x40x13mm. Built and aligned board SC29 £15. Or send your rig and we'll fit it. £28 inc. return P&P for mobiles. £31 inc. for base rigs.

MULTIMODE CB CONVERSIONS, send your 120 channel rig and we'll convert it to give 28.01 to 29.70MHz in straight sequences without gaps. Colt 1200DX, Cobra 148, Hy Gain 5, Multimode 2, Major M360, Tristar 747 & 777, Super Star 360, Concorde, etc. £62 inc. return P&P. Jumbo or Colt Excalibur 1200, £65. 80 Channel rigs such as Stalker 9 or Major M588 are modified to give 28.31 to 29.70MHz in straight sequence without gaps. £45.00 inc. return P&P. 200 Channel in 4 bands of 50 are converted to give 28.00 to 30.00MHz or 28.00 to 29.70MHz as required. Super Hy Gain 5, Lafayette 1800, Super Star 2000. £45.50 inc. return P&P. Nato 2000 £52.50, Super Star 2000-5x40CH £70. Colt 1600, 4x40CH. £65.50.

VAT & P&P INC PRICES

Delivery within 14 days subject to availability. 24 hr answering.



UNIT B6, MARABOUT INDUSTRIAL ESTATE,
DORCHESTER, DORSET. TEL: 0305 62250



PLEASE MENTION PRACTICAL WIRELESS WHEN REPLYING TO ADVERTISEMENTS

J. BIRKETT

RADIO COMPONENT SUPPLIERS

600 Piv 25 Amp THYRISTORS (SCR'S) @ £1.50
TOYOCON CRYSTAL FILTERS 10.7MHz BW

7.5KHz @ £1.95

LARGE TELESCOPIC AERIAL 10' Closed 64" Extended @ £2.30

B9A VALVEHOLDERS LESS SKIRT @ 20p, With Skirt @ 20p, B9A Plugs @ 25p.

CB04 TYPE VARIABLE CAPACITORS 10p.f. @ £1.60, 20p.f. @ £1.85, 50p.f. @ £2.30, 75p.f. @ £2.30, 00 Gang 350+350p.f. @ £1.95.

SURPLUS RECEIVER TYPE AERIAL TUNING UNIT 1 to 30MHz @ £23.60.

HEXADECIMAL THUMBWHEEL SWITCHES @ 75p.

SURPLUS DENCO COILS D/P Type Range Red 1.3,4,5, Green 1, 2, T Type Range 3T Yellow, 4T, 5T, Blue, 1T Red, 1T, 2T, 3T, 4T, 5T White All @ 60p each.

LOW PASS FILTERS 10.7MHz @ 3 for £1.00.

POWER VMOS VN10KM @ 50p, WM211 @ 40p, VN10LM @ 40p, VN90AA @ 80p.

NYLON SCREWS Cheese Head 4BA x 3/8" @ 20 for 30p, 2BA x 3/8" @ 20 for 30p.

CRYSTALS HC18U 6.114, 7.68, 8.867238, 9.83, 15.974, 19.968, 26.00, 26.583, 36.00, 53.675, 66.986MHz, HC25U 13.6275, 17.555, 17.565, 17.585, 17.595, 26.590, 26.740, 34.635, 34.675, 60.750MHz All @ £1.00 each.

AERIAL TUNING COIL 11 Taps 1 to 30MHz @ £7.95.

455KHz CERAMIC FILTER MURATA TYPE BFB455 @ 6 for £1.00.

BOX OF SMALL 455KHz IF/OSC TRANSFORMERS 8mm Square 100 for £1.95.

X BAND GUNN DIODES @ £1.65, SCHOTTKY DIODE Like 1N23 @ 45p.

200 MINIATURE POLYESTER CAPACITORS ASSORTED For £1.00.

WOOD AND DOUGLAS KITS AVAILABLE FOR CALLERS AND BY POST. ACCESS AND BARCLAY CARDS ACCEPTED, P.P. 60p UNDER £5, OVER FREE.

25 The Strait
Lincoln, Tel. 20767
(LN2 1JF)
Partners J.H.Birkett,
J.L.Birkett.



Books for radio amateurs

FDK

ELLIOTT ELECTRONICS

for the Radio Enthusiast

APPOINTED DISTRIBUTOR

OSY OLD MAN TO

THE 'HAM SHACK'

JAYBEAM AMATEUR ANTENNAS

RIGS, ANTENNAS, SWR BRIDGES, POWER SUPPLIES, TEST GEAR, COMPONENTS, MORSE KEYS, COAXIAL CABLES, ROTATORS, MICS, PLUGS AND SOCKETS, SWITCHES

Call us on (0533) 553293
OR COME AND LOOK AROUND AT
26/28 Braunstone Gate, Leicester

AERIAL ACCESSORIES AND MASTS

now, better than ever, the **NEW TRIO TR751E**

2 metre multimode!

£649.00 inc. VAT, Carriage £7.00



LOWE ELECTRONICS LIMITED Chesterfield Road, Matlock, Derbyshire DE4 5LE Telephone 0629 2817, 2430, 4057, 4995

SWL **D. Coggins** (Knutsford) reports that his FRG-7700, Icom R-7E and 20M inverted-V combined forces on 7MHz to enable hearing CN8BL, OD5AS, VE8RCS, VK2, VK3, ZL4OD, 5L6D, 5B4LP, TA1C, JAs, HH7PV, ZS6PB, CE8AGF (Tierra del Fuego), 4K1J (Antarctica), ZP5JCY, ZS6AOO and 9K2EC. Dave listens in the mornings, and at odd times throughout the evening to 2300.

G3BDQ seems to have shifted part of his attention to 3.5MHz, where his c.w. made it to UA1ODX, TA1C, and VK2AMB.

Next **G4VFG** (Ivybridge) after a period of silence; Peter offers, on c.w., the poor soul who had to sign Y34ZI/P/Y23OH—still it's good c.w. practice!

GOCNO (Radlett) has now got a 9m elevation to his tribander beam—a TET HB433DX with a TA33 director—and is busy refurbishing a linear to jack the r.f. output from 75 watts to "The Lot". Meantime, it is dreamtime—thinking of N5RM's rotating tower with four stacked TH7s—but Michael is one of the few who have beaming ability on 7MHz.

G3PMRs (Sandy) log for the period shows mainly 14MHz with the W3DZZ trap dipole, but c.w. on 7MHz connected with TI2OY, 9Y4TR and HI3LFE.

The 14MHz Band

Of course this is the band where most of the world's DX traffic goes on.

G3PMRs log is computerised, and Alan put a line through everything he didn't regard as DX; it still left such as the c.w. with UD6DFF, P43SF, UA0JV, VP2MDY, UI8OAE, UA1ODX (Franz Josef), FY8DP, UI8AFI, C56/DK7PE, UA0JGE, VK2DZD, UM8MS, TA3Y, UI8UU, JH1DLJ, UA0ZDN, PY2AYF, FG5BM, 5A0A, A61XL, KX6DS, VK2DHF, W7UN, UL7DAV, OY2H, FP5HL, 9L1GG, KP4BI, PY1BPR, PP7LL, UL7VBP, CM6DD, UD6KBL, RI8GN, UZ9QWA, UJ8JAX, VK6WT, ZD8CW, TA2Q, YV5KHX, VK3YT, EA9QD and VK6HD.

G4VFG says he has heard nothing of any interest on either mode, save for 9N1MM who "Got Away" anyhow!

G3BDQ (Hastings) mentions c.w. to TA1P, WOUCE, KA6IWO, EL2EF, ZS3E, P43SF, 7Q7LW, 5N4JCN, 5A0A, ZS6AFF, W0TOY, G3MHV/W6, ZC4JA, UL7PDG, UA0JH (Amur, Zone 19), FY5YE, N6MYX, VE5UA, 4S7WP, CY3EOW, 9M2FZ, 7X2CR, TA2Q, RI8BO, VE7PPH, UH8BBQ and S79AC, who is GW4ACO and QSL to his home QTH.

D. Coggins noted AL7GA, UA0AN, 5H3RB, VE8RCS and JY9DL, in what appear to have been just three sessions on the band.

The QRP signals from **GM4ELV** (Glasgow) managed to find K1ST/6W1, BV6IA, CN2AQ, RS3A, JA8FTN, PJ2FR, VP2EC, IMOWDN, CN5SE, 4X4TT, AL7CQ, UZOQWA (CQ Zone 19, ITU Zone 23), UG6LQ, VE7SZ, YB5NOF, ZS6AUD, YV5PV, ZZ5EG, AZ6ETB, 6W6NJ, VE8RCS, ZL4OD, VK2EQ, HL4CCM, JA7HMZ, 4X4JU who was looking for WAB contacts, 5L7H, 5L2BY and 5L0RL.

Most days the long path to JA, VK, ZL has been open in that order, 0700-0900Z says G3NOF. The short path to the Pacific, Asia and VK was often open 1000-1700, Africans 1500-2100, West Indians around 1100 and again around 2100, while Ws were heard between 1100 and midnight or later, the West Coast lads appearing around 1600-1700; and the South Americans were often good around 2200. It added up to s.s.b. contacts with BV6IA, C21FS, CN5SE, CN32FIC, CO2HQ, CW66PAX/ITE, D44BC, DJ6QT/9L, EX3TM, FM0A, FR4DL, FR5DB, H44RO, J37AH, JA4KFA, JM1BPP, JT7KAA, K1ST/6W1, PJ7A, RE4AC, TI2CC, TI2US, TR8CA, TU2QQ, TZ6FIC, VZAS, VE7IN, many VKs, VP2EC, VU2TTC, ZL8HV, 4S7RO, 4X9B, 5B4SA, 6W6JX, 7Q7LW, 9M8GH and 9X5WW.

We nearly missed the list from GOCNO. Michael used s.s.b. to work 4X6II, KC3PL, PY7ZZ, YV4RZ, YV5IYF, KB4VVGX/AA, W3CTR, W9HVR, KA3EED, 5N8ZHM, EX3TM, VK7EK, 4Z4ZA, WB2GKB, WA2YMJ, JH8EMH, UA9CAQ, 4X6SJ, UL8CWW, N3ARD, W8AH, KA2OAC and VK2APG.

New Bands

They don't get a lot of mentions this time, but there is a steady buzz of activity there. **G3BSN** (Clapham) says he has been motivated to try the band by GOGQT; in general it was best in the evenings, with the odd DX contact on c.w., such as with W2FJ, while daytime yielded G4PVA away in Wembley and LZ2KIM; that's whetted Phil's appetite a little so he promises to investigate further!

G4VFG notes that he can only offer a contact with SM6LUX, but that he now has a folded dipole up for the band, which might improve things and result in more reports.

Dave Coggins noted VK2NM on s.s.b., NF3P, GOAXE and KA3GGQ.

The c.w. signals on the band from G2HKU went out to UA3CN, RA9JA, W3NZ and W4QM/MM who was in the North Sea en route to Felixstowe.

That's the lot; still everything covers 10MHz, and 18 and 24MHz receive nary a mention. Has ANYONE out there anything to report?

21MHz

GOCNO notes c.w. with 5A0A, plus phone contacts with YC0BYW, 4X4FR, KN6M, K07ZZ, K5QBG, KK4FU, N5JHD, KJ4JM, W4OGD, VO1IF, 5B4TI, 5X5GK, 4X6ON, 4X4GO, 5A0A, DV1ANX, 6W6JX and KC4IH.

Dave Coggins mentions hearings of J28EM, ZS6DN, ZS6BXB, YC0WAR, C6CB, OD5BP, J37AH, AP2SQ and VU2GI.

A c.w. contact with ZY1DFF is offered

**Make sure your reports arrive by
June 26 for inclusion in the
September issue**

by G2HKU; this one turned out to be PY1DFF in a false beard.

There was nothing on the long path to the Pacific, VK/ZL or Far East, says G3NOF, and very little at all from N. America. Don made s.s.b. QSOs with A4XJV, AP2P, AY6D, CE4FXV, CE6EZ, CP8HD, CX9CO, CW66PAX/4ABY (the Pope's visit to Uruguay), DJ6QT/9L, DV1ASM, DV1ANX, DV1FZ, H24SA (5B4SA), JY5OL, K1ST/6W1, KC8QF/MM off Antarctica, P29NJS, TA1E, TA3C, TR8CA, TR8LD, TU2QT, TU2RJ, VK2IU, VP2EC, VP2ML, VP8BKQ, VU2ZAP, many YB/YC stations, YE0X, ZD9BV, ZP5LOB, ZSs, ZV9ZE (PY), 3C1MB, 3D6CW, 3G2EPB, 4X2J, 4X3N, 4X7T, 4X8S, 4X9B (these 4X calls were to celebrate Easter) 4X7DX, 5B4UZ, 5J4R, 5N4TME, 5T5NU, 6W6JX, 7P8DP, 8Q7CH, 9K2KW, 9N1MC, 9V1WO and 9V1TJ.

EA9CAM and 4X6MH provided a bit of pleasure for G4VFG, but the Gotaways were better—they included such as XU1SS, VK9XP (Christmas Island) and OD5IM.

The 28MHz Band

Space and Time close in on us, thanks to a power-cut taking out the box-of-tricks before part of the writing had been stored to disc! G4VFG has /M by way of a Belcom LS102 and linear, as well as the Yaesu plus GP antenna at home; the mobile, at lunch time raised DL6SBQ via aurora, G4SOF from 160km away, YU3DXX, IV3GJF and IV3DYS; the home station made it to ZD7BG, PY1HA and PY2CP.

G3BSN uses the band despite heavy QRM from business computers and the one-arm bandits in the local pubs. Between mid-March and mid-April there was IK8DYD on March 22, then nothing till April 14, then OK3EAW, Y27YN, DL1RDG, DL5RF and an 14M station were all worked, and it was noted that several other Gs were being worked by the Continentals. Phil also holds IK3CSU near Venice, and comments that these times are like being in a pile-up from the Continent, thanks to the number of Gs calling. G3BSN notes how we often talk about the Is having "kilowatts in bathroom shacks" and goes on to say that's just how we Gs sound over there! Obviously, G and I are nicely situated for one-hop sky-wave propagation.

G4HZW (Knutsford) noted good openings to Africa, a little S. America, and some-short-skip. G4SNA is on every night at 8.45 clock, on 28.5MHz and Tony worked him over a 180km path; other QSOs include 7Q7LW, 9Q5KI, C56/DK7PE, OK1AMS, SM2RMK, SM2NOT and TZ6VV; while VP8BGX, TR8JLD, ZS6, ZS3, LU and PY were heard.

Finally, G3NOF. Don noted several EU openings during the month, plus one to ZS on April 12 around 1500, and April 13 saw some 4X4s on the band around 1300. The only s.s.b. QSO was with ZS3WPX.

Reports to Norman Fitch G3FPK
40 Eskdale Gardens, Purley, Surrey CR2 1EZ.

VHF Up

The anticyclone which persisted for several weeks in April brought some glorious weather to mainland Britain with temperatures up to 25°C locally. Yet tropo conditions on the v.h.f. and u.h.f. bands were generally rather flat. On 50MHz the first Sporadic-E opening occurred on Easter 56

Monday, but there were no reports of any auroral activity.

Beacon News

For several years while working nearby, **Geoff Grayer G3NAQ** frequently operated the 4U1TU station in Geneva on v.h.f.

and u.h.f. He is now back in the UK and told me that there is a beacon on 50.07MHz with the call sign 4U6ITU. It uses a MuTek transverter and a 5-ele Tonna Yagi antenna donated by Random Electronics. A keyer has been built for it. The beacon cannot be operated continuously so can

Practical Wireless, July 1987

only be on when amateur activity is taking place from 4U1ITU. It will be switched on by request. The telephone number I have in my records for the shack is 010 41 995111, extension 5330.

Tiago de Jesus Frederico CT1WW has plans for a 50MHz beacon in Portugal. He is suggesting a 3W TX and a QRG (frequency) of 50.03MHz and the callsign CT0WW.

Further afield **Fred Anderson ZS6PW**, in a letter to Ken Ellis G5KW (KNT), confirms that the beacon ZS1STB at Still Bay is operating on 50.01MHz running about 40W to a Yagi at about 9m a.g.l. He has recently constructed a dual band TX that radiates beacon signals simultaneously on this frequency and on 28.300MHz, the latter using the callsign ZS1LA.

Contests

Eddi Ramm DK3UZ (EN) has sent the results of the first Dubus DX Contest on March 7/8 but which did not attract many entries. The 144MHz/single/c.w. section was won by DJ9YE (EN14a) who worked 34 squares worth 3570 points. The 144/single/mixed section lists twelve entrants the winner being F6IOC/P (CG68e) with 40 squares and 7160 points. No UK stations entered. The 144/multi/mixed part was won by DL6NAA (FK69b) with 62 squares and 31 000 points. The next Dubus contest is on July 4/5 1400 to 1400UTC and the general rules were given in the May VHF Up on page 58.

The Third Annual CQ World-wide VHF WPX Contest will take place from 0000 on July 18 through 2400UTC on the 19th, the idea being to work as many stations with as many different prefixes as possible. The bands are 50, 70, 144, 430 and 1296MHz. On 50, 70 and 144MHz each QSO is worth one point, on 430MHz two points and on 1296MHz four points. Each different prefix on each band counts as a bonus point and the final score is the total of QSO points multiplied by the grand total of bonus points.

There are four main sections for this event. 1 is for single operators subdivided into (a) all band; (b) single band; (c) all-band low power; (d) single band low power. 2 is multi-operator, (a) all band; (b) single band. 3 is portable with temporary power source only and 4 is f.m. mode. Low power is 30W p.e.p. output or less.

Contest exchanges must include the Universal square, e.g. IO91 or JN34. Signal reports are optional and need not be included on your log entry. Prefixes are the G3, F6, DH8, SM5 variety. However SM4ZZZ/6 counts as SM6 and WA9XYZ/G0 would be G0.

Logs go to CQ VHF WPX Contest, c/o S.C.O.R.E., PO Box 1161, Denville, NJ 07834, USA postmarked August 31 at the latest. Note that because of the very large number of European prefixes, UK operators stand a very good chance of winning this event as Geoff Brown GJ4ICD will tell you.

Next reminders of the 432MHz f.m. contest on June 14 and the Worked All Britain v.h.f. events on June 28. Details of these were published last month. The next two legs of the 10GHz Cumulatives are on June 21 and July 12 from 0900-2100UTC.

Probably the main contest coming up is VHF National Field Day, July 4/5, 1400-1400UTC. As last year, the 2.32GHz band is included and groups can add their 1.3 and 2.32GHz scores together in the open section. In the restricted 25W

p.e.p. output section, the 2.32GHz band may not be used. On 70MHz there are two separate periods; 1400-2200 c.w. only and 0600-1400 the next day is phone only.

Flemming Jul-Christensen G4MJC has sent a copy of the Danish amateur radio society's (E.D.R.) v.h.f./u.h.f./s.h.f. contest calendar for 1987. The first Tuesday evening each month is devoted to 144MHz activity and the first Thursday to 430MHz activity. Microwave operators have their turn on the first Monday.

County Codes

In the May VHF Up we published the official county codes for the British countries. Apologies to Berkshire readers for omitting their county, the code for which is BRK. Perhaps one of our Irish Republic readers would advise if there is any official abbreviation for their 26 counties which could be adopted in this column.

DXpedition News

Bob Thompson G6HUN (BRK) has sent details of more proposed activity from southwest Ireland between July 17 and 31. The Newbury and District ARS and the BBC Amateur Radio Group (Caversham) will undertake the mission activating UL, UM and VM squares. Operating times have not been given since they will depend on their finding suitable sites.

From August 1 to 10 they aim to provide continuous operation from a coastal site in VL square, 430m a.s.l. This period takes in the European v.h.f./u.h.f./s.h.f. contests on the 1st and 2nd and the RSGB Low Power v.h.f. and u.h.f. events on the 8th and 9th respectively. The activity will centre around 70.234, 144.234, 432.234 and 1296.234MHz. They will be QRV on 28.885MHz for any cross-band working.

The operators will include G6HUN, who is also EI3VTU, Al Bolton G4VXS/EI2VZB, Roger Stansfield G3UAX, John Wells G1AWD, Roger Beck G6IBI and Tim G4GWU. The group may be joined by EI2CA, EI5FK, EI7AYB and EI9FK. 50MHz permits had been applied for.

The VHF Convention

This year's RSGB National VHF Convention took place during the mini heatwave and was as well attended as last year. My first stop was at the RSGB's Propagation Studies stand where Ray Flavell G3LTP and Charlie Newton G2FKZ were on duty. As always, Charlie was a mine of information on auroral matters and of the solar phenomena which cause Ar events. He is now writing a definitive treatise on the subject, the culmination of decades of painstaking collection of data from thousands of radio amateurs and many professional scientific sources.

The official list showed 51 firms exhibiting selling everything from cheap "bought-as-seen" junk to the most expensive, fresh-from-the-factory transceivers. There were some excellent bargains to be had such as Yaesu h.f. transceivers model FT-757GX for about £200 under the current list price.

There were about nine stands put on by various groups, such as BYLARA, AM-SAT-UK and the WAB organisation. The latter has an extensive awards programme and their stand featured some of the very "posh" certificates on offer.

This year I did not attend any of the lectures as I was more interested in meeting friends old and new, many of whom are

regular contributors to this feature and its predecessor in the *Short Wave Magazine*. Talking to some who did, it seems they were well received and supported. During the VHF Committee forum, it was announced that the IARU had adopted the much criticised meteor scatter operating proposals for the random mode. This could well go down like the proverbial lead balloon since none of the dedicated m.s. operators I know have any intention of using them.

The 50MHz Band

By the time you read this, it should have been officially announced that the 50MHz band has been released to Class B licensees and that certain other restrictions have been eased as proposed to the DTI by the RSGB. It is worth repeating though that some of our European neighbours are very much against the allocation of any amateur radio band in this part of the spectrum. They wish to jealously guard it for use as a broadcast band. It must always be remembered that several countries have long term plans to use Band I for TV transmissions so are looking for any excuse to have us evicted for causing interference. Such interference could occur during a good tropo opening or via Es in the summer months. The moral is, stick to your licence conditions and do not exceed the authorised e.r.p.

The first reported Es opening was conveniently on Easter Monday, April 20 when Spanish and Portuguese stations were worked. It must be mentioned that the Spanish stations have no proper authority to use 50MHz but it seems their authorities turn a deaf ear to this activity so long as it causes no interference to other services.

CT1WW (WB) is reported to have worked about 70 UK stations including GI and GM between about 1430 and 1730. CT4KQ and EA1MO were also worked. **Paul Turner G4IJE** (ESX) told me he worked these three stations. On April 5 Paul completed an s.s.b. m.s. QSO with EI8EF (VO) in County Donegal, Eamonn being one of the few EIs yet to have permission to use the band.

John Jennings G4VOZ (LEC) mentions the dramatic increase in activity in April. It was possible to work six or more stations any evening. Although nothing exotic was worked, he has heard several of the EIs being contacted by others. New ones were G4YZK (WMD), G3CCH (LCN) and G3LTF (ESX) all on c.w. and G4RQP (IOW) on s.s.b. On the 13th, in rather ordinary conditions, John had his first f.m. QSO and RS55 reports each way with GW3LDH (CWD). There was no evidence of the flutter fading he usually gets with nearer stations in Derbyshire and Nottinghamshire. This was his first QSO outside England on f.m.

John Palfrey G4XEN (NHM) has been hearing the Scottish Rosemarkie beacon GB3RMK (IO77UO) via m.s. using a dipole antenna. **Dave Lewis GW4HBK** (GWT) worked EI9Q (Waterford) on April 13 and GU2FRO (SRK) the next day plus lots of locals.

Mike Johnson G6AJE (LEC) awoke his station from winter hibernation on April 14 when the anticyclone was over southern England. GB3NHQ beacon was S9 and he made a brief crossband QSO with G5UM (LEC). Between 1900 and 2100 Mike heard stations in ten counties using a single quad loop antenna pointing NW/SE. The more distant stations copied included G4BLX (SXE) on c.w., G3GRJ (NOR),

G4KOW (KNT), G5KW (KNT) and G3NOX (ESX).

The 70MHz Band

The good news for 70MHz operators is that they should soon have the potential to work the Class B licensees. This ought to increase activity. **Pat Billingham G4AGQ** (SRY) took part in the new 70/144MHz contest on April 12 and contacted G4HLX/P (OFE) and G4RFR/P (DVN) for two new counties all-time. G4BVY/P (CNL) could not quite copy Pat's call but he is quite satisfied with what he has achieved with just 10W to a home made turnstile antenna in the loft.

G4VOZ is pleased that activity is on the increase at last. John notes GOESB (SFD) on s.s.b. on April 3; G3PDT (WMD) on the 11th and who wishes there was more daytime activity. The same day, he travelled to Gloucestershire using the callsign G8LM/P for the first time this year but only managed three QSOs; GOESB, G4CCC/P (HPH) and G4APD (NHM). So John concludes that prior notice of such portable operation is essential and it appears to explode the myth that even if activity is low, there are lots of operators listening.

He reckons the April 12 contest to have been a success with good activity and scores at the end. John reports the largest number of new stations heard during any such event. He reckons this must have gladdened the hearts of the thirty or so stalwarts who always participate. New stations worked were G4CCC/P, G4HLX/P, G4THB/P (YSN), G4APD (NHM), G4KVI/A (BKS) all on s.s.b. and G3COJ (BRK) on c.w.

On the 14th and 16th G4VOZ worked EI9FK/P (Cork). Bill had notified some of the regulars beforehand so had plenty of takers. On the 14th conditions were average and many operators were grateful to G3RSI who helped Bill sort out the pile-ups. On the 16th conditions were much better and EI9FK/P was up to S5 at times. Another new station John worked was G5LL (LCN) the c.w. QSO being a bit of a struggle taking twenty minutes to complete.

GW4HBK also worked EI9FK/P (VL) and learned of the proposed activity from Bill's newsletter. Dave's best DX in the contest was G4THB/P and GJ3YHU was also QRV.

The 144MHz Band

Congratulations to **Angela Sitton** ex-G1XEO, now G0HGA having passed her Morse test. I had the pleasure of meeting her at the Convention. She is a very keen c.w. fan and has already entered the Annual Ladder. However she finds her QTH, Stevenage, a bit of a fistful to send.

Ian Rose (ESX) has also passed his Morse test on March 22 exchanging G1PDW for G0HDZ so has not spent quite so much time on the band as hitherto. His only table addition was EI2GK in Co. Wicklow on April 16.

Philip Everitt G1CRH (CBE) operated in the 144MHz part of the 70/144MHz event on April 11/12 for extra 1987 table points. Best DX were G1GEY (TWR) and G8TFI/P (CNL). Others he managed were G4APA/P (YSN), G3PIA/P (OFE), GM4RZWP/P (DGL), G8XVJ (CHS) and G4KIS/P (ATM). The GM and GI were new countries and Philip worked 32 stations in poor conditions.

Bob Nixon G1KDF (LNH) reports G4SXX (TYR) back on the band again and he worked him on April 15. In the Irish

contest on the 20th he contacted EI2FN/P and EI4GO/P in Co. Leitrim for his 21st EI county. Others worked were EI4GA/P (Cavan), EI9GJ/P (Wexford) and EI9FE (Tipperary).

Bob recently spent a short holiday in the Irish Republic and operated as EI3VVN/P using a Trio TR-9130, BNOS 160W amplifier and 9 ele Tonna Yagi. In addition to some operation from the homes of EI6AS (Dublin) and EI5FK (Cork) he made the following contacts: April 11, 1000 to 1030 13 QSOs from Co. Kildare; 1150-1430, Kilkenny, 32 QSOs; the 12th, 1830-1957, Clare, 24 QSOs; the 13th, 1605 to 2023, Waterford, 74 QSOs; the 14th, 1237-1308, Laois, 11 QSOs; 1440-1458, Offaly, 11 QSOs and 1549-1708, Westmeath, 27 QSOs.

All these were portable periods, some from hill tops, some from the road side and the best DX was probably from the Waterford site (WL) to GM3TSL (YQ) at 668km. Bob says it was a great short holiday his sole companion being his 14-year-old son who acted as antenna pole rotator.

Maurice Williams G1NVB (LCN) likes the new format of v.h.f. coverage and admits to chasing awards. He inquired about table scores that seem not to change for ages. If participants do not update their Squares Table figures for a year I usually delete them unless I hear they do intend to resume activity. His station consists of a Standard C-5800 multimode, 10-25W output, the antenna being an 8-ele crossed Yagi at 7.5m a.g.l. Maurice operates mobile for WAB purposes as he is very keen on that.

Gerry Schoof G1SWH (MCH) added another 16 counties to this year's total including QSOs with EI3VVN when in Dublin, Kildare, Kilkenny, Clare and Westmeath. Other long hauls in the first fortnight in April included contacts with G1KMI (DVN), GW8CMU/P (GNM), G8TFI/P and GW6JNE/P (GNS) on the 12th; G1BIW (ARM) on the 11th; GOAEA (IOS) on the 13th and G4SXX on the 15th.

Stuart Field G1VTR (SFK) likes the VHF Up feature having contributed to VHF before. He has now added a Yaesu FT-480 enabling him to work on s.s.b. mode. However it is destined to become the i.f. for a 1296MHz station in the future. New counties worked in the first half of April included G1WIU/P (GLR), G4WXX (MCH), G6IJF (LNH), GB4HHC (SXW) and GW6JNE (GWT).

G4AGQ found the band rather flat up to mid-April, the only DX of any note being DG4JA (DL) in the 70/144MHz contest. Flemming G4MJC (SXE) probably will not be QRV for a while pending another move of QTH. He is now up to 182 squares in the table so, provided his new QTH is less than 50km from Eastbourne, he can carry on collecting.

G4XEN (NHM) was on holiday in Mallorca recently and had a Yaesu FT-290R with him. John heard beacons EA6VHF (AY07j) on 144.918MHz with chirpy keying, and another which sends EA3CCK 6/JM19JO on 144.880MHz and which appeared to be a QRP TX. He suggests it could be heard in the Es season. Although he heard lots of f.m., RTTY and computer programs being sent over the air, in two weeks he did not hear a single s.s.b. or c.w. station.

Back home on April 14, G4XEN found reasonable tropo conditions to the east and worked PA6IARU at the IARU conference, the operator being SP6AZT from Wroclaw. Next worked was DFOHVK a special event station to commemorate an impending visit by the Pope. On the 15th

QTH Locator Squares Table

Station	Band (MHz)			
	1296	430	144	Total
G3JXN	80	126	172	378
G8TFI	79	141	126	346
G3XDY	78	131	180	389
G8DER	70	104	177	351
G4NDR	63	99	250	412
G3UVR	63	113	217	393
G4FRE	63	136	84	283
GJ4ICD	59	117	241	417
G8PNN	58	94	128	280
G4NBS	56	95	86	237
G6MGL	50	89	135	274
GW4LXO	45	100	240	385
G4DEZ	44	33	246	323
G3CQJ	44	102	175	321
GW4TTU	37	87	238	362
G4RQK	35	92	230	357
G1EFZ	32	86	200	318
G6YLO	32	104	128	264
G8GXP	30	140	307	477
G4DCV	25	71	248	344
G4MCU	25	82	201	308
G4MUT	24	87	140	251
G1KDF	22	85	139	246
G1DDX	20	27	49	96
GW3GBY	18	46	107	171
G6XVV	16	62	188	266
G6CSY	16	39	34	89
G3BW	15	38	269	322
GM8BDX	13	31	41	85
G6HKM	12	98	152	262
G6MXL	6	33	57	96
G3IMV	3	116	397	516
G6AJE	3	52	90	145
G4RSN	2	34	92	128
G2DHF	1	4	27	32
G4KUX	—	71	331	402
Y02IS	—	37	341	378
DL8FBD	—	69	274	343
G4IJE	—	—	338	338
G4XEN	—	98	232	330
G8XVJ	—	86	213	299
G4DHF	—	—	290	290
G4TIF	—	106	178	284
G6HKS	—	85	186	251
G4SWX	—	—	239	239
G3FPK	—	—	219	219
G6DZH	—	82	136	218
G4SSO	—	54	164	218
I4YNO	—	—	214	214
G4MJC	—	28	182	210
GW8UCQ	—	81	128	209
GM4CXP	—	30	178	208
G4SFX	—	—	208	208
G6ECM	—	—	200	200
G4IGO	—	—	198	198
G4MEJ	—	—	198	198
G8LFB	—	—	197	197
G4HGT	—	52	142	194
G4YCD	—	36	155	191
G1EGC	—	40	144	184
G0CHE	—	—	181	181
G1LSB	—	105	75	180
GM0BPY	—	54	123	177
G4YUZ	—	—	177	177
G4XEK	—	—	167	167
G8MKD	—	49	117	166
G8ZDS	—	41	123	164
GJ6TMM	—	31	128	159
G1GEY	—	30	124	154
G4DOL	—	—	154	154
EI5FK	—	19	131	150
GW8VHI	—	48	101	149
G4COM	—	52	94	146
G6XLL	—	36	109	145
G8RWK	—	13	105	118
G6XRK	—	1	117	118
G0FOT	—	54	49	103
G4TQK	—	—	101	101
G8XTJ	—	—	98	98
G4JZF/P	—	80	—	80
G1DWO	—	—	72	72
G0FBG/PA	—	17	54	71
GW6ZW	—	—	70	70
G0HDZ	—	—	55	55
GU4HUY	—	—	54	54
G1GRH	—	—	50	50
GM0GDL	—	7	38	45
G1HGD	—	7	38	45
G1VTR	—	23	6	29

Starting date 1 January 1975.
No satellite or repeater QSOs.
"Band of the month" 1296MHz.

Practical Wireless, July 1987

Very last chance to order at this
SPECIAL PRICE



£39.95

NEW AUTOMATIC ANTENNA ROTATOR – Aerial Techniques introduce their new automatic, economical rotator system for improvement of radio and television reception. Ideal for DXing and domestic use (pull in alternative out of area ITV regions), the full mount rotator accommodates ALL types of TV & FM aerial, large or small, having 192 lbs/in of motor torque. The system consists of two major components, the automatic control box and the rotor head unit, the vertical carrying capability of the latter is 45kg. The additional Support Bearing may be used for heavier load applications (up to three aerial arrays may be employed, depending on size). The attractively styled Control Console features continuous indication of beam/aerial heading, telling you the aerials position at all times. Bracket for Rotator support mast up to 52mm (2" approx) in diameter, stub/rotation mast is up to 40mm (1 1/2" approx) in diameter.

KINGROTOR Automatic Antenna Rotator and Control Console (uses 3 core cable) **£39.95**

SUPPORT BEARING for heavier load applications **£13.95**

YOKO model F1 VHF/UHF Multiband 5" screen Television. System B/G/I operation (5.5/6MHz sound) for UK & Continental use, ideal for TV-DXing, covers Bands 1, 3 & UHF; 12v battery & Mains operated (SAE leaflet) **£89.95**

(Carriage & insurance on above television £4.95)

'A TV-DXers Handbook' completely new and revised edition by Roger Bunney, a must for ALL DX enthusiasts **£5.95**

We are the specialist aerial company for all installations – domestic, fringe, distribution and DX. Try our comprehensive and illustrated **Catalogue at 65p** full of all the latest equipment, please include SAE with any other enquiries.

All prices inclusive of VAT & Carriage. Delivery normally 7-10 days. **ACCESS & VISA** Mail and Telephone orders welcome.



AERIAL TECHNIQUES (PW)
11, Kent Road, Parkstone,
Poole, Dorset, BH12 2EH. Tel: 0202 738232.



LOSING DX?

ANTENNA TUNER for outside or **INDOOR** antennas, end-fed LONG WIRES or dipoles, **BOOST DX** and reduce interference 100KHz-30MHz in 6 overlapping ranges, **IDEAL** for FRG7700 etc or 10W tx, **BANDPASS** design (not just usual high pass) with pre-wound high Q coils, **only £28.20**, get **MORE DX**.

ANTENNA FAULT? Poor reports? Not getting out? Check **FAST** with an **ANTENNA NOISE BRIDGE**, measure resonance 1-160MHz and **RADIATION RESISTANCE** 2-1000 ohms, **SIMPLY** null the noise, **only £24.20**. GET answers, **MORE DX**.

Each fun-to-build kit (ready-made to order) includes **ALL parts**, **CASE**, **pcbs** are fibre glass, **instructions**, **by-return postage**, (Europe same, Giro 21.923.4000) and **FREE "Kit News"**.

CAMBRIDGE KITS

45 (PU) Old School Lane, Milton, Cambridge.

SCOPES. Solartron general purpose dual beam DC to 15 Megs at 100 Mill/V Cm 10 Mill/V at 750Kc. T.B. 0.5 Us to 200 Mill/Sec Cm. EHT 4 Kv 5" CRT size 13x7x17" modern style unit tested with book. £125 **CRYSTALS**. Mixed lots of crystals in freq range 2/50 Mc/s approx 50 freqs. £8.50 Sets of crystals types Hc6/u & Hc25 in freq range 2.5/8. Mc/s 34 crystal 28 freq £9.50 per set **R.F. PRE SELECTOR** tunes 2/29 Mc/s in 4 bands direct cal with 10.1 sm drive as two tuned circs per band with 75 ohm in/out on 19" panel well made unit. £26.50 **PHOTO FLASH CAPS**. 215 Uf at 2.5Kv size 8x4x10" £14.50 Reflectors inc flash tube size 6x5" £6.50 reqs ext trigger. **VARIACS** panel mounting 240v to 0/270 at 2 amps. £18.50 **VIDEO TAPES** Sony V-60H 1/2" new 4 for £11.50 Audio tape 1800ft 1/4" 5 for £11.50 **TAPE REC.** Tanberg 3 speed neat unit. £45 **ARMY MAST KIT** 30ft 10 section 1" with guys stakes etc in carry bag new cond. £36 **DISH AE**. 32" dia 5" deep A/C X band Radar dishes new. £26.50 **TRIPPODS** Army heavy duty est 50Kg load 36" with 24v DC motorised head unit inc cables etc. £85 **SPEAKER** Army type semi weatherproof 3 ohm in metal case 6" dia. £8.50 **MONOCOSIGHT** elbow sight 5x27.5 adjust focus. £9 **COAX** UR57 HD 75 ohm 10mm OSD 15 mts for £6.50 30p mt over this. **BLOWERS** 115v 60c med size snail blowers outlet 2 1/2 x 2" new. £16.50 **HAND GENY** Army type nom O/P 12v DC at 1 amp stab with stand, cable, carry bag, new. £34.50 **Following for callers**. Comp term K/Brd & Printer £15.00 Airfield tape & Amp units 30 watts for 12v DC inc P.A. spk (were used as Bird Scareers) good basis for P.A. Amp ext soled. £35 two items.

Above prices include Carr/Post & VAT, goods S/Hand unless stated new. 2 x 18p stamps for List 40 allow 14 days for delivery.

A.H. SUPPLIES

122 Handsworth Rd, Sheffield S9 4AE.
Phone: 444278 (0742).

S.E.M. UNIT P, UNION MILLS, ISLE OF MAN

Tel: MAROWN (0624) 851277

S.E.M. QRM ELIMINATOR. Just had a 'phone call to say "I bought one at NEC and it's b---- marvellous." A neighbour had installed an ex-arcade games machine for his kids and this station couldn't operate because of the QRM until he used our **ELIMINATOR**. He was over the moon.

It can do the same for you. It connects in your aerial lead and stops the interference before it gets to your receiver. Any sort of interference, it can be next to your receiver (your computer?) or up to a couple of miles away, any freq. 1.5-30MHz.

So if you have a local interference problem, we can stop it. £85 Ex-stock.

If you don't believe its true, try one for 10 days, if it doesn't solve your problem, we'll refund, less £5 to cover costs.

NEW S.E.M. Dummy load. 100W with dummy load/through switch. So you leave it plugged in line. £22.00 Ex-stock.

NEW S.E.M. TRANZMATCH Mk III. Now has a switch to select DIRECT to aerial, BALANCED or UNBALANCED or DUMMY LOAD. The matching unit retains its tremendous versatility capable of matching virtually any aerial to 50 ohms at up to 1kW, balanced or unbalanced. The link coupled output isolates the aerial from the rig, which can cure TVI both ways. Their robust construction is proved by the ones in daily use for 15 years. 1.8-30MHz £110. Ezitune built in £39.50 (see below). Built in dummy load £8.90 Ex-stock.

S.E.M. 2 metre Transmatch, match your V.H.F. aerial, 1KW max. £32.00 Ex-stock.

S.E.M. EZITUNE. Do you use an antenna matcher? You need our Ezitune to tune it to your frequency without transmitting. Listen to the S9+ noise on your receiver and adjust your aerial tuner for a dip in the noise and you are matched up to 50 ohms (1:1 SWR). Protect your radio and stop tuning QRM. £45 boxed, or p.c.b. + fixing bits and instructions to fit in any A.T.U. £39.50. Ex-stock.

VERY WIDE BAND PRE-AMPLIFIERS

They cover from 3-500MHz with a noise figure of 1.5dB and an unprecidentated +30dB 3rd order IP at the INPUT. Gain is 9dB.

We make three types. Straight pre-amp, this has a signal loss if you switch it off, £32.00. One which switches to "straight through" when switched OFF, can be used for transmitting through (100W) if supplied with 12V on receive and 0 on TX, costs £37.00. An R.F. switched unit is £45.00. All Ex-stock. We are continuing to make our highly acclaimed dedicated 2 Metre pre-amps with adjustable 0-20dB gain and 1dB N.F. Receive only £21.90. R.F. switched £34.00. Ex-stock.



CONVERTERS for LF, MF, HF, VHF, UHF.

Our new H.F. CONVERTER opens new horizons for receivers, use with the new all mode V.H.F., U.H.F. receivers FRG9600 and ICR7000, extends their coverage down to 100kHz, giving you LF, MF, HF, VHF and UHF. You tune your RX from 100MHz up, e.g. 103.500 is 3.5MHz. It has two aerial sockets, one for H.F. into the converter and one for V/UHF switches straight through into your RX when you switch the converter OFF, i.e. No plugs to change. All this for £45.00. Ex-stock.

R.F. NOISE BRIDGE. If you are experimenting with aerials you need one of these units. Tells you the resonant frequency and impedance of your aerials and also invaluable for measuring 1/4, 1/2, etc., wavelength of feeders, etc. £45.00. Ex-stock.

WAVEMETER. A pretty little absorption wavemeter, to satisfy the licence conditions. 1.5-30MHz with a meter indication. £39.50.

IAMBIC KEYS. We use the world famous CURTIS chip which eliminates the little idiosyncracies common in other keys. Opto-isolators from the chip ensure that R.F. can't get in, a common problem with multi-chip keys. Compatible with any TX. £45.00. An excellent twin paddle key often mistaken for ones costing several times more at £19.50. Ex-stock.

2 METRE LINEAR POWER AMP/PRE-AMP. People are constantly telling us that comparing different makes our Pre-amp is best. (See Pre-amps for spec.) Three models. Sentinel 40 14x power gain e.g. 3W IN-40W OUT. Ideal for FT290 £85.00. Sentinel 60, 10W IN-60W OUT £95.00. Sentinel 100 10W IN-100W OUT £135.00. All Ex-stock.

AUDIO MULTIFILTER. Has fully adjustable BAND PASS, HIGH PASS, LOW PASS and 2 NOTCH filters. From 2.5kHz to 20Hz. Making the most versatile filter available. £75.00. Ex-stock.

T.V.I. Our Braid Breaker/High Pass Filter cures T.V.I. by plugging into the TV aerial socket. £7.50. Ex-stock.

S.E.M. SWITCH. 3 way ant. switch + 4th position to earth. 1kW. S0239S D.C.-150MHz. £23.00. Ex-stock.

12 MONTHS COMPLETE GUARANTEE INCLUDING ALL TRANSISTORS.

Prices include VAT and delivery. C.W.O. or phone your CREDITCARD No. Ring or write for further data. Orders or information requests can be put on our Ansaphone at cheap rate times.

John made an immediate m.s. sked with OK2KZR which was completed in 20 minutes from 1245. Tropo conditions were good on the 16th between southwest and southeast and early the next day beacon HB9HB was heard at good strength.

John Wimble G4TGK (KNT) worked G8TFI/P and G3BXF (NHM) on April 11. In a slight lift on the 16th he contacted EI9GJ/P (WIM) and EI2GK (WVN). EI is seldom workable from New Romney apparently. He also worked PA6IARU the operator being ON6JG. Apologies, John, for getting your call sign wrong in the Squares Table.

John Lemay G4ZTR (ESX) is slowly getting his station together at his new QTH in Colchester. He has an Altron 10.5m mast and is QRV on 70, 144, 430 and 1296MHz, though not all at once.

Colin Ford G4ZVS (WMD) now has 81 different c.w. stations worked in 1987 and found conditions good in the period April 14-17 with GB3VHF S9+20dB. He contacted F6FLB (Calais) on c.w. on the 16th at RST569 both ways.

G6AJE made the most of the contest on April 12 and Mike worked G4APA/P, GJ4ICD, G8TFI/P, G1GEY, GM4RZW/P, GW8HEZ (GNS), GW8CMU/P, F6IFR/P (JN09), GOCLP/P (CBA), G14KIS/P and G4VCJ (CVE) in the closing seconds of the event. On the 19th he worked G8RCF (SOM) and the following day G6IJM (LNH) and FC1MNP/P (JO00).

Graeme Caselton G6CSY (KNT) would like to trace the group or individual who operated LXODX during NFD in 1983. It is the only Luxembourg station he has ever worked so needs a QSL. Can any reader help? Maybe someone has a QSL card from this station.

Ela Martyr G6HKM (ESX) was away from home for ten days so activity was low this time. Her only new county was G8RCF (SOM) and she missed out on a Gloucestershire station.

John Fitzgerald G8XTJ (BKS) added a few more in limited operation including G1KMI/P on April 12, GU2FRO on the 16th, G1UUX/P (IOW) on the 19th and GM1JNC/P (DGL) on the 20th. New WAB squares were worked when Laurie Segal G6XLL (LDN) operated from Powys and Gwent and John has a claim in for 1200 areas worked.

Derrick Dance GM4CXP (BDS) has started operating again now that he no longer has the excuse of the inhospitability of an outdoor shack in the middle of winter to offer. He has updated his squares total but has voluntarily excluded scheduled m.s. type QSOs as he feels, "... a bit disillusioned with some of the false claims for 'complete QSOs' going around on this mode."

Paul Baker GW6VZW (GWT) operated in the April 11/12 contest, new counties being CNL, YSN, GDD and Cumbria, an all-time new one. He also worked GJ4ICD and GM4RZW/P. The high pressure of the 13/14th enabled him to contact EI3VVN/P (WL) and EI9GO (WM) both in Waterford, plus EI3CNB in Cork. WL was a new square bringing Paul's total to 70 on the band.

On April 16 **Nick Peckett G4KUX (DHM)** heard two German stations chatting to each other and assumed they were "locals" just across the North Sea. When he called in, one was DC7MH in Berlin. Later he worked OK1KHI/P and received as RS58 report. In the Irish contest Nick had QSOs into many counties in the Republic. On the 19th he worked the Ekofisk station LA1EKO (BQ) for the first time. The

Annual v.h.f./u.h.f. table January to December 1987

Station	70MHz		144MHz		430MHz		1296MHz		Total Points
	Counties	Countries	Counties	Countries	Counties	Countries	Counties	Countries	
G1KDF	—	—	83	8	58	7	16	4	176
G4NBS	41	5	54	10	44	11	15	6	185
G6HKM	—	—	55	13	43	9	14	4	138
G1SWH	—	—	72	8	40	6	—	—	126
G1LSB	—	—	54	11	40	10	—	—	115
G4DEZ	—	—	24	9	37	8	7	4	89
G4MUT	26	1	38	9	11	2	3	1	87
G6AJE	—	—	39	9	30	6	—	—	84
G1EHJ	—	—	39	7	25	6	—	—	77
G3FPK	—	—	59	12	—	—	—	—	71
G4ZTR	12	2	22	5	21	4	2	1	66
GW6VZW	—	—	56	9	—	—	—	—	65
G4AGO	13	1	28	8	11	3	—	—	64
G6MGL	—	—	25	6	25	2	1	3	62
G4VOZ	29	3	—	—	26	4	—	—	62
G8XTJ	—	—	51	9	—	—	—	—	60
G4TGK	—	—	50	9	—	—	—	—	59
GOHDZ	—	—	45	11	—	—	—	—	56
G1CRH	—	—	43	9	—	—	—	—	52
G4YIR	—	—	40	9	—	—	—	—	49
G1VTR	—	—	16	2	22	5	—	—	45
G1GEY	—	—	35	8	—	—	—	—	43
G2DHY	7	1	20	4	3	1	—	—	36
GW4HBK	32	4	—	—	—	—	—	—	36
G4SEU	25	3	—	—	4	2	—	—	34
GOHGA	—	—	28	4	—	—	—	—	32
G4WND	25	4	—	—	—	—	—	—	29
G6XRK	—	—	8	6	—	—	—	—	14
GM4CXP	—	—	10	3	—	—	—	—	13

Three bands only count for points. Non-scoring figures in italics.

next day he completed an m.s. QSO with I7HCB (HB19c).

Paul Pasquet G4RRA (SRY) has recently got going on c.w. m.s. He made a couple of skeds in the Lyrids with an SM3 and an HG8 but heard absolutely nothing from either. **Roger Colwell G4ZEC (BKS)** is a very keen c.w. operator and has entered the Annual Ladder with 340 already. His station consists of a Trio TS-711E and BNOS 180W amplifier. The antenna is a portable 13-ele Tonna Yagi with MuTek masthead pre-amp 10.5m a.g.l. and his QTH is 106m a.s.l.

The 430MHz Band

On April 17 G1KDF worked G8ZDS (CNL) on 144MHz and then suggested they try on 430MHz. The G8 said he only had 10W so did not think they would make it. However they did, easily. Bob worked G1BIW (ARM) on the 20th; EI6GF (Wexford) on the 22nd; GM4CXP on the 26th; G1JGS/P (IOW) who is out -/P most Monday evenings on the 27th and also on the 27th G14SXV (TYR) who now has a 21-ele Tonna Yagi.

Paul Brockett G1LSB (LCN) reports little activity up to mid-April but lists EI5FK/P (WL) on the 13th and on the 15th EI5FK (VL) from home in Cork. G1SWH added five more counties in the first half of April: G6UMP (WKS) on the 1st; G4RKV (KNT) on the 8th; EI5FK/P on the 13th; G14SXV and G1BIW on the 15th.

G1VTR lists six more counties for the Annual Table; GOEMH (GLR) on March 30; G8GXP (YSW) on the 31st; G1HWY (SXW) on April 13; GOEYO (HWR) and G4XOL (MSY) on the 15th and G8ECI (LCN) on the 16th. Stuart reckons the band to have "... blossomed into spring activity."

G4ZTR was only using 10W to a pair of 21-ele Tonna Yagis yet John managed to work EI5FK (VL) on April 15 and HB9AMH/P (DH) on the 17th. G6AJE's first GW this year was GW1SSQ/P (GWT) on April 17. On the 20th Mike worked G8HPD (HFD) and G1JGS/P (IOW) a county missed last year. G6HKM also found the IOW station but Ela was unsuccessful with a contact with G16ATZ on April 4. However she was called by G1PAM (SPE)

which was a new 1987 county to bring the tally up to 43 so far.

Philip Stanley G3BSN (LDN) has made extensive observations on 430MHz propagation over the years. He notes two main phenomena. First that a station may be heard calling on, say, SU20 at a certain strength but when they QSY to a different frequency their signal may be up to 12dB weaker or stronger. Second that there are day-to-day variations in signal strength from the same station.

Phil's comments are concerned with local stations since obviously we all experience these variations over DX paths. Regarding the first effect, I have noticed this on short distances on 21MHz when operating mobile. Many years ago I found that by moving slowly in a straight line towards the station I was receiving, the signal strength would vary and concluded it related to the number of wavelengths between the two antennas. These tests were carried out from completely open ground. Therefore, if both stations are fixed and the frequency is changed, the number of wavelengths between them will alter producing a similar effect.

As to the day-to-day phenomena, the attenuation of v.h.f. and u.h.f. or the path loss depends on such factors as the radio refractive index, which is derived from the water vapour pressure, the air temperature and barometric pressure, and the distance between stations. Ignoring the distance parameter, the others will change all the time and I am sure Phil's observations are verifying this.

G3BSN lists the following stations as regularly heard or worked from London: G1JGS (IOW), G6ICR (MSY), G6UUR (WMD), G8XVJ (CHS) and GW1SSQ (GWT). In the April 15/16 period Phil lists EI5FK, G10GDP (IO74KR), PAOZM (DM64e), PAOFRE (CL03j), ON4YZ, FC1LHP (BK12g) and PE1GHG (CL03e).

The Microwave Bands

Dave Ackrill G0DJA (WMD) operated in the 10GHz contest on April 12 and accumulated 141 points. All QSOs were two-way, best DX being 51km from Barr Beacon to G8SWZ at Titterstone Clee. A fault on Dave's 24GHz equipment in the

audio section precluded any operation on that band. He remarks that although the weather was warm and sunny, several people found conditions on all bands from 50MHz up to be down somewhat, including the GB3LEX beacon on 10.4GHz.

G1KDF reports on 1296MHz. Bob says that G16ECV (ATM) is active with 10W but he has not worked him in two tries. However he did contact G18AYZ on April 15 in that county. G4MTR (CBA) is a good signal from YO33G and was worked on the 18th. He is also QRV on 144 and 430MHz. On the 26th, after 16 months of random tests, Bob finally had a QSO with GM4YPZ (GRN) in YQ19g with initial assistance from G4CBW.

G3BSN listens on 1296.200MHz every evening as well as on 432.200MHz and Phil would welcome some contacts. On the DX front he has logged PE1GHG and PA0FRE both in CL03. G6AJE is still trying to find some time to get his 1296MHz station operational so advises, "Hang in there!"

G6HKM added only one more county on 1296MHz, Shropshire in the guise of G4LU on March 31. During a slight lift on April 23, Ela had a pleasant QSO with PE1EWR. She did not plan to enter the May 2/3 contest but expected to come on the band to give a few points away.

Final Miscellany

Angela G0HGA passes on a tip to budding c.w. addicts. She identifies it as "The syncopated fast character speed and marked gaps between words" method. To send a message faster as you get more proficient, you just shorten the gaps between letters and words. G4ZEC endorses this method although others may

find it off-putting but it may suit some Class B licensees who are practising the art on the air.

Angela also inquired about the c.w. ladder, whether she could count a GO who has upgraded from a G1 as an extra station worked. No. The idea is to work different stations or operators and in this case it is the same person in the same shack as before. However, it would be alright to count the same operator again if worked from home in England, then say -/A in Scotland.

Howard Staddon G6STI (LDN) mentions that those looking for VN square might listen for EI4AQB in Galway who has been active on Sundays on 144MHz from 0930 to 1400. I had the pleasure of talking with Brian Sheepwash G14KIS at the Convention. He does a fair amount of portable operation from the six Ulster counties and confirmed that there are no big stations on from Fermanagh. He usually operates on 144.165MHz so it is worth keeping a listen there. Unfortunately that part of the band in the London area is often used by stations practising c.w. It is a pity they do not use the all-mode section above 144.500MHz for this purpose as originally proposed.

On the more exotic side, more and more 144MHz operators report hearing W5UN

Annual c.w. Ladder

Station	Band (MHz)				Points
	70	144	430	µWave	
G4ZEC	—	340	—	—	340
G4XEN	—	145	8	—	153
G4OUT	—	90	—	—	90
G4ZVS	—	81	—	—	81
G0DJA	—	51	—	—	51
G4VOZ	18	—	16	—	34
G4AGQ	11	8	13	—	32
G2DHF	5	23	2	—	30
G4YIR	—	27	—	—	27
G0HGA	—	19	—	—	19
E15FK	—	10	6	—	16
GM4CXP	—	7	—	—	7
GW4HBK	4	—	—	—	4

Number of different stations worked since Jan. 1.

off the Moon. Of course he runs a very big station and several British operators have worked him with a single Yagi fed only with the legal power. The most important thing is to know where the Moon is and if it is visible at both ends. I have extensively adapted programs in *Amateur Radio Software* by John Morris, for the little Sinclair ZX-81. The Full e.m.e. Planner version is ideal for this purpose. If any reader would like some information please send an s.a.e. to me and I will send a resumé of what it does.

On the m.s. scene remember that June is a good month and many old hands reckon they get more success with random schedules than is often the case in major showers. The Arietids peak on June 11 and the Zeta Perseids on the 13th. There are several showers worth considering in the period July 10-12 if you choose the right time.

Issue	Deadline
September '87	July 1
October '87	July 29
November '87	August 26

RTTY

Reports to Ron Ham
Faraday, Greyfriars, Storrington, West Sussex R20 4HE.

"For a couple of evenings at the beginning of April I logged ZS6CC as a mailbox, around 1700, on 14.082MHz. Another station which regularly appears on 14.094MHz is the ARRL station W1AW, transmitting satellite and sunspot information," wrote C.R. Eve (St. Helier) on April 16.

In addition, C.R. Eve logged TG4VT working G and using 75 baud on the 4th, JA1ACB printing "CQ West Indies" on the 5th, YB5NOF working into G after calling "CQ Caribbean" on the 8th, JA1JDD in QSO with a DL on the 12th and DU7GJ which, despite bad QSB, promoted an immediate European pile-up at 1750 on the 16th.

"In general band conditions seemed to have improved during the past month, with considerable activity on 21MHz RTTY, said John Barber G4SKA (Tiverton) on the 20th. John proved this point when he worked stations in all 6 continents, on 14MHz, between 1630 and 2050 on the 16th. At 2102 on the 17th he contacted 3G87PAX who, after giving his location; Valparaiso and John his 559 report, he printed "THIS IS A SPECIAL PREFIX OF THE CHILEAN FEDERATION OF AMATEUR RADIO CLUBS IN HONOUR TO H.H. POPE JOHN PAUL II ON THE OCCASION TO HIS VISIT TO CHILE".

John's equipment, apart from his Commodore 64 computer, is all home built. On March 21 and 22, he exchanged keys with 22 countries on 3.5MHz and 12 on 7MHz and between March 20 and April 21, he worked 50 countries on 14MHz, ranging from Argentina to Australia and Alaska to

Country (Prefix)	Frequency (MHz)			
	3-5	7	14	21
Afghanistan (YA)			X	
Alaska (KL)			X	
Albania (ZA)			X	
Anguilla (VP2E)			X	
Argentina (LU)			X	X
Australia (VK)			X	
Austria (OE)	X		X	
Balearic Is (EA6)			X	
Belgium (ON)	X		X	
Botswana (A22)			X	
Brazil (PY)			X	X
Bulgaria (LZ)	X	X	X	
Canada (VE)	X		X	
Canary Is (EA8)			X	X
Chile (CE)			X	
Costa Rica (TI)			X	
Colombia (HK)			X	
Cyprus (ZC4)		X	X	X
Czechoslovakia (OK)	X		X	
Dominican Rep. (HI)			X	
East Germany (Y2)	X	X	X	
Ecuador (HC)			X	
Egypt (SU)			X	
England (G)	X		X	X
Faroe Is (OY)			X	
Finland (OH)	X	X	X	X
France (FE)	X	X	X	X
Greece (SV)			X	
Guatemala (TG)			X	
Guernsey (GU)				X
Holland (PA)	X		X	
Hong Kong (VS6)			X	
Hungary (HA)	X	X	X	X
Iceland (TF)			X	
Indonesia (YB)			X	

Country (Prefix)	Frequency (MHz)			
	3-5	7	14	21
Israel (4X)			X	X
Italy (I,IK,IT)	X	X	X	X
Jamaica (6Y)			X	
Japan (JA)			X	X
Lebanon (OD)			X	X
Madeira Is. (CT3)			X	
Malta (9HI)			X	
Morocco (CN)			X	
Norway (LA)	X	X	X	
Netherland Antilles (PJ2)			X	
Nigeria (5N)			X	X
Poland (SP)	X	X	X	
Portugal (CT)			X	
Puerto Rico (WP4)			X	
Rhodes (SV5)			X	X
Rumania (YO)	X		X	
Sardinia (IS)			X	
Scotland (GM)	X		X	
Sicily (IT9)			X	
South Africa (ZS)			X	
Spain (EA)	X	X	X	X
Surinam (PZ)			X	
Sweden (SM)	X		X	
Switzerland (HB)	X	X	X	
Ukraine (UT)			X	
United Arab Emirates (A6)			X	
Uruguay (CX)				X
USA (W)	X	X	X	
USSR (UA,UB)	X		X	X
Venezuela (YV)			X	
Wales (GW)	X	X		
West Germany (DF,DJ,DL)	X	X	X	
West Malaysia (9M2)			X	
Yugoslavia (YU)	X		X	X

Fig. 1: The RTTY chart of stations heard in the past month

South Africa and 12, plus 4 heard, on 21MHz. Your quarter wave vertical antenna for 14MHz and 3.5MHz dipole, tuned for all bands, are certainly earning their keep John.

"Data mode observations this month have brought a fairly representative selection of 45 prefixes, including two new countries, a YA1 on 14MHz RTTY from Afghanistan and a VS6 from Hong Kong on 14MHz AMTOR," wrote **Len Fennel G4ODH** (Wisbech). He copied AMTOR signals from each of the 19 countries listed in Fig. 2. Len's latest log, which ranges over almost all corners of the earth, brings his datawatch total to 141 countries.

I noted an increase in RTTY traffic during this period because, even with a limited number of band checks, I found signals from 7 countries on 3.5MHz, 4 on 7MHz, 19 on 14MHz and 3; EA, JA and LU on 21MHz. My best DX was VK3ADP working an Italian station and VK5RY in QSO with a G, on 14MHz, around 0830 on April 9 and 12 respectively and LU1MIX—MAILBOX—which was active on 21MHz at 2035 on the 11th.

Our thanks are due to John and Len for their detailed RTTY logs which, when combined, enabled me to compile the impressive list of countries seen in Fig. 1. It is worth noting, especially newcomers to

RTTY, that at least 10 S. American countries are included in Fig. 1.

Packet

Between March 15 and April 22, **Terry Stanley G0GTO** heard or worked stations in 48 countries, on 14MHz, using the Packet mode of communication. Just to whet the appetite these were: AL, A4X, CE, CP, CT1, DA, DU, EA, FE, HA, HB9, HP, I, IK, ISO, IT, IT9, JA, LA, LU, LX, LZ, OA, OE, OH, ON, PA, PJ2, PY, SM, ST, SV, SV1, TI, TF, TR, VE, VK, VS6, W, YB, YU, YV, ZF, ZL, ZS, 4X, 5H, 9K and last but not least 9M2. Terry also copied signals from Mailboxes operating in Brazil, Canada and Peru.

Finale

Well that's it lads and lasses, this column was born in *PW* and has developed with your help. The time has come for it to be expanded, but with my on-going work

*Send your reports to
Mike Richards G4WNC
at 200 Christchurch Road,
Ringwood, Hants BH24 3AS,
for inclusion in the
September issue*

Country (Prefix)	Frequency (MHz)			
	3-5	7	14	21
Australia (VK)			X	
Austria (OE)			X	
Canada (VE)			X	
Canary Is. (EA8)			X	
England (G)	X		X	
France (FE)			X	
Hong Kong (VS6)			X	
Italy (I,IK,IT)		X	X	
Norway (LA)			X	
Oman (A4X)				X
Spain (EA)		X	X	
Sudan (ST)			X	
Sweden (SM)	X			
Tanzania (5H)			X	
USA (W)			X	
Venezuela (YV)			X	
West Germany (DF,DJ,DL)	X	X	X	
West Malaysia (9M2)			X	
Yugoslavia (YU)			X	

Fig. 2: The AMTOR chart

in the field of propagation, the time has come to hang-up my keyboard.

I am handing the column over to the very capable hands of Mike Richards G4WNC who is much more active in the field of data communications than I.

I've enjoyed reading all your letters and reports and look forward to this continuing with the propagation column and reading the new RTTY column too.

Amateur Satellites

Reports to Pat Gowen G3IOR
17 Heath Crescent, Hellesdon, Norwich, Norfolk NR6 6XD

Phase IV Progress

The AMSAT Geostationary satellite presently destined for a 1991 operation has been undergoing considerable planning by a group of some twenty AMSAT scientists and engineers. The end of this year is the target time for the finalisation of the overall design concept. The result should be an OSCAR satellite that not only will be the most advanced to date, but one that will also augment many of today's new up-and-coming technologies in amateur radio. Many of the ideas under consideration are quite innovative, and have never, as yet, been utilised in any spacecraft design.

Readers will understand that positioning, temperature control, stability and attitude control are all essential in any spacecraft employing complex equipment and directive antennas. This is even more so in geosynchronous satellites that are at great distance and need to employ gain arrays and with narrow lobes, and so have to beam accurately to earth from orbit. They also sit in a rather tightly confined belt that is highly popular and thus rather overcrowded, and this means that maintenance of position is all important, as "bumps" could prove to be rather expensive!

The earlier satellites had no means of attitude stabilisation, and indeed the current RS series also are unstabilised, relying upon an antenna design with a sufficiency of uplink signal capture and downlink power to permit antennas approaching isotropic radiation (e.g. radiating in almost all directions equally).

OSCAR-6 was stabilised with bar magnets, so that after the initial toppling and tumbling following ejection after launch into orbit, (with no air damping or gravitational pull to decrease it) the on-board magnets would slowly line the spacecraft up with the earth's magnetic field and hence maintain orientation within the lines of force. OSCAR-7 and 8 followed a similar

tradition, with stability and attitude now seen as even more essential, as antennas other than the earlier simple dipoles that used the wider radiation patterns were employed. The new use of u.h.f. frequencies such as 432MHz needed greater antenna gains, hence more directive antennas, deemed necessary to overcome the elevated path losses existing at this part of the amateur radio satellite spectrum. All of these were Phase II spacecraft, and no commandable attitude control was provided for this series. Indeed, our latest amateur radio satellite OSCAR-12 also makes good use of fixed onboard magnets like the RS Radio series.

OSCAR-10, the first operational Phase III satellite, had actual beam antennas, phased to give circular polarisation to overcome Faraday rotation and to allow for the spinning spacecraft. This in itself made the controllable magnetic thrust essential to achieve the desired spin-rate. "Magnotorquing", i.e. the programmed computerised control of X,Y and Z axis electromagnets in the spacecraft by selective synchronised pulsing was used in order to orientate the spacecraft within earth's field so that it would face the solar cell panels into the sun to obtain optimum power. It also served the purpose of ensuring that the antennas would beam to earth from apogee to optimise both the received uplinks and transmitted downlinks, thus providing the best possible signal to noise ratio within the confines of limiting power production. Phase IV now takes us a stage further in attitude and position control, and advances other aspects such as thermal control and enhanced circuitry techniques.

Rick Fleeter WA8VKG, is working on propulsion systems, specifically on a unique concept for attitude control jets to ensure that the spacecraft stays where intended and points in the correct direction, i.e. at earth. Phase IV will be different from Phase I, II, and III developments as it

must not spin, gyrate, topple or tumble, but must be fully stable in all three axes. To ensure this, it is from time to time necessary to nudge the satellite slightly by the deployment of small onboard jets. The amount of fluid used is limited, and thus the useable lifetime of the satellite is determined by the amount of consumable fuel which it can carry, this being parasitic upon other apparatus for a given weight limitation. Rick's innovation lies in the efficiency of both the type of fluid used and of the controlling jets themselves, and his propellant and system envisaged is a very advanced one indeed.

Phase IV should use "Fluid Momentum Control", an idea pioneered by Lou McFadin W5DID, a Houston NASA engineer by profession, and being brought to practice by Bob McGwier N4HY, of Princetown, New Jersey who is working with Lou. The new system would eliminate the momentum wheel normally required by tri-axis stabilised spacecraft, which is very expensive, and, being dependent upon moving parts, is vulnerable to failure. The new concept would pump a ferro-magnetic fluid around the spacecraft to give momentum transfer and control, all done magnetically avoiding a motor driven pump.

Dick Jansson WD4FAB, also of NASA, is involved with the thermal design, i.e. the maintenance of a correct temperature balance of the spacecraft within the confines of the extremes of raw sunlight on one side and cold black space on the other. The RS spacecraft can employ an inert gas or air under pressure, with a small back-up booster heating element, relying upon convection currents, whilst the OSCAR series, designed by Jan King W3GEY, depended upon radiation from black surface and insulation of white or silver surface to maintain thermal stability. Dick will be working on a Phase IV system using a specially designed heat pipe regime to give precise temperature control over the entire satellite surface.

Practical Wireless, July 1987

Lee Electronics



NORMAN G4THJ

NEW HANSON SWR METERS

		P+P
SWR3	3.5-30MHz 200 Watts/50-150MHz 50 watts	34.00 (1.50)
SWR25	3.5-150MHz 1KW PEP with back light facility	34.00 (1.50)
FS500H	This peak reading meter has RMS/PEP with follow/hold facility in the range 1.8 to 60MHz/20/200/2KW	75.00 (2.00)
Still Available		
SWR15	Single meter SWR/Field Strength 3.5-150MHz	9.77 (1.50)
SWR25	Twin meter SWR/Power/Field Strength 3.5-150MHz	19.00 (1.50)
UH74	SWR Power meter switchable HF/2M/432MHz (10W) with remote head	24.95 (1.50)
T435	VHF/UHF Twin Meter 2/20/120W	52.50 (1.50)

WELZ PRODUCTS

SP330	1.8-500MHz 200W Dash Mount	95.00 (1.50)
SP600	1.6-500MHz 20/200/2kW	169.00 (1.50)
SP825	1.8-1.3GHz 2/15/150W	169.00 (1.50)
SP10X	1.8-500MHz 200W Pocket Size	34.00 (1.00)
AC38	3.5-30MHz Coax ATU 200CW/400C PEP	95.00 (1.00)

MORSE KEYSERS

EK150	Semi-Fully Automatic Electronic keyer with Built-in Monitor, Transistor or Relay Output 240VAC/120VDC	90.00 (1.50)
MK1024	As EK150 but with 1024 Bit Memory	139.50 (1.50)
HK707	Straight Up/Down Keyer	18.75 (1.00)
HK702	As HK707 only with a Heavy Marble Base	31.00 (1.50)
HK704	Squeeze Keyer	17.25 (1.50)
MK705	Squeeze Keyer	31.00 (1.00)
MK702	Manipulator Key on Marble Base	31.00 (1.00)
BK100	Semi Automatic Bug Key	24.75 (1.00)
EKM-1A	Morse Code Practice Oscillator with variable Tone	10.25 (1.00)

ROTATORS

AR1002	Automatic Antenna Rotator	45.00 (3.25)
AR2200	Heavy Duty Antenna Rotator	89.95 (3.50)
KR400C	Mid to heavy Vertical Load 200KG 6 core cable	169.00 (5.00)
KR600C	Heavy-vertical load 200KG Brake Torque 400KG/CM	219.00 (5.00)

ANTENNAS

TA285	2M Colinear Base Antenna/70cm Colinear	35.00 (7.50)
X50	Base Antenna 70/2	60.00 (7.50)
DPCPS	Base Antenna 80-10m	198.00 (7.50)
DPL EL770H	Mobile Antenna 70/2	29.95 (7.50)

POWER SUPPLIES

PX402	3A Continuous 4A Max 13.8VDC Fully Stabilized	24.95 (4.00)
EP2510	25A Continuous 30A Max 13.8VDC Fully Stabilized	155.00 (6.50)
DRAE	13.8VDC 12 Amps	86.50 (5.00)
DRAE	13.8VDC 6 Amps	65.00 (4.00)

ADONIS MICS

AM303	Base Mic SSB/FM Switch	49.50
AM503	Desk Compressor Mic as 803 with One Output. Two levels of compression	59.00 (1.15)
AM803	As 503 with Meter & 3 Outputs	89.50
FX1	Swan Neck Fet Mic with Control Box	49.00 (1.15)
202S	Flexible Neck Clip Mic with Control Box	37.50 (1.15)
HW7	Head Set Boom Mic For Yaesu/Icom/Trio	27.50 (1.15)

COAX SWITCHES

SA450	Diecast 2 Way S0239 3.5-500MHz	12.65 (1.00)
Toggle Type	CT1 3x S0329/CT2 2x SP239 1x PL259 3.5-150MHz	7.50 (1.00)

Special Offer on Toggle Switches £6.00 + P&P

NEW IMPORTS

Diamond X50	VHF/UHF Base Aerial	59.95 (3.00)
DPCPS	10-80MTR Vertical	185.00 (5.50)
Welz	CT1010 D/Load 200 watt cont 1kW Intermittent DC-150MHz	75.00 (2.00)
SP430	Mobile SWR/PWR/Volt Meter 140-150/420-450 MHz 60 watts	49.50 (1.50)
SP122	1.6-60MHz AVG/PEP 20/200/2kw (continuous 700W 1.6-3.5MHz 1kw 3.5-60MHz)	

All Popular Connectors - Termination - Sockets Ex Stock at Competitive Prices - TRY US!

400 EDGWARE ROAD,
LONDON W2
01-723 5521 Tlx 298765



Normally 24hr despatch but please allow 7 days for delivery.



NEAREST TUBE:
EDGWARE ROAD
PADDINGTON

OPENING TIMES:
9.30am-5.30pm Mon-Fri.
10am-4.30pm Sat.

SPECTRUM TRANSCIVE

The TX-3 RTTY/CW/ASCII TRANSCIVE program is now available for the Spectrum. It has all the facilities of the BBC and CBM64 versions and will operate with an interface or T.U.

Forget what you thought you knew about Spectrum direct decode systems. This one will transceive 300 baud RTTY or ASCII at 170Hz shift with only a simple interface. Its performance and facilities outclass other software by a large margin yet it is very easy to use. Some of the features are:

Split-screen type-ahead operation, receive screen unwrap, 24 large memories, clock, review store, callsign capture, RTTY auto CR/LF, CW software filtering and much, much more.

The program comes with an adapter board which plugs into the Spectrum expansion port and accepts the interface or T.U. It will work with any 48/128k Spectrum, including the +2. Tape + adapter £35. Users of the CW QSO program can upgrade for £25. BBC and CBM64 program £20 tape, £22 disc.

TIF1 INTERFACE has computer noise reduction, RX filters, TX outputs for MIC, PTT and KEY. Perfect for our TX-3 and RX-4 programs. Kit £15 (assembled PCB + cables & connectors), ready-made boxed with all connections £25 (state rig).

SPECTRUM RX-4 RECEIVE

We now have a version of this amazing program using the adapter board mentioned above. This enables even better reception of RTTY/CW/SSTV and AMTOR with any 48/128k Spectrum, including the +2. Uses TIF1 (see above) for all modes or a T.U. for RTTY and CW. Tape + adapter £40. Existing RX-4 users can upgrade for £21. RX-4 is also available for BBC, CBM64 and VIC20 £25 tape, £27 disc (not VIC20). The BBC RX-4 is now completely compatible with the Master Series. Master users may exchange their programs free of charge.

We also have superb BBC, CBM64, Spectrum, VIC20, Electron programs for Morse Tutor £6, Locator £7, Logbook £8 and RAE Maths £9 as well as a great UK/Europe and World Map and Locator for BBC/Electron £10. Any BBC or CBM64 program also on disc at £2 extra.

Prices include VAT and 1st Class p&p Inland, airmail overseas, normally by return. Eire, C.I., BFPO deduct 13%.



technical software (P.W.)



Fron, Upper Llandwrog, Caernarfon LL54 7RF. Tel. 0286 881886

THE HAMGEAR PMX PRESELECTOR

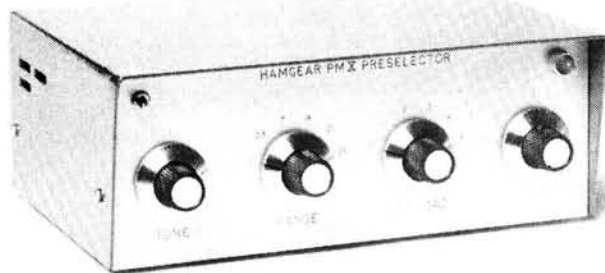

Introducing our new HF band preselector and antenna tuning unit combined, covering 1.7 to 34 MHz completely. The ATU section allows endless experiments with various lengths and types of antenna and offers correct matching of these antennas to your receiver.

The pre-amp section has a gain of 20 DBS which can be controlled down to zero gain, then on down to minus 15 DBS, allowing a boost just where the RX might need it or an attenuation where the band dictates. This unit represents the two most popular pieces of receiver ancillary equipment in one case and has been deservedly popular since we introduced the original version in 1964.

The case is all metal with brushed aluminium panel; unpowered, it requires 12 volts at 40 m/a; guaranteed for 12 months and priced at £69.00 post paid U.K.

ALSO AVAILABLE MAINS POWERED £78.00

Why not send for full details?

HAMGEAR ELECTRONICS
125 Wroxham Road, Norwich NR7 8AD.
Tel: Norwich (0603) 405611.

Phil Karn KA9Q is teaming up with Bob to produce a new spread spectrum ranging technique, which would permit a precise location determination of Phase IV (vital in a rather overcrowded and congested equatorial geosynchronous orbit to avoid possible collisions) which would not cause any QRM on ongoing QSOs nor demand any apparent section of the passband on the transponder.

Karl Meinzer DJ4ZC is busy with his innovative HELAPS (High Efficiency Linear Amplification by Parametric Synthesis) modulation system, as used to great effect in OSCAR-7 and OSCAR-10, to give optimum output, minimum heat dissipation, linear operation and minimal battery consumption. He is further improving the system continuously, and is now applying new technology that may well lead to its use even up to 2.4GHz, e.g. "S" band. Karl has also developed another remarkable digital communications technique called "Rectangular Spectrum Modulation" (RSM) which may well also be employed on the Phase IV spacecraft, and both of the new systems may even be put to good use on the coming AMSAT-DL Phase III-D satellite.

James Miller G3RUH is investigating the use of digital signal processing techniques that would automatically null selected frequencies in the uplink passband if a signal or signals exceeded a given threshold level. In other words, a long sought "alligator" deleter is underway, to take away the constant menace of those who have continuously abused the satellites with excessive powers at the expense of those who "play the game" and have their QSOs systematically ruined by attenuation of the entire transponder passband. (Your author will personally nominate Jim for a knighthood for services rendered when the end product is proved effective in practice!)

Mike Staal K6MYC, one of the founders of KLM who designed many of the specialised cross-Yagi antennas used for space communications, is also on the team and will be using his skills to produce the Phase IV v.h.f. and u.h.f. antennas. Gordon Woodcock, a hardware systems engineer at NASA's Marshall Space Flight Centre, will be using his skills to enhance the design of this very special new "OSCAR", and last but not least, the AMSAT Board of Directors will be responsible for planning and project funding. Their first meeting, to review concept planning and development was in Boulder, Colorado, over the week-end of 3 April.

RS-5 and 7

Both satellites were very active over the April to early May period to full solar illumination, but are now in eclipse conditions once again until the third week of July. RS-5 still functions well, but the ever declining battery condition meant that it was unable to support heavy activity, often commanding itself off when the supply voltage fell below the present minimal value. RS-7 supported both the ROBOT and the transponder for several occasions, but the demand on the battery supply, although better than RS-5, meant that it too self-commanded off, and further suffered from memory problems on the ROBOT, and so was later found to be able to support transponder operation only with any degree of reliability.

April 12 was Yuri Gagarin day in the USSR, and was a major activity day for both the existing RS satellites. (Yuri operated UA1LO, and was the world's first

spaceman). The satellites were crammed with stations calling "CQ GA" and making lots of QSOs, and your author joined in with 50W to a ground plane antenna to give a log of the following stations worked.

DF4MV, DK1KH, DL9EV, F3ZD, F9EA, G3VRX, G4CUO, G4ZHG, G0GJG, GM4ILS, HG5DE, KOIGH, LZ1AG, LZ1DP, NL7G, OH8RQ, OK3AU, OZ3LF, PAOLH, RA3NG, RB5AL, RB5AZ, RB5IRF, RC2CA, RS3A, SM3AKG, SM7BYU, SV0OE, TU2GA, UA1ASD, UA1ZCL, UA3GBT, UA3JWW, UA3PR, UA4CBW, UA4CET, UA4HNP, UA4NMF, UA9EVX, UA9SWR, UA9YS, UA0AET, UA0LJA, UA0QCB, UB5JW, UB5WBG, UL7CCY, UL7GBD, UL8GWW, UM8MAN, UO5OIW, UP2BAW, UP2BFR, UP2PEO, UT4JWD, UZ3TYA, UZ9CXM, UZ9YWA, YU5CEF, W1AX, W3TFA and W9AG.

Regular follower Bill Kelly heard many of these stations, plus a few more beside, including DF9FP, DJ3UH, DJ8TJ, DL1AR, DL5HKC, DL6LAA, F3KI, F3NB, F6HST, F9YW, G1LPT, G2CIW, G3BGM, G3CAG, G3DDG, G4JJ, G0DLJ, HB9AQZ, HB9BCG, HG3MA, HG5AM, HG8CF, IV3LCZ, OE1LM, OZ4D, PE1LPF, RA9FAT, RB5QU, SM3RZS, SM5IDM, UA3XWI, UA3GCD, UA3FHW, UA3FRS, UA3VB, UA4CBW, UA4NM, UK3A, UT5IT UZ1AWT, UW4AK, VE5XU and Y24SD. Bill says "It is so nice to see our old friends back again after a long sleep".

To be sure, 29.410 to 29.500MHz is by far the most active spot on the band these days, with several hundred stations active on the satellites audible in Europe, RS-5 and 7 have also been by far the most active satellites, as OSCAR-10 was "off", JO-12 off most of the time, and RS-9 still awaited.

Dave Rowan G4CUO, has also been putting a lot of time into the RS satellites, mainly concentrating on his favourite pursuit of transatlantic DX. He has worked N7ZL in Washington, KA9SPC and NI9P in Wisconsin, KA1ZFX in New Hampshire, KA3OIT and WA3IMN in Maryland, KA1LMX in Rhode Island, N4IQV in Virginia, W1NU, WA1LRI and WB1CNM in Mass, KB4XK in North Carolina, WOJ and WOIZ in Iowa, N5BA in Texas, KIOI in Colorado, K4GTP in Alabama, WD9AHJ in Illinois, WD8CDQ and WA8EMB in Michigan, and adds VY1CW, UA0AET, and SVOEC as extras.

The only criticism of the Mode "A" operation is that far too many stations, and some new "G"s in particular, are running far too much power, and ruining the sensitivity of the transponders to weaker DX that they would otherwise work if they came down to a maximum of 100W e.r.p. and improved their downlink performance.

Launches and Crunches

A further USSR Proton launch failed on 27 April when the 4th stage failed to get the three Navsats into the correct orbit intended. The first Proton failure was similar on January 30 (see later for details) but on March 19 the Raduga communications satellite was successfully placed into the correct geostationary orbit by the Proton. As the USSR has had twenty-nine launches this year so far (to mid-April) and put thirty-four satellites up, the loss is a small percentage. Other national launches in the same period show USA with just three launches of which one failed, Japan with two launches, no losses, and India with one launch, which failed. The ESA story has already been told.

Shuttle Shuffles

The improved Ariane-V vehicle can now lift 18 tonnes, but this is insufficient for the Hermes European mini-space shuttle that has now had to be re-designed, with no cargo doors and a reduction of crew from six to three in order to reduce the mass to some 15 metric tonnes. (It originally was 16 tonnes, but escalated to 27 last year!) The UK are now expressing an interest in Hermes, and we might yet see a "G-in-space" operation. The Soviet Cosmos organisation has indicated its interest in developing a space-shuttle type vehicle for future use, to provide an ideal means of initial MIR transfer. Meanwhile, NASA has decided to simplify its complex shuttle mission notation from the original "STS-51-J" "STS-41-B" and the like to a serialised nomenclature to give STS-26, STS-27, etc.

MIR & TDRS

Since our last column, things have really been progressing with the Soviet space programme, but even they have had their troubles. The first attempt to dock the 20 tonne "KWANT" (Russian for "Quantum") Astro-physics Laboratory failed when the Baikonur Proton launch of the evening of 30 March failed to couple with MIR on Sunday 5 April.

Long before the launch of KWANT John Branegan GM4IHJ forecast that prob-

ALLSATS EQX ON 14/6/87									
SAT	UTC	Br9	Next	Orbit	Next	Day			
F12	0126	268	115.7	29.2	64.3	20	U	min	+deg
RS5	0059	7	119.4	30	113.4	20			
RS7	0125	21	119.1	30	108.7	09			
Mir	0007	89	91.6	33.0	25.8	13			
Sal	0134	15	94	33.0	64.9	02			
RS1	0029	86	120.3	30.0	3.9	02			
UO1	0028	87	94.1	33.0	66.4	17			
UO2	0005	32	98.4	34.0	37.3	03			
NO9	0116	150	102	35.0	90.3	03			
N10	0050	79	101.2	35.0	78.4	00			
M13	0130	201	104	36.1	16.6	00			
M14	0057	166	104	36.1	16.6	00			
M/1	0118	247	109.3	37.4	90.8	05			

ALLSATS EQX ON 26/6/87									
SAT	UTC	Br9	Next	Orbit	Next	Day			
F12	0052	337	115.7	29.2	64.3	20	U	min	+deg
RS5	0143	39	119.4	30	113.4	20			
RS7	0108	38	119.1	30	108.7	09			
Mir	0120	192	91.6	33.0	25.8	13			
Sal	0049	84	94	33.0	64.9	02			
RS1	0135	124	120.3	30.0	3.9	02			
UO1	0030	86	94.1	33.0	66.4	17			
UO2	0044	42	98.4	34.0	37.3	03			
NO9	0025	137	102	35.0	90.3	03			
N10	0047	78	101.2	35.0	78.4	00			
M13	0022	209	104	36.1	16.6	00			
M14	0137	201	104	36.1	16.6	00			
M/1	0048	263	109.3	37.4	90.8	05			

Fig. 1

lems would occur. John told us: "The story of both American and Soviet Scientific and Tactical Data Relay Satellites (TDRS) is becoming a sad one" (The TDRS look down on the much lower space stations, and act as microwave relays of experimental and tracking data, sending signals back to base even when the space station is 130 degrees away from base). "The American TDRS-1 suffered from serious ground interference, and worse has no shuttle to talk to, whilst TDRS-2 was lost in the Challenger disaster."

"The Soviet story started in early 1986 when the LUCH microwave relay located in Geostationary orbit at 19 degrees west began putting good colour pictures to Soviet TV. This was followed by lots of signals appearing on the background to the MIR v.h.f. downlinks such as 6 pip signals warning the cosmonauts that they were approaching the first v.h.f. contact point of each orbit" "When the new crew joined MIR in February 1987, LUCH produced several additional features including a pip-tone every 30 seconds when LUCH was in range of MIR, but in late February and early March this all changed, when the exotic

background of signals disappeared, and the tempo of v.h.f. operating changed from casual voice usage to limited voice and intense testing of high speed telemetry signals on the v.h.f. downlink."

John continues "These new signals featured noisy p.s.k. and a curious noise modulated spread spectrum type of signal with lots of carriers". "In addition, the cosmonauts started talking on v.h.f. long before they got the Soviet air-space..." (to the *Yuri Gagarin* moored in international waters off Nova Scotia mentioned last month)

"This extra clue was important, as there was no point in using the ship if the LUCH relay at 14W was still working" John then checked with the British Interplanetary Society, and found that LUCH was not operational, and appeared to have drifted from its geosat slot. "Worse was to come," said John, "as the apparent failure of the January 30 PROTON launch which was destroyed by ground command was in fact a geostationary satellite intention for a LUCH 14W replacement or a new one at 90 degrees East", or, as GM4IHJ would put it "No LUCH!"

John points out that this would explain the high speed TLM activity on v.h.f., and that unless (the then planned only) KWANT had real time high density telemetry links to earth, and had big computers coupled to resolve its sensor findings, navigational problems would certainly arise. It is essential to get as much data to ground computers as possible, and as LUCH was no longer operable, the v.h.f. circuits, and probably the parallel u.h.f. around 400 and 920MHz circuits had insufficient capacity for the information. Additional information via the communications vessel moored off Nova Scotia may be just one of the several sources, so John predicts that MIR followers may well expect lots of new signals on all Soviet frequencies in many parts of the world.

The GM4IHJ forecast came true on Sunday 5 April, when the failure of the guidance system brought the KWANT and MIR within 200 metres, what one might call "a MIR miss"! A further attempt was made on Wednesday 8 April, with a successful coupling, but a failure as the air seal was not tight. On 12 April, cosmonauts Romanenko and Loveykin took a 3 hour 40 minute "space walk", manually uncoupled MIR and KWANT by 300mm and discovered a 400 x 400mm cloth bag lodged in the air seal collar, a residue from when the discarded Progress had been loaded with refuse before re-entry incineration. This was removed, and a successful docking and sealing was accomplished.

As a further Progress has since been docked, the result is a space station comprising four modules, i.e. MIR, KWANT, SOYUZ-TM-2 and Progress. The assembly is 40m long, and has a mass of 50 tonnes. It is very visible, the brightest object in the sky when the track brings it over after sunset or before sunrise. In Holland it has been seen by PAODLO even before sunset. Signals are very strong on 143.625MHz, and can be heard at S9 + 30dB by a standard 144 to 28MHz converter i.f. tuned to 27.625MHz, e.g. a CB f.m. receiver tuned to channel 3 (27.621MHz) at G3IOR, and even by a hand-held air band receiver. The greatest activity is produced on passes going from our south to north-east, when the space station is in range of the Soviet ground stations. The first indication is a brief one second unmodulated carrier, followed by the call "Metai Mara".

No further news is yet to hand on the MIR "ham-in-space" mission, but as the two current cosmonauts are now due for an early return in July or early August instead of the planned ten month stay, it can be hoped that a licensed amateur may evolve with earlier new crews.

Keplerian Elements

A number of readers have expressed the need for the semi-major-axis to be included in our sets of elements used in computer tracking programs. Whilst a number of programs do ask for this parameter, greater accuracy is possible by those using the mean motion. Some programs, such as those by Jim Miller G3RUH, ask for both SMA and MM. The SMA can be calculated from the MM, although the full mathematics for absolute precision can be very complex indeed. At least three formulas exist to perform this simply and approximately, one popular method being:

$$SMA = 42220 \times MM^{(-2/3)}$$

(The upward arrow indicates "to the power of")

A very good method, with greater (and more than sufficient) accuracy, was published in *ASR 130*.

$$SMA = (8681668.016 / MM)^{2/3}$$

If this conversion is added as part of the program requiring the SMA, our elements, the next set of which will appear next month, will cover all needs.

For this month, we include as Fig. 1 a new updated set of equator crossings for all the major satellites of interest for fortnightly periods this month. These have been highly popular with readers, and more frequent predictions have been requested, which we will later try to include if space permits. The GM4IHJ "eqxer" program for the Spectrum computer from which these are derived is available for just £3.00 (£4.00 outside the UK) from SARUG, G4INP QTHR. "REDSTAR" for the new RS satellites is held until RS-9 is orbited, so that it can include the data when available after launch. A new program for the NOAA satellites picture production being developed by G4IDE and G4INP has been postponed indefinitely, as no supporting hardware, e.g. a VERY stable receiver with 50kHz bandwidth, is generally available. Details of a means getting weathersat pictures by a G4IDE FAX program will appear next month.

JO-12

The use of the satellite has declined considerably over the past month, as it has been almost a matter of luck if it has been found on and active. The JAMSAT and JARL groups are now progressing well with programming the memory, and it is hoped that the full "JD" mailbox plus a long term firm operational schedule will be in force by the time this column reaches you.

The nearly empty pass-band has been put to good use by a team in Lincoln and Newark consisting of Wol G1LKY; Dave G4GUO; John G4ZHG; Ted G6MHS; and Ian G6JIK; who have been using the vacated pass band for SSTV. Despite the ferocious Doppler shift, by using low angle passes close to horizon, the tuning difficulties have been overcome. Fig. 2 shows a call and picture, using the G1FTU SSTV program for the Spectrum computer, received by G4CUO and Newark at 1346UTC on 12 April.



Fig. 2: THE SSTV pictures received by G4CUO

A photograph of our correspondent Leo Labutin UA3CR, holding the trophy presented to him for his dedication in the field of amateur satellites by AMSAT-UK last year is shown in Fig. 3. Leo tells us that the planned joint Soviet-Canadian trans-Arctic amateur skiing expedition should start with some seven Russian and five Canadian skiers from Novaya Zemlya in February 1988. They are due to arrive at Cape Columbia in June 1988, navigating by COSPAS/SARSAT information via Uo-SAT-OSCAR-11 digitaler, and communicating via the DCE and the RS satellites all the way if plans work out correctly.



Fig. 3: Leo Labutin UA3CR

All reports must arrive by June 26

Like most other stars in the Milky Way, our sun is a gaseous ball of energy and its complex radiations have considerable influence over the stability of the ionised regions of the earth's atmosphere and, consequently, the normal paths of terrestrial radio signals. Briefly, sunspot groups are a breeding ground for solar flares and when the mechanics are right and the waste from a flare strikes our atmosphere, then, disturbances, like those shown in Fig. 4, often occur. Solar flares and active areas around sunspots are known to be very powerful transmitters of radio waves which can be detected with a simple radio telescope 8.3 minutes after they originate on the sun.

Solar Activity

Cmdr Henry Hatfield (Sevenoaks) observed a single sunspot and 8 filaments at 1045 on March 29, one spot and 5 filaments at 1040 on April 2, one single and one double spot and 4 filaments at 1025 on the 5th and three groups, two with active plages, and 4 filaments at 0925 on the 10th. While the sky was clear Henry was able to photograph this area of the sun's disc, Fig. 5. He reported, "One of the groups (bottom left) is very definitely 'new cycle' containing one large and many small spots". During his observation at 0912 on the 11th, he located 5 filaments and noted that the plage, in the bottom left group, now appeared very angry. By 1026 on the 16th, one group was very faint and at 1100 on the 17th, one of the remaining two groups was still active. Henry's 136MHz radio telescope recorded an individual burst of solar radio noise on March 28 and varying periods of continual noise on March 29 and 30 and April 5, 8, 13, 15, 16 and 17. "The 19th to 21st was very quiet because the 'noise making sun spots' had gone round the west limb," said Henry.

"The sun is waking up," remarked Patrick Moore (Selsey), who logged a single spot, through cloud, at 1130 on March 30 and was able to draw the 3 spot groups, Fig. 6, which he observed around 1300 on April 10.

From his observatory in Bristol Ted Waring counted 11 sunspots on April 5, 27 on the 9th and 12 on the 14th.

Ron Livesey, the auroral co-ordinator for the British Astronomical Association, received reports of "unsettled" magnetometer readings on March 25-27 from Karl Lewis (Saltash) and the NOAA Laboratories, Boulder, Colorado. In addition to the usual lunar and solar reports, the April issue of *Solar News*, published by the London Solar Committee, has constructional details of a Jam Jar Magnetometer. More details about Solar News are available by sending an s.a.e. to the editor, Bert Chapman, "Brindles", Mill Lane, Hoove, Battle, E. Sussex TN33 9HT.

Peter Lewis G4VFG (Ivybridge) heard auroral reflected signals when he worked a German station on 28MHz on April 7.

Len Fennelaw G4ODH (Wisbech) noted auroral tones on the signals from the 50MHz beacon at Potters Bar GB3NHQ on March 30 and April 9, 10, 12 and 14. Len also reports tone-A signals from the 144MHz beacons in Angus GB3ANG on March 24, Cornwall GB3CTC on March 23, 27 and 28 and April 5, 9, 13, 18 and 19

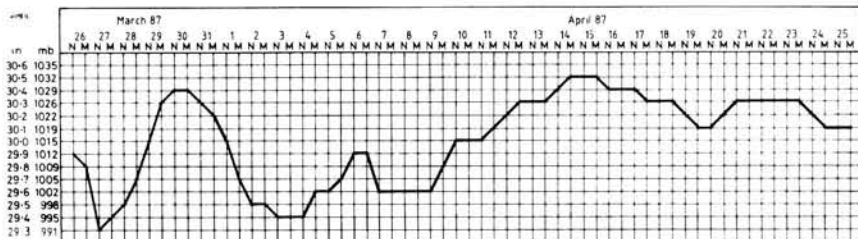

Fig. 1 ▲

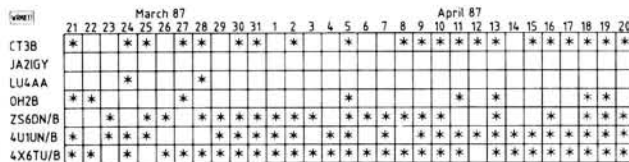

Fig. 2 ►

Fig. 4 ▼

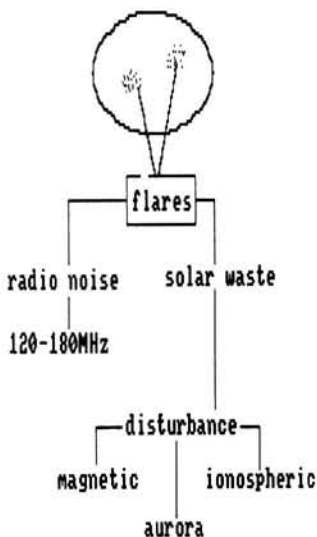

Fig. 3 ►

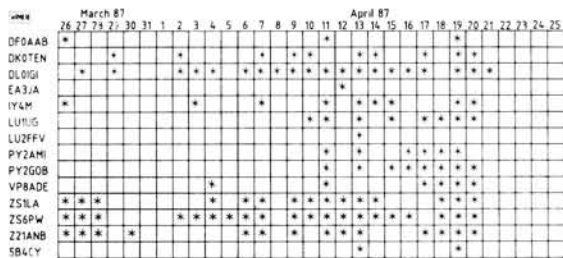

Fig. 5

and Wrotham GB3VHF on March 24 and April 1, 7, 9, 10, 13 and 18.

The 28MHz Band

Our congrats to Peter Lewis who worked 40 countries on 28MHz during 1986 which earned him a cup from the Torbay Radio Club.

Although Dave Coggins (Knutsford) logged a few Italian and Spanish stations during minor Sporadic-E openings on April 7, 20 and 21, he found that a more intense disturbance on the 19th produced signals from Austria, E. and W. Germany, Hungary, Israel, Switzerland and Yugoslavia. Dave recently added an Icom R-71E receiver to his station and says that it works very well on 28MHz with his 2-element quad antenna.

Peter Lewis heard a South African working into Europe on the 11th, contacted a

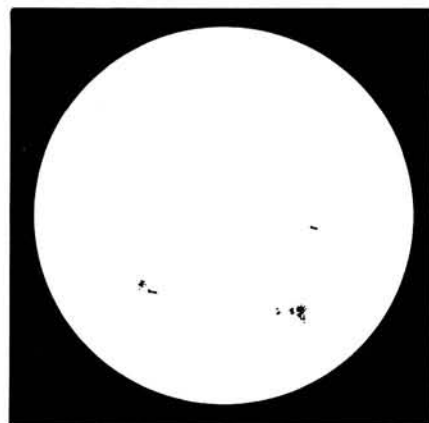

Fig. 6

Brazilian station during an F2 opening on the 13th and worked into Italy and Yugoslavia via Sporadic-E on the 14th.

Don Hodgkinson G0EZL (Hanworth) contacted two Italian stations on the 7th, heard signals from Malawi on the 13th and noted good conditions toward Israel on the 19th.

"The 20th was a very good day with propagation out to India in the morning, Sporadic-E up to TV Ch. E4 (62.25MHz) from Spain at 1240 and a path to the Caribbean in the evening," reports Gordon Pheasant G4BPY. He had QSOs with stations in Sweden on the 5th, Germany on the 8th, Germany and Hungary on the 10th, Malawi at 1600 on the 13th and India at 1030 on the 20th.

"I think the 1987 Sporadic-E season has arrived at last," remarked Ian Galpin G1SMD (Poole) after hearing signals from DL, I, OK, SP, YU and Y27 on the 14th.

Propagation Beacons

"At last I have discovered life on 28MHz! Conditions were favourable enough for me to log 3 beacons on April

11 and 5 more, including ZS1LA, previously unknown to me, on the 20th," commented Len Fennelow.

"There was a good opening on April 19, the Cyprus beacon on 28MHz was coming in by double hop Sporadic-E from 2000 to 2030," wrote Gordon Pheasant. In addition to hearing the Adelaide Is beacon VP8ADE, on the days listed in Fig. 3, Gordon also logged 4N3ZHK on April 20 and 21.

"The German beacon DKOTEN was very strong with me at 1245 on April 7," said Bill Kelly (Belfast).

At 1426 on April 17, Fred Pallant G3RNM (Storrington) heard a very weak f.s.k. signal on 28.272MHz and wonders if it was 9L1FTN.

"The 14MHz beacons in the E/W alignment were very good and consistent, but with LU4AA appearing only twice and OH2B about once each week," reports Len Fennelow, with his 14MHz beacon observations, Fig. 2, for the month prior to April 20.

Meteor reflected signals from the 50MHz beacons in Scotland GB3RMK at 725km and Wales GB3SIX at 355km, were received each morning, from March 26 to April 21, by Norman Hyde G2AIH at his QTH in Epsom Downs.

Len Fennelow can normally just about hear the signals from GB3ANG and GB3CTC and, even a small increase in strength can indicate the v.h.f. conditions are improving. This point was proved

when he logged the Angus beacon at S3 on April 12 and 14 and S9 on the 16th and the Cornish beacon at S5 on March 24 and 25 and S9 on April 16.

Don Hodgkinson logged CTC and VHF daily from March 26 to April 21 and the French beacon FX3THF on April 4, 12, 15, 16, 17 and 20.

Chris van den Berg (The Hague) logged VHF on March 26, 27 and 31 and April 5, 8, 9, 12, 13, 14, 16, 18, 19 and 20.

Tropospheric

The slightly rounded atmospheric pressure readings, for the period March 26 to April 25, Fig. 1, were recorded at my QTH and show the mid-April high that gave some DX.

Peter Lewis noted a lift on April 16 when he heard stations in Kent and France working through the North Hessay Tor repeater.

On the 17th, Bill Kelly reports hearing strong signals from the 144MHz repeaters in Barnsley, Burnley, Caldbeck, Duns, Isle of Man and Stockport in the UK and from Dublin, Dundalk and Waterford in Eire.

While conditions were good during the second week in April, Chris van den Berg heard signals through the 144MHz repeaters GD3DA, KN, KS and NB.

934MHz

DX on the 934MHz band is also allied to changes in the atmospheric pressure and

both the local and national weather conditions.

"Peterborough has, over the past years, proved a very difficult area to work from my QTH in Bedford," wrote John Raleigh DW-04, Secretary of The Four County 32cm Club. Although conditions on March 20 were not thought to be up, John received a call from Fred Wrapp NV-08 located at Woodston, Peterborough. Fred's signal was also heard by Bill Ellis WE-641 in Houghton-Regis.

Although many stations closed down around 2200 on March 21, Fred Mills TL-01 (Kempston) was among those who remained on the band until 2300 when his effort was rewarded by QSOs with stations in Boston and King's Lynn. During the pressure fall on the 17th, John worked several stations in Essex, Kent and Winchester.

Congrats to John Levesley G1TZT (Bransgore) who passed the Morse test in March and looks forward to using his new G0 call on the h.f. bands. On 934MHz, John's call is UK-627 and between 1830 and 2100 on April 12, he heard signals from Bridgend, Chichester and Portsmouth. While situated on Win Green Hill, Shaftesbury, from 1200 to 1600 on the 16th, he worked stations on Dartmoor and in Guernsey and Jersey at distances of 137, 190 and 175km respectively. Later that evening he added Buckfastleigh, Chichester, Haytor and The Quantocks to the day's score from his home QTH.

Broadcast Round-up

Peter Shore

Conditions for distant listening improved dramatically around Easter, with many far-off h.f. stations audible. It seems that now we are past the sunspot minimum, we may see a good number of DX catches made by both experienced and novice listeners.

Life would, however, be made more pleasant by a reduction in the amount of jamming on the bands. A spin through the bands reveals concentrated attempts to stop some stations from being heard—with the strongest efforts being levied against Radio Free Europe and Radio Liberty. The problem of course is that not only the frequency on which the jamming is aimed at is affected, but up to two channels on either side. What is more, these are frequencies often used by the stations of the states initiating the interference! Perhaps one day sense will prevail, and we shall be able to enjoy jamming-free listening. In the meantime, the Voice of America's Engineers are reported to be working on a device to cut out deliberate interference. It is hoped that the device will be able to be made from household materials enabling private citizens in the Soviet Union to build their own and hear VoA transmissions without fear of detection by the authorities.

International Broadcasting News

(Note: All times are UTC (GMT))

Europe

Radio Austria International has made some alterations to frequencies for European broadcasts:

0500–0900 now on 9.600MHz

0900–1300 now on 11.915MHz

Radio Sofia, Bulgaria, now broadcasts to Europe and North America on 11.720MHz

at 1830–2100, and from 2100 on 9.700MHz.

Radio Berlin International has dropped the medium wave outlet of 1359kHz: this may be adopted by the domestic services in East Germany in due course.

Deutsche Welle hopes to convince the Federal Government in Bonn that an expansion in the number of short wave transmitters is needed if the station is to maintain its position in the "league table" of international broadcasters. The station's technical director, Gunther Roessler, has said that fifteen additional transmitters are needed and that an increase of DM100 million was needed in the station annual budget. DW currently has 30 transmitters, of which nine are 500kW, compared with 80 BBC transmitters, twelve of which are 500kW. DW can be heard in English at:

0900–0950 on 9.715, 11.945, 15.160, 15.185, 15.205, 17.715, 17.780, 17.800, 21.650 and 21.680MHz.

1610–1650 on 6.170, 7.200, 9.685, 11.785, 15.105 and 17.875MHz.

Both of these transmissions are beamed to Australasia, but provide good reception in the UK.

Radio Finland was hit by a strike at the start of May, with no programmes heard on either the domestic or overseas services.

AWR Europe's programmes in English can be heard:

0600–0630 on 6.145MHz

0730–0800 on 7.165MHz

0800–0900 on 9.670MHz [Sunday only—DX programme at 0815]

1130–1200 on 7.165MHz

Radio Moscow's broadcasts to Great Britain and Ireland are heard:

1900–2000 on 7.33, 7.37, 9.52, 9.77 and 11.95MHz

Radio Kiev is now heard:

1800–1830 on 7.150, 7.330, 9.560 and 9.710MHz

2330–2400 on 7.260, 9.640, 9.800, 11.790 and 11.875MHz

0200–0230 on 13.645MHz

Radio Moscow's World Service continues to be heard in almost every band throughout the day and night. On Friday 1 May, both R Moscow World Service and Radio Moscow Internationale (the French Service) gave live coverage from 0550 of the May Day Parade in Red Square. All the Moscow home services audible in Europe joined together shortly after 0500 to give live coverage of the event.

Radio Yerevan in Soviet Armenia can be heard in Armenian at 2030 with French at 2050 on 9.895 and 6.065MHz.

Middle East

Radio Baghdad has English broadcasts: 2000–2145 on 9.875MHz to Europe 2300–0145 on 6.195MHz to N America Radio Damascus is in English on 9.950 and 12.085MHz at 2005 to Europe and at 2105 to North America.

The Voice of Turkey has been heard to change its 19m band frequency in recent weeks: the usual 15.235MHz channel has been observed to move to 15.200 and 15.220MHz for daytime transmissions. The 19m band channel carries Turkish programming in parallel with 15.430 and 11.955MHz between 1000 and 1500. English is broadcast:

0300–0400 on 17.760 and 9.560MHz

1230–1300 on 17.735MHz

2000–2100 on 7.155MHz

2200–2250 on 17.760, 9.560, 7.225 and 7.155MHz.

Israel relays its domestic Network B programmes in Hebrew on shortwave as: 0300–0510 on 13.750, 11.655, 11.605 and 9.385MHz

0510-1100 on 17.620, 17.555,
15.615 and 13.750MHz
1100-1300 on 17.620, 17.555,
15.615, 15.095, 13.750
and 11.585MHz
1300-1530 on 15.095 and 11.585MHz
1530-1730 on 15.615MHz
1730-2000 on 15.615, 15.095,
13.750, 11.585 and 9.640MHz
2000-2100 on 15.095, 13.750,
11.585, 9.460 and 9.385MHz

Meanwhile, the current schedule for English transmissions is:

0000-0025 and 0100-0125 on
11.610, 9.855 and 9.435MHz
0400-0415 on 17.685, 17.620,
15.585, 11.960, 11.700, 11.585,
9.855, 9.815 and 9.435MHz
1000-1030 on 17.815, 17.685,
17.630, 15.650, 15.640 15.095,
11.700, 11.620 and 11.585MHz
1700-1715 on 15.095, 13.750,
11.585, and 9.460MHz
1900-1930 on 17.685, 17.630,
13.725, 12.075, 11.700,
11.655, 11.610 and 9.010MHz
2130-2200 on 15.585, 15.485,
13.725, 11.610, 9.435 and 9.010MHz
2300-2330 on 11.610, 9.855 and
9.435MHz

Saudi Arabia's English Service has announced a new schedule for English language transmissions:

1600-2100 on 9.720 and 9.705MHz

Africa

Radio Bardai, the clandestine station hostile to the Chadian Government and believed to be broadcast from Libya, has been unheard on its 6.009MHz frequency since the end of April. This may be as a result of Ramadan changes, or the station may have closed down permanently following the change in fortunes of the rebels in their fight against government forces.

Meanwhile, Chadian Radio now opens at 0458 on 4.960MHz. Radio France International is now relayed from Moyabi between 0400-0600, and 1200-1400 in the 60m tropical band.

Africa Number One from Gabon may be heard:

0500-0800 on 11.940 and 4.830MHz
0800-1700 on 15.200 and 7.200 MHz
1700-2300 on 15.475 and 4.830MHz

Africa Number One is a commercial station beamed to French-speaking Africa, with all programming in French. In this column two months ago, it was mentioned that an External Service from Ghana was to be broadcast after an absence of several years; the station is on the air, with broadcasts on 6.130MHz between 0645-0900 and 1845-2100. This choice of frequency will make the station a rare find in Europe.

Radio Nacional do Angola in Luanda has been heard on 3.415MHz at 2000 carrying the Spanish International Service in parallel with 7.245, 9.535 and 11.955MHz.

Asia

Radio Afghanistan is heard with Pashto/Dari at 1330 on 11.985 and 4.450MHz.

Radio Bangladesh has English broadcasts as:

1230-1300 on 15.525 and
12.030MHz.

The 0800 Voice of Islam broadcast is also heard on these two frequencies.

FEBA Seychelles has been heard in English with good reception on 17.785MHz at 0710 until 0850 with a DX programme on Sundays at 0730. The address for contributions to this programme is: PO Box 2526, Bangalore 25, India.

WSZA Marshall Islands with a 10kW transmitter broadcasts:

0530-1005 on 5.940
1900-0530 on 6.070 [from 2000
Sundays].

KYOI Mariana Islands heard at 1625 on 11.900 MHz with 9.670MHz carrying the programmes from 1700. The address for correspondence is quoted as WCSN in Boston.

Radio Vertias Asia is now using 15.275 in parallel with 15.135MHz for English at 0130-0155.

Radio Japan's General Service in English can be heard from the Moyabi relay as per:
0700-0800 on 15.230MHz
1500-1600 on 21.700MHz
2300-2400 on 11.800MHz.

Australia

Radio Australia now broadcasts to Asia at 1330 on 7.135MHz. The station introduced a new Monday-Saturday Propagation Report on 4 May. This new service is designed to complement the weekly report heard on the *Talkback* programme, and covers the geo-magnetic field, the solar flux, sunspot number and the A-index. The report is heard at 0425, 0825, 1225, 1625 and 2025. The report from Mike Bird will also continued to be featured in Radio Netherland's weekly *Media Network* programme on Thursdays.

North and South America

WCSN in Boston has run into some problems for its first evening transmission to Europe at 1600: the frequency of 15.270KHz is now swamped by Radio Bucharest's Arabic Service. The station has introduced some frequency changes which run through to September:

1800-2000 on 15.230MHz
2000-2200 on 11.695MHz
2200-0000 on 15.300MHz
0400-1000 on 9.465MHz.

HCJB in Quito Ecuador has joined the growing number of stations which are installing "answer-lines". It is now possible to call up the station and leave DX tips for the *DX Party Line* programme, or comments for any other section. The number to call is +593 2 241 550. Ask for extension 489 [if a Spanish operator answers, as for "cuatro-ocho-nueve"]. If you wish to save some money, it's possible to call the UK Office on Bradford (0274) 721810 between 1800 and 0800. HCJB has now replaced 6.205MHz for the morning transmission to Europe—try 9.845MHz from 0645 to 0830 (0700 on Saturday and Sunday).

And with that we come to the end of this month's trip around the bands, but before I close, let me ask you whether the right information is being included in this column. Would you like to see more details of foreign language transmissions, or items on more unusual broadcasts from around the world? Drop a line to the *PW* Editorial Office in Poole... 73.

Don't forget to let Peter know what type of broadcast information you would like to see included in this column

PAST GEMS

Another Great Advance in Television

Wireless Magazine May 1934

A couple of months ago even the best informed of those who are aware of the progress that is being made in the development of television would not have been sufficiently optimistic to have held the opinion that the broadcasting of high-definition pictures on the ultra-short waves was an immediate possibility. As a laboratory experiment with a short line between the transmitter and receiver such pictures have been produced by various

workers, but the broadcasting of them presented an entirely different problem. Those who have had experience with ultra-short wave receivers will appreciate how tricky they can be and with the more exacting demands of television the difficulties are increased many times.

And now the Baird Company have shown that all the difficulties have been surmounted and that the broadcasting of high-definition television is quite practicable on wavelengths as low as 6 metres. This in itself is a remarkable achievement, but coupled with the facts that the pictures are perfectly steady and show all desired detail, proves what wonderful progress has been made.

On the occasion of the recent Baird demonstration of their new system the

transmitter was situated in one of the towers of the Crystal Palace and the receiver was at Film House, Wardour Street, a position where it can be assumed interference from machine static would be as bad as anywhere. But the received pictures were entirely free from any trouble of this kind and remained perfectly clear during the whole of the programme which lasted about an hour.

The Baird Company have made a departure from their ordinary practice in this latest apparatus the cathode-ray tube is being used instead of a mechanical device. The diameter of the end of the tube is twelve inches and this, of course, is the size of the picture.

Have you seen any early radio magazine cuttings that may interest us? Send them in.

Practical Wireless, July 1987



ICOM (UK) LTD/RETAIL.

Everything you need for your shack is available from Icom UK's retail shop. Andy G6MRI is on hand with new and secondhand stock from ICOM plus Yaesu, Trio, MET, Tono, Jaybeam, Welz, Drae, BNOS and many more. RSGB publications also available, if Andy can't help, you've got a problem. Why not call in, we are on the corner of Stanley Road and Kings Road, Herne Bay, Kent and open 9 - 5.30 mon-sat, lunch is 1-2.15, 1/2-day closing thursday afternoons open 9-1.00. BCNU.

Credit facilities available, plus VISA & ACCESS accepted.



ICOM (UK) LIMITED. The World System
2 Stanley Road, Herne Bay, Kent CT6 6SH. Tel: 0227 369464.

RST

MAIL ORDER CO.
Langrex Supplies Ltd.,
Climax House,
159 Fallsbrook Road,
Streatham, SW16 6ED.

**SPECIAL EXPRESS
MAIL ORDER SERVICE**

£ p	EM81	2.50	PL519	6.00	6AK5	5.99	6KD6	8.00
AZ31	2.75	EM87	2.50	PL802	6.00	GAL5	1.50	6L6G
CL33	4.00	EN91	6.50	PY33	2.50	GAM6	6.02	6L6GC
DV88/7	1.50	EY51	2.75	PY81	1.50	GAN6	4.75	7.50
DY802	10.50	EY86	1.75	PY62	1.50	GAN6	3.50	6L6Q
EB80C	10.33	EY88	1.75	PY83	1.25	GAQ5	3.25	607
E180F	12.05	EY500A	3.00	PY88	2.00	GAR5	25.00	6RHHB6KXN8
E810F	35.48	EZ80	1.50	PY500A	4.00	GAS7G	8.75	10.00
EABC80	1.25	EZ81	1.50	PY800	1.50	GAT6	1.25	6SA7
EB91	1.50	GY501	3.00	PY801	1.50	GALU5GT	5.00	6SC7
EBF80	1.50	GZ32	4.00	QQV02-6	38.00	GALU6	2.50	6SJT
EBF89	1.50	GZ33	4.75	QQV03-20A	26.25	GAW8A	3.75	6SL7GT
EC91	8.00	GZ34	4.00	QQV03-20A	48.38	6B7	3.25	6SN7GT
ECC33	4.50	GZ37	4.75	QQV06-40A	46.00	6B8	3.25	6SS7
ECC35	4.50	KT61	5.00	QV03-12	6.80	6BA5	1.50	6SG7M
ECC81	1.75	KT66	15.00	R18	3.00	6BA7	5.00	6U8A
ECC82	1.75	N78	15.00	R19	9.24	6BE6	1.50	6V6GT
ECC83	1.75	OA2	3.25	SP41	6.00	6BH6	2.50	6X4
ECC85	1.75	OB2	4.35	SP61	4.00	6B26	2.75	6XSGT
ECC88	3.50	OC3	2.50	U19	13.75	6B26	2.00	12AX7
ECC91	8.93	OD3	2.50	U25	2.50	6B7A	3.50	12BA6
ECF80	1.50	OC6	2.50	U26	2.50	6BR7	6.00	12BE6
ECF85	3.00	OC8	2.50	U37	12.00	6BR8A	3.50	12BY7A
ECF88	1.50	PC88	2.50	UJ37	12.00	6BWS	6.00	12E1
ECF91	1.50	PC88	2.50	UJ37	12.00	6BWS	6.00	12HG7
ECF93	1.50	PC88	2.50	UJ37	12.00	6BWS	6.00	30PL12
ECF94	1.50	PC88	2.50	UJ37	12.00	6BWS	6.00	30PL12
ECF95	1.50	PC88	2.50	UJ37	12.00	6BWS	6.00	30PL12

Open daily to callers: Mon-Fri 9 a.m.-5p.m.
Valves, Tubes and Transistors - Closed Saturday
Terms C.W.O. only, allow 7 days for delivery. Tel. 01 677 2424/7.
Quotations for any types not listed S.A.E. Telex 946708
Prices excluding VAT add 15% Post and packing £1.00 per order



ALTRON
COMPACT
Spacesaver
ANTENNAS
AQ6 20, 2 Ele and 3 Ele
4 BAND, 6, 10, 15, 20 M
AQ6-20, 4 Ele **NEW**

Our own unique design that WORKS
CLOSE COUPLED - HI 'Q' - CAPACITY HAT LOADED YAGI

Special features:

- Unique Altron fully sealed coils for max stability
- Resonant length elements for improved VSWR (1-1)
- Selectively detuned for optimum performance and gain (no gimmick quad needed)
- Easy trim spoked with lock nuts and spares
- Minimized wind load and weight
- Double insulated elements

As reviewed by G4HCL in HRT April '87

Typical performance			
Antenna model	AQ-20/2E	AQ6-20/3E	AQ6-20/4E
Forward Gain Dbd	3.8 to 4.8	5.5 to 7.5	7 to 9
Front to Back Db	13 to 15	16 to 18	18 to 23
Side Null Db	25	25	30
VSWR (typical)	1.1:1	1.1:1	1.1:1
Weight	7.5lb	12lb	16lb
Wind load	2ft ² 0.18M ²	3ft ² 0.27M ²	4ft ² 0.37M ²
Turning radius	76"/1930mm	96"/2438mm	117"/2971mm

PRICE + p&p £114.50 (6.00) £169.00 (8.00) £230.00 (10.00)
PRICES ARE INCLUSIVE OF VAT. TERMS. C.W.O. ACCESS. VISA.
WE DESIGN - WE MAKE - WE SELL DIRECT. You get best value
Callers welcome. Open Mon-Fri 9am-5 Sat 9am-12.15pm
ALLWELD ENGINEERING
Unit 6, 232 Selsdon Road
S. Croydon CP2 6PL
Telephone: 01-680 2995 (24 hr) 01-681 6734
STOCK ITEMS NORMALLY DESPATCHED WITHIN 7 DAYS

PRACTICAL WIRELESS KITS

Kit Name	Price	Components
PW DOWNTON FREQ. VOLTAGE CONVERTER	June '87	£19.70
SIDE-TONE OSCILLATOR	June '87	£9.60
PW ITCHEN LCR BRIDGE	Apr '87	£24.80
PW WOODSTOCK SHORTWAVE CONVERTER	Mar '87	£25.50
MASTHEAD PREAMP (144MHz)	Feb '87	£37.50
PW WESTBURY BASIC WOBBLATOR	Jan '87	£16.50
HIGH IMPEDANCE MOSFET VOLTMETER	Dec '86	£23.90
P.W. TAP W/ CONVERTER	Nov '86	£13.20
ACTIVE ANTENNA	Nov '86	£17.80
AUTOMATIC NICAD CHARGER Updated Version (see Feb '87)	Oct '86	£17.45 + £1.50 P&P
AUTOMATIC NICAD CHARGER	Oct '86	£16.20
SIMPLE 50MHz CONVERTER	Sept '86	£21.50
P.W. ARUN-PARAMETRIC FILTER inc. case	May '86	£48.00 + £2 p&p
P.W. ARUN-PARAMETRIC FILTER exc. case	May '86	£34.00 + £1 p&p
MEON 2 50MHz TRANSVERTER - 144 MHz I.F.	April '86	£42.50 + £1.50 p&p
JITTY MORSE MODEM	Jan '86	£31.85
CRYSTAL CALIBRATOR	Jan '86	£17.95
TWO TONE OSCILLATOR	Dec '85	£20.30
MEON 50MHz TRANSVERTER - 28MHz I.F.	Oct '85	£42.50 + £1.50 p&p
DIP OSCILLATOR	Oct '85	£19.90
CAPACITANCE METER	Oct '85	£21.30
U.F. PRESELECTOR	Sept '85	£21.90
ADD ON B.F.O. - inc. C804 + optional comps.	Aug '85	£12.95
BATTERY CHARGER CONTROLLER	June '85	£9.50
TRIANGULAR KEYS	Feb '85	£16.45
MORSE SENDING TRAINER	July '84	£12.00
AUTO NOTCH FILTER	July '84	£23.80
COIL FORMERS + CORES (Simple 50MHz Converter)	Sept '86	£2.70 per set

PLEASE ADD P&P AND 15% V.A.T. TO TOTAL ORDERS. TELEPHONE ORDERS ACCEPTED
P&P 20p unless specified. Article Requests \$10 required. All kits complete (less batteries).
(unless otherwise specified), including PCB (or stripboard), case, all components and hardware. Cheque or P.O. to: C.P.L. ELECTRONICS, 8 Southdean Close, Hemmington, Middlesex TW8 9HE. Tel. 0642 91157. Other kits available plus a wide range of components, test gear, hardware, etc. Free price list available on request. Goods normally dispatched within 14 days.

MAKE YOUR INTERESTS PAY!

More than 8 million students throughout the world have found it worth their while! An ICS home-study course can help you get a better job, make more money and have more fun out of life! ICS has over 90 years experience in home-study courses and is the largest correspondence school in the world. You learn at your own pace, when and where you want under the guidance of expert 'personal' tutors. Find out how we can help YOU. Post or phone today for your FREE INFORMATION PACK on the course of your choice. (Tick one box only)

Electronics	<input type="checkbox"/>	Radio, Audio and TV Servicing	<input type="checkbox"/>
Basic Electronic Engineering (City & Guilds)	<input type="checkbox"/>	Radio Amateur Licence Exam (City & Guilds)	<input type="checkbox"/>
Electrical Engineering	<input type="checkbox"/>	Car Mechanics	<input type="checkbox"/>
Electrical Contracting/Installation	<input type="checkbox"/>	Computer Programming	<input type="checkbox"/>
GCE over 40 'O' and 'A' level subjects			

ICS Name: _____ P. Code: _____
Address: _____
International Correspondence Schools Dept EES 77, 312/314 High St., Sutton, Surrey SM1 1PR. Tel: 01-643 9568 or 041-221 2926 (24hrs).

USE THIS

SMALL ADS

Whilst prices of goods shown in advertisements are correct at the time of closing for press, readers are advised to check with the advertiser both prices and availability of goods before ordering from non-current issues of the magazine.

SPACE

The prepaid rate for classified advertisements is 40 pence per word (minimum 12 words), box number 60p extra. Semi-display setting £13.24 per single column centimetre (minimum 2.5 cm). Please add 15% VAT to total. All cheques, postal orders etc., to be made payable to Practical Wireless. Treasury notes should always be sent registered post. Advertisements, together with remittance should be sent to the Classified Advertisement Dept., Practical Wireless, Enefoo House, The Quay, Poole, Dorset BH15 1PP. Telephone (0202) 678558.

Receivers and Components

SCANNERS 25-520MHz, 760-1300MHz, 300 channels, realistic PRO-2004. Full features £329.00 + £5.00 delivery. Access & Visa. All realistic scanners stocked. Catalogue £1.00. LINK ELECTRONICS, 228 Lincoln Road, Peterborough, (0733) 46770.

MORE FROM THEASBY ELECTRONICS Receiver ATU E27. Other products as before including Modulated Crystal Calibrator E19 ready built. SAE lists 31 Middleton, Cowling, Keighley, West Yorkshire BD22 0DQ.

CRYSTALS Made to order for any purpose and large stocks of standard frequencies for computers, modems, etc. Amateur CW (QRP) freqs £4.00 and CB conversion crystals at £4.50.

PROGRAMMABLE OSCILLATORS (PXO) for baud rates, MPU, and freq markers £12.50.

FILTERS Crystal, monolithic, mechanical and ceramic for all standard IF's. Special 10.695MHz for big improvement to most CB rigs at £4.50 each.

S.A.E. FOR LISTS. PRICES INCLUDE VAT AND POST

P. R. GOLLEDGE ELECTRONICS
G3EDW, Merriott, Somerset, TA16 5NS
Tel. 0460 73718

ELECTRONIC COMPONENTS IN HOVE, SCS COMPONENTS, 218 Portland Road, 0273 770191 (also Mail Order).

RADIO CANADA, Beijing, Australia, Voice of America. A Vega Selenia (5 x SW/MW/LW/FM) pulls these and dozens more. £36.95. Mains/battery, years guarantee. Return despatch. Which, "best buy". - CORRIGAN-RADIOWATCH, Building 109, Prestwick Airport KA9 2RT.

EDDYSTONE 1001, as new, boxed and unused since 1975. 550kHz-30MHz c.w./a.m.s.s.b. with high stability crystal option above 1.5MHz. Mains or int ext battery. £350 ono. Box 15.

SCANNER MODIFICATIONS. Specialist reception equipment. Extensive frequency listings. For free catalogue send large SAE to: S.S.C., PO Box 71, Bournemouth, Dorset BH9 1DL.

Special Offers

FREE MEMBERSHIP to a new national electronics club. For details and a free pack of components worth over £10 send only £1 p&p to: WOODSIDE, Dowsett Lane, Ramsden Heath, Billericay, Essex CM11 1JL.

Service Sheets

TECHNICAL INFO SERVICES 76 Church St - Larkhall - Lanarks

FULL SIZE SERVICE SHEETS
Ctv/Mus-c/Combis £3.50 per set + Isae
Any other published £2.50 + Isae

Complete TV Repair Course £9.50
Complete Radio Servicer/Repair £9.50
Practical Transistor Yearbook £5.80

Repair data/circs most TVs and Video
Mono TV or Videos £10.50: CTV £12.50

Almost every SERVICE MANUAL stocked
Main supplier NEWNES TECHN BOOKS
Sole supplier TV TECHNIC BOOKS
S.a.e. for free Review and pricelists

FOR FAST QUOTES
PHONE 0698 884585
After 5pm - 0698 883334

THE DATAMAN 1914-1966

For circuits, service sheets, manuals, handbooks, on all valve and early transistor equipment including audio, military (British & foreign), radio & TV. Quotation by return via phone or letter (S.A.E.), brochure supplied with S.A.E.

THE DATAMAN
Tudor House, Cossham Street, Mangotsfield, Bristol BS17 3EN
Phone 0272 565472

WORKSHOP SERVICE MANUALS

Thousands stocked. Most Makes, Models, Types, Audio, TV, Video, Test, Amateur etc. LSAE enquiries/quotation and FREE Review/price lists with details of our Unique Repair and Data Guides, from Valves to Video's.

MAURITRON (PW)
8 CHERRY TREE ROAD, CHINNOR, OXON, OX9 4QY.

Veteran and Vintage

NOW AVAILABLE Bumper Catalogue - 170 pages - for collectors of vintage radio, audio & TV equipment. Price: £3.00 post paid U.K., £4.00 post paid overseas surface mail. £5.00 post paid airmail - printed matter. VINTAGE WIRELESS CO. LTD., Cossham Street, Mangotsfield, Bristol BS17 3EN. Phone 0272 565472.

Software

RADIO SOFTWARE

48K SPECTRUM & SPECTRUM 128

RTTY - QSO review, printer dump, type ahead, memories etc. Both require filter
TRANSCIBE £8.50
RECEIVE ONLY £6.00

CW - Self tracking 8.30 wpm, type ahead, memories, etc.
TRANSCIBE £8.50
RECEIVE ONLY £6.00

SLOW SCAN TV - Save to printer, brightness, contrast & Inverse controls, tuning aid, etc.
RECEIVE ONLY £7.00

FILTERS - Unboxed RTTY only £6.00 C.W. only £7.00
Boxed RTTY C.W. Switchable £11.50
Ditto with Tuning LED £13.50

TERMINAL UNITS - No space to fully describe this superb unit. (Send for full details and specification) £45.00

S.A.E. for full details of these and other products:

J. & P. ELECTRONICS LTD.
New Road Complex, New Road, Kidderminster, DY10 1AL
Tel: (0562) 753893

COMMODORE COMPUTERS (+4, C16, 64, 128). "MICROCOM" cw/rtty tx/rx with superb morse tutor. "TURBO LOG" ultimate high speed station log. "MICROCOM INTERFACE" ready built. S.A.E. to: Moray Micro Computing, Enzie Slackhead, Buckie, Moray, AB5 2BR. Tel. 0542 7384.

Masts & Antennas

ANTIINTERFERENCE AERIALS. Data 26p. SAE. Aerial Guide £1.00/986 215. G2DYM, Uplowman, EX16 7PH.

ORDER FORM PLEASE WRITE IN BLOCK CAPITALS

Please insert the advertisement below in the next available issue of Practical Wireless for
insertions. I enclose Cheque/P.O. for £ CAT. heading

(Cheques and Postal Orders should be made payable to Practical Wireless)

NAME

ADDRESS

PRACTICAL WIRELESS
Classified Advertisement Department,
Enefoo House, The Quay, Poole,
Dorset BH15 1PP. Telephone (0202) 678558
Rate 40p per word, minimum 12 words.
Box No. 60p extra.
PLEASE ADD 15% VAT TO TOTAL

Company registered in England. Registered No. 1980539. Registered Office: Towngate House, 2 Parkstone Road, Poole, Dorset, BH15 2PJ.

7/87

YOUR LOCAL DEALERS

STOKE ON TRENT
MRZ COMMUNICATIONS LTD
 ICOM - Amateur/PMR/Marine/Air, YAESU - Amateur MRZ Desk PSU for ICOM/YAESU Portables. UK and EXPORT
Tel: (0782) 619658

IRELAND
Radcom Electronics
 Approved dealer for Icom, Yaesu and most accessories
 25 Riversfield
 Middleton, Co. Cork, Ireland
Tel: 021 632725/632804

WORCESTERSHIRE
A. Kelly Electronics and Communications Equipment
 RSGB Publications, Mutek, DRAE, Microwave Modules, Starmaster Keys, TAL Aerials, ALINCO. We buy and sell second hand equipment.
 3 Stoke Road, Aston Fields, Bromsgrove, Worcs. B60 3EQ.
Tel: 0527 71165
(Open 6 days a week, evenings by Appointment)

ESSEX
Selectronic
 The UK's leading suppliers of 934MHz personal radio equipment
 203 High Street, Canvey Island, Essex
Tel: 0268 691481
(Open Mon-Sat 9-5:30)
 Amateur radio equipment also in stock

HERNE BAY
Thanet Electronics
 The Official Icom importer
 2 Stanley Road
 Herne Bay, Kent
 CT6 5SH
Tel: 0227 369464
(Open Mon-Sat 9-5:30, except Thurs 9-1)

SOUTHAMPTON
South Midlands Communications
 Official Yaesu Importer
 S.M. House, School Close, Chandlers Ford Industrial Estate, Eastleigh Hants SO5 3BY.
Tel: 0703 255111

PORTSMOUTH
Telecomms
 Importers of the Nevada range of 934MHz equipment
 189, London Road, North End, Portsmouth, Hants, PO2 9AE
Tel: 0705 662145

DEVON
Reg. Ward & Co. Ltd.
 The South-West's largest amateur radio stockist. Approved dealer for Trio, Yaesu and Icom
 1 Western Parade, West Street, Axminster, Devon, EX13 5NY
Tel: 0297 34918
(Closed 1 00-2 00 and all day Monday)

BUCKINGHAMSHIRE
Photo-Acoustics Ltd.
 Approved Trio, Yaesu and Icom dealer (part exchange always welcome)
 58 High Street, Newport Pagnell, Buckinghamshire MK16 8AQ
Tel: 0908 610625
(Mon-Fri 9.30-5.30, Sat 9.30-4.30)

TYNE & WEAR
ESR Electronic Components
 Official North East dealer for VELLEMAN KIT
 Station Road, Cullercoats North Shields, Tyne & Wear NE30 4PQ
Tel: 091 251 4363
(Mon-Sat 9.30-5.30. Closed Thurs)

LONDON
AMCOMM OF LONDON
 Approved dealer for Yaesu and Icom
 373 Uxbridge Road, London W3 9RN
Tel: 01-992 5765
(Mail order a speciality)

DERBYSHIRE
Lowe Electronics
 The official importer of the TRIO range of equipment (See main ad. for the full list of all our shops)
 Chesterfield Road, Matlock, Derbyshire, DE4 5LE
Tel: 0629 2817/2430/4057

LONDON
Henry's
 27MHz/934MHz Rigs & accessories in stock. Lists - S.A.E. (A4) - 26p Full catalogue (TG/P) - large S.A.E. £1.00
 404 Edgware Road, London W2 1ED
Tel: 01-724 0323
(Open 6 days a week)

MERSEYSIDE
MGR SERVICES
 Wirral based communications
 ICOM - YAESU - M.MODULES - HOWES - CIRKIT - MUTEK - PART-EX - AERIALS - PMR - MARINE
 48, Shrewsbury Road, Oxton, Birkenhead, L43 2JZ.
Tel: 051 653 3437
(Callers by appointment 9 am-9 pm, Mon-Sat)

PLEASE MENTION PRACTICAL WIRELESS WHEN REPLYING TO ADVERTISEMENTS

RADIO SHACK SAVES YOU MONEY ON SCANNERS!

THE FINEST EVER SCANNER AT AN UNBEATABLE PRICE
 25-520, 760-1300 MHz, 300 MEMORIES ALL FOR £329.95



£329
(P&P £3.45)

Continuous tuning from 25 to 520 MHz and 760 to 1300 MHz 300 permanent memories in ten banks of 30 plus an additional ten channels used for temporary storage when in search mode. Switchable audio squelch allows you to ignore blank carriers. Three reception modes, AM, FM, (Wide) and FM (Narrow). Adjustable step size, 5kHz, 12.5 kHz and 50 kHz. Sensitivity (NFM) 0.5uV for 20dB S/N up to 1100 MHz Extremely attractive, information packed blue LCD display Headphone jack socket, tape recorder socket, external speaker socket, attenuator switch, 240 Volt operation and 13.8 VDC with optional mobile power lead.

Also still available
BC-200FB 16 CHANNEL SCANNER



£199.95 NOW SAVE £40
£159.95 (CP&P £3.45)



RADIO SHACK LTD

(Just around the corner from West Hampstead Station on the Jubilee Line)

Giro Account No. 588 7151 Telephone: 01-624 7174

**188 BROADHURST GARDENS,
 LONDON NW6 3AY**



Thinking of buying

A TWO METRE LINEAR AMPLIFIER

One of the most popular accessories available to the radio amateur is a two meter linear amplifier. 2 metres is the most overcrowded VHF band there is and an amplifier can give you the edge that you need for the DX. But, because of this overcrowding, signal quality is even more important than ever. The problems associated with wide, noisy signals are all the more acute because there are lots of signals near to each other.



2 METRES – LINEAR AMPLIFIER	L&LPM144-1-100	L&LPM144-3-100	L&LPM144-10-100	L&LPM144-3-180	L&LPM144-10-180	L&LPM144-25-180
Frequency Range Class of Operation Input Impedance Minimum Input Power Maximum Input Power Recommended Input Power Output Impedance Output Power Insertion Loss (straight through) Power Requirements	2W RMS 1W RMS 13.8Vdc, 14A+/-15%	144.000MHz to 148.000MHz Class AB1 50ohms unbalanced 500mW RMS 5W RMS 3W RMS 50ohms unbalanced 100W RMS +/-0.5dB 1.5dB +/-0.5dB 13.8Vdc, 14A+/-15%	15W RMS 10W RMS 13.8Vdc, 12A+/-15%	5W RMS 3W RMS 13.8Vdc, 27A+/-15%	144.000MHz to 148.000MHz Class AB1 50 ohms unbalanced 500mW RMS 15W RMS 10W RMS 50ohms unbalanced 180W RMS +/-0.5dB 1.5dB +/-0.5dB 13.8Vdc, 27A+/-15%	30W RMS 25W RMS 13.8Vdc, 22A+/-15%
PRE-AMP (LPM models only) Frequency Range Receive Gain Noise Factor Input Impedance Output Impedance Power Requirements		144.000MHz to 148.000MHz 12dB typical Better than 1dB 50ohms 50ohms 13.8Vdc, 100mA+/-15%			144.000MHz to 148.000MHz 12dB typical Better than 1dB 50 ohms 50 ohms 13.8Vdc, 100mA+/-15%	

If you don't look after your signal quality, you'll tread on other operators signals – and probably end up with a cluster of irate operators jamming you to get their own back. At the same time you'll waste a high proportion of your power by transmitting on lots of unwanted frequencies too. It can be so bad that you might just as well not have bothered getting an amplifier at all.

Don't forget the third harmonic either (432MHz to 438MHz), it's slap bang in the middle of the Amateur 70cm band. So if your amplifier is real bad you could be a better signal on 70 than you are on 2. Once you call CQ2, so everyone knows which band you're on, all the 70 boys will QSY and jam you too.

The advertisements for Amateur Radio Equipment never show a complete list of specifications. The basic ones are there, like operating frequency range and power consumption but the accurate performance specifications are never there. Third Order Inter Modulation Distortion (in effect a measure of the spreading), actual 6dB receive preamp bandwidth and many more important specifications are not detailed – even if they are you cannot always believe them.

To really tell what the performance of linears are like, you're better off reading the reviews. There was one where the receive preamp bandwidth was measured as **50 MHz** – horrendous.

BNOS Linear Amplifiers have all the features you need. Bypass Switching, Preamp Switching, a Power Meter, RF VOX/PTT Switching, Overdrive Shutdown etc . . . Later models even have ALC outputs and VSWR Shutdown features. An idiot diode guarantees that if you do connect it to the Power Supply incorrectly then you won't kill the linear – and of course an in-line fuse is fitted as standard.

Where BNOS Amplifiers really score though is inside the case. They're designed using the latest techniques and conservatively rated components. Switching control and biasing is controlled by dedicated Integrated Circuits while thermal sensing diodes automatically temperature compensate bias levels ensuring that the Amplifier stays in its linear class AB1 mode at all times. All BNOS amplifiers have internal filters to reduce spurious and harmonic outputs to insignificant levels.

The latest PUSH-PULL amplifiers use techniques for highly efficient low noise outputs maintaining BNOS's renowned performance at all power levels.

DON'T COMPROMISE QUALITY

BUY B.N.O.S. – THE REVIEWERS CHOICE

Go Racing this Summer with the Super Apache Scale Model Car!



The Apache

A superb ready-built scale-model off-road racer complete with a 2-CHANNEL DIGITAL PROPORTIONAL RADIO CONTROL SYSTEM – for the price of the RC system alone!

All this is included in the price:

Ready-built 1/14 scale model car (overall size 325 x 186 x 130mm, 12.8 x 7.3 x 5.1in.).

Front and rear low-profile semi-pneumatic rubber tyres.

Front wheel independent suspension.

High or low gear selection.

Sealed box with differential gearing.

Powerful motor gives scale speeds up to 140 mph.

Front and rear coil-spring shock absorbers.

2-channel digital proportional radio control transmitter (and receiver).

(Standard 27MHz AM – no licence required in UK).

Servo-controlled proportional steering.

Proportional motor speed control in forward and reverse.

EVEN MORE SUPER SUMMER SAVERS!!

If you are already a Maplin customer, soon you will be receiving (if you haven't already) a bumper bundle of smashing Summertime specials, plus the chance to win a beautiful, sleek, Ford XR3i (if you register in the prize draw before 1st July 1987).

If you are not a Maplin customer, but would love to know more about the special offers and have a chance to win the car, fill in the coupon below with your personal details, tick the appropriate box, and post it now.

*Batteries and ni-cad charger not included. Car requires 8 AA cells (ni-cad recommended YG00A £1.35 each). Transmitter requires 6 AA cells, (alkaline SX69A 55p each or ni-cad as above). NB – and if you have a collision at 100mph or more, you'll be pleased to hear that spare parts are available.

I'LL BE RACING THIS SUMMER WITH MY SUPERB APACHE CAR!

Please rush me my Apache model racer, with 2 channel digital proportional radio control system. I wish to receive:

	Code	Qty	Price
Apache model racer	SX08J		
AA ni-cad battery	YG00A		
AA alkaline battery	SX69A		
	Total		

All prices include VAT. Please add 50p towards postage. If order below £5.00, please add 50p handling.

I enclose cheque postal order made payable to Maplin Electronic Supplies Ltd., or see credit card details.

Here are my personal details:

Customer Number

Name

Address

I have never been a Maplin Customer, but I would be pleased to receive details of the super Summertime special offers.

Tick box.

If you have already received the Summertime special offers, please use the Order Coupon supplied with that.

Please register me in the prize draw.

Tick box.

I authorise you to debit my Credit Card account for the cost of goods despatched.

Credit Card Number

--	--	--	--	--	--	--	--	--	--	--	--	--	--	--	--	--	--	--	--	--

Access American Express Mapcard Visa

Delete as required

Note: Goods will be despatched only if the address given is the cardholder's address. If ordering by Credit Card please sign: