

PRACTICAL WIRELESS

APRIL
1971

17½p (3/6)

EXTRA

**pw
WORKSHOP
OSCILLOSCOPE**



**GUIDE TO Test Instruments
SUPPLEMENT**



**ALSO:
HIGH
IMPEDANCE
VOLTMETER**

ADCOLA Soldering Instruments add to your efficiency

ADCOLA 64

for Factory Bench Line Assembly

A precision instrument—supplied with standard 3/16" (4.75 mm) diameter, detachable copper chisel-face bit*.

Standard temp. 360°C at 23 watts.

Special temps. from 250°C—410°C.

***Additional Stock Bits**
(illustrated) available

COPPER

B 38 $\frac{1}{8}$ " — 3.2 mm CHISEL FACE

B 14 $\frac{3}{16}$ " — 2.4 mm CHISEL FACE

B 24 $\frac{3}{16}$ " — 4.75 mm SCREWDRIVER FACE

B 12 $\frac{3}{16}$ " — 4.75 mm EYELET BIT

B 58 $\frac{1}{2}$ " — 6.34 mm CHISEL FACE

LONG LIFE

B 42 LL $\frac{3}{16}$ " — 4.75 mm CHISEL FACE

B 38 LL $\frac{1}{4}$ " — 3.2 mm CHISEL FACE

B 14 LL $\frac{3}{16}$ " — 2.4 mm CHISEL FACE

B 44 LL $\frac{3}{16}$ " — 4.75 mm SCREWDRIVER FACE



Don't take chances. We don't. All our ADCOLA Soldering Instruments are of impeccable quality. You can depend on ADCOLA day after day. That's why they're so popular. You get consistent good service... reliability... from our famous thermally controlled ADCOLA Element and the tough steel construction of this ideal production tool.

* Write for price list and catalogue

ADCOLA

(Regd Trade Mark)

ADCOLA PRODUCTS LTD.,
(Dept. M), ADCOLA HOUSE, GAUDEN RD., LONDON, S.W.4.
Telephone: 01-622 0291/3 • Telegrams: Soljoint London Telex • Telex: Adcola London 21851

ERSIN

Multicore
5 CORE SOLDER

for fast, easy, reliable soldering

Contains 5 cores of non-corrosive flux, instantly cleaning heavily oxidised surfaces. No extra flux required.

SAVBIT ALLOY ALSO REDUCES COPPER BIT WEAR.

Economically packed for general electrical and electronic soldering. 75ft. 18 gauge on plastic reel. Recommended retail price **75p**.



THIN GAUGE SOLDER, ESSENTIAL FOR soldering small components and thin wires. High tin content, low melting point, 60/40 alloy, 170ft. 22 gauge on plastic reel. Recommended retail price **75p**.



A RANGE OF SOLDERS IN HANDY DISPENSERS.

REF.	ALLOY	SWG		
4A	60/40	18	15p *	
Size 5 (illustrated)	Savbit	18	15p *	
15	60/40	22	20p *	

*Recommended Price



INVALUABLE FOR STRIPPING FLEX, THE NEW AUTOMATIC OPENING BIB WIRE STRIPPER AND CUTTER.



easily adjustable for all standard diameters. Plastic covered handles can also be used as wire cutter. Recommended retail price **50p**



From Electrical and Hardware shops. If unobtainable, write to: **Multicore Solders Ltd., Hemel Hempstead, Herts.**

EX-RENTAL TELEVISIONS TWO-YEAR GUARANTEE

17" SLIMLINE
£11.95

19" SLIMLINE 405/625
£29.95

Carriage and Insurance £1.50

FREE ILLUSTRATED LIST OF TELEVISIONS

17"—19"—21"—23"
WIDE RANGE OF MODELS
DEMONSTRATIONS DAILY

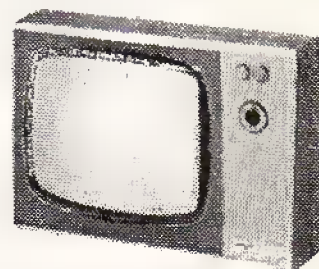

SPEAKERS 50np, 2 1/2" 8Ω, 4" 10Ω. BRAND NEW P. & P. 10np.

Transistors: Mullard matched output kit 37np. OC81D—2 OC81's. P. & P. FREE.

Transistor Radio Cases: 25np each. Size 9 1/2" x 6 1/2" x 3 1/2". P. & P. 15np.

Ferrite Rods 17np: 6" and 7" complete with LW/MW Coils. P. & P. FREE.

PRESS BUTTON SWITCHING UNITS, 4 Banks 17np, 6 Banks 27np. P. & P. 5np.

TV TUBES REBUILT GUARANTEED 2 YEARS

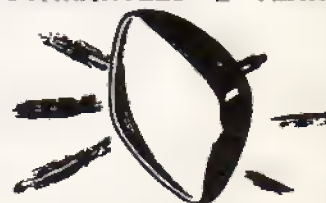

14"—£3.95 17" & 19"—£5.95, 21" & 23"—£6.45.
Exchanged Bowls. Carr. 60np.

(DUKE & CO. LONDON) LTD.

621/3 Romford, London, E12

Tel. 01-478 6001/2/3

COMPLETE STEREO SYSTEM

FOR ONLY

£40.95

CARRIAGE £1.75

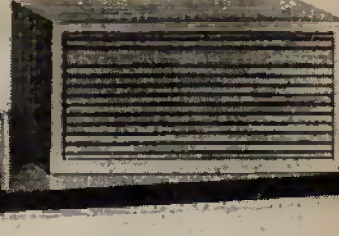
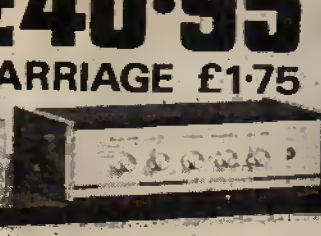
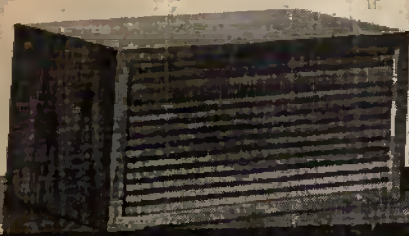

PREMIER STEREO SYSTEM "ONE" Consists of an all transistor stereo amplifier, Garrard 2025 T/C auto manual record player unit fitted stereo mono cartridge and mounted in teak finish plinth with perspex cover and two matching teak finish loudspeaker systems. Absolutely complete and supplied ready to plug in and play. The 10 transistor amplifier has an output of 5 watts per channel with inputs for pick-up, tape and tuner also tape output socket. Controls: Bass, Treble, Volume, Balance, Selector. Power on off, stereo mono switch. Brushed aluminium front panel Black metal case with teakwood ends: Size 12 x 5 1/2 x 3 1/2 in. high (Amplifier available separately if required £14.95 Carr. 40p.) **NOW AVAILABLE - MATCHING FM TUNER £22.05**

PREMIER STEREO SYSTEM "TWO"
As system "ONE" above but with Garrard SP25.
PREMIER PRICE £47 Carr. £1.75

MIDLAND AM/FM STEREO TUNER AMPLIFIERS

Two new all solid state receivers from Midland at economical prices. Beautifully styled in silhouette cabinets.

	MODEL 19-520	MODEL 19-542
Specifications	19 transistors, 12 diodes, 2 varistors	22 transistors, 12 diodes
Tuning range	FM 88-108 MHz FM Stereo Multiplex AM 535-1635 kHz	FM 88-108 MHz FM Stereo Multiplex AM 535-1605 kHz
Aerial	Internal AM and external FM	Internal AM and external FM
Frequency response	50-17,000 Hz	35-20,000 Hz
Power output	2 1/2 watts rms per channel (8 watts music power)	4 watts rms per channel (18 watts music power)
Inputs	Ceramic phone	Magnetic/Ceramic phone and aux.
Speaker impedance	4-8 ohm	8 ohm
Controls	Power on/off, Volume, tone, balance, tuning, AFC, Stereo indicator	On/off, Volume, bass, treble, balance, tuning, AFC, Stereo indicator
Function selector	AM, FM, FM Stereo, Phono (Stereo indicator light)	AM, FM, FM Stereo, Ceramic, Magnetic, Aux.
Size	15" x 8 1/2" x 3 1/2"	16 1/2" x 9 1/2" x 3 1/2"
PRICE	£30.45 Carr. & Ins. 50p	£44 Carr. & Ins. 50p



MODEL 19-520



MODEL 19-542

50 Watt Public Address Amplifier MODEL PA-5000

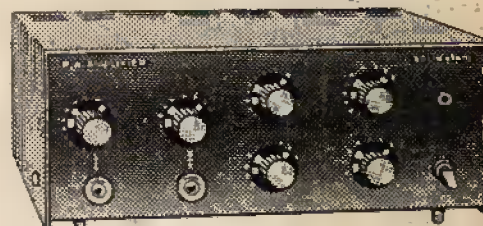

A top quality amplifier giving 50 watts rms power output (80 watts peak). Incorporates 8 transistors and 4 silicon diodes (silicon output transistors). Inputs for 2 microphones each with individual volume controls, plus radio/aux input. Master volume control and Bass and Treble Controls. Well presented front panel for ease of operation, on/off power flick switch and pilot light. Output impedance 4/8/16 ohms. Mike 1 & 2 sensitivity 2mV (50Kohms). Radio/Aux 300mV (100Kohms). Frequency response 50-20,000 Hz. Fused output and thermal overload protection. A.C. Mains 220-250v, 50/60 Hz. Size 13 1/2" x 9" x 5"

PREMIER PRICE £39 P. & P. 50p

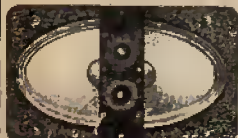

E.M.I. 13x8in. HI-FI SPEAKERS

Fitted two 2 1/2in tweeters and crossover network. Impedance 8 or 15 ohm. Handling capacity 10W. Brand new.

£3.47 P. & P. 40p

VERITAS V-149 MIXER

Battery operated 4-channel audio mixer providing four separate inputs. Size 6 x 3 x 2in. suitable for crystal microphone low impedance microphone, with transformer, radio, tape, etc. Max. input 1.5v. Max. output 2.5v. Gain 6 dB. Standard jack plug socket inputs, phono plug output. Attractive teak wood grain finish case.



MONO MODEL £3 STEREO MODEL £3.47 P. & P. 12p



HI-FI STEREO HEADPHONES

Designed to the highest possible standard. Fitted 2 1/2in speaker units with soft padded ear muffs. Adjustable headband. 8 ohms impedance. Complete with 6ft lead and stereo jack plug.

£2.47 P. & P. 25p.

STEREO STETHOSCOPE SET Low imp. £1.25 P. & P. 10p.

MONO STETHOSCOPE SET Low imp. 52p. P. & P. 10p.



POCKET SIZE MULTI-TESTER With wide angle, jewelled meter movement, ceramic long-life, low-loss switching, tough impact resisting case. Sensitivity 20,000 ohms/volt D.C. 10,000 ohms/volt A.C. 10 Ranges: 0-5-25-50-250-500-2500 volts DC. 0-10-50-100-500-1000 volts AC. 0-50µA-2.5 mA-250 mA DC. 0-6000 ohms-6 megohms, 10µµ-0.001 mid-1 mfd. -20 to +22dB. Complete battery, test lead and instructions. **£4.90 P. & P. 17p.**

SPECIAL OFFER!

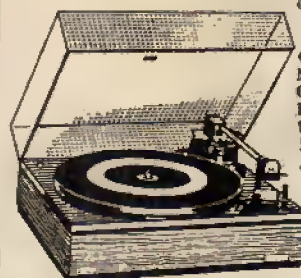

GARRARD SP25 MK II SINGLE RECORD PLAYER FITTED GOLDRING 850 MAGNETIC STEREO CARTRIDGE COMPLETE IN TEAK PLINTH WITH RIGID PERSPEX COVER.

Total list price over £24.
PREMIER PRICE

£18.90
P. & P. 50p.

"VERITONE" RECORDING TAPE

SPECIALLY MANUFACTURED IN U.S.A. FROM EXTRA STRONG PRE-STRETCHED MATERIAL. THE QUALITY IS UNEQUALLED. TENSILISED to ensure the most permanent base. Highly resistant to breakage, moisture, heat, cold or humidity. High polished splice free finish. Smooth output throughout the entire audio range. Double wrapped-attractively boxed.

LP3 3" 250' P.V.C.	23p	LP6 5 1/2" 1200' P.V.C.	62p
TT3 3" 450' POLYESTER	37p	DT8 5 1/2" 1800' POLYESTER	£1.12
DT3 3 1/2" 600' POLYESTER	57p	TT8 5 1/2" 2400' POLYESTER	£1.87
SP6 5" 600' P.V.C.	42p	SP7 7" 1200' P.V.C.	62p
LP5 5" 900' P.V.C.	59p	LP7 7" 1800' P.V.C.	75p
DT5 5" 1200' POLYESTER	75p	DT7 7" 2400' POLYESTER	£1.25
TAPE SPOOLS 3" 10p, 5", 5 1/2", 7" 9p.		TT7 7" 3600' POLYESTER £2.50	
Post and Packing 3" 5p, 5", 5 1/2", 7" 10p. (3 reels and over Post Free).			



TAPE CASSETTES
C60 (60 min.) 37p 3 for £1.05
C90 (90 min.) 62p 3 for £1.80
C120 (120 min.) 87p 3 for £2.55
P. & P. 5p.

All cassettes can be supplied with library cases at 3p. extra each

PREMIER RADIO

10 & 23, TOTTENHAM COURT ROAD, LONDON, W.1 TEL: 01-636 3451/2639
HEAD OFFICE & MAIL ORDER DEPT. 23, TOTTENHAM CT. RD. TEL: 01-636 3451



DISCOSOUND

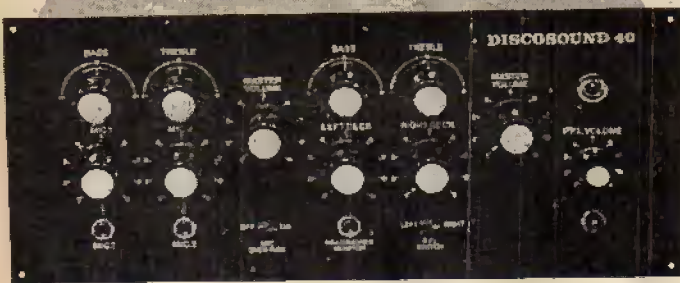

DISCOSOUND 40 PRE-AMP

The Discosound 40 offers the same specification as the D.J. Disco Amp without the power output stage. Size 16in x 7in x 7in. Self powered and ideal for use with the Discosound 100 Power Amplifier below and one of the outstanding features is that it is capable of running ten of these Power Amplifiers (Total 1,000W).

PRICE £40.50 inc. P & P.

DISCOSOUND 100 POWER AMPLIFIER

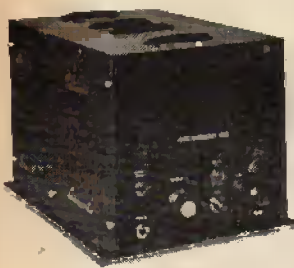

A 100W RMS (8 Ohms) High Fidelity power Amplifier which utilises all silicon transistors of modular construction and features full automatic overload protection against short or open circuits. Frequency response 20-20,000Hz ± 2dB. The High output is ideally suited for discotheques, groups, clubs, etc., or anywhere where reliability and quality are required. This unit is the companion model for use with our control pre-amp Discosound 40, or can be used with any other high quality pre-amp control unit. Completely built and tested on steel Chassis.

PRICE £49.50 inc. P & P.

DJ70S INTEGRATED MIXER-AMPLIFIER

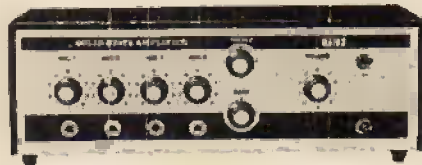

One of the finest units available on the market today, regardless of price. The front end of the unit consists of a four channel mixer with separate inputs and volume controls, plus a separate bass, treble and master volume control. One of the main features of this remarkable amplifier is its elaborate protection against short and open circuit and we can guarantee that it is virtually indestructible. Allied to this is its very high power output (70W R.M.S.), a frequency response (30-20,000Hz ± 3dB) that is superb, and distortion that is well below 1% even at full output. The unit is suitable for use with discotheques, groups, P.A., clubs, etc., or anywhere that high quality high output is required. Size: 15 1/2in x 5in x 6in.

PRICE £63.00 inc. P & P.

Also available DJ105S 30W PA Amplifier. Similar specification to above.

PRICE £41.00 inc. P & P.

For full details of these and all Discosound Products write direct to:-

DISCOSOUND,

122 BALLS POND ROAD, LONDON, N.1.
Telephone: 01-254 5779

Full money back guarantee if returned within 10 days.
All Discosound Products are guaranteed for 12 months.
Demonstrations given at any time.

VALVES

SAME DAY SERVICE
NEW! TESTED! GUARANTEED

SETS IR5, IS5, IT4, 384, 3V4, DAF91, DF91, DK91, DL92, DL94.
Set of 4 for £1.02. DAF96, DF96, DK96, DL96, 4 for £1.45.

1A7GT	-.37	25D4GT	-.57	DL92	-.23	EL500	-.82	PCL83	-.60	UBC41	-.52
1H5GT	-.56	30C1	-.32	DL94	-.37	EM80	-.41	PCL84	-.37	UBF80	-.34
1N5GT	-.38	30C15	-.83	DL96	-.38	EM81	-.41	PCL85	-.45	UBF89	-.33
1R5	-.28	30C17	-.80	DY86	-.28	EM84	-.33	PCL86	-.41	UCC84	-.35
1R5	-.21	30C18	-.87	DY87	-.28	EM87	-.37	PCL88	-.72	UCC85	-.36
1T4	-.16	30F5	-.78	EABC80	-.32	EY51	-.38	PCL800	-.77	UCF80	-.38
384	-.28	30FL1	-.63	EAF42	-.50	EY86	-.32	PEN44	-.42	UCH42	-.62
3V4	-.37	30FL12	-.72	EB91	-.11	EZ40	-.43	PEN36C	-.70	UCH81	-.32
5Y3GT	-.30	30FL14	-.72	EBC33	-.40	EZ41	-.43	PFL200	-.58	UCL82	-.35
5Z4G	-.37	30L1	-.32	EBC41	-.52	EZ90	-.23	PL36	-.48	UCL83	-.65
6/30L2	-.58	30L15	-.65	EBC90	-.22	EZ81	-.24	PL81	-.46	UF41	-.62
6AL5	-.11	30L17	-.73	EBF80	-.33	GZ32	-.43	PL81A	-.51	UF89	-.33
6AM6	-.18	30P4	-.85	EBF89	-.31	GZ34	-.48	PL82	-.30	UL41	-.60
6AQ5	-.26	30P12	-.77	ECC81	-.18	KT41	-.77	PL83	-.35	UL44	£1.00
6AT6	-.22	30P19	-.65	ECC82	-.23	KT61	-.48	PL84	-.32	UL84	-.35
6AU6	-.22	30PL1	-.63	ECC83	-.35	KT66	-.63	PL600	-.65	UM80	-.25
6BA6	-.22	30PL13	-.68	ECC85	-.23	LN819	-.83	PL604	-.67	UM84	-.22
6BE6	-.23	30PL14	-.70	ECC804	-.60	LN329	-.72	PL808	£1.17	UY41	-.41
6BJ6	-.42	30PL15	-.72	ECCF80	-.30	LN339	-.63	PM94	-.37	UY85	-.23
6BW7	-.60	35L6GT	-.43	ECCF82	-.30	N78	-.87	PX25	£1.17	VP4B	-.77
6CD6G	£1.10	35W4	-.22	ECH35	-.30	P61	-.50	PY32	-.55	W119	-.35
6F14	-.45	35Z4GT	-.25	ECH42	-.63	PABC80	-.85	PY33	-.55	Z77	-.22
6F23	-.78	807	-.45	ECH81	-.28	PC86	-.51	PY81	-.28	Transducers	
6F25	-.82	8083	-.62	ECH83	-.41	PC88	-.51	PY82	-.28	AC107	-.17
6K7G	-.12	AC/VP2	-.77	ECH84	-.37	PC96	-.42	PY83	-.28	AC127	-.18
6K8G	-.17	AZ31	-.47	ECL80	-.35	PC97	-.40	PY83	-.34	AD140	-.37
6SL7GT	-.27	B349	-.65	ECL82	-.33	PC900	-.37	PY800	-.37	AF115	-.20
6Y6G	-.17	B729	-.62	ECL86	-.40	PC94	-.32	PY801	-.37	AF116	-.20
6V6GT	-.32	COH35	-.67	EF39	-.23	PC95	-.30	R19	-.32	AF117	-.20
6X4	-.23	CL33	-.32	EF41	-.58	PC98	-.45	R20	-.65	AF118	-.48
6X5GT	-.23	CY31	-.33	EF80	-.24	PC989	-.47	U25	-.68	AF125	-.17
10F18	-.35	DAC32	-.36	EF85	-.31	PC189	-.51	U26	-.65	AF127	-.17
10F13	-.60	DAF91	-.21	EF86	-.31	PC805	-.65	U47	-.68	OC28	-.25
12AH8	£2.25	DAF96	-.36	EF89	-.26	PCF80	-.32	U49	-.85	OC44	-.12
12AT7	-.18	DF33	-.38	EF91	-.13	PCF82	-.32	U78	-.24	OC45	-.12
12AU6	-.23	DF91	-.16	EF183	-.23	PCF86	-.47	U191	-.62	OC71	-.12
12AU7	-.23	DF96	-.36	EF184	-.32	PCF800	-.67	U193	-.42	OC72	-.12
12AX7	-.23	DH77	-.22	EH90	-.42	PCF801	-.33	U251	-.72	OC75	-.12
19BG6G	-.87	DK32	-.37	EL33	-.43	PCF802	-.45	U301	-.52	OC81	-.12
20F2	-.67	DK91	-.28	EL34	-.47	PCF803	-.67	U329	-.72	OC81D	-.12
20P3	-.85	DK92	-.42	EL41	-.55	PCF806	-.60	U801	-.98	OC82	-.12
20P4	-.92	DK95	-.38	EL84	-.24	PCF808	-.72	UABC80	-.32	OC82D	-.12
25L6GT	-.25	DL35	-.25	EL90	-.26	PCL82	-.36	UAF42	-.51	OC170	-.22

READERS RADIO

85 TORQUAY GARDENS, REDBRIDGE, ILFORD, ESSEX. Tel. 01-550 7441.

Postage on 1 valve 5p, on 2 or more valves 3p per valve extra.
Any parcel insured against damage in transit 3p extra.

NOW AVAILABLE LASKY'S AUDIO TRONICS CATALOGUE 1971

THERE'S MORE &
MORE & MORE
FOR EVERYONE!

The great new 1971 edition of Lasky's famous Audio-Tronics catalogue is now available —FREE on request. The 44 newspaper size pages —many in full colour— are packed with 1000's of items from the largest stocks in Great Britain of everything for the Radio and Hi-Fi enthusiast. Electronics Hobbyist, Serviceman and Communications Ham. Over half the pages are devoted exclusively to every aspect of Hi-Fi (including Lasky's budget Stereo Systems and Package Deals). Tape recording and Audio accessories and introduces LASKY'S AUDIO TRONICS CREDIT CARD SCHEME offering holders one month interest free credit up to £50. Send your name and address and 15p for post and inclusion on our regular mailing list.

LASKY'S LTD., (Dpt. P.W.)
3-15 CAVELL STREET
LONDON, E1 2BN



ALPHA-ARENA • TELETON • H L • A M C • KOSS • APOLLO • SHURE • CELESTION

GARRARD

PRICES SLASHED! BY UP TO 0% 55%

GOLDRING

S M E • LEAK • SINCLAIR • WHARFEDALE • TRIO • LUXOR • PICKERING • PHILIPS ETC ETC

WHY PAY MORE? ALL GOODS ARE BRAND NEW & FULLY GUARANTEED FOR 12 MONTHS



SUPERB PLYNTHS AND COVERS as illustrated

Suitable for Garrard AT60, SP25, 2000, 2500, 3000, 3500, 5100, 2025, 1025, SL65B and B.S.R. McDonald range. Superbly finished plynth, ready cut for use (fully assembled). Complete with tinted perspex cover. This unit is finished in Teak polish and will blend in any home. Please state deck when ordering.

SUPERIOR PLYNTHS AND COVERS for Garrard AP75, AP76, SL72B, SL75B and SL95B £4.95 + 60p p & p (Recommended list price £10.00).

(£3.50 Plus 50p P & P)

A COMPLETE STEREO SYSTEM FOR ONLY £37.80 + £1.25 p. & p.

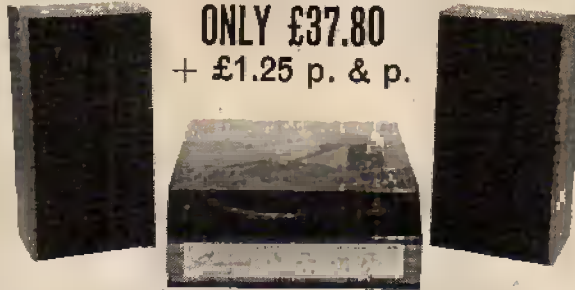

ITS PERFORMANCE CAN BE COMPARED WITH EQUIPMENT COSTING AT LEAST £130 THE APOLLO 100% MADE IN ENGLAND

This modern compact unit has been specially designed to give the maximum stereo performance in your home. Slenderly designed, the unit employs the latest Garrard 2025TC record deck which enables you to play your records manually or allow the machine to auto-change up to eight records automatically. The Garrard record deck is fitted with a cue and pause control which allows you to manoeuvre the arm of the deck to any chosen track of your record. Also used is a locking device to prevent the arm from moving whilst unit is in transit.

The amplifier used in this unit will give a true 5 watts (R.M.S.) per channel with maximum performance of base and treble. The controls are of a simple nature and allow you to adjust the balance of sound through each speaker, also the volume required, bass and treble.

The two speaker systems supplied with this audio unit are designed to give the best possible sound reproduction, the twin cone base unit will give a good bass response and the parasitic tweeter employed will clarify the high notes in your listening pleasure.

Finished in teak, this Hi-Fi compact unit will blend into any modern home and give you hours of listening pleasure in true stereo. 12 months guaranteed SPECIFICATION. Deck—Garrard 2025TC. Cartridge—Garrard G.C.538 with sapphire stylus. Output 5 watts (S.M.S.) per channel. Frequency: 40Hz to 20,000Hz. Speakers: Apollo 66 Three-way general purpose 15-16 ohms. 6" Twin cone base unit; 2 1/2" Parasitic Tweeter; LC Crossover; Suitable acoustic padding. Finish: Polished teak plynth and speaker cabinets; Charcoal tinted Perspex cover; Unit finished silver and black. Size: Unit 14 1/2" x 12 1/2" x 7 1/2". Speakers 14 1/2" x 8" x 6 1/2".

CARTRIDGES (p. & p. 12+p.)

GOLDRING G850	£4.20
GOLDRING G800	£6.99
GOLDRING G800E	£11.00
GOLDRING G800 super E	£16.00
SONOTONE 9TAHC	£2.35
SHURE M3d	£4.95
SHURE M4457/c	£7.20
SHURE M55	£9.20
SHURE M75E/11	£15.00

We have the complete SHURE range in stock.

SCOOP BUY

SMC-101 MOVING MAGNET STEREO CARTRIDGE.
PRICE: £3.25.

MCI-3 HIGH FIDELITY STEREO MOVING MAGNET CARTRIDGE.
PRICE: £8.00.

For complete specification on the above see our March Issue, Page 889.

SPECIAL OFFERS

SPEAKERS

Wharfedale — Denton — Triton — Melton — STE — MA.
Full range in stock at UP TO 50% DISCOUNT FOR PERSONAL CALLERS ONLY.

HEADPHONES

For 1 month only we offer 25% OFF list price of all KOSS models.
Example: PRO4AA. List price £28.00.
OUR PRICE £21.00 plus 37p p. & p.

SAVE OVER 30% ON A COMPLETE SYSTEM

GARRARD SP 25 MK III	List Price £16.45
PLYNTH AND COVER	£6.00
G800 CARTRIDGE	£13.00
HL AUDIO SA 707	£27.00
2 APOLLO 8 SPEAKERS	£27.50
	£89.95

OUR PRICE £56.94 + £2.50p. p. & p.

MANY OTHER BARGAINS IN STOCK FOR PERSONAL CALLERS DURING WEEK.

TURNABLES p.p. 60p

GARRARD 5100 with Cartridge	£7.97
GARRARD 2025 TC with Sonotone 9TAHC Diamond Cart	£8.50
GARRARD 3000 with Sonotone 9TAHC Diamond Cart	£9.50
GARRARD A70MKII	£10.97
GARRARD SP25 MK3	£10.97
GARRARD SL65B	£12.75
GARRARD AP76	£19.97
GARRARD SL72B	£25.00
GARRARD SL75B	£27.97
GARRARD 401	£27.50
GARRARD SL95B	£36.00
THORENS TD125	£61.00

PICK UP ARMS pp. 35p

SME 3009/S2	£25.50
SME 30012/S2	£27.50
GOLDRING Lenco L75	£9.99
GOLDRING Lenco L69	£6.75

STEREO AMPLIFIERS p.p. 50p

H.L. SA707 with Scratch Filter	£19.00
METROSOUND ST20	£27.75
AMSTRAD 8000	£20.97
TELETON SAQ200	£18.97
SINCLAIR 3000	£35.00
SINCLAIR 2000	£21.00
SINCLAIR PRO 60/2 Z30/PZ5	£15.97
TELETON SAQ 5015	£34.97
QUAD 303 & 33	£57.00
ARMSTRONG 521 (Teak cased)	£43.50

TUNER AMPLIFIERS pp. 75p

TELETON MX990 WITH SPKS	£48.50
TELETON R800 WITH SPKS	£47.50
TELETON CR10T WITH SPKS	£29.00
TELETON TFS50	£53.50
TELETON R4200	£33.00
TELETON F2000	£31.00
TELETON 7AT1	£81.00
TELETON R4300	£40.00
TELETON F2300	£40.00
TELETON CR55	£90.00
TELETON 10AT1	£195.00
TELETON 7AT20	£78.00
PHILIPS RH781	£54.00
A.M.C.7500 7 x 7 VHF	£31.00
MIDLAND 19.542 AM-FH MPX	£31.00

TUNERS p.p. 50p

TELETON GT101	£32.97
TELETON STO 201X	£28.00
TELETON STQ204X	£38.97
SINCLAIR 2000	£19.00
SINCLAIR PRO.80	£20.50
TRIO KT1000	£47.00

WHY PAY MORE—APOLLO 3-WAY SPEAKER SYSTEMS

The Systems are housed in handsome Slim-Line Cabinets of Modern Design, finished in Polished Teak with Padded Front Panel covered in I.C.I. Vynair Grille.

The **APOLLO 3-WAY SPEAKER SYSTEMS** are designed and built on the Infinite Baffle Principle and are completely Airtight and fully padded to damp out any Panel Resonance. Polished on all sides they can be used either vertically or horizontally and are ideal for Shelf or Wall Mounting.

Below are just a few from the **APOLLO** comprehensive range starting with:

APOLLO-15 3-WAY SPEAKER SYSTEM

Impedance 8 ohms. Power Handling 15 watts. RMS (30 watts peak). Frequency Range: 35 to 18,000Hz. Colour: Teak. Size 21 x 15 x 7 1/2 in. PRICE £18.50 each (p. & p. £1.00).

THE APOLLO-10 3-WAY SPEAKER SYSTEM employs a specially designed 10in. Bass Unit which has a high efficiency Anisotropic Ferrite Magnet and two 4in. Treble Units and LC

Crossover Network. Specification: Impedance 4-8 ohms (15-16 ohms to order). Power Handling 10 watts RMS (20 watts peak). Frequency Range 50 Hz to 18,000 Hz. Size 21 x 11 1/2 x 9 1/2. Finish: Polished Teak. OUR PRICE £13.47 each (85p. p. & p.).

APOLLO-8 3-WAY SPEAKER SYSTEM

As above but 7 watts RMS (14 watts peak). F.R. 55 to 18,000 Hz. Size 20 x 12 x 8in. £10.12 each (50p p. & p.).

APOLLO-66 3-WAY SPEAKER SYSTEM

As above but 5 watts RMS (10 watts peak). F.R. 75 to 18,000 Hz. Size 14 1/2 x 8 x 6in. PRICE £6.97 each (37p p. & p.).

PERSONAL CALLERS WELCOME. We are always available to advise on the best system to suit your need and pocket.

OUR OWN CAR PARK (at rear)
You have no parking problems when you pay us a visit.

UNBEATABLE VALUE
The largest and best quality range of stock at **LOWEST POSSIBLE PRICES** is usually available.

The prices shown are current at the time of going to press but are liable to alteration. They supercede any previous offer.

Send Postal Orders, Money Orders, Cheques, etc. to

For information only send stamped addressed envelope

AUDIO SUPPLIES

AUDIO SUPPLIES (PW4) 50 STAMFORD HILL LONDON, N.16 (The A.10)

Open 9.30 a.m.—6 p.m. Monday to Saturdays. EASY TO FIND. 50 yards from (B.R.) Stoke Newington Station. 67, 149, 247, 76, 243 Buses pass our door.

Tel: 01-806 3611

NOTE: Personal callers please note that cheques are only accepted if accompanied by a bank cheque card. (NOTE: NOT BARCLAY CARDS)

The Gerry



Adler Story.

Once upon a time Gerry Adler worked a 25 hour day making and selling valve filament testers. And very efficient they were too.

But at that time the Japanese could make them for about half the price, and sent Gerry one to prove it. It was as good as the ones he was making, so he sold it. And every other one he could get into the country.

After a time Gerry decided to go one step further. He designed some electronic equipment and had it built to his specification in Japan. Then he sold it here under the brand name 'Eagle'. Nothing particularly remarkable about that. But Gerry couldn't stand the idea of a barrier between him and his manufacturers. So he went to Japan. He poked his nose into all the electronics factories to find out how the Japanese worked. And when he got back he started to learn Japanese, and to study their history, culture and way of life. That way he had fewer communication problems and could get what he wanted.

That's what matters to Gerry. He's very fussy about what goes out under the Eagle banner. Because Eagle aren't in the filament testing business any more. They make just about everything electronic: amplifiers, test equipment, PA systems, intercoms, old uncle substation and all. Eagle is now twelve years old, and has opened offices in New York, Tokyo and Brussels.

This isn't just so much chest expansion on Gerry's part. He puts his money where his mouth is. If you think one of his products is not as good as a rival's, or it's faulty, or it's not all it should be, Gerry wants to know.

So write to him personally. He'll do something about it. He wants to make sure the Gerry Adler story has a happy ending.

Eagle International

we don't stand still.

Coptic Street, London WC1A 1NR.
Telephone 01-636 0961

Train for tomorrow's world in Radio and Television at The Pembroke College of Electronics

**Your first day on Television:
21st April 1971**

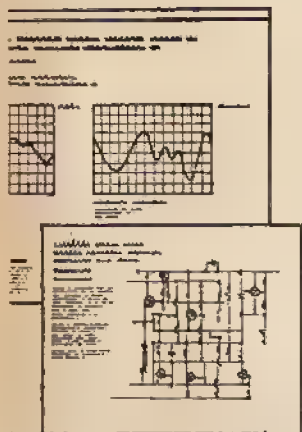

This is your opportunity to train as a television and radio engineer on our full-time 2 year College Diploma Course. That is the way to get into a rapidly growing industry with a tremendous demand for skilled technicians. You will be given theoretical and practical instruction on colour television receivers, following a syllabus specially designed to cover the new City and Guilds Radio, Television and Electronic Technicians' Course.

Minimum entrance requirements are Senior Cambridge or 'O' Level, or equivalent in Mathematics and English.

Complete the coupon below and we will send you the details about training for an exciting, new career.

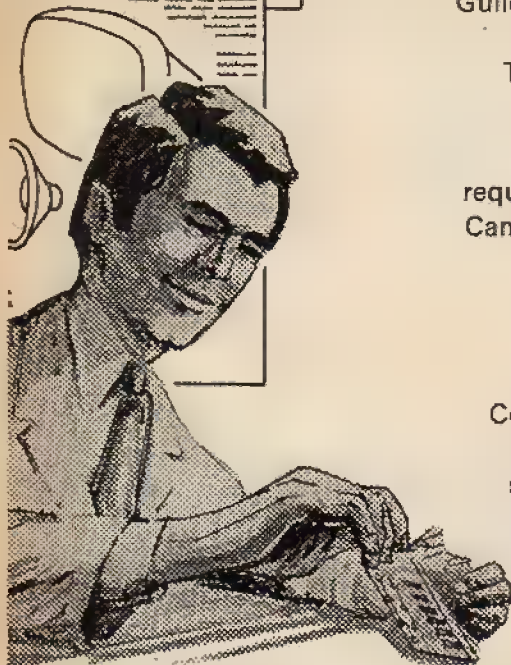

To: The Pembroke College of
Electronics, (Dept. PW1),
34a Hereford Road, London,
W2 5AJ.

Please send, without obligation, details of the Full-time Course in Radio, Television and Electronics.

NAME _____
ADDRESS _____

M. & B. COMPONENTS (LEEDS) LTD.

(INCORPORATING M. & B. RADIO)

38 BRIDGE END, LEEDS 1

Telephone 0532-35649

GEIGER COUNTERS

Well-known contamination meter comprised of main unit fitted with meter marked in 'Milli Rontgens/Hour', probe, lead and carrying case. A very sensitive set which will give a good reading from most pocket watches. Very low battery consumption. Audio output available from socket on front panel. Supplied in new or as new condition.

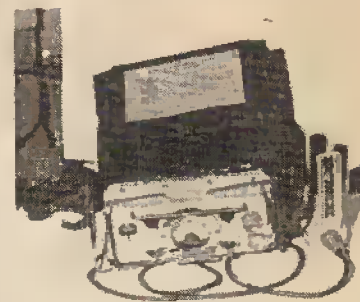

Model 1. Supplied with internal vibrator power supply unit, enabling set to work from 4 pen cell batteries £4.47 plus 37p p.p.

Model 2. Requires 2 HT batteries (not included) £3.75 plus 37p p.p. TRANSISTOR MODULATOR FRONT END 4 transistor modulator pre-amp panel 2 1/2" x 4 1/2". Fitted with preset microphone gain control and mod. filter. Originally used to drive an NKT404 which drove a pair of NKT404s. Supplied brand new with circuit of complete modulator £1.12 plus 7p p.p.

TRANSISTOR INVERTERS. Both models are brand new. Model 1. 12 vdc input 270 vdc at 150mA approx. output. £3.25 plus 20p p.p.

Model 2. 12 vdc input 330 vdc at 330mA approx output. £5.75 plus 25p p.p.

VHF RECEIVER UNIT TYPE R1933A. 18 miniature valve vhf receiver ideal for 2 metres, 4 metres or aircraft band. Requires p.s.u. and oscillator. £2.25 plus 30p p.p.

300 UNTESTED UNMARKED TRANSISTORS. £1.00 plus 10p p.p.

600 UNTESTED UNMARKED DIODES. £1.00 plus 10p p.p.

ELECTRO MAGNETIC COUNTERS. 4 digit GPO type counters. Used but tested. Six for £1.30 plus 3/6d. p.p.

DESK TELEPHONES. GPO type desk telephones complete with dials. Used but tested. Two for £1.62 plus 37p p.p. Four for £3.00 plus 50p p.p.

CONSTRUCTOR'S PARCEL NO. 1. Contains one 455Kc/s transistor FM IF panel, new but faulty; 60 untested unmarked diodes; 3 audio osc and timer 1/Cs with circuits; 6 miniature 12 vdc 100µF capacitors; 4 matched diodes; 5 2S3010 and 5 DT1602s. £1.87 plus 37p p.p. Send for lists of other parcels.

We also have in stock many other items of general interest. Please send s.a.c. for our latest lists.

BAKER 12in. REGENT

An inexpensive unit for the beginner in high fidelity and for general purposes. May be used to advantage with any Radio, Amplifier or Television receiver.

Maximum Power 15 watts

Bass Resonance 45 c.p.s.

Flux Density 12,000 gauss

Voice Coil impedance 3 or 8 or 15 ohm models

Useful response 45-13,000 c.p.s.

Nett weight 5 lbs.

GUITAR MODEL "GROUP 25" 25 watt rating £7

Latest catalogue 1/- with enclosure plans.

£7



Baker Reproducers Ltd

Bensham Manor Road Passage, Thornton Heath, Surrey. 01-684-1665

When in LUTON, BEDS, you must visit the . . .

SELF-SERVICE RADIO COMPONENTS SHOP

Serve yourself from a selection of 1,200 boxes of Manufacturer's surplus stocks and save money.

9 a.m. to 5.30 p.m. every day.

Closed all day Wednesday.

SURPLECTRONICS

216 LEAGRAVE ROAD, LUTON, BEDS

Which ever way you choose

LEWIS AUDIO SYSTEMS

Fine equipment competitively priced

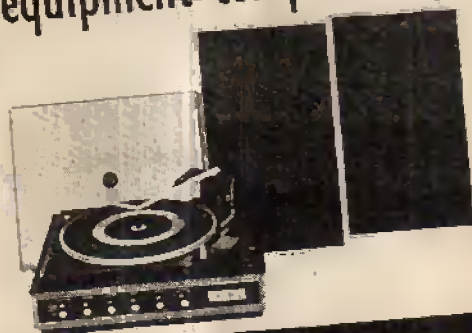

You are going to enjoy better listening for less cost and greater reliability

ready to play

LEWIS AUDIO SYSTEMS comprise ready built equipment designed and built to advanced technical standards of efficiency and styling. Their prices make true hi-fi available to a wider public than ever. Based on the excellent **Lewis Audio SA. 55** stereo amplifier in which FETS are used in the pre-amp to ensure better quality throughout, the range offers choice of free-standing amplifier with separate playing unit in plinth with plastic hard top or the **Compact** assembly in which the amplifier is built into the base of the plinth and motor assembly. Separate matched speakers are available for either system. Illustrated above is the Lewis S.55 Mk. II Compact System.

LEWIS AUDIO SYSTEMS

SA.55 STEREO AMPLIFIER—8 watts RMS output per ch. into 15 ohm speakers
Controls— input selector/Vol/Bass/Treble/Balance/ On-Off. Tape Record and replay facilities. DIN socket connections. Modern leak finished cabinet.
R.R.P. £18-90

PLINTHS WITH HARD TOPS & FITTED GARRARD UNITS

Garrard 2025TC with Sonotone 9TA/HC R.R.P. £16-50
Garrard 40B with Sonotone 9TA/HC R.R.P. £20-16
Garrard SP.25 Mk. III less cartridge R.R.P. £20-16

SC.55 Mk. II 'Compact' with Garrard 2025TC and SA.55 amplifier built into plinth R.R.P. £40-32

LOUDSPEAKERS

LS.16 'Major'—13" x 8" three way system in American Walnut finished cabinet. 8 ohms R.R.P. £11-70
LS.17 6" three way system in teak or Am. walnut finish. 15 or 8 ohms R.R.P. £10-80
LS.18 8" three way system in teak or Am. walnut finish 15 or 8 ohms. R.R.P. £12-60

● TRADE ENQUIRIES WELCOME

Coupon brings information

LOUIS & LEWIS (ELECTRONICS) LTD

154-155, HIGH STREET, BRENTFORD, MIDDLESEX
Telephone 01-560 1161

(BUILT OR KIT)

MARTIN AUDIOKITS

For the do-it-yourself enthusiast, the return of a great range of hi-fi modules

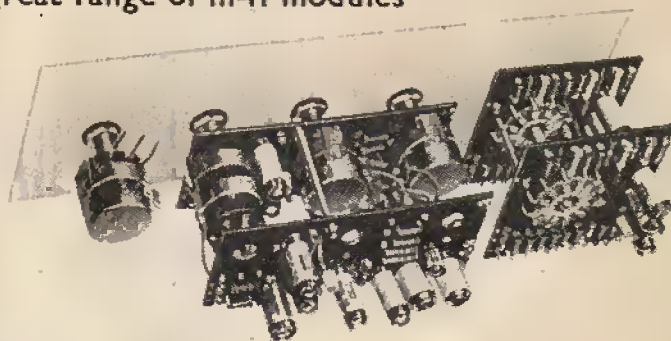

for the constructor

MARTIN AUDIOKITS were first to make modular unit construction available to the hi-fi enthusiast keen to save by building his own assembly. **AUDIOKITS** were first to feature "add-on-ability" by which a simple system could be expanded to high performance stereo equipment by the addition of easily added on units. Many who built with **MARTIN AUDIOKITS** years ago continue to enjoy unsurpassed quality and reliability from them to this day. **NOW YOU CAN BUY AUDIOKITS AGAIN** to allow you to build a high fidelity system to your personal choice and which will satisfy completely on performance, simplicity of assembly, robustness and reliability. These units are beautifully engineered and solidly built for a lifetime of trouble-free service. You can start with mono and add on units to make stereo, or build with stereo throughout.

TYPICAL MARTIN ASSEMBLIES

- 1478E** Five stage matched input selector unit; controls and pre-amp; power amp. (10 watts RMS into 15 ohms) power supply; front escutcheon plate (mono) Total price £17-50
1478SE Similar to above but for stereo. Total price £29-95
9748SE Stereo assembly for use with high grade ceramic and low power mag. pick-ups. Total price £32-95
All units are obtainable separately. State pick-up when ordering.



- EACH MARTIN AUDIOKIT MODULE IS COMPLETE IN ITSELF AND REQUIRES THE ADDITION OF NO FURTHER COMPONENTS TO IT.
- ALL UNITS INDIVIDUALLY TESTED AND CHECKED BEFORE LEAVING OUR FACTORY.

TO LOUIS & LEWIS (ELECTRONICS) LTD. 154 HIGH ST. BRENTFORD, MIDDX.

I am particularly interested in MARTIN AUDIOKITS
Please send details, (post free) to: LEWIS AUDIO SYSTEMS

NAME

ADDRESS

PW.1

Laskys

Astrad ORION

THE WORLD'S SMALLEST TWO WAVEBAND, 6 TRANSISTOR RADIO

Music, news, sport, wherever you are, 7-day money back guarantee if you are not absolutely delighted with the results. Make no mistake, this is a real radio, not a toy or crystal set! Fully built and tested, ready for immediate use. NO EXTRAS. This minute radio will play anywhere—anytime, beach, garden, park, home, office, school, etc. The super sensitive 6 transistor circuit is fully tuneable over both long and medium wavebands, with built-in ferrite rod aerial to provide excellent selection. The Orion operates from one tiny battery, either mercury or nickel cadmium, for long life and economical running costs. The output is via a crystal-type personal earphone, giving extreme clarity, which prevents disturbing other people when used in public parks, open spaces, etc. The small size of the Orion allows it to be carried easily in the pocket or handbag, and it is also supplied with an attractive presentation case. Complete with earpiece, battery and carrying case.

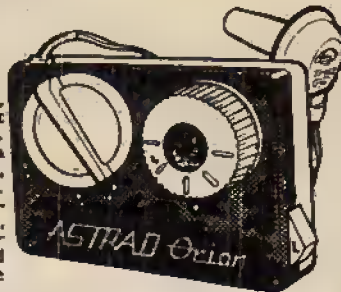

Specification: Waveband coverage. Medium 525kc/s to 1,605kc/s; Long 150kc/s to 308kc/s. Sensitivity: 35mV/m max. Selectivity (at -30kc/s detuning) -10dB. Power consumption: 4mA max. Power source: 1 x 1.4V Mercury battery. Mallory type RM625 or equivalent. Mallory battery is not rechargeable.

COMPLETE WITH EARPIECE ONLY RECHARGEABLE BATTERY POCKET CARRYING CASE **£1.48** POST 18p

*Spare rechargeable battery 18p extra—post FREE with radio.

BARGAIN PACKAGE COMPRISING—1 ORION RADIO 1 RECHARGEABLE BATTERY AND BATTERY CHARGER **£2** POST 20p

BATTERY CHARGER

THE BATTERY WE SUPPLY WITH THE ORION IS A RECHARGEABLE TYPE. BATTERY CHARGERS ARE AVAILABLE TO RECHARGE THE BATTERY AGAIN AND AGAIN. OPERATES ON HOME MAINS 200/240 VOLTS A.C.

Battery life is approx. 10 hours. Charging time: 10 hours. A spare battery will enable you to keep your Orion constantly in use.

LASKY'S PRICE 85p. POST FREE WITH RADIO.

EXCLUSIVE TMI & TM5

MODEL TM-1 1000 ohms/v MINI-TESTER

The first of Lasky's new-look top value meters, the TM-1 is a really tiny pocket multimeter providing "big" meter accuracy and performance. Precision movement calibrated to $\pm 3\%$ of full scale. Click stop range selection switch. Beautifully designed and made impact resistant black case—with white and metallic red/green figuring. Ohms zero.

- DC/V: 0-10-50-250-1,000 at 1K/OPV.
- AC/V: 0-10-50-250-1,000 at 1K/OPV.
- DC CURRENT: 0-1mA, 100mA.
- Resistance: 0-150k Ω .
- Decibels: -10dB to +22dB.
- Complete with test leads, battery and instructions.

LASKY'S PRICE £1.95 POST 13p



Size Only 3 1/2 in. x 2 1/2 in. x 1 1/2 in.

MODEL TM-5 5k OHMS/V POCKET MULTIMETER

Another new look pocket multimeter from Lasky's providing top quality and value. The "slimline" impact resistant case—size: 4 1/2 in. x 2 1/2 in. x 1 1/2 in., fitted with extra large 2 1/2 in square meter. Readability is superior on all low ranges; making this an excellent instrument for servicing transistorised equipment. Recessed click stop selection switch. Ohms zero adjustment. Buff finish with crystal clear meter cover.

- DC/V: 3-15-150-300-1,200 at 5K/OPV.
- AC/V: 6-30-300-600 at 2.5K/OPV.
- DC Current: 0-330 μ A, 0-300mA.
- Resistance: 0-10k Ω , 0-1M Ω .
- Decibels: -10dB to +16dB.
- Complete with test leads, battery and instructions.

LASKY'S PRICE £2.95 POST 13p

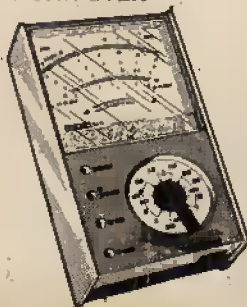

MP.60 McDONALD PROFESSIONAL SERIES FOUR SPEED SINGLE PLAY UNIT

High-precision low-mass fully counterbalanced pick-up arm, heavy balanced turntable, simply operated controls, viscous cueing device, slide-in cartridge carrier, four pole motor.



LASKY'S PRICE £12.50 post 35p

complete with plinth and cover **LASKY'S PRICE £15.75** Post 40p

610 AUTOMATIC TURNTABLE

Same specifications as the MP60 but with synchronous four pole motor and full automatic change facilities.

LASKY'S PRICE £15.45 Post 35p

WITH PLINTH AND COVER £18.75 POST 40p

510 AUTOMATIC TURNTABLE

Counterbalanced pick-up arm, pressed steel turntable, bias compensator, viscous cueing and synchronous four pole motor.

LASKY'S PRICE £13.45 POST 35p

WITH PLINTH AND COVER £16.95 POST 40p

310 AUTOMATIC TURNTABLE

Low-mass square section pick-up arm, cue and pause lever, visual stylus pressure indicator, slide-in cartridge carrier, four pole motor.

LASKY'S PRICE £9.95 POST 35p

WITH PLINTH AND COVER £13.45 POST 40p

BSR McDONALD PACKAGES

PACKAGE No. 1

BSR McDONALD 510 4 Speed Autochange	£17.00
AUDIO DEVELOPMENT AD76K Magnetic Cartridge	£ 4.50
BSR Afromosia Plinth with black mounting board.....	£ 5.00
BSR Smoked Perspex Dust Cover	£ 3.50
Recommended retail price	£30.00

LASKY'S PRICE £25.25 POST 40p

ADD £5.50 if M2100/E is preferred
ADD £6.50 if Shure M44/5 is preferred

PACKAGE No.2

BSR McDONALD 310 4 Speed Autochanger	£14.00
AD76K Magnetic Cartridge	£ 4.50
BSR Afromosia Plinth with black mounting board.....	£ 5.00
BSR Smoked Perspex Dust Cover	£ 3.50
Recommended retail price	£27.00

LASKY'S PRICE £23.50

ADD 50p if BSR Ceramic Cartridge is preferred

NOW AVAILABLE LASKY'S EXCLUSIVE

LASKY-McDONALD plinth and cover **£4.75** POST 25p available separately at

WAFER TYPE ELECTRO DYNAMIC

This revolutionary idea in sound reproduction functions in a similar manner to the cone loudspeaker system. In place of the conventional paper cone is a flat, rigid plastic panel only a fraction of the depth of the equivalent cone structure. With a flat rectangular panel a larger piston area is also available thereby reducing the size compared with an equivalent cone loudspeaker. Power capacity: 20 watts (peak). Freq. range, 40Hz-20,000 Hz. Input imp.: 8 ohms. Size: 1 1/2 in x 1 1/2 in x 1 1/2 in. Weight: 9oz.



Only 1 1/2" THICK!!

LASKY'S PRICE £5.75 each **£11** for two: Post 20p each

SONY TFM 8030L

BARGAIN SCOOP

HIGH PERFORMANCE 11 TRANSISTOR THREE WAVEBAND PORTABLE BATTERY/MAINS RADIO

This is a really top performance, top quality solid state receiver packed with SONY know-how and backed by the outstanding reliability for which SONY are renowned. Now this outstanding set is available from Lasky's at over 27% below the manufacturer's list price making it without a doubt the NUMBER ONE SCOOP of 1971! Just look at these outstanding features. Covers MW, LW and FM (VHF). 11 transistor circuit for high sensitivity and stability. Powerful output to 5" P.M. Dynamic speaker with rich clear tone quality. AFC for drift free VHF reception. Push-button wavochange selectors and tone control.

Choice of three power sources—9V battery, household mains or car battery with suitable adaptors. Dial light for use in the dark. External jacks for earphone, tape recording, external power input and car aerial. Ultra modern styling and superb finish with padded leatherette covered cabinet for superior sound damping with chrome trim, strong carrying handle.

The SONY TFM 8030L will enliven your leisure hours anywhere, anytime with exciting sound, news, sport, music, etc. Technical specification: Freq. range, FM 87-108MHz, LW150-Z85kHz, MW530-1,605kHz. Circuit: 11 transistors, 7 diodes and 2 thermistors. Aerial System: Directional telescopic for FM, internal ferrite bar for LW/MW. Power Output: 1.85W max. Speaker PM Dynamic—4Ωimp. Power Source: 9v power pack battery (Ever-Ready PP9 or equiv.), AC mains with adaptor, Car battery with adaptor. Size: 9½(W) x 8½(H) x 3½(D). Complete with earphone and battery and full instruction manual.

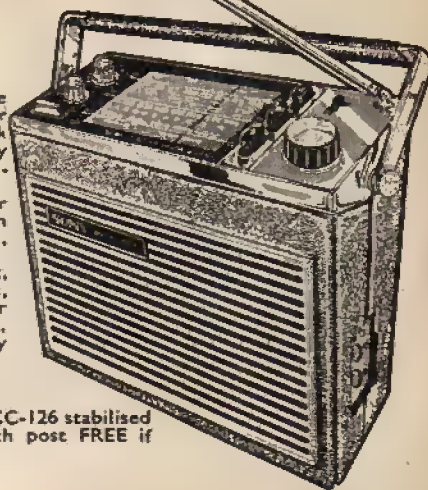

MANUFACTURER'S LIST PRICE £29.75

LASKY'S SPECIAL OFFER PRICE **£21.50**

Optional Extras. SONY AC-90e AC adaptor £4.00 DCC-126 stabilised car battery cord £6.00. Both post FREE if purchased with radio.

Post 35p

EXCLUSIVE Sinclair Project 60

DIGITAL CLOCK SCOOP!

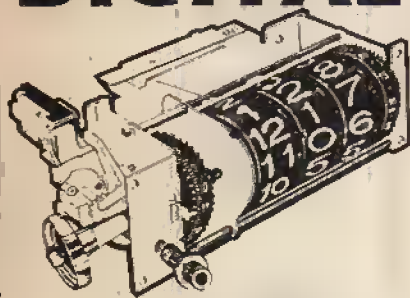

- MADE ESPECIALLY FOR LASKY'S BY FAMOUS MAKER
- MAINS OPERATION
- 12 HOUR ALARM
- AUTO "SLEEP" SWITCH
- HOURS, MINUTES AND SECONDS READ-OFF
- FORWARD AND BACKWARD TIME ADJUSTMENT
- SILENT OPERATION
- SYNCHRONOUS MOTOR

- SHOCK AND VIBRATION PROOF
- BUILT IN ALARM BUZZER

SPECIAL QUOTATIONS FOR QUANTITIES

This unique DIGITAL CLOCK is now available EXCLUSIVELY FROM LASKY'S in chassis form for you to mount in any housing that you choose. All settings are achieved by two dual-concentric controls at the front including: ON-OFF-AUTO and AUTO ALARM, "sleep" switch, 10 minute division "click" set alarm (up to 12-hour delay), time adjustment. Ultra simple mechanism and high quality manufacture guarantee reliable operation and long life. The sleep switch will automatically turn off any appliance—radio, TV, light etc. at any pre-set time up to 60 min. and in conjunction with the AUTO setting will switch on the appliance again next morning. The clock measures 4½W x 1½H x 3½D (overall from front of drum to back of switch) SPEC: 210/240V AC, 50Hz operation; switch rating 250V, 3A. Complete with instructions. HUNDREDS OF APPLICATIONS. COMPLETE WITH KNOBS

LASKY'S PRICE **£6.95** Post 18p

SPECIAL QUOTATIONS FOR QUANTITIES

TTC C-1051 METER

A completely new design 20,000 O.P.V. pocket multimeter with mirror scale and built-in thermal protection. Exceptionally large easy to read meter with D'Arsonval movement. Colour coded scales. Single positive click-in, recessed selection switch for all ranges. Ohms zero adjustment. Range spec. a.c. volts: 0-6-30-300-1,200V at 10K/ohms/V. DC volts: 0-3-15-150-300-1.2KV at 20K/ohms/V. Resistance: 0-50K-5megs. DC current: 0-60µA-300 mA. Decibels: -20dB to +17 dB. Extremely high standard of accuracy on all ranges. Uses one 1½V penlight battery. Strong impact resistant plastic cabinet—size only 4½ x 3½ x 1½in. Two colour buff/green finish. Complete with test leads and battery.

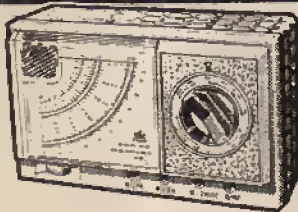

LASKY'S PRICE **£4.25** Post 13p

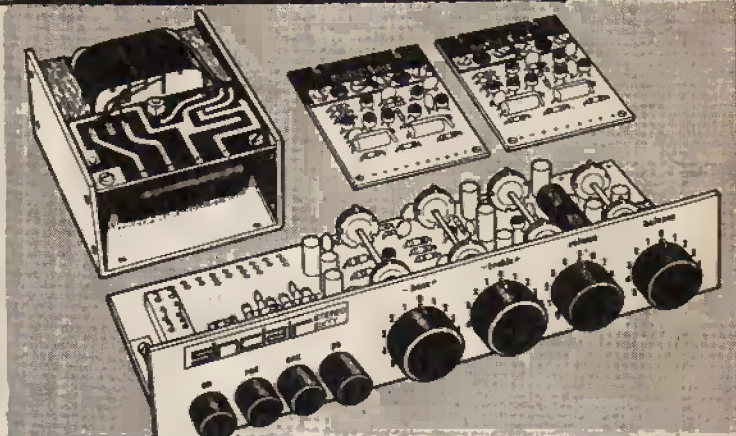

Project 60 is a range of modules which connect together to form a complete stereo amplifier. The modules are: 1. Z-30 high gain power amp. 2. Stereo-60 pre-amp. control unit. 3. The PZ-5 unbalanced and PZ-6 stabilised power supplies. A complete system comprises two Z-30's, one Stereo-60 and a PZ-5 or PZ-4.

STEREO 60 SPECIFICATION
Input sensitivities: Radio up to 3mV. Magnetic Pick-up 3mV: correct to R.I.A.A. curve ± 1dB; 20 to 25,000Hz. Ceramic Pick-up to 3mV; Auxiliary up to 3mV ● Output: 1 volt ● Signal to noise better than 70dB ● Front panel: brushed aluminium with black knobs and controls ● Size: 5½ x 1½ x 4in.

£8.95 Post 18p

Z-30 SPECIFICATION
● Power output: 15 w. R.M.S. into 5 ohms using a 35 volt supply ● Frequency response: 30 to 300,000Hz ± 1dB ● Distortion: 0.02% ● Signal to noise: better than 70dB ● Input sensitivity: 250mV into 100 K ohms ● Loudspeaker Imp: 3 to 15 ohms ● Power requirements: from 3 to 35V DC (The Z30 will operate from batteries if required)—Size: 3½ x 2½ x 4in.

£4.25 Post 18p

PZ5 30V unbalanced—sufficient to drive two Z-30's and a Stereo 60 for domestic applications. **£4.50** Post 13p

PZ6 35V stabilised—ideal for driving two Z-30's and a Stereo 60 for low efficiency speakers. **£7.50** Post 13p

PACKAGE PRICE For Stereo 60, two Z-30's and one PZ-5 **£19.25** Post 50p

OUT NOW LASKY'S NEW 1971 AUDIO-TRONICS CATALOGUE

Send your name and address and 13p for post and inclusion on our regular mailing list.

Lasky's Radio Ltd

207 EDGWARE ROAD, LONDON, W.2. Tel: 01-723 3271

33 TOTTENHAM CT. RD, LONDON, W1P 9RB. Tel: 01-636 2605
Open all day, 9 a.m.—6 p.m. Monday to Saturday

109 FLEET STREET, LONDON, E.C.4. Tel: 01-353 5812

152/3 FLEET STREET, LONDON, E.C.4. Tel: 01-353 2833
Open all day Thursday, early closing 1 p.m. Saturday

HIGH FIDELITY AUDIO CENTRE
42-45 TOTTENHAM CT. RD, LONDON, W1P 9RD. Tel: 01-580 2573
Open all day, 9 a.m.—6 p.m. Monday to Saturday



ALL MAIL ORDERS AND CORRESPONDENCE TO: 3-15 CAVELL STREET, TOWER HAMLETS, LONDON, E1 2BN Tel: 01-790 4821

HOW TO TELL A STEREO SYSTEM THAT LOOKS GOOD FROM A STEREO SYSTEM THAT SOUNDS GOOD—BEFORE YOU PART WITH YOUR MONEY.

There's only one way to buy stereo equipment. Listen to it. Lots of it. Until you find the sound you like for the money you've got.

Sound advice. But try acting on it in 99% of hi-fi dealers and you'll be asked to show the colour of your money. We at Roc think that's unfair. So we fitted out our store in the Edgware Road with a series of sound systems, so you can hear all the stereo you want until you find the equipment you like. With no hustling.

But if you're one of those poor unfortunates who cannot make it in person, we'll sell you a system by mail. We've got the best range in town from single speakers to complete stereo set-ups.

Here are just six of the systems we've got in stock.

Fill in the coupon and we'll have our systems brochure back to you by return:



Name

Address



ROC ELECTRONICS LIMITED
193 EDGWARE ROAD LONDON W2 1ET
TELEPHONE: 01-723 6211

System I.

Price: £39.90

Amplifier Output: 4 Watts per channel
Frequency Response: 50-10000 Hz.
Inputs: Tuner, Ceramic Cartridge
Controls: Volume, Tone & Balance
Speakers: 6 Watts Capacity:
Frequency Response: 40-16000 Hz.
Turntable: Garrard 2025TC, Ceramic Cartridge, Base and Cover
Matching AM/FM/FM Stereo Tuner

System II.

Price: £49.90

Amplifier Output: 8 Watts per Channel
Frequency Response: 40-18000 Hz.
Inputs: Tuner, Tape, Ceramic Cartridge
Controls: Volume, Bass, Treble and Balance
Speakers: 10 Watts Capacity:
Frequency Response: 40-19000 Hz.
Turntable: As system I.

System III.

Price: (A) £59.90 (B) £69.90

Amplifier Output: 15 Watts per Channel
Frequency Response: 30-18000 Hz.
Inputs: Tuner, Tape, Magnetic & Ceramic
Controls: Volume, Bass, Treble and Balance
Speakers: As System II
Turntable: System IIIA Garrard 2025TC, Ceramic Cartridge, Base and Cover
System IIIB Garrard SP.25 MK III, Magnetic Cartridge, Base and Cover

System IV.

Price: £79.90

Amplifier Output: 20 Watts per Channel
Frequency Response: 25-20000 Hz.
Inputs: Tuner, Tape Magnetic & Ceramic Cartridge
Controls: 2 Volume, Bass, Treble and Loudness
Speakers: 20 Watts Capacity:
Frequency Response: 35-20000 Hz.
Turntable: Garrard SP.25 MKIII, Magnetic Cartridge, Base and Cover
Matching AF/FM/FM Stereo Tuner: £36.00

System V.

Price: £115.00

Tuner Amplifier Output: 18 Watts per Channel
Frequency Response: 30-20000 Hz.
Inputs: Tape & Magnetic Cartridge
Controls: 2 Volume, Bass, Treble and Tuning
FM Sensitivity: 2.5 micro volts
AM Sensitivity: 100 micro volts
Speakers: 20 Watts Capacity:
Frequency Response: 35-20000 Hz.
Turntable: As System IV

System VI.

Price: £182.00

Amplifier Output: 30 Watts per Channel
Frequency Response: 20-30000 Hz.
Inputs: Auxilliary, Magnetic & Ceramic Cartridge
Controls: Volume, Bass, Treble, Balance, Loudness and Monitor
Speakers: 30 Watts Capacity:
Frequency Response: 35-20000 Hz.
Turntable: Thorens TD150AB Magnetic Cartridge, Base & Cover

This MONTH'S Best Buy . . .



AKG K50 Dynamic Stereo headphones

Complete with spare ear muffs.

Total (value £10.40) Our Price **£5.90** + 23p p. & p.

Available only from us at this price. Due to entire purchase of manufacturer's remaining stock this fantastic offer is open only while stocks last.

- * High-fidelity reproduction due to broad frequency response (20-20,000Hz)
- * Substantially increased stereo effect
- * Headphones fit the head gently and do not shift
- * Earpieces fit ears snugly (Cardanic suspension)
- * Tone quality superior to conventional loudspeakers.
- * Only expensive studio loudspeakers can match the reproduction quality of the K50.
- * Music can be reproduced at concert hall volume (l), preserving the lower bass notes and brilliant treble tones without causing any strain to the listener.



GARRARD SP25

mk II **£11.50** Plus 50p carriage

Normal price £15.57

Single record playing unit. Features include cue and pause and automatic pick-up return and switch off.

Wired with mains cable and 5ft. twin screened stereo cable, 5 pin din plug. 53p extra. AP75 Complete with base and cover £25 plus 75p carriage.

PLUGS?

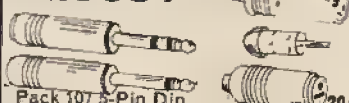

- Pack 107 5-Pin Din .. 20p
- Pack 108 3-Pin Din .. 18p
- Pack 135 1/2" Jack .. 25p
- Pack 130 1/2" Jack Stereo .. 48p
- Pack 103 Loudspeaker Plug .. 15p
- Pack 100 Phono Plug .. 6p
- Pack 230 3-Pin Socket .. 23p
- Pack 236 5-Pin Socket .. 30p
- Pack 234 Loudspeaker Socket .. 30p

Ready-made Leads
 3-pin to 3-pin Din .. 63p
 3-pin to open end .. 53p
 5-pin to 5-pin Din .. 80p
 5-pin to open end .. 65p
 5-pin to 4 phono plugs .. 93p
 Speaker lead Din to spade 12ft 38p. Extension lead Din plug to socket 12ft. 65p
 All leads approx. 6ft. in length. Post free, by return.

PLINTH & COVER £5-25

Unbeatable Value plus 50p p. & p.

Suitable for AT60; SP25; 3000; 2500; 3500. Superb finish. Spindle can be left in position with cover on. Cover of neutral smoke tint perspex. Also available for AP75; SL99; SL75 £6.88 plus 50p carr.



Replacement Stereo DIAMOND STYLI

8TA 9TA 9TANC GP91 ST4 ST9 EV26 GC8 **75p** each plus 13p p. & p.

Countdown SPEAKER

Teak Cabinet **£12** Insurance & carr. 38p

A speaker of outstanding specifications and technical merit. Solid teak cabinet size; 14" x 10" x 6". Originally designed for use with our Countdown stereo budget system but now available separately.



EMI 10w matched loudspeaker set 450

Our price **£3.75** Inc. 25p p. & p.

13 1/2" x 8 1/2" elliptical loudspeaker and independent high frequency units with associated crossover network. Frequency range 55 to 13000Hz. The cone of the bass unit has a surround designed for high travel giving freedom from distortion when operated at low frequencies. Also 350 KIT 20W

Frequency range: 20 to 20,000Hz. **£7.50** plus 40p p & p
 Normal price £12.50 plus 40p p & p
 Also 150 KIT 10W **£2.50** plus 40p p & p
 3, 8 or 15 ohms



SINCLAIR Project 60

SAVE nearly £5 Normal price £23.90

Designed for building into plinths etc., complete with two 230 Output stages **£19** plus 50p carr.

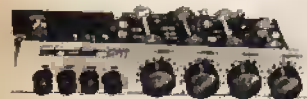

(20 watt) and power supply unit. Send S.A.E. for full technical brochure. **SINCLAIR 2000 AMPLIFIER** SAVE £6.30 Our price **£24.15**

Magnetic cartridges

Diamond **£4.75** styli

plus 13p p. & p. Today's value £6. Stylus replacement can be carried out without removing cartridge. Fully guaranteed.



Ronette 105 Stereo cartridge (Sapphire 78 Diamond LP) **£1.25** 13p. p. & p.

SONOTONE Cartridge ...

(Filled Diamond Styli) (Ceramic) list price £4.10



Sensitivity: 9TAHC 55mV/cm/sec **£2.50** plus 13p
 rms minimum at 45° at 1,000Hz measured on Decca SXL2057 p. & p.

PADGETTS RADIO STORES

OLD TOWN HALL, LIVERSEDGE, YORKS

TEL. HECKMONDWIKE 4285

40 ONLY. The much sought after Sighting Computer Mark XIVA. For the model maker. Condition Good. **£2.50p** (50/-) Carriage **£1.00** (£1)

AMPLIFIER UNIT TYPE A1413. Complete with 5Z4 and 6V6GT valves 250/230 volt. 50 cycle. Transformer. Clear. Condition, Untested. **£1.25p** (25/-). Carriage **75np** (15/-).

AIR POSITION INDICATORS. Contains Gears, Ball Races, Dimmer Units, Lamps, Four numbered counters, 24 volt Motor etc. Great interest to the model makers. In good condition. **75np** (15/-). Carriage **50np** (10/-).

GROUND POSITION INDICATOR. Contains 24 volt lamp, Prisms Mirror, Gears. Could interest schools & model makers. **75np** (15/-). Carriage **75np** (15/-).

NEW BOXED UNIT TYPE 8197. Contains two Toggle D.P.S.T. switches, also one Press Toggle D.P.S.T. Sixteen Miniature, 500 Ohm. Pre-set Pots R.X TX switches etc. **25np** (5/-). P. & P. **22np** (4/6). **£3.00** (£3) per dozen. Carriage paid.

TOGGLE SWITCHES. Ex Units D.P.D.T. **10np** (2/-). D.P.S.T. **5np** (1/-). S.P.S.T. Spring Loaded **10np** (2/-). D.P.S.T. Press Button Spring Loaded **10np** (2/-). P. & P on any switch **4np** (9d). Doz. Post Paid.

G.P.O. RELAYS EX-UNITS. 400 Ohms and 600 Ohms **50np** (10/-) per doz. P. & P. **25np** (5/-). Sample Relay **8np** (1/3). P. & P. **5np** (1/-).

MINIATURE BRASS LAMP HOLDER. **10np** (2/-). P. & P. **5np** (1/-). **90np** (18/-) per doz. Post Paid. Base Board Type.

RECLAIMED T.V. TUBES with 12 months Guarantee. 17" AW 43/80 **£1.50p** (30/-). MW 43/89 **£1.50p** (30/-). AW 43/88 **£2.00** (40/-). Carriage and Insurance on any tube **£1.00** (20/-).

12 CHANNEL COMPLETE UNTESTED T.V. SETS. **£2.50p** (50/-). Carriage and Insurance **£1.50p** (30/-).

SPEAKERS REMOVED FROM T.V. SETS. All 3 Ohm and P.M. 6x4. **15np** (3/-). 7x4. **25p** (5/-). 8x2 1/2 **25np** (5/-). Post on any Speaker **20np** (4/-).

VALVE LIST—Ex Equipment 3 months guarantee. Single valves. Post **3np** (7d), over 3 valves P. & P. Paid.

ARP12	5np (1/-)	PCC84	10np (2/-)	PY82	8np (1/7)
EB91	4np (9d)	PCF80	10np (2/-)	PZ30	25np (5/-)
EF85	15np (3/-)	30P12	25np (5/-)	U191	25np (5/-)
EBF80	15np (3/-)	30P5	15np (3/-)	U251	25np (5/-)
ECC81	15np (3/-)	PCL84	20np (4/-)	6BW7	10np (2/-)
ECC82	15np (3/-)	PCL82	20np (4/-)	6U4	25np (5/-)
ECL80	10np (2/-)	PCL83	25np (5/-)	6P28	25np (5/-)
EF50	5np (1/-)	PL36	25np (5/-)	20D1	15np (3/-)
EF80	8np (1/7)	PL81	20np (4/-)	20P1	25np (5/-)
EF91	4np (9d)	PY33	25np (5/-)	20P3	15np (3/-)
EY86	25np (5/-)	PY81	8np (1/7)	30P4	25np (5/-)

YOUR CAREER in RADIO & ELECTRONICS ?

Big opportunities and big money await the qualified man in every field of Electronics today—both in the U.K. and throughout the world. We offer the finest home study training for all subjects in radio, television, etc., especially for the CITY & GUILDS EXAMS (Technicians' Certificates); the Grad. Brit. I.E.R. Exam.; the RADIO AMATEUR'S LICENCE; P.M.G. Certificates; the R.T.E.B. Servicing Certificates; etc. Also courses in Television; Transistors; Radar; Computers; Servo-mechanisms; Mathematics and Practical Transistor Radio course with equipment. We have OVER 20 YEARS' experience in teaching radio subjects and an unbroken record of exam. successes. We are the only privately run British home study College specialising in electronics subjects only. Fullest details will be gladly sent without any obligation.

To: British National Radio School, Reading, Berks.

Please send FREE BROCHURE to

NAME

ADDRESS

..... Please

4/71

BRITISH NATIONAL RADIO SCHOOL

J. J. FRANCIS

(WOOD GREEN) LTD

123 ALEXANDRA ROAD, HORNSEY, LONDON, N.8. Tel: 01-888 1662

★ TRANSISTORISED FM TUNER
 6 TRANSISTOR HIGH QUALITY TUNER, SIZE ONLY 6x4x2 1/2 in. 3 I.F. stages. Double tuned discriminator. Ample output to feed most amplifiers. Operates on 9 V battery. Coverage 88-108 Mc/s. Ready built ready for use. Fantastic value for money. £8.87. P. & P. 12ip. Stereo multiplex adaptors £4.97.

AVO CT471A MULTIMETER
 Battery operated, fully transistorised. Sensitivity 100mΩ/v. Measures AC/DC Voltages 12mV to 1,200V. AC/DC Current 12mA to 1.2 Amp. Resistance 12 ohm to 120 MΩ. HF, VHF, UHF Voltage with multiplier 4v to 400v up to 50 Mc/s, 40mV to 4v up to 1,000 Mc/s. Offered in perfect condition. £55 each. Carr. 50p.

CRYSTAL CALIBRATORS NO. 10
 Small portable crystal controlled wavemeter. Size 7 x 7 1/2 x 4 in. Frequency range 500 Kc/s-10 Mc/s (up to 30 Mc/s on harmonics). Calibrated dial. Power requirements 300V. D.C. 15mA and 12V D.C. 0.3A. Excellent condition. £4.47. Carr. 37 1/2p.

B.C. 221 FREQUENCY METERS
 latest release 125 KHz-20 MHz. Excellent condition. Fully tested and checked and complete with calibrator charts. £27.50 each. Carr. 50p.

AM/FM SIGNAL GENERATORS
 Oscillator Test No. 2. A high quality precision instrument made for the ministry by Airmeo. Frequency coverage 20-80 Mc/s. AM CW/FM. Incorporates precision dial, level meter, precision attenuator 1μV-100mV. Operation from 12 volt D.C. or 0/110/200/250 volt A.C. Size 12 x 8 1/2 x 9 in. Supplied in brand new condition complete with all connectors fully tested. £45. Carr. £1.

AVO CT.38 ELECTRONIC MULTIMETERS
 High quality 97 range instrument which measures A.C. and D.C. Voltage. Current, Resistance and Power Output Ranges D.C. volts 250mV-10,000V. (10 meg Ω - 11 Gmeg Ω input). D.C. current 10μA-25 amps. Ohms, 0-1,000 meg Ω A.C. volt 100mV-250V (with R.F. measuring head up to 250 Mc/s) A.C. current 10μA-25 amps. Power output 500 micro-watts-5 watts. Operation 0/110/200/250V. A.C. Supplied in perfect condition complete with circuit lead and R.F. probe. £25. Carr. 75p.

ADMIRALTY 62B RECEIVERS
 High quality 10 valve receiver manufactured by Murphy. Coverage in 6 bands 150-300 Kc/s, 560 Kc/s-1.5Mc/s; 3.9-36.5 Mc/s I.F. 500/Kc/s. Incorporates 2 R.F. and 3 I.F. stages, bandpass filter, noise limiter, crystal controlled B.F.O. calibrator I.F. output, etc. Built-in speaker, output for phones. Operation 150/230 vol A.C. Size 19 1/2 x 13 1/2 x 16 in. Weight 11 1/2 lb. Offered in good working condition. £22.50. Carr. £1.50. With circuit diagrams. Also available B41 L.F. version of above, 15 Kc/s-700 Kc/s. £17.50. Carr. £1.50.

TO-3 PORTABLE OSCILLOSCOPE
 3in. tube. Y amp. Sensitivity 0.1v p-p/CM. Bandwidth 1.5 cps-1.5 MHz. Input imp. 2 meg Ω 25pF X amp. sensitivity 0.9v p-p/CM. Bandwidth 1.5 cps-800KHz. Input imp. 2 meg Ω 20pF. Time base. 5 ranges 10 cps-300 KHz. Synchronization. Internal/external. Illuminated scale 140 x 215 x 330 mm. Weight 15 1/2 lb. 220/240V. A.C. Supplied brand new with handbook. £37.50. Carr. 50p.

TO-2 PORTABLE OSCILLOSCOPE
 A general purpose low cost economy oscilloscope for everyday use. Y amp. Bandwidth 2 CFS-1MHz. Input imp. 2 meg Ω 25 P.F. Illuminated scale. 2in. tube. 115 x 180 x 230mm. Weight 8lb. 220/240 V a.c. Supplied brand new with handbook. £22.50. Carr. 50p.

SEW PANEL METERS

USED EXTENSIVELY BY INDUSTRY, GOVERNMENT DEPARTMENTS, EDUCATIONAL AUTHORITIES, ETC.
 ● LOW COST ● QUICK DELIVERY ● OVER 200 RANGES IN STOCK ● OTHER RANGES TO ORDER

NEW "SEW" DESIGNS!
CLEAR PLASTIC METERS
 TYPE SW.100 100 x 80 mm.
 50μA £3.47
 50-0-50μA £3.37
 100μA £3.37
 100-0-100μA £3.25
 500μA £3.12
 1mA £2.97
 20V. D.C. ... £2.97
 50V. D.C. ... £2.97
 300V. D.C. £2.97
 1 amp. D.C. £2.97
 5 amp. D.C. £2.97
 300V. A.C. £2.97
 VU Meter... £3.75

"SEW" CLEAR PLASTIC METERS
 Type MR.35P. 4 1/2 in. x 4 1/2 in. fronts.
 50mA £2.60
 100mA £2.60
 500mA £2.60
 1 amp. £2.60
 5 amp. £2.60
 15 amp. £2.60
 30 amp. £2.60
 20V. D.C. ... £2.60
 50V. D.C. ... £2.60
 150V. D.C. £2.60
 300V. D.C. £2.60
 15V. A.C. ... £2.60
 300V. A.C. £2.60
 8 Meter 1mA £2.87
 VU Meter... £3.50
 1 amp. A.C.* £2.60
 5 amp. A.C.* £2.60
 10 amp. A.C.* £2.60
 20 amp. A.C.* £2.60
 30 amp. A.C.* £2.60

"SEW" BAKELITE PANEL METERS
 Type MR.33P. 1 21/32 in. square fronts.
 200mA £1.37
 300mA £1.37
 500mA £1.37
 750mA £1.37
 1 amp. £1.37
 2 amp. £1.37
 5 amp. £1.37
 10 amp. £1.37
 3V. D.C. ... £1.37
 10V. D.C. ... £1.37
 10V. D.C. ... £1.37
 20V. D.C. ... £1.37
 100V. D.C. £1.37
 100V. D.C. £1.37
 300V. D.C. £1.37
 500μA £1.50
 500-0-500μA £1.37
 1mA £1.37
 1-0-1mA ... £1.37
 2mA £1.37
 5mA £1.37
 10mA £1.37
 20mA £1.37
 50mA £1.37
 100mA £1.37
 150mA £1.37
 5 amp. £1.50
 10V. D.C. ... £2.00
 20V. D.C. ... £2.00
 50V. D.C. ... £2.00
 300V. D.C. £2.00
 15V. A.C. ... £2.00
 300V. A.C. £2.00
 8 Meter 1mA £2.10
 VU Meter... £3.10
 1 amp. A.C.* £2.00
 5 amp. A.C.* £2.00
 10 amp. A.C.* £2.00
 20 amp. A.C.* £2.00
 30 amp. A.C.* £2.00

"SEW" BAKELITE PANEL METERS
 Type MR.65P. 3 1/2 in. x 3 1/2 in. fronts.
 50μA £3.37
 50-0-50μA £2.75
 100μA £2.75
 100-0-100μA £2.60
 500μA £2.60
 500-0-500μA £2.10
 1mA £2.10
 5mA £2.10
 10mA £2.10
 50mA £2.10
 100mA £2.10
 500mA £2.10
 1 amp. £2.00
 5 amp. £2.00
 10 amp. £2.00
 20 amp. £2.00
 5V. D.C. ... £2.10
 10V. D.C. ... £2.10
 20V. D.C. ... £2.10
 50V. D.C. ... £2.10
 150V. D.C. £2.10
 300V. D.C. £2.10
 500V. A.C. £2.10
 8 Meter 1mA £2.37
 VU Meter... £3.37
 50mA A.C.* £2.10
 100mA A.C.* £2.10
 200mA A.C.* £2.10
 500mA A.C.* £2.10
 1 amp. A.C.* £2.10
 5 amp. A.C.* £2.10
 10 amp. A.C.* £2.10
 20 amp. A.C.* £2.10
 30 amp. A.C.* £2.10

***MOVING IRON— ALL OTHERS MOVING COIL—**
 Please add postage

EDGWISE METERS
 Type PE.70. 3 17/32 in. x 1 15/32 in. x 2 1/2 in. deep.
 50μA £3.00
 50-0-50μA £2.87
 100μA £2.87
 100-0-100μA £2.75
 200μA £2.75
 500μA £2.60
 500-0-500μA £2.87
 1mA £2.87
 1-0-1mA ... £2.87
 5mA £2.87
 10mA £2.87
 50mA £2.87
 100mA £2.87
 500μA £2.60
 500-0-500μA £2.87
 1mA £2.87
 1-0-1mA ... £2.87
 5mA £2.87
 10mA £2.87
 50mA £2.87
 100mA £2.87
 500μA £2.60
 500-0-500μA £2.87
 1mA £2.87
 1-0-1mA ... £2.87
 5mA £2.87
 10mA £2.87
 50mA £2.87
 100mA £2.87

SEND FOR ILLUSTRATED BROCHURE ON SEW PANEL METERS—DISCOUNTS FOR QUANTITIES

POWER RHEOSTATS
 High quality ceramic construction. Windings embedded in vitreous enamel. Heavy duty brush wiper. Continuous rating. Wide range available ex-stock. Single hole fixing, 1/2 in. dia. shafts. Bulk quantities available.
 25 WATT. 10/25/50/100/250/500/1000/1500/2500 or 5000 ohms, 72ip. P. & P. 7ip.
 50 WATT. 10/25/50/100/250/500/1000/2500 or 5000 ohms, 21-05 P. & P. 7ip.
 100 WATT. 15/10/25/50/100/250/500/1000 or 2500 ohms, 21-37 P. & P. 7ip.

MARCONI TF142E DISTORTION FACTOR METERS. Excellent condition. Fully tested. £20. Carr. 75p.

TRANSISTORISED L.C.R. A.C. MEASURING BRIDGE
 A new portable bridge offering excellent range and accuracy at low cost. Ranges: R. 1Ω-11.1 meg Ω 6 Ranges ±1% L.1 μ H - 111 HENRYs 8 Ranges -2% C. 10pF ±1110mF. 6 Ranges ±2%. TURNS RATIO 1:1/1000-1:11100. 6 Ranges ±1%. Bridge voltage at 1,000 cps. Operated from 9 volts. 100μA. Meter indication. Attractive 2 tone metal case. Size 7 1/2 x 5 x 2 1/2 in. £20. P. & P. 25p

COSSOR 1049 DOUBLE BEAM OSCILLOSCOPES
 D.C. coupled. Band width 1Kc/s. Perfect order. £25. Carr. £1.50.

TE-20 RF SIGNAL GENERATOR
 Accurate wide range signal generator covering 120 kc/s-260 Mc/s on 6 bands. Directly calibrated variable R.F. attenuator. Operation 200/240V a.c. Brand new with instruction. £15. P. & P. 37 1/2p. S.A.E. for details.

LELAND MODEL 27 BEAT FREQUENCY OSCILLATORS
 Frequency 0-20 Kc/s. on 2 ranges. Output 500 Ω or 5k Ω. Operation 200/250V. A.C. Supplied in perfect order. £12.50. Carr. 50p.

MARCONI TF885 VIDEO OSCILLATORS
 0-5 mc/s Sine Square Wave £45. Carr. £1.

LAFAYETTE TE-46 RESISTANCE CAPACITY ANALYSER
 2 pF-2000 mFd 2 ohms 200 meg-ohms. Also checks impedance, turns ratio, insulation, 200/250V. A.C. Brand New £17.50. Carr. 37 1/2p.

ADVANCE TEST EQUIPMENT
 Brand new boxed in original sealed cartons VM78. UHF MILLIVOLT METER. 100 Kc/s to 1,000 Mc/s. A.C. 10mV to 3v. DC. 10 mV to 3v. Current 0.01 uA to 0.3 mA. Resistance 1 ohm to 10 megohm. £125.
 TR18. TRANSISTOR TESTER. Full range of facilities for testing PNP or NPN transistors in or out of circuit. £37.50. Carriage 50p per item.

MARCONI TF195M BEAT FREQUENCY OSCILLATORS
 0-40 kc/s. £20. Carr. £1.50

Latest Catalogue
 Our latest edition giving full details of a comprehensive range of HI-FI EQUIPMENT, COMPONENTS, TEST EQUIPMENT and COMMUNICATIONS EQUIPMENT. FREE DISCOUNT COUPONS VALUE 50p. (10/-) 248 pages, fully illustrated and detailing thousands of items at bargain prices.

SEND NOW!
 ONLY 37 1/2 p
 P & P 10p

G. W. SMITH & CO (RADIO) LTD.
 Also see next two pages



LIND-AIR AUDIO

C.1001 MULTI-TESTER



Overload protection. 20,000 opv. AC volts 10, 50, 250, 1,000v. DC volts 5-25, 125, 500, 2500v. D.C. Current 0-50 uA, 0-250 mA. Resistance 0-60K 0-6 Meg ohm. Decibels -20 to +22dB.

Size of meter 4 1/2 x 3 1/2 x 1in. Complete with case.

£4-25. P. & P. 17 1/2p

C.1050 MULTI-TESTER



10,000 opv. RANGES: DC Voltage: 0-3-15-150-600-1200 Volt (10,000 ohms per Volt). AC Voltage: 0-6-30-300-1200 Volt (5,000 ohms per Volt).

DC Current: 0-120 uA, 0-300 mA. Resistance: 0-50K, 0-5 Meg (R x 10) (R x 1K)

Decibels: -20 to +17dB.

£5-97 1/2. P. & P. 17 1/2p

C.1052 MULTI-TESTER



RANGES: AC Voltage: 6, 30, 120, 300, 1200 (15,000 ohm/V) DC Voltage: 0-6, 3, 15, 60, 300, 1200 (30,000 Ohm/V)

DC Current: 0, 0.03, 3, 30, 300 mA. Resistance: 0, 6k, 60k, 600k, 6 M ohms

Decibels: -20 to +63dB.

£7-35. P. & P. 17 1/2p

SM-370 MULTI-TESTER



20,000 opv. RANGES: DC Voltage: 0-5-25-100-500-1000V (20,000 ohms/V). AC Voltage: 0-5-25-100-500-1000V (20,000 ohms/V).

DC Current: 0-50 uA, 0-250 mA. Resistance: RX10, RX1K (300 ohms and 30K ohms at centre scale).

Decibels: -20dB to +16dB.

£3-55. P. & P. 17 1/2p

BATTERY ELIMINATOR



Enables transistor equipment to be operated from AC mains. 6/9/12v. output selector switch and

on/off switch. Case size 4 x 2 1/2 x 2in. complete with mains lead, connecting leads and instructions.

£2-97 1/2. P. & P. 17 1/2p

WELLER "EXPERT" SOLDERING GUN

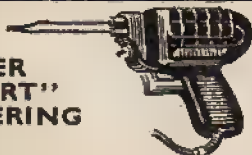

Comfortable and easy to use. 240v. AC. Instant dual heat 100/140 watt with two position trigger control.

£3-37 1/2. P. & P. 27 1/2p

SINCLAIR PROJECT 60



An attractive alternative for the enthusiast prepared to assemble these excellent modules to make a stereo assembly. Z.30 24 watt Power Amplifier £4-47 1/2. (2 required).

Stereo Sixty Control/Pre-amplifier £9-97 1/2.

PZ.5 Power Supply Unit £4-97 1/2.

SINCLAIR PROJECT 60 Package deal price £19-95. P. & P. 62 1/2p

Project 60 is supplied complete with instruction manual and templates for plinth mounting.

SINCLAIR IC-10 INTEGRATED CIRCUITS

10 watt Amplifier. Size only 1 x 0.4 x 0.2in. A true hi-fi amplifier complete with manual giving details of a wide range of applications and instructions. Guaranteed 5 years.

£2-97 1/2. P. & P. 7 1/2p

SPECIAL TRANSFORMER FOR OPERATING SINCLAIR IC-10 from A.C. mains 230/250v. Output 13v at 0.5 amp. 82 1/2p. P. & P. 12 1/2p

UNILEX AUDIO MODULES



Build a stereo amplifier for as little as

£16-75. Send 25p for Mullard "Do It Yourself Stereo" booklet. All items in stock

E.M.I. LOUSPEAKERS



MODEL 450 13 1/2" x 8" elliptical with twin tweeters, 8 ohm impedance. 10 watts. Brand New, guaranteed. Lind-Air Price

£3-97 1/2. P. & P. 22 1/2p

MODEL 150 13 1/2" x 8" elliptical, 3 and 15 ohm impedance. 10 watts. Lind-Air Price

£2-97 1/2. P. & P. 22 1/2p

CELESTION LOUSPEAKERS

7" x 4" elliptical. 8 ohms. New and guaranteed. £1-37 1/2.

P. & P. 22 1/2p

CABINETS FOR ABOVE

Teak finish with cloth fronts.

£2-47 1/2 each. P. & P. 22 1/2p

CARTRIDGE BARGAINS

A.D.C. 220X	£8.12
A.D.C. 220KE	£9.96
A.D.C. 660XE	£15.52
A.D.C. 990XE	£19.81
Audio Technica AT66-7D	£6.12
Audio Technica AT66-5D	£8.12
Audio Technica AT66	£6.12
Decca Deram Stereo	£5.12
Decca Deram Mono	£3.15
Goldring G800	£12.75
Goldring 800H	£10.50
Goldring G800 E	£18.50
Goldring G800 Super E	£26.00
Goldring G850	£6.50
Shure M3DM	£7.41
Shure M44 7	£10.15
Shure M31 E	£11.00
Shure M35 E	£12.50
Shure M75 E	£21.30
Shure V15 II	£40.75
Sonotone 9TAHCD	£1.75

Full range of diamond styli available for most current ceramic and crystal cartridges. All at £1.25 each. P. & P. 5p. Please state cartridge make and type number.

GARRARD HI-FI TURNTABLES



2025 T/C with stereo cartridge	£8.97
3000 with Sonotone	
9TAH CD stereo cartridge	£10.97
SP25 Mk III	£12.97
SL65 B	£15.97
Base and cover for above	£2.97
AP76	£19.50
SL72 B	£24.97
SL75 B	£28.35
SL95 B	£39.45
Base and cover for above	£3.97
401	£28.50

P. & P. Decks 62 1/2p. Base & Cover 50p. Deck/Base/Cover 87 1/2p.

THIS MONTH'S SPECIAL OFFERS!

SP25 Mk III with base £12.97. P. & P. 75p. SP25 Mk III with Sonotone 9TAHCD cartridge and base £15.72. P. & P. 75p.

SANSUI SPECIAL PURCHASE

SAVE OVER £14

FANTASTIC SANSUI 200 AM/FM MULTIPLEX STEREO TUNER AMPLIFIER



Solid state 17 watts music power. Fully tunable over Medium wave and VHF/FM Stereo. Inputs for gram and tape etc. Host of outstanding features—details on request. Rec. Retail Price £89.99.

LIND-AIR PRICE £75-60. P. & P. 57p

DE-LUXE STEREO HEADPHONES



With soft rubber earpieces. Impedance 8-16 ohms. Frequency response 23-13,000 cps. With lead and stereo plug.

£2-97 1/2. P. & P. 17 1/2p

STEREO HEADPHONE JUNCTION BOX

Enables Stereo headphones to be used with any amplifier.

£1-47 1/2. P. & P. 12 1/2p

HI-FI CATALOGUE



100 pages fully illustrated with 8 page P.A. section. All leading makes and accessories plus details of Budget Stereo systems.

25p P. & P. 5p

LA.20 STEREO SYSTEM

(SAVE £12)



Only takes a few minutes to set up the Lind-Air LA 20 Stereo Amplifier with the Garrard 2025 T/C Record Changer fitted stereo cartridge and a pair of Lind-Air General Purpose speakers and you have a superb stereo system at a money saving price. Total Rec. Price £53.47.

Price £41-47 1/2. C. & Ins. £1-75

S-DeC BREADBOARD

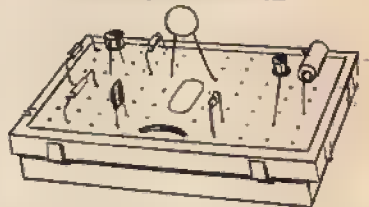

Solderless breadboard panels, for fast reliable component connections. Single DeCs. One S-DeC with Control Panel, Jig and Accessories for solderless connections to controls, etc., with booklet "Projects on S-DeC" giving construction details for a variety of circuits.

£1-00. P. & P. 17 1/2p

4-DeC KIT. Four S-DeCs with two Control Panels, Jigs and Accessories and the booklet "Projects on S-DeC" all contained in a strong attractive plastic case. Ideal for the professional user.

£3-95. P. & P. 22 1/2p

T-DeC KIT £2-50. P. & P. 17 1/2p

S-DeC STOR £2-50. P. & P. 22 1/2p

18/19, 25 & 53 TOTTENHAM COURT ROAD, LONDON W.1
Tel: 01-580 2225/7679
Open 9-6 Mon-Sat (Thurs until 7)

All Mail Orders and enquiries to Dept. PW4, Kirkham House, 54a Tottenham Court Road, London, W.1. Tel. 01-637 1601.

94-96, UPPER PARLIAMENT STREET, NOTTINGHAM
Tel: Nottingham 40403 (STD 0602)
Open 9-6 Mon-Sat (Weds until 7.30)

PRACTICAL WIRELESS

VOL 46 NO 12

Issue 770

APRIL 1971

TOPIC OF THE MONTH

Servicemen all

THIS MONTH readers might feel that the issue is heavily weighted in favour of test instruments, for not only do we have a special 8-page supplement on the subject but two major supporting articles describe the construction of test instruments. Our excuse is that apart from readers who enjoy trying their luck at repairing the family radio set, many others get bitten harder by the servicing bug and relish the challenge of tracing faults and the satisfaction of a successful repair. No doubt about it, the acquisition of the ability to probe around inside a piece of equipment and come up with the right answers, works wonders for self esteem!

The idea behind the supplement this month is to provide a broad survey of the test instrument scene, examining the features of the various items of equipment and outlining their applications. This will be followed in the May issue by the first of a brand new series of articles on radio and audio servicing conducted by those two old PW favourites Gordon J. King and H. W. Hellyer, voted for previous efforts in this field as top of the work bench pops.

But servicing is really only one side of the coin, because everyone—from the absolute novice upwards—needs some test equipment, even if this consists solely of a cheap test meter, or a battery and bulb to make continuity checks! It is fairly safe to say, therefore, that constructors alike from novice to expert, experimenters as well as dabblers and professionals in servicing should have some knowledge of fault finding techniques. But in order to carry out logical fault finding it is necessary to have a reasonable theoretical grounding—somewhat of a vicious circle. The new series starting next month will, we hope, be helpful in providing a foothold for readers wanting to take a more active part in servicing activities.

W. N. STEVENS—*Editor*

P.W. COVER PRICE

Owing to the rising costs of production, it has been necessary to increase the cover price of *Practical Wireless* to 20p (4s. 0d) with effect from the next, May, issue. Much as we regret this increase, it has been made inevitable by the hard economic facts of publishing in these days of spiraling prices.

Existing subscriptions will, of course, continue to run out to their normal expiry date. The new subscription rate will be £2.65 per annum.

NEWS AND COMMENT

Leader	1005
News . . . News . . . News . . .	1006
Electronotes by <i>S. Ginsberg</i>	1022
On the Short Waves by <i>Malcolm Connah and David Gibson, G3JDG</i>	1025
Practically Wireless by <i>Henry</i>	1050
MW Column by <i>Charles Molloy</i>	1058

CONSTRUCTIONAL

P.W. Workshop Oscilloscope, Part 1 by <i>A. Lester-Rands</i>	1008
"Rate your Reflexes" by <i>Halvor Moorshead</i>	1012
Hi-Z Voltmeter by <i>C. R. Bradley</i>	1016
Take 20, Rain Alarm by <i>Julian Anderson</i>	1029
Sound Effects Synthesiser, Part 2 by <i>F. C. Judd</i>	1044
I.C. of the Month (Digital Counting and Display Devices) by <i>L. A. J. Ireland</i>	1051
"Trojan" Top Band Transceiver, Part 2 by <i>Eric Dowdeswell, G4AR</i>	1053
A Small-C Checker by <i>Arthur Dow</i>	1061
Plug-in Tuner by <i>Richard Collins</i>	1065

OTHER FEATURES

The Committee Super-FET	1030
Going Back by <i>Colin Riches and Arthur Dow</i>	1069

SPECIAL FEATURE

Guide to Test Instruments by <i>Gordon J. King</i>	1033
---	------

MAY ISSUE WILL BE PUBLISHED
ON APRIL 8th

©IPC Magazines Limited 1971. Copyright in all drawings, photographs and articles published in "Practical Wireless" is fully protected, and reproduction or imitations in whole or in part are expressly forbidden. All reasonable precautions are taken by "Practical Wireless" to ensure that the advice and data given to readers are reliable. We cannot, however, guarantee it, and we cannot accept legal responsibility for it. Prices are those current as we go to press. All correspondence intended for the Editor should be addressed to Fleetway House, Farringdon Street, London, EC4A 4AD. Address correspondence regarding advertisements to Advertisement Manager, Fleetway House, Farringdon Street, London, EC4A 4AD. Copies of some back numbers are available and orders should be addressed to IPC Magazines Ltd., Back Numbers Department, Carlton House, Gt. Queen Street, London WC2B 5DD.

NEWS...

NEWS...

NEWS...

1971 R.S.G.B. President



At a reception held at the Bonnington Hotel, London, on 15th January, F. C. Ward G2CVV, Secretary of Derby and District Amateur Radio Society, was installed as president of the Radio Society of Great Britain. Over 150 guests attended the function, including J. Swinnerton G2YS, J. Graham G3TR, V. Desmond G5VM, W. A. Scarr G2WS, A. O. Milne G2MI, P. Hawker G3VA, W. Corsham G2UV, A. Forsyth G6FO, T. Hughes G3GVV, and L. Newnham G6NZ. Also present were representatives of the Ministry of Posts and Telecommunications, and 20 visitors from Derby including Mr. A. G. G. Melville, president of Derby and District Amateur Radio Society, and his wife.

The Mayor of Derby, Alderman Miss M. E. Grimwood-Taylor (whose father was a founder member of the Derby society) sent Mr. Ward her congratulations and best wishes.

Mr. Ward is employed by the Post Office Engineering Department, and at present is in the Radio Investigation Service. He is keenly interested in the history of amateur radio, and mainly through his efforts, Derby and District Amateur Radio Society (the oldest such society in the country) has a comprehensive collection of documents and equipment from the early days of amateur radio.

In his speech at the reception, the new president expressed the hope that all members of the R.S.G.B. would endeavour to enrol at least one new member, the aim being to double the existing membership by the end of his year of office.

Mr. Ward's call-sign G2CVV was issued to him in 1937. He is active on all bands from 160m down to 2m, and, he says, would be interested in the higher frequencies if there were more hours in the day!

Rank and Dolby

Rank Wharfedale have released a small Hi-Fi cassette tape recorder. Based on the Dolby system, this recorder, the DC9, is a four-track stereo/mono machine with piano key controls. Price is £115.

It is felt by Wharfedale that the Dolby system together with other improvements have enabled the company to design a player with a performance as good or better than that of big and expensive machines.

North Devon A.R.C.

The above Club has recently been formed. Meetings are held the second and fourth Wednesday in every month at: Crinnis, High Wall, Sticklepath, Barnstable, North Devon. Meetings start at 7.30 but members wishing to study for the RAE should be there at 6.30. Further details may be obtained from H. Hughes, G4LG, at the above address.

Contestitus

Those with "contestitus" will be pleased to note the following events for the mad month of March. March 6-7, ARRL DX contest (phone), 13-14 BERU contest, 20-21 ARRL contest (c.w.), 27-28 WPX s.s.b. contest. Don't forget to listen on April 4 in the low power 80 metre contest. It should bring out some transistor rigs who would appreciate a report.

Accessory guide

The British Radio Corporation has published a leaflet illustrating details of the wide range of accessories designed for use with BRC audio equipment.

There are nearly 30 different accessories in the range, including synchro-amps, pre-amps, slide synchronisers, mains adaptors for portable cassettes and radios, stethosets, footswitches, microphones, carrying cases and various connecting leads.

Each type of accessory is illustrated and a short description gives its applications. The picture shows a few of the accessories included.

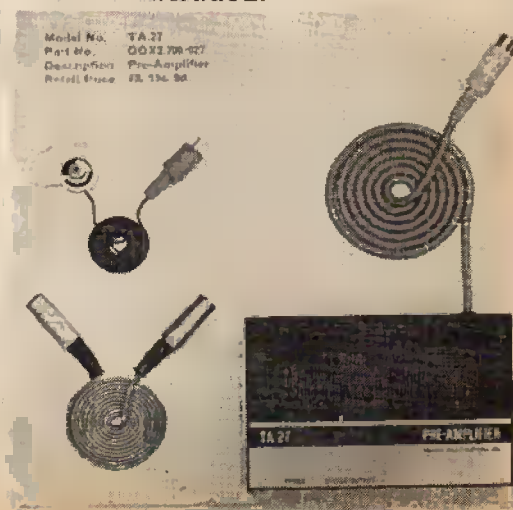

NEWS... NEWS... NEWS...

Price Drop

It certainly makes a change these days to hear of a reduction in prices, but this is exactly what Light Soldering Developments have done! Having recently relocated the production of their Litestat temperature-controlled soldering instruments in a new factory, they are now in a position to expand production and reduce costs.

They are therefore making reductions of 20% in the list price of both the Litestat 50 and Litestat 70 and spares including copper bits.

The Company are also introducing their new catalogue. In preparing this, they have taken the opportunity to incorporate details of all their products in one booklet using the A4 format (for our technical printing-type readers). Prices are shown in £sd and the new-fangled decimalised system and metric equivalents of all dimensions are given. Further gen from: *Light Soldering Developments Limited, 28 Sydenham Road, Croydon, CR9 2LL.*

Distribution Panel

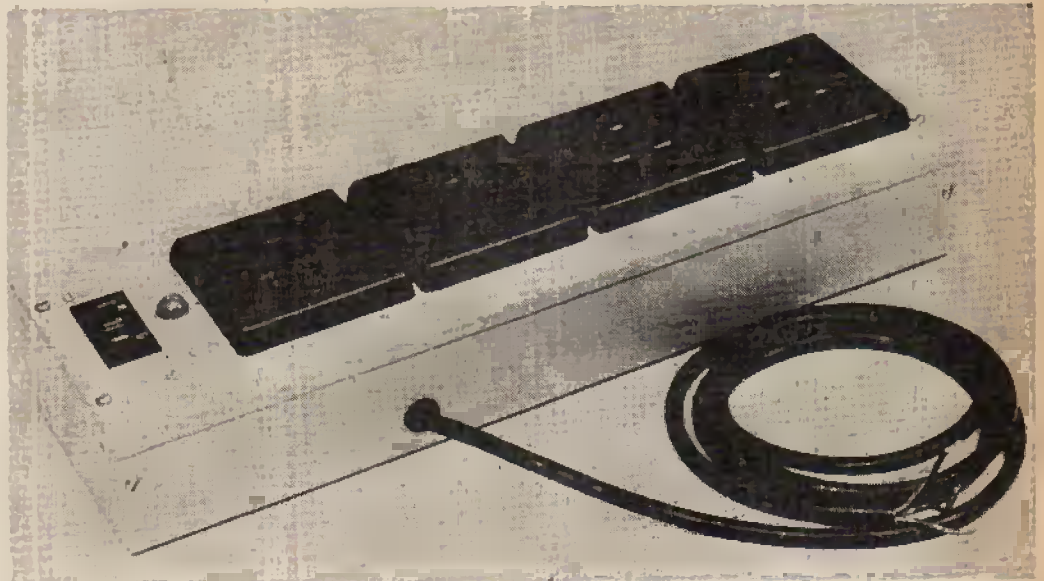

A new, multi-socket mains distribution panel is now included in the Lektrokit range.

Designated the LKU-413, it consists of four, 3-pin, 13A shuttered outlet sockets, mounted side-by-side on the top of the unit, a combined on/off switch and magnetic circuit breaker, a red neon indicator and 6ft. of extension cable as standard.

Available direct from the manufacturers, the new unit is priced at £6.30 including purchase tax. If required, the panel can be supplied with 30ft. of cable (LKU-413L) at an inclusive price of £6.97½. A.P.T. *Electronic Industries Ltd., Chertsey Road, Byfleet, Surrey.*

Sony mini-colour TV.

The Sony Corporation of Japan are introducing a transportable colour TV set (Model KV-132OUB) using their Trinitron colour c.r.t. Price is £199.75 and screen size is 13in. The Trinitron tube has only one electron gun against three of a conventional Shadowmask tube. This gun emits three simultaneous

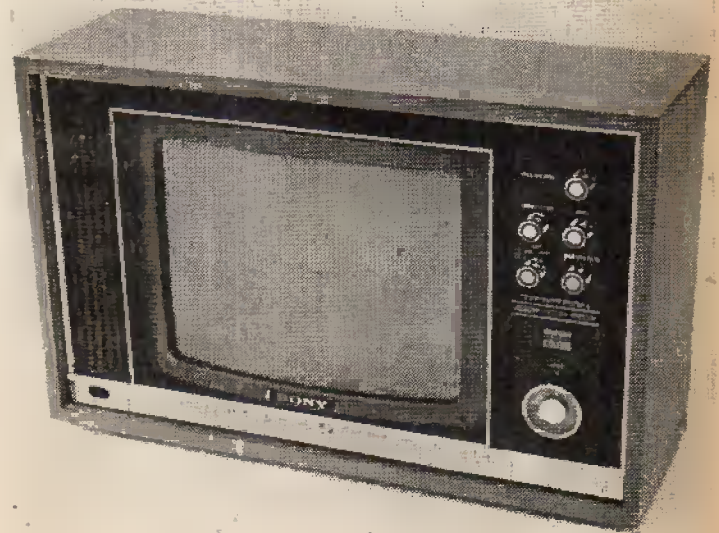

Sony KV-132OUB Trinitron colour TV.

in-line beams which are converged and focused through the Trinitron electro-optical system consisting of two large diameter lenses and a pair of electron prisms. An aperture-grill is mounted behind the screen and takes the place of the Shadowmask used in conventional tubes.

A description of the Trinitron tube appeared in the September 1970 issue of our sister magazine *Television.*

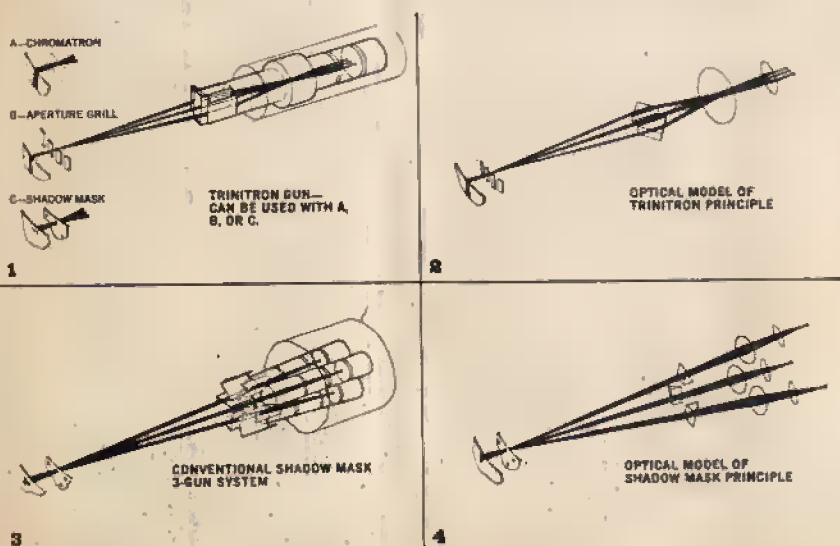

Diagrammatic representation of the Trinitron principle compared with that of the Shadowmask system.

A. LESTER-RANDS

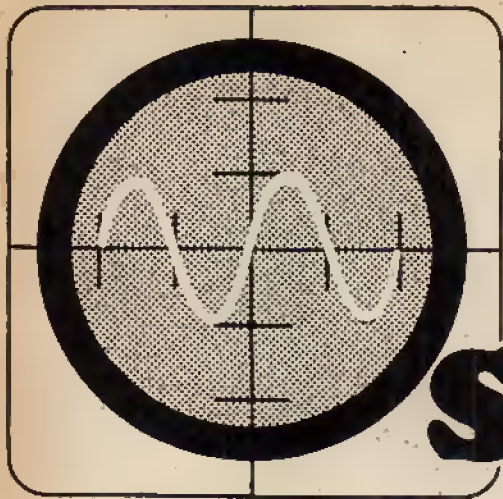

PW WORKSHOP scilloscope

PART 1

ON examining the circuit for the workshop oscilloscope, readers may wonder why valves have been used for the P.W. Workshop Oscilloscope. First of all, a cathode ray tube requires a heater voltage and high h.t. potentials for which a suitable mains transformer is necessary. It was found that as the requirements for the specified c.r.t. could be met with a fairly inexpensive standard 350-0-350v (plus heater windings) mains transformer, which would also provide potentials and heater supplies for a valve timebase and Y amplifier, there was little point in using transistors for a job which valves would do just as well and at no extra cost.

Most low cost general purpose oscilloscopes presently available use valves and as far as cost is concerned, the P.W. Workshop Oscilloscope can be built for much less than a commercially made equivalent.

CIRCUIT FUNCTION AND FACILITIES

The P.W. Oscilloscope is intended for general workshop use and is suitable for all audio work and many r.f. applications up to frequencies of at least 2MHz at which the main Y amplifier response is -3dB but extends up to nearly 5MHz. The fastest timebase speed allows the resolution and display of several complete cycles at frequencies around 1MHz and the slowest speed will allow the display of several complete cycles at frequencies as low as 10Hz.

The main Y amplifier has an input sensitivity of 250mV r.m.s. for a display of 4cm peak-to-peak (sine wave) and a nominal frequency response of 10Hz to 2MHz. The Y preamplifier has an input sensitivity of 10mV for a display of 4cm peak-to-peak (sine-wave) and a frequency response of 10Hz to 50kHz \pm 1dB. This additional stage to the Y amplifier chain is to provide adequate signal display from low level signal sources. The gain of the Y amplifier is continuously variable, regardless of which input is used, and each of the inputs have relatively large overload margins. The gain of the Y amplifier has been adjusted, in the relationship to the c.r.t. sensitivity, so that the final amplifier stage reaches clipping point after full Y plate deflection.

The timebase is a Miller-transitron circuit with its own sync amplifier that can be switched for internal or external signals. Each timebase range is continuously variable and each overlaps. The timebase can be switched off and the sync selector switch used to provide a small 50Hz sweep (internal signal source) or select a separate X plate amplifier with its own

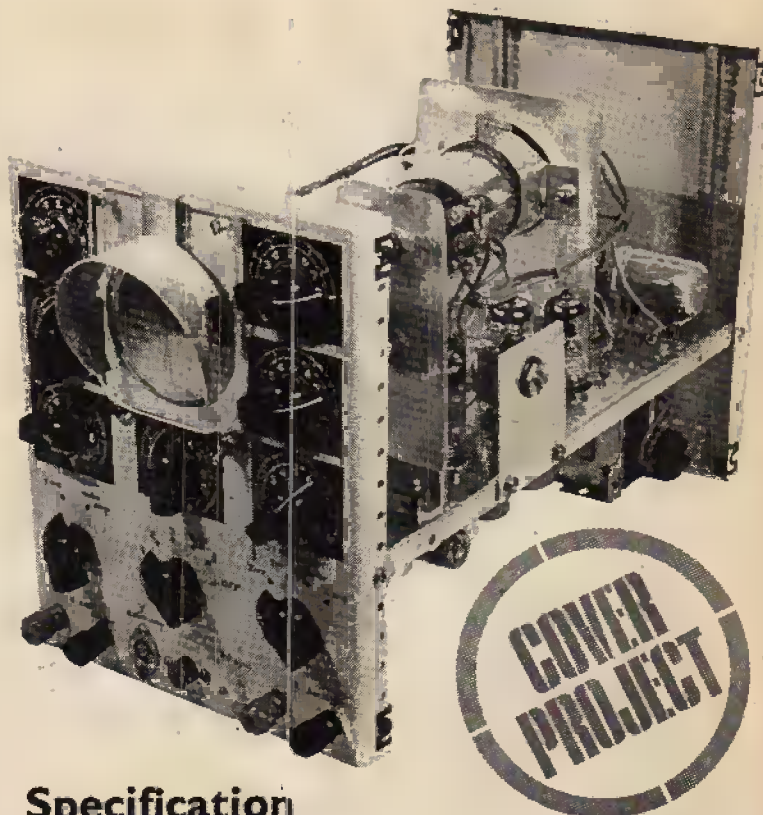

Specification

Frequency Responses

Y amplifier	10Hz to 2MHz
Y preamplifier	10Hz to 50kHz
X amplifier	10Hz to 50kHz
Timebase frequency	10Hz to 24kHz

Input Sensitivities

Y amplifier	4cm deflection for 250mV
Y preamplifier	4cm deflection for 10mV
X amplifier	4cm deflection for 1.5V

(Deflection peak-to-peak, volts in r.m.s.)

Controls

1. Y amp. gain	6. Timebase amplitude
2. Timebase Function	7. Brilliance
3. Y preamp. in/out	8. Focus
4. Timebase sweep	9. Y shift
5. Timebase fine sweep	10. X shift

Timebase Ranges

1. 10-50Hz	4. 500-4,500Hz
2. 30-270Hz	5. 2,700-24,000Hz
3. 90-800Hz	6. Off.

Valve Lineup

C.R.T. CV1526 (3EG1), 3-off EF80's, ECC81, ECC83, ECF80.

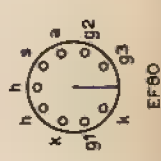
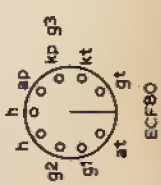
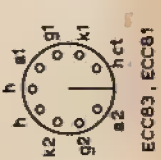
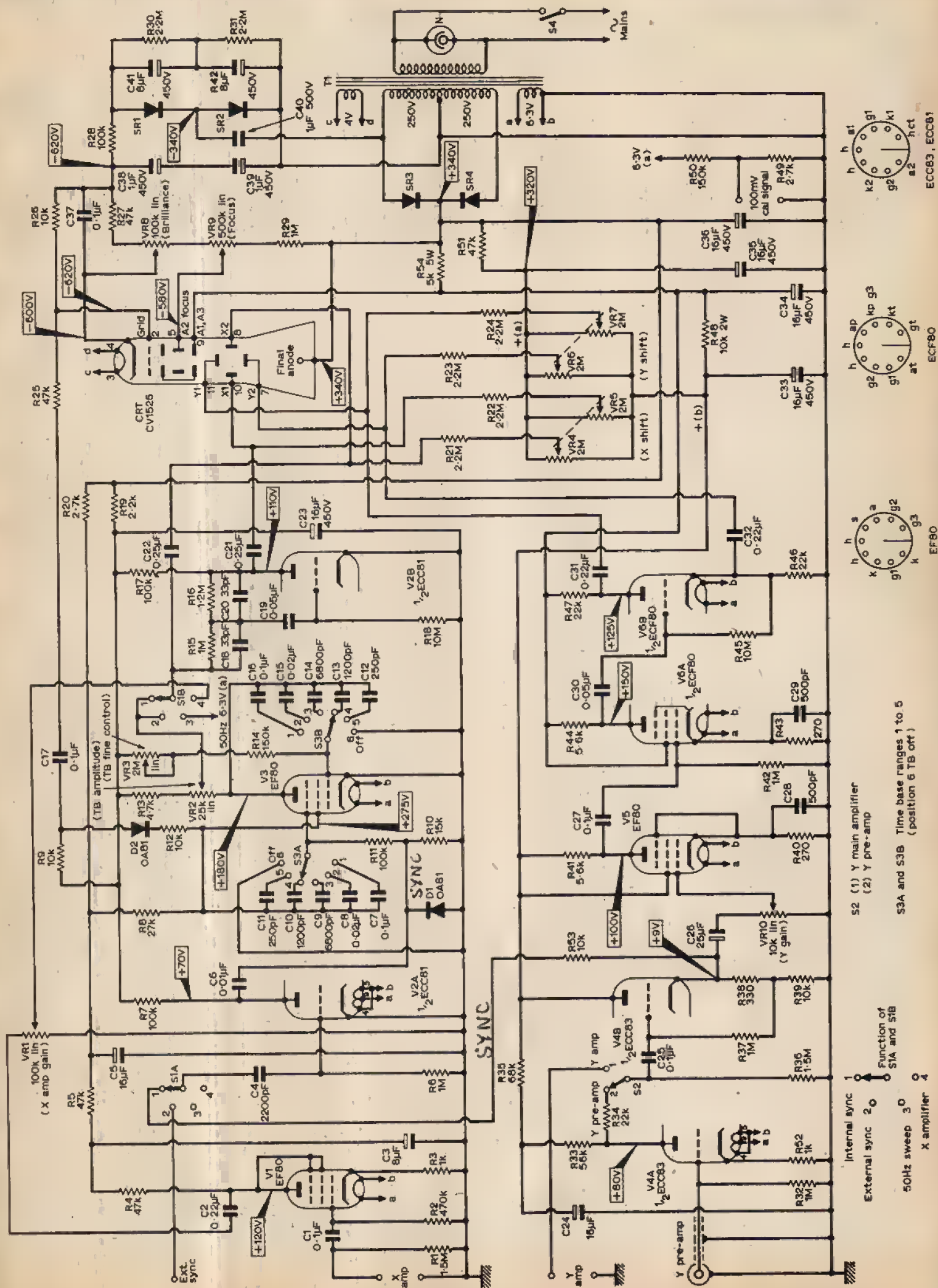

S2 (1) Y main amplifier
 (2) Y pre-amp

S3A and S3B Time base ranges 1 to 5
 (position 6 TB off)

Internal sync 1
 External sync 2

Function of S1A and S1B
 50Hz sweep 3
 X amplifier 4

Fig. 1: The complete circuit of the P.W. Workshop Oscilloscope.

★ components list

Case as used for prototype

Contil type Q 13 x 9 x 7in. West Hyde Developments Limited

Cathode Ray Tube

Type CV1526 (3EG1) Henry's Radio or
2½in. screen. Green trace RST Valve Company
12-pin B12B Base P.C. Radio Limited
(Price should be around £3.25)

CRT Base

12-pin B12B (suppliers as above)

Mains Transformer T1

230V pri-Sec. 350-0-350V 80mA
Heaters 6.3V and 4V Type MT2 Home Radio
(Catalogue No. TM2)

Rectifiers (SR1, 2, 3 and 4)

SR1, 2, 3 and 4 Type 1N2374 Silicon Henry's Radio Limited

Valveholders

B9A 9-pin (6 off)

Valves

V1, V3, V5	EF80	Mullard
V2A-B	ECC81	Mullard
V4A-B	ECC83	Mullard
V6A-B	ECF80	Mullard

Diodes

D1, D2 OA81 Mullard

Switches

S1A-B	2-pole 4-way
S2	Single pole 2-way
S3A-B	2-pole 6-way
S4	Mains on/off toggle type

Potentiometers

VR1	100kΩ lin.	VR8	100kΩ lin.
VR2	25kΩ lin.	VR9	500kΩ lin.
VR3	2MΩ lin.	VR10	10kΩ lin.
VR4/5	} 2MΩ (Dual Potentiometers) Home Radio		
VR6/VR7		(Catalogue No. VR78/2M)	

Resistors ½W 10%

R1 1.5MΩ	R14 150kΩ	R27 47kΩ	R40 270Ω
R2 470kΩ	R15 1MΩ	R28 100kΩ	R41 5.6kΩ
R3 1kΩ	R16 1.2MΩ	R29 1MΩ	R42 1MΩ
R4 47kΩ	R17 100kΩ	R30 2.2MΩ	R43 270Ω
R5 47kΩ	R18 10MΩ	R31 2.2MΩ	R44 5.6kΩ
R6 1MΩ	R19 2.2kΩ	R32 1MΩ	R45 10MΩ
R7 100kΩ	R20 2.7kΩ	R33 56kΩ	R46 22kΩ
R8 27kΩ	R21 2.2MΩ	R34 22kΩ	R47 22kΩ
R9 10kΩ	R22 2.2MΩ	R35 68kΩ	R49 2.7kΩ
R10 15kΩ	R23 2.2MΩ	R36 1.5MΩ	R50 150kΩ
R11 100kΩ	R24 2.2MΩ	R37 1MΩ	R51 47kΩ
R12 10kΩ	R25 47kΩ	R38 330Ω	R52 1kΩ
R13 4.7kΩ	R26 10kΩ	R39 10kΩ	R53 10kΩ

All resistors 10% ½Watt

Resistors (Special)

R54 5kΩ 5watt
R48 10kΩ 2watt

Capacitors (special)

C40 1μF paper type—500/600V working Home Radio

Capacitors

C1 0.1μF	C15 0.02μF	C29 500pF S.M.
C2 0.22μF	C16 0.1μF	C30 0.05μF
C3 8μF 350V	C17 0.1μF	C31 0.22μF
C4 2200pF	C18 33pF S.M.	C32 0.22μF
C5 16μF 350V	C19 0.05μF	C33 16μF 450V
C6 0.01μF	C20 33pF S.M.	C34 16μF 450V
C7 0.1μF	C21 0.25μF	C35 16μF 450V
C8 0.02μF	C22 0.25μF	C36 16μF 450V
C9 6800pF	C23 16μF 450V	C37 0.1μF
C10 1200pF S.M.	C24 16μF 350V	C38 1μF 450V
C11 250pF	C25 0.1μF	C39 1μF 450V
C12 250pF S.M.	C26 25μF 50V	C41 8μF 450V
C13 1200pF	C27 0.1μF	C42 8μF 450V
C14 6800pF	C28 500pF S.M.	

Note: C33/C34—may be dual type capacitors

C35/C36—may be dual type capacitors

All other electrolytics must be singles and all capacitors 350V working min.

S.M.—Silvered Mica

Miscellaneous items

Terminals 2 red, 2 black (X and Y inputs) insulated type
Sockets (Insulated) 2 for sync and cal. voltage
Socket Recessed co-axial type
Pointer knobs 10 off
Mains panel neon indicator 230V
Insulated spindle couplers (focus and brilliance controls) 2 off
2-18 way and 4-10 way miniature tagboards 1½in. wide
Aluminium 18 swg for screen etc.
Aluminium angle ⅜ x ⅜in.
Paxolin or perspex ⅛in. thick for brilliance and focus controls
Sundry capacitor clips and chassis tag strips
1 6-way standard tagboard 2in. wide

(pre-set) gain control. This latter facility is extremely useful for Lissajous pattern work over a wide frequency range and with low signal levels. The X amplifier sensitivity is 1.5V rms for a 4cm peak-to-peak (sine-wave) display and the frequency response is 10Hz to 50kHz ±1dB.

CONTROLS

The timebase controls include a selector for the five timebase ranges plus a timebase 'off' position, a timebase fine frequency control and a timebase amplitude control. The 'sync' switch selects either internal or external synchronizing signals, a 50Hz X sweep of about 1.5cm, or the X plate amplifier. Brilliance and focus controls are provided, of course,

and there are controls for X and Y shift with sufficient shift potential to move the trace vertically or horizontally to beyond the edge of the c.r.t. screen. The Y amplifier gain control is common to both Y inputs and is a front panel control but the X amplifier gain control is a pre-set mounted at the side. It can be easily adjusted with a screwdriver.

THE CATHODE RAY TUBE

Cathode ray tubes of currently available manufacture and type are quite expensive and are also difficult to buy because the demand is so low that few component dealers will keep them in stock. The tube chosen for the workshop oscilloscope is a type CV1526 (3EG1) which is readily available at low cost (see components list) and has a 2½in. diameter screen.

It operates with a final anode potential of approximately 1,000V and displays a green trace. *It should be emphasised that the workshop oscilloscope has been virtually designed around this c.r.t. and that the use of any other type is not recommended.*

THE CIRCUIT

The full circuit for the oscilloscope is shown in Fig. 1. E.H.T. for the tube final anode is derived from a voltage doubler arrangement (SR1-SR2) operated from one half of the secondary of T1, the 600V or so d.c. obtained from this being connected in series with the nominal 350V supply (SR3-SR4) to obtain the required total 1,000V or so. The 350V supply from SR3-SR4 provides the working potentials for the timebase, the X and Y amplifiers and the shift controls. The timebase generator, V3, is a conventional Miller-transitron arrangement and is followed by a paraphase amplifier, V2B, to provide balanced sweep voltages for the X plates. The timebase frequency ranges, each of which overlaps the other, are selected by S3A and B and the total frequency range is approximately 10 to 24,000Hz. Fine timebase frequency control is obtained by VR3 and amplitude by VR2. Synchronizing signals for the timebase can be supplied from either the Y amplifier at the cathode of V4B, or from an external source via the 'sync' switch S1A and B. This also selects the internal 50Hz X sweep voltage from the 6.3V heater supply or switches in the X plate amplifier V1.

The main Y amplifier is preceded by a cathode follower (V4B) which provides a high impedance input and low impedance output via the gain control VR10. The Y amplifier itself consists of V5 and V6A, the output of which is terminated by the phase splitter V6B. This delivers symmetrical paraphased signals to the Y plates via the isolating capacitors C31 and C32. For low level signals the additional Y amplifier stage (V4A) is provided and this has an input sensitivity of 10mV for 4cm peak-to-peak deflection.

The c.r.t. operates at a potential of approximately 1,000V between cathode and the final anode. The potential dividing chain R27, VR8, VR9 and R29 provides the brilliance and focus control voltages. The grid of the c.r.t. is returned to the cathode via R26 but is also connected via C17 to obtain a negative going pulse for trace flyback suppression.

The X and Y plates are both connected to the shift potential networks VR4, VR5, VR6 and VR7, etc. via high value series resistors (R21, R22, R23, R24) so that no loading is imposed on either the X or Y plates or their respective amplifier outputs. The shift potential developed across VR4, VR5, VR6 and VR7 at the points marked +a and +b is approximately 200V and is sufficient to move the trace vertically or horizontally completely off the tube screen. A 100mV 50Hz calibration signal is derived from the 6.3V heater supply via the potential divider R49/R50.

PERFORMANCE

The workshop oscilloscope will cater for all normal audio tests including square-wave testing, frequency measurement by the Lissajous pattern method over a wide range of frequencies and signal levels and has many general "electronics" radio and video frequency applications. The Table gives details of the performance obtained with the prototype and which should be easily obtainable from the circuit shown in Fig. 1, providing the specified c.r.t. and other components are used.

X SWEEP

With the tube E.H.T. at 1,000V the brilliance is sufficient for photography and the trace focus is sharp. It is worth noting that no spurious spot deflection due to mains transformer field was discernible and providing the transformer specified is used and positioned below and to the rear of the c.r.t. as will be shown later, it should be quite unnecessary to provide mumetal shielding. With the timebase range control switched to 'off' and with the Y amplifier gain control at zero, the spot should appear completely round and sharp and not more than 1mm in diameter at normal brilliance. Note also that with the X and Y shift controls at exactly half way travel the spot should be at the centre of the screen.

CONSTRUCTION

The prototype was constructed exactly in accordance with the circuit given in Fig. 1 and as shown in the photographs, in a Contil case type Q (see components list). This has overall dimension of 13x

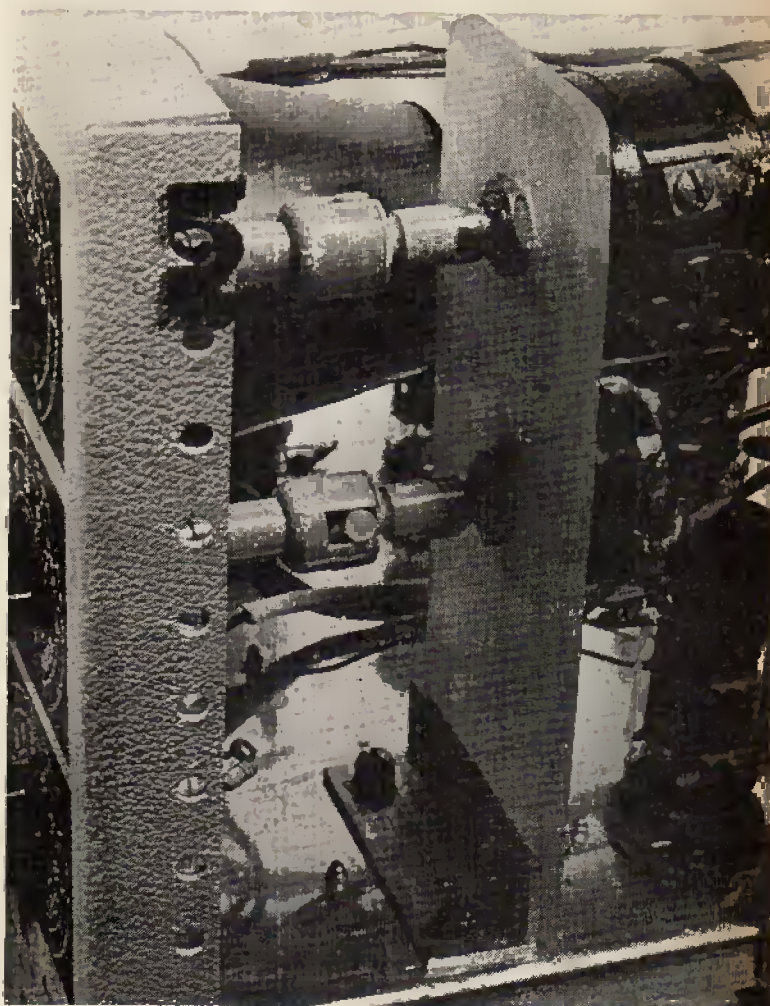

The insulated supporting bracket and insulated spindles for the focus and brilliance controls.

9x7in and is supplied with an internal chassis on which the c.r.t., the power supply and amplifier components and valves are mounted. A home constructed case of similar dimensions could of course be used. Construction also calls for an internal screen which supports the tagboards for the amplifier and timebase components, supporting brackets for the c.r.t. and the X amplifier gain control and a bracket of insulating material (paxolin or perspex) for mounting the brilliance and focus controls. Full details for construction and layout will be given in Part 2.

TO BE CONTINUED

RATE YOUR



REFLEXES

THE project described here has several uses. It will do as the title says: "Rate Your Reflexes"—but it also enables you to test your reactions against those of other people. It can incorporate other tests including manual dexterity and it is a very effective "Drunkometer" which will prove to yourself—or to other people—just how much alcohol affects your reactions. There aren't many ways of arguing with the man who says "I'm perfectly safe on the road after eight pints, etc." but this device will show him just how much slower his reactions are *even after only a couple of pints*. The results will be there for him to see for himself.

It is often true that the simplest games and tests are the most fun and that certainly applies to the reaction tester described here. At parties it has proved a real winner. Rather like the fortune teller who is never short of customers because people always want to know something about themselves that only someone else can tell them, the reaction tester will tell people how their reactions or reflexes compare to the average. Unlike the fortune teller, however, this device is scientifically accurate to quite a high degree—you *yourself* determine the readings and they cannot be disputed. Once people have got the hang of it the reaction tester fascinates them.

The reaction tester has proved so popular that those who have tried it have devised all sorts of games and tests. Some of these are mentioned at the end of the article but no doubt many will occur to you.

Operation

There are two distinct ways of using the circuit. Firstly there is the competitive side—at a signal

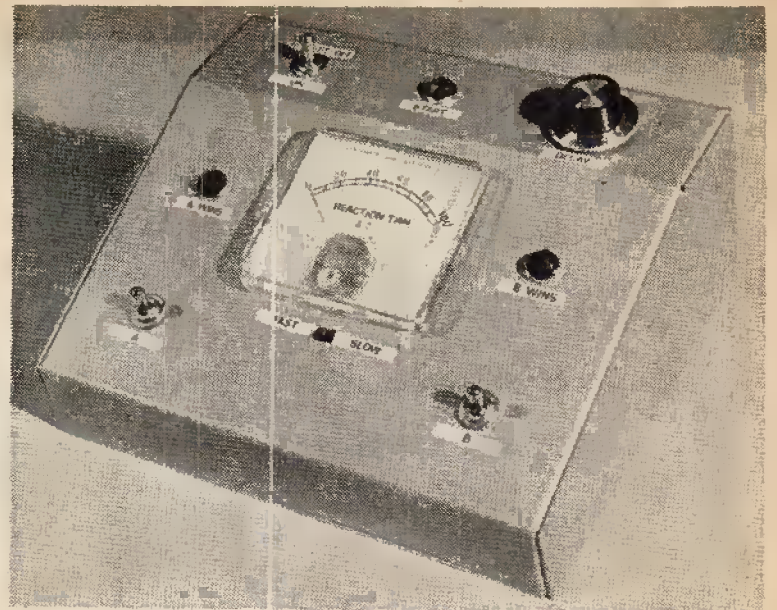

HALVOR MOORSHEAD

two "players" try to throw a switch as fast as possible, the one who is fastest is shown to be the winner by a second bulb lighting up above his switch. Even though the loser is a thousandth of a second behind the winner his bulb will fail to light and will not do so until the winner's switch is reset.

The competitive side can be built separately and will provide plenty of fun for very much less cost, but it does have limitations—it will only tell you who is the fastest of two players but no indication of the differences in their speeds and you cannot use it without another player.

The timer part of the circuit is additional and works as follows. As soon as the start signal bulb lights up, the needle of a meter starts to rise—and rise quickly—taking about a second to traverse the scale. As soon as the switches are thrown the needle stops and stays in the same position so that a reading can be taken of the time lapse between the "start signal" and the winner throwing the switch. It will of course only give the reading for the winner.

A considerable amount of thought was given to including a "cheat" device, that is one which would light up a bulb or sound a hooter if either switch was thrown prematurely but so much trouble was experienced with this that it was decided to leave it to the end. To the author's delight it was discovered that a "cheat" circuit is actually built into the existing circuitry and this will be explained later.

Although it may be rather pretentious, you could call the finished project a simple computer for it includes computer type circuits and this claim, made to non-electronic friends, should impress them!

The Circuit

There are three distinct sections to the circuit and these will be explained separately. They are the "start signal", the "winner" circuit and the "time indicator."

The "start" signal circuit should ideally be operated independently of either competitor and also ideally one would use some form of random circuit. However random circuits are very complex and it would be impractical to use one here.

The next best thing—and perfectly satisfactory in

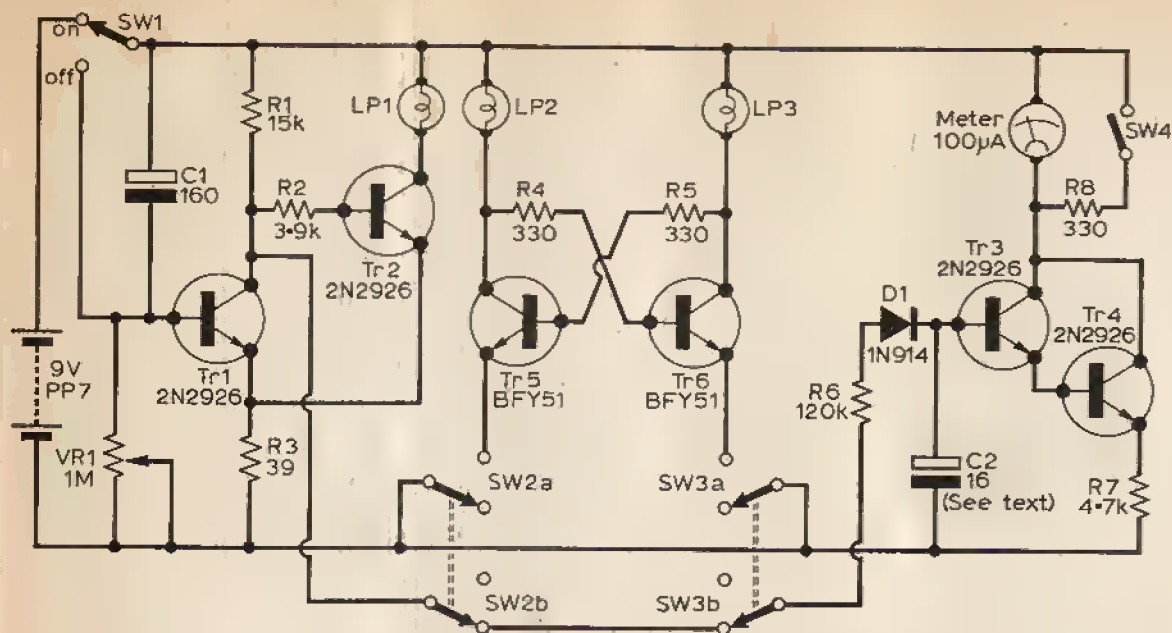

Fig. 1: The complete circuit of the Reaction Tester. Tr 1 and Tr 2 form the delay circuit which relies upon the charging of C1. Tr3 and Tr4 are coupled as a Darlington pair to form the high input impedance timing circuit while Tr5 and Tr6 are part of the "winner" indicator circuit.

use—is to use a time delay circuit in which the delay is of sufficient length so that it is impossible to remember or estimate exactly when the "start" signal will trigger.

Tr1 and Tr2, together with the associated components, act as a time delay circuit, the delay varying between instant and about 12 seconds. A longer delay was originally included but it was found that delays of much more than about ten seconds served no real purpose and tests became boring. A period of 12 seconds when you are waiting for something to happen is a very long time indeed.

The "start" signal circuit makes use of a Schmitt Trigger—that is a circuit which can only be in two states, on or off, and the switching action is very fast indeed.

Referring to Fig. 1, when SW1 is thrown to "on", C1 begins to charge through VR1. To begin with the potential across it is small—as it is charging—and therefore the base of Tr1, which is coupled to the junction of C1 and VR1, is at nearly supply potential and is switched fully on. This means that it is passing considerable current and the potential between the collector and emitter is very small. The base of Tr2 is coupled to the collector of Tr1 via a resistor R2 and the emitter joins directly to the emitter of Tr1.

When Tr1 is "on" the potential across it is so small that Tr2 will not have nearly enough potential between the base and emitter to be in a conducting state and will be completely "off" and the bulb LP1 will be off.

However, as C1 charges the potential across it increases and the base of Tr1 is moved slowly towards chassis potential until a point is reached when Tr1 approaches cut-off; this means that the potential across it rises and this in turn means that Tr2 starts to turn on. There is a regenerative action because of R3 and the switching action, once it starts, is very rapid. When Tr2 is on, current is allowed to flow through it and the bulb LP1 lights up.

The time delay will depend on the setting of VR1 and as mentioned this can be adjusted for any setting up to 12 seconds.

The values of R1, R2 and R3 are not over-critical for the operation of the bulb but their choice does affect the operation of the timer circuit which comprises Tr3 and Tr4 with their associated components.

When the "start" circuit is triggered the potential

★ components list

Resistors

R1 15kΩ	R5 330Ω
R2 3.9kΩ	R6 120kΩ
R3 39Ω	R7 4.7kΩ
R4 330Ω	R8 330Ω

All resistors ¼W, 10%
VR1 1MΩ linear track potentiometer.

Capacitors

C1 160μF 12V or higher.
C2 16μF—10V, Mullard—see text

Semiconductors

Tr1 2N2926G	Tr5 BFY51
Tr2 2N2926G	Tr6 BFY51
Tr3 2N2926G	D1 1N914
Tr4 2N2926G	

Switches

SW1 2-way, 1-pole toggle
SW2 2-way, 2-pole toggle
SW3 2-way, 2-pole toggle
SW4 On/off slide switch

Miscellaneous

Meter	100μA, 3½in face—see text
Case	See text
LP1, 2 and 3	6V, 40mA MES bulbs
Bulbholders	3 MES types
Battery	PP9, 9V.
Component Board	0.15in matrix plain Veroboard

at the junction of R1 and R2 rises and capacitor C2 begins to charge through R6 and D1 and this in turn starts to bias on the high impedance circuit (the Darlington Pair) comprising Tr3 and Tr4 in which the current increases with the rise in voltage at the base of Tr3. Even before the "start" circuit has triggered there is of course a small potential at junction R1 and R2 and the capacitor will be charged but it is not enough to bias the Darlington pair into conduction.

As soon as either of the competitive switches are thrown the charging line is broken and C2 is no longer being charged.

As the input impedance of the meter circuit is very high—in the order of 100MΩ—so little current will be drawn from the capacitor that it can be

ignored and so the meter continues to register a nearly true reading of the charge on the capacitor. This is of course proportional to the time which has elapsed between the light coming on and either of the competitive switches thrown.

The needle will rise very fast but, once stopped, will stay there. In fact the needle will fall very slowly due to the leakage of C2 and to a far lesser degree due to the current taken for Tr3, but the fall on the prototype was only about one division on the meter in ten seconds, a division being one fiftieth of full scale deflection.

The quality of the component used for C2 is important. One of the Mullard "Blue" range was used as these appeared to be very much better than imported types at holding the charge. Some Japanese components hardly held any charge at all, the

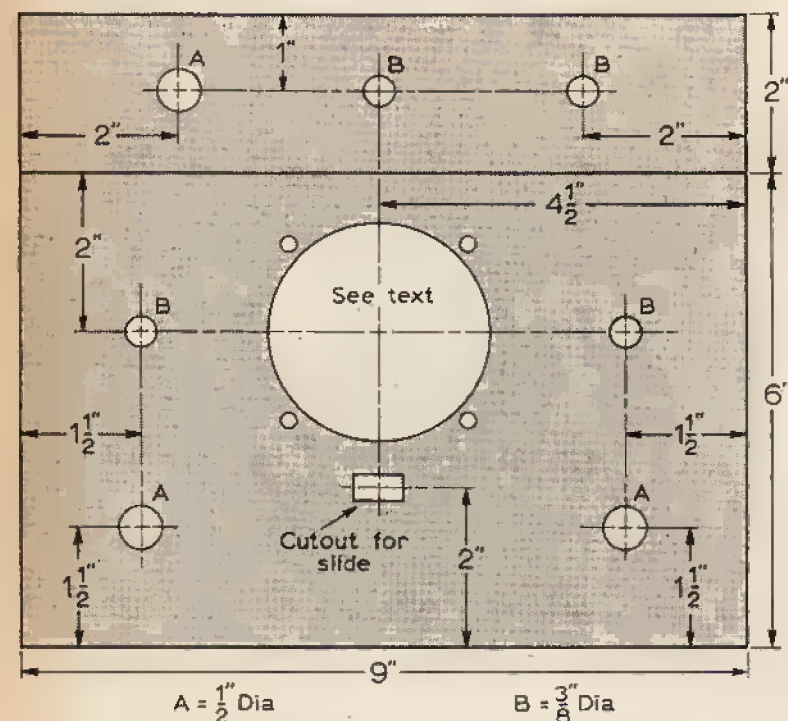

Fig. 2: The drilling of the face plate on the prototype. As can be seen from the heading photograph, this is angled.

leakage was so high. It is certainly worthwhile choosing a good component for C2 by experiment.

R6 is included to set the rate of charge. A small slide switch and R8 are included to shunt the meter to give two scales of reading.

In the prototype the unshunted meter takes about a second to reach full scale deflection, the 330Ω shunt reduces the rise rates to 20% of the original. On the "slow" setting readings above 7 are far from linear but this does not really matter.

The slow rate is only needed for certain experiments since all the simple tests can be completed in under a second by most people.

The "winner" indicator circuit comprises Tr5 and Tr6 with associated components. Let us assume that the person with the most rapid reactions is on SW2. When this is thrown the emitter of Tr5 is connected to chassis and since the base circuit is biased via R5 and LP3, as soon as the circuit is completed by SW2 the transistor conducts and LP2 lights up. When the other person makes his switch, the emitter of Tr6 is connected to chassis but as Tr5 is in conduction and fully switched on the voltage across Tr5 is so small that there is not enough to bias the transistor on. It therefore remains off whatever the position of SW3. So it comes down to whoever com-

pletes the indicator circuit first messes it up for the other.

Since the circuit has already been broken between the Schmitt Trigger and the timing indicator, the additional break contributed by SW3b doesn't affect the operation and the timing indicator registers the winners time only.

Cheat Circuit

From the circuit it will be seen that LP2 and LP3 can be switched on regardless of whether LP1 is alight or not. However if this is done one of the bulbs LP2 or LP3 will light and will draw a fair amount of current and this is not only taken from the battery but also from the charging timing capacitor C1 to a small degree. This has the effect of triggering the Schmitt circuit and LP1 will light. But since the line connecting the junction of R1 and R2 to R6 has been broken, the timing circuit will show no reading.

It could be claimed that this would give the same reading as for an instant reaction and this is true but the fastest reactions possible (I have it on good authority) are in the order of 1/10th of a second. If you believe that they are faster just try it. Not only does the cheat circuit work but it also shows who has cheated because of course their light is on!

Reset

Once a test has been completed it is necessary to discharge both capacitors C1 and C2 and this is done by switching off for about a second. SW1 is arranged so that it directly shorts out C1 while C2 will discharge through the base emitter circuits of Tr3 and Tr4.

C2, unlike C1, does not discharge instantly—it takes about half a second. If SW1 is thrown off and on again too quickly a small reading will still be shown on the meter.

Construction

There is available a very suitable case which might have been built for this very project; this is one of the "U" range marketed by H. L. Smith & Co. Ltd., of 287/9 Edgware Road, London W.2. The case, sized 9 1/4 × 7 1/2 × 3 1/2 in., is silver hammered finished and costs £1.20 plus postage and packing.

The meter is one of the Henelec or S.E.W. types with a 3 1/4 in. face and a large hole has to be cut in the sloping panel to hold it.

These meters are supplied in a cardboard box with a piece of card that acts as a perfect template for marking the size of the hole and the positioning of the mounting screws. A series of holes are drilled just inside the area marked out to remove the main aluminium and a file removes the rest.

SW2 and SW3 are mounted at the bottom left and bottom right respectively of the sloping panel; these can be marked "A" and "B" and the associated light mounted above them.

The start bulb is sited on the top "flat" with the Off-Reset/On switch and VR1 the delay potentiometer.

The two terminal contacts on the back of the meter provide a very suitable mounting for the component board and two holes should be drilled in this to enable it to be screwed on.

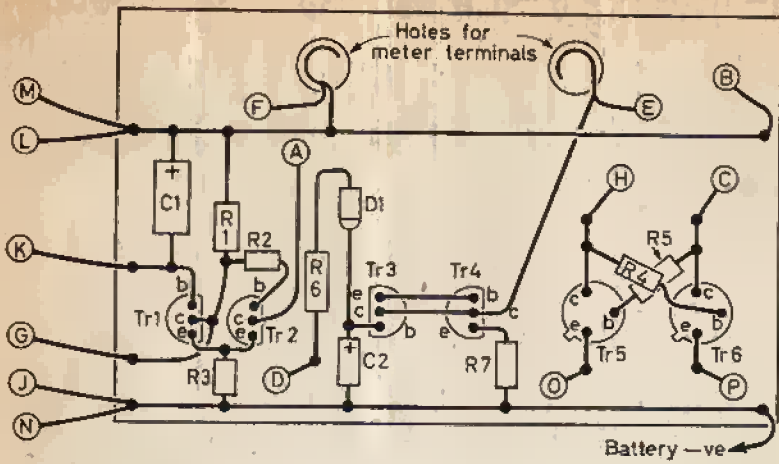

Fig. 3: The component layout on plain Veroboard. Note that Tr3 and Tr4 should read Tr5 and Tr6 and vice versa.

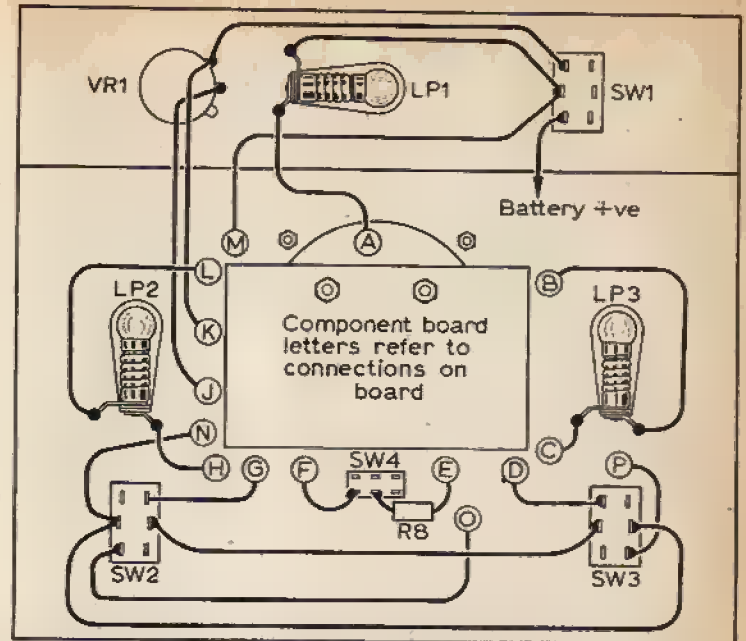
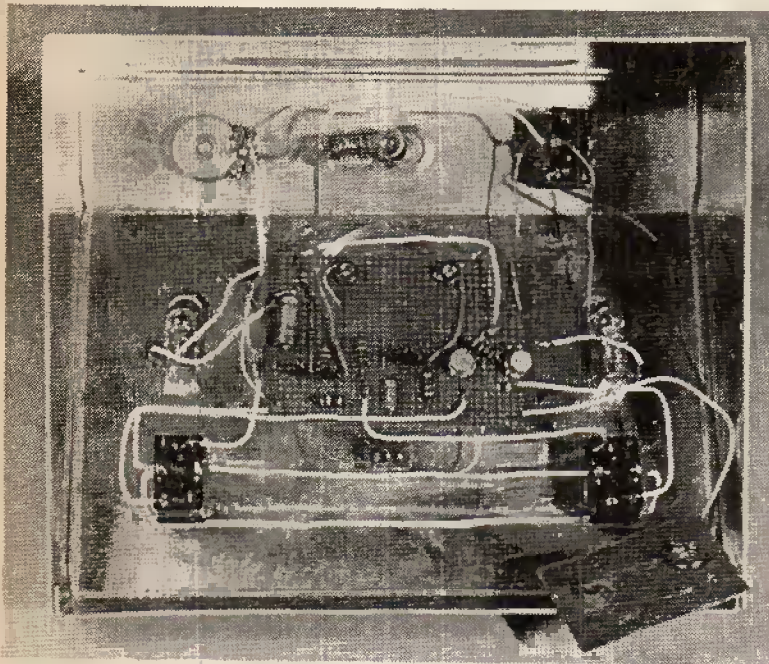
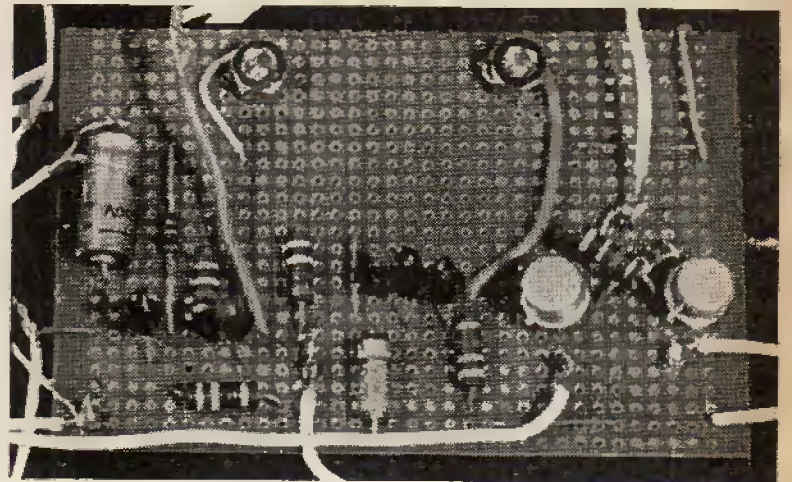

Fig. 4: The internal wiring of the reaction tester.



Compare this photograph with Fig. 4.



Closeup view of the component board. The meter terminals are visible at the top.

The component board is made from 0.15in matrix plain Veroboard and should be wired as shown in Fig. 3.

The wiring is shown in Fig. 4, the letters corresponding to the similar letter on the component board.

Using the Reaction Tester

It may be found on careful inspection that there is a very short delay between the bulb lighting and the needle starting to move. If this is so high that the fastest genuine reactions can be accomplished in the delay, the values of R1 and R2 should be experimented with. The delay is due to the voltage at the base of Tr3 having to reach a certain level before it begins to conduct.

The first tests can be done by yourself. With SW1 thrown to "on", switch either SW2 or SW3 as soon as the light comes on indicating "start". By the time you have thrown the switch a reading should have registered on the meter.

Try part-throwing the switch at the next test—that is, hold either SW2 or SW3 with such a pressure that the tumbler is just about to throw. This will remove as much of the mechanical delay (if one can call it that) as possible so that the time registered is only that of your reflexes. It will probably be found that this makes little difference. Then

try having the hand that you are going to switch with flat on the table and only move it when the light comes on and note that reading.

One interesting point has been noticed on the prototype. If the unit has been off for a period of much over 20 minutes, the first reading will be much slower than subsequent ones. This is probably due to the electrolytics reforming. For this reason make sure that the first reading of a series is ignored.

If you leave the delay at one setting and try a series of tests you will find that both competitors get better as, even if the time delay is at maximum, they begin to estimate the starting signal and get ready for it.

Try to take a series of twenty readings, take the average and have a pint of beer. After ten minutes or so your reactions may show a slight improvement but after a second pint and a further series of tests the reactions will show a marked decline. During these original tests one player was so fascinated that he continued to take readings till he had drunk eight pints—at which point he was unable to find the switch!

Averages must of course be used, as a single reading may be a fluke, either one way or the other.

A little ingenuity will enable you to make all kinds of tests and will provide hours of fun. ■

HIGH-Z

VOLTMETER

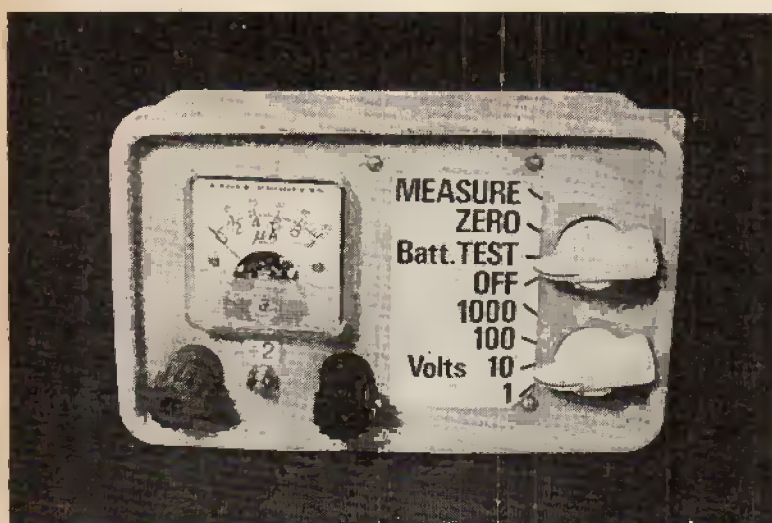
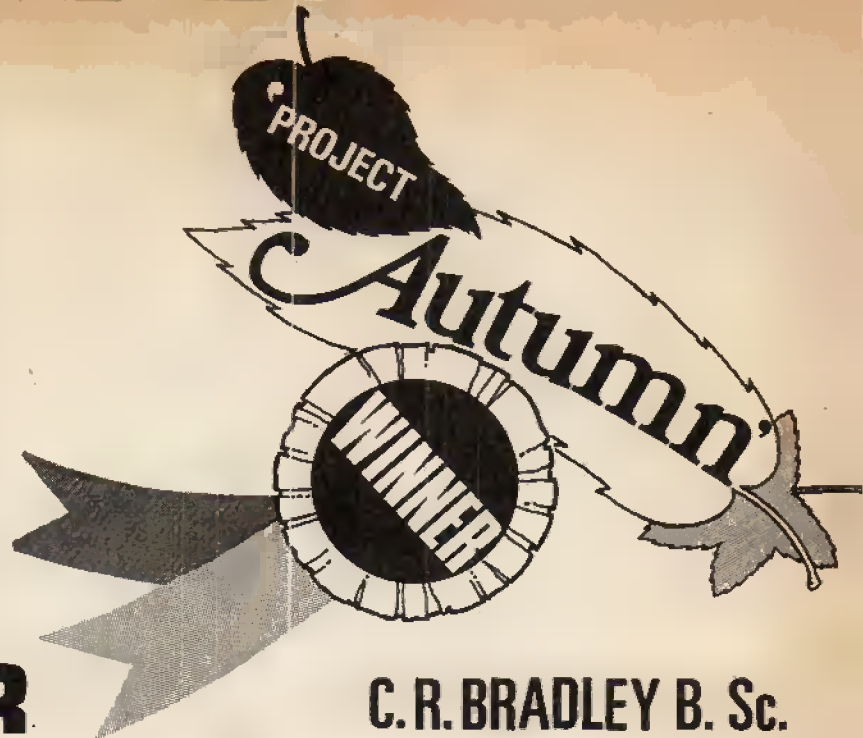

This article was the winner of the Project Autumn Silver Trophy Competition held last year. The judges considered it the best entry for several reasons including clear description and ingenuity. Although the likely popularity was not a major consideration in the judging, we believe that this project will be found to be very useful to the electronic experimenter.

RANGES (D.C. VOLTS)	
0-0.5-1-5-10-50-100-500-1000	
USEFUL MEASUREMENT RANGE	
0.05-1000V. All readings above 0.25V in upper half of meter scale	
CONTROLS	
Range switch: 1-10-100-1000V d.c.	
Function switch: Off-Battery Test-Short Circuit	
Input-Measure	
Pushbutton to divide range by 2	
Internal preset for meter calibration	
Two internal presets for meter zero setting with terminals open and short circuited respectively.	
FEATURES	
Both forward and reverse overload protection for meter movement. Long battery life	
INPUT IMPEDANCE	
Range	Impedance
0-1V	>7MΩ
0-10V	>3MΩ
0-100V	>5MΩ
0-1000V	>5MΩ

THE improved noise performance, and only slightly diminished gain, provided by modern silicon planar transistors working at low collector current have encouraged the use of ever decreasing currents in small-signal circuits. The correctness of voltage measurements made using a conventional moving-coil multimeter therefore becomes increasingly doubtful, since the voltage conditions in the circuit may be seriously upset by the current 'stolen' by the meter. An example is illustrated in Fig. 1 where a voltmeter with a 50 μ A movement, which is about the highest sensitivity compatible with reasonable ruggedness and price, reads 50% low at the base of a typical transistor amplifier.

The only way to measure voltages with confidence is to use a voltmeter of much higher internal impedance than the point in the circuit tested. Excellent designs for high impedance voltmeters frequently appear and generally consist of a highly stable operational amplifier driving a moderately sensitive meter movement. However one must expect to invest several pounds in building such an instrument, or many more pounds to buy the cheapest commercial article. The author's aim was to design a high impedance voltmeter of adequate versatility for all likely experimental needs, which could be built for the absolute minimum cost. By careful shopping for components, the total cost of the prototype came to £4.25, which compares well with the cost of a moving coil multimeter. The latter, with its a.c. voltage, d.c. current and resistance ranges,

remains the essential first purchase for the experimenter.

The specification of the high impedance voltmeter is shown in the table.

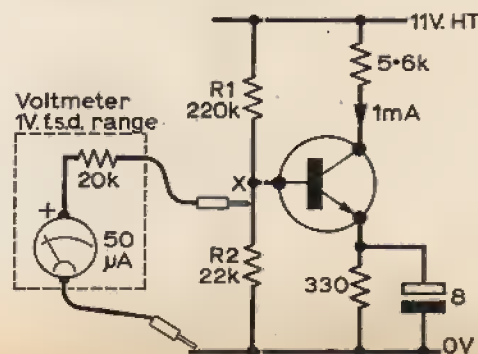

Fig. 1.

DESIGN

The very simplest circuit which has a high input impedance and can drive a meter is the emitter follower shown in Fig. 2. Here the voltage gain from base to emitter is unity. This is because if the base

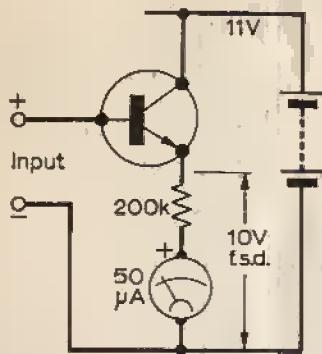

Fig. 2.

voltage is increased, base-emitter current and therefore collector current both increase, and the voltage drop across the emitter load rises until emitter and base voltages are similar. The 50 μA meter in Fig. 2 has a 200kΩ series resistor so we should get full scale deflection for 10V at the input terminals. The input impedance of the circuit is $\text{transistor gain} \times 200\text{k}\Omega$ or typically $100 \times 200\text{k}\Omega = 20\text{M}\Omega$. This suggests the circuit would form an ideal basis for a high impedance voltmeter. In practice two complicating factors arise, which are handled in the final circuit.

The first problem is that if any current at all flows from base to emitter, there is a voltage drop of about 0.7V across the junction. Thus the simple circuit would be useless for measuring a voltage around 0.5V, say. The second problem is that even with zero base-emitter current, the transistor passes a

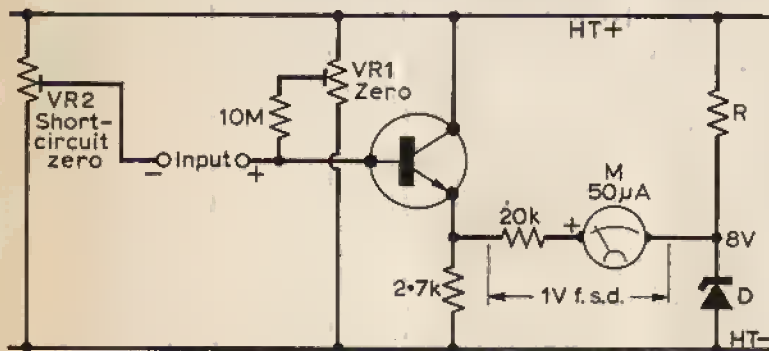

Fig. 3.

certain collector-emitter leakage current. Even with a silicon transistor, this leakage might be 5 μA or more and this would show on the meter. In addition, these two values of 0.7V and 5 μA vary with temperature.

The arrangement chosen to deal with this situation is shown in Fig. 3. Here the meter movement, with appropriate series resistor for the voltage range required, is connected between the transistor emitter and a constant supply of 8V provided by R and the zener diode D. Current is fed to the base by VR1 which is set up for zero meter deflection. This occurs when the emitter voltage equals the zener voltage. The transistor is then passing a collector-emitter current of $8\text{V} \div 2.7\text{k}\Omega = 3\text{mA}$ which leaves its leakage current far behind. As the base current is tiny (i.e.: $3\text{mA} \div \text{transistor gain}$) a very large 10MΩ resistor can be put in series with VR1 slider to preserve the high input impedance of the emitter follower.

The positive input terminal is now at $8 + 0.7\text{V}$. This voltage is also set at the negative input terminal by VR2, done by shorting the terminals together and

setting VR2 for zero meter deflection. Now ready for measurements as low as 0.05V on the 1V f.s.d. range shown, the arrangement is simple and cheap, and the only drawback compared with a more sophisticated balance operational amplifier is a more frequent need to readjust the zero controls with changes in temperature.

FULL CIRCUIT

The full circuit of the instrument is shown in Fig. 4 and has been developed from that in Fig. 3 as follows. The single transistor is replaced by two transistors connected as a Darlington pair, which behaves like a single 'super' transistor whose gain is the product of the gains of the two separate transistors. Since the 2N2926 (green) has a specified gain (beta) of 235 to 470, the pair has a very high gain indeed. The emitter-base junction of another cheap silicon transistor is connected in reverse to serve as the zener diode in Fig. 3; this is cheaper than using the real thing and just as efficient. A batch of a dozen of this transistor all gave zener voltages in the range 6.5 to 9V which is acceptable for this use. The zero controls are combined with the zener diode to save one resistor (R in Fig. 3); this arrangement also allows finer adjustment of the two controls.

The total series resistance of VR1, R9 and the 50 μA meter M is arranged to be 10kΩ; the meter therefore gives full scale deflection for $(50\mu\text{A} \times 10\text{k}\Omega) = 0.5\text{V}$ across this chain. The potentiometer VR1 is included so that the circuit can be set up for a meter movement of any likely internal resistance,

★ components list

Resistors

R1	3.3MΩ 2% ½W	R6	10MΩ 5% ½W
R2	TWO 10MΩ 2% ½W	R7	2.7kΩ 5% ½W
R3	TWO 10kΩ 2% ½W	R8	10kΩ 1% ½W
R4	TWO 100kΩ 2% ½W	R9	4.7kΩ 5% ½W
R5	390kΩ 2% ½W	R10	2.7kΩ 5% ½W

VR1, 2, 3 4.7kΩ (or 5kΩ) miniature skeleton preset potentiometers

All the above available from Electrovalue, 28 St. Judes Rd., Englefield Green, Egham, Surrey

Switches

S1	2-pole (or 3-pole) 4-way rotary
S2	3-pole 4-way rotary
S3	Push-to-close

Semiconductors

Tr1, 2	2N2926 (Green)
Tr3	2N2926 (Orange)
D1, D3	Any silicon diode e.g. 1N914
D2	Any germanium diode e.g. OA70

Meter

50 μA f.s.d., 1.5in. square approx.
Eagle MR-2P or SEW MR.38P (latter from Barnet Factors Ltd., 147 Church St., London, W.2)

Miscellaneous

Veroboard 0.15in. matrix, 1 7/8 (across tracks) x 3 1/2 in.
Insulated terminals, red and black
2 PP3 batteries and battery clips
4 8BA bolts, nuts, etc.
Scrap piece of polystyrene or foam rubber (see text)
2 pointer knobs
Polythene box (see text)
Letraset for labelling

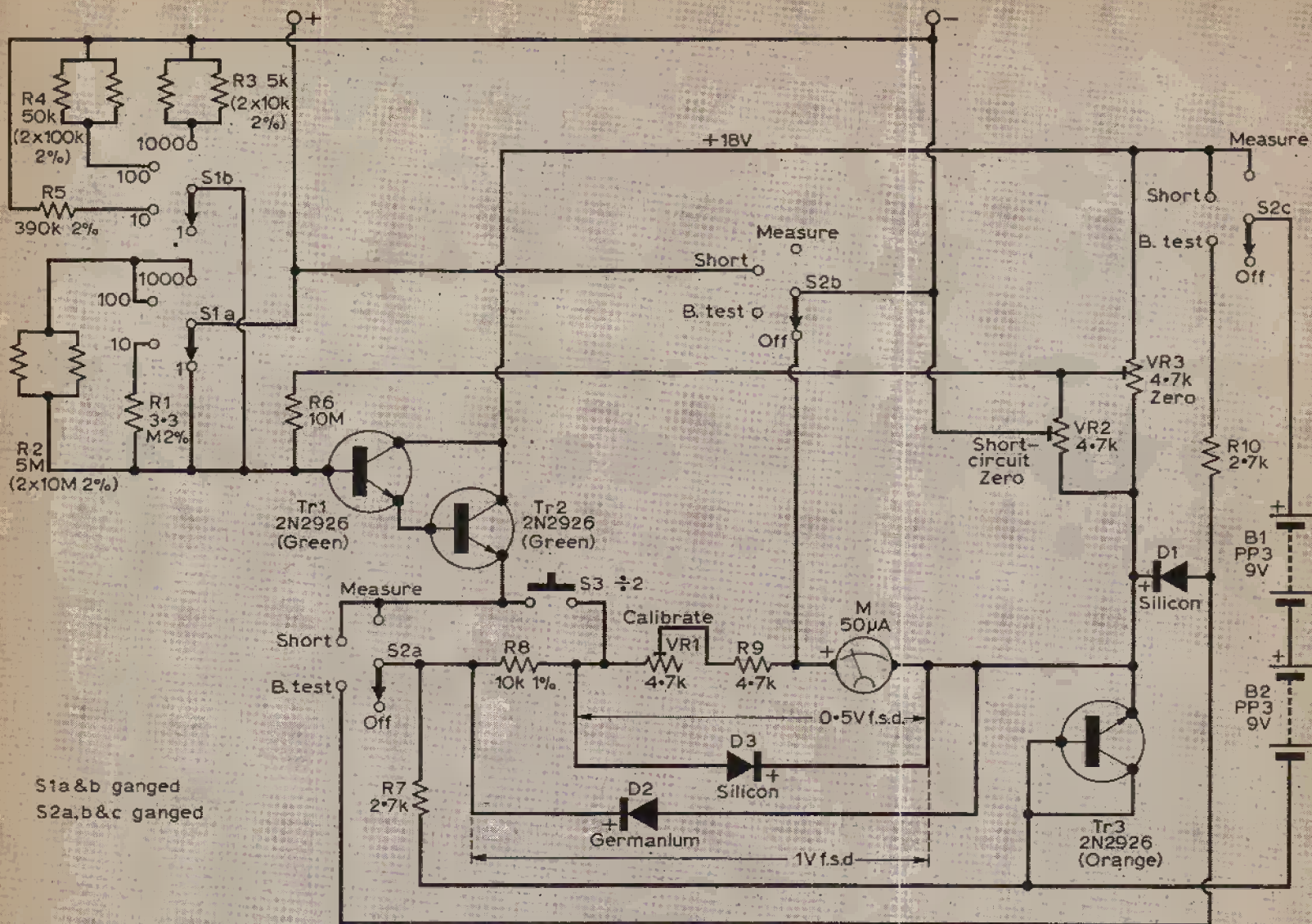

Fig. 4: The complete circuit of the high impedance voltmeter. Although seemingly complex, most of the circuitry is simply a refinement of that shown in Fig. 3. See the text for an explanation of the operation.

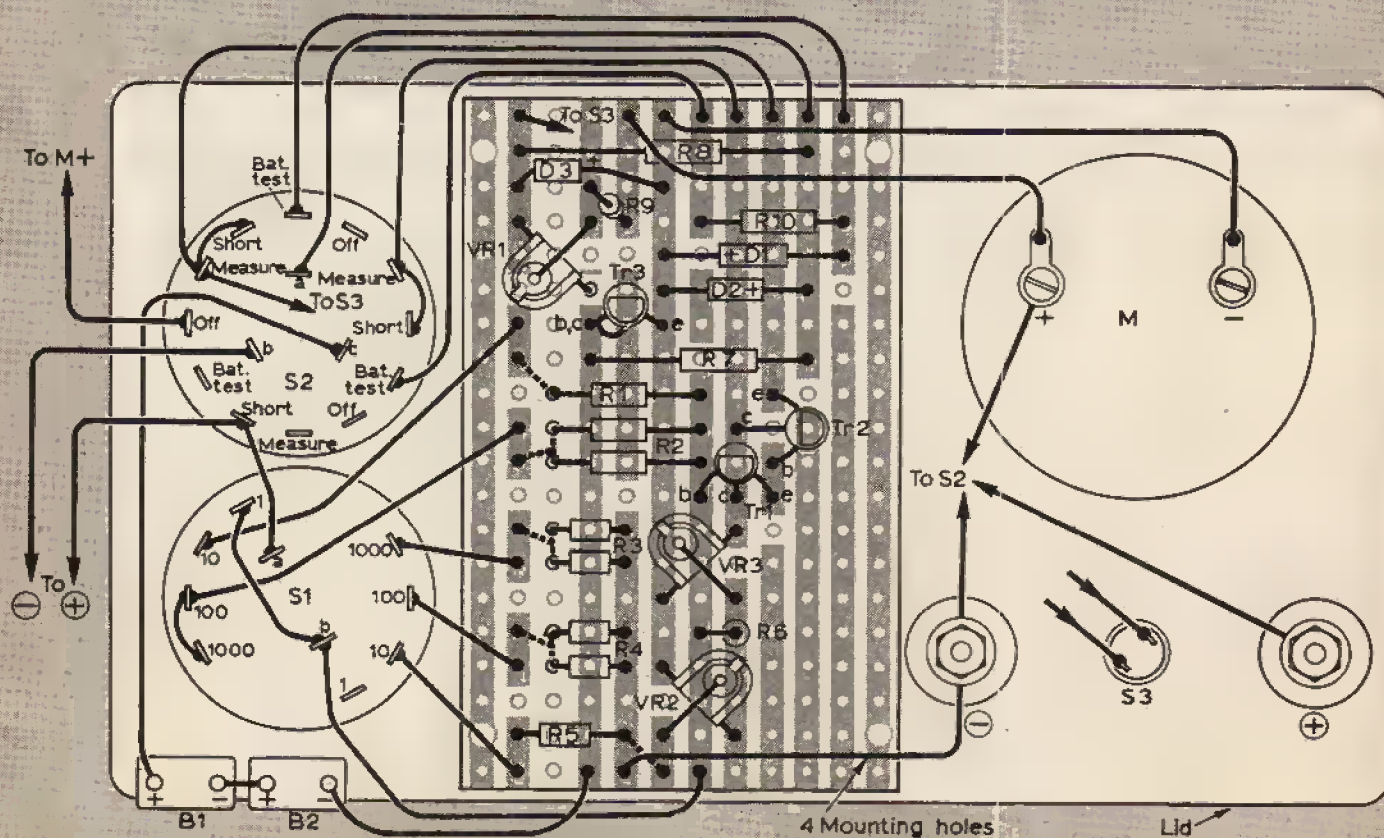
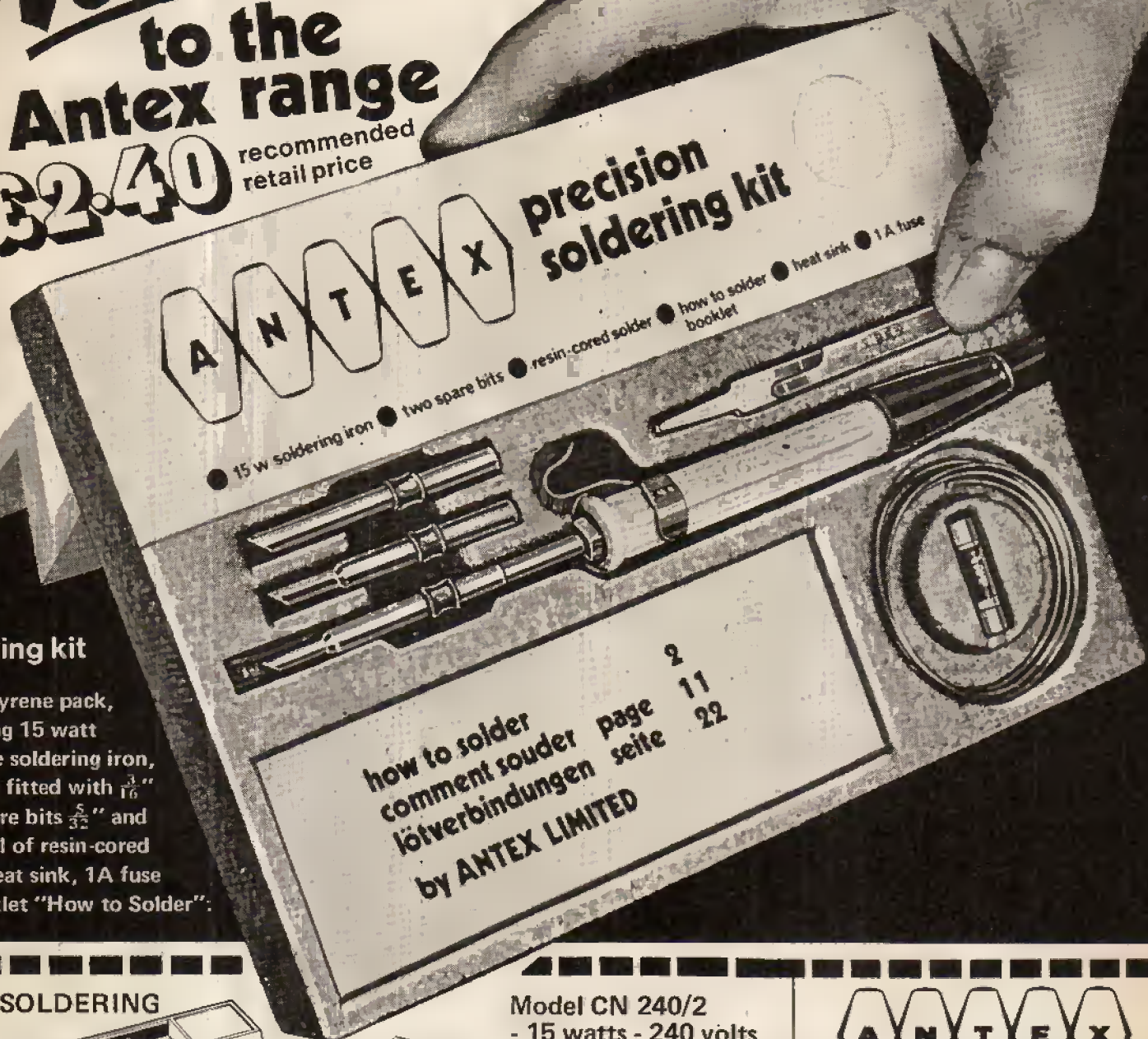

Fig. 5: The Veroboard layout of the components and the other connections.

introducing the New SK2 KIT to the Antex range

£2.40 recommended
retail price



SK2 Soldering kit

In polystyrene pack, containing 15 watt miniature soldering iron, 240 volts fitted with $\frac{3}{16}$ " bit, 2 spare bits $\frac{5}{32}$ " and $\frac{3}{32}$ ". Coil of resin-cored solder, heat sink, 1A fuse and booklet "How to Solder".

SK1 SOLDERING KIT

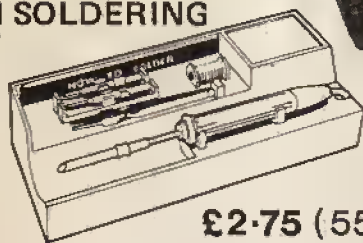

£2.75 (55/-)

In rigid plastic "tool box" containing Model CN - 15 watts - 240 volts miniature iron fitted $\frac{3}{16}$ " bit. Spare bits $\frac{5}{32}$ " and $\frac{3}{32}$ ". Reel of resin-cored solder, heat sink, cleaning pad, stand and booklet "How to Solder"

Model CN 240/2
- 15 watts - 240 volts

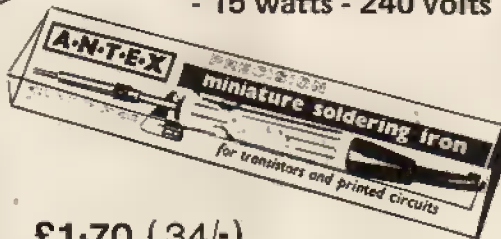

£1.70 (34/-)

Fitted with nickel plated $\frac{3}{32}$ " bit and packed in handy transparent box.

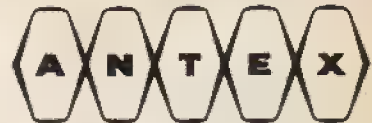

PRECISION MINIATURE SOLDERING IRONS

Antex, Mayflower House, Plymouth, Devon.
Telephone: Plymouth 67377/8.
Telex: 45296. Giro No. 2581000.

- Please send me the Antex colour catalogue
- Please send me the following
- | Quantity | Model | Bit Size | Volts | Price |
|----------|-------|----------|-------|-------|
| | | | | |
| | | | | |

I enclose cheque/P.O./cash value

NAME

ADDRESS

PW.4

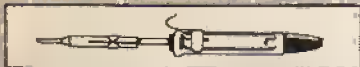

Model G - 18 watts. Fitted $\frac{3}{32}$ " bit. Spare bits $\frac{1}{8}$ ", $\frac{3}{16}$ " and $\frac{1}{4}$ " available. For 240 or 220 volts. £0.87 (17/5).



Model F - 40 watts. Fitted $\frac{5}{16}$ " bit. Spare bits $\frac{3}{32}$ ", $\frac{1}{8}$ ", $\frac{3}{16}$ " and $\frac{1}{4}$ " available. For 240, 220, 110, 20 volts. From £2.35 (47/-).

Model E - 20 watts. Fitted $\frac{1}{4}$ " bit. Spare bits $\frac{3}{32}$ ", $\frac{1}{8}$ " and $\frac{3}{16}$ " available. For 240, 220 or 110 volts. From £1.80 (36/-).

Model ES - 25 watts. Fitted $\frac{1}{8}$ " bit. Spare bits $\frac{3}{32}$ ", $\frac{3}{16}$ " and $\frac{1}{4}$ " available. For 240, 220 or 110 volts. From £1.80 (36/-).

FULLY TESTED AND MARKED

AC107	15p	OC170	23p
AC126	13p	OC171	23p
AC127	17p	OC200	25p
AC128	13p	OC201	25p
AC176	25p	2G301	13p
ACY17	15p	2G303	13p
AF239	37p	2N1302-3	40p
AF186	50p	2N1304-5	25p
AF139	37p	2N1306-7	30p
BC154	25p	2N1308-9	35p
BC171-BC107	18p	2N1389-FET	45p
BC172-BC108	13p	2N3844A	25p
BF194	15p	POWER TRANSISTORS	
BF274	15p	OC20	50p
BFY50	20p	OC23	30p
BSY26	37p	OC25	40p
BSY26	13p	OC26	25p
BSY27	13p	OC28	40p
BSY28	13p	OC35	25p
BSY29	13p	OC38	37p
BSA95A	13p	AD149	30p
OC41	13p	AUY10	£1-25
OC44	13p	2N3055	65p
OC45	13p	2N3034	25p
OC71	13p	DIODES	
OC72	13p	AAV42	10p
OC81	13p	OA91	9p
OC81D	13p	OA79	9p
OC139	13p	OA81	9p
OC140	17p	IN914	7p

NEW UNMARKED UNTESTED PAKS

H10	25	Mixed volts 1½ watt Zeners Top Hat type.	50p
B80	8	Dual Trans. Matched O/P pairs NPN. Sil. in TO-5 can.	50p
H11	30	Mat series "Alloy" PNP Transistors.	50p
B83	200	Trans. Makers rejects. NPN/PNP. Sil. and Germ.	50p
B84	100	Silicon Diodes DO-7 glass equiv. to OA200, OA202.	50p
H15	30	Top Hat Silicon Rectifiers 750 mA. Mixed volts.	50p
B86	50	Sil. Diodes sub. min. IN914 and IN916 types.	50p
H16	8	Experimenters' Pak of Integrated circuits. Data supplied.	50p
B89	50	Sil. Trans. NPN, PNP, equivalent to OC200/L, 2N706A, BSY95A, etc.	50p
B60	10	7 Watt Zener Diodes. Mixed voltages.	50p
H20	20	BY126/7 type Silicon Rectifiers 1 amp plastic. Up to 1,000 volts.	50p
H6	40	250mW. Zener Diode DO-7 min. Glass Type. AV.40% Good.	50p

NEW TESTED & GUARANTEED PAKS

B2	4	Photo Cells, Sun Batteries .3 to .5 volt, .5 to 2 ma.	50p
H8	4	BY127 Silicon Recs. 1000 P.I.V. 1 amp. Plastic. Replaces the BY100	50p
B73	4	1N4007 Sil. Rec. Diodes. 1,000 P.I.V. 1 amp. Plastic.	50p
B81	10	Reed Switches, mixed types, large and small.	50p
B89	2	5SP5 Light Sensitive Cells. Light Res. 400 Ω Dark 1M Ω	50p
B91	8	NKT163/164 PNP Germ. TO-5 equivalent to OC44, OC45.	50p
B92	4	NPN. Sil. Trans. AO6 B8X30 2N2369 500 MHz. 360mW.	50p
B93	5	GET113 Trans. equiv. to ACY17 to ACY21 PNP Germ.	50p
Bf9	200	Mixed Capacitors, Post and packing 13p Approx. Quantity counted by weight.	50p
Bs8	10	XB112 and XB102 equiv. to AC126, AC156, OC81/2, OC71/2, NK271, etc.	50p
H4	250	Mixed Resistors, Post and packing 10p. Approx. Quantity counted by weight.	50p
H7	40	Wirewound Resistors. Mixed Values. Postage 7p.	50p
H9	2	OCPT1 Light Sensitive Photo Transistors.	50p

FREE! Packs of your own choice up to the value of 50p with orders over £4.

RETURN OF THE UNBEATABLE P.I. PAK. NOW GREATER VALUE THAN EVER

Full of short lead semiconductors and electronic components, approx. 170. We guarantee at least 30 really high quality factory marked Transistors PNP and NPN, and a host of diodes and rectifiers. Mounted on printed circuit panels. Identification chart supplied to give some information on the transistors.

PI PLEASE ASK FOR PAK P.I. ONLY 50p
 10p P. & P. on this Pak

COLOUR T.V. LINE OUTPUT TRANSFORMERS. Designed to give 25KV when used with HL509 & PY500 valves. As removed from colour receivers at the factory.

ONLY £1 each. Post & Packing 23p

★ **ALL OUR TESTED SEMICONDUCTORS HAVE A WRITTEN GUARANTEE** ★

SEND FOR OUR **FREE** LISTS and CATALOGUE OF ALL OUR PRODUCTS. CHECK YOUR OWN EQUIVALENT WITH OUR **FREE** SUBSTITUTION CHART.

P.O. RELAYS 8 FOR £1
 Various Contacts and Coil Resistances.
 Post & Packaging 25p

NO CONNECTION WITH ANY OTHER FIRM. MINIMUM ORDER 50p. CASH WITH ORDER PLEASE. Add 5p post and packing per order. OVERSEAS ADD EXTRA POSTAGE.

LOW PRICE, HIGH QUALITY SPEAKER SYSTEMS

All cabinets are new and carefully designed acoustically with speakers mounted on ½ in. chipboard baffles. All speakers are ex-TV high quality with hi-flux magnets carefully matched and tested.

ADASTRA DOUBLE



5 stereo solid state amplifier housed in handsome cabinet veneered in natural teak. Size 11½ x 6 x 5½ in. 10 Transistors—power output 5 watts peak per channel. 220-240v A.C. Output impedance 12 to 15 ohms (our Cowdrey speaker system eminently suitable). Smart blue escutcheon. £14.70. P. & P. 55np.

CARTRIDGES

Stereo: Sonotone 9TA H/CDiamond £2.40. Ronette S105 Medium Output, £1.40. S106 High Output £1.40. Acos GP93 I Sapphire, £1.90. GP94 I Sapphire, £2. TA700 equivalent to B.S.R. SX1M, £1.75. Japanese equivalent to B.S.R. TC8s, £1.75. P. & P. 7np on each.



CAXTON COLUMN

This is a column cabinet 23½ x 5½ x 5½ in. deep finished in black or woodgrain cloth with blue or grey Vynair front. Keyhole slot for wall mounting. Fitted with three speaker units. 9 ohms impedance. Handles 8 watts. Makes all the difference in quality and volume of tape recorders and record players. Real bargain at £2.95. P. & P. 55np each.

ELF
 An extension speaker of quality, 9 x 5½ x 3½ in. veneered in natural teak with smart gold and mottled Vynair front 3 ohm speaker. The baffle is half inch thick. A real bargain at £1.90. P. & P. 30np.



IMP
 Wedge shaped extension speaker 7½ x 6½ x 4 in. (max.). Covered in walnut wood grain cloth with mottled Vynair front. Keyhole slot at back. Fitted with 3 ohm speaker unit. Only £1.25. P. & P. 30np each



THE FIESTA £2.95

P. & P. 30np. Brit. Isles. Fitted with 7 x 3 Speaker and Volume control. Teak veneered with Black Vynair.

10" x 7½" x 3½" deep. 3 ohm ex TV Speaker TRANSISTOR SPEAKERS

3 in. 35 ohm. 50np. p. & p. 7np.
SPEAKERS
 E.M.I. 13½ x 8 in, 3 ohm £2.50, 15 ohm. P. & P. 30np. E.M.I. 3 in tweeter 95np. P. & P. 10np. E.M.I. 13½ x 8 in. fitted two 2½ in. tweeters, 15 ohm £4.50. P. & P. 30np. E.M.I. 13½ x 8 in. (15 ohm) Hi-Fi quality £6.25. P. & P. 30np. E.M.I. Crossover 85np. P. & P. 5np. Bakers 12 in. 25 watt 8 and 15 ohms £7. P. & P. 30np. Eagle crossover 90np. P. & P. 5np. Xtal lapel Mike. 40np. P. & P. 5np. Tel. P.U. 65np. P. & P. 5np.

SPEAKER MATCHING TRANSFORMERS

3, 7, 15 ohms, 8 watt, 70np. P. & P. 15np.

VYNAIR

Widths from 40 to 54 in., 75np yd. off roll. P. & P. 10np. ½ yard 40np. P. & P. 10np. Send 5np stamps for samples.

MONO

GP.91 Stereo Compatible £1.25. Acos GP67/2 will replace Collaro and Garrard Mono cartridges, 95np. T.T.C. Crystal High Gain, 75np. B.S.R. TC8H Jap. equivalent £1.25. P. & P. 7np.

THE SHELLEY

Size 21 x 11 x 6½ in. An extremely elegant speaker system made of 12mm. chipboard covered with teak leathercloth with mottled Vynair front. This unique system uses three ex TV speakers. Carefully matched and tested. Will handle 10 watts and will match 8 ohms impedance. If preferred the speakers can be wired in series parallel to match 3 ohms impedance. A real bargain at £4.95 plus 65np P. & P. **MATCHING TRANSFORMER** for 15 ohms 80np post free.

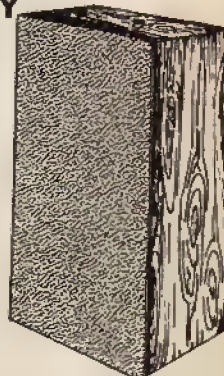

BROADWAY ELECTRONICS

(Nr. Tooting Broadway Underground Station)
 82 MITCHAM ROAD, TOOTING BROADWAY, LONDON S.W.17 01-672 3984 (Closed all day Wednesday)

and it need only be set once and left. If the actual resistance of the meter is known (to 1% accuracy), then VR1 and R9 could be replaced by a single 1% resistor to bring the resistance up to 10k Ω . However the present arrangement might still be preferred for economy.

An additional resistor R8 brings the series resistance up to 20k Ω , giving 1V f.s.d. Division of any range by two (i.e: doubling the meter deflection) is achieved by pressing S3 which shorts out R8.

The 1V, 10V, 100V and 1000V ranges are selected by S1. On the 1V range (0.5V when S3 pressed) the base of Tr1 is connected directly to the positive measurement terminal. For the other ranges, appropriate divider resistors are selected by the two sections of S1. The input impedance of the instrument varies with the range selected, partly because the aim has been to use inexpensive preferred value resistors throughout, but it is never less than 3.5M Ω . Pairs of resistors in parallel are used to obtain non-preferred values in the case of R2, R3 and R4; this arrangement can incidentally be shown to give one a statistically better chance of getting a high tolerance. The divider values R1/R5 may at first sight seem wrong for dividing by 10, but this is because the shunting effect on R5 of R6 and the impedance of Tr1 base has to be taken into account.

The meter is protected from forward overloads by D3 which starts to conduct when the voltage across it is about 0.7V i.e: 140% of f.s.d. A germanium diode D2 is used for reverse overload protection since it will conduct at about 0.4V i.e: -40% of f.s.d. (1V). Note that the reverse overload protection is ineffective if the +2 button is pressed. In the event of an extreme input overload of either polarity, it is more likely that one of the Darlington pair transistors (cost 10p each) will burn out than the comparatively expensive meter movement.

The function switch is S2. The battery test position is a necessary stop between off and measure. The batteries are tested by halving their voltage (nominally 18V) with R10 and R7 and applying the resultant voltage via D1 to the zener diode Tr3. The meter measures the voltage drop across D1. Since this cannot be more than 0.7V and the meter is giving 1V f.s.d. (the +2 is inoperative) the meter will not be overloaded. In fact a meter reading of 0.6 - 0.7V indicates fresh batteries, while any meter indication at all above zero indicates useable batteries.

In the short circuit zero position of S2, the measurement terminals are connected together for adjustment of VR2. In the off position, the batteries are disconnected and S2b places a short (actually a small portion of VR2 to simplify switching) across the meter movement. This helps to damp down oscillations of the needle if the instrument is jolted in carrying.

CONSTRUCTION

The instrument can be constructed in any convenient insulated box; the author chose the heavier type of polythene food container (size 5 $\frac{3}{4}$ in \times 3 $\frac{1}{2}$ in \times 2in) sold by camping shops, since its flexibility and the shape of the removeable lid gave some physical protection for the meter. There is also spare space inside which in practice proves useful for storing the test prods.

The components are wired on a small piece of

0.15in matrix Veroboard. There should be no difficulty fitting them on if the miniature types specified are used; the complete layout is shown in Fig. 5. Note that one conductor track is removed completely from the Veroboard, using a razor blade, and 17 breaks are made in the remaining tracks. The board is secured by four 8BA bolts to the box lid, with a piece of scrap foam rubber or polystyrene as a spacer (see Fig. 6), together with the meter, switches and terminals as shown. Before mounting, check that all

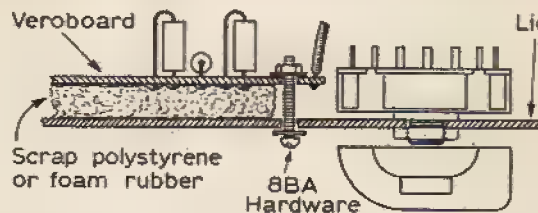
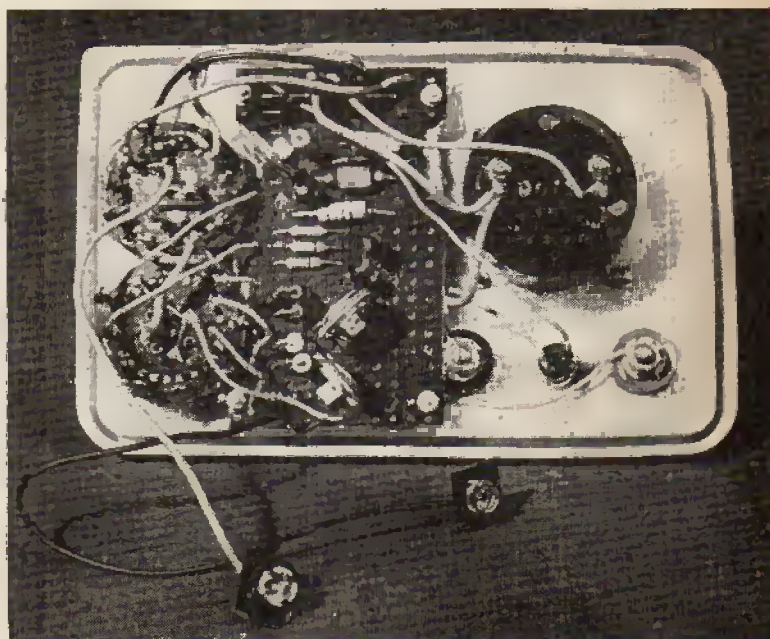

Fig. 6: The method used for mounting the component board.

these parts will fit together on the lid and allow the box to close; in the prototype it was necessary to trim the Veroboard slightly to clear the adjacent switches. The two batteries can be taped in any convenient position as they do not need frequent replacement. Two holes are made in appropriate positions on the box to allow adjustment of zero controls VR2 and VR3 from outside using a long screwdriver.

It is difficult to apply lettering direct to polythene. The panel labelling shown in the photograph was



An internal view of the completed high impedance voltmeter. Compare this with Fig. 5.

done by putting Letraset letters on white contact adhesive sheet (Woolworths) which sticks well to the box.

The meter scale is already labelled 0-50 which allows direct reading on ranges with the +2 button depressed, but is less appropriate for the 1V, 10V, 100V and 1000V ranges. For these a 0-1 scale can be added to the meter after removing the plastic face of the meter by gently pulling it away.

CALIBRATION

With the function switch at off, zero the meter by means of the screw on the meter front. This is purely a mechanical adjustment of the movement and must not be used instead of the electrical zero controls. Switch to measure and, with no input, adjust VR3

for zero meter deflection. Then switch to **short circuit zero** and adjust VR2 for zero. Initially it may be necessary to adjust VR3 and VR2 more than once. The calibration control VR1 can now be set. This is best done by connecting the voltmeter to any voltage in its range with a meter (any impedance) of known accuracy in parallel with it, and adjusting VR1 for corresponding readings. It is possible, though less easy, to set VR1 without any other meter. This is done by connecting the instrument to any voltage source that will give about 40 to 50% deflection on any range, and successively adjusting VR1 until pressing the $\div 2$ button exactly doubles the deflection.

USE

The function switch allows a quick check of the battery condition and the two zero settings every time the voltmeter is brought out for use. Once set accurately, VR1 should not be readjusted. It is necessary to readjust VR2 and VR3 occasionally, particularly with temperature changes. Allow a few seconds for the zero settings to stabilise when first switching on the meter.

The usual rule for meter usage should be followed, namely: select a higher range than the maximum voltage anticipated before connecting the meter to a circuit. In practice the $\div 2$ button proves extremely useful for doubling meter deflections of less than half scale. Remember that a meter measures most accurately over the upper 50% of its scale, where all measurements from 0.25 to 1000V can be made with this instrument. It is important that the Veroboard and switch wafers be kept clean and dry if measurements above about 500V are to be made as tracking problems could otherwise arise.

The impedance of the meter is high enough for confident voltage measurements in virtually all common circuits, except some high impedance valve grid and f.e.t. gate circuits. Unlike a moving coil multimeter, the impedance is virtually the same on all ranges.

It is possible to use the meter in a centre-zero mode for detecting d.c. nulls in bridges, etc. Set the function to **measure** and adjust VR3 for exactly half scale deflection, then switch to **short circuit zero** and adjust VR2 for the same deflection. The meter will now indicate voltages of either polarity at the terminals, the needle swinging to the right for a positive voltage at the positive terminal. The voltage swing over the whole meter scale is not changed, and the $\div 2$ button is still operative.

The batteries have a life of many months in normal use, or about a week if the meter is left on continuously. The instrument can in fact be operated on seriously run-down batteries, although the zero settings will drift badly. ■

TELEVISION

We are pleased to inform readers that our sister journal Television has now resumed publication following settlement of the recent printing dispute.

Issue dated **February 71** was published on February 12

Issue dated **March 71** will be published on March 8

Issue dated **April 71** will be published on March 29

We apologise to readers of Television for the loss of the December 70 issue and late appearance of subsequent issues.



Electronotes..

S. GINSBERG

COMPUTERS have been with us for some time but many people do not realise the degree of sophistication which is now being achieved. A fairly recent example is REDACAL. Basically a computer service, it enables any electronics customer to use a computer to solve problems. With REDACAL the design engineer has a powerful tool. He can, for example, ask this system to tell him of, say, an operational amplifier which has certain minimum and maximum gains. He might also specify that it must come within other limits, perhaps a 5V line. Within seconds, REDACAL will list all the currently available devices which will satisfy the conditions layed down and will also quote the current market prices, too.

But this system goes much further than providing such simple information. The designer can tell the computer what his newly designed electronic circuit is and seek its advice as to whether the circuit will work properly. For example, the designer can ask REDACAL in, say, the case of a square wave generator, what frequency the final output will be if all the capacitors and resistors were varied within a certain tolerance. Imagine if there were fifteen resistors in the circuit and they were all 5 per cent tolerance. They could all vary and this would affect the circuit. Once REDACAL has given a circuit the OK, the designer can literally put the design into production and know that the snags have been ironed out.

How does the designer tell the computer his problem? Easy, he simply telephones the computer and uses a thing called a modem (modulator/demodulator) which a standard telephone handset will sit in quite happily. He can also use a typewriter keyboard similar to the kind used in teleprinters. Thus any designer is no further away than the nearest telephone.

An interactive graphics terminal is available for circuit layout work. This is really a large cathode ray tube on which the designer can call up various shapes and pieces of circuit which he can then position very accurately with a light pen. He merely touches the portion he's working on with the light pen and points to the exact location he wants it and bingo—it's there immediately. Thus a designer can draw out a complex mask for an integrated circuit. When he has finished, he can ask the computer if there is a better way of drawing it, or if he has made any mistakes, etc. The system can then be used to provide masters for actually making the ICs. ■

LOOK!

PRACTICAL!

VISUAL!

EXCITING!

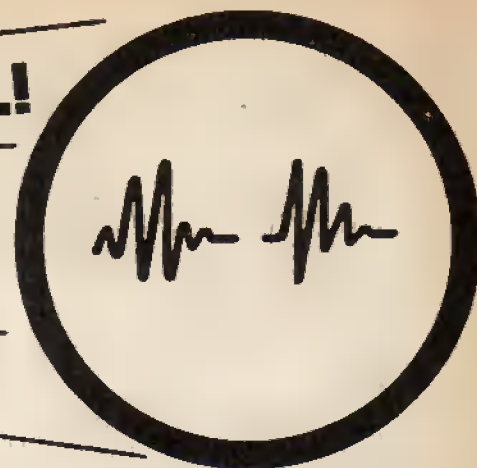

a new 4-way method of mastering
ELECTRONICS
by doing — and — seeing ...

1 ▶ **OWN and HANDLE a**

complete range of present-day **ELECTRONIC PARTS and COMPONENTS**

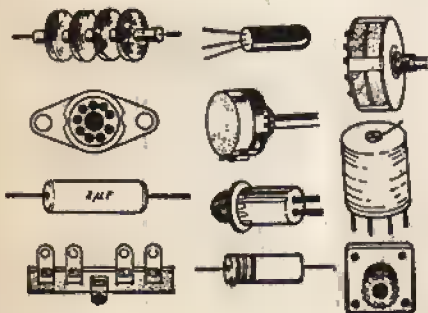

2 ▶ **BUILD and USE**

a modern and professional **CATHODE RAY OSCILLOSCOPE**

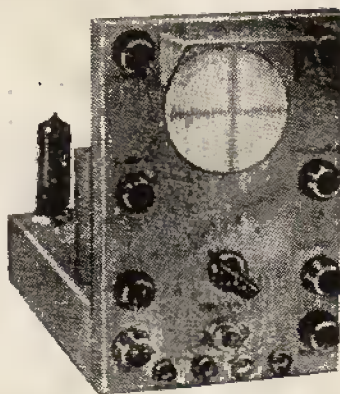

3 ▶ **READ and DRAW and UNDERSTAND CIRCUIT DIAGRAMS**

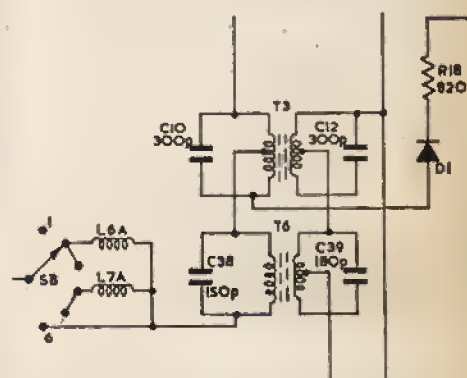

4 ▶ **CARRY OUT OVER 40 EXPERIMENTS ON BASIC ELECTRONIC CIRCUITS AND SEE HOW THEY WORK ... INCLUDING ...**

- VALVE EXPERIMENTS
 - TRANSISTOR EXPERIMENTS
 - AMPLIFIERS
 - OSCILLATORS
 - SIGNAL TRACER
- PHOTO ELECTRIC CIRCUIT
 - COMPUTER CIRCUIT
 - BASIC RADIO RECEIVER
 - ELECTRONIC SWITCH
 - SIMPLE TRANSMITTER
- A.C. EXPERIMENTS
 - D.C. EXPERIMENTS
 - SIMPLE COUNTER
 - TIME DELAY CIRCUIT
 - SERVICING PROCEDURES

This new style course will enable anyone to really understand electronics by a modern, practical and visual method—no maths, and a minimum of theory—no previous knowledge required. It will also enable anyone to understand how to test, service and maintain all types of Electronic equipment, Radio and TV receivers, etc.

FREE POST NOW
for
BROCHURE

or write if you prefer not to cut page

To: **BRITISH NATIONAL RADIO SCHOOL, READING, BERKS.** Please send your free Brochure, without obligation, to: *we do not employ representatives*

NAME.....BLOCK CAPS

ADDRESS.....PLEASE

P.W.4

LOW COST ELECTRONIC AND SCIENTIFIC EQUIPMENT AND COMPONENTS

SINGLE SPEED TAPE DECKS

After much effort we have obtained a further consignment of this popular single speed tape deck. Complete with Record/Replay heads, a separate erase head together with fast erase remote control facilities. A 1" single track on 7" spools 1 1/2"/sec. Three motor mains operated capstan. Buy now while stock exists. We cannot guarantee further supplies. Bargain Price £5.98.



NEW COMPLETE TELEPHONE DIAL ASSEMBLIES

Clear Perspex dial—100 markings. £0.88.



KEYNECTOR

Connects anything electrical in seconds without plugs or sockets. No more worries about dangerous live wires. Now you can make electrical connections safely, in seconds, with the revolutionary new Keynector. Cuts out plugs, sockets and saves time. A hundred different uses in the home, and a must for the do-it-yourself enthusiast. Only £2.58. Or send for a leaflet.

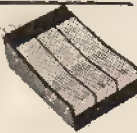

E.H.T. GENERATOR

Brand new D.C. CONVERTER. MULLARD TYPE 1049. INPUT 12V DC 0.3 amp. OUTPUT 1800V (min) at 1 mA. 2500V (min) on NO LOAD. Full spec. and circuit provided. Encapsulated module 1 5/8" W 2 1/4" H 1 1/4". Price £5.60 (p & p incl).

RIGHT ANGLED GEAR BOXES

Gear boxes give a drive of 14.5:1 at right angles to the input. Driveable through the 1/p shaft only. Dimensions 4" wide, 3 1/2" deep, 4 1/2" high. Robust construction in cast iron. Price £2.98, carr. £0.75.

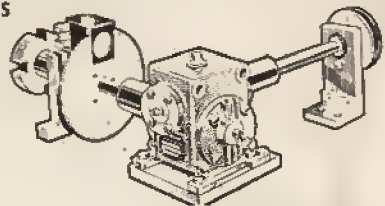

Suitable for rotating transmitter aerials.

MULTIMETER TYPE CT471B

Fully transistorized multi range instrument for measurement of voltage up to 1000 MHz (1500 MHz with reduced accuracy) and current up to 2 kHz and DC resistance. AC and DC voltage and current divided into 11 ranges. AC/DC volts 12mV-1200V. AC/DC current 12 μA-1.2A. DC resistance 5 ranges 0.1 ohm-1000 M ohms. R.F. voltages, 5 ranges 40mV to 4V. Battery powered. Offered in excellent condition. Tested before despatch. C/w handbook. £54.00. carriage £0.50.



NUMICATOR PRICE LIST

Quantity	Price each (less base)
1-3	£1.40
4-10	£1.35
11-25	£1.30
26-100	£1.20

Price Base. Bases £0.20 each.

Side Reading

Model	Lead Length	Color
XS3/FA	38m/m Lead	(Amber)
XS3/F	38m/m Lead	(Red)
XS3A/F	6m/m Lead	(Red)
XS3A	6m/m Lead	(Clear)
XS11/F	38m/m Lead	(Red)
XS23/FA	38m/m Lead	(Amber)

All Post Free

BATTERY-OPERATED TRANSISTOR TESTER—NEW

Type R2285 for checking leakage current and gain current of pnp transistors. Audio o/p Meter for calibration purposes. Price £5.0.

GRAMPIAN AMPLIFIERS

Type 385B 50W mains input, 200 ohm o/p audio power amplifiers. Only a few available. Selling well below the list price. £15.50 each carriage £2.00.

MINIATURE SQUARE COUNTER 6 DIGIT

By Veeder Root. Rotary ratchet type, adds 1 count for each 36° movement of shaft. £0.80.

BRAND NEW MOVING COIL DC TEST METERS

Compact and portable. W 2 1/4". H 1 1/4". D 3". In black plastic case. Available as follows: 3-0-3 Volts. Prod on Base. 0-15 and 0-300V Dual Range Voltmeter 0-3 and 0-300V Dual Range Voltmeter 0-7.5 Amps Ammeter. Our Price £1.75.

LINEAR THYRISTOR CONTROLLED LIGHT DIMMER—BRAND NEW

High grade full wave bridge circuit gives linear control of light brightness. Ideal for controlling room lighting and a.c./d.c. commutator motors fitted to portable electric hand drills. Fits standard 2in. conduit box. 240V, 50Hz, 400 W. Price £3.10.

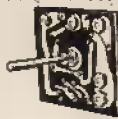

RESET TIMERS—ACRO TIMER BY HAYDON

Synchronous motor driven timer providing manual adjusted delay. Delay time is set on graduated dial. Press button closes contact and drives motor which drives an arm until it actuates the load switch. The cam then returns to initial position for repeat action. Various ranges available. 230V 50Hz Load contacts 15A 230V

ELECTRIC CLOCK MOTOR

NEW 200-250V, 50Hz, 2W. Synchronous induction motor. 2 revs. per hour. O/P shaft, 1/4in. dia. x 1/2in. long. Clockwise rotation. Three-holed mounting at 120° on 2in PGD. Price £1.25.

UNISELECTORS

New 6 Bank 25 way 50V 75 Ohms Make before break. Half circle type—2 sets of wider arms at 180°. PRICE £3.13. Miniature Uniselectors 3 Banks 12 Way 12V 35 Ohms. PRICE £5.25. Packing and postage free.

RAPID HEAT SOURCE . . .

from brand new Infra Red Tubular Quartz Lamps. Ideally suited as heat source for Drying Ovens, Egg Hatching, Incubators, etc. 240V, 1,440V, 20,000 Angstroms. Length 12in x 1/2in. dia. Price £1.00.

MEMORY CORE STORES

42 x 52-2K bit ferrite core store complete with 8 40A 10 load diodes. Ideal for building computer store or holding information in binary form. Price £2.83 post free.



Rx/IND APN-9

This is a combined swt tuned Rx and CRT Ind unit, the Rx section tunes approx. 1.8 to 2 Mc/s, uses tube 3BP1 3" green screen and 34 valves of the following types, 6SN7, 6SL7, 6H6, 5Y3, 6SK7, 6SJ7, 6SA7, VR105, 6Y6, 2X2, 6N7, also 100Kc xtal, Mu Metal shield, pots, swts, etc. Complete in case size 20 x 12 x 8" supply required 115v 400 c/s supplied new with magnifier, visor and circ. These units are well suited to scope conversion. Price £8 plus 75p carr.

TUNING UNITS

Type R.F.26 units these tune 50 to 65 Mc/s but can be modified up to 100 Mc/s fitted slow motion drive as 3 valves, I.F. O/P 7 Mc/s can be used with Rx that tunes 7 Mc/s supplied with circ good condition. Price £2.10 plus 40p post.

Rx UNIT 3645

This item is for use with the above RF unit or 24 unit, as 7 Mc/s I.F. strip with Det and O/P as high cycle P.U. requires 250v H.T. 80 Ma.—150v bias and 6.3v, complete in case supplied in used condition. Price £1.50 plus 75p carr.

TEST SET 210

Test unit for above RF unit or any equipment in range 20 to 85 Mc/s, this is a test osc that covers this range in 4 bands also as noise generator with 50 Ma meter, large S.M. dial 3 section Ae, 2Mc/s xtal check, requires 250v H.T. and 6.3v, supplied in case in good condition with cal charts. Price £3.25 plus 65p carr.

METERS

270 Deg. meter, meter 3 1/2" sq. basic movement 1.5 Ma, also available 6.5 Ma fitted range and on/off swt. Calibrated in Radio Altitude ideal for Rev. counters, supplied in new cond. Price 80p plus 15p post.

AMPLIFIER TYPE 1962

I/P 200/250v 50 c/s this is A.F amp in table cabinet, with 7 valves inc. push pull 6BW6, unit is fitted into monitor speaker and meter for monitoring valves. Main O/P is 600 ohm fitted on/off swt fuses etc., case size 19 x 12 x 10". Good basis for 10 watt amp with suitable o/p trans. Supplied in used condition. Price £4 plus 50p carr.

SPEAKER UNITS

Portable speaker in cabinet, size 18 x 18 x 6" fitted H.D. 8" unit 3 ohm also 600 ohm line matching trans and lead, supplied in new condition. Price £2.25 plus 65p carr.

MAINS TRANS

All 230v Pria C Cores. Type A. Sec 490-400-0-400-490v at 200 Ma, 5v 3a, 6.8v 4a, 6.3v 1.6a, 12v 1a, Price £2.25 plus 30p. Type B. Sec. 6.5v ct 5a 5 times will give 0 to 32.5v in 3.25v steps at 5a, Price £1.60 plus 30p. Type C. Sec 50v 1a, 6.3 .3a. Price £1.25 plus 25p. Type D. Auto 1.6 KVA tapped 190, 150, 110v, Price £4.50 plus 50p. Type E. Sec 12v 1.5a, Price 55p p.p. Note type D & E not C. core. All trans in good condition.

MISC. ITEMS

Osc. unit with valves 12AT7x3, EF91x2, LA2 pot core, jack sk, coax sk, 10 and 500K pots etc., new 70p, RF24 unit swt. tuned 20 to 30 Mc/s with circ. can be used with 3645 Rx above as 3 valves £1. O/P and Test unit modern unit with 2 vinkors 4 Sil P.N.P. transis, 4 miniature relays coil 1k 2p c/o diodes, min. valves, etc., new 85p. Meter 1 Ma edgewise scale Lin 0 to 2000 yds, size 3 x 1 x 3 1/4", tested £1. E.H.T. smooth cond. dual type .1 and .5uf 2Kv wk size 4 x 2 x 2" inc. term, 50p. Tube type 3BP1 with base and Mu Met shield 3" green screen ideal scope used with connections ex equip. Price £2.50p. Control unit with 2 500 Ua basic movement meters 3 yax swts. pots, close tol res etc. new £2. Mod. Kits with 8 group boards with approx 130 conds and res good quality, new boxed 80p. Handset G.P.O. style with press to talk swt in handle new, £1. Valves 6SN7 ex equip 5 for 50p. Amplifier A1413 I/P 230v with int P.U. as 6V6 amp 600 ohm o/p in case used cond. £2. Min plugs and sks 18 way 15p, 14 way 10p. Control panel with 15 min pots 1 meg. 100K, 1K all 1/2 shafts ex equip. 65p. Circuit Diagrams. 1392 Rx, 1475 Rx, 30p ea. Scopes Sol CD513.2 set of 3 circs, £1.50. 13A, 50p. Dumont 208 and OS-8, 50p ea. C.T38 Multimeter, 50p.

All the above prices inc. carr. or post. S.A.E. for list or enquiry Carriage charges apply mainland only.

A. H. SUPPLIES

57 MAIN ROAD,
SHEFFIELD S9 5HL

ELECTRONIC BROKERS (Dept. P.W.) 49-53 PANCRAS ROAD,
LONDON N.W.1 Tel. 01-837 7781 Telex. 267307

OPEN MON-FRI, 9-6pm

SHORT WAVES

MONTHLY NEWS FOR DX LISTENERS

THE first report for this month comes from new reporter **Steve A. Money** of Southsea. Steve has a Lafayette HE-30 receiver and a 50-foot long-wire antenna. He was lucky enough to be able to use a digital frequency meter to check the frequencies.

- 4110 *Urumchi, China* in Chinese at 2040.
- 4685 *Irkutsk, Siberia* in Russian at 2054.
- 4765 *RTV Congo, Brazzaville* in French at 1740.
- 4770 *ELWA, Liberia* in English at 0620.
- 4780 *Djibouti (RTF), Afars & Issas, French*, 1745.
- 4785 *Kunming, China* in Chinese at 0010.
- 4785 *Baku, Azerbaijan* in Russian at 1830.
- 4795 *Ulan Ude, USSR* in Russian at 0015.
- 4800 *YVMO, 'R. Lara'*, in Spanish at 2330.
- 4815 *Ougadougou, Upper Volta* in French, 2220.
- 4823 *Hanoi, Vietnam* in Vietnamese at 2230.
- 4850 *Nouakchott, Mauritania*, in French at 2215.
- 4885 *Novosibirsk, USSR*, in Russian at 2350.
- 4890 *VLT4, P. Moresby, Papua* in English at 2030.
- 4900 *YVNK, 'R. Juventud'* in Spanish at 0005.
- 4907 *Phnom Penh, Cambodia, Cambodian* at 2300.
- 4940 *Abidjan, Ivory Coast* in French at 2225.
- 4945 *HJDH, 'R. Colosal'* in Spanish at 0715.
- 4955 *HJCQ, 'R. Nacional'* in Spanish at 0015.
- 4965 *HJAF, 'R. Santa Fe'* in Spanish at 0700.
- 4970 *YVLK, 'R. Rumbos'* in Spanish at 2350.
- 4975 *Yaounde, Cameroon, vernacular* at 2115.
- 4980 *YVOC, 'Ecos del Torbes'* in Spanish at 2310.
- 4980 *Ejura, Ghana* with African music at 2200.
- 4985 *R. Malaysia, Penang* in English at 2345.
- 4994 *Omdurman, Sudan* in Arabic at 2130.
- 5035 *Bangui, Cent. African Rep.* at 2140.
- 5042 *Bissau, Port. Guinea* in Portuguese at 0035.
- 5051 *R. Singapore* in English at 2330.
- 5055 *Chita, USSR*, unknown language at 0045.
- 5095 *HJGG, 'Accion Cultura'* in Spanish at 2320.

John H. Saunders of Paekakariki in New Zealand sent in an interesting report on what can be heard in that part of the world, his log included:

- 5054 *R. Singapore*, English news at 1130.
- 6035 *R. Monte Carlo* in Italian at 0700.
- 6085 *DMR24, Munich, Germany, Home Sce.* at 0600.
- 6090 *R. Luxembourg* heard at 1730.
- 6540 *Pyongyang, N. Korea* in English at 1900.
- 9640 *R. Kuwait* with news in English at 1839.
- 9680 *TWR, Monte Carlo* in German at 0905.
- 11680 *BBC, London* in Swahili at 0330.
- 11765 *SBC, Berne, Switzerland* at 0600.
- 11765 *ETLF, Ethiopia* in French at 0400.

Graham Close of Diss in Norfolk is a new reporter and his equipment consists of a GEC 5-valve domestic receiver, a 75-foot long-wire and a TV antenna. His log included the following:

THE BROADCAST BANDS

Malcolm Connah

Frequencies in kHz ● Times in GMT

- 3338 *Radio Mozambique* at 1200.
- 5058 *Radio Tirana, Albania* at 2130.
- 6125 *Voice of America* with news at 0245.
- 6230 *Radio Tirana, Albania* at 0500.
- 9525 *Polish Radio* in English at 1645.
- 9625 *CBC, Radio Canada* in English at 0740.
- 11620 *AIR, Delhi* in English at 0900.
- 11710 *ABC, Australia*, sign-off in English at 1000.
- 11720 *R. Trans Europe* in English at 1000.
- 11795 *WINB, Red Lion, USA* in English at 2130.
- 11815 *TWR, Bonaire* in English at 0900.
- 11865 *R. Trans Europe, Portugal* at 1400.
- 11950 *NHK, Japan* with sign-off at 2130.

Colin Blanchard of Sutton Coldfield used his 5-valve domestic receiver and 50-foot long-wire to hear the following:

- 6025 *Radio Portugal* noted at 0210.
- 9660 *Radio Kiev, Ukraine* in English at 0100.
- 9805 *Radio Cairo* in English until 2300.
- 11765 *ABC, Australia, Sports News* at 0830.
- 11955 *BBC, Far East Relay, Tebrau* at 1815.
- 15320 *Radio Nederland, Bonaire* at 2015.
- 17710 *Austrian B.S.* in German at 1400.
- 17720 *WINB, Red Lion, USA* in English at 1815.
- 17740 *BBC, Atlantic Relay, Ascension Is.* at 1815.

John Young of Oxted in Surrey has a Pye domestic receiver which is 18 years old and 5 feet of mains flex as an aerial, with this combination he was able to hear:

- 5990 *CBC, Radio Canada* in English, 0715-0745.
- 6020 *Radio Nederland, Hilversum, English*, 0930-1050.
- 6025 *R. Portugal* in English, 2100-2130.
- 6135 *HCJB, Quito, Ecuador* in English, 0730.
- 6165 *SBC, Switzerland* in English at 1430.
- 7240 *Voice of the Palestine Liberation from Baghdad, Iraq* in English, 1900-1920.
- 7250 *Vatican Radio* in English, close at 2055.
- 7275 *RAI, Italy* in English, 1935-1950.
- 9625 *Radio Sweden* in English, 1100-1130.
- 9635 *R. Baghdad, Iraq* in English at 2010.
- 9715 *R. Nederland, Bonaire* in English, 0800-0920.
- 11735 *Moroccan R. & TV*, in English, 1700-1800.
- 11740 *ABC, Radio Australia* in English.
- 11750 *BBC, Far East Relay, Tebrau* at 1815.
- 11810 *R. Berlin International* in English at 2000.
- 11965 *Deutsche Welle* in German with close at 1810.
- 15235 *BBC, Atlantic Relay, Ascension Is.* at 1700.

All reports, which should be in frequency order, must arrive by the 15th of the month. They should be addressed to the author at 5 Ranelagh Gardens, Cranbrook, Ilford, Essex.

SHORT WAVES

THE AMATEUR BANDS

David Gibson, G3JDG

Frequencies in kHz • Times in GMT

IT'S been a fantastic month for the l.f. types with DX romping in from most parts of the globe. The h.f. bands have provided some goodies but twenty has developed its habit of dying rather early in the evenings. Ten metres is doing well but appears to be mostly North America. One solitary log arrived for two metres but surprise, surprise, someone sent in a 70cm log.

Details received about the WAB contests for 1971. These are: 14/21/28MHz March 14 (phone), March 28 (c.w.); 1.8/3.5/7MHz April 4 (phone), April 11 (c.w.); v.h.f. phone contest, June 20, any frequency above 30MHz. More details from **C. J. Morris**, G3ABG, 24 Walhouse Street, Cannock, Staffs.

N. Richardson (Bucks.), tells stories of a 46-element beam at 32ft. feeding a Garex 70cm. converter with a 9R59DE providing the eventual audio. Nick says that the crystal he is using is a bit near Channel 1 TV frequency and the result is nasty happenings on next door's telly. Despite this he managed to log six counties in one session. Call signs heard were: G3GWL, G3KPB, G3LQR, G3VZV, G8ACN, G8AEX, G8APZ/P, G8ATS, G8AUE, G8BBE, G8BJA, G8BGQ.

G. Richards (Isle of Wight), 4-over-4 slot fed, JXK converter, Mohican, sends details of calls heard on 144MHz. On a.m. and within a range of 60-90 miles: G2JF, G3FSA, G3NGK, G3UNT, G3XFW, G6LL, G8CEI, G8CHO, G8ECK, and on s.s.b. G3AKF, G3OUV, G3MCS. From 125-150 miles: G3DY, G3BHT, G3SBF, G6CW all s.s.b.

"We had the house rewired recently which knocked the RX gain up a bit", says **John Moore** from his Leicester shack. John's all-band log includes: 160-DL1FF, DL9KRA, GM3FSV, OK1AQW, OK1JAX, OK1JKA, OL4AMP, OL5ALY, OLØANU; 40-EA8HA, OL9LV, UL7AA, VE2APL; 20-CP6FG, CT3AS, FG7XT, FH8CY, FP8CS, FY7AE, M1I, OY3B, PY2PA, PY6HB, VE7IC, VP2AA, VP2VI, YV4TV, ZD7SD, ZL1AH, ZL4BO, ZMIABO, ZS1EI, ZS2MI, ZS5EY, 4M1A, 4U1ITU, 8R1U, 9Y4AR (all s.s.b.); 15-AX2AU, AX2AVT, VU2JM, W5ILR/TF, ZE2JA, 7X2ZHS, 9H1BP; 10-AX5MF, AX6CT, KV4AD, MP4BRA, SVØWBB, UA9WO, YV1ACX, ZE2JA, 9K2AL. Gear in use is a CR100/2, a.t.u. and 130ft. long wire plus one pair of earholes Moore type Sharp Mk1.

How low can you get? Not much lower than 1.8MHz in Amateur terms. That's just what **J. Leaver** (Lancs.) did. Jim has a homebrew (good lad Jim) receiver, a.t.u., 100ft. of wire round the loft and an earth mat 20ft. square and 3ft. deep (he's the only man I know who uses a spade for spring cleaning). Topband c.w. log reads; DL1HS, DL9KRA, GD3DB, GM3OXX, GM3YCB, K8DBI, OK stations 1ARI, 1ATP, 1ATY, 1DJD, 1KRS, 1MLJ, 2BFN, 2SIX, 3KAS, 3KWO, 5VSZ, OL1AMR, OL4AMU, OL4AOK, OL7AOU, PAØPN, UR2CXY, WIHGT, W3ANO, W3GM, W8KFX, W9UCW.

"I know my writing is terrible", comments **P. Harris** (Lincs.). Deciphered Harris heiroglyphics inform of the following signals on 80; CT2BC,

DUIFH, EA8MA, ELØK/5A1, EP2DX, ET3USA, FP8AP, MP4TDT, ON5DO/P/AP2, TA2BK/P/1, UAØADO, UF6DR, UI8LM, VE1AX, VE2WF, VE3PT, VP2VI, VS6DO, ZC4JW, 3V8AB, 7X2OA, 8P6DO, 9K2AL.

C. Henderson (Kent), B40, 120ft. end fed running NW/SE, went s.s.b'ing on 3.5MHz. Fruits of his labours include; EA3QW, EA6BN, K7H NJ, KX6BX, LU7AAC, LX1BJ, OD5BA, OX3WX, OY2R, OZ1LO, VE1IE, VO1FG, VO2DC, VS6DO, W2HCW, W3AZV, ZB2A, ZC4IK, ZM4KE, ZM4LM, 6W8DY, 9K2AZ.

T. Thornton (Berks.) says that 80 is providing nearly as much DX as any of the h.f. bands. He gives a list of times (GMT) when to listen as follows; 0800-1700 for Far East and Oceania, 0600 for North and South America and 2000 for South and East Africa and the Middle East. Tim's log for eighty reads; ON5DO/AP, CO2FA, CT2AK, DUIFH, EA6BN, EP2TW, ET3USA, FC2LG, FC8AP, HC1RF, HC2HM, HC2GG/1, HK3AVK, HK6BRK, HP1JC, HT1BW, IRØWX, IS1FIC, IT1ZGY, JX3MN, K5MU, LU7AAC, OD5BA, OX3WX, OY2R, PJ7JC, PY7ASQ, PZ1AK, TA2BK/1, K2LQQ/TF, TI2CF, VE7ZM, VO2JC, VP2MRK, VS6DO, VP2VI, XE1CE, YV5BQV, ZB2A, ZC4JW, ZL4NH, ZM2BCG, ZM2BHX, ZS1MH, 3V8AB, 3V8AL, 6W8DY, 9K2AL and 7X2OM on c.w.

R. Mortimore (S.Wales), has an H.A.C. one-valve receiver plus a three-transistor amplifier. A listen on 14MHz revealed; ET3USA, JA1KAV, KL7BK, KP4AST/M, VE1ASY, VE3FSV, VE7HP, VE9AT, 5H3MB, 7Q7LA, 8P6CC.

A. Crooks admits to lurking in Teeside but did a quick flit back to sunny Leicester. Stations heard on 21MHz while sunning himself in the warm winter sleet include; AX2XT, AX3ZJ, MID, OA8I, PY4BO, VK2FU, VK5FM, W5RG, WB6NVW, YV5BPG, ZL4HE, ZS6QD, 3V8AL, 7X2HS, 7X2OM. Equipment used was an RA1, PR30 and 33ft. of wire draped round the room.

Enter **P. Beeson Esq.**, (Staffs.) complete with HA500 and 61ft. end fed. Fifteen metre squeaks from; CE3JY/P/WC, ET3USA, JA3DNL, KP4DCR, KR6EZ, KR6IL, PJ7JC, SV1CB, VE3XX, VE6AWC, VK2FU, VK6WV, VS6BE, VS6DO, WA9YGT/KG6, ZL2TA, ZL3FO, 3V8AL, 4Z4HF, 7X2OM.

D. Robbins has been looking through a general list of call-sign country locations and finds that the UK has a nice little bunch from 2AA to 2ZZ. He suggests things like GRO for Rockall and GDO for the Isle of Dogs but I think F1DO would be better. Fifteen metre log using a CR70A and 70ft. end fed reads; CN8CS, CR6DB, CR7CH, EL2BA, G2MI/VP9, HC2HM, HR1KS, thirty seven JA's, KG4AM, KR6BD, M1B, VK2NN, PJØDX, PZ1DA, TG9MD, VP7DL, VP9GE, YN1CG, ZL3JC, ZL3SO, ZM3OH, ZP5FH, ZS6AXL, 3V8AL, 5U7AW, 5Z4KC, 7X2ON, 9Q5DL.

Logs for the Amateur Bands must arrive before the 15th. of each month. The address is: 12 Cross Way, Harpenden, Herts.

Send for your copy of the HEATHKIT 1971 CATALOGUE it's FREE on request



MARINE



SPEAKERS



CONSUMER

SHORTWAVE

HI-FI AND AUDIO

R/C MODELS

Here's the bumper Heathkit catalogue for you. Read about the wonder and fascination of kit building . . . see in full colour the world's best values in Hi-Fi . . . Radio, and even model radio control. Get up to date with what's new in scientific instrumentation . . . instruments for test and service . . in fact there is a Heathkit for almost every purpose, in every walk of life. A wealth of information is all yours for the price of a postage stamp, in the Free Heathkit Catalogue.

- ★ No previous knowledge of electronics required.
- ★ The constructional manual supplied with every kit shows you how.
- ★ Building Heathkit models is so economic.
- ★ Save up to 50 % over factory built equipment.
- ★ Money saving direct from factory prices.

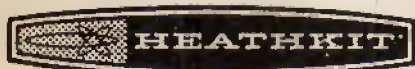

A Schlumberger Company

HEATH (Gloucester) **LTD,** GLOUCESTER GL2 6EE

(In block capitals)

Many other models in wide range . . .

**FILL IN THE COUPON FOR YOUR
FREE CATALOGUE TODAY.**

Name

Address

Post Code

51/4/71

MW/LW TRANSISTOR RADIO



Complete set of parts for this MW/LW Transistor Radio. Originally sold by world-famous company as a set for more than £17. Coverage 192-555m + 1070-1870m. 4 1/2" loudspeaker. Transistors 3 x AF117, OC81D + 2 OC81. Also works off car-aerial. Full instruction book 12p free with parts. State preference red, blue or tan and give alternative. Requires PP7 battery, price 22p extra. All parts £6-87 1/2 + 22p post or £10-50 fully built + 22p post. A few left of Super Six Kit (see previous issues) at £4-25 (+ 22p post). 9 volt 6 transistor superbet using 3HP AA17 in RF and IF stages powered by a two stage AF amplifier using OC81D. 2 x OC81. Output approx. 500MW.

STEREO AMPLIFIER type HV— 2 x 3 Watts

Fully built. On off sep. vol. and tone each channel 1 1/2 x 4 1/2 x 6in. high. EZ80, 2 x ECL86; for 3 ohm speakers, double wound main trans; fixing flange and base plate, suitable for crystal cart. tuner etc. £6-50 (40p p. & p.) 200-250V. A.C. Superior version — separate base, treble & vol. each channel with mono/stereo switch 75p extra.



MULLARD STEREO "DO IT YOURSELF"

Pre-amplifier EP9001 £3-10 2 amps. EP9000 £2-90 each. Power Supply EP9002 £4-60 Control panel £2-50 or the lot for £15-50 post paid. Booklet 25p (2 1/2p post)



MONO GRAM CHASSIS 3 WATT

3 Wave band long-med-short. Gram., 200-250V A.C. Ferrite aerial. Chassis 13 x 7 x 5in. Dial 13 x 4in. Double wound mains transformer 5 valves ECH81, EF89, EBC81, EL84, EZ80. Price £10-62 1/2 (37 1/2p p. & p.) Output trans. for 3-ohm speaker

NEW TAPE AMPLIFIER for 4 track B.S.R. Deck TD2. Mains and output Trans. 10" x 6" x 4" overall. Rect; ECC83, EL84. Mike and Gram Inputs. £7-25 (50p p. & p.) For 3-ohm speaker. (For 200-250V. A.C.)

6 PUSH-BUTTON STEREOGRAM CHASSIS

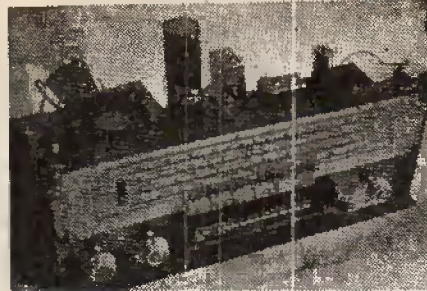

M.W.; S.W.1; S.W.2; V.H.F.; Gram: Stereo Gram Two separate channels for Stereogram with balance control. Also operates with two speakers on Radio. Chassis size: 15 x 7 x 6 1/2in. high. Dial silver and black 15 x 3in. 190-550M; 19-51M; 60-187M; VHF 86-100 Mc/s. Valves. ECC83, ECH81, EF89, 2x ECL86, EM84 and Rect. Price £19-95 carr. paid With Stereo Decoder fitted £7-50 extra.

1 1/2W MAINS GRAMOPHONE AMPLIFIER

EZ80, ECL82, O.P. Transformer (3 ohm). Vol./On-off and Tone Control. Double wound mains transformer. 2 1/2 x 2 1/2 x 2 1/2in. separate but wired to chassis, 4 x 2 1/2 x 4 1/2in. over valves £3-37 1/2 including 5in. Speaker (£2-75 less speaker). (Post paid.) (Two less 10%)

SINCLAIR AMPS & PRE-AMPS IN STOCK. RETURN OF POST SERVICE.

MAINS TRANSFORMERS (200-250V AC INPUT)

Postage in brackets. 6-3V at 2 1/2A 37p (10p) Out 250V at 50mA and 6-3V at 1 1/2A. 50p (12 1/2p). 22V at 1A + 6-3V at 2A and 250V at 50mA 75p (17 1/2p). 250V at 40mA, 24V at 1A and 6-3V at 1 1/2A 62p (12 1/2p). 250V at 50mA, 22V at 1A and 6-3V at 1 1/2A 87p (17 1/2p). 90V at 20mA and 1.4V at 250 mA 50p (12 1/2p).

USEFUL BOX 3 1/2" x 3 1/2" x 1 1/2" with fixing bracket 12 1/2p (Postage 10p). £1-25 per dozen post free. Metal with grey-green finish.

Complete set of parts with wiring diagram for battery eliminator to give 90v. H.T. at 20-30mA. and 1-4v. at 125 or 250mA. (adjustable). With undrilled aluminium box approx. 6 x 3 x 3", trans., choke, two rectifiers, condensers and plugs and sockets. Price £2-75 plus 25p p. & p.

French made (AMEC) relays. 9-contact changeover. 6v. d.c., 6-3v. a.c., 24v. a.c. or 220v. a.c. Size of enclosing perspex shroud 2" (plus pins) x 1 1/2" dia. Price with octal base valveholder 75p (6 for £4-00) plus 12 1/2p post any quantity.

GLADSTONE RADIO

66 ELMS ROAD, ALDERSHOT, Hants.

(2 mins. from Station and Buses). FULL GUARANTEE. Aldershot 22240 CLOSED WEDNESDAY. S.A.E. for enquiries please.

CHROMOSOMIC SOUND OPERATED LIGHT DISPLAY

This compact unit (size 8 1/2" x 5 1/2" x 3" high) is connected directly across the speaker output of an amplifier, it will then convert audio signals into a spectacular three colour light display (500 watts light output each colour) Send S.A.E. for further details. £18.50 P. & P. 87p Please call in No. 11 for demonstrations.



CRESCENT RADIO LTD

11 & 40 MAYES RD LONDON N22 6TL 888-3206

PLEASE NOTE PRICES IN DECIMALS

TRANSFORMER SCOOP

Primary 110, 220, 250 v. fused. Secondary 220 v. at 50mA, 6-3v. at 1 amp. Overall size 2 1/2" x 2" x 2 1/2" high. 62 1/2p each. P. & P. 15p.



CARTRIDGES Stereo Magnetic Teleton NM33 £3.97 Goldring 890H £7.50

BSR Type Replacements TCS Mono XTAL £1.37 TCS Stereo XTAL £1.97 X3H Mono Compat XTAL £1.37

BARGAIN COMPUTER BUMPER BOARDS

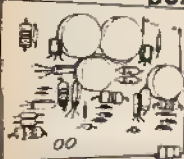

Many Resistors, Condensers, Diodes and Transistors (minimum of 4 transistors on each board). 5 BOARDS FOR 120p. Post Free.

ACOS STETHOSET

Used but in good condition. For personal listening and monitoring with tape recorders, transistor sets and record players. 200 ohm DC resistance. 5 ft. lead. 30p. Postage 7 1/2p.

MAIL ORDER DEPT. No. 11 MAYES RD, LONDON N22 6TL

E.M.I.

450 150 3,8,15 3,8,15 OHM 10 OHM 10 10 watts 13" x 8" dual cone £2.50 p. & p. 37 1/2p.



CHROME TV STAND

28 x 8 1/2 x 16in. high. This modern design TV Stand would make an ideal base for a coffee table and is a bargain at 162 1/2p. Post 25p



MOTOR Rated up to 11.5 volt 400mA. Size 1 1/2" long, 1/2" dia. Shaft 1/8" long 22 1/2p Post 2 1/2p

SOLID STATE BLOCK MODULES

Phone pre-amp E1311 Input 100k: gain 26dB max out 3 volt: max input 50mV. Tape pre-amp as above E1313. Power amp E1314 Input 1,000 ohms gain 20dB 300mW. Organ tone osc E1315 tone freq. 200-1k. Hz output 80mW. All above modules 9 volt. Dual flasher E1318 flash time 1-4 secs power 6 volt. Lamp 6v 150mA. All at £1.25 P. & P. 10p



LIGHT DIMMER

The unit comes complete with MK Ivory Front Plate and Control Knob, when used in place of Light Switch it will control your room lighting from, off to full brightness. Power—up to 300 watts interference suppressed

£2.75 + P. & P. 7 1/2p.

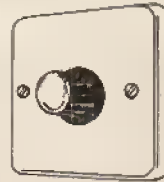

SHELF UNIT

Two teak finish shelves on a black frame (overall size 28" x 25" x 12" deep). This unit is wall mounting. 250p. Postage Free



DWELL TIME UNIT

These small units contain the following components: 700 ohm DPDT relay with base, 1µF 250v. paper, 0.01µF 400v. paper, 50µF 35v. electrolytic, 3 diodes OC200 transistor, a 2N2928 type transistor unmarked, a skeleton pre-set pot, 4 pin din plug & skt., 4 foot of 4 core screen. All housed in a small neat metal box. Can be made into many timing devices. 42 1/2p + P. & P. 7 1/2p



IMPORTED PANEL METERS

KA-35C 1 1/2" x 1 1/2" 50µA, 100µA, 500µA, 1mA, 5mA. S meter 1mA, 300v. All at £1.47 1/2 Plus 5p P. & P. KA-65C 2 1/4" x 3 1/4". 300v., S meter 500µA, 1mA. All at £1.97 1/2 Plus 7 1/2p P. & P.



COMPONENT CENTRE

8" x 6" one sided printed circuit board 10p each BY100 type rectifier 800 piv 750mA 18p each 4-pin transistor holders .. 2 1/2p each 2 1/2" 80 ohm loudspeaker .. 27 1/2p each 2 1/2" 8 ohm loudspeaker .. 32 1/2p each 2 1/2" 25 ohm loudspeaker .. 27 1/2p each U2 battery holders (blue plastic) .. 5p each 10 ohm w/w pots .. 12 1/2p each OC81 double heat clips .. 2 1/2p each Tape recorder rev. counters .. 25p each

Please include P. & P.

STEREO HEADPHONES

All Types 8 ohm S116 50 .. £2.37 DH623 illus. .. £2.97 SDH7D .. £4.00 (22:2—with volume controls on each ear £5.50 SDH205V—Good quality with volume controls £8.50 Postage—20p on all types.

G.E.C. RATCHET RELAY No RELIA/008/07 Coil—375 Ω 3-make break contacts. 1-changeover. All New and Boxed. 30p. each. Post 5p.

FLICK SWITCHES

250 volt 3A. Single Pole on-off. 1 1/2" nylon Toggle. 17 1/2p Plus Postage 5p



TAKE 20

JULIAN ANDERSON

A series of simple transistor projects, each using less than twenty components and costing less than twenty shillings to build.

HAVE you ever heard the ladies of the house let out a yell because the washing is out and it has been raining without anyone noticing?—or have you ever had to cope with soaking deck-chairs? Well, this month's project should put a stop to all that for it is a fairly simple rain alarm that will sound a "hooter" as soon as the first drop of rain reaches a sensor.

It is of course no good having such a device unless you can leave it on for long periods without the battery running down. The circuit used here draws so little current in the stand-by condition that the battery will suffer a natural death long before the circuit runs it down. An on/off switch has been included to enable the alarm to be turned off once it has been sounded otherwise you would have to put up with the "hooter" until the rain was stopped and the sensor dried out.

THE CIRCUIT

The key to the whole operation is the use of silicon transistors throughout with their almost negligible leakage currents—a germanium transistor version of the circuit would be operational all the time and obviously be useless.

Tr1 is the "switch" which is triggered by the rain. Rainwater, although very nearly distilled water and

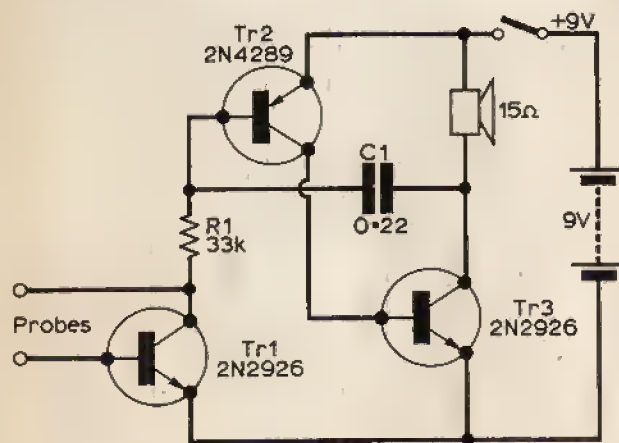

Fig. 1: The circuit of the Take 20 rain alarm

therefore not nearly such a good an electrical conductor as tap-water, has a definite resistance which is arranged to connect between the collector and base of Tr1. This will allow current to flow and allow Tr2, which is a low-cost p-n-p silicon type, to be biased into conduction. This in turn biases on Tr3 and a pulse of current is passed through the loud-

No. 24 RAIN ALARM

speaker. The base of Tr2 and the collector of Tr3 are in phase and by connecting a capacitor, C1, between them we have an oscillator which will produce an audio note in the loudspeaker as long as Tr1 is turned on.

As we have seen, Tr1, when switched on, sets up a chain reaction turning the other two transistors on and into operation. R1 is included, for, if Tr1 was completely switched on, damage may occur to the other transistors. Its inclusion only means that the minimum resistance between the base of Tr2 and battery negative is limited to 33kΩ.

When Tr1 is off (that is with nothing between the probes) the only current drawn is the leakage of the three transistors which is so small that we can forget it.

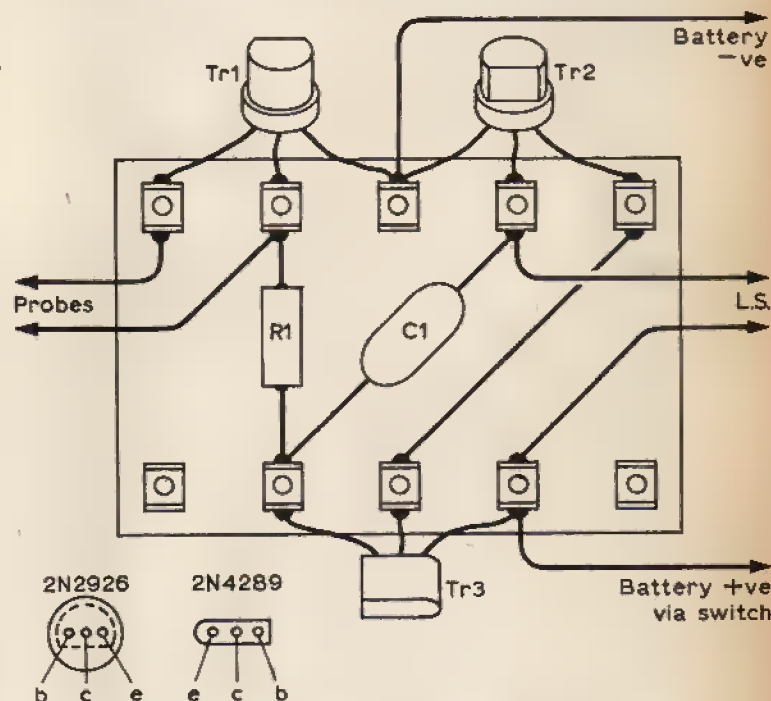

Fig. 2: A suggested component layout on a small tagboard.

CONSTRUCTION

A suggested layout for the components is shown in Fig. 2, the three transistors together with R1 and C1 are mounted on a tagboard. The probes can be made in a number of ways for it is only necessary to arrange for water to complete a conductive path between them. A sheet of plastic to which a piece of blotting paper has been glued with the probes pushed into the blotting paper works very well but will not last all that well. Alternatively a small piece of Veroboard can be used, one of the probe wires going to every second copper strip, the other probe connecting to the others. However, there are lots of ways for arranging for the rain-water to complete the circuit and with a little ingenuity you should be able to think up one of your own.

The COMMITTEE 'SUPER-FET'



UNDERCOVER
PROJECT

SOMEONE, somewhere, remarked that PW ought to consider publishing an article on a piece of equipment designed as a joint venture by the leading regular contributors. It needed only malicious encouragement, coupled with a subtle admixture of coercion, bribery and blackmail, for Mr. Eeven Steeven to find himself forming a small committee for this purpose and as a result of a second-generation application of coercion, bribery and blackmail, to discover that the following running order of volunteers had agreed to join him in this formidable and noble undertaking.

THE EXPERTS ASSEMBLE

The following have arrived:

Eric Foulpest, (G4NGB), Julius Andyman (of "Take 40" and "You too can build a computer for six and tuppence" fame), L. A. J. ("Icky") Iceland, Downy Arthur and Rickey Colins (founders of the PW Darby and Joan Club), A. S. Bricklayer (G8 and Bar), Rave Glibson (author of "Tahiti on a Hat-pin or Bust"), Salvador Hogshead (of no fixed abode).

Starting prices: Foulpest 2/1 favourite, Andyman 5/2, 100-8 the field. Arthur and Colins wear blinkers.

The following declined to support the project for reasons too numerous and scandalous to mention: Mr. F. Greyer, Q. Cameron-Highlander, Randy Lester ("The Electronic Entrepreneur"), J. Thornton Lawrence of Arabia and Aberystwyth (henceforth referred to as J. T.), Malcolm Conman ("DX on a G-string"), R. F. Gravyboat (author of "Up the Spout"), F. C. Judder and M. Wallis-Collection ("The Testmaster in sickness and health").

A special sub-committee was also formed to liaise among themselves and with powers to mind their own business. This comprised: Henry (to make rude remarks), Pax (to do the doodling), Maxwell (to make the coffee) and the office boy (to sweep up spare committee members). Components were obtained from Steptoe's Surplus Stores. Gowns by Renta-Rag Ltd.

MOMENTOUS DECISION

At the first meeting Mr. Steeven appointed Mr. Steeven as Chairman of the Committee with sole discretionary rights to abandon the project at the slightest provocation. The Committee then adopted the motto *Nil Nijinsky* which, for the ignorant is an allusion to the ancient precept that a camel is a horse designed by a committee.

During several sessions, each followed by a "session", various proposals were put forward—and then pulled back. Messrs. Colins and Arthur suggested that if it was not going back too far the committee might consider resurrecting a classic receiver design of the early '20s. The Chairman asked if they meant the 1820s or 1920s.

Mr. Iceland was soon up in arms at the idea remarking that readers would probably take such a set to be an Ancient Monument. However he would agree to any other suggestion provided it was for a disintegrated digital clock using nine NAND/AND and four EITHER/OR TTLs with positive flip-flap readout, which he happened to have in his junk box. During questioning Mr. Iceland agreed that he had the copy ready for such a project but had hesitated to submit it to the Editor fearing it might be below the usual standard of material in the magazine.

The Chairman remarked that nothing could be lower than the present level. (Applause and cries of "Resign").

COST FACTOR

Mr. Andyman supported Mr. Iceland's project with the proviso that the total cost to the reader should not exceed 20p. Nor should it use more than 20 components. After allowing for the nine NAND/AND and four EITHER/OR TTL's it should be possible to complete the design with not more than seven other components. Mr. Iceland's remarks are not recorded but it is understood that he muttered something about £200 and 2000 somethings.

Mr. Hogshead also approved of the disintegrated clock concept provided he was allowed to design the peripheral hardware for the necessary testing of the clock. He was prepared to completely re-design and up-date his VCR97 oscilloscope, his ultra-linear wide-band total distortion amplifier (EF50-EF50-EF50-EF50-PX4-PX25-DA100) and his guitar amplifier

which he had never got around to using anyway. Off the record, the walls of his flat had caved in and collapsed when he first turned up the wick on the 50W job but his wife had blamed it on the Concord/Concorde (this is for our French reading reader).

THE TENSION MOUNTS

At the 54th. session of the Committee it was reported that the Editor was getting a little nervous and impatient after waiting so long for the promised article and anyway he was constantly complaining of cramp in his fingers from the signing of the steady stream of allowance claim forms from a slightly unsteady Committee. The Art Director reported that so far he had not received any instructions on the artwork for the article.

Eric Foulpest thought that the clock idea was "all right" if the output of the clock could be used to drive a series of 10kW power amplifiers to radiate time signals at the bottom end of each amateur band from 1.8 to 2300MHz for 24 hours a day. It was also desirable, he said, to be able to direct the output of all the amplifiers onto the frequency of any pirate station in any amateur band.

He was willing to accommodate the entire equipment at his own QTH in return for which service he would expect to be allowed to use the equipment during contests with the power input reduced to 150W of course and to 10W on Top Band, naturally. (He's got to be joking! Ed.) Mr. Glibson commented that after listening around the bands recently it would be all contests and no time signals.

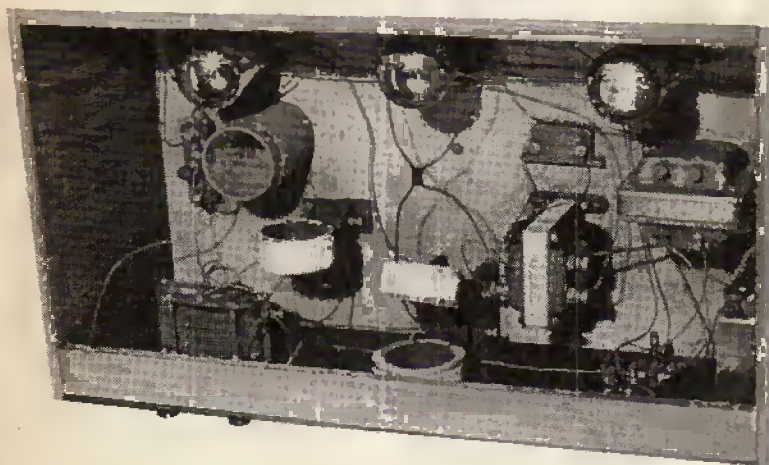

This excellent shot reveals the ingenious hybrid circuitry of the "Super-Fet". The familiar ST2-TD2-ZD2 line-up is followed by a DITTO2U2 audio gain-block located in the very centre of the layout. The plug-in power supply can be seen in the bottom righthand corner. The signal input attenuator is at the extreme left centre. (Photographs courtesy PW Space Centre).

THE BIG RE-THINK

At the 73rd. session Mr. Glibson submitted that all previous proposals should be forgotten and a fresh start made. The Committee agreed and went to lunch, then tea, then supper and so to bed.

Mr. Colins admitted that he had not really been paying attention at the previous meetings being mostly pre-occupied with his love life and his new house. He volunteered to write an article describing a bed, a vast bed, with a giant console from which he could control all the curtains, all the doors, all the radios and the TV's not to mention the tea-maker. Trouble was that he'd have to get out of bed to

service the equipment but he was working on that problem.

The Chairman interrupted Mr. Colins to remark that if Mr. Colins cared to submit his plans...but Mr. Colins cut in to say that he was not going to submit his plans to anybody especially as he was getting married soon.

Mr. Bricklayer arrived in time for the 99th. session of the Committee and apologised for his absence from the previous meetings. Without any further ado he proceeded to outline briefly the circuitry for his 64-dollar (sorry-transistor) *Super-Fet All Band Receiver*. Four hours later the Committee approved the design for publication without further discussion.

Circuit

The circuit is the same as the physical layout which can be seen in the photograph of the *Super-Fet*.

CONSTRUCTION

The layout is the same as the circuit which can be seen in the photograph of the *Super-Fet*. The only component worthy of comment is the band switch which has the following positions:-

- Band 1. Vienna Philharmonic.
- Band 2. Foden's Motor Works.
- Band 3. Plastic Ono.
- Band 4. Carrol Gibbons and the Savoy Orpheans.

TESTING

Don't bother to check the wiring, it won't work anyway. Connect up a 9V non-polarised battery, stand well back and switch on. Go out and buy a kit set.

CONCLUSION

If you want to do an article for PW but can't think of a subject, dream of all the things you'd like to make for yourself and then pick on something else. Above all else, don't make the mistake of doing this on April the First. ■

WHAT'S IN THE MARCH TELEVISION ?

(On sale March 8th)

■ HELICAL-SCAN VTRs

An upsurge of interest in videotape recording seems imminent. For amateur and semi-professional use this means the helical-scan v.t.r. Just what are the problems?

■ DIGITAL IC's

The price of digital i.c's has fallen very substantially in recent months so the time is ripe for their exploitation by the amateur constructor. A detailed account is given of their characteristics and their applications.

■ SERVICING TV RECEIVERS

Our series on TV receiver servicing continues with the Decca DR100/101 series of dual-standard models.

Britains most popular kits..

Heathkit the beginner as well as the experienced mans first choice. Want to know more . . . the unique Heathkit one-step-at-a-time construction manual is your guarantee to kit building success. To see for yourself how easy it all is, simply order the manual for the model of your choice (price only 10/- each). If you order a kit at a later date the manual price can be deducted. Your first step is to send for the Free catalogue, yours for only the price of a postage price stamp.

Stereo Record Player



Exciting Sound — Budget Price
Kit: K/SRP-1 - - £32.50
Carr. 80 NP

'SEVERN' AM/FM Radio



Beautiful Looks — Luxury Sound
Kit: K/SEVERN - - £19.90
Carr. 50 NP

Powerful Car Radio



Heathkit Value—Powerful Output
Kit: K/CR-1 (Less Speaker) £13.80
Carr. 30 NP

30W Stereo Amplifier

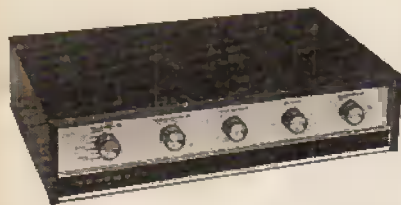

Stereo Gram, Radio, Aux inputs
Kit: K/TSA-12 £36.00
(cab extra) Carr. 50 NP

Economy SW Receiver

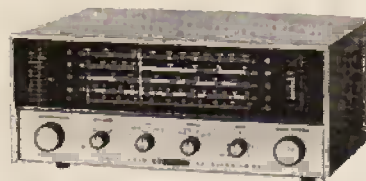

World-wide Reception
1 to 30 MHz plus 550-1620 KHz
Kit: K/GR-64 - - £25.00
Carr. 50 NP

Stereo tuner/amplifier



One of todays best values
Kit: K/AR-14 £59.00
(cab. Extra) Carr. 60 NP

Portable 'VVM'



For Hobbyists — Householders
Kit: K/IM-17 - - £17.30
Carr. 30 NP

Ambassador Speaker

Remarkable sound quality for its price



Kit: K/AMBASSADOR £33.00
Carr. 80 NP

Auto Tune-up Meter



For D.I.Y. Car Mechanics
Kit: K/ID-29 - - £15.80
Carr. 30 NP



A Schlumberger Company

HEATH (Glos.) LTD.
GLOUCESTER GL2 6EE

Many more wonderful kits to choose from

Please send me FREE Catalogue

NAME.....

ADDRESS..... POST CODE.....

Prices and specifications subject to alteration without notice.

51/4/71

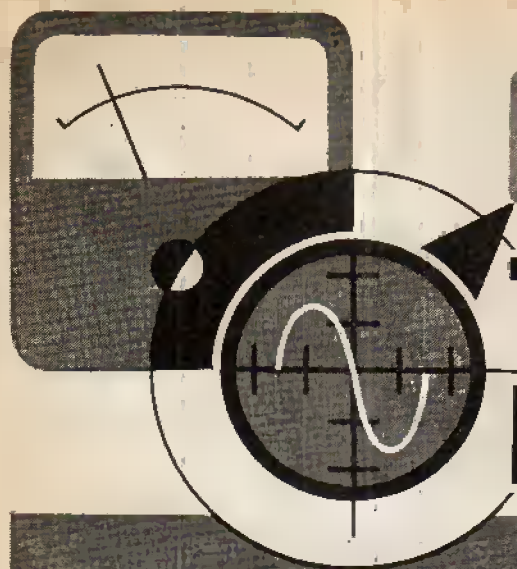

GUIDE TO TEST INSTRUMENTS

by **GORDON J. KING**

THIS supplement is designed to herald a new series of articles focussed on radio and audio servicing, starting next month. The servicing series will be handled by colleague H. W. Hellyer (Mac to his mates and the author of the recently acclaimed *Tape Recorders* book by *Fountain Press*) and yours truly, and between us we shall be exploring the theoretical and practical aspects of radio and audio equipment servicing, taking in the ordinary radio receiver as well as the more exotic hi-fi receiver (tuner-amplifier?) along with audio amplifiers and tape recorders, with Mac concluding the series on the latter note and reflecting his vast experience in the fields of tape recording theory and servicing.

We shall also be unweaving the enigmas of valve and transistor theory while introducing practical relationships. We shall demonstrate contemporary testing procedures, tell how to work out component values, delve into the mystery of multiplex f.m., introduce hi-fi specifications, have a look at pickup theory and practice; in fact we shall be embracing as widely as possible the entire area of 'servicing' and in order to do just that we might well find it necessary to split all or some of the five parts into two sections to yield a desirable balance between theory and practice.

Although the actual *using* of test instruments will be adequately highlighted in the series, such things as instrument basics, what instruments are available, what they do and how they do it, their salient features, respective importance and so forth will not be included. This is where I come in with this supplement, the plan being to set the instrument stage, so to speak.

There has been little intrinsic change in instruments over the decade. We still have meters for measuring voltage, current and resistance by means of a pointer; and we still have instruments for generating various types of signal, pure tone, pulsed or modulated. The versatile oscilloscope is still the same. There is still the cathode-ray tube with its pin-point of light which, under the control of a suitable timebase, traces out the signal waveform on its screen.

TEST METER SENSITIVITY

Nevertheless, there has been change, but of a detailed rather than intrinsic nature. Change has been necessary, of course, to enable servicing and testing to keep abreast of the rapidly developing state of the art. For example,

some of the early multimeters are now singularly unsuitable for accurate fault diagnosis, testing and adjustments in some of today's solid state equipment. This applies both to the d.c. and a.c. aspects. Transistors and integrated circuits commonly run on smaller voltages than valves, and the currents in some of their circuits are remarkably small meaning the voltage dropped across resistive elements is also of a small magnitude. Thus our test-meters nowadays need to measure very small voltages over a substantial length of scale to maintain accuracy of readout. Moreover, as small voltage settings on such instruments reflect a reducing shunt resistance across the test circuit, the sensitivity of the movement itself must be higher than considered adequate in the valve heyday. Thus while we used to get by with a sensitivity of around 1,000 ohms/volt, we now require a sensitivity of at least ten times that value. Fortunately, development has been on our side, and we can now obtain quite a fair 10,000 ohms/volt species for a relatively modest outlay. Indeed, models are available up to 100,000 ohms/volt.

Current taken by a d.c. voltmeter merely follows Ohm's law. For example, the resistance of a movement giving a full-scale deflection of 1V when passing 1mA of current must be 1,000 ohms. The test circuit will then 'see' a shunt of 1,000 ohms; moreover, it will have to yield the corresponding power to cause the pointer to swing full-scale. If this meter current upsets the circuit conditions the measurement will be in error.

A voltmeter like that has a sensitivity of 1,000 ohms/volt for obvious reasons. If the full-scale deflection is geared, say, to 100V, then series resistance would be included to increase the total resistance as 'seen' by the circuit to 100,000 ohms. But the sensitivity would still be 1,000 ohms/volt. Sensitivity is enhanced only by a movement which gives full-scale deflection for a smaller current. A movement which requires, say, 0.1mA (100 μ A) yields a sensitivity of 10,000 ohms/volt, while a 10 μ A movement steps up the sensitivity to 100,000 ohms/volt.

TEST METER ACCURACY

Clearly, it pays to use the highest voltage setting consistent with a usable readout, for then the current drawn from the test circuit is reduced. However, working like that can impair the readout accuracy for two reasons. One because small voltages are not easy to determine on a highish voltage scale, and two because the inherent accuracy commonly tends to deteriorate at small deflections.

Meter accuracy is often geared to full-scale deflection.



GUIDE TO TEST INSTRUMENTS

Thus a specification of $\pm 2\%$ of full-scale deflection means that on the 100V range, say, a true 100V could read as 98V or 102V (the latter just in advance of the final calibration mark). However, a true 50V on the same range could read as 48V or 52V, thereby corresponding to an error of $\pm 4\%$ at *half-scale* deflection. In practice, therefore, it is best to select a range giving the greater pointer deflection for the applied voltage. In that way the readout error is minimised.

A common multimeter sensitivity is 20,000 ohms/volt, a value which satisfies the requirements for the vast majority of servicing tests in both valve and solid-state equipment. Even so, there are times when even greater sensitivity is demanded; when, for instance, voltage is measured from a high resistance circuit. Unless the current flowing from the test circuit into the meter is minimised, a substantial ratio of voltage will be dropped test circuit, the meter thus recording only a small ratio of the real voltage present without the meter connected.

ELECTRONIC TEST METER

When choosing a test meter, therefore, a major consideration should be the sensitivity voltage. From first principles, the greater the sensitivity the better; but since accurate meters of exceptionally high sensitivity (say, 100,000 ohms/volt) are more costly and possibly somewhat less robust than their lesser sensitivity counterparts, some technicians and enthusiasts prefer the electronic test meter alternative. Such an instrument commonly exploits the same sort of readout (moving-coil movement) as the 'directly applied' instrument just considered, though there are digital equivalents referred to anon. A major difference is that the movement is not operated directly from the power available in the test circuit, but instead from the power inherent in a valve or transistor circuit. In other words, the active (valve or transistor) circuit serves as a 'buffer' between the source and the meter movement, meaning that significantly less power is drawn from the source to work the meter.

Prior to the transistor era, instruments like this were often called valve voltmeters. Even today valves are sometimes employed, but many are now changing over to transistors with the advantage of battery powering and hence portability. A term which embraces both types is *electronic test meter*, but we might still talk of the valve voltmeter or transistor voltmeter.

Valves were particularly handy for the application since the power in the anode circuit is controlled by voltage of extremely low power in the grid circuit. Stemming from this was a very high input resistance, established essentially by the input attenuator, which remained relatively high even on the lowest voltage range. Transistors of the bipolar type are themselves current operated (like the meter movement) and are thus somewhat less matched to the requirement. Nevertheless, over the years circuit artifices have been adopted to secure the highest possible input resistance; the base input, in fact, monitoring the small current from the test source which is then reflected as a much higher collector current in the meter circuit. The

field effect transistor, which is endowed with a very high input resistance, similar to that of a thermionic valve, is now extensively used in electronic test meter circuits.

The active circuit, of course, needs to be powered from the mains supply or batteries, and an arrangement is incorporated for setting the pointer of the movement to zero prior to the application of the test voltage.

MULTIRANGE METER

The bread-and-butter instrument is the multirange meter. This comes in both 'directly applied' and electronic form. The most common is the 'directly applied' version, without which it is impossible to perform even the most elementary of servicing operations requiring testing of some kind. The days of 'wet-finger' and neon bulb testing went out with the thermionic valve. Least complex of the species is for d.c. applications only; but the extra initial outlay for an instrument embracing a.c. ranges in addition to the d.c. ones is well warranted. Basic ranges are voltage, current and resistance.

RESISTANCE MEASUREMENT

Resistance is effectively measured in terms of current readout, the reading being directly in 'ohms'. An internal battery supplies the current and this is switched in series with the meter movement and an internal resistive arrangement, a part of which comes out to a 'zero set' control on the front. When the test leads are shorted the meter is caused to read full-scale by control adjustment, corresponding to zero 'ohms'. When the leads are connected across an external resistance the meter current is reduced and the deflection is less, the pointer then indicating the approximate value of the resistance.

This is the simplest means of resistance measurement. Greater accuracy calls for a special 'bridge' or a more sophisticated direct-reading meter. Most multimeters provide for at least two resistance ranges, but it is not unduly difficult to measure higher values than allowed for by the internal battery by adopting an external battery to give a full-scale deflection on the highest practical voltage range, then introducing the resistance for measurement in series with the battery. This, though, might involve some sort of scale recalibration or mere scale multiplication, depending on the nature of the instrument and the battery voltage.

The greater the voltage sensitivity of the instrument, the higher the resistance value measureable. Very low values of resistance are not so easily measured in the manner expounded; again, a special kind of resistance meter is required for this.

DIRECT CURRENT MEASUREMENT

The voltage sensitivity reflects the lowest d.c. measurable. For example, a meter with a d.c. sensitivity of 20,000 ohms/volt would probably have a d.c. current range down to $50\mu\text{A}$ (0.05mA), while a 10,000 ohms/volt meter would be unlikely to measure d.c. below $100\mu\text{A}$ (all full-scale of course). However, it is noteworthy that this basic relationship is sometimes affected by meter movement 'padding', which may be adopted partly for calibration purposes and partly for temperature compensation, with meter overload protection probably having some influence.

For testing in transistor circuits a meter of 20,000 ohms/volt sensitivity reading full-scale down to about 0.1V

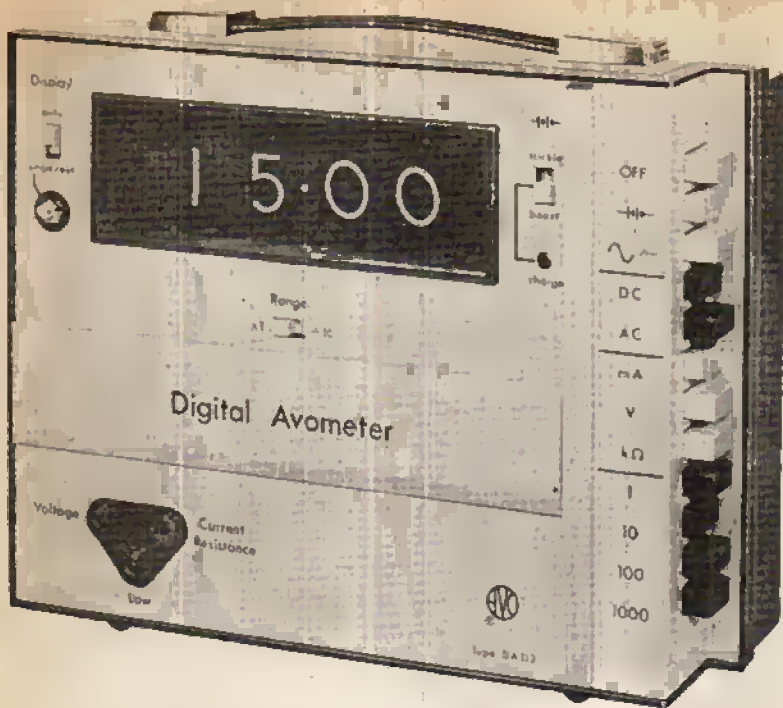

Fig. 1: The multimeter of the future—the Digital Avometer.

Fig. 2: The latest Electronic Avometer which operates from 4 mercury cells. Extensive multimeter range coverage is provided (see text).

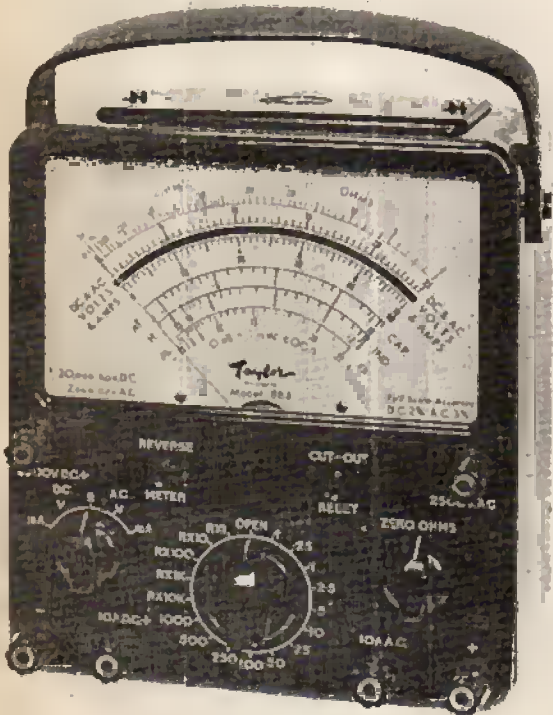
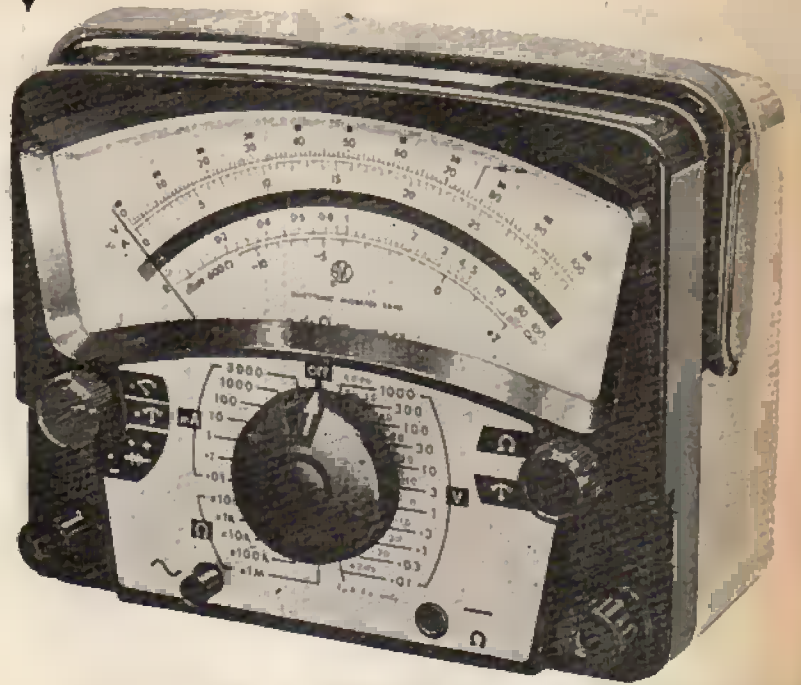

Fig. 3: The popular Taylor multimeter, Model 88B with a sensitivity of 20,000 ohms/volt d.c. and 2,000 ohms/volt a.c. Some idea of the scope range can be gleaned from the picture. Also see text.

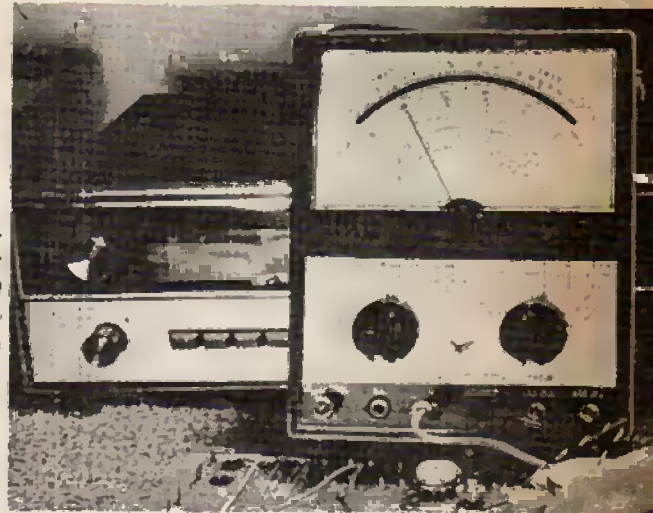

Fig. 4: Eagle K-1400 volt/ohm/milliammeter in action. This has a sensitivity of 20,000 ohms/volt d.c. and 5,000 ohms/volt a.c. and measures d.c. voltage 0-5kV in 8 ranges at accuracy better than $\pm 3\%$ f.s.d., a.c. voltage also 0-5kV but in 6 ranges, d.c. current 0-10A in 6 ranges, a.c. current 0-10A in 4 ranges and resistance in three ranges, to 20M Ω . Frequency response 10Hz to 100kHz (for 2.5V, 10V and 50V a.c. ranges), and a dB scale is fitted.

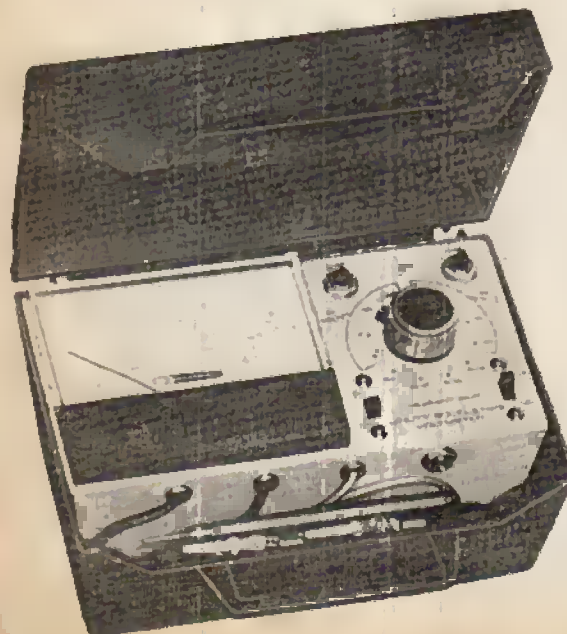
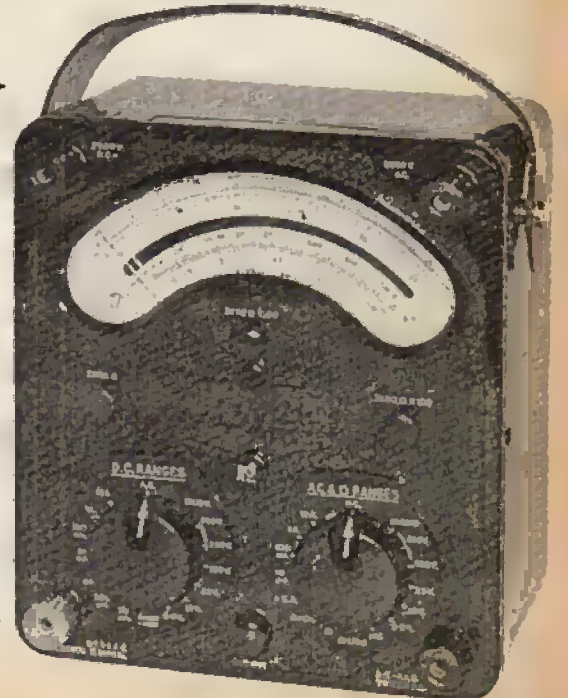

Fig. 5: An old favourite updated. The Avometer Model 8 MkIV. Meter movement sensitivity 50 μ A full-scale, providing a sensitivity of 20,000 ohms/volt on d.c. and 2,000 ohms/volt on a.c. Features include movement reverse control and overload protection. A.C. voltage accuracy maintained up to 15kHz on 250V range, suitable for audio frequency measurements. A dB scale is included.

Fig. 6: Heathkit Utility Solid-State Voltmeter, Model IM-17. This employs 4 silicon transistors, 1 field effect transistor and 1 silicon diode and has 4 d.c. voltage ranges from 1V to 1kV (full-scale) and 4 a.c. voltage ranges from 1.2V to 1kV (full-scale).





GUIDE TO TEST INSTRUMENTS

(100mV) would be useful. Complementary ranges might than be 0.25V, 1V, 2.5V, 5V, 10V, 25V, 50V, 100V, 250V, 500V, 1kV and, perhaps, 2.5kV. Remember that we often need to measure with fair accuracy down to 0.25V or less in transistor stages, so it is essential for the meter to feature well proportioned ranges down to at least 0.25V full-scale.

D.C. current ranges are also important, but possibly marginally less so than voltage ranges. This is because when testing in printed circuit equipment we endeavour to calculate the current by measuring the voltage dropped across a known value resistor in the circuit carrying the current, simple Ohm's law then giving the answer without the need to break the circuit to introduce a current meter.

Well proportioned voltage ranges are generally reflected in the d.c. current ranges, from the lowest full-scale value allowed by the meter movement to several amperes without external shunts. For example, a 20,000 ohms/volt multimeter might have full-scale ranges of 50 μ A, 100 μ A, 250 μ A, 500 μ A, 1mA, 2.5mA, 5mA, 10mA, 25mA, 50mA, 100mA, 500mA, 1A and 10A. These, it will be noticed complement the voltage ranges just mentioned.

A.C. MEASUREMENTS

A multimeter designed to measure a.c. *voltage* might not be equipped to measure a.c. current. There are two versions, the less costly one that measures a.c. voltage and the more costly one that measures a.c. current as well as voltage. In the valve days a.c. current measurements were more important than they are today, for valve heater current was an important parameter.

It is still desirable to be able to measure a.c. voltage, however, for some audio equipment, in particular, is sensitive to main voltage. We also commonly need to know the a.c. voltage across the secondary windings of the mains transformer feeding the rectifier or the a.c. voltage applied, say, to the motor of a tape recorder or turntable unit. To some extent, depending on instrument design, we can also use the a.c. voltage ranges to measure audio signal provided the level is sufficiently high. This is said with some qualification, however, since the meter loading on the signal source and the frequency response shortcomings of the meter circuit can seriously affect the readout accuracy.

A moving-coil movement responds correctly only to direct-current. This means that for a.c. measurements the instrument uses a rectifier, often of the bridge type. The nature of the a.c. circuit reduces the instrument's sensitivity on the a.c. ranges, and it is not uncommon to find that the a.c. sensitivity of a meter with a d.c. sensitivity of 20,000 ohms/volt is around the 2,000 ohms/volt mark. The a.c. volts ranges are thus generally fewer than the d.c. volts ranges, starting at about 1V full-scale instead of, perhaps, 100mV.

A meter which also measures a.c. current is similarly restricted, the first full-scale range being, perhaps, 1mA instead of 50 μ A or 100 μ A, as on d.c.

Knowing the mains loading (e.g., $W=VA$) of a radio receiver or item of audio equipment—even if solid state—

sometimes provides a clue as to a possible fault condition, and as this can be obtained only by measuring the a.c. input current the meter can usefully possess at least a fairly high current range.

The a.c. ranges are scaled in root mean square (r.m.s.) values based on sinewave input. Thus a signal which deviates from pure sinewave form will fail to provide an accurate r.m.s. indication.

OTHER MULTIMETER MEASUREMENTS

More advanced multimeters incorporate additional features which are sometimes useful for servicing applications. For example, a decibel scale (or scales) can be used in conjunction with the a.c. voltage ranges to measure the power response, say, of an audio amplifier, provided that the frequency response of the meter is reasonably 'flat' over the audio spectrum and that the voltage ranges match the audio voltage across the load ($W=E^2/R$). It is common for 0dB to correspond to 1mW into 600 ohms, and the scale or scales may extend from -10dB to +60dB or more.

Some models also provide for the measurement of capacitance and inductance with an external adaptor (the Taylormeter, Model 38B, for example).

MULTIMETER FEATURES

More costly versions are equipped with either mechanical or electronic overload protection, which is certainly very useful in the service workshop!

Another handy fitment is a switch for reversing the polarity of the test leads. Thus if the meter deflects against the stop, the switch can be operated to give a normal forward reading.

Maximum readout accuracy is given by the models with large scales (5in. or so), and to avoid reading error due to parallax effects, a section of the scale may carry a mirror (called anti-parallax mirror) so that the pointer can be aligned with its reflection when the reading is taken.

Number of ranges and facilities provided by a multimeter, of course, reflect its price. The small 'pocket' instruments are useful for field activities, but for workshop applications a more valuable investment is desirable.

ELECTRONIC MULTIMETER

The electronic multimeter generally boasts features in advance of those already described. The high input impedance is a useful attribute for certain tests, this sometimes being around 11M on d.c. and 1M or so on a.c.

A.C. frequency response, too, is significantly enhanced, sometimes by an external diode probe. The Heathkit 'Utility Solid-State Voltmeter', for example, has a ± 1 dB response from 10Hz to 1MHz. If the voltage sensitivity is in the order of millivolts full-scale, then such an instrument can almost be employed as an audio milli-voltmeter. The Avo Electronic Avometer Type EA113 goes down to 10mV on its lowest range with an accuracy of $\pm 1.25\%$ from 20Hz to 25kHz which makes it quite suitable for audio applications. The Grundig 'Universal Voltmeter', Model UV30 is another model suitable for audio work, in addition to the measurement of voltage and current, a.c. and d.c. This goes down to 100mV full-scale on the a.c. range with an accuracy of $\pm 3\%$ from 10Hz to 100kHz ± 0.5 dB. The instrument is battery powered and adopts field effect transistors.

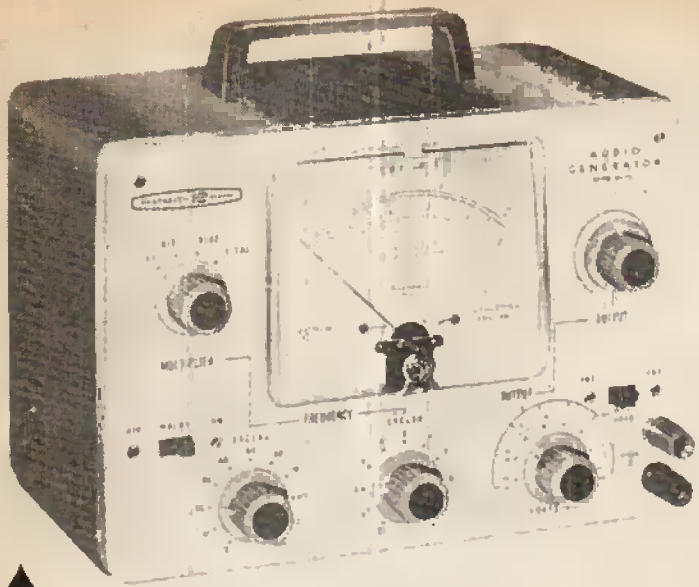

Fig. 7: Heathkit Audio Generator, Model AG-9U. Frequency range is from 10Hz to 100kHz with less than 0.1% distortion from 20Hz to 10kHz. Output voltage is indicated on a 4½ in. meter with three scales of 1 and 3 volts and -10 to +2dB.

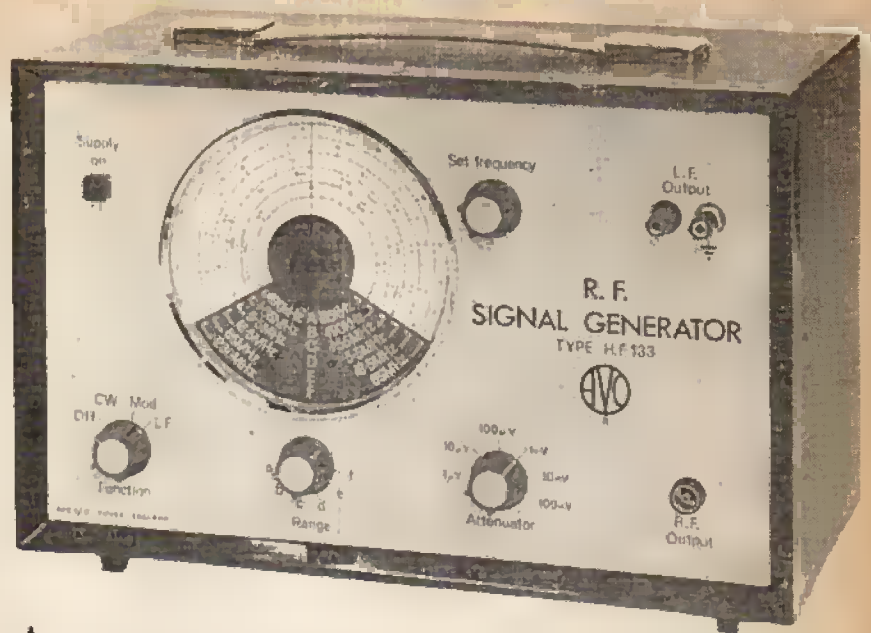

Fig. 8: An a.m. signal generator by Avo, Model HF133. The picture shows the facilities provided.

Fig. 9: The Heathkit (Heath, Gloucester Ltd.) Model 10-18U oscilloscope. This general purpose model has a 5in. tube, 4.5MHz bandwidth and 30mV (p-p)/cm. sensitivity. Sweep goes from 10Hz to 500kHz.

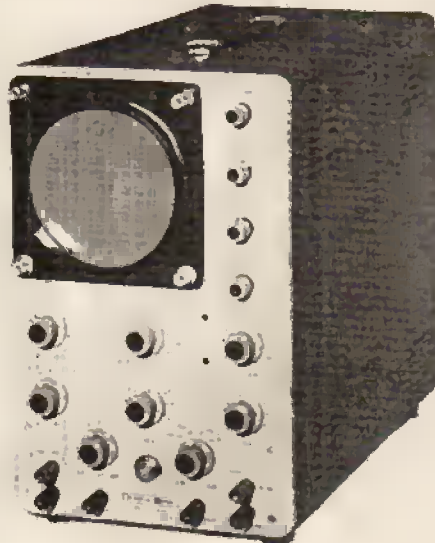

Fig. 11: A pocket-sized multimeter by Taylor, Model 127A. This is suitable for bench and field work in industry and for the student and amateur radio enthusiast. Sensitivity is 20,000 ohms/volt d.c. and 1,000 ohms/volt a.c.

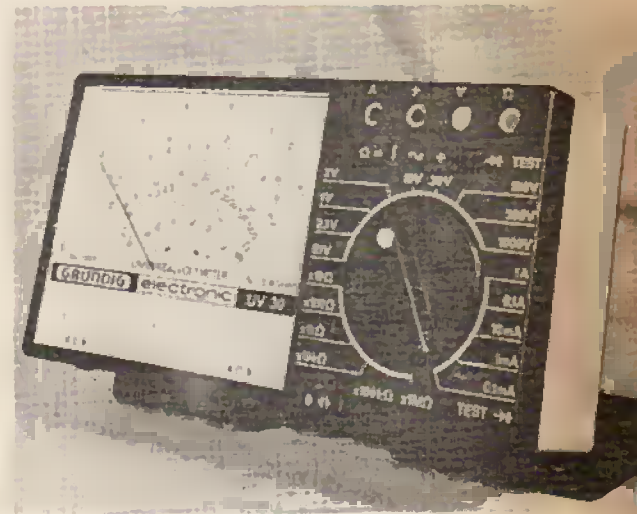
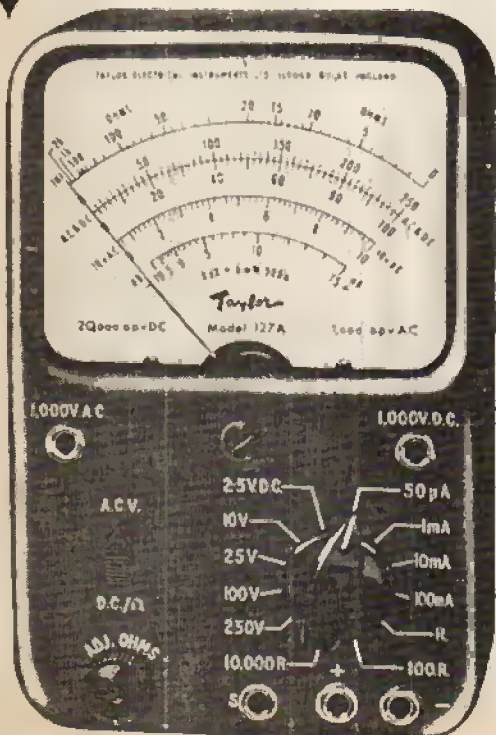
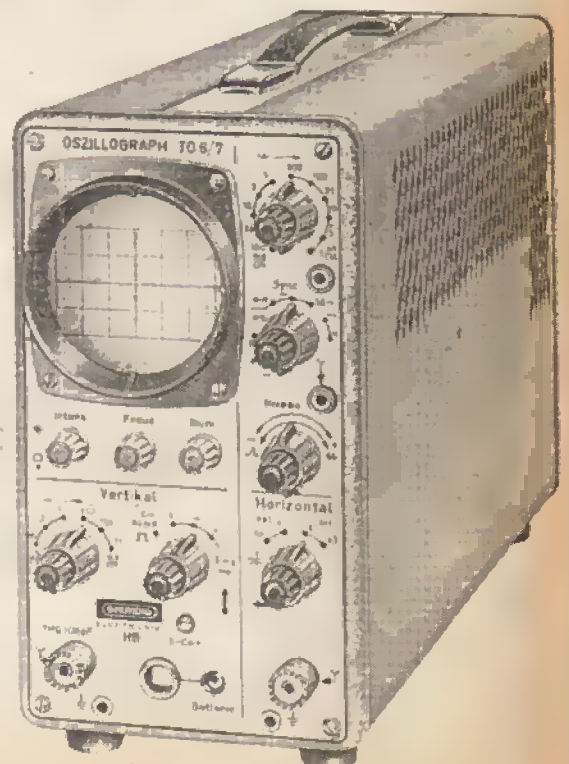

Fig. 10: A Universal Voltmeter by Grundig. Model UV30. This uses field effect transistors, is battery powered and pocket size. Impedance as high as 30M and resistance measurement from 1Ω to 500MΩ.

Fig. 12: Grundig Oscilloscope Model TO 6/7. This is an example from the very wide range of test instruments by Grundig. Using solid-state devices, it is suitable for mains and battery powering, with facilities for powering from external vehicle battery. Y bandwidth 0-6MHz -3dB and sensitivity 30mV/cm.





GUIDE TO TEST INSTRUMENTS

For checking the gain of r.f. and i.f. stages one needs to measure r.f. and i.f. input and output signals, and this mode of measurement is sometimes catered for by a diode probe designed for use with an electronic multimeter or similar instrument. Signals up to 100MHz (sometimes higher) can be measured by this method.

AUDIO MILLIVOLTMETER

This instrument differs from the multirange electronic meter in that it is designed to measure a.c. voltage only from low audio-frequency up to 30kHz or more. Some models, in fact, measure up to 1MHz or beyond this into the video-frequency spectrum.

Design is based on high response accuracy over the intended frequency range and also very high sensitivity on the low ranges. Indeed, some ultra-sensitive models give full-scale deflection from a signal as low as 100 μ V (sometimes less!). With such sensitivity it is possible to measure very low-level audio signals, such as those delivered by a magnetic pickup cartridge or microphone.

A multiplicity of ranges, based on a calibrated input attenuator, often extends the full-scale readout to several volts or tens of volts. Readings are commonly scaled in r.m.s. values, though there may also be peak voltage scales or a switch or control to change the readout from r.m.s. to peak.

As this sort of instrument is designed for audio and video applications it is almost certain to feature a decibel scale. The moving-coil meter is operated from rectified signal obtained from the output of an amplifier, the various ranges being catered for by switched attenuators.

Mains and battery powered versions are available and quite a few models are equipped with an amplifier output socket, prior to the meter rectifier, so that the measured signal can be viewed on the screen of an oscilloscope. This is useful when the instrument is reading audio distortion via a distortion analyser, for the 'scope display then reveals the nature of the harmonics of which the distortion is composed. Battery-powering leads to portability and reduces hum-loop problems when tests are being made in low-level circuits.

DIGITAL READOUT

Although digital instruments are fast becoming popular in laboratories, it will be some time before we can afford them specifically for servicing and experimental applications. At the time of writing a digital multimeter costs about three times more than an equivalent analogue instrument.

For lab. work the appeal lies in the accuracy, ease of readout and high sensitivity. For example, the Digital Avometer, Model DA112 features voltage ranges from 100 μ V to 1.5kV (with a 50% over-range facility) at an accuracy to 0.1%. Readout is from a 3½ digit display with automatic decimal pointing, and the design covers both mains and battery powering.

Cost lies essentially in circuit complexity, but with the

advancement of integrated circuits (of which many already employ) and mass demand, the cost is almost certain to decline eventually, though this may not be in the very near future!

SIGNAL GENERATORS

For radio servicing the signal generator must yield a modulated carrier-wave and operate over the bands corresponding to those tuned by the receiver. Modulation, too, must match the design of the receiver. Thus a.m. receivers require amplitude-modulation and f.m. ones frequency-modulation. The generator should also tune over the i.f. spectrum, commonly 10-7MHz f.m. and 470kHz a.m.

An important part of the design is the output attenuator. This should be reasonably accurate so that a fair approximation of the strength of the signal fed to the receiver is known. This is necessary for determining the sensitivity of the receiver. Calibration is either in decibels below the maximum signal output (sometimes referred to 0dB) or direct in μ V and mV. A switched attenuator generally sets the output range, which is then controlled by a 'fine' attenuator.

Some models have facilities for varying the modulation depth and a meter for setting the signal level prior to the attenuator, but for general servicing applications such refinements are not essential.

For range extension harmonic working is sometimes adopted. This is not generally a desirable scheme, although it tends to reduce cost. Fundamental working even into the higher frequency bands makes life less complicated and reduces errors which can sometimes result from harmonic working.

Models designed for radio and television servicing commonly incorporate a fixed-frequency audio oscillator, at 400Hz or 1kHz, for modulating the carrier-wave, and the signal from this is often brought out to a front socket, either at 'full force' or via a variable attenuator. This signal is useful for making tests in audio sections of receivers and in amplifiers. Modulation depth is fixed at approximately 30%, though it can vary slightly over the frequency ranges.

Even though the instrument might produce only amplitude-modulation, provided the modulation can be switched off and the r.f. range embraces Band II (from about 87 to 108 MHz), it can be used for f.m. receiver servicing to some extent (this will be explained in the forthcoming series).

F.M. generators are usually more costly than a.m. counterparts, but models are made which switch over a.m. and f.m., covering the range from about 130kHz to 250MHz over various bands.

For the visual alignment of radio receivers (using an oscilloscope to display the response characteristic), a special kind of signal generator is required, commonly referred to as a 'wobbulator'. The r.f. output from this swings either side of the nominal carrier frequency in synchronism with the X sweep of the oscilloscope, sufficient to embrace the full width of the response. A response display is then obtained by feeding the detector output of the receiver to the oscilloscope Y input.

AUDIO GENERATOR

For audio testing the generator should tune from at least 20Hz to 20kHz; but many go above this frequency. Signal output is a sinewave, but many instruments can be switched to change the sinewave to a square-wave,



Fig. 13: For more advanced measurements and tests, this Universal Bridge by Avo, Model B.150, caters for a wide range of inductance, capacitance and resistance measurements. Balanced null point is indicated by a meter, while the value of the component under test is automatically presented in digital form.

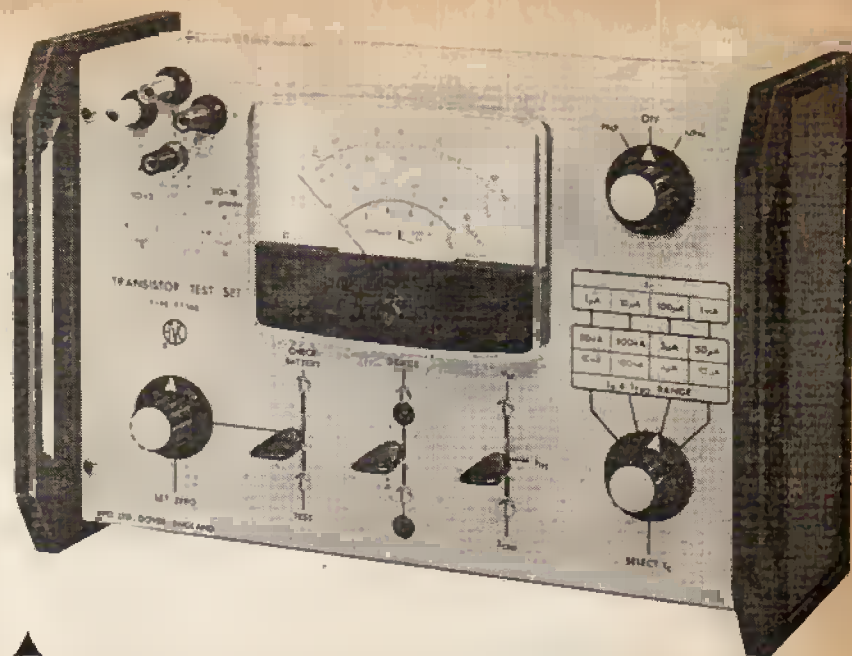

Fig. 14: Avo Transistor Test Set, Model TT.166. Design is for the measurement of bipolar transistor d.c. parameters. Tests can be made at very low collector currents appropriate to modern devices (1 μ A to 1mA), p-n-p and n-p-n. Operation is from two internal 9V batteries.

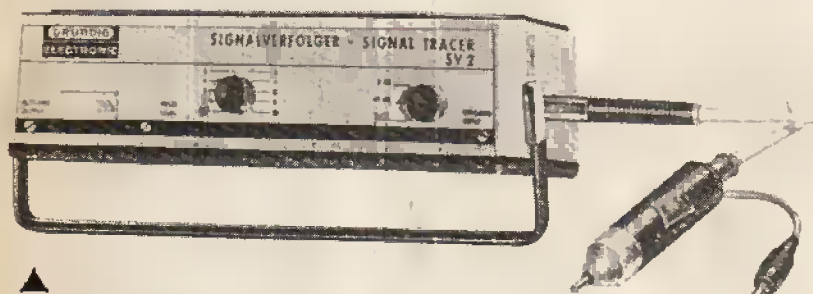

Fig. 15: Interesting Signal Tracer, Model SV2, by Grundig. Using transistors, the instrument is battery powered and of handy size. Signal is traced via a test prod which, after amplification, is indicated by meter or loudspeaker.

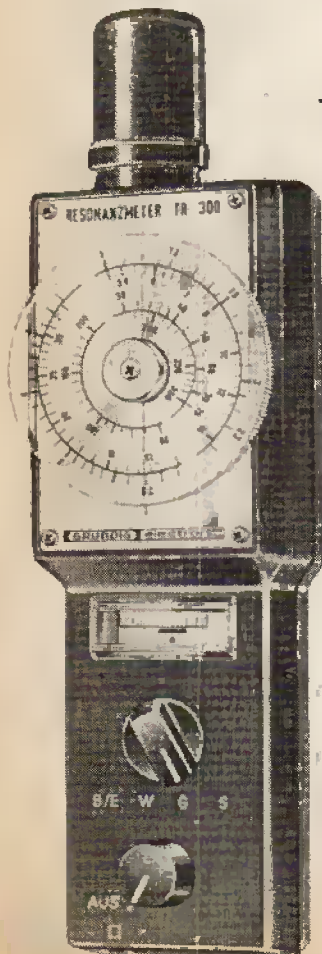

Fig. 17: Grundig Grid Dip Resonance Meter, Model TR300. This model covers 0.95MHz to 300MHz in 8 ranges (Model TR30 95kHz to 30MHz) and is battery powered. A very useful instrument for experimenters since not only is the frequency of an external tuned circuit indicated by a change in current, but switching changes the mode to absorption wavemeter and receiver, operated through a headphone set.



Fig. 16: The still popular Taylor Model 68A/M signal generator. Frequency range is from 100kHz to 240MHz (all on fundamentals) over 8 ranges. Although a.m. only, the instrument is suitable for the alignment of ratio detectors and f.m. r.f. and i.f. stages. A variable 400Hz audio output is available and an r.f. monitoring meter allows accurate setting of the signal applied to the attenuators.

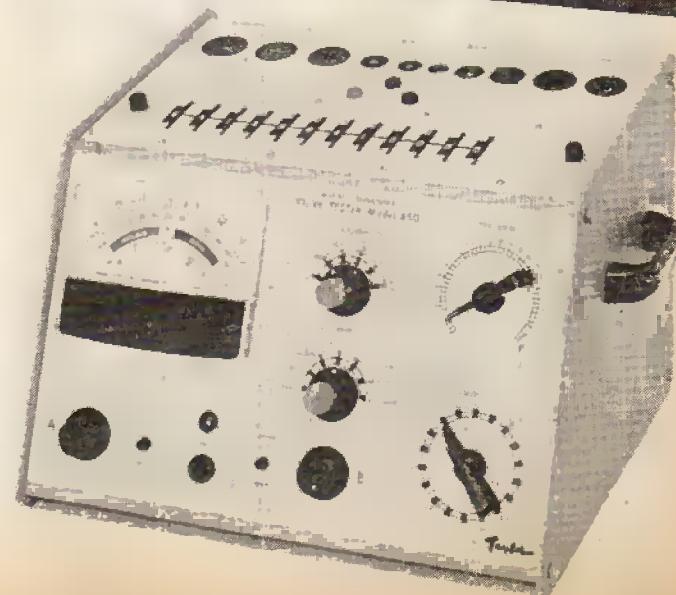

Fig. 18: Taylor Valve Tester, Model 45D. This general purpose instrument is capable of testing almost all thermionic valves with the exception of the larger transmitting type. There are ten valve bases, including the more recent B10B and B9D, and a special B14E base accepts a range of plug-in adaptors available; to cover new and old valves. Mutual conductance is measured (emission of diodes), and there is also a "replace —?— good" scale for speedy appraisal.



GUIDE TO TEST INSTRUMENTS

useful for 'transient' testing audio amplifiers.

The sinewave must be as pure as possible, especially when the signal is to be used for distortion measurements, and for this application the total harmonic distortion on the signal should be significantly less than 1%. However, it is possible to 'filter' the signal from a generator of relatively high distortion to delete the harmonics, thereby making it more suitable for t.h.d. measurements (this, too, will be explained in the forthcoming series).

Maximum output should be a volt or two (r.m.s.), and the attenuator should reduce this in decrements of 20dB, with a 'fine' attenuator varying the 'set output' down to zero. It is also important for the audio signal output to remain substantially constant over the entire frequency range.

OSCILLOSCOPE

For many radio and audio applications an oscilloscope with a Y bandwidth up to 3MHz can be very useful. Cost can be cut by building one's own from a kit of parts, such as the excellent Heathkits. The General Purpose Service Oscilloscope, Model OS-2 is a good illustration. This, by Heathkit, sells at £29.20 (carriage 60np) as a kit and for £44.20 (same carriage) in ready-to-use form.

For more specialised circuit investigations, however, a Y bandwidth to -3dB points) up to 10MHz and beyond is demanded; this applies to the study of very fast pulse signals and transients, etc.

X bandwidth is less critical for most normal applications (that of the Heathkit being 2Hz to 300kHz ± 3 dB, and the Y bandwidth 2Hz to 3MHz ± 3 dB). Y sensitivity (e.g., vertical deflection of the spot) is also important, and this should be at least 250mV p-p per cm. A useful feature is a 'voltage calibrator' which switches an a.c. voltage of known amplitude to the Y input.

For use with a wobulator an X (timebase) output terminal should be available, this then being coupled to the X or sweep input of the wobulator for securing a response display as already mentioned.

X sweeps should match the Y bandwidth in terms of waveform time. These are sometimes given as time (μ S, mS or S) per cm. of horizontal sweep.

It is also useful to be able to switch off the timebase so that external signals can then be applied to both the Y and X amplifiers. Certain tests of phasing require the use of these two circuits without the influence of the timebase.

The display is locked on the screen by a synchronising signal from the source, and most recent 'scopes embody an automatic circuit for this, the sync signal being extracted internally from the test signal.

Most instruments designed for general servicing still run on valves, particularly the less costly ones, but there is a trend towards the use of solid-state devices, giving a choice of mains or battery powering and the bonus of portability.

Screen diameter is not all that important for radio and audio servicing, though obviously the larger, the better; but some sort of calibration is desirable, and this commonly takes the form of a graticule scribed in cm. squares.

Another useful feature is X expansion. This merely

consists of an amplifier through which the timebase signal passes to the X plates of the cathode-ray tube. With the X expansion control—a variable attenuator—fully clockwise horizontal deflection just fills the screen. As the control is advanced so the deflection increases. It is thus possible to expand a waveform display horizontally (as well as vertically by the Y attenuator) to allow otherwise hidden artifacts to be examined. Turning on X expansion is tantamount to increasing the timebase sweep velocity, so the expansion control complements the sweep control.

It is sometimes required to examine two signals simultaneously and to compare one with the other. For this a dual beam 'scope is needed, with duplicated Y amplifiers, etc. Such instruments cost more than the single beam variety and are found mostly in laboratories. However, it is possible to secure two displays from a single beam model electronically, using a special switch. A good example is the Heathkit Electronic Switch, Model S-3U, which costs £16.30 as a kit or £28.30 in ready-to-use form.

DISTORTION ANALYSER

For audio amplifier servicing of a serious nature an important instrument is the distortion analyser. Basically, this consists of a tunable notch filter through which a sinewave signal after passing through the amplifier is fed to a sensitive audio millivoltmeter. The sinewave signal fed to the input of the amplifier under test is obtained from a low distortion audio generator, and the idea is that the 'notch' deletes the fundamental leaving only the harmonics. These are measured by the audio millivoltmeter and their total voltage is then compared with that of the sinewave signal proper across the same output load in terms of percentage total harmonic distortion.

A laboratory instrument at reasonable cost—Model Si452—is made by J. E. Sugden & Co. Ltd. of Cleckheaton, Yorkshire. When complemented with a millivoltmeter and generator t.h.d. readouts to less than 0.1% are possible.

Integrated instruments (e.g., embodying the audio generator and readout) are also available. These are generally very costly instruments, but for less exacting work inexpensive Heathkit models are available, one for t.h.d. measurement (Model M-58U) and another for inter-modulation distortion analysis (Model IM-48).

It is obviously impossible to survey the whole field of servicing test instruments in a supplement of limited space, but it is hoped that the foregoing, and the accompanying illustrations, will give a fair impression of the type of instruments currently on offer.

New Servicing Series

starts next month in

PRACTICAL WIRELESS

An introduction to fault-finding theory and practice in radio and Hi-Fi equipment.

Adamin

MICRO SOLDERING INSTRUMENTS

A range of micro soldering instruments combining high performance with really small dimensions and providing exceptional versatility.

Weighing about $\frac{1}{2}$ oz. (less flex) these miniature tools ensure the utmost accuracy and safety in use, resulting in consistently high standards of soldering with minimum operator fatigue.

Ultra-slim unbreakable nylon handles give a cool, comfortable grip for sustained delicacy of operation.

Slip-on bits are fitted over the element shaft, so absorbing all the heat produced and giving high performance with rapid heating and recovery. A wide range of interchangeable tip sizes is available to suit different types of work.

There are ADAMIN models from, 8 to 24 watts, in voltages from 6v. to 240v.

Please ask for New Leaflets 10/1005/7.

LIGHT SOLDERING DEVELOPMENTS LTD.

28 Sydenham Road, Croydon, CR9 2LL
Telephone 01-688 8589 and 4559



“NO



I'D RATHER HAVE A MINITEST™

The SEI MINITEST has made a remarkable impact in the pocket-sized multi-range meter market, by making itself a firm favourite with discerning people in the industry. Let's look into the reasons why. First, the appearance. Diminutive, neat, wipe-clean cyclocac case with shock and magnetic field proof steel liner. Controls are simple and easy to use. Second, the range. The Minitest measures a.c. and d.c. voltages d.c. current and resistance over 20 ranges to a sensitivity of 20,000 and 2,000 ohms per volt d.c. and a.c. respectively. Third, high voltage probes. These extend the range to 25 or 30kV d.c. Little wonder the Minitest is preferred!

SALFORD ELECTRICAL
INSTRUMENTS LTD
Peel Works, Barton Lane, Eccles,
Manchester M30 0HL
Telephone 061-789 5081 Telex 66771
A Member Company of GEC Electrical
Components Ltd.



SEI

S&C

PRACTICAL WIRELESS

ALL IN THE
MAY ISSUE, ON
SALE APRIL 8th

'STATION FOCUS' SIX

At best the performance of the average superhet receiver depends largely upon the proper alignment of the various tuned circuits. In this 'no-compromise' medium and long wave receiver, the "Station Focus" Six, separate panel controls are included for the correct alignment of the critical circuits.

The prototype has been built on a clear perspex panel, as shown on the right, and the photographs included in the article will greatly assist the construction and later checking of the circuit.

An attractive but simple wooden cabinet completes the receiver which, because of its simplicity is ideal for the beginner but because of its performance is also suited to the more advanced constructor.

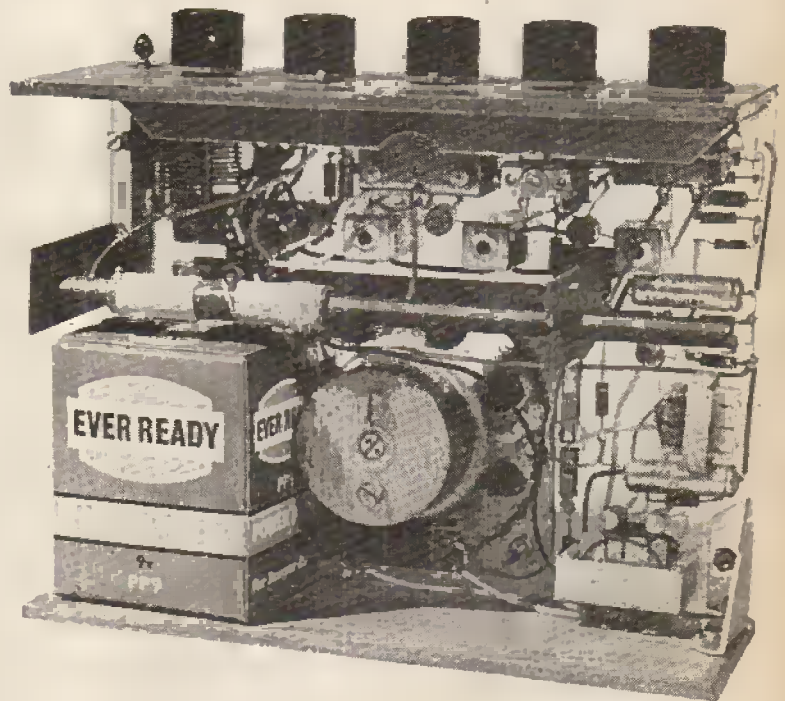

NEW SERIES... SERVICING AN INTRODUCTION TO FAULT-FINDING

There aren't many members of the electronic fraternity who haven't dabbled in servicing—even if it's only to change the battery or clean the earphone socket connections on a friend's radio.

This new series, starting from scratch takes the reader right through from basic principles to the more advanced aspects such as alignment of f.m. superhets and fault-finding on Hi-Fi systems.

It is written by G. J. King and H. W. Hellyer, authors of previous popular series on servicing. Be certain not to miss the start of this new series.

AUDIO FANS ARE NOT FORGOTTEN IN THE NEXT ISSUE AND A 10W TRANSISTORISED AMPLIFIER INCLUDING PREAMP. IS DESCRIBED.

MANY OTHER ARTICLES INCLUDE THE POPULAR "TAKE 20" AND "I.C. OF THE MONTH" SERIES.

BE SURE NOT TO MISS THE MAY ISSUE—ON SALE APRIL 8th. PRICE 20p.

hi-fi SIGNAL GENERATOR

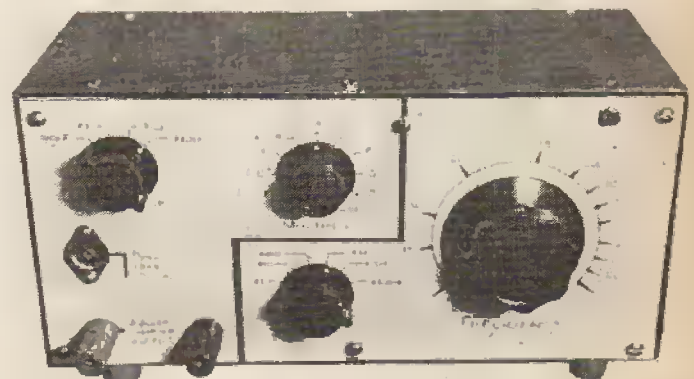

The high standards of modern audio amplifiers have made many older audio signal generators obsolete; it is obviously a waste of time trying to trace 0.1% distortion if the inherent distortion of the source is comparable.

Confidence in test gear is important and for this reason, starting in the May issue, the circuit and complete building instructions are given for a laboratory quality signal generator. Distortion at 1kHz is a mere 0.01% and output ranges run from 15Hz to 150kHz \pm 1dB though an additional range goes up to 1.5MHz.

Output can be up to 12V peak-to-peak and either sine or square wave outputs can be selected.

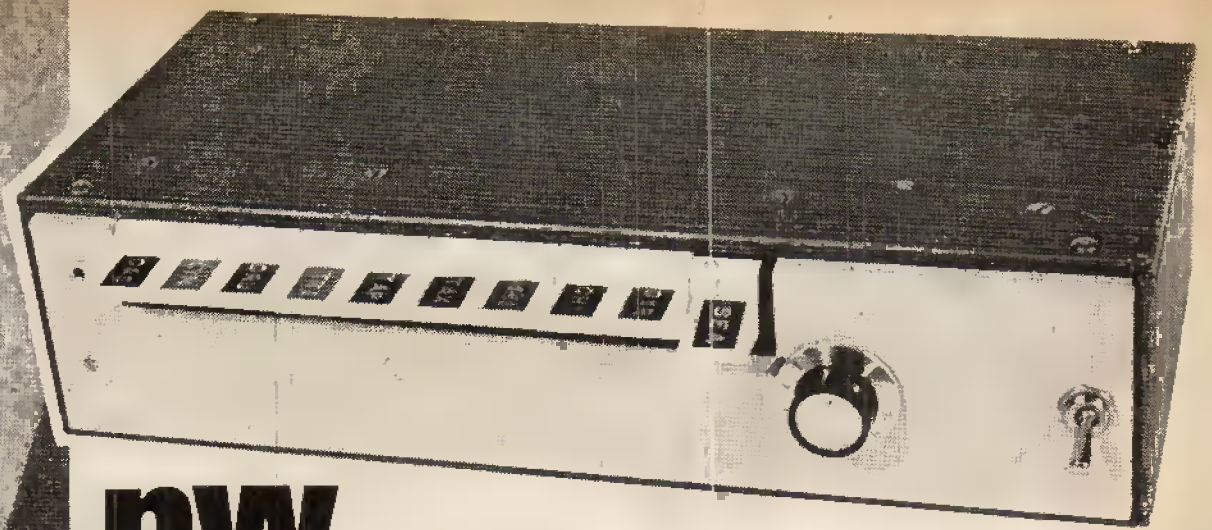

pw sound effects SYNTHESISER

PART 2

THE general layout of the complete unit and the circuits for castanets, cymbal and snare drum were dealt with in Part 1. With the exception of the Bell Chime circuit, all the others can be constructed and operated individually as each has a fairly large signal output. If all the generators are to be used together i.e., as in the original unit, they must be finally connected together via a mixing output pre-amplifier which will be dealt with later.

The next circuits include the Triangle No. 4, Wood Block No. 5, Taxi horn No. 6, Train Whistle No. 7 and Bell Chime No. 8 and each is assembled on an s.r.b.p. board as those in part 1. As will be seen from the board layout diagrams given in this article, some boards are pretty full with components. For this reason the components used should be as physically small as possible.

Circuit for Triangle—No. 4

The sound of a triangle is clear and high pitched and the waveform almost sinusoidal. The circuit as in Fig. 11 therefore, employs a phase shift oscillator adjusted for a frequency of approximately 4500Hz. The output from the oscillator Tr1 is first attenuated via R21 and then taken to the control amplifier Tr3. This amplifier is triggered by Tr2 which generates a control voltage waveform as shown in the Triangle Circuit waveform B Fig. 21. When the key No. 4 is closed a pulse (Triangle Circuit waveform A) is generated which causes Tr2 to conduct. This brings the emitter of Tr2 almost up to the supply voltage and C9 becomes charged. Tr3 takes its h.t. from C9 which then slowly discharges and produces the required decay effect. The sine-wave output from Tr1, although considerably attenuated, does slightly overdrive Tr3 and this helps to provide the characteristic metallic sound of a triangle. Note that the key click filter C7/R9 must be included. The resistor R14 in series with C9 reduces the otherwise very hard attack and C9 itself determines the decay time. If C9 is made larger the decay time will be larger and vice versa. The pitch should be adjusted as close as possible to 4500Hz and this can be done by either reducing the value of R1 slightly or by connecting another resistor in parallel as R1A. The circuit board layout is shown in Fig. 12.

Circuit for Wood Block—No. 5

This is a little less complicated than the other circuits and employs only two transistors. The circuit is shown in Fig. 13 and in this Tr1 is a phase shift oscillator biased to cut off and is turned on only when Tr2 conducts i.e., when the key (No. 5) is closed. The pitch and decay time are both very important if a realistic sound is to be produced. For instance, if the

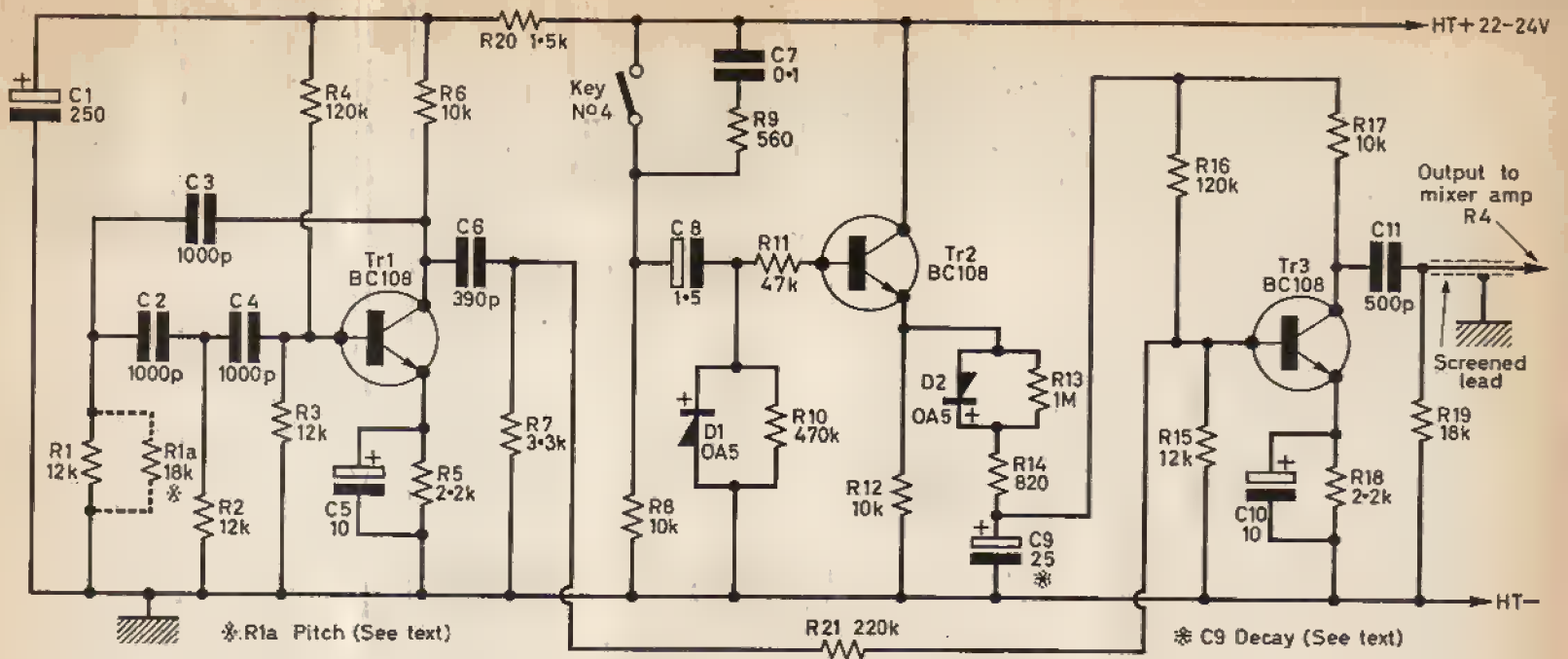

Fig. 11: The circuit of the triangle sound synthesiser.

decay time is too long the sound will be too much like a bell and if too short will sound like a click. Some adjustment of R9 may be necessary to achieve the right period of decay. Pitch can be altered by slight variation of R1 which is nominally 8.2kΩ. Adjustment of both decay time and pitch rather depends on aural estimation of the sound. The strike and decay control voltage and output waveforms are shown in Fig. 21. (Wood-block Circuit waveforms A and B respectively.) The circuit board layout is shown in Fig. 14.

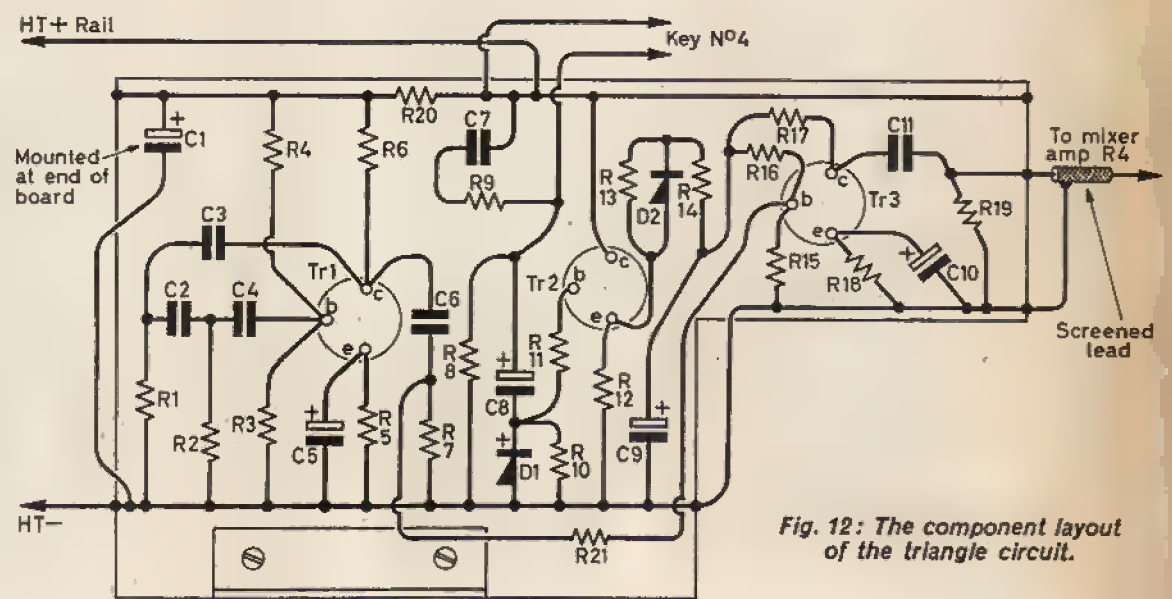

Fig. 12: The component layout of the triangle circuit.

Circuit for Taxi Horn—No. 6

This is another of the more complex circuits and employs four transistors as shown in Fig. 15. First however, note that the signal from the multi-vibrator

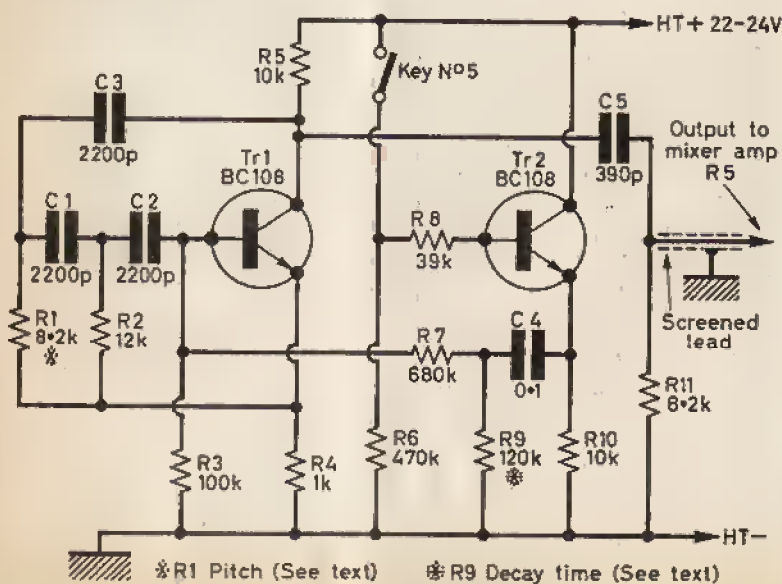
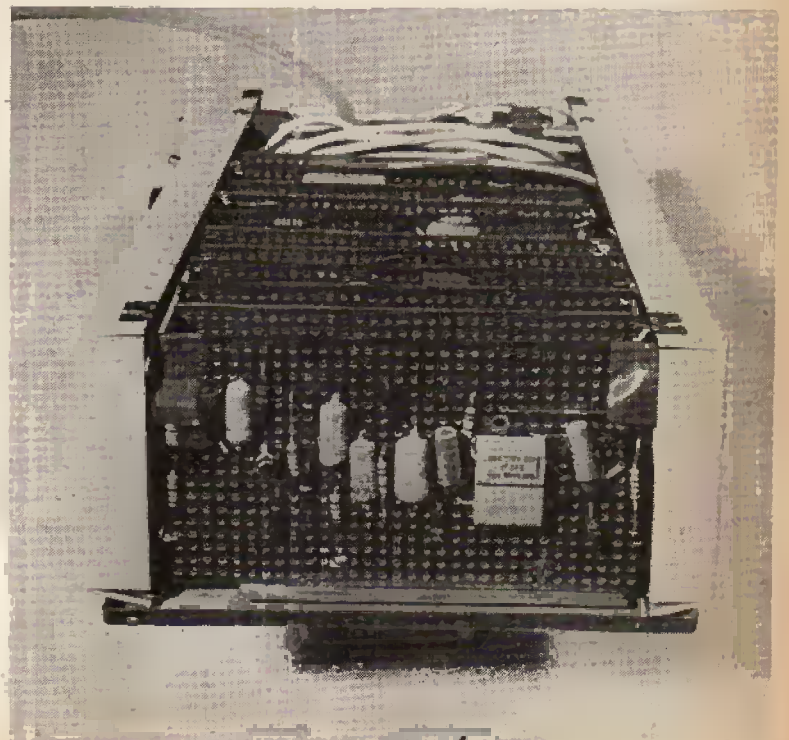

Fig. 13: The wood block sound circuit.



An internal view of the completed project. The board shown is for the castanets circuit.

Tr1-Tr2 is also used for the bell chime circuit No. 8. If the taxi horn circuit is to be used by itself the lead out to R16 on the bell chime circuit will not be necessary. The signal from Tr1-Tr2 is a typical multi-vib. waveform which is modified and attenuated by the network R6, R7, C5 and R12. The pitch should be adjusted to between 200 and 250Hz by slight variation of R2 and the attack/decay characteristic by R15 and R16. Depression and instant release of the key No. 6 should produce a short but typical 'honk' sound characteristic of old bulb type car horns. If the key is depressed

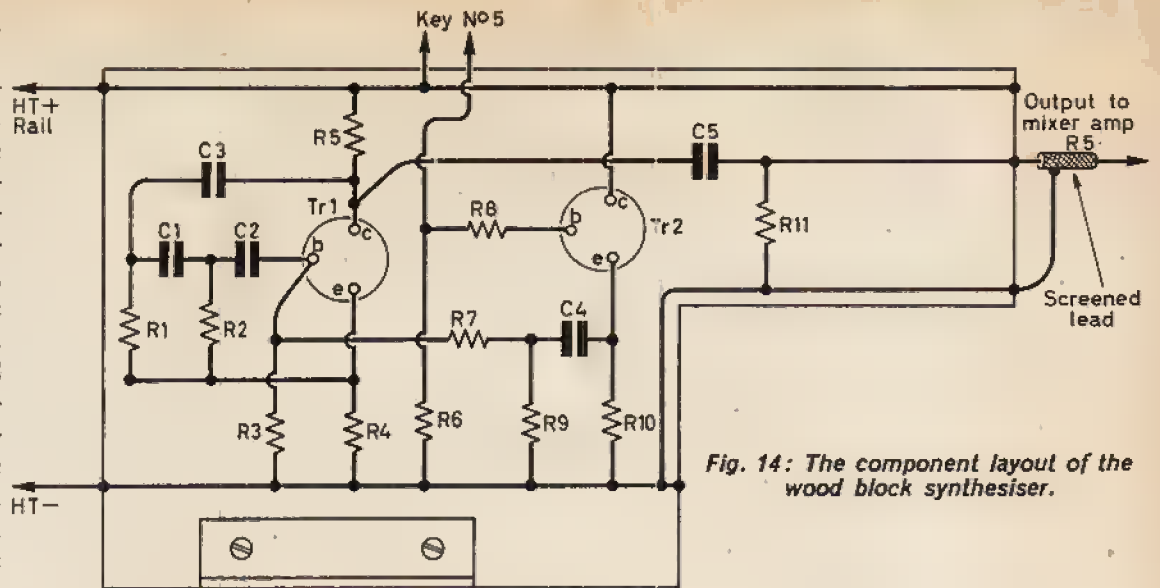

Fig. 14: The component layout of the wood block synthesiser.

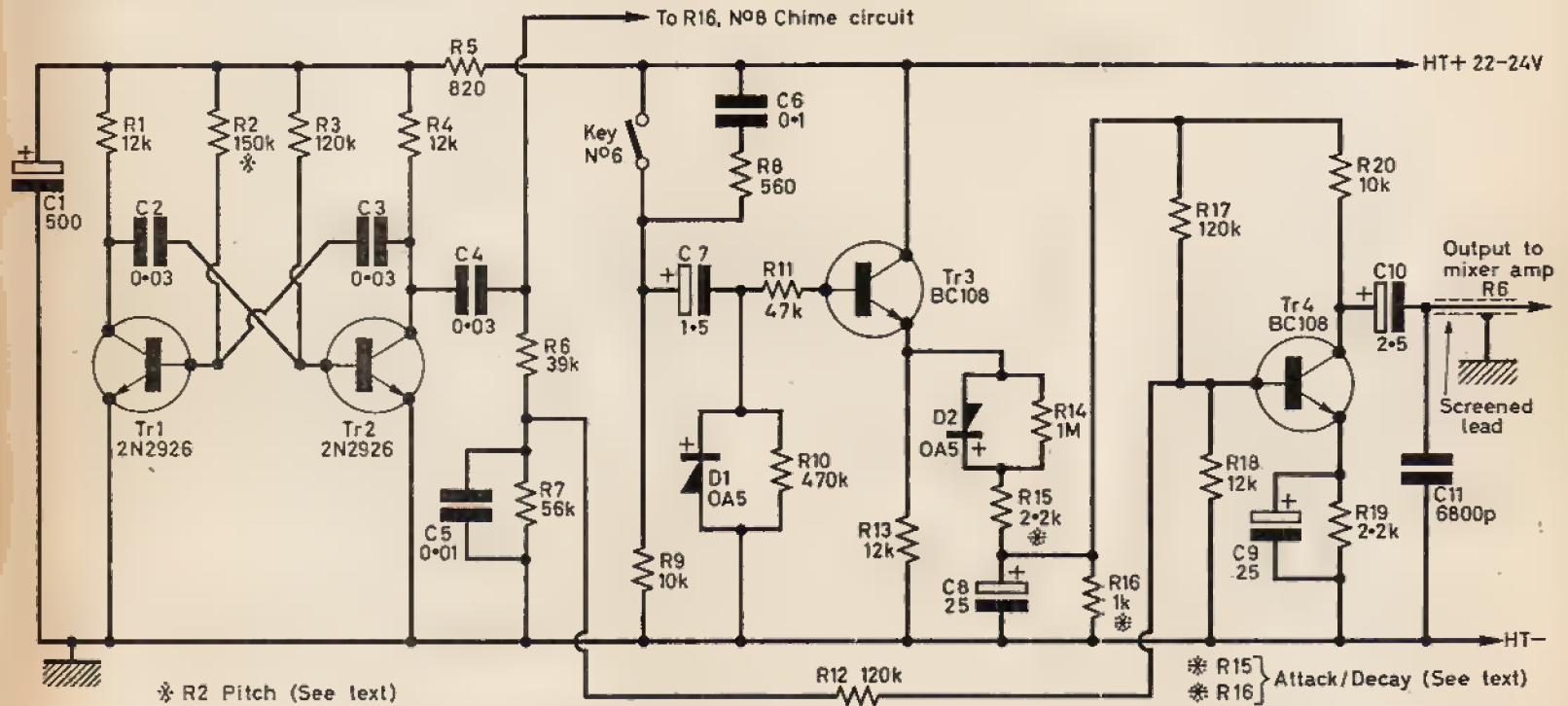

Fig. 15: The taxi horn sound synthesiser circuit. The various waveforms produced are shown in Fig. 21.

and held down the decay will be very slightly longer but the sound will die away completely. The circuit is triggered by Tr3 and the function of this transistor and its triggering voltages are the same as those (except for the decay time) for the triangle and cymbal circuits. The triggering voltage waveforms are shown in Fig. 21 (Taxi Horn Circuit waveforms A, B and C). The circuit board layout is shown in Fig. 16.

Circuit for Train Whistle—No. 7

Two transistors and a noise diode type Z1J are required for this circuit as shown in Fig. 17 and which produces a typical steam train whistle complete with noise content and pitch

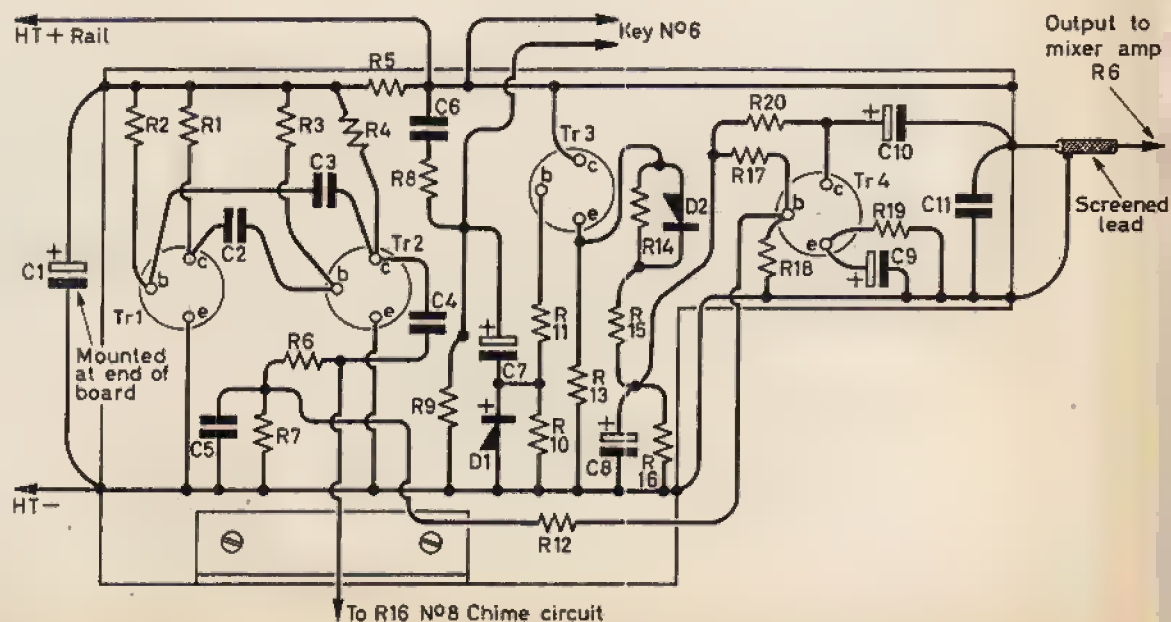

Fig. 16: The component layout of the taxi horn sound synthesiser.

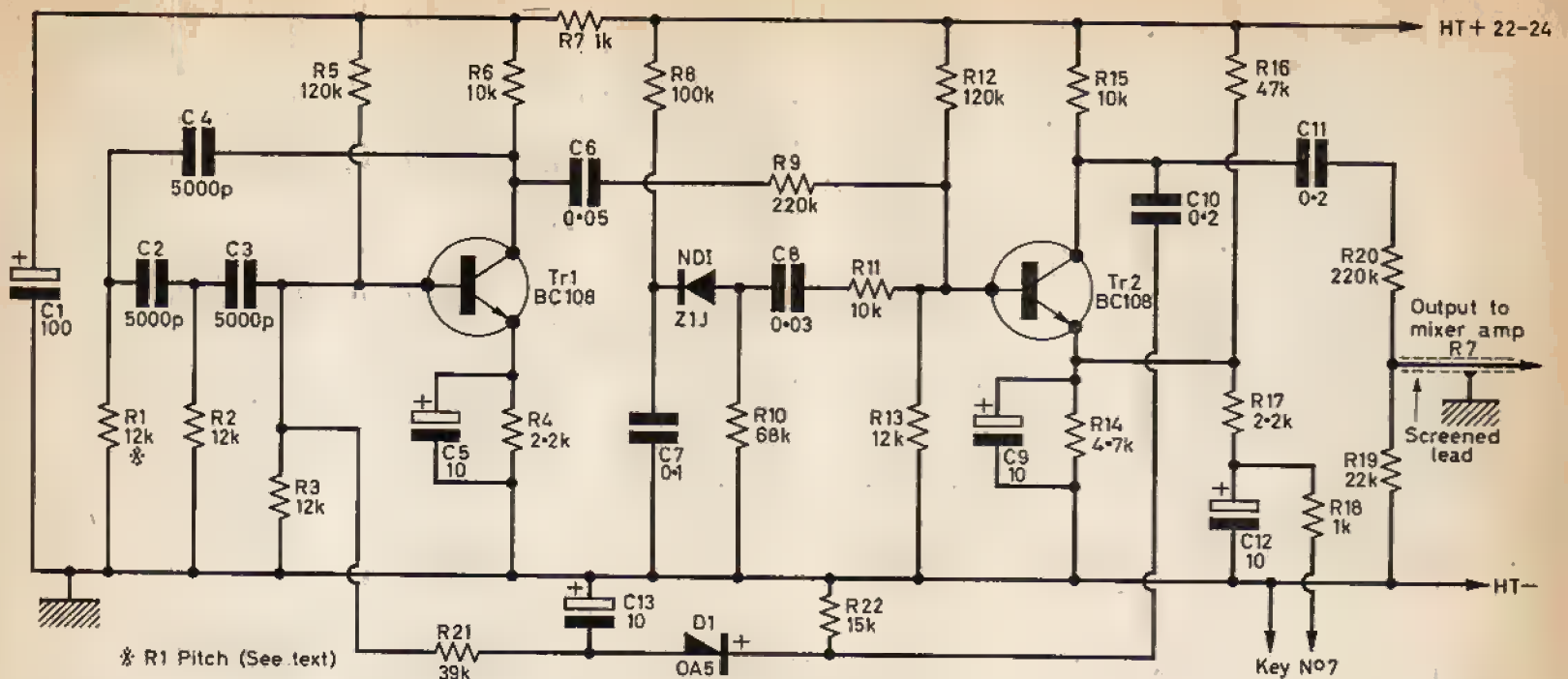

Fig. 17: The circuit used for simulating the train whistle sound.

variation. The transistor Tr1 is a phase shift oscillator, the output of which is attenuated via R9. The pitch should be approximately 1000Hz and adjustment to attain this can be made by slight variation of R1. The noise generator ND1 is the same as used for the cymbal and snare drum circuits and its output is slightly attenuated by R11. The transistor Tr2 takes the signal from Tr1 and ND1 simultaneously but is normally biased to cut off by R14/R16. When key No. 7 is depressed Tr2 conducts and passes the combined sine-wave and noise signals. However the signal output from Tr2 is also directed via C10 to the diode rectifier circuit R22, D1

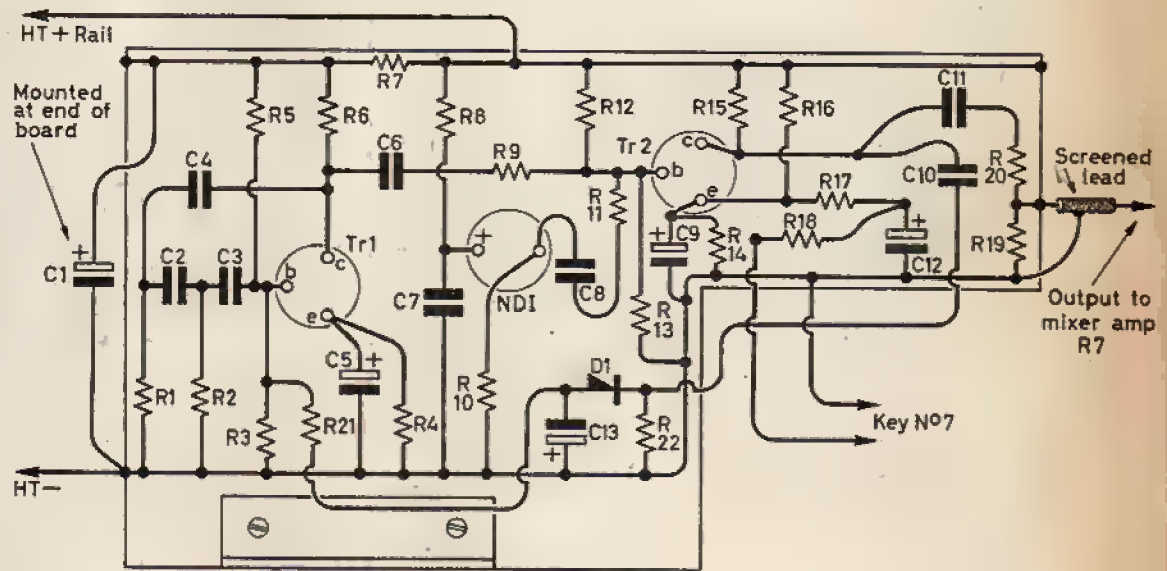

Fig. 18: The component layout for the circuit in Fig. 17, the train whistle synthesiser.

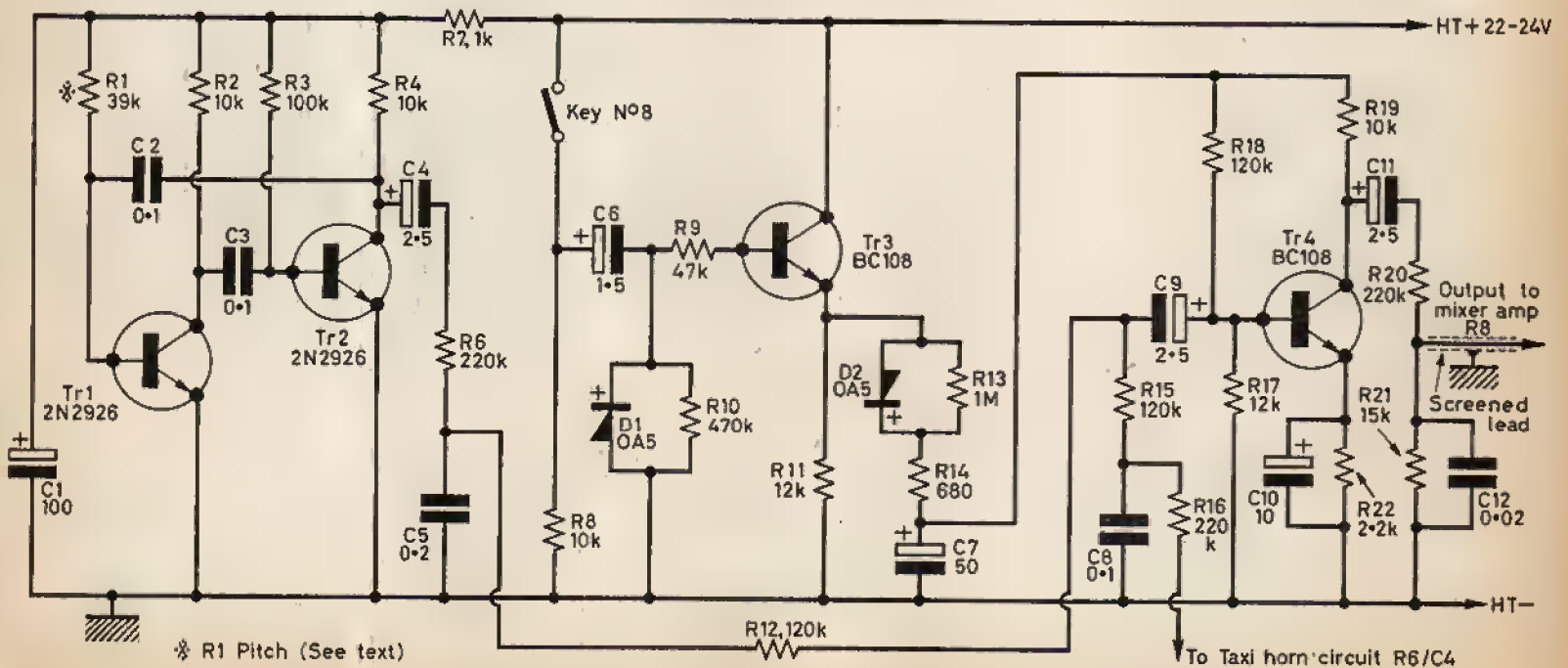

Fig. 19: The bell chime synthesiser. The waveforms of the various stages are shown in Fig. 21.

and C13. The negative voltage derived from this via R21 is applied to the base of Tr1 and produces a slight change in the pitch of the whistle frequency a fraction of a second after its initial sound. It is however, important that the white noise content of the whistle is not too great. The effect, which is that of hissing steam, should be only just apparent and should appear on the output waveform as shown in Fig. 21. (Train Whistle waveform B.) The output waveform should also appear slightly clipped at the top. Adjustment to the level of the white noise content can be made by altering the value of R1 slightly i.e., increase

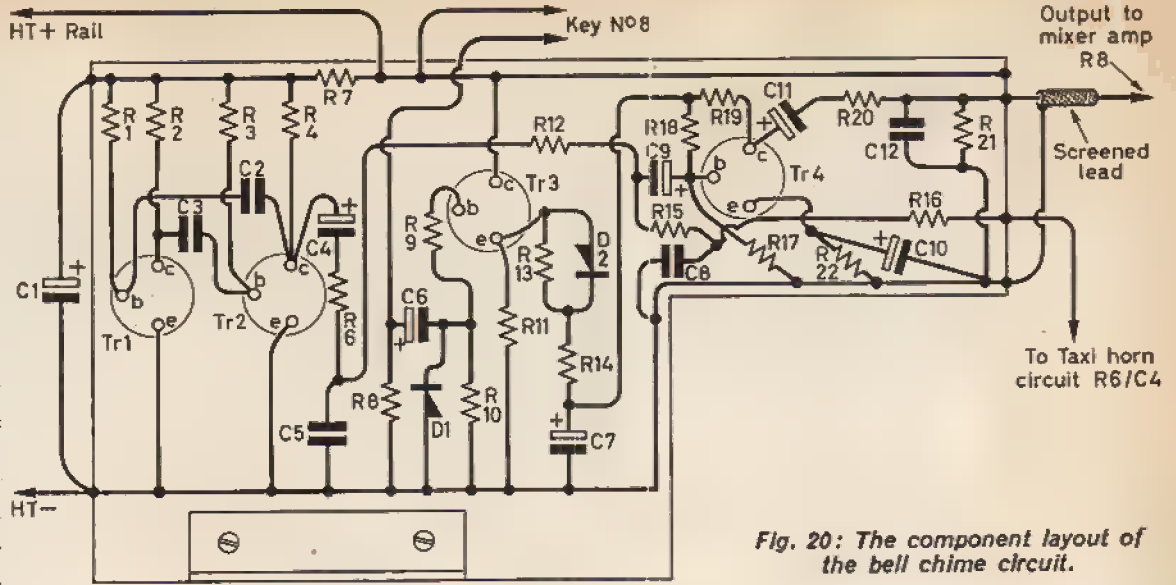
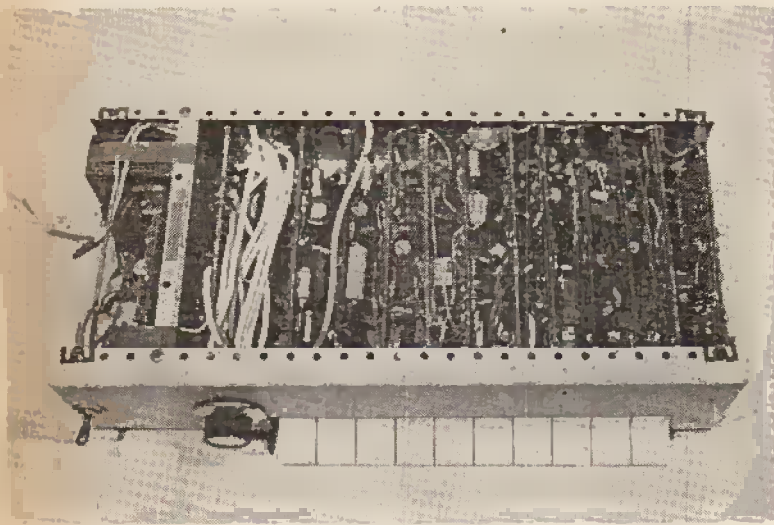

Fig. 20: The component layout of the bell chime circuit.



The various boards are shown at the centre and right, the power supply on the left.

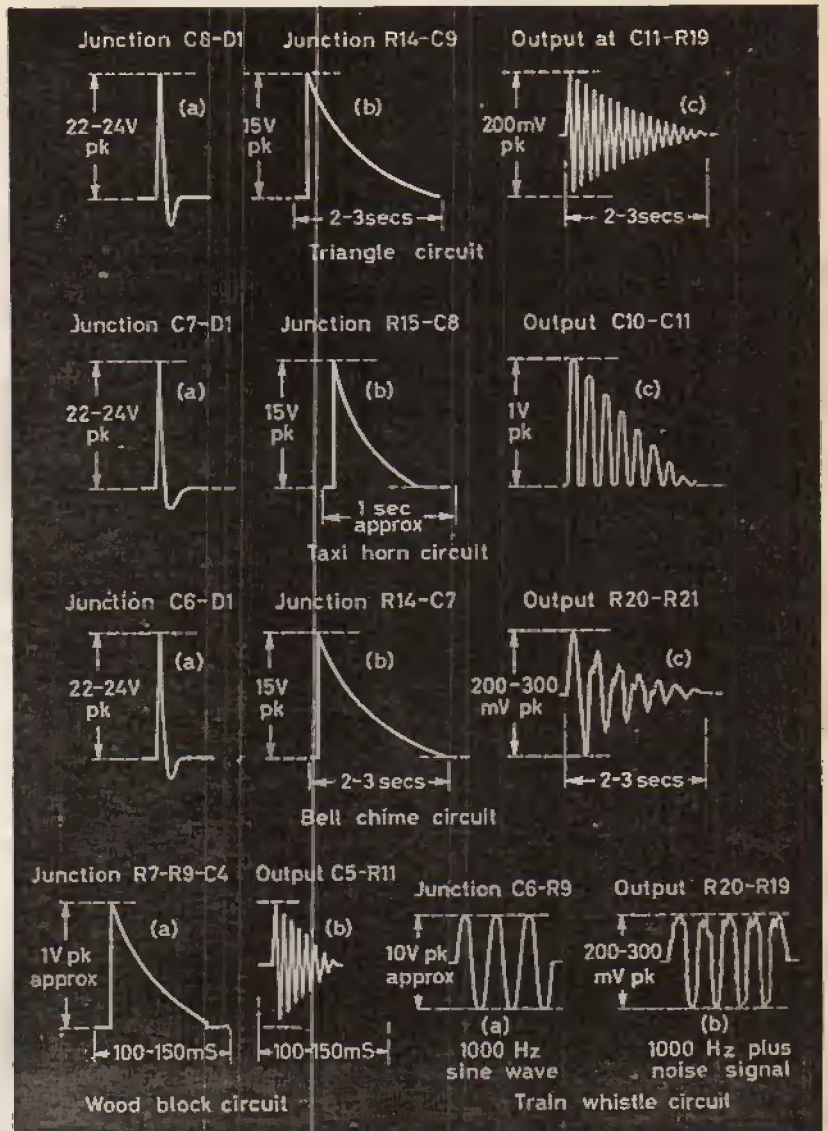

Fig. 21: The waveforms produced by the circuits described in Part 2. If possible these should be checked on an oscilloscope.

R11 for a decrease in noise content and vice versa. The circuit board layout is given in Fig. 18.

Bell Chime Circuit—No. 8

A deep bell chime, similar to that produced by a large clock for instance, is a complex sound made up of an undulating fundamental and many overtones. To achieve a close approximation of this without having to resort to the use of filters and/or a number of tone generators, a multivibrator has been used for the fundamental pitch and overtones. A strong beating or undulating effect is produced by adding another signal at almost the same frequency as the fundamental. This extra signal is obtained from the taxi horn oscillator. The harmonics of this also add considerably to those produced by the bell chime oscillator and the result, after suitable attenuation and 'voicing,' is a deep undulating but strident clock chime. The triggering circuit for the bell chime is produced by Tr3 which is switched on by key No. 8. The action of the circuit is the same as that used for the cymbal and triangle circuits and the decay time about the same i.e., two to three seconds. The output from the bell chime oscillator Tr1-Tr2 is voiced by R6/C5 and attenuated

by R12. The signal from the taxi horn oscillator is treated in much the same way by R16, C8 and R15. Both signals are fed to the base of Tr4. Further attenuation and voicing is introduced at the output from Tr4. The frequency of the signal produced by Tr1 and Tr2 should be adjusted by slight variation of R1 so that a slow audible beating effect is obtained when the sound is keyed. Do not alter the pitch of

★ components list—part two

Triangle Circuit No. 4

Transistors
Tr1, Tr2, Tr3 BC108 Mullard

Diodes
D1, D2 OA5 Mullard

Resistors

R1 12kΩ	R8 10kΩ	R15 12kΩ
R1A 18kΩ	R9 560Ω	R16 120kΩ
R2 12kΩ	R10 470kΩ	R17 10kΩ
R3 12kΩ	R11 47kΩ	R18 2.2kΩ
R4 120kΩ	R12 10kΩ	R19 18kΩ
R5 2.2kΩ	R13 1MΩ	R20 1.5kΩ
R6 10kΩ	R14 820Ω	R21 220kΩ
R7 3.3kΩ		

All ½W, 10% tolerance

Capacitors

C1 250μF	C7 0.1μF
C2 1000pF	C8 1.5μF
C3 1000pF	C9 25μF
C4 1000pF	C10 10μF
C5 10μF	C11 500pF
C6 390pF	

Circuit for Woodblock No. 3

Transistors
Tr1, Tr2 BC108 Mullard

Resistors

R1 8.2kΩ	R6 470kΩ
R2 12kΩ	R7 680kΩ
R3 100kΩ	R8 39kΩ
R4 1kΩ	R9 120kΩ
R5 10kΩ	R10 10kΩ

All ½W, 10% tolerance

Capacitors

C1 2200pF	C4 0.1μF
C2 2200pF	C5 390pF
C3 2200pF	

Circuit for Taxi Horn No. 6

Transistors
Tr1, Tr2 2N2926
Tr3, Tr4 BC108 Mullard

Diodes
D1, D2 OA5 Mullard

Resistors

R1 12kΩ	R8 560Ω	R15 2.2kΩ
R2 150kΩ	R9 10kΩ	R16 1kΩ
R3 120kΩ	R10 470kΩ	R17 120kΩ
R4 12kΩ	R11 47kΩ	R18 12kΩ
R5 820Ω	R12 120kΩ	R19 2.2kΩ
R6 39kΩ	R13 12kΩ	R20 10kΩ
R7 56kΩ	R14 1MΩ	

All ½W, 10% tolerance

Capacitors

C1 500μF	C7 1.5μF
C2 0.03μF	C8 25μF
C3 0.03μF	C9 25μF
C4 0.03μF	C10 2.5μF
C5 0.01μF	C11 6800pF
C6 0.1μF	

Circuit for Train Whistle No. 7

Transistors
Tr1, Tr2 BC108 Mullard
ND1 Noise diode Z1J Semitron (see part 1)
D1 OA5 Mullard

Resistors

R1 12kΩ	R9 220kΩ	R16 47kΩ
R2 12kΩ	R10 68kΩ	R17 2.2kΩ
R3 12kΩ	R11 10kΩ	R18 1kΩ
R4 2.2kΩ	R12 120kΩ	R19 22kΩ
R5 120kΩ	R13 12kΩ	R20 220kΩ
R6 10kΩ	R14 4.7kΩ	R21 39kΩ
R7 1kΩ	R15 10kΩ	R22 15kΩ
R8 100kΩ		

All ½W, 10% tolerance

Capacitors

C1 100μF	C7 0.1μF	C13 10μF
C2 5000pF	C8 0.03μF	
C3 5000pF	C9 10μF	
C4 5000pF	C10 0.2μF	
C5 10μF	C11 0.2μF	
C6 0.05μF	C12 10μF	

Bell Chime Circuit No. 8

Transistors
Tr1, Tr2 2N2926
Tr3, Tr4 BC108 Mullard

Diodes
D1, D2 OA5 Mullard

Resistors ½watt 10%

R1 39kΩ (see text)	R9 47kΩ	R16 220kΩ
R2 10kΩ	R10 470kΩ	R17 12Ω
R3 100kΩ	R11 12kΩ	R18 120kΩ
R4 10kΩ	R12 120kΩ	R19 10kΩ
R5 omitted	R13 1MΩ	R20 220kΩ
R6 220kΩ	R14 680Ω	R21 15kΩ
R7 1kΩ	R15 120kΩ	R22 2.2kΩ
R8 10kΩ		

(Note: R5 omitted due to circuit modification)

All ½W, 10% tolerance

Capacitors

C1 100μF	C7 50μF
C2 0.1μF	C8 0.1μF
C3 0.1μF	C9 2.5μF
C4 2.5μF	C10 10μF
C5 0.2μF	C11 2.5μF
C6 0.5μF	C12 0.02μF

the taxi horn circuit which should have been adjusted to between 200 and 250Hz. The pitch of the bell chime oscillator is best adjusted by substituting R1 with a variable of say 100kΩ in series with a fixed resistor of not less than 18kΩ, to prevent the base of Tr1 being taken straight to h.t.+. Pitch should then be adjusted until it is very

close to that of the taxi horn oscillator frequency i.e., until a slow beat becomes audible. Check the amount of resistance in circuit and replace with an appropriate value fixed resistor. It might be better to replace R1 completely with a small pre-set of say 50kΩ in series with a fixed resistor of 18kΩ. Again the effectiveness of the sound is best

judged aurally but the output waveform, if displayed on an oscilloscope, should appear complex and with considerable fluctuation in the amplitude of the harmonics. The triggering and output waveforms are shown in Fig. 21 (Bell Chime circuit waveforms A, B and C.) The circuit board layout is shown in Fig. 20.

TO BE CONTINUED

practically wireless commentary by HENRY

Tribology

NOT the study of rustic man, not a thesis on triple-ended anchorites, nor even a discourse on moonrock. Tribology is a word coined by the ball and roller bearing people, to mean the study of inter-acting surfaces in motion.

Passing lightly over the thought that some tribal rites, like "Top of the Pops," and the "Rolf Harris Show," would give Tribologists something to study, we nod sagely in the direction of the scientists and hark back to a reference we made when talking about headphones—computer-aided-design.

The thought is inspired by the news that the Science Research Council has given a grant of £9,730 to Bath University to further Dr. A. W. Keen's "Computer-Graphics-Aided Synthesis of Electronic Signal Processing Circuits. C.A.D. for short.

Down there in rural Bath, they argue that circuit design has "grown to the point where engineers tend to collect standard circuits from which they can draw when they are designing." Doctors Whipp and Martin, two lecturers on Dr. Keen's team, nod towards the increasing number of devices such as transistors used in instrument circuits and the growing need for some method which will allow not only the selection and assembly of standard circuits but also the automatic generation of new electronic circuit systems for a desired application.



Some tribal rites

Now that's a thought! Toss into the system for /50 computer—no, I am wrong, with the aid of this grant these lads hope to further their researches with a PDP 8 E complete with graphic display, early this year—well, toss an idea in SOMEWHERE, and what comes out? A completely packaged, plastic-clad, printed circuit, ergonomically engineered, probably deep-frozen to lock in the flavour of the multi-million bits.

Beautiful, shiny, perfectly concocted—but as neutral as a con-sciencious umpire. Bring in the tribological ergonomists and individuality flies out of the window! However, gone will be the kinky boards that could only be the dream-children of the Superstar factory, the panels from Messrs. Busbox with more lines to the inch than a miniature orchestral score; vanished those flexible, flimsy, finicky efforts that come from the Yoshi-Toshi Company. Disappeared like yesteryear's wiring harnesses, all dull colours and knotted string and bent as precise as the kink in a drill sergeants moustache. Declining like those dinky glass bottles with their warm and friendly glow . . .

Forgive an old engineer. Allow me to wipe away a nostalgic tear. The thought of some of our lost specialities makes me sad. The evocative whiff of burning transformers brings back memories and the pungency of toasted selenium is a haunting signpost to the days when apprentices listened when spoken to, customers put us on a par with the rent collector and a crossover was some form of token.

But although the keen Dr. Whipp or the whippy Dr. Keen would have us banish even more of the character that remains in radio, even though they would have "wireless" mean what it says, Henry suspects that the immutable obtuseness of the average computer will defeat them. To judge by our electricity bills, demands of the telephone company and the current computerised



Disappeared like yesteryear's wiring harnesses.

identity by which our friendly neighbourhood bank manager knows us, all that CAD will cough up for the boys of Bath is a row of inscrutable dots. Rationalising of circuitry is all very well, the aim to restrict the prolific growth of semiconductor devices is very commendable, but we suspect that the ultimate result will be to add a number of new integrated circuits to an already bewildering list. Take a look at some of those tuner amplifiers which already feature i.c.'s. Their overall circuitry is as complicated as before, their designer has taken advantage of a new device to extend his ideas within a certain budget. He could do even more with building brick circuits. Imagine the complexity that Bodgit & Co could produce from a handful of i.c.'s and some of the Bath-bricks, a bunch of wires and some presets. The trouble is that for every beautiful computerised block that condenses the Bath team's ideas there will have to be twenty modified versions to suit individual requirements or circuit designers.

And that's the trouble—there will have to be a bit off here and a bit off there until the poor old computer won't know what to disgorge. Computers are notoriously single minded. Those whip-keen laddies at Bath have been talking to computers so long that they think all designs can be divided into logical boxes. They should take a look at some of the articles for *Practical Wireless* that the Editor dares not publish.



OF THE MONTH

L.A.J. IRELAND

Number 18

Digital Counting and Display Devices

THIS month's article deals with a rather unusual topic in that we confine ourselves to the digital i.c. field which so far has not been considered in the present series. Yet the greatest advance in i.c. technology is being made in this field so that today relatively cheap m.s.i. (medium scale integration) circuits are on offer by many manufacturers making it possible for the amateur to construct low cost digital readout and counting circuits with a wide variety of uses.

It may appear at first approach that there are few possibilities of interest in this field. Indeed due to the inherent cost of constructing equipment using discrete components it was well beyond the range of the average constructor but once again mass production coupled with the mastering of m.s.i. technology has completely changed the picture.

Very compact decade counters can be built for less than £5 per decade which compares very favourably with the old dekatron units which proved very popular for any pulse counting requirements. In fact a maximum counting speed of around 20kHz was usually associated with such tubes whereas today there is little difficulty producing counting speeds in excess of 20MHz with t.t.l. logic circuits.

Within the SN74 series of i.c.'s are decade counters and decoder drivers. Two approaches are possible here depending on the type of display output required. One incorporates a cold cathode neon type tube using a common anode with ten separate cathodes formed in the shape of the 0-9 numerals and stacked behind one another.

An input pin is required for each cathode which in turn is usually connected to a decimal decoder circuit. Even though the gas filled readout tube may require around 200 volts for satisfactory operation, it is not necessary that the driver transistors be capable of withstanding this potential as the anode resistor will automatically reduce the voltage and limit the current through the driver transistors. Thus any transistor with a collector to emitter breakdown voltage around 60 volts will work quite well.

A complete decade counter using the new Bi-Pak SN series is shown in Fig. 1. Due to the complexity of the decoder and driver circuits only the logic symbols for the various units are illustrated and the amateur will have to get used to the black box approach to complex i.c. circuits as it would be virtually impossible to follow literally the hundreds of transistors and associated passive components in the present design.

One drawback of the above system is the high voltage required for the readout tube which neces-

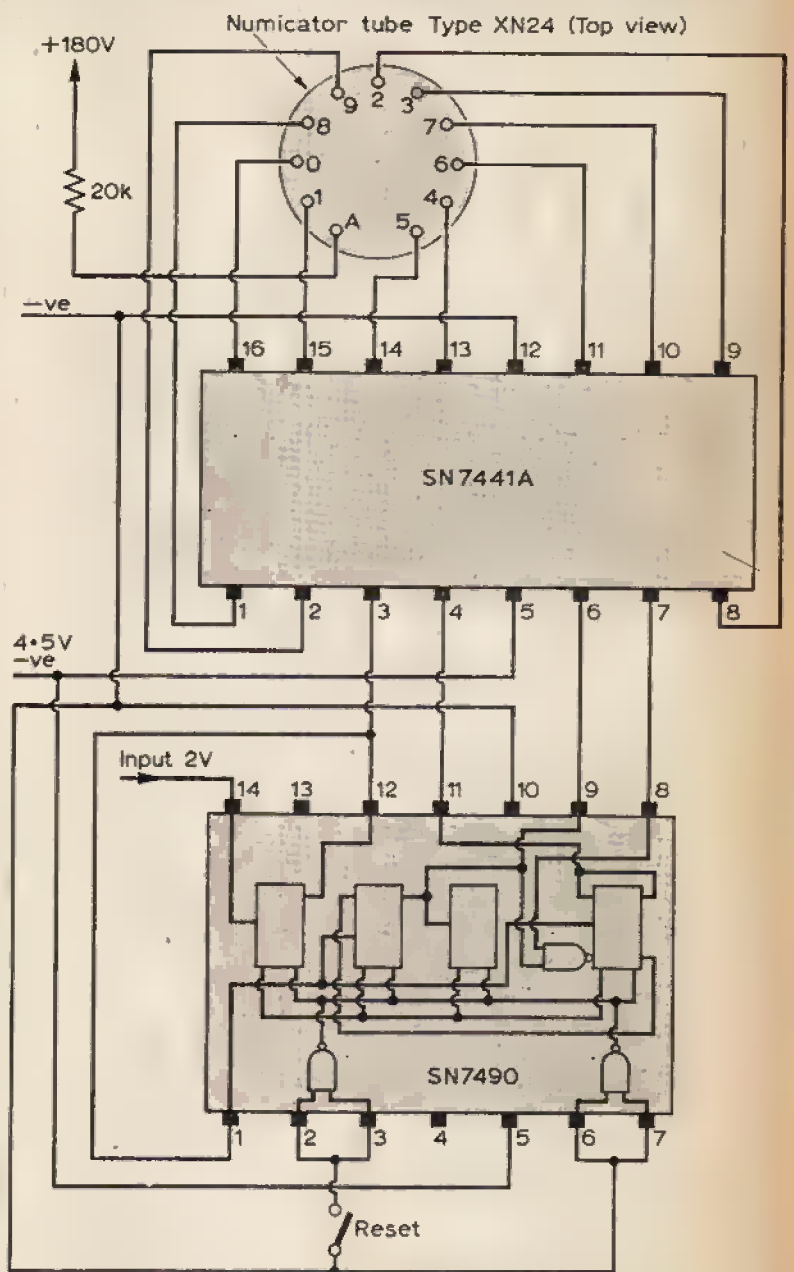

Fig. 1: A complete decade counter using the new Bi-Pak SN series.

sitates the use of some form of inverter if the unit is to be put to portable use. A more modern approach therefore to digital readout is the low voltage filament type of segmented tube consisting of seven independent strip filaments arranged in a figure eight pattern.

Any numeral between 0-9 can be found by illuminating the required segments. In fact eleven alphabet letters can also be created so to an extent the tube can be made to function as a limited alpha-numeric

display device with suitable decoding circuits. In the present design consideration will be given to the RCA numitron type DR2000.

The same decade counter with b.c.d. (Binary Coded Decimal) outputs as used in the first design will function here but a different decoding circuit is

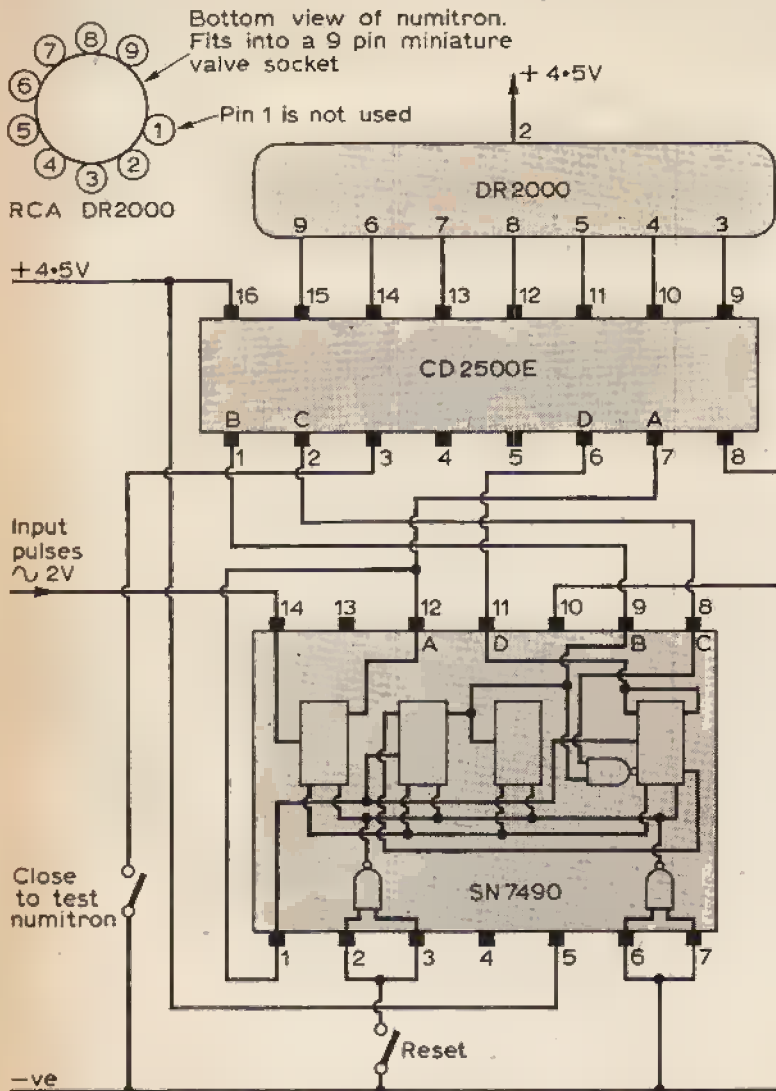

Fig. 2: Shows the interconnections of the units using the CD2500E decoder.

required. Whereas in the previous design a separate pin was needed for each numeral, here only seven are required and a b.c.d. to seven segment decoder is used—RCA type CD2500E.

Once again the complexity of the internal circuitry of this i.c. makes it impractical to draw so Fig. 2 shows the interconnections of the complete unit. A suitable printed circuit board pattern should not prove too difficult for the competent constructor and use could profitably be made of the new dual-in-line mounts advertised by some firms in this magazine. In addition to providing easy insertion and removal of the i.c.'s they also prevent damage to the i.c.'s from excessive heat in the soldering process.

Needless to say, numerous uses can be visualised for these counters. The 50Hz mains can be used as a frequency standard to make an accurate interval timer when coupled through an AND gate to the counter. Also interruptions in a beam of light or pulses from a geiger tube to determine the activity of a radioactive sample can be counted.

A very welcome development related to this field is the drop in prices of the new Gallium Arsenide solid state light emitting diodes. Single devices of this type can now be purchased for around £1.50. With no filament to worry about they are exceptionally robust and have an exceedingly long life span. Arrays using upwards of fifty of these arrayed in a 5 x 10 rectangular matrix are used in many alpha numeric readout systems and recently the first all electronic solid state wrist watch with digital readout has been released in the U.S. using four of these arrays. If the present trend continues they will certainly offer fascinating possibilities for the home constructor in the not too distant future.

IC type SN7441A and SN7490 are available from Bi-Pak Semiconductors.

IC type CD2500E and numitron DR2000 are available from:—Roberts Electronics Ltd., Hermitage Road, Hitchin, Herts.

Hivac Numicator type XN24 available from:—Hivac Ltd., Ruislip, Middlesex.

DECCA 3000 HI-FI SYSTEM WON BY BRISTOL READER OF 25 YEARS STANDING

A reader of *Practical Wireless* for 25 years has won the Decca Hi-Fi System Competition which was featured in our November Issue. He is Mr. Dyke of Bristol. At a recent lunch held by I.P.C. Magazines to congratulate Mr. Dyke, it was revealed that he had taken to reading the magazine after the excellent results he had found with a home-built 2-valve radio designed by F. J. Camm, an earlier Editor of P.W.—and he has hardly missed an issue since.

Mr. Dyke is a great fan of "Practically Wireless" by Henry and rates F. G. Rayer amongst his most popular authors. Being an 'old-timer' in the construction game he is also a keen follower of "Going Back".

The entry which secured the Hi-Fi System for Mr. Dyke was: 1-J, 2-K, 3-L, 4-E, 5-A, 6-D, 7-B and 8-C. The entry was the only correct one out of several thousands.

The Hi-Fi System was something Mr. Dyke had wanted for a very long time and it is the first prize of any value that he has ever won!



Norman Stevens on the left, Editor of *Practical Wireless*, congratulates Mr. and Mrs. Dyke on winning the Decca 3000 Hi-Fi System.

'Trojan' Top band Transceiver

ERIC DOWDESWELL
G4AR

PART TWO

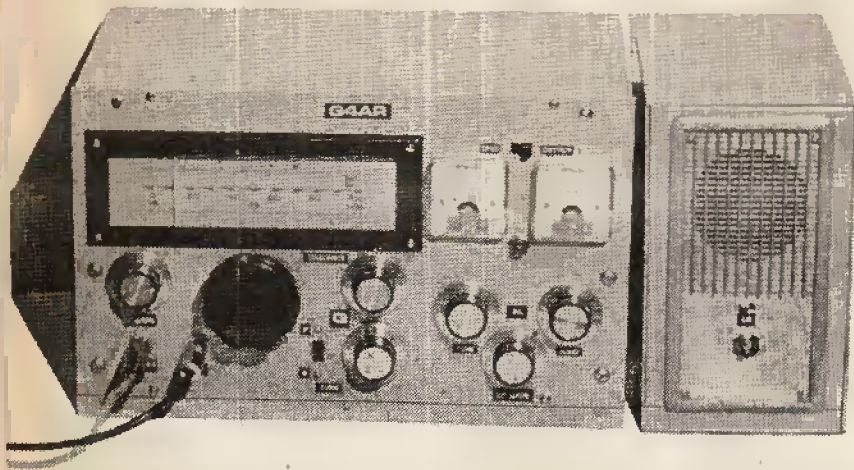

Final Assembly When the two circuit boards and the panel are completed as far as is possible they can be fitted to the aluminium framework, shown in Fig. 7, forming the sides and back of the chassis. The back has a hole for the outlet of the power supply cable form and another to allow adjustment of the transmitter mixer anode coil L4. The co-axial aerial socket is the only fitting on the back member.

In practice only the side members were fitted initially the back not being fitted until the transceiver was completed and aligned, the co-axial socket being allowed to float in the meantime. This allowed full access to the chassis, another advantage of this method of construction.

headphone and key jacks. The four switching diodes D3-6 are mounted on a piece of Veroboard and fitted close to the key jack.

The main tuning capacitor VC2 is mounted on a small aluminium bracket across the cutout in the left hand board and a certain amount of "packing" with washers may be found necessary to ensure that the spindle lines up with the tuning drive coupler.

The wiring between the panel components and the boards may now be completed and a general check-over of all the wiring made for short circuits or errors.

Power Supply Unit The circuit of the supply unit, Fig. 3, shows that the transformer T1 provides the h.t., the negative bias for the transmitter and the relay operating voltage as well as the heater supply. On the h.t. side choke input is used in order to improve the regulation and to keep the voltage down to around 270V so avoiding the use of wasteful dropping resistors.

Switch S2 is mounted on the back of the unit and is essential during the alignment procedure for cutting the h.t. to the p.a. The speaker is a 4in. one with a matching transformer T2 and slide switch S3 cuts out the speaker when headphones are being used.

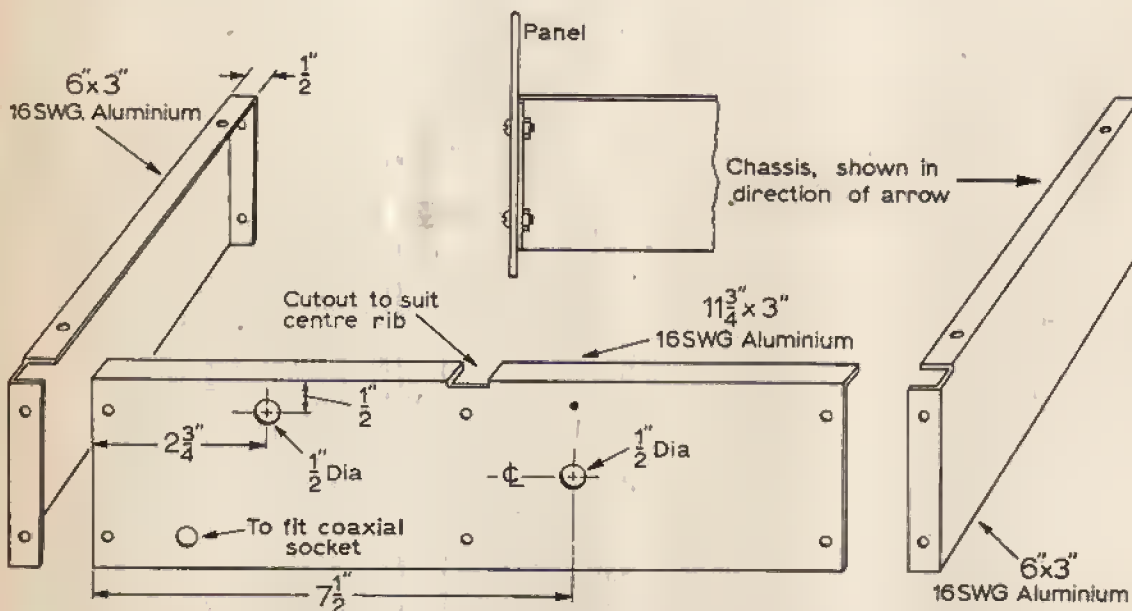

Fig. 7. Exploded view of chassis members. Note that panel extends below the bottom of the chassis, see Fig. 6. Part One. Since the rear member carries only the coaxial socket it can be left off until all wiring and constructional work is completed.

The boards are attached to the chassis with self-tapping screws, two along each edge except at the front. An aluminium bracket supports the two boards at the centre of the chassis and is bolted to the front panel and the back member. This can be seen clearly in the photograph of the underside of the completed transceiver.

The remaining components can now be fitted to the panel, namely the r.f. gain control VR1, Q multiplier tuning capacitor VC4, i.f. gain control VR2 and the

In wiring the two low voltage windings in series regard must be taken of their relative phase to ensure that the voltages are additive and reversing one winding if the relay operating voltage is low. The diodes and resistors are mounted on the bottom of the unit on a piece of Veroboard as can be seen in the photograph of the unit.

The eight leads from the transceiver are taped together and fitted to an octal plug, the leads being about twelve inches long. The receptacle on the power

unit is an ordinary octal valveholder. Note that the earth lead is duplicated to reduce the resistance of this lead.

A speaker fret $6\frac{3}{4} \times 3\frac{1}{2}$ in. in grey plastic (G. W. Smith Ltd.) was bolted to the panel of the power unit, part of the fret being cut away as shown in the heading photograph in Part One of this article. The cabinet was finally sprayed with a grey enamel to match the transceiver cabinet and panel.

ALIGNMENT

Before alignment, checks should be made to ensure that the various h.t., bias and heater voltages are approximately correct. Initially the transmitter valves V5, V6 and V7 can be removed. The i.f. gain control is set at half way and the b.f.o. and first oscillator coils L2 and L3 shorted out, as is the diode D2 in the product detector. The Q multiplier valve V8 can also be removed temporarily.

Connect a low reading a.c. voltmeter across the primary of the output transformer via a blocking capacitor of about $0.1\mu\text{F}$. Feed a modulated signal at 465kHz from a signal generator to the grid of the second i.f. amplifier V4 and adjust the cores of i.f.t.3 for maximum output, at all times keeping the signal input as low as possible consistent with a reasonable output meter reading.

Transfer signal to grid of V3 and repeat tuning procedure with i.f.t.2 finally feeding the signal to V2 and peaking i.f.t.1. Without changing the frequency of the input signal on 465kHz switch off its modulation, remove the short circuit from the b.f.o. coil L3 and the diode D2 and tune the core of the b.f.o. coil until a beat note is heard which should be

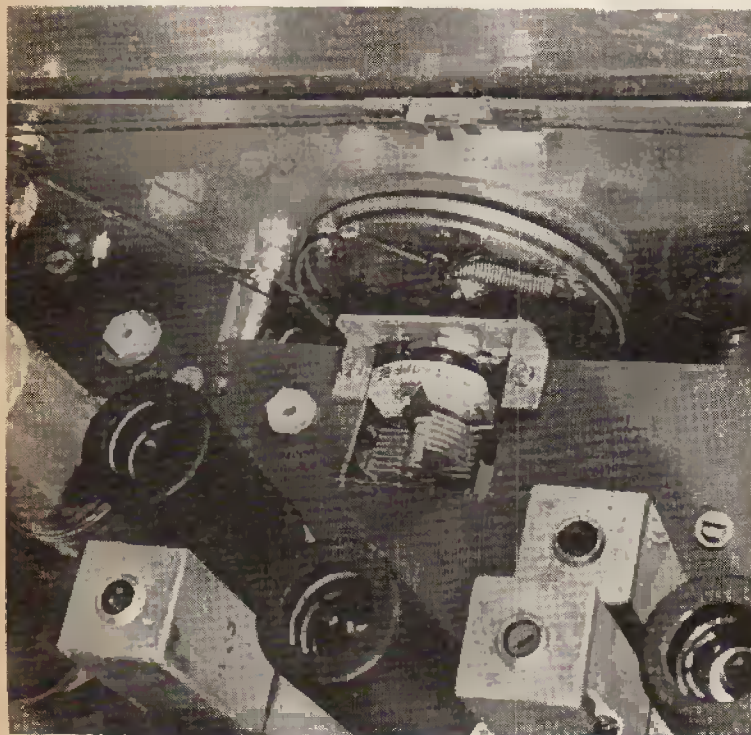

A close-up of the main tuning mechanism. Note cut-away dial plate to clear potentiometers and mounting bracket for VC2.

adjusted to zero-beat with the input signal.

The next step is to adjust the first oscillator for full coverage of the Top Band, i.e. 1.8 to 2.0MHz. Remove the short circuit from the coil L2 and feed in a modulated signal of 1.8MHz to the grid of the mixer valve V2 again shorting out the b.f.o. coil and the diode D2. With the main tuning capacitor VC2

near to maximum capacity adjust the core of L2 until the signal at 1.8MHz is heard. The oscillator itself should now be on 2265kHz which must be checked with a dip oscillator.

Turn the dial so that the capacitor is near minimum and feed in a signal at 2.0MHz and adjust trimmer TC1 until the signal is heard. These last two steps must be repeated until the required coverage is obtained.

RF Stage With the r.f. gain control about half way feed in a signal to the aerial socket at 1.9MHz and swing the p.a. tuning capacitor VC1a-b remembering that this peaks both the p.a. circuit and the receiver mixer grid circuit. It will be found to peak the 1.9MHz signal at two points on the dial corresponding to these two circuits. Adjust the core of L1 until the two peaks coincide when VC1 will be found to be near maximum capacity.

Q Multiplier The Q multiplier valve V8 can now be replaced. With the receiver working normally choose a quiet spot on the band with no signals and with the Q multiplier tuning control VC4 at mid point and switch S2 in the "peak" position tune the core of L7 until the background noise is at its lowest pitch. The selectivity control VR3 should be set at minimum.

If VR3 is now rotated a point will be reached when the stage will go into oscillation. On tuning in a signal the Q multiplier tuning control can be adjusted to peak the beat note at the same time increasing the selectivity control to just below the point of oscillation.

Without altering the main tuning dial any signal in the passband can be peaked, the maximum selectivity being just about all that any c.w. operator could desire.

With S2 in the "null" position interfering signals can be severely attenuated with the Q multiplier controls.

Transmitter Mixer Valves V5, V6 and V7 may now be replaced. Since the b.f.o. and first oscillator are now on their correct frequencies it is very likely that an indication of grid current will be shown on pressing the key. Switch S1 must be set to read grid current and the h.t. to the p.a. switched off.

The cores of the transmitter mixer and buffer amplifier coils L4 and L5 can now be adjusted to peak the grid current at the centre of the band and should reach around 3mA. Check and double check that the output is on Top Band using an absorption wavemeter.

A dummy load carbon resistor of between 50 and 70 ohms should now be connected to the aerial socket. This resistor should have a power rating of at least 5 watts and may be made up of several higher value resistors in parallel but they must be of carbon and can be mounted on a coaxial plug for convenience.

Turn the p.a. loading capacitor VC3 to maximum and peak signals with the p.a. tuning control. On pressing the key the anode current will be about 45mA and the p.a. tuning should be quickly tuned for a dip in anode current to about 20mA. Decrease the value of the loading capacitor and re-dip the tuning. Repeat this until the dipped value of the anode current is about 35mA. This represents an input of about 10W, the legal maximum on Top Band. Check again that the output is on the correct frequency using the absorption wavemeter.

TRANSISTOR RADIOS TO BUILD YOURSELF

Backed by after sales service

NEW! roamer eight mk 1 WITH VARIABLE TONE CONTROL

7 Tunable Wavebands: Medium Wave 1, Medium Wave 2, Long Wave, SW1, SW2, SW3 and Trawler Band. Built in Ferrite Rod Aerial for Medium and Long Waves. 4 section 24" retractable chrome plateu Telescopic aerial for Short Waves for maximum performance. Push pull output using 600 mW transistors. Socket for car aerial. Tape record socket. Selectivity switch. Switched earpiece socket complete with earpiece for private listening. Eight transistors plus 3 diodes. Famous make 7in. x 4in. Speaker. Air spaced ganged tuning condenser. On/Off switch volume control. Wave change switch and tuning control. Attractive case in rich chestnut shade with gold blocking. Size 9 x 7 x 4in. approx. Easy to follow instructions and diagrams make the Roamer Eight a pleasure to build.

Total building costs £6.98 (£6.19.7)

Parts Price List and Easy Build Plans 25p (5/-) (FREE with parts).

Overseas P. & P. 85p (17/-)

P. & P. 38p (7/7)

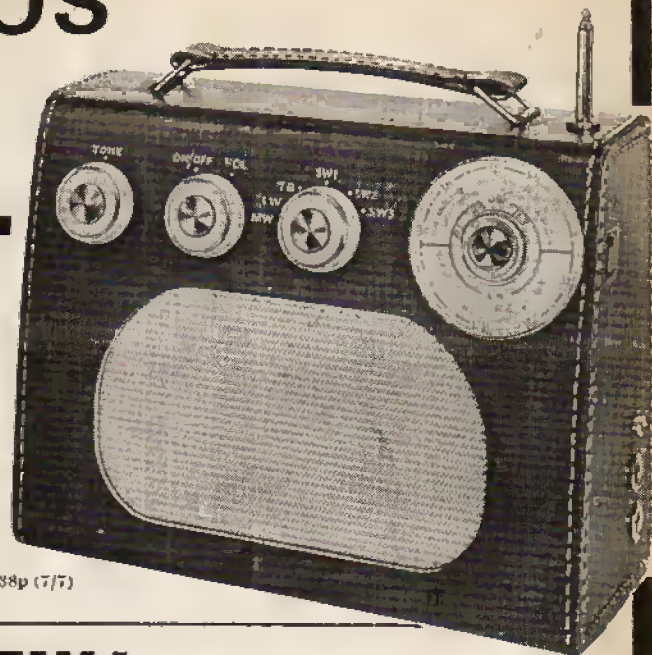

roamer seven mk IV

SEVEN FULLY TUNABLE WAVEBANDS—MW1, MW2, LW, SW1, SW2, SW3 and Trawler Band. Extra Medium waveband provides easier tuning of Radio Luxembourg, etc. Built in ferrite rod aerial for Medium and Long Waves. Retractable 4 section 24in. chrome plated telescopic aerial for peak Short Wave listening. Socket for Car Aerial. Powerful push-pull output. Seven transistors and two diodes including Micro-Alloy R.F. Transistors. Famous make 7 x 4in. P.M. speaker. Air spaced ganged tuning condenser. Volume/on/off control, wave change switches and tuning control. Attractive case with carrying handle. Size 9 x 7 x 4in. approx. Easy to follow instructions and diagrams make the Roamer 7 a pleasure to build. Parts price list and easy build plans 15p (3/-) (FREE with parts). Personal Earpiece with switched socket for private listening, 25p (5/-) extra.

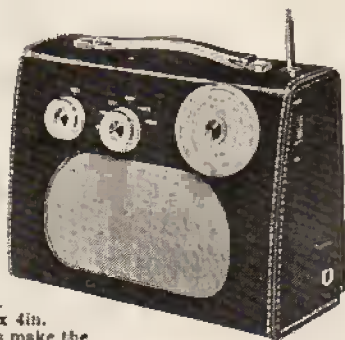

Total building costs £5.98 (£5.19.7)
P. & P. 38p (7/7)
Overseas P. & P. 85p (17/-)

NEW! trans eight

SIX WAVEBAND
PORTABLE WITH
3in. SPEAKER

Attractive case in black with red grille and black knobs and dial with spun brass inserts. Size 9 x 5½ x 2½in. approx. Tunable on Medium and Long Waves, three Short Waves and Trawler Band. Sensitive ferrite rod aerial for M.W. and L.W. Telescopic aerial for Short Waves. Eight improved type transistors plus 3 diodes. Push pull output. Battery economiser switch for extended battery life. Ample power to drive a larger speaker. Parts price list and easy build plans 25p (5/-) (FREE with parts). Earpiece with switched socket for private listening 25p (5/-) extra.

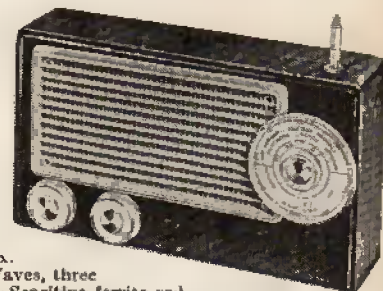

Total building costs £4.48 (£4.9.7)
P. & P. 28p (5/7)
Overseas P. & P. 65p (13/-)

pocket five

MEDIUM WAVE, LONG WAVE
AND TRAWLER BAND PORTABLE
WITH SPEAKER

Attractive black and gold case. Size 5½ x 1½ x 3½in. Tunable over both Medium and Long Waves with extended M.W. band for easier tuning of Luxembourg, etc. 7 stages—5 transistors and 2 diodes. supersensitive ferrite rod aerial, fine tone moving coil speaker. Easy build plans and parts price list 8p (1/7) (FREE with parts).

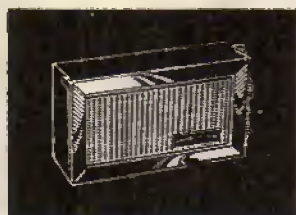

Total building costs £2.23 (£2.4.7)
P. & P. 18p (3/7)
Overseas P. & P. 50p (10/-)

transona five

MEDIUM WAVE, LONG WAVE
AND TRAWLER BAND
PORTABLE
WITH SPEAKER

Attractive case with red speaker grille. Size 6½ x 4½ x 1½in. 7 stage—5 transistors and 2 diodes, ferrite rod aerial, tuning condenser, volume control, fine tone moving coil speaker. Easy build plans and parts price list 8p (1/7) (FREE with parts).



Total building costs £2.38 (£2.7.7)
P. & P. 19p (3/9)
Overseas P. & P. 50p (10/-)

IMPROVED MODEL!

roamer six

SIX WAVEBAND PORTABLE
WITH 3in. SPEAKER

Attractive black case with red grille and black knobs and dial with spun brass inserts. Size 9 x 5½ x 2½in. approx. Tunable on Medium and Long Waves, two Short Waves, Trawler Band plus an extra M.W. band for easier tuning of Luxembourg, etc. Sensitive ferrite rod aerial and latest telescopic aerial for Short Waves. Improved circuit. 8 stages—6 transistors and 2 diodes including Micro-Alloy R.F. Transistors, etc. Easy build plans and parts price list 10p (2/-) (FREE with parts).

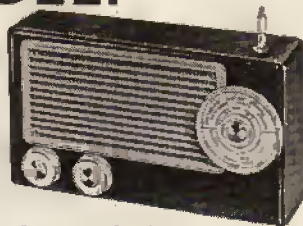

Total building costs £3.98 (£3.19.7)
P. & P. 23p (4/7)
Overseas P. & P. 65p (13/-)

RADIO EXCHANGE CO

61 HIGH STREET, BEDFORD. Tel. 0234 52367

I enclose £..... please send items marked

ROAMER EIGHT	<input type="checkbox"/>	ROAMER SEVEN	<input type="checkbox"/>
TRANSONA FIVE	<input type="checkbox"/>	TRANS EIGHT	<input type="checkbox"/>
POCKET FIVE	<input type="checkbox"/>	ROAMER SIX	<input type="checkbox"/>

Parts price list and plans for

Name

Address

PW.28

* Callers side entrance Stylo Shoe Shop

* Open 10-1, 2.30-4.30 Mon.-Fri. 9-12 Sat.

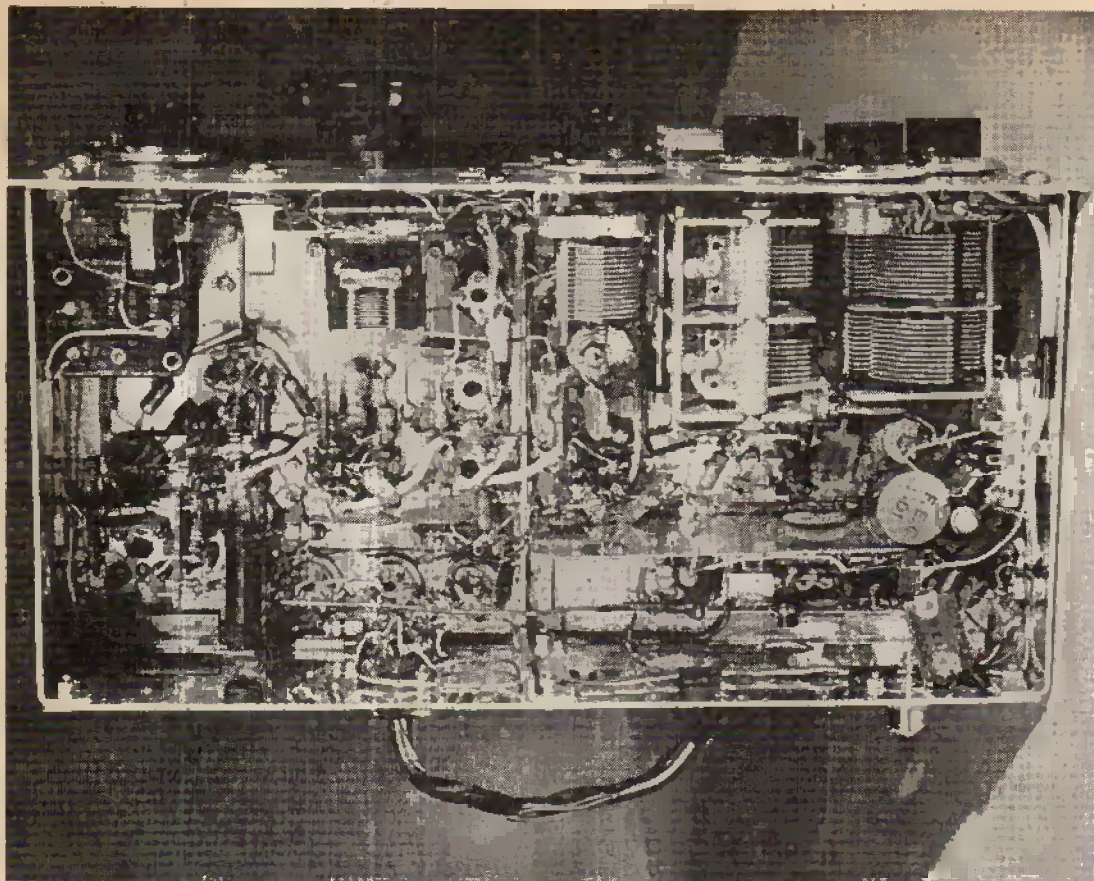

Below-chassis view of transceiver. The main components may be identified by referring to Fig. 5, Part One. The inner edges of the boards are supported by the aluminium bracket running vertically downwards in the centre of the chassis.

If it is found that the dip in the anode current on transmit does not quite coincide with the position of the p.a. tuning for maximum signals on receive, the transmitter should be carefully tuned and signals then peaked by adjusting the core of the receiver mixer coil L1. This should be done around 1.9MHz when it will be found that the alignment will hold over the whole band.

Once the transceiver has been aligned and the output frequency checked and found correct the r.f. output indicator can be used for tuning up the transmitter.

Final Alignment When the transceiver is working properly in all respects the whole alignment procedure should be repeated and although this may sound quite formidable in fact it takes only a few minutes.

In particular the tuning of i.f.t.1 will have been upset by the addition of the Q multiplier stage.

NOTES

As the finished chassis is a close fit in the cabinet the flanges on the sides of the cabinet must be cut away to provide clearance.

Holes are cut in the back of the cabinet, one to clear the power lead octal plug and the other for the co-axial aerial socket. Chassis cutters of 1½in. and ¾in. respectively were used for this purpose.

Aluminium angle trim was glued to the bottom front edge of the transceiver cabinet and the power supply cabinet, as a finishing touch, as well as to lift up the fronts of the units from the table. Conventional rubber or plastic feet can also be used to achieve the same effect.

Letraset was used to make up labels for identifying the various panel controls, switches etc.

If the receiver only is required there is no reason why this part of the transceiver should not form a project on its own. In this case the cathode returns of the r.f. stages should be returned to earth and the p.a. coil L6 replaced by a Denco Range 3 aerial coil.

The transmitter portion of the transceiver can be utilised on its own by feeding outputs from the first oscillator and the b.f.o. of a Top Band receiver into the transmitter mixer valve V5. Remember that any interference with these oscillators will affect their calibration. Other arrangements would have to be made for the changeover from receiver to transmit.

Although a higher voltage on the p.a. would be desirable from the point of view of efficiency by using a capacity input filter in the power supply it was decided to stick to choke input for the better voltage regulation that it provides.

The importance of using a calibrated absorption wavemeter for checking the transmitter output cannot be too highly stressed. It must be remembered that the r.f. output indicator will respond to any r.f. output including any spurious which may occur during alignment.

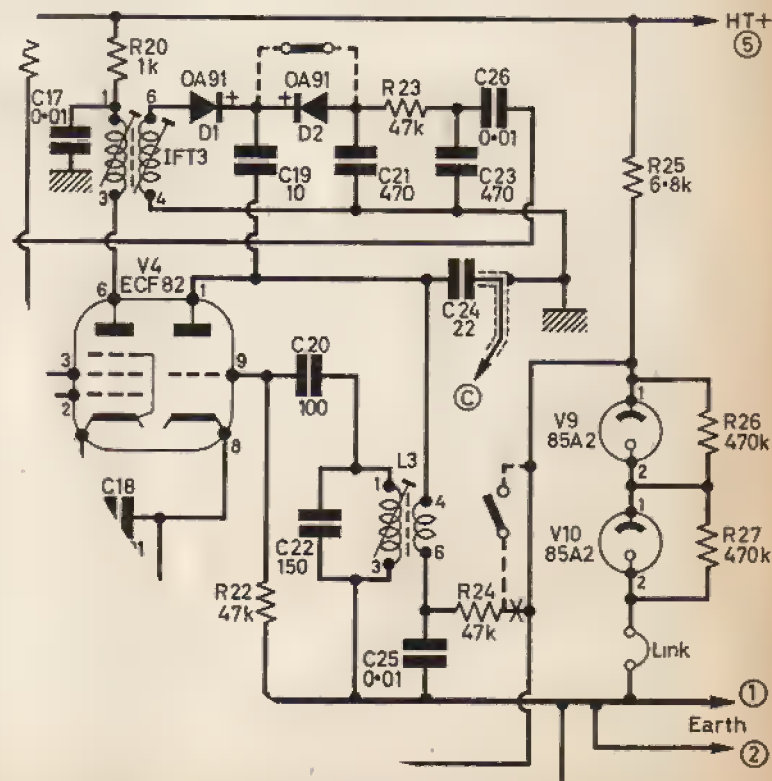

Fig. 8. Modification for reception of a.m. signals. One pole of a slide switch shorts out diode D2, the other pole opens the h.t. feed to the b.f.o., V4. Existing feed to b.f.o. must be broken at point X.

MODIFICATIONS

Since completing the transceiver the following modifications have been made to improve its versatility.

AM Reception As it stands the transceiver can be used to receive a.m. signals by tuning the carrier to zero-beat. This is not entirely satisfactory so a double-pole changeover slide switch was fitted to the panel. One pole is wired in series with the h.t. line to the b.f.o. and the other is wired across the product detector diode D2 which is shorted out on a.m. Thus on a.m. the b.f.o. is off and D1 becomes a normal diode detector, Fig. 8.

AM Transmission In order to be able to use a.m. telephony an open circuit jack socket was fitted to the back panel of the power supply unit and connected in parallel with the transmitter h.t. supply switch S2.

With the switch open the output of a small modulator can be plugged into the socket and the transmitter adjusted for proper modulation in the usual way.

When receiving a.m. signals the Q multiplier selectivity control may need backing off to obtain adequate bandwidth for reasonable speech quality.

It is important to note that when transmitting in the a.m. mode the b.f.o. must be on. The slide switch, mentioned above, must be moved to the "on" or "c.w." position before pressing the key to transmit. ■

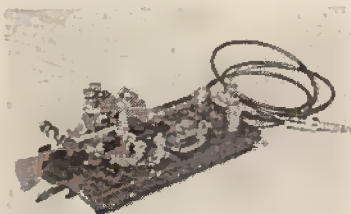

MAXWELL

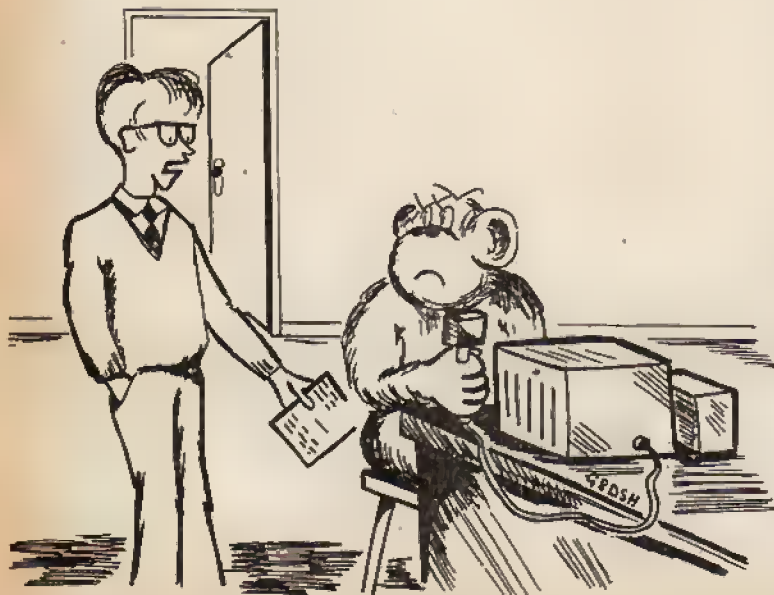

"It's the man from the G.P.O. about your party-political broadcast"

THE MW COLUMN

CENTRAL USSR and its Asiatic Republics to the south are usually neglected by the medium wave enthusiast. Local broadcasting in this area is on European frequencies and since the time zones are ahead of GMT, the majority of stations will have signed off before interference from Western Europe subsides for the night. Although there are a few all-nighters to be heard the best time for DX is at sign on, which occurs between 0100hrs and 0300hrs GMT. Saturday night is unfavourable owing to the extended schedules of many Europeans. **Harold Emblem** of Mirfield, Yorkshire, has been DXing this region and reports reception of Gorki on 827kHz; Simferpol Crimea 1313kHz (which was heard behind Stavanger at 1800hrs); Kharkov 1322kHz at 0240hrs; Saransk 1061kHz. DX logged recently by the writer includes Murmansk Lapland 656kHz at 2330hrs GMT; Ufa Bashkir 692kHz at 0106hrs; Kuybyshev 809kHz at 0140hrs; Garm Tadzhikistan 980kHz at 0050hrs; Baku Azerbaijan 1016kHz at 0130hrs. Those heard signing on at 0200hrs GMT were Yerevan Armenia 863kHz; Stavropol Caucasus 881kHz and Tbilisi Georgia 1043kHz. Others logged later in the night are Astrakhan 791kHz at 0206hrs; Markhagkala Dagestan 917kHz at 0205hrs; Tashkent Uzbekistan 1025kHz at 0230hrs. From nearby Iran, Tabriz 645kHz is often strong when it signs on at 0228hrs with a haunting Iranian melody played on a vibraphone, followed by a 3-pip time signal and the call 'Radio Iran.'

Identification can sometimes be a problem with USSR stations. Those that do identify locally use the word *Govarit* if in Russian, *Geplevar* in Turkmenian, *Danishir* in Azerbaijanian, *Khosum* in Armenian followed in each case by the place name. Radio Tashkent identifies in Uzbek with *Tashkentdan Gapiramis*. Harold points out that the BBC transmissions in Russian on 809kHz might be mistaken for Kuybyshev, but USSR stations usually transmit the 'Midnight in Moscow' interval signal two minutes before the hour or half hour, followed by a 6-pip time signal, while many carry the '*Programma Mayak*' which is mentioned in the identification. Sometimes a station broadcasts on one of the Tropical Bands as well as on the MWs. The writer has checked Ashkhabad 200kHz on the long waves against Ashkhabad 4825kHz on the 60 metre band and found the same local programme on each frequency.

Medium wave stations in the Caribbean are often prominent at this time of year. Listen between midnight and 0100hrs GMT for JBC 750kHz Point Galina, Jamaica; ZFY 760kHz Georgetown, Guyana; 4VEC 830kHz Cap Haitien, Haiti, in French; Radio Belize 834kHz in British Honduras; Radio Caribbean 840kHz in St. Lucia in French; WBMJ 1190kHz San Juan, Puerto Rico in English; ZBM1 1235kHz Hamilton, Bermuda; PJD2 1295kHz St. Martin in Dutch and English; Martinique 1310kHz in French.

Charles Molloy

"READ PEOPLE'S MINDS"—TEST THEIR NERVES—BEAT THEM AT CARDS—TEST THEIR MENTAL ABILITY, ETC. WITH THIS ASTONISHING ELECTRONIC BRAIN-BOX



ONLY £2.87 (57/6)

If you've seen a giant computer on show at an electronics exhibition, you will have seen people of all ages queuing to pit their abilities against the giant electronic brain. There is a tremendous fascination that attracts ordinary people and professional engineers alike to electronic games of skill, chance and mystery. With this "Brain-box" you will be able to perform mind-boggling feats. **THE MIND READING DEVICE** will make people swear you have "telepathic" powers. **THE AMAZING CARD TRICK UNIT** completely mystifies and baffles from one to six people. You correctly "guess" the two cards each person has selected at random from a pack they themselves shuffled. **THE ELECTRONICS NERVES TESTER** puts your friends to a very lively test. It gives out fall and finish signals (the winner is the person with lowest number of fall signals.) Can be adjusted from the easiest to strongest person. **THE ELECTRONIC MAZE** tests the mental ability of the player because it uses psychology with an electronic twist to it. You can change the maze pathways in seconds to prevent the maze becoming too stale after lots of use. Completely safe and foolproof. Size 18" x 12" x 6" (Max.). You can play all these games and more beside after building the "Brain box". **WE GUARANTEE THAT ANYONE FROM NINE TO NINETY CAN EASILY ASSEMBLE ALL THESE PROJECTS IN UNDER ONE HOUR!** You can't go wrong, no soldering, you get pictorial, easy as a.b.c. step-by-step simple instructions. **ONLY £2.87 (57/6) + 23p (6/6)** for all parts including chassis, switches, stylus, signalling lights, wire, nuts, screws etc. etc. Uses standard battery. Presentation Box 37p (7/6) extra as illus. if reqd. (PARTS AVAILABLE SEPARATELY) **FULL OPERATING DIRECTIONS WITH EACH OF THE PROJECTS.**

EAVESDROP ON THE EXCITING WORLD OF AIRCRAFT COMMUNICATIONS—JUST OUT V.H.F. AIRCRAFT BAND CONVERTER

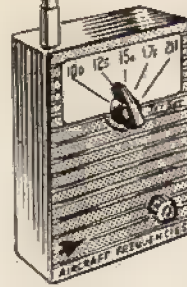

ONLY £2.37 (47/6)

Many thousands of v.h.f. Aircraft Band Converters now selling in U.S.A. Listen in to AIRLINES, PRIVATE PLANES, JETPLANES. Eavesdrop on exciting cross-talk between pilots, ground approach, ground control, airport tower. Hear for yourself the disciplined voices hiding tenseness on talk downs. Be with them when they have to take nerve ripping decisions in emergencies—Tune into the international distress frequency. Covers the aircraft frequency band including **HEATHROW, GATWICK, LUTON, RINGWAY, PRESTWICK ETC. ETC. CLEAR AS A BELL.** This fantastic fully transistorised instrument can be built by anyone nine to ninety in under two hours. (Our design team built four—everyone worked first time). No knowledge of radio or electronics required. No soldering necessary. Fully illustrated simply worded instructions take you step-by-step. Uses standard PP3 battery. Size only 4 1/2" x 3" x 1 1/2". All you do is extend rod aerial, place close to any ordinary medium-wave radio—even tiny portables) **NO CONNECTIONS WHATSOEVER NEEDED.** Use indoors or outdoors. **THERE WILL BE ENORMOUS DEMAND FOR THIS NEW DESIGN. SEND NOW. ONLY £2.37 (47/6) + 23p (4/6)** for all parts, including case, nuts, screws, wire, etc. etc. (parts available separately).

AMAZING TRANSISTORIZED CIGARETTE RADIO

Yes, a perfectly ordinary packet of cigarettes! But watch your friends' astonishment on hearing its range of stations loud and clear. Holds 10 cigarettes yet conceals sensitive, fully transistorised circuit (including tiny battery). A young boy can assemble it in under 2 hours. No soldering. Only 16 connections to make. **ALL PARTS** including semi-conductors. Simple as ABC Illustrated Plans, etc. **ONLY £1.47 (29/6) + 13p (2/6) p. & p.** Parts available separately.

TOTAL BUILDING PRICE £1.47 (29/6)



FIND BURIED TREASURE! TREASURE LOCATOR FULLY TRANSISTORIZED

NOW IT'S HERE AT LAST, after experimenting for four and a half months with a multitude of different circuits and carrying out actual field tests with prototypes, our design team have come up with this real winner. This fully portable transistorised metal locator detects and tracks down buried metal objects—it signals exact location with loud audible sound (no phones used)—uses any transistor radio which slips inside—no connections needed. **FINDS GOLD, SILVER, LOST COINS, JEWELLERY, KEYS, WAR SOUVENIRS, ARCHAEOLOGICAL PIECES, METALLIC ORE, NUGGETS ETC. ETC.** Outdoors or indoors. *Extremely sensitive, will signal presence of certain objects buried several feet below ground!* No knowledge of radio or electronics required. Can be built with ease in one short evening by anybody from nine years of age upwards, with the wonderfully clear, easy to follow, step-by-step, fully illustrated instructions—it really is easy as A.B.C. Fully transistorised—no valves. Uses standard PP3 battery. No soldering necessary. Size of detector head 13 1/2" x 10" x 2 1/2". **Great demand expected at this remarkably low price—ORDER WHILE PRESENT STOCKS LAST.** All parts including detector head case, nuts, screws, wire, simple instructions etc. etc. **ONLY £2.37 (47/6) + 23p (4/6) p. & p.** (Telescopic handle as illustrated £1.75 (35/-) extra.) Parts available separately. Made up looks worth £15!

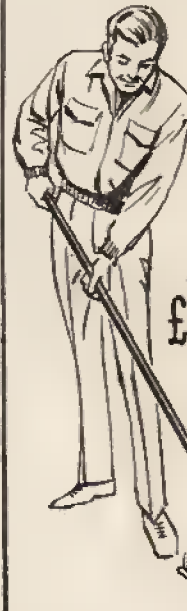

ONLY £2.37 (47/6)

SHORTWAVE TRANSISTOR RADIO

Can be built in one evening

At last! After trying countless circuits searching for easy build, work first-time short waver. Giving advanced world-wide performance, we chose this "Sky Roma". Anyone from 9 years up can follow the step-by-step, easy-as-ABC, fully illustrated instructions. (We built ten prototypes and every one worked first time) no soldering necessary. 76 stations logged on rod aerial in 30 mins.—Russia, Africa, USA, Switzerland, etc. Experience thrills of world wide news, sport, music, etc. Eavesdrop on unusual broadcasts. Uses PP3 battery. Transistorised (no valves). Size only 3" x 4 1/2" x 1 1/2". As tremendous demand anticipated price held to only **£2.25 (45/-) + 17p (3/6) p. & p.** for all parts incl. Cabinet, screws, instr. etc. (Parts available separately).

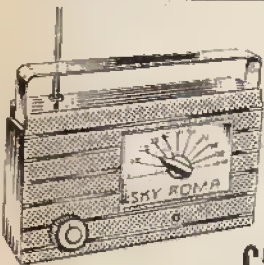

ONLY £2.25 (45/-)

REAL WORKING ELECTRONIC ORGAN

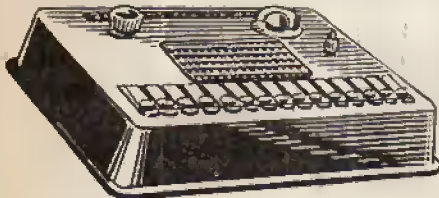

Don't confuse with ordinary electric organs that simply blow air over mouth-organ type reeds etc. Eight months were spent in creating and testing this superb, revolutionary electronic organ. Fully transistorised—no valves. Proper self-contained loudspeaker. Fifteen separate keys span two full octaves—play the "Yellow Rose of Texas", play "Silent Night", play "Auld Lang Syne", play lots and lots of similar tunes on this real working electronic organ. Although it's no theatre organ it's certainly no tiny thing, it measures 13 1/2" x 10" x 2 1/2". You have the thrill and excitement of building it together with the pleasure of playing a real, live, throbbing electronic organ. **Take it anywhere—play it anywhere. NO PREVIOUS KNOWLEDGE OF ELECTRONICS NEEDED—NONE WHATSOEVER.** No soldering necessary, it really is as simple as a.b.c. to make. Anyone from nine years upwards can build it easily in one short evening following the fully illustrated, step-by-step, simply worded instructions. **BIG DEMAND ANTICIPATED FOR THIS UNIQUE INSTRUMENT** at our low, low building price. **ONLY £2.75 (55/-) + 23p (4/6) p. & p.** for all parts, including case, loudspeaker, transistors, condensers, resistors, knobs, transformer, volume control, wire, nuts, screws, simple (but full) instructions, etc. etc. Uses standard PP3 battery (parts available separately). Have all the pleasure of making it yourself, finish with an exciting gift for someone.

ONLY £2.75 (55/-)

MAKE 5 PROJECTS INCLUDING 3 TRANSISTOR LOUDSPEAKER RADIO

TOTAL BUILDING PRICE £1.97 (39/6)

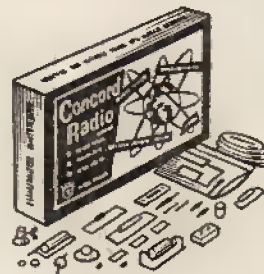

Amazing Radio Construction set! Become a radio expert for £1.97 (39/6). A complete Home Radio Course. No experience needed. Parts including simple instructions for each design. Illustrated step-by-step plans, all transistors, loudspeaker, personal

phone, knobs, screws, etc., all you need. Presentation Box 37p (7/6) extra as illus. if required (extra parts available separately). Send only **£1.97 (39/6) + 23p (4/6) p. & p.**

UNIQUE RADIO FOR BEDROOM OR OFFICE

No batteries, no electricity, never wears out

Tune in your favourite programmes or the news, or sports in the Office or in your bedroom. Uses sensitive, germanium diode originally evolved from wartime radar. Never buy a battery. Never use electricity. Never replace. Covers all medium waves. Clear beautiful tone. Size 4 1/2" x 2 1/2" x 1 1/2" in beautiful case. **ONLY 7 CONNECTIONS AND IT'S WORKING.** No soldering necessary. **CAN BE BUILT ALMOST BLINDFOLD IN UNDER 15 MINUTES!** Ideal for absolute beginner from 8 years of age upwards.

ONLY 97p (19/6)

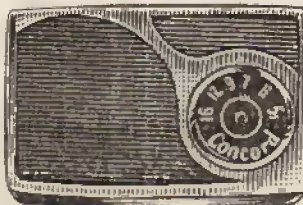

SPECIAL PRICE TO CLEAR STOCKS OF COMPONENTS. ONLY 97p (19/6) + 13p (2/6) p. & p. for all parts including beautiful case. Germanium semiconductor, tuning condenser, personal phone, wire, nuts, screws. **SIMPLE AS A.B.C. INSTRUCTIONS.** (Parts available separately).

EXAMINE AT HOME FOR 7 DAYS. YOUR MONEY REFUNDED IN FULL IF NOT 100% DELIGHTED.

CONCORD ELECTRONICS LTD (Dept. PW18) 8 Westbourne Grove, London W.2. (Nr Bayswater & Queensway Tubes. 1 minute ABC Cinema) Callers Welcome 9 a.m.-6 p.m. inc. Saturday

A SMALL-C CHECKER

ARTHUR DOW

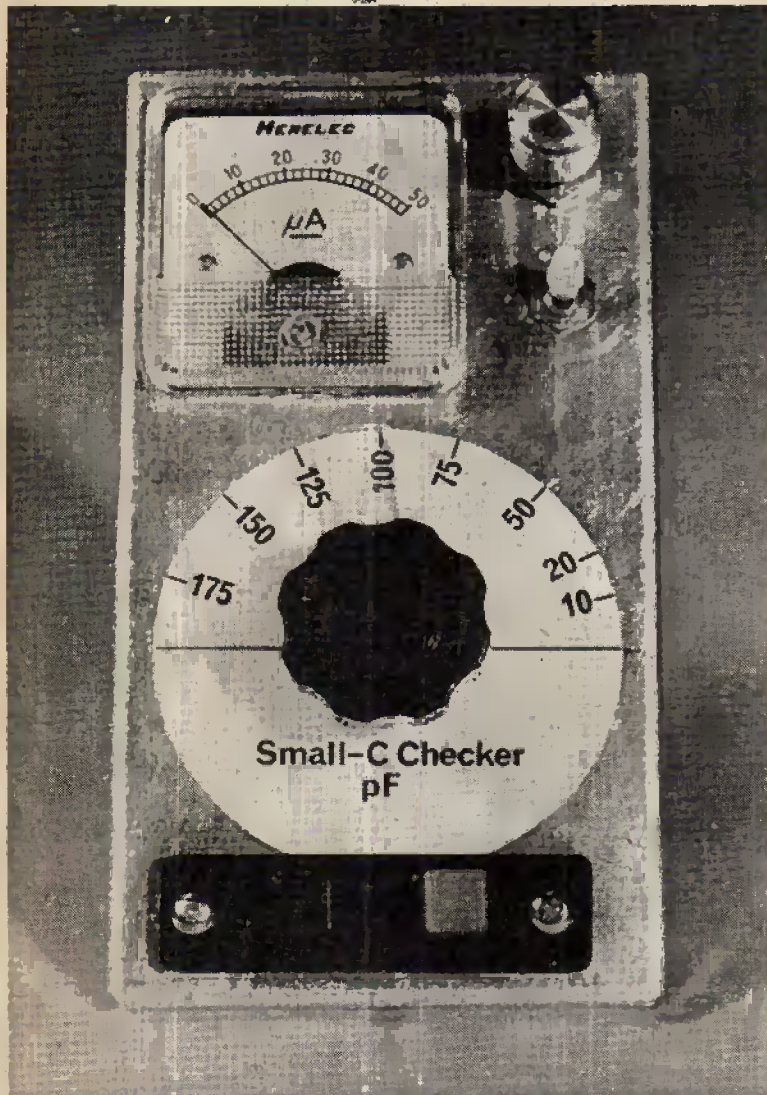

IN the course of time the average constructor accumulates quite a lot of odd small-value capacitors which eventually lose their markings and identity either by constant handling or by just being jostled around in the junk box. In any case they are then virtually useless and a positive menace and might just as well be thrown away. A 10pF capacitor used inadvertently with a tuned circuit instead of 100pF can cause an awful lot of trouble.

However by using this simple checker these capacitors can be rescued and re-marked and an hour spent in this way can be very rewarding.

The usual method of measuring capacity is with a bridge using an integral a.f. or r.f. oscillator to power the bridge. It occurred to the writer that since most constructors have a seldom used 1MHz crystal calibrator sitting on the workbench this could be put to good use as a signal source for a capacity checker.

In the event the checker proved so useful and was used so often that it was decided to integrate the oscillator and capacity measuring circuitry. This second unit is also described below.

METHOD

The usual bridge circuit has not been used. Instead a tuned circuit is resonated with the signal source at 1MHz, the unknown capacitor connected in parallel with the circuit and the tuning capacitor reduced in value until resonance is restored.

If the tuning capacity is calibrated (in pF) the decrease in its capacity to maintain resonance is equal to the value of the unknown capacitor.

The range of capacity that can be checked is approximately equal to the value of the calibrated capacitor, in this case up to about 200pF.

CIRCUIT MK I

The signal source at 1MHz is fed via a short coaxial lead to the input socket Sk1, Fig. 1, across which is connected the tuned circuit L1, VC1. With VC1 at maximum capacity the slug of L1 can be adjusted until the circuit resonates with the 1MHz source.

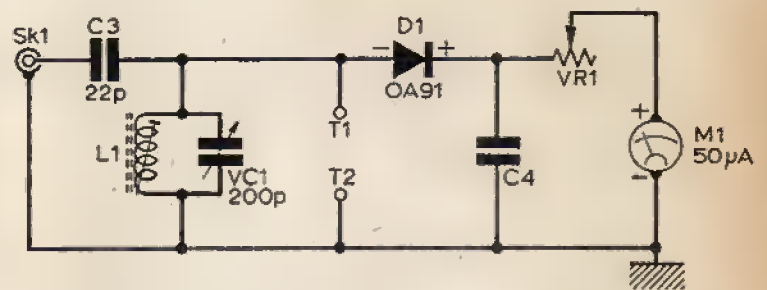

Fig. 1: Circuit of the Mk I capacitor checker.

Resonance is indicated by maximum deflection on the 50 μ A f.s.d. meter M1 fed from the rectifier circuit D1 and C4 connected across the tuned circuit. The f.s.d. of the meter can be adjusted over a wide range by the potentiometer VR1 to cater for differing input signal levels.

The capacitor to be measured is connected to the terminals T1 and T2. The range can be extended by increasing the value of VC1 but the accuracy of the read-out will be less.

SIGNAL SOURCE

The author had a 1MHz-100kHz-10kHz crystal calibrator available so this was used originally as a signal source for the checker, at 1MHz. There is no reason why an ordinary signal generator tuned to 1MHz should not be used but it should be stable in frequency and be fitted with an attenuator or other output level control.

CONSTRUCTION

All the components are mounted on the lid of a small aluminium box 5 $\frac{1}{4}$ x 2 $\frac{3}{4}$ in. and 2in. deep. A suggested layout is shown in Fig. 2 (the circuit-board and switch S1 being ignored), but there is nothing

critical in the placement of the few components. Care must be taken to ensure that terminal T1 is properly insulated from the lid, the two-terminal strip specified being fixed to the lid with 6BA bolts with a spacing nut between the strip and the lid, the wire from T1 being taken through a clearing hole in the lid.

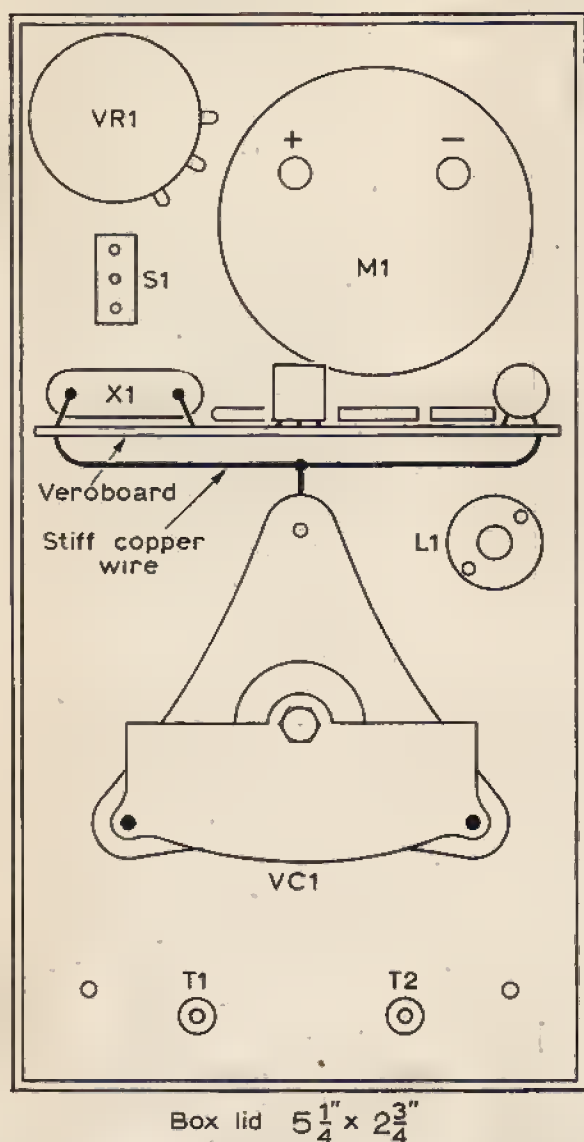

Fig. 2: Layout of the checker Mk II. In the Mk I version the circuit board and switch S1 are omitted and an input socket fitted.

These terminals are spring loaded which considerably facilitates the gripping of the wire ends of small capacitors.

The inductor L1 has its own fixing nut through which the slug can be adjusted with a conventional hexagonal trimming tool or it may be fixed in position with Araldite. Diode D1 and capacitor C4 are wired directly between components.

A stiff white cardboard dial, 2 1/2 in. diameter, is clamped underneath the retaining nut of VC1. A thin perspex pointer with a hairline scribed on it is stuck to the underside of the knob on VC1.

CALIBRATION

After checking the wiring, such as it is, set VC1 to maximum capacity and adjust the pointer to the zero line on the dial. Feed in a signal at 1MHz from the crystal calibrator and adjust VR1 for a reasonable deflection on the meter.

Adjust the slug in L1 for a peak on the meter reducing the signal input or increasing VR1 until the

★ components list

Resistors:

R1 220k Ω 1/4W R2 1k Ω 1/4W VR1 470k pot. (miniature)

Capacitors:

C1 1000pF SM C3 22pF SM
C2 820pF SM C4 0.01 μ F disc
VC1 200pF variable (Jackson Type 87/057)

Semiconductors:

Tr1 AF117 D1 OA91

Miscellaneous:

X1 1MHz crystal, type HC6U and holder (Henrys)
L1 Inductor, HQ4 (Electronic Techniques (Anglia) Ltd., Viking Works, Kirton, Ipswich, Suffolk.)
M1 Meter, 50 μ A f.s.d. (Henrys Type MRA38)
Battery 9V, (PP3) and connectors
Terminals, black and red (Henrys SLT2)
Piece of Veroboard. Knobs. Miniature on/off switch
Aluminium box 5 1/4 x 2 3/4 x 2 in. (H.L. Smith) or similar

peak deflection coincides with the f.s.d.

Using a series of capacitors of known value, preferably of 1% tolerance, connect each in turn across the terminals. When this is done the meter reading will drop as the tuned circuit is no longer resonant at 1MHz but it may be peaked again by reducing VC1 at which point the scale should be marked with the value of the known capacitor. Some constructors may wish to use the preferred range of values such as 22, 47, 68pF etc., when calibrating the dial.

In use VC1 is set to zero on the dial and VR1 adjusted for full scale deflection. The unknown capacitor is connected to the terminals and VC1 rotated to restore full scale deflection on the meter. The dial reading at this point being the value of the capacitor under test.

If, with the unknown capacitor in circuit, it is found that it is not possible to regain f.s.d. it is likely that the capacitor insulation is down although it may still be of the order of megohms.

CIRCUIT MK II

In view of the great use to which the checker was put it was decided to integrate the 1MHz oscillator and the capacity measuring circuitry to obviate the necessity of connecting the two units together every time a capacitor was to be checked.

The original crystal calibrator was a valved job so

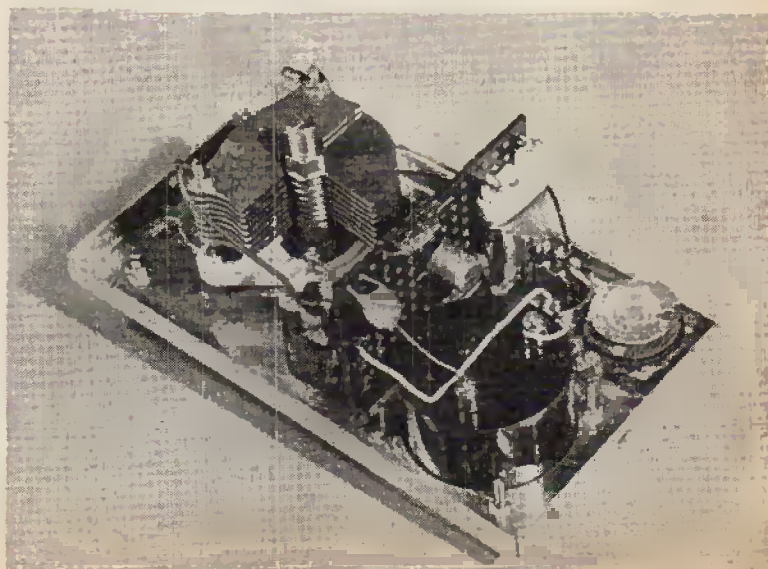

—continued on page 1066

PLUG-IN TUNER

RICHARD COLLINS

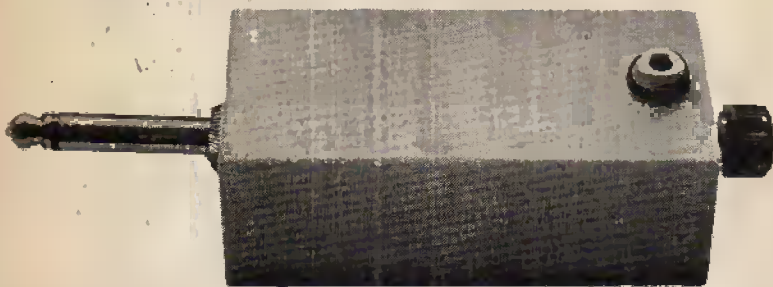

THIS simply constructed crystal tuner has many advantages to offer. It is easy to construct, compact and does not require any power source.

In this article the construction of a crystal diode tuner is described. It can be used to provide a signal that can be fed into a tape recorder, amplifier, or just a pair of high impedance headphones, so becoming a simple crystal receiver. Full constructional details are given so that a complete beginner may build the project.

The layout of the tuner is by no means critical and constructors can position the components to suit the box in which the unit is to be built.

The prototype was constructed in a small plastic case obtained from one of the advertisers in this magazine but any small box of similar size, be it made from plastic, metal, wood, etc., is suitable.

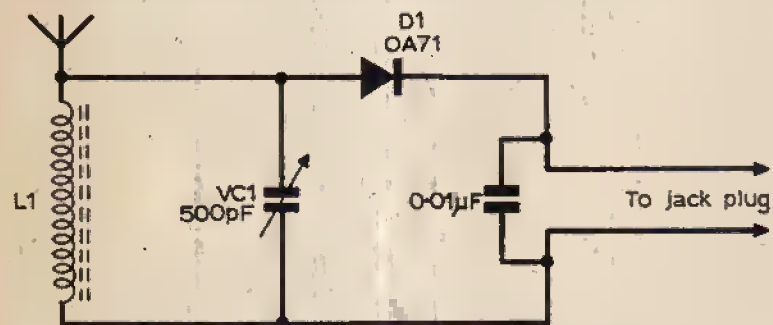

Fig. 1: Circuit of the crystal tuner. A resistor R1, 10kΩ, should be shown across the 0.01µF capacitor, but see text.

The complete circuit is shown in Fig.1 and from this it can be seen that very few components are employed; a coil, trimmer capacitor slightly modified, diode and resistor together with an aerial socket and the "business" end of a jack plug. The use of a jack plug helps to eliminate any losses of signal strength and reduces any hum that may occur.

There are only three holes to make in the case and the sizes of these are determined by the particular types and makes of components employed. One of these is for the aerial socket, one for the tuning capacitor and the third for the jack plug. The coil may be either glued to the casing or held in its position by employing fairly thick wire for connecting (bell wire from Woolworths will be ideal for this).

Before construction begins, the tuning capacitor or trimmer VC1 must be modified somewhat so that it can be used with a knob.

As can be seen from Fig. 2b, the original bolt has

been removed and a longer bolt inserted, (a lin. 6BA round-headed bolt will do). This should be screwed through the trimmer from the back. The trimmer should then be set in the "open" position and the end of the bolt snipped off so that about 1/4in. is left for fixing the "knob." This knob shown in the prototype was a small perfume bottle cap with a nut glued inside it. When the glue had set, a small amount of glue was spread onto the thread of the nut. After a while, the knob was screwed onto the thread and a good solid fixture was made. This knob can be fabricated from the lid of an old toothpaste tube or anything of similar size.

When the trimmer capacitor has been modified, a hole of suitable size should be drilled in one end of the case as shown in Fig. 3. Should constructors wish, they can use a small 500pF variable capacitor—the size being dependent on the size of case em-

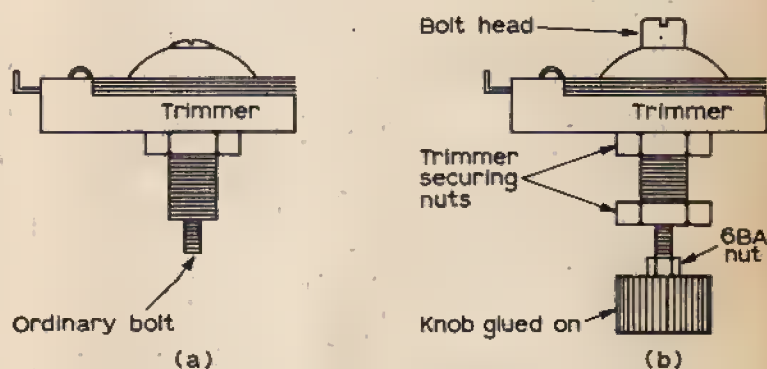

Fig. 2: Tuning capacitor modification.

ployed. Another hole to fit the aerial socket through should be drilled in a suitable position (if the case is made of metal, this socket should be of the insulated lead-through type).

The third hole, for the jack plug, should then be made. This, being the largest is best started off with a hot soldering iron in the case of plastic or wood (a drill and file are best used to make a neat job in a metal box).

If this hole is made slightly smaller than the thread on the shank of the jack plug, it can be screwed into the actual case for a tight fit rather than have a securing nut fitted. This is a preferred way of mounting as a securing nut may foul the jack connecting tags.

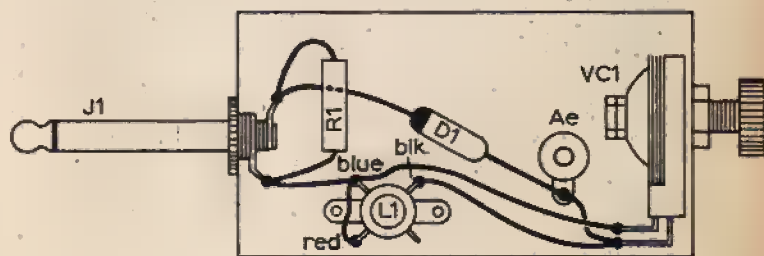

Fig. 3: Component layout and wiring diagram.

The three items may then be fitted in their respective positions (see Fig. 3) and the wiring commenced.

The coil, a Repanco DRX1 employed in the prototype was a medium/long wave component but only the medium wave winding was connected. A piece of wire should be taken and connected to the blue and red tags on the coil L1. This wire should then

be taken to one of the tags on the trimmer capacitor VC1. Another wire should be taken from the other tag of VC1 to the black tag on the coil. From the blue and red connections on the coil, a wire should be taken to the centre connection on the jack plug. Resistor, R1 should be connected across the centre tag and the other tag and the black end of the crystal diode should be connected also. The positive or red end of the diode should then be connected to the aerial socket. A wire should then be taken from this to the tag on the capacitor VC1 that goes to the black tag on the coil. Some constructors may wish to employ the long-wave winding on this coil and if this is so, a suitable on/off type switch may be mounted in any convenient position in the case. The tuner may now be tested and an aerial should be plugged into the socket and the jack plug connected to an amplifier input. Wires may be secured with Sellotape while testing takes place. When the tuning capacitor VC1 is rotated, a station should be heard. If two stations are heard simultaneously, a capacitor about 100 pF value should be inserted between the aerial and the aerial socket—this should help separation.

It has always been the author's policy that the best aerial is one that has as much wire up as high as possible and this is certainly the case as far as crystal receivers go. A length of wire between 50-100ft. should suffice.

If it is wished to build up this circuit just for use as a crystal set, the 10kΩ resistor may be omitted. ■

PRACTICAL WIRELESS QUERY SERVICE

Before using the query service it is important to read the following notes:

The PW Query Service is designed primarily to answer queries on articles published in the magazine and to deal with problems which cannot easily be solved by reference to standard textbooks. In order to prevent unnecessary disappointment, prospective users of the service should note that:

- We cannot undertake to design equipment or to supply wiring diagrams or circuits, to individual requirements.
- We cannot undertake to supply detailed information for converting war surplus equipment, or to supply circuitry.
- It is usually impossible to supply information on imported domestic equipment owing to the lack of details available.
- We regret we are unable to answer technical queries over the telephone.
- It helps us if queries are clear and concise.
- We cannot guarantee to answer any query not accompanied by the current query coupon and a stamped addressed envelope.

QUERY COUPON

This coupon is available until 8th April and must accompany all queries in accordance with the rules of our Query Service.

PRACTICAL WIRELESS, APRIL 1971

PLUG-IN TUNER—continued from page 1062

it was thought better this time to employ a transistor oscillator and to put it and the battery supply in the original box with the tuned circuit etc.

This version of the checker is therefore ready for instant use.

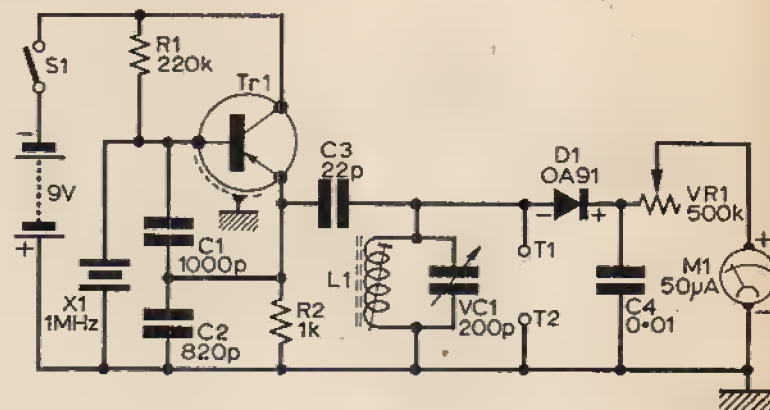

Fig. 3: Circuit Mk II incorporating a 1MHz oscillator signal source

The oscillator is straightforward and uses an AF117 p.n.p. germanium transistor and an HC6U style 1MHz crystal unit, Fig. 3, and is constructed on a small piece of Veroboard, Fig. 4. The board is mounted between the meter and the tuning capacitor VC1 by a stiff copper wire soldered to the earth side of VC1, as can be seen in the photograph.

The output of the oscillator is connected to the original tuned circuit by C3.

The method of measuring the value of an unknown capacitor is the same as before except that initially the step of adjusting the core of L1 should be repeated since the permanent capacity across the tuned circuit will now be different.

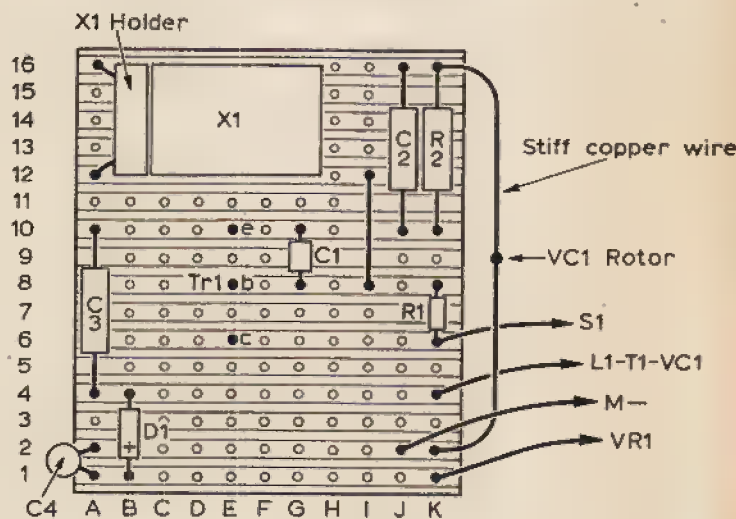

Fig. 4: Circuit board of the 1MHz oscillator built on Veroboard, 0.15 x 0.15in. matrix.

The miniature switch S1 could very well be part of the potentiometer VR1 which would save some space. If this is done make sure that the pot. is wired so that clockwise rotation of the pot. decreases its resistance.

The checker will be found very useful indeed in matching small values of capacitance where precise values are not important. In practice changes of less than 1pF can be detected.

Don't forget that the Small-C Checker can still be used as a frequency spotter with its internal 1MHz oscillator. Connect a short stiff wire to the live terminal and harmonics can be found up to at least 30MHz. ■

TECHNICAL TRAINING

in radio television and electronics

Whether you are a newcomer to radio and electronics, or are engaged in the industry and wish to prepare for a recognized examination, ICS can further your technical knowledge and provide the specialized training so essential to success. ICS have helped thousands of ambitious men to move up into higher paid jobs—they can help you too! Why not fill in the coupon below and find out how?

Many diploma and examination courses available, including expert coaching for:

- C. & G. Telecommunication Techns'. Certs.
- C. & G. Electronic Servicing
- R.T.E.B. Radio/T.V. Servicing Certificate
- Radio Amateurs' Examination
- Radio operator Certs
- General Certificate of Education, etc.

Now available Colour T.V. Servicing Examination Students coached until successful

NEW SELF-BUILD RADIO COURSES

Learn as you build. You can learn both the theory and practice of valve and transistor circuits, and servicing work while building your own 5-valve receiver, transistor portable, and high-grade test instruments—all under expert tuition. Transistor Portable available as separate course.

POST THIS COUPON TODAY

for full details of ICS courses in Radio, T.V. and Electronics.

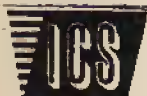

INTERNATIONAL
CORRESPONDENCE SCHOOLS

EST. 1891

Dept. 171, Intertext House, Stewarts Road, London, S.W.8.

Please send me the ICS prospectus—free and without obligation.

(state Subject or Exam).....

NAME

(BLOCK CAPITALS PLEASE)

ADDRESS

AGE.....OCCUPATION..... 471

INTERNATIONAL CORRESPONDENCE SCHOOLS

Selections from FELSTEAD ELECTRONICS' List

(Sent free for stamped addressed envelope to address below)
 Transistors etc. AC126 12½p. AF116 15p. A116 15p. AF117 20p. OA5 7½p. OA10 7½p. OA81 7½p. OA85 7½p. OC23 32½p. OC25 30p. OC26 37½p. OC28 42½p. OC35 42½p. OC44 14p. OC45 12½p. OC71 12½p. OC72 12½p. OC75 12½p. OC81 12½p. OC81D 12½p. OC82D 12½p. OC170 20p. OC171 12½p. Many more in list. S.D.B. BY100 800piv 14p. 6 amp series: BYZ13 300piv 20p. BYZ12 600piv 25p. BYZ11 900piv. 30p. BYZ10 1200piv 35p. (Charges 6½p. up to 11, paid for 12 and over). Sub-Min Transformers: OUV-PUT (3 Ω for OC72, etc.) 14p. (up to 6 6½p.). MULTIMETER. Our famous 20000 Ω per V 44-82½ (18p.). Details and other in list. SOLDERING IRON. Slim, modern, British high-speed 5½", all parts replaceable, highest quality, full guarantee: £1-7½ (10p.). DIAMOND STYLII Replacements for BSR TC8/LP, TC8/S, TC8LP/STEREO: COLLARO 'O': RONETTE BF 40LP: GARRARD GC3/LP and GC8/LP: ACOS GP65/67, all at 40p (6p). ACOS GP73, GP91: BSR ST4 (ST3, ST5), ST8 (ST9): SONOTONE STA, 9TA, 9TAHC: PHILIPS AG3306 3060 (3063, 3066, 3301, 3302, 3304); Garrard GKS25 all at 75p (6p). All are of the very highest quality. DOUBLE DIAMOND: ST4 (ST3, ST5); ST10 (ST3, ST8); 9TA, 9TAHC. 3306, GP91 (For GP62, GP93, GP94 cartridges); GP91SC for all GP91-SC Cartridges: All at £1.50 each (6p). PICK-UP CARTRIDGES All standard fittings and stylii. MONO GP67/2 75p. STEREO-COMPATIBLE (MONO) GP31/SC (£1.05). STEREO GP93 £1-27½, STEREO CERAMIC GP94 £1-92½, SONOTONE STEREO 9TAHC (DIA.) £2-37½. GOLDRING G850 £4-87½, G800 £3-50, G800E £13-50, G800 SUPER E £19-50 (6½p all types or Reg. Post, 22½p.). STYLII FOR ALL ABOVE TYPES, including GOLDRING available. RECORDING TAPE. Still the finest quality British Mylar available: Standard 5" 600 ft. 36p. 5½" 900 ft. 50p. 7" 1200 ft. 56p. LONG PLAY 5" 900 ft. 50p. 5½" 1200 ft. 56p. 7" 1800 ft. 90p. (7½p on 5" and 5½", 9p on 7"). MICROPHONES Crystal Mic 91, hand/desk 81p. MIC45 Curves metal handgrip £1-00. CM21 Grey hand desk 52½p. Stick '60' £1-2½. CM70 "Planet" machined metal tapered stick type with neck cord, adaptor to fit floor stands £1-47½ (all 9p) LAPEL (or hand) with clip 32½p (6p). All are fitted with leads. Dynamic, Cream hand/table MINY 77½p (9p). MS10 50K Ω for desk, tapered with base and slide-out adaptor £1-07½. MS11, Similar, but fixed on swivel swan neck to switch-fitted base £2-22½ (Either 15p). Type 209 Cardioid ball, 50K/600 Ω, omni-dir., built-in vol. control, on/off switch, special lead, handle (as good as money can buy) £6-30. DM160, Non-Dir. Ball, 50K cable, adaptor £3-87½ (27½p either). MICROPHONE INSERTS. Dia., 1-75" OR 0-9" either size 27½p (6p). EARPIECES with lead & min. jack plug (2-5 or 3-5 mm., state which) Magnetic 9p Crystal (3-5 only) 24p (Up to 3 for 6p on any). HEADPHONES De-luxe STEREO 8-16 Ohms. £2-47½. Same, fitted vol. control each earpiece £4-20. Both have lead and stereo jack plug (17½p). HIGH RES. 2000 ohm. Adjustable 92½p (12½p). SPEAKERS. 12" ROUND fitted tweeter, 3 or 15 Ω (state which) £1-87½ (27½) or for Stereo £4-25 pair, carr. paid. 2½" 3 OR 8 Ω (state which) 37½p (6p). EMI 13" x 8", 3, 5 or 15 Ω (state which) £2-12½ (25p): with single flared para. tweeter cone 8 or 15 Ω (state which) £2-27½ (25p): with two tweeters and crossover network 8 or 15 Ω (state which) £3-75 (25p). VIBRATORS. Genuine Plessey 12V 4-pin non-synch. 121HD4, 2½" ex. pins. 27½p. Am. 12V 4-pin, non-synch. 7/16ths. longer. 22½p. 12V 7-pin Synch. (128R7) 62½p (All types 6½p per vibrator). CONNECTING WIRE. Packs of 5 coils asstd. coils. ea. coil 5yds. Solid core 14p (6p). Flexible 18p (7½p). Super thin for transistor wiring 16p (6p). PICK-UP WIRE. Super thin twin flex. screened and sheathed 6p yd. (6p up to 6yds.—over free). RETRACTABLE Flex. Leads. (Curlics) 6ft. phonoplug ea. end 22½p. 12ft. 39p. 6ft. phono plug/phon socket other end 25p. 12ft. 42½p. (6p per lead all types). BATTERY ELIMINATOR. 240V AC input 3, 6, 7½ & 9V DC output at 400 m.a. Two switches' leads' pilot light and universal adaptor for all trans. appliances including all makes' cassette tape recorders and players £3-15 (24p). SEND SAE for full free lists—Teleton and small 3W and 7½W trans. amplifiers. Electrolytics, Vol. Controls, all types of radio switches, car and portable expanding aerials, Meters, Test prods, all types of Brit. & cont. standard and min. plugs and sockets, 6DR's Thyristors, croc. clips (various) terminals, etc. etc. and many "Special Offer" lines at lowest possible prices.

FELSTEAD ELECTRONICS (PW 43)

LONGLEY LANE, GATLEY, CHEADLE, CHES. SK8 4EE
 Cash with order only. No COD or Caller Service. Charges (Min. 16) in brackets after all items. Regret Orders under 25p excluding postage, unacceptable. SAE please for enquiries or cannot be replied to. Changes apply G.B. and Eire only. Overseas orders welcomed (lists free overseas).

FREE FLOG LIST No.6

Scores Special Bargains

SEND S.A.E. OR CALL AT ANY BRANCH FOR YOURS

HUGE RANGE OF SPECIAL SNIPS—STEREOS, DECKS, TAPE RECORDERS, AMPLIFIERS, SPEAKERS, TRANSISTORS, VALVES, COMPONENTS—AT ALL BRANCHES.

TECHNICAL TRADING

- ★ Portsmouth—350 Fratton Rd. Tel. 22034
- ★ Southampton—72 East St. Tel: 25851
- ★ Brighton—8 Queens Rd. Tel: 23975
- ★ ★ ARUNDEL—All Mail Order 15-17 QUEEN ST. Tel: 3280

ENORMOUS PURCHASE GUARANTEE. APPROX. HALF PRICE.

WORLD FAMOUS ★ TAPE ★

Standard Play	Double Play
3in. 150ft. 2/3	3in. 300ft. 4/-
4in. 300ft. 4/6	4in. 600ft. 3/-
5in. 800ft. 7/6	5in. 1,200ft. 15/-
5½in. 900ft. 10/6	5½in. 1,800ft. 19/6
7in. 1,200ft. 12/6	7in. 2,400ft. 27/-
Long Play	Triple Play
3in. 225ft. 2/9	4in. 900ft. 13/-
4in. 450ft. 5/6	5in. 1,800ft. 25/-
5in. 900ft. 10/6	5½in. 2,400ft. 34/-
5½in. 1,200ft. 13/-	7in. 3,000ft. 44/-
7in. 1,800ft. 18/6	
Quadruple Play	
3in. 600ft. 3/-	

Postage 1/- reel. 3in. 600ft. 3/-
 Post Free less 5% on three reels.
 Quantity and Trade enquiries invited

BUILD YOUR CIRCUITS on VEROBOARD

—the Universal Wiring Board—obtainable from your local Retailer

Trade enquiries to:

NORMAN ROSE (ELECTRICAL) LTD.
 8 St. Chad's Place, Gray's Inn Road, London, W.C.1

Technical enquiries to:

VERO ELECTRONICS LTD.

Industrial Estate, Chandler's Ford, Hants

GOING BACK...

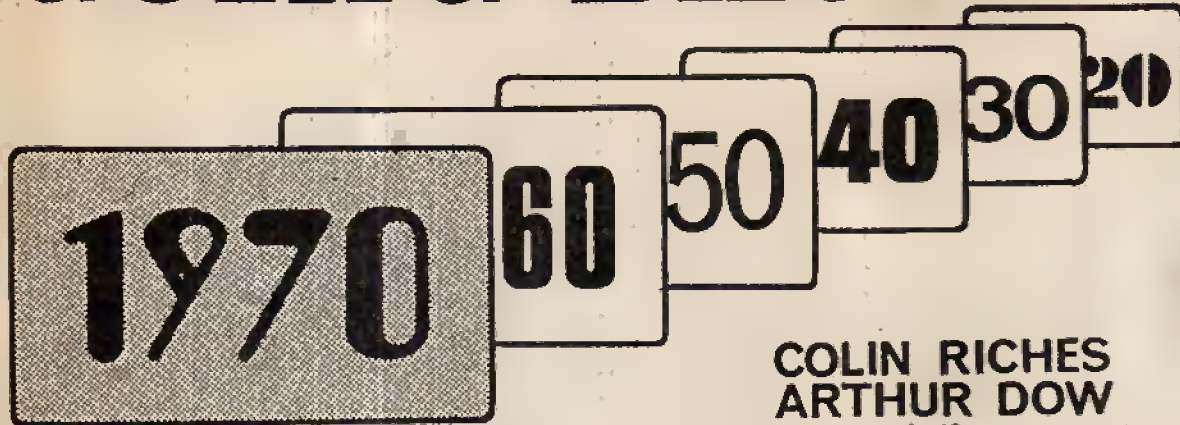

COLIN RICHES ARTHUR DOW

EVERY day of the week, except when there is a postal strike, we receive letters from readers interested in the Going Back article. The Reverend R. J. Mantle, M.A., from Aberdeen writes that he has a B.T.H. crystal wireless dated 1924 and another B.T.H. valve/crystal set with two crystals and one valve dated about 1927. He says that amongst his books on wireless, his most precious is a book entitled "A Beginner in Wireless" by E. Alexander, published in 1923. It has many interesting photographs like Marconi's Timed Spark c.w. Generator, the Brown Microphone Amplifier and Fleming's thermionic valves.

One suggestion that Reverend Mantle makes is that wireless of the 1920's should be known as "Veteran Radio" and that of the 1930's should be known as "Vintage Radio".—Any comments?

C. Langton Kirk writes to say that he has seen the name of N. Gilbertson mentioned in our August 1970 issue and wonders if this is the same one that he knew as a very good friend back in 1925-26. Both were interested in wireless as a hobby in those days. So, Mr. Gilbertson, if you worked in a cinema in Leicestershire in 1925, you are the correct man and Mr. C. Langton Kirk, 137 Hubert Road, Bournbrook, Birmingham, 29 6ET would like to hear from you.

Mr. W. G. Rumbold, M.I.E.E., tells us how he used to listen to the "shipping bands" on 600m where there was a constant stream of traffic in readable Morse always on tap. A little higher up in wave-

length (frequency was not spoken of then) were Croydon Airport, Castle Bromwich and Le Bourget with R/T on 900m.

Mr. F. C. Burgess, 58 Beaconhurst Drive, Beacon Bay, East London, C.P., South Africa, writes to say that he has in his possession an old Marconiphone two-valve set. He estimates its year of manufacture at approximately 1923. The set is still in good condition with its two plug-in coils and a small name-plate is affixed bearing the inscription "Marconiphone V2.

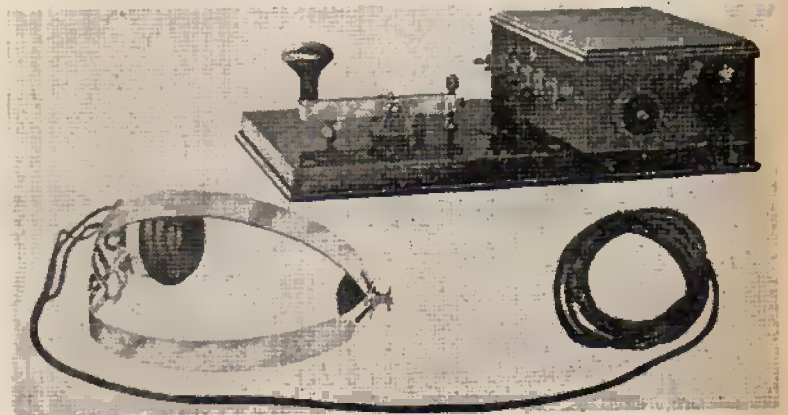

Marconi Morse practice buzzer.

Type R.B.I.A., A.S.206B Inst. No. C-A-7618." If any readers have any idea of the exact date of manufacture, will they drop a line to Mr. Burgess please?

A photograph we received the other week is of a Marconi Morse Practice Buzzer. Vintage is 1912. Slightly different from a modern transistor Morse oscillator, this one boasts a highly finished teak board on which is mounted an operating key and other parts. Enclosed in a case on the same board is a battery, high note buzzer and induction coils, one of which is provided with a convenient handle, by means of which the strength of signals in the telephone can be varied. The buzzer is arranged in a practically sound-proofed box, but can be removed for easy adjustment. A single head piece telephone was provided with the instrument, but a double head piece could be supplied if required at slightly increased cost.

Keith Cummins—better known to our sister magazine "Television" readers for his 625-line TV Receiver articles, sends us a photograph (left) of a receiver he has recently put in working order. It employs two valves and a 4.5V battery has been used for the l.t. supply giving each valve 2.25V in a series circuit. Keith says this helps since they are so ancient—and he is highly delighted by the performance. Date is approximately 1925.

Mr. Cummings' receiver and speaker (1925).



Wireless Experiments on an Aeroplane



Flanders' monoplane on which experiments with wireless were carried out in 1912.

One of our vintage radio enthusiasts, Mr. Leonard Adlard of Essex recently loaned us some copies of an old magazine called *The Marconigraph*—the official organ of the Marconi Co. All dated 1912, these magazines have some real gems of information in them and below we publish an extract which tells the story of an early exploit with an airborne transmitter.

"One of the applications of wireless is telegraphing from aeroplanes, airships and balloons. The advantage of being able to communicate with land or other stations whilst in the air has been well exemplified on many occasions.

On March 16th, 1912 when some wireless experiments were being carried out on Mr. Howard Flanders' monoplane at Brooklands Aviation Grounds near Weybridge, a curious incident occurred. On the previous evening a trial flight was made after the wireless apparatus had been fitted to the machine and everything seemed in perfect working order. On the Saturday morning, as the weather was exceedingly favourable for flying, the machine was taken out again, but it was then that the mishap occurred. The aviator was flying very low at the time, and on

landing his first skid apparently struck the ground owing to a too sudden descent and to the speed at which the aeroplane was moving at the time—approximately 60 miles per hour—the machine turning completely over. The aviator was thrown out of his seat, and when picked up was unconscious. The fuselage of the machine was smashed to two places and the propellor was also damaged. The wings had apparently escaped unhurt, but had to be stripped of their fabric and thoroughly overhauled. The exhaust pipes, radiators, and lubricating pipes on the engine were also damaged and the front skid of the aeroplane was broken in two. Amidst the debris, it would not have been surprising if the wireless apparatus had been smashed, especially as the oil tank beside which the wireless apparatus was fitted had been severely battered and was leaking badly. After removing the sand and dirt with which everything was covered, it was found, however, that the wireless apparatus had escaped quite undamaged and was in working order; even the aerial wire, which was attached to the broken fuselage remained intact!"
—Amazing!

CQ! CQ! CQ! CQ! CQ!

If you have a Vintage CQ you would like included in *Practical Wireless*, drop a line to Colin Riches and Arthur Dow who will include it in the earliest available issue.

APPARATUS REQUIRED

... ex-Cable and Wireless Morse Operator (now alas teletype) wishes to acquire two early Morse keys (brass) to cherish and use on the amateur bands.—J. A. Van Walwyk, G3YRW, 321 Parkside Avenue, Barnehurst, Kent.

... I am interested in knowing if anyone has any Telsen baseboard components which were produced in 1933. They include the dual-range coil, the combined dual-range short wave coil unit, the h.f. coil, screened tuning coils (pair or singles) and the twin tuning condenser with the built-in trimmer to match the coils. Also the 4, 5 and 7 pin valve holders.—G. Beasley, 31 York Avenue, Bedworth, Nr Nuneaton, Warks.

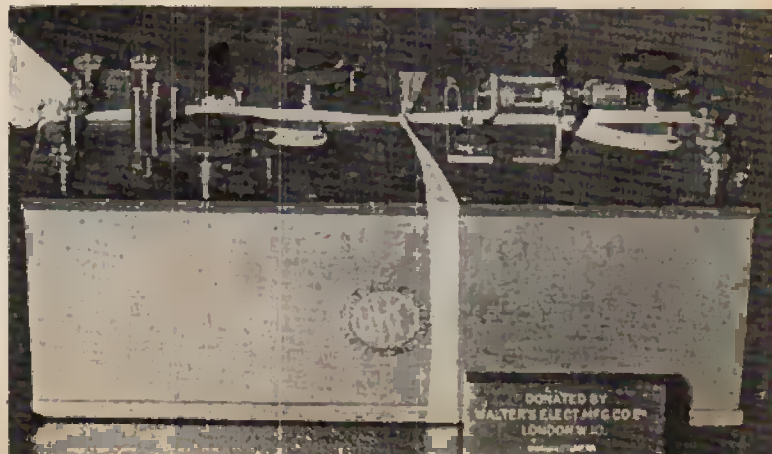

For those readers who have asked to see a close-up of the Walters Receiver (*News* . . . Jan. 1971).

R+TV

RADIO & TV COMPONENTS (Acton) Ltd.

Post to
21c HIGH STREET, ACTON, LONDON W.3. 6NG
Personal shoppers to 323 Edgware Road, London, W.2.
ALL ORDERS BY POST TO OUR ACTON BRANCH
Terms C.W.O. All enquiries S.A.E.

Complete Stereo System £43

WITH
VISCOUNT F.E.T.
FIELD EFFECT TRANSISTORS
AMPLIFIER

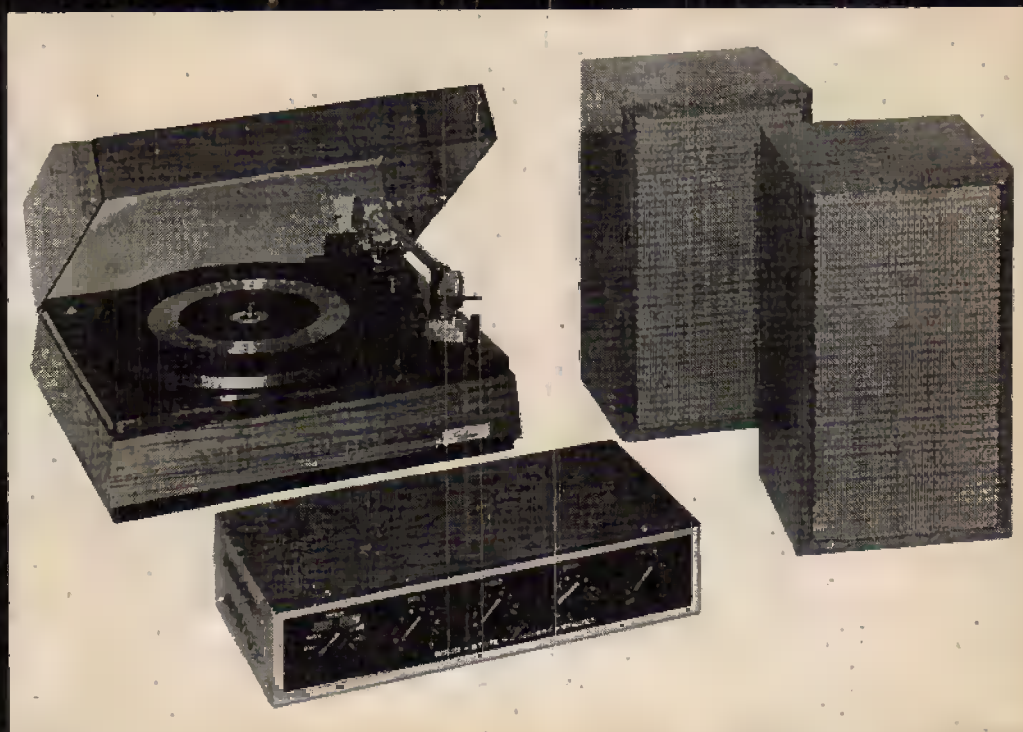

This superb stereo system is a real price break through. It comprises the VISCOUNT F.E.T. Mk I amplifier on which full details are given below, the famous Garrard SP 25 Mk III (including teak veneer base and transparent cover) with diamond cartridge or 2025 TC and the very successful DUO type 2 speakers. Measuring 17½in x 10½in x 6½in, the Duo type 2 speakers are teak finished with matching Vynair grills. They incorporate a 3 ohm, 13in x 8in drive unit and Parasitic tweeter. Max. power handling 10 watts. Price £13.50 per pair plus p. & p. £1.50.

Complete stereo system £43 plus £2.50 p. & p. or with Mk II Amplifier and Magnetic Cartridge £48 & £2.50 p. & p.

The Viscount

F.E.T. Mk I £14.25 + 50p. p. & p.

High fidelity transistor stereo amplifier employing field effect transistors. With this feature and accompanying guaranteed specifications below, the Viscount F.E.T. vastly surpasses amplifiers costing far more.

Specification—Output per channel 10 watts r.m.s. into 3 ohms Frequency bandwidth 20 Hz to 20 kHz + 1db at 1 watt. Total distortion at 1 kHz at 9 watts 0.5% Input sensitivities CER. P.U. 100mV into 3 meg ohms. Tuner 100mV into 100K ohms. Tape 100mV into 100K ohms. Overload Factor Better than 26db.

Signal to noise ratio—70db on all inputs (with vol. max). Controls—6 position selector switch (3 pos. stereo and 3 pos. mono). Separate volume controls for left and right channels. Bass ± 14db at 60 Hz. Treble (with D.P.S. on off) ± 12 db at 10 KHz. Tape recording output sockets on each channel. Size 12½in. 6in. 2½in. in simulated teak case. BUILT & TESTED.

MkII (MAG P.U.) £15.75 plus 50p. p. & p. Specification same as Mk. 1, but with the following inputs. Mag. P.U. CER. P.U. Tuner. Spec. on Mag. P.U. 3mV at 1 kHz input impedance 47K. Fully equalised to within ±1db RIAA. Signal to noise ratio—65db (vol. max).

The £25 Stereo system

The Duetto is a good quality stereo amplifier, attractively styled and finished. It gives superb reproduction previously associated with amplifiers costing far more.

SPECIFICATION—

R.M.S. power output 3 watts per channel into 10 ohms speakers.

INPUT SENSITIVITY. Suitable for medium or high output crystal cartridges and tuners. Cross-talk better than 30dB at 1Kc/s.

CONTROLS: 4-position selector switch (2 pos. mono and 2 pos stereo) dual ganged volume control.

TONE CONTROL Treble lift and cut Separate on off switch. A preset balance control.

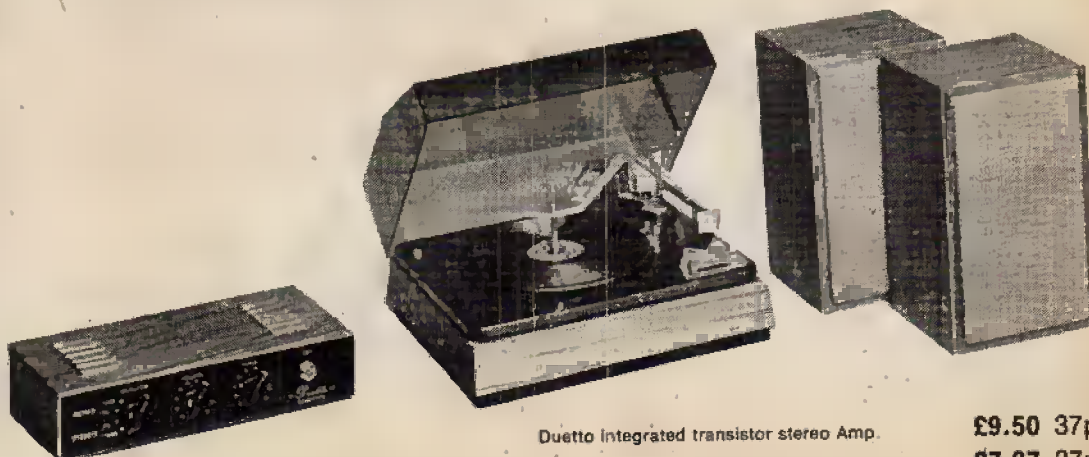

Duetto integrated transistor stereo Amp.	£9.50 37p
Garrard Changer from	£7.97 37p
Cover and teak finish plinth	£4.75 37p
Duo Type I speakers (see opp. page)	£4.20 37p
The above items purchased together	£25 £1.50

SOUND 50

50 WATT AMPLIFIER & SPEAKER SYSTEM

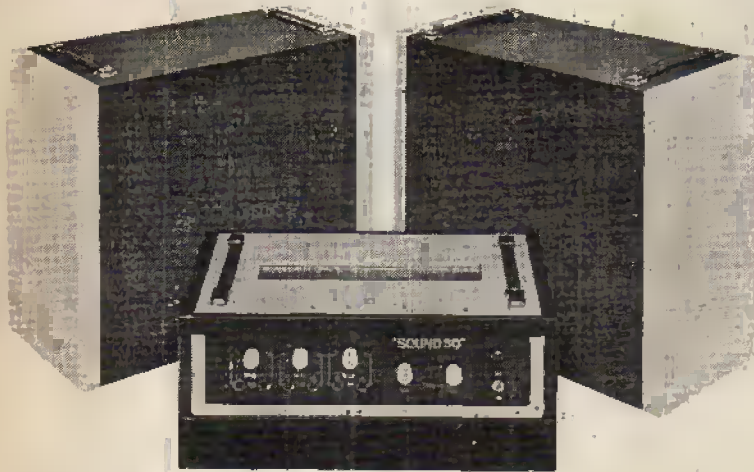

The Sound Fifty valve amplifier and speakers are sturdily constructed with smart housings and thoroughly tested electronics. They are designed to last—to withstand the knocks and bumps of life on the road. Built for the small and medium sized gig, they are easy to handle and quick to set up and can be relied upon to come over with all the quality and power you need.

Output Power: 45 watts R.M.S. (Sine wave drive). Frequency response: -3dB points 30Hz at 18KHz. Total distortion: less than 2% at rated output. Signal to noise ratio: better than 60dB.

Speaker Impedance: 3, 8 or 15 ohms. Bass Control Range: \pm 13dB at 60Hz. Treble Control Range: \pm 12dB at 10 KHz. Inputs: 4 inputs at 5mV into 470K. Each pair of inputs controlled by separate volume control. 2 inputs at 200mV into 470K.

To protect the output valves, the incorporated fail safe circuit will enable the amplifier to be used at half power.

SPEAKERS! Size 20" x 20" x 10" incorporating Baker's 12" heavy duty 25 watt high flux, quality loudspeaker with cast frame. Cabinets attractively finished in two tone colour scheme—Black and grey.

COMPLETE SYSTEM £50 Plus £4 P. & P.

Sound 50 amp and 2 speakers

or available separately.

Amplifier £28.50 plus £1.50 P. & P.

Speakers £12.50 each plus £1.75 P. & P.

LIQUIDATED STOCK DANSETTE TOURISTE MK3 CAR RADIO

ALL TRANSISTOR

Beautifully designed to blend with the interiors of all cars. Permeability tuning and long wave loading coils ensure excellent tracking, sensitivity and selectivity on both wave bands. R.F. sensitivity at 1 MHz is better than 8 micro volts. Power output into 3 ohm speaker is 3 watts.

Originally sold completely built for £15.4.6 (£15.23) Pre-aligned I.F. module and tuner together with comprehensive instructions guarantees success first time. 12 volts negative or positive earth. Size 7in x 2in x 4½in deep.

See top of previous page for address

SET OF PARTS

£6.30

plus P. & P. 37p.

Circuit diagram 13p. Free with parts

Speaker, baffle and fixing kit

£1.25 extra plus 20p. p. & p.

Postage free when ordered with parts.

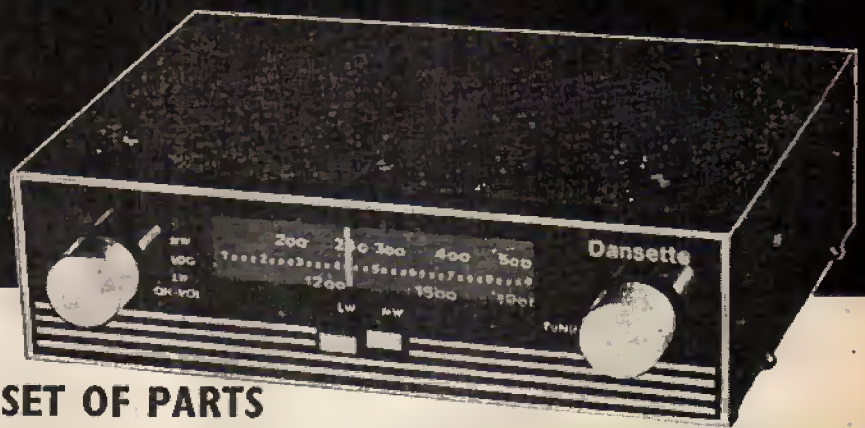

The ELEGANT SEVEN Mk. III
(350m W Output)

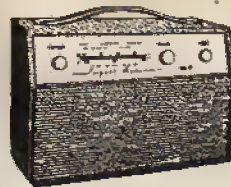

7 transistor fully-tunable M.W.—L.W. superhet portable. Set of parts. Complete with all components, including ready etched and drilled printed circuit board—back printed for foolproof construction.

MAINS POWER PACK KIT: 47p extra.

Price £5.25 plus 37p. P. & P.

Circuit 13p FREE WITH PARTS.

The DORSET
(600m W Output)

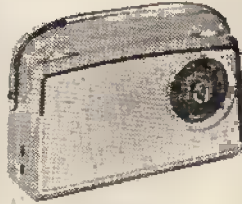

Price £5.25 plus 37p P. & P.

Circuit 13p FREE WITH PARTS

7-transistor fully tunable M.W.—L.W. superhet portable—with baby alarm facility. Set of parts. The latest modulated and pre-alignment techniques makes this simple to build. Sizes: 12 x 8 x 3in.

MAINS POWER PACK KIT: 47p extra.

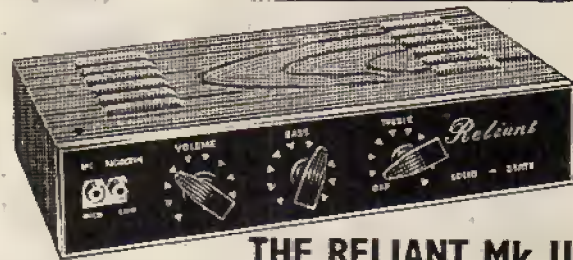

THE RELIANT Mk III
SOLID-STATE GENERAL PURPOSE AMPLIFIER

in simulated teak case £7.25 plus P. & P. 37p

SPECIFICATIONS

Output \pm 10 watts.

Output impedance—3 to 4 ohms.

Inputs 1. -xtal mic 10mV Tone Controls—Treble control range \pm 12dB at 10KHz. 2. -gram/radio 250mV. Bass control range \pm 13dB at 100Hz.

Frequency Response—(with tone controls central) Minus 3dB points at 20Hz and 40KHz. Signal to Noise Ratio—better than -60dB.

Transistors—4 silicon Planar type and 3 Germanium type. Mains input—220/250V. A.C. Size of chassis—10½in. x 4½in. x 2½in. For use with Std. or L.P. records, musical instruments, all makes of pick-ups and mikes. Built and tested.

THE DUO SPEAKER SYSTEM

Similar in design to those on the previous page the 2-way speaker system is beautifully finished in polished teak veneer. It is ideal for wall or shelf mounting either upright or horizontally.

Type 1 SPECIFICATION :—

Impedance 8 or 10 ohms (please state requirement). It incorporates high flux 7in. x 3½in. speaker and 2½in. speaker. Teak finish 11½in. x 6in. x 5½in. £4.20 each. 37p P. & P.

RADIO & TV COMPONENTS
R+TV
(ACTON) LIMITED

Sinclair Project 60

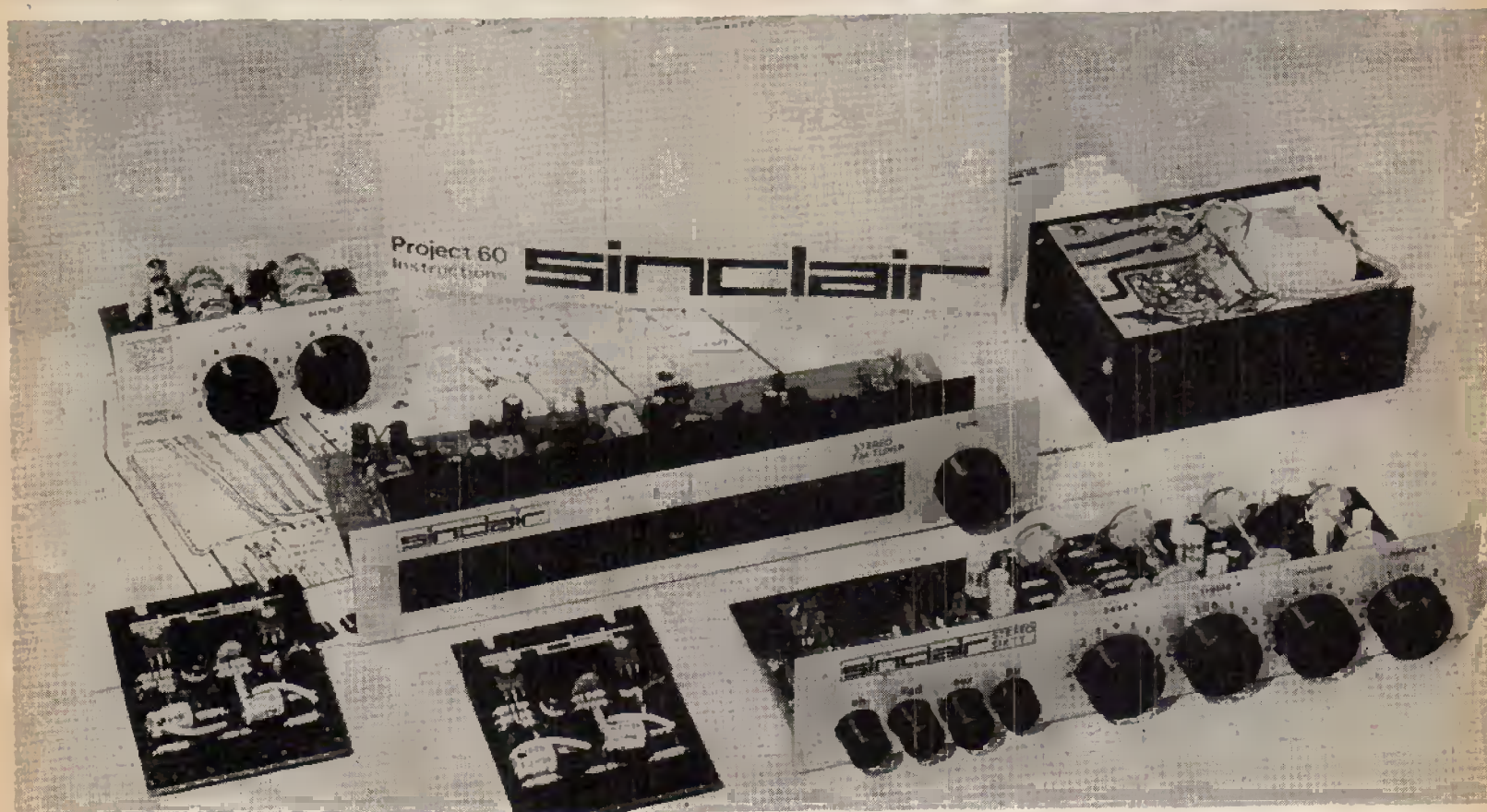

the world's most advanced high fidelity modules

Sinclair Project 60 presents high fidelity in such a way that it meets every requirement of performance, design, quality and value and now that the remarkable phase lock loop stereo FM tuner is available, it becomes the most versatile of high fidelity systems. With Project 60, it is possible to start with a

modest mono record reproducer and expand it to a sophisticated stereophonic radio and record reproducing system of fantastically good quality to hold its own with any other equipment, no matter how expensive. Project 60 is a unique high fidelity module system where compactness and ease of assembly are combined with

circuitry that is far in advance of any other manufacturer in the world. Thus it is extraordinarily easy to assemble any combination of modules using nothing more complicated than the simplest of tools, and you certainly do not have to be experienced to build with complete confidence. The 48 page manual free with Project 60 equipment makes everything easy and you can house your assembly in an existing cabinet, motor plinth, free standing cabinet or virtually any arrangement you wish. Once you have completed your assembly you will have superlatively good equipment to give you years of service and enjoyment. You will have obtained superb value for money because Project 60 is the best selling modular system in Europe and can therefore be produced at extremely competitive prices and with excellent quality control.

Sinclair Radionics Ltd., London Road, St. Ives, Huntingdonshire PE17 4HJ.
Tel: St. Ives (048 06) 4311

sinclair

System	The Units to use	together with	Cost of Units
A Simple battery record player	Z.30	Crystal P.U., 12V battery volume control	89/6 (£4.47½)
B Mains powered record player	Z.30, PZ.5	Crystal or ceramic P.U. volume control etc.	£9.9.0 (£9.45)
C 20+20 W. R.M.S. stereo amplifier for most needs	2 x Z.30s, Stereo 60, PZ.5	Crystal, ceramic or mag. P.U., most dynamic speakers, F.M. tuner etc.	£23.18.0 (£23.90)
D 20+20 W. R.M.S. stereo amplifier with high performance spkrs.	2 x Z.30s, Stereo 60, PZ.6	High quality ceramic or magnetic P.U., F.M. Tuner, Tape Deck, etc.	£26.18.0 (£26.90)
E 40+40 W. R.M.S. de-luxe stereo amplifier	2 x Z.50s, Stereo 60 PZ.8, mains trsfrmr	As for D	£32.17.6 (£32.87½)
F Outdoor P.A. system	Z.50	Mic., up to 4 P.A. speakers controls, etc.	£5.9.6 (£5.47½)
G Indoor P.A.	Z.50, PZ.8, mains transformer	Mic., guitar, speakers, etc., controls	£17.8.6 (£17.42½)
H High pass and low pass filters	A.F.U.	C, D or E	£5.19.6 (£5.97½)
J Radio	Stereo F.M. Tuner	C, D or E	£25.0.0

Sinclair Project 60

Z.30 & Z.50 power amplifiers

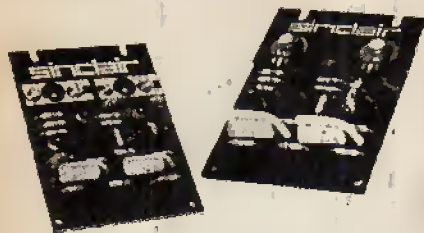

The Z.30 and Z.50 are of advanced design using silicon epitaxial planar transistors to achieve unsurpassed standards of performance. Total harmonic distortion is an incredibly low 0.02% at full output and all lower outputs. Whether you use Z.30 or Z.50 amplifiers in your Project 60 system will depend on personal preference, but they are the same size and may be used with other units in the Project 60 range equally well.

SPECIFICATIONS (Z.50 units are interchangeable with Z.30s in all applications).

Power Outputs

Z.30 15 watts R.M.S. into 8 ohms using 35 volts; 20 watts R.M.S. into 3 ohms using 30 volts.
Z.50 40 watts R.M.S. into 3 ohms using 40 volts; 30 watts R.M.S. into 8 ohms, using 50 volts.

Frequency response: 30 to 300,000 Hz \pm 1dB

Distortion: 0.02% into 8 ohms

Signal to noise ratio: better than 70dB unweighted.

Input sensitivity: 250mV into 100 Kohms.

For speakers from 3 to 15 ohms impedance.

Size $3\frac{1}{2} \times 2\frac{1}{2} \times \frac{1}{2}$ in.

Z.30

Built, tested and guaranteed with circuits and instructions manual **89/6** (£4.47 $\frac{1}{2}$)

Z.50

Built, tested and guaranteed with circuits and instructions manual **109/6** (£5.47 $\frac{1}{2}$)

Power Supply Units

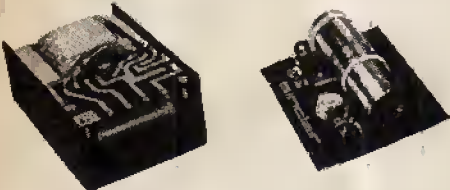

Designed specially for use with the Project 60 system of your choice.

Illustration shows PZ.5 to left and PZ.8 (for use with Z.50s) to the right. Use PZ.5 for normal Z.30 assemblies and PZ.6 where a stabilised supply is essential.

PZ-5 30 volts unstabilised **£4.19.6** (£4.97 $\frac{1}{2}$)

PZ-6 35 volts stabilised **£7.19.6** (£7.97 $\frac{1}{2}$)

PZ-8 45 volts stabilised

(less mains transformer) **£5.19.6** (£5.97 $\frac{1}{2}$)

PZ-8 mains transformer **£5.19.6** (£5.97 $\frac{1}{2}$)

Guarantee

If within 3 months of purchasing Project 60 modules directly from us, you are dissatisfied with them, we will refund your money at once. Each module is guaranteed to work perfectly and should any defect arise in normal use we will service it at once and without any cost to you whatsoever provided that it is returned to us within 2 years of the purchase date. There will be a small charge for service thereafter. No charge for postage by surface mail. Air-mail charged at cost

Stereo 60 pre-amp/control unit

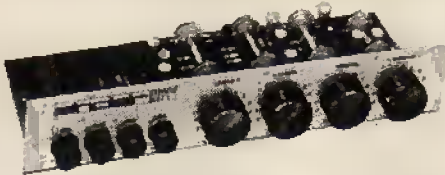

Designed for the Project 60 range but suitable for use with any high quality power amplifier. Again silicon epitaxial planar transistors are used throughout, achieving a really high signal-to-noise ratio and excellent tracking between channels. Input selection is by means of push buttons and accurate equalisation is provided for all the usual inputs.

SPECIFICATIONS

Input sensitivities: Radio—up to 3mV, Mag. p.u. 3mV; correct to R.I.A.A. curve \pm 1dB; 20 to 25,000 Hz. Ceramic p.u.—up to 3mV; Aux—up to 3mV.

Output: 250mV.

Signal-to-noise ratio: better than 70dB.

Channel matching: within 1dB.

Tone controls: TREBLE + 15 to -15dB at 10KHz; BASS + 15 to -15dB at 100Hz.

Front panel: brushed aluminium with black knobs and controls.

Size: $8\frac{1}{2} \times 1\frac{1}{2} \times 4$ ins.

Built, tested

and guaranteed.

£9.19.6 (£9.97 $\frac{1}{2}$)

Active Filter Unit



For use between Stereo 60 unit and two Z.30s or Z.50s, and is easily mounted. It is unique in that the cut-off frequencies are continuously variable, and as attenuation in the rejected band is rapid (12dB/octave), there is less loss of the wanted signal than has previously been possible. Amplitude and phase distortion are negligible. The A.F.U. is suitable for use with any other amplifier system. Two stages of filtering are incorporated—rumble (high pass) and scratch (low pass). Supply voltage—15 to 35V. Current—3mA. H.F. cut-off (-3dB) variable from 28kHz to 5kHz. L.F. cut-off (-3dB) variable from 25Hz to 100Hz. Distortion at 1kHz (35V. supply) 0.02% at rated output.

Built, tested and guaranteed

£5.19.6 (£5.97 $\frac{1}{2}$)

Stereo FM Tuner



first in the world to use the phase lock loop principle

Before production of this tuner, the phase lock loop principle was used for receiving signals from space craft because of its vastly improved signal to noise ratio over other systems. Now, for the first time, the principle has been applied to an FM tuner with fantastically good results. Other original features include varicap diode tuning, printed circuit coils, an I.C. in the specially designed stereo decoder and squelch circuit for silent tuning between stations. Sensitivity is such that good reception becomes possible in difficult areas. Foreign stations can be tuned in suitable conditions and often a few inches of wire are enough for an aerial. In terms of a high fidelity this tuner has a lower level of distortion than any other tuner we know. Stereo broadcasts are received automatically as the tuning control is rotated, a panel indicator lighting up as the stereo signal is tuned in. This tuner can also be used to advantage with any other high fidelity system.

SPECIFICATIONS:

Number of transistors: 16 plus 20 in I.C.

Tuning range: 87.5 to 108 MHz.

Capture ratio: 1.5dB

Sensitivity: 2 μ V for 30dB quieting; 7 μ V for full limiting.

Squelch level: 20 μ V.

A.F.C. range: \pm 200 KHz

Signal to noise ratio: >65dB

Audio frequency response: 10Hz—15KHz (\pm 1dB)

Total harmonic distortion: 0.15% for 30% modulation

Stereo decoder operating level: 2 μ V

Pilot tone suppression: 30dB

Cross talk: 40dB

I.F. frequency: 10.7 MHz

Output voltage: 2 x 150mV R.M.S.

Aerial Impedance: 75 Ohms

Indicators: Mains on; Stereo on; tuning indicator

Operating voltage: 25-30 VDC

Size: 3.6 x 1.6 x 8.15 inches: 91.5 x 40 x 207 mm

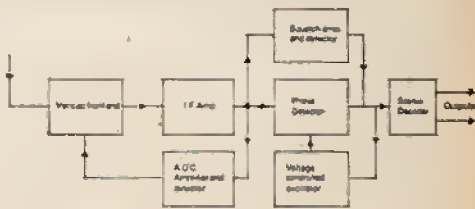

Price: **£25** built and tested. Post free

To: SINCLAIR RADIONICS LTD LONDON ROAD ST. IVES HUNTINGDONSHIRE PE17 4HJ

Please send _____

Name _____

Address _____

for which I enclose cash/cheque/money order.

PW.471

Sinclair IC10/Q16/Micromatic

IC10



The world's most advanced high fidelity amplifier

This is the world's first monolithic integrated circuit high fidelity power amplifier and pre-amplifier. The circuit itself is a chip of silicon only a twentieth of an inch square by one hundredth of an inch thick, having 5 watts RMS output (10 watts peak). It contains 13 transistors (including two power types), 2 diodes, 1 zener diode and 18 resistors, and is encapsulated in a solid plastic package which holds the metal heat sink and connecting pins. This exciting device is more rugged and has considerable performance advantages, including complete freedom from thermal runaway and a very low level of distortion. The IC10 is primarily intended as a full performance high fidelity power and pre-amplifier, for which application it only requires the addition of such components as tone and volume controls and a battery or mains power supply. It may also be used in other applications including car radios, electronic organs, servo amplifiers (it is dc coupled throughout) etc.

Circuit Description

The first three transistors are used in the pre-amp and the remaining 10 in the power amplifier. Class AB output is used with closely controlled quiescent current which is independent of temperature. There is generous negative feedback round both sections and the amplifier is completely free from crossover distortion at all supply voltages, making battery operation eminently satisfactory.

Each IC10 is sold with a comprehensive manual giving circuit and wiring diagrams for a large number of applications in addition to high fidelity. These include oscillators, etc. The pre-amp section can be used as an RF or IF, amplifier without any additional transistors.

Specifications:

Output: 10 watts peak, 5 watts RMS continuous.
 Frequency response: 5Hz to 100kHz $1 \pm$ dB.
 Total harmonic distortion: Less than 1% at full output.
 Load impedance: 3 to 15 ohms.
 Power gain: 110 dB (100,000,000,000 times) total.
 Supply voltage: 8 to 18 volts. (A Sinclair power unit, PZ.7 is available for mains operation).
 Size: $1 \times 0.4 \times 0.2$ in. plus heat sink and tags.
 Sensitivity 5 mV.
 Input impedance: Adjustable externally up to 2.5 Mohms.
 Price (with manual): **59/6** (£2.97 $\frac{1}{2}$) post free.

Q16

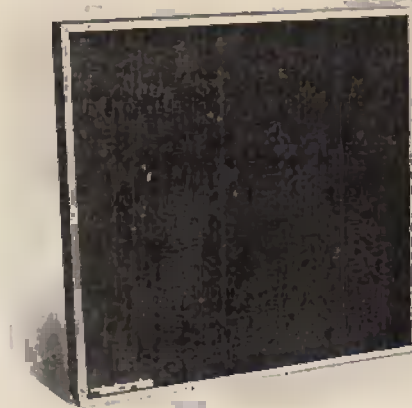

High fidelity loudspeaker

The Q16 employs the well proven acoustic principles specially developed by Sinclair in which a special driver assembly is meticulously matched to the characteristics of the uniquely designed cabinet. In reviewing this exclusive Sinclair design, technical journals have justly compared the Q16 with much more expensive loudspeakers. Its shape enables the Q16 to be positioned and matched to its environment to much better effect than is the case with conventionally styled enclosures. A solid teak surround with a special all-over cellular foam front is used as much for appearance as its ability to pass all audio frequencies.

This elegantly designed shelf mounting speaker brings genuine high fidelity within reach of every music lover.

Specifications:

Construction: Special sealed seamless sound or pressure chamber with internal baffle.
 Loading: up to 14 watts TMS.
 Input impedance: 8 ohms.
 Frequency response: From 60 to 16,000 Hz, confirmed by independently plotted B and K curve.
 Driver unit: Special high compliance unit having massive ceramic magnet of 11,000 gauss, aluminium speech coil and a special cone suspension for excellent transient response.
 Size and styling: $9\frac{1}{2}$ in square on face $\times 4\frac{1}{2}$ in. deep with neat pedestal base. Black all-over cellular foam front with natural solid teak surround.
 Price **£8.19.6**, (£8.97 $\frac{1}{2}$).

Micromatic



Britain's smallest radio

Considerably smaller than an ordinary box of matches, this is a multi-stage AM receiver brilliantly designed to provide remarkable standards of selectivity, power and quality for its size. Powerful AGC counteracts fading from distant stations; bandspread at higher frequencies makes reception of Radio 1 easy. The plug-in magnetic earpiece provided matches the Micromatic's output to give wonderful standards of reproduction. Everything including the special ferrite rod aerial and batteries is contained within the minute and attractively designed case. Whether you build a Micromatic kit or buy this amazing receiver ready built and tested, you will find it as easy to take with you as your wrist watch, and dependable under the severest listening conditions.

Specifications:

Size: $36 \times 33 \times 13$ mm ($1\frac{4}{5} \times 1\frac{3}{10} \times \frac{1}{2}$ in.)
 Weight: including batteries, 28.4 gm (1 oz.).
 Case: Black plastic with anodised aluminium front panel and spun aluminium dial.
 Tuning: medium wave band with bandspread at higher frequencies, (550 to 1,600 Hz).
 Earpiece: Magnetic type.
 On/off switching: By inserting and withdrawing earpiece plug.
 Kit in pack with earpiece, case, instructions and solder **49/6** (£2.47 $\frac{1}{2}$).
 Ready built, tested and guaranteed, with earpiece **59/6** (£2.97 $\frac{1}{2}$).
 Two Mallory Mercury batteries type RM675 required. From radio shops, chemists, etc.

To: SINCLAIR RADIONICS LTD LONDON ROAD ST. IVES HUNTINGDONSHIRE PE17 4HJ

Please send

Name

Address

for which I enclose cash/cheque/money order.

PW.471

Sinclair Radionics Ltd., London Road,
 St. Ives, Huntingdonshire PE17 4HJ.
 Tel: St. Ives (048 06) 4311

sinclair

LINEAR RANGE OF SOLID STATE A.C. MAINS AMPLIFIERS

Employing only high grade components and transistors.



LT55 6 WATT AMPLIFIER
A HIGH FIDELITY UNIT PROVIDING EXCELLENT RESULTS AT MODEST OUTPUT LEVELS.

Recommended Retail price **£11**
Size 9½ × 2½ × 5½ in. Approx.
Controls (5) Volume, Bass, Treble, Mains Switch, Input Selector Switch.

Sensitivity 5 mv (max).
Frequency Response 30-20,000 cps—2dB
Harmonic Distortion 0.5% at 1,000 cps
Output Rating I.H.F.M. 6 Watt
Input Sockets for "Mike," Gram and Radio Tuner/Tape Recorder.
Suitable for speakers 3-15 ohms.

LT66 12 WATT STEREO AMPLIFIER

A TWIN CHANNEL VERSION OF THE LT55 PROVIDING UP TO 6 WATTS I.H.F.M. HIGH FIDELITY OUTPUT ON EACH CHANNEL.
Switched Input Facilities
Socket (1) Tape or crystal PU
(2) Radio Tuner (3) Ceramic PU
Microphone.

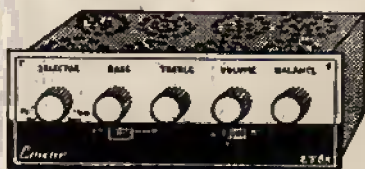

Recommended Retail price **£21**
Size 12 × 3½ × 6 in. Approx.

Controls (6) Volume, Bass, Treble, Balance, Mains Switch, Input Selector Switch, Stereo/Mono Switch.

Facia Plate Rigid Perspex with black/silver background and matching black edged knobs with silver finish centres.

If required an attractive wood cabinet with veneer finish can be supplied for any model

PLEASE SEND A STAMPED ADDRESSED ENVELOPE FOR FULL DETAILS OF ABOVE UNITS

AVAILABLE FROM YOUR LOCAL HI-FI DEALER

Prices From **£3.50**

Wholesale and Retail enquiries to:

LINEAR PRODUCTS LTD, Electron Works, Armley, Leeds

P.W. COMMUNICATIONS RECEIVER

(P.W. DEC. '70)

Was built entirely from parts supplied by us.

Kits of parts exactly to spec:—

2nd Converter/I.F. Kit.....	£7.90
Product Det. (with V/C).....	£2.90
Audio Amp	£1.80
Pre Sel./1st Con.....	£5.50
Power Supply	£2.50

COMPLETE KIT All of above plus sub chassis material and F/T capacitors **£20.00**

OTHER W. CAMERON DESIGNS

F.M. Tuner (Feb. 1969).....	£8.20
F.M. Stereo Decoder (May '70).....	£4.80
Stereo Amp (Dec.-Feb. '68).....	S.A.E. for list.

Post and packing per order 15p (Post free on complete kits)

C & D ELECTRONICS

1, Neville Road, St. Lukes Cross, Sunderland

NEW VALVES!

Guaranteed and Tested 24-HOUR SERVICE

IR5	27	30PL14	67	EBC33	23	EL33	46	PCF805	64	B19	31
IS5	21	CCH35	65	EBF89	30	EL84	24	PCF806	53	U25	53
IT4	16	DAC32	33	ECC81	17	EY51	35	PCL82	33	U26	33
384	23	DAP91	21	ECC82	20	EY86	31	PCL84	35	U191	60
3V4	37	DAP96	35	ECC83	23	EZ80	22	PCL85	42	U251	70
6/30L2	57	DF33	37	ECCF80	28	EZ81	23	PCL86	40	U329	70
6AQ5	25	DF91	16	ECCF82	23	KT61	46	PEL200	54	UABC80	30
6BW7	57	DF96	35	ECH35	27	KT66	32	PL36	43	UBF69	31
6F23	71	DK32	33	ECH81	28	N78	85	PL81	48	UCC85	36
6F25	60	DK91	27	ECL80	33	PC88	49	PL82	29	UCH81	32
25L8GT	22	DK92	41	ECL82	31	PC88	49	PL83	84	UCL82	34
30C15	62	DK96	36	ECL86	27	PC97	87	PL84	30	UCL83	49
30C18	63	DL35	23	EF39	22	PC900	35	PL500	64	UF89	30
30F5	72	DL93	23	EF80	24	PCC84	31	PL504	65	UL84	32
30FL1	62	DL94	37	EF85	23	PCC89	46	PY32	64	UY85	27
30L15	63	DL96	36	EF86	31	PCG189	50	PY33	64	Z77	18
30L17	71	DY86	26	EF89	23	PCF80	29	PY71	25		
30P4	60	DY87	26	EF91	12	PCF86	45	PY82	25		
30P19	60	EABC80	31	EF183	27	PCF801	32	PY801	35		
30PL1	61	EB91	11	EF184	30	PCF802	42	PY800	35		

Postage on 1 valve 5p, on 2 or more valves 3p per valve extra. Any parcel insured against damage in transit 3p extra. Office address, no callers.

GERALD BERNARD

83, OSBALDESTON ROAD, STOKE NEWINGTON, LONDON, N.16

SCOP PREVIEW! **SAVE £31.50 NOW!**

BRAND NEW 1971 MODEL **Fabulous PORTABLE/MAINS**
*NO MORE COSTLY OUTDOOR AERIALS!
FULLY TRANSISTORISED
MINI-TELE **FIRST CLASS MAKERS!**

*Gets all BBC1, BBC2, and ITV.
*Brilliant 625 lines picture.
*Full after sales service.
*12 months written guarantee.

with **BIG 12" SCREEN!**

OUR FANTASTIC DISCOUNT PRICE
ONLY £51.97 BOX CARR. ETC. £1
RECOMMENDED RETAIL PRICE **£83.47**

First Class Makers—We Must Not Mention Name!

THIS OFFER ONLY FROM US! Due to Shopertunities' sensational scoop purchase of entire advance shipment for cash not only do you get this fabulous, brand spanking new 1971 model, fully transistorised, portable/main, 625-line TV with BIG 12" SCREEN well ahead of everyone else but you **SAVE £31.50 AS WELL!** Even if you've got the biggest, most expensive colour TV already—you'll love this! And at our amazing price you could even afford to buy one as a second set! Brilliantly designed incorporating the very latest techniques and refinements! Beautifully made and finished. Superb performance! Carry it from room to room as desired, simply plug in—no waiting, no "warming-up," no old fashioned outside aerials—perfect sound and crystal clear vision almost instantly! Control sound from a whisper to a roar—no image rejection, even on maximum volume! Full range of simple controls. Extra smooth station selection dial. Size overall approx. 15½" × 11" × 11½". Weight 19½ lbs approx. 220/240v AC. Yes, only **£51.97** carr. etc. £1. (Certified guarantee sent with every set.) No more to pay! This fantastic offer may never be repeated—so why not get two or more, while the going's good? Get one for grandma! Get one for the children! Get one for the bedroom! Get one as a gift! At Shopertunities Incredible price you just can't lose! Send or call.

ONLY FROM US! FIRST SHIPMENT JUST ARRIVED!

BRAND NEW 1971 Model **RUSSIAN WORLD BEATER!**
WE COULDN'T EVEN MAKE THEM FOR THIS PRICE!

6 WAVEBAND **10 TRANSISTOR PLUS 3 DIODES**
PORTABLE RADIO

WORLD WIDE RECEPTION **£9.97**
THOUSANDS OF TRANSMISSIONS AND STATIONS THE WORLD OVER!
BOX POST ETC. 43p

NOT JUST A RADIO—BUT TECHNOLOGICAL MAGIC!

What everyone's been waiting for—THE LATEST 1971 MODEL, SUPERSEDING ALL PREVIOUS MODELS:—THE FANTASTIC BRAND NEW RUSSIAN "MERIDIAN" 6-WAVEBAND PORTABLE RADIO. DESIGNED FOR WORLD WIDE RECEPTION. Only finally put into production after incorporation of every conceivable possible up-to-date technological improvement had been carefully considered and thoroughly examined. So advanced it will probably make your present radio seem like a "crystal set"! It's far better than any 6-wave radio even they have produced! Finest value we've ever offered! We're almost giving them away at **£9.97**—a mere fraction of even today's Russian miracle price! We challenge you to compare performance and value with that of **£34** radios! *You can't lose. Instant refund if you are not astounded! Purer and sweeter tone than ever! Much wider band spread than hitherto for "pin-point" station selection! Once again the Russians have proved their fantastic ability in the field of electronics—brilliantly reflecting their advanced micro-circuitry techniques in the field of spaceship and satellite communications. YOU GET THIS AMAZING SET FROM US AT A PRICE THAT BEARS NO RELATION TO ITS TRUE VALUE! Yes, 6 separate wavebands, including Standard Long, Medium and Short Waves to cover the world! Unique side control waveband selection unit gives incredible ease of station tuning! Thousands of different transmissions and stations at your fingertips 24 hours a day, even ships at sea and messages from all over the world—nothing is secret! The radio enthusiast can have the world in the palm of his hand! Superb, sweet tone—controlled from a whisper to a roar that will fill a hall! Genuine push-pull output! Separate ON/OFF volume and Treble/Bass tone controls! Take it anywhere—runs economically on standard batteries. Internal ferrite rod aerial plus built-in telescopic aerial extending to full 33½ in. length. It's also a fabulous **CAR RADIO**—any speed, requires no additional aerial. **UNIQUE!** Elegant Black, White and Chrome finish case. SIZE 10½" × 8" × 3½" overall approx. Magnificently designed and made to give years of perfect service. With **WRITTEN GUARANTEE**, manual with simple operating instructions and circuit diagram. **ONLY £9.97, POST ETC., 43p.** Standard batteries 23p extra. Can also be used through extension amplifier, tape recorder or public address. Send or call.

SHOPERTUNITIES LTD. S/L Dept. WP/4, 184 UXBRIDGE ROAD, (facing Shepherd's Bush Green), LONDON, W12 8AQ (Thurs. 1, Fri. 7). Also 37 High Holborn, London, W.C.1 (Wed. 1, Thurs. 7). Both stores open from MON.-SAT. from 9 a.m. until 6 p.m.

(OVER 1,520 sq. yds.)

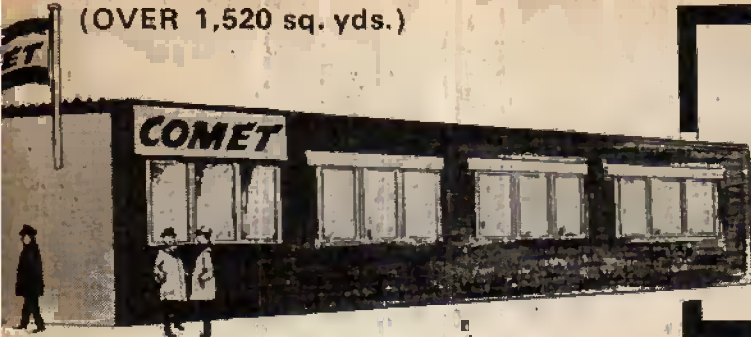

OVER 1000 ITEMS ALWAYS IN STOCK

ALL FULLY GUARANTEED - WITH AFTER-SALES SERVICE

All items offered are brand new, latest models in manufacturers' sealed cartons

	Rec. Retail Price	Comet Price
GOODMANS 15P	20.00	16.97
GOODMANS Audiom 18P	34.00	26.97
GOODMANS Twin Axiom 10	9.42	7.75
GOODMANS ARU 172	3.89	3.00
GOODMANS Trebax 100	7.45	5.50
GOODMANS Trebax 5K/20XL	8.40	6.50
GOODMANS Midax	11.20	8.50
GOODMANS Attenuator	3.07	2.25
GOODMANS Crossover Networks XO/950/5000	8.43	6.25
GOODMANS Crossover Networks XO/950	6.39	4.75
GOODMANS Crossover Networks XO/5000	2.30	1.75
WHARFEDALE 8 in. Bronze/RS/DD	5.00	4.00
WHARFEDALE Super 8/RS/DD	8.50	7.00
WHARFEDALE Super 10/RS/DD	14.00	11.50
WHARFEDALE WMT 1 Matching Transformer	0.84	0.75

LOW COST AUDIO SYSTEMS (complete)

ALBA UA552	47.50	35.98
ALBA UA862	62.99	47.98
ARENA MR 15	145.00	115.98
BUSH System 749/746/764	102.65	82.75
DECCA Sound 803	72.50	60.00
DECCA Sound 804	72.50	61.00
DECCA Sound 1203	97.50	80.00
DECCALIAN 5, complete with stand	65.50	53.00
EKCO S.R.G. 609	88.50	70.00
FERGUSON 2065	117.00	80.00
FERGUSON 3422	84.70	69.00
GOODMANS 3000 Suite	140.45	96.00
HMV 2416	129.70	105.00
HMV 2404/5/6	202.85	170.00
KB KA1250	72.00	56.00
KB KA1250/651	83.00	63.98
MARCONI Unit 4	77.45	67.00
MARCONI Unit 3	86.00	70.00
METRO SOUND Stereo 1010	77.32	66.00
PHILIPS GF 823	49.50	39.98
PHILIPS GP 824	67.50	55.98
PHILIPS RF 833	67.50	55.98
PHILIPS RF 834	88.00	73.98
TELETON 8-track Stereo	82.25	46.00
TELETON CRIOT/2025/1003 with stereo radio	62.10	45.98
TELETON CMS400	102.50	70.00
TELETON 2S60F	75.00	56.00
TOSHIBA SP8507	248.00	181.00
ULTRA 6405	79.75	67.00

TAPE RECORDERS AND TAPE DECKS

ALBA R22 Twin Track Battery/ Mains	50.25	24.98
AKAI M10L	245.05	189.99
AKAI X200D	190.00	160.00
AKAI X5000 W/L	177.98	140.00
AKAI X330	342.57	269.00
AKAI X-330D	312.56	245.00
AKAI X-360	380.08	284.00
AKAI X-360 D-deck	318.92	243.00
AKAI 1800SD	199.42	167.00
AKAI 1710L	89.85	68.90
AKAI CR80 8-track stereo recorder	115.03	99.98
AKAI CR80D 8-track stereo tape deck	95.00	79.98
AKAI 4000 4-track Stereo	124.90	100.00
AKAI 4000 D 4-track Stereo deck	89.96	70.00
BUSH TP 60 Cassette Tape Recorder	29.40	25.00
BUSH TP 70 Cassette Battery/ Mains Tape Recorder	29.95	24.00
BUSH discassette DC70	19.95	14.98
FERGUSON 3244 Stereo 4-track	97.90	80.00
FERGUSON 3245 Twin track	37.05	30.00

	Rec. Retail Price	Comet Price
FERGUSON 3246 4-track	43.00	34.00
FERGUSON 3247 4-track	48.45	39.00
FERGUSON 3248 4-track	54.30	42.00
FERGUSON 3249 4-track	64.30	50.00
FERROGRAPH 722	242.54	199.00
FERROGRAPH 724	242.54	199.00
FERROGRAPH 702/W 2 track tape deck	207.35	175.00
FERROGRAPH 704/W 4 track tape deck	207.35	175.00
GRUNDIG C200L Cassette	39.90	30.00
GRUNDIG TK 141 (4-track)	61.85	50.00
GRUNDIG TK 121 (Twin-track)	56.85	44.00
GRUNDIG TK 146 (4-track Auto)	68.14	53.98
GRUNDIG TK 124 Twin-track	44.90	35.00
GRUNDIG TK 149 4-track	57.64	48.00
PHILIPS 2202	29.90	24.00
PHILIPS 2205 Cassette Tape Recorder	43.15	34.98
PHILIPS 4404 4-track stereo recorder	95.00	73.98
PHILIPS 4407 4-track stereo recorder	110.00	89.98
PHILIPS 4302 Twin Track Auto	39.00	32.00
PHILIPS 4307 4-track	49.50	39.00
PHILIPS 4500 4-Track Stereo Tape Deck	126.00	99.00
PHILIPS 4408 4-Track Stereo	139.00	109.00
PHILIPS N4404 4-Track Stereo	83.00	70.00
PHILIPS N4308	60.50	50.00
PYE Cassette Recorder/Radio (Batt./Mains)	45.50	37.00
TELETON FXB 510 D 4-track Stereo	62.50	48.00
TELETON 5L40 Twin Track Battery/ Mains	38.50	25.00
TELETON TRC 130 cassette, with VHF/AM radio battery/mains twin motors	39.50	29.98
TELETON TC110 cassette battery/ mains	27.50	19.98
TOSHIBA GT 840 S	110.00	80.00
TOSHIBA GT 601v Twin Track	45.15	30.00
TOSHIBA 850 SA	94.00	60.00

BASES AND COVERS

GARRARD WB1 Base	3.86	3.25
GARRARD WB4 Base	5.69	4.75
GARRARD SPC 1 Cover	3.74	3.00
GARRARD SPC 4 Cover	4.44	3.75

SPECIAL OFFER OF BASE AND COVER TO FIT

GARRARD SP25, SL55, SL65B and 3500	Special Price	4.00
GOLDRING Plinth 75	8.52	7.00
GOLDRING Plinth 69	8.52	7.00
GOLDRING Covers for 69P and 75P	4.21	3.50
THORENS TX25 (for TD125AB)	8.22	6.50
THORENS TX11 Cover	4.11	3.75
Base and Cover for TD 125	15.18	12.50
SME Plinth System 2000	39.20	31.25
MOTORBOARDS only	4.95	3.00

HEADPHONES

AKAI	6.50	5.25
AGK K60	13.50	10.75
KOSS ESP-9 Electrostatic	69.00	53.50
KOSS ESP-6 Electrostatic	45.00	36.00
KOSS PRO-4AA	28.00	22.50
KOSS PRO-4A	23.00	18.50
KOSS KO-727B	16.50	13.50
KOSS K-6	12.50	9.95
KOSS SP-3XC	9.50	7.50
MIDLAND SH700	Special Price	3.95
SHIRO	Special Price	4.00
TELETON	5.00	3.25

TEAK CASES

Leak 70/30 Amp. case	7.17	6.25
Leak Tuner case	7.17	6.25
Leak Double case for amp. & tuner	9.93	8.50

Rec. Retail Price Comet Price

COMPLETE HI-FI SYSTEMS

Completely wired, mounted and ready for use

TELETON Stereo 8 track tape Audio system complete	52.25	46.00
---	-------	-------

GARRARD SP 25, mounted in base, plinth and cover with GOLDRING G800 Cartridge. Teleton 203 Stereo Amplifier 12 watts RMS, and 2 KELETRON 654/3 Speakers, each speaker is a 2 speaker system	84.33	56.00
---	-------	-------

GOLDRING GL 69P Mk. 11 mounted in base with hinged lid, GOLDRING G800 Cartridge, Rogers Ravensbrook Amplifier in Teak case. Two Wharfedale Super Linton Speakers	151.25	115.95
--	--------	--------

GOLDRING GL 75P mounted in teak base with hinged perspex cover complete with GOLDRING G800E Cartridge, Leak Stereo 30 Plus Amplifier in Teak case. 2 GOODMANS Mezzo 3 Speakers	194.30	149.00
--	--------	--------

THORENS TD 150AB Mk. II with TX11 dust cover, SHURE M55E Cartridge, LEAK Stereo 70 Amplifier in Teak case. 2 Wharfedale Dovedale 3 Speakers	224.50	175.00
---	--------	--------

THORENS TD 125AB Electronic Turntable complete with cover. SHURE V15-11 Cartridge, GOODMANS Maxamp, GOODMANS Stereomax AM/FM Tuner, 2 GOODMANS Magister Speakers	419.85	319.00
--	--------	--------



SECURICOR

Special Delivery Service

All in-stock items delivered by **SECURICOR** WITHIN 72 HOURS (Add £1.50 only for Securicor delivery)

ALL GOODS FULLY INSURED AGAINST LOSS OR DAMAGE WHILE IN TRANSIT

Complete Price List FREE on request!

COMET HIGH FIDELITY DISCOUNT WAREHOUSES

Reservoir Rd., Clough Rd., Hull HU6 7QD
68A Armley Rd. (Artist St) Leeds LS12 2EF
Teesway, Portrack Lane, North Tees Side
Industrial Estate KTS 18 2RH Tees Side.

Tel. 407906 and 407877
Tel. 32055 (5 lines)
Tel. 66132/65215 (5 lines)

(Service Dept., New Road Side, Horsforth, Leeds)
Comet guarantees that all prices quoted are genuine. All items offered available at these prices at the time this issue closed for press. Add 75p for post, packing and insurance on all orders (Cartridges 20p) or, if Securicor delivery required, add £1.50 only. Make cheques, Money Orders payable to "COMET".

Open daily to the public from 9-0 A.M. until—

5-30 P.M. MON.
1-0 P.M. TUES.
3-0 P.M. WED.
8-0 P.M. THUR.
8-0 P.M. FRI.
5-30 P.M. SAT.

Customers are welcome to call - Ample car parking facilities

Introducing R.S.C. MkIII SUPER 30 HI-FI STEREO AMPLIFIER

A COMPLETELY NEW DESIGN FURTHER IMPROVED IN BOTH APPEARANCE and PERFORMANCE. REPRESENTING VALUE FAR HIGHER THAN THE PRICES SUGGEST. Only **£25**

high grade components by leading manufacturers. Complete kit of parts.

Or FACTORY BUILT with 12 months guarantee **£33.75**

Or FACTORY BUILT in cabinet as illustrated **£36.75**

PRINTED CIRCUITRY, TWENTY SILICON TRANSISTORS. FOUR DIODES, FOUR RECTIFIERS.

TECHNICAL DETAILS (Applying to each channel where appropriate)

CONTROLS: PUSH-BUTTON SELECTOR (1) Disc (2) Radio (3) Tape (4) Mono L (5) Mono R (6) SPEAKER DIS. (7) Mains on/off. Bass, Treble, and Balance. Plus Ceramic/Map P.U. Switch.



- ★ SATIN SILVER METAL FACIA with black lettering. Black edged knobs with bright silver centres.
- ★ PUSH-BUTTON SELECTOR SWITCHING
- ★ NEON INDICATOR
- ★ JACK SOCKET FOR HEADPHONE CONNECTION
- ★ CABINETED MODEL VENEERED IN SATIN TEAK. SUITABLE FOR ANY MODERN PICK-UP CARTRIDGE or MAGNETIC, REGARDLESS OF PRICE. WE RECOMMEND USE WITH THE BEST ANCILLARY EQUIPMENT THAT CAN BE AFFORDED.

OUTPUT: 15 watts R.M.S. (Continuous) into 8 ohms HUM and NOISE—75dB Min. Vol. 10 watts R.M.S. (Continuous) into 15 ohms—65dB Full Vol.
 FREQUENCY RESPONSE: -3dB 7Hz to 70KHz HARMONIC DISTORTION
 TREBLE CONTROL: +16dB to -12dB at 14KHz 0-1% at 1000 Hz 1D W
 BASS CONTROL: +17dB to -16dB at 40Hz CROSS TALK—58dB
 SENSITIVITIES: Disc Mag. 2.5mV. Ceramic 35mV. Radio 120mV. Tape 120mV.
 REAR PANEL SOCKETS ARE FOR 3 PAIRS OF INPUTS (1) P.U. (2) Radio, (3) Tape Amp. Plus pair for tape recorder signal take off and 2 pairs for loudspeaker connections.

R.S.C. HIGH FIDELITY STEREO 'PACKAGE' OFFERS

Four fully wired units ready to 'plug in.'
 ★ SUPER 30 AMPLIFIER (15 + 15 watt) in veneered housing

★ GARRARD SP25 MKIII Turntable on Plinth with cover

★ GOLDRING CS90 Ceramic P.U. Cartridge with diamond stylus

★ PR. OF STANWAY II Speaker Units **£79.80**
 Special Total Price Carr. £1.50

★ Super 30 Amplifier (15 + 15 watt) in veneered housing

★ Goldring GL69 Transcription Turntable on Plinth as illustrated

★ Goldring Magnetic P.U. Cartridge.

★ Pair of Stanway II speaker units **£96.75**
 Special Total Price Carr. £1.50

Matching as recommended for optimum performance. Send S.A.E for coloured brochure showing other money-saving offers.

Package prices apply providing all individual units are purchased from any branch within 3 months. See leaflet.



ATTRACTIVE TEAK or AFROEMOSIA VENEERED CABINETS and PLINTHS

★ TA12 AMPLIFIER 6.5+6.5 watt in veneered housing

★ GARRARD SP25 MK III Player unit on Plinth

★ GOLDRING CS90 Ceramic P.U. Cartridge with diamond stylus

★ PAIR OF DORCHESTER Loudspeaker Units
 Special **£58** Carr. £1.25
 Total Price

Or Deposit £7.15 and 9 monthly payments £6.35 (Total £64.30).

Trans. Plastic Cover £3.15 extra. Package as above but with Garrard 3000 Auto-changer and Sonotone 9TA Ceramic Cartridge in lieu of SP25 **£51.75** Carr. £1.25

Or Deposit £6 and 9 monthly payments £5.70 (Total £57.60)

Trans. Plastic cover £3.15 extra.

TERMS AVAILABLE ON ALL PACKAGE OFFERS

AUDIOTRINE A55 HIGH QUALITY STEREO SYSTEM

5 + 5 WATT OUTPUT

GARRARD 5200 Changer with low mass pick-up arm and Stereo Cartridge. CONTROLS: TREBLE, BASS, VOLUME, STEREO, BALANCE.

Operation on 200-250v. A.C. mains.

Output rating. I.H.F.M

A REALLY SURPRISING STANDARD OF QUALITY IS OBTAINABLE FROM THIS COMPACT LOW PRICED SYSTEM

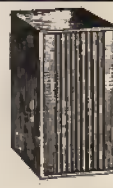

Luxurious Teak Veneer Finished Cabinets. Transparent plastic (tinted) cover included for main unit. Silver finished facia plate and matching control knobs.

PAIR OF LOUDSPEAKER UNITS

incorporating high flux 8 x 5 ins. speaker. Size approx. 13 x 7 1/4 x 8 1/2 ins.

Price complete **£42**

Carr. £1.25
 Terms: Deposit £5.50 and 9 monthly payments £4.50 (Total £46.)

LOW DEPOSIT CREDIT TERMS

AVAILABLE ON PURCHASES OVER £8 (KITS OF PARTS EXCEPTED)

INTEREST CHARGES REFUNDED

ON CREDIT SALES SETTLED IN 3 MONTHS

RSC G66 6+6 WATT high quality STEREO AMPLIFIER

Individual Ganged controls: Bass, Treble, Volume and Balance. Printed circuit construction employing 10 Transistors plus Diodes. Output rating I.H.F.M. Suitable for Crystal Pick-ups, etc., and for loudspeaker output impedances of 3 to 15 ohms. For standard 200—250v A.C. mains operation. Attractive silver finished metal facia plate and matching control knobs.

Complete KIT OF PARTS INCLUDING FULLY WIRED PRINTED CIRCUIT and comprehensive wiring diagram and instructions **£9.99**

Or FACTORY BUILT IN TEAK VENEERED CABINET as illus. **£12.50** carr 40p,

or dep £2 and 9 mthly pymnts. £1.45 (Total £15.05).



HIGH FIDELITY LOUDSPEAKER UNITS Cabinets latest

style Satin Teak or Afroemosis veneer. Acoustically lined or filled acoustic damping. Ported where appropriate. Credit terms available.

DORCHESTER Size 16 x 11 x 9in. appr. Range 45-15,000 c.p.s.

Rating 8-10 watts. Fitted High flux 13 x 5in. **£9.45** Carr. 40p.

Dual Cone speaker. Imp. 3 or 15 ohms.

STANWAY II Size 20 x 10 1/2 x 9in. approx. Rating 10 watts. Inc. 13 x 8in. speaker with highly flexible cone surround, long throw voice coil and 11,000 line magnet. High flux tweeter. Handsome Scandinavian design cabinet. Range 35-20,000 c.p.s. Imp. 15 ohms. Gives smooth realistic sound output. **£17.85**

See above for illustration



R.S.C. TA12 MKIII 6.5 + 6.5 WATT STEREO AMPLIFIER

FULLY TRANSISTORISED, SOLID STATE CONSTRUCTION

HIGH FIDELITY OUTPUT OF 6.5 WATTS PER CHANNEL

Designed for optimum performance with any crystal or ceramic Gram. P.U. cartridge, Radio tuner, Tape recorder etc. ★ 3 separate switched input sockets on each channel ★ Separate Bass and Treble controls ★ Slide Switch for mono use ★ Speaker Output 3-15 ohms ★ For 200-250v. A.C. mains ★ Frequency Response 20-20,000 c.p.s. -2dB ★ Harmonic Distortion 0.3% at 1,000 c.p.s. Hum and Noise -70dB ★ Sensitivities (1) 50mV (2) 400mV (3) 100mV. Output rating I.H.F.M. ★ Handsome finish Facia plate & Knobs. COMPLETE KIT OF PARTS WITH FULL WIRING DIAGRAMS & INSTRUCTIONS.

Factory built with 12 months guarantee **£19.50** or Deposit £3 and 9 mthly pymts **£2.05** (Total £21.45). Or in Teak veneer housing **£15.50** Carr. 40p.

£23 Dep. £3 & 9 mthly payments £2.55 (Total £25.95). Send S.A.E. for leaflet



'YORK' HIGH-FIDELITY 3 SPEAKER SYSTEM

★ Moderate size only 25 x 14 x 16in. COMPLETE KIT **£22**
 ★ Response 30-20,000 c.p.s. Impedance 15 ohms Carr. 63p
 ★ Performance comparable with units costing considerably more. Consists of (1) 12in. 15 watt Bass unit with cast chassis, Roll rubber cone surround for ultra low resonance, and ceramic magnet. (2) 3-way quarter section series cross-over system. (3) 8 x 5in. high flux middle range speaker. (4) High efficiency tweeter. (5) Appropriate quantity acoustic damping material (6) Handsome Teak veneered cabinet. (7) Circuit and full instructions. Terms: Dep. £4.50 and 9 mthly. pymts. £3.25 (Total £24.75)

DEMONSTRATIONS AT ALL BRANCHES

PARTRIDGE "JOYSTICK" SHORT WAVE AERIALS AND TUNERS AT ALL BRANCHES (S.A.E. for full list)

- BRADFORD 10 North Parade. (Half-day Wed.) Tel. 25349
- BLACKPOOL (Agent) O. & C. Electronics, 227 Church Street
- BIRMINGHAM 30/31 Gt. Western Arcade (Half-day Wed.) 021-236-1279
- DERBY 26 Osmaston Rd., The Spot (Half-day Wed.) Tel. 41361
- DARLINGTON 18 Priestgate (Half-day Wed.) Tel. 68043
- EDINBURGH 133 Leith St. (Half-day Wed.) Tel. Waverley 5766
- GLASGOW 326 Argyle St. (Half-day Tues.) Tel. CITY 4158
- HULL 91 Paragon Street (Half-day Thursday) Tel. 20505



MAIL ORDERS TO: Audio House, Henconner Lane, Leeds 13. Terms C.W.O. or C.O.D. No C.O.D. under £1. Postage 25p extra under £2. 30p extra over £2 or as quoted. Trade supplied. S.A.E. please with enquiries. Branches open all day Sats. MAIL ORDERS MUST NOT BE SENT TO SHOPS

- 32 High Street (Half-day Thurs.) Tel. 56420 LEICESTER
- 5-7 County (Mecca) Arcade, Briggate (Half-day Wed.) Tel. 28252 LEEDS
- 73 Dale St. (Half-day Wed.) Tel. CENTRAL 3573 LIVERPOOL
- 238 Edgware Road, W2 (Half-day Thurs.) Tel. PAD 1629 LONDON
- 60A Oldham Street (Half-day Wed.) Tel. CENTRAL 2778 MANCHESTER
- 106 Newport Rd. (Half-day Wed.) Tel. 47096 MIDDLESBROUGH
- 41 Blackett Street (Opp Fenwicks Store) (Half-day Wed.) Tel. 21469 NEWCASTLE UPON TYNE
- 13 Exchange Street (Castle Market Bldgs.) (Half-day Thursday) Tel. 20716 SHEFFIELD

THE RADIO CONSTRUCTOR

MARCH ISSUE

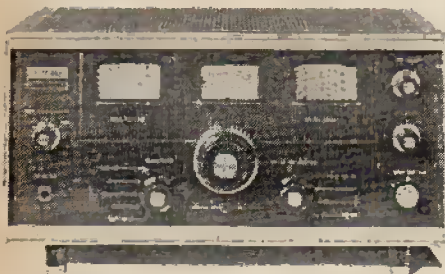

FURTHER MODIFICATIONS TO THE 'TRIO' 9R-59DE

In Part 1 of this two-part series, the author describes a series of comparatively simple modifications which collectively greatly improve the performance and stability of this popular communications receiver.

Part 2, to be published in the April issue, deals with the more complex modifications. These consist of an EF183 r.f. stage, an added i.f. stage with double-tuned i.f. transformers, tape recorder output and full r.f. alignment details, etc. etc.

THE RADIO CONSTRUCTOR

Also

TIMER WITHOUT ELECTROLYTICS

To obtain sufficiently long timing periods, the current trend in electronic timers is to employ an electrolytic component as the timing capacitor. This article describes a timing circuit which, by taking advantage of a pulsed transistor, enables a paper or plastic foil capacitor to be used instead.

PLUS MANY OTHER PROJECTS ON SALE NOW 3/6

Copies may also be obtained direct from the Publishers 4/- including postage. Published by:

Data Publications Ltd.
57 Maida Vale, London, W.9

THE RADIO CONSTRUCTOR

LOOK AT THESE PRICES

CARTRIDGES

Acos GP67-2, GP91-35C £1.12½; Acos GP93-1 £1.33½; Acos GP94-1 £1.62½; Sonotone 9TAHC £1.97½; All above in makers cartons; BSR X4H £1.50.

FS 2600 STEREO AMPLIFIER

5 watts per channel; In attractive Cabinet, P.U. Radio & Tape inputs Tape output & Speaker outputs Dim. 12½" x 5½" x 3½". Our Price £18-97½.

PLUGS & SOCKETS

Phono plugs, assorted colours 4½p; 45p per doz; Coaxial plugs, aluminium 7½p; Coaxial couplers 7½p; 2 pin DIN plugs 15p; 3 pin DIN plugs 16p; 5 pin DIN plugs 17p; 2 pin, 3 pin & 5 pin DIN sockets 7½p; Wander plugs 2½p; sockets 3½p; Banana plugs 5½p. Sockets 6p; 3-5mm J/Plugs 7½p and 12½p; Standard J/Plugs with solder terminals 10p; Chrome 15p; Side Entry J/Plugs black and chrome 24p; Insulated J/sockets—o/cct 16p, o/cct 17p.

ELECTROLYTIC CAPACITORS

4uF 150v 4p; 8uF 500v 15p; 8uF 12v 4p; 8uF + 8uF 450v 21p; 10uF 150v 4p; 12uF 25v 4p; 16uF 450v 14p; 16uF + 16uF 450v 23½p; 30uF 10v 4p; 50uF 10v 4p; 100uF 9v 4p; 100uF 12v 4p; 150uF 12v 4p; 320uF 9v 5p; 1500uF 30v 19p; 10uF 16v 7½p; 5000uF 25v 50p; 10,000uF 25v 75p; 20,000uF 30v £1-05.

MICROPHONES

Acos Mic 45 £1.12½; Acos Mic 60 99½p; Planet CM70 £1-50; Hand Mike 75p.

VALVES

PY81 36p; PCL82 39p; EF183 45p; EF184 45p.

PLEASE NOTE CHANGE OF ADDRESS

GEORGE FRANCIS (Dept PW),

12-14, Middle Gate, Newark, Notts.
Telephone: Newark 4733.

Vary the strength of your lighting with a

DIMMASWITCH

The DIMMASWITCH is an attractive and efficient dimmer unit which fits in place of the normal light switch and is connected up in exactly the same way. The ivory mounting plate of the DIMMASWITCH matches modern electric fittings. The bright chrome control knob activates an on-off switch and controls 40-600 watts of all lights except fluorescents at mains voltages from 200-250 V. 50 Hz. The DIMMASWITCH has built-in radio interference suppression. Price: £3-20 plus 8p post and packing. Kit Form: £2-70 plus 8p post and packing. Please send C.W.O. to:—

DEXTER & COMPANY

1 ULVER HOUSE, 19, KING STREET,
CHESTER CH1 2AH Tel: 0244-25883,

As supplied to H.M. Government Departments,
Hospitals, Local Authorities, etc.

BRAND NEW AB88D COMMUNICATIONS RECEIVERS. AC mains input 110 volts or 250 volts. Frequency in 6 bands 535 kc/s up to 32 megs, output impedance 2-5-600 ohms. Complete with crystal filter noise limiter B.F.O. HF tone controls. Price £90 including spare set of valves, headphones and manual.

COMPUTER BOARDS Min 30 transistors and diodes and rods, etc. 10 boards at 50p plus 12½p p.p.; 25 boards at £1-12½ plus 22½p p.p.

BARGAIN PARCELS 14lb at £1-45 plus 32½p p.p.; 28lb at £2-75 plus 52½p p.p.; 56lb at £4-50 plus £1-25 p.p. Contains pots, Res, Valves, Diodes, Tagboards, Chassis, Valveholders, etc. Good value save £££. Lucky Dip Service.

FURZILL BEAT FREQUENCY OSCILLATOR 0-10 kc/s, 110/250 volt. Good condition complete with spares. £5-50 plus £1-25 p.p.

VHF Receiver, Type 715, less crystal 60-100 Mc/s can be operated on 2 or 4 meters or made tunable 12 volt input, not tested; complete with valves and speaker. £3 plus £1 p.p.

VHF AERIAL TUNING UNITS consisting of the following: 1-1½" 500 micro/ampmeter, 1 small 2-gang 75 PF capacitor, 1 various large wattage resistors for dummy load. Pair gears B.N.C. type sockets. Will tune 10 metre with 25/30 watts R.F. input. Size only 5½" x 4½" x 5" Sealed. Price £1-37½ p.p. 25p

CRYSTALS AS NEW: He 6u, 5,345; 5,030; 5,005; 4,945; 4,875; 4,840; 4,795; 4,580; 4,660; 4,520; 4,510; 2,300; 2,295 Kc/s and 10 x J465 Kc/s. 50p each plus 8p. p.p.

SCOOP PURCHASE OF BRAND NEW CARBON RESISTORS. 10% tolerance ¼ & ½ watt. Preferred values in packets of 10. Our price 50p per 100, 50p per 200, £1-35 per 300, 500 at £2-12½. Our selection, p.p. 8p per 100 and 2½p per extra 100.

TRIMMER BARGAINS. These are 10PF sub-min. air-spaced trimmers on board with min. wire ended Xtal. Brand new. No details; Contents 12 trimmers, some ceramic caps. Xtal frequency 3RD overtone 249 mc/s-250 Mc/s, 255 Mc/s. No choice. Trimmers without Xtal—80p per doz. plus 17½p p.p. Trimmers with Xtal—75p per doz. plus 17½p p.p. Also 20 PF min. brand new air spaced. 50p per doz. plus 17½p p.p.

HERO MXS IN NEW CONDITION with 5 general coverage coil units including spare set of valves less power supply. Tested £25 p.p. £1-50.

ANY HEIGHT AERIAL TUBULAR SECTIONS ½" dia x 3 ft. long. Brass screw in type, copper coated and painted. New 20p each, p.p. 5p. Minimum order 6.

SIGNAL GENERATORS OSCILLATOR No. 2. Size 12in. x 8½in. x 9in. Ideal for VHF work. 20-30 Mc/s. Functions are AM/CW. Deviation up to 40 Kc/s RF meter. Measuring levels: RF output 1 microvolt to 100 microvolts set. Mod-set carrier controls. Good condition with accessories: 230V AC 12V DC. £20 plus 75p p.p.

R209 RECEIVER AM/CW/FM 1-20 mcs, four bands vernier tuning, 12 volt D.C. Input tested and working. Price £15, p.p. £1.

AERIALS NEW CONDITION. Whip type 4ft. 25p, 11ft-62½p, 14ft. 77½p. Used condition 4ft. 20p, 14ft. 62½p. All collapsible type p. and p. 4ft. 10p, rest at 17½p. Bases for above 25p, p.p. 2/6. New matching unit coax connection for above 30p, p.p. 5p.

Huge release of valves for the 62 set TX/RX, in original rubber packing consisting of QV04/7 x 61M, ARP12 etc, 10 valves in all at the bargain price as seen. 87½p plus 17½p p.p.

New Readphone and Mike rubber muff type. Low impedance. 97½p. p. & p. 17½p.

Magnetic Transducers new, price 37½p post and packing 10p.

New Aerial Wire on boards 7/22 uncovered. Length 75ft. 40p, 90ft. 47½p, 100ft. 55p, p.p. 12½p.

New small fuse boxes 250 volts 15 amps. 87½p each post and packing 15p.

Headphones, ex Gov. DLR No. 5 high impedance New 37½p 17½p p.p. Used condition 62½p 17½p p.p.

Meters moving coil ex equipment, good condition. Also 20 amp DC, 40 amp DC, and RF Therm-Couple Meters 0-1 amp and 0-2.5 amp, 2in. diameter. 50p post and packing 25p.

C.W.O. CARRIAGE CHARGES MAINLAND ONLY

A. H. THACKER,

Radio Dept.,
HIGH STREET, CHESLYN HAY,
Nr. Walsall, Staffs.

Practical Wireless Classified Advertisements

The pre-paid rate for classified advertisements is 8½p per word (minimum 12 words), box number 7½p extra. Semi-displayed setting £6 per single column inch. All cheques, postal orders, etc., to be made payable to PRACTICAL WIRELESS and crossed "Lloyds Bank Ltd." Treasury notes should always be sent registered post. Advertisements, together with remittance, should be sent to the Classified Advertisement Manager, PRACTICAL WIRELESS, IPC Magazines Ltd., Fleetway House, Farringdon Street, London, EC4A 4AD for insertion in the next available issue.

MISCELLANEOUS

TOP TRANSISTORS

Brand New and Individually Tested Transistors supplied unmarked, but packed separately for identification and guaranteed to be within their correct specification or money refunded. All at 9p. each or

Any 16 transistors for only £1.

ACY22	BSY27	OC201	2N3702
BC108	OC45	OC202	2N3703
BC109	OC71	ZTX300	2N3705
BFY51	OC72	2N706	2N3706
BFY52	OC200	2N2926	2N3708

Money back guarantee. P. & P. 5p.

J. M. KING (C)

17 Buckridge, Portpool Lane,
London, E.C.1

12 VOLT

FLUORESCENT LIGHTS

12 ins. 8 Watt tube ample light for caravan, tent, etc. Fully transistorised, low battery drain, Unbeatable at

£3-27½ post paid

or in kit form

£2-87½

BIG BARGAIN PARCEL 75p

POST PAID

Containing multi-contact relay, transistors, resistors, rectifiers, diodes, capacitors, pots, knobs, etc.

4 WATT GRAM AMPS.

Volume and tone controls, mains operation, 8Ω output, new and boxed

£3-63 POST PAID

SALOP ELECTRONICS Callers welcome
23 Wyle Cop
Shrewsbury, Shropshire S.A.E. for lists

MUSICAL MIRACLES

WAA-WAA Pedal. Complete kit of all parts, robust cabinet, mechanism & instructions. Huge sales, well proven design. Only £2.45 complete. Or built & tested £4.75 post free.

Rhythm Box. Build your own from our pre-built electronic circuit modules, e.g. box giving waltz, foxtrot etc., cost under £17.

Organ Percussion units £14. Bass pedal and other fascinating effects, fuzz, tremolo etc.

Send s.a.e. for list. D.E.W. Ltd.,
254 Ringwood Rd., Ferndown, Dorset.

ENAMELLED COPPER WIRE

S.W.G.	Per ½lb reel	Per 1lb reel
18-22	£0.62½	£0.92½
23-30	£0.65	£0.97½
31-35	£0.67½	£1.02½
36-40	£0.82½	£1.32½
41-44	£0.97½	£1.62½

Orders despatched by return of post. Please add £0.12½ per item P. & P.

Supplied by: Banner Transformers, Brooks St., Higher Hillgate, Stockport, Cheshire.

TRADE ENQUIRIES INVITED

MISCELLANEOUS

(continued)

BUILD IT in a DEWBOX quality cabinet. 2in x 2½in x any length. D.E.W. Ltd., Ringwood Road, FERN-DOWN, Dorset. S.A.E. for leaflet. Write now—Right now.

We stock all those components and materials required by the home Hi-Fi constructor, including speaker grille fabrics, BAF wadding, Peerless speaker kits, Helme Cabinet Kits, cross-over networks, inductors, etc. Special offers also available. Send stamps to value of 10np NOW for your copy of our new fully illustrated catalogue (catalogue cost refunded against purchases over 50np). No callers please, mail-order ONLY.

AUDIOSCAN Dept. PW4
4, PRINCES SQUARE,
HARROGATE, YORKS.

ELECTRONIC ORGAN

Solid state generator, 72 or 84 note with vibrato. Mullard pot cores, silicon N.P.N. Transistors, plug-in dividers for easy assembly and servicing. All parts standard. Ideal basis for any size of organ, will suit most set-ups. Large drawings and instructions £1 post paid.

SEON SMYTH,
234 Dumbarton Road,
Partick, Glasgow W.1.

SINCLAIR PROJECT 60 OFFERS. Two Z30 amplifiers, stereo 60 pre-amp, PZ5 power supply £18-75, or with PZ6 power supply £20-75. Two Z50 amplifiers, stereo 60 pre-amp, PZ8 power supply £20-75. Transformer for PZ8 £3. Q16 loudspeaker £7-90. Project 60 tuner £20-75. Other offers: S-DeCs 95p. T-DeCs £2-10. Modern miniature meters, 1½ in. square, similar to SEW 38p, 50 or 100 microamps £1-50. Sinclair Micromatic receivers, kit £2-20, assembled £2-70, batteries 27p extra. PNP Silicon transistors 2S300 series, untested but at least 80% are good. 50 for 40p, 100 for 70p. All goods are brand new. Money back if not satisfied. We regret that we are at present handling only mail order business. Postage 37p on Project 60 orders, 10p on others.—Swanley Electronics, 32 Goldsel Road, Swanley, Kent.

'DIRECTORY'; 450 parapsychical cases, Britain. Unusual electrical effects. £2. Paralaboratory, Downton, Wilts.

LETCHWORTH, Electronic Components, Communication and test equipment servicing. Open on Saturday only. W.T. Communication and Electrical, 14 Dixmore Yard, off Dixmore Avenue, Letchworth, Hertfordshire. (Turn in by Jet Garage in Dixmore Avenue.)

DAILY UFO FLIGHT PATTERNS (British, American), 37½p. UFO Map, S. England, 37½p. TV Notes on UFO Detection, and 2 Optical Circuits, 50p. Radar & Electronic Publications, "Highlands," Needham Market, Suffolk.

MISCELLANEOUS

(continued)

ENGINEERING SERVICE for constructors. Lathe work, milling, sheet metal, castings, etc. S.A.E. for details. Chelmsford Machine Tool Company, P.O. Box 55, Chelmsford CM1 2AU.

SERVICE MANUALS for Pre 1958 H.M.V. and E.M.I. MODELS. Radio and Record Player Manuals 25p each. Television Manuals 37½p each. Send C.W.O. stating model required. Also limited range of components and spares. Send details of your requirements. R.D.I. Ltd., Chilton Works, Garden Road, Richmond Surrey.

THE NEW

ELECTRONIC MUSIC FOR YOU

Then how about making yourself an electric organ? Constructional data available—full circuits, drawings and notes! It has 5 octaves, 2 manuals and pedals with 24 stops—uses 41 valves. With its variable attack you can play Classics and Swing. Write NOW for free leaflet and further details to C. & S., 20 Maude Street, Darlington, Durham. Send 2p stamp.

WANTED

CASH PAID for New Valves. Payment by return. **WILLOW VALE, ELEC-TRONICS,** 4 The Broadway, Hanwell, London, W.7. 01-567/5400-2971.

WE BUY New Valves and Transistors. State price: **A.D.A. MANUFACTURING CO.,** 116 Alfreton Road, Nottingham.

WANTED NEW VALVES, televisions, radiograms, transistors, etc. **STAN WILLETTS,** 37 High Street, West Bromwich, Staffs. Tel.: WES 0186.

WE BUY New Valves, Transistors and clean new components, large or small quantities, all details, quotation by return. **WALTON'S WIRELESS STORES,** 55 Worcester Street, Wolverhampton.

TOP PRICES PAID for NEW VALVES

popular T.V. and Radio types.

KENSINGTON SUPPLIES (C),

367 Kensington Street, Bradford 8,
Yorkshire.

HIGHEST CASH PRICES for Tape Recorders, 9.30-5. Immediate quotations. 01-472 2185.

WANTED NEW VALVES ONLY

Must be new and boxed
Payment by return

WILLIAM CARVIS LTD.
103 North Street, Leeds 7

TELEVISION AND RADIO TRAINING

(DAY ATTENDANCE COURSES)

This private College provides theoretical and practical training in Radio & TV Servicing. Courses of one years' duration, with daily attendance, are available for beginners and shorter courses for men with previous training in Electronics and Radio. Training courses in Radar and Radio Transmission are also available following the TV course. Write for prospectus to:—

London Electronics College, Dept B/4, 20 Penywern Road, Earls Court, London, S.W.5
Tel. 01-373 8721

LEC

MEN! You can earn £50 p.w. Learn Computer Operating. Send for FREE brochure—London Computer Operators Training Centre, C94 Oxford House, 9-15 Oxford Street, London, W.1.

R.T.E.B. Certs., City & Guilds, Colour TV, Radio, Computers, Radio Amateurs' Cert., Practical Electronics (with kit). Thousands of successes. Send for full details of Home Study Courses and illustrated book—FREE. **BRITISH INSTITUTE OF ENGINEERING TECHNOLOGY**, Dept. 137K, Aldermaston Court, Reading RG7 4PF.

A.M.S.E. (Elec.), City & Guilds, R.T.E.B. Cert., Radio Amateurs' Cert., etc., on 'Satisfaction or Refund' terms. Wide range of courses in Elec. Engineering, Design, Installation, Repairs, Refrigeration, Electronics, Radio & TV., etc. Send for full details and illustrated book—FREE.

BRITISH INSTITUTE OF ENGINEERING TECHNOLOGY, Dept. 124K, Aldermaston Court, Reading RG7 4PF.

RADIO OFFICER training courses. Write: Principal, Newport and Monmouthshire College of Technology, Newport, Mon.

TRAIN FOR SUCCESS WITH ICS

Study at home for a progressive post in Radio, TV and Electronics. Expert tuition for City & Guilds (Telecoms Techn's Cert. and Radio Amateurs') R.T.E.B., etc. Many non-exam courses incl. Colour TV Servicing, Numerical control & Computers. Also self-build kit courses—valve and transistor.

Write for FREE prospectus and find out how ICS can help you in your career.

ICS, DEPT. 541 INTERTEXT HOUSE, STEWARTS ROAD, LONDON. SW8

AERIALS

BAKER AND BAINES
UHF AERIALS

BBC and ITV 625 Colour: 10 ele £2.10; 14 ele £2.35; 18 ele £3.25; 22 ele £3.75. BBC 405 Aerials: Dipole £1.75; X aerial £2.15; H aerial £2.40; 3 element £5.20; 4 element £6.90. ITA 405 Aerials: 5 element £1.50; 8 element £2.70; 11 element £3.30; Double 5, 8 and 11 arrays available on request. Combined BBC-ITA 405 Aerials: Dipole plus 5 £2.70; Dipole plus 8 £3.10; H plus 5 £4.10; X plus 5 £4.50. Loft special Dipole, plus 5 £2.40. Diplexers, Triplexers, Matched Diplexers UHF/VHF. Poles, Lashings, Clamps, Couplers, etc. Coax 6p and 11p. Postage paid inland on aerials. Please state channel required when ordering. SAE will bring full lists.

METAL WORK

METAL WORK: All types cabinets, chassis, racks, etc., to your specifications. **PHILPOTTS METAL WORKS LTD.**, Chapman Street, Loughborough.

SITUATIONS VACANT

FIELD/BENCH ENGINEER required for Hi-Fi firm in Wimbledon. Must drive. Good salary and prospects. Please telephone 01-540 6543.

EAGLE INTERNATIONAL require Audio Engineers; excellent prospects. Must be fully conversant with Stereo Amplifiers, Tuners, Multiplex, etc. Contact Mr. Morrow 01-636 0961.

Radio Operators

There will be a number of vacancies in the Composite Signals Organisation for experienced Radio Operators in 1971 and subsequent years.

Specialist training courses lasting approximately 8 months are held at intervals. Applications are now invited for the course starting in September 1971.

Salary Scales

During training with free accommodation provided at the Training School:—

Age 21	£848 per annum
22	£906 " "
23	£943 " "
24	£981 " "
25 and over	£1,023 " "

On successful completion of course:—

Age 21	£1,073 per annum
22	£1,140 " "
23	£1,207 " "
24	£1,274 " "
25 (highest age point)	£1,351 " "

then by 6 annual increments to a maximum of £1,835 per annum.

Excellent conditions and good prospects of promotion. Opportunities for service abroad.

Applicants must be United Kingdom residents normally under 35 years of age at start of training course, and must have at least 2 years operating experience or PMG qualifications. Preference given to those who also have GCE 'O' level or similar qualification. Exceptionally well qualified candidates aged from 36-40 may also be considered.

Interviews will be arranged throughout 1971.

Application forms and further particulars from:

RECRUITMENT OFFICER (TRO 37)
Government Communications
Headquarters,
Oakley, Priors Road,
CHELTENHAM, Glos. GL52 5AJ
Tel: Cheltenham 21491 Ext 2270

SERVICE SHEETS

SERVICE SHEETS. Radio, TV etc. 8,000 models. List 10p. S.A.E. enquiries. TELRAY, 11 Maudland Bank, Preston.

RADIO, TELEVISION over 3,000 models. JOHN GILBERT TELEVISION, 1b Shepherds Bush Rd., London W.6. SHE 8441.

SERVICE SHEETS (1925-1971) for Televisions, Radios, Transistors, Tape Recorders, Record Players, etc., by return post, with free Fault-Finding Guide. Prices from 5p. Over 8,000 models available. Catalogue 13p. Please send S.A.E. with all orders/enquiries. Hamilton Radio, 54 London Road, Bexhill, Sussex.

SERVICE SHEETS

(continued)

TRADER SERVICE SHEETS

5/- each plus postage

We can supply Trader Service Sheets for most makes and types of Radios, Tape Recorders and Televisions—Manuals for some.

Cheques and open P.O.s returned if sheets not available.

OAKFIELD ENTERPRISES LIMITED

30 CRAVEN STREET, STRAND
LONDON WC2

Make	Model	Radio/TV

1970 List now available at 2/- plus postage

If list is required indicate with X

From

Address

enclose remittance of

(and a stamped addressed envelope) s.a.e. with enquiries please

MAIL ORDER ONLY (February PW)

RADIO/TV SERVICE SHEETS and MANUALS

S.A.E. with enquiries please. Mullard Valve and Semiconductor Data Book, 23p. Mazda Valve and Tube Data Booklet, 23p. Brimar Valve and Tubes Data List, 20p. Resistor Colour Code Indicator, 13p.

BELL'S TELEVISION SERVICES
Albert Place, Harrogate, Yorks HG1 4QA
Tel. 0423-86844

FOR SALE

MORSE MADE !! EASY !!

FACT NOT FICTION. If you start RIGHT you will be reading amateur and commercial Morse within a month. (Normal progress to be expected.)

Using scientifically prepared 3-speed records you automatically learn to recognise the code RHYTHM without translating. You can't help it, it's easy as learning a tune. 18 W.P.M. in 4 weeks guaranteed.

For details and course C.O.D. ring, s.t.d. 01-660 2896 send 4p stamp for explanatory booklet to:

G3CHS (BOX 11),
45 GREEN LANE, PURLEY, SURREY

Queen's Award to Industry

A PROUD DAY FOR REDIFON

THE Queen's Award to Industry for 1970 was formally presented to Redifon Limited and Redifon Air Trainers Limited on June 8 by Field Marshal Sir Gerald Templer, Her Majesty's Lieutenant for Greater London.

New marine radio telephone

MARINE Division has introduced a new SSB radio-telephone for operation in the marine 2 MHz band. It is designed to satisfy all current and future international regulations covering the phasing out of DSB transmissions, and to meet type approval

TEST ENGINEERS

£1144-£1500+

Continuing expansion means we need more test engineers with the practical experience and real technical knowledge to work on the alignment and testing of HF and VHF equipment.

Theoretical and practical experience of semi conductors, SSB and frequency synthesis will be a great advantage.

Age is not important, since initial earnings will be directly related to experience.

You could start at £1144, but with more experience this could be in excess of £1500.

Benefits include Pension, Life Assurance, 3 weeks holiday. Ring or write with brief details to:
Norman Manion,
REDIFON LIMITED
Broomhill Road, Wandsworth,
London SW18. 01-874 7281

REDIFON

A Member Company of the Redifusion Organisation

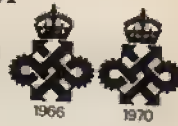

Redifon

REDIFON LTD. has won an order from Cable and Wireless to supply radio transmitting and receiving equipment for a new ground-to-air service in the Seychelles, where an airport is under construction for the first regular air service to the islands by land-based aircraft. Valued at over £25,000, contract also includes the provision of transmitters for a radio beacon which, while operating in the aeronautical

A NEW MILITARY RADIO STATION

A NEW 100 watt SSB (single sideband) military radio station, developed by the Communications Division is now in quantity production and delivery of an order valued at £156,000 for the Royal Air Force has already been completed.

EX COMPUTER PRINTED CIRCUIT PANELS 2in x 4in packed with semi-conductors and top quality resistors, capacitors, diodes, etc. Our price, 10 boards **50np** + 7np P. & P. With a guaranteed minimum of 35 transistors. Data on transistors included.

SPECIAL BARGAIN PACK. 25 boards for **£1**. P. & P. 18np. With a guaranteed minimum of 85 transistors. Data on transistors included.

PANELS with 2 power transistors similar to OC28 on each board + components. 2 boards (4 x OC28) **50np** + 6np P. & P.

9 OAS, 3 OA10, 3 Pot Cores, 26 Resistors, 14 Capacitors, 3 GET 872, 3 GET 872B, 1 GET 875. All long leaded on panels 13in x 4in. 4 for **£1** + 25np P. & P.

LARGE CAPACITY ELECTROLYTICS
10000MFD 30V } 40np + 6np P. & P.
16000MFD 12V }
or **£3.50** per doz. Carr. 50np

250 MIXED RESISTORS **62np**
‡ & † watt.

150 MIXED HI STABS **62np**
‡, † & 1 watt 5% and better.

EXTRACTOR/BLOWER FANS (PAPST)

100 CFM 2800 RPM 4 1/2in x 4 1/2in x 2in. Ideal for kitchen extraction, instrument cooling, etc., etc. **£2.5** + 25np P. & P. 240V AC 50Hz.

DIODES ex EQPT; SILICON
1 Amp 1000 PIV. 4 for **50np**.
20 Amp 150 PIV. 4 for **£1**. + 5np P. & P.

BARGAIN RELAY OFFER
Single pole change over silver contacts. 25V to 50V. 2.5kΩ coil. 8 for **50np**. + 5np P. & P.

KEYTRONICS mail order only
52 EARLS COURT ROAD,
LONDON W8 **01-478 8499**

LADDERS

VARNISHED TIMBER LADDERS from manufacturer. Lowest prices anywhere. 15 1/2 ft. extd. **£6.20**, 17ft. ext. **£6.50**, 20ft. ext. **£7**, 21 1/2 ft. ext. **£7.75**, 24 1/2 ft. ext. **£8.90**, 29ft. ext. **£10.25**, 31 1/2 ft. triple ext. **£12.25**, 36ft. triple ext. **£16**. Carr. 80p. Free lists. Also Aluminium Ext. & Loft Ladders. Callers welcome.—(Dept. W.L.S.) Home Sales, Baldwin Road, Stourport, Worcs. Tel: Stourport 2574. Placing order on C.O.D.

AUDIO EFFECTS

5 SHAW LANE, HALIFAX, YORKS.

Latest Design—Buy With Confidence From Proven Designers.

Radio Control.

Single channel T.X. Small compact crystal controlled printed circuit. Easy to build and tune. Push Pull O/P All silicon transistors. Micro action tone switch. Bottom oaded aerial. Coil on P.C. board. Fantastic, O/P. Everything bar case in kit form at **£6.00** (**£6.00**) post paid. Coils ready wound 10/- (50np) extra. Undrilled alloy case 8/- (40np). Ready built in case **£8.5.0**. (**£8.25**) post paid.

Super regon R.R.

Miniature, lightweight, supersensitive. Uses pp3 or pen cells. Silicon transistors. Front end works straight off. O/P without relay (drives actuator direct) or through 6v 300 OHM relay (not provided). Ideal for model aircraft. In kit form at only **£3.5.0**. (**£3.25**) post paid.

Available Shortly.

Superhet kit with cascade front end, dual AGC loops. Super selective.

Recommended soldering iron antex 15 watt **£2/6** (**£1.62**).

Ham Band Transistor Superhet Receiver Kit.

Uses denco plug in coils 600 KHZ to 30 KHZ in 4 ranges. Normally supplied with kit 1.5 MHZ to 5MHZ extra ranges 12/- (60np) each. Slow motion tuning. Push pull audio output to your 8 OHM speaker black perspex predrilled front panel. In kit form at **£9.12.6** (**£9.62**) ready built calibrated and guaranteed at **£15.5.0** (**£15.25**).

Power Controller.

Full wave control using branded triac rated 15amp 3kw. Single control zero to full power. In strong metal box with 13 amp main socket outlet ideal for fires, drills, floodlights, motors etc. Ready built at **£9.15.0** (**£9.75**). post paid. In kit form with full instructions **£7.5.0**. (**£7.25**) post paid.

Vox Switch.

Make a noise, it switches, high imp. L/P for XTl make. Drives your 12 volt relay. Ready built **£3.10.0** (**£3.50**). or in kit form **£2.7.6**. (**£2.37**).

Reverberation Amplifier.

Self contained transistorised. Batt operated. Entirely different approach to sound reproduction. With this unit proper sound delay through reverberation, tones are created truly third dimension for concert hall originality. Two controls adjust volume and reverberation. Simply plug in microphone, guitar etc and O/P into your amplifier encased in beautiful walnut cabinet 7 1/2" x 3" x 4 1/2" at only **£10.15.0** (**£10.75**) post paid.

Pocket Metronome.

Variable beat. Drives your speaker or earpiece provided uses pp3. In attractive plastic case at **£1.17.6** (**£1.87**) or as a kit at **£1.7.6**. (**£1.37**) both post paid.

Morse Oscillator.

Just attach your key. Drives your speaker or earpiece provided. Works on pen cells. Ready built in case as above **£1.5.0** (**£1.25**) as a kit 17/6 (87)np both post paid. Latest Mullard manual on audio amps etc. **£2/6** (**£1.62**) post paid.

Texas Transistors. Driver NPN and PNP complimentary symmetry. Pack of three 7/- (35np) post paid.

Est. 1943 **JOHNSONS** Tel: 24864

New! CV2—a unique triple-purpose VHF kit for the Amateur enthusiast. Integrated converter, receiver, and tuner-feeder. Fantastic single transistor performance! Comprehensive kit of high grade parts with three coils covering 80-178MHz, 9v battery, etc., together with simplified diagrams and instructions. Price complete, **£4**, post, packing and insurance paid, direct from makers. S.A.E. for literature.

JOHNSONS (RADIO)
St. Martin's Gate, Worcester
WR1 2DT

WHY PAY £60 OR MORE?

BATTERY MAINS COMPLETE FOR

PORTABLE RECEIVER

£35.50

OR SENT FOR
£7.50 DEPOSIT
& 6 M'TY PMTS
OF **£5.60**
(**£41.10**)
38p
P & P.

Picks up taxis, shipping (VHF Transmissions), TV, Ambulances, A.A., Pop Pirates, all B.B.C. and Continental Stations and 1,000s of Public Service Transmissions we are not allowed to mention

★ 18 Transistors

★ 5 Bands

★ Full 3 year unconditional g'tee.

Tremendous value! Not just a radio but a complete communications receiver. Frequencies: AM 640-1600 kcs; SW 4-10 m/cs; FM 88-108 m/cs; Air 108-134 m/cs; PSB 149-174 m/cs. Covers 1,000s Aircraft, Taxis, Shipping, Radio Hams, TV, Transmissions as well as your favourite radio programmes, B.B.C., Pirates, Continental stations, Automatic frequency control pinpoints stations, locks on and eliminates drift, battery operated with built-in adaptor for mains supply if required. Completely portable. Supplied with batteries, leather case, Size: 10" x 6 1/2" x 4". Lamp switch, tone switch, Hi-Fidelity earphone, fully adjustable telescopic aerial, INSTANT cash refund if not satisfied.

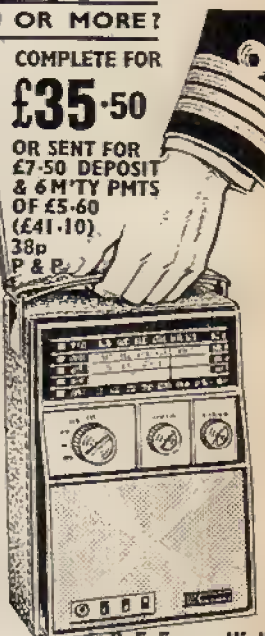

FREE - High-powered spotter telescope with cash order.

SCIENTIFIC & TECHNICAL SERVICES (Dept. PW1)
315 London Road, Westcliff, Essex
(Return of Post Service)

H.A.C. SHORT-WAVE KITS

WORLD-WIDE RECEPTION

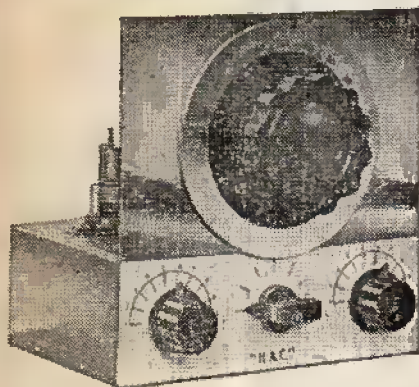

Famous for over 35 years for Short-Wave Equipment of quality, "H.A.C." were the Original suppliers of Short-Wave Receiver Kits for the amateur constructor. Over 10,000 satisfied customers—including Technical Colleges, Hospitals, Public Schools, R.A.F., Army, Hams, etc.

NEW "DX" RECEIVER

Improved one-valve model "DX" mark 2. Complete kit—price 66/- (post & packing 4/-). Customer writes: "Australia, India and America at loud volume."—"I am 14 years of age and have logged over 130 stations, plus countless Amateurs from all over the world."

Send S.A.B. for test report.

This kit contains all genuine short-wave components, drilled chassis, valve, accessories and full instructions. Ready to assemble, and of course, as all our products—fully guaranteed. Full range of other S.W. kits, including the famous model "K" and "K plus" (illustrated above). All orders despatched by return. (Mail order only.) Send now for free descriptive catalogue & order form.

"H.A.C." SHORT-WAVE PRODUCTS
29 Old Bond Street, London W.1

Fingers

The more 'fiddly' the job, the more you depend on your finger-tips. Make sure minor burns and blisters don't rob them of their skill. Apply **BURNEZE**, pronto! This unique scientific aerosol cools the heat out of a burn in just 8 seconds, anaesthetizes pain, reduces swelling. **BURNEZE**—the clever tip for burnt finger-tips. From chemists.



Potter & Clarke Ltd
Croydon CR9 3LP

KEYNECTOR

The safe quick way to connect electrical equipment to the mains



Send for full details

EB INSTRUMENTS
49-53 PANCRAS ROAD, LONDON N.W.1
Tel: 01-837 7781

£2.325
+ 25p P&P

In just 2 minutes, find out how you can qualify for promotion or a better job in Engineering...

That's how long it will take you to fill in the coupon below. Mail it to B.I.E.T. and we'll send you full details and a free book. B.I.E.T. has successfully trained *thousands* of men at home – equipped them for higher pay and better, more interesting jobs. We can do as much for YOU. A low-cost B.I.E.T. Home Study Course gets results fast – makes learning easier and something you look forward to. There are no books to buy and you can pay-as-you-learn on 'SATISFACTION – OR REFUND OF FEE' terms. If you'd like to know how just a few hours a week of your spare time, doing something constructive and enjoyable, could put you out in front, post the coupon today. No obligation.

WHICH SUBJECT WOULD INTEREST YOU?

Mechanical

A.M.S.E. (Mech.)
Inst. of Engineers
Mechanical Eng.
Maintenance Eng.
Welding
General Diesel Eng.
Sheet Metal Work
Eng. Inspection
Eng. Metallurgy
C. & G. Eng. Crafts
C. & G. Fabrication

Draughtsmanship

A.M.I.E.D.
Gen. Draughtsmanship
Die & Press Tools
Elec. Draughtsmanship
Jig & Tool Design
Design of Elec. Machines
Technical Drawing
Building

Electrical & Electronic

A.M.S.E. (Elec.)
C. & G. Elec. Eng.
General Elec. Eng.
Installations & Wiring
Electrical Maths.
Electrical Science
Computer Electronics
Electronic Eng.

Radio & Telecomms.

C. & G. Telecomms.
C. & G. Radio Servicing
Radio Amateurs' Exam.
Radio Operators' Cert.
Radio & TV Engineering
Radio Servicing
Practical Television
TV Servicing
Colour TV
Practical Radio & Electronics (with kit)

Auto & Aero

A.M.I.M.I.
MAA/IMI Diploma
C. & G. Auto Eng.
General Auto Eng.
Motor Mechanics
A.R.B. Certs.
Gen. Aero Eng.

Management & Production

Computer Programming
Inst. of Marketing
A.C.W.A.
Works Management
Work Study
Production Eng.
Storekeeping
Estimating
Personnel Management
Quality Control
Electronic Data Processing
Numerical Control
Planning Engineering
Materials Handling
Operational Research
Metrication

Constructional

A.M.S.E. (Civ.)
C. & G. Structural
Road Engineering
Civil Engineering
Building
Air Conditioning
Heating & Ventilating
Carpentry & Joinery
Clerk of Works
Building Drawing
Surveying
Painting and Decorating.
Architecture
Builders' Quantities

General

C.E.I.
Petroleum Tech.
Practical Maths.
Refrigerator Servicing.
Rubber Technology
Sales Engineer
Timber Trade
Farm Science
Agricultural Eng.
General Plastics

General Certificate of Education

Choose from 42 'O' and 'A' Level subjects including:
English
Chemistry
General Science
Geology
Physics
Mathematics
Technical Drawing
French
German
Russian
Spanish
Biology
B.I.E.T. and its associated schools have recorded well over 10,000 G.C.E. successes at 'O' and 'A' level.

WE COVER A WIDE RANGE OF TECHNICAL AND PROFESSIONAL EXAMINATIONS.

Over 3,000 of our Students have obtained City & Guilds Certificates. Thousands of other exam successes.

THEY DID IT—SO COULD YOU

"My income has almost trebled . . . my life is fuller and happier." – Case History G/321.

"In addition to having my salary doubled, my future is assured." – Case History H/493.

"A turning point in my career – you have almost doubled my standard of living." – Case History K/662.

"Completing your Course meant going from a job I detested to a job I love." – Case History B/461.

FIND OUT FOR YOURSELF

These letters – and there are many more on file at Aldermaston Court – speak of the rewards that come to the man who has given himself the specialised know-how employers seek. There's no surer way of getting ahead or of opening up new opportunities for yourself. It will cost you a stamp to find out how we can help you.

Free!

Why not do the thing that really interests you? Without losing a day's pay, you could quietly turn yourself into something of an expert. Complete the coupon (or write if you prefer not to cut the page). We'll send you full details and a FREE illustrated book. No obligation and nobody will call on you . . . but it could be the best thing you ever did.

BRITISH INSTITUTE OF ENGINEERING TECHNOLOGY

Dept D258, Aldermaston Court, Reading RG7 4PF.

(Write if you prefer not to cut this page)

POST THIS COUPON TODAY

To: B.I.E.T., Dept D258, Aldermaston Court, Reading RG7 4PF
Please send me book and details of your Courses in

Name..... Age.....

Address.....

Occupation.....

453A

B.I.E.T.—IN ASSOCIATION WITH THE SCHOOL OF CAREERS—ALDERMASTON COURT, BERKSHIRE

Published approximately on the 7th of each month by IPC Magazines Limited, Fleetway House, Farringdon Street, London, E.C.4. Tel: 01-634 4444. Printed in England by Index Printers, Dunstable, Beds. Sole Agents for Australia and New Zealand—Gordon and Gotch (A/sia) Ltd.; South Africa—Central News Agency Ltd.; Rhodesia and Zambia—Kingston Ltd.; East Africa—Stationery and Office Supplies Ltd. Subscription rate (including postage); For one year to any part of the world £2 5s 0d. (£2.25)

PRACTICAL WIRELESS is sold subject to the following conditions, namely, that it shall not, without the written consent of the Publishers first given, be lent, resold, hired out or otherwise disposed of by way of Trade at more than the recommended selling price shown on the cover, and that it shall not be lent, resold or hired out or otherwise disposed of in a mutilated condition or any unauthorised cover by way of Trade, or affixed to as part of any publication or advertising, literary or pictorial matter whatsoever.



BIET

HENRY'S RADIO LIMITED

ENGLAND'S LEADING ELECTRONIC CENTRES

HENRY'S RADIO

HI-FI · COMPONENTS · TEST · P.A. · DISCOTHEQUE · ELECTRONIC ORGANS · MAIL ORDER

TRANSISTOR AMPLIFIERS

NEW RANGES NOW IN STOCK
(Leaflets Ref. No. 6 and 8)
Post etc. 20p (4/-)

4-300 4 TR 9V 300mW £1.75 (35/-)
104 4 TR 9V 1W £2.12 (42/5)
304 4 TR 9V 3W £2.47 (49/5)
555 6 TR 12V 3W £2.75 (55/-)
PA7 6 TR 16V 7W £3.62 (72/5)
608 6 TR 24V 10W £4.12 (82/5)
410 4 TR 28V 10W £4.97 (99/5)
MPA12/3 6 TR 18V 12W £4.50 (90/-)
MPA12/15 6 TR 36V 12W £5.25 (105/-)
Z30 9 TR 30V 20W £3.75 (75/-)
PA25 10 TR (5pl) 25W £7.50 (150/-)
Z50 30V 40W £5.47 (109/5)
PA50 12TR (5pl) 50W £9.50 (190/-)
100 100W with Power Supply £45.00
Post 45p (9/-)

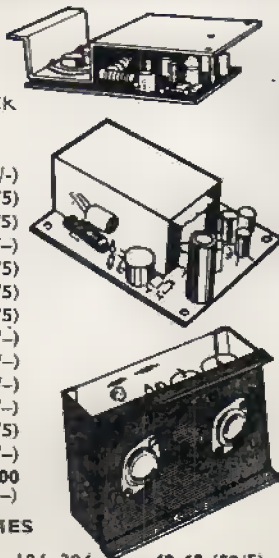

OPTIONAL POWER SUPPLIES

Post etc. 20p (4/-).
P.500 Switchable (One or Two) for 104, 304 £2.62 (52/5)
PS.20 Switchable (One or Two) for PA7 £3.47 (69/5)
MU24/40 Switchable (One or Two) for MPA12/3 or MPA12/15 £4.50 (90/-)
PZ5 for Z30 £3.97 (79/5) or PZ6 for Z30 £6.97 (139/5)
PZ8 for Z50 £5.97 (119/5) Transformer £2.25 (45/-)
P11 for 608 £2.87 (57/5) P15 for 410 £2.62 (52/5)
MU442 for 1 or 2 PA25 or 1 only PA50 £6.50 (130/-)

SINCLAIR PROJECT 60 PACKAGE DEALS
2xZ30 amplifier, stereo 60 pre-amp, PZ5 power supply, £19. Carr. 40p. Or with PZ6 power supply £21. Carr. 40p. 2xZ50 amplifier, stereo 60 pre-amp, PZ8 power supply, £21.50. Carr. 40p. Transformer for PZ8 £2.25 extra. Any of the above with Active Filter unit add £4.87 or with pair Q16 speakers add £16. Also new FM Tuner £23.

BUILD THIS VHF FM TUNER



5 MULLARD TRANSISTORS 300 kc/s BANDWIDTH. PRINTED CIRCUIT, HIGH FIDELITY REPRODUCTION. MONO AND STEREO. A popular VHF FM Tuner for quality and reception of mono and stereo. There is no doubt about it—VHF FM gives the REAL sound. All parts sold separately.

Free Leaflet No. 3 & 7. TOTAL £6.97 (£6.19.6) p.p 20p (4/-)
Cabinet 100p, Decoder Kit £5.97, Tuning meter £1.75
Mains unit (optional) Model PS900 £2.47 (49/5)
Mains unit for Tuner and Decoder PS1200 £2.62 (52/5)

BUILD YOURSELF A QUALITY RADIO



Excellent printed circuit design with full power output. Fully tuneable on both MW/LW bands. 7 Mullard transistors. Fitted 5in. speaker. Room filling power. Easy to build with terrific results. Two colour leather-cloth cabinet with silvered front. All local and continental stations. Complete detailed instructions.

Total cost £6.98 (£6.19.6). p.p 35p (7/-). Ask for leaflet No. 1. All parts sold separately.

HI-FI TO SUIT EVERY POCKET



CHOOSE 100 STEREO SYSTEMS FROM

and a complete range of individual units in stock—Demonstrations all day—visit our new Hi Fi Store. LOW CASH OR CREDIT/HP TERMS (Credit terms from £30 purchase—callers only).

FREE—Stock list No. 16, 17 on request—BEST VALUE IN U.K.

HENRY'S LATEST CATALOGUE



Now 350 pages. WHY NOT SEND AWAY TODAY

- ★ COMPONENTS, TEST GEAR
- ★ EQUIPMENT, MODULES
- ★ SPECIAL OFFERS, etc. etc.

Everything for the constructor. Complete with 50p value discount voucher for use with purchase. Price 50p Post Paid.

- FREE** 8 page Transistor, IC, Diode lists No. 36
- FREE** 20 page Organs to Build brochure No. 9
- FREE** Decks and Hi Fi Stock Lists No. 16/17
- FREE** PA, Disco and Lighting List No. 18
- FREE** Quotations for all Electronics—send list and S.A.E.

TEST EQUIPMENT FOR HOME, SCHOOL & PROFESSIONAL USE



AF105 50k/volt multimeter (illus.). Price £8.50 (190/-), p.p 20p (4/-). Leather case £1.42 (28/5).
200H 20k/volt. Price £3.87 (77/5), p.p 20p (4/-). Case 62p (12/5).
500 30k/volt multi-meter. Price £8.87 (177/5), p.p 20p (4/-). Leather case £1.50 (30/-).
THL 33 2k/volt. Price £4.12 (82/5), p.p 15p (3/-). Leather case £1.15 (23/-).
TE65 Valve voltmeter (illus.). Price £17.50 £17.10.0. p.p 40p (8/-).
SE250B Pocket pencil signal injector. Price £1.75 Post Paid.



SE500 Pocket pencil signal tracer. Price £1.50 Post Paid.
TE20D RF generator Price £15, p.p 40p (8/-)
TE22D Matching audio generator. Price £17, p.p 40p (8/-).
TE15 Grid dip meter. Price £12.50, p.p 40p
TO3 Scope 3" tube. Price £37.50, p.p 50p.
TE22 Audio Generator £17, p.p 40p (8/-)
(GET A COPY OF OUR LATEST CATALOGUE FOR FULL SPECIFICATIONS AND FURTHER RANGES).

NEW MINIATURE LOW COST AMPLIFIER

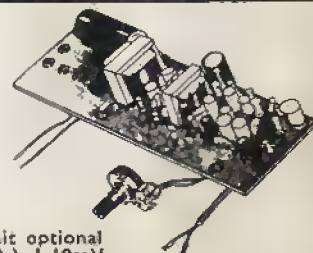

MODEL 4-300

9 volt operated or mains unit optional transformer (MT98 70p (14/-)), 1-10mV adjustable sensitivity, P/P output for 3-8 ohms. Fitted volume control and leads. Size 5 1/2" x 1 1/2" x 1". Thousands of uses—takes magnetic, dynamic and crystal inputs direct. Output 300mW—very high gain—built in rectifier circuit.

PRICE £1.75
(35/-) p.p 15p (3/-). Complete with FREE leaflet No. 8.

STC TIME DELAY MODULE



Ideal for experimenters, educational projects as well as for practical uses. Delay adjustable 3-15 secs. Operates 9-12 volts. Heavy Duty Relay Contacts. Complete with suggested applications sheet. Price £1.75 (35/-). Post Paid.

GARRARD TAPE DECK



9 volt operated 2-speed tape deck fitted Record/Replay 1/2 track and Erase/Bias Osc. Head. Complete with Oscillator/Record head circuit. Unit size 9" x 6 1/2" x 1 1/2" and 2 1/2" below motor board. Takes up to 4" spools. Supplied Brand New.

Price £9.97 (£9.19.6) P.&P.33p (6/6) 3 1/2" Tape Spool and spool 40p (8/-).

HENELEC SELF-POWERED PRE-AMPLIFIERS



Designed for use with PA25 and PA50 Amplifiers GOLD AND SILVER FINISH. Mains operated. Supplied with all plugs, etc. ADJUSTABLE OUTPUT UP TO 1 VOLT.

- ★ FET9/4. Mono with built-in mic. mixer. Accepts any ceramic or crystal cartridge. Plus tuner, tape, etc. Price £12.50 (£12.10.0) p.p 20p (4/-).
- ★ FET154 STEREO (illus.). Magnetic cart. input, tuner, tape, etc. Beautiful stereo sound. Price £16.50 (£16.10.0), p.p 25p (5/-)

Also suitable for use with any power amplifier. Suggested types PA25, PA50, MPA12/3, MPA12/15

SLIM MODERN DESIGNS USING THE LATEST SILICON TRANSISTORS FET's and IC's. DIN SOCKETS, Etc. fitted. Self powered.
PUSH-BUTTON SELECTION, ±20dB BASS AND TREBLE BOOST & CUT
All inputs provided plus TAPE RECORD and REPLAY.

SIMPLICITY TO MOUNT—EASY TO USE—DESIGNED FOR QUALITY, PERFORMANCE AND PRICE
All units no soldering—just edge connectors and plugs AS SPECIFIED FOR MANY "PRACTICAL WIRELESS" 1970 PROJECTS

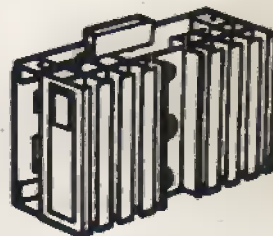

25 WATT AND 50 WATT SILICON AMPLIFIERS

LOOK AT THE SPECIFICATIONS

- ★ At full power 0.3% distortion.
- ★ At full power—1dB 11c/s to 40 kc/s.
- ★ Response—1dB 11 c/s to 100 kc/s.
- ★ Rise time 2μ sec.
- ★ Short circuit proof plus limiting cct.

FREE LEAFLET No. 25 on request

PA 25 10 transistor all silicon differential input 400mV sensitivity. 25 watts Rms into 8 ohms. Supplied with edge connector harness size 5" x 3" x 2".
PA 50 12 transistor version 50 watts Rms into 3 to 4 ohms. Size 5" x 3" x 4".
MU 442. Power supply or one or two PA.25 or one PA 50
PA 25 £7.50; PA 50 £9.50. MU 442 £6.00 P. & P. 20p each.

Electronic Components & Test Gear Centre
356 EDGWARE ROAD,
LONDON, W.2.
Tel: 01-402 4736
OPEN 9 a.m. to 6 p.m. MONDAY TO SATURDAY — 9 a.m. to 1 p.m. THURSDAYS — OPEN ALL DAY SATURDAY

High Fidelity Sales & Demonstrations Centre
354 EDGWARE ROAD,
LONDON, W.2.
Tel: 01-402 5854

Electronic Organs, P.A. & Discotheque Centre
309 EDGWARE ROAD,
LONDON, W.2.
Tel: 01-723 6963

Mail Orders, Special Bargain Shop, Industrial Sales
303 EDGWARE ROAD,
LONDON, W.2.
Tel: 01-723 1008/9