

TRIODE versus PENTODE—See Page 150.

Practical and Amateur Wireless

3^d
EVERY
WEDNESDAY

Edited by F.J. CAMM

a GEORGE
NEWNES
Publication

Vol. 10, No. 241.
May 1st, 1937.

AND PRACTICAL TELEVISION

Local
Station
Quality
Sets

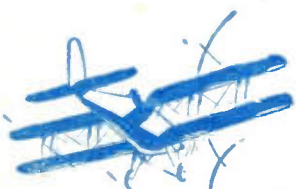

A Unique Book for the Air-Minded—

“ACE OF THE BLACK CROSS”

**Ernst
Udet**

The memoirs of Germany's greatest living air ace. Ernst Udet tells an unparalleled story of an enemy's heroic campaign. "A great tale it is!"—*Evening News*.

Get it from Your Library—6/- net Newnes : London



Cyclists—Make sure of this!

GREAT FREE INSURANCE

**£1 A WEEK DISABLEMENT
FOR 13 WEEKS
£50 FATAL ACCIDENT
BENEFIT**

OVER
£13,000
ALREADY
PAID OUT
BY THE
"CYCLIST"

NOTHING WHATEVER TO
PAY FULL PARTICULARS
IN

THE
Cyclist

THE LEADING CYCLISTS' WEEKLY

*Of all Newsagents and Bookstalls, or by post 3d.
from the Publisher, George Newnes, Ltd., Tower House,
Southampton Street, Strand, London, W.C.2.*

2^D EVERY
• WEDNESDAY

★ *Cyclists already holding "THE CYCLIST"
or "THE CYCLIST" Road Club Insurance
Certificates cannot avail themselves of this
New Free Insurance until their present certi-
ficates expire.*

EUROPE'S OLDEST S.W. TRANSMITTER SEE PAGE 158.



Practical

and Amateur

Wireless

Edited by F. J. CANN

Technical Staff:
W. J. Delaney, H. J. Barton Chapple, Wh.Sc.,
B.Sc., A.M.I.E.E., Frank Preston.



VOL. X. No. 241. May 1st, 1937.

ROUND *the* WORLD *of* WIRELESS

Quality Reception

THERE are two distinct classes of listener —those who wish to hear as many stations as possible, and those who desire the highest possible quality of reproduction and are satisfied with only the local station. It is an undoubted fact that for the highest possible quality, the receiver is restricted to a station situated within a very few miles, and any attempt at increasing the range of reception will in most cases result in a deterioration in the quality of the received signal. For the highest quality there are many aids to reception, such for example as contrast expanders, but these devices require very careful design in order to avoid harmonic distortion and other forms of trouble. With the ordinary domestic speaker and room acoustics, it is possible to make a quality receiver which is simple to build and operate and which employs normal components. On pages 156 and 157 we give details concerning the design of circuits of this type and examples of three receivers in theoretical form, and all those who are interested in this type of receiver should follow the details there given.

Insects Broadcast

AT the N.P.S., Teddington, a neat microphone-amplifier has been perfected for use in detecting the presence of destructive insects in timber. It is so sensitive that it has been found possible to distinguish between the different kinds of insects or larvae by noting the differences in the sounds which they make, although they may be far below the surface of the timber.

More Listeners

THE figures issued by the authorities for March show that there is yet another increase in the number of licences issued. The total figures were 616,582 issued, and 616,084 expired, showing a net increase of 41,498. This brings the total number of licences in force in England, Scotland, Wales and Northern Ireland (including free licences issued to the Blind) to 8,131,450.

Rudy Vallee Next Week

LISTENERS who remember the original Savoy bands will remember the saxophonist who took his christian name from Rudy Wiedoft, upon whose saxophone technique he based his playing. When Rudy Vallee returned to America he crooned

in addition to his playing, and as a crooner has made fame. His most famous number in America was the "Stein Song," and for some years Rudy has been one of America's highest paid artists as a crooner and band leader. He sailed for England on April 23rd, and will broadcast in a special half-hour of his own design from the National transmitters on May 8th.

A Gala Revue

ANOTHER high spot in Coronation week is a Gala Radio Revue which will be broadcast on May 11th from the Nationals, and on May 13th in the Regional programmes. A full programme is not yet arranged, but the B.B.C. announce

outside the Abbey and Buckingham Palace and along the route, and 15 for English and foreign observers. The whole system of wiring for this broadcast has been carried out by engineers of the Post Office. It should be realised, in order to understand the magnitude of this task, that each microphone point also has to be arranged with two-way communication between all points, and in addition, all circuits are duplicated in case of breakdown.

Blackpool Dance Festival

THE seventeenth Blackpool Dance Festival comprising ballroom dancing and stage dancing competitions for amateurs and professionals takes place early in May. On May 6th, P. J. S. Richardson is to broadcast in the Northern programme a running commentary on parts of the British Amateur Championship from the Empress Ballroom. On the following night commentaries on the British Professional Dancing Championship will be broadcast in the Empire programmes.

Music Items

A BROADCAST performance of unusual interest on May 5th (National) will be that of the Cinhalese artist, Surya Sena, who will sing a programme of folk music from Ceylon, Peru, Nepal and Sicily. Surya Sena is a Cinhalese artist of international repute, and this programme should prove of exceptional interest.

On May 6th (Regional), the first act of Gluck's "Alceste" will be broadcast when it is presented by a joint company of artists from the Paris Opéra and Opéra Comique, whose visit will be one of the features of the season.

The second act of "Aida" will be broadcast on May 7th (Regional), and the second act of "Carmen" on May 11th (Regional), the eve of the Coronation.

On May 7th (National), Joseph Lewis will conduct a Sullivan programme consisting of the Prelude to Act 4 of "The Tempest" and the Symphony in F, and on the same day (Regional), the celebrated violinist Juan Manen will broadcast a recital of music arranged or written by himself.

Variety from Southampton

ON May 5th a variety programme will be broadcast from the stage of the Hippodrome, Southampton.

ON OTHER PAGES

	Page
Transmitting Topics	147
Constructional Details of "Practical Wireless" Sets	149
Triode versus Pentode	150
Television Notes and News	151
Thermion's Page	153
Readers' Wrinkles	155
Local Station Quality Sets	156
Europe's Oldest S.W. Transmitter	158
British Long Distance Listeners' Club	159
Short-Wave Section	161
Letters from Readers	163
Facts and Figures about New Components	164
Readers' Problems Solved	167

that George Robey, Wilson Hallett, the Western Brothers and Mabel Constanduros have already been engaged. The production is by John Watt and the book is being specially written by Douglas Furber, who is probably best known for his songs "The Bells of St. Mary's" and "Limehouse Blues."

Fifty-eight Microphones

THE relaying of the Coronation ceremony will involve the use of 58 microphones, of which 32 will be used for relaying the Abbey service, 11 will be used for effects

ROUND the WORLD of WIRELESS (Continued)

Radio Beacons for Africa

PLANS are well advanced for the installation of 27 new radio direction-finding stations over Africa to assist pilots, and to make possible the operation of increased air mail and passenger services thousands of miles over the Empire air routes.

Two More Acts for Coronation Music-Hall

FLANAGAN and Allen and Billy Caryl and Hilda Mundy have been engaged to take part in the 90-minutes Music-Hall programme on May 15th—the last variety show of Coronation Week. Incidentally, Flanagan and Allen have just signed a contract for six B.B.C. Music-Hall dates, the biggest contract of its kind ever issued. They will be "on the air" once before their Coronation Week broadcast.

Birmingham Cathedral Bells

THE newly recast peal of bells at St. Philip's, Birmingham, the Cathedral Church of the diocese, are to be dedicated



The final stage of the modulator unit in the Empire Station at Daventry. The mechanical water interlocks, which prevent the supply of power to the valves until the cooling water is flowing, are clearly visible.

and to ring their first peal on St. Philip's Day. On May 1st listeners will hear a short description of the bells and their first peal. The inscription on the bells records that they were recast for the Coronation of King George VI, chiefly through the generosity of Sir Charles Hyde.

INTERESTING and TOPICAL NEWS and NOTES

Coronation Creates Radio Export Boom

WITH only twelve days to go to Coronation Day, the wireless industry is faced with so many orders for sets that it is working day and night to fulfil them, and thousands of British people overseas will now receive their sets too late for the Coronation broadcast.

According to a G.E.C. official there has been an enormous demand from overseas, and hundreds of thousands of people in the Empire, and all over the world, are demanding the latest sets in time for the Coronation so as to ensure perfect reception. The rush of last-minute orders has been very great, and in the past few weeks the General Electric Company alone has sent thousands of sets abroad. These orders are for short-wave sets, and the main destinations are South America, India, South Africa and British Malaya.

Cup Final Broadcast

MOST listeners will be interested to know that George Allison and Ivan Sharpe will broadcast a commentary on the Cup Final at Wembley Stadium on May 1st. This year's contest is between two northern teams, Sunderland and Preston North End. Ivan Sharpe, who will broadcast the first half of the match, a northerner himself, will be able to give listeners an intimate picture of the struggle between these two famous northern teams. Mr. Sharpe, it will be remembered, was one of the commentators at last year's Cup Final.

George Allison, who, because his own team, Arsenal, were one of the finalists last year, was unable to broadcast, is to describe the second half of this year's match. As a contrast, listeners will be taken over immediately after the Cup Final to the opening of the cricket season at Old Trafford, where Lancashire are opposed to Derbyshire.

SOLVE THIS!

PROBLEM No. 241

Excessive hum developed in Wallace's A.C. mains receiver and when measurements were made the current consumption of all the valves and the anode voltages were found to be excessive. What was the fault? Three books will be awarded for the first three correct solutions opened. Address your solutions to the Editor, PRACTICAL AND AMATEUR WIRELESS, Geo. Newnes, Ltd., Tower House, Southampton Street, Strand, London, W.C.2. Envelopes must be marked Problem No. 241 in the top left-hand corner and must be posted to reach this office not later than the first post on Monday, May 3rd, 1937.

Solution to Problem No. 240

The switch contacts across the intervalve coil long-wave winding were not making when the control was switched for medium-wave reception. The following three readers successfully solved Problem No. 239 and books are accordingly being forwarded to them: C. W. Picken, 2, Glebe Cottage, St. Stephens, Canterbury; A. Davie, 41, Kimberley Road, Edmonton, London, N.18; C. Roslyn, 51, Alredale Road, Balham, London, S.W.12.

Bournemouth Municipal Orchestra

THE Bournemouth Municipal Orchestra, led by Harold Fairhurst and conducted by Richard Austin, will broadcast from the Pavilion, Bournemouth, on May 2nd. The soloist will be Garda Hall (soprano).



Stella Roberta, the well-known vocalist in Mantovani's orchestra, is here seen with her new "Pilot" receiver.

Glinka and Smetana

ON May 8th the B.B.C. Scottish Orchestra, conducted by Guy Warrack, will play the Overture and a Suite from "Russlan and Ludmilla," by Glinka, and the Overture and three dances from "The Bartered Bride" and the Overture to "Libussa," by Smetana.

Orchestral Concert from Bristol

THE Grand Hotel Orchestra, under the direction of Adolphe Trotman, will broadcast from the Grand Hotel, Bristol, on May 3rd. The orchestra specialises in light music of the gipsy type, and every member has had experience of broadcasting, Edgar Hawke (1st violinist) having his own broadcasting combinations.

The New Vic

ON May 7th the Rutland Square and New Victoria Orchestra, directed by Frank Gomez, will broadcast from the New Victoria Cinema, Edinburgh. The programme will include: "The Procession of the Sirdar," by Ippolitow-Iwanow; "Brise d'Été," by Sanderson; Selection, "This England," arranged Debroy Somers; "The Crack Regiment Patrol," by Moses Tobani; Selection from the "Harlequinade" Ballet by Franz Gomez; "Song of the Troubadour," by Metra; Selection of Scottish Tunes, arranged Colin Campbell; Novelty Rhythmic Duet "Snakes and Ladders," by Engleman, arranged Mayerl; Irish Folk Tune, "The Gentle Maiden," arranged Reginald Redman; and a Selection of Sullivan Melodies, arranged Dan Godfrey.

TRANSMITTING TOPICS

THE "electronic" theory states, speaking in a practical sense, that an electric current is really nothing more than a movement of electrons (i.e., the smallest quantity of negative electricity which, with the proton, is the basis of all matter), and if the movement is in one direction, it is usual to refer to the current as being "direct current." It will be remembered, however, that it is also possible to make the flow of electrons reverse, periodically and set up what is known as an "alternating current."

Radiation

Radiation, when applied to the subject under consideration, refers to the radiation of energy from the transmitting source.

The energy takes the form of "electromagnetic waves," waves which have an electric and a magnetic component, and which travel at the same speed as light, namely, 186,000 miles or 300,000,000 metres per second.

This energy is only radiated when the electrons are forced to get a move on or are pulled up with a jerk; in other words, a circuit carrying "direct current" will not radiate during normal current flow, but only at the moment of switching on and off, i.e., starting and stopping.

With a circuit carrying "alternating current" (A.C.), however, the conditions are very different as the electrons are in a continuous state of starting and stopping, producing electro-magnetic waves as long as the current is switched on.

This state of affairs exists with all commercial A.C. supplies, but as the frequency is so low, usually 50 cycles per second, the energy radiated is very very small. The greatest radiation is produced by circuits carrying A.C. having very high frequencies; in fact, it will be found that the amount of energy radiated increases with frequency, i.e., the short wavelengths.

The waves have another characteristic in common with those of light, they can be reflected and refracted, as will be explained further on in this article, thus allowing direction of maximum radiation to be predetermined, as in the case of "beam" transmissions.

Characteristics of Radiated Waves

For normal broadcast requirements, it is possible to design transmitting aeri- als which will allow very even radiation in all directions, particularly in the case of long waves. Under such conditions, the strength of the signal at the receiving aerial will more or less depend upon its distance from the transmitter, the signal gradually getting weaker and weaker as the distance is increased.

With the higher frequencies (short waves), however, one cannot apply the same reasoning, as the behaviour of short waves is, to say the least, very erratic and greatly influenced by the items mentioned below.

Earth or Surface Waves

For clearness I am dividing the electromagnetic waves into two groups, one of which can be classified under the above heading, and we will consider that one first. When short waves are radiated from a transmitting aerial system some of them travel over the earth's surface or in the

To get a clearer understanding of this "ionised atmosphere," I would mention that the air molecules are ionised by collision due to bombardment by solar and cosmic radiations, and what really happens is that certain electrons and ions are rendered free to travel about, so to speak, on their own. The happy free state, however, doesn't exist for long; as the smashing up business goes on the free electrons and ions recombine to form neutral molecules, but, during their freedom the electrons have been on the move, and it is their movement which is chiefly responsible for the refraction of the waves which penetrate the ionised layer.

The Characteristics of Radiated Waves, "Sky" Waves and Fading, are Among the Subjects Dealt With in this Article. By L. ORMOND SPARKS

lower atmosphere, which is, comparatively speaking, fairly dependable, but, owing to the absorption of energy by earthed objects, such as trees, houses and the actual earth itself, they become attenuated or weakened rather rapidly and their effective range is, likewise, very limited. The effect becomes more pronounced as the frequency is increased, in fact, if the wavelength is down in the ultra-short band, the effective range almost becomes equal to the optical range, although, in view of the strange results now being obtained with the television transmissions, it does not seem possible to form any hard and fast rule.

Sky Waves

For the second group, I do not think a better

The whole idea will be more readily understood by referring to the accompanying illustration. Let "T" represent the transmission station; R and R1 receiving stations; and the shaded band "a" and "b" the ionised layer, or Heaviside Layer. The shading in the band "a" "b" is intended to represent the density of the layer, i.e., the greatest number of free electrons in the centre of the layer.

The station "R" is at a distance from "T" which comes within the range of the "earth or surface" waves, and the strength of the received signals will depend on the amount of absorption of energy by earthed objects between the two points. The other station, "R1," however, is beyond the effective range of the "earth" waves, and will depend on the "sky" waves for its signals, their path of travel being indicated by the dotted line "s" "s."

It will be noticed that the path is turned back towards the earth by the ionised layer, and the turning process is due to a combination of reflection and refraction, according to the frequency of the waves. The higher the frequency, the greater the depth of penetration of the layer, and, consequently, the greater the distance between "T" and the point where they come in contact with the earth.

A peculiar point about the Heaviside Layer is that its height is greater at night time, and this, in turn, again affects the range of the "sky" waves, as many amateurs will have, no doubt, noticed during reception tests.

It is assumed that there are other layers besides the Heaviside; in fact, it is known that another does exist, and it is known as the Appleton Layer, which varies in height according to the season. It is estimated to be as much as 300 miles above the earth's surface during certain periods.

Skip Distance

If the diagram is examined, it will be noted that any station situated in the area between "R" and "R1" does not receive either the ground or sky waves; in other words, it is in a "dead" area, and as the waves literally "skip" that distance it is usual to refer to such as the "skip distance."

(Continued overleaf)

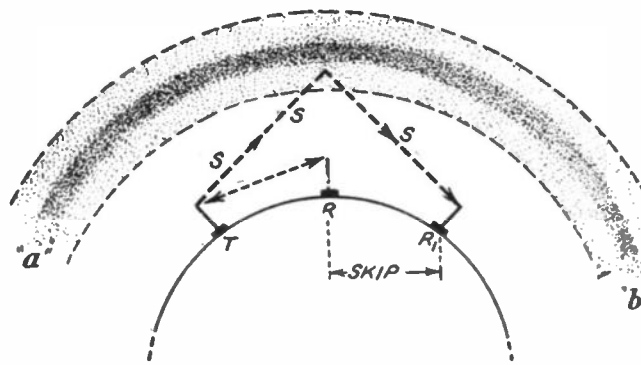

Diagram showing the effect of the reflected and direct waves of two separate receivers.

name can be found than that given above.

Though speaking about "Earth Waves" it must not be thought that all the energy is radiated in that manner; far from it, as the greater amount of energy is, undoubtedly, radiated skywards at a small angle to the horizontal, and thus clears all surrounding earthed objects.

It is quite possible that these waves would go on travelling higher and higher and be of no use for communication purposes, if it were not possible for them to be reflected and refracted in the same manner as light.

Heaviside Layer

At approximately 60 to 70 miles above the earth's surface there exists a layer of ionised atmosphere which is known as the Heaviside Layer, after Oliver Heaviside, who, in 1902, put forward the theory of its existence.

TRANSMITTING TOPICS

(Continued from previous page)

It will be appreciated, therefore, that a transmitter might, quite possibly, not be received by a station, say, 50 miles away, but his signals would be received at good strength by a station many hundreds or thousands of miles away.

As the frequency is reduced, i.e., wavelength increased, the sky wave is bent back earthwards at a more acute angle; in fact, above 50 metres, the waves will return earthwards within the range of the "earth" waves, besides, of course, greater distances as well.

Fading

Before connecting the two paths open to electro-magnetic waves with fading, it is necessary to get a general idea, even though it is a brief one, of "phase" relationship.

If two alternating currents are flowing in the same circuit, and they have identical frequencies, they will augment or nullify each other, according to whether they are in phase or out of phase with each other.

Assuming that they are "in phase" with each other, then the maximum amplitude will be equal to the arithmetical sum of the two, and, when such conditions exist, it is usual to state that the currents are "synchronised."

As the currents get "out of phase" the maximum amplitude will decrease, until when the phase difference or angle becomes 180 degrees, the amplitude falls to zero. This condition is known as "phase opposition."

I have mentioned that it is possible for a receiving station to be affected by earth waves and sky waves. Well, it is also possible for a time difference to exist between the reception of one and the other, such difference resulting in a phase difference between two groups of waves.

To make matters worse, the phase difference is not constant; it is possible for it to vary from moment to moment, and the resultant effect is to produce, by virtue of the brief explanation given above, fluctuations in signal strength which are often classified under the heading of "fading."

NEW MARCONIPHONE TELEVISION RECEIVER

Details of the Latest Development in Television Technique

BY the release of Model 703, the Marconiphone Company have brought into the de luxe market the complete home-entertainment provider. This consists of an all-wave radio receiver, plus an automatic record-changer, plus a complete cathode-ray tube television receiver. The overall size of the cabinet has been kept down to quite reasonable dimensions, in spite of the inclusion of so much apparatus, and the accompanying illustration shows how the various sections have been disposed. The automatic record-changer is on the left, with the radio receiver on the right, and the cathode-ray tube is vertically disposed in the centre, the picture on the tube end being viewed in a mirror set into the lid of the cabinet. This is provided with a patented stay or support, permitting the lid to be raised to 45° for viewing the television picture, or to 90° when using the gramophone section.

A concealed lamp is mounted in such a position that the television controls are floodlit, presumably so that the apparatus may be used in a darkened room without difficulty. The size of the picture is 10in. by 8in., and the mains consumption, when used on television, is 270 watts. The radio receiver covers four wavebands—16.7 to 53, 46 to 140, 185 to 560, and 750 to 2,200 metres. The radio section on the television wavelength is fixed-tuned. Among the many novelties

included in the complete equipment may be mentioned the elliptical loud-speaker, which provides a non-directional radiation of the sound waves and increased high-note response; a high-intermediate frequency providing freedom from image reception on all wavebands. A complete special dipole television aerial is installed free by the E.M.I. Service Company when the receiver is put into service. The price is 120 guineas.



A general view of the new Marconiphone Auto Television Receiver, showing the arrangement of controls, screen, etc.

Important Broadcasts of the Week

NATIONAL

Wednesday, April 28th.—"East Lynne," a play adapted by Tod Slaughter from the novel by Mrs. Henry Wood.

Thursday, April 29th.—Military Band programme.

Friday, April 30th.—B.B.C. Concert of Contemporary Music—7: British Music, to be given before an audience in the Concert Hall, Broadcasting House.

Saturday, May 1st.—A commentary on the F.A. Cup Final, from Wembley.

REGIONAL

Wednesday, April 28th.—Dance Band music, from Holland.

Thursday, April 29th.—"East Lynne," a play adapted by Tod Slaughter, from the novel by Mrs. Henry Wood.

Friday, April 30th.—Dance Band programme.

Saturday, May 1st.—Music in the Air: The Life and Work of Edward Elgar; orchestral and choral programme.

MIDLAND

Wednesday, April 28th.—Midland Football Clubs: West Bromwich Albion, a

sketch of the Club's history, policy, and players, past and present.

Thursday, April 29th.—String Orchestra! programme.

Friday, April 30th.—Music Hall Music: Orchestral programme, from the Hippodrome Theatre, Coventry.

Saturday, May 1st.—Music in the Air: The Life and Work of Edward Elgar, orchestral and choral programme.

WESTERN AND WELSH

Wednesday, April 28th.—Variety programme, from the Pavilion Bullroom, Bournemouth.

Thursday, April 29th.—Western Salon: a programme of Chamber Music performed in the Tudor Music Room at Marston Court, Marston Magna, in Somerset.

Friday, April 30th.—A Programme of songs and duets.

Saturday, May 1st.—Mendip Cave Crawl, feature programme.

NORTHERN

Thursday, April 29th.—A running commentary on the Yorkshire Darts Cham-

ionship Final, from the New Stadium, Leeds.

Friday, April 30th.—Northumberland Night: A programme of music, sketch and verse.

Saturday, May 1st.—Part of the Welsh Gymnasia, from the Surrey Street Methodist Chapel, Sheffield.

SCOTTISH

Wednesday, April 28th.—The Ceremony of conferring the Freedom of the City of Edinburgh upon the Duchess of Gloucester, from the Usher Hall, Edinburgh.

Thursday, April 29th.—Choral programme.

Friday, April 30th.—Sleep, a miscellany devised by Kathleen M. Macleod.

Saturday, May 1st.—Scots Songs.

NORTHERN IRELAND

Wednesday, April 28th.—Instrumental programme.

Thursday, April 29.—City Centre, feature programme.

Friday, April 30th.—A Mixed Bag of Short Plays: 1, The Wedding, by Thomas Carnduff; 2, The In-Laws, a personal story by M. J. McHugh; 3, The Cunning of Shamus O'Connell, by F. Marriott Watson.

Saturday, May 1st.—Orchestral programme.

Triode *versus* Pentode

An Impartial Comparison Bringing Forward the Advantages of the Triode. By PERCY RAY

A GREAT deal has been written on the advantages of pentodes over triodes. Unquestionably, pentodes have some advantages in the direction of sensitivity, but nowadays this is not a feature of paramount importance, as high gain is fairly easy of attainment in the other stages. The question, therefore, of the relative merits of triodes and pentodes resolves itself into a consideration of quality of reproduction.

It has been said so often that "the pentode valve is capable of giving quality equal to that of the triode, providing that, etc. . . ." but never does one see any suggestion of the quality of the pentode

the writer would suggest that output stages are almost invariably overloaded from time to time, and this in itself would account for the phenomena under discussion.

Causes of Distortion

It should be borne in mind that the distortion arising in the triode is caused by undue exaggeration of the second harmonic, and in the pentode the third harmonic, and there is no question whatsoever but that the ear will tolerate second harmonic distortion far more readily than third harmonic distortion, and if the output stage is to be overloaded, each valve will

of the triode output valve. Particular attention is drawn to the fact that these two valves were most carefully monitored, so that each was fully loaded to give the same output; consequently, the triode was producing second harmonic distortion to the extent of 5 per cent., and the pentode third harmonic distortion to the same extent. It is apparent, therefore, that the distortion in both valves is equal, and that the sweeping preference in favour of the triode valve is solely due to the fact, as outlined above, that the human ear is tolerant to 5 per cent. second harmonic distortion, but objects to the same extent of third harmonic distortion.

A Question of Quality

Before the quality from a pentode output stage could be raised to the level that it was indistinguishable from that of the triode, it was necessary to employ a very much larger valve used under working conditions that enabled it to develop the required output while accepting a grid swing of rather less than half the capacity,

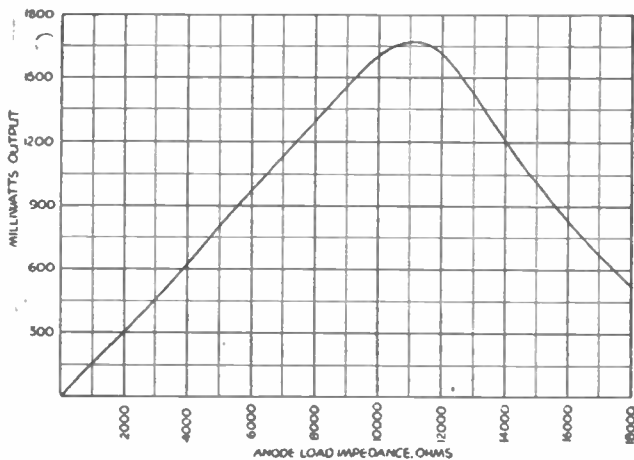

Fig. 1 (left).—Output curve of a pentode valve: showing that the anode impedance is very critical.

being better than the triode. So much has been said about the wonders of the pentode that the reader is asked to read the foregoing remarks with an open mind. Fig. 1 shows the inefficiency arising from incorrect matching between a pentode valve and its output circuit. The vertical direction shows efficiency (output), while the horizontal shows a range of anode impedance. It will be seen that the small discrepancy in matching brings about a very serious drop in efficiency.

Fig. 2 shows exactly the same curve plotted for a triode valve, from which it will be seen that, within reason, this type of valve is indifferent to its anode load over a wide range of impedance.

From the above remarks it is quite evident that where careless matching is employed the triode will give satisfactory quality, but the pentode, when fully loaded, will give bad quality in proportion to the discrepancy in its anode load.

Because the pentode requires far more intelligent handling than the triode, it would not be fair to condemn it, so after mentioning this rather interesting difference let us take the argument a little further. From now on, it may be assumed that each valve, where mentioned, is considered to have its correct anode load. After listening to a triode and pentode output stage with the care necessary for such an experiment, the writer maintains that the minimum of nine out of ten people will consider the quality from the triode to be superior, both on sustained notes, and in the handling of transients. Providing that neither valve is overloaded, there is no special reason why this should be, but

Fig. 2.—Output curve of a triode valve. Note how a too-high anode load has very little effect compared with the pentode, as shown by the curve in Fig. 1.

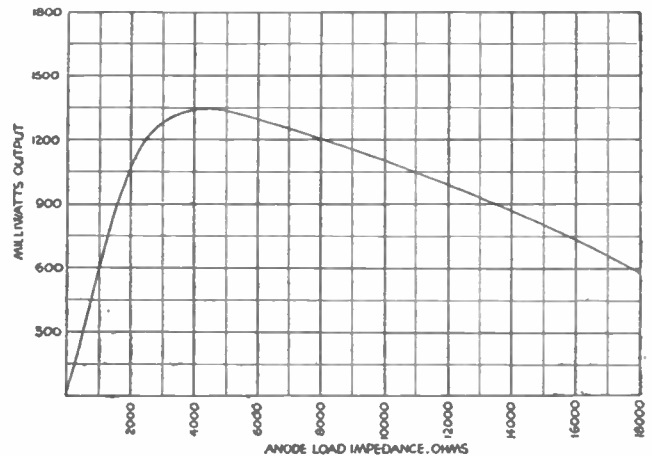

undoubtedly produce the type of distortion peculiar to it to a degree proportionate to the extent of the overload.

The writer has been carrying out experiments with a triode and pentode arranged for quick change over, and monitored at a cathode-ray oscillograph to see that neither valve was overloaded, and with an output meter to see that they were both giving the same output. With this arrangement, a small party in ignorance of the nature of the test voted each time in favour

but to the trained ear there was still an unpleasing response to transients, which, in the writer's opinion, is due to instantaneous bad matching due to a violent change in working valve impedance.

The pentode has undoubtedly served the listening public well, but with the slow increase of the superhet. and other forms of receivers with adequate gain, it seems safe to prophesy that the pentode will wane in popularity. After all, the pentode costs more money than the triode, in return for which the user is rewarded (in the writer's opinion) with inferior quality and unrequired sensitivity. The pentode will, however, probably remain popular in the output stage of short-wave superhets., where extra sensitivity really is required, and where it will be useful to accentuate deliberately the higher frequencies which have been cut either accidentally or in the interest of noise suppression.

While perhaps a little outside the true theme of this article, it may be useful to mention that directly-heated triode output valves are slightly preferable to those indirectly heated, as the anode current-anode volts curve of the former has a considerably greater straight portion than that of the latter.

**THE WIRELESS CONSTRUCTOR'S
ENCYCLOPÆDIA**

By **F. J. GAMM**
*(Editor of "Practical and Amateur
Wireless")* 4th Edition **5/-** net

Wireless Construction, Terms and Definitions
explained and illustrated in concise, clear
language.

From all Booksellers, or by post 5/6 from George
Newnes, Ltd., Tower House, Southampton Street,
Strand, London, W.C.2.

Practical Television

May 1st, 1937. Vol. 3. No. 48.

POINTS TO WATCH IN TELEVISION RECEPTION

IN the early days of radio many peculiar reception effects were experienced which tended at first to destroy some of the pleasure of listening, but this soon gave way to a fascination in fathoming the cause of these effects, and then trying cures. PRACTICAL AND AMATEUR WIRELESS was always to the fore in assisting its readers in this work, and now that television has a growing circle of lookers-in, the same service will be rendered for those taking advantage of the dual sight and sound transmissions. The propagation characteristics of the signal medium employed, that is ultra-short waves, are as yet a relatively unknown quantity. The original optical range of signal reception is being extended very materially, and sets are now installed at points which were thought to be right outside the signal area. Anyone who has looked in either regularly or occasionally cannot fail to be impressed with the results, and while in no way perfect they form a basis of investigation which gives ample food for thought and work for intelligent hands.

A Tuning Point

Carefree switching on and looking-in may be desirable in many cases, but it is as well to realise that on some occasions faults evidence themselves and make their appearance on the screen in a variety of ways. For a television receiver to operate satisfactorily it must pass the full picture frequency which extends from zero to over two million cycles. In consequence many of the sets working on the superheterodyne principle have intermediate frequency stages of the bandpass type, and the carrier wave should operate in the middle of the bandpass if the full frequency range is to be encompassed. It is possible, however, to adjust the tuning of the set over the narrow range usually allowed so that the receiver lies on one edge of the bandpass. The signal frequency is therefore attenuated by one side of the bandpass and the picture will bear evidence of this by showing a lack of definition due to the higher modulation frequencies being absent.

Interference Duration

This course is to be preferred in some cases where the received signal is quite low in magnitude and the gain of the set has to be increased to such an extent that the signal-to-mush ratio is reduced. The picture then exhibits a spotted or meshed appearance which destroys partially the pictorial effect and picture detail. On the other hand, if the degree of mistuning under the conditions mentioned is carried too far, then a peculiar form of distortion becomes apparent, which for want of a better name is often referred to as "plastic." The subjects portrayed in the reproduced picture seem to stand out in relief, while the loss of both the upper and lower frequencies of the modulation range destroy quite a proportion of picture detail, so that the condition should be avoided.

Quite a lot has been said concerning the effects of interference on a television picture

and the nature of the effect will, of course, depend on the source from which the trouble emanates. Motor-car ignition systems are still the worst offenders, and the degree of annoyance produced increases as the field strength of the vision signal decreases. Sometimes the small white splashes of light evidence themselves as wide bands stretching right across the picture and moving either up or down. On other occasions the spots are distributed quite sparsely over the screen. The length of each splash of light will enable the duration of the spark ignition to be calculated. Since the line frequency is just over ten thousand per second, each line takes a fraction under one ten thousandth of a second to trace. Assuming that in a picture 12ins. wide the length of the interfering light splash was $\frac{1}{2}$ in., then the spark time would be less than one four-hundred-thousandth of a second. Figures of this nature make one realise the enormous speed with which the spot on the screen traces out the light and shade of the received picture.

increase above ground level up to approximately 50ft. In other words, therefore, if a television set user by means of a mast raises his aerial by only 20ft., then the television signal increases by 6 decibels or is twice the strength of the previous value. Service installation engineers should not be looked upon as pedantic, therefore, if they seem to stress unduly to a would-be television set purchaser that the results will be improved materially if a tall mast is employed for accommodating the aerial.

Special Aerials

If it is awkward to position the mast on the house roof itself, or if the residence is on a main road, then it is essential to erect the pole at the end of the garden so as to be free from interference as possible, and to obtain a high input signal. The radiated television signal from the London station is vertically polarised so that the receiving aerial should be vertical also, although when quite close to the transmitter a horizontal aerial inside the house will suffice. In localities of poor reception strength, or where the electrical interference is severe, special aerials can be employed, and it is known that most of the television companies are carrying out experiments in this connection.

With an ordinary simple vertical ultra-short-wave dipole the length should be just slightly less than half the wavelength it is desired to receive. With the television service now operating sound and vision are radiated on two separate and distinct wavelengths. Since most sets use one aerial for



An animated scene from "Café Cosmopolitan," which gives full scope to present-day television technique.

Aerial Questions

In an effort to reduce the visible effects of interference many expedients have been tried. One suggestion was to incorporate a device which converted the white spots to black, so that although still present they would be less conspicuous to the eye. Repositioning the aerial will in many cases prove beneficial, especially if additional height is secured. The value of height cannot be over stressed too much and it is quite a good scheme to fix a mast to the chimney breast and place the aerial at the top. Field strength measurements have already been undertaken by the B.B.C. with the Alexandra Palace transmitter, and it is claimed that the signal increases in magnitude by 0.3 decibel for every foot

both signals a certain latitude is possible, but if it is desired to raise the vision signal to the maximum strength possible, then the dipole length should favour this wavelength (6.67 metres). If, on the other hand, the sound shows greater evidence of being upset, then the reverse will hold. The dipole aerial should give equal reception from all directions, provided it is not in close proximity to any form of metal shielding. To improve its reception in the direction of the desired television station, a second aerial of equal length, but having no electrical connection to the first, can be placed behind the main aerial. The distance separating the two can be a quarter of a wavelength, although half this distance may

(Continued overleaf)

PRACTICAL TELEVISION

(Continued from previous page)

be found satisfactory in some cases. It is advisable, therefore, to carry out a few experiments to determine the best arrangement for your own locality. The effect of this reflector is to induce signal energy in the main aerial which will add to that picked up from the Alexandra Palace transmitter. With interfering signals from the opposite direction, however, the reflector interference energy induced in the main aerial is in the opposite direction. It is seen, therefore, that the reflector assists the desired signal but cancels out or materially reduces the undesired signal, and set performance is naturally improved.

Sudden Light Changes

In dissecting or reassembling a picture into its component light values there are enormous differences in the rapidity with which the light changes have to be effected, quite apart from the enormous number of light variations which constitute a complete picture. This can produce some peculiar effects which, under certain circumstances,

are visible on the picture screen, and since there is a mechanical analogy many television engineers have called the effect "ringing." Taking the case of a black section, say, the black evening dress coat of a male artist standing before a white background, when the scanning spot passes from black to white an enormously high frequency is represented. If either the transmitter or receiver amplifiers are incapable of extending up to this frequency, then the reproduced picture edge of black to white, which should be sharp, is "fluffy" or ill defined.

On the other hand, the magnitude of the signal impulse may be so great that, due to over-correction of the high frequencies involved, the light intensity change on the receiver screen may be forced beyond its proper level. The white edging to the black coat then becomes much whiter than it should be for an infinitely small space of time before it acquires the correct shade. This over-shooting or ringing effect (so called because of the struck bell analogy) is annoying, for it looks as if there are two

pictures of the same thing not quite coalescing. The white edging will always be seen on the right of the scanned object, since the scanning spot movement is from the left edge of the picture to the right. A careful examination may reveal two or three light-intensity changes like rings over the width affected, showing that the circuits have "resonated" before the damping restored the correct light level.

Of course, the same thing happens with a white dress against a black background, but since the edging is now black it is difficult to observe on the black background. If the fault is not in the transmitter amplifiers an overhaul of the vision receiver circuit will effect a cure, and it must not be confused with the "ghosts" which arise as a result of reflections from the upper electrified layers discovered by Watson Watt. By measuring the width of the edging it is possible to calculate the particular frequency which is over-emphasised in exactly the same way as was shown earlier in the article for ear-ignition interference.

TELEVISION NOTES

Feeder Wires

THE feeder wires connecting a dipole aerial to a television receiver should not, generally speaking, be joined. Should it be necessary to move the receiver, necessitating a longer aerial lead, it is desirable to substitute a new lead altogether. Although a join can sometimes be carried out satisfactorily, the danger is that it will cause reflections, giving rise to a double image on the screen.

Reversal of the output of the receiving section of a television receiver will cause a negative picture to appear on the screen. A similar effect is obtained when the receiver is situated so close to Alexandra Palace that a signal of exceptional amplitude is fed to the receiver. This is caused by the modulating arrangements in the cathode-ray tube working beyond the straight portion of its characteristics, so that an increase on the modulating arrangements brings about a decrease in the electron beam, the electrons being scattered, and prevented from passing through the gun.

Dipole Aerials

AMATEURS experimenting with television may be tempted to fix up a dipole aerial made of wire to avoid the trouble of making the conventional dipole with comparatively thick metal rods. While such an arrangement may appear satisfactory, it should be regarded with some suspicion, as a dipole so constructed is very sharply tuned, and may tend to cut the wide side band range of the vision transmission, with consequent loss of picture definition.

Multi-stage Amplification

MANY readers have enquired why it is necessary for so many stages of amplification to be used in a television receiver for the vision side, when only a normal number of stages are necessary for the sound side, particularly when it is remembered that the cathode-ray tube requires less input than the loudspeaker.

The sound transmission is of a sensibly normal character and permits of inter-

mediate frequency amplification of normal stage gain. The vision transmission has an abnormal side band width of nearly 2 megacycles (2,000 kilocycles). It is therefore necessary to design the I.F. amplifier to pass this enormous band width, which forces the coils to be designed with very low dynamic resistance, resulting in a very small stage gain, making four or more stages necessary to obtain quite a moderate overall gain. The I.F. coils are, in fact, shunted with resistance over both primary and secondary of abnormally low value

EMPIRE RADIOTELEPHONE RATES.

The Postmaster-General announces that, on the occasion of the Coronation, the charges on the main Empire radiotelephone routes, which for the most part are at the rate of £1 10s. a minute, will be reduced to £1 a minute during the period from the 1st to the 31st of May inclusive. The £1 rate will apply to calls from any part of this country to Australia, Canada (First Zone), South Africa, India and Kenya.

Corresponding reductions will be made in the charges for extensions of these services, making the rate per minute for calls to New Zealand, £1 2s. 6d.; Southern Rhodesia, £1 3s.; Northern Rhodesia, £1 5s.; Ceylon, £1 2s.; and the Second, Third and Fourth Zones of Canada, £1 4s., £1 8s., and £1 12s. respectively. In the Canadian service, the reduced rates will be applicable only to calls over the direct London-Montreal route. All overseas calls are chargeable for a minimum period of 3 minutes.

of the order of 2,000 ohms. I.F. coils in ordinary broadcast receivers reach 200,000 ohms or more.

More Cable

MARKED speeding up in the laying of co-axial cable round London is noticeable for the large drums, clearly marked, are to be seen at many points on the planned route. The advantages of this cable are manifold, and a modified type is used in those large, flat installations where the transference of signals to the many receiving points has to be undertaken without any appreciable loss in strength, and a complete absence of amplitude or phase distortion. In the case of the very

long cable links, however, it must be borne in mind that before they can be put into daily service a long period of testing must be undertaken, for as yet the performance is a relatively unknown quantity in so far as television signals are concerned. This is due partly to the fact that repeater stations have to be added in order to compensate for the drop in signal, which must of necessity occur when sending any form of electrical signal over miles of cable.

Extra Programme Time

IT is stated in some quarters that viewers are to have an extra hour's transmission of television in the afternoon. The suggestion so far is that films only will be televised during this period, and that it will follow the usual 3 to 4 p.m. session. This is a step in the right direction, but it is most important to ensure that additional time is given in the evening when those in possession of receiving sets have a better opportunity of looking in. In any case, the B.B.C. of late has quite frequently overrun the allotted period by a further fifteen minutes. There is no necessity to work to exact time schedules as is the case with the network of the B.B.C. sound stations, and the efforts now being made to add to the variety and quality of the television programmes is most marked. Another point to consider is that technically the pictures are not yet up to the full standard possible with a 405-line definition.

For the Blind

IT has already been stressed how the deaf and dumb with a knowledge of the lip language can enjoy many of the present television programmes, whereas they cannot take advantage of the ordinary radio transmissions. Since television is a sight service, however, it is a little difficult to appreciate how it can be made suitable for appeal to the blind. This is the intention of one inventor, according to current reports, who is working on a scheme for the blind to "see" television pictures through their fingers. Due to the light intensity distributed over the resultant received picture an assembly of rods will be brought into action so that their ends raise from a level surface according to light values. Just as a blind person reads words through the Braille alphabet, so the resultant form of embossed picture produced by the rods will become intelligible to those without sight.



On Your Wavelength

BY THERMION

lads and songs of Grieg; 10.30 a.m., news bulletin; 11 a.m., women's hour.

everyone, at the same time one trouble is that the taste of the listening public does not stay put."

The italics are mine. If the taste of the listening public does not stay put, why do they continue with dance bands and crooners—mostly foreign crooners? No wonder there is so much unemployment among English variety turns.

The Search for Material

I SEE that Mr. Anthony Bertram has just left the B.B.C. for a tour of the country to visit listeners' homes where he will collect data for a series of talks. He will call on housewives and discuss their bathrooms, laundries, kitchens, the garden, and any other subject which, as a result of discussion, will tend towards the improvement of domestic conditions. I hope he pays particular attention to some of the baths, for many of those which I have seen in the blocks of modern luxury flats where people are herded together like sheep are deficient when it comes to human cleanliness. Everything there is for swank, and to give the impression that, although you are in service flats, they are really more expensive than a private dwelling. If you wish to bath you must squeeze yourself into some horrible little box.

Speakers' Voices

AT a recent conference at Birmingham Councillor Norman Tiptaft said: "The horrible examples



Germany's programmes.

we get sometimes of broadcast speakers with voices between a fog-horn and a crow wheezing out uninteresting platitudes like an old barrel-organ grinding out obsolete tunes are no good for talks on industry. Speakers' voices should be more carefully tested. The difference between an industry and a crooner is that the best industry is vitally alive, and the only good crooners are those that are irrevocably dead. This being a national institution, however, one must assume that somebody wants them, and agree on occasions to their filling the air with their

Brought to Task

A. P. R., of Bromley, brings me to task because he says he deplores the waste of my limited space in bandying words with K. B., of Hull. He says that a man in my position must always be open to receive scurrilous and impertinent letters, but as long as they are not libellous I ought to ignore them. He then makes the soft impeachment by saying that after all I am not a schoolmaster, but a much read columnist, and, as I have so often remarked, my success must be judged by the fire I draw.

Germany's Short-wave Stations

ONE of the morning papers recently devoted a large proportion of its leader page to an article on Germany's Short-wave Stations. Our new stations at Daventry will be ready shortly, but the B.B.C. has not at its disposal the sums of money which the German Government provides for the building and maintenance of its short-wave stations.

We must remember that after the B.B.C. has paid the crooners and the muck bands, they have very little money left for development, and they really do very well.

I note that an average programme from Zeesen is as follows: 6 a.m., German folk songs; 6.10 a.m., concert; 7 a.m., news bulletin; 7.55 a.m., greetings; 8 a.m., news bulletin; 8.15 a.m., what's happening in Germany; 8.30 a.m., concert; 9 a.m., Hitler Youth calling; 10 a.m., bal-



The bath in the modern flat.

horrible bleatings." Lady Bridgeman, Governor of the B.B.C., declaimed at the same meeting: "We have discovered it is not possible to please

Gradually Coming

ON my way to town the other morning I noticed a large hoarding outside a wireless store proclaiming the fact that they were the leading television specialists for that district. Wireless started that way, and I am sure that it will not be long before the whole country is served with television programmes. I understand that most of the Stores which have been enterprising enough to install television receivers have been disgusted at the programme material, for the customers almost without exception say that they would not spend £80 to see such poor programmes. The programmes are too airy and highbrow. Why not a little more nonchalance, sang-froid and bonhomie?

The B.B.C. is hard up for money, and I suggest that it could conveniently sack about one-third of its staff and make the others work up to normal standard. There are far too many people floating about doing

about one erg of work per day and being paid mighty highly for it. Why not make them work? That's what they would have to do in any ordinary commercial business. The system seems to be to give a man a job, to give another man the job to do the first man's job, to provide the second man with an assistant, and an assistant for the assistant to the assistant of the assistant to the assistant of the man who should really do the job. You know, the Colonel told the Adjutant, the Adjutant told the Company Sergeant Major, who told the Corporal, who told the Private! There is too much signing of forms and too much writing of interdepartmental memos. B.B.C. men waste a dickens of a lot of their day writing notes to someone else in the same building and reading them from other colleagues in the same building. They could do the job in half the time, but, of course, they must set it on record that they have asked a question about a certain subject. It impresses people so! My advice to the B.B.C., and I have been in business for just a few more years than they have, is that a business can be ruined by red tape, and eventually you find the whole staff doing nothing else but filling in forms and keeping card indexes up to date. When the B.B.C. becomes businesslike and scraps a large chunk of its unnecessary personnel we shall have better programmes.

Live Wires!

INCIDENTALLY, here is the way they do things in America. We often grumble at the lack of "news values" or topical items, and this extract is taken from an American radio News Service sheet issued by a well-known network.

"Bob Booth, red-headed Mobile Unit engineer of 500,000-watt WLW and WSAI, is ready to call a halt on evening fires.

"Tired and dirty after a day in his laboratory, where he is perfecting a new unit, Booth went home about 6 p.m., March 31st and got under the shower. At 6.45 p.m., the WLW-WSAI news room called him.

"'Big warehouse fire. Get the Mobile Unit there,' snapped H. Lee MacEwen, news editor.

"Booth jumped into his clothes without drying, sped to the scene and several times during the fire WSAI listeners heard graphic descriptions of the blaze. The fire burned for hours and it was 5 o'clock the next morning before Booth finally dragged home to complete his shower and have dinner."



Notes from the Test Bench

Eliminator H.T. Supply

RELIABLE eliminators are found to be quite suitable for supplying H.T. to most receivers. There are several points to be considered when choosing an eliminator, however. Most of the commercial types employ a metal rectifier, and their voltage output is governed to a great extent by the consumption of the valves used in the set. If the valve consumption is low the voltage output is high, and vice versa. The eliminator should, therefore, be chosen to suit the receiver in use. If the receiver consumption is 10 mA., an eliminator having an output of 120 volts at 10 to 12 mA should be used. This type would be unsuitable for a set consuming 20 mA, however, as overloading of the eliminator rectifier would result. On the other hand, an eliminator having an output of 120 volts at 25 mA should not be used to supply a receiver requiring only 120 volts at 7 mA unless the manufacturers state that the output is reasonably constant up to approximately 30 mA.

For the Vitesse

WHEN a receiver has more than one H.T.+ lead a further precaution has to be taken—the tappings on the eliminator must provide the correct voltage. The voltage obtained at the tapping will be governed to a great extent by the current passing through the lead connected to the tapping, and, therefore, voltage measurements must be made by means of a high resistance meter when the set is working. Eliminators used for supplying the Vitesse should have two tappings, preferably of the variable type, so that the critical voltages for the screens and oscillator anode can be carefully adjusted.

Checking Data Sheet Voltages

WE often receive letters from readers stating that the voltage readings on their PRACTICAL AND AMATEUR WIRELESS receivers correspond with those on our published data sheets at all points except the S.G. screen and detector anode. When further inquiries are made, it is generally found that a cheap meter has been used for the tests. A cheap low-resistance meter will give a reasonably accurate measurement of battery voltages and voltages at points in the receiver where maximum voltage is applied, such as to the anode of the output valve and H.F. pentode. At points where the voltage has been dropped by means of resistances a high-resistance meter must be used if sufficiently accurate readings are to be obtained.

Radio Societies—Correction

WITH reference to the list of clubs which I gave in the issue dated March 27th last I have now heard from Mr. Lawton, who was stated to be connected with the New Eltham Ratepayers Assn. Radio Section. He disclaims all connection with this society, and it appears that his name had somehow been confused. He is, of course, the secretary of the North Manchester Radio Society.

Useful Work

AS an example of the valuable work carried out by some Radio Clubs, listen to the following details, culled from a copy of the Coronation programme which the Southend Radio and Scientific Society recently produced:—

"Our chief obligation is the huge installation at the Southend General Hospital—presented by the Society at a cost of more than £600. Mr. H. Jagged and Mr. A. R. Knipe are immediately responsible for the efficiency of the equipment in the wards—175 pairs of headphones, 20 loudspeakers, and miles of wiring, not to mention plugs, volume controls and other auxiliary apparatus, all of which needs constant attention. The small band of helpers (including Miss Pauline Durrant, a lady member) give a large percentage of their spare time to this labour of love. Mr. Buckwell looks after the Crowstone Home for the Blind, and Mr. J. G. Ward does inestimable work, supervising the satisfactory working of no less than 60 receivers in the homes of necessitous blind persons. Then there is the Stamford Hill Cripples Home, which is similarly cared for. All of this work is carried on under the able direction of the Society's Honorary Charities Secretary, Mr. Fred Waller, of 49, Fermoy Road, Thorpe Bay, who would be very glad to hear from anyone who would care to help this work forward in any way. Disused receivers, which can be renovated and given to the blind people, would be especially welcome. "We do everything—periodical visits, replacements, and repairs—and our services are given entirely free. All this costs not only the valuable time of our members but also much money. Every visitor to the Exhibition can help, if only by purchasing a shilling ticket in our Prize Scheme. WILL YOU?"

50 Tested Wireless Circuits

By F. J. CAMM

(Editor of "Practical and Amateur Wireless")

Obtainable at all Bookstalls, or by post, 2/6
2/10 from George Neumes, Ltd., Tower
House, Southampton Street, Strand, London, W.C.2

A PAGE OF PRACTICAL HINTS

SUBMIT YOUR IDEA

READERS WRINKLES

THE HALF-GUINEA PAGE

A Microphone Stand

A STRONG microphone stand can be made with metal conduit tubing, as shown in the sketch. First cut pieces 1, 2 and 3 to suit the diameter of the microphone, and to allow for the elbow pieces. Screw the parts together with a T-piece in the centre of the bottom member to take the upright piece of tubing which can be cut to a suitable length either for a table or floor stand model. A circular wooden block with a raised centre part is drilled a good fit for the centre upright through which the leads are passed. The design of the microphone will decide the method of suspension, but a good way is to attach short pieces of steel wire, covered with sleeving, across the corners of the framing, as clearly shown in the sketch. The sleeving protects the rubber suspension bands.—J. R. TWEEDY (Morpeeth).

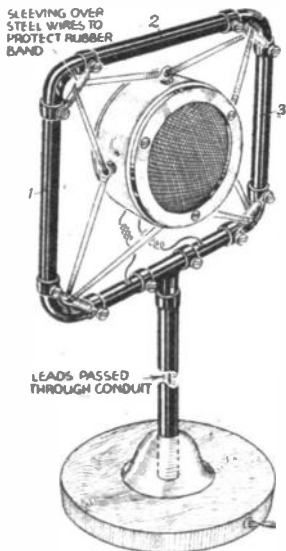

How a novel microphone stand may be built up.

A Home-made Oscillograph

WITH the aid of a moving-iron loudspeaker unit a simple but effective oscillograph, which may be used to analyse the output of a receiver, test for mains hum, etc., may be easily constructed. The

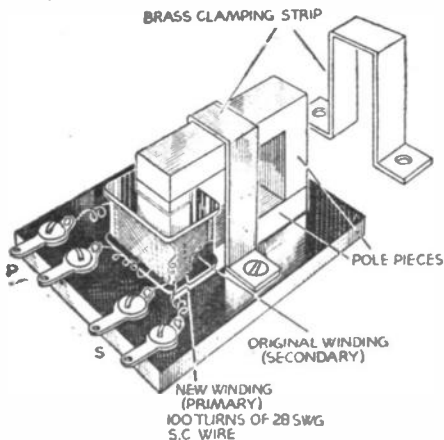

Mr. Lacey's suggestion for constructing a midget transformer.

THAT DODGE OF YOURS!

Every Reader of "PRACTICAL AND AMATEUR WIRELESS" must have originated some little dodge which would interest other readers. Why not pass it on to us? We pay £1-10-0 for the best wrinkle submitted, and for every other item published on this page we will pay half-a-guinea. Turn that idea of yours to account by sending it in to us addressed to the Editor, "PRACTICAL AND AMATEUR WIRELESS," George Newnes, Ltd., Tower House, Southampton Street, Strand, W.C.2. Put your name and address on every item. Please note that every notion sent in must be original. Mark envelopes "Radio Wrinkles." Do NOT enclose Queries with your wrinkles.

speaker unit is fixed in the centre of one end of the baseboard, with the armature stem arranged vertically. To this stem a small mirror is fixed. A flashlight bulb in a small lamphouse at one side of the baseboard is made to throw a beam of light on to this mirror, from which it is reflected and made to pass through a reading glass or other lens, which focuses the beam on to revolving mirrors. These mirrors consist of four pieces of mirror, each about 2in. square, arranged on the sides of a square box, as shown in the sketch, and mounted on the shaft of a clockwork or electric motor.

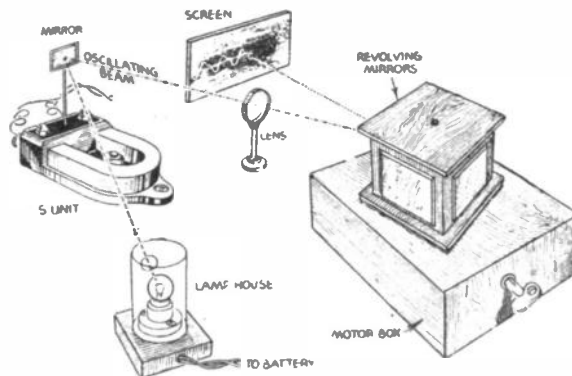

A novel home-made oscillograph.

The mirrors must revolve absolutely truly with no wobbling or jumping, and the motor must run at constant speed for a reasonable length of time. From the mirrors the beam is reflected on to a ground-glass screen, or it may be focused through a slit and thrown on to a screen. The speaker unit is connected to the output terminals of the set to be tested, when the output wave form will be shown on the screen. This simple oscillograph may be used for numerous other purposes.—F. W. GOODWIN (Tottenham).

the cost is next to nil. I first soldered a length of tapped rod to the largest of the thimbles, and after the other had been soldered to the base the whole was encased in an ebonite tube. An insulated terminal head provides the necessary control for capacity adjustment.—A. T. BASSETT (Edgware).

A Midget Transformer

A SERVICEABLE midget transformer, for use with the button type of microphone, can easily be made with a few

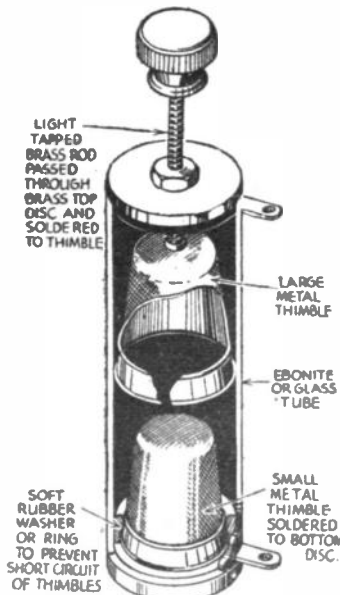

For very fine tuning a micro-variable condenser may be made as shown here.

Join Newnes' Practical Group!

PRACTICAL MOTORIST

The owner-driver's journal which tells you how to repair, overhaul, and obtain the best performance from your car. 3d.—every Friday.

PRACTICAL MECHANICS

The only English journal of its type. It deals with every branch of Science, Mechanics, Invention, Model-Making, Chemistry, Astronomy, Photography, Television. 6d.—Every Month.

THE CYCLIST

The leading weekly for every Cyclist, Clubman, Utility Cyclist, or Tourist. Join "The Cyclist" Road Club and enjoy FREE Insurance. 2d.—Every Wednesday.

QUALITY SETS

High Fidelity Reproduction Station Reception are this Article

preferred to using a larger single output valve to provide the same output.

Pentodes, Class B or Q.P.P. amplification will provide the same audio output more simply, but these systems all contain a large percentage of harmonic distortion, and cannot be considered when quality of reproduction is the primary object.

To secure high and uniform amplification by the intervalve coupling, a good transformer is necessary. Much has been written about the defects of transformer coupling as opposed to the resistance capacity method, but if the transformer possesses the properties of high primary inductance, low leakage and low self-capacity, then it is to be preferred, as resistance capacity coupling gives but little amplification for the stage and great care must be exercised in the values of the components, choice of valves, etc. Even so, the latter method gives true amplification of even the very low notes, but the high anode resistance necessary for this means that a high H.T. supply is necessary. Otherwise, the voltage applied to the valve will be such that it is working on the curve of its characteristic, and hence it will introduce distortion. Further, it would be easily overloaded. It is, however, the ideal coupling where a large stage gain is not necessary, such as between the first and second stages of an amplifier, where the first valve is a leaky-grid detector.

The push-pull output stage referred to above using PX.4 valves or their equivalent, requires a total grid swing of about 75 volts peak, and this is a further recommendation for transformer coupling, as one valve with resistance capacity coupling could not deliver this output without overloading. A further valve would be required

to provide another push-pull stage prior to the output valves. One intermediate audio-frequency stage is used, and the valve chosen has a fairly low amplification with high mutual conductance. It is able to deliver the required grid swing for the output stage with a maximum detector output of 10 volts.

Unfortunately, perfect reproduction is only available to a listener who lives near to a local transmitter, and who listens to that station only, for an H.F. stage prior to the detector means added selectivity, and a narrower band width to avoid interference. This introduces distortion due to high note cut-off and the inherent characteristics of H.F. valves.

the maximum undistorted output of the receiver is six watts.

Power Pack

The power pack consists of a mains transformer and a Westinghouse metal rectifier style H.T.11 giving an unsmoothed H.T. supply of 525 volts at 110 mA, allowing ample reserve to be dropped in the speaker field which should have a resistance of 2,500 ohms. The reservoir condensers should be rated at 1,000 volts D.C. working, to avoid breakdown under high H.T. surges when the set is first switched on.

The output stage is fed direct from the field winding, but the other valves are fed through a further L.F. choke, with appropriate decoupling condensers and resistances in order to give absolute stability with hum-free reproduction. The L.F. choke not only acts as a filter for the first stages, but also prevents any audio-frequency currents

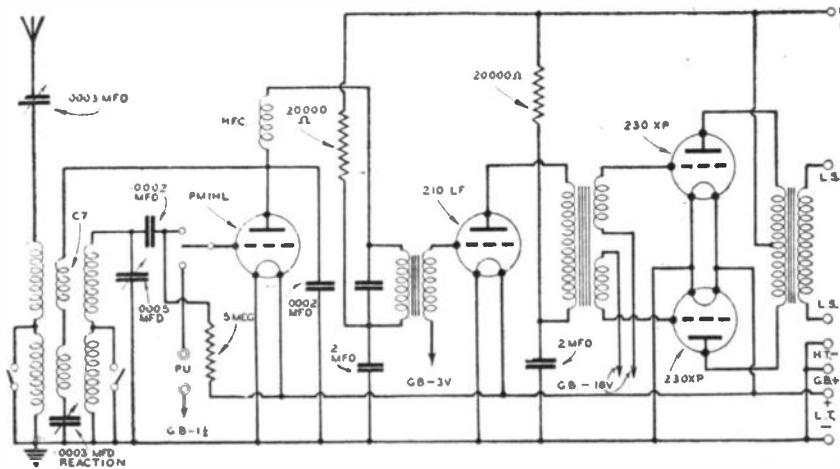

Fig. 3.—For the battery user this circuit will provide an output 1 watt, and may be operated from a battery eliminator if desired.

The Detector Stage

Having dispensed with the H.F. stage, our choice of the detector stage is limited to two—anode-bend or grid leak rectification. Readers are referred to our article "The Importance of the Detector Stage" which appeared in the February 27th issue, from which it will be seen that the obvious choice is leaky-grid rectification, since it has an output free from distortion from the low input available, requires a low anode voltage, and thus lends itself to R.C. coupling between it and the intermediate audio-frequency valve, and its selectivity is quite sufficient for our purpose. If we use highly selective tuned circuits prior to the detector valve we shall defeat our own object by providing a band width at, at the most, 10 kc/s, and thus introduce high note cut-off. An H.F. transformer will be sufficient to give the required selectivity, and at the same time allow the set to reproduce all the received signal as it appears on the aerial.

The foregoing gives us the outline of our receiver, and it now only remains to ensure that the correct values of condensers, resistances, etc., are used to provide adequate decoupling, and give stability and absence of hum. The completed circuit diagram is given in Fig. 1 and

in the output power supply from getting back into the previous stages, and thus causing instability and motor boating.

Note the separate filament supplies and biasing arrangements for the output valves. The output and intervalve transformers have already been discussed, and it is sufficient to add that the remaining components should be as carefully chosen.

The volume control is in the form of a variable grid leak for V.2, with special condenser arrangements to give constant tone, i.e., the treble and bass always bear a constant relation to one another, whatever the setting of the control. This arrangement gets over the difficulty usually met with in a volume control in this position, viz., that of poor high note response at low volume.

Condenser and Resistance Values

The value of the coupling condenser C must be chosen with great care. If too small, there is a loss of bass, if too large distortion is introduced. The values of C and the volume control VC, and the anode resistance R all bear a constant relation to one another, and the values given are such that the amplification at 50 cycles is 90 per cent. of the maximum. The rule is—the anode resistance should be two or three times the valve impedance, the grid leak four or five times the anode resistances, and the value of C in mfd. multiplied by the value of the grid leak in megohms should equal 0.1.

(To be continued)

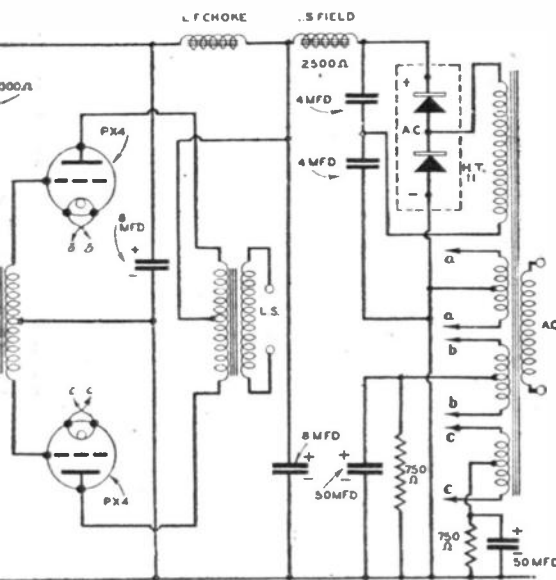

give an output of 6 watts undistorted.

Europe's Oldest S.W. Station

A Brief Résumé of Ten Years of Inter-Continental Broadcasting,
with Particular Reference to the New Short-wave Station PCJ

THE tenth anniversary of the first short-wave broadcast from Europe to the East is a notable wireless occasion that has recently been celebrated, and the romantic story lying behind it is one that cannot fail to be of interest to readers of PRACTICAL AND AMATEUR WIRELESS.

In the early days of wireless transmission the long and medium wavelengths were the only ones utilised to any great extent, but these proved by no means reliable and regular over distances of more than a thousand miles, and it became obvious that the key to the bridging of greater distances lay in the short wavelengths.

First Short-wave Programme

The laboratories of the Philips works at Eindhoven, in Holland, thereupon took the initiative, and, after the most careful and comprehensive investigations, it was decided to construct an efficient short-wave transmitter. The result was seen on March 11th, 1927, when for the first time the voice of the new Dutch short-wave transmitter encircled the earth on a wavelength of 30.2 metres. From a small studio, the walls of which were hung with loose lengths of cloth to prevent reverberation, the first short-wave programme was sent forth on its long journey from Europe. Incidentally, it is interesting to note that it consisted mainly of gramophone records which were changed before each call signal.

Success was immediate, and the next day a brief cable reading, "Marvellous short-wave reception," was received from Bandoeng, in the East Indies, and this was only the forerunner of many others recording excellent reception in Australia, New Zealand, South Africa, British India, South America, Canada, and even Japan. In fact, listeners in the United States reported that they could hear PCJJ—the call-sign of the new station—as clearly and powerfully as their own local stations!

The B.B.C.'s Request

Nothing could better illustrate the success of this pioneer broadcast than the fact that on May 20th of the same year the B.B.C. requested the PCJJ transmitter to radiate the Daventry programme to the whole world. This transmission was also perfectly successful, so much so, that wireless stations in South Africa, Australia, New Zealand, and in many other parts of the world, picked up the short-wave programme and relayed it to their local listeners, using their

own wavelengths. Then, on June 1st of this historic year, PCJJ received its greatest honour when Queen Wilhelmina and Princess Juliana spoke for the first time direct to Holland's Eastern colonies.

The next problem was that of converting the experimental station into a permanent one. A plan was evolved which resulted in the formation of a limited company, "N. V. Philips Omroep Holland-India," briefly known as PHOHI, which was registered on June

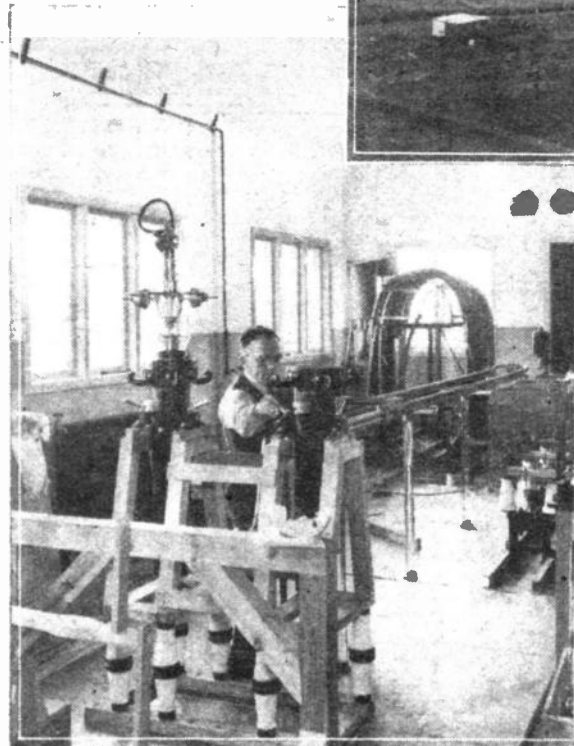

The upper illustration shows the aerial tower of the new PCJ station, and the lower is a view of the large water-cooled valves and tuning circuits.

18th, 1927. Regular transmissions henceforward took place on a wavelength of 16.88 m., with an output of 20 kilowatts, from a new short-wave transmitter built with the aid of the technical experience gained from PCJJ.

S.W. Station "PHOHI"

In 1930, however, owing to certain difficulties in organisation, the successful activities of PHOHI were interrupted. The Dutch Government attempted to distribute the transmission hours of the new station to the political and religious broadcasting bodies, which resulted in the new station closing down. So well-known and liked was PHOHI, however, that protests were lodged from all parts of the world, and, as a result of these, transmissions were resumed after an interval of two years on December 24th, 1932.



It was then found that an extended period of sunspots had radically altered the conditions of reception. To meet these the transmitter was adapted for a second wavelength to be employed during the winter months. The experimental transmissions with the new wavelength of 25.57 m. gave such satisfactory results that in April, 1934, the PHOHI broadcasts were recommenced officially.

The old PCJJ transmitter, which was now given the call-sign PCJ, remained in service without interruption and acted as a relay station for the new PHOHI. Here, also, the transmitter was adapted for a second wavelength so that the two stations had four different wavelengths at their disposal, and, according to the season of the year, could use either the 16.88 m., 19.71 m., 25.57 m., or 31.28 m. wavelengths—an arrangement that remains to the present

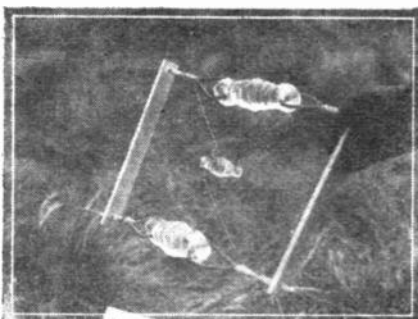

Part of the new dipole aerial ready for installation.

day.

Still Growing

Now modern radio conditions demand still further expansion, and a new PCJ is rising—on the shores of the Zuider Zee. Here, on the grounds of the PHOHI station at Huizen, the short-wave transmitter is being set up again and reinforced. The buildings are completed and, behind them, a steel auxiliary aerial tower is already being erected for the first experimental PCJ programmes.

Soon the wonderfully-shaped dipole aerial will be suspended in the high tower, there to carry the powerful voice of PCJ over countries and seas. When all is ready, PHOHI, supplemented by the reconstructed PCJ, will rank among the most powerful world radio transmitters.

THE BRITISH LONG-DISTANCE LISTENERS' CLUB

A MEMBER in Gibraltar sends an interesting report of some stations he has received and asks one or two questions concerning reception which other members may be able to answer. On March 21st he was listening at 16.45 G.M.T. when he heard on the 20-metre band station SV1KE calling "all stations on 10 metres." Signal strength was R7, quality poor, and the caller stated that he was standing by on 10 metres. After waiting a short time nothing more was heard of this transmitter. He says that there was also a German station causing some interference with G6AG, who was working SM5SV on 14,100 kc/s, and G6AG also heard it and remarked on the subject to SM5SV, stating that it might have been due to second-channel interference from one of the Zeesen transmitters. The German station, which was broadcasting a musical programme, closed down at 17.00 G.M.T. but no call was heard. What solutions can other members offer to this little problem, which may, of course, have been due to the particular local conditions?

This member also wishes to know



Mr. Croft in his 'den,' with a fine collection of QSL cards.

whether any other listener has heard a French-speaking station on about 8,950 kc/s broadcasting the programme of the medium-wave station at Algiers—heard at 20.45 G.M.T. on March 15th and 21.05 to 21.30 G.M.T. on March 21st. He states that announcements are also heard in Arabic.

Japanese Programmes

From Mr. H. G. P. Williams, of Hove, we have received the following details concerning the Japanese Broadcasting Corporation's programmes, which may interest listeners:—

Stations JYM and JZJ, on 10,740 and 11,800 kc/s respectively, transmit daily from 19.30-20.30 G.M.T., announcing in Japanese and English. Programmes consist of news in English, and Japanese orchestral and social records, and originate

in the J. B. Corporation's studios at Atogayama Field, Tokio. Starting to-day (March 25th), another transmission will be made, destined to America. Times of transmission, 21.00-22.00 G.M.T. Stations used, JVN, 10,650 kc/s, and JZJ, 11,800 kc/s. Also, on and from April 1st, an extension will be made to the languages used. On Mondays, Wednesdays and Fridays announcements will be made in English and German, while on Tuesdays, Thursdays and Saturdays English and French will be used. On Sundays English only will be used.

Good Work

Member Croft, of Totterdown, Bristol, has sent a photo of his listening den, which we reproduce on this page. As will be seen, he has received a large number of veris, and since joining the club last September he has had 132 cards from 32 countries.

Correspondents Wanted

Members who are anxious to get into touch with other listeners in different parts of the country may care to write to Mr. T. L. Stevens, of Post Office, Donnington Wood, Wellington, Shropshire. He is anxious to correspond with anyone in any part of the world and would like to start a Short-wave Club in his district. Mr. E. D. Fleming, of 6, Lindsay Place, Kelvindale, Glasgow, W.2, would also like to get into touch with other members of the B.L.D.L.C. in his district with a view to forming a branch.

PETO-SCOTT EVERYTHING RADIO—CASH C.O.D. or EASY TERMS

DO YOU KNOW?

Do you know that you can obtain all your radio requirements from us either for CASH, C.O.D. or under our famous Easyway System? No matter whether you require complete kits, or Loudspeakers, eliminators, pick-ups, or a selection of special components for a set you intend to build, we will be pleased to quote you our EASY TERMS without obligation. We are the oldest Radio by Mail House in the country and have been established since 1919, so you can order with confidence.

Peto-Scott NOISE SUPPRESSING ALL-WAVE AERIAL



- Eliminates Man-made Static.
- Increases Signal Strength on all Bands.
- Improves Selectivity.
- Waterproof and Weatherproof.
- Two Transformers.

Obtain utmost entertainment by using this Aerial Outfit, the first really economical solution for overcoming the noise of man-made static. AERIAL OUTFIT COMPRISES Duplex enamelled aerials, insulators, waterproof "lead-in" wire. Aerial and Set Transformers, assembled and ready with instructions and drawing illustrating the method of erection. CASH OR C.O.D. 17/6 CARRIAGE PAID Or 8 monthly payments of 2 6.

26 DOWN

CHARGE your L.T. for 1/2d. A WEEK!

Peto-Scott TRICKLE CHARGER
 ● 12 months' guarantee ● Nothing to wear out or go wrong ● Modern metal rectifier ● Air-cooled mains transformer ● Charges your 2v. accumulator at 1 amp. ● 7 days' approval against cash

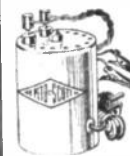

End outlay for accumulator re-charging. Never be "left without your radio" because your L.T.'s run down. The new Peto-Scott 1-amp. Trickle Charger charges your 2-volt accumulator at 1 amp. while you sleep. Wonderful! Fully efficient. Simple to use. A.C. Mains, 250-240 volts, 40/100 cycles. Cash or C.O.D. 12/6. Overall dimensions: 3 1/2" high, 2 1/2" diam. **CASH 12/6 PRICE**

NEW 6-valve 8-stage ALL-WAVE A.C. MAINS CHASSIS

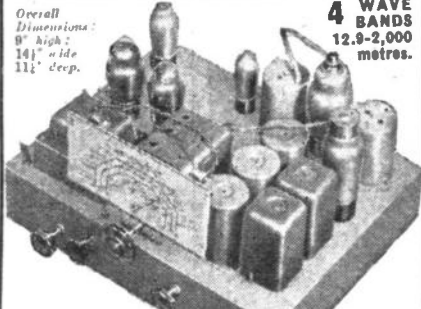

Overall Dimensions: 14 1/2" high, 14 1/2" wide, 11 1/2" deep. **4 WAVE BANDS 12.9-2,000 metres.**

Cash or C.O.D. **£8:17:6** with 6 British Valves. **12 MONTHS GUARANTEE.**

- 4 Wavebands: 12.9-35, 35-81, 200-550, 900-2,000 metres
- Inter-station noise suppressor
- Bandpass input
- A.V.C.
- Independent Volume and Tone Controls
- Station and wavelength calibrated dial.

BRIEF SPECIFICATION. The last word in 6-valve all-wave circuits. High quality output ensures excellent reproduction. Highest grade British components. Circuit: Bandpass Input to Hexode-Triode. Frequency Changer valve as Detector Oscillator. Bandpass Intermediate Frequency Transformer coupled to Variable-Mu H.F. Pentode as I.F. amplifier. Double-Diode as second detector coupled to triode I.F. Amplifier, resistance-coupled to a power triode output valve giving 3 1/2 watts output. Full vision dial and slow motion drive are fitted. Supplied complete with 6 British valves. For A.C. Mains only, 200-250 volts, 40/60 cycles. Cash or C.O.D. Carr. Paid £8 17 6, or £1 down and 11 monthly payments of 16s.

£1 DOWN

H.T. for 1d. a Week Peto-Scott H.T. ELIMINATORS



Costs only a penny a week to run! Model A.C.12 Eliminator.—Suitable for sets operating on an output of up to 12 m.A. A.C. 200/250-v., 40/100 cycles. Output 120-v. at 12 m.A. 4 Tappings, 60-v., 75-v., 90-v., and 120-v. Cash or C.O.D. Carriage Paid 30s., or 2 6 down and 10 monthly payments of 3s. MODEL MA 10 30 Eliminator and TRICKLE CHARGER. 22/10 6, or 5 down and 11 monthly payments of 6s. **2/6 DOWN**

Peto-Scott ALL-WAVE S.G.3 BATTERY CHASSIS

with S.G., Det. and Pen. Valves.

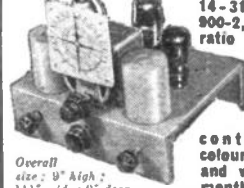

- 4 WAVE-BANDS: 14-31, 28-62, 200-550, 900-2,100 metres.
- Double ratio slow-motion drive, 8-1 and 100-1 reduction.
- New rotary type low-capacity switch, with silver-plated contacts
- Air-plane colour-coded dial (stations and wave-lengths)
- 12 months' guarantee.

BRIEF SPECIFICATION: For reception of a high order all day and every day, from all parts of the world. 3 British valves: Variable-Mu H.F. Pentode, High Efficiency Detector and Harries' High Efficiency distortionless output pentode. Variable selectivity by alternative air-coupled Broadband coils. Dual electrostatically screened short-wave, coll. H.T. consumption approx. 12 m.A. Each chassis supplied complete with Screened Grid, Detector and Pentode output valves. Fully tested on all wavebands before despatch. Cash or C.O.D. Carr. Pd. £3 19 6, or 5 down and 11 monthly payments of 7 6.

5/- DOWN

BRIEF RADIO BIOGRAPHIES—8

By RUTH MASCHWITZ

Claude Gardner

CLAUDE GARDNER has many experiences to tell of his career as a comedian, which sound amusing in retrospect but must have been extremely painful at the time.

His first job was in variety at a music-hall in the East End. He shared a dressing room with eight others and a number of snakes which were kept in a basket, but always managed to escape. On his last night, the confusion was so great that poor Claude lost his shirt. As he was making his way out the manager called him into the bar and suggested another booking. Claude was delighted and offered him a drink.

"Hi!" cried the manager to a group of men standing by. "This gentleman would like you to drink with him." To Claude's embarrassment, everyone immediately ordered a brandy and cigar! When he had paid the bill he had a penny left! This necessitated a walk from the East End to West Kensington, shirtless and clutching a huge paper parcel containing his costume and properties.

In those days acting was often a literally dangerous profession, for numbers of the audience used to go armed with a variety of missiles ranging from rotten eggs to 7lb. weights and knuckle-bones, which

they threw at anyone on the stage of whose performance they did not approve.

On another occasion, Claude's life was endangered by fire. During a fit-up tour he was on the stage doing his turn when he happened to look up into the flies and saw that the whole outfit was in flames. With great presence of mind, he went on with his patter and at the same time managed to attract the stage-manager's attention. The fire was put out by a stream of water which drenched the actors to the skin.

The longest journey Claude ever had to make to be in the theatre in time was when he accepted an invitation to fish in Scotland one Sunday. Inadvertently, he got into the wrong train, and when he arrived at his destination was told that there were no Sunday trains to Glasgow. To reach his matinee in time he had to cross to Larne in Ireland, go on to Belfast, then Dublin, catch a boat for Holyhead, go by train to Chester, and so to Glasgow. A good fishing story.

Stanelli

STANELLI is best known over the air for his "Bachelor Parties" and the Hornchestra. He is also an able violinist and has studied music since the age of five.

His first public appearance at the age of 16 was a failure, for he got the bird! Thrilled to the core at having an engagement at the Chelsea Palace, he practised a long classical piece which was quite unsuitable for his audience. Half-way through his performance the crowd became restive, and before he had finished

they began to clap rhythmically. A wealthy patroness of Stanelli's was sitting in the stage box, and he was horrified that she, too, had joined the clapping. The curtain was rung down, and almost in tears Stanelli rushed to his dressing-room. Five minutes later there was a knock on the door and his patroness sailed in, wreathed in smiles.

"Splendid, my dear!" she said. "I was delighted. The audience was so pleased with your performance that it began to clap before you had finished, so, of course, I joined in!"

The Hornchestra, an instrument of Stanelli's own invention, has broadcast many times. It is composed of motor-horns of every size and shape, with varying pitch and tone, on which Stanelli plays tunes. The idea of such an instrument occurred to him one day when he ran out of petrol driving in the Haymarket, and held up the traffic for five minutes. The resultant blast of horns made by the block of cars behind him gave him inspiration!

It took three months to complete a comprehensive collection of "notes." One particular horn, heard in the West End, he tracked down to Leighton Buzzard. Its owner was filled with suspicion when he was offered a brand new Klaxon in exchange for his own hooter, which had cost 4jd.!

During the War, when his battalion was ordered to France, Stanelli was asked to take his violin with him. He protested, but an offer was made for transport, and from Dover to the front line the 14 men in his draft each took it in turn to carry the fiddle.

CLIX

QUALITY COUNTS

Quality receivers call for the best of components throughout. Without perfect full surface contact you will introduce annoying clicks and crackles. The certain preventative of these unwanted noises is to be found in all CLIX components.

In the CLIX Fuse and Wall Plugs the patent pins are guaranteed to give perfect, permanent contact and these pins are non-collapsible. The Fuse Plug will also safeguard your receiver at its source of supply.

CLIX FUSE PLUG
Fitted with two fuses of either 1, 2 or 5 amp rating. Complete **1/8**

CLIX WALL PLUG
Type M. Self-centring Self-adjusting Complete **6d.**

These and CLIX Valveholders are recommended by "Practical and Amateur Wireless" for their "Quality" Circuits.

British Mechanical Productions, Limited, incorporating the business formerly carried on by

LECTRO LINX LIMITED

79 ROCHESTER ROW, LONDON S.W.1

THE ELECTRICAL ENGINEER POCKET BOOK

Some of the Contents:—

ACCUMULATORS	RECTIFIERS
A.C. THEORY	TABLES (MATHEMATICAL)
BATTERY CHARGING	TRANSFORMERS, A.C.
FUNDAMENTALS	TRANSMISSION
LIGHTING	SPACE HEATING
MAGNETISM	WATER HEATING
MOTORS	WIRING TABLES
	POWER-FACTOR CORRECTION

An essential everyday reference book—handy, practical and up to date.

Illustrations:— This handy pocket volume contains a profusion of diagrams and sketches together with graphs. Also included for convenience is a small section of blank pages for notes, calibrated pages for graphs, so that the pocket book can contain information of a particular or personal nature as well as being a reference book of general facts.

The Book Itself:— The Pocket Book is strongly bound in durable art. leather—deep red, richly grained and embossed in gold. The book measures approximately 6½ x 4 inches, and has rounded corners, so that it is in the truest sense of the word a pocket book. The paper has been specially chosen to give the minimum bulk consistent with good printing, again making for convenience in handling.

★ The Electrical Engineer Pocket Book can be obtained from all good newsagents and booksellers at 3/6 net or in cases of difficulty direct from the publishers, George Newnes, Ltd., Book Dept., Tower House, Southampton Street, Strand, London, W.C.2. at 3/8 post free.



SHORT WAVE SECTION

UNUSUAL S.-W. COIL DESIGN

Details of Some Short-wave Coils which May Be Constructed for Experimental Purposes - - - - - By W. J. DELANEY

OWING to the fact that coils for short-wave work only require a few turns, and that such complications as wave-change switching and ganging or matching are not required, the construction of these components provides the keen amateur with a very fruitful source of practical experiment. We have already given details for winding coils on the standard 4 and 6-pin formers which are now readily obtainable for the purpose (See PRACTICAL AND AMATEUR WIRELESS dated May 9th, 1936). But there are

Plug-in Reaction

Accordingly, a plug-in reaction or "tickler" coil is a valuable feature, especially in an experimental rig-up where circuit modifications may be made from time to time for test purposes. Alternatively, the primary winding on the coil former may be employed for reaction purposes, and the plug-in winding may be employed for coupling purposes. Experiment will show which winding will provide the most useful source of experiment in this respect. A simple way of making such a device is to wind the grid coil (with or without a primary winding) on a small ebonite former provided with pins on the base in the usual way. Inside this former a small disc or block of ebonite should be inserted and this should be provided with two sockets of the Clix parallel type. A small former is then obtained upon which a reaction winding may be placed and the lower end of this former is provided with

two Clix plugs, so that the former may be inserted inside the normal coil. A small loop of leather attached to the former will enable it to be withdrawn when desired and will facilitate changes. As an alternative idea the standard four-pin short-wave coil former (1 1/4 in. in diameter) may be used for the reaction winding, and two of the pins may be removed. The grid coil may then be placed upon a length of the standard 6-ribbed ebonite former of sufficient inside diameter to accommodate the smaller former, and a base and plugs may be fitted in the usual manner.

Dipole Coupling Coil

Another type of coil which may easily be made is that intended for use with a dipole or other aerial where a twin feeder is used. It will often be found that the coupling between the feeder and grid coil may best be carried out by winding a single turn round the grid coil, but the actual position of this coupling coil will be found to affect results. One scheme which is very useful is to wind it with an electrostatic screen between the two coils. To do this, the grid coil is wound in the usual way, and over this two or three lengths of ebonite are placed to act as spacers. The distance apart, or thickness of the spacers will again offer scope for experiment. Round these spacers a piece of aluminium or copper foil is placed, and this should be of such a size that the ends do not quite meet. A gap of about 1/16 in. to 1/8 in. should be left. A layer of thick brown paper, insulation tape or other material of a like nature should then be wrapped round this screen, and one or two turns of thick wire placed round this, the ends being joined to the ends of the twin feeder. A wire is soldered to the metal foil and is connected to earth.

The feeder (or the end of the small coupling coil) must not be joined to earth, but where it is desired to use an ordinary aerial system, with the coupling coil functioning as an aperiodic aerial coil, one end may be earthed. Such an arrangement would, of course, only be employed for experimental purposes in view of the weakness of the coupling which is provided. Such a coil may be used in arranging a Collin's Coupler for a transmitter, with suitable fixed condensers in series with the ends of the coil to avoid the high voltage on the tank coil from reaching the aerial, and several variations are possible.

STANDARD 4-PIN S.W. COIL FORMER.

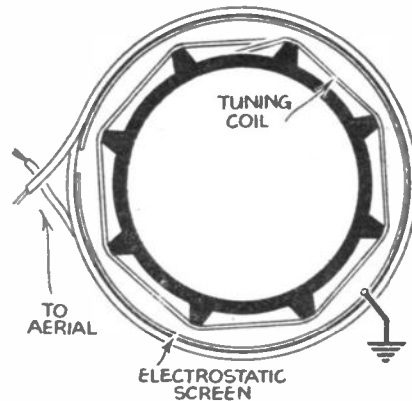
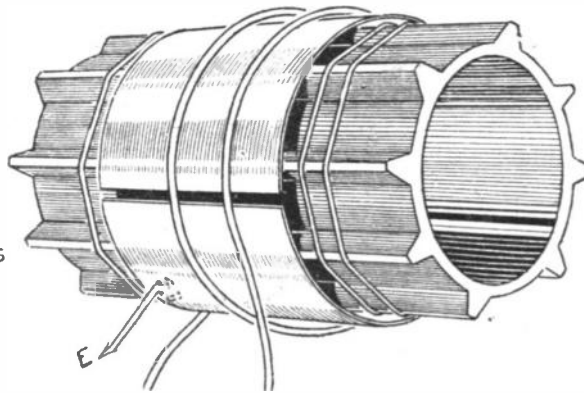
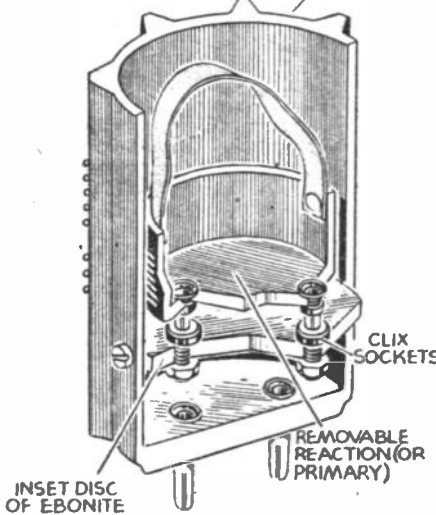

Fig. 1.—Suggestion for making one section of a S.W. coil on a removable former for experimental purposes.

Fig. 2.—A form of aerial coupling which has some very useful applications. In the upper illustration the screen has not been covered in order to make the arrangement quite clear.

many circuits used in short-wave reception where coils of a different type may be employed, or are essential, and these will now be described. The commonest difficulty met with by the beginner is the reaction circuit design, and when making a simple coil the reaction winding is often placed at one end of the grid coil or is interwound with it. This means that some experimental work has to be carried out whilst the coil is being made in order to find the most satisfactory size of reaction winding. When the detector valve is changed, or other circuit alterations are made, this particular winding may not be found so satisfactory. The reaction condenser only provides a certain adjustment, and the actual number of turns and their relation to the grid winding are of considerable importance.

Directional Aerials

Directional Aerials

RESULTS on the short waves, both from the point of view of transmission and reception, are considerably improved when a directional type of aerial is employed. As it is necessary to change the direction in order to give the widest range of reception, this means that the aerial array must be capable of movement, and in this respect various difficulties arise. The simplest scheme is to build a dipole (with a thin copper rod rather than wire) and to arrange for the dipole to give maximum response on the band in general use. A reflector should be arranged, half a wavelength behind this dipole, and the two may conveniently be mounted on a wooden framework erected on the roof. Means must be provided inside the house for rotating the aerial array, and preferably the movement should not be continuous, but stops should be inserted so that it can only be turned through 360 degrees. This will avoid difficulties due to the feeder wires becoming entangled, and will greatly facilitate the erection of the structure.

A framework may be made from deal scantlings, say 1 in or 1½ in. square section, screwed at the corners and well creosoted. An inner framework to suit the overall length of the dipole should then be constructed and a length of timber placed in

the centre with inserts of metal to form pivots. They must be well greased to avoid sticking due to the effects of rain, and at the lower end a large diameter pulley (obtainable from shops which sell the well-known constructional toy) may be fitted. This will enable the frame to be rotated from any distance, but if desired, the central pivot could be taken down straight through the roof.

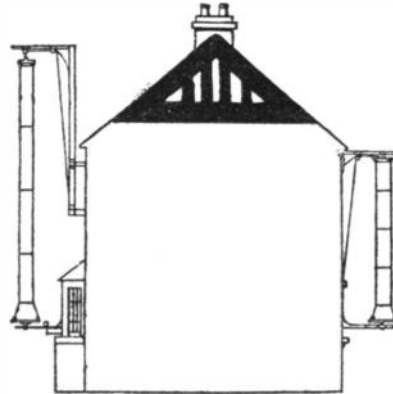

Diagram showing two methods of using the directional variable aerial system.

Multi-reflectors

Experiments may be made with more than one reflector, and the distance may also be varied in relation to the aerial proper. If more than three reflectors are employed they should be arranged in the form of a parabola, and naturally a more rigid structure will have to be constructed to accommodate the added weight. It will be found, especially on the television wavelengths at long distances from the London station, that a multi-reflector of this type will prove very valuable in giving increased signal strength with diminution of interference.

The Variable Directional Aerial

A variable aerial equipment may be obtained from the manufacturers at 62, Costa Street, Middlesbrough, Yorks. This consists of all of the essential parts with brackets, wire, etc. It is complete with a blueprint and assembly, and will be found to offer a very useful method of overcoming interference and giving improved results. A leaflet is supplied showing methods of using it, and the accompanying illustration shows two suggestions. A special tuner unit is obtainable for use with a receiver employing ordinary 4-pin or similar plug-in coils, and the design is such that it will operate efficiently right down to 10 metres, although arrangements are being made, and tests are being carried out, to lower the minimum still further. The price varies from 19s. 6d., according to the particular kit supplied.

Budapest's New Schedule

ON April 3rd last a new schedule of broadcasts was brought into operation for Hungary's two short-wave transmitters. HAS3 working on 19.52 m. (15.37 mc/s) is now on the air every Sunday from B.S.T. 15.00-16.00, and HAT4, on 32.88 m. (9.125 mc/s) every Monday, Thursday and Saturday from B.S.T. 01.00-02.00. Reports should be addressed to Radiolabor, Gyali-Ut, 22, Budapest (Hungary).

Short-wave Station in Curaçao

The first short-wave station to be installed in the Netherlands West Indies has been opened at Wilhelmstad, the capital of Curaçao. It operates on 31.67 m. (9.475 mc/s) daily; the call-letters are PCJ-1.

Madagascar on Three Wavelengths

With a view to ascertaining the most favourable frequency for its broadcasts, the French colonial station FIQA at Antananarivo (Madagascar) simultaneously transmits on every weekday between B.S.T. 19.30-20.30 on 25.40 m. (11.810 mc/s); 31.5 m. (9.523 mc/s) and 49.96 m. (6.005 mc/s). All announcements are made in the French language, the call being: *Ici station Française de radiodiffusion coloniale et équatoriale—Ici Tananarive*. Reports which are greatly desired by the organisers should be addressed to Direction des P.T.T., Hotel des Postes, Place Colbert, Tananarive, Madagascar.

An Enterprising Ultra-short-waver

W6XKG, Los Angeles (California), the experimental station of the Don Lee Broadcasting System, according to its announcements, is now on the ether

Leaves from a Short-wave Log

twenty-four hours daily. The frequency is 25.95 mc/s (11.56 m.). Many of its broadcasts have been clearly picked up on the other side of the North American continent even during the brightest hours of the day. Reception reports should be addressed to Station W6XKG, 1076 West Seventh Street, Los Angeles, Cal., U.S.A. British correspondents say that the transmissions from W9XAZ, Milwaukee (Wis.), on 26.4 mc/s (11.36 m.) are regularly heard in the United Kingdom. The difference in the frequency used is not a big one and therefore a search for the Los Angeles transmitter is warranted, and should meet with success.

NEWNES' TELEVISION AND SHORT - WAVE HANDBOOK

2nd Edition

By F. J. GAMM.

Price 3/6 or 3/10 by post from the Publishing Dept., George Newnes, Ltd. Tower House, Southampton St., Strand, London, W.C.2.

Japan Goes Ahead

The Japanese Broadcasting Corporation has received so many letters of appreciation from European listeners in respect to the special programmes transmitted through JVM, 27.93 m. (10.74 mc/s), and JZJ, 25.42 m. (11.8 mc/s), that it has decided to give all announcements in foreign languages to make the broadcasts perfectly clear to a larger number of foreigners. English is now heard in all transmissions; German is added on Mondays, Wednesdays and Fridays; and French on Tuesdays and Saturdays. Following the broadcasts for U.S.A. and Europe, which close down nightly at B.S.T. 21.30, the stations reopen with an exclusively Japanese programme at B.S.T. 22.00.

Another Mystery Solved

During the past month or so listeners have been puzzled by the reception of a French broadcast on 33.48 m. (8.96 mc/s) and 24.75 m. (12.12 mc/s). These transmissions do not, as was hitherto believed, emanate from Paris Radio-Colonial, but from FVA, Algiers (Eucalyptus), of which the main duty is a public radio-telephony service with France. The station has been carrying out tests with the rebroadcast of the Radio Algiers medium-wave programme occasionally on 33.48 m., and at other times on the lower wavelength between B.S.T. 19.30-22.00.

Have You Logged Chile?

Listeners report having heard broadcasts from CEB, Santiago (Chile), on 24.32 m. (12.381 mc/s) between B.S.T. 22.30 and midnight. The interval signal would appear to be a bugle call, and the announcement in Spanish includes the words: *Transmisione del Radio Santiago de Chile*.

LETTERS FROM READERS

The Editor does not necessarily agree with the opinions expressed by his correspondents. All letters must be accompanied by the name and address of the sender (not necessarily for publication).

An Amateur's Results

SIR,—I have never yet read in your columns of anyone claiming a large number of stations logged over a period of years, so I hope the following details will interest other readers.

During the last eight years I have logged 10,024 different stations in 130 countries. This total consists of:—

- 8,898 amateurs in 112 countries.
- 833 ships and commercial stations.
- 293 broadcasters.

I have 600 QSL cards from Hams in 78 countries, and have heard hundreds of Hams on 28 mc. in 40 countries.

Of course, the largest country is U.S.A., which totals about 4,700.

I hold the H.B.E. (Heard British Empire) Certificate, and first, second and third Certificates for R.S.G.B. reception contests in 1933-4-5.

My receiver is 0-v-2, battery valves, home-made coils, covering 8 metres to 2,000 metres.

Perhaps some PRACTICAL AND AMATEUR WIRELESS reader can better this, so what about it?

I have been a PRACTICAL AND AMATEUR WIRELESS reader since No. 1, and think it is as good now as No. 1 (or even better).—
CECIL A. BRADBURY (Burton-on-Trent).

Quality Receivers

SIR,—I am writing to you in the hope that I shall receive the same consideration as reputed "multi-year" readers. I have been a follower of PRACTICAL AND AMATEUR WIRELESS for a little over six months now, during which time I have obtained an appreciable amount of information from its pages.

To get down to brass tacks, I had a quality set built for me by a "local expert" some twelve to eighteen months ago. In justice to the builder, or designer (if he designed it himself), the set does give reasonably good quality. The main components are also of the best, comprising two H.F. pentodes, double-diode-triode detector, and a Ferranti transformer coupled Mazda PP5/400 output valve, Colvern and Polar four-gang coils and condensers.

I almost forgot to mention; the set is for A.C. mains.

However, I am of the opinion that it does not compare with a properly designed set with correctly matched components. The only two quality sets shown in your blueprint list are the A.C. Hall-Mark and Universal ditto, both of which are—as you must admit—too old to compare with the present-day standard of fidelity reproduction. Therefore, I am asking that a hundred per cent. quality set—or receiver with amplifier separate—be designed. I feel sure this must be the cry of hosts of other PRACTICAL AND AMATEUR WIRELESS readers. After all, your readers are not confined to batteries and short waves, the material for which has occupied PRACTICAL

AND AMATEUR WIRELESS pages for the last six months.—A. N. DOWNES (Brooklands, Cheshire).

[We do not admit that the receivers referred to are too old to compare with present-day standards. The circuits employed in these receivers are quite straightforward and, when properly operated, will give as good quality as can be desired under modern conditions. However, probably one of the circuits included in the article on Quality in this issue will be of use to you.—Ed.]

Practical Home Recording

SIR,—With reference to the article on this subject in your issue dated March 20th, 1937, I wish to point out that the "Simplat" blank consists of a glass base, with a surface coating of a gelatinous composition, and is neither "bakelite" nor "wax."

It is true, as Mr. Delaney suggests, that a worn steel play-back needle can be used for cutting, but this practice is not advisable, as it will result in badly-shaped grooves and undue surface-noise. A sapphire stylus for cutting should always be employed.

In the penultimate paragraph (page 16)

CUT THIS OUT EACH WEEK.

Do you know

—THAT screened leads should be employed with care as the screening adds to the stray capacities in tuned circuits.

—THAT in obstinate cases of mains hum it often pays to ignore the centre-tap in the heater transformer winding and provide an artificial centre-tap by means of a hum-dinger or similar component.

—THAT when using a battery variable-mu valve the grid bias battery must be disconnected from the potentiometer when the receiver is not in use, or it will discharge itself through that component.

—THAT the above arrangement may easily be carried out by using a three-point on/off switch.

—THAT in obstinate cases of interference from static, a buried aerial (or the use of the earth as an aerial) will often avoid the trouble.

—THAT an indirectly-heated mains valve cannot be used successfully as an anode-bend rectifier with automatic bias unless special precautions and circuit arrangements are adopted.

The Editor will be pleased to consider articles of a practical nature suitable for publication in PRACTICAL AND AMATEUR WIRELESS. Such articles should be written on one side of the paper only, and should contain the name and address of the sender. Whilst the Editor does not hold himself responsible for manuscripts, every effort will be made to return them if a stamped and addressed envelope is enclosed. All correspondence intended for the Editor should be addressed to: The Editor, PRACTICAL AND AMATEUR WIRELESS, George Newman, Ltd., Tower House, Southampton Street, Strand, W.C.2
Owing to the rapid progress in the design of wireless apparatus and to our efforts to keep our readers in touch with the latest developments, we give no warranty that apparatus described in our columns is not the subject of letters patent.

of the article "B.G.N." needles are mentioned; these should, of course, be "B.C.N.," i.e., Burmese Colour Needles.—D. ALDOUS, Technical Consultant, Messrs. V. G. Manufacturing Co., Ltd. (Park Royal).

Selenium

SIR,—Re the statement regarding selenium, in "Do you know," of April 10th, I should like to quote the following extract from an advanced "Text-Book of Inorganic Chemistry," by Partington:—

"Metallic Selenium which has been heated for some time at 210°C. has the remarkable property of possessing an electrical resistance which varies on exposure to light. . . ."

Also "Metallic selenium is formed when ordinary selenium is heated to 200-220°C. . . . It is insoluble in carbon disulphide, but is soluble in chloroform."—J. GLICKMAN (Eastbourne).

A Problem Solved?

SIR,—In "Queries and Answers" in your issue of April 10th, G. R., from Penge, asks about a station beginning I or CL. You say you cannot find a prefix CL. Might I suggest that CL is short for a station like I(No.)CL. Amateurs in England and France call one another like this; e.g., "G6KZ" might be called "6KZ" or "KZ." So this station could be something like I4CL or I5CL.—R. TRIEFUS (N.W.3.)

Scottish Broadcasting Stations

SIR,—Some time ago you published my report on short-wave reception in the Highlands. Now, I would like to submit my report on medium and long-wave reception here, and also, to raise some questions about the service provided.

Droitwich, on 1,500 metres, for a 150 kW station is very poor indeed, and is always subject to a bad heterodyne whistle. On this station fading is bad, and this, together with local electrical interference, makes the programme value at almost all times worthless.

Scottish National, 50 kW, on 285.7 metres, is subject to bad fading, and is most unreliable, as are the low power (20 kW) Nationals on 261.1 metres. Thus, as can be seen, a reliable National programme is not provided in the Highlands.

The new station at Burghead gives superb service. Thus the Regional programme is excellent.

The question I should like to raise is this: Why should a new 5-kW station be built at Nigg, Aberdeenshire, to radiate the Regional programme, when the National service is so deficient? Surely Burghead, 60 kW, can supply Aberdeen, only 65 miles distant, with a Regional programme.

My second question is: Why cannot a National transmitter be built at Burghead and synchronised with the Scottish National on 285.7 metres to supply the North of Scotland with an efficient National programme?—A. H. MILLER (Strathpeffer, Ross-shire).

[We invite the B.B.C. to reply to these criticisms.—Ed.]

Correspondent Wanted

SIR,—I have become greatly interested in "Short Wave" work. I have built the "Prefect 3" and am surprised by its performance and would be pleased to receive correspondence from any reader who has constructed this excellent receiver.—A. A. D. CASTELL (11, Calderon Road, Leytonstone, E.11).

QUALITY

Components for "QUALITY CIRCUITS"



These illustrations show only two components from our range. There are hundreds more. We supply all Gov't. Depts., the Radio Research Board and the B.B.C. They are only satisfied with the best!

List No. C.7.
H.F. Transformer 5/3
Reaction dual range.

List No. L.F. 14.
Carries 50 mA at 12/3
20H. Generous Core.



BULGIN

116 PAGE CATALOGUE

To A. F. Bulgin & Co., Ltd., Abbey Road, Barking, Essex.

Please forward me a copy of your complete catalogue No. 136 for which I enclose 3d. in stamps.

Name

Address

SEND FOR YOUR COPY NOW!!

ELECTRADIX BARGAINS

TELEPHONES for Office, House, Works, Garage and Field at Bargain Prices. Wall or table, Singles, pairs, or in sets with 10, 20, 30, 100 or 250-way switchboards. Single Wall Set 15/-, Coronation Fete Portable Signal phones in leather case, useful for P.A. jobs. Headphones from 2/9.

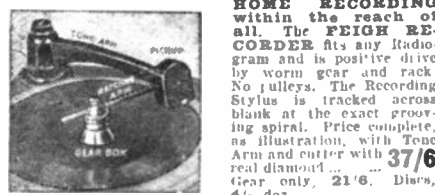

HOME RECORDING within the reach of all. The **FEIGH RECORDER** fits any gram and is positive drive by worm gear and rack. No julleys. The Recording Stylus is tracked across blank at the exact pre-arranged spiral. Price complete, as illustration, with Tone Arm and cutter with 37/6. Gear only, 21/6. Discs, 4/- doz.

EIGHT AUTO TRANSFORMERS, 150 watts. First Bench model for any input or output 0v. to 300v., 19 taps. Two panels with 11-stud switch, 45/- each.

NEW HUMPHREY TYPE MAGNETIC CHUCK, 18" x 6", for 220/250v. D.C., cost £30. Westinghouse Rectifier for use on A.C. mains; cheap.

NEW Large Triple-pole Iron-clad Vincent Switch and Fuses, 500v., 100 amps., 52/6. One D.P. Iron-clad Switch, 500v., 200 amps. Vincent, 35/-, and a ditto, 60 amps., 15/6.

CORONATION LAMPS, 25v., 80v., 115v., and 220v., 5/- dozen. 1,000 Porcelain Ceiling Roses with Ramie Junction Connectors, 5/- dozen.

CORONATION Fountain Electric Pumps, for A.C. or D.C. mains. Centrifugal, all-bronze pump, 3ft. lift, 120 gals. per hour. For 6ft. fountain, etc. With 50 yds. twin rubber cable and iron-clad D.P. switch, 67/7. Larger pumps quoted for.

NEW RECORD CIRCUIT BREAKERS, 600v. 800 amps. 8.P. with overload trip, 80/- (G.E.C. Trip, pole A.C. Breaker, 415v. 50 amps. with 3 overloads and a no-volt trip, 70/-; 10 amps. enclosed Circuit Breakers with magnetic blow-out, 9/6 each. Contactors and Min. Autos cheap. Engine Indicators, Dobbie McInnes & Elliott, in case, with 4 springs, 55/-; Big Pulvis Workshop Vacuum Cleaner or Dust Extractor on trolley with 1/2 h.p. motor, £8 10/0.

3 MOV. COIL SWITCHBOARD AMMETERS, 6 1/2" dial, 250 amps. and 350 amps., by J. & P., etc., 22/6 each to clear.

Electric Air Compressors, various sizes from 1/2 cub. ft. to 4 cub. ft. per min. Blowers and Air Exhausters. Kindly state wants and ask for our Surplus Stock List.

Send for Radio-Electrical-Scientific Illus. List "N" Free.
ELECTRADIX RADIOS
218, UPPER THAMES ST., LONDON, E.C.4.
Telephone: Central 4611

Facts and Figures

COMPONENTS TESTED IN OUR NEW LABORATORY

Hivac Midget Valves

In a recent issue we gave base connections and other data relative to various valve types and mentioned that the Hivac midget valves were available in three types only. It has been pointed out that this may lead to the supposition that there are only three midget valves, whereas there are actually five such valves. One of these is an S.G., one an output pentode and the other three are triodes, thus dividing the valves into three types or classes, as mentioned in the article in question. For the benefit of those readers who are anxious to utilise these valves in portable receivers we give below the main characteristics.

- Type XSG: Anode volts 120 max. Screen volts 60 max. Amplification factor 375. Impedance 500,000 ohms.
- Type XD: Anode volts 100 max. Amplification factor 16. Impedance 23,000 ohms.
- Type XL: Anode volts 100 max. Amplification factor 12. Impedance 14,000 ohms.
- Type XP: Anode volts 100. Amplification factor 5. Impedance 5,000 ohms.
- Type XY: Anode volts 100 max. Screen volts 100 max. Optimum load 25,000 ohms.

With the exception of the output pentode (type XY), the filament rating is 2 volts at .066 amps, but the pentode takes .14 amps. The prices are as follows: Type XD and XL, 10s. 6d.; Type XP, 12s. 6d.; Types XSG and XY, 15s. 6d.

Belling-Lee Flat Pin Plugs

FOR use at extension speaker points, the new Belling-Lee flat-pin plugs and sockets will be found of great utility, as apart from their electrical characteristics they offer a most neat and unobtrusive fitting, harmonising with any style of room decoration. The accompanying illustrations show the two types, the larger pattern being of the flush-mounting type

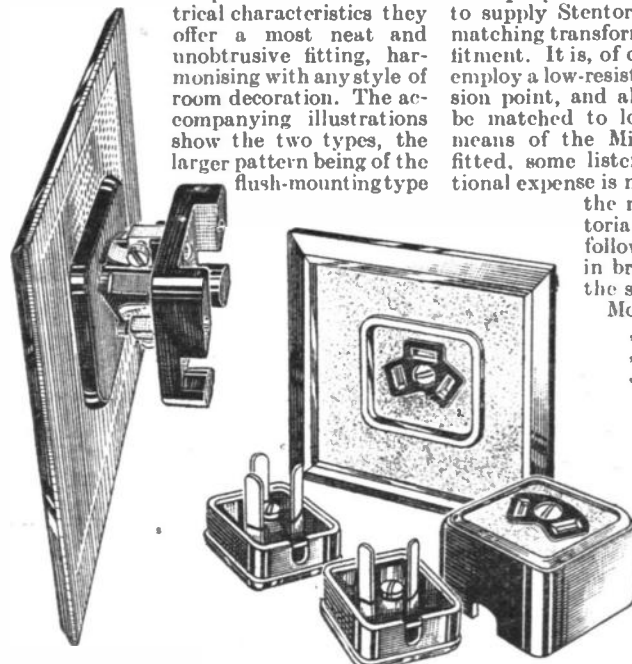

similar to an ordinary electric-light switch, and is finished in brown bakelite. The rear projection, with contact points, may be let into the ordinary box such as is used for flush-mounting light switches, and the speaker leads may be let into the wall material. The smaller model is intended for use where the wall cannot be recessed, and the overall projection is less than two inches. Both models may be obtained with either two or three pins and the prices are 2s. 4d. and 2s. 8d., respectively. If desired in cream finish, an extra charge of 10d. is made. The contact is positive and self-cleaning and the utilisation of flat pins and sockets prevents apparatus from being inadvertently inserted into ordinary lighting or mains sockets. These components are ideal for extension speakers, microphones and other similar apparatus.

Ridco "Ranger"

THE popular short-wave unit which was recently reviewed by us is now available in a pattern suitable for use on universal (A.C. or D.C.) mains. This has been carried out by fitting a valve rectifier and the usual smoothing equipment. The unit is enclosed in an attractive black cellulosed metal cabinet, measuring only 6in. by 5in. by 6in. As mentioned in our previous review, the chassis has been dispensed with in this unit by mounting components direct to the valveholder, which is suspended by means of rods from the top panel. The intermediate-frequency adopted in this unit is 545.4 kc/s, thus permitting it to be used with American and other single-waveband receivers. The price of this model is 52s. 6d., including two valves.

W.B. Speaker

THE Whiteley Electrical Radio Company announce that they are now able to supply Stentorians without the special matching transformer which is the standard fitment. It is, of course, often necessary to employ a low-resistance speaker at an extension point, and although Stentorians may be matched to low-resistance circuits by means of the Microlode device which is fitted, some listeners feel that the additional expense is not justified. Accordingly the makers will supply Stentorians in four ranges at the following prices. The figure in brackets gives the price of the standard cabinet model.

- Model 37 SX —52/6 (63/-)
- „ 37 JX —42/- (49/6)
- „ 37 CX —35/- (39/6)
- „ 37 BX —24/6 (29/6)

Rear view of the flush-mounting wall plate, and, on the right, views of the remaining Belling-Lee plugs and sockets.

RADIO CLUBS AND SOCIETIES

Club Reports should not exceed 200 words in length and should be received First Post each Monday morning for publication in the following week's issue.

Oxford Short-wave Radio Club

THE Oxford Short-wave Club is arranging a number of field experiments on 5 metres during the summer months commencing on Sunday, June 6th. Co-operation from other amateurs will be welcomed and any experimenter desirous of taking part should communicate with the hon. sec., Mr. E. G. Arthurs (2BHP), at 13, Walton Well Rd., when details will be forwarded from time to time as available.

Newbury and District S.W. Club

WE have recently held a competition open to all members for the neatest and most efficient short-wave set.

A radio representative from Messrs. Edwards and Goddings, Ltd., Newbury, judged the sets, and had to spend quite a time before he could decide on the best, as they were all very much alike as far as results were concerned.

One of the prizes was given by an anonymous person signing himself as "A Ham," and the other was given by Messrs. Edwards and Goddings, Ltd.

Hon. Sec.: L. Harden, 11, Highfield Avenue, Newbury, Berks.

Kidderminster and District Radio Club

READERS in Kidderminster and district will be interested to know that a newly-formed Radio Club has started under the heading of "Kidderminster and District Radio Club." Will all those interested in Kidderminster and District please get in touch by either writing or calling as soon as possible to Hon. Sec.: Harold A. Brown, Kidderminster and District Radio Club, 12, Stourport Rd., Kidderminster.

Swindon and District Short-wave Society (2CLY)

A MEETING was held on April 15th. Much interest in logging stations was shown by the junior members. Members are endeavouring to speed up their Morse ready for a full licence. A QSL competition is in progress, and will continue for a month. A.A. transmitting members are busy, too. Mr. E. W. Mortimer (2BMM) is now crystal controlled on 160 metres. W. G. Ford (SBVR) is doing splendid work with PAs. W. C. Barnes (2BWR) and P. Bailey (2CGN) are developing speech amplifiers. D. T. Boffin (BRS1469) has applied for A.A. licence, also Mr. Rose.

Hon. Sec.: W. C. Barnes (2BWR), 7, Surrey Rd., Swindon.

Portsmouth and District Wireless and Television Society

AT a meeting of the above society at 1A, Hudson Road, an interesting demonstration was given by Mr. Batt of a high-quality amplifier.

Mr. Batt gave blackboard circuits of the amplifier and a special tone control he had constructed.

A new W.B. 37S chassis loudspeaker, kindly lent by Messrs. Whiteley Electrical Radio Co., was put on test and members were delighted with the excellent reproduction. Several members gave in their names to borrow and test this speaker on their own sets. Thanks were given to Mr. Batt and Mr. F. Jordan for assisting, also

to Mr. Bull for gifts of a table and magazines for the library.

Harold Leigh, Chairman, 20, King St., Southsea.

The Croydon Radio Society

THE Croydon Radio Society's session concluded on Tuesday, April 13th, in St. Peter's Hall, Ledbury Road, S. Croydon. Mr. W. J. Bird presided. The occasion was quite informal, as the hon. secretary, Mr. H. G. Salter, presented one of his popular musical programmes on records. Being Coronation year, no better choice as the first item could have been selected than Eric Coates's "London Suite," including "Westminster" and "Covent Garden." In these days of jazz and tunes of doubtful melodic power, a record of Drury Lane Memories was much appreciated, young members as well as old thoroughly enjoying the tunes. Nor was

more serious music neglected, and the Vienna Philharmonic Orchestra's performance of Beethoven's Eighth Symphony was a great success. Similarly was Elisabeth Schumann's singing of "Standchen." Comedy is never forgotten in these programmes, and the mere fact that Tommy Handley and Jean Allistone appeared showed that the standard here was good. Incidentally, Mr. Salter took one bold step—he refused to play one single jazz item, but its absence was not regretted. As far as the Croydon Radio Society is concerned, crooners can become extinct. The new session begins on the first Tuesday in October, and in the meantime the society will be very interested to hear from PRACTICAL AND AMATEUR WIRELESS readers with a view to acquainting them of forthcoming good things.

Hon. Pub. Sec.: E. L. Cumbers, Maycourt, Campden Rd., S. Croydon.

MORE SHORT WAVE

Amazing Offer of Permanent Magnet Moving-coil CABINET SPEAKERS
LIST PRICE 39/6 **BARGAIN**



Wonderful Opportunity! Only a few of these magnificent cabinet model speakers are available at this smashing reduction. Secure yours today!

21/-

dust-proof cover and tapped for Power, Super Power or Pentode. Walnut veneered and inlaid hand-trench-polished cabinet, size 12" high x 12" wide x 6" deep. Rigidly built and lined with special non-resonating fibrous boards to prevent vibration and boom. Woven silk-covered speaker opening. 2/6 down secures balance in 8 monthly payments 2/6.

2/6 DOWN

Something Entirely NEW! "3-in-1" SHORT-WAVE KIT
Adaptor-Converter-Receiver
LIST VALUE 37/6 **BARGAIN**

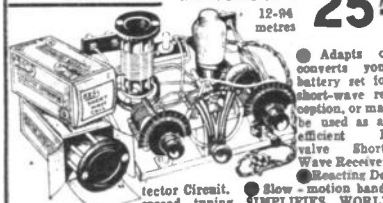

12-94 metres
Adapts or converts your battery set for short-wave reception, or may be used as an efficient 1-valve Short-Wave Receiver.
● Reacting Detector Circuit. ● Slow-motion hand-spread tuning SIMPLIFIES WORLD RECEPTION! ● Low-loss reaction condenser. ● Air-speed handspread and tank condensers. ● SPECIAL ANTI-BLIND-SPOT CONDENSER. ● 3 scales calibrated in degrees and tenths.
The N.T.S. "3-in-1" Short-Wave Kit is entirely unique in short-wave technique. This amazing combined Adaptor-Converter-Receiver is offered you for the first time... at an astonishingly low price. KIT "1" comprises every part for assembly, including 3 4-pin coils, wiring and assembly instructions, less valves only. Cash or C.O.D. Carr. Pd. 25/-, or 2/6 down and 10 monthly payments 2/6. KIT "2" with British valve, 21/9, or 2/6 down and 11 monthly payments 2/6.
If N.T.S. headphones required, add 7/6 to Cash Price, or 8d. to deposit and each monthly payment.

25/-

2/6 DOWN

Both these Kits fully described in Free Booklet offered below.

5 valve ALL-WAVE A.C./D.C. SUPERHET CHASSIS List Price **£8 : 10**

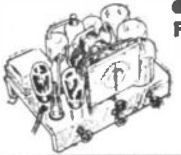

● with 5 British Valves and Field-Energised M.-C. Speaker. **BARGAIN £5.19.6**
● For A.C. or D.C. Mains, 200-250 volts. ● Octode Frequency Changer circuit employing 5 Valves. ● Automatic Volume Control. ● Illuminated airplane dial. ● Wavelength 17-2,000 metres. This wonderful triple-range set is as simple to operate and as economical to run as an ordinary 2-band receiver, and covers all three wavebands, long, medium, short, bringing you music and entertainment from every part of the world in addition to the usual English and Continental broadcasts. 7/6 down secures balance in 11 monthly payments 11/3.

7/6 DOWN

FREE! Write today for free Booklet describing in full, with actual photographs, 5 entirely new N.T.S. Bargain Short-Wave Kits, and range of Bargain Short-Wave Components, including the "3-in-1" and 4v. Bandsread Receiver Kits offered above.

All P.O.'s should be crossed and made payable to New Times Sales Co. All currency must be registered.

EST. **NEW TIMES SALES CO.,** 56 (Pr. W. 17), Ludgate Hill, London, E.C.4. 1924.

BARGAINS!

B.T.S. ADABAND
★ AMAZING BARGAINS★

List Price
£6. 12. 6
BARGAIN
£4. 19. 6



Your Set rests on top of the ADABAND BRINGS AMERICA to your present set! Simply slide beneath and plug into your existing receiver, of almost any kind. Walnut veneered cabinet. Single tuning control. Long, medium or short-wave reception on one switch without disconnecting. Wavelength 13-74 metres. A.C. D.C. MAINS MODEL. List Price £6 12 6. Bargain £4 19 6. Cash or C.O.D. (arrange 12/6 or 5/- down and 11 monthly payments of 9 6. BATTERY MODEL. List Price £5 5 0. Bargain £3 19 6, or 5/- down and 11 monthly payments of 7 6.

5/- DOWN

New 4-valve BANDSPREAD * SHORT WAVE KIT *
LIST VALUE 69 6 **BARGAIN 42/-**

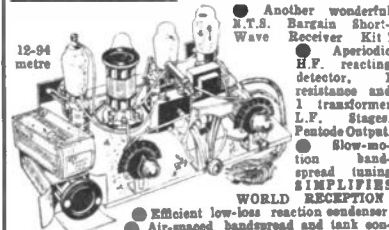

12-94 metre
Another wonderful N.T.S. Bargain Short-Wave Receiver Kit! ● Aperiodic H.F. reacting detector. ● 1 resistance and 1 transformer L.F. Stages. Pentode Output. ● Slow-motion hand-spread tuning SIMPLIFIES WORLD RECEPTION! ● Efficient low-loss reaction condenser. ● Air-speed handspread and tank condensers. ● 3 scales calibrated in degrees and tenths. Secure this new design short-waver with the wonderful performance right now! Assembled in an evening, it will bring you the programmes of the world clearly, powerfully, tuned-in with the greatest simplicity. A marvellous Kit at an astoundingly low price!
KIT "1" comprises every part for assembly, including 3 6-pin coils, wiring and assembly instructions, less valves only. Cash or C.O.D. Carr. Pd. 42/-, or 2/6 down and 11 monthly payments 4/-, or 2/6 with 4 British valves, 33 9 0, or 5/- down and 11 monthly payments 6 6.
If N.T.S. headphones required, add 7 6 to Cash Price, or 8d. to deposit and each monthly payment.

2/6 DOWN

Practical and Amateur Wireless BLUEPRINT SERVICE

PRACTICAL WIRELESS.		
	Date of Issue.	No. of Blueprint.
CRYSTAL SETS.		
Blueprint, 6d.		
1937 Crystal Receiver	9.1.37	PW71
STRAIGHT SETS. Battery Operated.		
One-valve: Blueprint, 1s.		
All-wave Unipen (Pentode)	—	PW31A
Two-valve: Blueprint, 1s.		
Four-range Super Mag Two (D, Pen)	11.8.34	PW36B
Three-valve: Blueprints, 1s. each.		
The Long-Range Express Three (SG, D, Pen)	24.4.37	PW2
Selectone Battery Three (D, 2 LF (Trans))	—	PW10
Sixty Shilling Three (D, 2LF (RC & Trans))	—	PW34A
Leader Three (SG, D, Pow)	—	PW35
Summit Three (HF Pen, D, Pen)	8.8.34	PW37
All Pentode Three (HF, Pen, D (Pen), Pen)	22.9.34	PW39
Hall-Mark Three (SG, D, Pow)	—	PW41
Hall-Mark Cadet (D, LF, Pen (RC))	16.3.35	PW48
F. J. Camm's Silver Souvenir (HF Pen, D (Pen), Pen) (All-Wave Three)	13.4.35	PW49
Genet Midget (D, 2 LF (Trans))	June '35	PM1
Cameo Midget Three (D, 2 LF (Trans))	8.6.35	PW51
1936 Sonotone Three-Four (HF Pen, HF Pen, Westector, Pen)	17.8.35	PW53
Battery All-Wave Three (D, 2 LF (RC))	—	PW55
The Monitor (HF Pen, D, Pen)	—	PW81
The Tutor Three (HF Pen, D, Pen)	21.3.36	PW82
The Centaur Three (SG, D, P)	—	PW84
The Gladiator All-Wave Three (HF Pen, D (Pen), Pen)	20.8.36	PW66
F. J. Camm's Record All-Wave Three (HF Pen, D, Pen)	31.10.36	PW69
The "Colt" All-Wave Three (D, 2 LF (RC & Trans))	5.12.36	PW72
Four-valve: Blueprints, 1s. each.		
Sonotone Four	1.5.37	PW4
Fury Four (2 SG, D, Pen)	—	PW11
Beta Universal Four (SG, D, LF, (C, B))	—	PW17
Nucleon Class B Four (SG, D (SG), L.F., C, B)	6.1.34	PW34B
Fury Four Super (SG, SG, D, Pen)	—	PW34C
Battery Hall-Mark 4 (HF Pen, D, Push-Pull)	—	PW40
F. J. Camm's "Linnit" All-Wave Four (HF Pen, D, LF, P)	26.9.36	PW67
Mains Operated.		
Two-valve: Blueprints, 1s. each.		
A.C. Twin (D (Pen), Pen)	—	PW18
A.C.-D.C. Two (SG, Pow)	7.10.33	PW31
Selectone A.C. Radiogram Two (D, Pow)	—	PW19
Three-valve: Blueprints, 1s. each.		
Double-Diode-Triode Three (HF Pen, DDT, Pen)	—	PW23
D.C. Ace (SG, D, Pen)	—	PW25
A.C. Three (SG, D, Pen)	—	PW29
A.C. Leader (HF Pen, D, Pow)	7.4.34	PW35C
D.C. Premier (HF Pen, D, Pen)	31.3.34	PW35B
Ubiqne (HF Pen, D (Pen), Pen)	28.7.34	PW36A
Armada Mains Three (HF Pen, D, Pen)	18.8.34	PW38
F. J. Camm's A.C. All-Wave Silver Souvenir Three (HF Pen, D, Pen)	11.5.35	PW50
"All-Wave" A.C. Three (D, 2 LF (RC))	17.8.35	PW54
A.C. 1936 Sonotone (HF Pen, HF Pen, Westector, Pen)	—	PW56
Mains Record All-Wave 3 (HF Pen, D, Pen)	5.12.36	PW70
Four-valve: Blueprints, 1s. each.		
A.C. Fury Four (SG, SG, D, Pen)	—	PW20
A.C. Fury Four Super (SG, SG, D, Pen)	—	PW34D
A.C. Hall-Mark (HF Pen, D, Push-Pull)	—	PW45
Universal Hall-Mark (HF Pen, D, Push-Pull)	9.2.35	PW47
SUPERHETS.		
Battery Sets: Blueprints, 1s. each.		
£5 Superhet (Three valve)	—	PW40
F. J. Camm's 2-valve Superhet Two-valve	13.7.35	PW52
F. J. Camm's £4 Superhet	—	PW58
F. J. Camm's "Vitesse" All-Waver (5-valver)	27.2.37	PW75
Mains Sets: Blueprints, 1s. each.		
A.C. £5 Superhet (Three-valve)	—	PW43
D.C. £5 Superhet (Three valve)	1.12.34	PW42
Universal £5 Superhet (Three valve)	—	PW44
F. J. Camm's A.C. £4 Superhet 4	—	PW59
F. J. Camm's Universal £4 Superhet 4	—	PW60
"Qualitone" Universal Four	10.1.37	PW73
SHORT-WAVE SETS.		
Two-valve: Blueprint, 1s.		
Midget Short-wave Two (D, Pen)	15.9.34	PW38A

Three-valve: Blueprints, 1s. each.		
Experimenter's Short-Wave Three (SG, D, Pow)	—	PW30A
The Perfect 3 (D, 2 LF (RC and Trans))	—	PW63
The Bandspread S.W. Three (HF Pen, D (Pen), Pen)	29.8.36	PW68
"Tele-Cut" S.W.3 (SG, D (SG), Pen)	30.1.37	PW74
PORTABLES.		
Three-valve: Blueprints, 1s. each.		
F. J. Camm's ELF Three-valve Portable (HF Pen, D, Pen)	10.5.36	PW65
Four-valve: Blueprint, 1s.		
Featherweight Portable Four (SG, D, LF, C, B)	—	PW12
MISCELLANEOUS.		
S.W. Converter-Adapter (1 valve)	—	PW48A
AMATEUR WIRELESS AND WIRELESS MAGAZINE CRYSTAL SETS.		
Blueprints, 6d. each.		
Four-station Crystal Set	12.12.36	AW427
1934 Crystal Set	—	AW444
150-mile Crystal Set	—	AW450
STRAIGHT SETS. Battery Operated.		
One-valve: Blueprints, 1s. each.		
B.B.C. Special One-valver	—	AW387
Twenty-station Loudspeaker One-valver (Class B)	—	AW440
Two-valve: Blueprints, 1s. each.		
Melody Ranger Two (D, Trans)	—	AW388
Full-volume Two (SG det., Pen)	—	AW392
B.B.C. National Two with Lucerne Coil (D, Trans)	—	AW377A
Big-power Melody Two with Lucerne Coil (SG, Trans)	—	AW388A
Lucerne Minor (D, Pen)	—	AW426
A Modern Two-valver	July '36	WM409
Three-valve: Blueprints, 1s. each.		
Class B Three (D, Trans, Class B)	—	AW386
New Britain's Favourite Three (D, Trans, Class B)	15.7.33	AW394
Home-built Coil Three (SG, D, Trans)	—	AW404
Fan and Family Three (D, Trans, Class B)	25.11.33	AW410
£5 5s. S.G.3 (SG, D, Trans)	2.12.33	AW412
1934 Ether Searcher; Baseboard Model (SG, D, Pen)	—	AW417
1934 Ether Searcher; Chassis Model (SG, D, Pen)	—	AW419
Lucerne Ranger (SG, D, Trans)	—	AW422
Cosor Melody Maker with Lucerne Coils	—	AW423
Mullard Master Three with Lucerne Coils	—	AW424
£5 5s. Three: De Luxe Version (SG, D, Trans)	19.5.34	AW435
Lucerne Straight Three (D, RC, Trans)	—	AW437
All-Britain Three (HF Pen, D, Pen)	—	AW448
"Wireless League" Threc (HF Pen, D, Pen)	3.11.34	AW451
Transportable Three (SG, D, Pen)	—	WM271
£6 Gs. Radiogram (D, RC, Trans)	—	WM318
Simple-tune Three (SG, D, Pen)	June '33	WM327
Economy-Pentode Three (SG, D, Pen)	Oct. '33	WM337
"W.M." 1934 Standard Three (SG, D, Pen)	—	WM351
£3 3s. Three (SG, D, Trans)	Mar. '34	WM354
Iron-core Band-pass Three (SG, D, QP 21)	June '34	WM362
1935 £6 Gs. Battery Three (SG, D, Pen)	—	WM371
PTP Three (Pen, D, Pen)	June '35	WM398
Certainty Three (SG, D, Pen)	Sept. '35	WM393
Minute Three (SG, D, Trans)	Oct. '35	WM396
All-wave Winning Three (SG, D, Pen)	Dec. '35	WM400
Four-valve: Blueprints, 1s. 6d. each.		
65s. Four (SG, D, RC, Trans)	—	AW370
"A.W." Ideal Four (2 SG, D, Pen)	16.9.33	AW402
2 H.F. Four (2 SG, D, Pen)	—	AW421
Crusaders' A.V.C. 4 (2 HF, D, QP21)	18.8.34	AW445
(Pentode and Class B Outputs for above: Blueprints, 6d. each.)	25.8.34	AW445A
Self-contained Four (SG, D, LF, Class B)	Aug. '33	WM331
Lucerne Straight Four (SG, D, LF, Trans)	—	WM350
£5 5s. Battery Four (HF, D, 2LF)	Feb. '35	WM351
The H.K. Four (SG, SG, D, Pen)	Mar. '35	WM384
The Auto Straight Four (HF Pen, HF Pen, DDT, Pen)	April '36	WM404
Five-valve: Blueprints, 1s. 6d. each.		
Super-quality Five (2 HF, D, RC, Trans)	May '33	WM320
Class B Quadrydne (2 SG, D, LF, Class B)	Dec. '33	WM344
New Class-B Five (2SG, D, LF, Class B)	Nov. '33	WM340
Mains Operated.		
Two-valve: Blueprints, 1s. each.		
Cousoelectric Two (D, Pen) A.C.	—	AW403
Economy A.C. Two (D, Trans) A.C.	—	WM286
Ulucorn A.C.-D.C. Two (D, Pen)	Sept. '35	WM394

These blueprints are drawn full size.
Copies of appropriate issues containing descriptions of these sets can in some cases be supplied at the following prices, which are additional to the cost of the blueprint. A dash before the Blueprint Number indicates that the issue is out of print.

Issues of Practical Wireless	..	6d.	Post paid.
Amateur Wireless	..	6d.	..
Practical Mechanics	..	7d.	..
Wireless Magazine	..	1/3	..

The index letters which precede the Blueprint Number indicate the periodical in which the description appears; thus PW refers to PRACTICAL WIRELESS, AW to Amateur Wireless, PM to Practical Mechanics, WM to Wireless Magazine.

Send (preferably) a postal order to cover the cost of the blueprint and the issue (stamps over 6d. unacceptible), to PRACTICAL AND AMATEUR WIRELESS, Blueprint Dept., Geo. Newnes, Ltd., Tower House, Southampton Street, Strand, W.C.2.

Three-valve: Blueprints, 1s. each.		
Home-Lover's New All-electric Three (SG, D, Trans) A.C.	—	AW385
S.G. Three (SG, D, Pen) A.C.	—	AW390
A.C. Triodyne (SG, D, Pen) A.C.	19.8.33	AW399
A.C. Pentaquester (HF Pen, D, Pen) A.C.	23.6.34	AW439
Mantovani A.C. Three (HF Pen, D, Pen) A.C.	—	WM374
£15 15s. 1936 A.C. Radiogram (HF, D, Pen)	Jan. '36	WM401
Four-valve: Blueprints, 1s. 6d. each.		
All-Metal Four (2 SG, D, Pen)	July '33	WM326
Harris Jubilee Radiogram (HF Pen, D, LF, P)	May '35	WM386
SUPERHETS.		
Battery Sets: Blueprints, 1s. 6d. each.		
Modern Super Senior	—	WM375
Varsity Four	Oct. '35	WM395
The Hequet All-Waver	June '36	WM407
1935 Super Five Battery (Superhet)	—	WM379
Mains Sets: Blueprints, 1s. 6d. each.		
1934 A.C. Century Super A.C.	—	AW425
Heptode Super Three A.C.	May '34	WM359
"W.M." Radiogram Super A.C.	—	WM366
1935 A.C. Stenode.	Apr. '35	WM385
PORTABLES.		
Four-valve: Blueprints, 1s. 6d. each.		
Midget Class B Portable (SG, D, LF, Class B)	20.5.33	AW389
Holiday Portable (SG, D, LF, Class B)	1.7.33	AW393
Family Portable (HF, D, RC, Trans)	22.9.34	AW417
TWO H.F. Portable (2 SG, D, QP21)	June '34	WM363
Tyers Portable (SG, D, 2 Trans)	—	WM367
SHORT-WAVE SETS—Battery Operated.		
One-valve: Blueprints, 1s. each.		
S.W. One-valver converter (Price 6d.)	—	AW320
S.W. One-valver for America	23.1.37	AW429
Rome Short-Waver	—	AW452
Two-valve: Blueprints, 1s. each.		
Ultra-short Battery Two (SG det., Pen)	Feb. '36	WM402
Home-made Coil Two (D, Pen)	—	AW440
Three-valve: Blueprints, 1s. each.		
World-ranger Short-wave 3 (D, RC, Trans)	—	AW355
Experimenter's 5-metre Set (D, Trans, Super-regen)	30.6.34	AW438
Experimenter's Short-wave (SG, D, Pen)	Jan. 19. '35	AW463
The Carrier Short-waver (SG, D, P)	July '35	WM390
Four-valve: Blueprints, 1s. 6d. each.		
A.W. Short-Wave World-Beater (HF Pen, D, RC, Trans)	—	AW436
Empire Short-Waver (SG, D, RC, Trans)	—	WM313
Standard Four-valve Short-waver (SG, D, LF, P)	Mar. '35	WM383
Superhet: Blueprint, 1s. 6d.		
Simplified Short-waver Super	Nov. '35	WM397
Mains Operated.		
Two-valve: Blueprints, 1s. each.		
Two-valve Mains short-waver (D, Pen) A.C.	—	AW453
"W.M." Band-spread Short-waver (D, Pen) A.C.-D.C.	—	WM368
"W.M." Long-wave Converter	—	WM380
Three-valve: Blueprint, 1s.		
Emigrator (SG, D, Pen) A.C.	—	WM352
Four-valve: Blueprint, 1s. 6d.		
Standard Four-valve A.C. Short-waver (SG, D, RC, Trans)	Aug. '35	WM391
MISCELLANEOUS.		
Enthusiast's Power Amplifier (1/6)	June, '35	WM387
Listener's 5-watt A.C. Amplifier (1/6)	Sept. '35	WM392
Radio Unit (2v.) for WM392	Nov. '35	WM398
Harris Electrogram (battery amplifier) (1/-)	Dec. '35	WM399
De-Luxe Concert A.C. Electrogram	Mar. '36	WM403
New Style Short-Waver Adapter (1/-)	June '35	WM388
Trickle Charger (6d.)	Jan. 5, '35	AW462
Short-wave Adapter (1/-)	Dec. 1, '34	AW456
Superhet Converter (1/-)	Dec. 1, '34	AW457
B.L.D.L.C. Short-wave Converter (1/-)	May, '36	WM405
Wilson Tone Master (1/-)	June, '36	WM406
The W.M. A.C. Short-Wave Converter (1/-)	July '36	WM408



QUERIES and ENQUIRIES

was used in the single-valve all-waver described in your issue dated March 6th last?—J. G. (Aldenhams).

A.C. Gramophone Amplifier

“Have you a blueprint of a gramophone amplifier to work off A.C. mains 250 volts? Can you give me particulars?—R. K. (Whitstable).”

THE only amplifier of the type mentioned is the Listener's 5-watt A.C. amplifier, blueprint WM.392. This particular print costs 1s. 6d., and the issue of the *Wireless Magazine* in which the constructional details were given is dated September, 1935. This may be obtained for 1s. 3d. by post from this office.

Frame Aerial

“I am building a small 3-valve portable set, but am not quite certain how to wind the aerial. The frame will be 10in. by 10in., and I would like to know the number of turns and the gauge of wire I should use.”—E. J. R. (Pengam).

IF you wish to cover medium and long waves, you will have to wind the frame continuously, but if reaction is being employed the medium and long-wave sections should be separated by a short space, and the reaction winding placed between the two sections. Use 75ft. of 24 D.C.C. wire for the medium-wave winding and about 135ft. of 30 D.C.C. wire in series for the loading coil. The reaction winding may consist of about 35ft. of 30 D.C.C. and its position may have to be found by experiment so that it offers the desired control on both wavebands. For wave-change switching a simple on/off switch across the long-wave loading coil will be required.

Twenty-station One-valver

“I have obtained the blueprint for this receiver, and should like to know what make of dual-range coil would be suitable. Also, will any make of Class B output transformer do, or do you recommend any special make?—E. L. D. (Snarebrook, E.).”

THE coil specified for this receiver may be obtained from Formo Products, of Mason's Hill, Bromley. It is Type A1. The valve is obtainable only from the Hivac Company, and is Type DB.240. It is a combined Class B and Driver valve, costing 15s. 6d. Any good standard Class B input and output transformers may be used, those specified no longer being on the market.

Single-valve All-waver

“Could you let me know what type the .0003 mfd. variable condenser is which

THE component in question is a differential reaction condenser and any well-known make may be used in this particular set. The two short lines on the theoretical symbol indicate the two sets of fixed plates and the long line indicates the moving plates of this particular component.

Transmission

“I would like to know the price of a plan in detail of a transmitter. I would like it

RULES

We wish to draw the reader's attention to the fact that the Queries Service is intended only for the solution of problems or difficulties arising from the construction of receivers described in our pages, from articles appearing in our pages, or on general wireless matters. We regret that we cannot, for obvious reasons—

- (1) Supply circuit diagrams of complete multi-valve receivers.
- (2) Suggest alterations or modifications of receivers described in our content-papers.
- (3) Suggest alterations or modifications to commercial receivers.
- (4) Answer queries over the telephone.
- (5) Grant interviews to querists.

Please note also, that queries must be limited to two per reader, and all sketches and drawings which are sent to us should bear the name and address of the sender. Requests for blueprints must not be enclosed with queries as they are dealt with by a different department.

If a postal reply is desired, a stamped addressed envelope must be enclosed. Send your queries to the Editor, PRACTICAL AND AMATEUR WIRELESS, George Newnes, Ltd., Tower House, Southampton Street, Strand, London, W.C.2. The Coupon must be enclosed with every query.

to be as simple as possible, as I am only a beginner. I want it to have as low a voltage as possible, and to transmit for a distance of about 200 yards or less. I have a pal about that distance away who would receive on an ordinary 2-valve set. I want it for Morse only.”—D. E. P. (Royston).

WE would remind you that the transmitting licence is not issued to enable you to communicate with a friend, but is supplied only for genuine research purposes. When applying for a licence you have to state the lines of experiment or research which you wish to undertake, and from your letter we would imagine that you would be unable to supply the necessary details. Full particulars concerning the licence may be obtained from the G.P.O. Radio Section at Armour House, London, E.C., and no experiments may be undertaken until the licence is issued. There are heavy penalties for an infringement of this law.

REPLIES IN BRIEF

The following replies to queries are given in abbreviated form either because of non-compliance with our rules, or because the point raised is not of general interest.

J. C. (Ulverston). We have several more up-to-date receivers, but cannot recommend any to build from the parts of your present set. We suggest you look through the Blueprint Service list and select a suitable set.

B. L. (Tamworth). The lighting switch may be faulty, due to the springs having weakened and arcing taking place in the “on” position. We suggest that you check this point and if found in order the set should be examined by a service agent of the makers.

L. S. (E.1). We have no book on the subject, but suggest that you follow the details given in our issue dated January 9th last.

J. N. (Wombly). If you cut out the motor and the noise ceases it will indicate some fault in that component. We are not familiar with the servicing details of individual commercial receivers and regret that we have no details of the set mentioned.

G. W. L. (Sidcup). The arrangement should work, but we have no diagram which would assist you and cannot recommend modifications of our published circuits.

T. W. H. (Hednesford). All of the issues are in print and cost 4d. each by post.

J. E. H. (Hford). We regret that we cannot trace the receiver as one of our designs. Can you give any further details?

G. C. (Edinburgh). You do not state whether the receiver is battery or mains operated. In the latter case the bias resistance may have burnt out due to the short circuit, or in the former case the H.T. battery may have been seriously damaged and this would account for the effects mentioned.

S. A. (S.W.8). We cannot state for certain, but suggest you ask the makers of your receiver whether a standard converter will function satisfactorily. If so, the blueprint may be recommended.

M. A. K. (Stoke). We regret that we have no blueprint of a suitable mains unit.

P. S. (Peterborough). The valve in question is obtainable from the G.E.C., price 50s.

G. J. B. (Bexley Heath). We regret that we have no details of the set referred to and therefore cannot advise you. The coils referred to were employed in the £5 Superhet.

B. S. S. (Ichen). We will bear your request in mind, but there are no gift books of the type mentioned so far in our series.

L. K. (Westcliff-on-Sea). We regret that we cannot insert a request as mentioned, but suggest that you write to Messrs. Foyle's, of Charing Cross Road, who may have a secondhand copy.

T. C. G. (N.17). The hum is more likely to be due to the circuit wiring or receiver design, and not to the tuning pack. Perhaps you could let us have some details of the receiver, when we may be able to suggest the cause of the trouble.

H. W. (No address). From your remarks we suspect the multi-contact switch. Make certain that the flexible fingers are not bent and that they contact evenly with both sides of the contacts on the discs.

No Name (Coventry). The trouble is undoubtedly L.F. instability. Try the effect of reversing the connections to the secondary of the L.F. transformer.

A. A. (Longford). A test in Morse will certainly have to be passed, and you should apply for full particulars to the Engineer-in-Chief, Radio Section, G.P.O., Armour House, London, E.C.

J. C. (Bristol 5). We regret that we are not familiar with the servicing difficulties of individual commercial receivers, and suggest you communicate with the makers or their nearest local service agent.

D. H. C. (West Brompton). We regret that we have no receiver of the type referred to in our blueprint list. We have not described a receiver of this type and think that it would be rather difficult to arrange for all-wave reception in a midjet portable.

T. W. M. (S. Croydon). We regret that the issues in question are no longer obtainable, but the makers are still in business at Gt. West Road, Brentford.

F. G. G. (Lincoln). The address of the Performing Right Society is 33, Margaret Street, London, W.1.

The coupon on Cover iii must be attached to every query.

1000 FREE INSURANCE

Enjoy the feeling of complete security in the worst storms by fitting a PIX ARRESTOR. One of the largest Insurance Institutions insures you against the risk of personal damage up to £1,000 and

£30 FOR THE SET

SUMMER STORMS AND LIGHTNING

They have satisfied themselves that with the PIX ARRESTOR the risk is NIL.

PIX, LONDON, S.E.1.

PIX LIGHTNING ARRESTOR

2/-

Miscellaneous Advertisements

Advertisements are accepted for these columns at the rate of 3d. per word. Words in black face and/or capitals are charged double this rate (minimum charge 3/- per paragraph). Display lines are charged at 6/- per line. All advertisements must be prepaid. All communications should be addressed to the Advertisement Manager, "Practical and Amateur Wireless," Tower House, Southampton Street, Strand, London, W.C.2.

RECEIVERS, COMPONENTS AND ACCESSORIES

Surplus, Clearance or Secondhand, etc.

RADIOMART

SHORT-WAVE MANUAL

Packed with short-wave information and circuits of mains and battery receivers, including straight, superhet and 5-metre transmitters, modulators, etc. Information on transmitting licences, aerials, Class B amplifications, neutralizations, superhet alignment, etc. The most comprehensive manual published, written by practical engineers, price 6d., post free, 7½d. including catalogue.

1937 Short-wave Catalogue only (3 times enlarged) price 1½d., post free.

44, HOLLOWAY HEAD, BIRMINGHAM 1

CONVERSION UNITS for operating D.C. Receivers from A.C. Mains, improved type, 120 watts output, at £2/10/0. Send for our comprehensive list of speakers, resistances and other components. **WARD**, 40, Farringdon Street, London, E.C.4. Telephone: Holborn 9703.

REPAIRS to Moving Coil Speakers, Cones and Coils fitted or rewound. Fields altered. Prices Quoted including Eliminators, Loudspeakers Re-paired, 4/-; L.F. and Speech Transformers, 4/- post free. Trade invited. Guaranteed. Satisfaction. Prompt Service. Estimates Free. L.S. Repair Service, 6, Balham Grove, London, S.W.12. Battersea 1321.

SHORT WAVE on a crystal set. Full building instruction and crystal 1½ post paid.—Radiomall, Tanworth-in-Arden, Warwickshire.

VAUXHALL—Polar Midget 3-gang condensers, straight or superhet, 8/0; Polar full vision, horizontal or Arcuate dial and drive, 5/-.

VAUXHALL—Flat, sheet aluminium, hard rolled 18-gauge, 12in. x 12in., 3/-; 18 x 18, 5/0; other sizes proportionate.

VAUXHALL—Polar station named scales, for horizontal dials, latest settings; 1/0 each.

VAUXHALL—Hivac valves, mains or battery, all types. Usual discounts from new prices.

VAUXHALL—Volume controls, Erie, Colvern, Centralab, 2/-; With Switch, 3/-, 2,000 to 2 meg. Fitted knobs and terminals.

VAUXHALL—T.C.C. electrolytic condensers, 8 mfd. and 4 mfd., 550 volt, 3/-; 500 volt, 2/6; 200 mfd., 10 volt, 2/6.

VAUXHALL—T.C.C. condensers, tubular, non-inductive, 0.1, 6d.; 50 mfd., 50v. working, 1/6; 50 mfd., 12v., 1/8; 0.05, 6d.; 0.002, 0.0002, 0.001, 0.0001, 4d. each.

VAUXHALL—T.C.C. mica 0.002, 2,000 volt test, 1/-; 0.0001, 4d.; 0.001, 0.01, 1/-; 1 mfd. Mansbridge, 1/3; 2 mfd., 1/8.

VAUXHALL—Resistances by well-known manufacturers, 1-watt type, 6d. each; all values.

VAUXHALL—Set manufacturers' surplus, skeleton type Westinghouse rectifiers, H.T.8, 9/6; H.T.9, H.T.10, 10/-; complete with fixing brackets.

VAUXHALL—Clif valveholders, terminals, 5-pin, 7d.; 7-pin, 9d.; baseboard mounting, 5-pin, 4½d., 7-pin, 1/-.

VAUXHALL—Pushback wire, four colours, 6 yds., 6d. 6BA screws or nuts, 4d. doz.

VAUXHALL UTILITIES, 163a, Strand, W.C.2, over Denny's, the Booksellers, Teniple Bar 9338. Send postcard for lists free. Post paid 2/6 or over, or c.o.d.

BANKRUPT Bargains. Lists Free. All goods new. Decca 1937 6v. A.C. superhet radiograms, 12gns. Decca Gv. A.C. allwave, £7/5/0. Ditto, 200-2,000 metres, £6/5/0. Burgoyne Dragon 5v. A.C. superheta, 1937, £6. Halyon A.C. S.W. converters with valve, 25/-; Ormond 3v. H.F. battery sets, MC speaker with valves, 5/6. Burgoyne 15gns. A.C. superhet tablegram, £8/15/0. Many others. Large stock valves, speakers, components.—Butlin, 6, Stanford Avenue, Brighton. Preston 4030.

PREMIER SUPPLY STORES

All goods guaranteed perfect; carr. paid over 5/-; under 5/- postage 6d. extra.

ALL POST ORDERS TO JUBILEE WORKS, 167, LOWER CLAPTON RD., LONDON, E.5. Phone: Amherst 4723.

CALLERS, AS USUAL, TO 165 & 165a, FLEET ST., E.C.4 (Next door to Anderson's Hotel), Central 2833. New Branch: 50 HIGH ST., CLAPHAM, S.W.4 (Wacaulay 2361).

Have you had our **GIANT ILLUSTRATED CATALOGUE AND VALVE LIST?** Send 4d. IN STAMPS FOR THIS BARGAIN LIST.

SHORT-WAVE COILS, 4- and 6-pin types, 1.1-26, 22-47, 41-94, 78-170 metres, 1½ each, with circuit. Special set of 3 S.W. Coils, 14-150 metres, 4/- set, with circuit. Premier 3-band S.W. Coil, 11-25, 15-43, 28-96 metres. Simplified S.W. receiver construction, suitable any type circuit, 2/6.

COIL FORMERS, in finest plastic material, 1½in. low-loss ribbed, 4- or 6-pin, 1/- each.

SUPER CERAMIC CONDENSERS, S. L. F., .00016, .0001 2/9 each; double-spaced, .00005, .00025, .00015, 3/- each. All brass with integral slow motion .00015 tuning, 3/9; .00015 reaction, 2/9. S.W. H.F. COILS, 9d.

MAINS VALVES famous Europa 4 v. A.C. types, 4/6 each. H.L. L., S.O., Var.-Mu-S.O., H.F. Pena. Var.-Mu-H.O. Pena. 1, 3 and 4-watt A.C. directly heated output Pentodes. Full-wave rectifiers, 250 v. 60 m.a. A.C./D.C. types. 30-volt 18 amp. S.O., Var.-Mu-S.O., H., H.L. Power and Pen. Following types all 5/6 each. Full-wave rectifiers, 350 v. 120 m.a. and 600 v. 120 m.a. 2½ watt indirectly-heated Pentodes, Octode Frequency Changers.

BATTERY VALVES 2 volta. H.F., L.F., 2/3. Power Super-Power, 2/9. S.O., Var.-Mu-S.O., 4- or 5-pin Pentodes, H.F. Pena., V.-Mu-H.F. Pena., 5/-; Class B, 5/-.

AMERICAN VALVES, Genuine American HYTRON and TRIAD first-grade Valves, 3 months' guarantee. All types in stock, 8/6 each. 210 and 260, 8/6 each. New Metal-Glass Valves, all types, 8/6 each. Genuine American DUOTRON Valves, all types, 3/6 each. Valve holders for all above types, 6d. each. OCTOE bases, 9d. each.

2-WATT A.C. AMPLIFIER, 2-stage for mike or pick-up. Complete kit of parts with 3 valves, 40/-.

7-WATT A.C./D.C. AMPLIFIER, 3-stage high-gain, push-pull output. Complete kit of parts with 5 specially matched valves, 84/6. Completely Wired and Tested, 88/9/6.

COSMOCOD PICK-UPS, with tonearm and volume control, 10/8 each. PICK-UP HEADS only, 4/6 each.

PREMIER MAINS TRANSFORMERS, wire-end type with screened primaries, tapped 200-250 v. Centre-tapped Mianams. Guaranteed one year. H.T. 8 & 9 or H.T. 10 with 4 v. 4 a. C.T. and 4 v. 1 a. C.T., 9/6. 250-250 v. 60 m.a., 4 v. 1 a., 4 v. 2 a., and 4 v. 4 a., all C.T., 8/6. 250-350 v. 120 m.a., 4 v. 1 a., 4 v. 2 a., and 4 v. 4 a., all C.T., 10/8. Any of these transformers with engraved panel and N.P. terminals 1/8 extra. 500-500 v. 150 m.a., 4 v. 2-3 a., 4 v. 2-3 a., 4 v. 2-3 a., all C.T., 17/6. **SPECIAL OFFER PHILIPS MAINS TRANSFORMERS**: 250-250 v. or 300-300 v. at 60 m.a., 4 v. 5 a., C.T.; 4 v. 1 a. Tapped Primary 100-250 volts, 6/11. 450-450 v. at 150 m.a. or 500-500 v. 100 m.a., 4 v. 4 a. C.T. 4 v. 4 a. and 4 v. 2 a. Screened Primary. Tapped input 100-250 v., 18/6. **AUTO TRANSFORMERS**, step up or down, 50 watts, 7/8; 100 watts, 10/6. **SMOOTHING CHOKES**, 25 m.a., 2/5; 40 m.a., 4/-; 60 m.a., 5/6; 150 m.a., 10/8. 2,500 ohms, 60 m.a. Speaker Replacement Chokes, 5/6. Electric **SOLDERING IRONS**, 200-250 v., A.C./D.C., 2/8.

SPECIAL OFFER. LISSON TWO-GANG SCREENED ALL-WAVE COILS, 12 to 2,000 metres, complete with switching and wiring diagrams, 8/11 per set.

TELEEN Multi-metres, 50 and 300 m.a., 8, 16 and 240 v., 9/6 each. Reads A.C. and D.C.

Special Offer BTH Energised Moving Coils, 10½in. diam. 1,650 ohms field. Power or Pentode transformer (state which), 14/6.

ROLA latest type P.M.s, 15/-; **GOODMAN'S** 6in. mains energised 1,000 ohms field, 10/6 each; **Jensen P.M.s**, 19/6.

TRANSFORMERS, latest type Teleen R.O.4 (list 12/8), 2/8. Lisson Hypernik Q.P.P. (list 12/8), 2/8.

OUTPUT TRANSFORMERS for Power or Pentode, 2/6; Multi-Ratio, 4/6.

TUBULAR CONDENSERS, non-inductive, all values up to .5 mfd., 6d. each.

Wire-end RESISTORS, any value, 1 watt, 6d.; 4 watts, 1/-; 8 watts, 1/6; 15 watts, 9/-; 25 watts, 2/6 each.

Reliable MORSE-KEYS with Morse Code engraved on bakelite base, 2/- each.

Bakelite case BUZZERS, 1/6; Walnut case "Loud-tone," 3/6 each.

Super Quality lightweight HEADPHONES, 2/9 pair.

TELEEN DISC DRIVES, W 184, 1/- each.

W.B. 1936 STEPHORIAN SPEAKERS, Standard model (list, 32/6), 22/6. Senior model (list, 42/-), 28/6. Brand new in original sealed cartons.

GRAMOPHONE MOTORS, Collaro Gramophone Unit consisting of A.C. motor, 100-250 v., high quality pick-up and volume control, 45/-; Collaro motor only, 30/-; Collaro Universal Gramophone Motor, 100-250 v. A.C./D.C., 60/8; Edison Bell double-spring motors, including turntable and all fittings, 15/-; Cosmo-cod Gramo. unit, comprising A.C. motor, pick-up and volume control (list 53/-), 58/8.

PLESSEY or POLAR 2-gang (2 x .0005) Condensers with Unil knob trimmer and Disc Drive, 5/11.

RECEIVERS, COMPONENTS AND ACCESSORIES

Surplus, Clearance or Secondhand, etc.

RADIO CLEARANCE

63, HIGH HOLBORN, W.C.1.

HOLBORN 4631

Final End of Season Clearance of High-class Receivers and Components.

Lisson A.C./D.C., plus Rectifier Receiver, fitted in Handsome Walnut Cabinet, Clock Face Tuning, etc. A really fine Receiver, to clear, £3 17s. 6d.

LISSEN DITTO, BUT ALL-WAVE (3 wavebands covered, Short, Medium, and Long), £4 19s. 6d.

REGENTONE ALL-WAVE 4-VALVE A.C. RECEIVER, fitted in Handsome Walnut Cabinet. Circuit: H.F. Pentode, Detector, Pentode Output, Valve Rectification, Large Type Moving-Coil Speaker, £4 12s. 6d.

BUSH A.C.23, 4-Valve Band Pass Receiver, fitted in Handsome Walnut Cabinet. A really up-to-the-minute Job, to clear at 4 gns.

The Following High-Class Surplus Stocks are Offered.

POLAR 3-Gang Straight Condenser, fully Screened, Top Trimmers, Three .0005 Sections. A Handy-sized Job, to clear, 4/11.

PLESSEY DITTO, 4/3.

COSSOR 2-Gang two .0005 Sections, with separate Vernier control. Both Main and Vernier Control operated from the Panel, 5/6.

5-Pin Chassis or Baseboard mounting Valveholders. A really First-class Job, 3d. each.

7-Pin Ditto, 7d. each.

PHILCO VALVE SCREENS, 1-Piece type, with Separate Base, 4d. each.

WEARITE 2-Gang Coils, complete with Switch, Fully Screened, Aerial and H.F., 3/11.

WEARITE 3-Gang ditto Bandpass, 5/11.

Single Coils, suitable for Aerial or H.F., fully screened, 1/11.

WEARITE all-wave chokes, 12-2,000 metres, 10d.

WEARITE Mains Transformer, 350-0-350 90 millamps, 4 volt 2.5 amp., 4 volt 5 amp., 6/6.

7-Pin Chassis-Mounting Valveholders, 6d.

Enquiries 1½d. stamp if reply expected.

Hours of Business, 9 a.m. to 7 p.m. Saturdays, 9 a.m. to 1 p.m. All Orders 5/- or over, Post Free. Orders under 5/- must be accompanied by a reasonable amount for postage.

C.O.D. Orders under 5/- cannot be accepted.

Orders from Ireland and Special Parts of Scotland are subject to certain increased Rates of Postage, and Customers are advised to apply for details of Postage before ordering.

RADIO CLEARANCE, 63, HIGH HOLBORN, W.C.1. HOLBORN 4631.

MISCELLANEOUS

WANTED, Modern used Short-Wave sets, parts, Eliminators, Speakers, Meters, Motors and Pick-Ups, etc. Bring or send. Spot cash paid.—University Radio, Ltd., 82 Hampstead Road, Euston, London, N.W.1.

WANTED—Battery Superhet Chassis, 3- or 4-valve. Box No. A 111.

DETECTION. Revolutionary theory, system, circuits, book, post anywhere, 1/1.—D'Arcy Ford, Gandy Street, Exeter.

GRAMOPHONE attachments for Radio, electric motors, 25/-; pick-ups, 9/6; portable gramophones, 12/-; spring motors, 4/6, dozen 86/-, 100 £12/10/0, 1,000 £100; walnut pedestal Anaxagram, £5; soundboxes, tone-arms, horns, cabinets, needles, gears, springs, accessories, cheapest. Quantity buyers obtain lower prices. Catalogue free.—Regentam, 120, Old Street, London, E.C.1.

EXPERIMENTER will buy Ferranti meters, components. Stamp.—Austin, 33, Fitzroy Road, Tankerton.

EXPERIMENTERS' OPPORTUNITY—Parcels containing Wireless Components, 40/- value for 5/6. Carriage 1/-.—Taylors, Radio House, Macaulay Street, Huddersfield.

REPAIRS

All British or American sets repaired or modernised by qualified engineers. Satisfied customers throughout the World are your guarantee. Send to-day for free estimate—free collection 10 miles radius of London.—Scott-Sessions and Co., Exchange Works, Duke Avenue, Muswell Hill, London, N.10. Phone: Tudor 4101.

VALVES

10,000 VALVES in stock. Replacements for any American radio, 3/-; Big range Hivac Valves at really keen prices.—Radiographic, Ltd., 66, Osborne Street, Glasgow, C.1.

Recently Published

THERMIONIC VALVES IN MODERN RADIO RECEIVERS

By **ALFRED T. WITTS, A.M.I.E.E.** An up-to-date handbook for service engineers, students and keen amateurs. It provides comprehensive and reliable information covering the whole field of modern theory and practice in the application of thermionic valves to radio receivers. 122 pages, 8s. 6d. net (by post 8s. 11d.).

Order from a bookseller or direct from
PITMAN, Parker St., Kingsway, London, W.C.2

EASY PAYMENTS

"THERE'S NO PLACE LIKE HOLMES."

	Deposit	Monthly Payments
W.B. 37 J	32 6	3 7 9 of 3 7
ROLA. F720 P.M.	36 -	3 10 9 of 3 10
ROLA. G.12 P.M.	55 5s.	9 7 11 of 9 7

ANY MAKE OF SPEAKER SUPPLIED.

	Deposit	Monthly Payments
B.T.H. PIEZO-ELECTRIC PICK-UP	35/-	3 10 9 of 3 10
AVOMINOR	40 -	4 5 9 of 4 5
GRAHAM-FARISH SENSITY SUPER	50/-	4 7 11 of 4 7
GRAHAM-FARISH ALL-WAVE KITS	57/6	5 3 11 of 5 3

Valves, Battery and Mains Valves supplied on H.P. PARTS FOR ANY SET. ANY MAKE OF SPEAKER. New goods obtained for every order.

Send us a list of parts or valves you require or any speaker or set you may select and we will forward you a definite quotation in 3 or 4 days' time in the Wireless Press. Thousands of satisfied customers.

H. W. HOLMES,

New Address: —333, EUSTON ROAD, LONDON, N.W.1.
Phone: Euston 1434.

EASY TERMS

WE OFFER THE LOWEST TERMS FOR ALL RADIO SETS. Radiograms, loud-speakers, valves, and all accessories. It will pay you to receive our quotation—Send list of requirements and we will quote by return. Prompt Delivery. Cash and C.O.D. Established 1925 (Phone National 1977).

THE LONDON RADIO SUPPLY CO.,
11, Oat Lane, Noble St., London, E.C.2.

RECORD

The quality valve in the COMPLETE range

RECORD RADIO LTD., 2/3, Eldon Street, E.C.

EARN EXTRA MONEY

by fitting out the M.P.R.7 Watt Amplifier to dances, socials, etc. Complete with Four Valves, Speaker and Volume Control. Push-Pull output. Will reproduce Gramophone Records or be in at all Band strength. Supplied ready for connecting to pickup or microphone. For 10 mains only. Price: £5-5-9 net, or 10 monthly. Send for full particulars. Phone: Romford 11. M.P.R. Electrical Co., 252, Victoria Road, Romford, Essex.



PATENTS AND TRADEMARKS.

KINGS PATENT AGENCY (Director: B. T. King, Patent Agent). Advice, Handbook and Consultations free.—146A, Queen Victoria Street, E.C.1. Phone: City 6161.

ADVERTISEMENT INDEX

	Page
Bulgin, A. F., & Co.	164
Electradix Radios	164
Holmes, H. W.	Inside Back Cover
Kings Patent Agency	Inside Back Cover
Lectro Linx, Ltd.	160
London Radio Supply Co.	Inside Back Cover
M.P.R. Electrical Co.	Inside Back Cover
McCarthy Radio	Inside Back Cover
New Times Sales Co.	165
Peto-Scott Co., Ltd.	157
Pitman	Inside Back Cover
Fix	167
Premier Supply Stores	168
Record Radio	Inside Back Cover

RECEIVERS, COMPONENTS AND ACCESSORIES
Surplus, Clearance or Secondhand, etc.

SOUTHERN RADIO'S Wireless Bargains. All goods guaranteed and sent post paid.

VIDOR 3-valve Battery Portable Receivers, complete with 3 Osram valves, special Vidor long life batteries and accumulator, moving coil speaker, brand new, in sealed cartons; £3 17 6.

LUCILLE.—5-valve American Midget sets, complete with 5 valves, moving coil speaker, ready for use on any mains 100-250 volts A.C. D.C., long and medium waves; £3 15, new, in sealed cartons.

RECORD CHANGERS.—Garrard Model R.C.4.

Plays automatically and changes eight 10in. or 12in. records of any kind; new, in sealed cartons; £8.

SPEAKERS.—Celestion Soundex permanent magnet, 10"; Telsen permanent magnet, with 10-ratio transformer, to suit any receiver, 12/6; Telsen loud-speaker units, 2/6; all brand new and boxed.

COILS.—Telsen iron core, W349 (Midget size), 4/-; type W478 (twin), 9/- pair; type W477 (triple), 16/- per set; type W476 (triple superhet, selector and oscillator), 16/- per set. Telsen dual range H.F. transformer and aerial coils, type W154, 3/- each; all ganged coils complete on base with switch; Telsen I.F. transformer coils, 110 kc.s., 5/-; Telsen dual range coils, with aerial series condenser incorporated, type W76, 4/-; Telsen aerial condensers, with shorting switch, 2/-; all Telsen components, brand new, in sealed cartons.

AMERICAN Valves.—A full range of valves for all American receivers; 6/- each.

MISCELLANEOUS Bargains.—All brand new in original sealed cartons: Telsen A.C. D.C. multimeters, test anything, radio or electrical, 8/6; Telsen 2-range voltmeters, 3/-; 3-range meters, including milliamperes, 4/-; Ace (P.O.) microphones, with transformer, ready for use with any receiver, 4/6; Bell transformers, 200-250 volts input, 3, 5, or 8 volts output, 3/6; Morse signal units, incorporating buzzer, tapper and flash, with international code, complete with batteries and bulb, 3/9 each; lightweight headphones, double-pole, 4,000 ohms each earpiece, 3/- pair.

REGENTONE Eliminators, A.C. 200-250 volts, type W5a, with trickle charger, 37/6.

SOUTHERN RADIO.—Branches at 271-275, High Rd., Willesden Green, N.W.10; 46, Lisle St., London, W.C.2. All mail orders to 323, Euston Rd., London, N.W.1.

SOUTHERN RADIO, 323, Euston Rd., London, N.W.1 (near Warren St., Tube). Phone: Euston 3775.

HEADPHONES. Guaranteed. Brown, Sterling, B.I.H., G.E.C., Brandes, etc. 2,000 ohms, 2/6; 4,000, 5/-; postage 6d. SPECIAL. Ericsson, 4,000 ohms, as new, 7/6. Telefunken, adjustable, lightweight, 7/6. CRYSTAL SETS. Burne-Jones. Complete. Guaranteed. 5/6. Ditto, double circuit, 8/6. Sensitive permanent detectors, 1/6. Crystal detectors, complete parts, 1/-; Crystal with whisker, 6d.; postage 1d.—Post Radio, 183, Caledonian Road, London, N.1.

FREE ADVICE BUREAU COUPON

This coupon is available until May 8th, 1937, and must be attached to all letters containing queries.
PRACTICAL AND AMATEUR WIRELESS,
1/5 37.

MISCELLANEOUS

MORE THRILLING THAN FICTION.—Newnes Wide World Library contains the best true-life travel and adventure books, great literature and exhilarating reading. Each 2s. 6d. net from all Booksellers.—George Newnes, Ltd., Tower House, Southampton Street, Strand, London, W.C.2.

PERPLEXITIES and TANTALISERS.—"The Strand Problems Book" is the finest collection of puzzles of all kinds ever assembled, mathematical, geographical, literary—acrostics and codes, by W. T. Williams (Tantalus) and G. H. Savage. Only 2s. 6d. net from all Booksellers.—George Newnes, Ltd., Tower House, Southampton Street, Strand, London, W.C.2.

EVERYMAN'S WIRELESS BOOK, by F. J. Camm. 3s. 6d. net. An invaluable book of reference explaining the operation, upkeep and overhaul of all types of wireless receiver. 200 illustrations. From all Booksellers and Newsagents.—George Newnes, Ltd., Tower House, Southampton Street, Strand, London, W.C.2.

TELEVISION.—Newnes Television and Short-wave Handbook, by F. J. Camm, deals authoritatively with Seaming System—Drums, Mirror Screws, Discs, etc., Neon Lamps, The Cathode-Ray O (Photograph, How to Build Short-Wave and Ultra-short-wave Receivers. Fully illustrated. 3s. 6d. net. From your bookseller.—George Newnes, Ltd., Tower House, Southampton Street, Strand, London, W.C.2.



MCCARTHY

NEW BATTERY ALL-WAVE SUPERHET £7

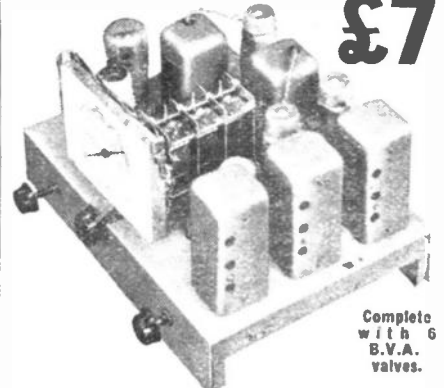

Complete with 6 B.V.A. valves.

The only receiver of its type now on the British market. Results on all 3 wavebands equal to mains receivers of equivalent type. Latest technical developments incorporated in circuit. Latest types valves, transformers, tuning coils, switches, etc.

Specification in brief: radio frequency amplifier, first detector with separate triode oscillator, I.F. amplifier, double diode detector, I.F. amplifier, low consumption pentode output, D.A.V.C. volume control and tone control both operative on gramophone. Illuminated dial with station names. Wave-ranges: 16-52, 200-550, 900-2,000 metres.

ALL-MAINS ALL-WAVE SIX with radio frequency stage

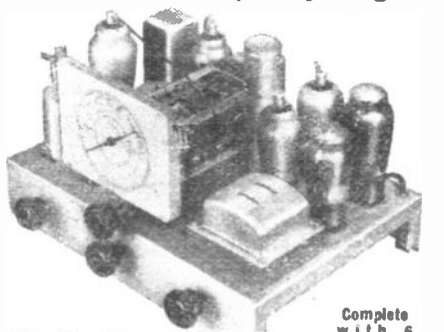

Complete with 6 B.V.A. valves.

£8.50

"De Luxe" 6 valve receiver, with 8-valve performance (specially recommended for tropical and foreign reception conditions). Built on special cadmium-plated 16 gauge steel chassis. Varley Iron-cored I.F. coils. 14-wound tuning coils. 3 wave-ranges—16-2,000 metres. Illuminated "Airplane" dial with principal station names.

Circuit comprises: Pre-selector radio frequency amplifier (operative on all wavebands), triode-hexode frequency changer, double band-pass coupled I.F. amplifier, double diode detector, D.A.V.C. applied to 3 tuning valves, I.F. amplifier and pentode output. Variable tone control and volume control operative on radio and gramophone.

Important!

The prices at which McCarthy Chassis are advertised include Marconi Royalties. Readers should, for their own protection, make sure before purchasing any receiver that the quoted price includes the Royalty payment.

All McCarthy receivers supplied complete with valves, knobs, pilot lamps, leads, mains cable and plug. 12 months' guarantee. Cash with order on 7 days' approval.

Deferred terms on application, or through London Radio Supply Co., 11, Oat Lane, E.C.2.

Write for catalogue of complete range of McCarthy receivers.

MCCARTHY RADIO LTD.
44a, Westbourne Grove, London, W.2

Telephone: Bayswater 3201/2

THE OUTSTANDING WORK FOR ALL ELECTRICAL AND WIRELESS ENGINEERS

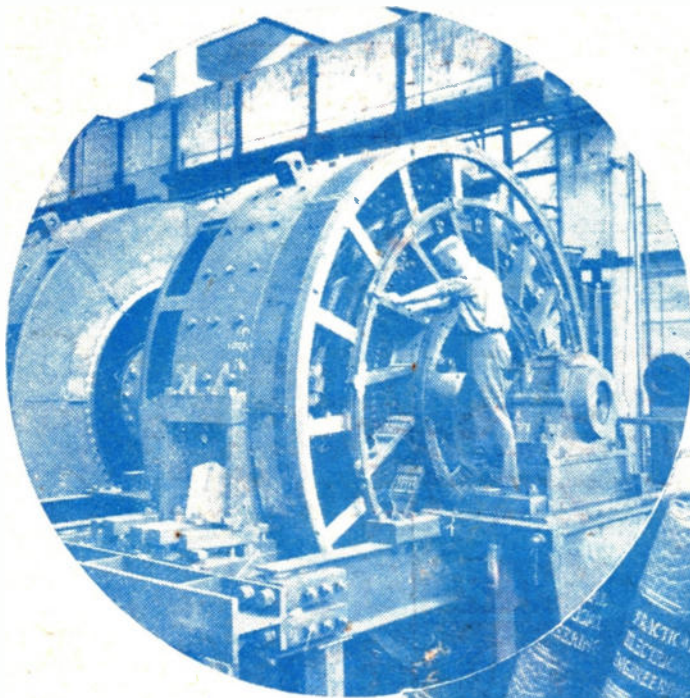

“ PRACTICAL ELECTRICAL ENGINEERING ”

IN Electrical Engineering, advancement and success come to the man who is best equipped to tackle and understand the multifarious jobs and problems he may encounter. This new and up-to-date work will help you to acquire the necessary combination of theoretical and practical knowledge. It is invaluable alike to the Student and to the practising engineer. It shows the approved methods of dealing with every type of work, from the installation, erection, wiring and maintenance of an electrical plant for a small house to that of a large factory replete with the most up-to-date equipment.

In addition, the most modern application of electricity, including sound - film reproduction, wireless, etc., are fully dealt with and the work contains a great deal of most valuable data which cannot be found in any other handbook.

Send for the illustrated prospectus — and judge for yourself.

Complete in 5 Handy Volumes

Bound in full Blue Moroquette. This strong binding is oil- and water-proof so that the books may be used freely in the Workshop, etc., without risk of damage.

A few of the important subjects :

- WIRELESS AND GRAMOPHONES.
- ELECTRICAL MACHINERY.
- GENERATION AND DISTRIBUTION.
- INSTRUMENTS AND METERS.
- WIRES AND CABLES.
- LIGHTING AND ILLUMINATION.
- INSTALLATION WORK.
- OPERATION AND MAINTENANCE WORK.
- INDUSTRIAL USES OF ELECTRICITY.
- THEATRE AND CINEMA WORK.
- TELEGRAPHY AND TELEPHONY.
- ELECTRIC TRACTION.

POST THIS COUPON TO-DAY

We will send you full details of this most valuable reference work



Helped him to get out of a rat.

A. W. M., Manchester, says —
“ I am employed in a large electrical works, and I consider that the purchase of *Practical Electrical Engineering* is one of the best investments I have ever made. It has helped me to get out of a rat, and my prospects of advancement are now much brighter than they were a few months ago before I had bought and studied this wonderful book.”

OVER
30 SPECIALIST CONTRIBUTORS
MORE THAN
1,000 ILLUSTRATIONS
2 FOLDING PLATES
SECTIONAL MODELS
IN FULL COLOURS
OVER 1,900 PAGES

To The HOME LIBRARY BOOK COMPANY

(George Newnes, Ltd.)

TOWER HOUSE, SOUTHAMPTON ST., LONDON, W.C.2

Please send me, without any obligation to purchase, full particulars of PRACTICAL ELECTRICAL ENGINEERING and details of your scheme of Easy Payments with immediate delivery.

Name

Address

..... PRAC. W. 1537
If you do not wish to cut your copy, send post card mentioning “Practical Wireless” to address above.

George Newnes, Ltd.