

SUPERHETS FOR THE SHORT WAVES!

Practical Wireless

3^D

Published every Wednesday by

GEORGE NEWNES LTD.

Vol. 3. — No. 72.
FEBRUARY 3rd, 1934.

Registered at the G.P.O. as a Newspaper.

AND PRACTICAL TELEVISION

EDITED BY F.J. CAMM

More about

F.J. CAMM'S

FURY 4 SUPER



Also Inside

- CIRCUITS WORTH TRYING
- CHOOSING VALVES
- PRACTICAL HINTS AND TIPS
- TELEVISION SUPPLEMENT
- SOLDERING TAGS OR TERMINALS?
- BEGINNER'S SUPPLEMENT
- SHORT-WAVE SECTION
- ETC., ETC.



WREN-EASTON 3

the easiest set in the world to build and to understand

PILOT AUTHOR KIT

Backed by **PETO-SCOTT**
Pioneers of Kits since 1919

KIT "A." Complete Kit with Ready-drilled Panel, Metaplex Base-board, less valves and Cabinet. Cash or C.O.D. Carriage Paid. **£4-10-0** or 12 monthly payments of **8/3**

For full details see our full page announcement, page 879, "Practical Wireless," Jan. 20th, 1934.



PETO-SCOTT CO. LTD. 77, CITY ROAD, LONDON, E.C.1.

LOOK AT THIS WEEK'S SPLENDID FIRST PRIZE!

£350

FIRST PRIZE £100

and a
FORTNIGHT'S LUXURY CRUISE

SECOND PRIZE
£50
THIRD PRIZE
£25
FOURTH PRIZE
£20
FIFTH PRIZE
£15

THIS week we offer a splendid first prize of £100 in cash and a Fortnight's Luxury Cruise. If you win, and cannot get away for a holiday, you may have £20 in cash instead—making a total of £120!

£10. £5. £5.

20 of £2 20 of £1
80 of 5/- 160 of 2/6

"NAPS" is the title of a new phrase-forming competition. It has made an instant appeal to all readers. It is quite simple. You form a sentence from a list of words and compose another phrase having an apt bearing on the sentence. Now read the full details and note how easy it is to win.

HOW TO WIN

FIRST, from the list of words below choose any one, two, three or four to form an Example line. In order to give you greater scope, you may take any two which, joined together, form one—such as PASS and AGE—PASSAGE, or CAN and DID—CANDID. These would each be counted as one word.

After you have made your Example line you compose a phrase having an apt bearing on the Example. Your phrase must not consist of more than five words—any five words you like.

Here is a specimen of joined words to use in the formation of an Example. The word "AS" combined with the word "SET" gives "ASSET." Add the three words to THE FAMILY and "ASSET TO THE FAMILY" becomes an Example line. Compose a phrase such as "ERNEST" EARNING and you have a "Nap" that is bound to catch the judges' attention.

A good Example line, compiled of separate words from the list, would be "COLLEGE ACCENT" and a "Naps" phrase, such as "PUT ON"—"TAKEN OFF" would immediately attract the judges' eye.

See how easy and entertaining is this new phrase contest! Your money-making pastime for winter evenings!

RULES.—1.—You may enter as many "NAPS" as you wish. 2.—The entrance fee is 3d. for one line, 6d. for two, and so on. Postal Orders for amounts of 6d. and over should be made payable to "Editor," Tit-Bits, crossed "& Co." and YOUR FULL NAME AND ADDRESS MUST BE WRITTEN ON THE BACK. 3.—The Prizes will be awarded in the order of merit, according to the opinion of Mr. Gilbert Frankau, who will make the final decision. 4.—The Editor's decision in all other matters relating to this contest is final. 5.—Proof of posting will not be accepted as proof of receipt or delivery. 6.—No employes (or members of their families) of George Newnes, Ltd., and associate companies are allowed to enter.

SCAR LET THE A GO ALSO TO DO AT IN PASS AS AND	OF TEN SET REST ORE SOME THING AGE WITH SO ON TENSE SMASH	GRAB MOTORS FRIEND MONEY FOR FAMILY GAME CAN DID. HER PROPOSAL COURTING	ACCENT RAT KISS DARK LOOKING AFTER POLICE COLLEGE EXPERIMENTS SUITOR DOLLAR LEFT
------------------------------------------------------------------------------------	-----------------------------------------------------------------------------------------------	----------------------------------------------------------------------------------------------------------	-------------------------------------------------------------------------------------------------------------------

A FEW READY-MADE EXAMPLES:

EXPERIMENTS WITH THE DOLLAR	IN THE DARK LOOKING FOR A SUITOR TEN IN FAMILY SOMETHING TO KISS POLICE! SUITOR ALSO SCARLET THE GAME OF COURTING AGE OF MOTORS AFTER THE PROPOSAL THE CANDID FRIEND A TENSE GAME	IN THE PASSAGE ASSET TO THE FAMILY MONEY TO LET SOON AFTER THE SMASH COLLEGE ACCENT LOOKING FOR HER THE SUITOR TO GRAB SET AT REST LEFT A SCAR RAT TO GO FOR THE THING TO DO
--------------------------------	-----------------------------------------------------------------------------------------------------------------------------------------------------------------------------------------------------------------	------------------------------------------------------------------------------------------------------------------------------------------------------------------------------------------------------------------

COLLEGE ACCENT—"PUT ON"—"TAKEN OFF"
ASSET TO THE FAMILY—"ERNEST" EARNING

Mr. GILBERT FRANKAU, the famous author, has agreed to examine and adjudicate upon the selection of attempts submitted to him by the Judges. He will select those attempts which appeal most to him and arrange them in order of merit.

<p><small>I agree to enter this competition on the printed conditions, and to abide by the published decision, which I will accept as final.</small></p> <p>Signed.....</p> <p>Address.....</p> <p>No. or Postal Order..... P.L.W. 3.</p>	EXAMPLES. ONE TO FOUR WORDS.	"NAPS," ONE TO FIVE WORDS	ENTRY FEE.
			3d.
			6d.
			9d.
			1/-
			1/3
			1/6
			1/9
			2/-
	CLOSING DATE, TUESDAY, FEBRUARY 13th. Address your envelope Naps 3, "Tit-Bits" Comp. Dept., 39, King St., Covent Garden, W.C.2		

our Latest Gift Offer!

Newnes' EVERYMAN'S WIRELESS BOOK

has been specially prepared for readers of 'P.W.' by F. J. Camm.

For fuller details see last week's issue of "Practical Wireless."

THE enthusiasm with which readers of this paper have accepted this offer is conclusive proof of the urgent need for such a Work among practical men. The response to this great Gift Offer has been almost overwhelming and our remaining stock of unreserved copies is being reduced day by day. If you have not yet reserved your copy do so without delay.

We definitely guarantee that all reservations received immediately will be met.

FOLLOW THESE SIMPLE RULES.

Fill in and post the Reservation Form and stamped addressed label.

On receipt of the Reservation Form and label, we will send you a Voucher on which to qualify for your copy of Newnes' Everyman's Wireless Book. The volume will be reserved for you, and will be despatched immediately we receive the completed Voucher.

Affix to the Subscription Voucher which we post to you on receipt of your Reservation Form 9 Gift Stamps cut from the bottom left-hand corner of the back cover of "Practical Wireless" for 9 weeks commencing this, last week or the week before.

When your Subscription Voucher is complete, send it, together with a Postal Order for 2s. Od., which will include the cost of registration, postage, packing, insurance, etc., to "Practical Wireless" Presentation Department, and your Volume will be despatched to you immediately. No reader may qualify for more than one copy of the Encyclopaedia.

This offer applies to persons residing in Great Britain and Ireland. Readers in the Irish Free State must pay any duty imposed.

Any query regarding this offer must be accompanied by a stamped addressed envelope.

POST THIS RESERVATION FORM IMMEDIATELY TO

PRACTICAL WIRELESS

Presentation Department, 22, Tavistock Street, London, W.C.2.
In accordance with the conditions of your special offer, please send me a **SUBSCRIPTION VOUCHER** on which to qualify for my copy of Newnes' Everyman's Wireless Book. I am a regular reader of "Practical Wireless."

Reader's Name.....
Full Address.....
Newspaper.....
Address.....
Reader's Signature..... *Leave blank.*

Fill in this form and the label on left in Block Letters. Stamp the label as directed and post both of them in an unsealed envelope (4d. stamp only required).

4d. Stamp must be affixed here.

ADDRESS LABEL

If undelivered, please return to Geo. Newnes, Ltd., 22, Tavistock Street, London, W.C.2.

Name.....
Street.....
Town and County.....

By sending in your Reservation Forms at once you will ensure a copy of Newnes' "Everyman's Wireless Book" being specially set aside in your name and can then immediately start qualifying for it in accordance with the simple conditions set out above.



**VARIABLE-MU
SCREENED-GRID CIRCUIT**

MOVING COIL SPEAKER

SINGLE DIAL TUNING



● Vivid, true-to-life reproduction—magnificent “all-Europe” performance—dignified cabinet design. These are the three great features which have made the Cossor Radio Console an outstanding example of moderately priced radio. Let your ears convince you of its superb tone—hear a Cossor Radio Console working at your local wireless shop.

COSSOR CLASS "B" BATTERY CONSOLE Model 3456

Complete Receiver, as illustrated, with Cossor 220 VS Variable-Mu Screened Grid, Cossor 210 HL Detector, Cossor 215 P Driver and Cossor 220 B Class "B" Output Valves. Single-dial tuning, selectivity control and combined volume control and "on-off" switch. Wavechange switch for 200-530 and 900-2000 metres. Handsome walnut finished Console Cabinet, 2 ft. 11 in. high, 1 ft. 7 in. wide, 11 in. deep, giving ample accommodation for batteries. Permanent Magnet Moving Coil Loud Speaker of the latest type. Gramophone Pick-up Plug and Socket. **PRICE £9.19.0**

Price does not include Batteries or Accumulator. Hire Purchase Terms: 20/- deposit and 10 monthly payments of 20/-.

COSSOR ALL-ELECTRIC CONSOLE (for A.C. Mains) Model 3468

Specification similar to Battery Model 3456, but operating from Electric Light Supply. Complete with four Cossor A.C. Mains Valves viz.: M.V.S.G. (Met.) Variable-Mu S.G., 41 M.H. (Met.) Detector, 41 M.P. Output and 442 B.U. Rectifier. Mains Energised Moving Coil Speaker. Illuminated tuning-dial. For A.C. Mains only, 200/250 volts adjustable, 40/100 cycles. **PRICE £10.15.0**

Hire Purchase Terms: 25/- deposit and 10 monthly payments of 21/-.

COSSOR ALL-ELECTRIC CONSOLE (for D.C. Mains) Model 3469

As Model 3468, but for operation on D.C. Mains. Supplied complete with three Cossor D.C. Mains Valves viz.: D.V.S.G. (Met.) Variable-Mu S.G., D.H.L. (Met.) Detector and D.P. Power Output. For D.C. Mains only, 200/250 volts (adjustable). **PRICE £10.15.0**

Prices do not apply in I.F.S. Hire Purchase Terms: 25/- deposit and 10 monthly payments of 21/-.

Legs are detachable on all Console Models and the receivers can be used as table models with legs detached.

**COSSOR
RADIO CONSOLES**

● To A. C. COSSOR LTD., Melody Dept., Highbury Grove, London, N.5.

Please send me free of charge, your 20-page Catalogue of Radio Receivers B.20.

Name.....

Address.....

PRAC. 3/2/34.....

SOLDERING TAGS OR TERMINALS?

OUR READERS SUPPLY THE ANSWER. SEE PAGE 946.



EDITOK:
Vol. III. No. 72 || F. J. CAMM || Feb. 3rd, 1934.
Technical Staff:
W. J. Delaney,
H. J. Barton Chapple, Wh.Sch., B.Sc. (Hons.), A.M.I.E.E.,
Frank Preston, F.R.A.

ROUND *the* WORLD of WIRELESS

Many Thanks!

CORDIAL thanks to the many readers who have written in congratulation concerning our new receiver, the 1934 Fury Four Super, and thanking us for our moderation in the space devoted to it. Quite naturally we have the interests of every reader at heart, and excellent as the Fury Four Super is, it is a part of our policy not to cut down the amount of general reading matter in order to make room for descriptions of our receivers. In every case we prefer to enlarge the issue to carry the extra descriptive matter.

Antarctic Saturday Broadcasts

MOST of the American short-wave fans make an attempt every Saturday night to tune-in *direct* the broadcasts of KJTY, from the Byrd Antarctic Expedition. They have already been picked up on and around 26 metres, a channel which would appear to have been recommended for DX work by the Marchese Marconi when he was interviewed by one of the members of the expedition. There is no reason for which owners of short-wave sets in the British Isles should not try for these signals: the time for a search is about G.M.T. 3 a.m. (Sundays).

The Modern Tower of Babel

BROADCASTING in some European countries is greatly complicated by the fact that more than one language may be necessary to give a service to the entire population of a State. Belgium, Switzerland, Czechoslovakia, and even France (in view of its reconquered areas) are compelled to transmit programmes in from two to three tongues. In Norway the problem is not so acute, although the country uses two languages, *Riksmål*, somewhat similar to Danish, and *Nynorsk* (Neo-Norwegian) of more modern origin. In its programmes the Oslo studio makes every effort to reconcile the wishes of the supporters of both these tongues.

The Paris P.T.T. High-power Station

WORK on the new station at Villebon-sur-Yvette, destined to replace the *École Supérieure* (P.T.T.) transmitter, is being hurried forward, as the authorities are anxious to launch it on the ether with a national programme on July 14th.

Sponsored Concerts

LISTENERS to European broadcasts will have noticed to what extent publicity programmes destined to the British Isles have been developed during the past few months. Sponsored programmes, announced in the English language, are now regularly transmitted from Athlone, Fécamp, Poste Parisien, Juan-les-Pins, Ljubljana, Barcelona (EAJI), San Sebastian (EAJ8), and through Madrid EAQ on 30 metres. In most instances, the broadcasts are carried out in the later evening hours.

National Wireless Sets

FOLLOWING the example of Germany, where the authorities have designed and placed upon the market a cheap wire-

NEWNES' EVERYTHING WITHIN

All readers who have not done so should at once send in their reservation forms (see page 937 of this week's issue) for the above volume. The offer for this remarkable volume (a new work by the Editor of this journal) will shortly be withdrawn. Do not miss the opportunity of acquiring a copy of this unique radio consultant, which not only explains in simple language the theory of wireless, but also provides the listener and the amateur with a valuable home doctor for radio. Reserve your copy Now.

less receiver for general use, Poland, under the name *Delephone*, is also turning out a set from its national works. Contrary to the method adopted by Germany, where the instrument must be paid for on delivery, the Poles are giving facilities to buyers, inasmuch as listeners may purchase the instrument by twelve instalments, remitted to the Post Office with the monthly contribution towards the annual listening licence. It is hoped that the new regime will result in an increase of registered listeners, which to date number roughly 315,000.

A Visit to Rugby

ON February 17th the Midland Regional studio will take listeners to the Rugby wireless stations; the programme

will be relayed by London. It will include a visit by "mike" to the top of one of the 820ft. masts, from which position an engineer will give a description of the scene.

Berlin's Anti-fading Aerial

THE aerial of the new 100-kilowatt Berlin transmitter consists of a single wooden mast 165 metres high (544 ft.) down the centre of which runs a copper rod lin. in diameter. The mast is crowned by a circular aerial which has been found to increase radiation and also greatly decrease fading of signals.

Radio Advertising Verboten!

RECENT regulations drawn up by the German *Reichsfunk* now forbid any private advertising to be broadcast from the State transmitters. The only publicity allowed is that organised by the Ministry of Propaganda for the benefit of the nation as a whole.

Radio Normandy's Wavelength

IT is unfortunate that the French State should have compelled the Fécamp station to reduce its wavelength to the bottom of the band, as not only is the channel (200 m.) an unfavourable one, but it carries with it stringent restrictions regarding power. The station is complying with the request, but we believe that this is only a temporary measure, and that negotiations may result in a more suitable channel for this popular broadcaster.

Still Holding the Lead

DURING December, 1933, the Post Office authorities in Great Britain issued roughly 799,000 licences, bringing up the total to the end of the month to 5,973,700 registered listeners. Not very far from six millions, which puts us well on top of the list.

Where Is Istanbul?

SOME surprise has been expressed regarding the fact that the Constantinople broadcasting station should have disappeared from the list of long-wave stations. Turkey was given a long channel, which is being used for Angora. Constantinople (Istanbul) will not appear in our logs as the wavelength allocated is 261.1 metres, which it shares with London National.

ROUND *the* WORLD of WIRELESS (Continued)

High-power Station at Dniepropetrovsk

THE new 100-kilowatt station in the Ukraine (Russia) has been brought into service, and now works on 328.6 metres, a channel shared with PTT Limoges. The power of this transmitter is such that its broadcasts can be heard in the British Isles.

German Plans for 1934

IN addition to the alterations already made in the power of the Munich, Muehlacker and Berlin transmitters, in August, 1934, we may expect to hear Breslau, Langenberg and Heilsberg broadcasting on 100 kilowatts. Moreover, plans have already been passed for new relay transmitters at Dresden and Stettin, as well as for a station at Coblenz. Koenigs Wusterhausen on the "long waves" will be increased to 150 kilowatts. Possibly the 1,634.9 metre wave-length may be retained if all stations working on channels above 1,000 metres do not take up their allotted positions.

Broadcasts from South Polar Regions

THE Columbia broadcasting system now transmits every Saturday night at 10.0 p.m., Eastern Standard Time (3.0 a.m. G.M.T. on Sundays) over its network of fifty-nine stations a special programme given by the members of Admiral Byrd's Second Antarctic Expedition. Later, for the benefit of European listeners, a relay will also be carried out by W2XE, Wayne (N.J.), on 49.02 metres. The signals, although sent direct from "Little America" in the polar regions, will be relayed through one of the powerful Buenos Aires short-wave transmitters to New York via the Radio Corporation of America's station at Riverhead (Long Island). In exchange, special broadcasts containing all news of interest to the members of the Expedition will be sent by the Columbia stations.

Listeners' Request to Close Local Station

NORWEGIAN radio fans have petitioned their Government to close down the temporary station which the authorities had opened for their benefit at Vardø as its broadcasts interfere with the direct reception of programmes from Oslo and from foreign sources. Even at Vadsø, where a transmitter is to be erected to take the capital radio entertainments via the short-wave station at Jeløy, listeners have expressed the opinion that they would prefer to be without a local service. It is thought, on the other hand, that conditions would improve if the power of the Oslo station were materially increased.

Entertainment Relays from Midland Regional

TWO hours of the Midland Regional programme on February 10th are devoted to a round of entertainment—the programme being relayed from three Central Halls and from a theatre at Coventry. Murray Ashford's entertainers at the

INTERESTING and TOPICAL PARAGRAPHS

Central Hall, Coventry, open and close the bill. Elsie Suddaby and John Holt sing at Walsall; Bransby Williams will be heard in character sketches and Marjorie Astbury in violin solos from the Central Hall, Birmingham; and there will be a short play by Coventry Repertory Company, produced

CONTROLLING EUROPE'S WAVELENGTHS.



A section of the small laboratory at Brussels which will form the "nerve centre" for the direction and control of the new wave lengths of the broadcasting stations of Europe. Tucked away in this laboratory, with charts and maps, high-powered receiving sets, direction charts and a dozen different telephones, will be Mr. Raymond Brillard, the technical chief of the Union Internationale de Radiodiffusion.

by A. Gardner Davies, at the Opera House there.

Thanks to an Amateur Transmitter

IN the U.S.A., where the number of amateur "fans" is legion, many services have already been rendered by them in cases where no other assistance was available. Recently, when listening, one Ed Stevens, of Seattle, picked up an S O'S call emanating from a lonely island off the coast of Alaska. It concerned the serious illness of a child for whom no medical attendance was forthcoming. Passing the call on, Stevens was able to get in touch with one of the Northern military posts which, in response to his appeal, promptly despatched an aeroplane and thus conveyed, without delay, the sick child to a hospital on the mainland.

A Period Feature Broadcast

A PERIOD feature is the chief attraction for Midland Regional listeners on February 5th, the age chosen being that of Dr. Johnson, whose birthplace at Lichfield is the second most famous literary shrine in the Midlands. The great Cham of Letters and his biographer, Boswell, will be represented on their Hebrides tour through the medium of Murray Maclaren's short play *Dr. Johnson on Skye*, which has a Jacobite motif. The programme of period music includes Handel's Concerto Grosso, a Boyce Symphony and dances from Arne's *Comus* which are to be played by Birmingham Philharmonic String Orchestra, conducted by Johan Hock; Arne's Sonata in A, given on the harpsichord by Michael Mullinar, and songs from *The Beggar's Opera* and *The Mock Doctor* by Alex Penney.

Curiouser and Curiouser!

ACCORDING to a report from Stockholm a Swedish engineer, Balsac von Platen, claims to have solved the problem of the wireless transmission of power. No details of the invention or apparatus used are given, but it is stated that a company has been formed to exploit this sensational discovery.

Radio to the Rescue

BY contributing an amount said to be in the neighbourhood of three hundred thousand dollars, the National Broadcasting Company of America would appear to have assured the continuance of performances at the Metropolitan Opera House, New York. Relays of operas with some of the world's greatest singers are regularly made over the N.B.C. Network.

Switch Over to Battersea

FEBRUARY 23 marks the date of an interesting experiment to be carried out by the B.B.C. engineers. They will attempt one of the most difficult of any outside broadcast yet undertaken—that of installing microphones to tour the Battersea power station. As these generators have an output reaching as much as 100,000 kilowatts, special precautions must be taken to shield the broadcasting apparatus.

SOLVE THIS!

PROBLEM No. 72.

Arthurs built up a mains four-valver, which gave splendid results when first put into commission. After an hour's use signals suddenly became distorted and dropped to less than half the original strength. The set was switched off and left until the next day, when the same thing occurred. Upon testing the various H.T. positive points, Arthurs found that when the set was operating satisfactorily the voltage on the detector anode was only about 25 volts, and as soon as the drop in volume occurred this voltage also dropped to 5 volts. What was wrong? Three books will be awarded for the first three correct solutions opened. Address your envelopes to The Editor, PRACTICAL WIRELESS, George Newnes, Ltd., 8-11, Southampton Street, Strand, London, W.C.2, and post to reach here not later than February 5th. Envelopes must be marked Problem No. 72.

Solution to Problem No. 71.

When he purchased his new components Arrowsmith forgot that he required a low-frequency choke, not an H.F. choke. Therefore he had not provided an adequate load for the valve with the H.F. component.

Two readers only successfully solved Problem No. 70, and books have accordingly been forwarded to them:

J. R. Acock, 96 Woodside Road, Sidcup.
H. Wilson, 30 Lanant Road, Chelsea, S.W.3.

Some Circuits Worth Trying

By H. J. BARTON CHAPPLE, Wh.Sch., B.Sc.

There is No Substitute for Actual Experience, so to Become Thoroughly Acquainted with New Radio Developments, try a few Experiments Yourself. Here are Some Useful Circuits to Help You

A LARGE number of listeners have, no doubt, already completed the building of their new season's set, and are looking about them for some fresh activity to occupy the winter evenings, and it will therefore be helpful to offer some suggestions for useful circuits which they may try in order to widen their general experience. In many cases most of the components can be taken from that valuable collection of spare apparatus which all real experimenters amass in the course of time, and for this reason only the main outline of the circuits and a few practical hints will be given, leaving the detailed design and layout to be developed by the individual experimenter. First we will begin with a few circuits, each employing a single special feature or providing the material for a single experiment. The reader can then develop other circuits embodying such features and thus, perhaps, map out the main lines for his next complete receiver.

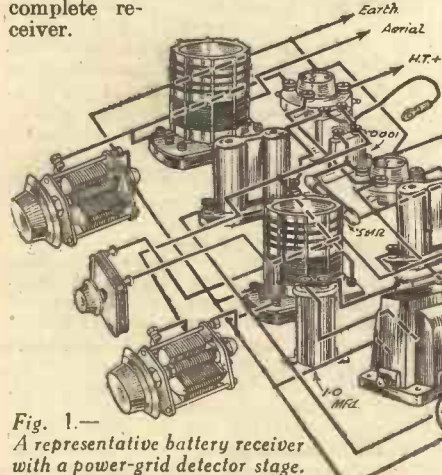

Power-grid Detection
Let us take the detector stage first. Have you ever tried anything more than the ordinary leaky-grid system? If not, try a real "power-grid" detector for your first experiment. You will want to rig up a circuit containing at least one high-frequency stage, for power-grid is mainly a device to rectify signals of considerable strength. Figs. 1 and 2 show typical circuits for both battery and A.C. mains operation. The main points which require attention are the grid and anode circuits of the detector. Any good detector valve may be used, and matters must be so arranged that the maximum high-tension voltage for which the valve is rated is applied at the anode. For example, if a battery valve is employed, which can be used at "maximum anode volts 150," be sure and use 150 volts.

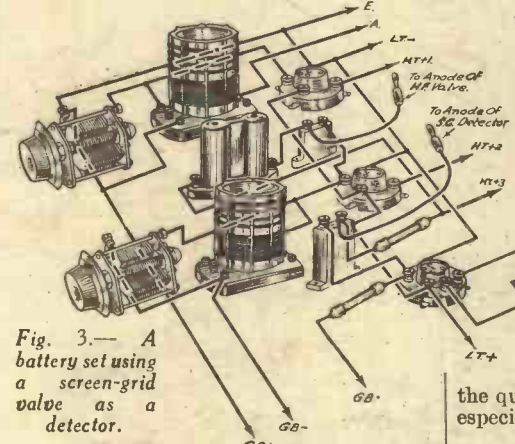
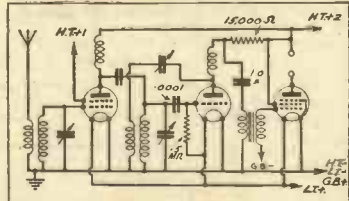
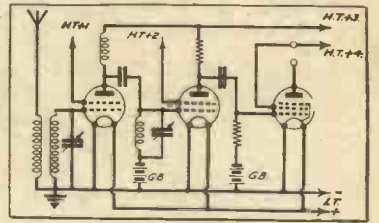

Fig. 3.— A battery set using a screen-grid valve as a detector.



Instead of the usual .0003 mfd. condenser and 2-megohm grid leak, a grid condenser of about .0001 mfd. and a leak of 1/3 to



the transformer core. Approximate values for the essential components are marked on the diagrams.

Remember that no greater amplification will be obtained with power-grid detection, but the quality of reproduction will be better, especially with strong input signals.

Two Interesting Circuits

Another interesting detector circuit is shown in Fig. 3 in which a screen-grid valve is employed as detector. By virtue of its high amplification factor such a valve makes a very sensitive detector. Best results are obtained from the "anode bend" method of rectification, which necessitates the use of a certain amount of negative grid bias; consult the instruction slip issued by the valve maker for the correct value. Because this type of valve has a very high impedance, resistance-capacity coupling is essential to obtain good results, and the anode resistance should be of the order of 1/4 to 1/2 megohm. A circuit with one high-frequency stage is

(Continued overleaf)

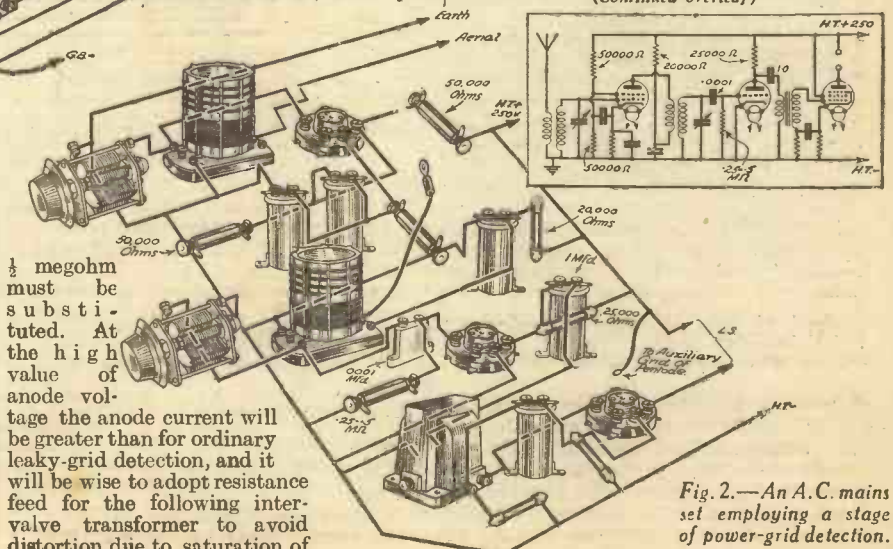
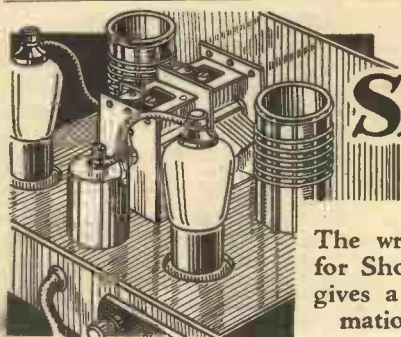

Fig. 2.—An A.C. mains set employing a stage of power-grid detection.



Superhets for SHORT WAVE Listening

The writer considers that the Superhet is ideal for Short-wave Listening, and in this article he gives a considerable amount of Practical Information in regard to this Type of Circuit.

By FRANK PRESTON.

It is rather unfortunate that more amateurs do not use a superheterodyne circuit arrangement for short-wave reception, because this would solve a large number of the difficulties which frequently arise. The detector-L.F. type of circuit is ideal for the experimenter, and takes some beating for the person who is expert at "twiddling the knobs," but for those who desire to go in for short-wave listening, as opposed to experimenting, the superhet is without a peer. A receiver of this kind can easily be tuned by means of a single knob and without the need for those delicate reaction adjustments which are always called for with a short-wave set of the "straight" type. It is often considered that a superhet must necessarily have a large number of valves, and therefore that it must be expensive. This is not the case, for a four-valve super for short-wave reception will easily give loud-speaker signals quite as good as those to be obtained with a three-valve "straight" arrangement. In the hands of an inexperienced amateur, in fact, the volume to be obtained will be much greater, besides which, far more stations will easily be receivable.

A Four-valve Short-wave Superhet

The circuit at Fig. 1 shows how extremely simple a four-valve short-wave superhet really is, and it should be stated that a set built around this circuit can be relied upon to give excellent results under practically any conditions. A standard dual-range short-wave tuner is employed in the aerial circuit, and this feeds into a combined detector-oscillator first valve. This is of the screen-grid type and operates on the anode-bend principle. Initial setting of the reaction is carried out on the .0001 mfd. reaction condenser, and any further adjustment is made on the screening-grid potentiometer, which enables the exact degree of feed-back to be obtained under all conditions. Normally, it is only necessary to set the reaction controls to their optimum positions, after which stations on any part of the waveband in use can be tuned-in by the simple process of rotating the (slow-motion) dial of the .0003 mfd. tuning condenser.

The detector-oscillator feeds into the screen-grid intermediate frequency amplifier through an I.F. transformer of the type tuning to 150 kcs., this frequency being produced by the first valve operating on the autodyne principle. A second and similar I.F. transformer is used to couple the I.F. amplifier to the second detector, which works on the usual leaky-grid

system. A standard form of L.F. coupling is then used between the second detector and the pentode output valve.

A receiver of this kind can be made up very easily, and if the aerial coil and I.F. transformers are screened, the layout is

31.38 metres, or Rome on 25.4 metres. After these adjustments have been made, any number of stations can be tuned in, and sometimes the signal strength can be increased by making a final slight adjustment of reaction. It should be mentioned that nothing will be heard if the first valve is not oscillating, so that in some cases reaction will have to be increased as the condenser is set for the higher wavelengths. In any case reaction control is not critical and should present no difficulty whatever.

A Simple Converter

When it is not proposed to construct a complete receiver especially for short-wave use, it is still possible to use the superhet idea in the form of a converter which may be used in conjunction with the ordinary broadcast set. If the latter is provided with one or more H.F. stages, only a single valve will be required, and the circuit should be like that shown at Fig. 2. It

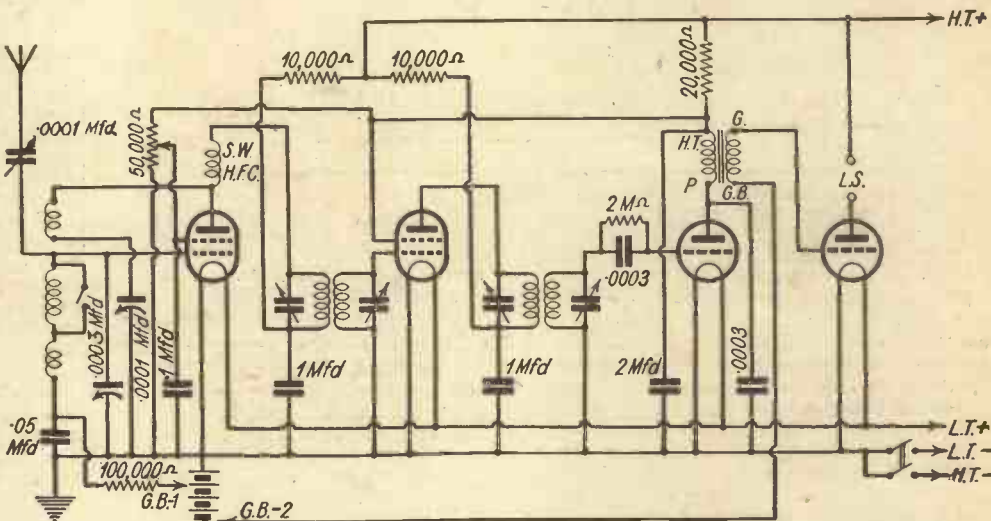

Fig. 1.—The circuit of an excellent 4-valve S.W. Superheterodyne; this is referred to in the text.

by no means critical. It is best to employ circuits on top, with the filament, high-tension, and L.F. components underneath. Standard valves are used throughout, and these may be those which have previously been employed in an ordinary broadcast receiver. In most cases it will be found best to apply a negative G.B. voltage of about 1.5 to the first valve, but alternative voltages up to 4.5 should be tried.

Initial Adjustments

The initial adjustments consist of setting the reaction controls until the first valve is oscillating freely (generally indicated by the cessation of a faint "hissing" sound heard in the speaker) and setting the trimmers on the I.F. transformers until maximum signal strength is obtained from a station which is not normally subject to fading. A suitable signal is generally provided by Zeesen on

will be seen that this is just the same as the first valve of the complete receiver

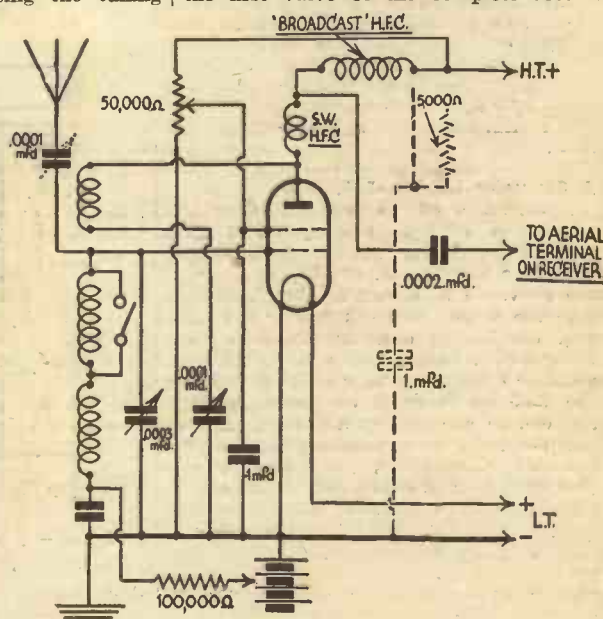

Fig. 2.—A simple S.W. Converter suitable for use with any broadcast receiver having an H.F. amplifier. The circuit is almost identical with that used for the first valve in Fig. 1.

previously discussed, and that the output lead is merely joined to the aerial terminal of the broadcast receiver. The two filament leads should be connected to the filament terminals on one of the valve-holders in the set so that both set and converter can be switched on simultaneously. Inter-

always be set to give maximum signal strength, but once it has been adjusted it will "hold" over the complete wavelength range of the converter.

For Mains Sets

The circuits given so far have been in re-

own mains supply equipment, and this might be considered superfluous. As a matter of fact, however, it is quite essential with most receivers, because the output of the mains equipment is generally just sufficient for the set itself. On the other hand, if the H.T. and L.T. supply circuits are not fully loaded, the converter could be fed from them if desired. The converter will require 4 volts at 1 amp. for the heater of the valve and about 180 volts at 7 milliamps. for high-tension purposes. When there is so much power to "spare" in the supply circuits of the receiver the heater of the new valve can be wired in parallel with those of the other receiving valves and the high-tension supply can be taken through a 5,000 ohm resistance connected to the positive side of the smoothing equipment. Ample decoupling must be provided, and, therefore, a 2 mfd. condenser must be joined between the "anode" side of the resistance and earth.

An Ideal All-wave Receiver

I consider that a combination of a four-valve (two V.M.) broadcast receiver and a short-wave converter of the type represented by Fig. 4 is an ideal outfit for so-called all-wave reception. It is easier to design than a single receiver fitted with coils covering the several wavebands and, not being in the nature of a compromise, can generally be made to be much more efficient. It is a simple matter to arrange a switch to transfer the aerial lead-in from the converter to broadcast receiver, and vice versa, and it is best to arrange things so that the anode and cathode circuits of the converter are connected to the supply source irrespective of whether the set is being used for short-wave or broadcast reception. The load on the mains transformer is thus maintained at a constant level, and this is frequently more

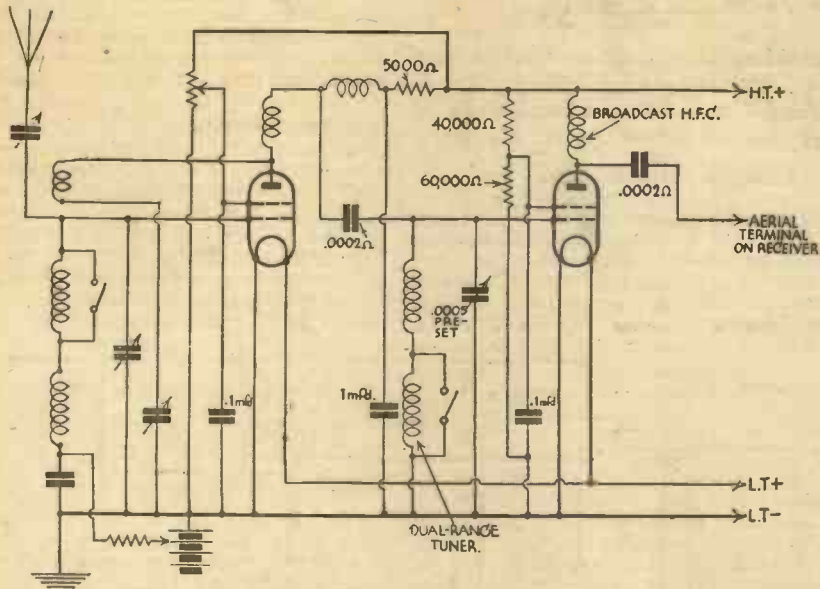

Fig. 3.—This circuit represents an excellent converter arrangement for use in conjunction with a non-H.F. broadcast receiver.

mediate-frequency amplification is carried out by the H.F. valves in the broadcast receiver, and coupling between the converter and first receiver valve will be on the tuned-grid system, the "broadcast" H.F. choke being used along with the .0002 mfd. fixed condenser for this purpose.

In use, the set is first tuned to about 2,000 metres, or the highest wavelength possible, and the reaction controls on the converter are operated exactly as described before. The screening-grid potentiometer and anode-circuit lead from the converter are shown as being joined together and taken to a tapping on the H.T. battery, but in practice it will sometimes be found that better results are to be obtained by inserting a 5,000 ohm decoupling resistance and 1 mfd. condenser as shown by broken lines.

A Converter for Det.-L.F. Sets

A converter of the type just described cannot be used in conjunction with a non-H.F. receiver, but it is a simple matter to add an I.F. amplifying stage to the converter as shown in Fig. 3. In this case the second valve is fed by a tuned-grid circuit, an ordinary broadcast coil being used in conjunction with a .0005 mfd. variable condenser. This latter may be of the bakelite-dielectric or pre-set pattern and can be mounted on a chassis, since it will not need to be altered after the preliminary adjustments have been made. The converter is connected to the set as described before, and after the receiver has been tuned to its highest wavelength the pre-set tuning condenser in the converter should be adjusted until signal strength attains a maximum on some particular station. After that, nothing but the aerial tuning condenser and (occasionally) the reaction controls need be touched. It ought to be mentioned that the reaction control on the broadcast receiver should

spect of battery-operated converters, but all of them can readily be modified for mains working. A mains-operated converter using an indirectly-heated A.C. valve is given at Fig. 4, and this can be used very successfully in conjunction with almost any mains A.C. receiver having an H.F.

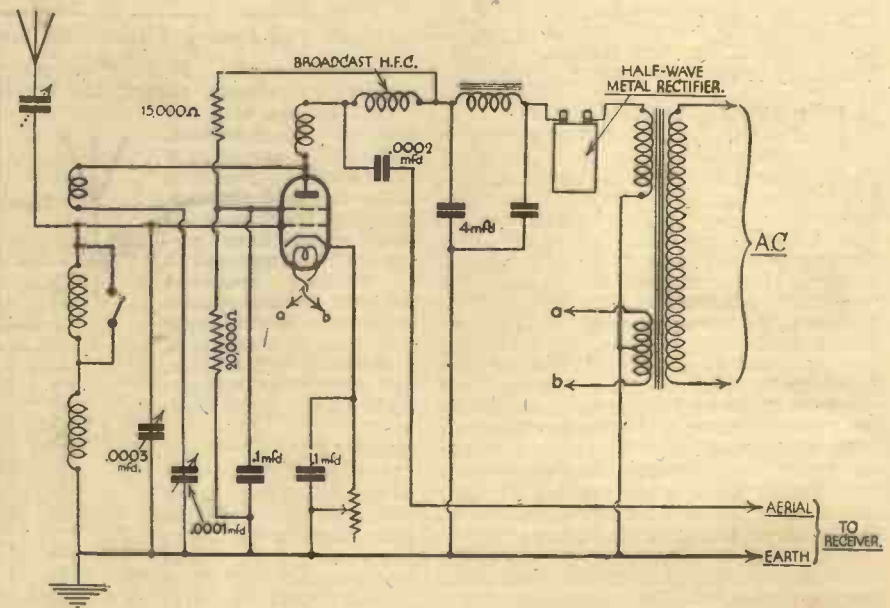

Fig. 4.—The circuit of an all-mains converter complete with its own power supply circuits.

amplifier. As a matter of fact, the converter shown is ideal for use in conjunction with a powerful two-V.M. receiver like the "Quadpak," which was described in PRACTICAL WIRELESS dated December 2nd and December 9th, 1933. It will be observed that the unit shown is provided with its

important than the fact that a small amount of current is wasted when the short-wave section is not in use.

One disadvantage of the scheme just outlined is that it becomes necessary to have two tuning dials and an extra knob (for reaction) on the front of the set.

HOW TO CHOOSE AND USE THE BEST VALVES



PART II.

In this Series of Articles the Author Explains the Function of the Various Types of Valves Employed in Modern Receivers.

If there is one stage more than another in a receiver in which it is difficult to go wrong in the choice of valves, it is the detector stage. This is very largely due to the fact that the range of choice is limited. Receiver design, at any rate, in so far as the detector stage is concerned, has now become practically standardized, some form of leaky-grid rectifier being almost universally chosen. Up to a few seasons ago there was no little rivalry between the partisans of anode-bend rectification and of the leaky-grid detector. In anode-bend detection, the valve is given sufficient negative bias to bring the working point down to the bottom bend of the grid volts-anode current curve, with the result that positive half-waves of the incoming signal are amplified and the negative half-waves are almost entirely suppressed. The system works well and gives good quality, provided the incoming signals are fairly strong. It is comparatively insensitive to weak signals, however, and is apt to introduce considerable distortion on weak signals and on exceptionally strong signals.

Detector Modification

The ordinary leaky-grid detector, on the other hand (see Fig. 1), in which negative half-waves of the incoming signal are fully amplified and positive half-waves almost entirely suppressed owing to grid current damping, is very sensitive to weak signals. It is, however, liable to distort very strong signals.

About two years ago the modification known as "power grid" detection was introduced. This system is basically identical with leaky-grid detection, but the valve is operated at a much higher anode voltage. The effect is greatly to extend the grid base of the valve, and hence its signal-handling capacity. In other words, a power grid detector, while retaining the sensitivity of the earlier leaky-grid detector, will rectify much stronger signals without distortion.

It must not be imagined that by increasing the anode voltage to any detector valve, ordinary leaky-grid is immediately con-

verted to power-grid. Alterations must also be made to the grid circuit of the detector valve. In the first place, to ensure the due discharge of the grid, a smaller resistance value of grid leak is usually necessary, one quarter to one half megohm being the normal value. Then it is usually advisable to reduce the size of the grid condenser from the standard .0003 microfarads to .0001 microfarads.

Valve Types Standardized

Since one or other of the forms of grid rectifier is now practically universal, valve-makers have been able to standardize on a comparatively small range of detector valve types. Generally speaking, a valve of the so-called "H.L." type is satisfactory for almost any set. The "H.L." valves have characteristics between the old "H," "H.F." or "R.C." types, and the "L" or "L.F." types, that is to say, their impedance and amplification factors are in general lower than those of the "R.C." type but substantially higher than those of the L.F. types. The "H.L." type, therefore, will give a good account of itself from the stage-gain point of view when used in conjunction with modern audio-

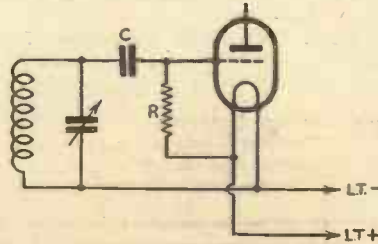

Fig. 1.—General arrangement for leaky grid detector. For ordinary purposes $C = .0003$ mfd. and $R = 2$ megohms, but for power-grid detection C is reduced to .0001 mfd. and R to $\frac{1}{4}$ or $\frac{1}{2}$ a megohm.

frequency transformer coupling, yet is perfectly satisfactory for resistance-capacity coupling in those circuits which still employ this device, providing the anode resistance does not exceed about 100,000 ohms.

Another point in connection with power-grid detection in particular is that the increased anode voltage results in a considerably increased anode current. Few low-frequency transformers, except the most expensive modern types, will carry the full anode current of such a valve without introducing distortion due to magnetic saturation of the transformer core. It is highly desirable, therefore, to adopt the resistance-fed method of connection,

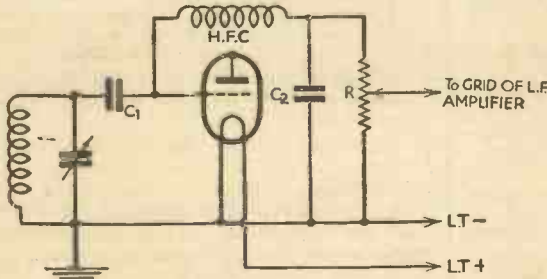

Fig. 3.—A method of using a triode as a diode detector. C_1 and C_2 are small condensers of about .00005 mfd. and R is a $\frac{1}{2}$ megohm potentiometer as a volume control.

whereby the direct current portion of the anode current passes through a high resistance in the anode circuit, only the audio-frequency component being passed through the transformer winding via a coupling condenser, as indicated in Fig. 2. The characteristics of the "H.L." type of valve are particularly suitable for this method of coupling.

Generally speaking, therefore, if it is desired to fit a new detector valve to a battery-operated set, it will suffice to employ one of the "H.L." class. It is, however, necessary to give special consideration to sets of old design employing R.C. coupling with a high value of anode resistance of the order of 250,000 ohms or more. For such a circuit, a valve of the "R.C." class is advisable. Such a valve will have an impedance of 40,000 ohms or

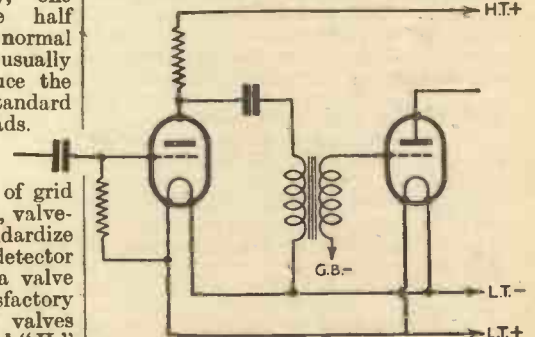

Fig. 2.—Parallel-fed audio-frequency transformer coupling, which is essential with power grid detection.

a little more, as compared with 20,000 ohms for a valve of the "H.L." type, and an amplification factor of about 50, as compared with approximately 28.

For Mains Sets

Turning now to A.C. mains sets, it will be found that most valve-makers list alternative types of detectors. Some makers indeed, offer four types, but all can be roughly divided into two classes—a "high-gain" class having amplification factors of about 75, with an impedance between 30,000 and 40,000 ohms, and a general-purpose type, with an amplification factor of about 35 and an impedance of about 12,000 ohms.

The choice between the two types is easily made. Simple two-valve sets employing detector and one low-frequency stage should usually be fitted with the high-magnification valve, because in a set having no high-frequency stage, the additional amplification in the detector stage is very valuable.

Any set equipped with one or more high-frequency valves should, however, definitely be fitted with the medium-gain detector for two reasons. First, very high gain in the detector stage is not essential in such a set, and second, the medium-magnification valve will handle without distortion larger grid inputs than the high-gain type—and with modern highly efficient radio frequency amplification, quite big voltages are available at the detector grid.

Some manufacturers are still listing a low-impedance triode having an amplification factor of about sixteen and an impedance of about 5,000 ohms. Such a valve is seldom likely to be required in the detector stage of the average set, being more suitable for use in the last low-frequency stage before a big output valve.

(To be continued.)



Readers' opinions in favour of terminals will be given next week.

On page 743 of our issue dated December 23rd the Editor invited readers to give their opinions on the relative merits of terminals and soldered joints. We received an enormous number of entries and those in favour of soldering were, by an overwhelming number, in the majority. This completely upsets the view previously held—that amateurs prefer terminals because few of them can solder. Our competition demonstrates finally that most people to-day can use a soldering iron, and confirms the statements we made that the view previously held in favour of terminals was based on ill-considered opinions. It would seem that the technical press has misled the industry on this point. We publish below some of the opinions in favour of soldering. Further opinions will be given next week.

Soldered Joints More Permanent

SIR,—I prefer soldered joints, as they are efficient and do not oxidize or slack off.

Terminals must be tightened occasionally, and with modern chassis sets are liable to slack off when the set is removed from cabinet, due to the slight whip—if stiff wire is used.

Contact area in mains sets is seldom sufficient.

Only advantage of terminals is for an experimental hook-up, of temporary nature.—R. T. CREASEY (Aylesbury).

Soldering Saves Time

SIR,—My preference is always soldered joints. Reasons? Well, in the first place, soldering, if done properly, is a good, sound job—never works loose (as do terminals in time), is quickly done and enables one to get at awkward places where spanners or pliers are difficult to operate. Short, direct wiring (essential in short-wave work), cheaper! I say this because some components can be bought with just soldering tags on them, easier to dismantle, as in the case of the man who is always trying something different, he doesn't want to waste a lot of time fiddling about with terminals; and lastly, all of us who really profess to be constructors or experimenters will not let "learning how to solder" stop us from using it. Try! that's our middle name, and once we've mastered this very simple (and it is simple) job, we shall never go back to terminals.—W. C. MEACHEM (Bletchley).

Manufacturers Use Soldered Connections!

SIR,—I prefer soldered connections. They are tidier, stronger, more efficient, more permanent, more easily made. Terminal connections not infrequently slacken off; the surfaces in contact are not protected from oxidation, and they encourage careless workmanship. With soldered joints cleanliness is the first essential. Moreover, properly made, such connections effectively resist atmospheric action, are practically everlasting and their electrical resistance remains low. Set manufacturers invariably use soldered joints in their products—they would hardly do so were the terminal connection more efficient.—T. LESLIE SMITH (Oldham).

Non-standard Nut Sizes

SIR,—My vote goes to soldered joints. Not because I am enamoured of the process, but because the variation in

diameters of nuts of different manufacture is great enough to render your gift spanners useless in many cases.

In an almost inaccessible position the gift spanners would have been a great boon; but no, so the soldering iron has it. By the way—no amount of explanation would enable some people to make a creditable joint—no amount of showing even will make them appreciate the fact that the iron and work must be clean and the iron hot enough.—A. W. R. (Bournemouth).

Better Contact with Soldered Connections

SIR,—I have been a reader of PRACTICAL WIRELESS since No. 1, and I am writing to say that I am one of the people who prefer soldered joints. Not only are they tidier and more secure, but they are far better from the electrical point of view, and that is what matters. My suggestion is that all components should have real solder tags and not ones which are merely held in place by the terminal nut.—J. D. MORRIS (St. Annes-on-Sea).

Soldering for Economy

SIR,—Soldered joints for me, please, for the following reasons:—

1. Economy (less wire used or wasted).

Books have been awarded to the following competitors:—

Mr. W. Moses, 3, Palm Avenue, South Shields.
Mr. W. Branston, Reindale, Hawkinge, nr. Folkestone.

Mr. T. Smith, 150, Belgrave Road, Oldham.
Mr. A. Redstone, 93, Capstone Road, Bournemouth.

Mr. W. Meachem, 21, Harwood Street, New Bradwell, Bletchley.

Mr. R. Creasey, 99, Walton Road, Aylesbury, Bucks.

Mr. T. Chappell, Newerne, Upper Limply, Stoke, nr. Bath.

Mr. R. Hughes, Ceilwart Ganol, Barmouth.
Mr. J. Stevens, 106, Alexander Street, Dundee.

Mr. J. Morris, 2, Grange Road, St. Annes-on-Sea, Lancs.

Mr. S. E. Felstead, 27, Warwick Street, Woolwich, S.E.18.

Mr. Arthurbook, 4, Goolden Street, Manchester.

Mr. H. Munro, 59, Bellwood Street, Glasgow.
Mr. J. Kane, 66, Pembroke Cottages, Donnybrook, Dublin.

Mr. W. Holt, Springfield Lane, Ealerton, St. Helens.

Mr. A. Walker, 18, Sandwell Street, Slaithwaite.
Mr. F. Browne, R.A.F. Station, Boscombe Down, Amesbury.
Mr. J. Greene, 134, Devonshire Road, Forest Hill, S.E.23.
Mr. T. Lane, 26, George Street, Shotton Colliery, Co. Durham.
Mr. J. Sellors, 50, Russell Hill, Purley.

2. Cleanliness (no filings—the result of war between pliers and terminal nuts, and no dirty finger marks on coloured insulation on wires).

3. Neatness (no kinks in wiring on account of faulty manoeuvres with pliers).

4. Efficiency (no cracked mouldings and stripped threads).

5. Temper (normal, and nerves O.K.).

6. Pride (gazing on finished design and satisfaction in knowledge that every component is securely connected).—Wm. E. MOSES (South Shields).

Soldering is Easier and Neater

SIR,—Let us have the soldered connection by all means. Easy to fix and easy to unfix, neater wiring and safer wiring. The advantages of this type of connection easily outweigh the other, especially with coils and transformers, where a good connection is vital. The alternative, of course, could be left if the soldering tags came direct from the wiring of the component, and not under the terminal washer, where they might as well not be if the terminal itself is slack.—JOSEPH STEVENS (Dundee).

Soldering is Safer

SIR,—In my opinion soldering is by far superior to terminals. Not only is one assured of an electrical connection, but it is far quicker and easier once a few simple rules have been mastered.

When one realizes the vast amount of trouble and time taken to bare the wire, make a loop, take off the terminal and fit it on again, this soon becomes evident. And that is not all. A few days ago I was wiring up a receiver for a friend and using pull-back wiring wire, when I came across a 1 megohm grid leak. This had such small terminals that the nut had to be inverted before connection could be fixed to it. Many of these terminals are very annoying, with a lot of waste under the nut before coming to the screw.

Another instance where I have experienced trouble is with the terminals on air-cored coils. Many is the connection I have seen broken through screwing down the terminal too hard, thus turning the nut underneath and twisting the coil wire attached to it.

This all boils down to the obvious remedy "Solder Your Joints."—R. W. HUGHES (Barmouth).

THE B.B.C. TECHNICAL AND FOREIGN PROGRAMME JOURNAL

3rd WORLD-RADIO

THE OFFICIAL ORGAN OF EMPIRE BROADCASTING

B.B.C. WORLD-RADIO

B.B.C. PUBLICATION

European Programmes
set out hour by hour

the simplest and most convenient
arrangement yet devised

•
AUTHORITATIVE
TECHNICAL FEATURES
EVERY WEEK

•
Ralph Stranger's
prize competition
Serial
'RADIO ISLAND'

•
COME TO THE RESCUE OF A CAST-
AWAY PARTY OF SCIENTISTS AND
HELP TO BUILD A WIRELESS RECEIVER
AND TRANSMITTER FROM RAW
MATERIALS FOUND ON A DESERTED
ISLAND IN MID-PACIFIC • JOIN IN THIS
FASCINATING COMPETITION AND WIN
A MONEY PRIZE • *Free Entry for All.*

PRICE THREEPENCE • EVERY FRIDAY • EVERYWHERE

The 1934 FURY FOUR

Tuning and Operating Notes of the Latest *Practical Wireless* Receiver, which is Covered by A.C. 1934 Fury Four Super will be Described Next Week. Full Constructional Details and

By F. J. CAMM

JUST at the moment selected to pen this contribution my personal post has arrived, with an overwhelming proportion of envelopes from all districts, and of all shapes and sizes, bearing the superscription "FURY FOUR SUPER" in the top left-hand corner. Last year's Fury Four was the outstanding receiver for home constructors, and it was, I am given to understand by members of the radio trade, made in greater numbers than any other receiver described during the contemporary period.

I have received many hundreds of letters from readers who have built it—some laudatory, some asking for advice, and a few containing complaints that the receiver did not come up to expectations.

My Personal Guarantee of Satisfaction

I want therefore to preface this article with a re-affirmation that, provided the parts I specified are used, every receiver designed by me does all that I claim for it. It has always been my policy to understate the case, and in the few cases of complaint which I have investigated I have found that the trouble has been due either to a faulty component or to the reader's mistake in wiring up.

So confident am I of the capabilities of the Fury Four Super that I enthusiastically recommend it to every reader who did not build up the previous edition; and to

those who did I would adjure them to revise the old Fury Four and convert it into the receiver which is the subject of this present article. *This the reader may do at trifling cost.* All readers may build the Fury Four Super confident that it will do everything claimed for it. I have been connected with radio from the very start and I believe (I say it in all modesty) I was the very first radio journalist to appreciate the possibilities of broadcasting.

I edited a sixteen-page periodical devoted to wireless for amateurs nearly twenty years ago, and this journal made its regular appearance for a number of years. I have designed every type of radio receiver—crystal as well as valve, and there is scarcely a piece of wireless apparatus which I have not tested. Much of it I have designed. I think I can fairly claim that

I have not fallen into a stage of *laissez faire* in radio design, by producing receivers which are merely regurgitated versions of old receivers with additional knobs, the virtues of which are extolled in voluptuous and almost poetic language with suitable excerpts from the classics; nor have I ever devoted a preponderance of space to descriptions of my receivers. I readily realize that every reader of PRACTICAL WIRELESS may not wish to make the Fury Four Super, and it would be unfair of me to allot space to a subject which the general reader feels should more properly be devoted to some general but practical topic. I could easily fill PRACTICAL WIRELESS with extended descriptions of the capabilities of my Fury Four Super, but I prefer the reader to judge for himself without any artificial urge in the form of a journalistic smoke-screen of irrelevant extravagancies or flights of fancy. Whenever it is my privilege to describe a receiver of my design the number of pages comprising "Practical Wireless" is increased to carry that description, so that space is not filched from the general reader.

And yet I could be almost poetical myself regarding the Fury Four Super. Notwithstanding the fact that it is not a superhet, it possesses selectivity in the extreme and in the best interpretation of that term. It will receive an abundance of British and foreign programmes; its quality of reproduction

H.T. Volts—100. G.B. Volts—16.5. V.-M. Vol. Control—Full On.

H.T. Current Consumption (with "Booster") from 9 milliamps (minimum) to 16 milliamps (max.). Average Consumption—11 milliamps. Reducing Volume by means of V.-M. control cuts down average consumption to approximately 8 milliamps.

L.T. Current Consumption .76 amp.

Top Chassis

View of the 1934 Fury Four Super

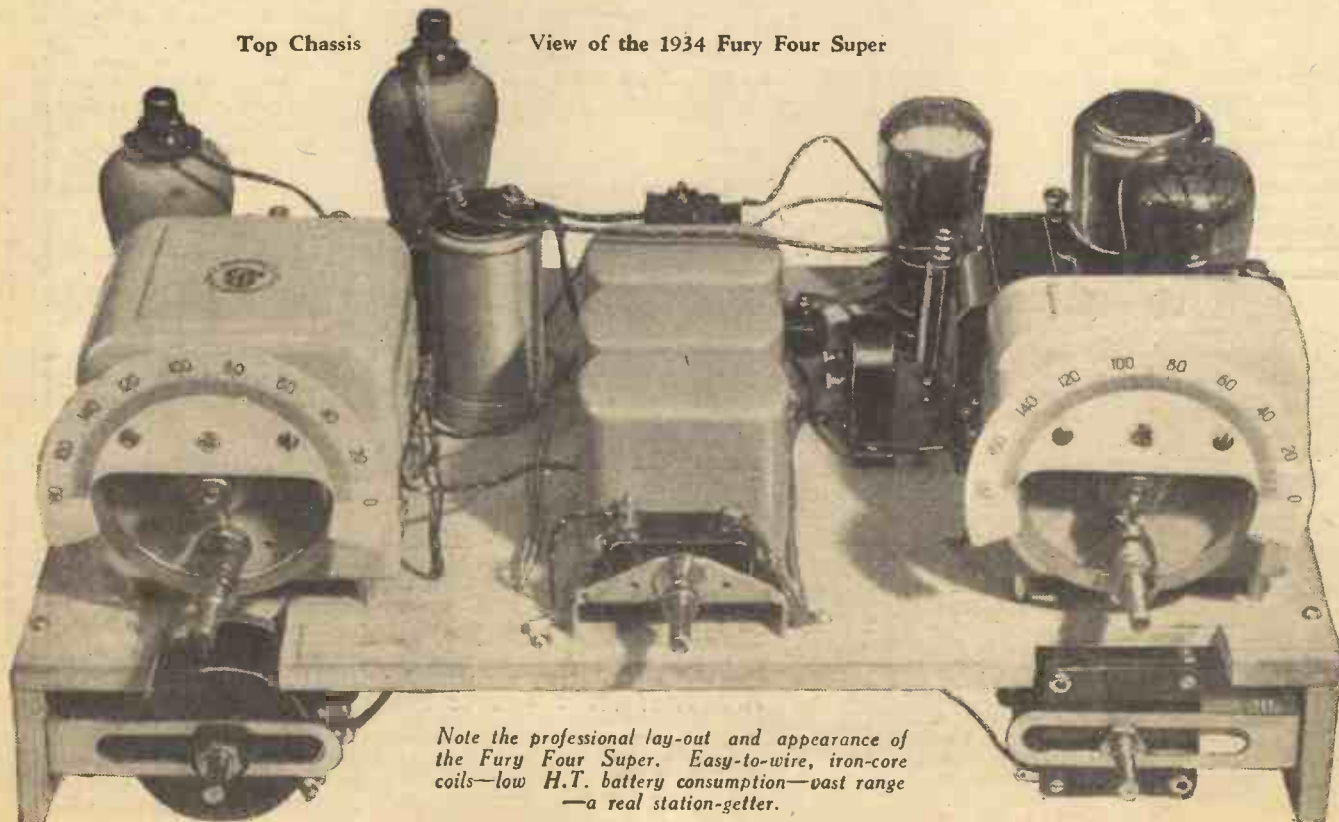

Note the professional lay-out and appearance of the Fury Four Super. Easy-to-wire, iron-core coils—low H.T. battery consumption—vast range—a real station-getter.

SUPER

our FREE Advice Guarantee. The Diagrams were Given Last Week

leaves nothing to be desired, its current consumption is less than half of that of the old Fury Four. This has been made possible by the use of the Graham Farish Battery Economiser, and whereas last year's Fury Four consumed about 20 milliamps of H.T. current, the Fury Four Super consumes just a little more than 9 milliamps.

Final Adjustments

If you have carefully followed out the wiring diagram given last week there is very little else for you to do save to make the trifling final adjustments which may be necessary. There is no need for me to dwell upon the use of the pre-set condenser. I believe it is the custom to devote at least a page to a description of how to use the pre-set condenser, and to refer to it under some fancy name. I would not offend the intelligence of my readers by telling them how to do this, but would cover the point by stating, in passing, that it should be adjusted to the point where selectivity and signal strength combined with sensitivity effect the best compromise. The J.B. double-gang condenser has two trimmers on it, and I have found that matching is best carried out by adjusting the trimmer remote from the panel to its mid-point and effecting the final adjustment with the trimmer nearest the panel.

In tuning, the secondary tuning condenser should be rotated so that the dials are moved more or less in step; when the station is tuned in to its maximum volume, final tuning should be effected by means of the secondary condenser only.

The battery consumption will naturally be affected according to the use which is made of the potentiometer control. This really needs to be used in intelligent

combination with the reaction control. Quite often it will be found necessary to increase the potentiometer control and to decrease reaction, or *vice versa*. No trouble whatever will be experienced with low frequency whistles owing to the excellence of the B.R.G. Pass-feeder. If any whistle is present it will probably be due to mal-adjustment of the W.B. Microlobe speaker. The extremely modern design of this

**THE ONLY RECEIVER CARRYING A
GUARANTEE OF PERFORMANCE
UNDER A FREE ADVICE WARRANTY**

pleases me. I like immensely the convenience of that switch-arm at the back, for it enables the listener to match up the speaker whilst the set is in operation speedily and unfailingly. Do not forget to make that very necessary adjustment, so that the speaker impedance matches that of the output valve. Give the speaker the chance to do that of which it is capable.

Spend a few moments adjusting the grid bias to the best tapping; you are relieved of making any adjustments to the H.T.,

for I have long ago abandoned the old-fashioned idea of using separate battery cords, preferring to use voltage-dropping resistances to ensure the correct values of anode voltages.

The A.C. Fury Four Super

Next week I shall describe the construction of the A.C. Fury Four Super, and I have so arranged the power pack that it will fit into the existing speaker cabinet. No one will deny that the Fury Four strikes a modern note with its two-piece Peto-Scott cabinet, selected so that those readers who already have a speaker need only buy the bottom half. I should welcome

letters from readers who have built the Fury Four Super, so that I may judge its performance in various parts of the country. Needless to say, it has been thoroughly put through its paces; it has been tested under all sorts of conditions, and in the form here presented it is,

I am certain, the most ideal arrangement of four valves of a general-purpose style of receiver.

The 1934 Fury Four Super on Test

By FRANK PRESTON

MR. F. J. CAMM recently gave me the opportunity of putting his latest receiver through its paces, and I was more than surprised with the excellent results which were obtained, even under adverse conditions. Although this 1934 receiver is in many ways similar to the 1933 model, its performance is vastly superior and compares more than favourably with any set which has ever been offered to the home constructor. Despite its simplicity, bearing in mind the fact that four valves are employed in a circuit of the most up-to-date kind, it would be difficult to conceive any improvements which would be justified in practice.

Tuning was found to be a remarkably simple operation and there was no difficulty whatever in manipulating the two dials together so that a large number of stations could be received, free from interference, in a very short time. The reaction and volume controls were also found to work very

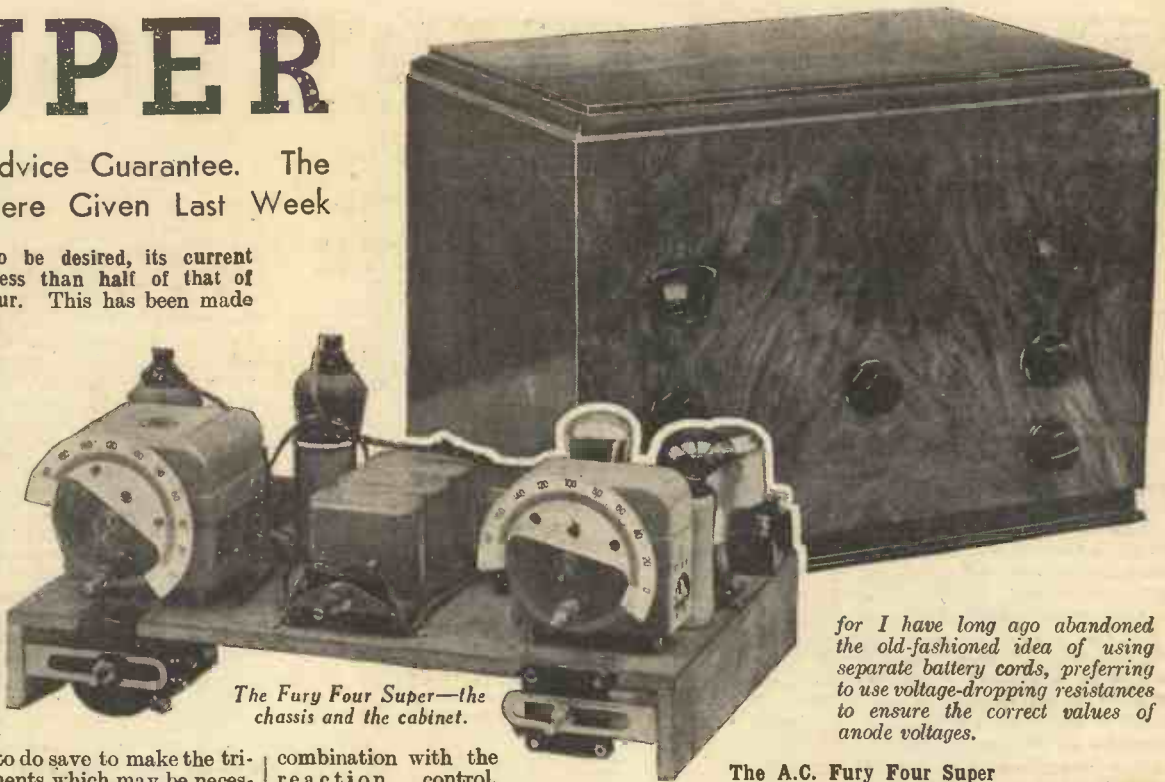

The Fury Four Super—the chassis and the cabinet.

Cabinet work designed for your convenience.



The 1934 Fury Four Super with the two-piece Peto-Scott cabinet.

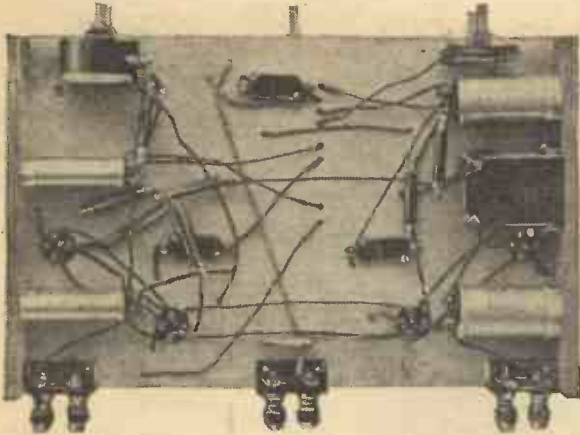

Sub chassis of the 1934 Fury Four Super.

In regard to the volume control, which, of course, functions by applying a variable biasing voltage to the grids of the two variable-mu valves, it was particularly pleasing to find that this gave a perfectly smooth control of volume over its entire range. When receiving the locals, Daventry, and Radio-Paris, the volume control had to be slackened off consider-

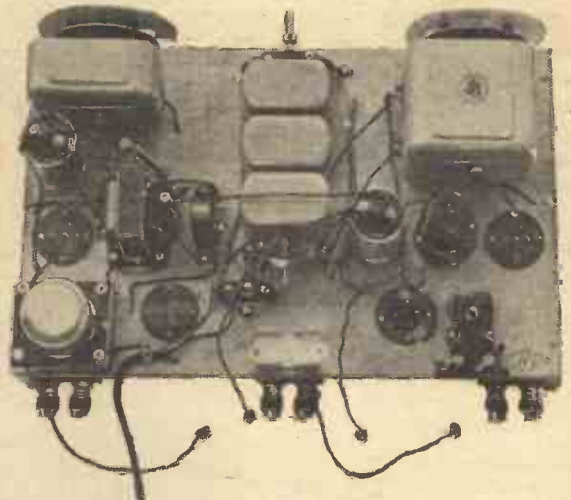

Top view of the chassis.

smoothly when required, although in most cases these could be ignored until the required transmission had been tuned in, after which they could be used in conjunction with each other to enable the volume level to be adjusted to a nicety, and any trace of interference to be eliminated without difficulty.

The "1934 Fury Four Super" was first tried on an average aerial situated about 15 miles from Brookmans Park and badly screened by nearby buildings. In broad daylight it was an easy matter to bring in all the English Regional and National stations on the medium wave-band; as well as Daventry National, Radio-Paris and Huizen on the long waves, without making any use whatever of the reaction condenser. This is a point which is worthy of emphasis, since, although reaction can be very useful, it is always liable to introduce a certain measure of distortion when used excessively. It is also worthy of note that there was an ample margin of selectivity when reaction was completely slacked off. This might not appear very important in "cold print," as it were, but it is a fact that far too many of the so-called selective receivers depend almost entirely upon reaction for their sharp-tuning properties.

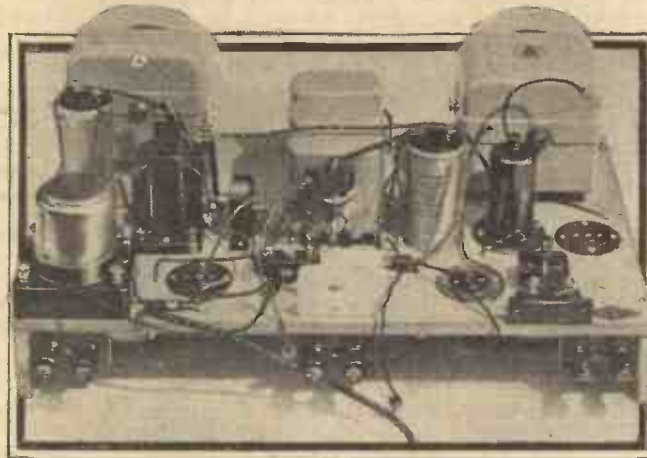

Front view of the chassis.

ably in order to prevent overloading, and to keep the volume down to a comfortable level for normal listening.

Quality of reproduction was found to be a commendable feature, not only when receiving the nearby stations, but also in the case of foreigners which are often worthless for entertainment purposes, due to the tremendous amount of distortion which takes place and the loud "background" noises which accompany them

This leads us to the point where special mention should be made of the real absence of "hisses" and other noises which are frequently so noticeable with a powerful set such as this. No matter what position the volume control potentiometer was set to, there was a definite absence of unwanted noises or interference of any kind.

In a later test of the "1934 Fury Four Super," which was carried out during the evening and under more favourable conditions, it was literally possible to obtain good reception of stations at almost every setting of the tuning dials. At this stage the opportunity was taken to adjust the trimmers on the two-gang condenser. First

of all the pre-set condenser was screwed about "half-in" and the star-wheel trimmer on the first condenser section was screwed in as far as it would go and then unscrewed for two complete turns. London National was then tuned in, and the volume control set to its lowest position so that signals were only just audible. Without altering the volume control, signal strength was then brought up to its highest level by carefully rotating the star-wheel trimmer on the second condenser section. The complete operation was completed in about three minutes, and after that it was found that no further adjustment of any kind was called for. Both tuning dials kept almost exactly "in step" over the whole of both wavelength ranges and it was an easy matter to rotate both knobs simultaneously.

Interference—Free Reception

This series of tests was carried out soon after the new Lucerne wavelength plan has come into operation, so there was some slight difficulty in identifying some of the stations whose wavelengths had been modified. Nevertheless, it was very noticeable that practically every transmission was received entirely free from interference, and could have been recognised had there been time to wait until the call signal or interval signals were given.

When using a gramophone pick-up reproduction was of the same high quality as on radio, and there was ample volume to fill even the largest room.

LIST OF COMPONENTS FOR THE 1934 FURY FOUR SUPER

One set "Ferrocort" Type "G" Coils (G.10, G.14, G.13) (with Switch—see notes in last week's issue) (Colvern).
 One "Nugang" Single Variable Condenser, .0005 mfd. with Type A Drive (Jackson Bros.).
 One "Nugang" 2-gang Variable Condenser, .0005 mfd. with Type A Drive (Jackson Bros.).
 One Disc Type H.F. Choke (Lissen).
 One 1 megohm resistance with wire ends (Lissen).
 One Pre-set Aerial Condenser, .0003 mfd. (Lissen).
 One "Pentode" Nichoke (Varley).
 One Graded Volume Control, Type C.P.158, (Varley).
 One Super H.F. Choke, Type H.F.4 (Bulgin)
 One Fuse Holder, Type F.5 (Bulgin).
 One 100 m.a. Fuse (Bulgin).
 One G.B. Bias Clip, Type 2 (Bulgin).
 Three 50,000 ohm $\frac{1}{2}$ watt "Ohmite" Resistances (Graham Farish).
 Five 1,000 ohm ditto (Graham Farish).
 One 25,000 ohm ditto (Graham Farish).
 One 500 ohm ditto (Graham Farish).
 One .0002 mfd. Reaction Condenser (Graham Farish).
 One "Booster" Unit (Graham Farish).

Two 1 mfd. Fixed Condensers, Type 9200 B.S. (Dubilier).
 Four 1 mfd. ditto (Dubilier).
 Two 2 mfd. ditto (Dubilier).
 One .0001 mfd. ditto Type 670 (Dubilier).
 Two .0002 mfd. ditto, Type 670 (Dubilier).
 Three 4-pin Chassis-Type Valveholders (Clix).
 One 5-pin ditto (Clix).
 Four Wander Plugs marked G.B.1, G.B.2, G.B.3, G.B.+ (Clix).
 One Passfeeda Coupling Unit (B.R.G.).
 Two Large Component Brackets (B.R.G.).
 Three Terminal Mounts (Belling-Lee).
 One 4-way Battery Cord (Belling-Lee).
 Six Type B Terminals (Aerial, Earth, L.S.+ L.S.—, Pick-up, Pick-up) (Belling-Lee).
 One "Westector" Type W.4. (Westinghouse).
 One "Metaplex" Chassis (Peto-Scott).
 One "Fury Super" Cabinet (Peto-Scott).
 Four Valves, Types P.M.12M., P.M.12M., P.M.2DX., P.M.22. (Mullard).
 One Moving Coil Loud-speaker, Type P.M.6. (W.B.).
 One 120-volt H.T. Battery (Siemens).
 One 16-volt G.B. Battery (Siemens).
 One 2-volt L.T. Battery (Block Batteries).
 Connecting Wire, Length Metal Braiding, Screws, etc.

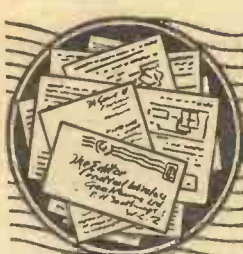

READERS' WRINKLES



Grid-leak Connections

A USEFUL tip when connecting up a grid-leak for experimental purposes and dispensing with soldering, is to make a groove in the metal ends of the leak by

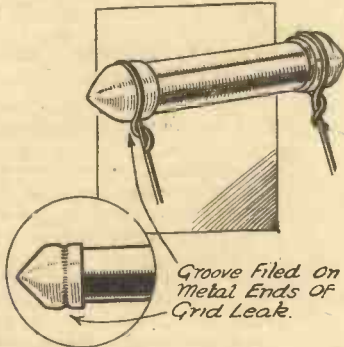

A method of making grid-leak connections.

means of the cutting edge of a pair of pliers or a file; then bind the ends of the wire around the groove and tighten with the pliers, as shown in the sketch. This will be found to be quite effective and enables the experimenter to try out different types of leaks.—C. Ross (Liverpool).

Two Lighting Hints

MANY constructors possess a crystal detector, either loose or on an old set which is no longer used. This can easily be made into a handy light by replacing the crystal cup with a bulb-holder (flash-lamp type), and the arm carrying the cat's whisker with a nut and bolt. One contact to the holder is made through one bracket to the centre screw, the body of the holder being connected to the other bracket *via* a thin wire passing through the glass tubing. This light will be found useful inside the set for inspection purposes, but it is particularly serviceable as a turntable light in a radio-gram,



A handy radio-gram turntable light.

THAT DODGE OF YOURS!

Every Reader of "PRACTICAL WIRELESS" must have originated some little dodge which would interest other readers. Why not pass it on to us? We pay £1-10-0 for the best wrinkle submitted, and for every other item published on this page we will pay half-a-guinea. Turn that idea of yours to account by sending it in to us addressed to the Editor, "PRACTICAL WIRELESS," George Newnes, Ltd., 8-11, Southampton Street, Strand, W.C.2. Put your name and address on every item. Please note that every notion sent in must be original. Mark envelopes "Radio Wrinkles." Do NOT enclose Queries with your Wrinkle.

especially if the glass is of the half opaque type.

The once popular valve window is now no longer used, but it can easily be turned into a handy gadget, *i.e.*, an indicator light. The opening is usually covered with gauze or clear celluloid. This should be removed and replaced with a similar shaped piece of white (opaque) celluloid or equivalent material. On the back of

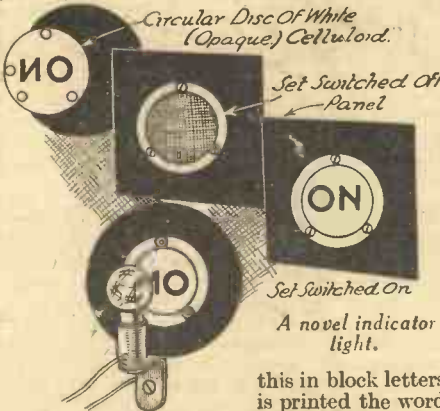

A novel indicator light.

this in block letters is printed the word ON, using Indian ink. It must be printed backwards, *i.e.*, as if viewed in a mirror, and should preferably be inked twice to ensure a solid black. This is fitted with the window on any convenient place on the set, with a small bulb behind wired to the filament or heater circuit. When the set is switched off, all that will be seen is the white surface, but when the set is switched on the bulb will illuminate the celluloid, the word ON showing through as black lettering on a white background.—D. CONQUEST (London, S.E.15).

A Simple Two-way Telephone

ANYONE possessing a set fitted with pick-up terminals and an extension speaker can easily make his own two-way telephone system by arranging a simple switching device as shown in the diagram. All that is required is a four-pole double-throw switch, although two double-pole double-throw switches will do, because they can be easily ganged together. If a rotary switch is available this should be used as it enables a more rapid change-over to be made. One pair of connections

is taken to the loud-speaker terminals on the receiver and another pair to the pick-up terminals, whilst the moving arms of the switch are taken to the loud-speakers, one pair to each. When calling up the

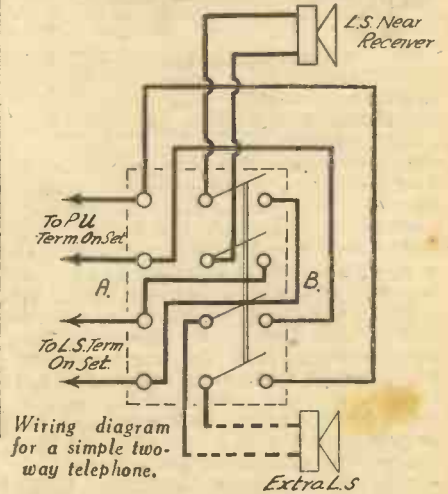

Wiring diagram for a simple two-way telephone.

extension, the radio-gramophone switch must be over to gramophone and the switch turned over to the side A. It is not necessary to speak very close to the speaker (which, of course, is now used as a microphone); when the message is finished, say "Over" and turn the switch over to the side B so that the extension speaker is now used as a microphone, whilst the speaker resumes its legitimate duties. When the caller at the extension end has finished his message he calls "Over" and that is the signal to switch over to side A again and then speak.—R. H. BANNER (Chesterfield).

Temporary Testing Prods

A VERY efficient pair of testing prods can be made from two lengths of strip solder, and can be used for tracing faults, short-circuits, etc. The solder strips are much safer than ordinary flex, owing to their tendency to stay bent to any required shape.—G. A. TAYLOR (Manor Park).



Flexible testing prods for use in connection with a flashlamp bulb.

READERS' WRINKLES

(Continued from previous page)

Ingenious Mains Tester—A Correction

On page 857 of our issue dated January 20th we illustrated a wrinkle for determining the character of the house mains supply. Owing to a misunderstanding the circuit

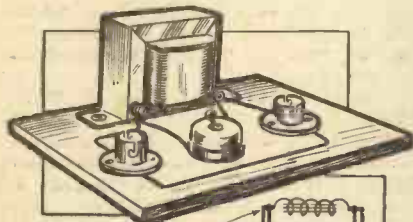

An ingenious mains tester. The corrected circuit.

arrangement was wrongly described, and it will be seen, if the original circuit is examined, that the mains supply is short-circuited when the switch is closed. The choke and its switch should, of course, be in series with one mains lead and not in parallel. The correct diagram is shown herewith, and it will be seen that the mains lead is joined direct to one side of the low-wattage lamp, whilst the other mains lead passes through the iron-cored choke. When the mains supply is switched on, and the switch on the testing unit is opened, the lamp will show a certain brilliancy which will remain unchanged when the switch is closed if the supply is D.C., but which will vary in brilliancy as the switch is opened and closed if the supply is A.C. As originally mentioned, the impedance of the choke accounts for the difference on the alternating supply and the choke may be adjusted to provide a suitable distinction in the brilliancy.

Soldering Flexible Wander Leads

HAVING experienced considerable trouble through G.B. and similar leads breaking away at the point of soldering, I overcame the fault in the following manner. Instead of soldering the flex direct on to the wiring of the set, it is attached to a

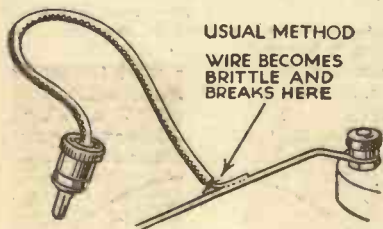

IMPROVED METHOD

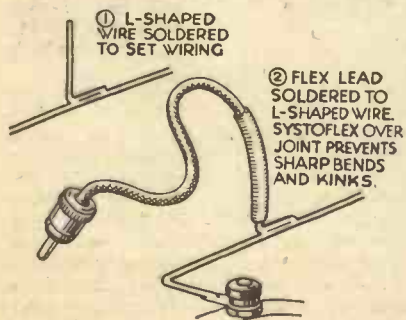

A method of soldering flexible wander leads.

small L-shaped piece of wire as shown; the L-shaped piece is then soldered to the wiring, and a short piece of systoflex slipped over the joint of flex and L-piece as shown in the accompanying sketch. The systoflex covering will be found to obviate sharp bends and kinks in the soldered end of the flex, which appears to be the source of trouble in exposed joints. —L. E. SHELLEY (East Sheen).

Speedometer as Counter for Coil-winding
An excellent counter for use in winding coils and transformers can be made from a second-hand speedometer, which may be bought very cheaply.

Remove the counting machine and fit to your coil winder. This will depend on the type of winder and counter. A portion of the flexible shaft taken from the driving cable of the speedometer can be fitted to the winder spindle by soldering or a set screwed sleeve.

Fit the winder and counter so that the

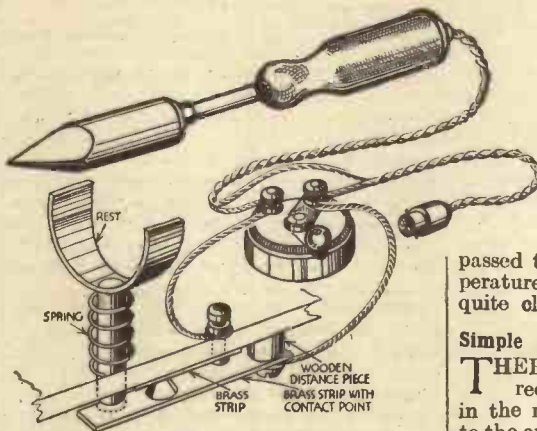

An automatic switching arrangement for an electric soldering iron.

trip reading registers either one-tenth or one revolution for each revolution of the winder. If the first is done, then the trip reading will register in tenths of turns up to a hundred, and the mileage reading turns up to 100,000. If the latter the trip will register turns up to 1,000 and the mileage up to 1,000,000 turns. This makes coil-winding much easier and guarantees accuracy in the number of turns. —W. CALVERT (Coventry).

A Soldering-iron Tip

THE use of weight-operated devices seems to be very popular and we have had suggestions for switching off a gramophone motor by the weight of a pick-up; switching off a set by the weight of the 'phones, etc. The following hint will prevent many a soldering-iron from being burnt-out and will assist in obtaining good work. A small stand is made from wood, with a rigid support at one end and a spring-operated rest at the other. This should be fitted so that the weight of the iron bit will just depress it and break the electrical connection which is accommodated under the base. A resistance, having a value found by experiment, is wired in series with one lead to the

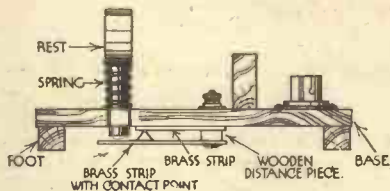
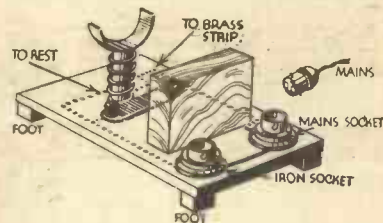

Details of rest and switch for an electric soldering iron.

iron, and the resistance is short-circuited only when the iron is removed from the stand. Thus when soldering the iron receives the full load, but when the iron is placed down the resistance is brought into circuit, and thus prevents the iron from passing a high current during the time that wires are being put into place in a receiver, or some other operation is being carried out. Obviously the value of the resistance must be chosen so that sufficient current is passed to keep the iron at a working temperature. The sketches show the device quite clearly.

Simple High-voltage Supply

THERE are times when the experimenter requires a reliable source of H.T. in the region of 300/350 volts, but owing to the expense of a transformer and rectifier all he can do is to wish. It does not seem to be generally known that quite an effective power pack may be built for only a few shillings by using chemical rectifiers in a special voltage-doubling circuit.

(Continued on page 961)

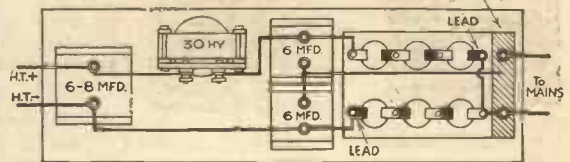
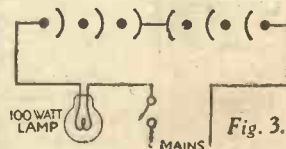
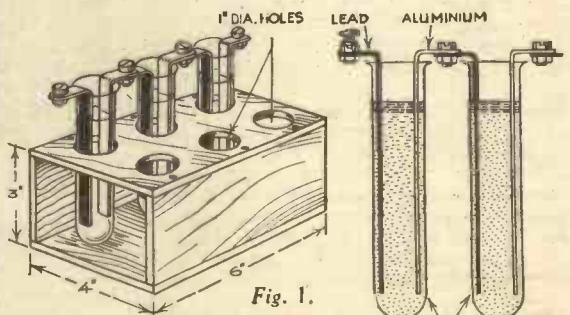

A simple battery of chemical rectifiers for supplying H.T. current

Practical Television

Presented Free with "Practical Wireless."

FEBRUARY 3rd, 1934. Vol. I. No. 5.

DISTORTION IN TELEVISION RECEPTION

A Complete Explanation of all the Forms of Distortion which can Occur in Television Reception, and the Cures. By W. J. DELANEY.

ALTHOUGH the technique of receiving speech and music is practically the same as that required for the reception of televised images there is one vast difference. This lies in the fact that the eye and the ear are totally different in their reception of anything which is offered to them. This may seem a slightly difficult point to comprehend, but the following explanation may clear up any doubt which you may have regarding the truth of the remark. The ear, by interpretation, will put in or extract from a musical item in order to enable the brain to receive a clearer understanding of the item. This may be proved by any listener who visits a friend with a radio receiver. It may be found that the friend boasts of the bass response of his set, and yet when you visit him you form the opinion that your receiver is more productive of bass, a statement which he probably contradicts when he hears your outfit. Similarly, the high note response may be apparently better heard on one receiver than another by different individuals, and it is due to the fact that the user, through constantly listening to the set, has more or less adapted his hearing to it. It is also well-known that in various individuals the capacity for hearing high notes is restricted, aged persons failing to hear notes which are well within the scope of young people. The eye, however, cannot be easily cheated, and it certainly does not compensate for deficiencies as does the ear. Persistence of vision may be held, by some, to be a compensating factor, but for good television



Fig. 1.—The received image should bear a close resemblance to this illustration, all half-tones being well represented.

with a radio receiver. It may be found that the friend boasts of the bass response of his set, and yet when you visit him you form the opinion that your receiver is more productive of bass, a statement which he probably contradicts when he hears your outfit. Similarly, the high note response may be apparently better heard on one receiver than another by different individuals, and it is due to the fact that the user, through constantly listening to the set, has more or less adapted his hearing to it. It is also well-known that in various individuals the capacity for hearing high notes is restricted, aged persons failing to hear notes which are well within the scope of young people. The eye, however, cannot be easily cheated, and it certainly does not compensate for deficiencies as does the ear. Persistence of vision may be held, by some, to be a compensating factor, but for good television



Fig. 2.—A common fault experienced when first tuning-in to the transmission.



Fig. 3.—Another fault which occurs due to the lack of synchronism.

pictures it is essential that the quality of the output of the television receiver shall be complete in order to enable a good picture to be obtained, and the following details explain some of the failings of the television image which may be experienced and their cure.

Phasing and Framing

Although the questions of phasing and framing have been dealt with previously in these pages they are briefly dealt with here in order to keep this article complete. The television disc or drum has to rotate at the same speed as the transmitting apparatus, and, in addition, the same relation has to obtain between the two pieces of apparatus. Thus, if we take as a subject which is being televised, the picture shown in Fig. 1, it may be seen on the screen in the form shown in Fig. 2, or Fig. 3. With either of these forms of distortion it is only necessary to vary the speed of rotation for a second or so in order to bring the picture squarely in the centre of the lens. If the apparatus is fitted with synchronizing gear, and the image is stationary but split as shown



Fig. 4.—If the signals are too weak, or the lamp is too brightly illuminated from a separate source, the received image will appear like this.



Fig. 5.—If the receiver has high-frequency response, the image will be accompanied by white patches surrounding the dark sections, somewhat after the manner shown in this illustration.

in Fig. 3, it will only be necessary to rotate the synchronizing gear round the motor shaft. The object, no matter whether synchronizing gear is fitted or not, is to obtain the picture squarely in the "frame," and it will soon be found that a variation in speed will quickly move the picture to the desired position, although the "framing" control must be adjusted where this is fitted.

Quality Response

Dealing with the disc apparatus, which is undoubtedly the simplest to understand, it will be fully appreciated that the range of tone which has to be obtained must vary

from the brightest high-light to the deepest shadow, and this means that the neon lamp must, for the first mentioned detail, be at maximum brilliancy, and for the shadow must be extinguished. Therefore, the signal currents which are passed through the lamp must not only vary to that degree, but must also be adjusted in conjunction with the normal current passed by the lamp so that it may have those two extreme effects. Suppose, for example, that the receiver is capable of correctly handling the lowest as well as the highest frequency which is transmitted, but that the voltage which is applied from a separate source to the neon is too great. This will mean that the signal current will not be strong enough to extinguish the lamp, and the received image will appear as shown in Fig. 4, where the entire "field" will be brilliantly illuminated and the image will appear faintly. The same effect will, of course, be obtained if the signal strength is too low, and this may be remedied to a certain extent, when a separate source is employed for striking the neon, by reducing the current passed by the lamp. When the lamp is included in the anode circuit of the output valve, and the normal anode current is relied upon to provide the striking voltage, a weak signal will produce a similar effect, although it may be found that the lamp will go right out at times, resulting in dark patches.



Fig. 6.—A poor low-frequency response will result in dark patches beneath the chin and loss of detail in the face, as shown here.

If the design of the radio side is not good and the low-frequency response is lacking, the received image will have an appearance somewhat similar to that shown in Fig. 6, although it must be appreciated that all of the illustrations accompanying this article are slightly emphasised in order to give in print an idea of the kind of image to be expected under the various conditions. It will be seen, therefore, that if the low-frequency response is

(Continued on next page)



Fig. 7.—Interference such as may be caused by local oscillation or undue use of reaction will break up the image into squares or produce a chequered pattern as shown here. Some types of motor interference may produce a similar pattern, although the white patches will predominate.



Fig. 8.—L.F. instability produces dark lines passing across the picture, as represented in this illustration. Motor interference sometimes causes a similar effect, as does the reaction control before the oscillation point is reached.

(Continued from previous page)

lacking the picture will be faint, and the difference between these and a weak signal will lie in the dark shadows which may be seen under the chin, for instance, and very often in the bright patch which appears above the head of the subject. Generally speaking, dark patches appearing on an image point to lack of low-note responses in the receiver, and the remedy is to improve the low-frequency couplings, using larger types of valves; substituting R.C. coupling for transformer coupling, etc. It is, of course, essential that devices which remove the high-frequency response must not be used to "strengthen" the bass, as they will introduce further difficulties, so that in general it may be stated that the best procedure is to employ R.C. coupling for one stage, and use plenty of H.T. and grid bias. It is, of course, essential to avoid all forms of distortion.

Excess of High Frequencies

Should the receiver be so designed that the high frequencies are in excess the effect will be similar to Fig. 5, where the image is accompanied by white patches surrounding any dark object, such as the hair and eyes. In other respects the picture may appear quite good, although movement of the image will render these white patches slightly confusing, but an examination of this illustration in conjunction with your received picture will enable you to decide whether the higher frequencies are in excess or not.

Oscillation

Where the receiving portion of the apparatus is fitted with a reaction control, this must be very sparingly employed, or the picture will be entirely spoilt. The effect of reaction on music is well known. As it is advanced towards the oscillation point the tone becomes deeper and muffled.

The effect on the television image will be similar to that shown in Fig. 7, where the contrast becomes very marked, and the picture breaks up into its component squares and is very contrasty. If the set is permitted to oscillate a chequered pattern will appear to pass across the screen, the exact pattern, the slope of the lines, etc., varying according to the type of image. Instability in an H.F. stage will produce a similar effect, although in this case it may be found that the pattern is much smaller and remains more or less stationary. Low-frequency oscillation, or motor-boating, will probably produce dark lines running vertically down the picture, and these will travel across from one side of the picture to the other (Fig 8). A different effect is encountered if interference from the motor is experienced, and the usual two fixed condensers connected across the brushes, with the junction earthed, should always be included in this part of the apparatus.

I AM sure that readers were interested to read "Radioptic's" provocative article which appeared in last week's issue, but I strongly suspect that the writer gave rein to his own point of view with his tongue in his cheek. Criticism properly ministered is invaluable, but I feel sure that the engineer has followed the line of so many other television critics and passed judgment without a proper practical investigation, for he shows very frequently a lack of perspective while his "facts" are incorrect. Finally, although I appreciate that his attack on television investigators in general was quite impersonal, I took his comments very much to heart, for he criticised certain lines of recommendation which I have repeatedly suggested to readers of PRACTICAL WIRELESS myself. That being the case, I felt compelled to take up the cudgels and wage a counter-attack.

Transmitter Improvements

Taking the comments in turn, it is quite correct to say that very great improvements have been made on the transmitting side, but primarily this is more noticeable for the simple reason that initially the

MY REPLY TO "RADIOPTIC"

By H. J. BARTON CHAPPLE, Wh.Sch., B.Sc. (Hons.),
A.C.G.I., D.I.C., A.M.I.E.E.

transmitting side was very much behind the state of the art at the receiving end. This is borne out very conclusively by an examination of two of the accompanying illustrations which show in Fig. 2 one of the original disc transmitters with a fixed



Fig. 1.—A well-made trammel with screw adjustment for marking out scanning discs.

disc (that is to say, it could not follow any artist movement), fixed photo electric cell banks and intrinsically weak scanning spot light. Fig. 4 indicates a radical change, for the immobile transmitter table has given way to a portable mirror drum scanner, improved and adjustable photo

electric cell stands correctly positioned for maximum light reflection, a better light spot and one which follows artist movement, and much better cell amplifiers.

Our "Radioptic" engineer would have appreciated these mechanical and electrical improvements much more if he had been associated with their development, or alternatively had made it his business to see the results of the early work and compared it with the vastly improved results accruing from the present type of apparatus. I am in no way trying to infer that present-day results are perfect; that would be ridiculous, but to make that an excuse for not evolving systems which give high definition and yet will not be available for a television service for some time to come is sadly lacking in perspective and betrays a narrow outlook. Far from being careless, the television pioneers are fully alive to defects, but instead of being encouraged to even greater effort by sympathetic appreciation of their problems, they are constantly faced with cynical critics who are superficial in their examination of the difficulties.

Leaving his general comments, our critic

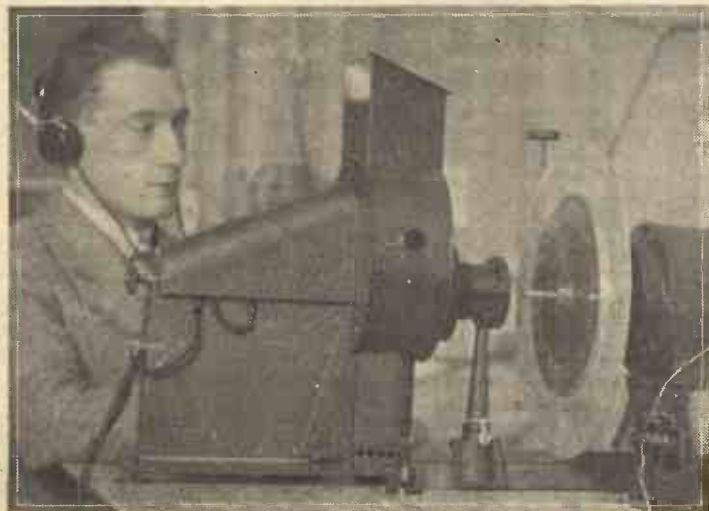

Fig. 2.—The old type disc television transmitter used so extensively in the earlier days of television broadcasting.

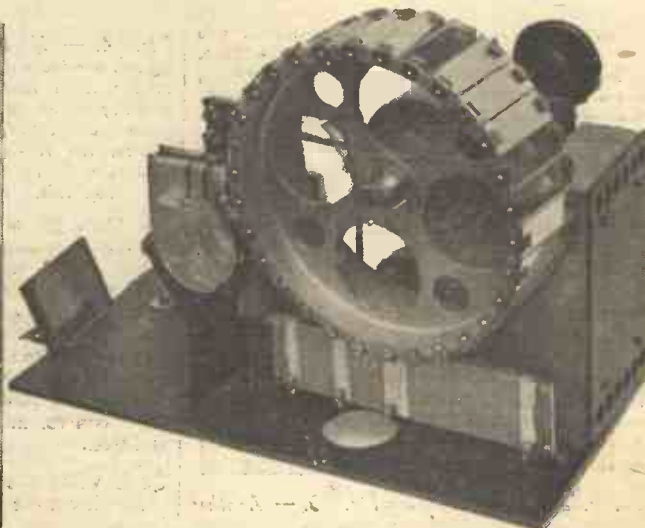

Fig. 3.—Showing the ingenious, but very effective mechanical filter used between mirror drum and motor shaft.

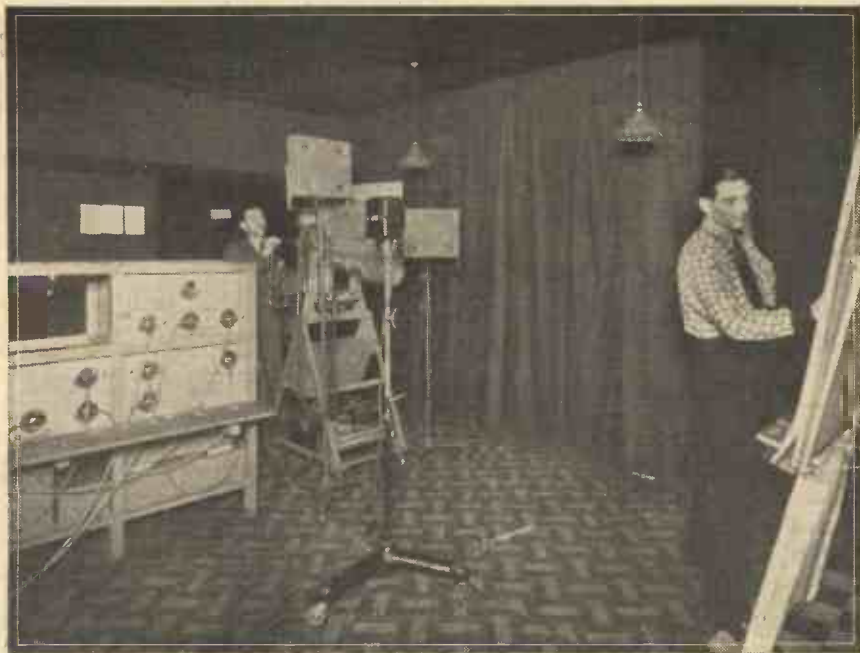

Fig. 4.—A more up-to-date television transmitter installation, showing mobile drum scanner, cells, amplifiers, etc.

endeavours to justify his remarks by particularizing and dealing with certain sections of the apparatus which strike him as being amateurish (rather a slur on the many capable amateurs who have proved their worth in so many branches of radio, especially in short-wave transmitting, to mention only one example) and wholly lacking in engineering design.

First of all he takes the motor. Of course, there are some motors sold which are quite unsuitable for the work, but it is all a question of price. If the television constructor does not pay a good price for this product, of course the armatures and spindles are likely to be unbalanced. But cannot the same remarks apply to all classes of radio components? If a fair and reasonable price is not paid for coils, condensers, transformers, loud-speakers and so on, will they boast of a performance in any way comparable with their more expensive prototypes? Of course not, and if I wanted to give free publicity I could very well supply a list of makers who market eminently satisfactory motors for all classes of mechanical television receivers. And, by the way, as far as motors are concerned, I was always taught to regard 750 revolutions per minute as comparatively slow speed and not comparatively high, as stated by "Radioptic."

The next piece of "constructive" criticism is in connection with the brass spindle bush so often used for mounting the disc on to the motor shaft. The difference that would accrue from using an aluminium alloy is negligible, for the "resistance to motion" of the disc, provided it is made reasonably light, is in the windage created by the revolving 20-inch disc. In any case, it would be useful for "Radioptic" to know that there are several firms who do use aluminium bushes, so the advice is somewhat out of date.

While at first sight a single grub screw grip between disc flange or boss and motor shaft may appear unsatisfactory, provided the motor shaft is a proper fit in the boss hole, the screw pressure over the long boss

hole surface does not throw the disc sufficiently out of truth to make any noticeable difference in the received image. In any case, many firms supply their discs with treble grub screws (one at each 120 degree angle), but I rather fancy that the prime reason for adhering to the grub-screw method is once more our important one of cost. The same happens with our radio receivers—the ideal with 100 per cent. efficient components throughout is beyond our pockets generally, so we content ourselves with the next best, but that cannot be put forward as an excuse to say that the best is not available for us to use if we want it.

I am afraid the suggested tapered shaft and conical boss hole is a most inappropriate and bad alternative. In ninety-nine cases out of a hundred it is necessary to adjust the disc's position relative to the shaft end, but "Radioptic's" "better method" drives the disc on the shaft at one position only. The split-cone scheme with a knurled screw adjustment is far superior, and only the other day I examined a marketed mirror drum having this very good feature. In addition, Fig. 1 will show that this same method of mounting for a scanning disc was used even with the old transmitter!

While on the subject of drum mounting, it may interest "Radioptic" to know that the "unscientific" television engineers have found that it is better not to mount the mirror drum of a television receiver direct on to the driving motor shaft. To reduce any tendency to hunting arising from drum inertia preventing a quick response to changes of speed a filter must be fitted so that the drum does not follow small variations, but only responds to the steady synchronizing signal. This takes the form usually of a spring coupling between the drive and the scanning device, and one particular case of this is shown in Fig. 3. The drum is mounted on a bush so that it moves freely, while the bush is gripped to the motor shaft, which it just fits. A coiled spring links the bush and the drum, so that the drive is flexible, while two stops limit the amount of relative movement between bush and drum.

Discs and Disc Holes

Returning now to the last two points raised by "Radioptic," he complains of the relatively flimsy character of the scanning disc, and asserts that it lends itself readily to buckling. Surely he knows that when the apparatus is complete it is enclosed in its cabinet, and is therefore free from rough usage. The constructor is fully aware of this so-called fragility of his scanning device, and, in consequence, while assembling his apparatus, treats it with the respect it merits. If we handled loud-speaker cones, coil windings, glass valves and so on in a careless or rough manner, damage would soon occur, but we do not blame the designers for this, but regret our own "ham-handedness."

The "so-called television engineers" (I quote this expression from the article of last week) naturally assume that the television constructor has reasonable intelligence, and knows how to handle his components carefully, and I am sure this would be borne out by those readers of PRACTICAL WIRELESS who have worked with television apparatus. From personal knowledge I know that dozens of disc designs have been tried, but for cheapness, simplicity and accuracy the ordinary spoked and apertured disc has been found the best.

Now for the real climax of the article which demanded an answer—hole-punching in discs. The mechanically-minded amateur should be most scientific in the methods he adopts for marking out and punching his discs. A trammel arrangement with screw adjustment is suggested, a press to make the holes, or a clamp to grip the metal and prevent buckling! Does not "Radioptic" know that expensive machines have been installed by those manufacturers who make and supply accurate scanning discs, and yet the price of their finished products is something of the order of 10s. to 12s. 6d. To make "a trammel arrangement with screw adjustment so that a scriber is moved the correct distance towards the centre by giving the screw a single turn" (this was our contributor's suggestion) may be all right for one disc size, but surely he knows that every different disc diameter needs a different distance and different-sized holes. As a rule, the amateur only wants one disc, but the cost of making his trammel alone, provided he had the necessary mechanical skill, would be greater than buying a disc ready made. I know that such trammels have been made on occasions, and over two years ago I was asked to examine and comment on the dividing device illustrated in Fig. 1. It was made, however, by a trained engineer and not an amateur.

By the time our constructor had made or bought his marking-out trammel, made or bought his press for making the holes, he would have spent enough money to buy several ready-made discs without any thought of the time expended.

No, "Radioptic," while the television engineer for manufacturing purposes does not, of course, use the somewhat tedious method of marking out each single disc and punching the holes individually, the amateur can surely be encouraged to carry out the work in that fashion if he prefers not to buy a disc ready made. I take strong exception to the suggestion that the methods are thoroughly bad. Tedious, if you like, but if the amateur goes about his work properly, then the resulting holes are clean and no buckling or stretching takes place.

==GIVEN FREE==

IN THIS WEEK'S

TIT-BITS

THE "WORLD-RADIO"

CHANGE OF

WAVELENGTH CHART

IN order to assist listeners to determine the new dial readings at which the various stations are now being received, this special Chart will be included with every copy of "Tit-Bits" on sale Friday. The Chart is printed on card so that it can be kept as a permanent reference when stations have been identified and their dial readings ascertained. A full list of stations in alphabetical order, with their frequencies, wavelengths and power, is also given.

LISTENERS WHO WISH TO OBTAIN A COPY OF THIS CHART CAN DO SO BY BUYING "TIT-BITS" ON SALE FRIDAY.

ORDER YOUR COPY TO-DAY

TIT-BITS

ON SALE FRIDAY — USUAL PRICE, 2^D.



THE EASY ROAD TO RADIO

THE BEGINNER'S SUPPLEMENT

WHAT IS A RECTIFIER?

A Lucid, Non-technical Article Explaining the Principle and Function of one of the Most Important Components in a Mains Receiver.

A RECTIFIER is any device used for converting *alternating* current into *direct* current. In wireless the term is usually used to refer to the apparatus

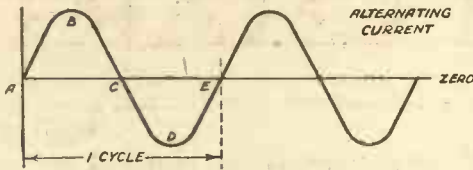

Fig. 1.—A graphic representation of an alternating electric current.

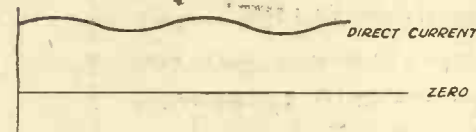

Fig. 2.—Direct Current is represented by the above graph.

used for converting the alternating current supplied by the electric-light mains into direct current suitable for providing high-tension current for the receiver.

First of all let me explain the difference between alternating and direct current. The former, as its name suggests, alternates backwards and forwards. It flows first in one direction along the carrying wires and then in the opposite direction. At one instant, that is, at the change over of direction, there is no current flowing at all. The next instant the current starts flowing, gradually increasing in magnitude until it reaches a maximum, after which it dies down again to zero. It then starts to move in the opposite

direction, increasing to its maximum value, and again subsiding as before.

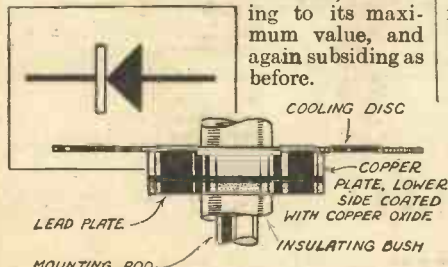

Fig. 3.—Details of one unit from a metal rectifier.

A.C. and D.C.

With the majority of electric-light mains, this process or *cycle*, as it is called, is repeated something like fifty times per second. It is usually represented graphically by the curved line in Fig. 1. At the instant of time represented by the point A there is no current flowing. In about 1/200th of a second, that is, from A to B, it rises to its maximum value. This is represented by the height that B is above the zero line. In another 1/200th of a second it has sunk to zero again, as shown by the drop in the curve to the point C. From C the current commences again, but in the opposite direction, and reaches its maximum at D. It then sinks once more to zero at E, and so the cycle is completed.

Now, current of this nature is entirely unsuitable for supplying the valves of a receiver. What is required is a current flowing steadily in one direction all the time—that is to say, a *direct* current. Such a current is shown graphically in

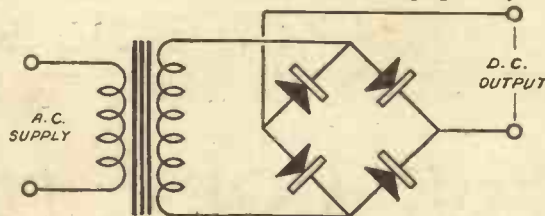

Fig. 8.—The "bridge" method of using a metal rectifier.

Fig. 2. The line representing the current is shown as being slightly "wavy," because in practice it is difficult to get the voltage absolutely constant in value. However, this small amount of ripple is negligible.

Of course, there are electric-light mains which supply *direct* current as well as those giving *alternating* current. Naturally, it is only with the latter that a rectifier is necessary. There are two types of rectifier in general use—one is the *metal* rectifier and the

other is the *valve* rectifier. Each has its own particular merits.

Principle of the Metal Rectifier

The metal rectifier is simply an assembly

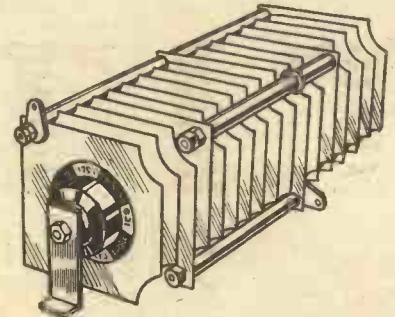

Fig. 4.—A complete metal rectifier assembled from units such as the one in Fig. 3.

of alternate plates of oxidised copper and lead. Details of a single unit of this assembly are shown in Fig. 3. Actually the active elements are the film of copper oxide and the lead. The two plates are pressed firmly together so that the copper oxide and lead are in close contact. In

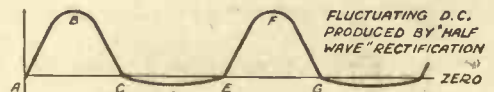

Fig. 5.—This graph shows the result of half-wave rectification.

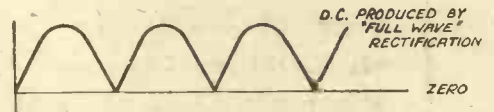

Fig. 7.—This illustration shows the result of full-wave rectification.

practice a number of these units are used as in Fig. 4. They are connected in series or parallel according to the voltage and amperage of the current to be dealt with.

Now, if an electric current is passed through the unit from the lead to the copper it offers a comparatively low resistance; but a current in the opposite direction, from copper to lead, meets with considerable opposition. Herein lies the virtue of the apparatus, for if an alternating current (one which moves first in one direction and then in the other) is applied to the copper oxide-lead joint the latter will allow it to pass readily in one direction, but will practically stop it when it attempts to flow in the opposite direction. The result is a current which flows in one direction in a series of "jerks." It rises from zero to its maximum figure and then dies down. There is then a wait of about 1/100th of a second, during the time the current is attempting to flow in

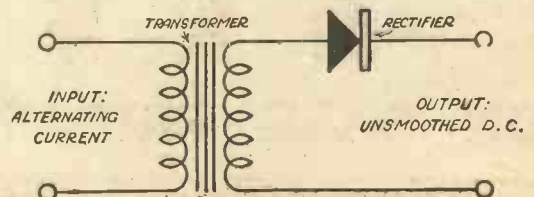

Fig. 6.—Circuit showing the use of a metal rectifier.

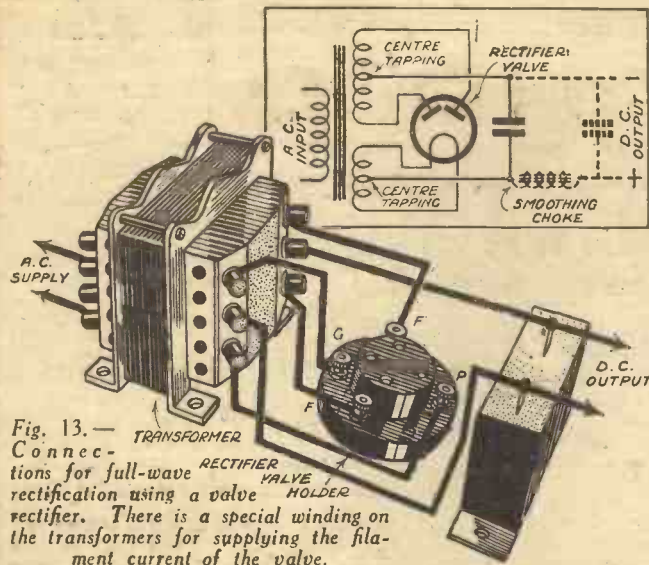

Fig. 13.—Connections for full-wave rectification using a valve rectifier. There is a special winding on the transformers for supplying the filament current of the valve.

the opposite direction, but cannot owing to the very high resistance of the rectifier, and then it again rises in the same direction as at first, and once more dies down and so on.

A graphical representation of this process, which is called *half-wave rectification*, is shown in Fig. 5. From A to B the current rises; from B to C it sinks to zero again; and then from C to E it practically ceases. A slight hump below the zero line shows that a very small current flows in the opposite direction during this period. This is, of course, due to the fact that the rectifier is not "perfect" in action. Although it offers a very high resistance when the polarity is reversed, it is not a complete insulator, and therefore a small current is bound to flow.

The circuit arrangement for a half-wave rectifier is given in Fig. 6. It is extremely simple, but has certain drawbacks. One is that the direct current produced requires considerable smoothing before it is fit to supply the receiver.

Smoothing

A better arrangement is that known as *full-wave rectification*, in which both halves of the alternating current are utilized. There are two circuits available—one is called the *bridge circuit* and the other the *voltage-doubler circuit*. They are shown respectively in Figs. 8 and 9. The choice of the one or the other depends on the output required. The former method gives an output voltage of about 70 or 80 per cent. of the input voltage, whereas the latter gives an *increase* in output voltage—not actually double the figure as theory demands, but something like 50 per cent.

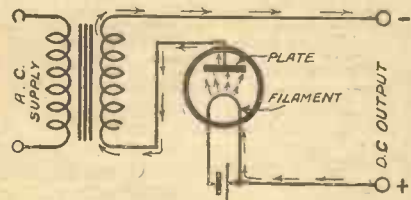

Fig. 12.—Connections for a simple valve rectifier. Arrows show path of electrons representing the rectified circuit.

(Incidentally, the two fixed condensers used in the voltage-doubler method are an essential part of the arrangement apart from their smoothing properties.)

The graph in Fig. 7 shows the nature of the current from a full-wave rectifier. You will notice that although this approaches nearer to the ideal than the current from a half-wave rectifier, yet it is still a series of pulsations rather than a smooth current. In order to carry out the necessary smoothing a fixed condenser, called a reservoir condenser, is used in conjunction with an iron-cored choke. Fig. 10 shows this condenser and choke as connected in the voltage-doubler circuit. The effect of the condenser is like that of a large silencer or expansion chamber fitted to the exhaust pipe of a motor car. As you know, the exhaust gases enter the silencer in a series of spurts corresponding with each opening of the exhaust valves, but owing to the elasticity of the gases, the size of the expansion chamber, and

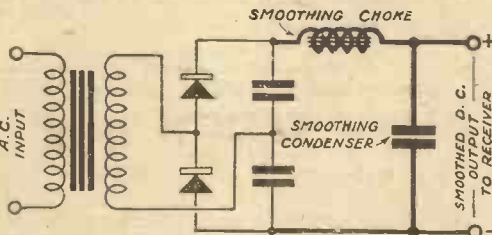

Fig. 10.—How the current is smoothed after rectification by means of another condenser and a choke.

the restricted outlet, the pressure of the gases when they leave is more or less constant. With the reservoir condenser each surge of current charges it up and then when the current drops between the surges it discharges itself and so tends to keep the output even.

The principle of the choke is exactly the opposite of that of the condenser, for whereas the condenser *accepts* each surge of current, the choke *resists* them. For this reason the choke is connected *in series* and the condenser *in parallel* with the rectifier. As the current through the choke rises, so a back E.M.F. (electro-motive force, or voltage) due to the inductance of the choke is created which *opposes* the flow of current. Then as the current falls the induced E.M.F. changes its direction and *assists* the passage of the current. Thus the effect of the choke is to maintain the

current at a constant level—to make it less "jerky." You will notice that the choke comes first and then the reservoir condenser, thus the current is first partially smoothed by the choke and then the job is completed by the condenser.

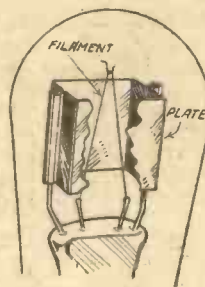

Fig. 11.—The fundamental parts of a simple valve rectifier.

Valve Rectifiers

Now let us have a look at the *valve* rectifier. This in its simplest form is similar to an ordinary receiving valve, but it has no grid—there is just the filament and the plate as in Fig. 11. It is connected up as shown in Fig. 12. This circuit is basically the same as the half-wave circuit of Fig. 6.

Since the current from the transformer is alternating, therefore, the plate becomes alternatively positive and negative. When it is positive it attracts the electrons which are being given off by the heated filament so that there is thus a stream of electrons from filament to plate, in other words an electric current flows through the valve. When the plate becomes negative the electron emission from the filament is repelled (electrons are, of course, negative particles of electricity). Like repels like, and no current flows through the valve. The resulting current is thus a uni-directional pulsating current similar to that represented in Fig. 5.

A more usual type of valve rectifier has two plates and gives full-wave rectification. The circuit is shown in Fig. 13.

It is usual to supply the current from the mains. The transformer is therefore provided with another secondary winding specially for this purpose. This extra winding is clearly shown in Fig. 13.

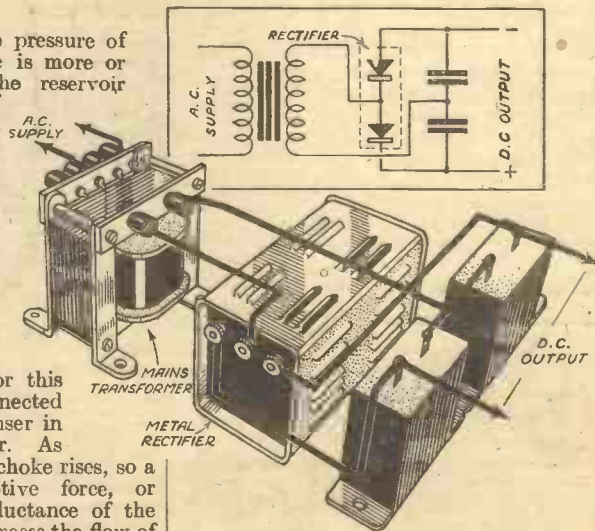

Fig. 9.—How a metal rectifier is connected up when using the "voltage-doubler" method.



F. J. CAMM'S

FURY SUPER

PILOT AUTHOR KIT EXACT TO SPECIFICATION



The Pilot Kit SERVICE was founded in 1919.

See the PILOT on the carton. It's a real guarantee.

ALL THE RAGE PILOT CLASS 'B' SPEAKER - AMPLIFIER KIT

Assemble this amazing Unit yourself in less than half an hour. Gives seven times the volume with mains quality from your existing battery set. Complete Kit comprises B.V.A. Class "B" Valve, Peto-Scott Permanent Magnet Moving Coil Speaker, B.R.G. Driver Transformer and Input Choke, seven-pin Valveholder. Peto-Scott Baffle and Baseboard Assembly, all necessary Wires, Screws, and plug-in Valve Adaptor, with full-size Diagrams and Assembly instructions.



Complete with Speaker Cash or C.O.D. **55/-** Or Send Only 6/- Balance in 11 monthly payments of 5/-

SUITABLE FOR ANY BATTERY SET

NEW LISSEN SKYSCRAPER FOUR ALL-WAY CHASSIS MODEL, complete kit comprising all components, including set of Lissen Valves. Cash or C.O.D. Carriage Paid, **£5/12/6**. Balance in 11 monthly payments of 10/3 only

NEW TELSEN 323

LATEST TELSEN KIT RELEASE. Less Valves. Cash or C.O.D. Carriage Paid, **29/6**. Balance in 5 monthly payments of 5/3. **TELSER 323 KIT** with set of 3 Valves. Cash or C.O.D. Carriage Paid, **£2/15/6**. Balance in 9 monthly payments of 6/- only

ROLA F6P.M. PERMANENT MAGNET MOVING-COIL SPEAKER, with input transformer. Cash or C.O.D. Carriage Paid, **£2/9/6**. Balance in 8 monthly payments of 6/- only

NEW W.B. P.M.4A. MICROLODE PERMANENT MAGNET SPEAKER, complete with switch-controlled multi-ratio input transformer. Cash or C.O.D. Carriage paid, **£2/2/0**. Balance in 7 monthly payments of 5/8 only

NEW BLUE SPOT 29 P.M. PERMANENT MAGNET MOVING-COIL SPEAKER. With input transformer. Cash or C.O.D. Carriage Paid, **£1/12/6**. Balance in 6 monthly payments of 5/- only

NEW GARRARD MODEL 202A. 12-in. Turntable. Electric Motor for A.C. mains. Cash or C.O.D. Carriage Paid, **£2/10/0**. Balance in 8 monthly payments of 6/- only

ATLAS G.A.25, for Mains, Class "B" and Q.P.P., four tappings; 60/80, 50/90, 120, 150, 25 m/A. Cash or C.O.D. Carriage Paid, **£2/19/6**. Balance in 10 monthly payments of 6/- only

PETO-SCOTT PERMANENT MAGNET MOVING-COIL SPEAKER



Power or Pentode Complete with input transformer. Send 2/6 with order. Balance in 5 monthly payments of 4/-.

Cash or C.O.D. **19/6** Carriage Paid.

2/6 DOWN

Class "B" Model, Cash or C.O.D. Carriage Paid **£1/2/6** or 2/6 down and 6 monthly payments of 4/-.

CASH - C.O.D.

£8-15-0 or 12 monthly payments of **16/-**

KIT "A" Author's Kit of Specified Parts, including Peto-Scott METAPLEX Chassis ready drilled but less Valves, Cabinet and Speaker. Cash **£8 15 0** or C.O.D. Carriage Paid.

KIT "B" As for Kit "A," but with set of specified valves only. Cash or C.O.D., Carriage Paid, **£11 9 6** or 12 monthly payments of 21/-.

KIT "C" As for Kit "B," but with Peto-Scott Twin De Luxe Cabinet, but less Speaker. Cash or C.O.D. **£13 14 6** Carriage Paid or 12 monthly payments of 25/3.

If W.B.P.M.6 Speaker is required, add **£1/12/6** to Cash Prices or 3/- to each monthly payment.

KIT-BITS You pay the Postman. We pay post charges on all orders over 10/- GREAT BRITAIN ONLY.

1 Peto-Scott Metaplex Chassis, ready drilled and slotted	£ 9. 0
1 set Colvern Ferrocart type "G" Coils (G.10, G.13, G.14)	4 0
1 J.B. "Nugang" Single Variable Condenser, .0005 mfd. with type "A" drive	1 17 6
1 J.B. "Nugang" 2-gang variable condenser .0005 mfd. with type "A" Drive.	10 6
1 Varley "Pentode" Nichoke	17 8
1 Varley Graded Volume Control type C.P.158	11 6
1 Graham Farish Booster Unit	5 6
1 Westinghouse Westector type W.4	7 6
1 British Radiogram Passteela L.F. Coupling Unit.	7 8
	10 6

CONVERT YOUR FURY SUPER TO A MAGNIFICENT RADIOGRAM



with the 1934 WALNUT ADAPTARAM

This amazingly popular Peto-Scott Cabinet has brought the joys of the Radiogram to thousands of British Homes. Built by master craftsmen of the piano trade. Real inlaid walnut, mortised, tenoned, French polished. With motor-board, ready to take your set, speaker, and power equipment. Comes to you ready drilled to take your FURY SUPER or with plain front, or vignetted to take panels, 14in. by 7in. 16in. by 7in. 16in. by 8in. Baseboard design, 14in. Baseboard 3/8 extra.

YOURS FOR 8/3

MODEL "A" Cash or C.O.D., 63/-. Carriage and packing 2/8 extra. Yours for 8/3. Balance in 11 monthly payments of 5/9 (Carriage Paid). Special drillings or other special cut-out designs, add 3/- extra to Cash Price or 3d. to each monthly payment.

MODEL "B" Standard 1934 Adaptagram with Double Spring Motor, 12in. Plush-covered Turntable, Automatic Stop, B.R.G. Tone-arm with Pick-up and Volume Control Complete—Automatic needle Cup. Cash or C.O.D. Carriage Paid. Or 12 monthly payments of 12/-, Carriage Paid. **6 Gns.**

MODEL "C" A.C. Mains only. Standard 1934 Adaptagram Cabinet—Collaro Induction Electric Motor with Tone-arm, Pick-up, Volume and Control in one Unit, 12in. Plush-covered Turntable, Automatic stop—Automatic Needle Cup. Cash or C.O.D. Carriage Paid. Or 12 monthly payments of 13/8, Carriage Paid. **7 Gns.**

Ask for Mahogany no extra. D.O. Model Prices on application. **Send For 1934 CABINET CATALOGUE.**

PETO-SCOTT PERMANENT MAGNET MOVING COIL 1934 EXTENSION SPEAKER

SUITABLE OUTPUT FOR **1001 RECEIVERS** in Beautiful WALNUT Cabinet.

Yours for

5/- down

Balance in 7 monthly payments of 5/6.

CASH or C.O.D. Carriage Paid.

39/6



DESIGNED WITH 30 RATIOS

For Power, Super Power, Pentode-Class "B"—in fact, every type of output valve known. Alterations to ratio readily without removing Speaker or back of Cabinet. See inset.



In addition to the extraordinarily wide range of output ratios—thirty, covering the requirements of every type of home-constructed and factory-built set, old or new—the Peto-Scott Extension Speaker is built with an inclined baffle, supported on felt cushions which completely eliminate all resonance and boom, enhancing the already perfect tonal balance. Complete with Combined Volume Control and Switch. Obtainable only direct from PETO-SCOTT. **SPEAKER ONLY** (less cabinet). Cash or C.O.D. Carriage Paid, 29/6. Or yours for 4/- down and 7 monthly payments of 4/-.

PILOT Class "B" CONVERSION KIT

Converts your present Battery Set to Class "B" Amplification. Complete with all necessary components, including driver transformer, Class "B" output Choke, W.B. 7-pin valve-holder, B.V.A. 240B valve, wire and screws, etc. Full-size Blueprint, assembly instructions and diagrams. Cash or C.O.D., **37/6**. Balance in 7 monthly payments of 5/6.

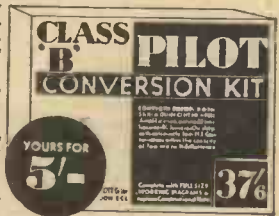

IMPORTANT—Miscellaneous Components, Parts, Kits, Finished Receivers or Accessories for Cash, C.O.D. or H.P. on our own system of Easy Payments on orders over £2. Send us a list of your wants. We will quote you by return. O.O.D. orders value over 10s. sent carriage and post charges paid Great Britain only. **OVERSEAS CUSTOMERS CAN SEND P.O.S WITH CONFIDENCE.** We carry a special export staff and save all delay. We pay half carriage—packed free. Send full value plus sufficient for half carriage. Any surplus refunded immediately. Hire Purchase Terms are NOT available to Irish or Overseas customers.

PETO-SCOTT Co., Ltd., 77, City Rd., London, E.C.1
Telephone: Clerkenwell 9406-7
West End Showrooms: 62, High Holborn, London, W.O.1.
Telephone: Holborn 3245.

Dear Sirs:
(a) Please send me
(b) I enclose Cash-Deposit
NAME
ADDRESS
P. W. 3/2/31.

OSTAR-GANZ

UNIVERSAL MODEL SETS

"UNIVERSAL" HIGH VOLTAGE MAINS VALVES EASILY CONVERT YOUR BATTERY SET TO ALL-MAINS, and enable anyone to build a splendid "Universal" A.C., D.C. set. Highly efficient and most economical in every way. **NO TRANSFORMERS, NO RESISTANCES, NO BARRETTERS** needed. Astounding results guaranteed by our technical staff. Free reprint of article on "How to Convert a Battery Set to All-Mains" as described in "Practical Wireless" sent on request.

"UNIVERSAL" KITS also supplied. Blue Print with each kit. 3, 4, 5 and 7 Valve Receivers. 3 and 4 Valve Radiograms. 2 and 3 Valve Amplifiers. Complete List "N" and all details of the full range of Ostar-Ganz High Voltage Mains Valves Free on request. Remember, too, that Ostar-Ganz "Universal" High Voltage Mains Valves work equally as well on either D.C. or A.C., so there's never any need to scrap them because your electric supply is changed. Leaflets on Ostar-Ganz "Universal" sets and circuits as described in this and other radio papers sent free on request.

Sole Agent for Great Britain

EUGEN FORBAT, 28-29, Southampton Street, Strand, London, W.C.2.
Phone: Temple Bar 8808.

These are the most economical sets to buy and use. They also work off either A.C. or D.C. supply without alteration. These sets are remarkably free from mains hum. Reproduction is superb.

Full range available, including the

"HIGHMU 3" UNIVERSAL MODEL SET, employs a highly selective circuit with Ferrocart nickel iron coils. Highmu detector D130, and multigrad output Pt.3, capable of an undistorted output of 2.8 watts. Indirectly heated rectification system is utilized by the EG. 50 rectifier valve, so giving hum-free reception. Fitted with latest type mains energised moving coil speaker in walnut cabinet; ready for use.

Price 29 9s. 0d.

A postcard will bring you full details and prices. Unquestionably the greatest value obtainable in all-mains sets. Write now.



Read this
QUALITY
Produces
EFFICIENCY

TESTED BEFORE DESPATCH

The original BECOL ebonite low loss formers are thoroughly reliable. They are used in all parts of the world. Look for the BECOL trade mark. Ask your dealer. If unable to supply write direct. SEND NOW, enclosing 6d. (post free) for third edition up-to-date handbook of tuning coils for DUAL RANGE, BAND-PASS, and SUPER-HET. circuits. Fully illustrated with data. A very interesting handbook.

RODS, SHEET, TUBES, PANELS

The BRITISH EBONITE Co., Ltd.,
Hanwell, London, W.7.

AS GOOD AS THE BEST
NON-MICROPHONIC
ENTIRELY BRITISH
FULLY GUARANTEED



Post Free from

3/6

SAVE 50%

The 3 VALVES for the R.I. WREN-EASTON, 16/- . If your dealer is not yet stocking 362 send for them post free direct from the makers.

"362" BATTERY TYPE VALVES: H.L. & L. 3/6. Power, 4/- Super-Power, 4/6. S.G., 7/6. Var.-Mu, 7/6. "Class B," 9/- Pentode Type, 10/- (Metalised, 3d. extra).
"362" Patent UNBREAKABLE TOLEDO BATTERY TYPE VALVES: H.L., 4/6. Power, 5/6. Super-Power, 6/- S.G., 10/- Var.-Mu, 10/-.

COMPLETE 362 CLASS "B" KIT, including Class "B" valve, 7-pin valveholder, Input and Output Transformers, with full instructions. 28/6.
CLASS "B" MOVING COIL SPEAKER incorporating CLASS "B" Input and Output Transformers and Class "B" Valve. Only four wires to connect. 50/-.

Cash with order. Cheques and P.O.'s must be crossed and made payable to:—
THE 362 RADIO VALVE Co., Ltd. (Dept. W.), Stoneham Road, London, E.5.
Trade Enquiries Invited.

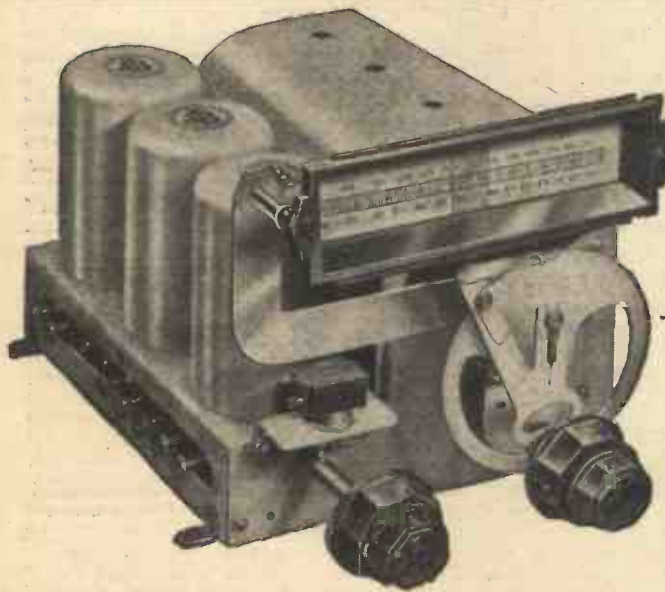

2 Free Blueprints! THE REMARKABLE LINACORE

3-valve
circuit
equal to a
Superhet



COUPON

By sending this coupon NOW you will receive free a blueprint of an ideal battery or mains model "LINACORE" circuit which from 3 valves will give you results equal to a "Superhet." Enclose 2d. only for postage, and state which.

For battery receivers type BPB
For Mains receivers type BPM (as illustrated) **69/6**

To JACKSON BROS.
(London) Ltd., 72, St. Thomas' Street, London, S.E.1.

Please send Free blueprint of Mains Model } Delete one not
Battery Model } required

I enclose 2d. in stamps for postage.

NAME

ADDRESS

Pr. W.

RADIO RAMBLINGS

By JACE

Gottings from my Notebook



Television Kit Set

AN indication of the growing popularity of television in the home is the introduction by a very well-known firm of a mirror-drum television receiving apparatus in kit form. This is not simply the television side of the apparatus, but includes also a most efficient mains receiver, employing two S.G. stages, a diode-tetrode and a pentode output valve, in addition to iron-core tuning coils. A valve rectifier is used to supply the various voltages, and this portion of the apparatus is built on a simple baseboard, above which is fitted a "shelf" upon which are arranged the mirror-drum and its associated accessories. The viewing screen is arranged in front of this shelf and thus comes above the mains tuning controls. The apparatus is absolutely complete, and the total cost of the kit is only £18.18s., which is a very reasonable figure when you consider the amount of apparatus which is included. A set of blue-prints is included, and the constructional work is not at all difficult.

New Tuning Dials

WE have become so accustomed to the usual semi-circular or straight type of tuning scale, that any departure from this method arouses interest and creates not a little argument amongst the many devotees of the different forms. The latest novelty in dials has been produced by the makers of the well-known Ultra range of receivers, and takes the form of a clock. The aperture in the cabinet front is square, and the wavelength markings of the medium and long-range band are arranged in the form of a circle, the long-range band occupying the right-hand side of the "dial," and the medium band ranging round the left-hand side. The readings are continuous, the lowest setting starting at a point midway between 6 and 7 o'clock, and the change from medium to long occurring at 12 o'clock. The indicating pointers take the form of clock hands, and the general appearance is very pleasing, giving the receiver an aspect which is a change from the usual "laboratory" arrangement of most receivers. Any change such as this is, of course, welcomed, and will tend to still further popularize radio for the non-technical user.

H.F. Loud-speakers

A NEW type of loud-speaker has recently been developed in America and on the Continent which is intended to give particularly good response to the very high audio frequencies up to something like 12,000 cycles. This speaker gives practically no response to frequencies lower than 3,000 or so, and is therefore not intended for use by itself, but in conjunction with a moving-coil unit which, as is well known, gives maximum response to frequencies lower than some 4,000 cycles. By using the two together it is possible to obtain an almost perfectly uniform response to the complete range of audio frequencies,

and thus reproduction of a hitherto unheard-of quality is to be obtained. The new high-frequency speaker uses a piezo-electric crystal instead of the usual magnet and coil arrangement, and its function depends upon the principle that a torsion effect on the crystal can be produced by applying an E.M.F. between its faces. In use it is generally desirable to feed the two speakers (H.F. and moving-coil) through a special filter device so that the lower frequencies are applied to one speaker and the higher ones to the other. So-called high- and low-pass filters are made especially for the purpose and are supplied along with the H.F. speaker.

Artist Broadcasts While in Pain

NONE of the millions of listeners who heard Peter Dawson broadcast in the recent B.B.C. transmission of "In Town To-night" realized that he was suffering agonizing pains from lumbago whilst singing. It had been arranged for a transmission to be given in this popular Saturday night feature of the famous Australian bass baritone making gramophone records in the "His Master's Voice" studios at St. John's Wood. He had been in bed for a fortnight, and at the last moment it was thought that the broadcast would have to be cancelled. His doctor forbade him to get up, but against his medical advice, he rose from his sick bed and, wrapped in rugs, left in a specially heated car for the studios. He took his place before the microphone, and listeners were switched over to the studios to hear him finishing the chorus of *The Glory of the Motherland*.

Some Secrets of Record Making

MAX KESTER, the well-known personality of B.B.C. broadcasting, who is on the staff of "His Master's Voice," speaking from the H.M.V. machine room, revealed to listeners for the first time many of the closely guarded secrets of record making. The remarks of George Dillnutt and Harry Fleming, who have been making records for more than twenty-five years, were clearly heard; after which Peter Dawson made a record of Besley's *England*. Max Kester then explained to listeners that it would be reproduced immediately through the recording wax in order that Peter Dawson might correct such details as balance and interpretation. Whilst the singer was trying to obtain relief by holding a hot-water bottle to his back in the studio, his voice, as he had sung his song a minute before, was reproduced from the thick wax record and broadcast. The listening millions then heard him criticize his own singing, whilst Ray Noble, the well-known dance music composer, who was conducting the orchestra, and Mr. W. H. Streeton, the recording manager, made suggestions for alterations in the placing of the orchestra. The microphone in the machine room was then switched on and listeners heard Max Kester describing how

the wax revolved at exactly seventy-eight revolutions per minute and the way in which a vacuum drew away the tiny shaving made by the cutting point. This unusual broadcast finished with Peter describing how in twenty-five years he had recorded more than 3,000 different songs. In view of the interest in the broadcast, "His Master's Voice" are making special arrangements to release this record of *England* in the very near future.

Metal-coated Valves

IN all radio apparatus it is very important that the various circuits and components carrying radio-frequency currents should be adequately screened from each other. Otherwise the different components act as the plates of a condenser, allowing high-frequency energy to pass from one circuit to another, resulting either in loss of signal or, more disastrous still, unwanted reaction effects which are liable to render the receiver unstable.

The usual method of screening is to enclose each component in an earthed metal can, but in the case of valves the purpose can be served by a metallic coating applied to the bulb and connected to earth via one of the filament pins or, in the case of mains valves, via the cathode pin. The metallization of valves, therefore, serves as an electrostatic screen to avoid unwanted retro-action. In this connection it greatly simplifies the design of the H.F. screening and the task of deciding upon the best lay-out of the components. Metallizing has other uses, however. It ensures greater uniformity in performance as between valve and valve of any particular make and type; and it also reduces the effective inter-electrode capacity of the valve, improving general stability and permitting fuller use to be made of the amplifying power of the valve.

Naturally metallizing is restricted to valves employed as high-frequency or intermediate-frequency amplifiers and as detectors. In many instances valves for these purposes are supplied either metallized or clear as required, but in some makes certain types are only available with metallized bulbs. For example, Mullard two-volt screen-grid valves (P.M.12A and P.M.12M), and detectors (P.M.1HL and P.M.2DX), can be obtained in both forms, but in the mains range the multi-mu screened pentode (V.P.4) and the double-diode-triode (T.D.D.4) are supplied metallized only, while the "straight" screened pentode (S.P.4) and the two detectors (354V and 904V) can be obtained either metallized or clear.

READERS' WRINKLES

(Continued from page 952)

The cells are easily made, either from pickle jars or test tubes. A most efficient arrangement is to make six cells from lin. test tubes and mount them in a rack (Fig. 1). The cells may be made as shown in Fig. 2.

When they have been assembled it is necessary to "form" the electrodes, which is quite a simple operation. Connect up as shown in Fig. 3 and switch on the current, when, after a short time, the lamp will become dim and finally go out altogether. The electrodes are then formed, and after renewing the solution they are ready for use. The smoothing condensers and choke complete the power pack, and the parts should be assembled as shown in Fig. 4.—J. S. SOMERS (Leeds, 7).

[It should be pointed out that the above system of connection to the mains is contrary to I.E.E. regulations.—ED.]



CHASSIS MOUNTING VALVEHOLDERS

appreciated by all set designers
therefore specified for the

"1934 SUPER FURY"

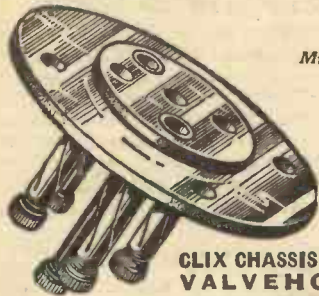

Mr. F. J. Camm
again chose
CLIX.

CLIX CHASSIS MOUNTING VALVEHOLDERS

STANDARD TYPE AS SPECIFIED

- 4-Pin with terminals 8d.
without terminals 5d.
- 5-Pin with terminals 9d.
without terminals 6d.

Resilient sockets guarantee full-surface contact with ANY type of valve pin and definitely prevent arcing. For easy entry and withdrawal the sockets move laterally and align with valve pins.



CLIX "MASTER" PLUGS

Positive METAL to METAL wiring. Firm grip and full contact with ALL sockets with internal diameters from 1/16 in. to 5/32 in. battery socket. Curved ends for easy insertion. Price 1 1/2d. ea.

Clix "1934" Folder "N" Free.

Cheapest PERFECT Contact

LECTRO LINX Ltd., 79a, Rochester Row, London, S.W. 1.

EASY PAYMENTS

"There's no place like HOLMES."

The first firm to supply Wireless parts on easy payments. Nine years advertiser in Wireless Press. Thousands of satisfied customers.

EPOCH SPEAKERS

		Monthly Payments.	
SUPER DWARF	23/6	4/4	5 of 4/4
20th Century	35/-	4/10	7 of 4/10
11in. SUPER	45/-	4/11	9 of 4/11
B5.P.M.	84/-	7/8	11 of 7/8

Lissen Skyscraper 4 ...	112/6	10/-	11 of 10/3
TELSEN 325 Star Kit	39/6	5/5	7 of 5/5
EXIDE H.T. Accum., 120v.	60/-	8/-	9 of 8/8
BLUE SPOT 25PM.	32/6	4/5	7 of 4/5
ATLAS ELIMINATOR, No. GA25	59/6	5/-	11 of 5/6
D.T.H. Pick-up	21/-	3/10	5 of 3/10

Parts for any Kit Set. Any make of Speaker.

H. W. HOLMES, 29, FOLEY STREET, Great Portland Street, London, W.1.

Phone: Museum 1414.

7 DAYS' FREE APPROVAL!

H.T. ELIMINATORS AND TRICKLE CHARGERS.

BRITISH THROUGHOUT. 2 YEARS' GUARANTEE. A.C. models incorporate Westinghouse metal rectifier and a special power supply for illuminating tuning dials. Trickle charger 15s. 0d. extra. Catalogue free from actual manufacturers:

V.M.C. RADIO COMPANY,
D.C. 15/- 154, Holmleigh Road, LONDON, N.16. A.C. 30/-
No Trade Discounts.

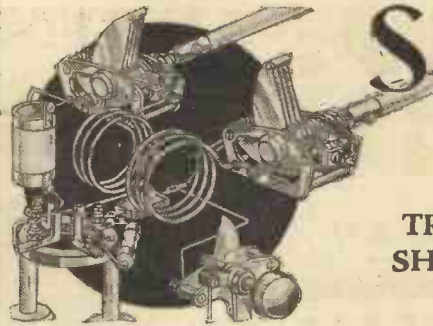

Short Wave Section

TROUBLE-TRACKING IN SHORT-WAVE RECEIVERS

By B. M.

TROUBLE-TRACKING in short-wave receivers sometimes presents some curious difficulties which are not always easy to correct by the methods which are normally used for medium and long-wave receivers. As far as the home constructor is concerned, trouble may be encountered in a short-wave receiver in two different ways—either the receiver has been badly designed and/or badly built in the first place and refuses to work correctly from the first time of switching on, or else a fault develops after the receiver has been working satisfactorily for a while.

Ignoring short-wave superhets alone, we will give our attention to the type of receiver shown in the diagram. This is a

any slight deviation from the original is bound to make some difference to the actual operation of the coil, in some cases making the coil quite useless. The size of the wire itself, the diameter, length, and material of the former, the number of turns, and the exact spacing between the coils are all important.

Assuming that the coils are correct and correctly wired up, further failure to produce oscillations may be due to a faulty detector valve, an incorrect size of reaction condenser, an inefficient H.F. choke, insufficient high tension on the detector valve, too tight a coupling between aerial and tuning coils (in the case of receivers without an H.F. stage), wiring too long,

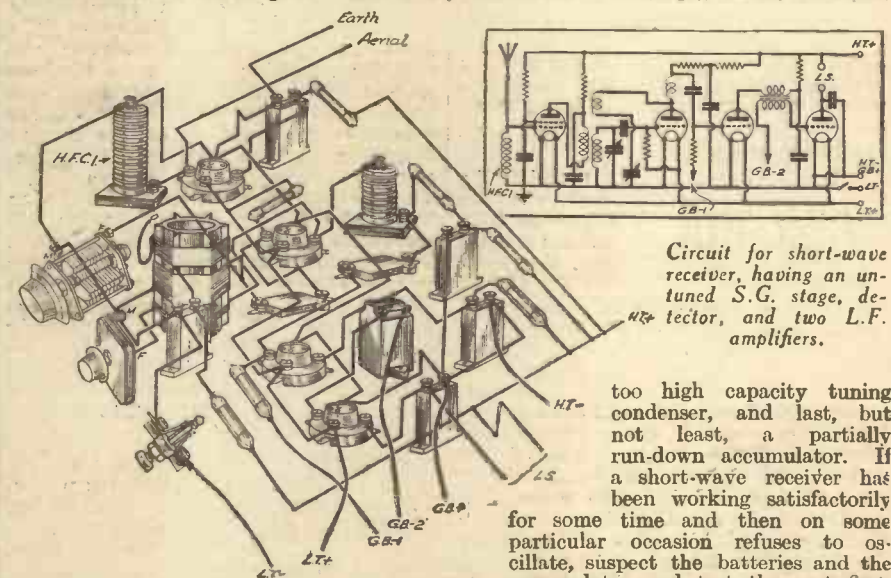

Circuit for short-wave receiver, having an untuned S.G. stage, detector, and two L.F. amplifiers.

straightforward arrangement consisting of an untuned screen-grid stage, detector, and two low-frequency amplifiers. This circuit, stage for stage, is the basis of the majority of short-wave receivers in use to-day. Some omit the screen-grid valve, whilst some omit the resistance-capacity amplifier stage and, again, a number of receivers only use the two remaining valves for head-phone operation.

Failure to produce oscillations is generally the first short-wave trouble to be encountered, and this may be due to one or more of many causes. The first and obvious query is—are the coils correctly made and wired up in the correct sequence? If commercial coils are in use, it should only be necessary to check up the way in which they have been wired into the remainder of the circuit. If home-made coils have been used, the golden rule is to make them to some reliable specification and stick to that specification. The coil data has already been worked out and put into practice by an experienced designer, and

too high capacity tuning condenser, and last, but not least, a partially run-down accumulator. If a short-wave receiver has been working satisfactorily

for some time and then on some particular occasion refuses to oscillate, suspect the batteries and the accumulator and test them at first, on load, because although this may read as a rather obvious point, don't forget that with a medium and long-wave receiver oscillations are generally easier to produce, and also that it is generally possible to hear signals of some sort when the receiver is far removed from the oscillating point, whereas a short-wave receiver (except those of the superhet type) is useless if it cannot be made to oscillate and things have to be kept in a high state of efficiency in order to maintain satisfactory oscillation.

In designing the detector stage layout do not forget that oscillations will be hard to produce, if not impossible, if the coils are mounted too near any metal shielding, and in this respect a metallized valve is as good as a solid metal screen, so that if it is proposed to use a valve of this type, the tuning coils should be mounted at least two inches away.

In the diagram shown, the high-frequency stage is untuned; the choke HFC₁ should be a short-wave type.

THREE TYPICAL USES FOR WESTECTORS

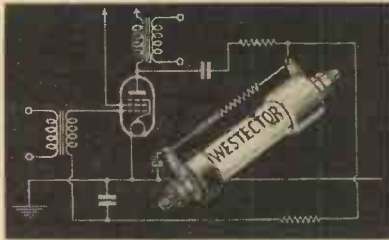

BATTERY ECONOMY

Used as a battery economiser, the Westector enables a large output to be obtained from a battery set without using special equipment, and is applicable to any type of receiver.

AUTOMATIC VOLUME CONTROL

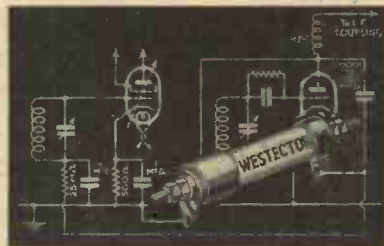

Usually the introduction of Automatic Volume Control necessitates complicated alterations. But even delayed A.V.C. may be obtained in a simple manner with the Westector.

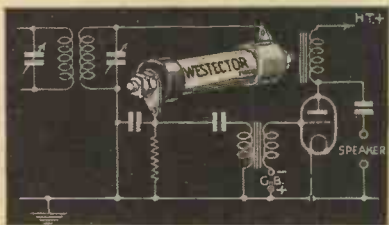

HIGH-QUALITY DETECTION

When used as the second detector in a Superheterodyne, the Westector gives straight line rectification with distortionless detection, and it is almost impossible to overload it.

You will want to know more about this useful component. It is incorporated in many commercial receivers, A.V.C. Units, etc. The coupon below and a 3d. stamp to Dept. PRA, will bring you full details—a copy of our booklet "The All Metal Way, 1934."

COUPON

The Westinghouse Brake & Saxby Signal Co., Ltd.,
82, York Road, King's Cross, London, N.1.

Please send me "The All Metal Way, 1934," for which I enclose 3d. in stamps.

Name.....

Address.....

PRA 3.2.34

Amazing Station Separation

Great Success of the

WREN-EASTON MICRIONISED 'CLASS B' RECEIVER

"The Easiest Set in the World to Build"

Thousands of "Practical Wireless" readers have built up the R.I. "Wren-Easton" Micrionised Class B Receiver. They are saying that it gives amazing station separation with the purest and most realistic tone that has ever been rendered by a battery-driven set.



Furthermore, it is so economical to run. Mr. Camm said:

"The current consumption was measured and the average current for one hour's use was only four milliamps, thus providing very economical running" (*Practical Wireless*, Jan. 20th).

If you have not begun to build this receiver, do so now—if you have mislaid your copy of the circuit

POST COUPON below at once for another.



The Great Selectivity of the R.I. "WREN-EASTON" Receiver is due to the

MICRION IRON CORE COIL WITH ADJUSTABLE INDUCTANCE

"MICRION" was described in a test report by "Wireless World" as 30% to 40% better than other coils.

It is the secret of the selectivity of the "Wren-Easton" and can also be used in practically any existing receiver to bring in station after station with clear-cut separation.

It is easily fitted in a few seconds, no troublesome alterations to the circuit or re-calibration being involved. A turn of the micrometer adjusting screw enables it to be matched with existing coils and valves, or to suit varying aerial conditions. **12/6**

Ask your dealer for the "Micrion" instructional leaflet which tells you how to fit the coil in your set.



Constructors are reminded that their radio dealer can supply all components for the "Wren-Easton." In the event of any difficulty please write to R. I. direct, who will tell you the nearest R. I. "Wren-Easton" Kit stockist.

"WREN-EASTON" CIRCUIT FREE!

Sign this Coupon and enclose 2d. in stamps for postage.

Name.....

Address.....

PRW

The Advt. of Radio Instruments, Ltd., Croydon, Surrey.

HERE IS A SELECTIVITY UNIT

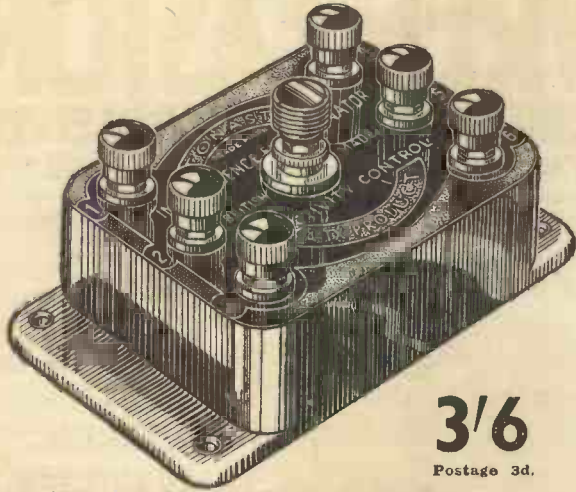

3/6

Postage 3d.

THE "TONASTAT"

The addition of a "TONASTAT" in the aerial lead of any receiver fitted with a single tuning control, whether straight set or superheterodyne, is invariably an advantage, in that it provides correct aerial matching.

SEE "TEST" REPORT ON PAGE 966.

Obtainable from all dealers or from:

that is NOT just a "gadget" to attach willy-nilly to any set and "hope for the best."

The "TONASTAT" has been carefully designed to meet the individual needs of practically every type of set in present-day use, be they 1924 or 1934 models.

NO OTHER SELECTIVITY UNIT COSTING SO LITTLE CAN DO SO MUCH AS THE "TONASTAT."

It offers a wide variety of combinations in connections to meet varying conditions of reception.

THE "TONASTAT"

GIVES HIGHER SELECTIVITY TO ALL TYPES OF SETS.
 MAKES IT EASIER TO TUNE DOWN TO 200 METRES.
 GREATLY REDUCES INTERFERENCE.
 STOPS BREAKTHROUGH OF MEDIUM ON LONG WAVES.
 COUNTERS NOISES FROM EARTH LEA DS.

BALANCES YOUR AERIAL WITH ANY SELECTED STATION.
 REDUCES MUSH AND SIDEBAND SPLASH.
 CUTS DOWN WHISTLE INTERFERENCE.
 INCREASES THE NUMBER OF STATIONS RECEIVED AND VASTLY ADDS TO THE PLEASURE OF LISTENING.

With every "TONASTAT" there is supplied simple circuit wiring diagrams and a table of "TONASTAT" circuits recommended for use with 2 to 5 valve sets employing aerials from 40 to 100 feet long, for sets using indoor aerials, for sets using mains aerials, and for replacing the aerial by a "TONASTAT." Descriptive Folder "N." Free.

T.X. PRODUCTS Co.,

(Dept. "N") 32, QUEENSWAY, PONDERS END, MIDDLESEX

Telephone: Enfield 2823

50% reduction in H.T.
and prolonged battery life

In addition to its other advantages just consider the resultant economy of the "Power Puncher." For example, in an average 3-valve set (1 S.G. Detector and Small Pentode) you save 50% of H.T. consumption. In other words you save at least one H.T. battery renewal per year and in some cases two. A complete unit in itself—requires no extra rectifier or resistances.

Write to-day for our new components' leaflet—it is free.

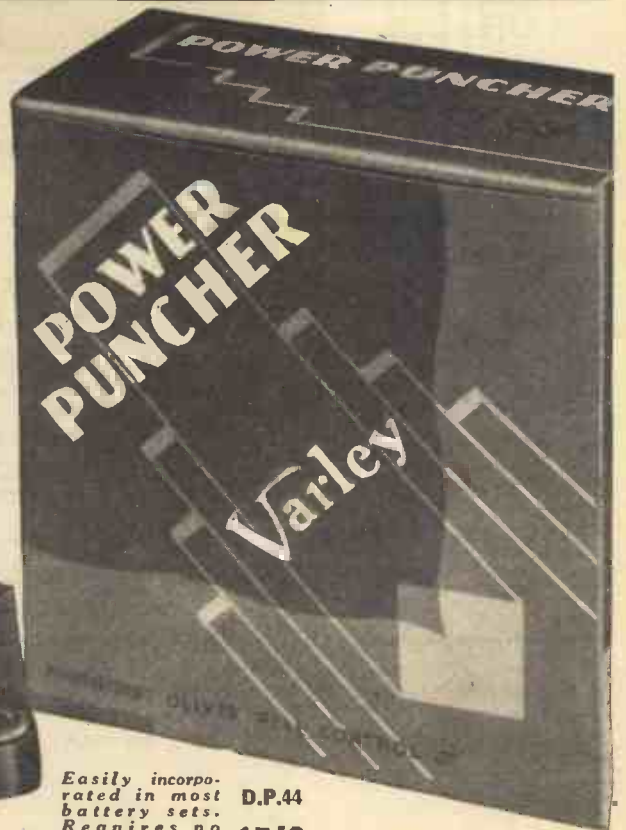

Easily incorporated in most battery sets. Requires no special transformers or valves.
D.P.44
15/6

Varley
 (Proprietors: Oliver Pell Control Ltd.)

ELECTRADIX MICROPHONES

Efficient, Cheap and Reliable Instruments for Home Broadcasting

FOR home broadcasting, and for many other experiments which have been described in these pages from time to time, a good microphone is indispensable. There are, of course, many different types of microphone available for the home-constructor, and the prices of these instruments vary considerably. The illustration on this page shows a range of microphones and special transformers which are supplied by Electradix Radios, and in this group will be seen no fewer than six different models, ranging from the small "button" type in the foreground, to the large pedestal type at the rear. The small button costs only 1s., and is of approximately the same diameter as this coin. Its overall length is only one inch, and although the sensitivity is not abnormal it can be productive of remarkable results. As an instance, it may be attached to a fairly large thin sheet of some substance to act as a sounding

it is capable of fair quality musical reproduction and is very sensitive.

On the left of the front row is Model 11B, a more robust version of the previously-described microphone, which costs 7s. 6d. This is finished in a neat blue cellulose enamel and is furnished with a two feet length of silk flex for connection purposes. The sensitivity is slightly better than Model No. 11 and quality is proportionately higher with a consequent reduction in background noises. This will prove a very good all-round instrument for the serious experimenter and is capable of really fine results when coupled to a suitable circuit. The flexible lead which is attached would render this particular model very useful for a sports meeting as it could be passed through a buttonhole and the various races, etc., could be announced without encumbrance.

This particular model is incorporated in the centre and right-hand stand models in the group, and these are, of course, much more convenient for public meetings, or occasions where the instrument is to be stood on a table for relaying a speech. The microphones are spring-suspended in the outer ring, ordinary rubber being used in the tall model, and helical springs in the model on the right. These prevent practically all of the background noises associated with the hand models, and also prevent the transmission of sounds other than those which are directed towards the microphone. Both models are finished with a neat bronze lacquer and a silk flexible lead. The super model on the extreme left is built on very substantial lines and the framework, as well as the microphone, is a most robust affair. It is capable of really high-class results, and is free from many of the objections usually found with low-priced microphones.

It is necessary with practically all microphones to employ some form of input transformer in order to correctly match the grid circuit of the valve with which it is employed, and three such transformers may be seen in the group. In the centre is an unshrouded model designed for microphones No. 11 and 11B, and this has a ratio of 90 to 1. It costs 3s. 6d. On the left is Model 2T, designed for the stand models and is provided with a ratio of 100 to 1. It costs 7s. 6d. For microphones No. 12 and 12S the transformer on the right should be used. With a ratio of 75 to 1 the cost of this transformer is 4s. 6d.

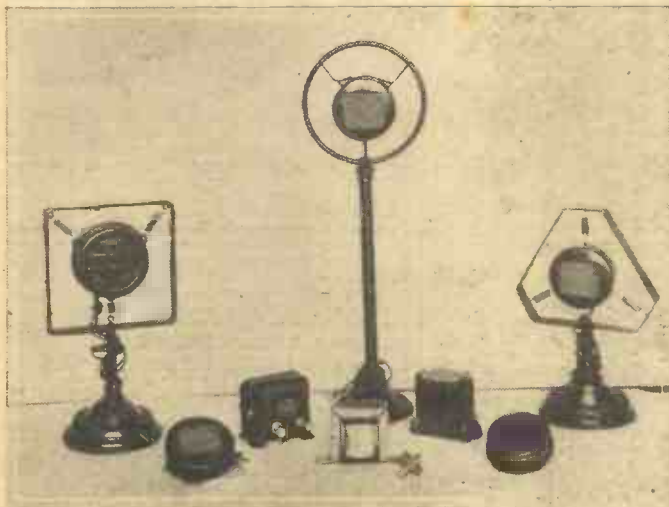

A group of various types of microphones sold by Electradix Radios, Ltd.

board, and then when connected to a two-stage amplifier good 'phone signals may be obtained from a person talking six feet from the microphone. The quality is not, of course, good enough to enable a musical instrument to be reproduced in another room, although the output may be modified by suitable condenser shunts. For experimental purposes, however, there will be found many interesting applications of the device and its price brings it within the reach of everybody.

On the right of this button may be seen a round model known as Type No. 11, and this costs 5s. 6d. This consists of a moulded bakelite case inside which is mounted a microphone button of slightly larger dimensions than the 1s. model, and it is provided with a large mica diaphragm attached to the centre pole. Connections are brought out to two terminals on the rear, and the front is enclosed by a metal gauze with silk backing at the rear to prevent damage to the mica diaphragm. The sensitivity is naturally much higher than in the case of the 1s. model, and quality is also better. There is naturally a slight background or rustling noise, but

DUBILIER RESISTANCES

There are
over 7,000,000
Dubilier
Resistances in
constant use by
British Listeners

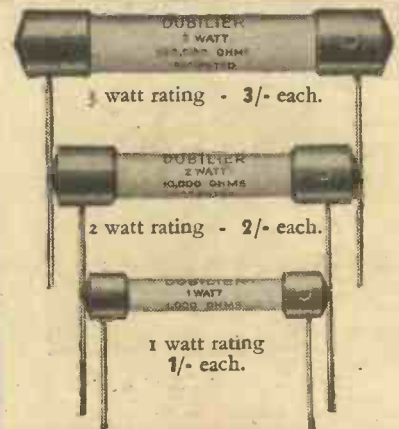

Each one
conclusive proof
of
Dubilier's
outstanding
Reliability

When building the 'Fury Super' insist upon Dubilier Resistances for reliability.

DUBILIER RESISTANCES

DUBILIER CONDENSER CO. (1925) LTD.
Ducon Works, Victoria Rd., North Acton, London, W.3

FACTS & FIGURES

Components tested in our Laboratories

BY THE PRACTICAL WIRELESS TECHNICAL STAFF

GRAHAM-FARISH "SLOT"

A NEW type of aerial-selectivity device has been received from Messrs. Graham Farish, which, although only a small variable condenser, possesses several interesting points. The base of the device measures only approximately one inch by one and a half inches. Connected to the two terminals are two circular metal plates, separated by a disc of mica. Beneath the lower plate is a circular disc to which a small metal knob is joined. A soldering tag is joined beneath the terminal, which is connected to the upper plate. The upper disc is bent to force it away from the mica separator, and a threaded rod passes through the centre of the entire assembly. When the ebonite knob is rotated it presses the plates together and thus increases the capacity, and the lower metal knob enables the two plates to be short-circuited when it is pressed into contact with the small tag. Thus, the device may be joined in series with the aerial, the plates short-circuited, and the receiver adjusted to any required station. A touch

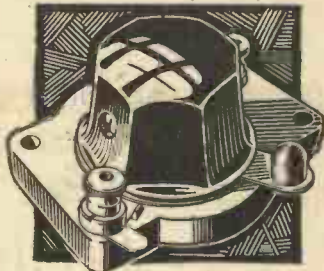

The Graham-Farish "Slot" selectivity device.

of the metal knob brings the condenser into circuit and the knob may be adjusted to provide any required degree of selectivity. It is therefore a simple matter to bring the Slot into use as required. The price of this useful little device is only 2s.

TONAX DOUBLE-CONE ADAPTOR

MANY listeners still prefer the double-cone method of assembling a loud-speaker, and where a really good driving unit is in use this method of making a speaker certainly has some very good points to its credit. The Tonax adaptor unit under review is designed to simplify the assembly of the two cones on the centre driving rod, and also includes a method of modifying the tone of the complete assembly. Four thin aluminium cone washers and four felt washers are intended for clamping each cone to the split collet which is also supplied. This is provided with a milled ring which permits of its being thoroughly tightened with no risk of looseness developing and resulting in chatter. Four celluloid (flat) washers are also supplied with the complete adaptor, and these are intended to be fitted between the cone and the clamping washer in order to modify the tone. To shape the washers they should be inserted in warm water and then clamped, whilst still wet, between two of the aluminium washers and locked up tight until dry. The tone of the reproduction may be modified quite considerably by using these washers in conjunction with the felt and aluminium washers. The complete apparatus costs 1s. 6d.



NEW HAMBLING TUNING COIL

A NEW tuning coil, especially designed for the new wavelength conditions, has been received for test from Messrs. A. W. Hambling. As may be seen in the illustration, this is carried on a six-ribbed bakelite former, and is arranged in the usual manner. The upper winding is the medium-wave grid winding, and this is provided with a tapping point to aid selectivity. The reaction winding is arranged next, whilst the long-wave winding is accommodated in the slots at the lower end of the former. A metal screen completely encloses the coil, and this is not provided with slots as is usual with this type of coil, and it



The new Hambling dual-range coil.

thus removes one of the chief drawbacks of the screened coil, namely, short-circuits. When the terminals are arranged just inside the screen it frequently happens that a long length of bared wire passes through the slot in the screen and whilst the set is in use vibration causes the wire to short against the screen, sometimes with disastrous results. With this new coil the terminals are arranged round the side of the base, and thus the coil is totally enclosed and there is little risk of short-circuits. The range covered by the coil is from 180 metres to 530 metres, and from 900 metres to 1,900 metres, and the price of the coil is 5s. Under test the coil gave very satisfactory results.

THE TONASTAT

WE have seen many devices produced to improve selectivity, and although in most cases a simple condenser principle is employed, we have found certain firms who have designed a large moulded case to contain a simple compression condenser or perhaps a fixed condenser and some unnecessary wires, and have given the entire unit some fanciful name in order to beguile the unsuspecting listener into parting with money for something which, whilst it will certainly improve selectivity owing to the enclosed condenser, is not worth the total amount asked for it. The Tonastat is definitely not in this class, but is a device which

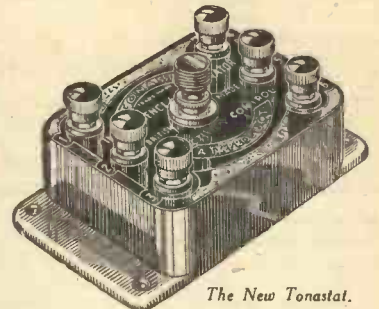

The New Tonastat.

has obviously been the outcome of much thought and careful design. The usual compression condenser is included in the centre of the moulded case, but in addition there are two small inductances wound in such a manner that they also act as capacitors, that is, one end of each winding is left disconnected, and the two coils on each former are close wound. The ends are brought out to terminals and thus it is possible to connect the Tonastat to a receiver in various methods and produce any required degree of selectivity, whilst by certain combinations of the coils and condenser it is also possible to reduce various forms of interference. The device costs 3s. 6d. from all wireless dealers, or 3s. 9d. by post from T. K. Products Co., 32, Queensway, Ponders End, Middlesex.

RADIO INSTRUMENTS Q.D.P. CHOKE

WITH the return to favour of the Quiescent Push-pull circuit there will be a demand for suitable coupling components, and Messrs. Radio Instruments have already produced an output choke which is designed especially for the newly-introduced Marconi and Ostram Q.P.21 valve. As is explained on another page in this issue, this consists of two pentode valves inside one glass envelope, and the optimum load is in the neighbourhood of 25,000 to 30,000 ohms. The choke is provided with four terminals on the output



The Radio Instruments Q.D.P. choke.

side, and it is possible, by a suitable combination of the terminals, to obtain ratios of 1.2 to 1, 1.7 to 1 or 2 to 1. Under these circumstances it is thus possible to employ the new Q.P. 21 valve with speakers which are designed for triode or pentode valves, and to obtain a correct matching load for the valve. The cost of this choke is 12s. 6d. The original R.I. transformer, list No. DY.34, which has a ratio of 1 to 8, should be employed to couple the Q.P. 21 valve to the preceding valve, and this transformer costs 15s., plus a royalty of 1s. 6d.

A NEW VALVE

It is interesting to note that in the extensive range of Marconiphone receivers there are models which incorporate a form of quiescent push-pull amplification. As many of our readers will remember, this arrangement necessitates the use of two pentode valves arranged in a push-pull circuit, and the two valves are biased down to their bottom bend. This circuit arrangement did not find favour with the experimenter when it was first introduced, owing principally to the necessity of purchasing two separate pentode valves, and owing also to the rather difficult task of balancing the two valves.

In their own receivers they were able to make all the necessary adjustments to obtain best results, and with certain other modifications they renamed the circuit P.C.P. These letters stand for parallel conductance principle.

Experiments have been continued by the Marconiphone Company, and as a result a new valve has been introduced by them known as the Q.P.21. This is of the multiple-valve type, incorporating in one glass bulb the elements of two pentode valves. The two anodes and the two control grids are brought out to separate terminals, and the two filaments are in parallel. In order that the valve may be fitted with a standard 7-pin base the two priming grids are joined together and thus require only one pin. The characteristics of the valves have been arranged so that one of the original drawbacks of the Q.P.P. circuit have been overcome, and there is no necessity with this double valve of adjusting each priming grid to obtain equal anode currents in the two valves. Instead, the priming grid is adjusted, together with the grid-bias voltage, to produce a total anode current of approximately 2.6 mA. at 150 volts H.T. or 3 mA. at 120 volts H.T. The following figures give some idea of the working characteristics of a sample valve which we have tested.

H.T. Voltage (Anode and Screen).	Total Quiescent Anode Current.	Grid-bias Volts.	Approximate Power Output (milliwatts).
100	2.3	0.0	350
120	3.0	7.5	570
150	2.6	10.5	970
170	2.9	13.5	1,250

It will be seen from the above table that there is a great deal to be gained by using a large value of high-tension voltage, although the total anode current consumption remains of a very low order. The quiescent current is, of course, the total value shown with no signal, and this rises according to the strength of signal received. Over a normal evening's listening the average current should work out at a figure of about 6 mA. only with the maximum H.T., and this represents a very great improvement on the normal Class B arrangement. The input transformer should have a ratio of 1/10, and the anode-to-anode load should be approximately 24,000 ohms. In most cases it will be found desirable to use a filter circuit across the two anodes, and this should be made up with a .01 mfd. condenser and a 10,000-ohm resistance in series. The actual values will, of course, depend upon the actual speaker which is employed.

The price of the valve has not yet been fixed by the makers, but it must be remembered that with this method of amplification there is no necessity for a driver stage, and the Q.P.21 may follow a detector stage direct.

Mr. Camm's
'FURY FOUR'
(W.B. Speaker solely specified)

Mr. Camm's
'SUPERSONIC SIX'
(W.B. Speaker solely specified)

Mr. Camm's
'1933 SUPERSET'
(W.B. Speaker solely specified)



AND NOW THE 1934
FURY SUPER

W.B. 'MICROLODE' SOLELY SPECIFIED

Mr. F. J. Camm has specified a W.B. 'Microlode' Speaker SOLELY for EVERY important set since its introduction first astonished the wireless trade and public.

There are vital reasons for this splendid tribute from a famous pioneer of receiver design.

Perfect matching to the receiver, due to the unique 'Microlode' feature, gives better balance of tone. The unique 'Mansfield' magnet, 30 per cent. stronger than a good cobalt steel magnet of equal weight, gives better sensitivity and wonderfully crisp attack.

You should hear the difference a 'Microlode' will make to your set: it will amaze you!

'MICROLODE'
(Regd. Trade Mark)
Moving-coil Speakers
PM6 - - 32'6 PM2A - - 79'6
PM4A - 42' - PM1A - 120' -

Write now for the new folder.
Whiteley Electrical Radio Co., Ltd.,
Dept. D, Radio Works, Mansfield, Notts.

Sole Agents in Scotland: Radiovisor Ltd., 233, St. Vincent St., Glasgow, C.2.
Sole Agents in I.F.S.: Kelly and Shiel, Ltd., 47, Fleet St., Dublin.



ANNOUNCEMENT

★ to men who want careers in RADIO



The I.C.S. Radio Courses cover every phase of radio work, from the requirements of the youth who wishes to make wireless engineering his career to the man who wants to construct and maintain a broadcasting set for his home.

The Radio industry is progressing with amazing rapidity. Only by knowing thoroughly the basic principles can pace be kept with it. Our instruction includes American broadcasting as well as British wireless practice. It is a modern education, covering every department of the industry.

OUR COURSES

Included in the I.C.S. range are Courses dealing with the Installing of radio sets and, in particular, with their Servicing, which to-day intimately concerns every wireless dealer and his employees. The Operating Course is vital to mastery of operating and transmitting.

There is also a Course for the Wireless Salesman. This, in addition to inculcating the art of salesmanship, provides that knowledge which enables the salesman to hold his own with the most technical of his customers.

We will be pleased to send you details of any or all of these subjects. Just fill in, and post the coupon, or write in any other way, stating which branch of Wireless interests you—the information you require will be forwarded at once.

International Correspondence Schools, Ltd.,
Dept. 94, International Buildings,
Kingsway, London, W.C.2.

Without cost, or obligation, please send me full information about the Courses I have marked X

- COMPLETE RADIO
- RADIO SERVICING
- RADIO EQUIPMENT
- RADIO SERVICING AND SALESMANSHIP
- WIRELESS ENGINEERING
- WIRELESS OPERATORS

Name..... Age.....

Address

RADIO CLUBS AND SOCIETIES

Club Reports should not exceed 200 words in length and should be received First Post each Monday morning for publication in the following week's issue.

SLADE RADIO

There was an evening of entertainment at the meeting held recently, and the first half of the programme consisted of an excellent selection of gramophone records which included several of unusual interest. In the second half a microphone test was held in which parties of four members who were only known by numbers had to speak for three minutes each on any subject they chose. The test was for quality of voice, interest of subject, and manner in which speech was concluded. The remaining members in each case recorded their opinion by vote. At the conclusion the apparatus used was inspected by the members with great interest.—Hon. Sec., 110, Hillaries Road, Gravelly Hill, Birmingham.

HORSHAM RADIO CLUB

This club is now holding meetings every Thursday at the Nelson Hall, Trafalgar Road, Horsham, from 7 p.m. to 10 p.m. The club is making good progress, and it will interest local readers to know that Dr. E. C. Bradford has been elected Hon. President and Capt. J. L. Mason Hon. First Vice-President. A number of members are showing a keen interest in short-wave work, and it is hoped to start a morse class which will occupy thirty minutes at each meeting. A beginners' section is also run for those who wish to learn something about radio in general. Subscription to the club is 3s. per year, entrance fee 6d. Interested readers are invited to call or write to the Hon. Gen. Sec., Joseph R. H. Cade, 24, Hurst Avenue, Horsham.

SIDCUP AND DISTRICT RADIO AND TELEVISION CLUB

The lecture on recent developments in valve manufacture given recently at a meeting of this club by Mr. W. G. J. Nixon, of the General Electric Co., proved of great interest. In a very comprehensive talk Mr. Nixon touched upon the earliest valves and described the manufacture of the latest types, which included the Catkin. With the aid of a large number of very good lantern slides he made clear the construction of the electrode assembly, and explained in detail the various methods used by the General Electric Co. for insuring rigidity. Another feature of the lecture was the showing of the new Catkin film, from which members were able to witness the manufacture of "Catkins" from the early stages to the completion of the valves ready for sale. Full particulars of the club's activities can be obtained from the Hon. Secretary, Mr. W. F. Smith, 4, Rowley Avenue, Sidcup, Kent.

BOLTON RADIO CLUB (Affiliated to the A.-A.R. & T.S.)

An interesting lecture on their latest receivers was given by Messrs. Marconiphone Co. at the last meeting of the Bolton Radio Club, and attracted over 200 members and friends. In accordance with their policy of entertaining and educating their members, this club has arranged many attractive lectures for the near future, full particulars of which may be obtained from Mr. Wm. H. Prescott, 125, Deansgate, Bolton, Lancs. Through their affiliation with the Anglo-American Radio and Television Society this club is able to offer its members many additional services. On January 5th Mr. Dean gave a talk on modern valves, which was thoroughly enjoyed by about 120 members and friends.

THE CROYDON RADIO SOCIETY

A lecture by the society's technical adviser always attracts a large attendance, and this was so on January 9th, at St. Peter's Hall, S. Croydon, when he lectured, with illustrations, on "Musical Frequencies." He soon made it clear why harmonics added to a pure note made it sound richer or more brilliant. This was strikingly illustrated by him sounding a 1,000-cycle pure note on his home-made oscillator and comparing it against a 1,000-cycle note produced on a violin by Mr. A. Bateman, the society's musical adviser. Obviously the many overtones on the stringed instrument gave it the much more brilliant tone value. Thus, unless our receiver reproduced these overtones, which could go up to 12,000 cycles, we would never hear by wireless the violin as it should be heard. Several things in a receiver destroyed top frequencies. Tuning did, and the worst culprit was the loud-speaker, the cone of which must be light and rigid. Size of room limited bass response, and pitch of a violin dropped in a large hall. The bass clarinet came over well, as its harmonics were not extensive, but the oboe was difficult, due to its overtones being stronger than the fundamental. Thanking the Technical Adviser, the Vice-Chairman, Mr. C. L. Amos, said the lecture had been particularly instructive inasmuch as the advice in it should be borne in mind for the society's loud-speaker night on February 6th, to which PRACTICAL WIRELESS readers are welcome. On January 30th the New Year's first short-wave night takes the form of a demonstration by Mr. F. Betteridge of his newly-designed short-wave superheterodyne receiver.—Hon. Secretary, E. L. Cumbers, Maycourt, Camden Road, S. Croydon.



"We're Fluxite and Solder—the reliable pair!" — Famous for Soldering—known everywhere!

"The SET may look lovely—it may have cost much! — To make SURE it is PERFECT—add this finishing touch!"

See that Fluxite and Solder are always by you—in the house—garage—workshop—anywhere where simple, speedy soldering is needed.

ALL MECHANICS WILL HAVE FLUXITE

IT SIMPLIFIES ALL SOLDERING

All Ironmongers sell Fluxite in tins: 4d., 8d., 1s. 4d., and 1s. 8d. Ask to see the FLUXITE POCKET SOLDERING SET—complete with full instructions—7s. 6d. Ask also for our leaflet on HARDENING STEEL with Fluxite.

FLUXITE, LTD.
(Dept. W.P.), ROTHERHITHE, S.E.16.



FOR ALL REPAIRS!

EASY TERMS PROMPT DELIVERY

Any Amplion, Blue Spot, Baker, Celestion, Epoch, R. & A., Rola, Sonochorde, Gramplan, Igranic, Lamplugh, Magnavox, Ormond, W.B., or Ferranti Moving Coil Speaker Supplied.

Send 5/- only

and pay the balance by monthly instalments. No references. Entirely private and confidential.

KITS, PARTS, SETS, ELECTRIC CLOCKS ON EASY TERMS.

Send for Catalogue and list of 83 Speakers.
TURNADGE AND PARTNERS, LTD.
Ludgate House, Fleet St., London, E.C.4.
Telephone: Central 1903.

H.T. THAT LASTS YEARS

Dead silent background. When you install a dry battery your set is full of life and power. But all too soon it falters, and so does reception. Install a Standard Leclanche Battery, and end the problem for good. Gives you full, abundant power year in-year out at half cost of dry batteries. Annual replenishment all that is necessary. Purest form of current known. Beautiful tone and complete, carriage paid.

Permanent freedom from H.T. worries. 120 v., 12,500 m.a., £2 complete, carriage paid.

ALL STANDARD BATTERY SPARES SUPPLIED.

WATES METER

4 in 1. This famous precision instrument now gives 4 readings—0-30 m.a., 0-180 v., 0-15 v., 0-6 v. 3/6 post free.

WATES' GLASS ACCUMULATOR, 2 v. 40 amp. hrs., 7/-.

THE WET H.T. BATTERY CO. (Pr.)
26 Lisle Street, London, W.C.2. Gerard G121.



PRACTICAL LETTERS FROM READERS

The Editor does not necessarily agree with opinions expressed by his correspondents. All letters must be accompanied by the name and address of the sender (not necessarily for publication).

A Suggestion from S. Africa

SIR,—I have only recently started reading PRACTICAL WIRELESS, but am sorry that I did not commence sooner. After reading my first copy I was struck with the number of interesting and useful articles and simple explanations of difficult subjects.

On page 550 of the November 25th, 1933, issue of your magazine I noticed a letter from a South African reader, who suggested that you should publish an A.C. all-wave three. I have for some time been looking out for a diagram of a set of this type, as it seems to be the kind of set that satisfies our requirements (in South Africa) best. I, too, had thought of a circuit with S.G. (or H.F. pentode), detector, and pentode output.

Alternatively, a set of the type just mentioned, but with A.V.C. (which, I suppose, would make a fourth valve necessary), would be very welcome, as we are often troubled with fading.

I am sure that many South African readers would be very grateful if you were to publish a design for either of the above sets.—J. S. ELDER (Cape Province, S. Africa).

Reception on Ultra-S.W. Band

SIR,—I note with interest the queries of your correspondent "Mac N.10," which shows that he has been enjoying reception on the 3.5 mcs. amateur band. Most of the stations he mentions have been received and logged here. The power of the transmitters varies from 12 watts in the case of HB9K (Lausanne) to 60 in that of F8PU (Bordeaux). I am studying "WX," or weather (cyclonic influence) on this type of reception, and should like to get in touch with your correspondent "Mac."—H. O. CRISP (BRS207) (2, Ramsay Road, Forest Gate, London, E.7).

From a Limehouse Reader

SIR,—I am sorry that I am a little late in acknowledging the tool kit, but I can assure you that it was not because the gift was unappreciated. I've had PRACTICAL WIRELESS since No. 1, and look forward to every Wednesday morning. I thoroughly enjoy the articles therein. I was very pleased with the gifts, especially the tool kit, and through showing them to friends I have gained you two more readers.—A. HENDRY (Limehouse).

An Australian Reader's Thanks

SIR,—Thank you for the very useful formulæ concerning chokes—their inductance, etc. It appears to be very simple and straightforward. I must also take this opportunity of thanking you for your excellent magazine, which I have taken since the third issue. I learned more from it in three months than I learnt in a year and a half from two other publications. I am very interested in television, and am delighted to see any articles concerning it in PRACTICAL WIRELESS. Any articles explaining the more difficult, theoretical

side of wireless are also greatly appreciated.—D. J. COLE (Footscray, Victoria, Australia).

A Welsh Reader's Comments

SIR,—I read the "Practical Letters from Readers" page with great interest each week, and notice that in the December 23rd issue Mr. G. W. Fortnam has written asking for a five-valve circuit to be published. The first thing an amateur wireless constructor considers before he builds a set is the cost. If it is too expensive he would probably turn it down, and if you did publish a five-valver as G. W. F. suggests, I'm afraid a great number of your readers would not be able to build it. This is the first time I have written to you and I wish your excellent paper every success. I have taken it from about No. 9, and shall continue to do so, as it has helped me to understand a great deal about wireless. PRACTICAL WIRELESS is the best paper that ever appeared on a bookstall, and it certainly lives up to its title.—I. JONES (Barry).

CUT THIS OUT EACH WEEK.

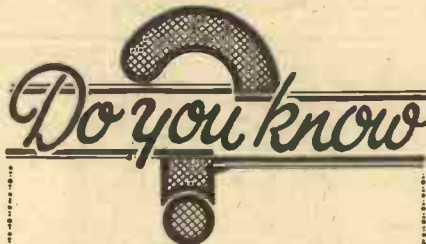

- THAT a primary winding on a mains transformer should be screened from the remaining windings to prevent hum.
- THAT a heater winding interposed between primary and secondary windings will act as a screen for the above purpose.
- THAT a fixed condenser should hold a charge indefinitely, and the drier the surrounding air, the longer will the charge be held.
- THAT the self-capacity of a tuning coil is of much greater importance on the short-wave band than on the long-wave band.
- THAT there is shortly to be a revival of the Quiescent Push-pull system of amplification owing to the introduction of a double pentode valve.
- THAT a vertical aerial is to be preferred for ultra-short-wave reception.
- THAT a hollow metal tube fixed about eighteen inches from the walls of the house will be found a very efficient arrangement for the above purpose.

NOTICE.

The Editor will be pleased to consider articles of a practical nature suitable for publication in PRACTICAL WIRELESS. Such articles should be written on one side of the paper only, and should contain the name and address of the sender. Whilst the Editor does not hold himself responsible for manuscripts, every effort will be made to return them if a stamped and addressed envelope is enclosed. All correspondence intended for the Editor should be addressed: The Editor, PRACTICAL WIRELESS, Geo. Newnes, Ltd., 8-11, Southampton Street, Strand, W.C.2.

Owing to the rapid progress in the design of wireless apparatus and to our efforts to keep our readers in touch with the latest developments, we give no warranty that apparatus described in our columns is not the subject of letters patent.

DUBILIER CONDENSERS

*Unfailing
reliability—
Superlative
performance—
characteristic
of Dubilier
Condensers*

These Dubilier Condensers are SPECIFIED for the "Fury Super"

Type 9200

Four Type 9200/BS-1 mfd 1/9 each
Two " " " 1 mfd 2/- each
Two " " " 2 mfd 2/6 each

Type 670

One .0001 mfd 1/- each
Two .0002 mfd 1/- each



*There's a type
and size to
suit your
every need*

DUBILIER CONDENSERS

DUBILIER CONDENSER CO. (1925) LTD.
Ducon Works, Victoria Rd., North Acton, London, W.3

RUN YOUR MODEL FROM THE MAINS



Running your models from the mains is the cheapest and most efficient way. Heyberd have Transformers especially suitable for this work. The standard transformers are designed for 200-250 volt, 40-100 cycle A.C. mains. Special models can be obtained for 100-110 volt, or 25-cycle mains.

T. 100. Output: 18v. 2 amps., with variable studs to increase in one-volt steps from 6-18 volts. PRICE 18s. 6d.

T. 101. Output: 22v. 3 amps., with fixed tappings at 6 and 12 volts. Variable studs increase up to 22 volts in one-volt steps.

Cut out this ad., write your name in the margin, and send for full details of these Transformers.

F. C. HEYBERD & CO.,
10, Finsbury Street, E.C.2.

MAKE YOUR SET SUPER SELECTIVE



VARIAL

1/6

gives aeriels every desired degree of selectivity, cutting out interference from other stations. Fixed in a moment on any set on any aerial with no alterations. Can be supplied already attached to a coil of Superial—the only self-contained variable aerial.

100 ft.	75 ft.	50 ft.	The World's most Selective Aerial
4/6	3/6	2/9	

INVISIBLE AERIALS

Run Superial through ELECTRON Insulator Pins, and have the ONLY efficient indoor or invisible aerial. OAK, MAHOGANY, BLACK. Six in a box, 6d.

THE NEW LONDON ELECTRON WORKS LTD.,
6, EAST HAM, E.6.

AMPLION PLASTAPE INDOOR AERIAL

10 AIR SPACED	15 FEET	2/-
INSULATED	20 FEET	2/6
COPPER STRANDS	30 FEET	3/6

AMPLION (1932) LTD.

SEND TO FOYLES FOR BOOKS!

New and second-hand books on Wireless and all other subjects. Over two million volumes in stock. Catalogues free on mentioning your interests.
119-125, CHARING CROSS RD., LONDON, W.C.2.
Telephone: Gerrard 5680 (7 lines).

PATENTS AND TRADE MARKS.
KING'S PATENT AGENCY LTD., 146b, Qn. Victoria Street, E.C.4, offer "Advice Handbook" and Consultations free. 49 years' references. Write, call, or 'phone (Central 0682). Director, B. T. King, C.I.M.E., Reg. Patent Agent, G.B., U.S.A., and Canada. 'Phone: City 6161.

CATALOGUES RECEIVED

To save readers trouble, we undertake to send on catalogues of any of our advertisers. Merely state, on a postcard, the names of the firms from whom you require catalogues, and address it to "Catalogue," PRACTICAL WIRELESS, Geo. Newnes, Ltd., 8/11, Southampton St., Strand, London, W.C.2. Where advertisers make a charge, or require postage, this should be enclosed with applications for catalogues. No other correspondence whatsoever should be enclosed.

PIX PRODUCTS

TWO interesting leaflets have recently been issued by The British Pix Company, Ltd., one dealing with "Pix" that useful little component which gives selectivity to a set, and the other giving particulars of the "Modula," a handy remote control device. The "Pix" is a small cylindrical component which is inserted in the aerial lead for improving selectivity and cutting out unwanted stations. To insert the "Pix" it is only necessary to undo the lead-in wire from the aerial terminal and connect same to one end of the "Pix," and then join the other end to the aerial terminal. The "Modula" is simply fitted on the arm of a chair, a table, or in any other convenient position by means of an armchair strap, or prestud fitment. A turn of the knob and the programme can be faded out or the volume increased at will. Copies of either of the leaflets can be obtained from The British Pix Coy., Ltd., 118, Southwark Street, London, S.E.1.

REGENTONE RECEIVERS

FROM the Regentone people comes a booklet bearing the title of "Hello Mike," in the first part of which is given a series of caricatures of various well-known broadcasting stars, including Christopher Stone, Clapham and Dwyer, Mabel Constanduros, Henry Hall, Norman Long, and Al Bowly. In the second part of the booklet, particulars and prices of a range of Regentone receivers are given including the Quadradyne, a high-class embodying one-knob control, straight-line full vision scale, interference eliminator and heterodyne filter. There is also the Regentone Band-Pass Four, for either A.C. or D.C. mains and incorporating many of the latest improvements in receiver design. Another fine model is a Superhet Console, capable of giving 3½ watts undistorted output. Twin synchronized speakers are provided, the whole being housed in a handsome walnut cabinet. Particulars are also given of the popular Regentone Mains Unit. Interested readers should write for a copy of the booklet to Regentone Ltd., Worton Road, Isleworth, Middx.

February Practical Mechanics Now Ready

THE February issue of our sister journal, PRACTICAL MECHANICS (6d. from all newsgents) is now on sale. This is a particularly brilliant issue of this brilliant monthly, and it contains, in addition to an excellent article on the Principles of Mechanical Robots, many well-illustrated articles on Experiments with Photo-electric Cells, Petrol-driven Model Aircraft, Television Systems, How Your Watch Works, Making Your Own Gramophone Records, Lathe Work for Amateurs, Microscope, Model Railways, Practical Electricity, The Latest Novelties, Cinematography, Photography, Money-making Ideas, New Tools, Gadgets, and Accessories, as well as a valuable free patent advice feature. The whole issue is abundantly illustrated.



ELECTRADIX MICROPHONES



A New Practical Home Mike for Wireless Broadcasting at Home. A solo mike for hand or stand in fine bakelite case with back terminals, front metal grille. No. 11. New and finely finished. 5/6

No. 11A. Special in solid Brass body unequalled at the price on speech and music, 7/6. Pedestal Mike No. 10B is 10in. high 12/6. No. 12B Ring Pedestal, 18/6, as illus. Eisel. 5/6

relex-type Table Broadcaster, 52/6, for Studio Recording, etc.

MICROPHONE BUTTONS for all purposes. 1/- Volume Controls, 6d. Microphone Carbon Granules. In glass capsule, enough for four buttons. Grade No. 1, 5d.; No. 2, Medium, 1/-; No. 3, Fine, 1/6; Carbon, solid back, blocks, 3d. Mouthpieces, curved or straight, 10d. Carbon diaphragm, 55 m/m, 4d. Panel Brackets, pivoted, 5/- Reed Receiver Unit for Amplifier making, 3/- Headphones, 2/9 pair. Leaflet with diagrams free.

DEAF AIDS. For those hard of hearing, the lowest-priced aid is our Hear Easy Pocket Set at 18/6, complete. We are able to offer Brown's Aids to the Very Deaf at a greatly reduced price. These comprise his Aural Box for use in church or at the talkies. The Oasiphone, which can be connected to a radio set, for the totally deaf.

THE FRENOPHONE, a glass disc gramophone amplifier of sounds that is a scientific instrument costing £25, of wonderful interest, 35/10/-.



MICROPHONE BUTTONS for all purposes.

Always sold at 3/6. Our price has usually been 1/-—We have supplied thousands to home users.



"MICROPHONE MARVELS." A profusely illustrated Booklet by Lafone 9d. post free.

We are makers and carry the biggest and most varied stock in London.

P.A. Mikes and complete outfits by B.T.E., Brown, Marconi, and Siemens, cheap. State details of your wants.

MICROPHONES FOR ALL PURPOSES. MATERIALS. PARTS. Ask for our Mike List "A."

ELECTRADIX RADIOS,
218, Upper Thames Street, E.C.4.
Telephone: CENTRAL 4611

GET THE 'R.T.I.' 1934 HANDBOOK FREE

For particulars of Home-study Training in Radio, Television, and Talkies. We have courses from £2. No text-books used and every lesson full of interest. Recommendations given to Certificated Students.

RADIO TRAINING INSTITUTE of Gr. Brit.
85, New Oxford Street, London, W.C.1

RADIO SUPPLIES

Send your list of Radio needs for our quotation. Kits, Parts, Sets, etc. Everything in Radio stocked, prompt delivery. 7 days' approval. Catalogue free. Taylex & Standard Wet H.T. replacements stocked. N. TAYLOR, 9, GROVE RD., BALHAM, S.W.12

USE SIFAM METERS

MOVING COIL METERS

Best for all radio purposes, used by all radio enthusiasts. New knife edge pointer, new dials with fine scale divisions, giving greater accuracy. All meters guaranteed. From 7/6

MAGNETIC CONTROLLED METERS

D.C. only. Thousands in daily use for radio and charging purposes. In new moulded cases, 2 1/2in. overall, 2in. hole in panel. From 7/6

SIFAM METERS FOR ALL RADIO TESTS...

SIFAM ELECTRICAL INSTRUMENT Co. Ltd., York Works, Browning St., S.E.17. Telephone: Rodney 574.

LET OUR TECHNICAL STAFF SOLVE YOUR PROBLEMS

REPLIES TO

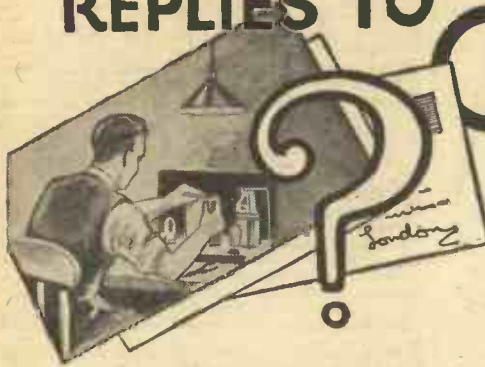

If a postal reply is desired, a stamped addressed envelope must be enclosed. Every query and drawing which is sent must bear the name and address of the sender. Send your queries to the Editor, PRACTICAL WIRELESS, Geo. Newnes, Ltd., 8-11, Southampton St., Strand, London, W.C.2.

The coupon on this page must be attached to every query.

QUERIES and ENQUIRIES by Our Technical Staff

SPECIAL NOTE.

We wish to draw the reader's attention to the fact that the Queries Service is intended only for the solution of problems or difficulties arising from the construction of receivers described in our pages, from articles appearing in our pages, or on general wireless matters. We regret that we cannot, for obvious reasons—

- (1) Supply circuit diagrams of complete multi-valve receivers.
 - (2) Suggest alterations or modifications to receivers described in our contemporaries.
 - (3) Suggest alterations or modifications to commercial receivers.
 - (4) Answer queries over the telephone.
- Please note also that all sketches and drawings which are sent to us should bear the name and address of the sender.

MATCHING THE LOUD-SPEAKER

"I am very keen on experimenting, and am continually using different makes of loud-speaker and output valve. Although I have a tapped output choke, I cannot employ a low-resistance speaker and I find that the transformer which the makers fit to the speakers is not always suitable. Would you advise me to make up a tapped output transformer for various values? If so, could you give me any details concerning its construction?"—G. T. (Hampstead).

A tapped transformer would no doubt be of very great assistance to you if you do a lot of experimenting. We would suggest that you obtain 100 pairs of No. 30 Stallot stampings, and make a bobbin to fit this core. For the primary use 1 lb. of No. 32 enamel wire, and wind this into one half of the bobbin. The approximate inductance of this winding will be 20 henries or so, and it will carry 60 mA. comfortably. The secondary should be wound with about 300 turns of No. 24 enamel, and take tapplings from various points from fifty turns upwards. The exact points will depend upon the likely ranges you may require, although, for general experimental use, probably tapplings at every 50 will prove most useful. The tapplings will, at the above calculation, provide ratios from a minimum of 1 to 50 up to a maximum of 1 to 10. You could, of course, increase the size of the secondary up to a ratio of 1 to 1 if desired.

SWITCH DEFECT

"I am experiencing a certain amount of trouble with my Orbit receiver. Some evenings it gives all I can want so far as range and quality is concerned, and I can get dozens of stations on the medium wave-band. On some occasions, however, I find that I can only hear the National and Regional, and volume is not up to standard; it is, in fact, only equal to a one-valver. When I turn to the long waves results seem quite good, and then when turning back to the medium the set is O.K. again. Can you suggest what might be wrong?"—B. Q. A. (Highbury, N.).

The trouble is probably due to a faulty switch contact in the coils, and you can verify this by waiting until results are bad again and then carefully pushing and pulling the switch rod by means of the control knob. If you find that this brings results back to normal you should return the coils to the makers in order that they may be seen to. We presume, of course, that you have not bent or otherwise damaged the rod in mounting the coils, and also that the coil screens are correctly placed over the coils and do not make contact with any of the wires which are joined to the terminals on the coil bases.

POOR REACTION

"I enclose a diagram of my three-valve set, and would like you to tell me whether you can see anything wrong. I cannot get any good reaction control on either wave-band, and I have had the coils examined by the dealer who supplied me, and have also tried larger condenser for reaction and changed the H.F. choke. When I use a .001 variable for reaction I can

make the set howl, but it jumps into oscillation too quickly and there is no gradual building up. I should be pleased to have your remarks."—G. W. (Northampton).

The circuit seems to be perfectly straightforward, and the most likely cause of the fault, although we do not name any components, is the anode by-pass condenser. This is in parallel with the reaction circuit and, consequently, it should be low in value compared with the reaction circuit. The .0005 mfd. condenser you show will offer a lower impedance path to the H.F. currents than the reaction winding and .0001 mfd. reaction condenser, and you can verify this by dis-

DATA SHEET No. 72

Cut this out each week and paste it in a notebook.

RESISTANCE RATINGS

Resistance Ohms	.5 Watt		1 Watt		1.5 Watt	
	Max. Current mA	Max. Voltage	Max. Current mA	Max. Voltage	Max. Current mA	Max. Voltage
100	70.0	7.0	100.0	10.0	122.4	12.2
250	44.7	11.2	63.2	15.8	77.5	19.3
500	31.6	15.8	44.8	22.3	54.4	27.2
1,000	22.3	22.3	31.6	31.6	38.7	38.7
1,500	18.2	27.4	25.8	38.7	33.3	50.0
2,000	15.8	31.6	22.3	44.7	27.3	54.7
2,500	14.3	35.4	20.0	50.0	24.4	61.2
3,000	12.9	38.7	18.2	54.7	22.3	67.0
3,500	11.9	41.7	16.9	59.1	20.7	72.4
4,000	11.1	44.7	15.8	63.2	19.3	77.4
5,000	10.0	50.0	14.1	70.7	17.3	86.6
6,000	9.1	54.7	12.9	77.4	15.8	94.8
7,000	8.4	59.2	11.9	83.6	14.6	102.4
8,000	7.9	63.3	11.1	89.4	13.8	109.5
9,000	7.4	67.1	10.5	94.8	12.9	116.1
10,000	7.0	70.7	10.0	100.0	12.2	122.4
15,000	5.7	86.5	8.1	122.4	10.0	150.0
20,000	5.0	100.0	7.0	141.4	8.6	173.2

The formula for ascertaining wattage dissipation is $C^2 \times R$. It must also be remembered that certain types of resistance will stand up to a 50 per cent. overload, and, therefore the makers' instructions must be followed.

connecting the by-pass condenser entirely. If you then find that the small value reaction condenser gives you satisfactory control, we would advise you to replace the present ordinary type condenser by a reaction condenser of the differential type, connecting the extra set of fixed plates to earth.

D.C. AERIAL CIRCUIT

"I am situated where the D.C. supply mains are very noisy, and, after hearing the sets run by two or three of my neighbours, I am rather uncertain about having a set at all. The sets I have inspected are all home-made, and it appears that nearly all the noise is introduced via the earth lead, as one of my friends has tried various forms of interference eliminator on the mains side. Can you give me any help in choosing a set which will remove these troubles?"—G. A. (Finchley).

You will probably find that the noise will be removed when the earth lead is disconnected, and in this case we would advise you to go ahead and build any particular type of set which you prefer, but be careful in your choice of aerial coil. This should be of the H.F. transformer type so that the aerial circuit is completed through the coil to earth with no direct electrical connection to the remainder of the circuit. The usual way is, of course, to employ a fixed condenser between the "earth line" and earth. The H.F. transformer arrangement avoids this condenser and provides a separate aerial circuit. We think you will find that this will cure your trouble.

SPEAKER FIELD FOR BIAS

"I am using a mains set with a directly-heated output valve. I have now obtained a loud-speaker with an energized field and am uncertain how to use this to obtain grid-bias for the output valve. I already have a good choke for smoothing the H.T. supply and would like to use this field for bias purposes. Could you give me a sketch showing the best arrangement?"—T. G. (Romford).

The sketch herewith shows the most likely arrangement for your particular case, but we would advise you to obtain a copy of PRACTICAL WIRELESS, dated March 18, 1933, in order to read the article which dealt with the utilization of energized field windings in various parts of a mains circuit.

SUPER-HET TRACKING

"I have built up a super-heterodyne receiver somewhat on the lines of your Premier but using parts which I had and which were chosen on account of their quality. I find the following fault, however, which I am unable to cure. When the set is adjusted to a wavelength of about 250 metres I can adjust the trimmers and get a foreign station at really good strength, and the setting is fairly critical. As I tune up the scale, however, I find the setting goes out, and I cannot get the Midland Regional without readjusting the trimmers. The same thing happens on the long waves, and if I trim on Daventry I cannot get any medium-wave stations. Can you help me at all?"—T. H. (Edgware).

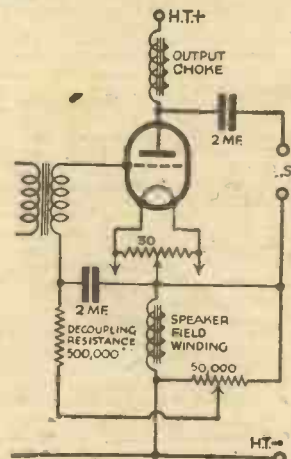

It would appear obvious that the tracking of your tuning condensers is incorrect for some reason. We presume that you have arranged the necessary components according to the particular tuning coils which you are using, and have followed the maker's instructions regarding the use of a separate padding condenser or a ganged condenser with separate special plate section. In the former case the value of the padding condenser may be wrong, thus giving you the wrong "law," as you tune through the wave-band. The same effect can be caused through using a shaped plate of the wrong type where the difference between the received frequency and the new frequency does not follow the same law as is required by the coils in use. You should find out what make of condenser the coil manufacturers recommend.

A RECTIFIER FAULT

"My A.C. mains receiver, of which I enclose a circuit diagram, has been working very well for the last two years, but lately the volume seems to have gradually fallen off until it is now barely audible. Can you please suggest the reason?"—A. K. (Manchester).

We notice that a valve rectifier is employed in the mains portion of your receiver, and it is probable that this is the cause of trouble. If the same rectifier has been in use since the set was new it has probably lost its emission. The simplest test would be to replace the valve, or have it tested by your dealer.

FREE ADVICE BUREAU COUPON

This coupon is available until February 10th, 1934, and must be attached to all letters containing queries.

PRACTICAL WIRELESS, 3/2/34.

Miscellaneous Advertisements

Advertisements are accepted for these columns at the rate of 3d. per word. Minimum charge 3/-. All advertisements must be prepaid.

PEARL and PEARL, 100, Bishopsgate, London, E.C.2. All the following bargains guaranteed new goods. Cash or C.O.D. Carriage Paid.

IGRANIC Permanent Magnet Moving-Coil Speakers. Standard Model; 7-in. cone Tapped Transformer for Pentode, Power and Common. Minimum input 200 milliwatts. Maximum input 3 watts. Brand new sealed cartons. Our Price, 18/11.

IGRANIPAK complete tuning unit, comprising (1) Completely screened coils with built-in wavechange Switch; (2) Igranic 3-gang Condenser with cover; (3) Escutcheon and Disc Drive Assembly with pilot lamp attachment; (4) Mains Switch; (5) Three 5-pin Valve holders; (6) Grid Leak and Condenser; (7) Engraved Terminal Board. Complete with circuit. List Price, 57/6. Our Price, 27/11.

IGRANIC Indigraph Vernier Dials. List Price, 6/- Our Price, 2/11.

Ditto, as above, with micrometer adjustment. List Price, 7/6. Our Price, 3/6.

IGRANIC Tapped "C.C." Output Unit. Invaluable for use in receivers employing a power output valve. Protects the loud-speaker by diverting the heavy current of the last valve from the loud-speaker winding, preventing demagnetization and making possible a closer adjustment of the loud-speaker movement with subsequent increased sensitivity. The Igranic Tapped "C.C." Output Unit is enclosed in a brown bakelite moulding incorporating a bi-metal core and is designed to pass a maximum current of 30 milliamperes. Tappings may be so arranged to provide for the choke acting as an auto-transformer, giving either a "step-up" or "step-down" effect to suit the particular type of loud-speaker employed. List Price, 8/6. Our Price, 4/11.

IGRANIC Potential Divider. Has a total resistance of 15,000 ohms, divided into ten equal steps of 1,500 ohms each. With the Potential Divider across an eliminator output of approximately 220 volts, the maximum safe carrying current is 35 milliamperes across the whole resistance. Providing current is being taken from one tap only (other than taps "0 and 10") the safe current from "0" to any tapping point is 25 milliamperes. The current obtainable from the Divider when using taps "0" and "10" is governed only by the limitation of the components feeding the Divider. The terminal board is fitted with eleven contact sockets to which connections may be made by means of Igranic "Springmore" or other Wander Plugs. List Price, 10/6. Our Price, 3/11.

IGRANIC Class "B" Driver Transformer. Tapped 1 to 1 and 1 1/2 to 1. List Price, 11/6. Our Price, 5/6.

DUBILIER 4.5 High Test Condensers. 1,000 volt D.C. Tapped 2.25. Our Price, 3/6.

LEWCOS All-Wave Choke. Suitable for all wavelengths from 15 to 2,000 metres. It consists of an enamelled copper spaced winding on a deep ribbed former, having the minimum of contact with the former, and this winding is in series with a medium and long-wave choke winding, all completely enclosed in a copper screen. List Price, 6/6. Our Price, 3/6.

LEWCOS Frame Aerial eliminates outdoor aerial and increase selectivity. List Price, 27/6. Our Price, 9/6.

LINCOLN STEWART A.C. Eliminators, 200-250 volt input, 25 m.a. output, 3 positive and one negative tappings. List Price, £2.19.6 Bargain, 32/6.

EDISON BELL gilt gramophone tone arms for use with pick-up. List Price, 7/6. Our Price, 1/6.

TRIOTRON MAGNA 4-pole balanced armature units type P, beautiful tone, well made. Listed at 27/8. Special offer, 9/3.

THE "Gem" single spring fibre drive gramophone motors complete with all fittings. Special bargain, 6/11.

EDISWAN 2-volt non-spill accumulators, 70 ampere hours. Over-all measurements, height, 6 1/2 in., width, 3 1/2 in., depth, 3 1/2 in.—7/6.

THE well-known famous Lincoln Stewart permanent magnet moving-coil speaker. Over 2,000 already sold to "Practical Wireless" readers. Price, 16/11.

REGENTONE Pentode 2-valve A.C. all-electric receiver, complete with valves. Original Price, £6.10.0. Our Price, £2.19.6.

LINCOLN STEWART D.C. Eliminator, 25 m.a., 4 tappings, no variable tapping. List Price, 32/6. Our Price, 16/6.

SOVEREIGN Permeability tuner, complete with blue print for constructing 3-valve Permeability Tuned Receiver, complete with Dial and Escutcheon. List Price, 15/-, to clear, 7/11.

MILLGATE A.C. 1 amp. Trickle Charger, Westinghouse Rectifier for 2, 4 or 6 volt accumulators. Price, 19/11.

THE "Lincoln Super" Permanent Magnet Moving-Coil Loud-speaker, all purpose universal tapped transformer for Q.P.P., Class B, Pentode, Power and Super-Power output. Will carry 3 watts undistorted output. List Price, 42/- Our Price, 19/6.

FORMO 2 mfd. Mansbridge Condensers, tested at 800 volts D.C. Our Price, 1/11.

LOTUS friction disc drive with bevelled dial, complete with handsome metal escutcheon and fitting for dial lamp. List Price, 5/- Bargain Price, 2/11.

(Continued at top of column three)

The Diploma of the National Institute of Radio Engineering is a passport to a well-paid post in the Wireless Industry



THIS BOOK WILL TELL YOU HOW TO QUALIFY FOR IT

TO THE NATIONAL INSTITUTE OF RADIO ENGINEERING 55-57 GUILDHALL STREET, PRESTON

Please send me free and post free a copy of "Wireless as a Career"

Name

Address

OSBORN CABINETS

5/- to £10.

Catalogue containing **37** DESIGNS

with amazing Osborn Box Baffle post free.

CHAS. A. OSBORN, Regent Works, Arlington Street, New North Road, Islington, London, N.1.



LATEST BLUE SPOT PICK-UP

The new Blue Spot Pick-Up 33 gives brilliant reproduction without needle scratch and with exceedingly light record wear. From 50 to well over 4,000 cycles. Has wire-wound volume control, also rotating head which facilitates needle changing. Easily fitted to any gramophone or home-built radiogram.

26 DOWN

SPECIAL TRIAL OFFER

SEND ONLY 2/6 and have this superb Blue Spot Pick-Up for 7 DAYS' TRIAL. If satisfied, pay further 2/6 at once, then 7 monthly payments of 5/-. (Cash, in 7 days, 35/-) Full instructions enclosed. Send to-day!

E. J. HERAUD, Ltd. (Dept. P. 41), NUMBER ONE, EDMONTON, LONDON, N.18 Satisfaction or Money Back Guaranteed.



REPAIRS—REWINDING—OVERHAULS. Loud speakers, 4/-; Blue Spots, 5/-. New cones fitted to Moving Coil speakers, 6/-. Eliminators, Mains transformers, etc., quoted for. Special components and sets made to order. Quick service. Laboratory tested. Repair Dept. C., Weedon Power Link Radio Co., 80, Lonsdale Avenue, East Ham, London, E.6. 'Phone Grangewood 1837.

AGENTS wanted all Districts to sell High Class Three Valve Receivers. Also Kits and Components. Liberal commission. Apply by letter in first instance. A. L. Burt, 11A, Kingsbury Road, Birmingham.

CHARGING WITHOUT MAINS—Thousands are charging their own accumulators, why don't you? "Tonic" trickle-charger kits keep 2-volt accumulators fully charged. Ideal for remote districts. From 7/-, postage, 9d. Full particulars, stamp.—Williams, Netherend, Cradley, Nr. Birmingham.

WANTED good Modern Wireless Parts, Sets, Eliminators, Meters, Valves, Speakers, etc. Spot Cash waiting. Send or bring. We pay more than any other Dealer. Open 9-8.—University Radio, 142, Drummond St., Hampstead Rd., N.W.1.

(Continued from column one)

SLEKTUN dual range screened coils, 200-550 met, 800-2,100 met. Every coil complete with wiring diagram. List Price, 6/6. Our Price, 2/11.

SLEKTUN H.F. Coils for use with above dual range aerial coils. List Price, 8/6. Our Price, 2/11.

FORMO screened 3-gang condensers with trimmers, complete with dial and escutcheon. List Price, 21/6. Our Price, 9/6.

K.B. D.C. "Pup," self-contained, simple, safe and trouble-free. The K.B. 2-valve D.C. "Pup" is an excellent and reliable mains operated receiver. List Price, £7.10.0. Our Price, £3.12.6.

SURPLUS H.M.V. 3-gang .0005 mfd. Variable Condensers with drum drive, beautifully made in one piece to avoid backlash. To clear, 7/6.

BRAND new Zetaxov Radiogram Cabinets, fitted with motor board and compartment for records (over-all measurements—height, 3ft. 2in., width, 2ft. 4in., depth, 1ft. 6in.). Cost over £6 to make—Special offer, £2.15.0 Carriage paid.

POLAR 3-gang screened variable condenser, 6/11.

600 Horizontal Set and Speaker Cabinets. Solid Walnut (made for Philco), 22in. wide, 10 1/2 in. deep, 11in. high, 6/11. Cost £1 to make. This item carriage forward.

PEARL & PEARL. All above bargains sent Cash or C.O.D. Carriage Paid. 100, Bishopsgate, London, E.C.2.

ERICSSON 3/1 L.F. Transformers, List Price, 17s. 6d. New and guaranteed. Our price, 2s. 3d. post free U.K.—Pioneer Radio, Coptic St., London, W.C.1.

GRAMOPHONES, Radiograms, 64 page. How to make 'm, 3d. Motors, Arms, Pick-Ups, Speakers, Horns, Springs, Repairs, Accordians. Regentprac, 120, Old Street, London, E.C.1.

JUNIOR 2 1/2 in. bench lathe is ideal for your experimental work. Price with compound rest 32/-, list 1 free.—Ward & Pollard, Orchard Works, High Street, London, S.E.18.

ELECTRIC CLOCKS: "IGO" British Electric Clocks, brand new, perfect, 3-inch dials, in handsome metal cases. Two shapes, square or gothic, at a choice. 200-250v. A.C., 50-cycles, 13s. 9d.—Epton, 93, New Road, London, E.4.

SOUTHERN RADIO'S Bargains.—Set manufacturer's guaranteed surplus.

VARIABLE Condensers.—Lotus 3-gang 0.0005, 12/6; Lotus 2-gang, 0.0005, 8/6; Lotus Dy-block single, 0.0005, 4/9 (list 9/6); all these condensers are complete with dials, escutcheons, knobs, fully screened with trimmers, and boxed; Igranic variable, 0.0003 and 0.0005, 2/3; Hydra block condensers, 16 mfd. (2+2+8+2+1+1), 1,000v. D.C., 7/- each; 20 mfd. (2+2+2+2+2+2+2+2+1+1+1+1), 1,500v. D.C., with terminals, 11/6; Dubilier 4 mfd. (2+1+1), 1,000v. D.C., 2/9; 4.5 mfd. (2.25+2.25), 3/-; fixed 4 mfd., 2/3; 2 mfd., 1/6; 1 mfd., 1/-.

SPEAKERS—Blue Spot permanent magnet, with Universal transformer for power, pentode, super power or class B, 23/- (list 39/6); D.C. mains energised, all voltages, 16/6; Magnavox "154", 17/6; Celestion Soundex P.P.M. permanent magnet, 17/6 (list 27/6); Blue Spot 100U inductor, complete with chassis, 13/6 (list 39/6).

BLUE Spot, 66K, complete in cabinet, 16/- (list 42/6); G.E.C. Stork, in magnificent cabinet, 19/6 (list 35/15); all speakers new in original cartons.

PICK-UPS—B.T.H. Senior 1934 model, with volume control, 28/6 (list 37/6); Blue Spot, model "88", with volume control, 26/- (list 63/-); Marconi No. 19 (1934), 26/- (list 32/6).

CONSTRUCTORS' Kits—Ready Radio Meteor "A" 3-valve, screened grid kits, with cabinet and moving coil speaker, less valves, £3/7/6; with valves, £4/10 (list £8/7/6); Ready Radio S.T. 400 kits, all specified components, by Scott Taggart, £2/19/6 (list £4/17/6).

MISCELLANEOUS—Ferrocart coils, G.1, G.2, G.3, with switch, 31/9 (list 39/6); "Igranipaks," complete tuning unit for A.C. or D.C., 29/6 (list 59/6); Igranic super-het, screened coils, set of 4, 12/6 (list 50/-); Benjamin Class "B" transformers, tapped, 1 to 1 and 1 to 1, 6/6 (list 10/6); Benjamin Class "B" universal output chokes, 6/6 (list 11/-); Ready Radio Instant Universal transformers, for matching any valve to speaker, 11/6 (list 37/6); Rotorhym and Radiophone volume controls, all values, 3/- each; with switch, 3/3 (list 10/6); S.T. 500 coils, 5/6 per pair; Hellesen's 8 mfd. electrolytic condensers, 2/3 each; Westinghouse metal rectifiers, H.T. 6, 7, 8, 9/3 each; Amphion loud-speaker units, 2/3; Ferranti choke, 20 henry 60 m.a., 6/9 each; Kolster Brandes gramophone motors, dual, for A.C. or clock work, complete with turntable and all accessories, 110/250 volts, 25/- each (list 63); all new and guaranteed.

MAINS Transformers and Chokes.—Please send for complete list; specials can be supplied within 3 days of order.

ALL Transformers and Chokes Guaranteed for 12 months.

ALL Goods Guaranteed and Sent Carriage Paid.

BRANCHES at 271-275, High Rd., Willesden Green, B.N.W.10, and at 46, Lisle St., W.C.2; please send all post orders to 323, Euston Rd., N.W.1.

SOUTHERN RADIO, 323, Euston Rd., London, S.N.W.1 (near Warren St. Tube). 'Phone: Museum 6324.

PREMIER SUPPLY STORES

offer the following Set Manufacturers' Surplus New Goods at a fraction of the original cost; all goods guaranteed perfect; carriage paid over 5/-, under 5/- postage 6d. extra (Ireland, carriage forward).

PREMIER SUPPLY STORES announce the purchase of the entire stock of a world-famous Continental valve manufacturer. All the following types of standard mains valves at 4/6 each. H. H.L. L. Power. Directly heated 6-watt Pentode. Directly-heated 9-watt Pentode. High magnification. Screen-grid, low magnification Screen-grid, Variable-Mu Screen-grid. 250 volt 60 milliamp. full-wave rectifiers.

THE following types 5/6 each. Indirectly-heated Pentode. 12 watt output Triode (P.X.4 Type). 350 volt 120 milliamp. full-wave Rectifier. 500 v. 120 ditto, 6/6.

ELIMINATOR Kits, including transformer, choke, Westinghouse metal rectifier, T.C.C. condensers, resistances and diagram, 120v. 20 m.a., 20/-; trickle charger 8/- extra; 150v. 30 milliamps., with 4v. 2-4 amps. C.T. L.T., 25/-, trickle charger 6/6 extra; 250v. 60 milliamps., with 4v. 3-5 amps. C.T. L.T., 30/-; 300 v. 60 m.a., with 4 volts 3-5 amps. C.T. L.T., 37/6; 150 volts 50 milliamps, 27/6; other outputs to order at pro rata prices.

AMERICAN Triple Gang 0.0005 Condensers, with trimmers, 4/11; Premier chokes, 40 milliamps. 25 hys., 4/-; 65 milliamps. 50 hys., 6/-; 150 milliamps. 30 hys., 10/6; 60 milliamps. 80 hys., 2,500 ohms, 5/6.

HARLEY Pick-up, complete with arm and volume control, 12/6.

BRITISH RADIOPHONE Wire Wound Potentiometers, with mains switch incorporated, 10,000, 50,000, 25,000 ohms, any value; 3/6.

PREMIER British-made Meters, moving iron, flush mounting, accurate, 0-10, 0-15, 0-50, 0-100, 0-250 m.a., 0-1, 0-5 amps; all at 6/-.

SPECIAL Offer of Mains Transformers, manufactured by Philips, input 100-120v. or 200-250v., output 180-0-180 volts 40 m.a., 4v. 1 amp., 4v. 3 amp., 4/6; 200-0-200v., 4v. 1a., 4v. 3a., 4/6.

ALL Premier Guaranteed Mains Transformers have Engraved Terminal Strips, with terminal connections, input 200-250v. 40-100 cycles, all windings paper interleaved.

PREMIER H.T.8 Transformers, 250v. 60 m.a., rectified with 4v. 3-5a. C.T. L.T., screen primary, 15/-; with Westinghouse rectifier, 25/-.

4 v. 3a. C.T., 6v. 2a. C.T., 9v. 1a., 12v. 1a., 7/6 each; 4v. 4-5a., 22v. 1a., 8/6 each; 10v. 3a., 14v. 4a., 10/- each.

PREMIER H.T.9 Transformer, 300v. 60 m.a., with 4v. 3-5 a. C.T., L.T., and screened primary, 15/-; with Westinghouse rectifier, 26/-.

PREMIER H.T.10 Transformer, 200v. 100 m.a. rectified, with 4v. 3-5a. C.T., L.T., and screened primary, 15/-; with Westinghouse rectifier, 26/-.

PREMIER Mains Transformers, output 135v. 80 m.a. for voltage doubling, 8/6; 4v. 3-4a., C.T., L.T., 2/- extra; Westinghouse rectifier for above, giving 200v. 30 m.a., 8/6.

PREMIER Mains Transformers, output 250-0-250v. 60 m.a., 4v. 3-5a., 4v. 2-3a., 4v. 1-2a. (all C.T.); with screened primary, 15/-.

PREMIER Mains Transformers, output 350-0-350v. 90 m.a., 4v. 3-5a., 4v. 2-3a., 4v. 1-2a. (all C.T.), with screened primary, 15/-.

PREMIER Mains Transformers, output 400-0-400v. 100 m.a., 4v. 4-5a., 4v. 2-3a., with screened primary, 15/-.

PREMIER Auto Transformers, 100-110/200-250v., or vice versa. 100-watt, 10/-.

CENTRALAB Potentiometers, 50,000, 250,000 half meg., any value, 2/-; 200 and 400 ohms, 1/-.

RELIABLE Canned Coils with Circuit, accurately matched, dual range, 3/- per coil; ditto iron core, 3/6.

PREMIER L.T. Supply Units, consisting of Premier Transformer and Westinghouse rectifier, input 200-250v. A.C., output 8v. half amp, 14/6; 8v. 1 amp, 17/6; 15v. 1 amp, 19/-; 6v. 2 amp, 27/6; 30v. 1 amp, 37/6.

MAGNAVOX D.C.144, 2,500 ohms, 17/6; D.C.154, 2,500 ohms, 12/6; D.C.152 Magna, 2,500 ohms, 37/6, all complete with humbucking coils; please state whether power or pentode required; A.C. conversion kit for above types. 10/-; Magnavox P.M. 7in. cone, 18/6.

CRAMPION P.M. Loud Speakers, 9in. cone, handles 4 watts; 18/6.

CRAMPION M.C. Loud Speakers, 2,500 ohm field, 9in. cone, handles 5 watts; 21/-.

ELLIOTT First-grade Moving-coil Meters, 0-30, 0-50, 0-100, 0-150 m.a., projecting types, 15/- each; 0-100 0-150 m.a. flush types, 17/6 each.

B.T.H. Truesped Induction Type (A.C. only) Electric Gramophone Motors. 100-250v.; 30/-, complete.

AMPLION Moving-coil Speakers, type E.M.644, dual fields, 2,500 and 5,000 ohms (100 and 200v.), with output transformer, 12/6; A.C. conversion kit for this speaker, 10/- extra.

WESTERN ELECTRIC Condensers, 250v. working, 1 mfd. 6d., 2 mfd., 1/-.

SPECIAL Offer of Wire Wound Resistances, 4 watts, any value up to 10,000 ohms, 1/-; 8 watts, any value up to 15,000 ohms, 1/6; 15 watts, any value up to 50,000 ohms, 2/-; 25 watts, any value up to 50,000 ohms, 2/6.

POLAR 3-gang, totally screened, 0.0005, with complete disc drive, split end vanes, and trimmers 3/6; Polar 2-gang, with complete disc drive, padding condenser and trimmer, 0.0005, 6/6.

COLLARO Electric Gramophone Motor, complete with all fittings, turntable and automatic stop, 100-250v. A.C.; 35/-, listed £3.

ROUND Condensers, 0.0005 2-gang, semi-shielded, 2 g.; brass vanes, with trimmers, 3/6.

WIRE Wound Potentiometers, 15,000 ohms, 1/6; 50,000 ohms, 2/-; 500,000 ohms, 3/-.

HOME Radio Microphone, complete, 5/-; simply plug in to pick-up terminals.

LARGE Selection of Pedestal, table and radio-gram cabinets, by best manufacturers, at a fraction of original cost for callers.

WESTERN ELECTRIC Mains Transformers, 500-0-500v. 150 m.a., 4v. 3-5a., 4v. 2-3a., 4v. 2a., 4v. 1a. C.T., 4v. 1a. C.T., 19/6.

1,000 Ohm 150 m.a. Wire Wound Variable Resistance, 2/-; Burnped 2-watt resistances, all values from 0.5 to 50 ohms, 3d. each; holders, 2d. each.

T.C.C. Condensers, 250v. working, 1 mf., 1/3; 2 mf., 1/9; 4 mf., 450v. working, 4/-; 750v. working, 2 mf., 3/-; 4 mf., 6/-.

T.C.C. Electrolytic Condensers, 440 volts working, 4 mf. or 8 mf., 3/-; 15 mf. 100 v. working, 1/3; 6 mf. or 15 mf., 50v. working, and 50 mf. 12v. working, 1/-; 25 mf. 25v. working, 1/3.

T.C.C. Block Condensers, 250v. working, 4 x 4 x 1 x 1 x 0.5, 5/6; 2 x 2 x 0.1, 2/-; 2 x 2 x 2 x 1, 2/3; 2 x 2 x 1 x 1 x 1 x 0.1 x 0.1, 3/-; the above three condensors at same price by Dubilier 300 v. working.

H.M.V. Block Condensers, 400v. working, 4 x 4 x 1 x 1 x 0.5, 5/6; 4 x 4 x 1 x 1 x 1 x 0.1 x 0.1 x 0.1, 6/-; 4 x 2 x 1 x 1 x 1 x 0.5, 4/6.

DUBILIER Condensers, 2 mf. 1,200v. working, 4/-; 4 x 4 x 2, 300 v. working, 3/-; 8 mfd. dry electrolytic, 450v. working, 3/-; 0.01 mfd., 1,000v. working, 1/-.

THE Following Lines 6d. each, or 5/- per dozen—Chassis valve holders, screened screen-grid leads, any value 1-watt wire end resistances, wire end condensers, 0.0001 to 0.1, R.I. varicaps, trimming condensers.

PLEASE mention PRACTICAL WIRELESS when ordering.

PREMIER SUPPLY STORES

20-22, High Street, Clapham, S.W.4, Macaulay 2188. Closed 1 o'clock Wednesdays; open to 9 o'clock Saturdays. Nearest Station, Clapham North, Underground.

VALVES.—A.C./Pen., D.C.2/Pen, 10/-; A.C./S.G./V.M., A.C./S.I.V.M., A.C./H.L./D.D., A.C./S.G., D.C.2/S.G.V.M., D.C.2/S.G., 9/-; S.G.215V.M., S.G.215, P.D.220, 8/-; A.C./H.L., U.U.2, U.U.60/250, 7/-; American Valves: multigrid, 10/-; triod, 9/-; replacement, or money back guarantee. A.C. Eliminators, 200/250v, output 6 tappings, 150-30, 19/6; D.C. Eliminators, 150v, 35 m/a, 150-0 Variable, 13/6.

—Radio, 20 Lady Somerset Road, London, N.W.5, Gulliver 4565.

TELEVISION EXPLAINED, CONSTRUCTED, illustrated Handbook, 1/- Kits from 50/- Lists Free.—Bennett Television, Redstone Copse, Redhill.

RADIO-AUTO-GRAM buy Modern Second-Hand Components for Cash.—39, Talketh St., Southport.

RADIO CABINETS. 50 designs, 25% less than cost. Single Cabinets sold to callers.—Stenbæk Ltd., 363, Essex Road, Islington.

ADVERTISEMENT INDEX

Amplion (1932), Ltd. Page 970
British Broadcasting Corporation: World Radio 947
British Ebonite Co., Ltd. 960
Colvern, Ltd. Back Cover
Cossor A.C., Ltd. 938
Dubilier Condenser Co. (1925), Ltd. 965, 969
Electradix 970
Eugen Forbat 970
Fluxite, Ltd. 968
Foyles 970
Hayberd, F. C., & Co. 970
Heraud, E. J., Ltd. 972
Holmes, H. W. 962
International Correspondence Schools 968
Jackson Bros. (London), Ltd. 960
King's Patent Agency, Ltd. 970
Lectro Linx, Ltd. 962
National Institute of Radio Engineering 972
New London Electric Works, Ltd. 970
Newnes "Tit-Bits" 956
Osborn, Chas. A. 972
Peto-Scott, Ltd. Front Cover Strip
Radio Instruments, Ltd. 963
Radio Tech. Inst. 970
Sifam Electrical Instruments, Ltd. 970
Taylor, N. 970
The 362 Radio Valve Co., Ltd. 960
TX Products Co. 964
Turnadge & Partners, Ltd. 968
Varley, Ltd. 964
V.M.C. Radio Co. 962
Westinghouse Brake & Saxby Signal Co., Ltd. 963
Wet H.T. Battery Co. 968
Whiteley Electrical Radio Co., Ltd. 967

THE 'RADIO GOLD-MINE' for the lowest liquidation prices ever.

L.E.C. CLASS B. BARGAINS.—Special G.M. Drivers 4/6. Output chokes 4/6. V-holders 6d.

L.E.C. CLASS B UNIT, comprising mounted transformers, P.M.C.M. Speaker and valve, 35/-.

L.E.C. CLASS B CONVERSION KIT, with full instructions, 10/6.

THE 'RADIO GOLD-MINE' will save you pounds and pounds.

L.E.C. COIL BARGAINS.—Dual Range. Brownie, 1/-; Screened Iron Cored 4/3. Screened Ordinary 2/6. Short Wave 2/6.

L.E.C. VARIABLE CONDENSER BARGAINS.—L.0003 and .0005 S.M. 2/11. Ordinary 2/3. Solid dielectric 11d.

L.E.C. EXTENSER BARGAINS.—Wavemaster (list 18/6). S.M. .0005 4/11. Ready Radio (list 12/6), .0006 3/11.

THE 'RADIO GOLD-MINE.'—Secure yours to-day, 3d. post free.

L.E.C. SMALL FIXED CONDENSER BARGAINS.—Dubilier and Edison Bell .00094, .0001, 2, 3, 4, 5, .001, 2, 3, 4, 5, 6, 7, 8, 9, tubular type .0001, .0003 mfd., all 3d. each, 2/9 doz.

L.E.C. MANSBRIDGE AND ELECTROLYTIC BARGAINS.—1 mfd. 10d.; 2 mfd. 1/4; 4 mfd. 2/9, all Philips 750 v.test. Philco 8 mfd. electrolytic, 3/11.

L.E.C. FIXED RESISTANCE BARGAINS.—L. Special offer. Spaghetitis. Every size to 100,000 ohms 5d. Higher values 7d., or 4/8 and 6/6 doz. Erie, all values to 51,000 ohms, 4d. H.M.V.4 watt, 100,000 ohms, 5d.

THE 'RADIO GOLD-MINE.'—Radio's greatest Surplus Lists.

L.E.C. VOLUME CONTROL BARGAINS.—Centralab 400 & 500,000 ohms, 11d., with switch, 1/1.

L.E.C. MAINS TRANSFORMER BARGAINS.—H.T.8 Input 200-240v. Output, 180v. 4v.3 amp., 4/10. H.T.9 200-240v. Output, 300v. 4v.4 amp., 5/3.

L.E.C. SPEAKER BARGAINS.—Nuvolion P.M.M.C. 16/10. Cone Units 2/6. Bal. Armature, 3/10.

L.E.C. SUNDRY COMPONENTS BARGAINS.—L.P.F. Transformers 1/6. H.F. Chokes 9d. V-holders, 4-pin 2d., 5-pin 3d., 7-pin 6d. Switches, 2-point 4d., 3-point 5d.

L.E.C. 'GOLD-MINE' KIT BARGAINS.—Absolutely unprecedented value. Complete in sealed cartons with diagrams, instructions and sundries. Straight 11-valve 8/6, 3-valve 10/6, S.W. Adaptor 8/6, Class B Adaptor 10/6; S.Grid 111, 18/6, S.W. 111, 18/6.

THE 'GOLD-MINE' IRON CORED CLASS B.111 KIT at 27/6 is the greatest bargain Radio has yet produced. Actually included in kit are 1 pair Class B transformers (list 17/-), 1 Extensor for automatic wave-change tuning (list 18/6), 1 Iron Cored Coil (list 8/6). Completely assembled metallised chassis makes construction as simple as A B C. No soldering. Will give 20-30 stations at full Moving Coil Volume. Price 27/6 post free.

THE 'GOLD-MINE' IRON CORED CLASS B. S.G.IV. at 35/-, as above, but includes two tuned circuits, with dual coils and extenders. 40-60 stations at full volume.

THE 'RADIO GOLD-MINE' at 3d. post free is the greatest investment you will ever make. The most comprehensive lists of up-to-date surplus goods yet produced; with a general price level absolutely the lowest ever. Do not delay. Send (enclosing 3d. stamps) to-day.

LONDON EAST CENTRAL TRADING COMPANY (Dept. M.33), 23, Bartholomew Close, London, E.C.1 (telephone: NATIONAL 8523). Any goods over 10/- value Postage Free. Cash or C.O.D.

THE following valves are guaranteed unused and perfect, and any valve differing from the makers' characteristics will be exchanged, and all latest types.

A.C./Pens, P.T.4s, A.C.S.G./V.M.s, Pen.4Vs, M.V.S.G.s, D.P./Pens, A.C.S.2/Pens, M.M.4Vs, P.T.625s, V.M.S.4s, D.C.2/Pens, D.P.T.s, P.M.24M.s, M.P.T.4s, V.M.S.4s, A.C.S.I/V.M.s, P.M.22As, D.C.2S.G.V.M.s, 11/-; M.S.4s, M.S.4Bs, A.C.S.G.s, 8.4V.s, 8.4V.B.s, M.S.G./L.A.s, D.S.B.s, A.C.S/2s, D.C.2S.G.s, 9/6.

"Class B" P.M.2B, P.D.220, 220B, 9/6. M.L.4s, A.C.P.s, P.M.2As, 8/-; A.C./H.L.s, 164V.s, 354V.s, A.C.2/H.L.s, 41M.H.L.s, U.10s, U.U.60/250s, M.H.4s, M.H.L.4s, 7/6; V.S.2s, 215S.G.s, 220S.G.s, P.M.12s, P.M.12A.s, 9/-; 442B.U.s, D.W.3s, 8/6; 215P.s, 220P.s, L.P.2s, 5/0; P.T.2s, P.M.22A.s, 9/-; H.L.210s, H.210s, L.210s, L.2s, 4/0. All Types of Brand New American Valves in Stock. First-class makes: 247s, 235s, 224s, 236s, 237s, 233s, 18's, 15's, 59's, 58's, 89's, 238s, 239s, 244s, 12/-; 227s, 226s, 245's, 280s, 9/6; 242s, 232s, 11/-; U.X.250s, 281s, 17/6. Dubilier or Erie resistors 1 watt type, 7d. Westinghouse rectifiers unused H.T.8, 10/-; H.T.9, H.T.10, 11/3. Dubilier or T.C.C. electrolytic condensers 8 M.F.D., 3/9. Magnavox, D.C. 152 (2,500 ohms) or 6,500 ohms, 9in. cone, 25/-; Superhet Radiopaks 22/12/6. Carriage Paid. Cash with Order or c.o.d.—Ward, 45, Farringdon St., E.C.1. Holborn 9708.

BIRMINGHAM RADIMARTS February list now ready, included ironcored bandpass kits, ditto packs, mains equipment, valves, short-wave gear, etc., all by renowned makers and guaranteed new and perfect. Hundreds items 1934 goods, not junk. Send 1d. stamp. THE SQUARE DEALERS, 19, JOHN BRIGHT STREET, BIRMINGHAM.

COLVERN *for super selectivity*

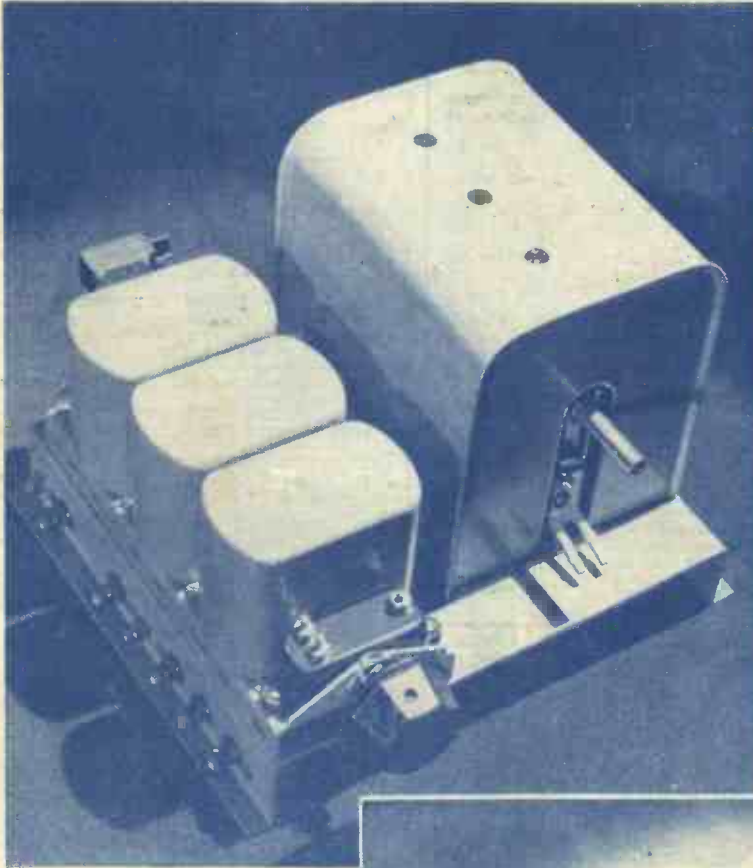

THE COLPAK FERROCART TUNING UNIT

- The ideal tuning unit for Amateur and Expert Constructors alike. Saves endless time, trouble and money.
- Built of the finest components only, carefully tested and perfectly matched.
- Like all Colvern products, it is built to a very high standard of engineering precision, and as it incorporates Ferrocart coils, the most advanced coils yet made, the highest degree of selectivity and sensitivity is ensured.
- Make certain of the best results—get a Colpak for your next set. The type illustrated on the left is "Colpak" Type H. (Mains) at 57'6"

Made under licence from the patentee, Hans Vogt.

- F. J. Camm, the "Practical Wireless" expert set designer, used and specifies Colvern Ferrocart coils for his "1934 Fury Super."
- Ferrocart coils ensure unsurpassed selectivity and unflinching accuracy. Every coil is thoroughly tested and guaranteed to be identical with those employed in the designer's original receiver.
- Follow Mr. Camm's specification—use Ferrocart for the 1934 Fury Super. One set Ferrocart coils, types G.10, G.14, C.13, at 37/6 per set, with on and off switch 1/6 extra.

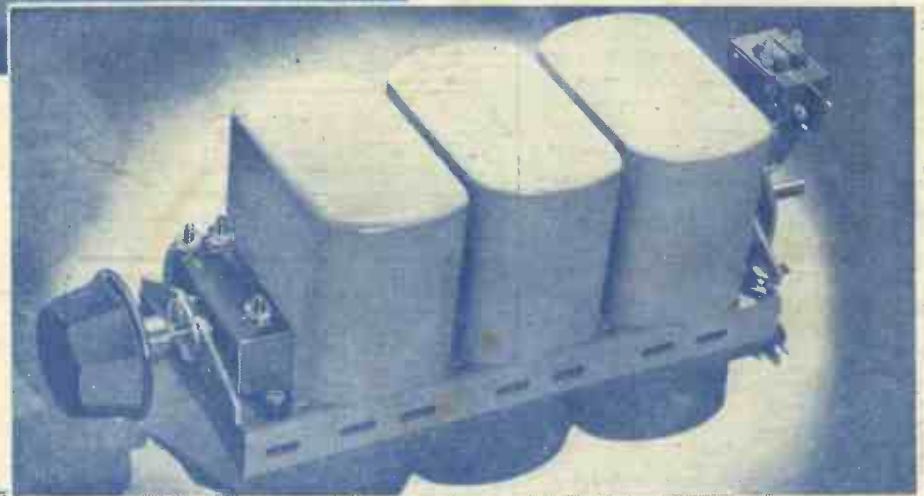

- COLVERN, LTD., Romford, Essex. London Wholesale Office: 150, King's Cross Road, W.C.1.

Ferrocart

..chosen for the new Fury Super

P. W. Gift Stamp No. 5

Printed by NEWNES & PEARSON PRINTING CO., LTD., Exmoor Street, Ladbroke Grove, W.10, and published by GEORGE NEWNES, LTD., 8-11, Southampton Street, Strand, W.C.2. Sole Agents for Australia and New Zealand: GORDON & GORCH, LTD. South Africa: CENTRAL NEWS AGENCY, LTD. *Practical Wireless* can be sent to any part of the world, post free, for 17/4 per annum; six months, 8/8. Registered at the General Post Office for Transmission by Canadian Magazine Post.