

ORDER NEXT WEEK'S ENLARGED SHOW ISSUE NOW!

Practical Wireless

3^d

Published every Wednesday by

**GEORGE
NEWNES
LTD.**

Vol. 2.—No. 47.

AUGUST 12th, 1933.

Registered at the G.P.O. as a Newspaper.

THE LATEST SPEAKERS REVIEWED



RECEPTRU

FOR TRUE RECEPTION

—the wonderful new low loss lead in cable definitely eliminates crackle, background noises, mush and all man-made static. It improves selectivity and increases sensitivity. Get one to-day. You can fix it in less than five minutes.

OF ALL DEALERS in lengths of 15 feet **10/-**

Longer sizes at proportionate prices.

BRITISH RADIOPHONE LTD., ALDWYCH HOUSE, LONDON, W.C.2

NEW!

The COSSOR Melody Maker

MODELS 341 & 342

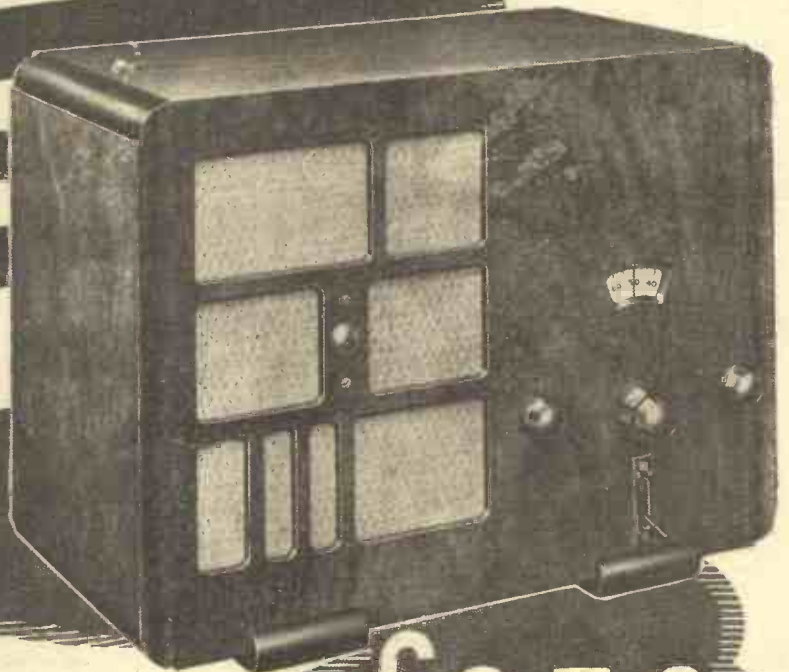
3-VALVES — PENTODE OUTPUT**VARIABLE-MU S.G. STAGE****ONE-KNOB TUNING****SELF-CONTAINED LOUD SPEAKER****£6=7=6**

You can now have all the advantages of a highly-priced Receiver for only £6. 7. 6.—the price of the Cossor Melody Maker (Model 341). This remarkable Set has Variable-Mu S.G. Stage giving "all-Europe" range and amazing selectivity—Pentode output for big, undistorted volume—all-metal chassis—combined volume control and "on-off" switch, etc.—every up-to-date feature of design. In spite of its many advantages the Cossor Melody Maker is so simple that you can assemble it yourself even if you know nothing about wireless. Send the coupon for a full-size Constructional Chart.

MODEL 341

Complete Kit of Parts for assembling Receiver as illustrated, including Cossor Variable-Mu Screened Grid, Cossor Detector, and Cossor economy Pentode Valves. Fully screened coils, Cossor Double-Gang Condenser, Blued, gun-finished all-metal chassis, and all the parts for simple home assembly. Handsomely finished cabinet 18½" x 13½" x 10" of modern design with space for batteries and accumulator. Balanced Armature Loud Speaker of the latest type: provision for gramophone Pick-Up Plug and Jack it required. Wave-length range 200/530 and 900/2,000 metres. Price **£6.7.6**

Hire Purchase Terms 16/- deposit and 10 monthly payments of 12/6 or, alternatively, 20/- deposit and 6 monthly payments of 20/-.

MODEL 342

Identical with Model 341 described above except that Permanent Magnet Moving Coil Loud Speaker is supplied. Price **£7.2.6**

Hire Purchase Terms 17/6 deposit and 9 monthly payments of 15/6.

COSSOR MELODY MAKER

BATTERY MODELS 341 & 342

Prices do not apply in I.F.S.

To A. C. COSSOR LTD., Melody Dept., Highbury Grove, London, N.5.
Please send me free of charge a full size Constructional Chart C. 16, which tells me how to build the Cossor Melody Maker (Models 341 & 342).

Name.....
Address.....

K-1440, 12/3/33

A. C. Cossor Ltd., Highbury Grove, London, N.5. Depots at Birmingham, Bristol, Glasgow, Leeds, Liverpool, Manchester, Newcastle, Sheffield, Belfast, Cardiff and Dublin.

♥ 3239

OUR STAND AT RADIOLYMPIA IS NO. 8 GROUND FLOOR!



**Practical
WIRELESS**

ROUND

WIRELESS

New Station for Czechoslovakia

AS according to the Lucerne Plan the Czech State was allotted a full channel—namely, 765 metres (393 kc) the Government has decided to erect a power station on some site close to the Hungarian border mainly with a view to combat anti-Czech broadcasts.

Lugano via Sottens

RECEPTION of broadcasts from the Tessin transmitter on 1,147 metres is not always an easy matter for distant listeners in view of its close proximity in wavelength to Kalundborg (Denmark). From time to time we may be given an opportunity of hearing the Lugano programmes through an easy channel as now and again they will be re-broadcast through the Sottens stations.

Sofia's New Transmitter

THE 3 kilowatt station presented to the Queen of Bulgaria by the city of Rome is now being erected in the immediate neighbourhood of Sofia. It will work on 214 metres (1,402 kilocycles). The Bulgarian Government is seriously contemplating the erection of a 50 kilowatt transmitter on some favourable site in the country, in which case, when it is completed, the Sofia 3 kilowatt will only be used as a relay.

Yugoslavia Forges Ahead

IT is reported that the Belgrade Government has now definitely passed an order to the Marconi Company for a 40 kilowatt station to be built as early as possible. The entire broadcasting system is to be reorganized to bring it on a level with neighbouring States.

An Ultra-Modern Sanatorium

MUSSOLINI, who is an ardent radio fan, is anxious that broadcasting in Italy should be available to the entire population. In a recently opened sanatorium personal suggestions made by *Il Duce* for the benefit of patients have been carefully carried out by the authorities. A central receiving station installed in the building feeds headphones and loudspeakers throughout the establishment,

order NOW next week's **Greatly Enlarged Issue of PRACTICAL WIRELESS**, dated August 19th, on sale August 16th.

A Complete Stand-to-Stand Report will be given in our **Second Greatly Enlarged Show Issue** dated August 26th, and on sale August 23rd.

opinion that, "as the former is mainly used for the advertising of foreign products, broadcasts on an arbitrarily chosen wavelength, and does not supply full details of its radio entertainments, they cannot be of interest to German listeners." As regards Russia, so long as their transmissions consist of Red propaganda the German Press does not consider that its subscribers can derive from such broadcasts either pleasure or benefit (*sic*).

Curiously enough, the local police authorities recently discovered a plot to blow up Radio Strasbourg, and a report states that a similar attempt was to be made on the Radio Strasbourg station. It should be explained that the latter broadcasts news

etins in German which do not always coincide with the official versions given by Berlin!

Broadcast of Tidworth Tattoo

SPECIAL arrangements for the transmission of this show in the National Gramme last week had to be made by the B.B.C. engineers. In this instance, owing to the configuration of the ground, it was not advisable to place microphones in fixed positions as, the field being comparatively small, the grandstand tends to echo back the sound of the drums. A "mike" was therefore carried behind the Massed Bands and both it and its bearer were camouflaged in green, so as to make them inconspicuous against the wooded background. It is most probable that the spectators who were unaware of this hardly noticed the hooded object as it followed the musicians.

B.B.C. and Radiolympia

SOME alterations have been made in regard to the planning of the radio theatre on which the B.B.C. will stage an original revue and also variety hours during the course of the Exhibition at Olympia. As now designed the theatre will hold not 1,500 but 2,000 spectators at each performance. Moreover, admission tickets to these shows will be sold at the box-office (and will not be supplied by some stallholders) as was originally proposed.

German Interval Signals

THE Hamburg group of studios, following instructions issued by headquarters, has adopted new musical interval signals for its stations. Hamburg, in future, will broadcast between items a few notes from the Boatswain's song in Wagner's opera *The Flying Dutchman*; Hanover has adopted an old folk-song: *We Jolly Hanoverians*; Bremen, in its turn, reverts to a Frisian traditional: *When the North Sea waves are breaking on the strand*, and, finally, Kiel and Flensburg, when working from their own studios, will use an old German hymn which seeks to prove that Schleswig and Holstein are intimately related.

ROUND *the* WORLD of WIRELESS (Continued)

Testing Out Common Waves

THE Basle and Bern transmitters are now working on a common wavelength, the Basle channel (244.1 m., or 1,229 kilocycles); the experiment is being carried out in order to ascertain the practicability of using such common waves, as prescribed by the Lucerne Plan. So far as can be judged, unless both transmitters are crystal-controlled except within the actual "city range" of the stations mutual interference has occurred.

Modernizing Sing Sing

EXPERIMENTS are to be made at Sing Sing prison (New York) with a low-power 5 metre transmitter and receivers for the use of the warders on their rounds. The apparatus is of a portable nature, weighing only six pounds, and can be carried as a military pack, the high-tension dry batteries contributing to the greater part of the weight. By this method it is hoped to enable the warders to keep in touch with the Chief Warden's office on their patrols through the penitentiary.

Moscow's Open-Air Radio Theatre

IN the central park of the capital the Soviet authorities have installed a gigantic stage capable of providing space for two thousand artistes for the performance of open-air plays. Seats around this vast arena will accommodate an audience of twenty thousand spectators. It is proposed to relay these displays to the main broadcasting transmitters for the benefit of listeners throughout Russia.

Russia's New Radio Plan

THE Soviet is now considering the construction of a 1,000 kilowatt transmitter, having regard to the success achieved by the 500 kW. station recently built at Moscow-Noghinsk. In addition to this super, Russia already possesses five others rated at 100 kilowatts, and fifty-six of power ranging from 2 to 25 kilowatts. That country the State is the sole supplier of wireless receivers of which, according to the latest statistics, there are already three million in use. They are turned out at the rate of 600,000 sets per annum. The policy to be adopted in future will be that of erecting more powerful transmitters with a view to the making of simpler and less expensive receivers. By doing so the State hopes to increase the production to some one and a half million yearly.

Listen While You Drive

AUTOMOBILE radio has definitely caught on in the United States, where, during 1932, 143,000 receivers were specially built for motor-car owners. At the factories it is estimated that 86 per cent. of the cars constructed this year will be supplied complete with special roof aerials. All sets are provided with remote control affixed to the steering wheel, and are designed for sharp tuning, the majority embodying a super-heterodyne circuit. As there are at present 20,000,000 car-owners in the United States, American manufacturers consider the 1933-1934 prospects very favourable to the radio trade.

INTERESTING and TOPICAL PARAGRAPHS.

Piccard's Next Attempt

PROFESSOR JEAN PICCARD, in the United States, hopes to break his twin brother's altitude record in the

stratosphere this summer. On this occasion the balloon will be equipped with both transmitting and receiving radio apparatus to enable him to broadcast a running commentary during the ascent. The weight of the complete radio equipment will not exceed 100 lbs. Transmission with a power of three watts will be carried out on 15,760 kilocycles, the receiving set being tuned to 6,100 kc/s. As the flight, which is to be made from Chicago, may last twenty-four hours, all stations of the National Broadcasting Company's network will stand-by for the reception of signals and Piccard's description of the experiment. Every effort is to be made to secure two-way communication with the aviator when he reaches his highest altitude. The broadcast will probably be taken by all American and Canadian medium and short-wave stations and will be relayed to Europe through the usual Rocky Point channels.

Have You Logged La Paz?

REPORTS on reception of the new Bolivian short-wave broadcasting station at La Paz have already been made by listeners in the British Isles. The transmissions—a relay of the main station working on 500 metres—are effected during the day on 19.61 metres, and at night on 49.3 metres. Announcements of items as well as the call will be heard in the Spanish language only. All reports for confirmation should be sent to *El Comité Ejecutivo pro Radio, La Paz, Bolivia, South America.*

On Top of the Himalayas

POSSIBLY within the next year a monastery similar to that established in Switzerland by the monks of St. Bernard may be opened on the Si- territory between India, China, and Thibet on one of the highest points of the Himalayas dominating the junction of important native trade routes. Owing to fog and heavy snow-falls, many lives are annually lost in this mountainous district, and the monks hope to offer assistance to travellers. A fully equipped transmitting and receiving radio station will be installed in the monastery to permit two-way communication with the outside world.

Stringent Laws in Czechoslovakia

TO resist propaganda broadcast by the neighbouring German stations, the Czech authorities have decreed that political speeches if heard by their nationals may not be transmitted to the outside public by means of loud-speakers. The breaking of this rule not only results in a heavy fine, but also entails the confiscation of the transmitter's wireless apparatus.

British Wireless for Norway

IN connection with the re-organisation of the Norwegian broadcasting system, a second Marconi broadcasting transmitter has been ordered by the Norwegian Government for erection at Bergen.

The new station will have a power of 20 kilowatts in the aerial, similar to that ordered last month for installation at Trondhjem.

SOLVE THIS!

PROBLEM No. 47.

Bradley bought a set of commercial ganged coils and a ganged condenser, and built up a receiver strictly in accordance with the instructions supplied with the coil. The range of the coils was such that he should have heard Fécamp, but when the set was put into use he found that the lowest setting of the condenser was just above Fécamp, and he could not, therefore, hear this station loud enough. Why was this? Three books will be awarded for the first three correct solutions opened. Address your envelopes to The Editor, PRACTICAL WIRELESS, Geo. Newnes Ltd., 8-11, Southampton Street, Strand, W.C.2, and post to reach us not later than August 15th, 1933. All envelopes should be marked Problem No. 47.

SOLUTION TO PROBLEM No. 46.

The fixed condenser used in Jackson's output filter circuit was defective and was short-circuited inside the casing. This resulted in the H.T. supply being short-circuited through the circuit made up from the output choke and loud-speaker windings in series.

The following two readers received books in connection with Problem No. 45:—

E. G. Jackson, 64, Clapham Road, S.W.9.
B. L. Stuart, Brinnington Hall Lodge, Brinnington, Stockport.

THE LATEST LOUD-SPEAKERS REVIEWED

By W. J.
DELANEY

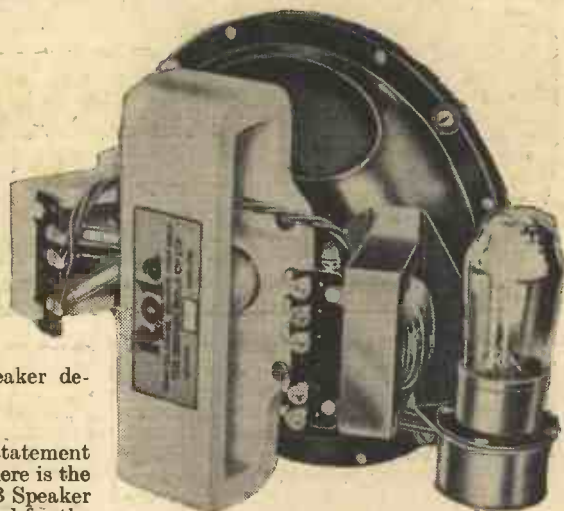

A Description of Some of the Changes Which Have Taken Place in Design and Construction During the Past Year.

NO fundamental change in design has taken place during the past year so far as the domestic loud-speaker is concerned. That is to say, the principles which are adopted to enable music and speech to be reproduced in the home from the broadcast receiver are exactly the same as they were a year ago. In every case a conical diaphragm is caused to vibrate, either by means of a magnetic armature attached to the apex of the cone, or by means of a coil of wire attached to a short cylinder which takes the place of a "point" on the cone. In the latter case the speech currents which come from the output valve are passed through the small coil, and this is suspended in a magnetic field, and the interaction of the magnetic lines of force and the varying speech currents causes the cone to be moved backwards and forwards, and so give rise to a reproduction of the sounds which are received by the broadcast apparatus. This is, of course, all old news to the majority of our readers, but they will wish to know what changes have taken place during a year which probably has seen more changes in wireless technique than any year which has yet passed. We have had, for instance, radical changes in practice and design in valves, coils, and transformers, but the speaker is, in principle, exactly the same as it was last year. Obviously, small changes have been introduced into manufacturing processes, and into the "mechanism," if it can be so called, but the fundamental principles are exactly the same, and there has been no

new type of speaker, or speaker development, introduced.

Midgets

Perhaps to some my last statement would appear to be wrong. There is the Midget speaker and the Class B Speaker Unit which are being introduced for the Exhibition this year. Surely, these are developments? Well, they are in one direction, but they are only the same types of speaker which we have had during the past twelve months, and except for being smaller in the one case, and built complete with an amplifying stage in the other, they are still the same in principle. However, let us examine these in turn. Taking first of all the Midget, what is this for? The introduction of car radio, and the probable introduction of the Midget receivers (which are already popular in America), has led to the necessity for a very small loud-speaker which is capable of giving fairly good reproduction. Obviously, it should be quite a simple operation to take a standard loud-speaker, and, by making every part half its size, produce a speaker which is a replica of the original standard loud-speaker. Would it work, however? I am afraid not. It is true it would make a noise, but so far as reproducing music is concerned we would get a poor travesty of the original. There are several important features which have to be borne in mind when designing a speaker with a total overall diameter of only 6ins. or so. You no doubt all know that the size of the diaphragm governs the kind of reproduction which is given by the speaker. To enable a really low organ note to be reproduced a very large and slow movement of the air is necessary, and for this reason best reproduction of a note of this sort is given by a large cone which is very freely suspended. The tiny cone will be too stiff to give a slow, easy movement such as is required by the very low musical notes, and accordingly it will fail to give them their full strength. On the other hand, the high notes, which demand only a short, quick movement, will be most readily dealt with by the small cone, and, therefore, it is safe to assume that a small cone will, normally, tend to give a high-pitched, unbalanced reproduction. This is where design comes in, and you can see now why the real midget loud-speaker has been so long in arriving. The Midgets which are obtainable now, and these include the Amplion "Sonette," the Rola Midgets, the Gramplan Midgets, and others, have been carefully designed, and the weight of the diaphragm, the size of the speech coil, and all the other parts which lead to the determination of the overall response, have been so chosen that the reproduction is really of a high standard. We naturally cannot expect such a speaker to handle 5 watts, but the Midgets which have so

far been brought to my attention will definitely handle the output from a Class B valve or a similar rated mains valve, delivering approximately 2 watts, and the results are really good. If you are thinking of building a small portable, either for general use, or for the car, one of these speakers will prove ideal, as it will enable a high standard of reproduction to be obtained and permit of really good volume for open-air dancing, etc. The Gramplan Company have produced some special balanced pairs of Midgets. As I pointed out above, the large cone deals easily with bass notes, whilst the small cone will fail to handle such notes as easily as the top notes. Accordingly, it is fair to assume that by using two speakers, one designed to cover the lower half of the musical scale, and the other to deal with the upper half, we should get a fairly straight-line curve, and in practice this has already been done by Celestion, Rola, Magnavox, and one or two other firms who specialize in loud-speakers. The new Gramplan Midget pairs measure only just over a foot in length, and are approximately 3ins. deep. The characteristics of the two speakers are well chosen, and give a really remarkable output.

Class B Speaker Units

The remaining development in new speakers is the combination of a complete Class B amplifying stage with a good moving-coil loud-speaker. In previous articles dealing with Class B amplification it has been pointed out that, in addition to giving an output of approximately 2 watts, this type of valve delivers really high quality, and owing to the absence of any grid-biasing adjustments, etc., it is possible to get the best from the L.F. stages with very little effort. The standard is so high, in fact, that one is justified in using a really high-class moving-coil loud-speaker.

It is now possible to obtain the new speaker in such a form that the existing receiver may be used, and by the simple addition of the speaker unit, the present apparatus is converted to a powerful receiver of the type you have always admired. The Class B stage looks after the quality of the output, and the moving-coil speaker handles the signal and does full justice to the volume and quality which is delivered to it. Whatever type of Unit is purchased, you may be sure of getting really fine results, and the Ferranti, the Rola, the Gramplan, and others are available for your choice.

Olympia Radio Show

Tuesday, Aug. 15th to Thursday,
Aug. 24th. 11 a.m. to 10 p.m.

Two Special Enlarged Numbers

of

Practical Wireless

August 19th issue

COMPLETE GUIDE TO THE SHOW

A Forecast of the Exhibits, in
At-a-Glance-form, with a guide to
the Show alphabetically arranged.

August 26th issue

STAND-TO-STAND SHOW REPORT

A comprehensive report on each
exhibit by our Technical Staff.

Order These Issues Now!

Measuring Radio and Audio Frequency Voltages

It is quite an easy matter to make voltage measurements in a circuit where only direct current is present, but to determine the A.C. voltage between two points is quite a different matter, especially when, as is the case with radio measurements, the frequency may be anything from ten to ten million cycles per second. Whilst the moving-coil meter finds extensive use in direct current measurements, it is quite useless where A.C. is concerned; most of the types of the popular moving iron instrument are equally valueless, though some of these are designed for low-frequency A.C.

There are three instruments of the type mentioned above, that is, instruments where the quantity to be

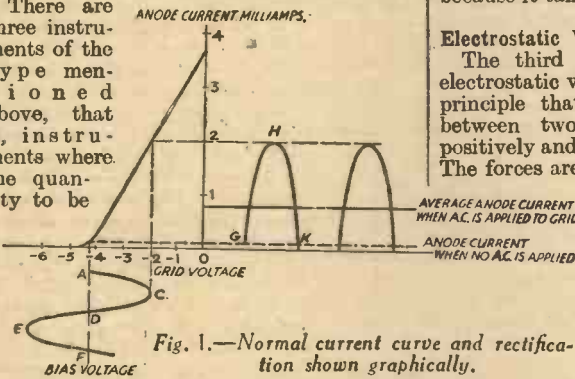

Fig. 1.—Normal current curve and rectification shown graphically.

measured is read off from a pointer and scale, which can be used with A.C., but they are, unfortunately, not suitable for both radio and audio frequency measurements.

The first of these is the rectifier instrument, in which the current is rectified by a metal oxide rectifier and is then passed through a D.C. instrument. This is probably the most useful and accurate type of A.C. meter, as it has many of the good

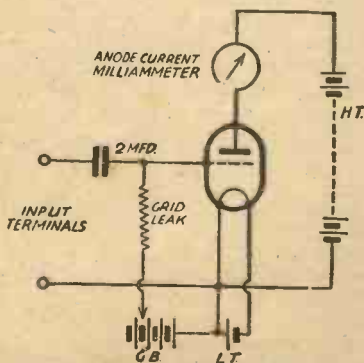

Fig. 2.—A simple valve voltmeter.

properties of the moving-coil instrument; it is, however, only of use up to frequencies of about 5,000 cycles, since the metal rectifier does not rectify to the same extent for frequencies above this and the readings of the scale become inaccurate.

An Article Dealing with the Different Types of Instrument Used. By G. L. GRIDALE

Thermo electric meters may be used on any frequency, since they merely measure the heat produced in a wire when a current to be measured is passed through it. The heating effect is the same for a given current at any frequency, but the meter cannot be used for voltage measurements, because it takes so much current.

Electrostatic Voltmeter

The third type of A.C. meter is the electrostatic voltmeter, which works on the principle that an attractive force exists between two conductors when one is positively and the other negatively charged. The forces are always very small and large voltages must be used to produce a deflection of the needle. The electrostatic meter can only be used accurately with potentials of some hundreds of volts, and for high voltage measurements it is ideal, as it takes no current.

All these instruments have one or more properties which make them unsuitable for our purpose. Fortunately, however, there is quite a simple device available, and that is the valve voltmeter. This will quite accurately measure A.C. of practically any frequency, the precision being governed by the precision of the D.C. measuring instruments involved and by the constancy of working conditions. The great quality of the valve voltmeter is that it takes very little power from the circuit to which it is connected, that is, it has a high impedance. It is well known that makers of voltmeters state the number of ohms per volt of their instruments, and that the better the instrument, in general, the greater the resistance per volt. The statement is equivalent to stating how many amperes are taken by the instrument on full-scale deflection. For 100 ohms per volt we know that a full scale deflection will take one-hundredth of an ampere or 10 milliamperes. So the resistance of a voltmeter for D.C. must be high and in the same way the impedance of an A.C. instrument should be as large as possible.

The general principle of all valve voltmeters is the same, though there are numerous variations to the circuit. The A.C. voltage to be measured is applied to the grid circuit of the valve and this is arranged like an anode bend detector and

the change in plate current is either observed or compensated by a grid-bias change.

In the simplest type of voltmeter the grid-bias is kept at a constant value. Fig. 1 shows a curve of anode current

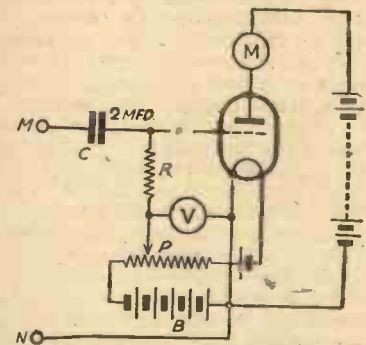

Fig. 3.—The Moulin valve voltmeter.

variation with grid bias, the common characteristic curve of a valve. The valve is biased to the point marked A, nearly to the current cut-off point, just as Q.P.P. valves are biased. Now the A.C. voltage is applied to the grid. If we follow this through the cycle starting at A and increasing to C, we find that the anode current also increases from G to H; continuing through the cycle the grid voltage decreases again to the old value and the anode current also returns nearly to zero, to the point K. This completes half of the cycle, and so far the anode current has increased with the grid voltage. But now

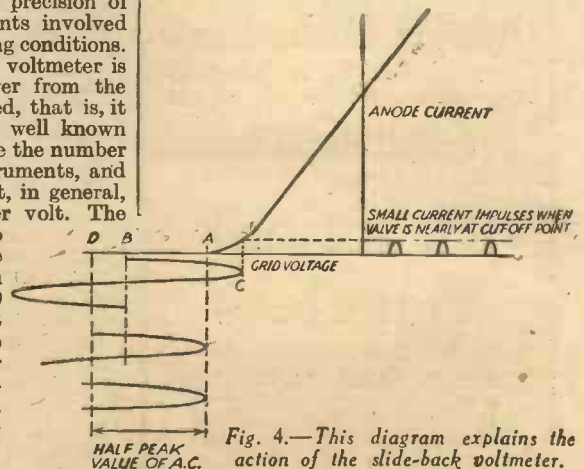
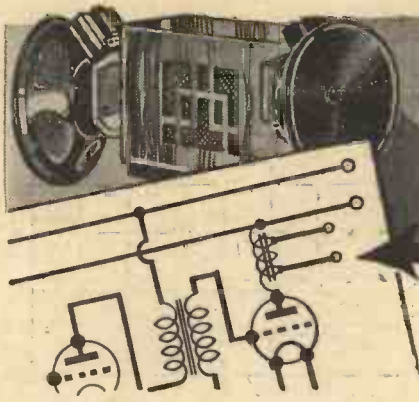

Fig. 4.—This diagram explains the action of the slide-back voltmeter.

we have to consider what happens when the grid swings still more negative. The voltage is carried right back past the value for zero anode current and the anode current cannot become negative so that it just stays at zero whilst the grid completes

(Continued on page 666)



Speaker Matching Pointers

By H. J. BARTON CHAPPLE, Wh.Sch., B.Sc., A.M.I.E.E.

TWO phrases which are cropping up constantly in radio journals are "the optimum load of an output valve" and "speaker matching." These have a very special significance and readers cannot have their attention drawn too frequently to them if "quality" is to be the real aim of the set user. The first phrase means that in order to obtain the maximum output from your set the impedance of the apparatus (loud-speaker and so forth) connected in the anode circuit of the output valve must at any rate be approximately equal to an "optimum" or ideal value, which depends upon the type and characteristics of the valve used.

The implication of the phrase "speaker matching" is that if the impedance of your speaker differs greatly from the optimum load for your output valve, matters must be adjusted by the use of a suitable output transformer or tapped choke, or distortion will arise. It is in this connection that the amateur frequently encounters difficulty, for in order to determine accurately the correct ratio for the output transformer, it is necessary to know the optimum load for the valve and the impedance of the loud-speaker, and then to perform a mathematical calculation which, although fairly simple in itself, is apt to puzzle those whose maths have become a bit rusty.

Optimum Load

In order to assist readers over this problem I propose to discuss briefly why each valve has its "optimum" load value, how a transformer can "match up" a speaker to a valve, how the essential calculation should be made, and, finally, to submit various methods whereby this calculation may be simplified to a considerable degree.

To begin with, then, why is there an "optimum" or best value for the load in the anode circuit of an output valve? You will, of course, agree that the power output of a valve is represented by multiplying together the effective variations in the anode current of the power valve and the value of the effective A.C. voltage drop across the load. In the case of a simple set the load is the speech winding of the speaker. It should also be clear to you that if the impedance of the speaker (that is, the opposition it offers to varying currents) is very small compared with the impedance of the valve itself, the voltage drop across

the speaker will also be small, and naturally the power expended in the speaker will be small.

The relation between the output and the load impedance for a given valve can be calculated, and can also be determined experimentally. If corresponding values of load and output be plotted on squared paper, the resultant curve will be of the form shown in Fig. 1. Here, you will observe, at low load values the output is small, as we would expect, but the output increases fairly rapidly as the load is increased. Beyond a certain load value, however (A in Fig. 1), the increase of

percentage distortion of output for different outputs. For a definite set of conditions, that is, grid bias, anode voltage and load, the output of a valve depends upon the strength of the signal voltage applied to its grid. As the characteristic curve of the valve is not quite straight, there will be a certain amount of distortion, and the distortion will be greatest at full output, because in order to get this full output the grid swing will cover more of the curved portion of the characteristic. Thus you will see that the distortion curve indicates greater distortion at big output than at low output.

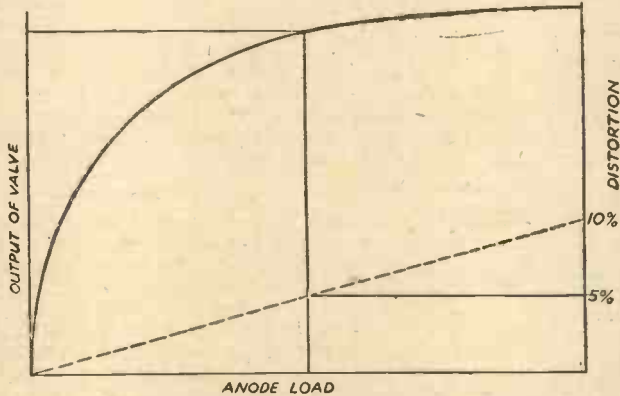

Fig. 2.—The relation between output and load with the addition of distortion curves.

It has been found by experience that as much as 5 per cent. distortion can be permitted without seriously impairing the quality of reproduction, so the published "optimum" load is selected as that value of load impedance which gives the biggest output consistent with reasonably small percentage distortion. In the curve reproduced in Fig. 2 the optimum load would probably be taken as A, for with this value practically the maximum possible output is obtained, and the distortion is within the limit of 5 per cent.

It may here be remarked that the distortion curve plotted in Fig. 2 is the second harmonic distortion curve. In the case of a pentode output valve the third harmonic distortion is likely to be

more serious than the second harmonic, and must be taken into consideration when deciding upon the optimum load.

Adjusting Matters

We must now consider why an output transformer can adjust matters if the impedance of the loud-speaker does not happen to be more or less equal to the optimum load. First of all, what is the impedance of the speaker? It is not necessarily the resistance of the speech winding. The opposition the winding offers to alternating current is different from that which it offers to direct current, and, moreover, is different for every frequency. It is usual to use, for the purposes of calculation, the impedance at a definite frequency—usually at 1,000 cycles. This figure is quoted by most speaker makers in their catalogues and leaflets. In some cases, however, the resistance only is quoted. In that case you will not be far wrong if you consider the impedance of a moving iron speaker to be the same as its resistance, and of a moving-coil speaker to be about one and a quarter times its resistance.

If the speaker impedance is (Continued overleaf)

output with increasing load is not so great, while after reaching the point B, further increase in load impedance makes little or no appreciable improvement in the power output.

Distortion

It would appear, therefore, as if any value of load impedance between, say,

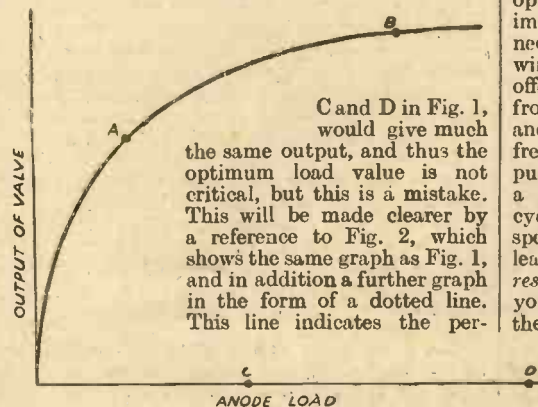

Fig. 1.—A curve showing the relation between output and load.

C and D in Fig. 1, would give much the same output, and thus the optimum load value is not critical, but this is a mistake. This will be made clearer by a reference to Fig. 2, which shows the same graph as Fig. 1, and in addition a further graph in the form of a dotted line. This line indicates the per-

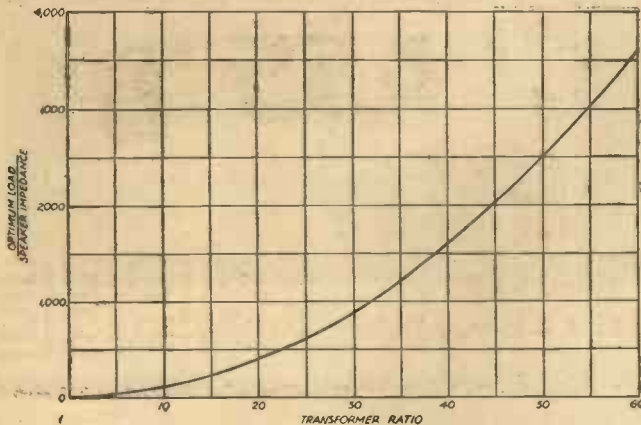

Fig. 3.—A matching chart for low-resistance speakers.

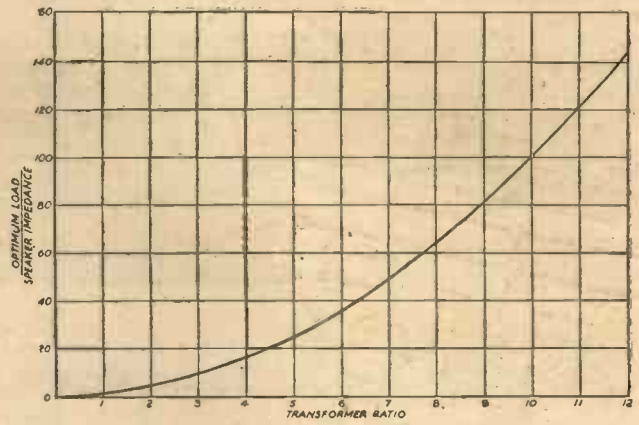

Fig. 4.—A similar chart to Fig. 3, but for high-resistance speakers.

SPEAKER MATCHING POINTERS

(Continued from previous page)

greatly different from the optimum load for the valve with which it has to work, a transformer of suitable ratio must be used to balance matters. The primary winding of the transformer is connected in the anode circuit of the valve, and the speaker is connected in the secondary circuit of the transformer. If the turns ratio of the transformer is correctly chosen, the primary winding will form a suitable load for the valve, while the speaker winding will form a suitable load for the transformer. The correct value of the ratio of the output transformer is calculated from a formula. I will not worry you with a long explanation of how the formula is deduced, but will give it to you right away:—

Transformer ratio=

$$\sqrt{\frac{\text{Optimum load of valve in ohms.}}{\text{Impedance of speaker in ohms.}}}$$

For those who are not mathematicians, I must explain that this means that to ascertain the correct ratio you divide the optimum load of the valve by the speaker impedance, and find the square root of the result. The answer to this little sum is the accurate value of the transformer ratio.

Of course, in many instances the result will be an awkward number like 1.82, or something similar. There is no need to try and purchase a transformer with an odd sort of ratio like that, for the actual value is not quite so critical, and the nearest standard ratio to the figure you obtain from your calculation will in many cases be found satisfactory.

Helpful Data

For the convenience of non-mathematical readers, the graphs reproduced in Fig. 3 and Fig. 4 have been prepared. To use these graphs, all you have to do is to divide the optimum load by the speaker impedance. Then find a point on the upright scale of Fig. 3 or Fig. 4 corresponding to the result of your division. Follow this point horizontally across the paper until you meet the curve, and then follow the point downward until you meet the horizontal scale at the bottom, on which you can read off the correct transformer ratio. Two curves are provided, one for use when the result of the division is comparatively small, say under 150, and the other for higher values up to 4,000.

MEASURING RADIO AND AUDIO FREQUENCY VOLTAGES

(Continued from page 664)

the second part of the cycle. The anode current thus follows out the positive half of the cycle, but remains at zero for the negative half. If we were to place a meter in the anode circuit and put very low-frequency A.C. on the grid, we should see the anode current first rise and then fall back to zero, where it would remain for half a period. The cycle would then be repeated. In practice the meter does not fluctuate up and down, but shows a steady average reading. When the A.C. is applied the current rises to some value and this value is determined by the voltage of the A.C. and it depends in no way upon the frequency. The voltmeter must be calibrated from known A.C. voltages, and this is one of its great disadvantages, for the battery voltages must be kept absolutely constant or the calibration will change.

Slide-back Valve Voltmeter

In order to overcome these difficulties, a second type of valve voltmeter is used, which is called the slide-back valve voltmeter by virtue of the fact that the grid bias is not kept constant but is slid back in order to compensate the increase in anode current when the A.C. is applied to the grid. The circuit of the instrument is shown in Fig. 3; the grid bias is applied through the grid-leak R from the potentiometer P and battery B. The grid bias is read off on the voltmeter V. Switches have been omitted from the diagram for the sake of simplicity.

The mode of action is as follows. The valve is biased till it just takes zero current and the A.C. is applied in the same way as before, but instead of noting the increase in the anode current we alter the setting of the potentiometer until there is once again just no current. The difference between this bias and the previous no-current bias is half the peak value of the A.C. voltage. An examination of Fig. 4 will show why this is so. When there is no A.C. the valve must be biased to A for cut-off of anode current. The A.C. is then applied and the current rises as before. Then the bias is increased. With the bias at B there will still be slight humps or impulses of anode current when the A.C. swings the grid voltage past the cut-off value at A; though these humps are quite small, they result in a small average anode current and this will remain until the bias is increased so much that the A.C. does not swing the grid voltage past A. When this is true the peak will reach just to A, which was the previous cut-off value. The increase in bias necessary thus gives the semi-peak value of the A.C. If the RMS value is required this must be multiplied by 1.41. It should be noted that in the above explanation the grid bias means the bias from the battery, as indicated by the voltmeter, and the grid voltage is the actual voltage of the grid at any time. Though the grid bias is constant for any one setting, the grid voltage is constantly changing, due to the superimposed A.C.

The advantages of the slide-back voltmeter are that it gives the voltages directly from the readings of a voltmeter without the use of any calibration curve, the valve and batteries and the anode meter being

mere indicators. The chief disadvantage is the matter of initial expense, since two meters are necessary, and one of these must be very sensitive for use in the anode circuit. The range should be as low as possible. The meter V should be of such a size that it will cover the A.C. range required. A two-range meter is better here. The valve should be chosen to have as great a slope as possible near the cut-off point.

High and Low-frequency Oscillator

To find the A.C. voltage between two points the terminals of the meter are joined to the points by two pieces of wire, which should be as short as possible. A high and low-frequency oscillator is a useful accessory to the voltmeter. With these two pieces of apparatus the amplification of a valve or a complete amplifier can be obtained simply by measuring the voltage going into the grid and that coming out of the plate. A D.C. voltage does not affect the working of the voltmeter, since there is a large blocking condenser in the grid lead. The output voltage of a valve can be found by connecting the voltmeter directly between plate and filament. A constant input such as that from a valve oscillator must be used, but the B.B.C. tuning note might be used if the oscillator is not available. The tuning note is often on for five minutes or more, and this is enough time to get a quick set of readings on a receiver if done with care. A valve oscillator is much better, though.

It should be noted that the valve voltmeter can also be used as a valve tester if the meter M can be used with a shunt to read up to 20 milliamperes or so.

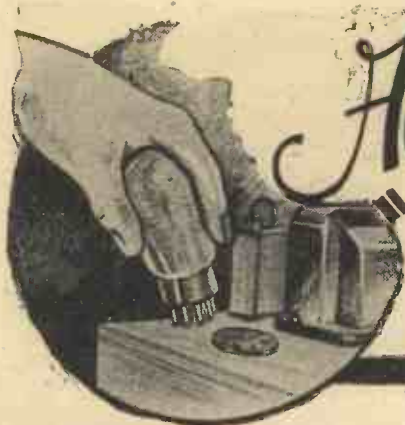

Adding CLASS "B" to the "SELECTONE" THREE

IN designing the "Selectone" 3-valve receiver some months ago I had in mind the production of a first-class up-to-date battery set which could be built for a modest sum. My expectations were more than justified by the results obtained and many readers have testified to the excellence of the instrument. I, personally, was so pleased with the "Selectone" that I have used it in my own home as a standard broadcast receiver ever since it passed through its final tests. The receiver has proved more than satisfactory in every way, but with the introduction of Class "B" it was decided to keep the set up-to-date by modifying it to include the latest system of amplification.

Having two low-frequency stages, the "Selectone" is particularly well suited to Class "B" and the change-over is both simple and inexpensive. Briefly, all that is required is to replace the third (power) valve-holder by a 7-pin component, exchange a special "driver" transformer for that used to couple the second and third valves, and fit a suitable output choke. The total cost of the modification, exclusive of the Class "B" valve, may be as low as 28/-, but for another 1/6 (the price of a fixed condenser) the refinement of tone control can be included.

Advantages of Class "B."

The set in its new form, that is with the inclusion of Class "B," is even better than before, and the volume of really pure reproduction of which it is now capable is tremendous. As you know, the Class "B" valve gives an undistorted output of about 2 watts which, compared with the original output of about 120 milliwatts, is really enormous. In point of fact, the actual signal output from the loud-speaker is equal to that to be obtained from a powerful mains receiver using an A.C. pentode in the final stage. It might be argued that so great a volume is never required in the house, but it is often a distinct advantage, particularly when it is combined with purity of an order that has probably never before been experienced by the user of a battery set. Quite apart from the maximum volume to be obtained,

This Article Explains How Any 2-L.F. Receiver may be Modified to Include the Latest Development in Low-frequency Amplification, and Takes the "Selectone" as a Typical Example. By FRANK PRESTON, F.R.A.

however, it must be remembered that Class "B" does actually provide a greater degree of amplification than do other systems, so that weaker and more distant stations which were previously quite weak are brought up to enjoyable programme strength.

More Power Without Extra Cost.

At first sight it would appear that the extra volume must be paid for in the way of high tension current, but this is not necessarily true, because the new valve is

Reducing H.T. Consumption.

By cutting down the H.T. to 100 volts the current consumption is reduced to less than 8 milliamps, although the undistorted signal output is still more than 1 watt, or equal to that of a mains receiver of the smaller type. These figures speak for themselves and there is no reason why I should comment on them! It should be pointed out that the one slight disadvantage of Class "B," is that the consumption of low tension current is increased from .4 to .7 of an ampere, but so long as the accumulator is of reasonable capacity this is of very little consequence.

If great economy of current is particularly required it can be obtained by using the 210 H.L. valve instead of the P. 220 as "driver." This will cut down the maximum speaker volume to a certain extent, but even so an output of very nearly 1 watt is still within reach when using 90 volts high tension. The average H.T. current under the latter circumstances is not much more than 6 milliamps, and can therefore be derived from the smallest type of battery.

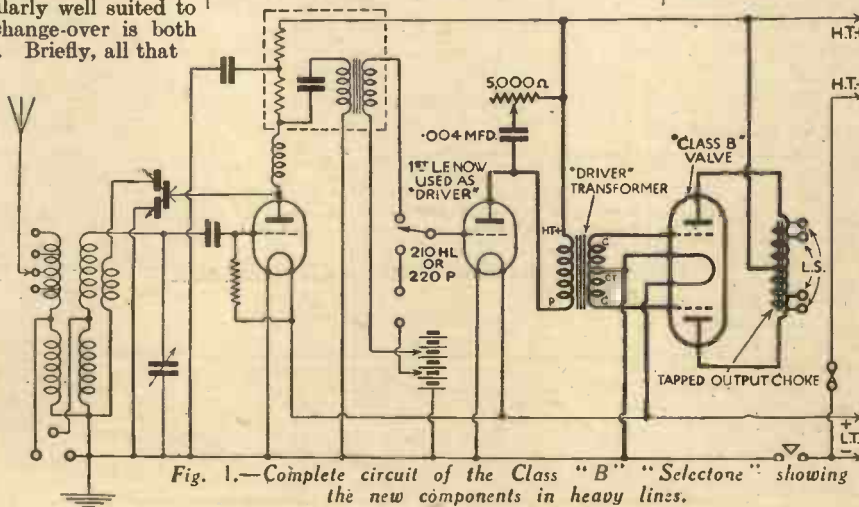

Fig. 1.—Complete circuit of the Class "B" "Selectone" showing the new components in heavy lines.

distinctly more efficient than other types. In other words, it will give a greater output for any given input. By way of being more precise I will state the actual measured anode current of the modified "Selectone." When using the P 220 power valve in the "driver" stage and with a total high tension voltage of 120 (a combination which gives nearly 2 watts output on stations up to ten miles or so) the total current taken from the high tension battery when the set is not tuned to a signal is just about 8 milliamperes, or rather less than that required by the valves previously employed. After tuning in a strong signal the current rises to an average value of approximately 11 milliamperes. This is just 1 milliamp more than the current taken originally, despite the fact that the signal output is increased fourteen-fold.

The Necessary Alterations.

And now we can turn our attention to the question of carrying out the necessary modifications. It should first be explained, however, that although these remarks will be directed principally towards one particular receiver the actual method of procedure will apply just the same to the conversion of any set having two low-frequency stages.

In Figure 1 you can see the complete circuit of the modified "Selectone," but in order to make the alterations quite clear the new components and wiring are drawn in heavy lines, whilst the part of the circuit which remains unchanged is shown faintly. Even at a first glance it is obvious that the changes are few in number and involve less than a dozen connections.

(Continued overleaf.)

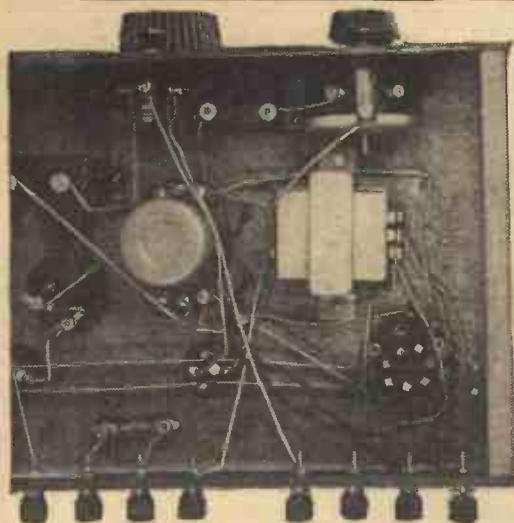

Fig. 3.—This photograph shows the "driver" transformer and new wiring.

(Continued from previous page.)

If you compare this diagram with the original one reproduced on page 768 of "Practical Wireless" No. 16 you will see that the "Rectatone" transformer has been substituted by a special "driver" transformer. A 5,000 ohm variable resistance was previously connected across the "Rectatone" to provide tone control, and the same resistance is now used in conjunction with a .004 mfd. fixed condenser for a similar purpose. The secondary winding of the "driver" feeds the grids of the Class "B" valve and its centre-tapping is taken to H.T.—. So that the original speaker—or any other standard type for that matter—can be employed, a tapped choke is used in the output circuit. The choke is one specially designed for Class "B" and has the necessary total impedance of 8—10,000 ohms under working conditions. It provides three output ratios of 1.5 : 1, 2 : 1 and 2.5 : 1; the Class "B" valve can thus be matched to any type of speaker, preferably a moving-coil or inductor dynamic. When the speaker is designed for use with an ordinary power valve it should be connected to the terminals which give a ratio of 2 : 1, or if it is of the "pentode" type it will be joined to the terminals which provide a 1.5 : 1 ratio. The Celestion "Soundex" loud-speaker specified for the original receiver has a tapped transformer which can be matched to either power or pentode valves, but slightly better results seem to be obtained by using the "pentode" tapplings. You can, however, try it both ways and make your own comparisons.

New Components Required

The few extra parts required are :—

- One Benjamin Class "B" transformer.
- One Benjamin 7-pin valve-holder (for chassis mounting).
- One Varley Class "B" output choke.
- One Cossor "240B" valve.
- One .004 mfd. T.C.C. fixed condenser (if tone control is required).
- Short length "Glazite" and flex.

Fig. 5.—A general view of the Class "B" "Selectone."

Practical Details

In commencing to modify the set the first thing is to disconnect all wires from the third valve-holder, "Rectatone" transformer and tone-control resistance; also remove the wire joining terminals "L.S.+" and "H.T.+" The former two components can then be removed entirely. Next, the hole in the baseboard from which the valve-holder has been taken must be enlarged from 1 1/4 in. to 1 1/2 in. diameter to receive the

Fig. 2. (below)—This wiring plan shows all the new connections required when adding Class "B" to the "Selectone." Compare it with the full plan given on page 808 of "Practical Wireless" No. 17.

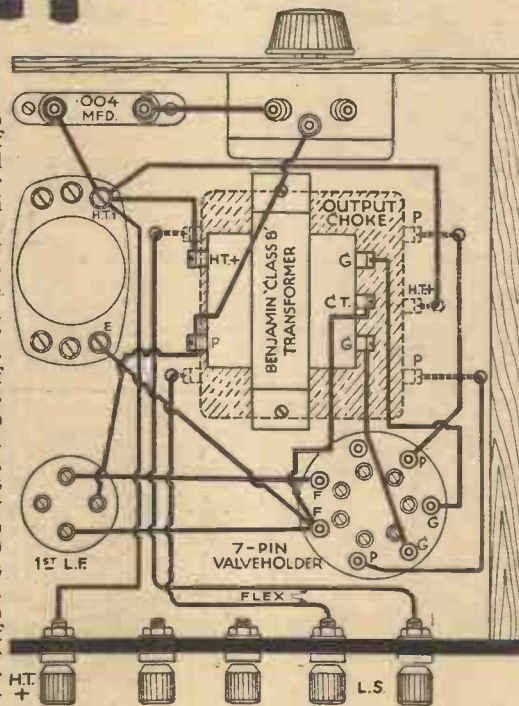

Type of "Driver" Valve	High-Tension Voltage					
	90		108		120	
	G.B.—	G.B.—1	G.B.—	G.B.—1	G.B.—	G.B.—1
210 H.L. ...	3v.	1 1/4 v.	3v.	1 1/4 v.	4 1/2 v.	3v.
220 P. ...	7 1/2 v.	0v.	0v.	7 1/2 v.	9v.	7 1/2 v.



Fig. 4.—Here we see the output choke and the enlarged hole for the 7-pin valve-holder.

larger 7-pin holder. This little job can be done most easily by means of a half-round file. The valve-holder can then be mounted in position by screwing it to the underside of baseboard with the terminals arranged as shown in Fig. 2; it will be noticed that the filament terminals (the two which are closest together) are toward the second valve-holder. The Class "B" transformer is now attached to the underside of the baseboard, in the position indicated in the wiring plan, and photograph, and, if tone control is to be included, the .004 mfd. condenser may also be screwed in place.

Now turn the chassis over and attach the output choke on top of the baseboard. Its position is clearly shown in Fig. 4, and it will be found that this component fits nicely between the grid-bias battery, tuning condenser and valve-holder. Before wiring can be proceeded with, five 1/4 in. holes must be made through the baseboard near the terminals of the output choke; these are clearly shown in Fig. 2.

Simple Wiring

The wiring is straightforward enough, as you can see from the plan of Fig. 2; this drawing shows only the new wires, and all others will remain exactly as before. All connections except two are made in Glazite, but those from the speaker terminals to the output choke are in flex so that they may easily be transferred to alternative terminals when different output ratios are required. In Fig. 2 the 7-pin valve-holder is shown as having terminals, whilst that illustrated in the photographs is fitted with soldering tags only. This difference is explained by the fact that when I first modified my own set the new type of valve-holder was not actually on sale, but the makers kindly supplied me with a rough hand-made one for experimental purposes. The proper commercial components will be available by the time this is in print and will have terminal connections. Although the valve and holder have seven

(Continued on page 677)

COLVERN FERROCART COILS

There is now a Ferrocart Coil for practically every modern radio receiver.... We have written a booklet explaining the advantages of Ferrocart Coils and containing suitable circuit diagrams....

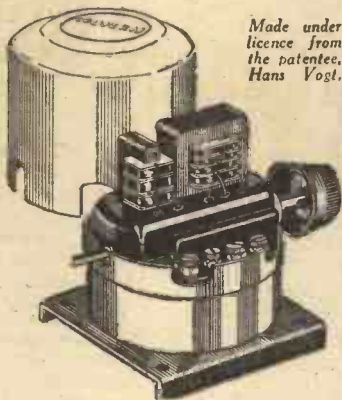

Made under licence from the patentee, Hans Vogt.

May we send you a copy? It's free!

Radio Olympia — August 15th — 24th.

See Our Stand No. 56.

COLVERN LIMITED,
ROMFORD, ESSEX

London Wholesale Depot, 150, King's Cross Rd., W.C.1.

"AIRSPRUNG"

An Outstanding Development
in Valveholder Design

CLIX introduces the first
Anti-Microphonic, Non-metal Chassis Mounting
VALVEHOLDER

POWERFUL LOUDSPEAKERS working close to valves throw off sound waves which create distortion. This NEW CLIX Chassis Mounting Valveholder is designed to absorb all such vibrations, thus preventing distortion and prolonging the effective life of the valve.

It is also ideal for SHORT WAVE work, with the minimum amount of material used in the construction, the sockets are practically air-insulated.

4-Pin - - 1/2

5-Pin - - 1/3

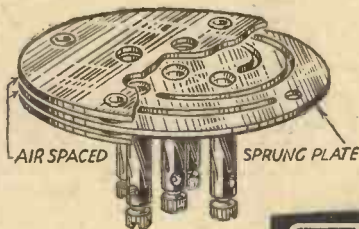

SEE THE FULL RANGE OF CLIX PERFECT CONTACT COMPONENTS ON STAND 37. OLYMPIA.

Folder 'N' on request.



LECTRO-LINX LTD., 79a, Rochester Row, London, S.W.1.



EDISWAN

The name that means 'EXCELLENCE'

BALANCED CAPACITY
COSTS NO MORE
and gives you longer life
with less charging

E.L.M.2.	20 a/h capacity	- 4/3
E.L.M.4.	45 a/h capacity	- 8/-
E.L.S.5.	40 a/h capacity	- 11/-
E.L.S.7.	60 a/h capacity	- 12/6
E.L.S.9.	80 a/h capacity	- 15/6
E.L.7.	60 a/h capacity	- 10/3
E.L.9.	80 a/h capacity	- 12/3



Balanced Capacity is the newest development in accumulator manufacture. It means that the positive and negative elements are designed to function in exact electrical balance, making it possible to charge more quickly and discharge more slowly without damaging the cell. The Ediswan "Extra-life" accumulator will thus last longer and give you much better service than an ordinary unbalanced type—yet it costs no more. A definite economy.

FROM ALL GOOD RADIO DEALERS

EDISWAN

EXTRA-LIFE

ACCUMULATORS



THE EDISON SWAN ELECTRIC CO. LTD.
PONDERS END, MIDDLESEX

EDISWAN - the Better Service Batteries

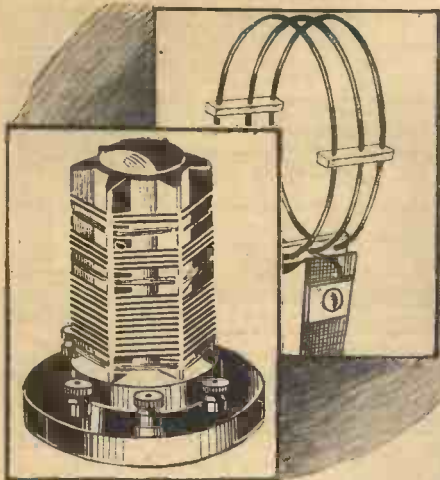

Coils For SHORT WAVE RECEIVERS

By K. E. BRIAN JAY

THE most important part of a simple short-wave receiver is undoubtedly the grid circuit of the detector-valve. This is the circuit that handles the incoming signal, and upon it depends the voltage available for operating the detector (and hence the signal strength) and the number of stations that can be heard at once (i.e., the selectivity). I have dealt in a previous article with the condensers to be used in this part of the circuit and now I will discuss the coil to be associated with the condenser, for these two components are the vital ones in the grid-circuit.

Fig. 1 shows a typical circuit, using band-spread tuning, and in what follows, the two variable condensers C_1 and C_2 will be regarded as a single condenser C . First of all, I want to talk about the tuned circuit as a whole, that is, the coil L^1 and the parallel tuning condenser C , so that we may see what is to be asked of the coil. The primary purpose of the tuned circuit is to discriminate between incoming oscillations, that is, to provide selectivity, by making the receiver sensitive to only one wavelength at a time. It does this by virtue of the fact that its resistance to an alternating current, called its reactance, for any particular condenser setting and size of coil, is very great indeed for one certain frequency called the resonant frequency. The voltage set up across the ends of the coil by a current of this frequency is much greater than the voltages set up by currents of other neighbouring frequencies. This can be seen at once from Ohm's law:

$$E = I.X$$

where E is the voltage, I the current, and X the reactance. Clearly, E will be greatest for the largest value of X , and consequently a wireless station transmitting on the resonant frequency will be heard to the exclusion (more or less) of all other stations, because X is greatest at the resonant frequency and decreases rapidly with increase or decrease of frequency.

The second property of the tuned circuit is that it magnifies the applied voltage at the resonant frequency, and this magnification depends on the inductance and resistance of the coil, which we see is now beginning to assume a special importance. Actually, this magnification is expressed in mathematical shorthand as:

$$2.\pi.f.L$$

R

where π is our old friend 3.1416, f the resonant frequency, L the inductance of

the coil, and R its resistance. Two things at once leap to the eye, namely, that if the magnification is to be big, the inductance must be as large and the resistance as small as possible.

Thick Wire for S.W. Coils

So far, everything I have said applies to coils for any wavelength whatever, but now I will show the bearing of these things on short-wave coils in particular. One of the first things you notice about most short-wave coils is the very thick wire used. The reason for this is pretty obvious, for the thicker the wire the lower the resistance. Actually, the resistance concerned is not the ordinary D.C. resistance, but the resistance to high-frequency currents, a much more complex quantity. Now D.C. currents travel through every part of the cross-section of the wire, but high-frequency currents travel only through a thin skin a molecule or two thick, on the surface of the conductor, so that apart from any other considerations the high-frequency resistance will always be much greater than the D.C. resistance and will increase with frequency, because the higher the frequency the thinner the skin through which the currents travel. This skin effect makes it possible, and desirable, to use copper tube instead of wire for transmitting inductances, and there is no reason why, from the point of view of resistance only, such coils should not be used for reception. From other points of view, especially expense and compactness, they would not be so attractive! The reason for reducing resistance as much as possible is, as we see from the formula above, that the higher the resistance the smaller the magnification, and since the actual number of turns required on a short-wave coil is not great, it is quite possible to use very thick wire and still have a coil that is not too unwieldy. However, when thick wire is used, a coil diameter of the order of two and a half to three inches is necessary to preserve reasonable coil proportions, and this immediately introduces fresh complications, because the larger the coil diameter the bigger the area covered by the magnetic field associated with it and consequently the greater the interaction of coil with other components in the receiver. Ultimately, interaction of this kind will give rise to instability, but long before such conditions arise it will have set up relatively large coil losses in the form of an actual loss of energy in eddy currents and an apparent increase in resistance, because the high-frequency resistance of a coil is far from being decided by the wire gauge only; if

the coil diameter is large, a metal condenser end-plate three inches away may introduce more losses than would result from halving the wire size. The necessity for a large coil diameter, therefore, is the first reason for doubting the value of thick wire in short-wave coils.

Resistance Losses

A second point arises in connection with resistance losses, however, that is of even more importance. Every simple short-wave receiver makes use of reaction, the application of which increases the sensitivity of the receiver up to a maximum, at which point it starts to oscillate. How does it do this? Simply by reducing the effective resistance of the coil. That is to say, the use of reaction amounts to making R as small as we wish until when the valve begins oscillating R becomes effectively zero. Why, then, worry about resistance at all when we can make it as small as we like by adjustment of the reaction control? Well, of course, it's not quite as simple as that; things never are in this life. In the first place, the higher the resistance of the coil the more reaction we have to apply to induce the set to oscillate, and this means increased losses and often an unmanageable receiver; in an extreme case we may not be able to get the receiver to oscillate at all. Second, and rather more important, is that only with a perfect reaction control will the resistance decrease continuously right up to zero; in practice it will reach a very small value and then suddenly become zero, so that the set spills over, as it were, into oscillation. In bad cases of this kind you can hear the effect in the sudden thud as the receiver begins to oscillate. Now, for listening to telephony we want the receiver in that condition of just not oscillating when the effective resistance has become very small indeed, and in order to obtain this state of affairs the coil should be made of reasonably low resistance. I think, however, that I have said enough to show that, owing to the reaction effect and the losses of large diameter coils, the use of very thick wire such as 16 or 18 S.W.G., is undesirable.

(To be continued).

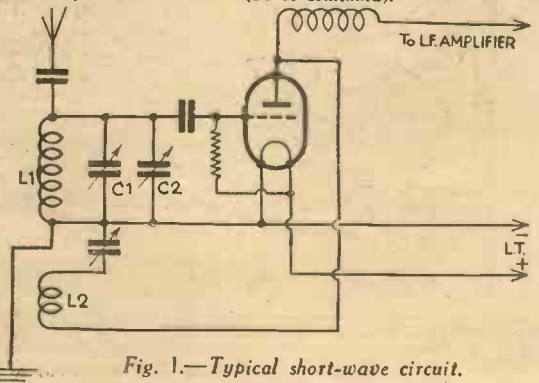

Fig. 1.—Typical short-wave circuit.

READERS' HALF-GUINEA WRINKLES

The HALF-GUINEA Page

A Neat H.F. Choke

THE old type of four-pin H.F. transformers, as shown in the accompanying sketch, make ideal formers for H.F. chokes. The following is the procedure: Remove the old windings and also unscrew two of the pins, preferably the closest or "filament" ones, leaving the remaining two as soldering tags. Next wind on the required number of turns, soldering the ends to the most convenient pin. From a piece of square wood moulding and three-ply make up a bracket, as in sketch, to fit

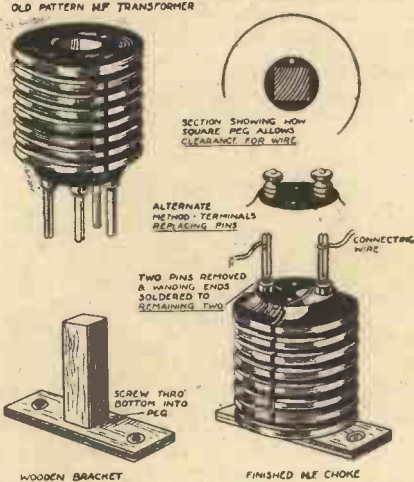

Making an H.F. choke from an old H.F. transformer.

fairly tightly into the centre hole of the former. The finished choke can then be pushed on, and the whole screwed to the baseboard, or bolted to the panel as desired. The square peg will leave ample clearance for the wire leads inside, as shown, but if preferred these can, of course, be taken to the pins on the outside. I have used a choke made in the above manner quite successfully in a portable set.—R. GRAPER (St. Albans).

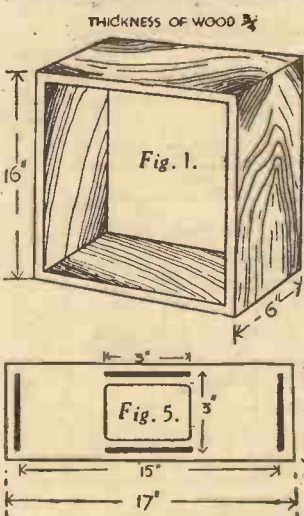

THAT DODGE OF YOURS!

Every reader of "PRACTICAL WIRELESS" must have originated some little dodge which would interest other readers. Why not pass it on to us? We pay £1-10-0 for the best wrinkle submitted, and for every other item published on this page we will pay half-a-guinea. Turn that idea of yours to account by sending it in to us addressed to the Editor, "PRACTICAL WIRELESS," George Newnes, Ltd., 8-11, Southampton Street, Strand, W.C.2. Put your name and address on every item. Please note that every notion sent in must be original. Mark envelopes "Radio Wrinkles." Do NOT enclose Queries with your Wrinkle.

Building a Cone and Chassis

HERE is a simple method of building a cone and chassis, which may prove useful to some readers. First of all, take four pieces of wood, and nail them together to make a box without either lid or bottom, as in Fig. 1. Then, across one end, stretch a piece of strong brown paper, soaked in water. To do this, brush the edge of the box with glue, then with the paper overlapping a little, stretch and just tack over the sides with drawing pins. When quite dry, it will be taut like a drum skin, and the surplus at the edges can easily be cut away with an old razor blade.

Making the Cone

Now comes the making of the cone itself, and from many trials I find this method a great advantage over any single thickness cone. A sheet of ordinary cartridge paper is cut into three cones, as in Fig. 2. First, the medium-sized cone is gummed on to the large one, then the small one on the medium one, making the centre three thicknesses of paper. When thoroughly dry, draw together and gum the flap. After this, cut the edge, as in Fig. 3, and gum in the centre of the stretched paper. When dry again, cut out the centre of stretched paper, up to inside edge of cone, leaving the cone on the stretched paper baffle (see Fig. 4), which is all vibrating area.

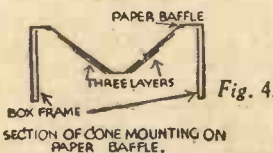
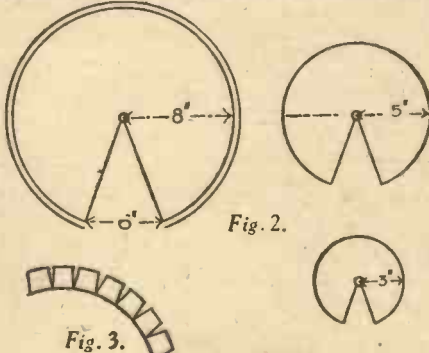

Chassis Construction

The next stage is the remainder of the chassis, which simply consists of a piece of three-ply, cut as in Fig. 5. As will be readily seen, with a screw each side to fit in slots, it is easy to centralize the unit to fit the cone. After adjustment the screws are tightened. To eliminate rattle, a piece of flannel or rubber must be used as a pad between the unit and three ply; also, a spot of melted wax in the reed end of chuck, cuts out reed dither.

Finally, four pieces of L-shaped tin are quite sufficient to fasten the completed job (Fig. 6) on to a baffle board. The reinforced cone gives a tone and volume in excess of a single one, and with the exception of the unit, a couple of shillings covers the cost.—H. CHADWICK (Rochdale).

A Novel Concealed Speaker

A NOVEL and efficient concealed speaker can be made from an old card table or from new wood, as shown in the accompanying sketch. The top is made from a piece of seven-ply wood perforated with round or square holes, or cut as an ornamental fret under which is fixed the baffle, leaving a 4-in. space as shown. The whole may be covered with a thin cloth, adding to the general appearance, and a vase or ornament can be stood in the middle to take off the plain effect.—

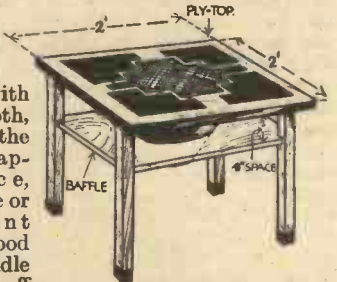

A concealed loud-speaker made from an old card table.

D. H. ROGERS. (Colchester).

Wire Bobbins as Coil Formers

ORDINARY wooden 8oz. and 1lb. wire bobbins can easily be converted into coil or choke formers.

One end of the bobbin is divided into six parts, as shown, the bobbin placed on a table, and the lines carried down by means of a square. Radial saw-cuts are then made in the flanges of the bobbin sufficiently wide to take strips of 1/4 in. ebonite or old gramophone record.

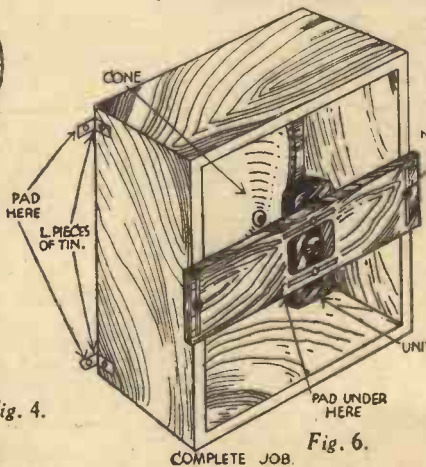

Fig. 6.

Showing how a loud-speaker cone and chassis can easily be made.

(Continued overleaf)

RADIO WRINKLES

(Continued from previous page)

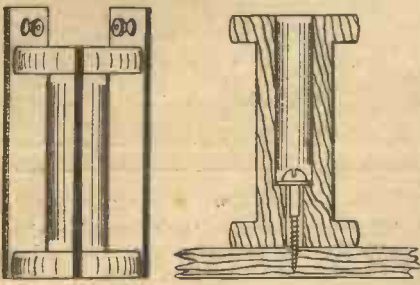

Wide saw-cuts can be made by using two or three coarse blades together in a hack-saw frame, the cuts being trimmed with a smooth file. The grooves need to be such that the strips hold securely when they are pressed in by hand. Some of the strips may be made



A simple coil-former made from a wire reel.

about 1/4 in. longer than the others, so as to carry the terminals, or the terminals can be fixed to an ebonite base. The former may be fastened to a baseboard by counter-boring it with a 1/8 in. twist drill and using a round-headed wood-screw and washer, as shown in the sectional view. Alternatively, it could be held to a plain ebonite base or one of the plug-in type by means of a threaded rod tapped into the base and carrying a nut and ebonite washer at the top.—B. PUGH (Barry).

A Simple General Purpose Tester

THE simply-constructed galvanometer herein described was made by the writer as an instrument which could be used to locate faults in many types of circuits, and it has proved itself of extreme utility in this respect. The galvanometer consists essentially of two parts only, one being a freely suspended magnetic needle of the pocket compass type, and the other a coil of insulated wire which can be connected in the circuit to be tested. These two components are mounted on any convenient baseboard, as shown in the sketch, in such a manner that the magnetic needle swings freely in a horizontal plane and the axis of the coil is horizontal and passes through the centre of the needle. The coil former can be of any suitable non-magnetic material, such as stiff cardboard, wood, ebonite, aluminium, or brass. Any number of turns of insulated wire can be used on the coil, but the larger the number of turns the more sensitive the instrument becomes to small currents. Generally, it will be found that about one or two thousand turns of wire of about 40 gauge will give ample sensitivity for all ordinary purposes.

Using the Instrument

THE method of using the instrument is as follows. The galvanometer is placed on a horizontal surface and arranged so that the needle comes to rest pointing at right angles to the axis of the coil (the position shown in the sketch).

Let us assume, for example, that it is required to test a transformer secondary winding for continuity. A battery is connected in series with the galvanometer and with the transformer winding to be tested. If the winding is complete, then current will flow through the galvanometer

coil and cause the needle to deflect, but if there is a break in the winding the needle will remain stationary—unless, of course, the insulation of the transformer is very poor and allows sufficient leakage current to pass to cause deflection of the needle.

The foregoing will suffice to show how this instrument can be used for testing either H.T. or L.T. circuits for continuity or for insulation. By suitable arrangement of resistances in conjunction with this galvanometer it can be used for measuring resistances by the wheatstone bridge method, and also as a rough form of ammeter or voltmeter.—A. H. TOMS (Hove).

Cleaning Accumulators

HERE is a simple method of quickly and efficiently cleaning the sediment out of a glass accumulator. Take a sharp-pointed knife (preferably an old one). Heat it in the fire until it is red hot, and then pierce the moulded composition on the top of the accumulator about 1/4 in. from the inside edge of the glass. Now work the knife round, following the shape of the container. As soon as the knife gets to a dull colour reheat in the fire and start again. About half an inch at a time will be sufficient to cut before the knife needs re-heating. When all the four sides have been cut the

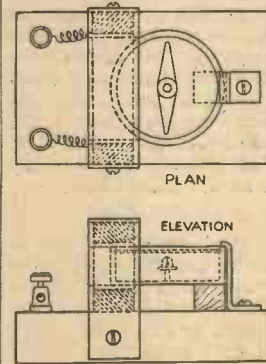

Wiring details of the simple tester.

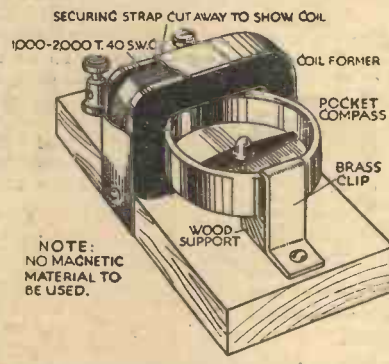

An idea of the complete instrument may be gained from this illustration.

inside of the accumulator can then be lifted out by getting hold of the two terminals. The plates and the glass container can then be thoroughly cleaned out in cold water.

After this is done, replace the plates, re-heat the knife, and, using the flat portion of the blade this time, run it round the cut portion of

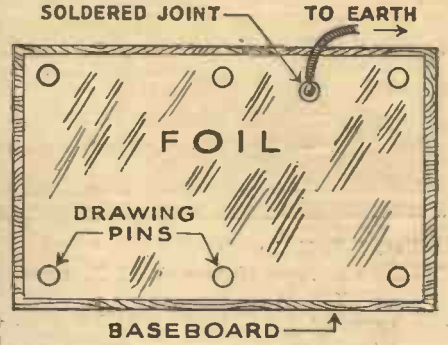

Attaching foil to the under surface of a baseboard

the moulded composition, when it will knit together. This will make the top leak proof, and as good as new. This method makes a far more efficient job than giving the accumulator several changes of water, as this does not ensure getting rid of the sediment owing to the closeness of the plates to the side of the container.—A. E. WRIGHT (Sheffield).

Simple Screening

IN simple sets of the detector L.F. type I have often found that instability and direct pick-up may be avoided by fitting a screening

plate beneath the baseboard. This can, of course, only be carried out where there is no sub-baseboard wiring. The illustration shows how I carried out the simple alteration. A sheet of foil is cut slightly smaller than the baseboard, and this is simply attached by means of ordinary drawing pins. To complete the arrangement a short wire is soldered to the foil and this is then joined to the earth terminal. On some sets I have found that this clears up the tone of reproduction.—A. MARSH (Wolverhampton).

(Continued on page 680)

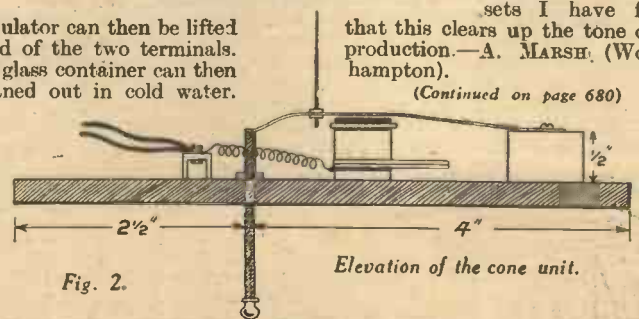

Fig. 2.

Elevation of the cone unit.

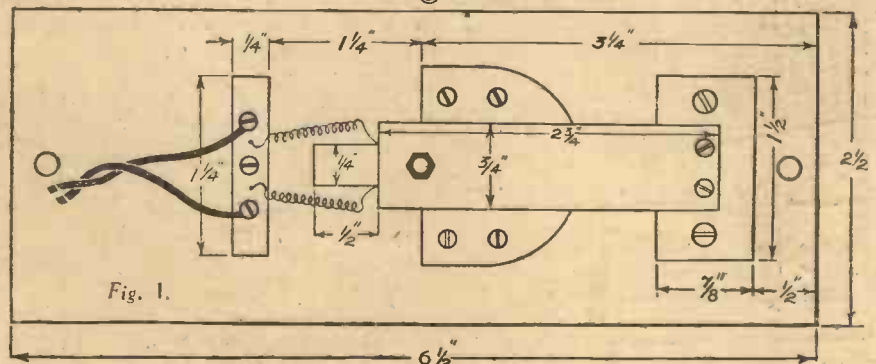

Fig. 1.

Plan and measurements of the cone unit. (For text see page 680.)

The NEW VALVES

A Review of the Many New Valves that have Recently Been Introduced

By FRANK PRESTON, F.R.A.

Concluded from page 653, Aug. 5th issue.

THE variable-mu feature is useful from the volume-control point of view, and makes the valve ideal for use in superheterodynes in which A.V.C. is provided. Screening between the two electrode systems is so complete that there is no interaction between the tuned circuits of the oscillator and detector, and no radiation when an outside aerial is employed.

the lesser-known firms of valve manufacturers are now turning their attention to this subject. One firm has recently introduced a range of universal valves fitted

to the further development of special valves for automatic volume control and "car-radio." The Class B double-diode-pentode, short-base variable-mu, and high-frequency pentode are, I consider, destined to be widely used during the next twelve months.

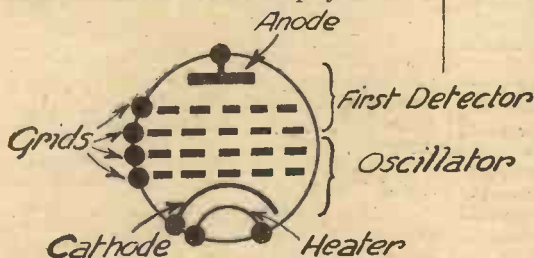

Theoretical diagram of the Hexode electrodes.

All-Metal Valves

Although their characteristics are the same as those of previous valves, the latest "Catkins" are worthy of special reference. These are made in all A.C. types, and instead of the electrodes being enclosed in the conventional glass envelope the copper anode forms the outer shell. In some models a perforated metal cylinder surrounds the anode, but this merely serves the purpose of a screen. Catkin valves are small in size, unbreakable, and have particularly rigid electrode supports. As a result they are ideal for sets that must be compact and which are subject to vibration or hard use. They are thus particularly well suited to the "car-radio" sets which are now being produced and which seem more than likely to become extremely popular during the coming year.

Valves for A.C.-D.C. Use

It seems inevitable that sets of a "universal" character that can be used equally well on either A.C. or D.C. mains must eventually be placed on the market. Such sets depend entirely upon the valves they employ, and it is interesting to observe that two or three of



The Cossor 240B 7-pin base valve.

with 20-volt, .18-amp. heaters which can be operated from any kind of mains supply. The usual mains transformer is not required, and the heater of the half-wave rectifier is simply wired in series with those of the receiving valves. On A.C. mains the rectifier changes the high-tension supply to direct current, but on D.C. it merely acts as a limiting resistance.

What of the Future?

To attempt to prophesy what other new valves will come into being during the next year or so would be a very difficult matter, but it seems fairly obvious that there cannot be nearly so many changes as there have been in the immediate past. What changes there are will probably be of a minor nature and will be in regard

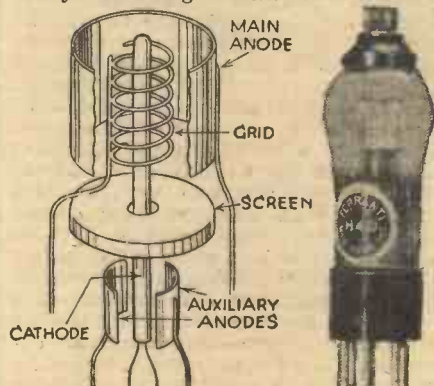

Showing the form of construction of a double-diode-triode valve.

The Ferranti double-diode-triode.

This review of new valves would scarcely be complete without a reference to what has, perhaps wrongly, been termed the "cold valve." Actually this is not a valve in the usually accepted sense of the word, but is rather a metal rectifier. It is similar in principle to the rectifiers used in eliminators for changing A.C. into D.C., but it is intended for use with H.F. current.



The new Cossor double-diode-pentode valve.

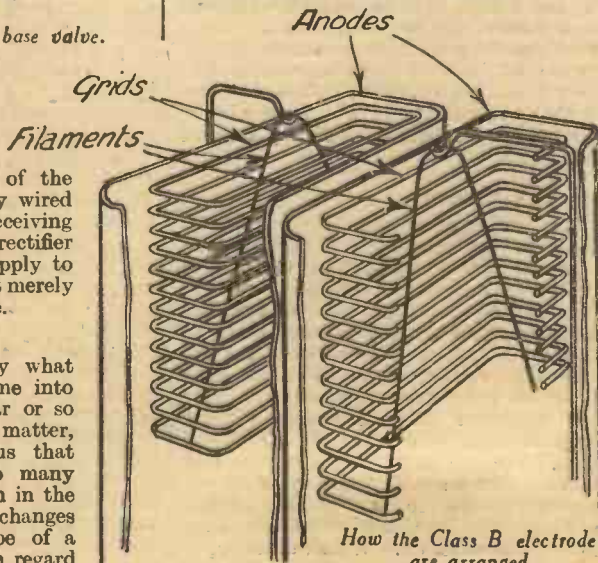

How the Class B electrodes are arranged.

The First Article on this Subject appeared on page 475 of our issue dated June 24th, 1933.

**FURTHER
NOTES
ON**

PERMEABILITY TUNING

By LAMBDA

IN the previous article on this subject the writer reviewed the existing tuning systems, showing their disadvantages, explained permeability, the way the new system operated, and its advantages. It is now proposed to deal with further aspects of this new system emphasizing some of the points dealt with and giving further details of the system itself. We know that circuits can be tuned to any desired frequency by varying either the capacity or inductance or both, but up to the present, owing to mechanical considerations, tuning by varying the capacity has been by far the most popular method. As resistance increases with frequency the electrical properties of a tuned circuit do not remain constant over the whole of the tuning scale. We therefore come to the conclusion that if constant selectivity is required when tuning over the waveband the ratio of inductance to resistance must be kept constant. With valve receiving circuits an important phenomenon known as parallel resonance is employed to obtain selective voltage amplification. When this type of circuit is tuned to resonance it is represented by a non-inductive load—the dynamic resistance—as previously explained. This is connected to the plate of a valve which possesses internal resistance. If the inductance of such a circuit could be varied for tuning and at the same time keeping the dynamic resistance constant, then the amplification of the valve would be constant throughout the tuning range. In permeability tuning the coil itself is designed to have the desired performance at the higher frequency band to be covered, that is, at the lowest wavelength. The apparent inductance is increased to tune to the lower frequency by introducing the magnetic core into the field of the coil, with the result that as it is gradually inserted more lines of the magnetic field are intercepted by the core and the average apparent permeability of the medium surrounding the coil increasing from 1 (which is taken as the permeability of air) to a certain maximum when the coil is totally inserted in the core.

Iron Core Material

Like many other scientific inventions, the subject of tuning by magnetic iron cores has been the object of research for many years and many attempts have been made to solve this problem. As far back as forty years ago attempts were made to produce compressed cores of iron dust. Since then continuous research has been conducted and ferro-magnetic cores have been produced made of finely divided particles using various highly permeable alloys. These alloys were experimented with, allowance having to be made for the tremendous loss in permeability which resulted from the numerous air gaps between the particles. Whilst some types

of iron have a permeability of about 400, many of the alloys used in these experiments had a permeability very considerably in excess of this figure. Unfortunately, however, when made into dust their permeability was very low indeed, hardly reaching 20 or 30.

It was at first thought impossible to use iron-core coils for the high frequencies employed in radio circuits, but such is not actually the case, although the gain in using iron is not so great for radio frequencies as it is for ordinary low frequencies. Because of the relatively small permeability required for tuning through the range of radio frequencies the permeability obtainable in finely divided pure iron is found to be adequate. We must consider, however, what losses, if any, are permissible in such a system in order that the desired degree of selectivity may be maintained.

At radio frequencies hysteresis losses are very small, so that we need not consider that matter any further. The other chief source of loss is due to eddy currents. The direction of the eddy currents is opposite to that of the current in the winding, hence at any point in the centre the magnetomotive force acting is really that produced by the winding diminished by a certain amount due to these eddy currents. Further, the strength of these eddy currents decreases with the thickness of the laminations or particles. In other words the eddy current losses expressed in terms of resistance introduced are roughly proportional to the square of the frequency and to the length of the circular path around each minute particle. Therefore the smaller the particle the less the eddy current loss.

Another consideration in the choice of powdered material is its uniform purity, which materially affects permeability. In order to obtain powder in sufficiently small grain size it is reduced by hydrogen or obtained from carbonyl of iron. Both methods will produce a powder of reasonable uniformity, purity, and size. The size of the grain being employed in these coils is of the order of one five-thousandth of an inch and they will float in air.

For the broadcast waveband a variable inductance of about seven times is required and by compression permeability of this order can be obtained. One of the problems to be overcome, however, was the insulation of each of these individual minute particles. The solution was found in the development of an entirely new insulating varnish capable of very fine filming and able to withstand extremely high pressures up to 25 tons per square inch. All the particles of the iron are insulated with this varnish in loosely powdered form and then mixed with a small amount of phenol resin powder for binding purposes. This mixture is then pressed into heated moulds of the required shape. The hardened material thus formed is fairly strong and has the appearance of solid iron. It contains about 95 per cent. of iron and about 5 per cent. of bakelite

and insulating varnish. The permeability of this material remains constant throughout a range of frequencies from 50 to 2 million cycles.

Application in Radio Receivers

For practical purposes the coil is slightly tapered, wound with Litz and the outer shell also being tapered to correspond. By tapering the coil the necessary variable magnetic density can be more easily obtained. The inductance of the coil is 65 microhenrys and is tuned to 1,500 kc/s. (200 metres) by a fixed capacity, with an adjustable leaf, of .00016 mfd.

When employing several circuits tuned together it is not essential to have exactly the same value of inductance in each circuit. Providing the coils have the same physical dimensions, if we insert two identical cores the same permeability change is produced in each circuit and they will, therefore, track perfectly and will always tune to the same wavelength if mechanically adjusted correctly.

Aerial Tuning

An important feature with permeability tuning is that we now have a method of tuning the aerial circuit and keeping it in exact alignment with the other coils. This will enable us to secure considerable gain in the aerial circuit due to being able to tune exactly to resonance, consequently a decrease in the amount of subsequent amplification can be achieved. An improvement in the "signal to noise" ratio can also be effected.

Superheterodyne Receivers

In superhet receivers the oscillator coil can be ganged quite satisfactorily and ganging will hold over the tuning scale to within about 0.1 per cent. The advantages of permeability tuning in ordinary tuned radio frequency receivers, however, are so great that it is possible that with the greatly increased selectivity obtainable it will be more generally used in this type of receiver, particularly as better quality will be obtained without the complication of an oscillator circuit and the need for two detectors. Adequate screening will be necessary which, although reducing the inductance of the coil, will increase the working frequency range of the receiver.

As no tuning condensers are necessary the number of leads emerging from the screens are reduced to a minimum, considerably simplifying receivers for the constructor. The frequency to which this system is tuned at any moment is almost proportional to the distance to which the core has been removed from the coil. By slight correction in the shape of the core the relation may be made exact, thus giving a uniform or straight line frequency distribution of the channels on the dial. To design a receiver covering several wavebands it is only necessary to use tappings

(Continued on page 684)

Bring your set up-to-date

NO MORE UNSIGHTLY AERIALS

An astonishing improvement in performance



Now dispense entirely with your old-fashioned aerial and get vastly improved reception. Just connect up the aerial and earth terminals of your set to the AIRCLIPSE Auto-Inductive Aerial. You will be astonished at the instant improvement in the performance of your set. Sensitivity and selectivity will be increased. The AIRCLIPSE, with its principle of auto-induction, filters incoming signals. It brings everything through crystal-clear—stops overlapping, gets distant stations with amazing clarity.

Tests prove it equal to the best outdoor aerial, and far superior to any indoor aerial. Only 3½ x 1½ inches. It is absolutely non-directional and can be placed inside or outside the set. Equally effective on both long and short waves. It enables any set to be moved from room to room. You need it for convenience—for safety—to cope with crowded broadcast conditions.

AIRCLIPSE

For Battery and A.C. Mains Sets PROV. PAT 9377/33
AUTO-INDUCTIVE AERIAL

5/-

Obtainable of all radio dealers, or in case of difficulty order direct from:

Airclipse Lfd., 182 Vauxhall Bridge Road, London, S.W.1
Telephone: Victoria 5022

the **R & A**
“CHALLENGER”

is now available in Five Models—

Whatever your Output—whether Super Power, Pentode, Class B or Q.P.-P. there is a Challenger Reproducer with correctly designed transformer. The “Challenger” series is unique; each model of equal eminence as a perfect reproducer of speech and music.

- ‘STANDARD’ model, for use with Super Power and Pentode Valves.
- ‘TYPE B8’ for use with Cossor Class B Valves.
- ‘TYPE B15’ for use with Mullard and Mazda Class B Valves.
- ‘TYPE P.’ An Extension Reproducer for use with Commercial Receivers.
- ‘TYPE Q’ for Quiescent Push-Pull (15,000 ohms. Plate-to-Plate Load).

Each model is complete with Transformer.

The complete range of R. & A. Reproducers, including the new ‘Alpha’ and Type 60 models, will be displayed at **Olympia, Stand 44**. Your dealer will gladly demonstrate, and new list will be sent free on request.

Take no risks—choose the **CHALLENGER** model designed for your set.

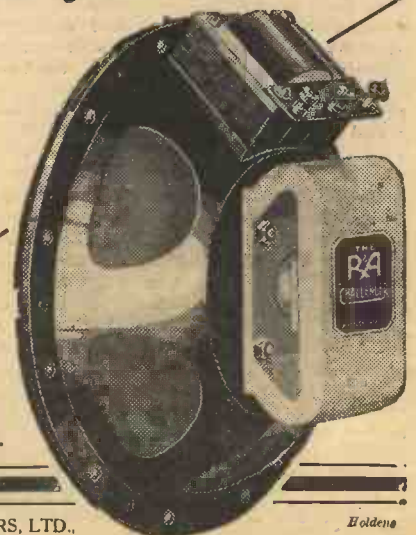

35/-

EACH MODEL COMPLETE.

REPRODUCERS & AMPLIFIERS, LTD., WOLVERHAMPTON.

Boldens

RADIO RAMBLINGS

By GRID LEAK

Gottings from my Notebook



The H.F. Pentode

THE pentode valve seemed in danger of dying at one time, but the new H.F. pentodes have given it a new lease of life. These are all the rage just now, and their sudden rise in popularity is even more surprising when it is remembered that the Cossor Company have had an H.F. pentode on the market since May, 1930. However, it seems quite possible that the H.F. pentode will wipe the screen-grid valve out of existence long before anybody expects it.

World's Greatest Radio-using Countries

CANADA is running Britain very closely for the honour of having the greatest number of wireless sets in proportion to the population, and they have now in use 770,436 receiving sets. This puts them fifth on the list of which Britain is fourth of world radio users, the first five of which are as follows:

Denmark, one set for every 8.12 people
U.S.A. " " 10 "
Sweden " " 12.12 "
Britain " " 13 "
Canada " " 13.12 "

This list I do not, however, believe to be quite true, for most of the radio amateurs I know seem to have more than one set, and I don't possibly see how these could appear in the statistics. In fact, I know one man who has no less than eight sets, all of them in working order and not less than two years old. Can any of you break this record? If so, I should like to hear of it.

New High Power B.B.C. Transmitter

I SEE that a further move has been made with regard to the new station to replace the long-wave one at Daventry. The B.B.C. has placed the order for the transmitter with the Marconi Company, and the whole job is being designed in co-operation with the B.B.C. engineers. A new system of modulation is to be used, known as "series modulation," of which I hope to tell you more later, and the output of the transmitter will be 100 kilowatts on the unmodulated carrier wave. Up to 90 per cent. modulation will be possible, so that quite hefty signals may be expected from this station soon. A section of the transmitter of special interest is the frequency controller, which will be used to keep the station rigidly on its wavelength in accordance with the very stringent international regulations. Not that the B.B.C. are offenders in this respect, as followers of the Brussels curves will appreciate, but only by constant check is the transmission held at a constant frequency, and it is a pity more Continental stations do not keep their wavelength "curves" as straight as those of the British stations. Each of the valves used in the new transmitter will be heated by a separate lighting dynamo. This is to some extent an innovation, and possesses many advantages over

the method hitherto employed of heating the filaments in parallel. This independent generation of filament voltage allows of a more critical voltage being applied to the filaments, and if one or more of the filaments go out of action there is no corresponding rise in the filament voltage on the other valves, as is often the case where all the filaments derive their current from one generator. The consumption of each valve filament is about 460 ampères at 32 volts. Imagine carrying home accumulators to run a set like this for an evening's entertainment!

Unique Telephone Installation

AT the World Power Conference held at Stockholm a unique Wireless Telephone installation was installed by the L. M. Ericsson Co., which is an important advance on methods previously used for reception of lectures and speeches.

The transmitter antenna was mounted around the walls of the conference chamber and each member carried a receiver outfit on his person. This receiver outfit, of very small dimensions, consisted of a coil antenna, a detector and a headphone. The receiver coil was put around the shoulder, and the receiver box fixed in a buttonhole, or a pocket. If the member's seat was below one of the antenna wires the plane of the loop had to be vertical and parallel to this wire. On the other hand, if the member's seat was anywhere else the loop had to be more or less horizontal. The best position was easily found after a short trial. Two similar installations were made, one for each of the halls reserved for the Conference, operating on different wavelengths in order not to disturb each other.

Standardized Positions for Control Knobs

I SHOULD like to see the position of the knobs on radio sets more or less standardized in the same way as the controls of motor-cars have been done. If you can drive one car you can drive practically any make, but rarely can you approach a strange wireless set and immediately proceed to bring 'em in right away. Commercial sets are no doubt the worst offenders in this respect, as in most home-built sets the reaction knob, for instance, is usually in the bottom right-hand corner with the tone control or volume control knob somewhere handy. This is not always the case with a commercial receiver, however, for I was recently handling one in which the reaction and tone control were as far left as it was possible to put them. This is decidedly unorthodox to a set-builder's eyes, as we generally like our signals to come in at the left-hand side of the set, and leave by the back door on the right. I think this is the best plan, and I believe it would be an improvement if a generally accepted position of the different knobs were agreed upon by set manufacturers. Another complaint I have to make against commercial set

knobs is that they are much too small. Some of them are but very little larger than kettle-lid knobs, and are very difficult to handle to say the least of it. A fault that is directly due to small knobs is the unsightly scratches that appear on the panel of the set behind the knobs where your finger nails rub in your endeavours to grasp the tiny controls. On a highly-polished panel this looks bad, and I know it is not beyond our manufacturers to pay attention to little details like this.

British versus American design

IN talking of knobs it strikes me that our sets are rapidly becoming more symmetrical, both on the panel and behind. This is in no small way due to the increased use of ganging which allows of the bank of variable condensers being placed in the centre of the set, with the H.F. on the left side, and the L.F. on the right. The pentode valve also by cutting out a L.F. stage helps to centralize the "works" as does the modern practice of making sets nearly as deep as they are wide. I was discussing these points of modern set design with a radio friend the other day, and to illustrate his remarks he showed me a magnificent American receiver he had just acquired. According to American practice the back was left open, even though it was a huge radio-gram, and all the works could be plainly seen. I must say, however, that in comparison with a British receiver, costing just half as much as the American, the workmanship of the latter was very much inferior. The arrangement of the valves, however, was good, the detector being placed quite near to the panel while the screened-grid and pentode valves were placed in a row behind. I noticed, however, that the ganging was not very consistent over the whole range of the tuning scale as the tuning was much sharper in the middle, and there was a definite falling off in volume and clarity on either side.

A Useful Plug Connection for A.C. Mains

MANY of you will have seen the advertisement clock erected in London, and which is stated to be the largest clock in the country, if not in the world. About 600ft. of neon tubing has been used in its construction, and it is interesting to note that the clock movement has been supplied by Smith's English Clock Co., Ltd. This movement is synchronous with the alternating current mains in the same way as the smaller clocks sold for domestic use, and is, of course, as reliable as the frequency of your A.C. mains. Those of you who use a synchronous clock may know of the little device that can be obtained for them, and also for use on a mains wireless set, by means of which a permanent connection may be made to the mains without the need for monopolizing an electric plug connection. Modern builders are not over generous with lighting or heating plugs, and the Wyléx fused connector manufactured by the Smith Clock people allows of a radio or a clock being connected to an electric plug without disturbing its ordinary utility in the domestic supply. It often happens that a wireless set has to be put temporarily out of commission while a heater or even the household flat-iron is put in use through shortage of plug connections, and if this is the case with an electric clock it at once loses its accurate time-keeping propensities. The "Wyléx" connector is retailed at 2s. from any dealer.

ADDING CLASS "B" TO THE "SELECTONE" THREE!

(Continued from page 668)

pins, only six are actually used, the seventh being a "dummy," That is why one terminal does not require any connection.

G.B. Voltages

When all wiring has been completed, the "new" receiver will be ready for test. Replace the "210 Det." valve in the detector holder, with either the "210 H.L." or "220 P." in the first L.F. holder and insert the "240 B." There are now only two grid-bias negative tappings, "G.B.—1," coming from the pick-up terminal, and "G.B.—" from the "Transfeeda." The correct positions for these will depend entirely upon the H.T. voltage available, and the type of valve used as "driver"; the table on page 668 will, therefore, be of assistance.

It will be seen that in every case the bias voltage is somewhat higher than that recommended when the valves are used for normal L.F. amplification, but this is found to produce equally good results with an appreciable saving in H.T. current consumption. Incidentally, it might be explained that it is permissible, and indeed wise, slightly to over-bias any valve which is being used as a "driver."

Tone Control Adjustment

Operation of the receiver will be almost the same as before. The only difference is in respect to the tone control resistance; as the knob is rotated *anti-clockwise*, the .004 mfd. condenser will be brought to bear more upon the circuit and will thus reduce high note response. You will remember that "top cut-off" was previously obtained by turning the potentiometer in a *clockwise* direction.

Results

Little need be said in regard to the results obtained with the "Class 'B' Selectone." I can only say that the volume and quality of reproduction are as good as can be obtained from any receiver regardless of its type. The local stations are naturally heard to best advantage, but a number of others can be very well received under normal conditions. Even when using the "210 H.L." as driver, and with 108 volts high-tension, the signal output is ample for all normal requirements, including outdoor listening. When extra "punch" is called for, however, it is a simple matter to change over to the 220 P. valve, and you will then have enough to fill a hall or to enable you to dance on the lawn, as you prefer. Reproduction of gramophone records is just as good as that to be obtained on "radio" and compares very favourably with the results given by the most expensive radio-gramophone.

Please Note

It is mentioned above that the modifications described can be applied to any set having two low-frequency valves. There is just one alteration which might be suggested in the latter case, however. That is, that instead of using a 5,000 ohms variable resistance and .004 mfd. fixed condenser for tone-control, these components might be replaced by others having values of 50,000 ohms and .01 mfd. respectively. The first-mentioned values are quite suitable for the "Selectone," which uses a very selective tuning circuit, but they might not give quite sufficient correction in every other receiver.

GET YOUR COPY FROM STAND 98 RADIOLYMPIA PRICE - 6d.

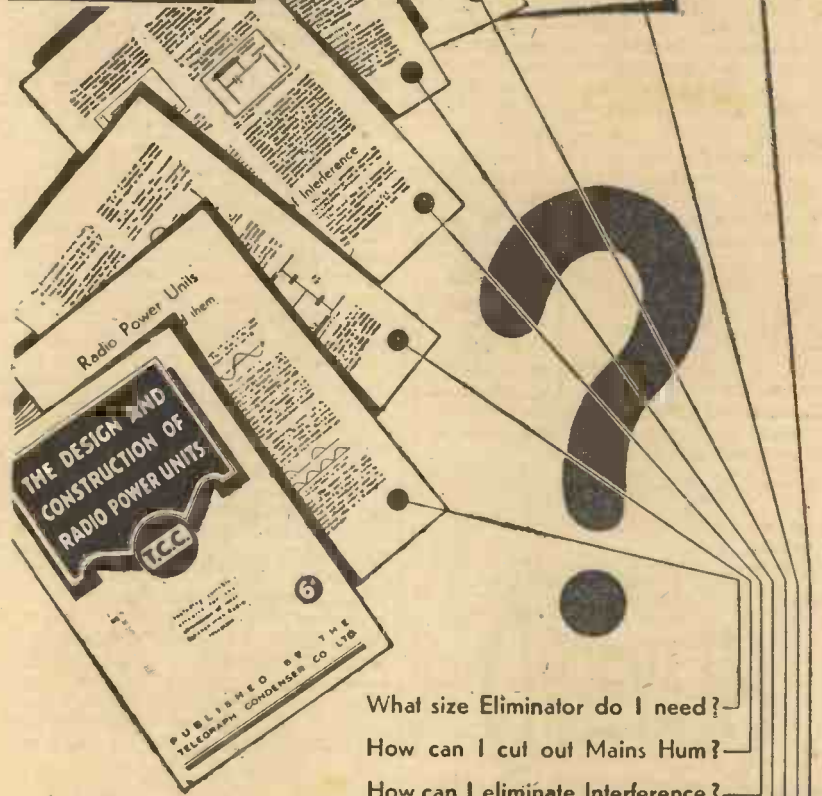

- What size Eliminator do I need?
- How can I cut out Mains Hum?
- How can I eliminate Interference?
- When should I use an Electrolytic?
- How do I build an A.C. Power Pack?
- What special precautions for D.C.?
- What resistance do I need?

YOUR MAINS PROBLEMS! — this Book answers them all

T.C.C.
ALL-BRITISH
CONDENSERS

GET YOUR COPY

COUPON To The Publicity Dept., The Telegraph Condenser Co. Ltd., Welles Farm Rd., N. Acton, London, W.3.

Please send me a copy of your book "The Design and Construction of Radio Power Units," for which I enclose six penny stamps to cover cost and postage.

NAME.....

ADDRESS.....

FRAC. 12/9/33. Please write in block letters



**Mains Units
by Specialists!**

When choosing Mains Apparatus it is advisable to buy from Specialists. Only thus can you be sure that your purchase is safe, sound and reliable. Heyberd Mains Units and Components are not skimmed or "cut down" to a price. Skilled technicians, using the finest British materials, produce Heyberd Mains Apparatus. A searching test is carried out at each stage of manufacture—that is why all Heyberd Units and components carry the well-known Guarantee. For nearly eleven years Heyberd have specialised in Mains apparatus, and the result of their research and experience is at your service. A complete display of the latest Mains Units, Kits, Transformers, Home Chargers and Amplifiers will be shown at Radiolympia. You will be welcomed at the Heyberd Stand.

STAND
16
OLYMPIA

POST COUPON NOW

I enclose 3d. stamps for NEW revised Handbook, "Mains Power for your Radio."

Mr.

Address

Prac.

10, FINSBURY STREET, LONDON, E.C.2



MONARCH OF THE MAINS.

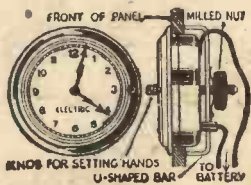

**FIT THIS
ELECTRIC
CLOCK**

TO YOUR SET!
NO MAINS NEEDED!
KEEPS CORRECT TIME!
NO WINDING!

Works off small battery lasting 12 months, or can be plugged into G.B. battery without affecting reception. Uses practically no current. Fits into hole 3 1/2 in. dia. in any panel up to 1/2 in. thick. Easy to fit—no screws required. Only 1/2 in. from front of panel to back of case. Swiss movement. Hands set from front. Nickel-plated bezel. Useful addition to any set.

RIVERSIDE MFG. Co., Ltd.,
Dept. 21, Crisp Road,
Hammersmith, W.6.
Telephone: Riverside 6392.

12/6
COMPLETE WITH BATTERY
POSTAGE 6D



Famous Maker's Offer!
£5 Radio-Gram 65/-
SEVEN DAYS' FREE TRIAL
(OR 10/- MONTHLY)
Polished Oak! and Piano built!
The acoustic Tone brings a fine thrill. Makers to Radio-Press, B.B.C., 3,000 clientele.
MODELS FROM 35/- to £15.
Photographs and List FREE.
PICKETTS' Famous Bull
(B.P.), Albion Road, Bezzieheath
£6-15-0

IMPRESSIONS ON THE WAX
A REVIEW OF THE LATEST DISCS

THE programmes of the past month or so have yielded their usual crop of pieces to collect. Here are a few of which outstanding recordings exist, and which can safely be bought to increase the number of records for entertainment now, and for many years to come.

By E. REID-WARR

Mozart's Most Popular Piece

Without doubt, *Eine Kleine Nachtmusik* answers this description in every way. Originally its appeal was intimate—chamber music, in fact. Now it has become a fully-fledged orchestral show piece, but it is so delightfully tuneful throughout as to retain all of its charm. There are four movements—*Allegro, Romanze, Minuetto, and Rondo*, each of which goes on to one side of two records I recommend unreservedly—*Columbia LX144-5*. There is everything which makes music endearing somewhere in this composition—gladness, beauty, sentiment, grace. And it is all so very understandable, too. Hear this recording by the British Symphony Orchestra under Bruno Walter and be captivated by it.

A Spanish Dance to Keep

Moskowski's *Malaguena* is quite often heard in wireless programmes, and can safely be included in those pieces which always come up fresh. There is a tendency to worship at the more modern shrines of De Falla and Albeniz, but their music has not the appeal of the type of dance of which this record is so good a representative. You will find a first-rate performance on *H.M.V. C2235* by the New Light Symphony Orchestra. There is an enchanting waltz, *Abandonado*, by Posadas, on the other side, which makes it as good value as any record I know.

A Charming Old Song of 1619

It was probably a very unorthodox thing to put bird calls into a song in the early Stuart days, but *Sweet Suffolk Owl* is an example. This song is one of the madrigal group, and was written by Thomas Vautour. Those who want something unusually attractive three centuries old will find it on *Columbia 5549*, where it is sung by the St. George's Singers unaccompanied. It is quite a revelation to hear the very clever composing which comes from those days. There is a twin number, *Upon a Bank with Roses set about* (Ward), on the other side.

The "New World"

Most of us know Dvorák by his Humoresque, but this trifle will be forgotten forever after hearing the No. 5 Symphony in G Minor, one of the biggest symphonies ever written—big in every sense of the word. There is something in it for every mood. The opening movement seems essentially modern, alternating from grave to gay. Then the Largo. One of the loveliest

things imaginable, a plaintive air, almost hymnal, closing in a sublime passage with the organ. The following third movement, modern again, with enough thematic material to supply the song writers of a nation for years. In this section almost every instrument is heard by itself. The last (fourth) movement swings pleasantly along to an impressive climax of sublime power. To hear the *New World* is more than a treat—it is an experience. It has been superbly recorded by the Philadelphia Symphony Orchestra on five *H.M.V.* records, *D1893-7*, and everybody should become acquainted with this superb symphony, every bar of which can be understood and appreciated by the ordinary listener.

A Waltz of Great Merit

This is *Die Schoenbrunner*, by Lanner. It is one quite in the Viennese tradition—a mixture of Strauss and Waldteufel, perhaps. I want especially to commend a magnificent performance by the Vienna Symphony Orchestra on *Columbia DB1064*. Here it is played with an opulence which is quite remarkable and by what seems a full-strength "turn." And on the other side is that old favourite *The Skaters*, by Waldteufel.

Ideal Light Music

Linke wrote much in this category, but *Amina* is a piece which is always liked, however much it is heard. It has a peculiar quality which makes one "feel good," rather as if it were played as the opening piece to a very jolly show. If you hear it played by the London Palladium Orchestra on *H.M.V. B3756* you'll understand perfectly what an effective aperitif *Amina* is.

The Ballad de Luxe

Airlie Dix's *Trumpeter* is probably the most-sung ballad in existence, and only a really good singer can save it from being painful. And yet it is the subject of one of the most impressive records I know. It would probably be described in a programme as a song scena, since effects and acting of parts are included. On *Columbia 9776*, Raymond Newell, Ion Swinley, a military band and chorus, really bring the *Trumpeter* to life. It is, perhaps, a trifle harrowing, but only because the whole thing is so very well done. There is nothing like it, and anyone who wants a stirring dramatic story should hear this record.

TWO FINE NEW RECORD ISSUES

Haydn's "Military" Symphony

A new recording of this has just been issued, and it is so very good as to earn extended mention. First of all, it is shockingly misnamed, and so do not expect to hear martial strains. This, really the 100th in G Symphony, has a strong English

(Continued on page 684)

Facts and Figures

Components Tested in our Laboratory

BY THE PRACTICAL WIRELESS TECHNICAL STAFF

MAGNUM DUAL CONDENSER

THE illustration below shows the newly-introduced Burne Jones dual ganged condenser of the bakelite type. This is a most interesting component, consisting of two bakelite-dielectric condensers ganged on a single central spindle. Separating them may be seen a brass plate which is in contact with the driving spindle, and therefore, when connected in the normal manner in a standard circuit, this screen is earthed. The slow motion drive which is supplied is of the standard Mag-

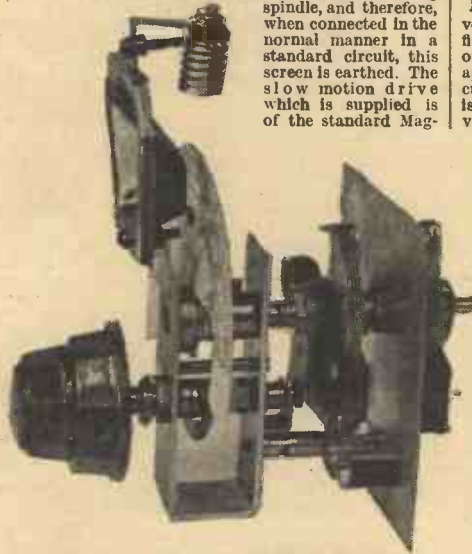

The Magnum dual-gang bakelite-dielectric variable condenser.

num type, and in addition the small concentric control knob rocks the fixed vanes of the first condenser through several degrees. This device is necessary, of course, for trimming purposes. In addition to the neat bronze escutcheon, a bracket and panel light socket are fitted so that the complete component may form the tuning unit of a really good broadcast receiver. The action is quite smooth, and the component was tested in one or two simple receivers with admirable results. The price of the complete unit is only 10s. 6d.

NEW POLAR CONDENSERS

IT will be seen from the illustration on this page that the well-known Polar condensers manufactured by Messrs. Wingrove and Rogers have been re-designed. The first point of interest is that the condenser is now mounted on its side which results in a rather larger dimension from the baseboard, although on the other hand, the actual baseboard space which is taken up is slightly smaller. The actual constructional details are very similar to the original pattern, robustness being the chief feature. The vanes are locked at the ends, so preventing possible short-circuits, and the spacing is perfectly uniform. With the end method of mounting the trimming condensers are brought to the top, and the dust cover which is now fitted is provided with holes on the upper surface so that a screwdriver

or similar instrument may be inserted and the trimmers easily adjusted. The popular battleship-grey cellulose finish is adopted, and the condensers represent very good value. They are highly recommended.

TELSEN COMPONENTS

THE new range of Telsen components, samples of which have been received by us, represents some very good improvements in existing designs. Dealing first with the electrolytic condensers, the illustration on the next page will give some idea of the neat appearance of these condensers. In place of the customary aluminium canister, the Telsen condenser is finished in a neat black surface, upon which the various details such as rating, name, etc., are engraved in gold. They are of the dry pattern and, consequently, may be mounted in any position, although the vertical position is generally found most convenient. For the latter purpose, Messrs. Telsen supply a neat mounting platform (shown in the illustration), although they may, of course, be mounted on a wooden chassis, provided a wire or other method of connection is made between the case and the negative source of supply. When a metal chassis is employed, the case is automatically connected to the negative pole via the metal chassis. These are very sound condensers, and may be recommended.

The reaction condenser has also been re-designed, and is now totally enclosed. It is of the same shape as the old type, but the condenser is enclosed in a moulded case, and when fitted into position the condenser becomes quite airtight and therefore dustproof. As in the previous condenser under review, the component is finished in black with gold lettering. This lends it a most distinguished appearance. The price remains unaltered.

The iron-core tuning coils have already been mentioned, and these are the smallest tuning coils we have yet examined. The total height of the coil, on its bakelite base and with the screening can in position is only two and a half inches. The diameter of the screening can is less than one and a half inches, and—the coil former is only five-eighths of an inch in diameter. Six terminals are provided on the base for connection, and these are clearly embossed with the figures from 1 to 6.

AIRCLIPSE AUTO-INDUCTIVE AERIAL

A VERY novel device for use as an aerial has been submitted for test by Messrs. Airclipse, Ltd.. It is a very neat device in a moulded bakelite case just over an inch in diameter and about three inches long. One end is fitted with two terminals, and at the other end a long flexible lead projects. One terminal is marked for attachment to the aerial terminals of the receiver, whilst the other terminals is joined to the earth terminal on the receiver, the flexible lead being then connected to a convenient earth point, or if there is no such point available, it is simply left loose. Upon examination the device is found to consist of three separate windings on a cylindrical former, a short winding being provided from the E terminal, and two separate windings from the remaining points. These are wound in such a manner that inductive and capacitive couplings exist, and the makers claim that the design is such that the results are equivalent to a good outside aerial, with the additional feature that a filtering effect is provided and tends to remove fading, etc. On test the device certainly proved very

(Continued overleaf)

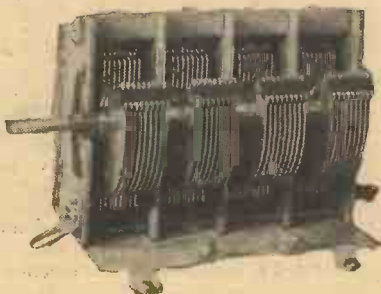

A four-gang Polar condenser of new design.



Stop that cackle!

Some sets are like the Hen—all cackle and scratch. Hens are made that way, but Radio Sets shouldn't be.

Cut the cackle and get pure resonant reception—quality and volume—by using Graham Farish Components. These instruments are scientifically designed, meticulously tested, and guaranteed to give you better radio.

OHMITE Resistances

The most popular and efficient type of fixed resistance for all general purposes. "Better than wire wound." All values 50 ohms to 5 megohms.



100° F. Temperature risc.

Ohms	Milliamps	Ohms	Milliamp
1,000	40	20,000	8
2,000	35	30,000	6.75
3,000	29	40,000	6
Other values pro rata.		100,000	3.5
Heavy Duty type, approximately double the above ratings, price 2/3.			

GRAHAM FARISH PRODUCT

Graham Farish Ltd., Masons Hill, Bromley, Kent.
Export Office: 11/12, Fenchurch Street, E.C.3.

ANNOUNCEMENT

★ to men who want careers in **RADIO**



The I.C.S. Radio Courses cover every phase of radio work, from the requirements of the youth who wishes to make wireless engineering his career to the man who wants to construct and maintain a broadcasting set for his home.

The Radio industry is progressing with amazing rapidity. Only by knowing thoroughly the basic principles can pace be kept with it. Our instruction includes American broadcasting as well as British wireless practice. It is a modern education, covering every department of the industry.

OUR COURSES

Included in the I.C.S. range are Courses dealing with the Installing of radio sets and, in particular, with their Servicing, which to-day intimately concerns every wireless dealer and his employees. The Operating Course is vital to mastery of operating and transmitting.

There is also a Course for the Wireless Salesman. This, in addition to inculcating the art of salesmanship, provides that knowledge which enables the salesman to hold his own with the most technical of his customers.

We will be pleased to send you details of any or all of these subjects. Just fill in, and post the coupon, or write in any other way, stating which branch of Wireless interests you—the information you require will be forwarded at once.

International Correspondence Schools, Ltd.,
Dept. 94, International Buildings,
Kingsway, London, W.C.2.

Without cost, or obligation, please send me full information about the Courses I have marked X

- COMPLETE RADIO
- RADIO SERVICING
- RADIO EQUIPMENT
- RADIO SERVICING AND SALESMANSHIP
- WIRELESS ENGINEERING
- WIRELESS OPERATORS

Name..... Age.....

Address

FACTS AND FIGURES

(Continued from previous page)

efficient, the results obtained being very similar to those which we normally get on a very good indoor aerial. In our particular case we could not get such good results as with a good outdoor aerial, but as the apparatus had to be dismantled for examination before test, it had probably been slightly damaged, and this would account for the lack of optimum results. There is no doubt, however, that the device is very efficient and will be found most useful where a good outside aerial cannot be erected, or severe interference is experienced. The price is 5s.

COSMOCHORD PICK-UP.

An interesting new Pick-up is announced by the Cosmochord Company, and is known as the "Universe" Super Pick-up. It is claimed that the output rises as high as 4 volts, and that the characteristic has been designed to give the maximum response on the bass, thus compensating for recording deficiencies. The cut-off is at approximately 4,000 cycles, and this,

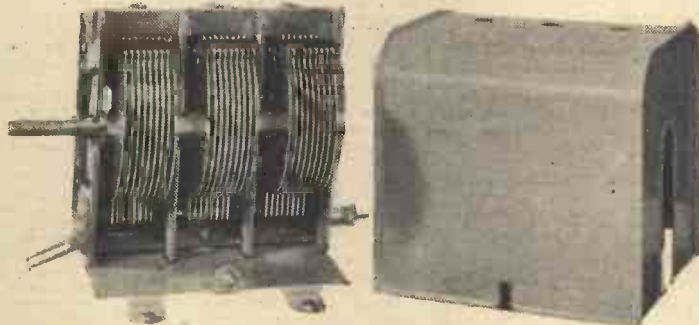

The new Polar three-gang condenser from which the vertical method of mounting may be seen.

combined with a shunt type resistance, reduces needle scratch to a minimum. A special weight compensator is fitted at the end of the arm so that the actual weight on the record may be adjusted to a minimum. The price, complete with volume control (5,000 ohms.) is 22s. 6d., and we shall give a more detailed report of this Pick-up when we have had an opportunity of testing it.

EPOCH MOVING-COIL MICROPHONE

A NEW type of microphone is announced by the Epoch Radio Manufacturing Company, and should prove a most interesting development. The manufacturers claim that this type of microphone forms as great an advance over all other types of microphone as does the moving-coil loudspeaker over all other types of speaker. The sensitivity is of a very high order, and no pre-stage amplification or batteries are necessary. Internal noises are absent, and the instrument should prove of great value for public address work and similar work where speech has to be relayed. The price is £4 4s., and a special built-in transformer is obtainable at an extra charge of 12s. 6d.



The new Telsen electrolytic condenser, and special mounting bracket.

WILBURN (PEAK) CONDENSERS

THE latest list from Messrs. Wilburn and Company shows some interesting types of fixed condensers, both paper and electrolytic. The latter are available in 4 mfd. and 8 mfd. types at 4s. 3d. and 4s. 9d. respectively. These are of the type designed for 450 volts D.C. peak working, and will withstand overloads of the order of 150 volts. The leakage is remarkably low for this type of condenser. A special neat bracket is obtainable in order that these condensers may be conveniently mounted on a wooden baseboard, and these brackets are fitted with a terminal. The price is 6d. The range of paper condensers (non-inductive) includes those designed for 250 volt D.C. working up to 1,500 volt D.C. working, the latter types being tested at 4,500 volts D.C. Small tubular condensers with wire ends may be ob-

tained in capacities from .005 to .1 mfd. at a cost of 1s. These are of the 750-volt D.C. test type, designed for 250 volts D.C. working. A similar condenser, but with terminals at the ends in place of the wire connections, may be obtained for 1s. 6d. Buffer condensers (centre-tapped type) are obtainable with values of .001, .1, 1 or 2 mfd., at prices from 2s. 6d. to 6s. 3d., whilst the complete range of Peak condensers is completed by the blocks of various capacities up to 4+4+2+2, costing 10s. 6d.

BULGIN PUSH-PULL Q.M.B. SWITCH

A NEAT little push-pull switch of the quick-make-and-break type is obtainable from Messrs. Bulgin at 1s. 9d. This has the normal appearance of a simple push-pull switch such as is used for switching on or off the battery circuit of a receiver, but the plunger is adapted in this particular case to cause a small "U"-shaped piece of metal to be thrown one way or the other by means of a small spring. It passes between two spring contacts in the "On" position, and these are left about 1/16 in. apart in the "Off" position, so that there is very little chance of leakage.

The component will be found most efficient for many purposes where a simple make-and-break is required.

RADIOPHONE VALVEHOLDERS

SOME neat chassis-type valveholders have been received from Messrs. British Radiophone. These are of the thin paxolin type, with patented sockets made to provide a really good grip on the solid pin type of valve. The sockets are bent up from strip copper, and an extended lug in the centre is taken

round to provide an additional thickness in the centre of the socket. As this naturally is of smaller diameter than the remainder of the socket, the valve leg must be gripped quite tightly at this point and rigidity is thus ensured. The holders are obtainable for 4, 5, and 7 pin valves, and cost 4d., 5d., and 6d. respectively.

RADIO WRINKLES

(Continued from page 672)

A Simple Cone Unit

TO make this simple cone unit, the following materials will be required: Metal 2 1/2 in. by 7/10 in., baseboard 2 1/2 in. by 6 1/2 in., 1 telephone (2,000 ohms), wood 6 1/2 in. by 2 1/2 in. by 1/2 in., 6 BA rod 3 in. long, two 6 BA nuts, 4 BA rod 3 in. long, two 4BA nuts, 1 4 BA terminal top, screws, and a piece of clockspring. Most constructors probably will have some of these materials in their junk box. Although simple to construct, most satisfactory results have been obtained using a free edged cone of 8 in. diameter. As will be seen from the diagrams, construction is simplicity itself, and will not require much explanation. The only tools required are a screwdriver, drill, and tinsnips. A hole to take the 4 BA rod is first drilled in the baseboard and the telephone magnet screwed into position. The wood block carrying the metal diaphragm is then placed in position and the diaphragm firmly fixed to it by means of two wood screws, as shown in Fig. 1. The shape of the diaphragm is important, as best results will only be obtained if the portion of the diaphragm over the magnets is parallel with them. A small piece of clockspring, shaped as indicated in Fig. 2, is fixed to the diaphragm by means of the stylus bar. The stylus is made from 6 BA studding filed down to a convenient size where the stylus enters the chuck used in the cone. The terminal block, carrying the connecting wires is the one used in the original telephone, and will be found quite satisfactory for its new purpose.



Practical Letters

from
Readers.

The Editor does not necessarily agree with opinions expressed by his correspondents.

Short-Wave Reports Wanted

SIR,—Our client, Mr. J. F. W. de Kort, of Bragaweg 34, Bandoeng, Java, Dutch East Indies, would be glad to receive reports on the reception, in this country, of his short-wave transmissions. His station works every working day from 23.45 till 00.15 G.M.T. on a wavelength 49.02 metres. Call PK1WK Bandoeng, Java, D.E.I. Announcements are in Dutch and English.—W. R. EVERETT (London, E.C.).

Television

SIR,—I must commend you on your articles concerning television, a subject to which a large number of our earlier wireless pioneers are turning their activities. I am only sorry that so little publicity is given to it at Radiolympia in late years.

I am sure that your readers appreciate the very practical articles which are the mainstay of your journal. As a reader from No. 1, who failed through foolish doubt, to qualify for your Wireless Encyclopædia, I am wondering if you have any volumes of the work left over from the last edition. If so, perhaps I and several other disappointed readers might qualify for a copy.

Thanking you for your magnificent weekly journal.—E. S. WEEKS (Hants).

A Treat a Week

SIR,—Although having taken various wireless weeklies for many years and PRACTICAL WIRELESS for only the last sixteen weeks, I must express my appreciation of the very fine practical matter which it contains.

Other readers' thanks and praise for the Encyclopædia has made me extremely desirous of obtaining this book myself, but I have seen no reference since I became a regular reader, as to how they became the proud possessors of same. Can you help me?

Thanking you for giving me a treat a week.—W. E. BOWKETT (South Wales).

Radio Luxembourg

SIR,—I am very much surprised to read in this week's PRACTICAL WIRELESS that you advocate the suppression of Radio Luxembourg owing to his power and difficulty of cutting him out.

It is a wonderful station, clear tone, no fading, with really enjoyable mixed programmes.

My set is a plain straightforward Det. and two transformer coupled amp. (not S.G.), and I have no difficulty in cutting him clean out in three degrees on either side of his best tuning point. Please do not agitate for his destruction. A friend of mine who lives about half a mile from here has a S.G. three all mains and he can cut Luxembourg dead out two degrees either side of his best tuning point.—R. W. STEPHENSON (Hounslow).

An Enthusiastic Reader

SIR,—I have to thank you for the "Eelex Earth Bowl," awarded to me as a prize, which arrived safely.

Like most of PRACTICAL WIRELESS articles, circuits and hints, the prize distribution was "Up to the minute." I have been a reader since No. 1 was published and before that time my knowledge of wireless was limited to the words "Aerial and Earth." I knew absolutely nothing. I am glad to pay tribute to PRACTICAL WIRELESS for the knowledge I have obtained.

I built up the "Dolphin 3" from No. 1. I must admit I felt frightened when my parts arrived, but through your instructions and wiring diagram being so clear and instructive, I found it quite an easy task.

I have also learnt a great deal from the pages of the Encyclopædia which, of course, I wouldn't or couldn't do without. Please carry on with the good work. There must be hundreds of novices who blessed the day PRACTICAL WIRELESS was published. Again, many thanks and best wishes for the success of "our paper."—A. KILLINGBACK (Essex).

What Readers Think

SIR,—May I take this opportunity to express my opinion of your paper? Here it is (a mere novice's). (Continued overleaf)

CUT THIS OUT EACH WEEK

DO YOU KNOW?

- THAT an improvement may often be effected in long-distance reception by interchanging aerial and earth connections to the receiver.
- THAT adequate ventilation should be provided in a powerful mains receiver.
- THAT fixed condensers should not be fitted too close to a mains valve owing to the heat which is given off by this type of valve.
- THAT hum may be caused in a cabinet by acoustic means, as well as through electric sources.
- THAT if two resistances of equal value are joined in parallel the current carried by each is half of the total flowing through the circuit.
- THAT the response curve of a loud-speaker is altered if the diaphragm is exchanged.
- THAT for the above reason a new cone should not be fitted to a speaker without the makers' approval.
- THAT a special type of electrolytic condenser is now obtainable for use in the biasing circuit of powerful receivers.

NOTICE.

The Editor will be pleased to consider articles of a practical nature suitable for publication in PRACTICAL WIRELESS. Such articles should be written on one side of the paper only, and should contain the name and address of the sender. Whilst the Editor does not hold himself responsible for manuscripts, every effort will be made to return them if a stamped addressed envelope is enclosed. All correspondence intended for the Editor should be addressed: The Editor, PRACTICAL WIRELESS, Geo. Newnes, Ltd., 8-11, Southampton Street, Strand, W.C.2.

Owing to the rapid progress in the design of wireless apparatus and to our efforts to keep our readers in touch with the latest developments, we give no warranty that apparatus described in our columns is not the subject of letters patent.

EASY TERMS

Everything Wireless supplied on lowest terms.

THE NEW BLUE SPOT LOUD-SPEAKER UNITS. The new Blue Spot range represents, in our opinion, the finest value in loud-speaker units available. With the new cones the quality and sensitivity is still further improved. New Season's models now in stock.

NEW BLUE SPOT 99 PM MOVING-COIL UNIT, with transformer. Cash Price, £2.19.6, or 5/- with order and 11 monthly payments of 5/6.

NEW BLUE SPOT 45 PM MOVING-COIL UNIT, with transformer. Cash Price, £2.5.0, or 5/- with order and 9 monthly payments of 5/-.

BLUE SPOT 6GR UNIT, with large cone and chassis. (The most sensitive balanced armature unit made.) Cash Price now £1.18.0, or 5/3 with order and 7 monthly payments of 5/3.

NEW BLUE SPOT PICK-UP, including built-in volume control. Cash price, £1.15.0, or 5/- with order and 6 monthly payments of 5/8.

NEW BLUE SPOT 62 PM MOVING-COIL UNIT, including transformer, built into high-grade cabinet. Cash Price, £3.7.6, or 6/3 with order and 11 monthly payments of 6/3.

MULTITONE CLASS "B" UNIT, including Cosor valve. This unit, plugged into your set will give you all-mains volume and quality of reproduction. Ready for immediate use. Cash Price, £2.11.6, or 7/- with order and 10 monthly payments of 5/.

Descriptive leaflet of all the above on request. All prices carriage paid.

To avoid delay will customers kindly send first payment with order.

Estd. 1925 THE Phone: NATIONAL 1977

LONDON RADIO SUPPLY COMPANY
11, OAT LANE NOBLE STREET LONDON, E.C.2

IF YOUR RECEPTION IS ONLY "LOCAL"

SUPERIAL
THE AERIAL WHICH MADE BROADCASTING POPULAR
ELECTRON'S SUPER-AERIAL

WILL MAKE IT CONTINENTAL



because it is the most selective aerial. The extra heavy rubber insulation not only cuts out interference, but abolishes masts, insulators and separate leads-in. Don't buy inferior imitations, but insist on SUPERIAL the only efficient invisible or indoor aerial. Get your £100 Free Lightning Insurance today from your wireless shop.

100 ft 3/6: 75 ft 2/6: 50 ft 1/9: 25 ft 1/4
THE NEW LONDON ELECTRON WORKS 126 EAST HAM LONDON E.6

FREE BARGAIN BULLETIN

Thousands of end-of-season lines to be cleared at Gift Prices. A FREE GIFT of useful Drilling Template sent Post Free with lists to all applicants. J. H. Taylor & Company, 28, Radio House, Macaulay Street, Huddersfield.

FAMOS 2 Magnet bal. arm. speaker units, large 4 pole type. List price, 21/-, to clear 6/-.
AMPLION cone speaker unit in Walnut domed-top cabinet, 7/6 complete.
ERICSSON 2-1 (suit 3-1) L.F. Transformers. Listed 17/6; each, 3/3.
AMPLION speaker units. Over 75 per cent. reduced. Each 2/3.
All new and guaranteed and sent carriage free U.K.
PIONEER RADIO MFG. CO., LTD., OPTIC STREET, W.C.1. Museum 9607.

PRACTICAL LETTERS

(Continued from previous page)

PRACTICAL WIRELESS is absolutely O.K. and the best radio paper going, from the tuppennies to the bobs. I have taken it from No. 1 and intend to go on taking it. I remember when **PRACTICAL WIRELESS** was first announced excitement reigned supreme here, in Newport—all the news-agents had sold out in about an hour, and I, with others, didn't receive No. 1 until the following week.—**E. V. SPARKE** (Newport).

A Satisfied Reader

SIR,—I received your letter and have altered my wiring as per your instructions; I have also added the components you suggested, and I wish to thank you for your very kind assistance, the set is working wonderfully well considering the components it consists of.

I am using three old G.P. valves and a home-made coil; I tested it out yesterday and received many foreign stations at good loud-speaker strength, included among them being Fécamp, Trieste, Poste Parisien, Toulouse, Vienna.

I am going to call my set, for obvious reasons, "The Mongrel Three," for no two parts match.

I have been taking **PRACTICAL WIRELESS** since No. 1 was issued, so am endeavouring to learn a little about the mystery of wireless.—**W. MACDONALD** (Croydon).

A Suggestion

SIR,—I have been a regular reader of **PRACTICAL WIRELESS** since No. 1 was published, and I hope to continue to be the same. Yet I have a bone to pick with you.

I should like to see you designing one or more sets incorporating some of the latest

developments and at the same time keeping the cost in mind.

I suggest the following Straight Three's: Det. P125 as driver and new Cossor Class B valve B220, with band-pass tuning without ganged condensers; or other selective Straight Three's with the new Class B valve, and so one can use, if desired, some of their old components.

I should think this arrangement with the new Cossor Class B valve, L.T. and H.T.

consumption would not be much more than the old Straight Three. If you design a set of this kind, I am sure lots of readers and non-readers, who still stick to the old sets, would re-build, knowing what is in store for them next year. Wishing you continued success, greater amplification, and a bigger output.—**J. BUNTING** (Sheffield).

[I note your remarks and am giving them careful consideration.—Ed.]

RADIO CLUBS & SOCIETIES

Club Reports should not exceed 200 words in length and should be received First Post each Monday morning for publication in the following week's issue.

SLADE RADIO

A lecture on "H.F. measurements" was given by Mr. R. G. D. Holmes A.Inst. W.T., A.I.Rad.E., at the meeting held last week. A coil voltmeter was described and also how to use it, after which inductance, self capacity, H.F. resistance, dynamic resistance and how to measure them was described and the formulas given. A few words on permeability tuning brought a most interesting lecture to a close, and a number of questions were raised. Full details of the society and advance programme may be had on application to the Hon. Sec., 110, Hillaries Road, Gravelly Hill, Birmingham.

MIDLAND AMATEUR RADIO SOCIETY

This society is probably one of the strongest purely local societies in the world. Of its one hundred and fifty members, no less than forty-six hold full

transmitting licences, and the following are some of the successful achievements by some of its members, during 1932-33: The winning of the B.E.R.U. Trophy, given for the best performance of any station in the British Empire, during the B.E.R.U. Test. Our member scored almost twice as many points as those obtained by our nearest competitors, and so brought the Trophy back from Australia. Receiving Test Challenge Trophy—First in the whole of the Empire. Senior Transmitting Test—First in Great Britain and Second in the Empire. Junior Transmitting Test—First in Great Britain and seventh in the Empire. The R.S.G.B. Test—First.

The society's activities are extremely varied. At a "Junk Sale" held on behalf of the Birmingham Mail Christmas Tree Fund, for the provision of food and clothing for poorer people, the sum of £21 2s. was raised by the members. We give a number of trophies for experimental and research work, in all departments of radio. Last year a complete transmitter was built by the society, and operated under portable licence with a large measure of success. Lectures are given, not only on short-wave work but on everything appertaining to radio and television. The society is proud to number amongst its members many well known legal, medical, and theological notabilities. Meetings are held in the Oak Room of the Hope and Anchor Hotel, the use of the room being given free by Councillor Eli Fletcher, who is also an enthusiastic member. There is no entrance fee to the society, the annual subscription being 5s. only, and the Hon. Secretary, W. H. D. Nightingale, G5NI, will be pleased to welcome all interested in radio on application to either his private address, "Winswood," Beaks Hill Road, Kings Norton, Birmingham, or his business address, Radio Mart, 19, John Bright Street, Birmingham, 'Phone No. Mid. 3254.



Mr. L. S. Hargreaves, Managing Director of Aerialite Ltd.

.....I have produced **THE FINEST AERIAL**



The success of Aerialite Aerial Wire last season so convinced me that wireless enthusiasts definitely appreciate every step made in the progress of radio reproduction, that I have now produced a super aerial, **LEVENSTRAND**, which **BETTERS THE BEST**. This super aerial has a larger copper surface than any other on the market, which ensures better results than have ever been possible before. Double thickness of the now famous Aerialite covering ensures perfect insulation, and our stupendous offer of £200 **FREE LIGHTNING INSURANCE** with every coil is your guarantee and safeguard from lightning. **LEVENSTRAND** is absolutely guaranteed to give better results, more stations and greater volume.

THERE IS NO STEEL WIRE IN **LEVENSTRAND**.

50 ft. 1/9, 75 ft. 2/6, 100 ft. 3/6.

PERCOLITE ALL-COPPER EARTH TUBE

PERCOLITE proves how all important is a good earth. This improved chemical earth gives remarkable results compared with any other. Percolite will definitely improve reception and is the world's best earth by test. Simple to fix, Percolite is the earth that gets right **2/6** down to it. **PRICE**

AERIALITE 7-STRAND PURE COPPER AERIAL. You can still obtain **AERIALITE 7-strand Pure Copper Aerial Wire** in boxes. Prices: 50 ft. 1/3, 75 ft. 1/10, 100 ft. 2/5. From your dealer or direct from:

AERIALITE LTD. AERIALITE HOUSE
AMBER ST., MANCHESTER

THE HEART OF THE SET

362 VALVES

DIRECT BY POST FROM THE MAKERS AT 50% SAVING.

362 Valves are British throughout. Non-Microhomic and Fully Guaranteed. Equal to any—better than most! See them at:

Post Free from **3/6**

OLYMPIA, STAND No. 226.

R.C., H.F., L.F., or Det., 3/6. Power, 4/- Super-Power, 4/6. 5.G. or Var-Mu, 7/6. Pentode type, 10/- All in 2v., 4v., or 6v. Metallised 3d. extra.

"CLASS B" 2-v. filament, 9/- 7-pin base, A.C. MAINS VALVES, 4-volt, 1 amp. (Indirectly Heated). Prices 7/6 to 12/6. Full List post free.

Cash with order. Cheques and P.O.'s must be crossed and made payable to: **THE 362 RADIO VALVE Co., Ltd. (Dept. W.12), 415, Mare Street, Hackney, London, E.8**

MODERN WIRELESS SETS AND HOW TO MAKE THEM
 By F. J. CAMM

This handbook explains the construction of a number of highly-efficient receivers, designed around the latest and most up-to-date components, such as band-pass and screen coils, variable-mu valves, etc. They have been designed to eliminate most of the drawbacks to efficient wireless reception. Most of the sets have compartments for the batteries and accumulators, and make use of built-in speakers. They are all extremely selective, cheap to make, and simple to construct.

EIGHTY PAGES FULLY ILLUSTRATED
6d.

On sale at all Newsagents and Bookstalls, or post free 7d. from George Newnes, Ltd. 8-11, Southampton Street, Strand, London, W.C.2.

'LISTENERS IN'!

LOOK TO-DAY AT YOUR WIRELESS LICENCE

IT MAY BE WORTH £50

Compare your number and claim your reward

£50 will be paid to holder of Licence No. AM 606314

£25 will be paid to holders of Licences: Nos. AM 629719 AN 248950

£10 will be paid to holders of Licences: Nos. AQ 014176 AO 964205

£5 will be paid to holders of Licences: AM 168697 AM 947333 AO 181418 AN 636825 AL 192700

£2 will be paid to holders of Licences:

AH 983625	AK 008754	AM 029340	AN 588728	AO 532208	AP 374996	AP 14520
AI 744709	AK 436690	AM 544734	AN 476092	AO 920000	AP 218426	AP 367520
AJ 620000	AM 287631	AM 660871	AN 108342	AO 232545	AP 440009	AP 996318
AJ 549672	AM 699947	AM 887609	AN 022451	AO 639572	AP 638194	AP 219453
AJ 353861	AM 50012	AN 383613	AN 700024	AO 063292	AP 002528	AP 837627
AK 152558	AM 973456	AN 239945	AN 695237	AO 887128	AP 425327	AQ 243609

£1 will be paid to holders of Licences:

AH 700965	AJ 225133	AL 210010	AN 188749	AN 770628	AO 327948	AP 82000
AH 346268	AJ 45789	AM 296380	AN 40281	AO 795919	AO 374216	AP 330712
AH 277424	AJ 727041	AM 867332	AN 952930	AO 350225	AO 461000	AP 375600
AL 738166	AL 740963	AM 640777	AN 366891	AO 058437	AO 715828	AP 052026
AI 284963	AL 368234	AM 75213	AN 859738	AO 192318	AP 467720	AP 798261
AI 009410	AL 457118	AM 374968	AN 434695	AO 884246	AP 043419	AP 296047
AI 428212	AL 892995	AN 692870	AN 238544	AO 417230	AP 655208	AP 928076
AJ 593600	AL 075243	AN 061221	AN 927610	AO 753605	AP 864821	AP 981003

This offer applies to licences which are actually in force on Saturday, August 12, 1933.

Before the awards are paid, claimants will be asked to undertake a simple publicity service in distributing leaflets to encourage the sale of licences amongst those who at present do not fulfil their obligations by taking out a Post Office Wireless Licence before receiving broadcast programmes. Claims cannot be considered in connection with any Licence the date of issue of which is after August 10, 1933.

For full particulars for claiming awards and a long list of other numbers see

TIT-BITS

ON SALE EVERYWHERE SATURDAY AUG. 12.

PRACTICAL HANDBOOKS

Clearly written and fully illustrated.

This series covers a wide field and will prove of the greatest value to everyone interested in models and how to make them; woodwork and other crafts.

Accumulators

An up-to-date handbook dealing with every type of accumulator, methods of charging them at home, care and maintenance, also explains how to erect a charging station.

Motor Car Upkeep and Overhaul

Information covering the engine, decarbonising, valve grinding, the lighting system, the carburetter, cooling system, lubrication, springs and shock absorbers, steering gear, brakes, wheels, axles, tracing noises, etc. etc.

Toy Making for Amateurs

How to make clockwork toys, model aeroplanes, model locomotives, model boats, ingenious toys operated by sand, wooden models and toys, electrical toys, steam toys, guns, kaleidoscopes, acrobats, etc.

Twenty-Five Tested Wireless

Circuits

All the sets described have been designed to meet modern needs. They range from simple crystal receivers to a seven-valve super-heterodyne, and all have been made and tested before inclusion.

Simple Electrical Apparatus

An excellent little book for those who wish to make simple and useful electrical appliances, such as galvanometers, electric motors, dynamos and Leyden jars.

Model Boat Building

Contains designs for battleship, speed boat, paddle steamer and yachts. Excellent models can be built with the simple directions and diagrams given.

The Home Woodworker

Clear instructions on how to make a large variety of articles in wood, together with many useful hints on wood-working.

Model Aeroplanes and Airships

Contains full descriptions of easy-to-make models of every description that will fly.

The Handyman's Enquire Within

Hundreds of practical ideas and hints of value to the man who is clever with his hands.

25 Simple Working Models

Ingenious and practical designs for electric, steam and clock-work models.

NEWNES' HOME MECHANIC BOOKS

Obtainable at all Newsagents and Bookstalls, or by post 1/2 each from George Newnes, Ltd., 8-11, Southampton St., Strand, W.C.2

1/-

WITHOUT FEE YOU CAN CONSULT

The "Tit-Bits" Barrister or Solicitor

Advice on all legal questions—Rent Acts, Workmen's Compensation, Marriage Laws, House Purchase, Adoption, Insurance, etc.

Our Doctors

All matters relating to health.

Our Dentist

Advice regarding all dental troubles.

The Careers Expert

How to train for trades, professions, business.

The Pensions Expert

On Old-Age, Widows', Orphans', Army and Navy Pensions, etc.

Our Domestic Science Authority

The home; cookery; how and what to buy; labour-saving devices; dyeing and cleaning; etiquette; furnishing and decorating.

Our Child-Welfare Expert

Diet, sleep, clothing, play, etc.

A Beauty Expert

Care of complexion, hair, eyes, hands, etc.

Our Holiday Bureau

Where to go; how to travel; cruises, etc.

Our Film Expert

Facts about the "stars" and films. Amateur cinematography.

The Sports Expert

Football, Tennis, Cricket, Racing, Athletics, Billiards, Greyhound and Speedway Racing, etc.

A Veterinary Surgeon

Dog ailments, diet, care and attention, etc.

Our Cycling and Motor-Cycling Experts

Touring advice. Tyre and engine troubles, maintenance and repair, etc.

Address all letters to
THE EDITOR OF

TIT-BIT'S

who will be happy to give you, by post, advice and assistance upon any matter that is worrying you. All letters must contain the Free Advice Coupon to be found at the top of the Editor's Page.

George Newnes, Ltd.

FOR EVERYONE • FOR EVERY OCCASION

The MOVIE CAMERA

WHY "spend" your holiday? Why not keep it and enjoy it all over again? You will be able to do this if you take a movie camera with you. Movie cameras are even easier to use than ordinary "still" cameras. Let "Home Movies" tell you how to make pictures that will be a lasting pleasure to you and yours.



"HOME MOVIES" caters for every home movie interest. Even if you have not yet started the hobby you will like this delightful magazine



YOU WILL FIND EVERYTHING YOU WANT TO KNOW ABOUT THIS POPULAR HOBBY

in
HOME MOVIES
AND HOME TALKIES
NOW ON SALE **6^d** EVERYWHERE

Obtainable at all Newsagents, Bookstalls and Dealers, or post free 7½d. (Subscription rates: Inland and Abroad 7/6 per annum. Canada, 7/- per annum) from Geo. Newnes, Ltd., 8-11, Southampton Street, Strand, London, W.C.2.

George Newnes, Ltd.

P. W. Gift Stamp No. 46

Printed by NEWNES & PEARSON PRINTING CO., LTD., Exmoor Street, Ladbroke Grove, W.10, and published by GEORGE NEWNES, LTD., 8-11, Southampton Street, Strand, W.C.2. Sole Agents for Australia and New Zealand: GORDON & GOTCH, LTD. South Africa: CENTRAL NEWS AGENCY, LTD. Practical Wireless can be sent to any part of the world, post free, for 17/4 per annum; six months, 8/8. Registered at the General Post Office for Transmission by Canadian Magazine Post.