

53 Collette

A NEW DEPARTMENT IN PORTABLES!

Practical Wireless

3^D

Published every Wednesday by
GEORGE NEWNES LTD.

Vol. 2. — No. 33.
MAY 6th, 1933.

Registered at the G.P.O. as a Newspaper.

Building the FEATHERWEIGHT PORTABLE FOUR



FULL SIZE
BLUEPRINT
Free
Inside

GARD AGAINST LIGHTNING

Lightning strikes through Wireless Aerials. Make your home safe. Fix a Graham Farish "Gard" between Aerial and Earth Lead-in.

From all Radio Dealers, or post free from—

GRAHAM FARISH, LTD., MASONS HILL, BROMLEY, KENT

1/6



£100
GUARANTEE
Every Graham Farish
Gard Lightning Arrester
Carries £100 Guarantee

HAVE YOU SEEN THE ALL-ELECTRIC A.C. SAFETY "SKYSCRAPER"?

Go to your radio dealer and see the All-Electric "Skyscraper." Get the **FREE CHART**, from which you will see at a glance that Lissen have made easy for you the building of this All-Electric Receiver and also made it **SAFE**. This is the most powerful, most sensitive, most modern All-Electric Set ever put into the hands of the home constructor—and the **FREE CHART** contains the most comprehensive and most detailed building instructions ever supplied.

To make **SUCCESS AND SAFETY CERTAIN** unique features and right up-to-the-minute technical developments are incorporated in the All-Electric "Skyscraper" which you could not get even in [very expensive factory-built Mains sets. **THAT IS WHERE YOU SCORE BY BUILDING YOURSELF.** You get a receiver that will bring you every receivable programme at full entertainment strength on a fine moving coil loudspeaker.

Self-contained Safety Power Unit—Special Universal Safety Fuse Plug—4 Matched Valves with Variable Mu Screened Grid H.F. Stage and brilliant Power Pentode Output—One Dial Tuning with Single Knob Volume and Reaction Control—Triple Aerial Selectivity Tapping and alternative Mains Aerial—All-Metal Chassis and Under-baseplate wiring—beautiful Walnut Cabinet which you put together yourself, and complete full-power Moving Coil loudspeaker.

THE FIRST COMPLETELY SAFE-COMpletely PRACTICAL-ALL-ELECTRIC RECEIVER FOR THE HOME CONSTRUCTOR

KIT COMPLETE WITH 4 VALVES £7 - 19 - 6



ASK DEALER OR POST COUPON

The **CHART** of the All-Electric A.C. Safety "Skyscraper" is **FREE** from any dealer or by posting **COUPON** below.

LISSEN A.C. SAFETY "SKYSCRAPER"

To **LISSEN LTD.**, Publicity Dept., Isleworth.
 Please send me **FREE** copy of the Chart of "All Electric Safety A.C. Skyscraper."
 Name.....
 Address.....
 PR. A.C. 5



Practical Wireless

EDITOR:
 Vol. II No. 33 || F. J. GAMM || May 6th, 1933
 Technical Staff:
 H. J. Barton Chapple, Wh. Sch., B.Sc. (Hons.), A.M.I.E.E.
 W. J. Delaney, Frank Preston, F.R.A., W. B. Richardson

ROUND *the* WORLD of WIRELESS

Roumania's Super Power Station

BLAJ, in Transylvania, where a 1-kilowatt experimental transmitter has been installed, will possibly prove the definite site of the super-power station for which a contract has already been placed by the Roumanian authorities. The site, however, is conditional on the transmitter being permitted to use the wavelength of 1,870 metres, a channel formerly allocated to the Bucarest Broadcasting Company. Should, however, a wavelength of roughly 1,200 metres be granted, it is proposed to erect the new plant in the neighbourhood of Brasov (formerly Kronstadt). The power of the station will be 150 kilowatts. The transmitter now in operation in the capital may be transferred to Jassy, Galatz or Braila.

Vienna, Loud-speakers and Open Windows

THE police authorities at Vienna have warned all radio enthusiasts that during the spring and summer months, heavy fines will be inflicted in every case where loud-speakers are used in houses and flats whilst windows remain open. During the warmer evenings it is the habit of Austrians to take their meals on balconies overlooking the streets, and the noise caused by innumerable loud-speakers and gramophones has compelled the authorities to take precautionary measures.

France's Wireless Bill

THERE is a strong possibility of the new wireless telephony bill being passed by the French Chamber of Deputies and Senate during the present session, as the Commission of Finance has adopted the clauses dealing with the taxes to be levied on wireless receivers and components. France, during the past six years, has made several attempts to raise money for the upkeep of the radio stations in this manner, but hitherto has not succeeded. It is even now expected that considerable opposition will be met before a bill can be passed which would authorise the State to monopolise the broadcasting services.

More Czech Stations Advocated

NOTWITHSTANDING the fact that, excluding the Prague high-power transmitter, Czechoslovakia possesses four provincial stations, certain districts of the

country are not adequately covered. A petition put forward by the Czech Radio Club for the installation of a further relay at Pilsen is being considered by the authorities. Pilsen, formerly in Bohemia, is the well-known "Lager" brewing centre.

Italy Offers Radio Prizes

IN order to encourage the sale of licences the E.I.A.R. offers to all listeners a

The Highest European Aerial Mast

RADIO-BUDAPEST, the new super-power station now under construction on the Island of Csepel in the Danube, will possess for its aerial system a mast 320 metres (1,056 feet) in height, or 20 metres higher than the Eiffel Tower. The actual weight of this steel tower will exceed 230 tons. It is hoped to have the station ready by next autumn.

Tallinn's Alternative Channel

IN view of the fact that Tallinn's broadcasts on 298.9 metres are "sandwiched" between those of Hilversum and North National on much higher power, it is frequently easier to hear the Estonian programme through the Tartu relay on 585 metres, just under the shipping band. The difference in the distance of these two cities from London is only roughly twelve miles. The call from Tartu on (pre-war maps, *Dorpat*) when broadcasting from its own studio is: *Hallo! Hallo! Tartu lainehelisada Kuuskümmän wijs 585.7 metri, and the interval signal a bell. When the Tallinn (Reval) programme is taken, you may hear: Siin Tallinn ja Tartu, and announcements will be given by a man or a woman. Estonia works to Eastern European time, and consequently her clocks are now only one hour ahead of B.S.T.*

The Naples Pipes of Pan

EITHER direct from Naples or through Rome when a relay of the former city is carried out, you will regularly hear a flute-like interval signal strongly reminiscent of the Pipes of Pan. It is a simple melody repeated in various keys. Naples, like most of the other Italian studios, possesses a woman announcer. The station broadcasts on 319 metres, and the call, as most programmes are S.B. with Rome, is usually *Radio Roma-Napoli*.

A Giant Valve

AT the Marconi Osram Valve Co's. works at Hammersmith, some 250 different types of wireless valves are made, but recently this firm turned out what is stated to be the largest single-unit sealed-off transmitting valve in the world. This valve was a veritable giant for it weighed 75lbs., and stood nearly 4ft. high; it is designed for use in a 500 kW. transmitter.

IN THIS ISSUE:

- BUILDING THE FEATHER-WEIGHT PORTABLE CLASS B FOUR** page 266
- CUT THE CRACKLE** page 261
- ALL ABOUT IRON-CORE TUNING COILS** page 251
- tone, VOLUME CONTROL** page 258
- THE PENTODE EXPLAINED** - page 274
- SHORT-WAVE SECTION** page 278

reward of 20 lire on proof that they have induced a friend to register his wireless receiver with the authorities. In addition, a radio lottery has been launched in which prizes of from 500 to 15,000 lire can be won. Tickets are also awarded to listeners who, in the same way, assist the development of the broadcasting system.

When Oscillation is *Verboten*

SINCE the advent of the Hitler Government in Germany and its increased participation in the broadcast programmes, fines for interference of any description with reception have been greatly increased. In cases, however, where radio listeners are convicted of disturbance through oscillation during a ministerial broadcast, the unlucky culprit is not given any option, but is hauled off to prison.

ROUND *the* WORLD of WIRELESS (Continued)

Blimp versus Mast Aerial

TO study ways and means for the reduction of the fading effect in broadcast transmissions, the KDKA, East Pittsburgh, engineers are carrying out experiments with a small blimp as an aerial support. The airship is twenty-five feet long with a diameter of ten feet. It is floated at a height of roughly 1,500 feet above the station buildings and trails a five-hundred feet aerial. By this method it is hoped to extend the range of the transmitter and to counteract fading effects over a larger area.

Reduced Advertising Programmes in Canada

THE Canadian broadcasting authorities have decreed that in the case of sponsored broadcasts by business or other concerns not more than five per cent. of the programme time must be devoted to actual microphone publicity. In some of the entertainments put out by the United States studios a longer period in the programme is allowed for advertising the wares of the firm responsible for the broadcast.

New Interval Signal for Berlin

TO replace the metronome signal which the station has used for some considerable time, the Berlin studio has adopted, between items, the first bars of one of Germany's favourite military marches *Volk ans Gewehr* (People, to Arms). This, according to the Reichsrundfunk, better expresses Germany's nationalist movement. The long-wave Königs Wusterhausen (Deutschland-sender) transmitter will continue to use the first notes of the Potsdam Church carillon for the same purpose.

The New Radio Toulouse Station

PENDING official authority—which is expected daily—to bring the new 80 kilowatt St. Agnan transmitter into regular service, this station will continue to carry out experimental broadcasts between B.S.T. 9.0 and midday and again between 12.30 and 1.30 a.m.

Morocco and Radio Pirates

THE *Office Chérifien* with a view to the suppression of radio pirates in Morocco, has decreed that all dealers when effecting any sale of wireless components, must report the names and addresses of clients to the local Post Office. The P.T.T. authorities exercise full control over broadcasting and other transmitters, and have decided to wage war against unlicensed possessors of wireless apparatus.

Radio Licences on the Increase

DURING the month of March the Postmaster-General issued approximately 450,000 listening licences, which shows on the total number of 5,498,700 in force, a net increase of some 71,000 new wireless fans.

B.B.C. and Opera Relays

THE B.B.C. will mark the opening of the Grand Opera season at Covent Garden on May 1st by relaying Act Three

of *Der Rosenkavalier* (Richard Strauss) to National listeners. On the following evening the Regional stations will broadcast the whole of Wagner's *Rheingold*. The third act of the *Valkyrie* will be transmitted in the National programme on May 3rd. Relays of Covent Garden performances, on either National or Regional wavelengths, will be given frequently throughout the season.

A Japanese Programme

ON May 4th (National) and the 6th (Regional) the B.B.C. proposes to broadcast an adaptation of three of Japan's most famous No Plays which date from the 15th and 16th centuries. In Japan a performance of a No Play lasts six hours; on this occasion the three to be broadcast will occupy less than sixty minutes.

WIRELESS FOR POLICE.



The above illustration shows a motor-cycle combination for police work fitted with a Marconi six-valve single-control police receiver operating with a short rod aerial.

SOLVE THIS!

Problem No. 33.

Robins had an All-mains receiver, home-built. The circuit was the conventional Screen Grid, Detector and Pentode valve, and the mains section employed a U.10 rectifier, which delivered 250 volts at 60 mA. As he wished to use larger output valves he purchased a pair of Mazda PP5/400 valves and a new rectifier, a Cosorr 460BU. This should (according to the catalogue) deliver 500 volts at 120 mA, but when the receiver was switched on results were worse than with the original arrangement. What had Robins overlooked? Three books will be awarded for the first three correct solutions opened. Address your solution to The Editor, PRACTICAL WIRELESS, Geo. Newnes, Ltd., 8-11, Southampton Street, London, W.C.2, and mark your envelopes Problem No. 33. Do not enclose any other correspondence with your solution.

SOLUTION TO PROBLEM No. 32

The anti-microphonic valve-holder was causing the trouble, as it was very loosely sprung and the weight of the valve caused the contacts to drop sufficiently to touch the metal chassis. This, of course, shorted the H.T. The following three readers received books in connection with Problem No. 31. A. Burman, 196 Canterbury Road, W. Croydon. W. Rowlands, 1 Crooklands Terrace, Dalton-in-Furness. H. Fraser, 68, St. Johns Road, Waterloo, Liverpool.

America's Giant Transmitter

CINCINNATI'S new four-hundred-thousand dollar super station is to be erected at Mason (Ohio). Work on the 830 feet high steel tower which is to serve as an aerial has already begun. The structure itself will be "cigar" shaped and thirty-five feet in diameter at its widest point; it will be stayed by means of eight two-inch bridge cables, and when complete will weigh nearly 450 tons. It is hoped that this ultra modern aerial mast may be ready by June when, until the new station is built, it will be used by the present WLW, 50 kilowatt transmitter.

The New French Wireless Bill

THE French Financial Commission has adopted certain paragraphs of the new Budget which calls for a listening tax on all wireless receivers in France, in addition to a surtax of 15 per cent. of the retail price of valves sold in that country.

Interesting Radio Statistics

TO visualise the progress made in the broadcasting systems of the various European States it is necessary to compare the number of registered listeners with the general population. Some idea may be conveyed by the following figures which show the number of licences issued per thousand inhabitants: Denmark (150); Great Britain (149); Sweden (103); Austria (78); Germany (72); Switzerland (62); Belgium and Norway (48); Hungary (38); Czechoslovakia (35); Poland (10); Italy (7); Jugoslavia and Spain (4). Holland, where no tax is levied is estimated at 82 per 1,000.

An Old Spanish Custom!

FOR some years Spain has endeavoured to reorganise her broadcasting system, and it has been the custom of her wireless Press to put forward new schemes at fairly regular intervals. Apparently, a perfected plan has been submitted for discussion at the next meeting of the Broadcasting Union at Lausanne. It calls for authority to build a 160 kilowatt station to operate on 1,450 m., one of 100 kilowatts on 413 m.; two of 50 kW. on a wavelength above 300 m., and two of 20 kW. on a channel higher than 259 metres. These wavelengths could be shared with transmitters operating in Estonia, Latvia and Finland, without causing mutual interference.

Radio Tessin Testing

IT is reported from the continent that the third of the Swiss Regional stations (Monte Ceneri) has begun its experimental transmissions, and can now be heard on the air in the early hours of the day.

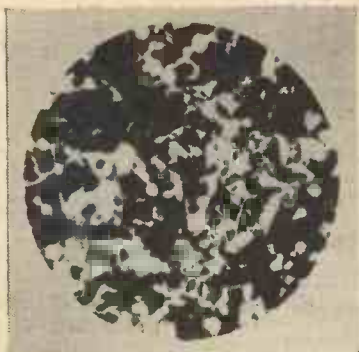

Fig. 1—Photomicrograph of iron filings. Equal magnification.

IRON CORE TUNING COILS

A Practical Article dealing with Iron Core Coils, Their Construction and Advantages

By PAUL D. TYERS



Fig. 2—Photomicrograph of "Nuclean" dust. Equal magnification.

REMEMBER about ten years ago using an American receiver in which some of the high-frequency circuits contained iron cores, and it is only now that the universal application of the iron core tuning coil appears to be imminent.

It must not be imagined that there is anything new about an iron core tuning coil. The idea of using iron in comparatively high-frequency circuits is probably about thirty years old at least. The first application of dust cores was, I believe, in connection with telephone work where they were used as loading coils. The name of Pupin is familiar to everyone as a pioneer of dust core loading coils.

There are, no doubt, three questions which are of most interest to the wireless enthusiast, and it is these three which I will endeavour to answer. First, why use an iron core; secondly, what are its advantages; and, thirdly, what is it, and how is it made? The three questions are so intimately connected, that I think it will be best to deal with them as a whole.

The principle of the iron core coil is really very simple. When designing a coil, our aim is always to reduce the losses to a minimum, because obviously the greater the losses, the lower will be the efficiency. Sensitivity or magnification will decrease, and what is probably most important of all, the selectivity will go down, giving flat tuning, particularly if the losses are very high.

Tuning Coil Losses

The losses in a tuning coil can be regarded as an equivalent resistance. I expect everyone is familiar with a resonance curve which indicates the sharpness of tuning of a coil at a particular frequency. The lower the losses, the sharper will be this curve. In other words, voltages are obtained across the tuned maximum circuit at the peak. If this is very wide and flat, quite a large voltage will still be obtained on either side of the tune point, with the result that quite strong signals will be obtained from adjacent transmissions.

Now the losses in a coil are made up of a number of different factors. Since the coil is wound with wire, the wire has an appreciable resistance, and the pure ohmic resistance of the winding is always one of the constituents of the total equivalent resistance of the coil. It is, in fact, one of the most important. For a coil of any given value or inductance, there is always

a definite relation between diameter and length and gauge of wire, which will give the minimum effective resistance.

The inductance of a coil depends upon its length and diameter, and the number of turns, and also upon the nature of the material inside the coil. In an ordinary tuning coil, apart from the former on which it is wound, there is nothing but air. The material of which the former is made has no effect upon the inductance if it is non-metallic, but it may introduce what are known as dielectric losses. These losses vary considerably with different materials.

Effect of Metal in a Coil

We know that in a transformer we always have a magnetic core. Now the effect of metal in a coil is to increase the inductance tremendously. The extent to which it is increased depends upon the material of which the core is composed. Magnetic materials such as iron have a property known as magnetic permeability. If the permeability is very great then the inductance is enormously increased. In fact, the inductance is a direct function of the permeability.

If, therefore, we have two coils, one having a permeability twice that of the other, we shall obtain double the inductance with the second core. Supposing we still want only our original value, we can remove a large number of turns and use the higher permeability core, thereby

of losses which do not exist with a simple air core coil. These losses are due to hysteresis effects and eddy currents. Hysteresis losses in a core are controlled by the actual nature of the magnetic material or the alloy, and they vary considerably with different grades of material. The eddy current losses are controlled by the mechanical formation or construction of the core. If we consider for one moment an ordinary mains transformer or low-frequency transformer, we find that the core is composed of a large number of stampings or laminations. The core itself is not composed of ordinary iron, but consists of an alloy of iron with silicon, or iron combined with nickel.

Another property of an iron core is that its effective permeability varies with frequency. At mains frequencies, that is, of the order of 90 cycles per second, it is fairly constant, while the variation over the entire range of speech frequencies is not really very great.

When we are dealing with radio frequencies, however, a totally different state of affairs exist. If we simply take an ordinary iron alloy core and laminate it in the usual way, we shall obtain quite a good permeability, but the losses will be colossal. This difficulty can be overcome by splitting up our core into an extremely large number of particles.

Accordingly, instead of laminating the core in the usual manner, we make the metal into the form of a dust or powder which is compressed into some form of solid block. This, one might consider, is the end of the dust core problem, but it is really at this point that it just commences.

Dust Cores

The number of people who have investigated and developed various types of iron cores is really enormous, and it is only exceeded by the number of patents which have been filed on the subject during the last thirty years or so. I think it can be definitely stated that it is only within the last few years that renewed attention has been directed to dust cores for really high radio frequencies, corresponding to those used for ordinary broadcast transmissions.

Dust core problems are partly electrical and partly metallurgical or chemical. In order to keep the losses down to a reasonable value, and at the same time obtain a useful permeability, it is necessary to employ an extremely small grain size. One

(Continued overleaf.)



Fig. 3—Iron Cores. Left to right: early type of Ferrocart $\frac{1}{2}$ ring; high permeability $\frac{1}{2}$ core (Standard Telephones); complete Standard Telephones ring core.

obtaining our original inductance. As we now have less wire, we have obviously removed quite a large proportion of undesirable ohmic resistance from the coil, and accordingly, we have decreased our losses very considerably. This is the fundamental principle of the iron core tuning coil.

Hysteresis Losses

All this seems very simple, but as a matter of fact, there is quite a number of other considerations which complicate the problem enormously. Adding a magnetic core to a coil introduces other sources

(Continued from previous page.)

of the photographs (Fig. 1) is a photomicrograph of very fine iron filings. Compare this with the photomicrograph of a dust core material (Fig. 2), and the iron filings will look almost like large stones. When taking the photomicrographs, I employed equal magnification so that the comparison is a true one.

Several processes have been used for producing iron of minute grain size. Both mechanical and chemical methods have been employed, and, in some cases, the two have been combined. Some of the dust cores for radio frequencies are composed of fairly pure iron. When the iron is produced by chemical means, it is difficult to get anything but fairly pure iron because alloys cannot easily be produced by pure chemical reactions.

One of the most interesting processes which has been devised for obtaining very small iron dust is that known as the carbonyl process, the iron being deposited from iron carbonyl. The method is very similar to that used in the nickel carbonyl process. Haematite iron is also another source of supply, the iron being produced from haematite, which is one of the iron oxides, by a rather complicated process.

When mechanical means are used, the iron has to be ground into the form of a powder or almost impalpable dust. In such a case it is almost impossible to use a pure iron, because the iron would be soft, and it would tend to tear and drag. Accordingly, an alloy is generally employed which is of a more brittle nature. A hard brittle material can easily be ground down to a very fine powder. Quite apart from iron and other alloys, dust cores have been produced from partially magnetic materials, such as magnetic oxide of iron, and also certain magnetic pyrites.

An interesting point which arises in the use of a very fine powder is that of compressing it into a very small space. A very fine powder bulks tremendously because the particles have very little mass and lie very lightly upon each other. Accordingly, there is quite a large air space. If a quantity of powder is compressed, as soon as the pressure is released the particles tend to separate again. This difficulty, however, is easily overcome by adding a binding agent.

Binding Agents

Wax, gums, resins, shellacs, celluloid, and cellulose compounds have all been used as binding agents. The iron dust is made into a paste and is allowed to set. According to the nature of the binding material and the quantity used, so the resulting core material has varying degrees of mechanical strength. It is obvious that if too much binding material is used, the quantity of iron which can be obtained in a given space is reduced, which means that the permeability will fall. Accordingly, every endeavour is made to keep it down to a minimum.

Some iron cores have been produced by moulding at extremely high pressures with bakelite powder. Some of the earliest experiments consisted in loading ordinary

bakelite powder with iron, but, of course, the quantity of iron present was comparatively small. If the bakelite is reduced to a very small quantity, then the resultant core tends to become very brittle, and exceptionally high pressure is necessary in the moulding process. Brittleness is not altogether a defect, because it is not really practicable to wind the coil directly on the core for reasons which will be explained later. Accordingly, the core can be put into a small moulding which acts as a complete mechanical protection. Under these conditions the binding material can be reduced very consider-

insulating material between the particles must be small in quantity compared with that of the particles, as otherwise the permeability falls as already indicated. The best insulation is, no doubt, obtained by chemical methods in the form of a minute coating, but it is a matter of extreme difficulty to determine to what extent the particles of any core material are actually insulated. Microscopic examination even with high magnification does not yield much information.

Core Materials

The comparison of photographs of some of the various core materials and coils is interesting. One very popular form of core is in the form of a small ring of square or rectangular cross section. These rings are usually about 1½ in. in diameter, while the centre hole is about ¾ in. in diameter. A core of this type at radio frequencies may have a permeability of the order of 10. Two

examples of this are Atmalloy and Ferrocart. The former is a British commercial production which appears to be of the iron and binding agent type. The material is pressed into a small channel shaped ring moulding which can be clearly seen in the photograph. Ferrocart is a German production, and here the iron is deposited on thin paper, which is wound into the form of a ring, or alternatively, it is pressed into the form of sheets, which can be stamped into laminations.

A somewhat similar coil wound on a ring core is produced by Standard Telephones and Cables, Ltd. This has a permeability of the order of about 13, and accordingly, the cross section is smaller. When iron alone is used, the permeability depends very largely upon the proportion of iron to binding material, and the pressure which is applied.

Torroidal Winding

In order to take full advantage of the core material, it is general to use a closed core. This is done by winding the inductance either on a bobbin with a shell type core similar to an ordinary transformer, or utilising a torroid wind. A torroid wind consists of a coil which is doubled back on itself, so that the first and last turns are adjacent. Coils of this type have to be wound on a special machine, the wire being threaded round and round the ring as the winding proceeds.

A form of construction devised by the writer for torroid winding consists of splitting the core either into two or four sections, which are formed into a square. The four sections are wound separately on an ordinary machine, and the torroid is built up from the sections which are connected in series.

One of the difficulties in winding a torroidal coil lies in the accurate matching of a series. Slight irregularities are compensated for by moving the turns so that some are close together, and this has the effect of making a minute variation in the inductance. The turns are then subsequently fixed by some form of sealing compound.

(Continued on page 277.)

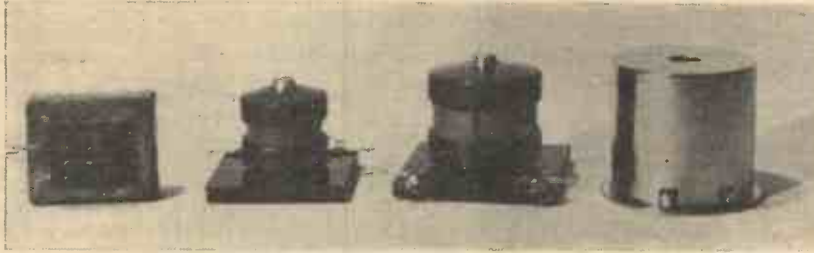

Fig. 4—German Ferrocart coils.

ably, with a resultant gain in the efficiency of the core.

Insulating the Particles

Many attempts have been made to improve the insulation between the adjacent particles, and quite a number of patents have been filed for various methods. Insulation between the particles is similar in effect to laminating an ordinary core stamped from sheet steel. The binding agent added to the core tends to serve as an insulating material between the particles, but in the writer's opinion, the problem of insulating the particles, if such is considered necessary, is one of the most difficult. This is a point which may not be universally agreed, but it is based upon the writer's own investigation. Some idea of the difficulty of insulating the particles can be obtained when it is remembered that the grain size of the iron in a high-frequency core may be only of the order

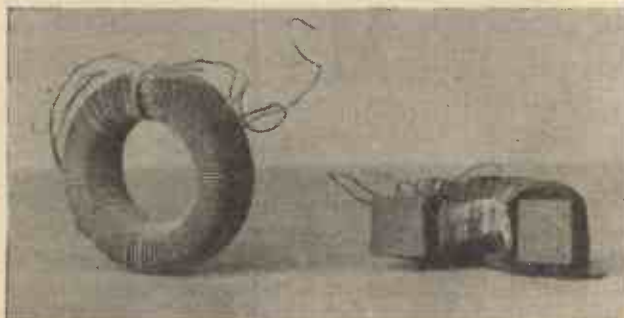

Fig. 5—Experimental complete and half torroid coils. Note the spaced winding on the larger core.

of a few thousandths of a millimetre in diameter. If we assumed a grain size of one five thousandth of a millimetre, and if we assumed that the grains were all circular, a representative small ring core would actually contain the amazing number of eighteen billion. When it is remembered that the grains are not all quite uniform in size, and that they pack in far more closely than they would if they were all in the form of uniform spheres, the quantity is probably about double.

The individual insulation of these grains is perhaps a rather more difficult problem than it appears to be at the outset. The

MAINS TRANSFORMER CONNECTIONS— How To Trace Them

WHILE at a friend's house the other evening he complained to me that the transformer in his all-mains receiver had burnt out some time ago. He had returned the defective component to the makers and they had forwarded a new one to replace it, but when it was unpacked it was found to be devoid of any markings to indicate to which soldering tags on the transformer the leads from the set were to be taken. Having no testing equipment with me at the time I turned out my friend's junk box and discovered a D.C. voltmeter reading 0.6 volts, and an old 25,000 Ω resistance, the winding of which was luckily intact.

Components Used For Testing

Fig. 1 shows the transformer as sent from the makers (the lettering above and below the tap is mine), and Fig. 2 shows the voltmeter, resistance and a H.T. battery wired up to provide the means to apply tests. The reasons for the inclusion of the resistance are twofold, firstly to safeguard the windings of the voltmeter as every test is commenced with the resistance full in, and secondly, to obviate the necessity of constantly changing the wander-plug in the H.T. battery.

On inspecting the set it appeared as shown in Fig. 3. At the top left-hand corner you will notice a voltage selector marked 110, 120, and 220 volts, and these together with the return to the mains plug, through the mains switch, show us that four tapings on the transformer are required to accommodate the mains (wires

9, 10, 11 and 12). By diligently tracing out the destination of the other leads, I found that No. 4 was from the earth, therefore it was H.T. negative, No. 7 was H.T. positive, as it eventually fed the anodes of the valves, Nos. 6 and 8 were the

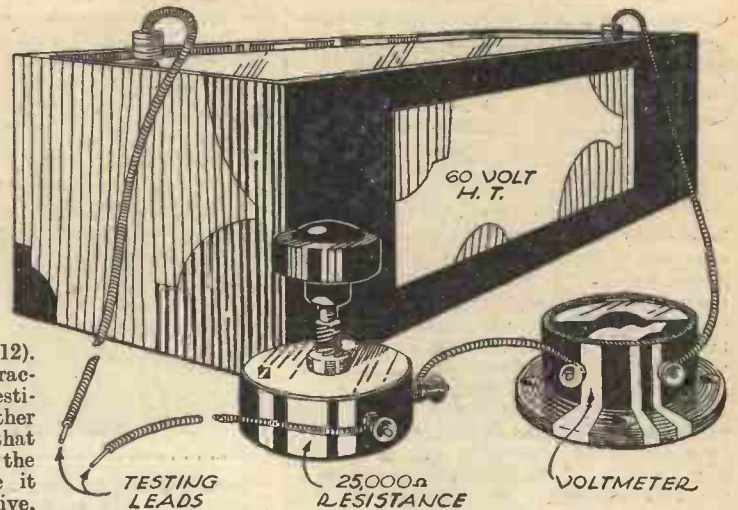

Fig. 2.—The testing equipment.

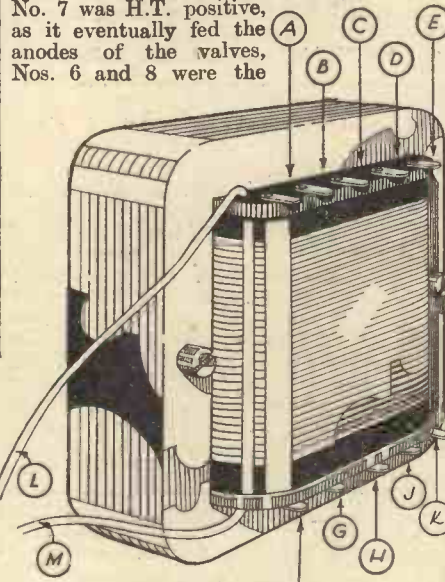

Fig. 1.—The transformer as sent from the makers.

filament wiring of the rectifier valve, and Nos. 3 and 5 were the plate connections of the same valve.—A glance at Fig. 4 will give you the idea of the circuit, and from this you will see that on the transformer there are four windings, two of which are centre tapped, the mains winding having four connections to it, as mentioned above.

The Testing Apparatus

The testing apparatus was then brought into play and somewhat indiscriminately testing between the taps on the transformer A, B, C and D were found to be connected in some way together as were also E, F, G; H, J, K; and L, and M. As the latter two leads were long flexible ones, and were the only long leads capable of reaching to the "hum-dinger" or centre-tapped resistance across the valve filaments in the set, these were assumed to be the A.C. supply to the filaments. Tags A, B, C and D were now tackled, and the readings on the voltmeter were carefully noted. Between A and B the reading was low; between B and C the reading was high comparatively, and between C and D the reading was again low, but slightly higher than in the case of A and B. From these tests it was evident that A is connected direct to one side of the mains, B is the 110-volt tapping, C is the 120-volt tapping, and D is the 220-volt tapping. An explanation of how I arrive at this may prove of interest. The difference between 0 and 110 volts is 110, the difference between 110 volts and 120 volts is 10, and the difference between 120 volts and 220 volts is 100. From this you will see that the resistance of A to B will be high, of B to C will be low, and of C to D will be also high, but on account of the slightly less amount of wire in this winding as compared with A to B (110 and 100) the reading on the voltmeter will be slightly higher.

Continuing the Test

I then dealt with winding E, F, G. The reading on the voltmeter was high, indicating a low-resistance winding, and the readings between E and G, and F and G were found to be equal,

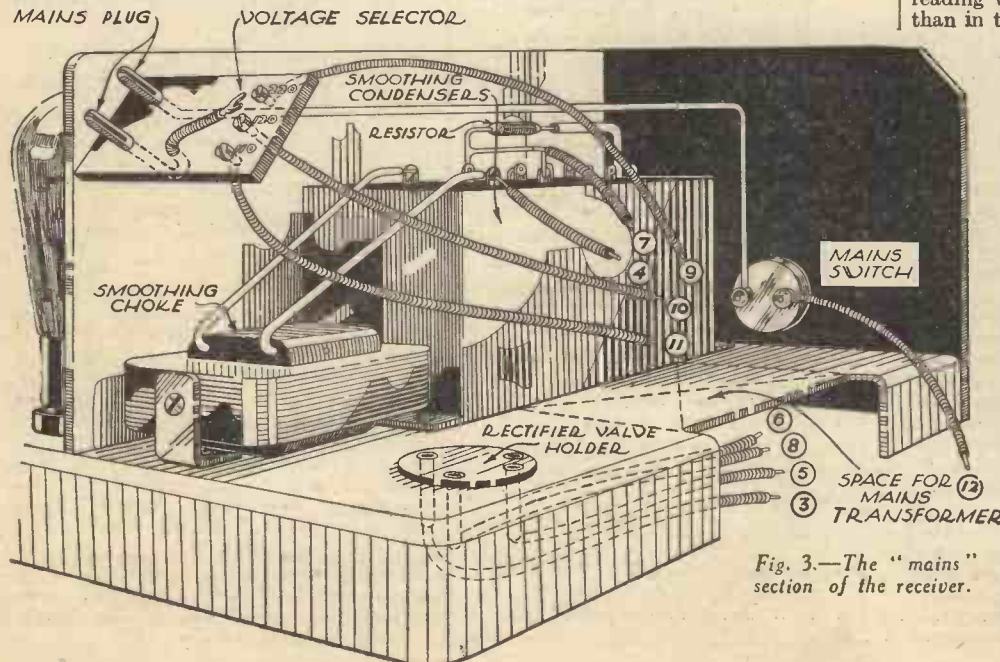

Fig. 3.—The "mains" section of the receiver.

COMPLETING—

SELECTONE A.C. RADIO-GRAM TWO



THE first thing is to mount the electric turntable, and the motor-board of the cabinet is already drilled for this purpose when obtained. The turntable has single-hole mounting, so it is only necessary to pass the bush through the hole provided, and secure it on the underside with the ring-nut. Felt washers are supplied with the electric turntable, and these should be arranged on the mounting bush to insulate the motor-board from vibration. Next, the Q.M.B. switch must be attached to one corner of the motor-board and a 7-16in. hole will be required for this purpose. Connections to the switch should then be made, as shown in Fig. 4; it can be seen that one wire of the twin flex is broken and the two sides of the break are attached to the switch terminals. As the flex supplied is a good deal longer than necessary, it must be cut off to such a length that it will just reach the primary terminals of the mains transformer when the set is placed in position.

Connecting the Pick-up

The pick-up can next be attached, its exact position being determined by means of the thick cardboard template supplied with it. As a matter of fact, the small hole in

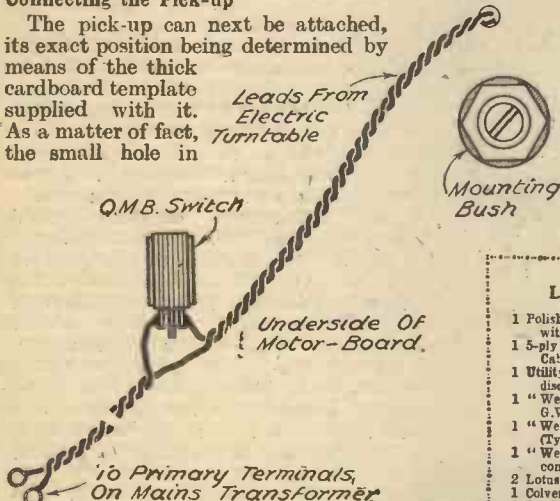

Fig. 4.—Showing connections for the Selectone turntable.

the right-hand corner of the motor-board almost exactly corresponds with the position for the centre of the pick-up base, so the connecting leads can be passed through this. It will be found that the pick-up lead is not long enough to reach the appropriate terminals on the set, and so it must be lengthened with a short piece of twin shielded wire. This is connected as shown in Fig. 5. There are three wires from the pick-up lead—two brown and one black—and the former two come from the pick-up proper, whilst the latter is connected to the metal parts and to the metal-braided shield; it is for "earthing" purposes only. The two brown wires are connected to the shielded wires and the black one is attached to the screening braid. These three connections are best made by soldering, and afterwards the joints should be covered with short lengths of insulating tape. At the "set" end of the pick-up lead a short wire is secured to

Details of construction of the set itself were given last week, and the process of completing the radio-gramophone is now dealt with.
By FRANK PRESTON, F.R.A.

the metal braiding and is joined, along with one of the ordinary pick-up wires, to that terminal which is connected to earth—this detail also is shown in Fig. 5.

As the metal screening braid of the pick-up lead is earth-connected, care must be taken that it cannot come into contact with other parts of the receiver. For this reason it is best to take the lead along the underside of the motor-board and down the side of the cabinet, loosely fastening it in position by means of small staples or brass cup-hooks.

LIST OF COMPONENTS

- 1 Polished Plywood Panel, 10in. by 7in. (supplied with Cabinet specified).
- 1 5-ply Baseboard, 15in. by 14in. (supplied with Cabinet specified).
- 1 Utility "Mite" .0005 mfd. Condenser with disc drive.
- 1 "Wearite" 3-point Wavechange Switch (Type G.W.C.).
- 1 "Wearite" Changeover (Radlogram) Switch (Type G.C.O.).
- 1 "Wearite" 20,000 ohm volume control with combined Mains Switch.
- 2 Lotus 5-pin Valve Holders.
- 1 Colvern Type "T.D." Coil.
- 2 Dubilier .003 mfd. Fixed Condensers.
- 1 Dubilier 400 mfd. Fixed Condenser.
- 1 Graham Farish Ohmite 1 megohm Grid Leak.
- 1 Graham Farish Horizontal Grid Leak Holder.
- 1 "Wearite" Screened H.F. Choke (Type H.F.P.).
- 1 Lissen "Hypernik" L.F. Transformer.
- 1 Lissen "Tone Compensator."
- 3 Belling-Lee Terminal Mounts.
- 6 Belling-Lee Type "R" Terminals, 2 marked "Pick-Up" and 1 each marked "A," "E," "L.S.+", "L.S.—"
- 1 Heyberd Type W.25 Mains Transformer, giving outputs of 135 volts, 70 mA. and 2-0-2 volts, 4 amps.
- 1 Heyberd Type 751 Smoothing Choke.
- 1 Westinghouse Style H.T.7 metal Rectifier.
- 4 Dubilier (400 volts D.C. working) 4 mfd. Condensers.
- 1 Dubilier (400 volts D.C. working) 2 mfd. Condenser.
- 2 Dubilier (400 volts D.C. working) 1 mfd. Condensers.
- 1 Belling-Lee Fuseholder with .5 amp. fuse.
- 1 Graham Farish Ohmite 100,000 ohm, 1 watt Resistance.
- 1 Graham Farish Ohmite 50,000 ohm, 1 watt Resistance.
- 1 Graham Farish Ohmite 1,000 ohm, 1 watt Resistance.
- 1 Graham Farish Ohmite 250 ohm, 1 watt Resistance.
- 1 Heyberd Mains Flex with Lamp Adaptor.
- 2 Coils Glazite, screws, short length flex.
- 1 Mazda A.C.2 H.L. Valve, metallized.
- 1 Mazda A.C.P. Valve.
- 1 Simpsons Electrical Turntable.
- 1 Becker G.M.B. On-Off Switch.
- 1 B.T.H. "Minor" Pick-up.
- 1 Celestion "Sounder" Speaker Chassis.
- 1 "Camco" Selectone-Tablegram Cabinet.

Using the Gramophone

To set the gramophone into operation the radio-gram switch should first be pushed in, the set switched on in the normal way, and the gramophone turntable connected by means of its own switch. Since the driving mechanism of the turntable consists of a synchronous motor, it will not rotate until the turntable is given a flick with the finger. Let it run for a few seconds to attain its normal speed before putting the pick-up on to the record. The volume of gramophone reproduction is varied by means of a small lever projecting from the base of the pick-up track arm, and it will probably be found that this has to be set to very nearly its minimum position in order to reduce volume sufficiently to make it suitable for the average room. At the end of a record, the pick-up is lifted off and the turntable stopped by holding a finger against the rim (it is not necessary to switch off the current between different records).

The Tone Control

The tone control operates just the same on gramophone music as on radio, and will be found very useful for cutting out needle scratch as well as for its normal purpose. It is not difficult to find a setting at which the scratch is almost entirely eliminated without producing any noticeable loss of higher musical frequencies. By making intelligent use of the tone control potentiometer, the greatest possible amount of enjoyment can be obtained from any record, and a slight adjustment for different kinds of music will prove very beneficial. As was pointed out last week, clockwise

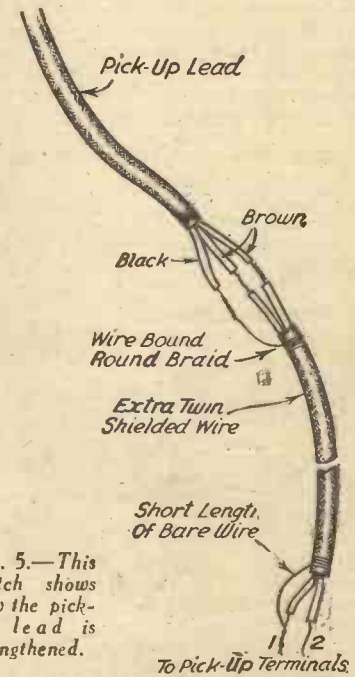

Fig. 5.—This sketch shows how the pick-up lead is lengthened.

rotation of the knob increases the set's response to the higher notes (and to needle scratch, incidentally), whilst an anti-clockwise movement produces a greater response to the bass.

THE HALF-GUINEA PAGE

Radio Wrinkles FROM READERS

Automatic Switch for Motor-board Light

THE accompanying sketches show a simple method of making an automatic switch for a motor-board light in a radiogram. A small strip of springy brass, A, is fixed to the back of

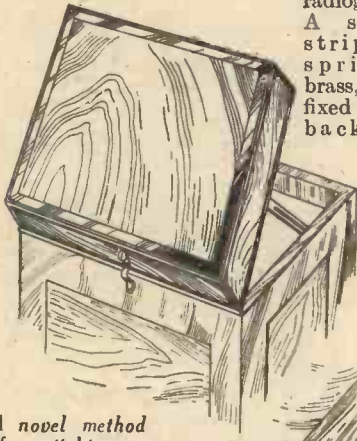

A novel method of switching a motor-board light.

the cabinet lid on the outside. This is bent as shown to form a contact; it should be drilled for a screw which holds it to the lid and clamps the connection. Immediately below it a large drawing-pin or flat head screw, B, should be placed, in such a position that when the lid is opened the strip rests on the head; the connection to this is merely placed under the head. The spring may be bent to make contact for any desired angle of the lid, which allows one actually to see the light extinguished before closing the lid tight; moreover, the switch does not disfigure the cabinet work since it is fixed at the back out of sight.—"LAMPLIGHTER" (Sunderland).

Machine for Winding Chokes

A SIMPLE machine for winding chokes and coils can be made as shown in the accompanying illustration, which shows

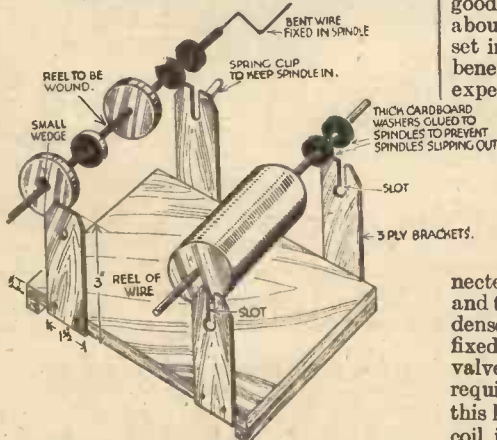

A simple machine for winding chokes and coils.

THAT DODGE OF YOURS!

Every Reader of "PRACTICAL WIRELESS" must have originated some little dodge which would interest other readers. Why not pass it on to us? We pay £1-10-0 for the best wrinkle submitted, and for every other item published on this page we will pay half-a-guinea. Turn that idea of yours to account by sending it in to us, addressed to the Editor, "PRACTICAL WIRELESS," George Newnes, Ltd., 8-11, Southampton Street, Strand, W.C.2. Put your name and address on every item. Please note that every notion sent in must be original. Mark envelopes "Radio Wrinkles." Do NOT enclose Queries with your Wrinkle.

the details of construction quite clearly. The machine can be made to fit any size choke or coil. The former to be wound is wedged to spindle, but wire reel can be left loose to travel along the spindle with the movement of the winding. When in use the machine can be clamped to a table.—E. HILL (Brynamman).

Improving Long-wave Reception

MANY listeners using a dual-wave coil receive only comparatively weak signals on the long-wave band, although

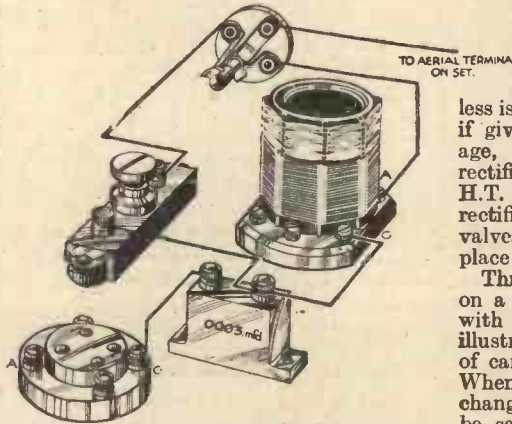

Adding components for improving long-wave reception.

reception of medium-wave stations is quite good. Here is a gadget which has brought about a marked improvement in my own set in this respect, and I pass it on for the benefit of other readers who may be experiencing the same trouble. Fix an old type three-point switch on the panel and take the aerial lead direct to the terminal of the switch which is in contact with the spindle, instead of to the dual-wave coil (see sketch). The terminal of the switch with the short tab should then be connected up with the aerial tapping of the coil, and that with the long tab to a pre-set condenser, and then through the usual .0003 fixed condenser to the grid of the detector valve. When medium-wave stations are required the switch is pulled out, and this has the effect of bringing the dual-wave coil into use. On pushing the switch in, the coil is cut out, and the result is a big

increase in the volume of long-wave stations.—T. THORNTON (Doncaster).

A Useful Connector

A VERY handy multiple connector, suitable for a variety of purposes where it is necessary to join several wires

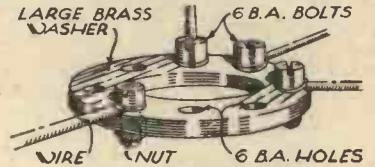

A useful multiple connector.

together at one common point, is shown in the accompanying sketch. This useful little gadget is made by simply drilling a ring of holes (to clear 6BA screws) in a brass washer of suitable diameter. Some 6BA. round or cheese-headed screws are slipped through the holes and, after looping the ends of the wires round them in the usual way, nuts are run on and tightened so as to grip the wires securely. Excellent connections result from this dodge.—NORMAN HURST (Wimbledon).

A Use for Old Valves

MANY readers have, no doubt, a few valves that have lost their emission, and, as far as wireless is concerned, are useless. These valves, if given a slightly increased filament voltage, will serve quite well as half-wave rectifiers. For those readers who have H.T. eliminators of the half-wave, valve rectifier type two or three of these old valves in parallel will effectively take the place of the standard rectifier valve.

Three valve-holders should be mounted on a piece of board and wired in parallel with a suitable resistance as shown in the illustration. A 30-ohm resistance capable of carrying at least 1/2 amp is necessary. When switching on the attachment or when changing its valves the resistance should be set at zero. The resistance can then be carefully adjusted to the minimum position at which satisfactory results can be obtained. Once set, the resistance should not be altered unless results become poor when it may be advanced a little. It is important to see that the valves used have together a filament consumption of at least .2 amps.—J. HICKMOTT (West Kensington).

(Continued overleaf)

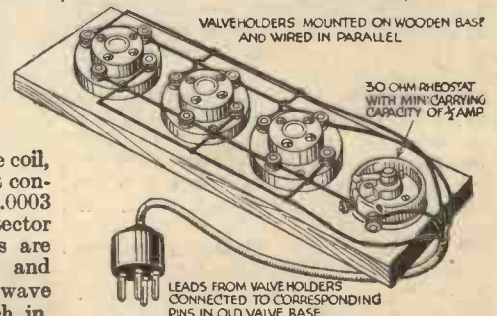

Using old valves as half-wave rectifiers.

RADIO WRINKLES

(Continued from previous page.)

Deflector for Speaker Cabinet

AS most listeners know, a loud-speaker cabinet should not be boxed in at the back, as this produces a hollow sound when speech is being reproduced. It is hardly enough, either, to bore a few holes in the back covering board, as it is sometimes done. Then the loud-speaker is generally placed with its back to the wall for convenience sake, and if it is too close

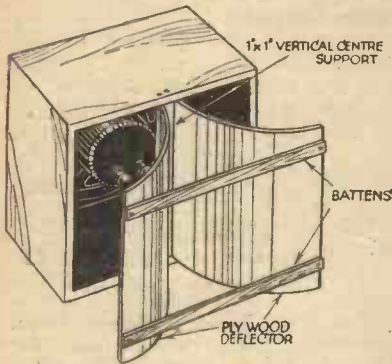

A deflector for a speaker cabinet.

some of the resonance effects of a built-in back will be noticed. The deflector boards here described, which can be fitted to any cabinet type of speaker, utilise to the full the vibrations emanating from the back of the cone, deflecting them side-ways and outwards, without producing resonance within the cabinet. The deflectors are made of thin plywood, which is screwed to each side of a central upright about 1/2 in. square. This upright is placed, just inside the back of the cabinet, and screwed top and bottom. The plywood is curved outwards in two halves, and held in place by one or more thin battens, say of 1 in. by 1/2 in., screwed across the backs. The curves of the boards should be somewhat as indicated in the diagrams. The increase in the total volume of sound from a cabinet to which this arrangement is fitted is very apparent to the ear. The device may be stained or polished to match the other part of the loud-speaker. For a cabinet 2 ft. square, two pieces of plywood about 23 in. by 17 in. will be required, and the battens of the same length as the cabinet is wide.—MERVYN KNOTT (Reading).

Plywood Panel Brackets

NEAT panel brackets can be made very easily from five-ply wood. They are cut as shown in the sketch and attached to the panel and baseboard with screws. When one bracket has been made it can be used as a template for the other, and if the constructor possesses a treadle fretsaw he can cut out both together. The size and shape could, of course, be altered to suit individual requirements. They can be stained to match the panel, and answer the same purpose as the commercial metal brackets, take up less space, are more easily fixed, and cost practically nothing.—C. ENGLAND (Sheffield).



A neat panel bracket made of plywood.

Using Loud-speakers as Microphones

HERE is an idea which might be of use to some readers, especially those who have the misfortune to have a relative ill in bed. I have my receiving-set and loud-speaker in the kitchen with an additional loud-speaker in a bedroom, and, naturally, these can be used in their proper capacity at the same time, but by throwing the switch attached to the additional speaker (No. 2) in the bedroom to the "mike" position that speaker becomes a microphone, and the sick person can transmit any message. By returning the switch to the ordinary position and then placing the switch of the kitchen loud-speaker (shown as No. 1) into the "mike" position that speaker becomes a microphone, and a reply can be given, and thus much saving of time and labour in climbing one or more flights of stairs is saved. By leaving the switch of No. 2 speaker in the "mike" position, No. 1 speaker can still be used to receive the broadcast programme, and any call made by the invalid will be heard above the received broadcast programme, provided, of course, that the latter is not being received too loudly—it should be toned down sufficiently. Reference to the sketch will show that the additional wires to the 1st L.F. transformer do not in any way affect reception when not switched in. There is a slight reduction in signal strength when No. 2 speaker is used as a mike at the same time as No. 1 is in use in its legitimate purpose. It should be noted that having

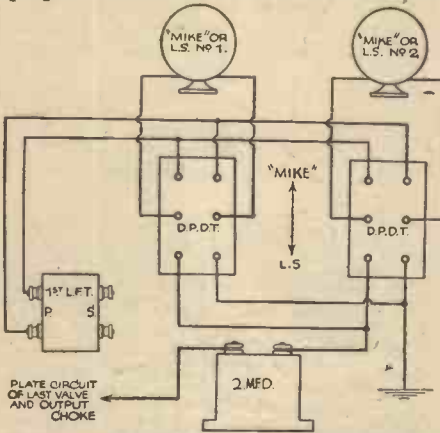

Method of using loud-speakers as microphones.

received a broadcast it will be necessary for that to be tuned out before No. 1 speaker is converted into a mike as otherwise the broadcast will be transferred to No. 2 speaker and the message might not be heard.—W. SULLIVAN (Merthyr Tydfil).

Covered-in Aerial-earthing Switch

READERS who use an outside earthing switch may find the following hint useful, as it prevents corrosion of the contacts by weather and also any undue leakage caused by rain, soot, etc. Materials required are one old wooden electric light fuse box with a hinged glass lid, one single pole double-throw switch with porcelain base, three lead-in tubes about 4 in. long, with nuts, and one cocoa-tin lid. Firstly, fill in the back of the box with a piece of 1/2 in. wood to which the switch has been screwed, and then drill a 3/8 in. hole in the top, bottom and one side of the box. Take the lead-in tubes to pieces and cut off about 1/2 in. of the ebonite tubing, and then cut the remainder in half. Bind some insulation tape around the centre of the brass rods to prevent it touching the sides of the hole, and re-assemble the lead-in

tube after threading the rod through a hole in the box and tighten up the lock nuts each end so that the ebonite is tightly butted against the wood on each side, and

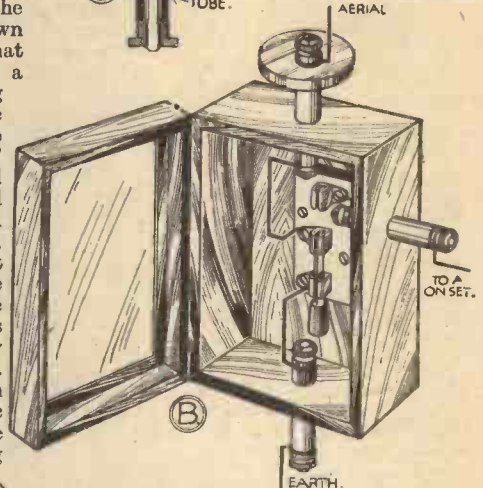
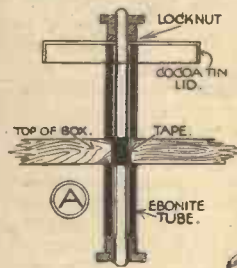

A weatherproof casing for an aerial-earthing switch.

lock nut, after having been drilled 1/2 in. in centre. This serves to throw off any rain which may settle at the base of the tube. Sketch B shows the completed gadget.—F. H. HOUGHTON (London, S.E.).

Plug Switch for Loud-speakers

THE accompanying sketches show a switch for connecting two loud-speakers in series, made from a couple of coil bases and five terminals. The pins were taken out of the coil bases, the holes being used for screwing to a wood base 4 in. long by 1 1/2 in. wide. One pin is converted into a wander plug. The wiring connections are shown in the sketches.—ERNEST TAYLOR (Bristol).

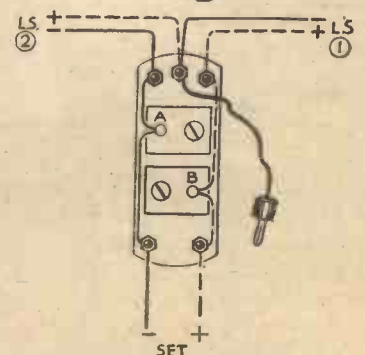

Plug-in switching arrangement for two loud-speakers.

SAFETY FIRST!

Further Suggestions for Protecting the Receiver and its Accessories from Damage. (Concluded from page 218, April 29th issue)

Preventing Reaction Condenser "Shorts"
REACTION condensers are always connected across the high tension supply, through the H.T. choke and reaction winding, so that a short-circuit might have disastrous results. The danger of a short is fairly remote when using a condenser of the bakelite type, but with one of the air dielectric variety there is always some chance of the vanes touching and thus ruining the high tension battery. This possibility can easily and effectively be guarded against by connecting a fixed condenser in series with the reaction condenser (either plain or differential) as shown in Fig. 12. The extra condenser will have no effect on the normal working of the set so long as its capacity is high in proportion to that of the reaction condenser—any value from .002 mfd. upwards will serve perfectly well.

especially if it exceeds some 400 volts, so a "thermal delay" switch is often included in the H.T. circuit to prevent any such damage. The switch has four terminals and is connected up as illustrated in the

ages it offers definite advantages from the "safety" point of view.

"Safety First" In Receiver Operation

So far we have considered the matter of safeguarding the receiver principally from what might be termed the constructional side, but there are a number of "safety first" rules which apply to the operation of our set. For instance, it is very unwise to make any alteration to grid bias voltages without first disconnecting the high tension supply, either by withdrawing the negative wander plug or by completely switching off. This rule is clearly stated on the instruction sheet accompanying every power valve, but is, nevertheless, frequently ignored because non-compliance does not necessarily result in any immediate perceptible harm. It certainly will lead to trouble sooner or later, since the anode current passed by a power or pentode valve jumps up to a very high value when grid bias is removed. As a consequence both the valve and the H.T. battery are subjected to a great strain.

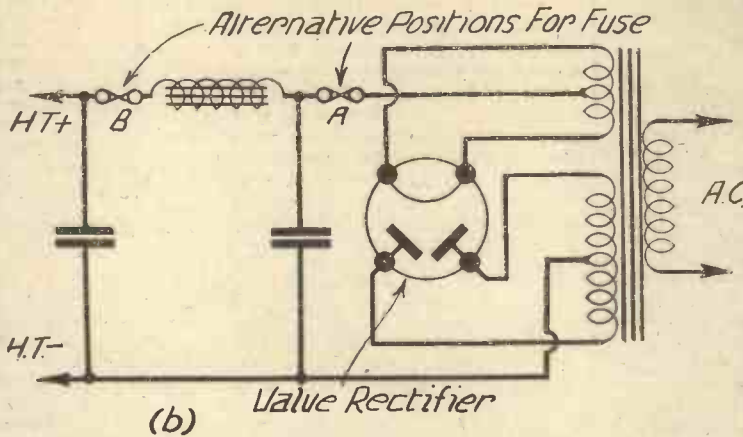

Fig. 10.—Alternative positions for fuses in a mains receiver; position A is to be preferred.

Thermal Delay Switches

To return to A.C. mains receivers for a moment. It is known that when first switching on, the high tension voltage rises to a very high peak value, often nearly

twice that maintained under normal working conditions. The reason for this is that some little time elapses before the cathodes of indirectly-heated valves heat up to their proper temperature. Until that temperature is reached the valves pass little or no high tension current and therefore there is practically no "load" on the H.T. supply—hence its excessively high voltage. This high peak voltage is liable to cause the breakdown of smoothing condensers and even of valves,

since the anode current passed by a power or pentode valve jumps up to a very high value when grid bias is removed. As a consequence both the valve and the H.T. battery are subjected to a great strain.

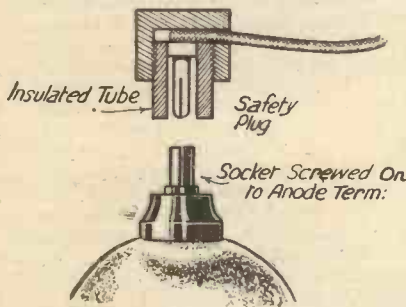

Fig. 11.—A safety anode connector.

twice that maintained under normal working conditions. The reason for this is that some little time elapses before the cathodes of indirectly-heated valves heat up to their proper temperature. Until that temperature is reached the valves pass little or no high tension current and therefore there is practically no "load" on the H.T. supply—hence its excessively high voltage. This high peak voltage is liable to cause the breakdown of smoothing condensers and even of valves,

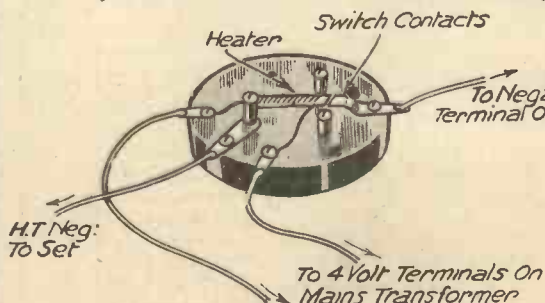

Fig. 13.—The connections for a thermal delay switch.

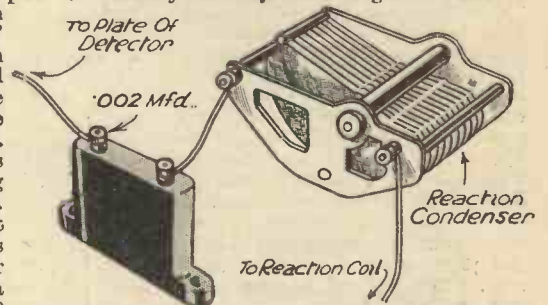

Fig. 12.—Preventing a short circuit of the H.T. battery due to the vanes of a reaction condenser touching each other.

Another important rule generally given on the instruction sheets of pentodes is that the anode circuit should never be broken whilst the priming grid is connected to the H.T. supply. The reason is that the sudden removal of the anode "load" causes a high "surge" voltage which can easily damage the valve. Interpreted into rather more simple language this rule really means that the loud-speaker should not be disconnected from a set using a pentode output valve without first switching off.

TONE-VOLUME CONTROL

A Cheap Combined Unit for Use with Loud-speakers and Radiograms

By A. C. BURNS, M.Sc., F.I.C.

VARIOUS tone-control circuits have been discussed from time to time in the radio press and some are available at any radio stores, though often by no means cheap. Generally speaking, the "tone control" incorporates some form of choke, condenser and variable

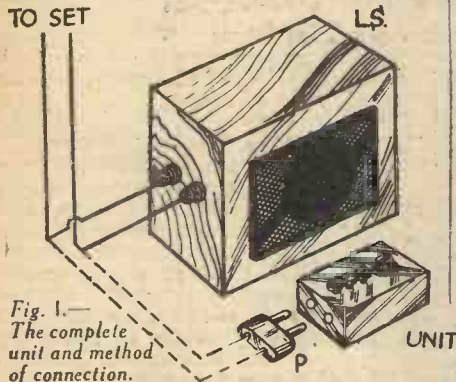

resistance or potentiometer and, for really effective control, these components must be of critical inductance, capacity and resistance respectively. It is not always safe to specify fixed values, for much depends upon the characteristics of both receiver and loud-speaker circuits and upon the type of loud-speaker in use. The correct values are determined only by careful trial and most experimenters are not sufficiently fortunate to be able to borrow sets of condensers, chokes, etc., from the radio stores with a view to determining their precise requirements before purchasing.

The writer has found the following components, if arranged as shown, to be effective when used with the "average" set. The unit is neat in appearance, conveniently small, and can be made up at a cost of 10s. 6d. The containing box may be constructed of quite thin wood, which, if dry, will demand no especial precautions by way of insulation. The only other items are:—One condenser, 0.1 mfd.; one choke, 0.3 henry (Wearite); three simplest form of push-pull switches; one variable resistance or potentiometer, 20,000 ohms; one simple form of jack and plug or one 2-pin plug and sockets. With the exception of the choke, these may well be taken from "spares" in your junk box. The choke is of rather unusual value, as regards inductance and capacity, and is especially designed by the manufacturers for use in tone-control circuits. A useful choke can be made up by winding 4,000 turns of No. 30 or 32 silk-covered copper wire round a 2in. former. About 1½ lbs. of wire are required and the resulting inductance is about 0.8 henry. It may even be found that a winding of one or other of your disused transformers will have a suitable choke effect, i.e., may cause a distinct cut-off or elimination of the lower notes when shunted directly across the loud-speaker terminals. In such case, the winding may be employed as a choke, provided

that it does not introduce an undesirable drop in volume. Chokes of higher inductance and condensers of higher capacity may be substituted, if available, since the effect of these is ultimately controlled by means of the variable resistance in the unit. This latter, however, should preferably not exceed 50,000 ohms, otherwise the rotation of the potentiometer knob will cause too sudden a cut-off instead of a gradual repression of higher or lower notes, as the case may be. Even a 1,000 ohms variable resistance may suffice in some cases, particularly in conjunction with moving-coil speakers with speech-coils of very low resistance.

It will be noted that the control is shunted across (i.e. is in parallel with) the loud-speaker terminals and is simply attached (see diagram 1) by means of 3ft. or 6ft. of twin-flex, provided with a suitable 2-pin plug. The unit may then be placed next to the speaker or may rest on the arm of a comfortable chair. Longer leads may be used, but are not always desirable, since long leads in themselves mean increased capacity, with possible losses in the higher frequency register.

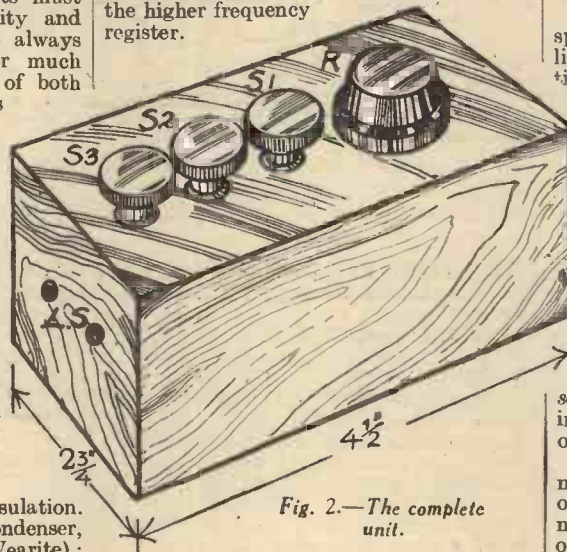

Fig. 2.—The complete unit.

To Operate the Unit

For volume only, leave S_3 and S_2 depressed, withdraw S_1 and slowly rotate the resistance knob, R. This method of controlling volume is very useful when the set is in one room, the speaker and unit being in another—at any rate, as a temporary measure, for naturally the better method is to control volume from the actual receiver end.

To remove bass notes and boomy reproduction, the "by-pass" effect is increased through the choke, causing the notes of lower frequency to gradually fade out. Leave S_1 and S_3 depressed, withdraw S_2 , and rotate resistance knob as before. Make a note of that point at which a more desirable "balance" is obtained in the reproduction, then depress S_2 and note the return to the original quality.

It will be observed that increased repression of the lower notes is accompanied

by loss of volume. The more the knob is rotated, the less resistance there remains across the loud-speaker terminals and the more the choke comes into action. The resistance of the choke windings is comparatively low, hence the fall in volume of reproduction. With the type of choke specified and with the "average" modern receiver, the fall in volume is slight, but with some outfits it may be necessary to boost up the signal strength somewhat by adding a little reaction, in proportion as the choke is brought more and more into effect. Most sets of to-day, however, have a good margin of volume to spare and are not normally (particularly in the evenings) working "full-out." Any loss in volume due to the use of the tone-control choke, therefore, may be remedied by turning up the volume-control of the receiver itself.

This method of control is very useful in eliminating to some extent the excessive "boom" which is associated with some of the cheaper moving-coil speakers of to-day and with some of the dearer, but now obsolete, patterns. Certain gramophone recordings, too, are inclined to be boomy in reproduction and this may be improved by the use of the control choke. Usually, however, the fault with reproduction from records lies in the other direction, i.e. needle-scratch and associated high-frequency noises.

Muffled Speech

You have doubtless, at times, found speech to be somewhat indistinct when listening-in to Daventry National, particularly when using a good receiver and speaker of up-to-date design. The effect is sometimes so pronounced as to render a radio play from this station too difficult to listen to with comfort. The fault is not at the receiving end and will doubtless disappear when the new transmitter is erected. As an experiment, note the quality of the announcer's voice during the 6 p.m. News Bulletin transmission from Daventry National. Then switch over to Midland Regional, or, better still, to Northern Regional to hear the same transmission. Note the difference and improvement in the quality of reproduction of the same voice from these latter stations.

Now return to Daventry National and, by means of the tone-control, gradually cut off the lower notes until the speech becomes more crisp and "definite." Quite a number of so-called good moving-coil speakers give somewhat poor reproduction of speech, and, therefore, benefit by tone-control. On the other hand, the better-class balanced-armature cones usually give an attractive crispness to speech, simply owing to their failure adequately to produce notes below a certain frequency.

(Continued on page 260.)

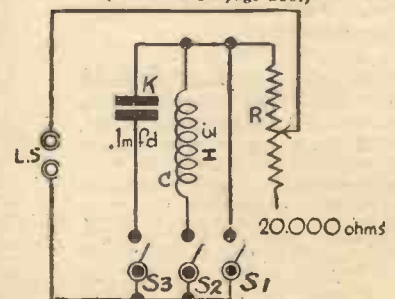
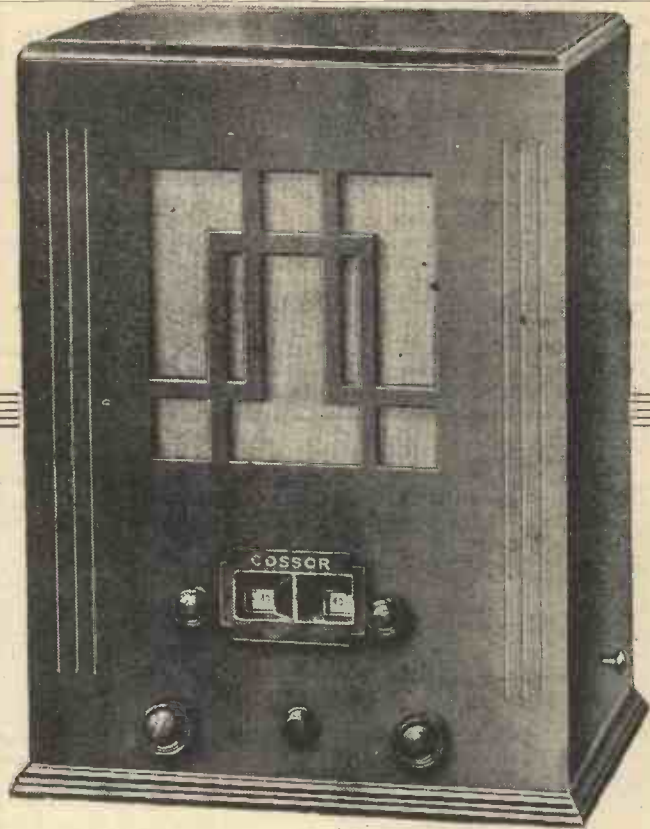

Fig. 3.—The theoretical circuit of the unit.



KINGS OF THE AIR



"I am more than delighted with the Melody Maker. Its **TONE** and **SELECTIVITY** surpass anything I have yet tried ... **VOLUME**... more than required when on full"

BATTERY MODEL 335

With Self-Contained Loud Speaker

Kit of Parts includes 3 Cossor Valves (220 V.S.G. Variable-Mu Metallised Screened Grid, 210 H.L. Metallised Detector and 220 P. Output); Individually Shielded Coils. All-metal Chassis and all parts for assembling the Receiver as illustrated; handsome cabinet 18½ in. x 13½ in. x 10½ in. and 10 in. Balanced-Armature Loud Speaker. Provision is made for fitting Gramophone Pick-up Socket and Plug.

Price **£6.17.6**

Hire Purchase Terms: 17/6 deposit and 9 monthly payments of 15/-

BATTERY MODEL 334

Kit of Parts, similar to Model 335 except that no loud speaker is supplied. Handsome cabinet 10½ in. x 17½ in. x 13½ in. Price

£5.15.0

Hire Purchase Terms: 15/- deposit and 9 monthly payments of 12/6

BATTERY MODEL 333

Kit of Parts, complete with Valves for building Cossor Melody Maker Chassis for fitting to your own cabinet. Specification as Model 335 but without loud speaker or cabinet. Price

£4.19.6

Hire Purchase Terms: 15/- deposit and 9 monthly payments of 10/6

And that is what a delighted Cossor user thinks about his new Melody Maker. You too can enjoy such praiseworthy radio performance at a price lower than ever before. And when you realise that the Cossor Melody Maker incorporates a Cossor Variable-Mu Valve . . . individually shielded coils . . . graded volume control, in fact every up-to-date feature in radio design, you will readily appreciate why the Cossor Melody Maker represents the greatest possible value-for-money in Screened Grid Radio. The coupon will bring you full details.

COSSOR MELODY MAKER

Prices do not apply in I.F.S.

To A. C. COSSOR LTD., Melody Dept., Highbury Grove, London, N.5

Please send me free of charge a full size Constructional Chart that tells me how to build the Cossor ~~All Electric~~ Melody Maker.

~~Battery~~ (*Strike out type not required).

Name	My usual Retailer is
Address	Address
PRAC. 6/5/33.	

ALL-ELECTRIC MODEL 337

With Self-Contained Loud Speaker

Kit of Parts for All-Electric Melody Maker Model 337 similar to Model 335 (as illustrated) but for all-electric operation, including Cossor Valves, hand-somely finished Cabinet, 18½ in. x 17½ in. x 10½ in., Loud Speaker and all parts. For A.C. Mains only 100-125 or 200-250 volts (adjustable), 40-100 cycles. Price

£8.10.0

Hire Purchase Terms: 20/- deposit and 9 monthly payments of 18/6

ALL-ELECTRIC MODEL 336

Kit of Parts, similar to All-Electric Model 337 except that no loud speaker is supplied. Handsome cabinet 10½ in. x 17½ in. x 10½ in. Price

£7.10.0

Hire Purchase Terms: 21/- deposit and 9 monthly payments of 16/-

ALL-ELECTRIC MODEL 338

Kit of Parts for All-Electric Melody Maker Model 338 Chassis. Identical with Model 336 except that no cabinet is supplied. Escutcheon and template for drilling your own cabinet is included. Price

£6.15.0

Hire Purchase Terms: 28/6 deposit and 6 monthly payments of 20/-

Models 336 and 338 are available for use on A.C. Mains only, 200 to 250 volts (adjustable), 40-100 cycles.

(Continued from page 258.)

To Restrict the Higher Notes: Control of Gramophone-Needle Scratch and Heterodyne Whistles

Depress S_1 and S_2 , and withdraw S_3 . Rotate R and note gradual suppression of the higher notes with "apparent" introduction of more and more bass. Actually, of course, the bass notes cannot be produced by the control unit, but only appear to be increasing in proportion as the higher notes are eliminated. This form of control is not usually required in conjunction with moving-coil speakers, as it would only serve to introduce boominess. It is, however, useful with several types of balanced-armature cones and similar speakers, also with certain horns, with their over-dominant high-pitched notes.

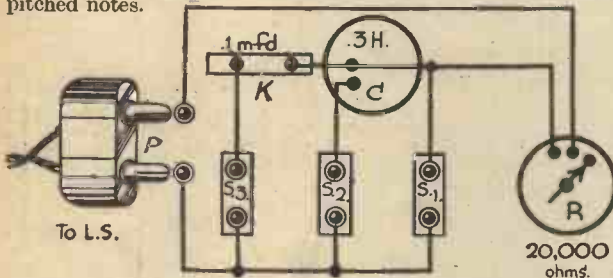

Fig. 4.—The switches, choke etc., connected in semi-pictorial form.

Certain forms of heterodyne whistle and, in some cases, other interference noises of a high-frequency character, can be partly depressed by means of the condenser (K) controlled by the variable resistance (R). Complete removal of these whistles, etc., would, in many cases, mean an undesirable depression of the higher notes of the musical scale. The adequate removal of

heterodyne whistles requires more critical values of choke, condenser and resistance than is available in this tone unit, and careful tuning to a particular band of frequencies is necessary.

Radiogram Control

A certain degree of tone-control is useful in radiogram operation. The scratch-level of some makes of record is unpleasantly prominent, and will permit of a certain amount of reduction without serious loss of "brilliance." Needle-scratch is associated also with mechanical resonances in the pick-up itself, but this aspect of the subject does not call for discussion here. The ideal operation of radiograms, especially where these are housed in too lightly-made cabinets, is to have the receiver and turn-table in one room, the speaker in another. The radiogram, naturally, has its own volume and tone-control, but the above-described unit, being alongside the speaker in the other room, naturally allows of some further control.

The "Beginner" in radio matters commonly fails to appreciate why there should be such differences in the quality of reproduction from different makes and types of loud-speakers (not forgetting, too, differences in receiver circuits), which are yet reproducing one and the same transmission. A few experiments with this type of tone control will quickly reveal the even drastic effects of introducing further capacity, inductance and resistance to either loud-

speaker or receiver circuits. After all, both receiver and speaker are made up of components of varying degrees of capacity, inductance, and impedance. Tone-controls essentially improve the "balance" of reproduction by removal of undesired or over-stressed frequencies—they cannot add anything that is not already present or which the receiver itself cannot pass on to the speaker. Do not, therefore, expect significant results when operating the control choke (S_2) in conjunction with some types of balanced-armature cone speakers, though there will be a distinct effect with speakers working on the inductor principle. Most older pattern cone and horn units do not adequately reproduce the bass notes at the lower end of the scale, so that there is little or nothing for the tone-control to cut out. If you find this to apply to your speaker, then obviously you ought to instal a new one with a much wider frequency response.

Furthermore, bear in mind that a good loud-speaker does not necessarily improve a bad receiver—indeed, it will more probably reveal defects which the older speaker was incapable of reproducing. In this respect it obviously follows that the failure of a speaker adequately to respond to manipulation of the tone-control unit may be due actually to deficiencies in the receiver itself and not in the loud-speaker. Such deficiencies may be traced to the incorporation in the receiver circuit of obsolete forms of chokes, transformers, condensers, etc.

In conclusion, units of the type above-described are most efficient when the loud-speaker windings are choke or transformer-coupled to the output valve, thereby preventing saturation of the choke.

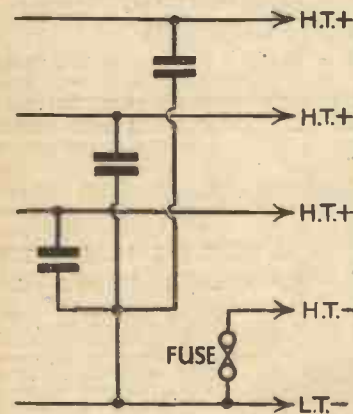

Fig. 1.

It is not always appreciated that the positioning of a fuse in a wireless set, although in itself a simple matter, is liable to cause trouble unless certain points are watched. This fact was demonstrated quite forcibly when some routine tests were being undertaken on a powerful five-valve wireless receiver fed from H.T. batteries and an accumulator. After all the connections had been made, the set was switched on via the appropriate control, but no signals could



The abnormal current under these conditions would naturally be sufficient to blow the fuse lamp filament and each condenser was therefore tested separately but found to be in perfect condition. Another solution had to be found, and since it was known that when a large capacity fixed condenser is charged initially, there is a momentary heavy current rush, it was felt that this in itself may have been sufficient to cause the burn out.

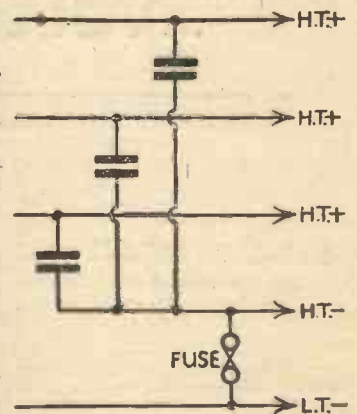

Fig. 2.

be heard in the loud-speaker. It was confirmed that the valve filaments were operative, but the set still appeared "dead," so a few quick tests were made with a voltmeter in order to locate the fault.

It was soon found that an H.T. fuse, in this case a low consumption bulb filament rated at 60 milliamperes, located between the H.T. — and L.T. — terminal connections, was burnt out. A replacement was effected immediately and the set switched on once more. Still nothing happened, and on re-examining the fuse it was noticed that the bulb filament had burnt out again.

A Charging Current

Attention was therefore turned to the set itself and although everything appeared in perfect order it was noticed that the 2 mfd. fixed condensers were shunted between the H.T. + and L.T. — tapping as indicated in Fig. 1. If it happened that any of these condensers had developed a short circuit, obviously this would cause a short circuit between the H.T. + tapping and the H.T. —, since H.T. — was joined to L.T. — through the fuse and in consequence the lamp was in circuit.

To safeguard the fuse from this, therefore, the common ends of the existing 2 mfd. condensers were joined to H.T. — instead of to L.T. — as shown in Fig. 2. The fuse was in this way removed from the "charging current" circuit and on switching on the receiver again all went well. Just bear this little point in mind when a similar thing happens in your own case.

Something Secret

THE conversation in suburban trains covers a wide range of topics, of which radio holds its own. I could not help overhearing an argument the other morning on the relative qualities of two receivers. One radio fan said he had a receiver "with a wavelength capable of picking up the programmes from the most distant stations." In the ordinary course of events this remark would not have been noticeable for any trace of particular interest. My brain must have been extremely active, for it appeared to me he must have trained the wavelength to go out and bring back the goods. Not knowing how much programmes weigh, I wonder whether this is a feat of strength or not, but anyway, it's a good stunt to have such a receiver.—L.K.



THE ills to which radio sets are heir may be divided into three main classes; the total failure of the set to reproduce signals, distortion of the programme and the development of noises not included in the broadcast. The first two types of trouble from their very nature are comparatively easy to detect, the one by finding by a process of substitution the faulty component or connection, and the other by investigating operating conditions, checking anode and bias voltages, component values and the like. But unwanted noises are often due to quite obscure causes, and the defects



Fig. 1.—Getting a flat and clean surface on a terminal.

are far more difficult to trace, and when found, usually require far more skill in curing. Noises may, in their turn, be subdivided into two classes, those due to external influences, and commonly known as "interference," and those due to defects mainly within the receiving apparatus.

Symptoms, Causes and Cures

Interference has recently been treated exhaustively in PRACTICAL WIRELESS, so this article will be devoted almost exclusively to a survey of the symptoms, causes and cures of these noises—scratchings, crackles, pops, howls and hums which may be generated within the set itself. The main causes of noisy reception are, first, poor contacts and partial disconnections; second, partial or intermittent short circuits; third, the effects of accumulations of dust and damp; fourth, poor condition of batteries and other components; and fifth, mechanical causes.

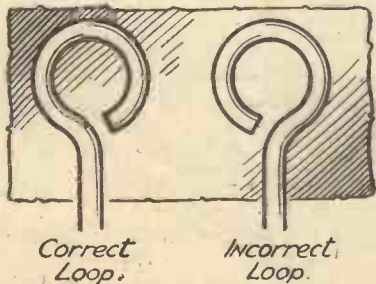

Fig. 2.—The correct method of making a loop to avoid looseness.

A Talk About Eliminating Noisy Reception.
By BEAT HEAVYCHURCH

Poor Connections

The operation of a radio receiver depends upon the passage of electric currents of various sorts—radio frequency, audio frequency and direct current, through circuits consisting of many different pieces of apparatus—coils, condensers, chokes, valves, resistances and transformers. Each of these components has to be connected into the circuit by wires, and the number of different joints and connections in even the simplest set amounts to several dozens, and even more if the permanent connections within the components are taken into consideration. Each of these many joints is liable, if incorrectly made, to be a source of noise, and there is also a risk of wires breaking.

The actual noise generated by such a fault may range from a scratching or breathing sound to violent crackles, depending

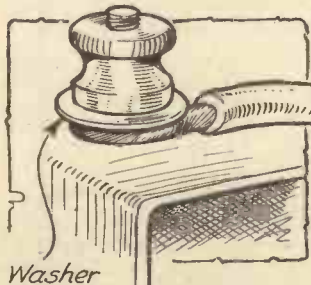

Fig. 3.—A washer used to clamp flexible wires tightly.

upon the part of the circuit affected, and the nature of the current flowing in it. The most common locations of loose contacts are loose terminal screws. Although I am a great believer in soldered joints, I realise that a good screwed joint is far better than a poor soldered connection. There are some people who just cannot solder, easy though the job is when rightly tackled, and for them, I say, make screwed joints. But do see that the nuts are tightly screwed up, and that they and the wires they secure are scraped or sand-papered clean and bright. (Fig. 1).

Oxydised surfaces never make good and permanent joints, and sooner or later crackles will develop. When binding wires under a nut, make a loop in the wire in a clockwise direction, that is, from left to right (Fig. 2). Then it will not work loose. Do not try to screw a flexible lead under a nut. One or more strands are bound to work loose and jam the screw thread,

and you will never tighten it down. In this case, place a washer between the flex and the nut (Fig. 3). The same precaution is recommended if more than one wire is to go under one nut.

Corrosion

Low-tension battery connections are very liable to produce partial disconnections due to corrosion, either at the terminals or in the wires due to the creeping

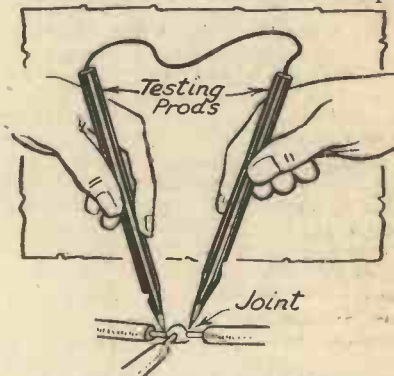

Fig. 5.—Bridging a joint to test a soldered connection.

of acid or fumes (Fig. 4). The terminals should be sand-papered bright each time the connections are made, and the wires should be well protected by good rubber insulation. High resistance contacts in the low-tension wiring give rise to most annoying disturbances. A frequent culprit is the battery switch, the spring contacts of which, by long use, become bent outwards and fail to make good connection. The remedy, a pair of pliers, is obvious, but the operation requires a little care.

Another very frequent cause of poor connections is the "dry" soldered joint—a joint in which the junction is mechanically strong, but which, because of dirt, which causes the formation of a kind of non-conducting slag, is of high electrical resistance. Dry joints are extremely difficult to detect. If a dry joint is suspected

(Continued overleaf.)

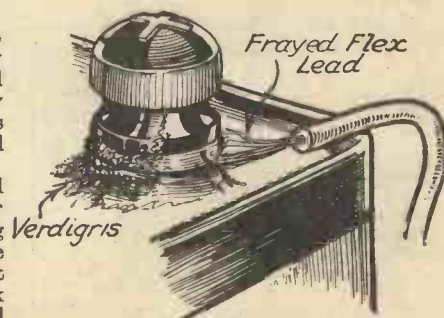

Fig. 4.—The effect of acid splashes and fumes on flexible wires.

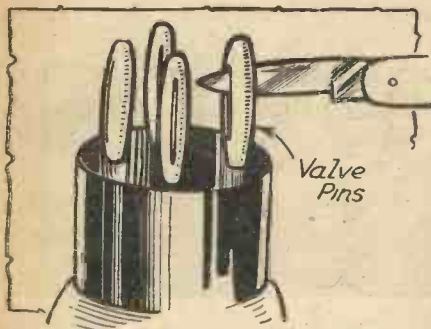

Fig. 6.—The old type valve legs should be opened to ensure a tight fit in the socket.

(Continued from previous page.)

in any set being tested, go over all the joints with a good hot iron and a spot of Fluxite—but a less drastic method is to bridge each joint in turn with a temporary connection, such as the testing prods (Fig. 5) which every amateur should possess.

Poor contacts often occur at valve holders. Sometimes the trouble lies in the valve pins, which require gently opening out with a small penknife (Fig. 6) or, if the pins are of the solid type, the sockets of the valve holder may require similar attention. A vulnerable point in many valve holders is the spot where a riveted joint is made between the socket and the metal part which forms the terminal. It is best to avoid holders with riveted joints if possible, and to select those where all the metal for any one terminal is in one piece.

Partial and Intermittent Connections

Closely allied to bad joints are partial disconnections and intermittent connections. These are almost always the result of broken wires inside some sealed component. The primary windings of intervalve transformers are a fruitful field for reaping this form of trouble—secondary windings are not so liable, because they do not carry current, and are, moreover, isolated from the high tension battery. High-frequency chokes, connected in the anode circuits of high-frequency and detector valves, are also susceptible to break-down in this way, and these two types of component should be among the first to be tested if a broken connection is suspected. What often happens is that a wire breaks off short in the winding at the point where it is connected to the terminal of the component, and makes partial or intermittent contact. This can usually be detected by tapping or shaking the component, when the scraping together of the two disconnected parts will cause a great increase in the crackle.

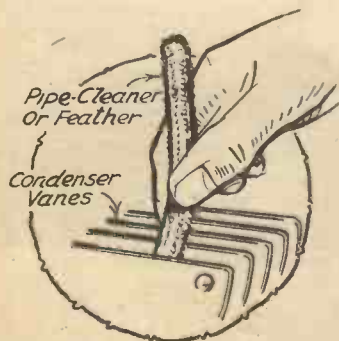

Fig. 8.—Dust in between condenser vanes gives rise to grating noises when tuning.

An intermittent or poor earth connection (Fig. 7) will often produce both loss of volume and a greatly increased tendency to oscillation. If your trouble is general instability of the receiver, look first to your earth.

Most distressing noises are produced by partial or intermittent short circuits on the high-frequency side. Often the trouble can be traced to an aerial or down lead which, in windy weather, chafes against a gutter, a tree branch or other body. Gradually the insulation is rubbed off, and then, every time the swinging wire touches the object, there is a momentary earth connection. A general tightening up, and perhaps a hold-off insulator will put matters right.

A partial or intermittent short circuit can also easily occur in variable condensers, due to one or more of the vanes being bent so that a moving vane touches a fixed plate. In the case of tuning condensers a harsh, grating noise will result, but in the case of reaction condensers, the noise will be much louder and even alarming, due to the fact that high tension current is being made and broken at the short circuit. This trouble can be tracked down by switching off the set and gently turning each condenser dial, when a grating contact will be heard and



Fig. 7.—Make sure the earth connection is sound.

felt. Re-adjustment of the condenser plates is rather a delicate operation, but if the fouling is not very severe, a repair is well worth trying. A partial short is sometimes found in reaction condensers on metal panels due to the breakdown or careless fitting of insulating bushes.

Dust and Damp

It is really extraordinary how much dust and dirt can enter the best designed radio cabinet, while if the case is properly constructed, or open at the back, as so frequently happens in radiograms, or if the set is used without a cabinet—a favourite trick of ardent constructors, its condition after a week or two will be deplorable. Dust, and even insects between condenser plates is a frequent cause of crackling. The only remedy is to dismount the condenser and carefully clean it with a bent pipe cleaner or feather (Fig. 8). A layer of dust, especially damp dust, will greatly alter the value of a grid leak, render a fixed condenser leaky, and cause considerable fluctuations in the resistance of fixed resistors. All these effects may produce noisy reception. Periodically every set should be examined and cleaned up. If a vacuum cleaner is available, a few minutes attention with this machine will work wonders (Fig. 9), and a small pair of bellows is not to be despised. High tension batteries should also be wiped over occasionally, as accumulations of damp and dirt cause high-tension leakage and more noise.

Another large class of "noise faults" are those due to deterioration of certain essential components and accessories. Failing low tension is apt to be noisy, because the filament current varies and "modulates" the anode current. Similarly, a worn out high tension battery develops varying resistance and thus varying high tension current, the changes in value being passed on from valve to valve as the unwanted modulation. The worst possible case, of course, is where a high resistance fault develops in a part of the equipment which is common to the circuits of several valves. The normal variations in anode current of one valve cause a varying voltage drop across the high resistance fault, and this is reflected in the anode circuits of all other valves. Low frequency instability is thus set up, and its effects may range from a gentle "ticking" to the "pop-pop-pop-pop" reminiscent of a motor boat, while in really bad cases unbearable howling is generated. The cure, of course, is to maintain batteries in efficient condition, and to guard against motor boating by decoupling the anode circuits of the various valves.

Microphony

Cracklings in moving-coil speakers are often due to loose connections to the moving coil; scratchings and scrapings may be due to the coil being out of centre—good speakers have provision for adjusting the centering — or even to vibration of the tinsel commonly placed behind the fret.

Two other causes of unpleasant noise need mention. First, microphony—that building up of a whistle, shriek or groan due to the vibration of valve electrodes under the influence of a powerful loud speaker. The vibration may be conveyed from the speaker to the valve via the chassis, or through the air. Mounting the valve holder on a sorbo pad, and damping bulb vibration with plasticene stuck on the valve are partial remedies, but usually a badly microphonic valve needs changing for one of a newer non-microphonic construction. If possible, the loud-speaker should not be situated close to the high frequency or detector valves, but where this is unavoidable, the precautions mentioned above are still more essential.

Mains hum is most objectionable. A well designed A.C. mains set should be perfectly hum free. It is impossible, in the space at command, to give complete instructions for curing hum, but a potentiometer for obtaining the true electrical centre of the filament transformer secondary, overhaul of the smoothing circuit, attention to earthing and the spacing out of A.C. leads are the first points to be attended to. In particular, A.C. leads, whether mains leads or low tension wiring, should be kept as far as possible from the H.F. and all grid wires. Ample smoothing, decoupling of anode and grid circuits, including automatic bias devices, may all be necessary to cure really bad cases.

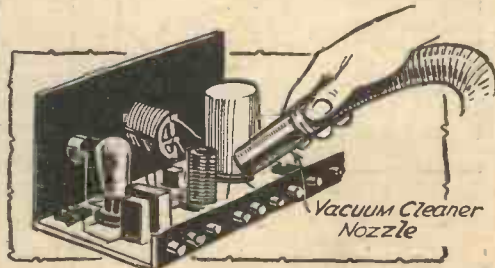
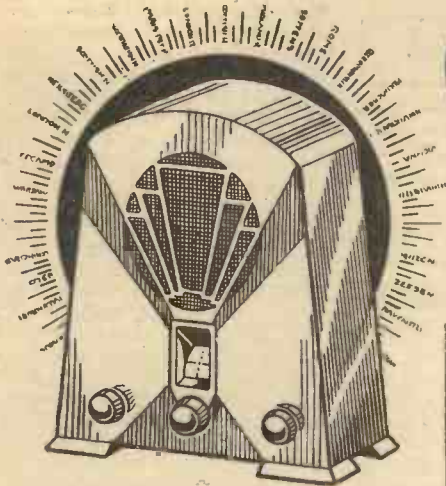

Fig. 9.—A vacuum cleaner will remove the greatest of all troubles—dust.

OUR VIEWS ON RECEIVERS



IN this receiver we have several most ingenious and novel features, and it certainly represents a radical departure from normal set design. Starting with the cabinet it will be seen that this does not follow the orthodox arrangement of a small loud-speaker grille situated above or below the tuning controls, but it is cut out to form a pleasing design all over the front, and attractive silk backing is employed to set off the design. The baffle for the speaker is a separate board fitted behind this silk, and this prevents the rather obvious lay-out which characterizes the ordinary set. Situated in the centre of the front is a most elaborate tuning dial, and this is unlike any other which we have so far seen. Two ivory scales are arranged round the tuning knob, and these scales are graduated in stations, wavelengths and kilocycles. The principal European stations are marked, and, therefore, it is most simple to tune to a station by using the name, the wavelength or the frequency reading appropriate to the station. In place of the customary pointer a beam of light is employed for tuning, and this is brought into operation by pushing the tuning knob in towards the cabinet. When this is pushed a short way a contact is made and a small pilot lamp enclosed in a narrow metal box is illuminated, and the carrier for the lamp is turned

SIX-SIXTY TYPE 3-32 CHASSIS

with the control knob. This is situated behind the ivory scales and is quite close to the scale and, therefore, a very narrow beam of light is seen to travel round the scale as the knob is turned. When the required setting is obtained, the knob is pulled slightly outwards and the lamp is extinguished, thus saving an unnecessary drain on the accumulator.

The Circuit

The other details will be mentioned as they are met in the examination of the circuit, which follows the more or less standard arrangement of screen grid, detector and pentode valves. Special Six-Sixty valves are employed, the output being a S.S. 220 Pen, which operates with a very small grid-bias, but gives quite a large output. The small grid-bias required is obtained by means of a resistance in the common negative circuit, and thus the necessity for a grid-bias battery is avoided. Capacity reaction is employed, and the condenser which is employed for the purpose is mechanically linked to a variable resistance which is connected between aerial and earth. Thus selectivity is slightly improved as the reaction is advanced, as the input to the grid circuit of the S.G. valve is reduced and the signals in the detector circuit are increased. This forms a very valuable feature in tuning and greatly assists in receiving a distant station clear of interference. The remainder of the circuit is more or less standard, but all values appear to have been chosen so as to obtain not only the maximum signal strength from each stage, but also to ensure stability and obviate risk of breakdown.

The Controls

The front of the cabinet, as has already been stated, is occupied principally with the loud-speaker grille design and the main tuning control, and, in addition to this, there are two small knobs situated on the right and left, and slightly below, the main tuning knob. The left-hand control is the main selector switch, and this is provided with four separate positions. When upright, the medium waves are in use, and when turned one-quarter of a revolution to the right the long waves are brought into action. A further rotation of a quarter of a circle brings the gramophone pick-up connections into circuit, and the final quarter of a revolution switches the receiver off. The right-hand control is the reaction device,

which has already been mentioned. At the back, all that can be seen of the receiver is the rear portion of the metal chassis, on which is a small adjusting screw for the aerial trimmer, and this obviously only requires adjusting when the receiver is first put into commission and thereafter may be ignored. The H.T. negative lead is provided with a fuse-plug.

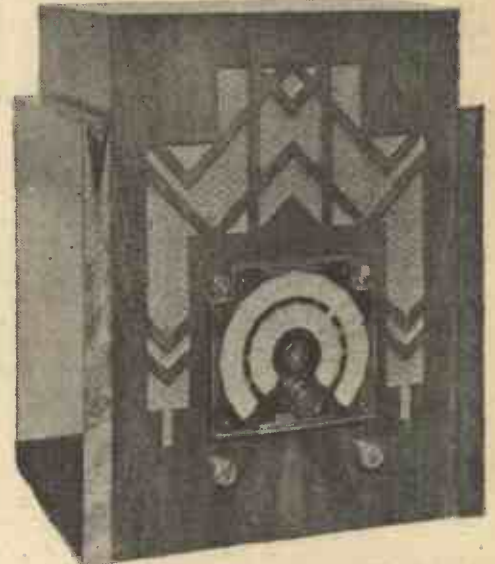

Front view of the 3-32 Chassis.

Results

The performance set up by this receiver was very good indeed, and the H.F. stage certainly pulled its weight. Upwards of a dozen stations were easily tuned in with no difficulty at all, the dial being simply set to the requisite reading. With a very poor indoor aerial six or seven stations could be received with quite good volume, and there is no need to carry out any difficult manipulation of selectivity and reaction control in order to obtain stations free from interference—due to the very efficient band-pass aerial circuit which precedes the S.G. valve. On the long waves, all the principal stations are easily tuned in.

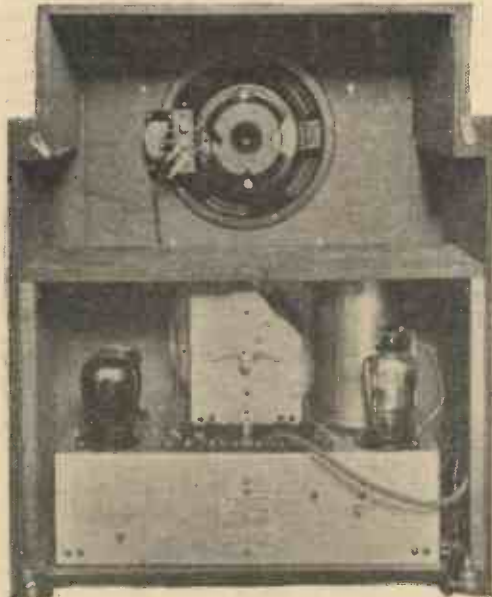

The neat interior of the Six-Sixty Chassis.

RECEIVER: Type 3-32 Chassis.
 MAKERS: Six-Sixty Radio Co., Ltd.
 CIRCUIT: S.G., Detector and Pentode Valves, Band-Pass Aerial Tuning; Combined Reaction Condenser and Aerial Resistance; Automatic Bias for Pentode Stage; Fused Battery Leads; Illuminated Selector Dial Calibrated in Stations, Wavelengths and Frequency; Balanced Armature Loud-speaker.
 RESULTS: Outstanding simplicity in handling and high standard of performance from the point of view of selectivity, quality and range.
 PRICE: £10-10-0.

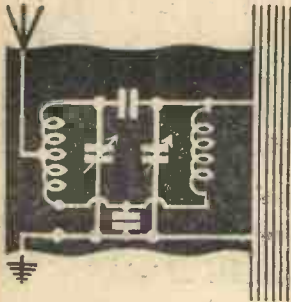

RADIO RAMBLINGS

By JACE

Gettings from my Notebook

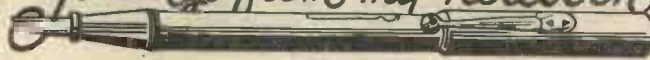

The Mains Aerial

WE have previously mentioned in these notes that a "mains" aerial is often almost as good as the usual extended outside wire. The conventional way of using the mains as a source of pick-up is merely to connect a fixed condenser of .0001 mfd. to .001 mfd. between one supply lead and the aerial terminal. Unfortunately this system is not always satisfactory because any interference which happens to be superimposed on the supply is introduced into the receiver at its most sensitive point and is thus amplified just the same as are the legitimate signals. The natural result is that reception is far from pleasant.

Eliminating Interference

JUST recently we happened to be trying out an A.C. set in a room where no aerial was available so we were obliged to use the mains. It was soon found that this was no use because everything was drowned by a loud "whine." The difficulty was soon overcome, however, by connecting two condensers in series across the mains and taking the "aerial" connection from their centre tap. At first a pair of .0005 mfd. fixed condensers were employed, but even then a small amount of hum was audible. On replacing one of them by a .001 mfd. pre-set condenser and adjusting this carefully, reception was all that could be desired. The idea underlying this scheme is that the aerial terminal must be connected to a "neutral" point, and if the two condensers are of exactly the same capacity any "ripple" or irregularity in the supply leads is cancelled out.

You might like to try this method so the connections are given in Fig. 1. There are just two points to watch: the first is to see that the pre-set condenser is of good quality, and the second is that it should be adjusted with an insulated screwdriver, or a piece of wood shaped off to an edge,

to guard against the possibility of getting a shock by touching a "live" point. It is also a good "safety first" idea to connect the pre-set condenser to the "set" side of the fuse so that in case of a short-circuit no damage will be done.

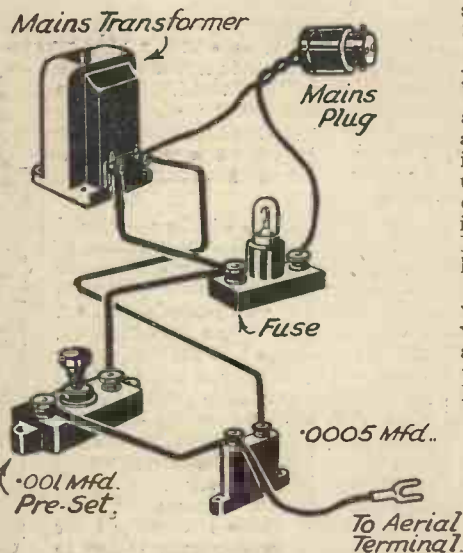

Fig. 1.—The method of eliminating interference with a mains aerial.

A Universal Receiver with Standard Valves

WE were recently asked if it was possible to make a receiver to work from either A.C. or D.C. mains and using standard mains valves. It sounds rather a stiff problem, but after a little consideration the three-valve circuit shown in Fig. 2 was evolved. Our querist made up the set and has since reported excellent results on both kinds of supply.

A study of the circuit diagram shows that

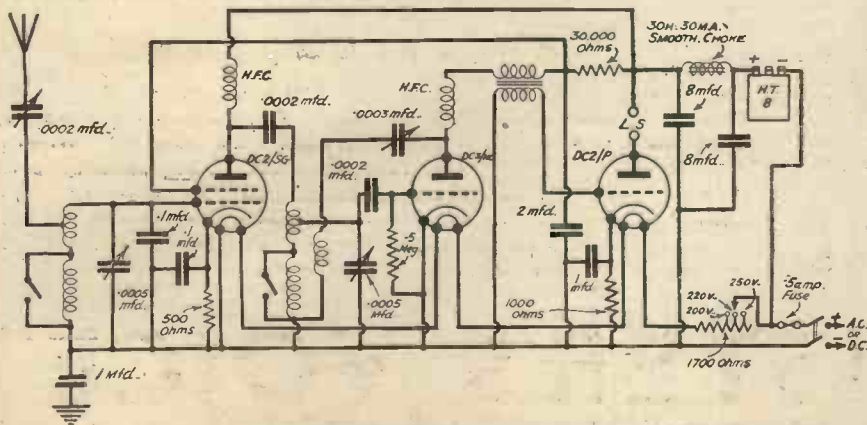

Fig. 2.—The circuit of an S.G.-Det.-P. Universal (A.C. or D.C.) receiver using standard D.C. valves.

the arrangement follows very closely on that of an ordinary D.C. set, but a Westinghouse Style H.T. 8 metal rectifier is included in the positive H.T. supply lead. The valves are Mazda D.C. types, a DC2/SG being used in the screened grid stage, a DC3/HL for detector and a DC2/P in the power output stage. All these valves take .1 amp. of heater current and have voltage ratings of 20, 25 and 35 respectively. The heaters are all wired in series with

each other and with a 1,700 ohm resistance which limits the supply voltage to 80. The resistance is tapped after 1,200 and 1,400 ohms so that it may be adjusted to suit mains voltages from 200 to 250 volts. This latter component can be bought ready-made from Messrs. Bulgin, or can easily be constructed at home by winding 71 yards of 38-gauge Eureka resistance wire on a glass tube and taking tappings after 50 and 58 yards. It will not become very hot in use, but should for preference be mounted in such a position that air can freely circulate around it. The remainder of the circuit is fairly straightforward and follows the usual S.G.-Det.-L.F. arrangement. When connected to A.C. mains the H.T. supply is rectified by the metal rectifier, but on D.C. the latter component acts merely as a limiting resistance.

Since the receiver is in direct contact with the supply mains (as are all "universal" receivers) it will always be "live," and therefore precautions must be taken to ensure against short-circuits or shocks. In this respect ample safety is secured by inserting condensers in both aerial and earth leads and by well sinking grub screws in the various control knobs. Incidentally it might be mentioned that sets very similar to that illustrated are extremely popular in America just now, and we can see no objection to their adoption in this country. They are not expensive to build and have a very modest current consumption—that described takes about 25 watts per hour.

Class "B" and Tone Correction

THE Class "B" valve, like pentodes, has a tendency to give over-emphasis to the higher audio frequencies so that in most cases some form of tone-compensation is called for. When using pentodes the usual thing is to connect a fixed condenser and a resistance in series across the primary terminals of the output transformer, and although this same method could be applied to Class "B" it is open to a serious objection. It has been explained in these columns before that the H.T. current consumption of a Class "B" valve is proportional to the signal strength which the valve is called upon to give. Thus it would be wasteful to suppress any frequency band which had been amplified at the expense of high-tension current.

The most economical way of preventing shrillness is, therefore, to include the tone control arrangement in some part of the circuit preceding the output valve. A good place is across the primary winding of the "driver" transformer, but equally good correction can be obtained by the use of a tone-control transformer between the detector and "driver" valves. As a matter of fact either of the latter methods effects a distinct economy by cutting down the average Class "B" anode current by as much as 15 per cent.

THE NEW "3 IN 1" INSTRUMENT

1 SUPERHET RADIO (7 VALVES)

2 ELECTRICALLY REPRODUCING GRAMOPHONE

3 IMPROVED AUTOMATIC RECORD - CHANGE



THIS complete "3 in 1" home entertainer gives you :

FIRSTLY, seven-valve radio employing a super-heterodyne circuit and variable mu valves, with the extended range, complete freedom from overlap and "background," and that extraordinarily high degree of selectivity this means.

SECONDLY, an electrical gramophone, as simple to turn on as electric light, and which reproduces your own records electrically.

THIRDLY, the latest improved type of automatic mechanism to play eight records without any attention, or to repeat one record indefinitely.

Reproduction on both radio and gramophone is through an electromagnetic moving coil speaker giving a tone absolutely "true-to-life." There is nothing experimental about this model. Its thorough reliability has been proved over a period of many months before introduction.

The cabinet work is particularly noteworthy. It definitely acknowledges that radio is a new thing, and must be treated newly. In basic principles the design recognises the soundness of past craftsmanship, but new thought is apparent in the clean lines, the contrasting of exquisite grainings, and the absence of dust-catching mouldings. And because sound is influenced by cabinet design, this Autoradiogram has combined much thought, scientific skill and art in achieving "true-to-life" tone quality—for after all, the sole object of the instrument is to please the ears.

This is but a brief description of "His Master's Voice" newest radio-gramophone. You will find below a more detailed specification. But to appreciate this model fully, you must see, examine, and hear it for yourself at any "His Master's Voice" dealers.

IN ONE SIMPLE
INSTRUMENT

all for **55** GNS.

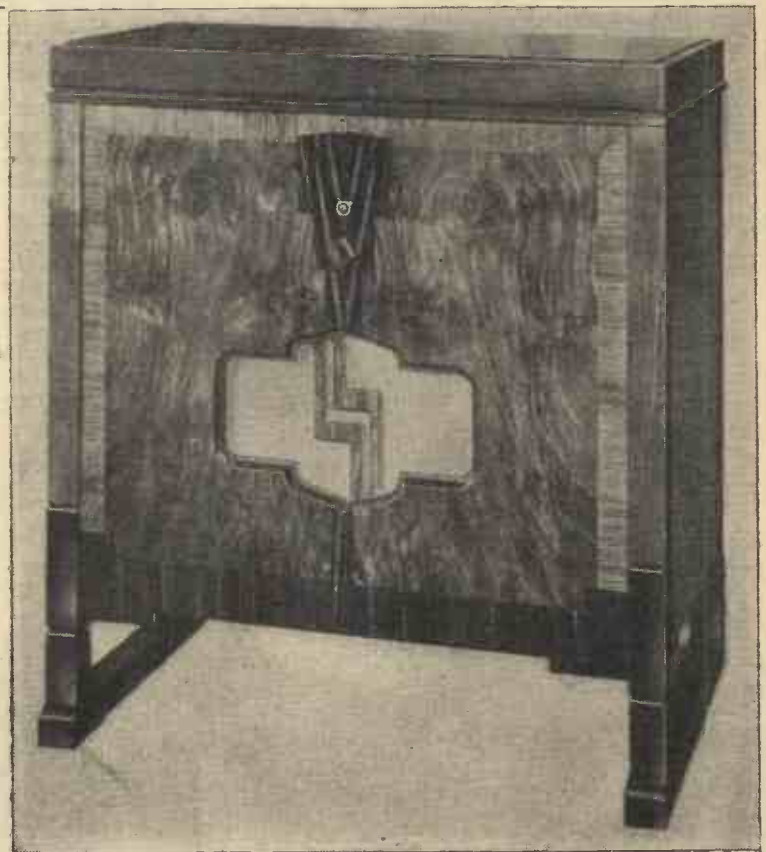

SPECIFICATION

"His Master's Voice" Superhet Autoradiogram Seven, Model 524 :
Circuit. Seven-valve superheterodyne; all mains. Three band-pass circuits employed. *Variable mu valves.* Tuning by specially compensated 4-gang condenser. *Brilliance control* to adjust tone. *Three control knobs only:* tuning, volume and master switch. *Calibrated wavelength scale,* illuminated and giving the names of principal stations opposite their wavelengths. *Automatic record-changing mechanism,* giving continuous record programme of half-an-hour or more, with eight ten or twelve-inch records. *No pre-setting necessary.* Push button rejects any record at will. For A.C. or D.C.

"HIS MASTER'S VOICE"



View showing the partly assembled receiver.

AN inspection of the illustrations on these and the following page will reveal the ingenious system I adopted in the construction of the cabinet and the arrangement of the receiver portion of the Featherweight Portable Four. A circuit diagram was given last week, and I propose, therefore, to confine the first part of this article to a description of the cabinet.

Accessibility

From the point of view of accessibility the Featherweight Four easily scores over

anything hitherto placed before the home constructor. Every part of the receiver can be got at during erection, and it also is a delightfully simple matter to adjust it afterwards. The fretted front baseboard carries a strip baseboard (if I may use the term), and the diagrams on the following page show how the various parts are assembled. Almost the entire structure forming the cabinet is made from walnut or oak 1 in. wide by 1/2 in. thick. This section of wood is obtainable from any stores supplying fretwood, and you are therefore, by the expenditure of a few pence, relieved of the task of sawing and planing the wood to this section yourself.

No Joints!

Notice also that the cabinet is so designed that you merely require a saw in order to make it. I have entirely dispensed with the normal style of woodworking joint, realising that many of my readers would not be woodworkers. I have used the perforated strips which are obtainable, together with the perforated angle-brackets in the well-known constructional toy sold under the trade name of Trix, at 6d. a box. You do not even have to drill the strips, and once you have cut out the various lengths of wood it is merely a matter of minutes to screw the parts to-



gether after fretting out the grille to the shape shown. When completely assembled you will find that whilst the structure is entirely rigid it is practically featherweight. I have even saved you



Class B Amplification, specially designed and covered by My Personal

a considerable amount of work in the baseboard, for the spaces between the strips save a considerable amount of drilling and enable the sub-baseboard arrangement of the components to be carried out with a minimum of work.

Assembling the Components

Chassis mounting valve-holders are used, and these are fixed with their legs between the rear-most strips. The other components span the spaces

THE MOST IN PORTABLE FREE BLUEPRINT WITH THIS



The completely assembled

THE LIGHTEST YET!

provided by the three strips. The three strips themselves are merely nailed to the two end strips, the points of the nails being clinched over. Notice that the front strip of the baseboard is slotted at the ends to clear the frame aerial and in the

ORIGINA



"Overweight" Portable Four by F.J. CAMM

Complete Constructional Details of my
Light-weight Portable employing
for "Practical Wireless" Readers
Free-advice Guarantee.

GENIOUS
EVER!
NT GIVEN
ISSUE!



led receiver.

LITY!

centre to clear the Rola speaker. The baseboard is screwed and glued from the outside to the front. The two tuning condensers (the extremes of the three top knobs), the reaction condenser (the central top knob), the wave-changeswitch (the left bottom knob), and the on-off switch (the right bottom knob) are next secured to the front and after the remainder of the components have been fitted to the baseboard wiring is commenced. Do not

SMALL IN SIZE!!

secure the front to the cabinet until wiring is complete, and leave the frame aerial winding until the last.

The full-size blueprint given with this issue should enable the wiring to be carried out without difficulty. An inspection of this will

That costing 6s. 11d. per yard is a particularly serviceable and stout brand, and it is also obtainable in a variety of colours. Cut a piece 1in. wider than the front and glue both the wood and the back of the leather cloth. Press it into even contact with the front and turn the edges over. Drawing pins may be partly pressed into the fabric until the glue has set.

The Grille

Next, pierce the grille in the centre of each opening, making diagonal cuts, and proceed to pull these ends through, and glue them to the back of the grille. Here again drawing pins will assist in keeping the ends in place until the glue is dry. When the glue is thoroughly hard, glue over a piece of old gold gauze and finally attach the loud-speaker by means of the four nuts and bolts provided. Use bolts with plated heads.

show that a surprisingly small number of wires only are required.

Covering the Front

Before attaching the speaker, but after the remainder of the wiring is completed, the front should be covered with the particular leather cloth which the builder selects. You will require, if you purchase the 54in. wide variety, 1yd. only. It is obtainable at all prices from 4s. 11d. per yard upwards.

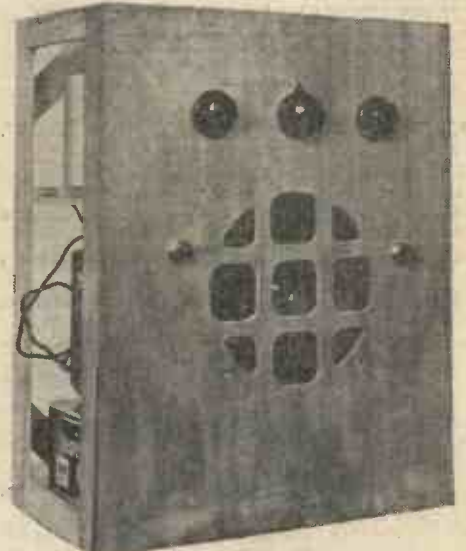

The front before covering.

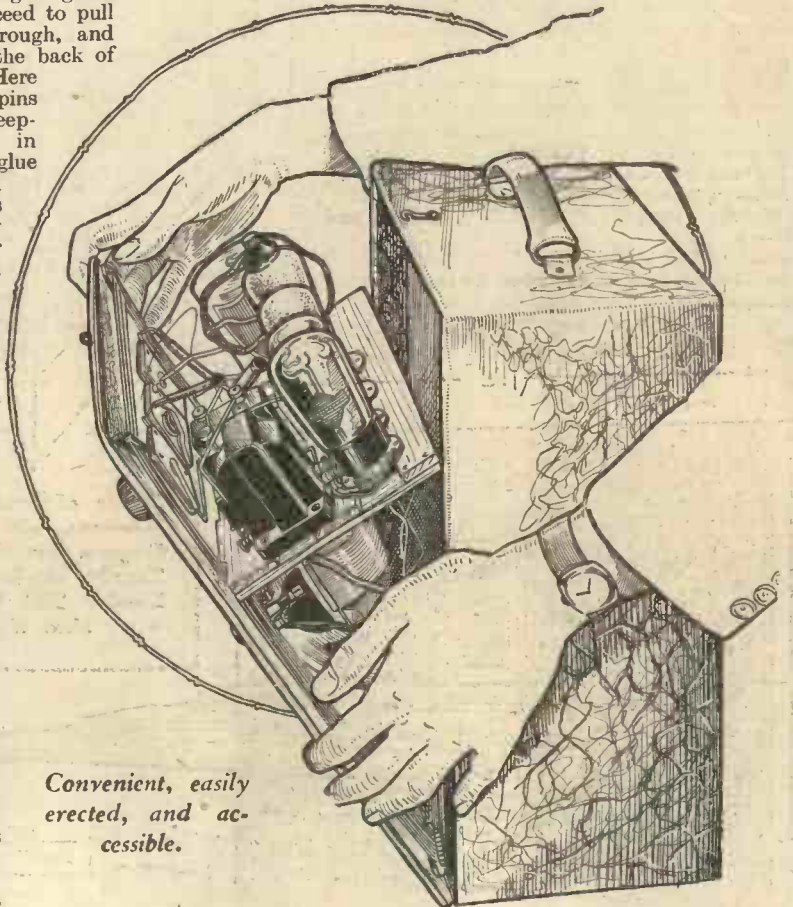

Convenient, easily erected, and accessible.

as these show on the front of the cabinet. Complete the wiring to the loud-speaker and then plant on the four notched frame aerial brackets in the positions shown in the photograph. (Contd. overleaf.)



SPECIFICATION OF FEATHER-WEIGHT PORTABLE.

- Two Utility Bakelite Condensers, .0005 Type W. 297.
- One Wearite H.F. Choke, Type H.F.P.A.
- One Lissen Dual Range Shielded Coil.
- One Graham Farish Litlos Condenser, .0003.
- One Graham Farish Ohmite Spaghetti Resistance 10,000 ohms.
- One Graham Farish Ohmite Spaghetti Resistance, 50,000 ohms.
- One Graham Farish Ohmite Spaghetti Resistance, 100,000 ohms.
- Three Clix 4-pin Chassis Type Valve-holders.
- One Clix 7-pin Chassis Type Valve-holder.
- One Bulgin On-Off Switch, Type, S.38.
- One Bulgin Wave-Change Switch, Type S.36.
- Four Bulgin Frame Aerial Spacers, Type I.12.
- One Bulgin Senator Transformer, Type, L.F. 12.
- One Lissen Class B Driver Transformer.
- One 2 megohm Grid Leak, with wire ends, Lissen.
- One T.C.C. .01 mfd. Fixed Condenser, Type M.
- One T.C.C. .0002 mfd. Fixed Condenser, Type M.
- One T.T.C. .002 mfd. Fixed Condenser, Type M.
- One T.C.C. .1 mfd. Fixed Condenser, Type 50.
- One T.C.C. 1 mfd. Fixed Condenser, Type 50.
- One T.C.C. .001 mfd. Fixed Condenser, Type M.
- One Cossor 220 S.G. (Metallized) Valve.
- One Cossor 210 H.F. (Metallized) Valve.
- One Cossor 215 P Valve.
- One Cossor 240 B Valve.
- One Rola Loud-speaker, Type F.5-PM-14-Class B.
- 2 ozs. 24 D.C.C. wire (medium-wave) and 2 ozs. 34 D.S.C. wire (long-wave) for frame.
- One Ediswan 120 volt H.T. Battery, ref. 69706.
- One Ediswan 9 volt Grid Bias Battery, ref. 69807.
- One Ediswan 2 volt accumulator, E.L.M.2.
- Four Wander Plugs, (H.T.+ , H.T.— , G.B.+ and G.B.—).
- Two Spades (L.T.+ and L.T.—).
- One coil Glazite, flex, screws, wood for case, carrying handle, etc.

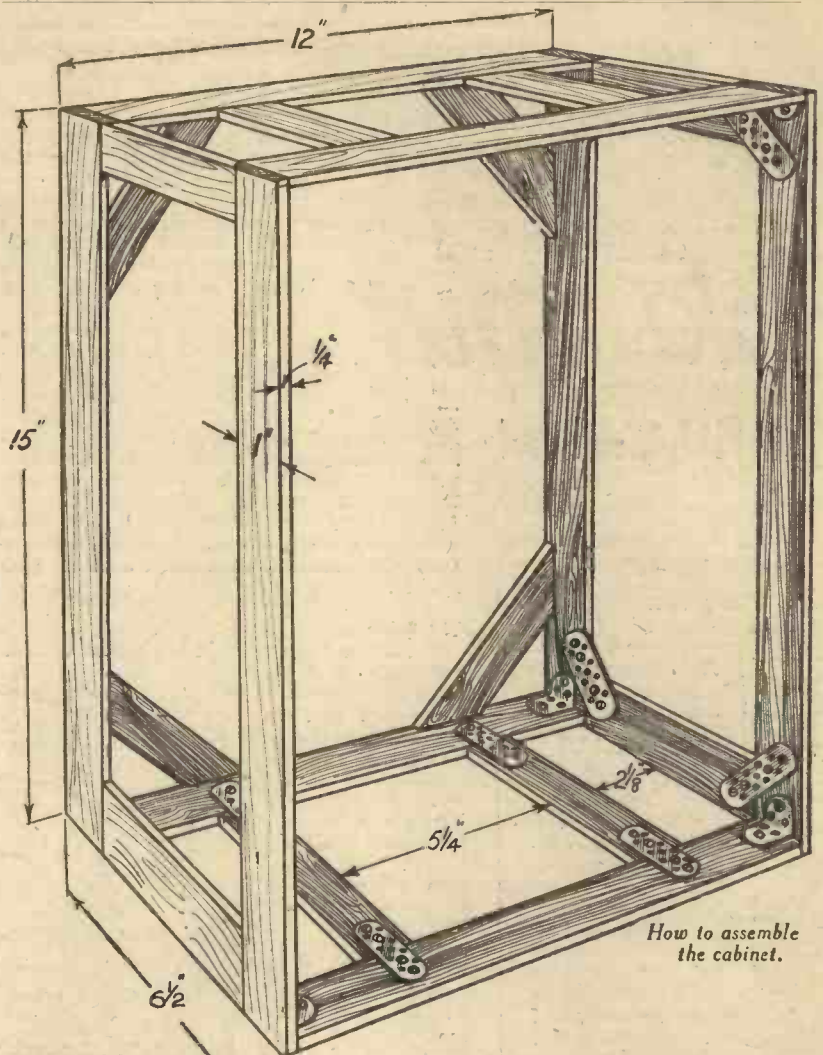

How to assemble the cabinet.

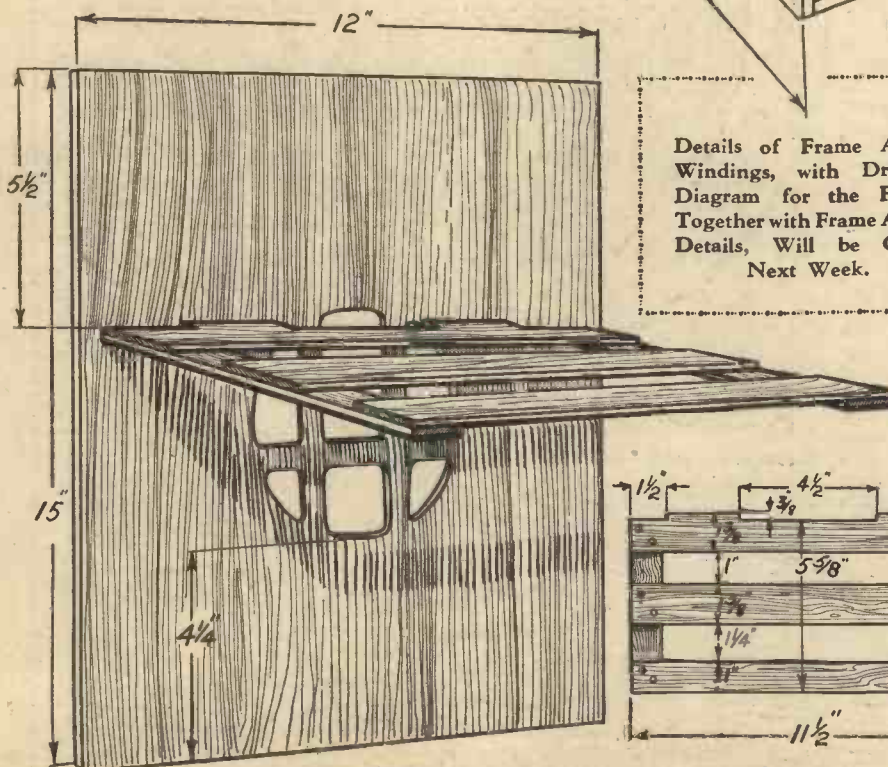

The front and baseboard.

Details of Frame Aerial Windings, with Drilling Diagram for the Front, Together with Frame Aerial Details, Will be Given Next Week.

(Continued from previous page.)

These have ten comb-like slots into which the long-wave windings and the short-wave windings are piled. For the long-wave winding use 46 turns; and for the short-wave winding 18 turns. Connections are taken from these to the three-point wavechange switch. Further to secure the frame aerial winding, sealing-wax or Chatterton's compound should be used to hold them in the slots.

The large slots are for the long-wave winding and are the inner-most slots.

Covering the Frame with Card-board and Leather Cloth

Now put the set aside and proceed to cover the framework itself with thin cardboard. Damp this and leave it to dry when it will be found that the cardboard will have shrunk and considerably braced up the framework.

Next, attach the leather cloth, cutting the entire covering in one piece and leaving about lin. margin all round to glue inside. But of this I shall have more to say next week.

PICK YOUR BARGAIN

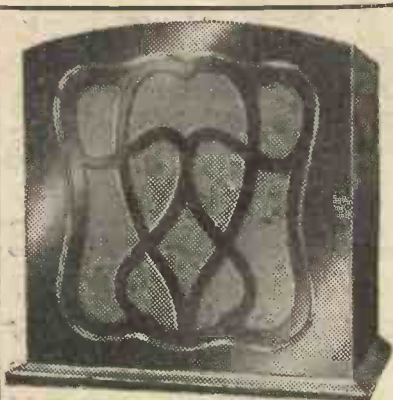

KENWELL POWER PACK

Electrifies your present Battery Set. For A.C. Mains. With Matched Moving-Coil Speaker in Handsome Walnut Cabinet, as illustrated. Usual Price, £7/15/0. Our Price, £4/0/0, or 12 monthly payments of 7/4.

LOEWE A.C. MAINS RECEIVER. Complete 3-Valve Set, with Permanent Magnet Moving-coil Speaker. Ready to play. List Price, 9 Gns. Our Price, £6/10/0. or Deposit £1/0/0, balance in 11 monthly payments of 11/-.

MARCONI PHONE RADIOGRAM, A.C. only. Model 330. List Price, 32 Gns. Our Price, 19 Gns., or 24 monthly payments of 18/7.

ALL-ELECTRIC RADIOGRAM with Garrard Automatic Record Changer, A.C. only, 3-valve S.G. Detector, and Pentode. Moving-Coil Speaker. Our Price, 22 Gns., or Deposit £5/2/0 and 11 monthly payments of 36/-.

ALL-ELECTRIC RADIOGRAM with Electric Motor, A.C. only, 3-valve S.G., Detector and Power. Moving-Coil Speaker. Our Price, 12 Gns., or 12 monthly payments of 22/3.

KENWELL ALL-ELECTRIC 2-VALVE SET. Detector and Pentode complete with Speaker, ready to play. For A.C. or D.C. Usual Price, £7/10/0. Our Price, £4/0/0, or 12 monthly payments of 7/4.

KENWELL 2-VALVE DE LUXE A.S.2. Detector and Pentode. Complete with P.M. Moving-Coil Speaker. Ready to play. Usual Price £9/15/0. Our Price, £5/5/0. or 12 monthly payments of 9/8.

Send **2/6** only
 Just pay a further 2/6 on delivery. Balance in 6 monthly payments of 2/6.
LOEWE CABINET SPEAKER with 4-pole Balanced Armature Movement. Our Price, CASH **17/6** or C.O.D. Carriage Paid
USUAL PRICE 39/6.

W.B. P.M.4 MOVING-COIL SPEAKER. With input transformer. Cash or C.O.D. Carriage Paid, **£2/2/0.** Balance in 7 monthly payments of 5/9 only

NEW BLUE SPOT PERMANENT MAGNET MOVING-COIL SPEAKER 29 P.M. With input transformer. Cash or C.O.D. Carriage Paid, **£1/12/6.** Balance in 6 monthly payments of 5/2 only

BLUE SPOT UNIT AND CHASSIS. Type 99 P.M. including matched transformer. Cash Price, **£2/19/6.** Balance in 11 monthly payments of 5/6 only

ROLA PERMANENT MAGNET-MOVING-COIL SPEAKER F.6. With Universal tapped input transformer. Cash Price, **£2/9/6.** Carriage Paid, **4/6** only

ROLA PERMANENT MAGNET-MOVING-COIL SPEAKER F.6. With Universal tapped input transformer. Cash Price, **£2/9/6.** Carriage Paid, **4/6** only

JUST RELEASED

LISSEN ALL-ELECTRIC SKYSCRAPER 3

Complete with 4 valves and constructional chart in sealed Lissen carton. Cash or C.O.D. Carriage Paid, **£7/19/6.** Balance in 11 monthly payments of 14/8. Send **14/8** only

PILOT AUTHOR KIT
Exact to specification
FEATHERWEIGHT PORTABLE

As described in this week's issue.

KIT "A" Author's Kit of first specified parts, less valves, cabinet, panel, baseboard and speaker, CASH or C.O.D. Carriage Paid, **£3/1/3.**

Delivered, Carriage Paid on first payment of **5/8**
 Balance in 11 monthly payments of 5/8.

KIT "B" As Kit "A" but with valves only. Delivered, carriage paid, on first payment of **9/10**

Balance in 11 monthly payments of 9/10. Cash or C.O.D. Carriage Paid. **£5/7/6.**

A.C. TWIN

KIT "A" Author's Kit of first specified parts, less valves, cabinet, panel, baseboard and speaker, CASH or C.O.D. Carriage Paid, **£7/1/6.**

Delivered, Carriage Paid on first payment of **13/-**
 Balance in 11 monthly payments of 13/-.

KIT "B" As Kit "A" but with valves only. Delivered, carriage paid, on first payment of **18/-**
 Balance in 11 monthly payments of 18/-.
 Cash or C.O.D. Carriage Paid, **£9/16/6.**

KIT "C" with valves, cabinet, panel, and baseboard, but less speaker. Delivered, carriage paid, on first payment of **21/3**
 Balance in 11 monthly payments of 21/3.
 Cash or C.O.D. Carriage Paid, **£11/11/6.**

KIT-BITS Selected C.O.D. items. You pay the postman. We pay post charges on orders over 10/-.

- 1 Lissen Dual Range Shielded Coil .. 6 6
- 1 Bulgin Senator Transformer L.F.12 .. 6 9
- 1 Lissen Class "B" Driver Transformer .. 12 6
- 1 Set of 5 T.C.C. Condensers as specified .. 8 0
- Wire, Glazite, Flex, Screws and 4 Bulgin Frame Aerial Spacers .. 6 3
- 1 Set of Specified Valves .. £2 6 3
- 1 Rola Class "B" Speaker .. £1 12 6

SUPERSONIC SIX

KIT "A" Delivered Carr. Paid, on first payment of **12/6**

Author's Kit of first specified parts, including ready-drilled panel, but less valves, cabinet, and chassis. Cash or C.O.D. Carriage Paid, **£6/16/6.** Balance in 11 Monthly Payments of 12/6

Set of 6 Specified Valves: **£3-11-6** or add 6/7 to each monthly payment.

KIT-BITS Selected C.O.D. Items. You pay the postman. We pay post charges on orders over 10/-.

- 1 Peto-Scott Paxolin Panel and Aluminium Baseboard drilled to specification .. 10 9
- 1 Set of 4 Wearite Coils as specified .. £2 2 0
- 1 T.C.C. Special 8 mfd. Condenser Block .. 14 6
- 1 Lissen Hypernik L.F. Transformer, 3:1 .. 12 6
- 2 Polar .0005 mfd. Var. Condensers with S.M. Dials .. 13 0
- 1 Set of 6 Specified Valves .. £3 11 6

CASH, C.O.D. or EASIWAY



PILOT GUARDIAN Q.P.P. 4-VALVE KIT

KIT "A" Complete Kit of Parts including ready-drilled panel, but less Valves and cabinet. CASH or C.O.D. Carriage Paid, **£3/19/6.** 7/6 Deposit and 11 monthly payments of 7/3. Send **7/6** only

KIT "B" As Kit "A" but with Valves less cabinet. CASH or C.O.D., Carriage Paid, **£9/18/0.** Delivered, Carriage Paid on First Payment of **12/6**
 Balance in 11 monthly payments of 12/6.

KIT "C" As Kit "A" but with Valves and Table Cabinet. CASH or C.O.D. Carriage Paid, **£7/13/0.** Delivered, Carriage Paid, on First Payment of **14/-**
 Balance in 11 monthly payments of 14/-.

KIT "D" As Kit "C" but with Console table cabinet, less speaker. CASH or C.O.D., Carriage Paid, **£8/3/0.** Delivered Carriage Paid, on First Payment of **15/-**
 Balance in 11 monthly payments of 15/-.

Send for Full Size Blue-Print and Constructional Chart. Usual price 1/- Sent FREE to "Practical Wireless" readers.

IMPORTANT Parts, Kits, Miscellaneous Components. Finished Receivers or Accessories for Cash, C.O.D., or H.P. on our own system of Easy Payments, send us a list of your wants. We will quote you by return. C.O.D. orders value over 10/- sent carriage and post charges paid.

PETO-SCOTT CO. Ltd. 77, City Road, London, E.C.1.
 Telephone: Clerkenwell 9406-7.
 West End Showrooms: 62, High Holborn, London, W.C.2. 'Phone: Holborn 3248.
 Dear Sirs, Please send me CASH/C.O.D./H.P. for which I enclose £.....s.....d. CASH/H.P.
 NAME
 ADDRESS
 Pr. W. 6/5/33.

STRICT PRIVACY GUARANTEED — WE DEAL WITH YOU DIRECT

The BEGINNER'S SUPPLEMENT

Conducted by F.J. CAMM

THE EASY ROAD TO RADIO



Current Density

THE amount of current per each square inch of cross-sectional area which passes through a conductor. For instance, if a conductor has a cross-sectional area of 1 sq. in. and a current of 10 amperes is flowing through it, the density is 10.

With direct current the density is easy

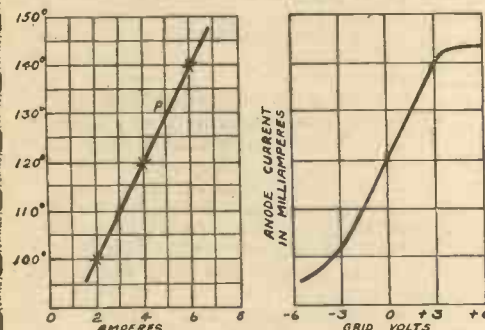

Fig. 1.—Two examples of curves as applied to wireless.

to calculate since the distribution of current through the conductor is uniform but when we come to alternating currents a peculiar state of affairs exists. The current tends to be densest near the surface of the conductor. In the case of a round wire, for example, there would be more current passing just under the surface of the wire than in the centre. This phenomena, which is known as the "skin effect" becomes more marked as the frequency of the current increases, that is to say, it is most noticeable with high-frequency currents. In the case of radio-frequency currents, the skin effect is so strong that with large conductors, as are used in transmitting, a solid wire may very well be replaced by a tube of the same external diameter without increasing the high-frequency resistance.

Curve

A convenient way of finding out the characteristics or behaviour of wireless apparatus such as valves under certain conditions is to draw a graph or "curve." If the behaviour under one or two known sets of conditions is recorded graphically on squared paper and the points marked are joined by a line it is possible to tell by the shape of the line what behaviour to expect under intermediate unknown conditions.

A knowledge of the meaning of curves and how to plot them is very useful to the radio amateur. A simple example of

THE BEGINNERS' A B C OF WIRELESS TERMS

(Continued from April 29th issue, page 234.)

how to plot a curve is given in Fig. 1. Suppose it was known that when a current of 2 amps. was passing through a certain conductor it would become hot, the temperature being 100 degs., and also that if the current were increased to 4 amps. the temperature would go up to 120 degs. Also again that a current of 6 amps. would mean a temperature of 140 degs. This might be useful as far as it went, but it might not be enough. We might want to know the temperature at 3 or 5 or 7 amps. A simple way to determine this without experiment would be to draw a curve as in Fig. 1. The paper is divided into squares and "amperes" marked at equal distances horizontally, while the temperature in degrees is marked vertically. To plot the curve a small cross or mark is made where the vertical line up from the point marked "2 amps." crosses the horizontal line corresponding to 100 degs. In the same way the position where the 4 amps. line crosses the 120 degs. line is also marked.

PERMANENT MAGNET

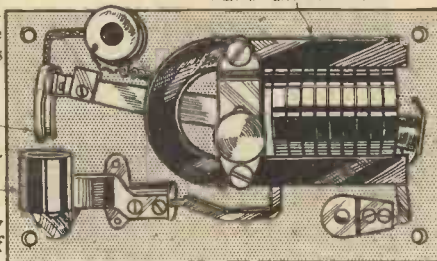

Fig. 2.—Example of a cut-out.

The last point to be plotted is where the vertical line from "6 amps." crosses the horizontal line representing 140 degs.

If these three points are joined up by a line we have a "curve" from which we can determine the current flowing at any temperature between 100 and 140 degrees. Likewise, we can find the temperature for any current between 2 and 6 amperes. Suppose we wanted to know the temperature at 5 amps. By following up vertically from the 5 amp. position on the base line we strike the curve at the point P.

By following along horizontally we see that this point is opposite "130 degs.," on the vertical scale. The temperature at 5 amps., therefore, is 130 degs.

Incidentally, this particular curve happens to be a straight line, but it is nevertheless still considered mathematically as a "curve." The other curve in Fig. 1 is, perhaps, more familiar in appearance, although not so simple as the one on the left. It records what happens to the current passed by a valve when the voltage applied to the grid is varied from -6 to +6. It shows, for instance, that at -3 volts the anode current is just over 2 milliamps., and that at 0 volts it has risen to 6 milliamps., and so on.

Cut-off

The limits of frequency above which no reproduction takes place. For instance, a loud-speaker may reproduce all musical notes quite well until a certain high note is reached. Above this it will not produce any sound. In other words there is a "cut-off" above that particular note. Again, there may be some organ music transmitted which may come through clearly except that the very low notes are lost altogether. This would indicate cut-off below a certain frequency. Cut-off of this type is not so common as a general falling off in response. This is often met with, but should not, strictly speaking, be termed "cut-off." Cut-off implies complete absence of response above or below a certain frequency.

Cut-outs

An automatic cut-out is an instrument used to break or make a circuit automatically according to some predetermined electrical circumstances. A well-known example is provided by the device used in some battery-charging circuits to prevent the batteries from discharging through the dynamo should the latter inadvertently stop for any reason. You can quite understand that the voltage of the batteries on charge may be quite high. Normally this is overcome by the voltage of the dynamo which is somewhat higher than that of the batteries, thus causing current to flow from the dynamo through the batteries. If, however, the voltage

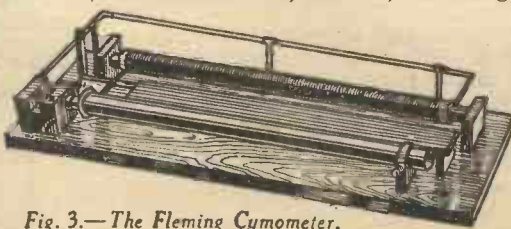

Fig. 3.—The Fleming Cymometer.

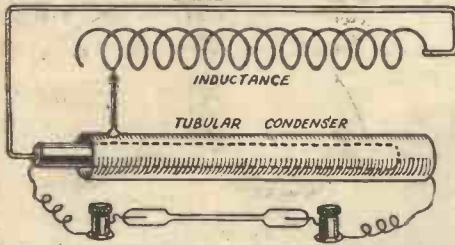

Fig. 4.—Diagrammatic representation of the essential parts of a cymometer.

of the dynamo falls below that of the batteries (through its slowing down due to a failing engine or for some other reason) then the batteries will discharge through the dynamo with possibly disastrous results such as ruining the batteries and burning out the windings of the dynamo.

In the cut-out shown in Fig. 2 a pivoted arm carries dippers which dip into metal cups containing mercury, thus completing the circuit. The dippers are held in this position so long as the dynamo is charging by reason of the current passing through a coil in the cut-out which attracts an iron armature attached to the arm. If the current reverses, as when the dynamo fails and the batteries start to "charge" the dynamo, then the armature is repelled and the dippers raised, so breaking the circuit. The reverse process takes place as soon as the dynamo commences again.

Cymometer

A type of wavemeter invented by Dr. J. A. Fleming. It consists essentially of a long tubular condenser and a long small-diameter inductance so arranged that they can be both increased with one and the same control. The actual instrument is shown in Fig. 3, but the method of working it can be more easily understood from the diagrammatic drawing (Fig. 4). If the outside tube of the variable condenser is drawn to the right the capacity existing between the two concentric tubes becomes less. At the same time the slider attached to the outer tube and bearing on the bare wire turns of the inductance or tuning coil will slide along and reduce the number of turns in circuit, thus reducing its effective inductance. When the circuit composed of the condenser and inductance is in tune with the oscillating circuit near which it is brought the fact is indicated by flashes of light in the neon tube placed between the two terminals. The wavelength of the transmitter can then be determined by reading the scale mounted on the cymometer. This type of wavemeter is not used now-a-days as it is replaced by more sensitive and accurate types.

Cymoscope

An instrument used for detecting the presence of wireless waves by visible means. A very early form is shown in Fig. 5. It consists of a single metal loop cut at one point and having metal balls mounted on the ends. Short waves of sufficient intensity will cause a spark to jump between the points. Replacing the spark gap by a small lamp makes the instrument more sensitive, while increasing the number of turns of wire will make

it respond to longer wavelengths. Such a device, but including a variable condenser for accurate tuning is also shown in Fig. 5.

Cycle

Any sequence of events occurring at regular intervals of time. For alternating current cycle see "ALTERNATING CURRENT."

Damped Waves

Wireless waves which occur in successive trains. The first waves of each train are large, but the successive ones gradually get smaller and finally die down altogether. Then follows another similar

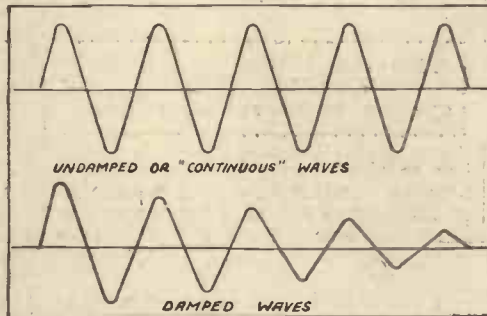

Fig. 6.—Diagram showing the difference between damped and undamped waves.

train starting at large amplitude and dying down again. This process goes on continuously. The rise and fall in amplitude gives a characteristic musical note to the transmissions, therefore this type of wave cannot be used for telephony purposes. It is confined solely to

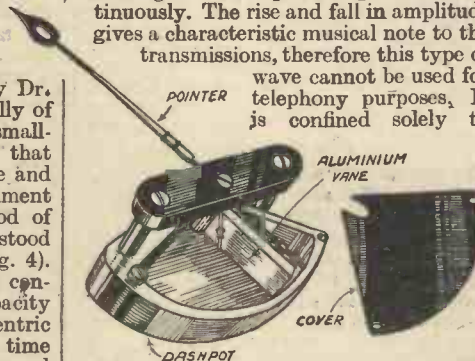

Fig. 7.—How a moving iron type of instrument can be damped.

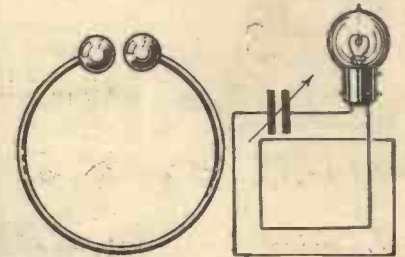

Fig. 5.—Two forms of cymometer used for detecting the presence of wireless waves.

transmissions in the morse code. For telephony such as broadcasting undamped or continuous waves must be employed. The difference is illustrated in Fig. 6. (See also "CONTINUOUS WAVES.")

Damping

This is a term used to indicate the gradual falling off in amplitude of a periodic vibration or train of oscillations. It is applied to electrical waves. (See "DAMPED WAVES") and to such technical matters as the steadying or "damping down" of the vibrations of the pointer of a voltmeter or ammeter.

With most measuring instruments, unless some method is employed to slow down the vibrations of the pointer it will go on oscillating backwards and forwards a long time before coming to rest. A popular method of overcoming this with moving iron instruments is shown in Fig. 7. It consists of attaching a small aluminium vane to the lower end of the pointer. This vane moves in a sector-shaped aluminium box known as a "dashpot." The vane does not touch the inner sides of the dashpot, but moves very near to them so that the air in the dashpot has very little room to pass round the vane. In this way rapid swinging of the pointer is prevented since the air cannot get quickly past the vane every time it moves.

A FINE HANDBOOK
 25 Tested Wireless Circuits by F. J. CAMM
 96 Pages Fully Illustrated. 1/- or 1/2 post free from
 George Newnes, Ltd., 6-11, Southampton Street, Strand,
 London, W.C.2.

PRACTICAL WIRELESS BLUEPRINT SERVICE

In order to meet the requirements of readers who prefer to work from a full-size blueprint when building up any of the "Practical Wireless" Receivers, we can now supply full-size Blueprint Wiring Diagrams of all the "Practical Wireless" Blueprint Receiver. Described in Issues dated

No.	Receiver	Date
1932		
1.	Dolphin Straight Three ..	Sept. 24th
		Oct. 1st
2.	Long Range Express Three ..	Sept. 24th
		Oct. 1st
3.	Mains Express Three ..	Oct. 8th
4.	Sonotone Four ..	Oct. 8th
		Oct. 15th
5.	Bijou Three ..	Oct. 29th
6.	Argus Three ..	Nov. 5th
		Nov. 12th
7.	Empire Short-Wave Three ..	Nov. 26th
		Dec. 3rd
8.	Solo Knob Three ..	Dec. 10th
		Dec. 17th
9.	Midget Two ..	Dec. 17th
		1933
10.	Selectone Battery Three..	Jan. 7th
		Jan. 14th
		Jan. 21st
11.	Fury Four ..	Jan. 21st
		Jan. 28th
		Feb. 4th
		Feb. 11th
		Feb. 18th

receivers for 1s. each, post free. When ordering, quote the number. Copies of the paper containing descriptions of the particular receiver cost 4d. each. Address orders to: The Publisher, George Newnes, Ltd., 8-11, Southampton Street, Strand, W.C.2.

Blueprint Receiver. Described in issues dated

Receiver	Date
Fury Four (continued)	
12. Featherweight Class B Four valver	Feb. 25th
	Mar. 4th
	Apr. 29th
	May 6th
13. Q.P.-P. Three-Four ..	Feb. 25th
	Mar. 4th
	Mar. 11th
	Mar. 18th
14. Alpha Q.P.-P. Three ..	Mar. 25th
	Apr. 1st
15. Ferrocart Q.P.-P.Hi-Mag Three	Mar. 25th
	Apr. 1st
	Apr. 1st
	Apr. 8th
	Apr. 15th
17. Beta Universal Four ..	Apr. 8th
	Apr. 15th
	Apr. 22nd
	Apr. 29th
18. A.C. Twin ..	Apr. 15th
	Apr. 22nd
	Apr. 29th
19. Selectone A.C. Radio-Gram Two	Apr. 22nd
	Apr. 29th
	Feb. 25th
20. A.C. Fury Four ..	Mar. 4th
	Mar. 11th

As startling in its effects as the invention of the pneumatic tyre

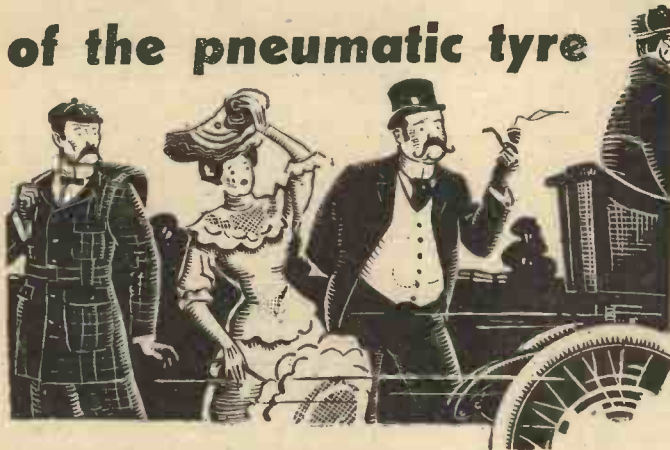

Suddenly, one day, motor-car speeds were doubled—pneumatic tyres had arrived, making comfortable speed possible at last. How people stared! To-day, in radio, double-capacity accumulators have arrived—a revolution no less far-reaching—

the plate-less accumulator

- ① No bigger than the ordinary 40 a.h. type — yet each charge lasts twice as long (capacity 80 a.h.)
- ② Much longer life, too — no plates to buckle, nor can the plates disintegrate.
- ③ A lovely cylinder of coloured bakelite instead of a lumbering glass "box".

THE new accumulator means double value. The secret? No plates! Thus — no waste weight, no interference with the charging of the paste. No heavy casing needed, either—the negative electrode is itself the battery's container! Modernise your set with one to-day!

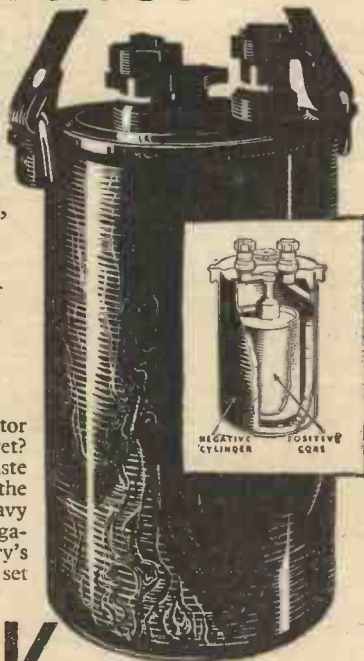

BLOCK plate-less accumulators

2. **80** AMP. **11/6^d.**
v. **80** HRS.

BLOCK BATTERIES LTD., ABBEY RD., BARKING, ESSEX. TEL.: GRA 3346

STUDY
AT
HOME

IN YOUR
SPARE
TIME



CAN HAVE A
COLLEGE TRAINING
IN ALMOST ANY CAREER
FOR A FEW SHILLINGS MONTHLY

MATRICULATION

There are many ways of commencing a career, but Matriculation is the jumping-off board for all the best ones.

CIVIL SERVICE

Suitable to both sexes. Ages 15½ to 24.

G.P.O. ENG. DEPT. CUSTOMS AND EXCISE;
INSP. OF TAXES, Etc. NO EXPERIENCE
REQUIRED. OPEN EXAMS.

We prepare candidates for all

INSTITUTE EXAMS.

TECHNICAL, INSURANCE, COMMERCIAL,
GENERAL, POLICE, Etc., Etc.

ENGINEERS ALL BRANCHES

There are examinations which are open and suitable to you, others which are not. Get our advice before deciding.

Let me give you that fatherly advice which is FREE to you, but which may mean so much to you in the future.



DO NOT DELAY — There may be chances for you to-day for which you may be too late to-morrow. Every day counts in a man's career.

J.W. Bennett

LET ME BE YOUR FATHER

Accountancy Examinations
Advertising and Sales Management
A.M.I. Fire E. Examination
Applied Mechanics
Army Certificates
Auctioneers and Estate Agents
Aviation Engineering
Banking
Boilers
Bookkeeping, Accountancy and Modern Business Methods
B.Sc. (Eng.)
B.Sc. (Estate Management)
Building, Architecture and Clerk of Works
Chemistry
Civil Engineering
Civil Service
All Commercial Subjects
Commercial Art
Concrete and Structural Engineering
Draftsmanship, all branches
Engineering, all branches, subjects and examinations
General Education
G.P.O. Eng. Dept.
Heating and Ventilating
Insurance

Mathematics
Matriculation
Metallurgy
Mining, all subjects
Mining Electrical Engineering
Motor Engineering
Municipal and County Engineers
Naval Architecture
Pattern Making
Police, Special course
Preceptors, College of Pumps and Pumping Machinery
Radio Reception
Road Making and Maintenance
Salesmanship
Sanitation
Secretarial Exams.
Ship-building
Shorthand (Pitman's)
Structural Engineering
Surveying
Teachers of Handicrafts
Telephony and Telegraphy
Transport Inst. Exams.
Weights and Measures "Insp."
Wireless Telegraphy and Telephony
Works Managers

If you do not see your own requirements above, write to us on any subject.

IT COSTS NOTHING TO ENQUIRE

WE TEACH BY POST IN ALL PARTS OF THE WORLD

Also ask for Our New Book (FREE OF CHARGE)

THE HUMAN MACHINE SECRETS OF SUCCESS.

Note Address carefully:

**THE BENNETT
COLLEGE, Ltd.**
(Dept. 192), SHEFFIELD.



Dept. 192

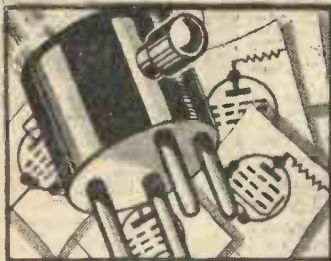

FURTHER PRACTICAL NOTES

— ON —

PENTODES

(Continued from page 228, April 29th issue.) H. T. GODLEY, F.R.A.

THE purpose of the screening grid mentioned last week is to reduce the effective capacity between the control grid and the anode, literally pulling the electrons through the exceedingly fine mesh of the control-grid and neutralizing the screening effect of this grid. Thus, it is possible to obtain an amplification factor running into several hundreds.

Now the S.G. valve is, of course, essentially a high-frequency valve, and is therefore called upon to handle only very small signal oscillations, often merely the un-amplified signals from the aerial. It is a fact, however, that when an attempt was made to use this valve in the output stage, where it was called upon to handle considerably larger oscillations, it was found that the velocity of the electrons was so great that a reverse electron flow, or secondary "emission," from the anode was set up, causing the electrons to return from the anode to the "screen" grid, thus reducing the effective anode-current and rendering the valve useless as an output valve.

To overcome this secondary emission, yet another grid was interposed, this time between the "screen" grid and the anode, and by connecting this "suppressor" grid to the filament the effect of the secondary emission was reduced sufficiently to enable a very high amplification factor to be retained when handling large grid-swings. In short, therefore, the pentode is really a S.G. valve modified by the addition of the "suppressor" grid, enabling it to be used as an output valve.

Fitting a Pentode

Many people have written to me from time to time, asking whether, by fitting a pentode, greater volume will result! This is a question that cannot be answered without some knowledge of the circuit of the receiver. Although the later pentodes are designed to handle fairly large grid-swings, yet they are still overloaded much more easily than an equivalent triode.

Suppose that the required undistorted output were 500 milliwatts, i.e., half a watt, then a super-power valve capable of giving such an output would require a total grid-swing of some 36 volts, which would certainly not be available from the detector. Therefore, we would have to use between the

an L.F. valve with a fairly high magnification factor, applying it to the grid-swing of some 8 or 9 volts from the detector stage, which, after being amplified by the valve and stepped up through the intervalve transformer, would result in the 36 volt grid-swing required by the super-power valve, thus enabling it to deliver the required half a watt for the loud-speaker.

Now the average battery pentode will handle a total grid-swing of only 15 volts or so, but for this small input will deliver the required half a watt. It will be obvious, therefore, that if we were to use a pentode in place of the super-power valve, we should not get any more volume, but we should certainly get severe distortion due to the pentode being badly overloaded by the output from the first L.F. valve. On the other hand, if the pentode were used in place of the first L.F. valve, the signal input to which is only 8 or 9 volts, the pentode would not be overloaded, and we could dispense with the other stage. By coupling the pentode to the detector with a 7:1 instead of a 3:1 transformer, the signal input to the pentode would just be sufficient to "load" it nicely, enabling it to deliver its maximum output of half a watt.

In such a case, therefore, the use of a pentode does not result in greater volume, but it does enable you to simplify the receiver and to economise in battery costs while still retaining the same volume as was originally obtained from two L.F. stages.

If, on the other hand, the existing set has only one L.F. stage, the use of a pentode in this stage will definitely result in greater volume, due, of course, to the fact that for a given input from the detector the pentode will give a much greater output than would the triode.

Increasing Efficiency

There is nothing difficult in fitting a pentode, as no wiring has to be altered, it being merely necessary to connect the auxiliary grid to H.T. positive. The suppressor

grid is connected internally to the filament, and is thus automatically earthed. There are, however, several modifications which can be made, all of which are worth while, as they will result in increased efficiency and better quality of reproduction. In the first place, it is usual to couple the pentode to the detector by means of a transformer and not by a resistance-capacity coupling, and in order to obtain a sufficiently large grid-swing to load the pentode, the trans-



Fig. 2.—A direct anode connection.

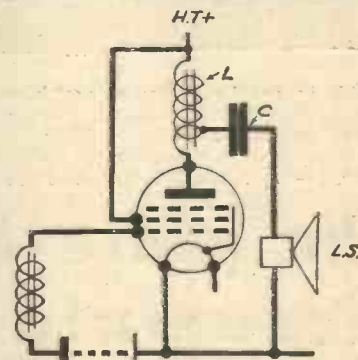

Fig. 4.—A choke filter output.

former should be one of the special pentode types in which the step-up ratio is higher than usual. The average ratio for a triode transformer is about three-to-one, whereas, in the case of a pentode, a ratio of seven-to-one can be employed with advantage.

The next point to consider is the coupling of the pentode to the loud-speaker. If in your present set the loud-speaker is wired directly between the positive end of the H.T. battery and the anode of the last valve, as in Fig. 2, you should, upon fitting a pentode, incorporate in the circuit some arrangement which will divert the H.T. current from the loud-speaker and which will also allow the maximum transfer of signal energy from the valve to the speaker (impedance-matching). There are two or three suitable arrangements, such as an output transformer (Fig. 3), choke-capacity-filter (Fig. 4) or a combination of the two (Fig. 5). The impedance of the valve will almost certainly not be just right for use with your particular loud-speaker, and if this state of affairs is not corrected, only a fraction of the signal energy available from the valve will reach the loud-speaker, the result being distortion and poor volume.

By using an output transformer having the correct ratio, the impedance values can be accurately matched and thus full benefit is derived from the pentode.

(Continued on page 275.)

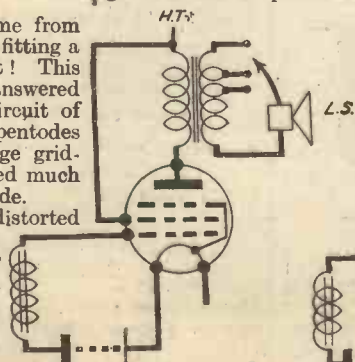

Fig. 3.—A pentode output transformer.

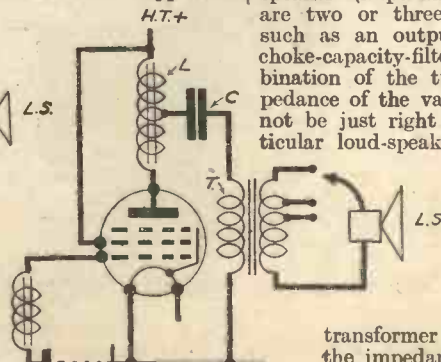
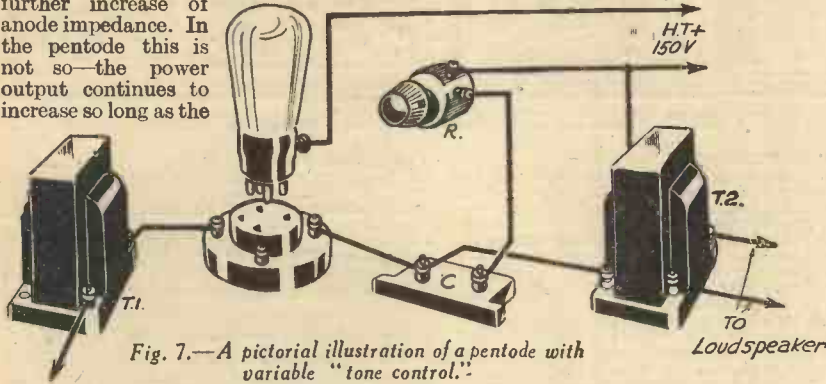

Fig. 5.—A combination of choke and transformer coupling.

(Continued from page 274.)

Matching Impedances

The necessity for accurately matching the impedances assumes particular importance in the case of a pentode valve, the reason being that, in a triode, the power output increases with anode impedance up to a point, but having reached this point, remains fairly constant regardless of any further increase of anode impedance. In the pentode this is not so—the power output continues to increase so long as the



impedance in the anode circuit increases, and there is no point where the power output becomes constant as in the triode. The audible result of this characteristic is rather high-pitched and shrill "pentode-tone" which, if not corrected, is so unpleasant to the ear. It is a simple matter to overcome this high-pitched tone, as will be explained later—for the moment we must revert to the output transformer.

There are many pentode output transformers on the market, the secondary windings of which are tapped at three points, and by trying each tap in turn and using that which gives best results, the impedances are more or less accurately matched. This method is, however, a trifle haphazard, and probably some of my readers would prefer to know exactly what ratio they should use.

In the case of a triode output valve, the "load" impedance is assumed to be twice its actual impedance, but in the case of a pentode the matter has to be treated a little differently, as, owing to its high impedance under working conditions, it is not advisable to take twice the impedance as being a suitable "load" impedance. For all practical purposes, a satisfactory compromise is arrived at by assuming the "load" impedance to be 8,000 ohms—this value is correct for most of the standard battery pentodes on the market. The required transformer ratio is found by using the formula $\sqrt{\frac{R}{S}}$ where r is the

required ratio, R the "load" impedance, and S the average loud-speaker impedance. Assume that a low-impedance moving-coil loud-speaker has to be matched to a pentode, the average impedance of the speaker being 20 ohms, then the formula becomes $\sqrt{\frac{8000}{20}}$ which, boiled down, comes to 20, the correct transformer ratio being 20 : 1.

Output Filter

If it is decided to use the choke-capacity-filter as in Fig. 4, which is, perhaps, somewhat cheaper than the output transformer arrangement, it is necessary to use a special pentode choke as these are designed to have sufficient inductance when carrying the full anode current, and moreover, are tapped for impedance-matching purposes. It will be seen that one side of the loud-speaker is connected to earth, the other

side being connected to the centre-tap on the choke through a fixed condenser. This condenser must not be too small, as if anything less than two microfarads is used, the tendency will be for the quality to be lacking in bass-note response. The smaller the condenser the less bass notes. Furthermore, this condenser must be a good-class component, as the speech

voltages generated by the valve may be very high, and if the condenser is a "cheap" one, it may soon break down. In the case of large power pentodes, these peak voltages may be as much as two or three thousand volts, and therefore the insulation of every component in the output stage must be capable of withstanding these surges.

Particularly in the case of these large pentodes, the loud-speaker must never be disconnected from the set while the set is "on," the reason being that by so disconnecting the speaker, a considerable increase in anode impedance is caused and the extremely high peak voltage thus caused may be sufficient to break down the insulation of one of the components, however good they may be, or may even crack the base of the valve itself. Assuming the circuit to be as in Fig. 2, it will be clear that by disconnecting the loud-speaker, the connection between the battery and the anode of the valve is broken, but the connection between the battery and the auxiliary grid is not. Under these conditions, the anode is dead while the auxiliary grid is still at high potential, and this will probably damage the valve. If an output transformer or choke is used, as recommended, then, of course, disconnection of the speaker does not break the anode circuit, and, therefore, the point is not of such importance.

Tone Control

Now to go back to the question of the characteristic "pentode-tone," it is a fact that a pentode reproduces the treble frequencies much more vigorously than the middle and bass frequencies with the result that the reproduction sounds high-pitched and shrill. Fortunately, it is a simple matter to overcome this effect, it merely being necessary to connect a small fixed condenser in series with a resistance across the loud-speaker itself, or if one is fitted across the primary of the output transformer. By using a variable resistance as shown in Fig. 7, the impedance of the tone-control becomes variable, thus permitting gradual control of the high-note attenuation to suit individual tastes.

In the majority of cases, it will be found that a variable resistance of 50,000 ohms used in conjunction with a mica-dielectric condenser of .01 mfd. will be suitable.



The public becomes more and more critical of the standard of reproduction and the Engineers of the Blue Spot Company, after the most exacting and painstaking research, have produced a range of Moving Coil Speakers which represents the latest achievement in speaker technique both from the point of view of design and reproduction. Here is model 29 P.M.—a splendid achievement.

CONVINCING POINTS

Astounding reproduction over whole musical scale • Scientifically designed matching transformer for Power, Super Power, Pentode, Q.P.P. (Triode) and class B Output • Q.P.P. Pentode model 2/6d. extra • Troublesome solder tags dispensed with—in their place we provide efficient terminals for easy valve matching • New process Cone and Speech Coil—no fouling in the gap • Copper plated Chassis with felt surround • No excessive bass, no shrill top. Don't buy a Moving Coil Speaker until you have heard this new Blue Spot.

Mounted to special baffle and perfectly fitted in attractive Oak Cabinet with new Blue Spot fret, Model 22 P.M. 45/-.

Write for Catalogue P.R.68.S, post free from THE BRITISH BLUE SPOT COMPANY LTD. 94/96 Rosoman Street, Rosebery Av., London E.C1. Telephone: Clerkenwell 3570. Distributors for Northern England, Scotland and Wales: H. C. RAWSON (Sheffield and London), Ltd. 100 London Road, Sheffield.



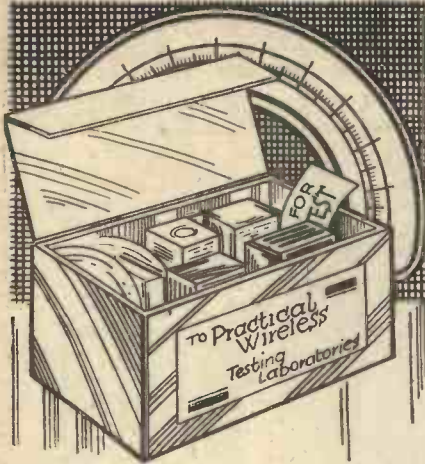

Facts and Figures

Components Tested in our Laboratory

BY THE PRACTICAL WIRELESS TECHNICAL STAFF.

ATLAS PENTODE CHOKE

THE question of coupling the loud-speaker to the anode circuit of a pentode valve is not a simple one. There are quite a number of points to be watched, not the least of which is the question of impedance matching. The choke illustrated on the right is manufactured by the well-known firm of H. M. Clarke of Manchester, and is a most substantial component. It is approximately 6in. long, and about as tall, and as may be seen in the illustration, it is fitted with six terminals. The ends of the actual winding are joined to the two outside terminals, and the remaining four terminals are connected to tapings so that it is possible to obtain ratios of 1 : 1, 1.23 : 1, 1.5 : 1, 1.6 : 1,



The Atlas Pentode Choke.



Emicol pocket and panel meters.

1.9 : 1, 2.1 : 1, 2.7 : 1, 3 : 1 and 5 : 1. It is therefore possible to match practically any make of pentode with any type of speaker. The winding is very substantial, having a D.C. resistance of only 385 ohms, but with an inductance of 48 to 50 henries. It is wound with heavy gauge wire, and will carry currents up to about 100 mA., but the maximum recommended current, in order to obtain a satisfactory inductance value, is 60 mA., at which the inductance is about 35 henries. This is a very high-class component, and will be found admirable for high-quality mains receivers. The price of the model illustrated is 21s., and it is also obtainable in an unshrouded form at 17s. 6d.

EMICOL INSTRUMENTS

THE two instruments illustrated on the left are two popular models manufactured by the Electrical Measuring Instruments Co., Ltd., and are respectively a pocket meter, Type 4-104, and a panel instrument, Type 4-14. Both of these are of the moving-iron type, and are fitted with a dead-beat movement. Although cheap they are very good instruments, and have an accuracy which is sufficient for all normal purposes. The pocket instrument is available in two types — voltmeters and ammeters. There are six separate ranges in the voltmeter type, and in addition, two double-reading meters. The single-reading meters cost 5s., and 5s. 6d., according to the range, and the double-reading meters cost 6s. for a 0-6volts and 0-120 volts, and 6s. 2d. for a 0-6 volts and 0-150 volts. The panel instruments are available as voltmeters, ammeters and milliammeters, and a special type of high-resistance voltmeter is also available with a reading of 200 ohms per volt. These cost 11s., whilst the ordinary types are only 6s. The cases of both of these types of instrument are finished in black crystalline, and measure only 2in. in diameter. They are therefore highly suitable for the ordinary listener who only desires to keep check on his battery voltages or the operation of his valves, although, owing to their good movements, they may be found equally suitable for the enthusiastic experimenter who desires to carry out accurate measurements and undertake serious experimental work.

R.I. CLASS B COMPONENTS

RADIO INSTRUMENTS have now produced their range of Class B components, and these are divided into two classes—driver transformers and output choke. There is only one output choke, but this is tapped to provide ratios of 1 : 1, 1.2 : 1, 1.5 : 1 and 1.8 : 1. The driver transformers, however, are of four separate types, DY.37, DY.38, DY.39 and DY.41. The two latter cost 11s., and the other transformers 15s., whilst the output choke costs 12s. 6d. The DY.37 and DY.38 are of the double-ratio type of transformer, and the two other transformers are of the single-ratio type, so that it is possible to use practically any driver valve with any of the existing or shortly-to-be-produced Class B valves. It may justly be said, therefore, that Messrs. Radio Instruments have produced a most comprehensive range of Class B components so that full advantage may be taken of the principle with any type of valve. The electrical characteristics of the components are very good indeed, the power efficiency of the drivers being in no case lower than sixty-five per cent., and in the case of the DY.38, arranged to give a 2.5 : 1 ratio, the efficiency is ninety per cent. The makers of these components supply a very complete data sheet with all particulars of the windings, load, etc., and it is thus possible to choose the best type of transformer for individual requirements. They may be highly recommended.

W.B. CLASS B SPEAKERS

WE have already commented upon the new Mansfield loud-speakers made by the Whiteley Electrical Radio Co. Ltd., and this firm is now able to

supply this particular model with input transformers suitable for either Q.P.-P. amplifiers or the new Class B valves. This is, of course, only a centre-tapped transformer of the push-pull type, but the question of matching must be fully studied if the speaker is to give of its best, and the W.B. speakers certainly stand up well to test. On our Class B Unit and with the Q.P.-P. Amplifier these new models gave splendid results, and were fully up to the original model using an ordinary matching transformer. We have already commented on the sensitivity of this particular type of loud-speaker, and with a Class B stage, fully loaded, the output from the P.M.4 is ample for the ordinary living-room, and, in fact, many would say that it was too loud. The brilliance of the Class B stage is fully reproduced and the effect of this full reproduction of harmonics and other top notes gives to music a "forwardness" which lends a new rendering to the term "reproduction." The price remains at 42s. for the P.M.4, and at 27s. 6d. for the P.M.5.

McDANIEL CLASS B TRANSFORMER

AN interesting small type of driver transformer has been received from Messrs. McDaniel and Co. of Romford. This is of the unshrouded type, having a core clamped in a metal skeleton casing, and the windings are only protected by Empire Tape. A small paxolin square is eyeleted to the top and carries the terminals. These are rather on the small side, but as the whole component is so small no exception can be taken to this as it enables the transformer to be incorporated in an existing receiver with ease. The primary winding has a D.C. resistance of approximately 500 ohms, and the total resistance of the secondary is also in this neighbourhood. The ratio is therefore 1 : 1, and it is thus suitable for the Cosor 240.B valve. As this is the only Class B valve at present available (other than the 362 valve which possesses similar characteristics) it is quite suitable for present-day requirements. The price is 8s. 6d., and it therefore compares favourably with other driver transformers at present on the market.



McDaniel Class B Driver Transformer.



Radio Instruments' Class B Driver Transformer & Output Choke.



IRON CORE TUNING COILS

(Continued from page 252.)

In the writer's built-up torroid system, matching is effected by slight displacement of one of the members, so that the mutual inductance is varied by an appreciable amount, while gap leakage is also affected, so that in this way matching becomes extremely easy. When a bobbin wound on a shell core is used, the inductance is usually matched by varying the air gap.

There is one fundamental difference between a coil wound on an ordinary laminated core working at audio frequencies, and one wound on a dust core. If we place two coils on a closed ring core, the coupling is substantially the same irrespective of the distance between the coils. In the case of a dust core, this is not the case, and the side limbs of a shell core are only partially effective. Accordingly, from the point of view of economy in design, it appears to be best to concentrate as much core into the actual field as possible, and it is for this reason that the torroid appears to be most popular. The leakage is also probably smaller.

The fact that a dust core coil has a magnetically closed core means that the stray field or leakage is quite small. This is another point in favour of the dust core coil, because it enables a screen to be placed very close to it without introducing any appreciable losses, and much space is thereby saved.

In conclusion mention must be made of two factors which are probably of more interest to designers than users. As there is a mass of metal inside the core, the coil and the core act as two elements forming a condenser, and the self-capacity of a coil of this type tends to become greater than that of an air coil with a corresponding inductance. It is necessary, therefore, to space the turns reasonably well away from the core, as otherwise the self-capacity becomes too high, and this in turn tends to reduce the tuning range.

Another interesting point is that the inductance varies appreciably with frequency. This is due to the permeability changing slightly with frequency, and it has already been pointed out that change in permeability produces a corresponding change in inductance. By suitable design, however, it is possible to produce an extremely efficient coil which will tune over the usual broadcast wavelengths. The coil can be made extremely small, and it can be fitted with an equally small screen. The resulting coil has an efficiency of the same order as that of a large coil wound with heavy Litz wire. Probably only those who have conducted research on dust core materials have any real appreciation of the tremendous possibilities. It is interesting to see, however, that already iron core coils are appearing on the British radio market.

THE MOTOR-CYCLISTS' REFERENCE YEAR BOOK, 1932-1933.

The Motor-Cyclists' Encyclopaedia.

Edited by F. J. CAMM (Editor of "Practical Wireless").

The Only Year Book relating to Motor-Cycles (Fourth Year of Issue).

Complete and comprehensive information relating to Machines, details, facts, and figures regarding records, legal matters, overhauling.

Classified Buyers' Guide, etc., etc. 128 pages, 1/- net or 1/2 by post from

George Newnes, Ltd., 8-11, Southampton Street, Strand, London, W.C.2.

The "SENATOR"

"THE CHOICE OF CRITICS"

Registered Design No. 773746.
SPECIFIED EXCLUSIVELY
for the New
"FEATHERWEIGHT PORTABLE"

This Midget Transformer has been the most remarkable success of the season. It is a small component of the highest efficiency and demonstrated to the Radio Industry the great advance in Transformer design. The "SENATOR" makes an ideal Parallel Feed Unit in place of old-fashioned Transformers, and results in better amplification with much purer tone.
Send for 80p. Catalogue "N" Enclose 2d. Postage.

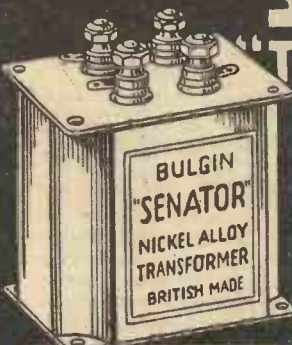

UNIVERSAL MOUNTING
Inductance 80 Henries
Size 1 1/8 x 1 1/8 x 2".
Price 6/9 Each
UNIFORM AMPLIFICATION.

TRADE  MARK.

NOTE THE CURVE

A F BULGIN & CO LTD ABBEY RD BARKING ESSEX CRANGEWOOD 3266

Another Magnificent Number



THE HOME PHOTOGRAPHER

THE RELIABLE MAGAZINE FOR EVERY AMATEUR PHOTOGRAPHER

Obtainable at all Newsagents, Bookstalls and Dealers, or post free 7d. (Subscription rates: Inland and Abroad, 7/6 per annum; Canada, 7/- per annum) from George Newnes, Ltd., 8-11, Southampton Street, Strand, London, W.C.2.

THE HOME PHOTOGRAPHER and Snapshots

is written in language you can understand, and is fascinating as well as informative. Packed with beautiful pictures, it tells you how to get the finest pictures with the apparatus you have, and how to save money by doing your own developing and printing. Its remarkable photogravure supplement—in colours obtainable IN YOUR OWN prints—has been universally admired, while monthly competitions with valuable money prizes are a regular feature.

Contents for May

- PRIZE WINNERS IN OUR "WATER" COMPETITION
- HOW TO TAKE YOUR FIRST FILM—
- YOUNG PHOTOGRAPHERS' SECTION—
- BEAUTIFUL PLACES FOR BEAUTIFUL PICTURES—
- NEW APPARATUS TESTED AND REVIEWED
- HINTS AND ADVICE ON EVERY PHOTOGRAPHIC SUBJECT
- PHOTOGRVURE SUPPLEMENT

6d

ANNOUNCEMENT

★ to men who want careers in RADIO

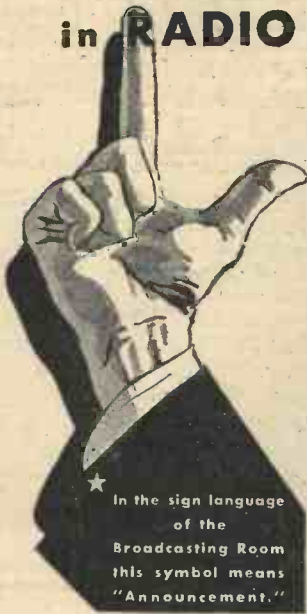

The I.C.S. Radio Courses cover every phase of radio work, from the requirements of the youth who wishes to make wireless engineering his career to the man who wants to construct and maintain a broadcasting set for his home.

The Radio industry is progressing with amazing rapidity... Only by knowing thoroughly the basic principles can pace be kept with it. Our instruction includes American broadcasting as well as British wireless practice. It is a modern education, covering every department of the industry.

OUR COURSES

Included in the I.C.S. range are Courses dealing with the Installing of radio sets and, in particular, with their Servicing, which to-day intimately concerns every wireless dealer and his employees. The Operating Course is vital to mastery of operating and transmitting.

There is also a Course for the Wireless Salesman. This, in addition to inculcating the art of salesmanship, provides that knowledge which enables the salesman to hold his own with the most technical of his customers.

We will be pleased to send you details of any or all of these subjects. Just fill in, and post the coupon, or write in any other way, stating which branch of Wireless interests you—the information you require will be forwarded at once.

International Correspondence Schools, Ltd.,
Dept. 94, International Buildings,
Kingsway, London, W.C.2.

Without cost, or obligation, please send me full information about the Courses I have marked x

- THE I.C.S. WIRELESS COURSES
- THE I.C.S. RADIO COURSES

Name..... Age

Address

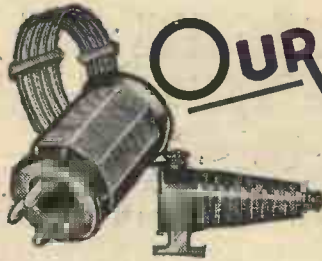

OUR SHORT WAVE SECTION



THERE is unfortunately a mistaken impression amongst those with but a vague idea on short-wave matters, that the only transmissions, apart from amateur telephony and code stations, are confined to broadcasting. The number of commercial stations which it is possible to receive during the day is a little surprising to the new hand. Owing to the many different languages used, identification is difficult, and, in addition to this, information and data concerning these stations are very difficult to obtain. The purpose of this article is to assist readers who are short-wave listeners to identify a number of commercial stations now on the air.

A number of foreign commercial telephony organizations welcome reports upon the reception of their transmissions, but, so far as the writer is aware, British transmitters neither ask for nor desire them, and readers are warned that there is a clause printed on their receiving licence concerning the unintentional reception of transmissions not intended for general reception. The regulations relative to this matter should be rigidly adhered to in every detail. When searching for S.W. broadcast transmissions, one cannot avoid tuning in those transmissions, and whilst the matter heard is of little, if any, interest, good use can be made of them if identification is at all possible.

As an example, let us take Station WOO, of Deal, U.S.A. This transmits on a wavelength of 17.52 metres, and other wavelengths. The writer assumes that the majority of short-wave enthusiasts have an approximate idea as to the tuning range of their coils, and in his case receives 17.52 metres at about 20° on the dial, using a four-turn aerial coil, with a tuning range of 16 to 29 metres. Well, there at least is one calibration point at the bottom of the dial, and the entry in the log is WOO—20° 17.52 metres. As WOO uses crystal control of wave-length or frequency, and the majority of commercial transmitters use identical apparatus or Marconi Franklin drive, the listener's data will be very accurate. Further explanation is unnecessary, and I intend to comment in the following paragraphs upon commercial transmitters located in South America, U.S.A., France, Germany, Java, and various other countries, and also to give details and data concerning the ship-to-shore telephony services.

Argentina

Station LSM, 14.19 metres, Buenos Aires, South America. This station works with a number of European stations irregularly, and will be heard at intervals just before noon and sometimes during early morning.

The call letters in Spanish are as follows: L—ai'ley. S—ai'sey. M—ai'mey.

Another station of the South American group is LSG, which has been heard transmitting on 15.07 metres. This wavelength, however, is sometimes used by

IDENTIFYING THE SHORT-WAVE TELEPHONY STATIONS

In this Article the Writer explains how Short-Wave Commercial and Ship to Shore Telephony Stations can easily be identified
By ALF. W. MANN

station LSY. A definite schedule seems to be the rule, and these stations should be received from 3 p.m. daily, according to the amount of traffic to be dealt with.

The call by which this transmission may be recognized is phonetically:—

Hillo Parie (Hello Paris)

the station with which telephony is worked being Ste. Assise, which is located near Paris.

France

The French transmitter located at St. Assise, FTM, will often be heard on 15.5 metres from 3 p.m. onwards, calling LSG Buenos Aires; the latter, replying on 15 metres:—

ai'ley tay ai'sey,

Java

Station PLE, which is the better known of the Java group, still continues commercial telephony transmissions, although the famous Tuesday afternoon broadcasts have been long discontinued. The wavelength used by PLE is 15.93 metres, and is sometimes heard working PCK Holland around about 11 a.m. one or two mornings during the week. Another station working PCK is PMB on 14.55 metres.

Rio de Janeiro

A correspondent informs me that he has heard several commercial phones, the transmitters of which are located in Rio de Janeiro, PSK on 36.6 metres, and PSH on 29.35 metres, which, I understand, work with LSN, the latter being on 14.27 metres, according to my log.

Australia

Station VK2ME is well known to old hands, and is one of the Amalgamated Wireless group located in Sydney, N.S.W., Australia. This station carries out telephony with Java and England and, at intervals, certain American stations; the wavelengths used being 15.5 metres, 28.5 metres, 30.75 metres, 37.7 metres. On the 28.5 metres wavelength, VK2ME may sometimes be heard calling GBX; the latter transmits on 27.5 metres.

Ship to Shore Telephony

The wavelengths assigned to ship and shore telephony are 17.05 metres, 22.68 metres, 33.95 metres, and 71.82 metres. The number of ships fitted with telephony apparatus is steadily increasing, and among those to be heard at intervals are the:—

- s.s. *Majestic* (call G.F.W.V.),
- s.s. *Olympic* (call G.L.S.Q.),
- s.s. *Leviathan* (call W.S.B.N.),
- s.s. *Empress of Britain* (call G.M.B.J.),
- s.s. *Belgenland* (call G.L.J.Q.).

OUR SHORT WAVE SECTION

(Continued from previous page.)

The following land stations carry on telephony with the aforementioned and other stations: GBA—14.7 metres; the American WOO, which was incidentally one of the first to work this service, transmits on a number of different wavelengths, one being 17.52 metres. GBB and GBC used to work ships, but the former station is most frequently heard calling SUZ, Cairo, the Egyptian commercial telephony station. GBC has been heard on a wavelength of 22.06 metres.

CGA—62.70 metres, was the Canadian station of Drummondville, which worked with ships at intervals, but has not been heard recently.

German Ships

A number of German liners are now fitted with wireless telephony apparatus, three of the most famous being:—

- s.s. *Berlin* (D.D.B.R.),
- s.s. *Albert Ballin* (D.D.N.Y.),
- s.s. *Europa* (D.D.A.C.),

and may be heard on the usual ship wavelengths.

Italian Ships

It is reported that a number of Italian ships are to be heard testing on ship to shore telephony. The writer, however, has only heard the s.s. *Conte Rossa*, whilst in some foreign dock with an almost unpronounceable name. The wavelength used was approximately 16.5 metres, and the station calling, Coltano, in Tuscany, Italy. The *Conte Rossa* later changed over to 17.18 metres.

Coltano is the Italian naval short-wave transmitting station, and it is claimed that communication with any Italian ship at sea will soon be possible.

A lady correspondent in Ceylon informs me that the *Conte Rossa* was in Colombo harbour some months ago, and the music provided by the ship's orchestra was broadcast by the Colombo medium-wave broadcasting station. As this, and a number of other ships, cruise around the world at intervals, during which telephony tests are carried out, the owner of the most humble receiver may get a surprise as to the reaching-out propensities of his receiver, if fortunate enough to tune in these ship transmissions.

Another Magnificent Number

THE May "Home Photographer" is packed with beautiful pictures, and the reading matter is fascinating as well as informative. It tells you everything you want to know. Its remarkable photogravure supplement has been universally admired, while its competitions with valuable money prizes are a special feature.

The HOME PHOTOGRAPHER and SNAPSHOTS

THE RELIABLE MAGAZINE FOR EVERY AMATEUR PHOTOGRAPHER

Obtainable at all Newsagents, Book-stalls, and Dealers, or post free 7/6d. from George Newnes, Ltd., 8, 11, Southampton Street, Strand, London, W.C.2.

EASY TERMS

Everything Wireless supplied on lowest terms. Prompt Delivery Guaranteed. Price List Free on request.

NEW BLUE SPOT UNITS

Just released.
NEW BLUE SPOT 99 P.M. MOVING-COIL UNIT. With order Cash Price £2/19/6. 5/-
And 11 monthly payments of 5/6.

NEW BLUE SPOT PERMANENT-MAGNET MOVING-COIL SPEAKER 29 P.M. With order transformer. Cash Price £1/12/6. 5/-
And 6 monthly payments of 5/2.

12 EXIDE W.H. HIGH TENSION ACCUMULATORS. (20 Volts, 5000 M.A.). The cheapest With order and best High Tension Supply where Mains are not available. Cash Price £9/15/0. And 11 monthly payments of 7/-.

ATLAS ELIMINATOR A.C. 244. Three H.T. With order tapplings. 20 M/A output. Cash Price £2/19/6. 5/-
And 11 monthly payments of 5/8.

ALL CARRIAGE PAID. QUOTATIONS BY RETURN.
To avoid delay will customers kindly send first payment with order.

THE LONDON RADIO SUPPLY COMPANY,

Dept. P Established 1925.
11, OAT LANE, NOBLE ST., LONDON, E.C.2
Phone: NATIONAL 1977.



Filtron
THE EARTH THAT GROWS A ROOT!
For Sensitivity and Silent Background.
Price 2/- of all Dealers.

LOUD SPEAKERS REPAIRED 4/-

(Blue Spot a Speciality, 5/-)
Transformers 4/6, all repairs magnetised free. Eliminator Repairs quoted for. 24 Hours Service. Discount for Trade. Clerkenwell 9069.
E. C. MASON, 44, EAST ROAD, LONDON, N.1.

A Complete Range of KNOBS



MATCH UP!
... that odd assortment of knobs on your panel by making a selection from our range.

POINTER KNOBS
Black.
K.3. 1 1/2" dia. x 3-16" bore 6d.
K.4. 1 1/2" " x 1/4" " 6d.
K.5. 1" " x 3-16" " 4d.
K.6. 1" " x 1/2" " 4d.

WALNUT KNOBS
K.11. 1 1/2" dia. x 3-16" bore 6d.
K.12. 1 1/2" " x 1/4" " 6d.
K.13. 1" " x 3-16" " 4d.
K.14. 1" " x 1/2" " 4d.

OCTAGON KNOBS
Black.
K.7. 1 1/2" dia. x 3-16" bore 6d.
K.8. 1 1/2" " x 1/4" " 6d.
K.9. 1" " x 3-16" " 4d.
K.10. 1" " x 1/2" " 4d.

RIBBED KNOBS
Black.
K.15. 1 1/2" dia. x 3-16" bore 4d.
K.16. 1 1/2" " x 1/4" " 4d.

ARROW LINE
Black.
K.17. 1 1/2" dia. x 3-16" bore 4d.
K.18. 1 1/2" " x 1/4" " 4d.
Delivery ex. stock.

BULGIN
SEND FOR 80 PAGE CATALOGUE & MANUAL
Enclose 2^d Postage.
(Dept. 'N'),
A. F. BULGIN & Co., Ltd.,
ABBAY ROAD, BARKING, ESSEX.

Again, the designer's choice...

SPECIFIED
for the
"FEATHERWEIGHT PORTABLE"
1, 7-Pin (Floating Type)
3, 4-Pin (Standard Type)

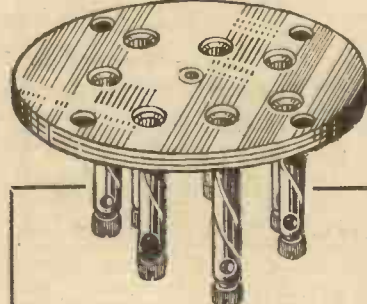

7-Pin (Floating Type) - 1/-
Specially designed for CLASS B and double diode triode valves.
5-Pin (Standard Type) - 9d.
4-Pin (Standard Type) - 8d.
Obtainable from all dealers.
Write for Folder 'N' for details of the wide range of CLIX Contact Components.

CLIX NEW FLOATING TYPE 7-PIN VALVEHOLDER (Chassis Mounting)

As receiver and valve design advances, the design and construction of CLIX Components advance also to meet the most modern requirement. Experienced designers, realising the excellence of CLIX valveholders, continuously specify them.

CLIX new 7-pin model incorporates an entirely new and patented "floating" principle which allows the sockets to automatically align with incoming valve pins and prevent jamming.

Turned resilient sockets guarantee full-surface contact with ANY type of valve-pin and without fear of collapse.



LECTRO LINX, LTD., 79a, ROCHESTER ROW, LONDON, S.W.1.

PRACTICAL WIRELESS POSTAL RADIO BARGAINS

**SAVE MONEY...ORDER DIRECT
ORDER WITH CONFIDENCE.**

UNIQUE PORTABLE BARGAIN



LISSEN 2v. Pentode TRANSPORTABLE
This famous Lissen 2-valve Pentode portable is complete with Lissen 120v. H.T. Battery, Lissen 9v. G.B. Battery, Lissen 2v. Accumulator and Lissen valves; incorporates balanced armature speaker. Ideal Portable for holidays, in the car, or on picnic. Special purchase enables us to offer them at this remarkable price. Stocks limited; get yours to-day.

PEARL & PEARL £2-19-6 Carr. Paid.
190, BISHOPSGATE, LONDON, E.C.2



FIT THIS ELECTRIC CLOCK TO YOUR SET!
NO MAINS NEEDED!
KEEPS CORRECT TIME!
NO WINDING!

Works off small battery lasting 12 months, or can be plugged into G.B. battery without affecting reception. Uses practically no current. Fits into hole 3 1/2 in. dia. in any panel up to 1/2 in. thick. Easy to fix—no screws required. Only 1/2 in. from front of panel to back of case. Swiss movement. Hands set from front. Nickel-plated bezel. Useful addition to any set.

RIVERSIDE MFG. Co., Ltd.,
Dept. 21, Crisp Road,
Hammersmith, W.6.
Telephone: Riverside 6392.

12/6
COMPLETE WITH BATTERY
POSTAGE 6D

AMPLION

LOUDSPEAKERS

AT BARGAIN PRICES

A.C.6.	25/- Oak Cabinet Speaker	12/11
A.B.4.	59/6 Walnut Cabinet Speaker	17/6
A.B.6.	90/- Walnut Cabinet Speaker	25/-

MORE SPEAKER BARGAINS
for "Practical Wireless" Readers

DO IT AT HOME and SAVE £ £ £



Boot repairing with Rhino-Sole is simplicity itself; a plastic compound easily spread on with a knife, it can be moulded to any desired shape or thickness and hardens ready for wear in a few hours. "Rhino-Sole" repairs rubber as well as leather footwear and is ideal for worn tennis shoes, gum boots, goshoes, etc.

1/6
Per Tube Post 3d.

Every tube is guaranteed and contains enough Rhino-Sole for 2 good soles and dozens of patches. Send P.O. for 1s. 9d. to

STEVENSON'S (Dept. P.), 144, Greenway Avenue, WALTHAMSTOW, LONDON, E. 17.
Trade Enquiries to 172, Fleet Street, E.C.4.

60 Volt BATTERIES

FOR **2/3**



We will tell you how you can make your own wireless Batteries by a simplified patented process at an average cost of 2/3 for 60 volts. You can make them for yourself and save money and sell them to your friends and make money. Many intelligent men and women are doing this. One man made £960 in spare time only. Send to-day for definite proof of money earned and free details how to start to:

England-Richards Co., Ltd.,
Dept. (248), King's Lynn, Norfolk.

GUARANTEED COMPONENT AND RECEIVER BARGAINS

G.E.C. 50/- "Stork" Oak Cabinet Speaker	19/6
Lamplugh "Silver Ghost" 42/- Permanent Magnet Moving coil Speaker	29/6
Lamplugh 34/- D.C. Moving Coil Speaker	15/-
Lamplugh 34/- A.C. Moving Coil Speaker (using pot as choke)	15/-
Celestion 27/6 M12 unit and chassis	11/9
Lincoln-Stewart 47/6 Permanent Magnet Moving Coil Speaker	16/11
Lissen Horn Units	2/6

Cash or C.O.D.
Carriage Paid.

Famous Maker's Offer? **£5 Radio-Gram CABINET for 65/- SEVEN DAYS' FREE TRIAL (OR 10/- MONTHLY)**

Polished Oak! and Piano built! The acoustic Tone brings a fine thrill. Makers to Radio-Press, B.B.C., 3,000 clients.

MODELS FROM 35/- to £15. Photographs and List FREE.

"D" PICKETTS Piano-Tone Cabinets, (P.R.), Albion Road, Bexleyheath.

FOR DE-LUXE RADIO-GRAMS PICKETTS CABINETS
Recommended for Best Results!

All Advertisements for

PRACTICAL WIRELESS POSTAL RADIO BARGAINS PAGE

should be addressed to
The Advertisement Manager,
PRACTICAL WIRELESS
8-11, Southampton St., Strand, W.C.2.

SOUTHERN RADIO Wireless Bargains; Ready Radio constructors' kits:

303 3-valve battery kit, less valves, 18/6, with 3 Mullard valves (P.M.1LF, P.M.2DX, P.M.2), 36/- each (list 70/-); Meteor S.G. 3-valve kit, less valves, 26/-, with 3 Mullard valves (P.M.12a, P.M.2DX, P.M.2), 49/- each (list 25/7/6); Meteor S.G. 3-valve "A" kit, including cabinet, Celestion P.M. speaker, and kit of parts, less valves, £37/6, with 3 valves as above, £412/6 (list 28/17/6); Mullard Radio for Million 3-valve A.C. kits, complete, with 3 Mullard valves (P.E.N. 4v, 354v., 84v.), £312/6 (list 26/10). All kits advertised are brand new, and contain 1 in original sealed cartons; valves advertised are the manufacturers' specified valves.

CELESTION P.M. Sounder Speakers, brand new, 16/- each (list 27/0); Cydon 3-gang condensers, 0.0005, shrouded and trimmers, 9/0 each (list 32/-); genuine Amplion loud speaker units, 2/9 each (list 12/6); screened chokes (H.M.V.), 1/- each; condensers: 4 mfd., 2/6 each; 2 mfd., 1/9; 1 mfd., 1/- each; all 750 volt test; blocks, 12 mfd. (2+2+2+2+2+1+1), 6/9 each; 10 mfd. (2+2+2+2+1+1), 6/3 each; all 1,500 volt test; mains transformers, all capacities, in stock, and specials quoted for; all goods guaranteed. Carriage paid.—Southern Radio, 323, Euston Rd., London, N.W.1 (near Warren St. Tube). Phone: Museum 6324.

Long Distance Wireless Secrets

A book every listener has been waiting for. This practical work will solve your difficulties and enable you to obtain the best results of which your set is capable.

FINDING FOREIGN STATIONS

By R. W. HALLOWS
3/6

Obtainable at all Booksellers, or by post
3/9 from George Newnes, Ltd., 8-11,
Southampton St., Strand, London, W.C.2

GUARANTEED COMPONENT AND RECEIVER BARGAINS

Regentone 2-valve A.C. Receiver with Mullard valves.	Original price £6 15 0	Special bargain offer	59/6
Regentone 3-valve A.C. Receiver with Mullard valves and Moving Coil Speaker	Original price £12 0 0	Bargain price	£6 19 6
The famous Pye "Q" Portable, complete with batteries, accumulators, etc., as delivered from the manufacturers	Original price £14 14 0	Bargain price	£9 9 0
Three-gang screened condensers (made for Zetavox Receivers. Guaranteed accurately matched. With trimmers			8/6
Four-gang condensers, as above			12/6

For callers only at any branch—Hundreds M.P.A. assorted cabinets from 2/6
Many other radio bargains for personal callers at any of the branches given below.

PEARL & PEARL,
190, Bishopsgate, London, E.C.2

Branches:

11, Liverpool St., E.C.2.	100/101, Houndsditch, E.C.2.	276, Pentonville Road, King's Cross.
---------------------------	------------------------------	--------------------------------------



Practical Letters from Readers.

The Editor does not necessarily agree with opinions expressed by his correspondents

A Magnificent Volume

SIR,—I have just received my presentation copy of the Wireless Constructor's Encyclopædia, and I must express my surprise at such a magnificent volume. It makes a worthy companion to PRACTICAL WIRELESS, and I thank you for both. The binding is excellent, and it would be cheap at double the price. The matter in it is written in a style easy for the veriest novice to understand and yet even the oldest "fan" could not find fault with it. Your articles are, above all, practical, which is what we amateurs want.—R. G. VALE (Stroud).

Pigtail Connections to Condenser Spindles

SIR,—I would like to make some comments with reference to the Short-wave article in the March 25th issue of PRACTICAL WIRELESS.

Your contributor, "Togni," states that a pigtail connection to the spindle of a variable condenser is sufficient to eliminate noise caused by imperfect or intermittent contact between spindle and bush.

The usual form of pigtail, the spiral, possesses inductance of no mean value, and an intermittent contact between spindle and bush causes the inductance of the circuit as a whole to vary, thus causing almost as much noise as when without pigtail.

Also, there is no pigtail fitted to the front bush of the average condenser, and as the difference of potential must be considerable between front and rear plates, the rubbing contact evil is still present.

To overcome these difficulties, I have constructed a condenser with "skeleton ebonite end plates and no metal bushes. The pigtail connection is a strip of phosphor bronze, allowed to twist throughout its length, which is only one inch. The result is a condenser which is silent even below 10 metres.

The noise from a potentiometer can be eliminated by the simple method of not using one. I am working with a 2 meg grid-leak and 90 volts H.T., I get smooth reaction control with the grid leak connected direct to positive filament, and find a potentiometer unnecessary. This also applies to wavelengths below 10 metres. Noises from a swinging aerial, intermittent earthing of stay wires, etc., can be subdued by using an untuned screen-grid valve in the aerial circuit.

In conclusion, I should like to state that I am desirous of getting into touch with S.W. experimenters in the Stretford district. Wishing your paper every success.—W. FAULKNER (Stretford).

Article on Televisor Construction Wanted

SIR,—I should be glad if you would publish instructions on building the parts and constructing a home-made Televisor, if possible. As far as I can see, they are fairly expensive, and for all the use one

would make of them it does not seem worth while to go to so much expense.—J. SWAN (Cambuslang).

[We hope to shortly publish an article on this subject.—ED.]

An Appreciation: and a Criticism

SIR,—I beg to acknowledge safe receipt of the "Wireless Constructor's Encyclopædia," for which I thank you very much indeed. It is splendid value for the money, and contains really useful and practical matter of the utmost assistance to the novice and the veteran of wireless construction. Particularly interesting is the section devoted to television, enabling even the most ignorant person to grasp the fundamentals of this newest of sciences. I am also the possessor of the PRACTICAL WIRELESS binding case for data sheets, and I was absolutely surprised at its solid construction and workmanship. There is only one fault I can find with it, and that is in the method of securing the sheets. As the binder is made at present, with the press buttons on top, you either must

wait until the series of data sheets is complete before fixing them, or you must take them off each week to put on the next one. If the press buttons had been placed at the bottom of the sheets, each one could be put on without disturbing the others. Still, we can't have everything to suit us always, but PRACTICAL WIRELESS is the nearest approach to that, so best wishes for the future.—CHARLES MORTIMER (Jnr.) (St. Pancras, London, N.W.).

An Excellent Work

SIR,—I wish to acknowledge receipt of your book the "Wireless Encyclopædia," which is an excellent work, and most useful to anyone interested in wireless. It is a veritable mine of information, and right up-to-date with illustrations helping to make everything easy and clear. It exceeds all my expectations, and I can honestly recommend it to anyone desiring to know more about their sets, accumulators or anything connected with wireless. With PRACTICAL WIRELESS to keep us up to date with the latest improvements, and your Encyclopædia to refer to, there is little more that a wireless fan wants. Accept my best thanks for the book, wishing PRACTICAL WIRELESS every success in the future.—JAMES WM. CARROLL (Hull).

Wonderful Example of High-class Craftsmanship

SIR,—Thank you for my presentation volume which I received in good condition. I find it a most useful work of reference, and indispensable to a budding amateur like myself. The interesting manner in which the subjects are dealt with is splendid, and easily understandable, as is also the alphabetical order in which the articles are written, thus obviating the trouble of wearisome searching through indexes, which more often than not prove fruitless. The articles are very useful and practical, and the binding and printing are first rate. The whole volume is a wonderful example of high-class craftsmanship in every sense of the word.

As for PRACTICAL WIRELESS, it needs no suggestions from me but this: keep it Practical. Thank you again for the "Wireless Constructor's Encyclopædia" and wishing PRACTICAL WIRELESS every success.—ERNEST L. BEAMER (Liverpool).

"An Invaluable Work"

SIR,—I have just received my copy of your "Wireless Encyclopædia," and herewith tender my very best thanks. Its store of clear and concise information will stand me in good stead and I am exceedingly glad I have not missed your second chance to acquire this invaluable work. Wishing PRACTICAL WIRELESS every success.—W. E. R. (Guildford).

"A Fine Work"

SIR,—I feel I must write and congratulate you on offering such a fine work as the "Wireless Encyclopædia" to the public. Everything in it is explained in an interesting fashion, and the diagrams help one considerably to understand thoroughly each detail. The work is excellently bound and printed on good paper. Like PRACTICAL WIRELESS, it is first class. Thanking you again, with best wishes for the future of PRACTICAL WIRELESS.—R. W. ARTINGSTALL (Stalybridge).

(Continued overleaf.)

CUT THIS OUT EACH WEEK

DO YOU KNOW?

—THAT although a small condenser will often suffice in a decoupling circuit, the smallest that should be used, in the interests of stability, is .1 mfd.

—THAT dual matched loud-speakers present a great advance in reproduction, and correctly used are capable of practically "perfect" reproduction.

—THAT it is not practicable to build up, at home, a matched pair of moving-coil loud-speakers.

—THAT a tone-control circuit is often advisable with a Class B output stage, although the loud-speaker will decide the necessity of this.

—THAT a swaying aerial may prevent the reception of a station working on the short waves.

—THAT for the above reason, a short-wave aerial and lead-in should be anchored to insulators so that it cannot move in any direction.

—THAT a special form of valve has now been developed to enable an ordinary battery eliminator to be used with Q.P.-P. and Class B output stages.

—THAT it is a Neon device and is to be known as a "Stabiliser."

NOTICE

The Editor will be pleased to consider articles of a practical nature suitable for publication in PRACTICAL WIRELESS. Such articles should be written on one side of the paper only, and should contain the name and address of the sender. Whilst the Editor does not hold himself responsible for manuscripts, every effort will be made to return them if a stamped addressed envelope is enclosed. All correspondence intended for the Editor should be addressed: The Editor, PRACTICAL WIRELESS, Geo. Newnes, Ltd., 8-11, Southampton Street, Strand, W.C.2.

Owing to the rapid progress in the design of wireless apparatus and to our efforts to keep our readers in touch with the latest developments, we give no warranty that apparatus described in our columns is not the subject of letters patent.

HEYBERD
for the
latest
receivers!



Confident in the knowledge that Heyberd mains apparatus cannot be beaten, PRACTICAL WIRELESS technicians have exclusively specified the following components for their two latest circuits. Build one of these sets to-day!

FOR THE "A.C. TWIN."
Heyberd "A.C. Twin" Transformer. Secondary Outputs: 350 + 350 v. 60 ma. 2 + 2 v. 2 amps. and 2 + 2 v. 2.5 amps. Price **29/6**

FOR THE "SELECTONE A.C. RADIOGRAM."
Heyberd W.25 Transformer. Secondary Outputs: 0-110 v. 70 ma. and 0-135 v. 70 ma. 2+2 v. 4 amps. Price **22/6**

Heyberd 751 Choke. 50 henries, 800 ohms, 50 ma. Price **12/6**

Heyberd Twin Flex with lamp adapter. 8 feet length—ends trimmed and looped. Price **1/6**

Large stocks available. If you cannot obtain locally—write direct.



Post Coupon
for Heyberd
handbook on
Mains Working

I enclose 3d. stamps for New Handbook of Mains Equipment. Packed with Technical Tips, Service Hints and diagrams

Mr. _____
Address _____
Prac. _____

F.C. HEYBERD & Co.,
10 FINSBURY STREET, LONDON, E.C.2,
One minute from Moorgate Str

Genuine AMPLION Units, Limited number. Over 75 per cent. reduction. Guaranteed. To clear 2/3 each, carr. paid.—G.B. Pioneer Radio, Coptio St., W.C.1.

WHAT IS "ENGINEERING OPPORTUNITIES"?

"ENGINEERING OPPORTUNITIES" is a 250-Page Handbook that has been prepared after years of patient search into the possibilities of various Engineering Careers. It shows clearly and definitely the way in which you may carve out a successful career in your chosen branch of Engineering, irrespective of your age, education or experience.

Among a host of other things, it outlines Home-Study Courses in all branches of Civil, Mech., Elec., Motor, Aero., Wireless and "Talkie" Engineering and shows the easiest way to pass A.M.I.C.E., A.M.I.Mech.E., I.E.E., A.M.I.A.E., M.I.M.T., G.P.O., Matriculation, Civil Service and other Examinations.

"ENGINEERING OPPORTUNITIES" is a unique Handbook that you should most certainly read. Send for your copy to-day—FREE of any cost.

British Institute of Engineering Technology, 390, Shakespeare House, 29/31, Oxford Street, London.

A Magazine of Electrical Progress
THE PRACTICAL ELECTRICAL ENGINEER
Every Month

At all Newsagents & Bookstalls One Shilling

(Continued from previous page.)

The "Sonotone" : Remarkable Results

SIR,—I wish to congratulate you on your fine radio weekly, PRACTICAL WIRELESS. Also let me convey my thanks for your "Encyclopædia," which is full of good things. It might interest you to know that I have built the "Sonotone 4" with Q.P.-P. using the "Transfeeda" in the first stage followed by the Q.P.-P. I have tried the set as per your circuit with wonderful results, but I am always after that little extra which seems impossible with an ordinary battery circuit. Anyway, here's the result of my experiment. Volume: enough for a dance hall; quality: perfect; stations: 84 medium-wave, 19 long-wave and 7 American. I must thank you for the most wonderful set I have built in my fifteen years as a radio engineer.—G. A. H. (Edgbaston).

THE COSSOR NEON STABILISER

WHEN a battery eliminator is used to operate a receiver employing either a Q.P.-P. stage or a Class B valve, the varying current of the output valves gives rise to some peculiar effects. First of all, the majority of small mains units employ a series resistance in the H.T. positive lead to reduce the mains voltage to that normally required by battery valves, namely 150 volts maximum. In the case of a D.C. mains unit this will be quite a large value of resistance, and in the A.C. units the rectifier, whether valve or metal, will be arranged to give the output with a small series resistance to drop the excess voltage. Now it is well known that the passage of a current through a resistance results in a voltage drop, and the voltage depends upon the

current which is passed. For instance, the passage of 1 milliamp through a resistance of 10,000 ohms will result in a voltage drop of 10 volts, whilst 10 milliamps flowing through the same resistance will result in a drop of 100 volts. (Voltage equals the product of current in amps. and resistance in ohms). A feature of the Q.P.-P. or Class B output stage is that the anode current varies with the volume of the signal received, and a meter inserted in the anode circuit of such a stage will show variations throughout the playing of a single musical item, and will also show that when the volume of a received station is reduced, so is the current reduced, but varying volume due to the number of instruments which are being played, or the musical expression, will also result in a varying anode current. Obviously, therefore, if a mains unit is employed, the varying current through the unit will result in a varying voltage output.

The Stabiliser

This fault results in serious distortion due to a varying voltage on the output valve, a varying voltage on the detector and S.G. valves in the receiver, and this latter fact may cause serious instability due to oscillation. In order to overcome these defects Messrs. Cossor have produced a device known as a Neon Stabiliser, which is a small neon discharge device having a cathode and an anode, and is fitted with a standard valve base. The peculiarity of this device is that it works in exactly the opposite way to the resistance in the mains unit, that is to say, as the current across the Stabiliser increases the voltage drop is less, and vice versa. Therefore, by connecting this device across the mains unit the total output remains sensibly constant. The Stabiliser, known as the S.130, costs 7s. 6d., and a further article describing its application will be published in a future issue of PRACTICAL WIRELESS.

RADIO CLUBS & SOCIETIES

Club Reports should not exceed 200 words in length and should be received First Post each Monday morning for publication in the following week's issue.

NORTHERN MERSEY SIDE WIRELESS SOCIETY (SOUTHPORT)

A meeting has been arranged by this society to take place on Monday, May 8th, when rules, regulations and programme will be arranged. Applications for membership and admission to this meeting should be made, sending full details, to C. H. Turner, 62, Zetland Street, Southport, not later than Saturday, May 6th.

DENNISTOUN TRAMWAY DEPOT RADIO CLUB

The first outing of above club took place on Wednesday, April 19th, 1933, when thirty members set off from club headquarters by reserved bus to inspect the Scottish Regional Broadcasting Station situated at Westerglen, near Falkirk. On arrival at the station the party was received by the Chief Engineer, who provided members with description cards showing layout of building, also data concerning apparatus about to be inspected.

A tour was then made of the entire station, the power house, Diesel engines, filament current and high-tension motor generators, transmitter hall control rooms, and aerial masts being explained in detail by engineers conducting party round. The visit, which was of an hour's duration, was highly appreciated by those privileged to take part in proceedings. Hon. Sec., Wm. McKenna, 90, Paton St., Glasgow, E.1.

SLADE RADIO

A lecture, entitled "Measurements of Characteristics of Low-frequency Amplifiers," was given by Mr. D.

McDonald at the meeting of the above society held recently. He dealt with wave forms and breaking up into sine waves; also intensity of sound. After drawing the circuit of a simple two-stage amplifier, he described how to measure the frequency response and how to make a thermionic voltmeter. A method of measuring the response of an intervalve transformer without a valve was also shown. Overload or distortion was then dealt with, also load and harmonics and how to measure them from the output. The lecture proved of great interest and was enjoyed by the members. Hon. Sec., 110, Hillaries Road, Gravelly Hill, Birmingham.

INTERNATIONAL SHORT-WAVE CLUB

I shall be glad to send any of your interested readers a copy of our "New World Time Chart" if they will apply to the address given below, enclosing a 1d. stamp. A. E. Bear, 10, St. Mary's Place, Rotherhithe, London, S.E.16.

HACKNEY RADIO AND PHYSICAL SOCIETY

Our last two meetings have been confined to discussing the design of a new receiver for the use of the members of this society and to the installation of a microphone. From these discussions a most satisfactory design has been evolved.

An interesting programme, copy of which is appended has been arranged for the ensuing weeks. Local readers of PRACTICAL WIRELESS are invited to inquire for particulars of these meetings.

- May 8. Wood Finishes for the Amateur.
 - " 15. Gramophone Recital—Mr. Squire and Mr. Heath.
 - " 22. Modern Super Het design—Mr. A. Twiss.
 - " 29. Valve Characteristics—Mr. G. Deal.
 - June 5. Whistun.
 - " 12. Quiescent Push-pull, Class B, and other forms of Amplification—Mr. A. Twiss.
 - " 19. Adding a S.G. Valve to D. and one L.F. Receiver—Mr. Cole.
 - July 26. Remote Control—Mr. Cole.
 - July 3. Simple Calculations and Measurements—Mr. Cole.
 - " 10. The Use of Chokes.
 - " 17. Universal High Voltage Mains Valves—Mr. A. Twiss.
- A. F. Rogerson, Hon. Secretary, 19, Sewdley Street, Clapton, E.5.

LET OUR TECHNICAL STAFF SOLVE YOUR PROBLEMS

REPLIES TO



If a postal reply is desired, a stamped addressed envelope must be enclosed. Every query and drawing which is sent must bear the name and address of the sender. Send your queries to the Editor, PRACTICAL WIRELESS, Geo. Newnes, Ltd., 8-11, Southampton St., Strand, London, W.C.2.

QUERIES and ENQUIRIES by Our Technical Staff

The coupon on this page must be attached to every query.

ONE OR MORE SPEAKERS?

"I should very much like to know if I am using more from my batteries through having two or three loud-speakers in action."—(No name, Southampton.)

This is a common worry to many who are new to wireless, and is also on the same lines as the theory that the reception of distant stations leads to greater wear and tear on the batteries. The factor which governs the consumption from the batteries is the valves which are used, and therefore twenty loud-speakers could be used with no more consumption of H.T. or L.T. Naturally, if the loud-speakers are all connected in series in the anode circuit of the output valve there would be a large voltage drop, and this would have to be made good by using a larger battery, but the current consumption would remain unchanged.

HETERODYNE WHISTLE

"When I tune to the North Regional station I get a horrible whistle through the signals, and if I slightly tune below that station I can hear a sort of bubbling sound with voices. What is the cause of this, and how can I remove it? It completely spoils my reception of this station, and I find much from the station to interest me in place of the London transmissions."—(R. H., Wembley.)

The noise you hear is due to the close proximity of the German transmitter at Langenberg, and the Russian transmitter at Ivanovo-Voznesenk. The latter uses the same wavelength as the North Regional, and Langenburg is only 10 kc/s above it. The result is what is known as "side-band splash," and unfortunately there is no cure. You can cut off the top notes of the response of your receiver, and this will remove the whistle, but there will still be the cross-talk effect, and until the ether is cleared up by those responsible we are, unfortunately, compelled to put up with this trouble. There are one or two other spots on the tuning dial where the same thing occurs, and no matter how good the receiver the trouble is always present.

GANGING A CONDENSER

"I am going to rebuild my set, using a three-gang coil unit, and to get one-knob control I am thinking of using my old three condensers and joining up the spindles. Will this work out in practice, or is there any snag which I must guard against? I appreciate that the three condensers will have to be ganged, but I could make up a simple coupling device and arrange for this to be locked at any position. I can work out the details, as I have a lathe and am an engineer by profession."—(R. J., Edinburgh.)

There is nothing to stop you from making a ganging device and connecting the three condensers together. Neither is there anything to prevent you from ganging these three condensers at any part of the scale by arranging for your device to be clamped in any position. But the point which must be guarded against is the matching of all three condensers at all parts of the dial. You will find this is a difficult proposition, and is overcome in the commercial three-gang condenser by splitting the end plate of each section of the condenser and then rotating the rotors whilst tuning a circuit. By means of a special oscillator it is possible to ascertain when any one section goes out of tune, and the split section of the condenser out of tune is then bent until it is matched. In this way it is possible to have all three condensers dead in step at any point, and you will find this a little difficult to do at home without elaborate apparatus. If you can arrange three small trimmers capable of panel adjustment, your idea is workable, but you will find that the trimmers will require frequent adjustment when tuning from zero to maximum on your tuning dial.

FREE ADVICE BUREAU COUPON

This coupon is available until May 13th, 1933, and must be attached to all letters containing queries. PRACTICAL WIRELESS 6/5/33.

SPECIAL NOTE

We wish to draw the reader's attention to the fact that the Queries Service is intended only for the solution of problems or difficulties arising from the construction of receivers described in our pages, from articles appearing in our pages, or on general wireless matters. We regret that we cannot, for obvious reasons—

- (1) Supply circuit diagrams of complete multi-valve receivers.
- (2) Suggest alterations or modifications of receivers described in our contemporaries.
- (3) Suggest alterations or modifications to commercial receivers.
- (4) Answer queries over the telephone.

Please note also, that all sketches and drawings which are sent to us, should bear the name and address of the sender.

MATCHING LOUD-SPEAKER

"I have got an old moving-coil loud-speaker which I have pulled to pieces and rebuilt. The speech coil I have wound to a resistance of 10 ohms, and it has no method of arranging a transformer. I know it will want matching to my output valve to get the best from it, but I am not certain what transformer to get. How can I find exactly what my valve requires to get correct matching?"—(T. P., Hampstead.)

You do not tell us what valve you are using, so you will have to work out for yourself the correct ratio of the transformer. The first thing to know is the correct (or optimum) load of the particular output valve. If this is not available, you must find from Data Sheet No. 10 the A.C. impedance of the valve, and multiply this by two. The answer will be the optimum load, unless you are using a pentode, when it will be slightly greater than twice the A.C. impedance. You must then divide this figure by the resistance of your speech coil (10 ohms), and the square root of the answer will be the ratio of the correct transformer.

ELIMINATOR TO BLAME

"I have a four-valve receiver, S.G. detector, H.L. and P. The set was working well with a battery, but now I am using an eliminator and I find that the set is less selective, and there is a hum and crackling when I tune in North Regional or some foreign station. There is a small howling also when the dial readings are 130. Can you help me to set these right? I took out the valves and have put them back in the order I have stated. Should the H.L. be next to the screen grid?"—(T. H. M., Hampstead.)

Obviously, if the receiver worked satisfactorily from batteries, the mains unit is causing your trouble. The lack of selectivity may be caused by an increased H.T. voltage on your S.G. valve. Check the output from the eliminator and compare with your battery supply. Hum and crackling may be due to a faulty resistance or an overloaded eliminator, although if only occurring at one point on the dial it may be due to the condenser plates touching, or some etheric disturbance on that wavelength. The order of your valves is quite O.K., although you will probably find that the detector valve and the H.L. valve are interchangeable.

OVERLOADED OUTPUT STAGE

"I have a three-valve set. It was first of all made as a two-valve set, bringing in Daventry and Radio-Paris on the long waves, together with a few short-wave stations very well. I decided to add another valve, but the results are far from satisfactory. The National is not so loud or clear, and the tone in general is absolutely dead, with fearful oscillation. The new valve is resistance-fed. I should be very much obliged if you could help me."—(R. T., Hazeldene, Churt.)

The trouble may be due simply to the fact that your output valve is not of the type which will handle the output from the two preceding valves. An overloaded output valve often gives weak signals accom-

panied by distortion. On the other hand, the choice of your anode resistance for the R.C. stage may be wrong, and you may be using a value so high that the valve is receiving only a few volts H.T., giving rise to distortion and weak signals in that stage. You should therefore check over all the values in this stage and make quite certain that the valve is receiving ample H.T.—not less than 80 volts should be applied to the anode, as it is an L.F. stage. The oscillation is no doubt L.F. trouble, and may be cured by decoupling the additional stage which you have added. The extra resistance required for the decoupler will result in a further drop in H.T., so that a very much larger H.T. battery may be needed.

Q.P.-P. OR CLASS B?

"Can the Q.P.-P. amplifier in issue of March 4th be used with a battery set known as the Screen Grid Four? I use a permanent magnet moving-coil speaker. If the Q.P.-P. is unsuitable for the above set, can you suggest anything to strengthen weak signals?"—(H. G., South Africa.)

We would recommend Class B as an addition to your set in place of the Q.P.-P. amplifier. Make up

DATA SHEET No. 33

Cut this out each week and paste it in a notebook.

SEVEN-PIN VALVEHOLDER CONNECTIONS

Type of Valve	Numbering on holder.							Terminal on valve top.
	1	2	3	4	5	6	7	
Class B	G2	G1	A1	F	F	—	A2	—
Single Diode Tetrode (Indirectly Heated)	—	G1	G2	H	H	C	D	A
Double Diode Tetrode (Indirectly Heated)	D1	G1	D2	H	H	C	G2	A
Low-Frequency Pentode (Indirectly Heated)	—	G1	G2	H	H	C	A	—

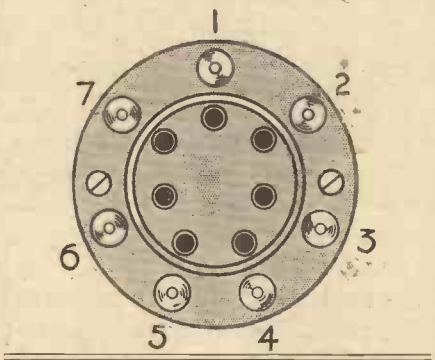

the Class B unit described in the issue dated April 8th, and couple this direct to your output terminals. You will find this will give a very great increase in signal strength, and will also "steady" your output. To avoid overloading you should fit some form of volume control in the first L.F. stage, and this will depend on the method of coupling you are employing in that stage. If resistance-coupled, a variable grid leak will be sufficient, and if transformer-coupled, a potentiometer should be joined across the secondary winding of the transformer. The value should be chosen according to the particular make of transformer, and the maker's instructions should be followed in this respect.

CATALOGUES RECEIVED

To save readers trouble, we undertake to send on catalogues of any of our advertisers. Merely state, on a postcard, the names of the firms from whom you require catalogues, and address it to "Catalogue," PRACTICAL WIRELESS, Geo. Newnes, Ltd., 8/11, Southampton St., Strand, London, W.C.2. Where advertisers make a charge, or require postage, this should be enclosed with applications for catalogues. No other correspondence whatsoever should be enclosed.

MAZDA VALVES

WHEN choosing or using a valve it is essential to know all the finer points in the characteristics of that valve, and although the majority of manufacturers supply a printed slip with the carton, this generally restricts itself to the principal working voltages. The Mazda valve catalogue contains, in addition to the standard valve curves and operating data for each of the valves included in their extensive range, circuit diagrams for several receivers, with complete values for all components employed; notes on the use of D.C. mains valves; and a complete tabulated Index to the complete range. Readers who would like a copy of this book should write to The Edison Swan Electric Co., Ltd., 155, Charing Cross Road, London, W.C.2.

MAINS TRANSFORMER CONNECTIONS—(Continued from page 253.)

thus proving this to be the filament winding for the rectifier valve with centre tap at C.

The winding H, J, K lastly claimed my attention, and this proved, as it should have done, a high resistance winding with equal readings between H, J and J, K, giving me the centre tap at J.

As a further test before insertion in the

Broadcast Query Corner

UNDER the above title, with the assistance of a recognized authority on foreign broadcasting matters and a regular contributor to wireless publications both at home and abroad, we have inaugurated a special Identification Service, which should prove of great assistance to our readers. When tuning in well-known stations it happens frequently that listeners pick up wireless transmissions of which they fail to recognize the origin. It is to solve these little problems that the Broadcast Query Service has been organized.

Replies to Broadcast Queries

T. T. A. (Newburgh): G5QX, J. N. Smith, 73, Oakland Avenue, Bloomfield, Belfast, N. Ireland; G6LS, regret, cannot trace: write to Radio Society of Great Britain, 53, Victoria Street, S.W.1; G5IA, G. M. Whiteley, "The Hollins," Sowerby Bridge, Yorkshire; G5JO, L. Jones, 50, King St., Cambridge; G2KM, C. Stainton, 37, New Bridge Rd., Hull, Yorkshire; G2BY, H. A. Whatley, "Lyndhurst," Great West Rd., Lampton, Hounslow, Middlesex; G6RG, B. Groom, 157, Wood St., Galashells, Selkirkshire, Scotland; G2XY, H. T. Littlewood, 82, Stainburn Crescent, Chapel Allerton, Leeds, Yorks; G5RM, R. A. Minter, 60, High St., Bromley, Kent; G2BH,

set the mains were connected to the appropriate tapping on the primary and a 4-volt flash-lamp bulb was connected across L and M and it lit brightly. The bulb was then connected across E, G and then G, F, and it glowed with an equal intensity across each of these. As winding H, J, K was the only one left, it could be safely assumed to be correct.

All that remained to do then was to insert the transformer into the set and join the leads to their respective soldering tags.

Fig. 4.—Theoretical diagram of the mains transformer.

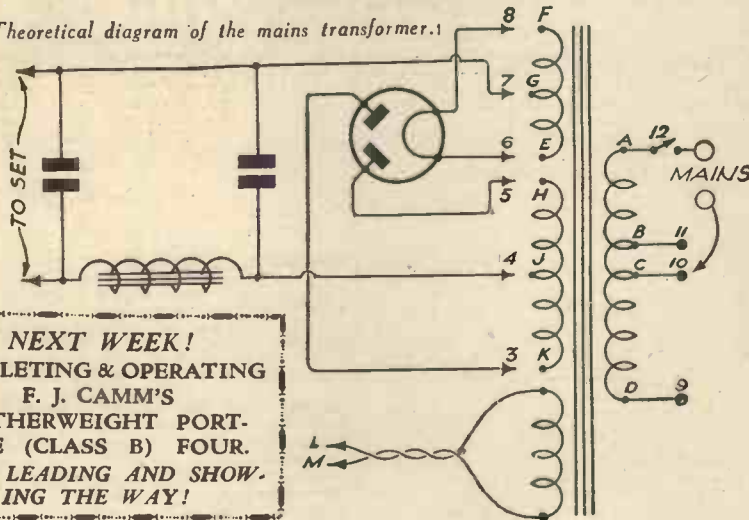

NEXT WEEK!
COMPLETING & OPERATING
F. J. CAMM'S
FEATHERWEIGHT PORT-
ABLE (CLASS B) FOUR.
STILL LEADING AND SHOW-
ING THE WAY!

G. W. Wiggleworth, 90, Blenheim Rd., Barnsley Yorks; G2LF, A. W. Knight, 32, St. Mary's Rd., Peckham, S.E.15, London; G2GF, P. E. A. Griffiths, 12, Genceo Mansions, Chapel St., Brixton, S.W.9, London. SPARKS (Belfast): DDNY, Germany. Call incorrect, but if initials correct, Germany; GBC, Rugby; BSA, probably GSA, London Terminal (Rugby-Canada); G6UH, H. E. Smith, "Arava," Granville Road, Limsfield, Surrey; G6XR, G6HN, G5LD, G5NO—regret, cannot trace; write to the Radio Society of Great Britain, 53, Victoria Street, S.W.1; G6XM, W. James, 28, Grant Square, North Camp, Aldershot; G15QX, N. J. Smith, 73, Oakland Avenue, Bloomfield, Belfast. HOPEFUL (N.W.11): (1) Moscow on 1,000 m.; extra late news; (2) Leningrad. J. QUINN (Swinton): Can probably be ordered through any music dealer. ELJAESSE (Bedminster): F8AJ, Aymon Claudet, Rue Georges Sand, Vierson (Cher); F8SO, F8WAZ, cannot trace; write to Réseau des Emetteurs Français, 17, rue Marey, Paris, Vie; G6YA, A. H. Radford, 42, Wrington Crescent, Bedminster, Bristol; G2FC, cannot trace; write to Radio Society of Great Britain, 53, Victoria St., S.W.1; OXZ, Skamlebaek, Denmark; FTZ, Ste. Assise, France; FYQ, Lyons (France); FLE, Eiffel Tower, Paris; G5CP, regret, cannot trace.

IF YOUR RECEPTION IS BAD

SUPERIAL
THE AERIAL WHICH MADE BROADCASTING POPULAR
ELECTRON'S SUPER-AERIAL
WILL IMPROVE IT



Whether it is a bad set or a bad locality SUPERIAL will make your reception definitely better, because it is the most efficient and powerful aerial ever devised. The extra-heavy rubber insulation stops interference and noises, abolishes masts, insulators and separate leads-in, and increases the signal strength.

The only efficient indoor or invisible aerial. Lightning proof 100—get your £100 Free Insurance today. From all dealers.

100 ft 3/6: 75 ft 2/6: 50 ft 1/9: 25 ft 1/4
THE NEW LONDON ELECTRON WORKS 1256 EAST HAM LONDON E.6

MAYFAIR RADIO

offers Brand New Set Manufacturers' guaranteed surplus Moving-Coil Speakers. ROLAS (50 only). P.6, listed 35/-. In following voltages. 2,000 ohms; 2,500 ohms; 4,700 ohms; 6,500 ohms at 18/-. with transformer. State if power or pentode. As above, P.7, list 47/6, at 25/-. PERMANENT MAGNETS: P.6 P.M. list 49/6, at 28/-. P.7 P.M. list 43, at 32/-. P.6 P.M., Class B, list 49/6, at 28/-. CONDENSERS, multiple blocks, 1,500 test, working 500 VDC, Peak Voltage 700. 20 mfd. 4+4+2+2+2+2+2+1+1 @ 11/-. 11 mfd. Block 4+2+2+2+1 @ 6/9. All carriage paid cash with order, or C.O.D.—MAYFAIR RADIO, 31, George Street, Hanover Square, London, W.1.

THE IMPROVED "TONIC"

self-generating trickle-charger kit keeps 2-volt accumulators fully charged. Electric mains and charging stations unnecessary. Ideal for remote places, 7/- each, postage 9d. Particulars, testimonials, with pleasure. WILLIAMS, Netherend, Cradley, Birmingham.

ADVERTISEMENT INDEX

	Page		Page		Page
Amplion (1932), Ltd.	279	G.B. Pioneer Radio	282	Newnes "Motor Cyclist"	270
Bargain Page	280	Graham Farish, Ltd.	Front Cover Strip	Newnes "Practical Electrical Engineer"	282
Bennett College, Ltd.	273	Gramophone Co., The	265	Pearl & Pearl, Ltd.	280
Block Batteries, Ltd.	273	Heayberd, F. C., & Co.	282	Peto Scott, Ltd.	269
British Blue Spot Co., Ltd.	275	International Correspondence Schools	278	Pickett Bros.	280
British Institute of Engineering Technology	282	Lectro Linx, Ltd.	279	Radio Instruments, Ltd.	Back Cover
British Rola Co., Ltd.	270	Lissen, Ltd.	Inside Front Cover	Reproducers & Amplifiers, Ltd.	Inside Back Cover
Bulgin, A. F. & Co., Ltd.	277 and 279	London Radio Supply Co.	279	Rhino Sole	280
Cossor, A. C., Ltd.	259	Mason, E. C.	279	Riverside Mfg. Co., Ltd.	280
Edison Swan Electric Co., Ltd.	Inside Back Cover	Mayfair Radio	284	Siemens Electric Lamps & Supplies Ltd.	270
England-Richards Co., Ltd.	280	New London Electron Works, Ltd.	284	Southern Radio	280
		Newnes "Home Photographer"	277	Williams, T.	284

The R & A "CHALLENGER"

No reproducer to compare with the "Challenger" is obtainable at or near its price. It is the ideal instrument for small receivers which employ the average super power or pentode valve, and also for large receivers with outputs up to 3 watts undistorted A.C.

Ask your dealer to demonstrate and refuse any others, which may be offered as substitutes. There is no substitute for the R. & A. "Challenger."

"PRACTICAL WIRELESS" states:—

"Sensitivity . . . certainly of a high order . . .
 "Results excellent . . . response would satisfy any
 "but the hypercritical . . . From 30 cycles up to
 "the heterodyne whistle the response seemed a
 "practically straight line. . . Bass full without
 "boom . . . speech exceedingly clean and natural . . .
 "We unhesitatingly recommend this model."

Complete
 with 3-ratio
 Transformer

35



**Acclaimed by the
 Trade and Public
 the best of its kind**

REPRODUCERS & AMPLIFIERS LTD.

WOLVERHAMPTON



EDISWAN

The name that means "EXCELLENCE"

**THE GREATEST BATTERY VALUE
 - at any price!**



GUARANTEE
 The Edison Swan Electric Co. Ltd. guarantees that Ediswan Batteries are of full voltage and capacity. Should any Ediswan Battery fail to give satisfactory service, we undertake to deal with customer's complaint within 24 hours of receipt of defective battery.

**60 VOLTS
 5/6
 STANDARD CAPACITY**

When you buy an Ediswan battery you don't have to take it on trust. It has run the gauntlet of the most exacting tests. It has been passed as fit to bear the Ediswan Guarantee. It's ready for a long life of good service.

Standard Capacity - 10 M/a
 99 volts 9/- 108 volts 10/- 120 volts 11/-
 150 volts (new type) - - - 14/6
 Also tapped for Q.P.P.
 Super Capacity types - - - 20 M/a

Write for your FREE Copy of "How to get the most out of your H.T. Battery." Full of useful data.

EDISWAN

**Guaranteed RADIO
 H.T. BATTERIES**

The Edison Swan Electric Co. Ltd.



Ponders End, Middlesex

EDISWAN - the Better Service Batteries

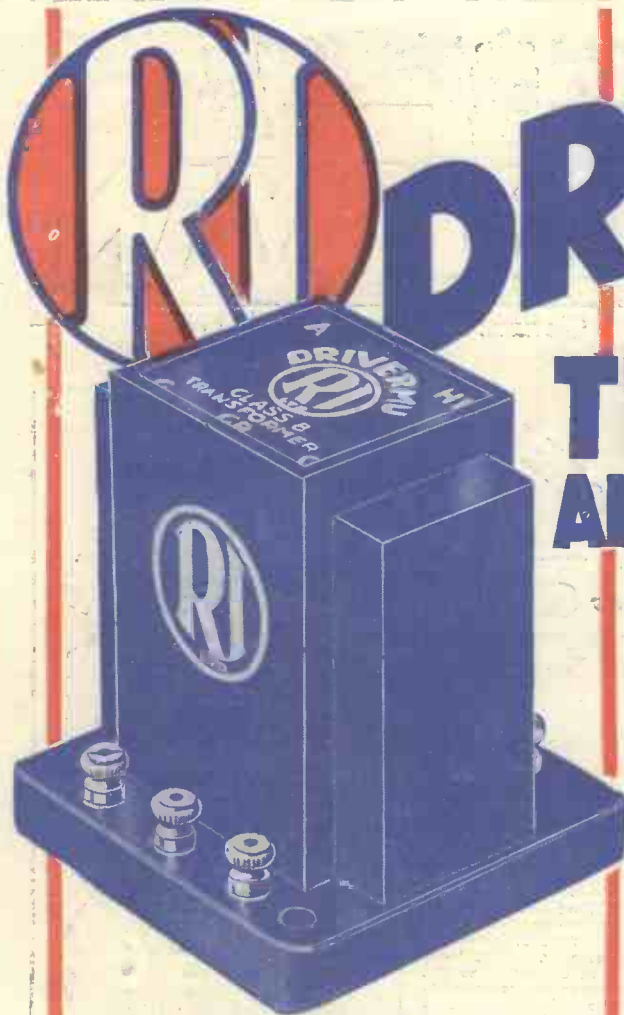

DRIVERMU

"CLASS B"

TRANSFORMERS AND "CLASS B" CHOKES

The still more power and still less H.T. consumption for battery set development has reached an extraordinarily high peak of efficiency with the advent of 'Class B' valves used with R.I. 'Drivermu' Transformers and D.Y.40 Output Chokes.

THE R.I. WAY TO GREATEST AUDIO POWER & H.T. ECONOMY

In 'Class B' amplification, the 'Class B' valve must be correctly matched with the particular type of preceding valve which is employed as a driver. The success of the system depends upon this matching of the valves, and the 'Drivermu' Transformer is the most efficient method of coupling available. 'Drivermu' Transformers have been designed in conjunction with the principal valve manufacturers, and are guaranteed to give maximum power, minimum H.T. current consumption, and complete freedom from distortion, which are the principal claims made for the system.

'DRIVERMU' COVERS ALL COMBINATIONS OF 'CLASS B' & DRIVER VALVES

No matter which 'Class B' valve and driver valve is chosen for the particular output required, there is a 'Drivermu' of correct ratio to match them most perfectly.

R.I. 'CLASS B' 'DRIVERMU' TRANSFORMER

The illustration shows models DY39, DY41 and DY42. Models DY37 and DY38 are not in bakelite case.

Carefully designed for push-pull input into any 'Class B' type output valve and for use following any type of driver valve. The efficiency is of the order of over 80%, and the primary Inductances are very high when carrying maximum driver anode current.

R.I. 'DRIVERMU' TRANSFORMERS

List No.	RATIOS.		PRICE Royalty 1/6 extra
	Total	Per Secondary	
DY37	1:1 and 1.5:1	2:1 and 3:1	15/-
DY38	2:1 and 2.5:1	4:1 and 5:1	15/-
DY39	1:1	2:1	11/-
DY41	2:1	4:1	11/-
DY42	1.5:1	3:1	11/-

R.I. 'CLASS B' OUTPUT CHOKE

Provides most satisfactory output coupling between every type of 'Class B' output valve and loudspeakers normally suitable for use with any type triode or pentode valve in normal or push-pull arrangement. Over 90% efficiency.
No. D.Y. 40. Ratios 1:1, 1.2:1, 1.5:1 and 1.8:1. 12/6



HOW TO SELECT THE VALVES & CORRECT COMPONENTS FOR 'CLASS B' SET CONSTRUCTION OR CONVERSION

'CLASS B' BROCHURE FREE

The R.I. Brochure explains 'Class B' and contains tables for easy selection of right valves and components, also diagrams for application of 'Class B' to new receivers or existing models. Post this coupon, in id. stamped unsealed envelope.

Name

Address

Radio Instruments Ltd., Croydon, Surrey. Phone: Thornton Heath 3211

P. W. Gift Stamp No. 32