

G. Dyson

Free Next Week! WIRELESS CONSTRUCTOR'S HANDY METAL GAUGE

Practical Wireless

3^d

Published every Wednesday by
**GEORGE
NEWNES
LTD.**

Vol 1.—No. 18
JANUARY 21st, 1933

Registered at the G.P.O. as a Newspaper

HALF GUINEAS

for READERS



FREE INSIDE!
DATA SHEET
No. 6
"HIGH AND LOW
FREQUENCY CHOKES"

SEND
US YOUR
"RADIO
WRINKLE"

Whether it's bought
Or whether it's built,
Earth your Receiver
By fitting a FILT!

GRAHAM FARISH FILT
PERCOLATIVE CHEMICAL EARTH

If you cannot readily
obtain a FILT from
your radio dealer order
direct, post free, from
sole manufacturers:
**GRAHAM FARISH
LTD.,**
201, Mason's Hill,
Bromley, Kent.

PRICE
2/6
COMPLETE

—Fascinating New Serial—
NO MONEY TO MARRY ON
 By **EDGAR FRANKLIN**

The wedding of William and June, the daughter of a rich business man, was to take place in a fortnight's time. But suddenly June sprang a bombshell on everybody by insisting that William must elope with her that very day.

William Gwynn was once more face to face with the large, wealthy father of June.

"Hello, Will. Sit down! This is something that has to be discussed at once, of course."

"What is it?"

"This business of your marrying June. You're expecting to do that a week from Friday? Well, you're not!"

"What?" gasped William.

"No. June has changed her mind," said Henry Stannard. "Fact is, June doesn't want to wait till next week. She is going to marry you to-day!"

"But—but we can't do that!" William stammered. "The invitations are all out for Friday week and—"

"I know, Will."

"What for?" William asked. So many things were racing through his mind. Sheer joy, of course, that the only perfect girl so far produced by the human race was to be his own at once. And also a quantity of plain consternation as he realised that in his pocket reposed exactly six dollars and in his bank account—nothing!

"I don't know!" Stannard said irritably. "Seems she has some damned romantic notion of being carried off this evening at nine. So there you are, and you'll have to hustle, you haven't got much time."

"It's impossible," said William. "We can't let it go through. I'll have to talk to June. Where is she?"

"She's here, Will," said June, with a sigh, as she entered.

William rose to greet her.

"You've something to say to me, Will?"

"You bet I have!" said Mr. Gwynn. "Let's sit down and talk this out."

Miss Stannard shook her head.

"Not here. It's nicer in the porch, I think. You needn't come, father, I can make Will understand."

William followed her hurriedly.

"Were you telling father that you didn't want to marry me to-day?"

William laughed.

"Want to?" If I did just what I want to do, I'd pick you up and carry you off through that window, now!"

"No, Will," June sighed. "My things—my travelling things, that is—won't be up here before three or four this afternoon. They're sending them up by special messenger. We'll have to wait till evening. Billy, boy," purred the Stannard heiress, "you've got your new car now?"

"No—not yet."

"You'll have to get it this afternoon, then."

"It sounds mighty fine, darling. There's nothing I'd like better. But, don't you see, darling, we can't. What in thunder ever put this notion into your head, anyhow?"

"I think it's a lot more romantic!"

"That isn't the only reason."

"I'll tell you, then. It's high time, Billy, that you were married and settled down. You're much too susceptible to the charms of anything in skirts that happens to be in the neighbourhood."

William found himself caught up in a bewildering host of difficulties as a result of June Stannard's ultimatum. Read of his desperate attempts to obtain money for his honeymoon in the brightest and cheeriest serial story of the year.

Starting in the February

SUNNY

SEVENPENCE

MAG.

Obtainable at all Newsagents and Bookstalls, or by post 8½d. from George Newnes, Ltd., 8-11, Southampton St., Strand, London, W.C.2.

Geo. Newnes, Ltd.

PART EXCHANGE PART EXCHANGE PART EXCHANGE

SEND COUPON FOR FREE QUOTATION

<p>WHAT WOULD YOU ALLOW ME FOR:—</p>	<p>I AM THINKING OF BUYING:—</p>
<p>ON CASH OR H.P. TERMS Cross out whichever does not apply</p>	
<p>NAME</p>	
<p>ADDRESS</p>	
<p>Post to-day to:—Co-Radio Ltd., Dept. C.5., 78, Neal Street, W.C.</p>	
<p>THIS PUTS ME UNDER NO OBLIGATION.</p>	

CORADIO

78, Neal St., Shaftesbury Avenue, W.C.

A Record Bargain! 1933 BROWN Moving Coil SPEAKER

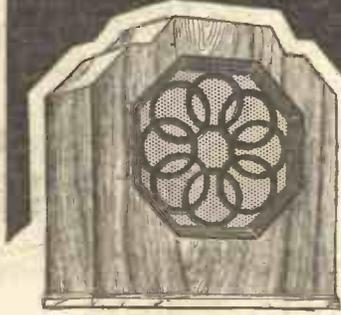

**LIST PRICE £3.19.6
 OUR PRICE 39/6**

Just consider! An entirely new 1933 BROWN PERMANENT MAGNET MOVING COIL Cabinet Speaker at TWO POUNDS BELOW LIST PRICE! This is not merely a bargain, it is sensational value, and, moreover, you can pay by monthly instalments of only 5s. 0d.

Accept this wonderful offer!

7 DAYS FREE TRIAL 26 FOR ONLY DEPOSIT

SEND ONLY 1/6 for the British-Made **WATES UNIVERSAL METER**

—the only popular priced instrument which tests resistance as well as batteries, valves circuit and all components. Four readings on one dial. Send only 1s. 6d. for it on 7 days' trial, if satisfied complete purchase by 5 monthly payments of 2s. 0d. (Cash in 7 days, 12s. 6d.)



The Moving Coil Unit with tapped Transformer is extremely sensitive and highly suitable to work with sets from 2 valves upwards, giving deep, rich tone, and extraordinary volume without distortion. The pole faces of the Unit are entirely protected to prevent dust and metal particles entering the gap. The beautiful Walnut Cabinet of modern design is 13ins. high, 13½ ins. wide, and 6½ ins. deep, with handsome ebony-finish vulcanite fret. Let us send you this magnificent Speaker for 7 days' trial for only 2s. 6d. deposit, if satisfied pay further 2s. 6d. at once, then 8 monthly payments of 5s. 0d. (Cash in 7 days, 39s. 6d.) Unrepeatable bargain!

E. J. HERAUD, Ltd., Dept. P.12, NUMBER ONE, EDMONTON, LONDON, N.16.
 Branches: 78/82, Fore St., Edmonton; 77, West Green Rd., Tottenham; 34, St. James St., Walthamstow; and 139, Hestford Rd., Enfield Wash.

FOR EVERY SET — there's a PILOT AUTHOR KIT

CASH — C.O.D. — or H.P.

EVERYTHING RADIO

CARRIAGE PAID TO YOUR DOOR

BLUE SPOT SPEAKER UNIT AND CHASSIS. Type 100 U. Cash Price £1/12/6. Carriage Paid. Balance in 0 monthly payments of 5/2. **Send 5/2 only**

EPOCH "20 C" PERMANENT MAGNET MOVING-COIL SPEAKER. (New Edition). With 5-ratio input transformer. Cash Price £1/15/0. Carriage Paid. Balance in 5 monthly payments of 6/6. **Send 6/6 only**

BLUE SPOT UNIT AND CHASSIS, Type 99 P.M. Including matched transformer. Cash Price £2/19/6. Balance in 11 monthly payments of 5/6. **Send 5/6 only**

ROLA PERMANENT MAGNET MOVING-COIL SPEAKER F.6. With universal tapped input transformer. Cash Price £2/9/6. Carriage Paid. Balance in 11 monthly payments of 4/6. **Send 4/6 only**

R & A "VICTOR" PERMANENT MAGNET MOVING-COIL SPEAKER DE LUXE. With 6-ratio input transformer and protecting grille. Cash Price £3/10/0. Carriage Paid. Balance in 11 monthly payments of 6/5. **Send 6/5 only**

R & A "CHALLENGER" PERMANENT MAGNET MOVING-COIL SPEAKER. With special Ferranti multi-ratio input transformer. Cash Price, Carriage Paid, £1/15/0. Balance in 5 monthly payments of 6/6. **Send 6/6 only**

LISSEN "SKYSCRAPER" S.G.3 COMPLETE WITH VALVES

CHASSIS KIT	CABINET KIT
with (Lissen) S.G., Detector and Pentode Valves. Cash Price, Carriage Paid, £4/9/6. Delivered, carriage paid, on first payment of .. 8/3	with (Lissen) Valves, Walnut Cabinet and special Balanced Armature Loud-speaker. Cash Price, Carriage Paid, £6/5/0. Delivered, carriage paid, on first payment of .. 11/6

ATLAS ELIMINATOR. Type A.C.244. Three tappings: S.G., Detector and Power. Output: 120 volts at 20 mA. Cash Price £2/19/6. Carriage Paid. Balance in 11 monthly payments of 5/6. **Send 5/6 only**

HEAYBERD HOME BATTERY-CHARGER Model A.O.3. for A.C. Mains only. Charges 2, 4, or 6v. accumulators at 1 amp. Cash or C.O.D. Carriage Paid. £2/2/6. **Send 5/3 only**

GARRARD INDUCTION GRAMOPHONE MOTOR. For A.C. mains. Model 202. Mounted on 12-inch nickel motor plate with fully automatic electric starting and stopping switch. Cash Price £2/10/0. Carriage Paid. Balance in 11 monthly payments of 4/7. **Send 4/7 only**

PETO-SCOTT 1933 ADAPTAPRAM. Beautifully constructed of solid walnut with contrasting Walnut Veneers. Ready to take your set and gramophone motor. Cash or C.O.D., £3/3/0. Carriage 2/6 extra. Balance in 11 monthly payments of 5/9. **Send 8/3 only**

W.B. PERMANENT MAGNET MOVING-COIL SPEAKER, Type PM4. Complete with transformer. Cash Price £2/2/0. Carriage Paid. Balance in 7 monthly payments of 5/9. **Send 5/9 only**

SELECTONE Described this week

KIT "A" CASH OR C.O.D. Carriage Paid.
Author's Kit of specified parts, including **ready drilled panel**, but less valves and cabinet. **£4-8-0**
or 12 monthly payments of 8/-

KIT "B"
As Kit "A" but with valves, less cabinet. CASH or C.O.D. Carriage Paid. **£5-10-9**
or 12 monthly payments of 10/2.

KIT "C"
As Kit "A" but with valves and cabinet. CASH or C.O.D. Carriage Paid. **£6-13-3**
or 12 monthly payments of 12/3.

KIT-BITS Selected C.O.D. lines—You pay the postman—We pay post charges on orders over 10/-

1 PETO-SCOTT Oak-faced plywood panel, 14in. & s. d. by 8in., ready drilled; Peto-Scott 5-ply baseboard, 14in. by 8in., ready drilled ebonite strip, 14in. by 1 1/2in.; connecting wire, screws, and wood as specified ..	8 0
1 UTILITY Standard .0005 mfd. Condenser with UTILITY type W.181 Microdial ..	16 0
1 COLVERN type "T.D." Coil ..	8 6
1 BENJAMIN Transfeeda ..	11 6
1 VARLEY Rectatono Transformer ..	15 0
3 Specified Valves ..	1 2 9
1 CAMCO Excelsior Oak Cabinet as specified ..	1 2 6

SOLO 3 KNOB

KIT "A" Author's Kit of specified parts, including ready drilled panel, and cabinet. Carriage paid. £3-0-0
or 12 monthly payments of 5/6.
Specified Valves £1-2-9. Cabinet 15/-

STOP PRESS OFFERS

AMPLION PERMANENT MAGNET MOVING-COIL SPEAKER with tapped input transformer. Cash or C.O.D. Carriage Paid. £1/19/6. Balance in 5 monthly payments of 7/4. **Send 7/4 only**

GARRARD AUTOMATIC RECORD HANGER for A.C. mains. Mounted on unit plate complete ready for fitting in position, including Garrard pick-up and tone-arm. Cash Price £10/0/0. Carriage only Paid. Balance in 11 monthly payments of 18/6. **Send 18/6 only**

AMPLION PICK-UP with arm base and volume control. Cash or C.O.D. only. Post Paid. **25/-**

PETO-SCOTT S.G.3 RADIO

A great technical achievement. Self-contained in one Cabinet of beautifully-grained walnut. High-grade components on all-steel chassis. Slow-motion single-dial tuning. Screened grid, detector and power valves. MOVING-COIL SPEAKER. Designed to give reliable Radio Reception in every part of the British Isles of B.B.C. and Foreign Programmes.—Complete, ready to play, with Exide and Drydex Batteries and Aerial Equipment. Fitted Mullard Valves.



SEND NOW 12/-
No Extra for Easy Terms

This is an honest-to-goodness offer from a firm established in 1919—solely for the purpose of building Wireless Sets and bringing radio within the reach of all. Peto-Scott himself gives every purchaser of his Set a personal guarantee of satisfaction. We give you credit over sixteen months, making no extra charge for Easy Terms. Carriage Paid complete with Aerial Equipment, £9/12/0. You send us 12/- with order and 3/- per week (paid monthly) for 15 months. This means you own the best British Radio money can buy.

THE PETO-SCOTT WALNUT CONSOLE (RADIO)

Constructed in Walnut with contrasting inlaid Walnut Veneers. Comes to you with vignette froth, as illustrated, ready to take your own set. No skill or expensive tools are required to transform your radio into a beautiful Console instrument, presenting the professionally finished appearance of the most luxurious Radio Receiver money can buy. Carriage and Packing 2/6 extra England and Wales. Deposit: 8/2 and Cash or C.O.D. 11 monthly payments of 5/8. Carriage Paid. **62/-**
Baffle Board ready Drilled 3/8 extra.
Dimensions: 36 in. high; 21 in. wide; 18 in. deep. Panel 18 in. by 8 in. Baseboard 14 in. deep.
1933 ADAPTAPRAM CABINET for RADIO and GRAMOPHONE 63/-. Carriage 2/6 extra.



1933 KELSEY SHORT-WAVE ADAPTOR

Tune-in the Short-Wave Stations in the World's Stations on your present Short-Wave Stations on your Existing Set. Plug the Kelsey Short-wave Adaptor—it fits without any alteration. No extra valve required; no extra apparatus. Ready for immediate use and sold complete with Dial Calibration Chart and simple tuning notes, specially compiled by an expert. **45/-** CASH or C.O.D. Or 9 monthly payments of 5/6.



IMPORTANT. PETO-SCOTT CO. Ltd. 77, City Road, London, E.C.1.

West End Showrooms: 62, High Holborn, London, W.C.2. Telephone: Clerkenwell 9406/7. Dear Sirs, Please send me CASH/C.O.D./H.P. _____ for which I enclose £. d. CASH/H.P., Payment, _____

NAME _____ ADDRESS _____ Pr.W. 21/1/33

The Most Talked About Set of the Season "SKYSCRAPER" RADIO



Its builders are its best Salesmen

Never before was there such a set within the reach of the home constructor. Never before such power from a battery set. Never before so many enthusiastic letters from constructors or so much talk about any radio set as this Lissen "Skyscraper" Kit has elicited. 50-60-70 loudspeaker stations—everybody who builds a "Skyscraper" gets results like that!



THE ONLY KIT YOU CAN BUILD YOURSELF EMPLOYING METALLISED S.G HIGH MU DETECTOR AND ECONOMY POWER PENTODE VALVES

This new Lissen "SKYSCRAPER" Kit Set is the only one on the market that you can build yourself employing a Metallised Screened Grid Valve, High Mu Detector and Economy Power Pentode. Around these three valves Lissen have designed a home constructor's kit the equal of which there has never been before. Why be satisfied with whispering foreign stations when you can BUILD WITH YOUR OWN HANDS this Lissen "SKYSCRAPER" that will bring in loudly and clearly distant stations in a profusion that will add largely to your enjoyment of radio?

Lissen have published a 1/- Constructional Chart, giving the most detailed instructions ever printed for the building of a wireless set. You can't go wrong—every part, every wire, every terminal is identified by photographs. Everybody, without any technical knowledge or skill, can safely and with COMPLETE CERTAINTY OF SUCCESS undertake to build this most modern of radio receivers from the instructions given and the parts Lissen have supplied.

GREAT LISSSEN CHART FREE!

You can get the Lissen "Skyscraper" Chart FREE from any radio dealer, or by posting the COUPON below direct to factory.

YOURS FOR ONLY 8/6 DOWN

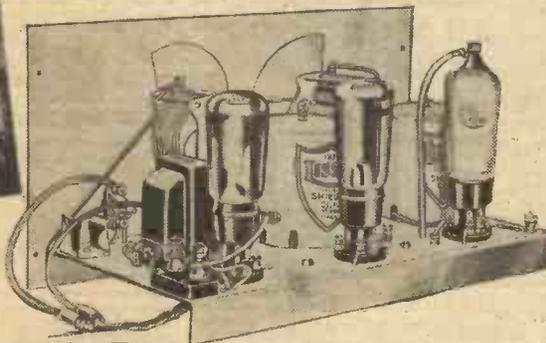

To-day you can buy the LISSSEN "SKYSCRAPER" KIT on Gradual Payment Terms. "Skyscraper" Chassis Kit, complete with Valves. CASH PRICE 89/6. Or 8/6 down and twelve monthly payments of 7/6.

"Skyscraper" Kit complete with Walnut Cabinet and in-built Loudspeaker, as illustrated, £6 5s. Cash. Or 11/6 down and twelve monthly payments of 10/6.

COUPON

To: LISSSEN Ltd., Dept. P.R.33, Worpole Road, Isleworth, Middlesex.

Please send me FREE copy of your 1/- Skyscraper Chart.

Name

Address

LISSSEN

"SKYSCRAPER" 3 KIT

THE "FURY FOUR" By F. J. CAMM! See Page 833



EDITOR: Vol. 1. No. 18. || F. J. CAMM Jan. 21st, 1933.
 Technical Staff: H. J. Barton Chapple, Wh. Sch., B.Sc. (Hons.), A.M.I.E.E. Frank Preston, F.R.A., W. J. Delaney, W. B. Richardson.

ROUND *the* WORLD of WIRELESS

Next Week's Great Free Gifts!

READERS have had plenty of evidence since the publication of No. 1 of PRACTICAL WIRELESS on Sept. 24th last that this paper exists earnestly to foster the interests of the home constructor. The WIRELESS CONSTRUCTOR'S ENCYCLOPEDIA, specially prepared and made exhaustively comprehensive, was made available to regular readers of the paper. Our series of WIRELESS DATA SHEETS provides the reader with valuable facts and figures in easily consulted form.

NEXT WEEK, however, we are giving TWO FREE GIFTS, for in addition to Data Sheet No. 7 (which is entitled "Condensers and Condenser Values") there will be presented Free with every copy, in an envelope, the Home Constructor's Handy Gauge, made in a stout gauge of steel, which you see illustrated actual size in the centre of this page. This gauge is an almost indispensable tool, for it may be used as a screw gauge, as a tap drill gauge, as a valve leg gauge (for triodes and pentodes), as a wire loop former, as an insulation stripper, as a wood scraper, as a universal trammer for scribing holes on panels, baseboards, etc. The exact uses to which the gauge may be put forms the subject of a special article, which will also appear next week. You cannot buy one of these gauges, for it has been specially made for PRACTICAL WIRELESS. Note that you have *nothing* to do in order to get it, except to buy next week's issue. YOUR Gauge will be secured to the cover of YOUR copy. There is always a great demand for gift issues, and it is necessary for you to order now. Note also that next week's issue (on sale on Wednesday, January 25th) is the same price—3d.

The "Fury Four."

ON page 833 of this week's issue you will find a preliminary announcement concerning a new wonder set—the "Fury Four"—which is destined to make radio history. Fuller details of the "Fury Four" will be given in January 28th issue! This receiver has engaged the designer, Mr. F. J. Camm (Editor of PRACTICAL WIRELESS), in exhaustive ex-

periments over the past four months. It is entirely new in principle, and it has been designed so that even those with a limited purse can make it up. So remarkable is the set that we venture to think it will be made in its thousands. It will receive, on any evening, over 100 stations without jamming; it is extremely selective, simple to operate, easy to build, cheap, incorporates the very latest ideas (including two S.G. valves) and, what is more impor-

despatching the volumes with all speed. If you have not yet done so, therefore, affix the gift stamps to your subscription voucher and forward the completed voucher in accordance with the instructions thereon to-day.

Wireless Set in a Walking Stick

ANOTHER well-meaning experimenter in Berlin has devised a means of cramming a wireless receiver into a hollow walking stick, the whole of the apparatus, apart from the headphones, being contained in the stick. Modern traffic conditions allow of no distractions for pedestrians, and when walking in the country I personally can think of no better programme to listen to than Nature's own broadcasts.

NEXT WEEK'S GREAT FREE GIFTS!

(ACTUAL SIZE)

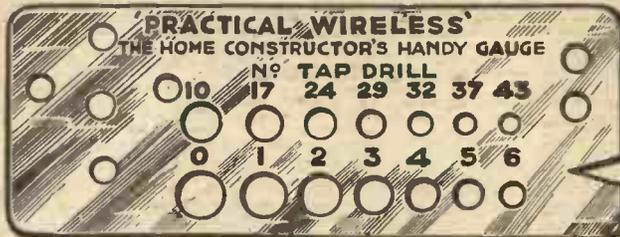

THIS HANDY UNIVERSAL GAUGE, MADE OF STEEL, ALSO DATA SHEET No. 7 "Condensers & Condenser Values"

tant from the point of view of the reader, it has the personal guarantee of the designer, the Editor of PRACTICAL WIRELESS, that it will do all we claim for it. Every reader who builds the set may rest assured that the Editor will give his personal attention to every query relating to this set, to ensure that readers obtain the same phenomenal results which he has achieved. Turn to page 833 and read his preliminary notes on the set.

"The Wireless Constructor's Encyclopædia"

IF you have not yet sent in your coupon according to the conditions given in our December 24th issue, you should do so without further delay. We are, of course,

Brussels Extends its Programmes THE Brussels No. 1 and No. 2 stations are now giving a continuous broadcast on Sundays from 10.0 a.m. until 2.0 p.m., and from 5.0 p.m. until midnight; on Saturday evenings dance music is also transmitted until midnight.

New Long Wave Station at Droitwich WHILE the next "big noise" to be heard in this country will be the new West Regional I hear it is practically certain that the new long-wave station at Droitwich will follow closely on its heels. This will be a good thing for I do not think I would be a mile out if I said that the long-wave National has a greater following than any other British station. If you consider this you will see that it is not surprising because 5XX's signal is always consistent, the quality is good, although not always excellent, and the ether around that wavelength has enjoyed a long run of comparative freedom from interference.

Sponsored Programmes by "Atlas"

MESSRS. HADDON, CLARKE and Co., the makers of the famous "Atlas" series of receivers and components, have now arranged for sponsored programmes to be broadcast on their behalf from Radio-Paris, 3.0-3.30 p.m. and Radio-Normandie, 5.30-6.0 p.m. and 10.0-10.30 p.m. each Sunday.

ROUND the WORLD of WIRELESS (Continued)

Broadcasting Films in France

MANY Continental stations in the course of their radio entertainments relay performances from local cinemas. Radio Strasbourg (France) now makes a regular feature of this kind of broadcast. All necessary explanations are given by the announcer in a running commentary where the film in itself is not sufficiently explicit.

Penny-in-the-slot Wireless

A RADIO engineer in Durham has patented an invention which he proposes to offer to manufacturers and dealers selling wireless instruments on hire-purchase terms. Unless regular instalments are paid by dropping coins into a special slot by means of a time switch, the instrument automatically "closes down." Arrangements can be made by which a set will work for a day, week or month according to the amount paid.

Early-Morning Transmissions

ALTHOUGH broadcasts may be heard in the early hours of the day from a number of Continental stations, up to the present most of the French studios do not take the air before breakfast time. In future, the *Poste Parisien* (Paris) will awaken its listeners with a fanfare of trumpets at 7.30 a.m., to be followed by a news bulletin, a course of physical exercises, and a concert of gramophone records.

The Luxembourg Giant

IN view of the fact that official authority to operate has not yet been received from the State, the Radio Luxembourg super-power station is not supposed to broadcast. It may be heard testing, however, daily between 11.0 a.m. and midday, and again between 6.15 and 8.30 p.m., G.M.T., on a wavelength in the neighbourhood of 1,190 metres. The opening signal consists of a series of prolonged siren-like notes and buzzes. For an obvious reason, no call is given out during the broadcast, and no announcements are made between items of music, yet every listener in France knows that it is Radio Luxembourg. Owing to the delay in opening the station, the inhabitants of the Grand Duchy are refraining from buying wireless instruments.

Moscow on High Power

THE new 500 kilowatt transmitter which the Soviet authorities have installed at Noghinsk is now nearing completion and will shortly be brought into operation. It will replace the old Komintern station, which until recently was working on 1,481 metres. A 20 kW. transmitter at Rostov (Don) and another power station at Kiev, in the Ukraine district, may be inaugurated simultaneously at an early date.

Radiodiffusion in Switzerland

THE Swiss Administration of Posts and Telegraphs, in order to enable subscribers to hear the broadcast programmes

INTERESTING and TOPICAL PARAGRAPHS

by telephone, has established a network of instruments in over twenty-five cities. With a view to giving a choice of home and foreign radio entertainments, the receivers to be leased to subscribers are to be modelled on the dial system.

Their Neighbour's Loud-speaker

THE Municipality of Tunis has decreed that too much radio is bad for the nerves of the inhabitants of its city. From

THE POLICE AND WIRELESS



Receiving in a wireless car orders which have been transmitted by police headquarters.

8.0 p.m. to 7.0 a.m. listeners must either switch off their sets or take steps to ensure that wireless entertainments or gramophone music cannot be heard by their neighbours or by passers-by in the street.

SOLVE THIS!

Problem No. 18.

Smith converted his three-valve receiver for use on the Short Waves. The conversion consisted of altering the value of the grid-leak and better wiring, with the addition of a 400 ohm potentiometer across the L.T.— and L.T.+ terminals. The set worked quite well for a time, but Smith found that, although the valves had not been altered, the accumulator required much more frequent charging. What was the cause of this? Three books will be awarded for the first three correct solutions opened. Mark envelopes Problem No. 18, and send to the Editor, PRACTICAL WIRELESS, Geo. Newnes, Ltd., 8-11, Southampton Street, London, W.C.2, to reach us not later than January 23rd.

SOLUTION TO PROBLEM No. 17

Rogerson forgot to insert the coupling condenser between anode and transformer primary, and therefore the H.T. was short-circuited by the resistance and transformer primary in series.

Only two readers succeeded in giving a correct solution of Problem No. 16, and books have therefore been forwarded to:—

D. W. Lemmon, 32, Surnton Park Road, Irlams-o'-th'-Height, Manchester; Patrick J. Best, 32, Derry Road, Ribbleson, Preston, Lancs.

Free Listening Licences

FOLLOWING raids by the Belgian police with a view to the discovery and prosecution of radio pirates, the Labour Party in Belgium has requested the Government to issue free licences to the unemployed. This step was taken in Germany some months ago, where, in addition, no tax is collected from the blind or from war invalids.

Another Super Station for Romania?

EXPERIMENTS which have been carried out with a 1 kilowatt transmitter relay of the Bucaarest programmes having proved very satisfactory, it is reported that if financial conditions will permit a 150 kilowatt station is to be erected at Craciunelu. The most favourable channel for the broadcasts was found to be 1,980 metres.

Flying Radio Reporters

AS news bulletins form the major portion of the Moscow broadcasts, in order to develop this feature the studio officials have organized a fleet of six aeroplanes which will enable special reporters to make running commentaries on any event of general interest. Each aircraft is fitted with a short-wave telephony transmitter to permit it to keep in touch with the nearest broadcasting station. It is further intended to equip two of these planes with recording apparatus, and thus allow a re-broadcast of the talk at a future date.

Hilversum and Huizen

FROM January 1, listeners may have noticed that the A.V.R.O. and V.A.R.A. broadcasting associations are being transmitted on the higher waveband. Although it is generally stated that the stations exchange wavelengths, this is incorrect, inasmuch as the transmitters continue to operate in the same channels. What actually does take place is that the studios exchange transmitters. During the period January-March, therefore, you will hear Hilversum announcements on 1,875 metres, and Huizen entertainments on 296.1 metres.

D.X. Work

SOME time ago I mentioned in these notes that there was every indication that reception conditions during the present winter would be as good as they had ever been before during the past seven or eight years. My prophecy has been more than fulfilled already, and I can honestly say that conditions are better than I have ever known them. I have kept a more or less continuous reception log since the days when Eiffel Tower, Writtle (Two Emma Tock) and The Hague were the only sources of broadcast entertainment, but never have distant stations come in so well as they do at present. In saying this I make full allowance for increased transmitting power and receiver improvements.—JACE.

AN IMPORTANT ANNOUNCEMENT—

MY "FURY FOUR"

Preliminary Statement by F. J. CAMM
Concerning his Remarkable New Receiver,
Details and Photographs of Which will be
Given Next Week!

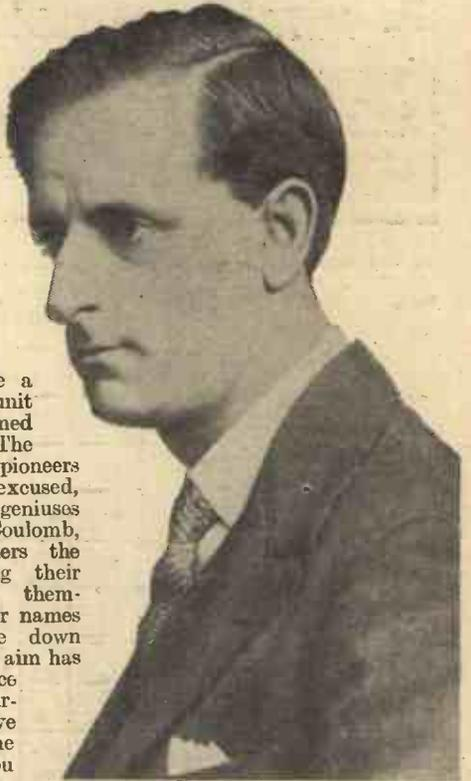

IT is with extreme pleasure that I announce to every reader of PRACTICAL WIRELESS that, after four months of earnest endeavour, experiment, and test, I have succeeded in producing a new type of wireless receiver yielding such remarkable results that I confidently predict that it will be made in its thousands. As Editor of this paper, I am in a unique position to gauge from the hundreds of letters I receive every day the type of set which the home constructor requires, and which no designer of home-built receivers, as far as I am aware, has as yet supplied. The difficulties readers have encountered form a valuable guide to the snags encountered in home-constructed sets, and the queries received by my Technical Staff accentuate the fact that excellent as so many home-constructed sets are, no designer of sets for the amateur has, so far as I am aware, incorporated in one receiver the requirements which those letters indicate to be, under modern conditions of the ether, an urgent necessity.

The unassailable and unrivalled position now occupied by PRACTICAL WIRELESS directed my thoughts to the production of a receiver which would be, in the first place, worthy of the paper, and which, secondly, would exorcise from the home-constructed receiver the drawbacks and the bugbears which the amateur unfortunately has come to regard as inseparable from home-built receivers. That was four months ago. My efforts to produce such a receiver have been intensified by the letters which continue to reach me daily. My endeavours, unceasingly directed to this end in our laboratory, guided my efforts along certain lines, culminating in the production of the "Fury Four." I am an engineer by education and training, and with the caution which that training gives I suppressed the enthusiasm which is the natural corollary to achievement, and embarked on a series of strenuous tests to satisfy myself that every reader of PRACTICAL WIRELESS could, by following the very complete constructional details to be given in following issues, duplicate, immediately he had attached the last wire to the set, the remarkable results of which my set is capable.

With the one object of providing my readers with a really outstanding receiver which would not readily go out of date, I have very carefully analysed modern radio reception and difficulties so that I could anticipate the snags instead of, as is so often the case, leaving the reader to do so. The "Fury Four" is no ordinary set. I have built into it my sixteen years' experience of radio design and construction, and having got the design right, I felt that time could not be delayed in placing before the readers of this paper an announcement of the utmost importance to every home constructor of wireless sets in the country. To accelerate the tests necessary before the announcement could be made, not alone myself, but members of my staff and many other radio experts have been despatched by aeroplane all over the country, and their reports agree in striking manner with mine. It is no chance set merely put out as a journalistic stunt, for wherever it has been put on test (and the testing zones have been far flung and specially selected because they provide the difficulties necessary to make those tests of value), it has responded in a remarkably uniform degree, and confirmed the results which I have sincerely set out to attain.

You will be afforded ample proof that these claims are not an over-statement of the capabilities of the set. Logging charts from various parts of the country will be placed before you. Every detail necessary to construct the "Fury Four" will be published in these pages, and I guarantee that, using the components I specify, you will immediately have a receiver which represents a marked advance on anything before published.

The "Fury Four" is, as its name implies, a four-valve receiver employing two S.G. valves and a pentode output stage. It is, I believe, the practice in the electrical and radio industries for designers to name sets after themselves, a practice originated by the pioneers of electricity, who vied with one another in their

efforts to produce a new electrical unit which could be named after them. The vanity of these pioneers can, of course, be excused, for one can forgive geniuses like Ohm, Volt, Coulomb, Ampere, and others the vanity of naming their discoveries after themselves, so that their names might reverberate down the centuries. My aim has not been to produce a set for such purposes, but to serve my readers, and the "Fury Four," you will agree, is an easily remembered and euphonious title.

Expert wireless designers frequently fail to achieve success because they set up wrong standards. Opticians, for example, set up impossible standards and proclaim that everyone needs glasses who falls short of them. The home constructor, therefore, is perhaps to-day excusably weary of the claims for particular sets, which fail to materialize. If the standards are wrong the design must be wrong; my standards are not impossible standards. Briefly, they are these: The set must be extremely selective, with absence of overlapping; it must provide ample volume on all stations received; it must be capable of receiving at least 100 stations; it must be simple to operate, it must be cheap to build, it should be free from background, it should be economical to run; it should operate equally well on medium and long wave-bands; it should be trouble-free, stable, easy to construct, and, most important of all, it should be backed by a guarantee of satisfaction by its designer. In other words, a reader who fails to achieve what the designer claims should be entitled to free advice until it functions in the manner claimed. This guarantee I readily give, for every builder of the "Fury Four" may avail himself of my personal advice, free of charge, on any little difficulty he may encounter, and I shall not be satisfied until every reader obtains the results I claim. If he follows the instructions I shall give later this he is bound to do.

One little feature I have incorporated in the "Fury Four" is the use of voltage dropping resistances so that the builder is relieved of the necessity of adjusting H.T. voltage. He merely places the negative plug into the negative socket of the H.T. battery and the positive winder plug into maximum H.T. voltage. The fixed resistances will ensure that the correct voltages are applied to the anodes of each valve. I have also made use of these resistances to act as decouplers, a purpose which they quite successfully serve, for a feature of the "Fury Four" is its entire absence of background noises.

A point which the home constructor will appreciate is that I have eliminated the need for accurately balancing the three tuned circuits necessary in a modern receiver by tuning the detector grid coil by a separate condenser and the remaining two coils by a double gang condenser. I shall have more to say later about this ingenious method of tuning. I do not think it possible to incorporate in one receiver arrangements for receiving short, medium and long waves, for short-wave reception is admittedly tricky, and to render it efficient the medium and the long waves must suffer. Having in mind the depth of the pocket of the average home constructor, I have purposely kept the cost extremely low, for it may be built for about Five Pounds. The "Fury Four" is a set which will make radio history. Next week I shall describe the set and its performance in great detail.—F. J. C.

WHAT STATION IS THAT?

How to Calibrate Your Receiver

A Practical Answer to the Question

By HAROLD E. J. ORTON

AMATEUR constructed receivers have a number of possible advantages over commercially-constructed ones,

but in one respect, many commercial receivers score. I speak of the calibration in wavelengths of the tuners.

At first sight, it might be thought that except when using one of the few wavelength-calibrated "packs" on the market, the difficulty of calibrating must prevent amateurs from competing in this matter with manufacturers. However, this is far from the case. By the means I shall describe in this article, every amateur can calibrate his receiver in wavelengths, and provided he takes reasonable care he will be rewarded by an accuracy considerably greater than that found in most commercial receivers.

Making a Graph

To provide the wavelength settings for calibration, a graph has to be used. A considerable number of amateurs will have already made graphs, and in any case the necessary procedure of making a graph is pretty well known, so I do not propose to say more than a few words on the subject. If you do not understand what is meant or done as regards graphs, please study carefully Fig. 1, and I think you will soon realize what it is all about. The graph shown is a very diminutive affair; graph paper is usually sold in sheets of about 18in. by 24in., and a full sheet should be used for calibration. The dots on the graph represent stations, of course, and the position of each dot is obtained by tuning in a reliable station, noting its dial-reading and wavelength, and marking the

point on the graph where a horizontal line from the dial-reading (as represented on the graph) would cross a vertical line

fine inscriptions can be made with indian ink. As somewhat of a novelty, a dial in which the numbers are white and the background black can be made by using a thin paper, and having a photographic print taken from it in the same way as when printing from a negative.

If a dial of the old-fashioned rotating type is used, a disc can be fixed to the panel, and some mark on the dial can be used as a pointer.

When the blank disc has been made, a line should be drawn on it, starting from the equivalent to zero, to a position equivalent to the top of the scale. In the case of aperture dials, this line should coincide with the middle of the aperture. The line is the dividing line between the respective markings for long

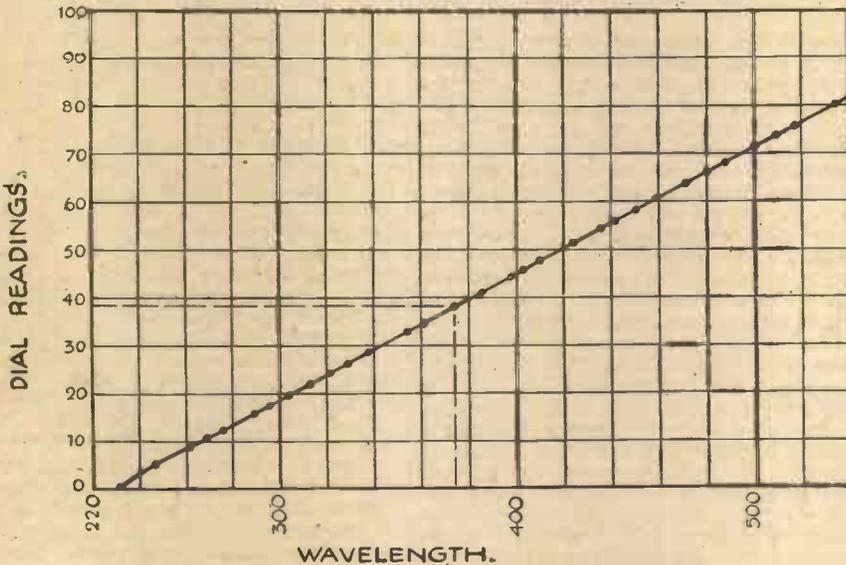

Fig. 1.—The dotted line shows how to read from a graph.

drawn from an appropriate position on the wavelength scale. The lines need not be drawn, of course, the lines on the graph paper serving as guides. When a considerable number of dots are marked, they are linked together to form a line or curve, and the graph is finished.

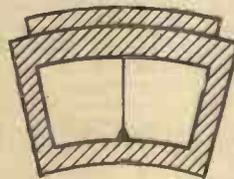

Fig. 4.—An aperture dial with hair line fixed to give accurate readings.

Calibrating the Dials

Now, to get on with the calibrating of the dials. A disc has to be prepared, similar in shape to the original one, inscribed in degrees. As to the material to use, white celluloid, with one surface roughened by fine emery-cloth, is ideal. As substitutes, one can use a good, hot-pressed drawing-paper, or any other material upon which

waves and medium waves. At each end, on this first line, a short line should be drawn to mark the limits of the tuning range. Fig. 2 should make this quite clear.

The next thing that has to be done is to locate, on the blank disc, the positions of each 10 metres on medium waves, and each 100 metres on long waves. With the old-fashioned type of dial, the new disc can be fixed in position on the panel, the wavelength positions then being easily marked. If an aperture dial is being calibrated, the new scale should be temporarily fixed in position over the original scale and illuminated from behind—the idea being to enable the positions of the degrees to be seen through the new disc. If illuminated dials are used, the light is automatically provided, but when such dials are not used, the original scale may have to be removed from the dial and, together with the blank disc, held up to a light.

(Continued on page 836.)

Fig. 2.—A disc preparatory to being calibrated.

Fig 3.—A nearly finished wavelength calibrated dial.

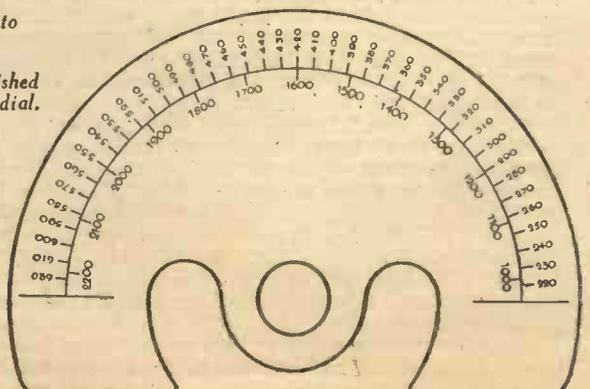
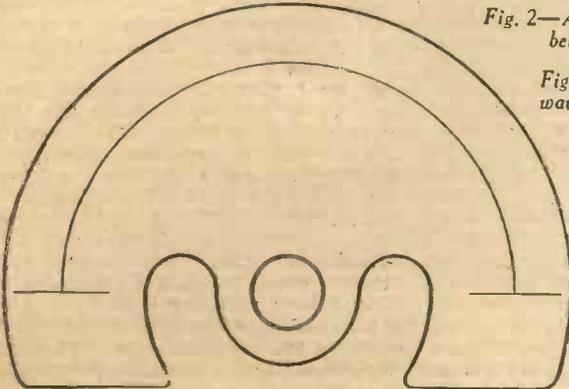

BARTON CHAPPLE on HOLDING THE FOREIGNERS

Various Methods of Ensuring Consistent Reception of Long-distance Stations.

THE SECOND ARTICLE

FROM the conclusions arrived at in the first part of this series, it would appear that by feeding back to the grid circuit of a multi-mu valve some negative voltage developed in a later stage of the receiver, and varying with the signal strength, a constant volume level could be maintained. The reason is, of course, that the increased voltage drop due to an increased signal would act as additional negative grid bias on the multi-mu valve, and thus reduce the effective degree of radio-frequency amplification.

Let us now see how such automatic control can be applied. There are a number of points in a radio circuit the potential of which varies with the signal strength. Most of them, however, are not admissible for automatic volume control purposes. In some instances the use of a certain voltage drop in this way would result in raising the potential of the multi-mu grids to that of the high-tension supply, involving considerable practical difficulties. In other cases the snag is that the available voltage drop is also modulated at radio or audio frequency. It will be shown later how these difficulties can be overcome.

Using the Grid Leak

Perhaps the most successful method of applying automatic volume control to a multi-mu valve or valves is by making use of the difference of potential which exists across the grid circuit of the ordinary leaky grid detector. Fig. 1 shows the conventional diagram for such a detector. It will be realized that the whole operation of cumulative grid detection is based on the flow of grid current. There must, therefore, be a difference of potential across the ends of the grid leak (through which, of course, the grid current flows).

If, therefore, the "grid" end of the grid leak is connected back to the grid coil of

the multi-mu valve, any increase in the signal as reaching the detector grid would impress a correspondingly increased negative potential on the multi-mu valve's grid, and thus tend to restore the signal to normal strength. A theoretical diagram of this arrangement is given in Fig. 2. Note that this is not a practical circuit as many essential and incidental components have been omitted for the sake of clarity. The heavy line A-B represents the connection between the grid of the detector valve and the grid coil of the multi-mu valve. It is through this connection that the negative potential at A is transferred to B. The condenser C.3, which is of fairly large

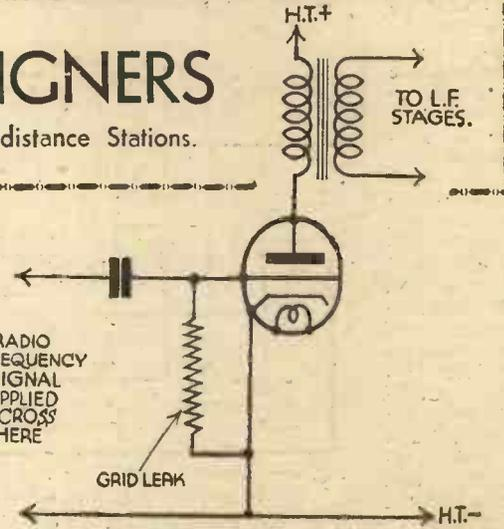
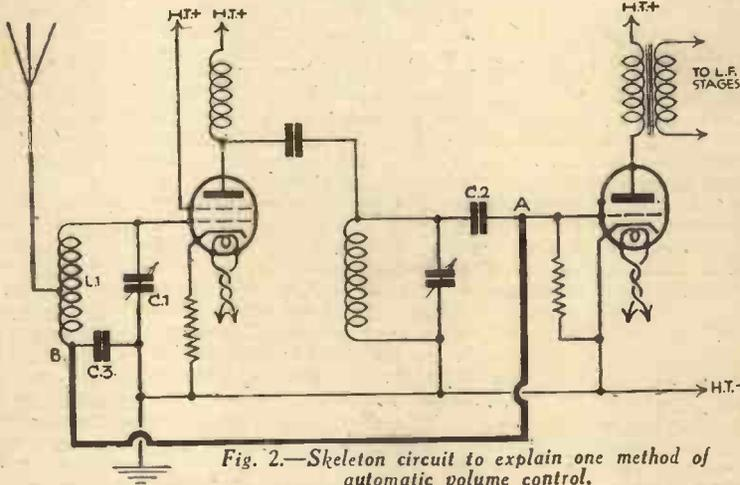

Fig. 1.—Circuit of a leaky grid detector.

complete filter and decoupling arrangements in order to avoid radio frequency voltage variations being fed back to the grids of the multi-mu valves, where, of course, they would produce a reaction effect leading to instability.

The circuit depicted in Fig. 3 includes a radio frequency choke L.3, and a bypass condenser C.5 for this purpose, while further smoothing is obtained by the decoupling resistance R.4. Here again it is necessary to point out that the actual values of the various components cannot be given quite so precisely as could be wished as they depend largely upon the characteristics of the valves employed and upon general circuit conditions. For the same reason only conventional tuning arrangements are indicated in the diagram. In a practical circuit the constants of the normal receiving net-

work must be taken into account and each receiver dealt with on its merits. However, there are probably many listeners who may like to carry out a little private research work on the problem of automatic volume control, so it will be advisable to analyze the circuit given in Fig. 3 and allocate provisional values for the various components to form the starting point for experiments.

Modifications

The scheme thus outlined forms the basis of an entirely satisfactory method of automatic volume control, but several additions have to be made before a practical

working arrangement can be produced. In the first place it must be remembered that the current flowing in the grid leak bears a radio frequency modulation. It is therefore necessary to provide rather

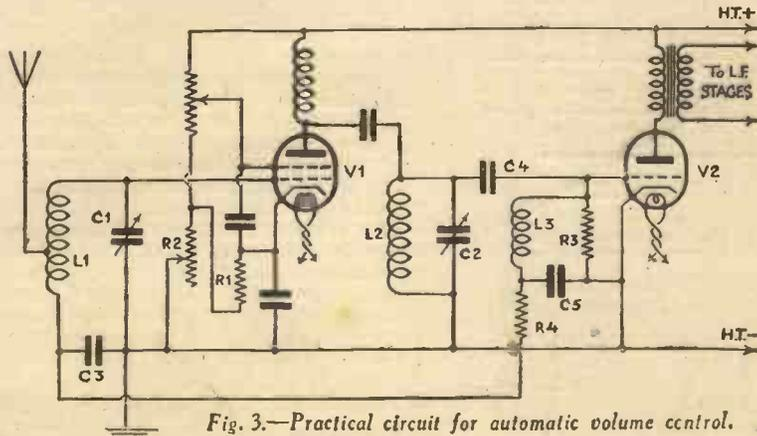

Fig. 3.—Practical circuit for automatic volume control.

Analyzing the Circuit

V.1 is the multi-mu screened grid valve, and V.2 the detector valve, both of the indirectly heated A.C. mains type. A simple tuning system, L1, C1, is shown for the aerial tuning and a similar simple arrangement for the tuned grid coupling between the multi-mu valve and the detector valve. Naturally, in a modern set such devices as, for example, band-pass tuning would exist, but here we are concerned only with the essential arrangements for automatic volume control. R.1 and R.2 are resistors in the cathode circuit of the multi-mu valve and are so arranged that they automatically bias the valve. R.1 is of fixed value and the bias it provides is the normal amount required to prevent the valve from running into grid current.

Its value is always quoted by the valve maker, but it can also be calculated by the well-known formula:—resistance in ohms equals desired minimum grid bias divided by the anode current of the valve in milliamps and multiplied by 1,000. R.2 is a variable resistor and can be used

for hand control of the multi-mu valve in the ordinary way and for pre-setting the volume level which it is desired to maintain automatically. Its maximum value will again depend upon the anode current of the valve and upon the amount of bias it is desired to provide. A value of about 10,000 ohms is of the right order for the average long grid base multi-mu valve and a much smaller value, say 2,500 ohms or less, for valves with a short grid base. C.4 is the normal detector grid condenser and R.3 the grid leak. The voltage to be used for automatic volume control is taken from the grid end of R.3 through the high-frequency choke L.3, which can be of the ordinary type. A condenser C.5 of, say, .0001 mfd. provides a bypass for any high-frequency component, while R.4 is a decoupling resistance having a value of twice or three times the grid leak resistance. The condenser C.3 to which reference has already been made should be of about .05 mfd.

A Defect

Although technically correct, the method of automatic volume control described above, and the several variants of it, suffer from one defect, namely, that the varying negative potential available at the grid of the average detector is comparatively small, so that the control it offers is not of great magnitude. It is doubtful, therefore, whether the scheme as outlined could be successfully applied to a single multi-mu valve, or, at any rate, to one of the long grid base valves requiring a maximum bias of the order of 40 volts. If, however, two or three multi-mu valves are employed, the control is more valuable because its effects are cumulative. That is to say, the

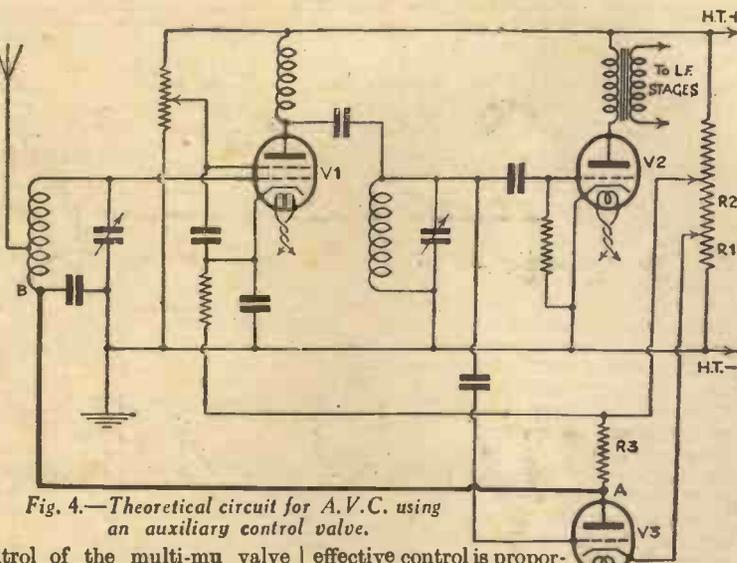

Fig. 4.—Theoretical circuit for A.V.C. using an auxiliary control valve.

effective control is proportional to the square of the controlling bias in the case of two valves, and to its cube in the case of three valves.

There is, however, another and very interesting method of applying automatic control by which almost any desired degree of control may be obtained. This method makes use of a separate control valve for supplying the varying negative grid-bias to the multi-mu valve or valves. This separate valve is connected as an anode bend detector, and its grid receives the same signals as are applied to the grid of the normal detector-valve of the receiver. Since the anode current of an anode bend detector rises when a signal is being received, it is a simple matter to connect in the anode circuit of this auxiliary control valve a resistance of suitable value, and to so arrange matters that the voltage drop across this resistance, which, of course, will increase as the signal increases, is fed back as a variable biasing voltage to the grid of the multi-mu stage or stages.

A Better Method

This system will be understood best from the skeleton theoretical circuit reproduced in Fig. 4. In this circuit, V.1 and V.2 are respectively the multi-mu and normal detector-valves of the receiver, and V.3 is the automatic volume control valve. This is shown as a three-electrode indirectly heated valve. The cathode of V.3 is connected to a low positive voltage, so that its grid is negative with respect to the cathode—that is, the valve is adjusted

for operation as an anode bend detector. The grid is connected to the normal detector grid, via a small coupling condenser, and its anode is maintained at a suitable positive potential. The resistance R.3 is connected in the anode circuit of the control valve. When the amplitude of the signal reaching the grid of the detector-valve and the grid of V.3 increases, the anode current of V.3 also increases, the voltage drop across R.3 increases in proportion, and the decreased potential at the point A is transferred to B by the connection shown as a heavy line.

Additions and Modifications

As in the previous case, considerable additions and modifications are necessary to convert this theoretical circuit into a practical one. In the first place, the arrangement for obtaining the cathode bias and anode voltage of the control valve may be improved by using, instead of a separate potentiometer across the high-tension supply, a series resistance at the negative end of the high-tension supply. This resistance must be capable of carrying the whole high-tension current of the set, and may be tapped to provide grid-bias to the output and other valves. Then, because the signals applied to the grid of the control valve are of radio frequency, and the anode current of that valve must, therefore, contain a heavy radio frequency ripple; the smoothing circuit in the link between the points A and B must be very carefully designed. An efficient radio frequency choke, with a by-pass condenser arrangement on similar lines to the smoothing circuit of a high-tension supply unit, but, of course, modified as to type of choke and values of condensers to suit radio-frequencies, is indicated here, and this may be followed also, with advantage, by a decoupling resistance. Neglect of this portion of the circuit would undoubtedly result in instability.

As a basis for experiment, a sensitive valve, of a type known to operate successfully as an anode bend detector, should be selected for V.3. The cathode bias of this valve should be calculated in the usual way, and the point at which the anode voltage for V.3 is tapped off should be adjustable. A maximum of about 60 volts would provide sufficient margin for experiment, while the anode load R.3 should be in the neighbourhood of 10,000 to 20,000 ohms, depending, again, on the amount of control bias it is required to apply to the multi-mu valves and on the value of the anode current of V.3. In the third part of this series it is hoped to give a more complete practical circuit, and more definite values of the various components.

HOW TO CALIBRATE YOUR RECEIVER

(Continued from page 834.)

When the preliminary marking, which should be in pencil, is finished, the lines and numbers should be neatly filled in with a mapping-pen. See Fig. 3. Further filling in can next be done. On an average dial, there is only room for a tick for every two metres on medium waves, which is quite satisfactory. On long waves, a tick at every twenty or twenty-five metres is convenient.

Fixing the Disc in Position

When the marking of the new disc is

THE SET WHICH WILL MAKE RADIO HISTORY!

F. J. CAMM'S

FURY FOUR

See page 833 for preliminary announcement.

FULLER DETAILS NEXT WEEK!

The Most Remarkable Receiver Since Broadcasting Began.

complete, the disc has to be attached in position. With drum and disc dials, the new calibrated scale can either be attached over the original scale or substituted for it. The material of the new disc, and the method of fixing of the old one, have to be taken into account, so choice in the matter must be left to the reader.

One other point is worthy of mention. A number of aperture dials have pointers so situated that accurate reading is rather difficult. In these instances, it is distinctly advisable, and nearly always readily practicable, to attach a piece of thin wire or cotton across the aperture, as in Fig. 4, which enables highly accurate reading to be readily taken, and the full advantage of wavelength calibration to be realized.

The Wireless Constructor's Encyclopaedia!

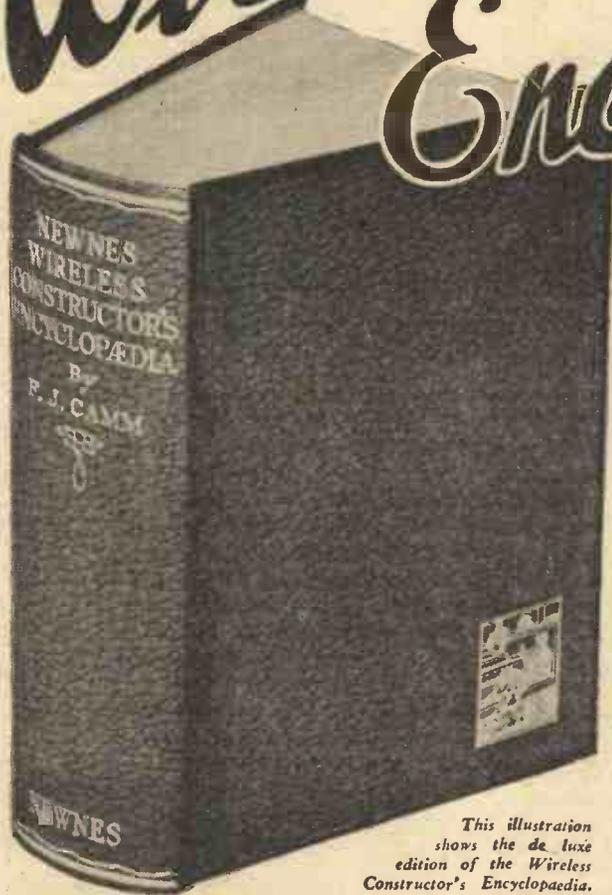

This illustration shows the de luxe edition of the Wireless Constructor's Encyclopaedia.

If you have not yet claimed your presentation copy of the Wireless Constructor's Encyclopaedia you should do so without delay!

We are despatching the presentation volumes of the WIRELESS CONSTRUCTOR'S ENCYCLOPAEDIA with all speed. Gift stamps which appeared on the back covers of PRACTICAL WIRELESS from our first issue (dated September 24th, 1932) to December 24th, 1932, should be attached to the subscription voucher sent to all readers who reserved copies, and the completed voucher should be sent in accordance with the instructions thereon without delay. If you have lost or mislaid your subscription voucher and have been unable to claim your volume for this reason, you will be glad to know that you can still obtain your copy of the WIRELESS CONSTRUCTOR'S ENCYCLOPAEDIA if you send at once the thirteen Gift Stamps, attaching them to the label below, together with a postal order for 2s. 4d. for the Standard Edition, or 3s. 6d., if you desire the de Luxe Edition, to "Practical Wireless" Presentation Department, 39, King Street, Covent Garden, W.C.2. If you have mislaid some of your Gift Coupons enclose 2d. extra for each coupon which is missing.

SOME READERS' OPINIONS

"I thank you for your Practical Encyclopaedia, which I think is an admirable and comprehensive book."—B. O. K., Catford.

"I have received my Wireless Constructor's Encyclopaedia, and must say I am very pleased to have such a book."—J. W., New Malden.

"I must say that the book you have sent me is far beyond my expectations, and I am thoroughly satisfied with the same. . . . It is a magnificent volume, of which I shall feel justly proud to be the owner."—V. F., Earl Shildon.

"I thank you for your Encyclopaedia. It is a valuable work, well illustrated, and the circuit diagrams are, I think, a good addition to the book."—F. W. S., Sheffield.

"I thank you very much for the copy of the Wireless Encyclopaedia. I cannot explain what pleasure the book has given me in reading through it."—O. G. P., Walthamstow.

"I have received my presentation book and just had to write to you to say what a wonderful book it is; certainly the best gift ever offered to the general public. Packed full of the most useful information and put together in the best possible way."—F. W., Brighton.

"Many thanks for your presentation volume. It is a fine work, and is just the thing for the constructor."—J. H., Rotherham.

"I thank you for the Constructor's Encyclopaedia. From my perusals of *Practical Wireless* I thought that the Encyclopaedia would be good, but it is even better than I expected, and I am sure it will prove invaluable to keen amateurs."—L. D. L., St. Annes/Sea.

"I would like to thank you very much for the Constructor's Encyclopaedia which I have received. It is compiled in a very neat volume and well explained in every detail. It is a pleasure to be able to read such a book."—A. W. F., Shepton Mallet.

"I have received the Encyclopaedia. Many thanks for such a valuable volume."—J. S. O., Beaconsfield.

"I beg to acknowledge with thanks the Encyclopaedia sent to me. It is, in my opinion, a very fine book, and must prove most instructive and interesting to every wireless amateur."—T. H., Bristol.

BOOKS WITH CARE

Name

Full Address

If undelivered please return to—

"PRACTICAL WIRELESS" Presentation Dept.,
39, King Street, Covent Garden, London, W.C.2.

PART VI.

WHAT is TELEVISION?

A Short Series Explaining the Fundamental Principles.

By H. J. BARTON CHAPPLE,
Wh. Sch., B.Sc. (Hons.), A.C.G.I.,
D.I.C., A.M.I.E.E.

DURING the course of some of the previous articles I have been forced to gloss over the exact interpretation of the expression "Synchronism," but in view of its extreme importance in relation

chromism. Here the same pair of pendulums not only execute exactly timed swings, but both their motions at any

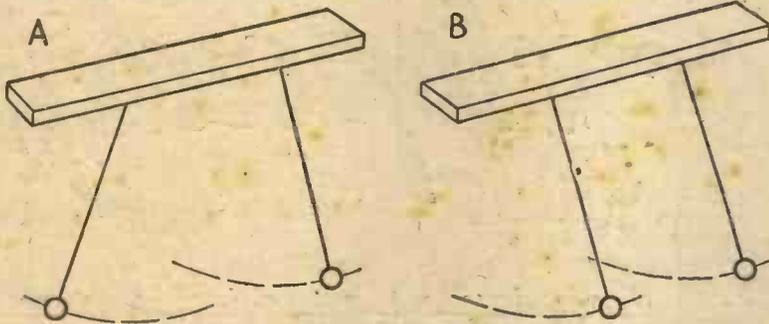

Fig. 1.—The analogy of a pair of pendulums.

to successful television reception I propose to devote this instalment to a consideration of the problems involved and describe how they are solved.

First of all let us tackle the subject by clearing the air as to the true meaning of synchronism, for I find so often that this simple term is confused and only a hazy impression exists in the mind of the individual. Obviously, the term has an application in divers directions other than television, and it may help to make matters plain if I give two simple every-day analogies.

Analogies

In Fig. 1A is shown a pair of pendulums, identical in length and weight, suspended from a beam and set swinging. The time executed for each swing by each pendulum is the



Fig. 2.—A black band introduced artificially. The spot light is masked out, and there is a momentary period of darkness, and thus no light is reflected on the photo-electric cell.

same, but they are not in "phase," that is to say, when one is reaching the top of its motion in one direction, the other is reaching the top of its motion in another direction. In consequence, at no time are they "in step" and the condition fulfilled is known as isochronism, a term indicating identity of speed or time movements, but an absence of "phase." We have to turn to the condition shown in Fig. 1B before we have true syn-

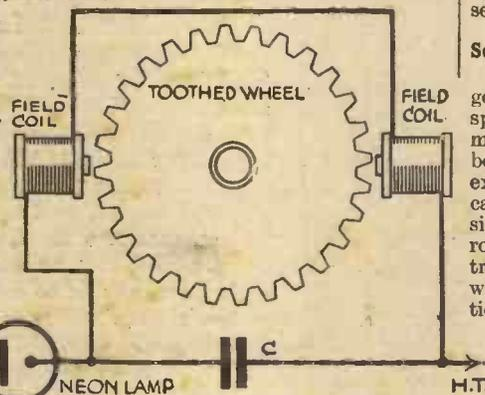

Fig. 3.—Diagram showing connections of the Neon and Synchroniser.

instant are identical, and it is this double condition which must be satisfied for synchronism to be fully established.

For a second example suppose we take the case of two electrically driven clocks used in the same house, that is to say, they are working off the same mains. The angular movements of the minute and hour hands will be the same, but unless they have both been set to the same Greenwich time they will register different times at the same instant. Under these circumstances they will be only isochronized and synchronism will not take effect until the hands of both clocks are set to register the same time at the same instant.

It is thus seen that while we can achieve isochronism without bringing about synchronism, it is impossible to establish synchronism without having first satisfied the condition of isochronism. In any television system isochronism is first of all achieved through the agency of the mechanism incorporated in the apparatus and generally this is done automatically, but the question of "phasing" has to be undertaken by each individual operator and is quite simple, as we shall see later.

The Simplest Scheme

Having appreciated what synchronism demands, the next point to consider is how

it can be achieved for the purpose of successfully establishing proper television reception at any point. The simplest of schemes will no doubt occur to the reader, namely, that of driving the transmitter and receiver motors from the same alternating current mains network. Synchronous motors worked under these conditions are admirable and in the U.S.A. quite wide networks are linked up covering large areas, and this in itself solves what is admitted to be television's most acute problem. In this country, however, it will be necessary to wait until the ambitious "Grid" system is well advanced before advantage can be taken of linked electricity mains over large areas. For the benefit of readers who happen to reside in the localities, however, it is as well to mention that the same electrical supply company which feeds the motors of the television transmitter at Broadcasting House covers the Marylebone area and sections of Hampstead.

Several Suggestions

Many and varied have been the suggestions put forward to maintain identical speeds between the transmitter and receiver mechanisms, but the majority have had to be discarded on the grounds of complication, expense, additional channels of communication, and so on. What is required is a simple and inexpensive method whereby the rotating mechanism of the television transmitter can produce regular signals which in some way can control the revolutions of the scanning disc or mirror drum at the receiving end.

One suggestion put forward was to arrange to short-circuit the photo-electric cells six times per revolution



An early form of automatic synchronising using a thirty bar commutator working in conjunction with a relay.

COSSOR MELODY MAKER

Prices reduced

was
£7-17-6

now
£6-17-6

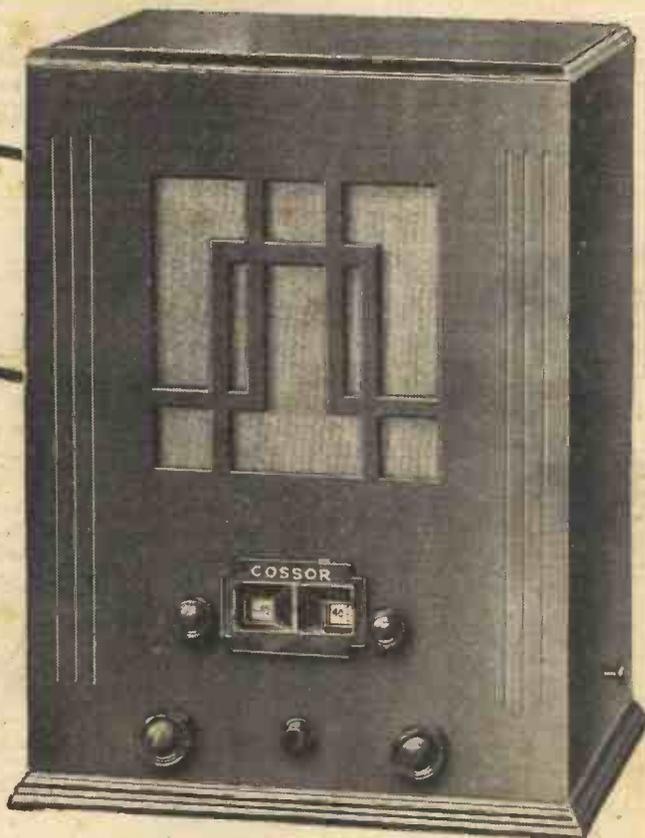

For less than ever before you can now own an up-to-date Screened Grid Receiver—the Cossor Melody Maker—equipped with every modern refinement and having the performance and appearance of an expensive factory-built set. The remarkable efficiency of the Cossor Melody Maker—its selectivity, its range, its high all-round performance—has resulted in an extraordinary degree of popularity. So great has been the demand that even the vast resources of the great Cossor works have been severely taxed to meet it. The enormous production of Melody Makers has permitted wholesale reduction in manufacturing costs. This reduction is passed on to you. Send the coupon for full details.

BATTERY MODEL 335

with Self-Contained Loud Speaker

Kit of Parts includes 3 Cossor Valves (220 V.S.G. Variable-Mu Metallised Screened Grid 210 H.L. Metallised Detector and 220 P. Output); Individually Shielded Coils. All-Metal Chassis and all parts for assembling the Receiver as illustrated; handsome cabinet 18½ in. x 13½ in. x 10½ in. and 10 in. Balanced-Armature Loud Speaker. Provision is made for fitting Gramophone Pick-up Socket and Plug.

£6.17.6

Hire Purchase Terms: 17/6 deposit and 9 monthly payments of 25/-

BATTERY MODEL 334

Kit of Parts, similar to Model 335 except that no loud speaker is supplied. Handsome cabinet 9½ in. x 13½ in. x 10½ in.

£5.15.0

Hire Purchase Terms: 15/- deposit and 9 monthly payments of 12/6

BATTERY MODEL 333

Kit of Parts, complete with valves for building Cossor Melody Maker Chassis for fitting to your own cabinet. Specification as Model 335 but without loud speaker or cabinet.

£4.19.6

Hire Purchase Terms: 15/- deposit and 9 monthly payments of 10/6

ALL-ELECTRIC MODEL 337

with Self-Contained Loud Speaker

Kit of Parts for All-Electric Melody Maker Model 337 similar to Model 335 (as illustrated) but for all-electric operation, including Cossor Valves, handsomely finished Cabinet, 18½ in. x 17½ in. x 10½ in., Loud Speaker and all parts. For A. C. Mains only 200-250 volts (adjustable).

£10.17.6

Hire Purchase Terms: 25/- deposit and 10 monthly payments of 21/6

Prices do not apply in I.F.S.

ALL-ELECTRIC MODEL 336

Kit of Parts, similar to All-Electric Model 337 except that no loud speaker is supplied.

Handsome cabinet 10½ in. x 17½ in. x 10½ in.

£9.15.0

Hire Purchase Terms: 19/6 deposit and 10 monthly payments of 19/6

ALL-ELECTRIC MODEL 338

Kit of Parts for All-Electric Melody Maker Model 338 Chassis. Identical with Model 336 except that no cabinet is supplied. Escutcheon and template for drilling your own cabinet is included.

£8.15.0

Hire Purchase Terms: 32/6 deposit and 8 monthly payments of 20/-

Models 336 and 338 are available for use on A.C. Mains only, 200 to 250 volts (adjustable), 40-100 cycles.

To A. C. COSSOR LTD.,
Melody Dept., Highbury Grove,
London, N.5.

Please send me free of charge a full size Constructional Chart, which tells me how to build the Cossor ^{Battery} ^{All-Electric} Melody Maker.
(Strike out type not required.)

Name

Address

P.F.A.C. 21/1/33.

My usual
Retailer is

Address

**COUPON BRINGS YOU FULL-SIZE
CONSTRUCTIONAL CHART**

A. C. Cossor Ltd., Highbury Grove, London, N.5. Depots at
Birmingham, Bristol, Glasgow, Leeds, Liverpool, Manchester,
Newcastle, Sheffield, Belfast, Cardiff and Dublin. ♡ 2203

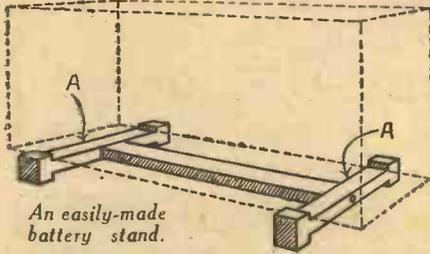

An easily-made battery stand.

H.T. Battery Stands

HIGH-TENSION batteries are still a comparatively expensive item of equipment, and one cannot afford to take any risks that may shorten the life of a big battery through premature deterioration. As damp is one of the things that are detrimental, it is important to keep the battery cool and dry. The best plan is to arrange the battery so that the air can circulate freely all round the outer case. A simple way of achieving this end is to place the battery on a wooden stand that will raise it off the table, shelf, or cabinet-floor on which it would otherwise rest. The battery-stand shown in the sketch can be made very easily at little cost. The end pieces marked "AA" in the sketch can be cut from stripwood lin. square section, while the central bar may be lin. wide by 3/4 in. thick. The three strips are assembled with glue and a couple of wood screws or nails. The dimensions of the stand depend, of course, on the size of the battery that is to be accommodated.—**NORMAN HURST** (Wimbledon).

Repairing Accumulator Terminal Screws

DOUBTLESS many wireless enthusiasts have experienced the trouble of terminal screws on an accumulator breaking off through corrosion. Such terminal screws can be made good by the following method. On referring to the sketch, which is practically self-explanatory, it will be noted that the lugs which are attached to the plates have two screws soldered to them. The tops of the lugs were filed flat and two cheese-head brass screws, the same diameter and pitch as the thread in

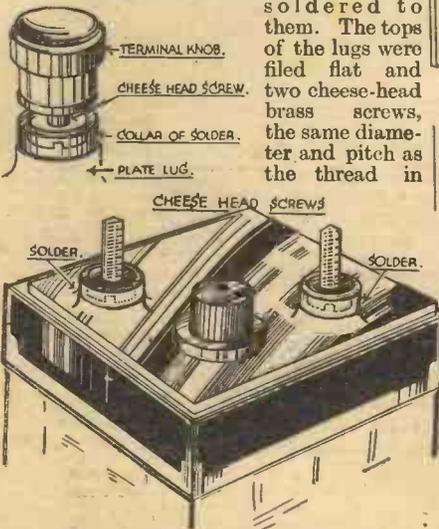

A method of repairing broken terminal screws on an accumulator.

terminal nuts, were obtained. A large blob of solder was then placed on each lug with a soldering iron and the heads of the screws were then tinned and held in position with a pair of pliers, a collar of solder being worked around the heads with a hot soldering iron. The top parts of the collars were afterwards

filed flat to give a good bearing surface for the terminal tags. The method was only adopted as a temporary repair, but it has stood up to its work for several months without failing, and appears to be as strong as the original screws. It also has the combined advantage of being easy to repair in the event of breaking again, and the cost of the repair is practically nil.—**G. F. BARNETT** (Ravenscourt Park).

Mounting a Metal Panel

ALTHOUGH metal panels are not very often used in the ordinary type of broadcasting receiver, they nevertheless have a distinct advantage in preventing hand capacity effects when using a short-wave receiver. The following method of arranging the metal panel without the aid of angle supports is simple, and has an exceptionally neat appearance, completely screening from view any jagged edges which might otherwise be visible. Obtain two (or more according to the size of the panel

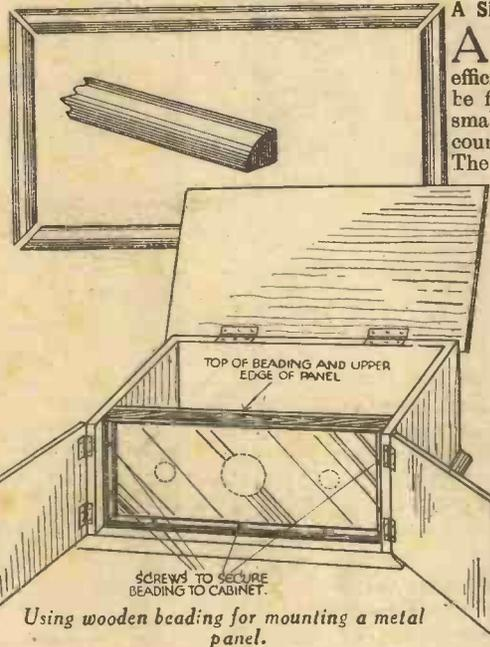

Using wooden beading for mounting a metal panel.

to be mounted) polished wooden stair rods (costing about 3d. each), as shown in the accompanying illustration. Cut same into four lengths, taking care that the ends of each are cut at 45 degrees. Next, place the lengths around the front of the cabinet and secure by means of screws in the positions indicated. The panel should now be placed in position, and a pencil impression made on same from the front around the inner edge of the beading, which will help as a good guide for drilling the holes which are necessary to hold the panel in place. After drilling these out—also the holes required for the condensers, switches, etc., according to the circuit in use—the panel can then be screwed in position from the rear. If a separate base-board is used the panel can

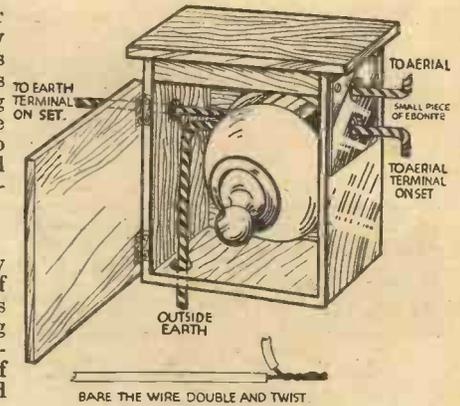

BARE THE WIRE DOUBLE AND TWIST

An efficient earthing switch.

easily be attached to same and the instruments mounted before placing in position in the cabinet.—**H. WEARING** (Devonport).

A Simple Earthing Switch

AN ordinary house lighting switch of the tumbler type makes a very efficient earth switch. The switch should be fitted outside the house, enclosed in a small box with hinged front, the box, of course, serving to exclude rain and dirt. The connections need little explanation. The lead in should not be cut at the switch, but the wire bared, doubled, and twisted and inserted into one point of the switch, the free end of lead being taken to lead-in tube. The earth lead is treated likewise and connected to the other point of switch, and the free end to earth on set. To operate, switch on for earthing aerial, and switch off to use set.—**E. F. FROST** (Colchester).

Automatic Switching for Aerial Condenser

MOST owners of inexpensive sets, such as a Det., and 2 L.F., have found that much volume is lost on long waves through the aerial condenser being in circuit, although it is indispensable on medium waves. The majority have some method of shorting it, with a piece of wire or otherwise, but this means fiddling inside the set when it is desired to change the waveband. Here is illustrated a device which automatically shorts the series condenser on long waves only. The device consists of two pieces of springy metal bent as shown, the rear piece being bent over at the top and cut to a point. The length of these pieces is determined by the height of the switch spindle above the baseboard. When the switch is out, for the medium waves, the contacts should come apart, the front one clearing the spindle of the switch. The terminals A B are, of course, connected to the terminals on the aerial condenser.—**READER** (Walker-on-Tyne).

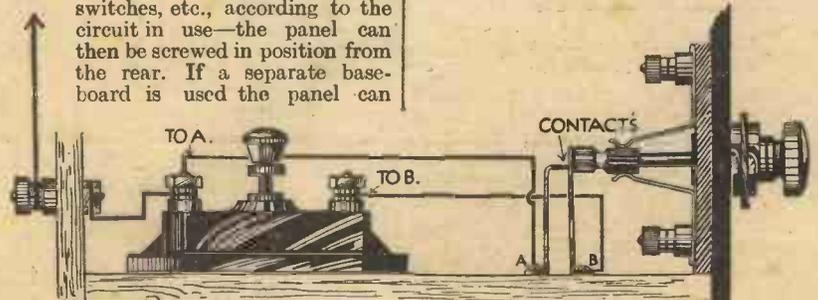

Simple automatic switching for aerial series condenser.

Connecting Up, and Using the Selectone

By FRANK PRESTON, F.R.A.

NOW that you have finished the construction of your Selectone you will naturally be very anxious to give it a test and see what it will do.

First, fit the G.B. battery in its clip, and put in the wander plugs. Plug "G.B.+" goes into the "+" socket, but the positions of the other plugs will depend to a certain extent on the voltage of the H.T. battery employed. Assuming it to be of 108 volts, "G.B.-" should be put in the 1½-volt socket, "G.B.-1" in the 3-volt socket, and "G.B.-2" in the 6-volt socket. If a 120-volt battery is to be used, plugs "G.B.-" and "G.B.-1" should be taken to the 3 volt and 4½-volt sockets respectively, whilst plug "G.B.-2" should be put in the 9-volt socket. Now insert the valves into their respective holders as indicated in Fig. 3. Connect the H.T. and L.T. batteries by means of suitable lengths of flex (when I say "suitable" I mean that

the lengths must be such that the wires will reach to the batteries, wherever you propose to store them).

Attach the aerial and earth leads to terminals "A" and "E," and then connect two speaker wires to terminals "L.S.+" and "L.S.-"—it doesn't matter which way round the latter wires are connected. The speaker is fitted with an output transformer, having ratios suitable for either ordinary or pentode output valves; in this case the wires should be connected to those terminals provided for "ordinary" valves.

The First Trial

And now we are ready for giving the Selectone a "trial run." Do not put it in the cabinet until you have tried it and so verified everything. Do not forget to pull out the radiogram switch knob to

put the set into the "radio" position, and to put the wave-change switch into the position required—for long waves, push in, and for medium, pull out, the knob.

For a start, put the coil plug into socket No. 1, which provides maximum sensitivity and minimum selectivity. Set the reaction condenser to its minimum (fully anti-clockwise) position, turn the tuning dial to zero and commence to rotate it by means of the slow-motion knob. Continue this until a station is heard and then increase strength by carefully adjusting the reaction condenser. If the condenser is turned too far, the set will oscillate (whistle), so care must be taken not to turn it past the point at which distortion begins. Incidentally, it should be added that oscillation can cause interference to neighbouring receivers, but it is not of a very serious nature, due to the loose coupling between the aerial and grid coils of the tuner.

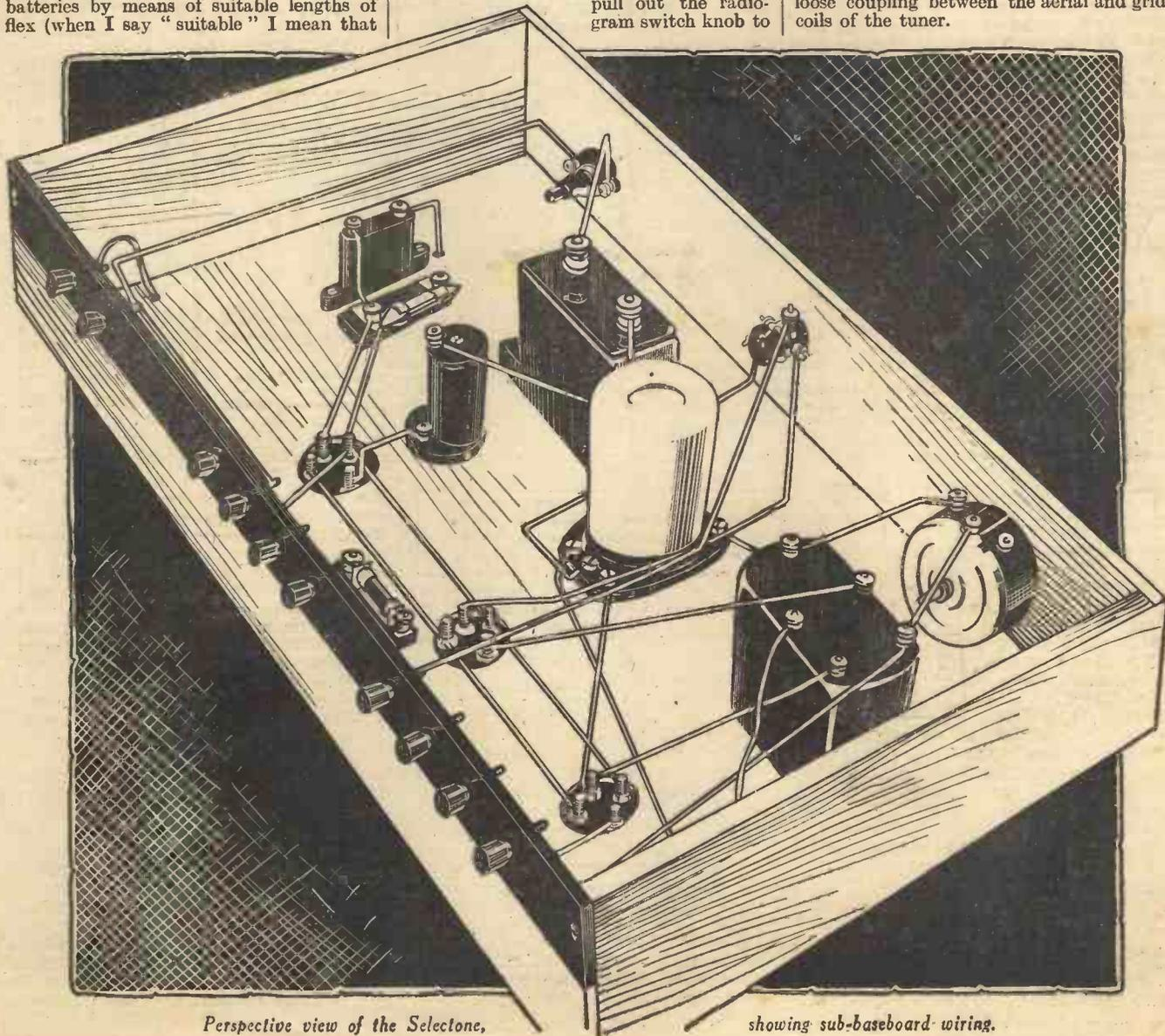

Perspective view of the Selectone,

showing sub-baseboard wiring.

Having brought the signal up to full strength you can adjust the tone control; when set to the maximum clockwise position the resistance is entirely out of circuit and, consequently, reproduction is low pitched and rather boomy, but by turning the knob in an anti-clockwise direction reproduction is gradually raised in pitch until it becomes "thin" and "screechy." Somewhere between the two extremes you should be able to obtain just the tone you require. Do not be misled by the fact that as the control is turned towards the "shrill" position there is a certain reduction in overall volume; this is quite normal.

Overloading

Due to the high amplification properties of the Selectone it is possible to overload the second and last valves when listening to local stations. Overloading is indicated when good reproduction cannot be obtained with any setting of the tone control and can be obviated in two ways. The first is to turn back the reaction condenser, and the second is to transfer the coil plug to a lower tapping (sockets 2, 4 and 5). In one or two cases, where a long aerial is used near to a powerful station, it might be necessary to connect a .0001 mfd. pre-set condenser in series with the aerial lead-in. The latter has not been included in the set itself because it will only be necessary in very rare instances. Overloading could be avoided by replacing the 210 H.L. and 220 P. valves by types 215 P and 230 X.P., respectively, but the latter valves would give less amplification on distant stations besides consuming considerably more high-tension current.

Getting Distant Stations

After having tuned in the first

stations, others can be received in a similar manner. Remember, that the set is in its most sensitive condition when it is just off the point of oscillation—indicated by a faint "breathing" sound—and so when searching for very distant or low-power stations, it should be kept in this condition by advancing the reaction knob at the same time as the tuning condenser. For most purposes, however, it will be sufficient to set the reaction condenser roughly, and tune in with the slow-motion knob of the tuning dial only. When two stations can be heard together, selectivity must be sharpened by advancing the reaction condenser and/or by putting the coil plug into a socket of a higher number. The optimum setting of the tone control will be dependent upon the degree of selectivity employed, and will vary for different stations. Of course, it is not essential that the tone control should be altered from, say, its midway position, but by making suitable adjustments, distant stations can be brought in as clearly as the locals. As you are well aware, the latter is quite impossible with ordinary receivers, and explains why distant stations are not usually so clear as the nearer ones.

If you make a note of the dial settings for stations identified, these will be of great assistance in helping you to locate others. Once you have made a log of stations received it will be an easy matter to get any

particular one just when you want it. Suppose, for instance, that you have logged Fécamp on 50 degrees. To get it again you will set the tuner to 50, advance reaction almost to oscillation point, and slightly re-tune, if necessary. Tuning can be carried out with great accuracy because the micro dial gives a reduction drive of 100 to 1. In other words, the knob must be turned through fifty complete revolutions to drive the pointer from 0 to 180 degrees. Moreover, tuning is so sharp that many stations can be tuned in and out again in little more than half a degree.

After having had some experience of tuning you can try altering the grid-bias voltages to plugs "G.B.—" and "G.B.—2." Before making any changes, switch off the set, and then try moving one plug at a time. Remember that the H.T. consumption will be least when the maximum amount of bias is employed; therefore, use the highest G.B. voltages which give good results.

Using A Pick-Up

The Selectone can be used as an excellent gramophone amplifier by connecting a pick-up to the terminals provided, and pushing in the radio-gram switch knob. Find the best value of grid-bias for plug "G.B.—" in the same way as before—it will probably be either 1½ or 3 volts.

If it is required to use the tone control on gramophone reproduction, the pick-up volume control must be of rather lower resistance than normal. When a volume control is not used, the pick-up should be shunted by a resistance of suitable value—generally about 30,000 ohms for a low resistance instrument, and 150,000 ohms for a high resistance one.

LIST OF COMPONENTS FOR THE SELECTONE

- 1 Vibrant plywood panel 14in. by 8in.
 - 1 Utility Standard .0005 mfd. condenser.
 - 1 Utility type W. 131 micro-dial.
 - 1 Lissen .00015 mfd. differential condenser.
 - 1 Colvern type "T.D." coil.
 - 1 Lissen 3-point wavechange switch.
 - 1 Telsen on-off battery switch.
 - 1 Wearite type "G.C.O." radio-gram switch.
 - 1 Lissen 5,000 ohm potentiometer.
 - 3 Eddystone chassis mounting valve-holders.
 - 1 T.C.C. .0002 mfd. fixed condenser.
 - 1 Dubilier 3 megohm grid leak.
 - 1 Dubilier grid leak holder.
 - 1 Telsen Standard H.F. choke.
 - 1 Benjamin Transfeeda.
 - 1 T.C.C. 2-mfd. condenser.
 - 1 Varley Rectatone transformer.
 - 1 Belling Lee baseboard fuseholder with 60 m.a. fuse.
 - 10 Belling Lee "Junior" terminals; 1 each marked A, E, L.T.—, L.T.—, H.T.—, H.T.—, L.S.—, L.S.— and 2 marked Pick-Up.
 - 6 Belling Lee wander-plugs; marked G.B.—, G.B.—, G.B.—1, G.B.—2, H.T.—, H.T.—.
 - 1 Strip Becol ebonite, 14in. by 1½in.
 - 1 Bulgin G.B. battery clip.
 - 1 Coil Glazite connecting wire.
 - 1 short length flex.
 - 1 5-ply baseboard, 14in. by 8in.
 - 2 pieces hard wood, 7½in. by 3in.
 - 1 piece 3-ply, 14in. by 2in.
- Approximate total cost—£4 10s. 0d.
- Accessories.**
- 1 Camco "Excelsior" or "Aston Senior" cabinet.
 - 3 Cosmor valves; 1 type 210 Det. (metallized), 1 210 H.L. and 1 220P.
 - 1 Ediswan 9v. G.B. battery.
 - 1 Ediswan 105v. super-capacity H.T. battery.
 - 1 Ediswan 2v. 40 a.h. accumulator.
 - 1 Celestion Soundex permanent magnet moving-coil loud-speaker.

THE following is a method by which the H.F. resistance measurement of tuning coils can be accurately obtained. In the diagram, L_1 is the coupling coil to oscillator, L_2 , C_2 any coil and condenser to tune, R the H.F. resistor, L_T the coil under test, and C_1 a good condenser to tune L_T .

Firstly, with switch in R position, tune L_2 , C_2 to resonance with oscillator. Secondly, throw over switch and tune L_T , C_1 . This circuit is then behaving as a pure resistance in the L_1 , L_2 , C_2 circuit. Therefore, by returning switch to R position and adjusting R until the same reading is obtained on the valve voltmeter, the R thus obtained is the effective resistance of L_T , C_1 at the frequency of measurement. It is advisable on obtaining an approximate value for R , to retune L_2 , C_2 to eliminate any error of tuning due to any large alteration of R , and also to check tuning of L_T , C_1 . The resistance thus obtained is the effective resistance of coil L_T and condenser C_1 , and if C_1 is extremely good, the resistance can be taken as the resistance of the coil for most purposes. This error,

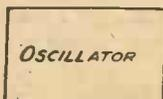

MEASUREMENT OF H.F. RESISTANCE

however, can be corrected as follows.

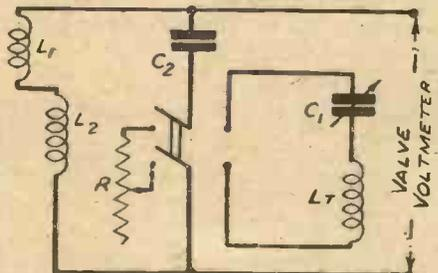

The circuit arrangement for measuring H.F. resistance.

Obtaining the Power Factor

By means of a shearing bridge, or similar low-frequency method, the power factor of the condenser C_1 can be obtained accurately at any capacity within its range.

The capacity of measurement should be noted. Now for condensers of this nature, RwC can be assumed to be the power factor. The error thus introduced will be of the order of .08 per cent. on a commercial broadcast condenser. Again, RwC^2 is a constant for condensers of this type for all frequencies; so if the power factor obtained is multiplied by the capacity of measurement, a value is obtained for RwC^2 . In the case of the above mentioned condenser, this would be about 50×10^{-14} .

Referring to the L_T , C_1 circuit again, C_1 (in farads) to tune L_T is known from the calibration of the condenser, $w=2\pi f$ is known from the calibration of the oscillator; so the resistance of C_1 can be obtained at the frequency of measurement. This value is then subtracted from the obtained resistance of L_T , C_1 circuit, giving the effective resistance of L_T . The error due to the switch can be neglected, for it is common to resistance and L_T , C_1 circuits. It is also advisable to screen everything except the L_T , C_1 circuit in order to avoid direct pick-up in this circuit, which would give a lower effective resistance, or possibly even a negative resistance.

'A definite advance...'



says *Mr. H.J. Barton Chapple* Wh. Sch. B.Sc. (Hons)
D.I.C. A.M.I.E.E.

This well-known radio and television authority pays striking tribute to the new W.B. "Mansfield" Speaker Magnetic System

"... The ultimate result is a really astonishingly high flux density for the size of the magnet used... fidelity of tone of outstanding merit... sensitivity very noteworthy, comparable in many respects with externally energised types without the necessity for mains or batteries. The Speaker will handle an input more than sufficient for quite a large room and yet can be worked satisfactorily from a small two-valve set.

"My conclusions... this new P.M.4 speaker is a definite advance in the permanent magnet class."

Write for copy of Mr. Barton Chapple's full report. The "Mansfield" (patent) Magnetic System is a revolutionary development. It makes possible a magnet 30% more efficient than a good cobalt steel magnet of same weight and 10% more efficient than a chrome steel magnet of three times the weight. It enables a steel chassis to be used without magnetic loss. It eliminates the bugbear of loss of magnetism. Ask your dealer for a demonstration; you will be **AMAZED**.

The revolutionary "MANSFIELD" Moving-Coil Speakers



- "Mansfield" Senior. P.M.4.
Complete with tapped output transformer - - - - - **42/-**
Or in handsome cabinet : : : **67/-**
- "Mansfield" Junior P.M.5.
Complete with tapped output transformer - - - - - **27/6**
Or in handsome cabinet : : : **39/6**

Whiteley Electrical Radio Co., Ltd., Dept. E, Radio Works, Mansfield, Notts.
Irish Free State Distributors: Kelly & Shiel, Ltd., 47, Fleet Street, Dublin.

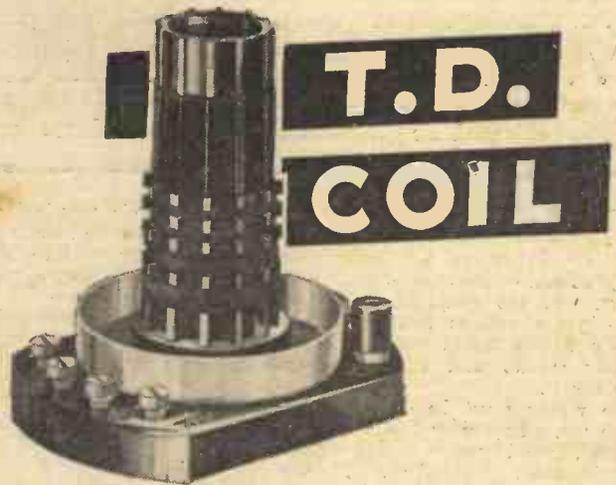

for the

SELECTONE

In 1933 super selectivity will be more than ever necessary. Start the New Year by constructing the "Selectone," the last word in selectivity in straight detector L.F. receivers.

The "Selectone" incorporates the Colvern TD Coil, which is completely screened and incorporates tapped aerial coupling and reaction.

Four alternative aerial tapings are arranged as sockets with a wander plug. The first two tapings give aerial couplings similar to those normally employed, but with greatly increased selectivity.

Numbers 4 and 5 give a high degree of selectivity with weak aerial coupling suitable for use in a swamp area. There is no break through on the long wave-band from B.B.C. stations.

Price 8/6

Send for the Colvern Booklet, Radio List No. 10.

COLVERN LIMITED,
MAWNEYS ROAD, ROMFORD

PRACTICAL HINTS ON WIRELESS RECEIVER DESIGN

The Conclusion of the Notes on Lay-out and Construction

By JACE

The Wiring

AFTER the general layout has been decided upon, all the components should be mounted loosely by single screws, and the panel fixed in position; any slight alteration can then be made quickly before finally putting in the remaining screws and making everything quite secure.

The wiring must be done next. In a simple set, where very few wires are required, bare 16 gauge tinned copper wire is most convenient. If the wiring is at all involved, or if the set is mains operated, it is best to use insulated connections. The bare wire can be insulated by passing it through suitable lengths of systoflex sleeving; or insulated material, such as Glazite, can be employed. In any case the wire will be coiled when bought, so it should be straightened by holding one end in a pair of pliers and pulling it through a duster held in the hand. Another way is to grip the end of the wire in a vice and pull steadily until it stretches slightly. There is an old and fairly well-known rule to the effect that wires in the grid and plate circuits of valves operating at high frequency should be kept as far apart as possible, and should not run parallel to each other. This rule is still as important as ever, and many cases of H.F. instability and uncontrollable oscillations can be traced to its neglect.

Shielded wires are often useful if employed judiciously, but, generally speaking, they should not be used for grid-circuit connections, because the screening might have some effect on tuning. Wires of this kind are particularly useful for making connection to the anode terminal of a metallized S.G. valve, or for connecting

the anode terminal of the detector valve holder to the reaction condenser; in either case they tend to improve H.F. stability. When building a portable set it is very desirable to use shielded wire for making loud-speaker connections, since it prevents them from "picking up" H.F. currents from the near-by frame aerial. In all cases the braided metal forming the screen should be effectively connected to earth, for other-

to a few of the more important ones which can have a very marked effect on the set's performance. Among these latter must be classed the fixed condensers used to bypass the H.T. supply to the screening grids of S.G. valves, and also that used for coupling a pair of band-pass coils; in each case the components must definitely be of the non-inductive type. Ordinary condensers might cause various kinds of instability which would probably be difficult to trace. Resistances used to provide automatic grid bias to S.G. valves or for by-passing the band-pass coupling condenser should also be non-inductive to ensure that they shall not be the cause of parasitic oscillation or similar trouble.

Ordinary push-pull switches should on no account be employed for connecting the mains supply; their contacts would quickly burn away due to sparking, and the danger of receiving a shock would be very great. Mention of this matter might appear superfluous, but I recently saw the result of a mistake in choosing a mains switch. Luckily the constructor concerned escaped without injury, but his set caught fire from sparks caused by bad contact at the switch points.

Of course, it should be borne in mind that manufacturers are, in general, well aware of some of the points which have been raised in this article, and in many cases have made some attempt at removing the difficulties encountered by the home-constructor. Quite a number of these are, however, of the home-constructor's own making, and can be obviated by careful thought when planning a receiver, or adhering strictly to the instructions laid down by the designer of the receiver which is being built.

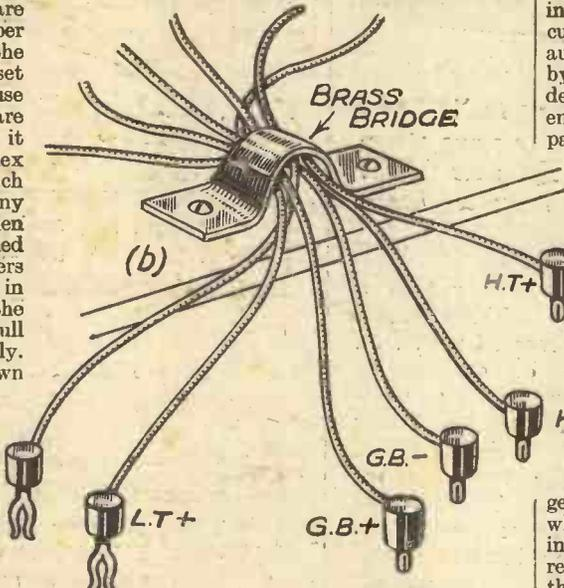

Fig. 6.—Multiple leads anchored to baseboard by a metal bracket.

wise it will not serve its intended purpose. The simplest way to make the earth connection is by means of a length of thin wire bound round and soldered to the braid as shown in Fig. 7.

Another practical point in wiring up a receiver concerns the cores of L.F. transformers and chokes; where possible they should be connected to earth. Some makers provide an earth terminal specially for this purpose, whilst others connect one of the holding-down screw eyelets to the core so that an earth connection can be made to the holding-down screw. Where neither of these provisions is made, a wire can often be attached to a core-clamping bolt.

Choosing Components

Although it is not intended in this article to deal with the question of choosing components, it might be as well to refer

THIN WIRE BOUND ROUND AND SOLDERED METALLIZED S.G. VALVE

SHIELDED WIRE

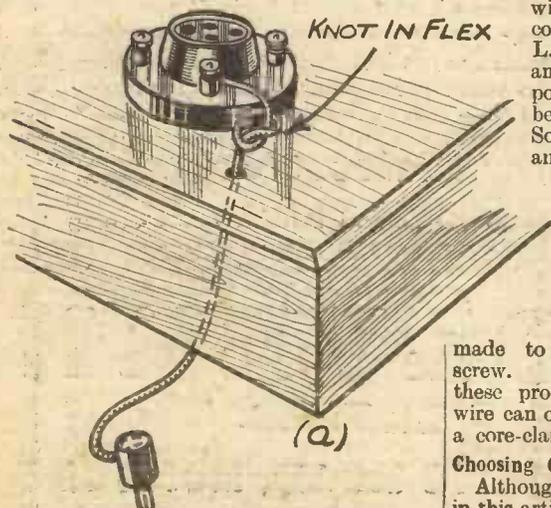

Fig. 5.—One way of anchoring a flexible battery lead.

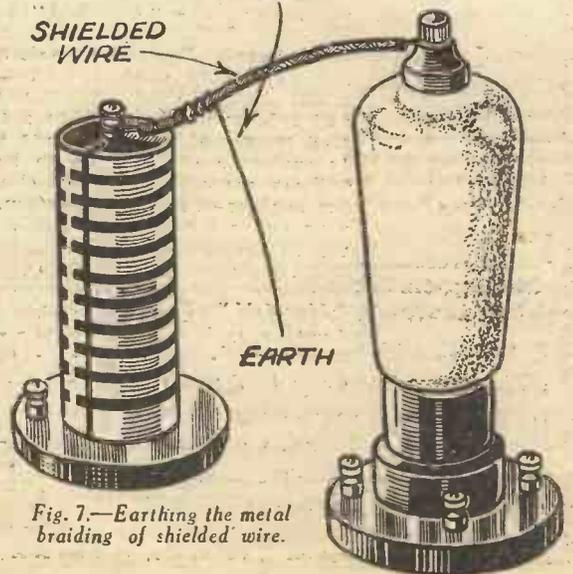

Fig. 7.—Earthing the metal braiding of shielded wire.

BRITAIN wants dry cell BATTERIES

Our Licensees Will Have a PROSPEROUS NEW YEAR.

Wireless will be more popular than ever in 1933. Wireless Batteries more than ever in demand. It means a PROSPEROUS YEAR for our Licensees—become one yourself NOW!

6.000.000 British Homes are without ELECTRIC POWER of any sort. *Each Home with Wireless needs Batteries!*

Millions of British homes are in regular need of Wireless Batteries! Millions more are in need of other sorts of dry cell batteries. Just think of all the numbers of people in your district who need them!

NOW—just imagine the golden opportunity you would have of MAKING MONEY if you could supply these people with BETTER Batteries—at a LOWER Price than they can obtain anywhere else! It is a proposition which pays. This is the opportunity we offer you TO-DAY!

YOU CAN MAKE MONEY MAKING BATTERIES

Making Batteries according to our Patented method and formula is easy. Any intelligent man or woman can do it.

One Man Earned £960 in Spare Time

The Wonderful part of it is that you need not have the slightest experience or technical knowledge. You need no expensive plant—only a few simple tools and hand presses, most of which you can make yourself at trifling cost. It is so simple that you can start on your kitchen table and even the children can help you!

And you can make up to £300 per year licence!

Profits Guaranteed!

And we will purchase sufficient of your output to guarantee you a weekly Profit provided your work comes up to the required standard, which is easily attainable! And we will continue your training FREE until you reach that standard.

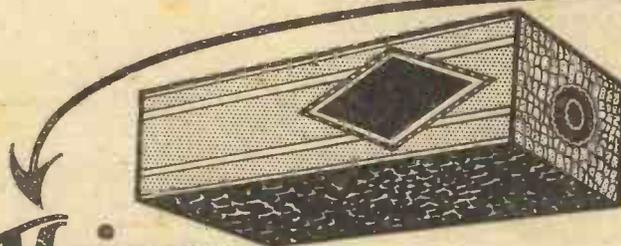

**This way—
A Guaranteed Genuine Home SPARE-TIME BUSINESS!**

Why hesitate? Why delay? Here is your **OPPORTUNITY** to earn a comfortable spare-time income in a business which is increasing by leaps and bounds!

SEND THIS COUPON

for **FREE** Details **How to Start**

COUPON:

To Mr. V. England-Richards, The England-Richards Co., Ltd., 244, King's Lynn, Norfolk.
Sir,—Please send me at once, and FREE, full details as to how I can Make Money at Home in my spare time, and also Testimony from those already making money and proof that one man earned £960 in spare time. I enclose 2d. in stamps for postage.
Print your name and address boldly in capital letters on a plain sheet of paper and pin this coupon to it. "Practical Wireless" 21/1/33.

CHOOSING AND USING

In this Article FRANK PRESTON, F.R.A., Deals with the Various Points of View

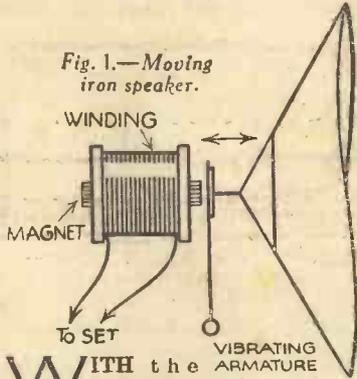

WITH the great variety of loud-speakers now available, the choice of any particular instrument is an extraordinarily difficult and somewhat embarrassing proposition, unless one has a fair knowledge of the relative merits of various types. And one's troubles are more likely to be intensified than relieved if the help of friends (however well meaning) is sought.

The musical friend who has a powerful set will say, "Really, old boy, you can't expect to get good reproduction unless you have a moving coil; you will miss the bass altogether," whilst the man with an inexpensive home-made three-valver will declare that "moving coils are all right for those who like a boomy kind of music, but give me a balanced armature every time." Another will be quite emphatic in his aversion for both moving coils and balanced armatures. "The inductor has 'em both whacked," he will say. Among the circle of friends one is sure to meet the man of small means who started wireless with a crystal set, graduated to a single-valve-with-phones, and later managed to scrape together a three or four valve set and to buy a horn type of speaker. This is the real enthusiast without doubt, and he

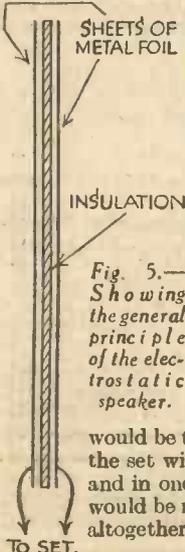

Fig. 5.—Showing the general principle of the electrostatic speaker.

Obviously the ideal way to choose a speaker would be to try one of each kind on the set with which it is to be used and in one's own home. But that would be most impracticable, if not altogether impossible. I therefore

propose to discuss with you the pros and cons of the five or six different patterns, so that you can decide which will best suit your own conditions.

Having settled on the type, I shall recommend you to hear a few different makes of that type in your own home and then decide which pleases you most. It is impossible to be dogmatic or specific regarding the matter of choice because individual tastes are, after all, of most consequence. And besides, you might be prepared to spend five pounds, or even more, or the permissible outlay might be restricted to as many shillings.

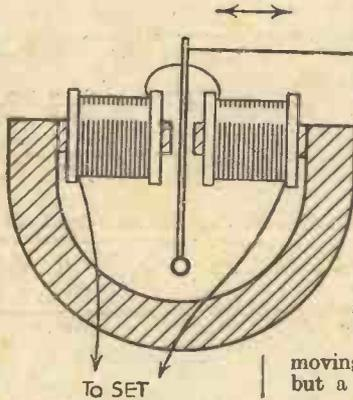

Fig. 2.—"Moving Iron" Speakers. Balanced armature type of speaker.

moving iron. This is now almost obsolete, but a few models are available at about

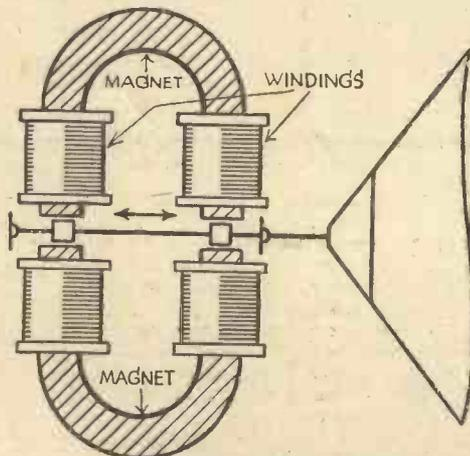

Fig. 3.—Inductor dynamic speaker.

five shillings. The "cheapness" is not confined to price, however, but is reflected by performance; the moving iron will give very little bass and will probably have a "resonance peak" in the region of 3,000 cycles. The latter will have the effect of rendering the reproduction of violin music "hard" and metallic and will probably make a piano sound more like a harp. On the other hand, this type of speaker is undoubtedly sensitive and might give better results than most on, say, a two-valve set which has a very small output of signal energy.

The Balanced Armature

The balanced armature is really an improved form of the moving-iron speaker, which it has almost entirely supplanted. It is un-

doubtedly the most sensitive type of speaker obtainable, and a good sample (costing about a guinea for the unit and chassis) is capable of giving quite a good performance on frequencies from about 150 to 5,000 cycles. The very form of construction makes it impossible for a balanced-armature speaker to do justice to bass notes; if good sensitivity is to be obtained, the vibrating reed (see Fig. 1) must be close to the pole pieces, and its movement is consequently restricted. In other words, the diaphragm (or cone) can only move through a small distance. As you are well aware, the diaphragm vibrates more slowly at low than at high frequencies, and thus, if the sound output is to remain more or less constant throughout the range, a greater diaphragm movement is necessary in the former case. The result is that, if a balanced-armature speaker is used with a fairly powerful set, there is every probability that a certain amount of "jarring" or "grating" will be experienced on very low notes, due to the armature actually touching the pole pieces. Like the moving iron, the balanced armature almost invariably has a resonance peak round about 3,000 cycles. This is not always a disadvantage, because very often the low-frequency amplifier does not give good response to the higher notes, with a result that the over-amplification due to the speaker is automatically cancelled out. Of course, tone correction devices could be made to "iron out" the resonance peak, but they would probably prove too costly.

Despite the disadvantages stated above, the balanced armature has much to recommend it, especially for a not very powerful two or three valve battery set and when the question of price is of distinct importance. It will give good reproduction of speech, whilst music is rendered with a certain crispness, even though it does show rather a lack of "body" and "depth." This type of speaker is undoubtedly better for a set of the kind referred to than is a similar-priced instrument in the moving-coil class.

Inductor Dynamic

An inductor-dynamic speaker is almost equal in sensitiveness to those we have

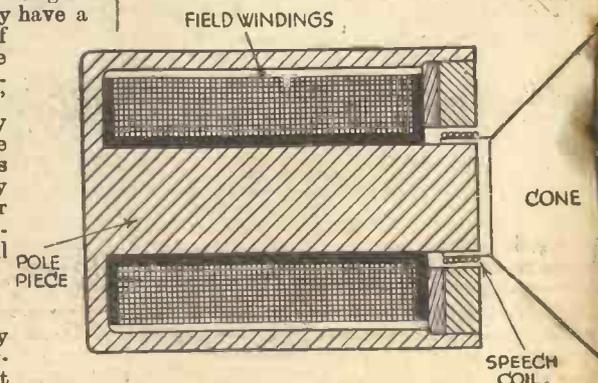

Fig. 4.—Energised moving-coil speaker.

YOUR LOUD-SPEAKER

arious Types of Loud-speakers and Examines Them from the View of the User.

already considered, and at the same time is able to give good bass response, due to the fact that the armature moves parallel to the pole pieces and is therefore not restricted by the latter. (If you are not familiar with the construction of this type of speaker, you will get a good idea of the salient features from Fig. 1.) The inductor is probably the best kind of speaker for a battery set of medium power, but it is, of necessity, somewhat expensive. At the same time a good specimen will provide a noticeably greater volume than will a similar priced moving coil for a given input of sound energy. Moreover, the inductor will handle a large volume without distortion, and is in this respect equalled only by a moving coil. Perhaps the only "fault" in the opinion of many is that the inductor has a tendency to give over-emphasis to low notes and so to produce rather a "boomy" effect. This criticism does not apply to every specimen, and, in any case, the extra bass response is a definite advantage when the set itself rather favours the upper register.

on to the moving coil. This type of speaker has gained immense popularity during the past few years, and I personally think its merits have in many ways been grossly exaggerated; the moving coil is certainly not every set's "meat." A good moving coil, if used with a fairly powerful set having a super power output valve,

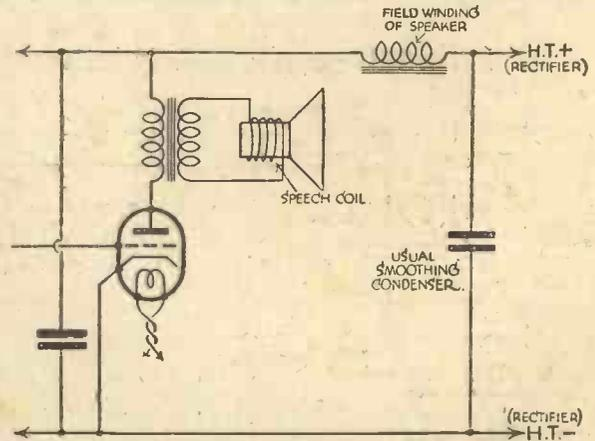

Fig. 6.—Using the field winding of a moving-coil speaker as smoothing choke in A.C. receiver.

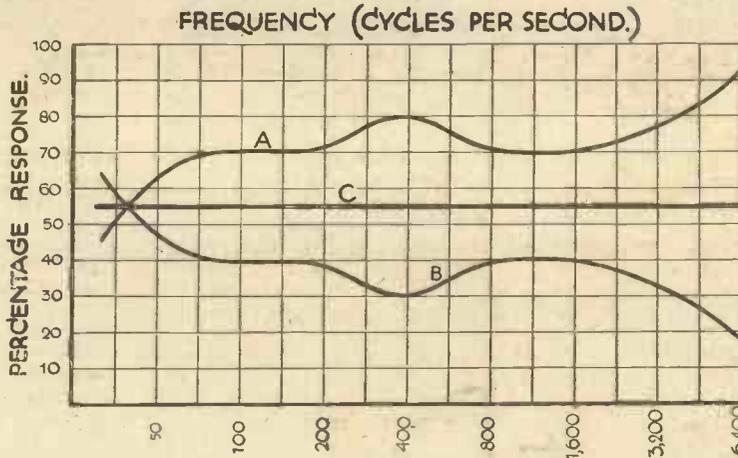

Fig. 7.—Curves showing the effect of combining two matched units to form a dual-compensated speaker.

of perfection. Despite the many improvements, however, the small permanent-magnet moving coil is distinctly less sensitive than a good balanced armature, and although it does give somewhat better reproduction than the latter, it is not quite so suitable for a battery set having only a small power valve in its output stage. At this juncture it might not be out of place to explode a common fallacy—a large speaker does not require a greater input power than a small one of similar type for efficient operation, and, as a matter of fact, the very reverse is generally the case; a larger speaker has a more powerful magnet system and is consequently more sensitive. This applies to speakers of all types.

more sensitive. This applies to speakers of all types.

For Larger Sets

For use with a receiver having a power output in excess of about 500 milliwatts the speaker must be either an inductor or a moving coil whilst for an output greater than 1,000 milliwatts or so a moving coil is essential. But as an output of over 1,000 milliwatts could only be obtained from a fairly powerful mains-driven set, a moving coil would be chosen in any case because its field could be energized from the H.T. supply.

After reading the last two paragraphs you might have drawn the conclusion that the really small permanent-magnet moving coil is merely an "extra" for which we can find no special niche. That is not the case, as any reader may judge by the numerous examples of this class of speaker on the market. It is eminently suitable for the person who requires "correct" and not merely "pleasant" reproduction from a medium-power set and at the minimum of expense. As we have seen before, it is not quite so sensitive as speakers of other types and is thus suitable only when the set gives a fairly generous output. In all fairness it should be pointed out that, although the type of speaker under observation is considered rather insensitive as judged by present-day standards, it is immeasurably more sensitive than any type of speaker obtainable only a few years ago.

(To be continued)

Moving Coils
And now we must pass

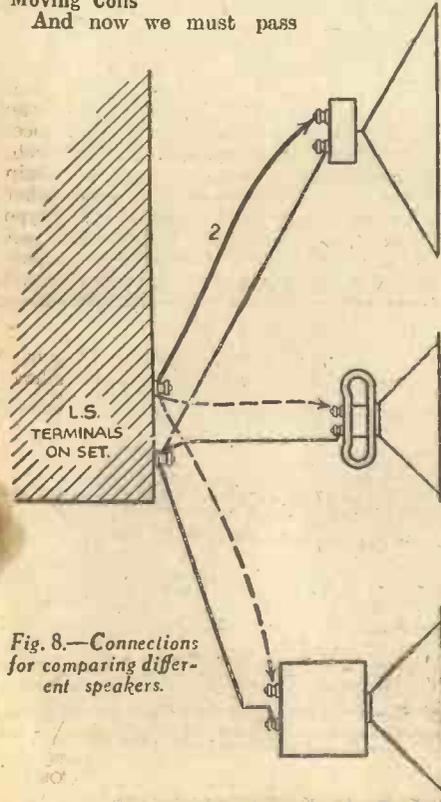

Fig. 8.—Connections for comparing different speakers.

SPEAKERS ON TEST.

will undoubtedly give the best possible form of reproduction, but under any other circumstances its superiority is by no means a foregone conclusion. In the first place a moving coil is never quite so sensitive as a balanced armature, although one taking its field current from the mains does not fall far short. For this reason I should strongly recommend any set user who has a D.C. mains supply to employ a moving coil with any except the smallest set. When the mains supply is A.C., however, the cost of the necessary rectifying equipment brings the price of the complete speaker up to a fairly high figure. And that is not justifiable with most domestic receivers, because an inductor would give equally good results for a smaller expenditure. Of course, a separate rectifier is not required if the set is an all-mains one consuming upwards of, say, 40 milliamps H.T. current, because in that case the field winding of the speaker can be energized satisfactorily by using it as a smoothing choke in the high-tension circuit (see Figure 6). By employing this arrangement an actual economy would result, due to the saving of a separate smoothing choke, and thus a moving coil would be the ideal speaker.

In addition to those speakers whose fields require to be energized by some external voltage source, we have the permanent-magnet models which have recently been brought to such a high state

THE PRACTICAL WIRELESS SELF-BINDER

for our

FREE-GIFT DATA SHEETS

CLAIM YOURS TO-DAY!

The loose binders for preserving in permanently consultable form the Data Sheets which are being given every week in PRACTICAL WIRELESS are NOW READY, and all readers who sent in reservation forms as published in our Dec. 24th issue should claim their binders in accordance with the conditions therein printed, without delay.

The PRACTICAL WIRELESS DATA SHEETS LOOSE LEAF Binder as illustrated here has a stout linen-covered stiff-board cover specially made to stand hard wear, having a special flap with cloth hinges and enamelled press-button fitting for speedy insertion and removal of the Data Sheets which, as will be noticed from the sheet in this week's issue, are specially "holed" to fit. There is an extremely useful manilla gusset pocket on the inside back cover for holding loose sheets, newspaper clippings, notes, and other odds and ends.

If you require one of these binders you should fill in the label below, enclosing a postal order for 1s. 6d., to include cost of registration, postage, packing, insurance, etc., and send to PRACTICAL WIRELESS, Presentation Department, 39, King St., Covent Garden, London, W.C.2. Immediately on receipt of this your binder will be despatched.

FILL IN THIS LABEL AND POST TO-DAY

BOOKS WITH CARE

Name.....

Full Address.....

If undelivered please return to

PRACTICAL WIRELESS Presentation Dept.,
39, King Street, Covent Garden, London, W.C.2

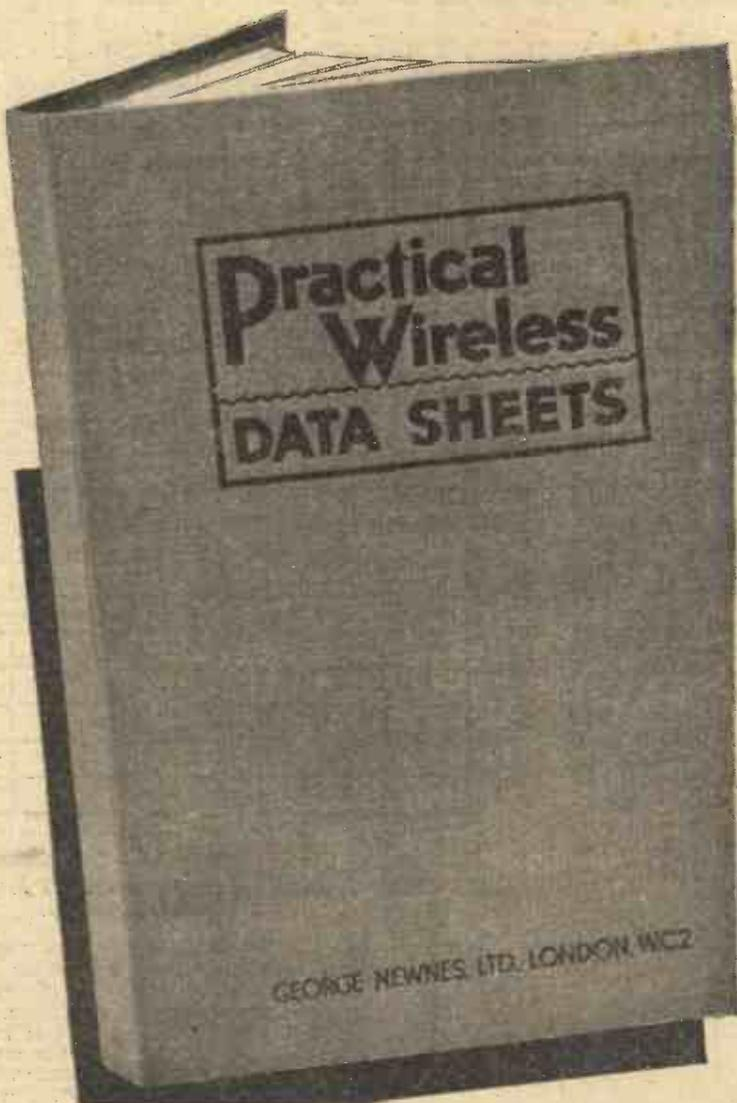

The PRACTICAL WIRELESS Data Sheets Loose-Leaf Binder measures 11" x 8"

**THE FOLLOWING DATA SHEETS
HAVE ALREADY BEEN ISSUED:**

- Data Sheet No. 1—
Accumulator Charging - Dec. 17th, 1932
- Data Sheet No. 2—
Coils & Coil Winding - Dec. 24th, 1932
- Data Sheet No. 3—
Resistances - - - Dec. 31st, 1932
- Data Sheet No. 4—
Mains Transformers - Jan. 7th, 1933
- Data Sheet No. 5—
Wire and Wire Gauge - Jan. 14th, 1933

Fill in this Label, in Block Letters, and send, with postal order for 1/6, to: "PRACTICAL WIRELESS" Presentation Dept., 39, King Street, Covent Garden, London, W.C.2.

Those new readers who are desirous of completing their files of these Data Sheets may have those already issued for 2d. each from the address given above.

Television Broadcasts from New York

TELEVISION in America is being developed considerably and the National Broadcasting Company is building new television studios on the eighty-sixth floor of the Empire State Building in New York at 1,000ft. above the level of the street. A short-wave transmitting aerial is being erected on top of an airship mooring mast on the top of the building at 1,250ft. above the street, from which the television signals will be broadcast. In addition, the General Electric Company, at their laboratories at Schenectady, are experimenting with the transmission of television signals along a light beam. Of course, broadcasting is possible along light beams or cathode rays, and I have related in these columns how this was done from the U.S. airship, "Akron," but it is new to attempt the transmission of television by this means. The images as received will be some 6ins. square and will be seen directly on the end of a cathode ray.

Sponsored Broadcasts from Athlone

THERE is a possibility of our being able to listen to still further sponsored programmes in the near future, when the wireless station being built at Athlone by the Marconi Company is completed. A new company, known as the International Broadcasting Co., has been formed with the object of developing advertising programmes from the new Irish station. It is believed that the new concern is connected with a company of similar title which is responsible for many of the sponsored broadcasts from Continental stations, and it is stated that several British manufacturers are considering making use of the Athlone transmitter for advertising purposes. I hope the material sent out will be of better quality than some of the sponsored stuff we have had lately, and I should like to throw out a suggestion that more use be made of the nights for the broadcasting of these programmes. We get rather a surfeit of British advertising on Sundays, where certain dull nights during the week a few more alternative British programmes to turn to would be welcomed.

At Britain's Large Proportion of Home Constructors

THERE is no doubt that this feature of being able to be ahead of the times, coupled with the fact that many pet ideas may be incorporated in one set, form the main attraction of home construction as we know it. I further believe, too, that the British pride of workmanship is a further contributory cause of the way in which wireless receiving-sets making captured the imagination of the intelligent young and not-so-young men in this country. It is certain that no other country in the world—even America—possesses so many home-built sets in proportion to the population as Britain, and sets, moreover, that for the most part are of a quality seriously to challenge some commercial receivers. Then, again, those of us who started in radio at the commencement of broadcasting are now ten years older—but have we stopped building sets? We certainly have not, and I am beginning to think that once a radio fan, always a radio fan! This means that while a new generation of set-builders have grown up, the old hands are still at it, so that with a concerted publicity campaign of most of the big noises in radio it is difficult to see how radio can do otherwise but progress.

BULGIN SIGNAL LAMPS
In a Class alone.

THERE is no doubt about your switching if you fit a Bulgin Signal Lamp on your set. The warm, red glow adds a real touch of life to your panel, and enhances its appearance.

- | | | |
|-----------------|---|--------------|
| List No. | FLUSH MOUNTING TYPE. | Price |
| D.9 | Slight projection only. Bulb instantly removable from the front. One hole fixing. Highly nickel-plated finish. | 2/6 |
| D.7 | BRACKET TYPE.
For console or Radio-gram receivers. Large Ruby lens. | 1/6 |
| D.11 | TUBULAR DIALITE.
A highly nickel-plated fitting for dial illumination. Takes all standard bulbs. | 3/6 |
| D.17 | PANEL ILLUMINATOR.
With automatic switch and ruby lens. | 3/9 |
| M.E.S.8 | CLIP-ON LAMPHOLDER.
Small bulb holder with spring-on clip
Low consumption bulbs. All ratings. Each 6d. | 3d. |

Send for 80-page Catalogue "N." Enclose 2d. postage.

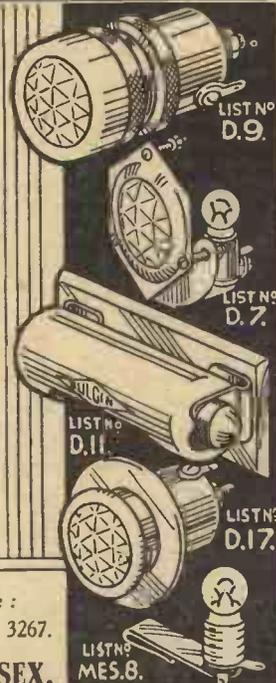

Telephone :
Grangewood 3266.

Telephone :
Grangewood 3267.

A. F. BULGIN & Co., Ltd., ABBEY RD., BARKING, ESSEX.

KEEP THE HOME TIDY... NO 3



The MODERN home has no unsightly wires!

The old-fashioned outside aerial that was always causing trouble, corroding and rusting, losing its efficiency when touching window frame or wall is now superseded in the modern home by a modern aerial.

★The Garden is not desecrated with an ugly pole.

All the expense of erection and its inconvenience is now a thing of the past. In the modern home as soon as the set arrives, 2/- is spent on a PIX Invisible Aerial. This aerial being combined in 30 feet of adhesive tape of very narrow width is just pressed into position above a picture rail, wainscoting, where it cannot be seen. It is as good as an outside aerial of the same height. But costs less, and keeps the home tidy.



PIX INVISIBLE AERIAL.

30 ft. 2/-
Double length, 3/0

BRITISH PIX COMPANY, LTD.
(Dept. 373), 118/28, Southwark Street, S.E.1.

IDEAL FOR USE IN FLATS.

FUSES and FUSE-HOLDERS

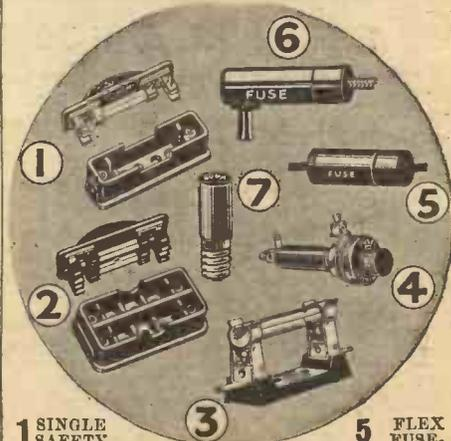

- | | |
|--|---|
| 1 SINGLE SAFETY BASEBOARD FUSE-HOLDER 1/6 | 5 FLEX FUSE-HOLDER 1/- |
| 2 TWIN SAFETY BASEBOARD FUSE-HOLDER 2/6 | 6 WANDERFUSE 1/- |
| 3 SINGLE OPEN FUSE-HOLDER 9d. | 7 "SCRUFUSE" .. 6d. |
| 4 PANEL FUSE-HOLDER 1/6 | Ratings : 60 m/a. 150 m/a.
250 m/a. 500 m/a.
750 m/a. |
- SPARE FUSES. All ratings and sizes, 6d. each.
Each rating a different colour (avoiding possibility of error).

Dealers will fit other ratings in any of these holders at the time of purchase.

BELLING-LEE FOR EVERY RADIO CONNECTION

Advt. of Belling & Lee, Ltd., Cambridge Arterial Road, Enfield, Middlesex.

It is really surprising how few people with A.C. mains charge their accumulators at home, when for a few shillings an excellent charger can be made. The trickle charger described in this article uses a tantalum rectifier, which can be made for about 2s. 6d by anyone with a smattering of electrical knowledge, and

A Trickle Charger for 7s. 6d.

By F. W. CHAMPION

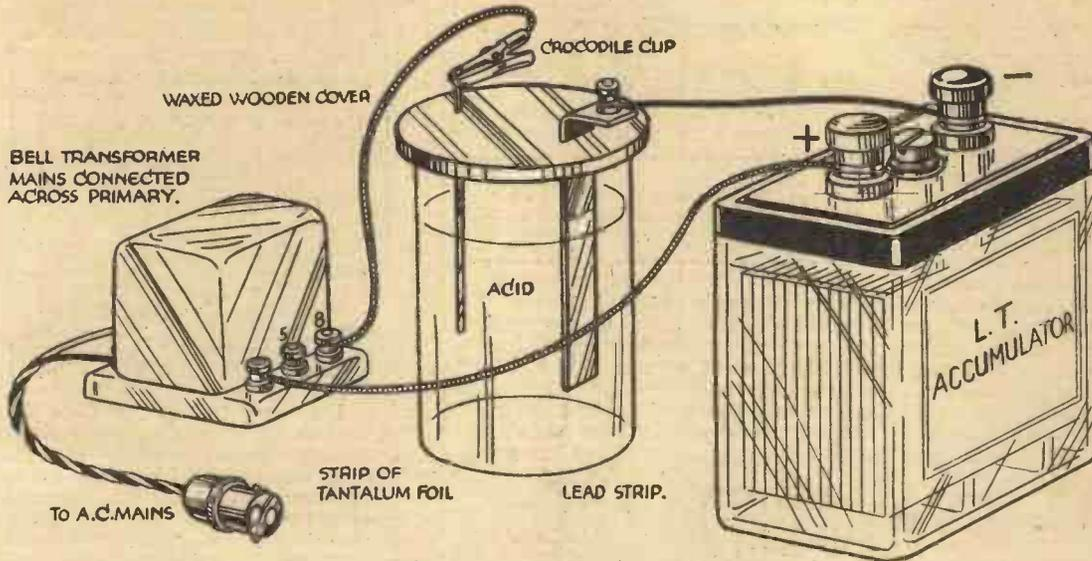

Two refinements may be made, which although not essential, tend to improve the working of the rectifier, and prevent sparking and spluttering. One is to pour a small quantity of heavy oil on top of the acid to form a film about $\frac{1}{16}$ in. deep; the other is to add a small quantity of iron filings or a small nail to the acid before using the charger. The filings will dissolve in the acid and form iron sulphate, which will improve the conductivity of the electrolyte. The rectifier then runs much cooler than it otherwise would.

After connecting up the rectifier and inserting the adapter in

which will operate for many months without attention.

Firstly, as probably the reader knows, the A.C. mains voltage must be stepped down to about 4 volts or so for charging a 2-volt accumulator this is accomplished in this particular charger by an ordinary bell transformer which can be purchased at most electricians for about 4s. to 5s. 6d. These little bell transformers give an output of roughly $\frac{1}{2}$ amp. at 5 volts, and are quite satisfactory for the purpose. The alternating current output from the transformer must then be rectified, which could, of course, be carried out with a metal rectifier, but this method is ruled out on the score of expense. The only really satisfactory alternative is an electrolytic rectifier which may take several forms. A very common type is the aluminium-lead combination, consisting of a strip of aluminium and a strip of lead immersed in a solution of ammonium phosphate; this type of rectifier is not very satisfactory, however, as it needs a good deal of cleaning and attention and also needs "forming" before use.

An Electrolytic Rectifier

However, there is one really satisfactory electrolytic rectifier which can be made easily and cheaply, and will run for long periods without attention. This is the

tantalum rectifier, which consists of a tantalum strip and a lead strip immersed in dilute sulphuric acid.

The writer has had a half-wave tantalum rectifier in use for eight months, during which time the electrolyte has been changed once, while the lead and tantalum electrodes are good for many thousand hours' further use.

Tantalum, of course, is a very inert metal, and should last for ever, providing the electrolyte is pure and not too much current is passed. The actual tantalum rectifier used in the trickle charger, consists of a lead electrode 5 ins. long by $\frac{1}{16}$ in. wide and $\frac{1}{16}$ in. thick; also a tantalum strip 3 ins. long by $\frac{1}{16}$ in. wide and about the thickness of stout paper. These two electrodes are immersed in ordinary accumulator acid contained in a glass jam jar provided with a wooden cover well doped with melted candle wax to make it acid resisting. A slot is cut to accommodate the top of the lead strip, and a hole is drilled for the piece of tantalum foil. Melted sealing wax can be forced well into the cracks to make a firm, acid-tight joint. Connection is made to the electrodes with crocodile clips or by small clamps. The complete trickle charger should be connected up with ordinary red and black flex exactly as shown in the accompanying diagram.

the lighting socket, immerse the two output leads in salt water, when it will be found that the wire from the lead electrode gasses furiously while the other wire remains normal, the wire which gasses is, of course, the negative connection, and must be connected to the negative terminal of the accumulator. The average 2 volt 10 amp. accumulator should be put on charge all night once or twice a week and will be kept in tip-top condition without any visits to the charging station.

As regards running costs, the consumption of current from the mains is about 3 watts, which, of course, is negligible. Finally, tantalum is obtainable from any scientific supply store and is quite inexpensive, as only a very small quantity is needed.

The cost of the complete charger need not exceed 7s. 6d., which amount is made up as follows:—

	s.	d.
Bell transformer	4	6
Tantalum strip	1	0
Acid	6
Strip of lead	2
3yds. flex	6
Bayonet plug	6
2-terminal spades	4
	7	6

"WHAT IS TELEVISION?"

(Continued from page 839.)

tips are of opposite polarity, and there are several methods of joining this section of the apparatus to the wireless receiver tuned in to the television signals. Fig. 3 illustrates one scheme where the output valve, neon lamp and synchronizing coils are all in series, a fixed condenser being connected in parallel with the pair of coils.

Electrical Brake

In action the current passing through the small field coil makes them of opposite

polarity, and if the speed of the disc at the receiving end is identical with that at the transmitting end the resultant magnetic pull on the teeth of the cogged wheel introduced by the synchronizing impulse at a frequency of 375 times per second will balance out in each cycle of changes. If the disc tends to run fast, however, the impulse occurs at a different part of the cycle, and produces a magnetic pull on the cogged wheel teeth tending to drag them back. This retarding impulse acts as a brake and the disc is forced to drop back to its normal isochronous speed.

The method works very well in practice

when set up correctly and fed with sufficient current, but there is always a tendency for a slight vertical "hunting" motion. On the other hand, since there are no wearing parts needing replacement the scheme has found favour, and in a fourth illustration will be seen an amateur making adjustments on his home-made vision apparatus which includes the cogged-wheel synchronizer plainly visible in the centre of the picture. In the last instalment of this series I shall deal with all the important points arising from the actual procedure of watching a television image received by wireless.

Receivers and their Records

We shall be pleased to advise readers regarding purchase of complete sets.

WITH the progress made on the transmitting side of broadcasting, coupled with the vast improvement in the quality of signals, and the daily increasing number of wireless entertainments available from both near and distant foreign countries, the listener to-day demands radio receivers which are in keeping with the present conditions. He is no longer satisfied to hear mere musical sounds backed by the information that they emanate from some hundreds of miles from his station. To-day he requires from manufacturers receivers which will permit him to "reach out" for foreign transmissions with the certainty that he will hear programmes at such quality that they may be considered of entertainment value. Moreover, with the continued increase in the number of transmitters squeezed into the wavebands allotted to the broadcasting services, both on this side of the Channel and in Europe generally, tuning the average set has become more difficult, and the separation of stations from others operating on near-by channels has compelled makers to design receivers which will answer more exacting requirements. Fortunately, the solution of the problem has been facilitated by the revival of the superheterodyne circuit, and of those at present launched on the market the *R.I. Six-valve A.C. mains* table model under review is a successful example.

The receiver has been housed in a walnut cabinet of a striking design; it is a handsome piece of furniture which, without doubt, will meet with the approval of the female members of the household. The lower part of the front, below the loudspeaker fret, has only three knobs—namely, the tuner, that operating the combined wave-change, gramophone and "on" and "off" switch, and the volume control.

Tuning is remarkably easy as there is only one knob to operate. The volume control has a smooth action, but must be used with judgment. Excessive amplification of loud signals causing valve overload will result in poor quality of production, and somewhat less strength is obtained in this case than if the volume control is carefully handled. Moreover, excessive amplification produces the effect of double hump tuning—i.e., the signal will be received at two positions of the dial at maximum strength with a relatively weak region between the two readings. The range of wavelengths covered is from 210-560 metres and from 850-2,000 metres. It is a particularly liberal allowance which permits the reception of a number of stations below, say, Radio-Normandie, and yet will readily tune in broadcasts from Budapest.

R.I. SIX-VALVE SUPER-HETERODYNE (A.C. MAINS)

A novel feature adopted in the *R.I. Superhet.* consists of a shutter which, operated by the wave-change switch, automatically reveals the "short" and "long" wave scale of the illuminated dial, whichever happens to be in use. This well-thought-out contrivance will be found of great practical assistance when tuning in stations as, by



The R.I. six-valve Super-Heterodyne Receiver, A.C. mains model.

limiting the area of degrees seen, it is possible to secure greater exactitude in the condenser readings. The illuminated scale itself is calibrated in wavelengths. The shutter also serves a multiple purpose, as not only does it show the actual wave range which is being tuned, but it also indicates when the receiver is used for gramophone reproduction; a special label appears when the set has been switched off. The simplicity of its working would enable a mere child to operate this superhet., which, in reality, for the local stations, merely needs plugging into a power or light socket in any room where electric mains current is available.

The circuit has been well designed to cope with to-day's conditions as well as, so far as can be anticipated, with those of the near future; it complies well with the requirements of listeners who demand good quality reproduction with the highest degree of selectivity. To ensure this latter

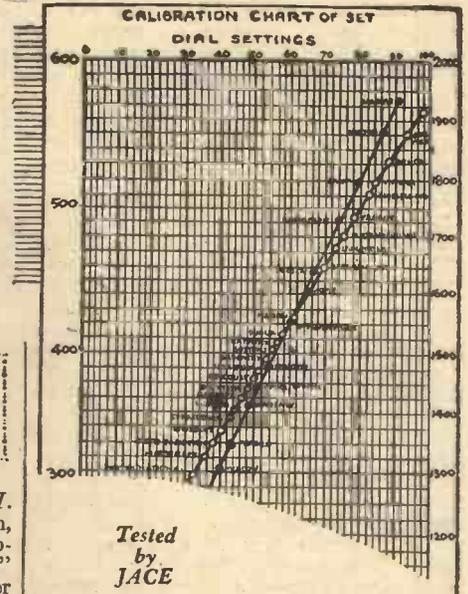

Tested
by
JACE

quality band-pass tuning has been incorporated in both the pre-selector stage and the intermediate coupling circuits, and, what is an important point, in connection with the separate oscillator and pre-selector band-pass circuits triple-ganged condensers have been adopted. For the second detector stage power-grid detection is employed, this being transformer coupled to the pentode output valve.

Six valves, including the rectifier, have been found necessary to attain the required results, four of which are effective amplifying stages. These have been carefully selected for their individual qualities; they consist of a full wave rectifier (UU120/350), AC/HL, AC/2HL, AC/SGVM, all metallized, and an AC/Pen., for the output stage; in fact the most modern Mazda products. The layout is very neat; it has been symmetrically planned; the metal chassis is of robust construction, and ample room has been allotted to the components. The receiver is adjustable to work on an A.C. mains supply for voltages varying between 200-250 volts and from 40/100 cycles. The mains and smoothing equipment are of good design, and in every way conform to the regulations of the I.E.E. The set is very silent in operation and practically no mains hum was perceptible. For the reception of distant

broadcasts it is essential that a good outside aerial should be used, but it need not exceed forty to fifty feet; in addition, both leads connecting the set to aerial and earth should be kept as short as possible, and should be well separated and effectively insulated. Where an outdoor aerial is inconvenient, the capacity aerial in the receiver itself may be plugged into the aerial socket for reception of broadcasts from moderate distances and from local transmitters. Within fifteen miles from Brookmans Park perfect reception of both London Regional and National programmes was secured without either aerial or earth; with a capacity aerial the volume control had to be brought back almost to zero point.

The receiver is equipped with an electrically-excited moving-coil speaker which provides good quality of production; it is fitted to an internal baffleboard specially

supported in order to obviate any risk of cabinet vibration. Bass is well reproduced and speech is crisp and clear providing the volume is not pushed to extremes. The tone quality, however, may also be regulated by the knob at the rear of the cabinet; according to its adjustment bass or treble may be increased as desired, and it can be suited to the actual broadcast tuned in. The control is also useful for suppressing "atmospherics," and in many instances heterodyne whistles, etc., which frequently mar a transmission. The *R.I. Superhet.* possesses the advantage, when used for the electrical reproduction of gramophone records, of *not requiring* any extra external potentiometer volume control. The leads from the pick-up are merely plugged into their respective sockets at the back of the set, the switch is turned to the position showing the word "Gram," and both volume of sound and tone of reproduction can be regulated in the same way as when the receiver is set for the reception of broadcast transmissions. Moreover, when reverting to radio, the pick-up leads may remain connected. The reproduction of gramophone records was found to be very satisfactory, the volume of sound being ample for a large-sized room.

As regards sensitivity and selectivity the set put up an excellent performance. The slightest movement of the condenser tuned in transmissions, and a large log was rapidly compiled. Clear reception was secured of many stations at the lower end of the medium waveband; these included loud-speaker signals from Warsaw (No. 2), Aberdeen, Königsberg, Radio-Normandie (Fécamp), Kiel, Lodz, and Nürnberg, in varying strength in apparent relation to the

power of the transmitters. Such broadcasts as those from Stavanger and Belfast could be distinctly heard, although not at a useful volume, but for the purpose of identification and calibration they were clearly readable.

On the evening on which the test was made the B.B.C. carried out relays of European transmissions, and for the sake

TWO FREE GIFTS NEXT WEEK!

(1) The Wireless Constructor's Handy Gauge

(See Page 831)

(2) Data Sheet No. 7
Condensers and Condenser Values

ORDER NEXT WEEK'S COPY NOW!

of experiment the self-same broadcasts were directly tuned in. Greatly to the credit of the Superhet., the programmes, through this medium, were better heard. In some instances, as in the case of Warsaw, Vienna, Hilversum, Milan, louder signals were obtained, and, if anything, a purer quality. No difficulty was experienced in the course of the evening in separating Breslau from

Poste-Parisien, and providing the volume control was turned back it was possible to hear Frankfurt-am-Main and Radio Alger (Algiers) clear of the London National and Regional broadcasts. In the same way Bratislava and Heilsberg were fairly well separated, and a programme from Söttens was logged with but occasional "side splash" from Midland Regional. In the later hours such stations as Barcelona (EAJ1), Madrid (EAJ7), Katowice, and Wilno were easily identified; in fact, most stations with a power of 3 kW. or more provided good signals. On the longer waveband the receiver was equally efficient, and starting at Leningrad, which in its new position could just be caught at the bottom of the scale, four Russian stations were heard working, in addition to Oslo, Kalundborg, Motala, Warsaw, Eiffel Tower, Daventry, Radio-Paris, and Huizen. Königs-wusterhausen, although clear of its neighbours, did not appear to work at its usual power.

To wander from station to station with this receiver afforded considerable pleasure. As the condenser knob was twirled it was found that the programmes, with but few exceptions, could be received with the minimum degree of interference. Tuning, as already stated, was remarkably easy, and even in the hands of a novice the *R.I. Superhet* will furnish a large number of broadcasts at ample volume for even a large-sized living-room.

The receiver is made by Radio Instruments, Ltd., Purley Way, Croydon; its price is 25 guineas. A receiver of this calibre, which combines razor-edge selectivity with good reproduction, should satisfy the requirements of every purchaser.



QUALITY Produces EFFICIENCY

TESTED BEFORE DESPATCH

The original BECOL ebonite low loss formers are thoroughly reliable. They are used in all parts of the world. Look for the BECOL trade mark. Ask your dealer. If unable to supply, write direct. Send now, enclosing 6d. (post free) for up-to-date handbook of tuning coils for DUAL RANGE, BANDPASS, and SUPER-HET. circuits. Fully illustrated with data. A very interesting handbook.

RODS. SHEET. TUBES. PANELS
The BRITISH EBONITE Co., Ltd.,
Hanwell, London, W.7

LEARN MORE ABOUT YOUR WIRELESS

Whether you are beginner or expert, study of this comprehensive and up-to-date work will result in both pleasure and profit. Its author is acknowledged to be one of the most brilliant exponents of Modern Radio both in theory and practice, and this "Outline" is filled with knowledge. It should be on every enthusiast's bookshelf.

THE OUTLINE OF WIRELESS

By RALPH STRANGER

8/6

Obtainable at all Booksellers, or post free 9/- from George Newnes, Ltd., 8-11, Southampton Street, Strand, London, W.C.2.

WATES DISTANCE SWITCH

"can be thoroughly recommended"
SAYS H. J. BARTON CHAPPLE

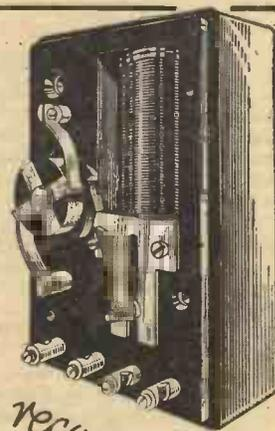

Costs only 9/6. Send P.C. for details of this new trouble free instrument that gives radio all over the house, fully controlled at every point. Thousands already sold.

STOCKTAKING
RECEIVER BARGAINS
A small collection of Wates receivers, battery and all mains, to clear at less than half prices. CALL AND SEE THEM

SET
SWITCHED ON
OR OFF FROM
ANY ROOM

WATES RADIO LTD.,
184-188, SHAFTESBURY AVENUE, LONDON, W.C.2

Tune in
on
this



NEW WIRELESS INSTRUCTION

The I.C.S. Wireless Courses cover every phase of wireless work, from the requirements of the youth who wishes to make wireless engineering his career to the man who wants to construct a broadcasting set for his home, and, at the same time, to know how and why it operates and how to locate any faults that may develop.

No branch of industry has ever progressed as rapidly as wireless and the rate of progress is increasing. Only by knowing thoroughly the basic principles can pace be kept with it. Our Instruction includes American broadcasting as well as British wireless practice. It is a modern education, covering every department of the industry.

OUR COURSES

Included in the I.C.S. range are Courses dealing with the Installing of radio sets and, in particular, with their **Serviceing**, which to-day intimately concerns every wireless dealer and his employees. The Operating Course is vital to mastery of operating and transmitting.

There is also a Course for the wireless salesman. This, in addition to inculcating the art of salesmanship, provides that knowledge which enables the salesman to hold his own with the most technical of his clients.

We will be pleased to send you details of any or all of these subjects. Just fill in and post the coupon, or write in any other way, stating which branch of Wireless interests you—the information you require will be forwarded at once.

—YOU MAY USE THIS COUPON—

International Correspondence Schools, Ltd.,
Dept. 94, International Buildings,
Kingsway, London, W.C.2.

Without cost, or obligation, please send me full information about the Courses I have marked x

- THE I.C.S. WIRELESS COURSES
- THE I.C.S. RADIO COURSES

Name Age

Address

An Excellent Moving-coil
Speaker,
The
W.B., at
39/6.

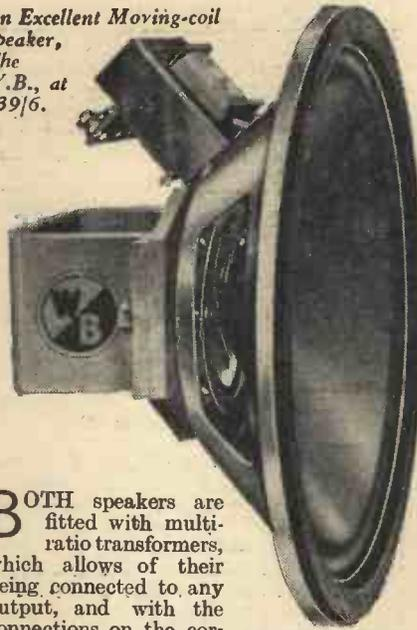

BOTH speakers are fitted with multi-ratio transformers, which allows of their being connected to any output, and with the connections on the correct terminals I next tried them on a three-valver with pentode output. I must confess the bass response of both did not come up to that obtained when connected to the large all-mains set with super-power output, but manipulation of the tone control remedied this without noticeable loss of volume. This loss of volume is one of the outstanding features of low-frequency tone control and serves to illustrate to us how much "noise" we obtain from the upper registers. I used a "Lissen" tone-control potentiometer and attachment for connecting to the L.F. transformer which retails at 12s. 6d. complete. All terminals are plainly marked and the device can be quickly tried out without extensive alteration to the existing wiring of the set.

Output Transformer

A word may be said about the output transformer usually fitted to modern moving-coil speakers. Instructions are given with the speaker regarding the connecting up of the transformer tappings of which there are generally four or more. The lowest ratio tapping is intended for super-power valves of low impedance, and the tappings increase in ratio to approximately cover the range of valve impedances up to that of the pentode, this being the last tapping provided. Do not, however, be guided by the instructions too rigorously. Try the tappings on either side of the one suggested by the makers if you are using a power output valve and determine for yourself which gives the best results. With a pentode valve you are practically limited to the one tapping provided, although you may ring the changes still further if your set is already fitted with an output transformer. Again, if your set has a choke output-filter incorporated the moving-coil speaker may be attached to the output terminals without difficulty, and in this case the best results would often be obtained from a different tapping to that advised by the instructions. A choke output considerably improves the quality by checking any tendency to motor-boating that your receiver may possess and the absence of high-tension current in the output-transformer windings is an added protection both to the speaker and to the transformer. A warning must be given with regard to the alteration of the connections to the tappings of the transformer.

Are You Getting MOVING-COIL QUALITY?—2

(Concluded from page 813, Jan. 14th issue.)

Never alter these connections while the set is switched on, as the danger of peak voltages is acute with sudden changes in load. This is particularly the case with pentode valves as the current surge on open circuit is often of sufficient magnitude to seriously damage the emission of the valve or the fixed condensers in the set or eliminator.

Interaction Troubles

The speaker should not be placed too close to the set if interaction difficulties are met with, as with a badly microphonic detector or output valve "singing round the ring" troubles are sometimes set up. In the case of sets of the console type where the moving coil is incorporated in the same cabinet, encasing the offending valve with Sorbo rubber or similar material will often effect a cure. I have seen Plasticine and even chewing-gum used to advantage in stopping microphonic noises! As some moving coils are rather susceptible to mains hum, it is as well to keep the speaker leads as far away from the power-supply leads as possible, and in extreme cases the use of metal-sheathed cable is indicated.

Before perfect quality can be expected from your moving coil it is essential that the output from your set should be as perfect as you can get it, because, as I have already stated, the remarkable sensitivity of the moving-coil speaker gives prominence to your output deficiencies. I propose dealing with some of the causes of poor quality directly due to troubles in the set itself; cures are suggested, and should be applied before criticism of the speaker's reproduction is made. It is an excellent plan to insert a milliammeter in the H.T. negative lead in order that the correct value of grid bias be applied to the output valves or valve. The grid bias should be adjusted until the "kicking" of the needle is brought down to a minimum, and I must again add the warning that no adjustments of the grid bias be carried out until the set is completely switched off.

Distortion and poor quality troubles can be grouped into two main categories as a rule, those that are directly caused through inherent defects in the circuit or design of the set, and those that are caused through defects in the components used or in the valves or current supply. If you carefully follow the designs for sets published in PRACTICAL WIRELESS, you should not be troubled with any of the first, but you will realise the importance of using the components and valves specified and of strictly adhering to the lay-out suggested. Components and wiring badly spaced are a frequent source of poor quality difficulties, and the cure is too obvious to need further comment.

HAVE YOU CLAIMED YOUR
WIRELESS CONSTRUCTOR'S
ENCYCLOPAEDIA? SEE PAGE 837

The Decoupling of the H.F. Circuit

THE advantages of decoupling from the point of view of stabilizing the set, and preventing reactions on the aerial circuit have already been discussed. It was not specifically pointed out that it is the aerial and aerial-circuit that have to be protected from reaction or feed back of any kind, but this follows from the general principle that self oscillation or squealing is most commonly caused by the reaction of a more advanced stage on an earlier stage. Obviously when there are two or more stages of H.F., it may be a question of any later stage reacting on an earlier stage or on the aerial.

But there is an entirely different reason why the H.F. stage or any H.F. stage should be effectively decoupled. The modern S.G. valve, and especially the variable- μ type has a graph or characteristic that may be described as all made up of anode bend, there is little or no straight. Now the amplitude due to the incoming signal after amplification in the aerial tuned circuit (whatever it may be) is still of very small amplitude, of the order of .05 volt (vector), and this being so, the curvature of the characteristic does not give rise to distortion. But when an audio-frequency surge from the H.T. battery is admitted, as is inevitable if the precaution of decoupling is omitted, the H.F. oscillation finds itself riding on a wave of low frequency sometimes high up on the valve characteristic, and sometimes low; this is indicated in the accompanying diagram. Now, although the low frequency wave cannot itself come through



to the detector, owing to the constants of the circuit being only adapted to pass H.F., this does not end the matter, for the amplification of the H.F. depends upon the position in which it finds itself on the valve characteristic and so, as it varies its position, due to the superposed low-frequency wave its amplification varies in like manner. This constitutes, in fact, a modulation of the signal, and when this is received by the detector, the low-frequency wave is reconstructed just as though the impossible had happened and it had come through direct (see diagram).

It would, therefore, seem that it is just as necessary to avoid low-frequency (acoustic frequency) feeding back to the H.F. anode circuit, as it is to prevent a feed back from the power stage to a previous L.F. stage, and the consequence of neglect may give rise to similar

forms of instability such as "motor boating." How far this is to be feared in practice it is difficult to say, the whole subject of "motor boating" is of such complexity, that the greatest authorities on Radio seem to give it the widest possible berth. Morecroft in his large tome "Principles of Radio Communication," does not throw any more light on the subject than would be expected from the veriest tyro amongst amateur constructors of receiving sets. In Turner's "Wireless" there appears to be nothing either. The only thing that the author of the present note can from his own experiences assert, is that if each stage is fed by separate and independent batteries and if the lay-out is in the form of a "line" aerial one end of

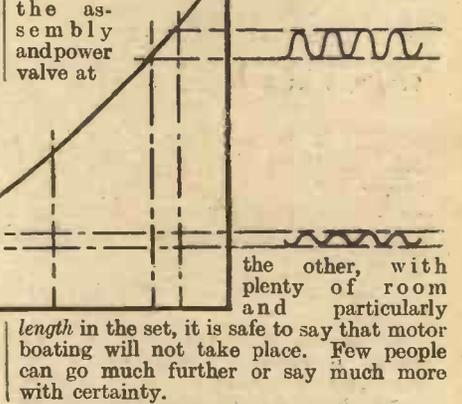

THE "impedance" of a valve, however, is varied principally by the voltage applied to the grid. While, therefore, it is not subject to the same laws as a pure resistance it is not a true impedance. "Anode resistance" is probably the most suitable term coined so far. Some radio engineers use the term "differential resistance" which sounds very learned, but is not very clear as to its actual meaning.

Valves are often compared on the basis of their "mutual conductances," the mutual conductance being the change in anode current occasioned by a one-volt change in grid voltage, and expressed in "milliamps per volt." Now the conductance of a circuit is the reciprocal of its resistance, and a little juggling with Ohm's Law will reveal that the reciprocal of the resistance is equal to the current divided by the voltage. The unit of conductance is the "mho" and the conductance in mhos is equal to the current in amperes divided by the pressure in volts. The mutual conductance of a valve, in milliamps per volt, therefore, is, if anything, a number of milli-mhos. But in a true conductance, the factors of current and voltage are the current and voltage in one and the same circuit, whereas the factors in the valve's mutual conductance are the current in the anode circuit and the voltage in the grid circuit. It is on account of this that the word "mutual" was introduced, but the term is rather unconvincing, and does not convey much to the non-technical mind. "Factor of goodness" is a far more descriptive phrase.

The mutual conductance is sometimes referred to as the "slope" of a valve. As most valves are fixed dead upright in the receiver, this term requires a little explanation. It is not the slope of the valve which is meant, but the slope of the grid volts anode current characteristic

MORE RADIO MISNOMERS

By "CYNIC"

curve; and this is, in fact, a measure of the mutual conductance.

"Reaction." Many receivers employ "reaction" in the detector stage—a very vague and misleading term. In this device, part of the energy in the anode circuit of the valve is passed back to the grid circuit and is re-amplified by the valve. "Re-amplification" is a far better term than "reaction."

Some of the alleged misnomers we have just discussed might become the subject of a highly technical discussion for which these pages are not the right place, so let us examine a few of the simpler radio terms. The "high tension" and "low tension" supplies will do to begin with. "High" and "low," for example, are only relative terms. The 150 volts "high" tension of the average receiver is distinctly "low" compared with the 132,000 volts of the "grid" electric power scheme. So why not call the "high tension" the "anode supply" and the "low tension" the "heater current"? Again, "low" frequency is high compared with commercial electric supply periodicities, and "high" frequency is low compared with, say, light or X-rays. Please let them be "audio-frequency" and "radio-frequency" in future. The last stage valve of a receiver is not a "power amplifier." It is, in actual fact, a "power release valve," but "output valve" is a well-known and very satisfactory term. This valve operates a "loud-speaker," I feel a little

sorry for the poor instrument which is only credited with the power of speech when it can also sing, and play the saxophone and a half a hundred different instruments! I do think we might promote him to the title of "sound reproducer" from now on.

"Battery." When I meet the term "battery" it rather annoys me. The dictionary states that "battery" is the act of beating, or a collective name for a number of cannon (things that can "batter"). Of course, the electric "battery" is the collective name for a number of electric cells—but surely a more apt collective noun could be found. An accumulator, again, does not accumulate in the correct sense of the word. It merely stores energy. It never possesses more energy than has been put into it, so that "charging" an "accumulator" is somewhat like putting money into a box and taking it out as required. It is certainly not analogous to investing it or placing it on deposit at interest so that a profit *accumulates*. There are dozens of other radio terms I would like to pick to pieces, but my space is nearly exhausted. I must, however, have one final thrust—this time at the "set-makers" and the "sets" they make. "Sets" of what, if you please? The term has been in common use since the inception of broadcasting and I cannot make out how it originated. It cannot mean a set of parts—for the first "sets" were complete instruments. If any reader can enlighten me on this point I shall be most interested—and meanwhile I shall continue to refer to my box of tricks as my "receiver" on every possible occasion.

Self Binders for Data Sheets are now ready. (See Page 850.)



Practical Letters

from

Readers.

The Editor does not necessarily agree with opinions expressed by his correspondents

Topping Accumulators

SIR,—Your efforts to substitute practical instruction in the art of wireless for the “mumbo-jumbo” one is accustomed to come across from time to time are deserving of commendation. The tendency to foist a species of technical mysticism on the wireless public generally is not only useless but at times positively harmful. Simple apparatus is vested with an undeserved reputation of being difficult to maintain or instal, and your efforts in counteracting this attitude are all to the good. In connection with this I would take to task Mr. W. Burchell (Westcliff) for his letter on “Topping Accumulators.” The elaboration of the really simple job of topping-up is not only unnecessary but disadvantageous, in that it suggests that an accumulator is a difficult and indeed a dangerous thing to maintain. It is true that water should not be added to sulphuric acid, but this, like many other statements, requires qualification—water should not be added to concentrated acid or great heat may be generated. There is, of course, no harm in adding water to electrolyte which already contains a preponderance of water, but to demonstrate this point I have taken some actual tests. A number of Exide accumulators in various states of charge and discharge were topped up with an amount of distilled water equal to 10 per cent. of the total quantity of electrolyte, both the electrolyte and the topping-up water being at ambient temperature. The experiment was repeated and the amount of topping-up water increased to 20 per cent. The results of these tests are given below and the figures speak for themselves:—

Sp. Gr. of Acid. Before Topping- up.	Temperature Rise. 10% dilution.	20% dilution.
1.140	0.25°C.	0.4°C.
1.200	0.5°C.	0.8°C.
1.250	0.95°C.	1.5°C.

In conclusion may I assure your readers that any good battery is not likely to become at all “hot under the collar” if topped-up in the ordinary way, but is, in fact, eager to reciprocate in good service the ordinary simple care and attention which I have no doubt you will advise in your admirable publication.—STANLEY BROWN (Manchester).

Short-wave Coil Unit

SIR,—I enclose a photograph of a short-wave coil unit which I have made with the valuable help of the article on page 326 of

PRACTICAL WIRELESS, November 5th, 1932. The unit consists of aerial, grid, and reaction coils, mounted in the simple manner shown in the illustration. The coil will eventually be mounted in the upright position on the baseboard of a 2-valve Super-Heterodyne short-wave adapter to cover a wavelength 18 to about 50 metres with 0.00025 variable condensers. Connections to the unit will be

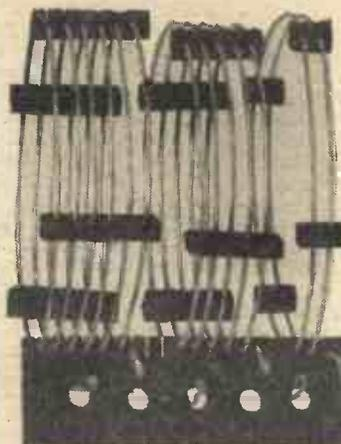

The finished short-wave coil unit by F. W. Westley.

made by soldering direct on to the ends of the coils. This unit having only cost about threepence to make, owing to the

extremely economical method of mounting, I thought it may interest some other readers.—F. W. WESTLEY (Leyton.)

Auto-Grid Bias.

SIR,—Following your article in a recent issue of PRACTICAL WIRELESS on Automatic Grid Bias, I note that you have omitted that which may be a very important illustration, namely, the application of Auto-G.B. on the detector valve when used as the first amplifier on a gram pick-up.

You will observe by the accompanying diagram that no G.B. is applied to the valve when used as a detector on radio.

I find that decoupling resistance is best left out altogether.—P. EDGELL (Hanwell).

CUT THIS OUT EACH WEEK

DO YOU KNOW?

—THAT IMITATION IS THE SINCEREST FORM OF FLATTERY.

—THAT the lowest station transmitting broadcast programmes is Buenos Aires on a wavelength of 14 metres.

—THAT amber is not the only material which becomes electrified by friction.

—THAT there is a formula which enables one to find the peak separation of band-pass filters.

—THAT the wiring of the electric bell system often provides a better aerial than the electric light mains.

—THAT the detector stage is the most important in a mains set from the point of view of H.T. smoothing.

—THAT the voltage of an accumulator should be read whilst the valves are switched on if a true reading is desired.

—THAT a valve volt-meter is the most efficient type of measuring instrument.

—THAT a stroboscope is the most efficient instrument for finding the speed of the gramophone turntable.

NOTICE.

The Editor will be pleased to consider articles of a practical nature suitable for publication in PRACTICAL WIRELESS. Such articles should be written on one side of the paper only, and should contain the name and address of the sender. Whilst the Editor does not hold himself responsible for manuscripts, every effort will be made to return them if a stamped and addressed envelope is enclosed. All correspondence intended for the Editor should be addressed: The Editor, PRACTICAL WIRELESS, Geo. Neunes, Ltd., 8-11, Southampton Street, Strand, W.C.2.

Owing to the rapid progress in the design of wireless apparatus and to our efforts to keep our readers in touch with the latest developments, we give no warranty that apparatus described in our columns is not the subject of letters patent.

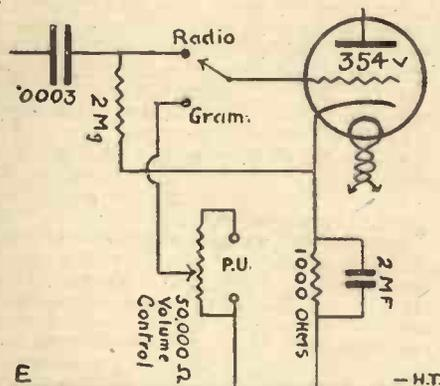

Diagram illustrating Mr. P. Edgell's letter.

A Scottish Reader's Satisfaction

SIR,—F. M. B.'s request for a Det 2LF set interested me. About six years ago I purchased an American “Fada” 3-valve Neutrodyne. Despite its origin it gave first-class service up to last autumn. After definitely refusing to perform further, I decided it was time I knew more about its working parts than that of the switch. I then made my first purchase of a wireless journal and it turned out to be PRACTICAL WIRELESS, No. 3. Issue after issue I searched in vain for someone seeking knowledge about a similar set. Being Scotch, and thus timorous by nature, I didn't like to consult your wireless doctor, for I felt that something like 4,999,999 wireless fans would, on seeing my letter, say, “Here goes Aberdeen.” To-night I feel considerably bucked up, for evidently it is not only hard-hit Scottish glen farmers

who still have to be putting up with ancient circuits. F. M. B., who dwells in London, and should know, says thousands of pioneers in "listening-in" love and retain their first loves. From knowledge gained by reading your paper I tested my set and discovered two dud transformers. These I replaced with two Hypermu R1 LF. Nothing but the best for an old and faithful servant. Through further praise in your journal of up-to-date valves I decided that the three Yankees were a bit hefty on current consumption. I next purchased three English type valve holders, split the 3 volt accumulator in three, found one section dud, and purchased a 2 volts P.M. 2 DX for detector, a PMHL for 1st stage and a PM 202 for 2nd and output stage. After reading the instructions enclosed in the valve containers I found my PM 202 would develop inward troubles if not worked in conjunction with a grid-bias battery. My next purchase was a 17 volt grid bias and a bit of flex. I disconnected the GB 1st stage from the HT—added a bit of flex and plugged it into the negative 1.5 tapping. The GB 2nd stage from the earth required another bit of flex which was plugged into — 10. Into the positive tapping I plugged a bit of flex and connected it to LT—. Results are entrancing with an uncased old Brown V hanging from a peg in the ceiling. All the big fellows in Europe and Asia Minor walk in with a slight touch of the dials. No crowding, and volume enough to make the ham which hangs on the other peg above the old hearth dance.—WILLIAM WALLACE (Aberdeen.)

Much Better Even Than Expected

SIR,—I was very pleased to receive my "Wireless Encyclopædia," and write to thank you very much for it. I was surprised to see the size of it and large number of pages. It was much better even than I expected, and full of useful information. The first subject covered, i.e., accumulator charging, will be of great assistance to me as I am hoping to get into the wireless business soon. Thanking you again for the splendid encyclopædia.—R. BRAND (Loughton.)

Another Appreciation

SIR,—I feel I must thank you for the safe reception of the Wireless Encyclopædia and should like to add my appreciation, both of it and also PRACTICAL WIRELESS, the former being as practical as our weekly. Again thanking you.—W. G. BALMAN (Peckham.)

"A Capital Book"

SIR,—Wireless Encyclopædia to hand. It is a capital book, and will be very useful.—E. RUSHWORTH (Alsager.)

"A Wonderful Book"

SIR,—I have received my copy of "The Wireless Constructor's Encyclopædia" and think it is a wonderful book. I shall always have it in front of me when dealing with anything connected with wireless. I shall always be a reader of PRACTICAL WIRELESS. Thanking you.—S. WRIGHTON (Swanley Junction.)

An Appreciation

SIR,—Having taken PRACTICAL WIRELESS since No. 1, I must express my sincere appreciation. Every individual is separately catered for and considered, and I am very much interested in your way of encouraging readers to submit Radio wrinkles. Wishing your valuable paper every success.—L. GABBITAS (Shoreditch.)

RADIO CLUBS & SOCIETIES

UNITED RADIO SOCIETIES

The United Radio Societies aim to promote peace by encouraging interchange of correspondence, etc., between members of societies comprising the Union.

The Union is not joining by individuals but by societies, each society joining will be supplied with the names and addresses of members of the other societies of the union and, in exchange, will supply them with names and addresses of their own members. By this means the aims of peace are far more readily and rapidly promoted than if societies carry on international correspondences between themselves. In other words, "United we stand, divided we fall." Besides the great help this will do towards promoting goodwill and fellowship between nations, individual societies of the Union cannot fail to enrol new members through the scheme, for members of the different societies will discuss their own societies with each other, resulting in many enrolments.

The Union charges nothing for admission, and any society interested, or even local clubs, are invited to write to the organiser, Leslie W. Orton, "Kings-thorpe," Willowbank, Uxbridge, England, for details. Please enclose a stamped addressed envelope.

BRISTOL AND DISTRICT RADIO AND TELEVISION SOCIETY

The British representative for the Ostar Ganz high-voltage valves in Great Britain, Mr. Eugen Forbat, together with Mr. K. E. Alford, B.Sc., are making the first official announcements regarding these revolutionary valves in the form of a lecture in the Bristol and District Radio and Television Society (President, F. W. Rixon) at the Bristol University Geographical Lecture Theatre at 7.30 p.m. on January 20th, 1933. As this lecture is sure to be of special interest to all interested in modern radio valve design, a cordial invitation is extended to all who can make it convenient to attend.

SLADE RADIO

There was a lantern lecture on Rotary Converters, etc., by Mr. R. H. Woodall, of Messrs. Rotax Ltd., at the meeting of the above Society held last week. In this he explained the developments which have taken place and also described the various types now available.

Among those dealt with was a hand type which can be used in the case of emergency, and which would be particularly useful in some of the isolated parts of the world and could be used to summon help, etc. A demonstration was given using an Eddystone ALL WAVE FOUR, H.T. and L.T. being supplied by a G-150V. converter.

The results were good, and it was noticed that the machine was entirely silent in operation.

It was stated that using this machine it is possible to get down to 8-10 metres without interference.

Full details of the Society may be obtained on application to the Hon. Sec., 110, Hillaries Road, Gravelly Hill, Birmingham.

INTERNATIONAL SHORT WAVE CLUB

I should like to bring the London Section of this organisation to the notice of readers of PRACTICAL WIRELESS.

We are holding regular meetings at the R.A.C.S. Hall, Wandsworth Road, S.W.

The object of these meetings is to help the short-wave listener get better reception. We arrange demonstrations and lectures which are very much appreciated. Also listeners can meet and exchange their ideas and reports.

I should be pleased to give future dates of meetings, also full particulars of the I.S.W.C., together with specimen magazine if your readers will enclose 1/6 stamp. A. E. BEAR, 10, St. Mary's Place, Rotherhithe, London, S.E.16.

NEXT WEEK'S GREAT FREE GIFT!

Turn to page 831 for details of our **WIRELESS CONSTRUCTOR'S GAUGE (Made in Steel)**, to be Given Free with Every Copy of Next Week's Issue!
Order Next Week's Copy Now! Same Price!

CLIX FOR PERFECT CONTACT

"Fit-all" SPADE TERMINAL 2d.

"MASTER" PLUG 1 1/2d.

PANEL TERMINAL 2 1/2d.

To ensure Perfect Contact, use CLIX for THE "SELECTONE"

"Amateur Wireless" says of the "Master" Plug: "A clever piece of work... We must say that this is one of the nicest plugs we have handled..." All CLIX components are designed to do the job easier and with greater efficiency. Write for Folder "N."

LECTRO LINX LTD., 79a ROCHESTER ROW, S.W.1

10,000 GRAMO-MOTORS FROM STOCK

BIG CASH DISCOUNT ALLOWED! Make a Gramophone or Radiogram. Order loose kits or sets and assemble them at home. Get for 3d. our new 64-page Catalogue with scale drawings and instructions how to make them. We sell motors from 7/6, tone-arms, sound boxes, 1/8, pick-ups, big volume horns, loudspeakers, radio kits, complete receiving sets, gramophones, radiograms. Repairs done. Established 1903. **THE REGENT FITTINGS Co., D.285, 120, Old Street, London, E.C.1.**



SERADEX MOULDED RESISTORS



1 1/2 watt rating. Fitted wire ends. Made in usual values from 100 ohms to 2 Megs. Price each 8d.; Per dozen 7/6. Lists for stamp.

48, WAKE GREEN ROAD, BIRMINGHAM.

LOUD SPEAKERS REPAIRED. 4/-

(Blue Spot a Speciality, 5/-) Transformers 4/-, all repairs magnetised free. Eliminator Repairs quoted for. 24 Hours Service. Discount for Trade. Clerkenwell 9069. **E. O. MASON. 44, EAST ROAD, LONDON, N.1.**

LOUD SPEAKER REPAIRS

Any make Unit, Transformers, etc., from 3/-; Blue Spots, 5/-; Moving Coils, Eliminators, etc., from 5/-. Repairs guaranteed laboratory tested and returned C.O.D. post. Special trade terms or by contract. **WEEDON POWER LINK RADIO CO., 185, Earlsam Grove, London, E.7. (Phone: Maryland 4344).**

Indispensable for Your Bookshelf.

WIRELESS STEP BY STEP

By "DICTRON" (Ninth Edition.)

Obtainable at all Booksellers or post free 2/9 from **George Newnes, Ltd., 8-11, Southampton Street, Strand, London, W.C.2.** **2/6**

What we Found..

COMMENTS ON COMPONENTS



MORLEY SHORT-WAVE COILS

THE Morley is a very interesting model of short-wave coil, designed to cover the wave-band from 12 to 70 metres with a .00025 mfd. tuning-condenser. An eight-ribbed former is used for the coil, and this is slotted and wound with heavy gauge wire, widely spaced. The winding comprises an Aerial Coil, Grid Coil, and Reaction coil, and the grid coil is tapped and connections taken inside to a silver-contact, self-cleaning switch, operated by the rod and control knob on the panel. Terminals are provided on the ebonite base for connection, so that the complete coil may be conveniently fitted into an existing set. The two wave-bands covered by the coil are from 12 to 30 metres and from 28 to 70 metres, and the size and position of the aerial coil has been so chosen that it gives a satisfactory coupling on both bands. The price of this coil is 6s. 9d., at which it represents very good value. This firm also manufactures a series of ganged and screened coils, which differ from others on the market in that the screening-can has a domed top. The most interesting of this range is a pair of Three Range (Ultra-Short, Medium, and Long-Waves) Coil, consisting of the short-wave coil above mentioned, together with a standard dual-range coil, both mounted on a single base. The switch knob is adjusted to cover the three bands. The price of this is 15s. complete, and the base is 7½ in. by 3 in.



The Morley short-wave coil.

LDTUS 3-GANG CONDENSER

THIS is a splendid example of a completely screened and ganged condenser suitable for tuning three circuits. This is supplied complete with disc drive, fitted with lamp-holder for illuminating the dial. The sections of the condenser are accurately matched up, the now familiar split-end-plates being provided for factory matching. This is one of the features which necessitates that the home-constructor should not take the cover off the assembly and attempt to interfere with the inside. It is extremely difficult to design each section of a three gang assembly, so that at every degree on the tuning scale the three sections have exactly the same value, and in order

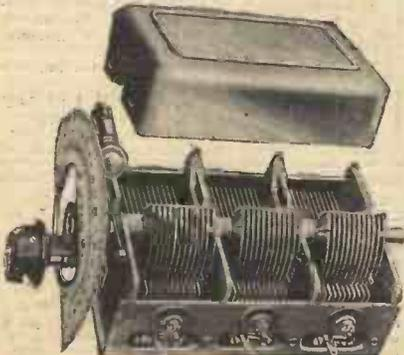

The Lotus 3-gang condenser.

Only a slight movement of one of these sections is required to upset the balance. The disc drive supplied with the condenser is a substantial affair with no backlash or slip. The degrees are clearly marked, and a neat escutcheon window is supplied for fitting to the panel.

ANOTHER BRITISH RECORD FOR AN ALL ENGLISH WORKS

THE steady growth in the number of Radio Licences issued in Great Britain is a matter of the greatest interest. It seems only recently that the number reached the amazing figure of one million. Then our astonished eyes read two millions, then three, and now it is announced that the colossal number of over 5,000,000 listeners in have purchased their annual licence. The enterprising efforts of various radio manufacturers made this progress possible by bringing within the reach of everybody cheap and reliable components and assembled sets. One of the most important of these was the early introduction of Electron wire, which by its simplicity and low price immediately made broadcasting possible for the millions, removing the bogey of expensive and unsightly aerial masts always difficult and sometimes impossible to erect, more particularly in large towns. The Electron series of aerials comprises a

New Superial, Electron's Super Aerial, in various lengths, and the Electron 100 per cent. Copper Aerial, for those who require an all copper stranded conductor with a protective covering against verdigris and atmosphere, particularly corrosion by the sea. Superial being insulated with vulcanized rubber, covered with the finest quality braiding, heavily waxed and compounded, is proof against exposure, proof against lightning, and so sure are the manufacturers of the infallibility of the New Superial, Electron's Super Aerial, they offer a £100 Free Lightning Insurance. This explains why the sales of the Electron Aerials have kept pace with the growth of radio enthusiasts. Sales already exceed 7,000,000 and Electron are going to sell another 7,000,000 of "the aerial which made broadcasting popular."

MELBOURNE SHORT-WAVE COILS

THE Melbourne short-wave coils are of the plug-in type, having air-spaced windings, spaced and held rigid by small ebonite strips clamped at three points round the circumference. The wire employed is of heavy gauge and enamelled, and a neat twin plug is fitted to the base for connection purposes. These are obtainable with 2, 3, 4, 6, and 9 turns, and the price varies from 1s. 6d. for the smallest to 2s. for the largest. These provide a simple method of employing a set for all wave-lengths, as standard broadcast coils may be plugged-in in place of the short-wave coils and thereby cover a complete range. The makers are the Melbourne Radio Supply.

GRAMPIAN SPEAKERS

A NEW Permanent Magnet Moving-Coil Speaker has recently been placed on the market, and is illustrated below. This is the Gramplan speaker manufactured by Gramplan Reproducers Ltd., and selling at 39s. 6d. This has an overall diameter of 7½ in. and weighs 5½ lbs. The chassis is built up of aluminium, and the magnet is very substantial. The strength of the field is 34,000 lines, and the speech coil is wound to a resistance of 1.7 ohms. To enable this to be employed with any type of valve, a multi-ratio output is fitted to the chassis and six different ratios are obtainable from the four terminals which are fitted to the transformer. The lowest ratio is 15 to 1, and the highest 70 to 1. The power handling capacity is given as 3,750 milliwatts, and it will,

that this should be so, the end vane of each moving section is slotted, and by means of an oscillator circuit at the factory, each section is adjusted by bending the sections so that no matter what part of the scale is chosen, the reading for each condenser is identical

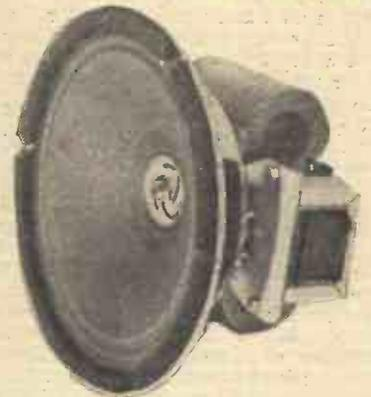

The Grampian P.M. loud-speaker.

therefore, deal comfortably with the output of practically every home receiver. On test, speech was found remarkably faithful, no lack of brilliance being noticed, and no boominess. On musical items the overall response seemed particularly good, with a good proportion of bass. This was found to be produced by a bass resonance below 100 cycles, which gave a depth to the reproduction without noticeable boom. At the price mentioned, namely 39s. 6d., this is a very satisfactory item. An energized model is also made by this firm, and sells at 30s. The principal details of this model are: Field winding, 2,500 ohms; Inductance of field 70 henries; Power handling capacity 3,750 milliwatts; Speech coil resistance 1.7 ohms; weight 4lbs. 10ozs. A similar output transformer is also fitted to this model.

WHITELEY P.M. SPEAKERS

WE have recently drawn attention in our pages to the fact that moving-coil speakers require a fairly large output of undistorted signal in order to give satisfactory results. The Whiteley Electrical Radio Co. Ltd., have drawn our attention to the fact that their PM4 speaker will work comfortably on an output of only 60 milliwatts. This, of course, is a very low value, and it enables the user of even the smallest wireless set to get really first-class results from the moving-coil type of speaker. The illustration herewith shows the new cabinet which has been designed to house the Whiteley PM5 speaker, and this is now obtainable for 39s. 6d., complete. It is known as the Mansfield Junior Cabinet.



The Mansfield Junior cabinet loud-speaker.

OUR FIRST PICTURE

The Snags We Struck and How We Overcame Them

THE trouble started when a few of us clubbed together, bought a ciné camera and decided to produce a picture to be shown at the firm's annual dinner. Everyone was enthusiastic, and a hastily-thought-out plot left us with only the cast to be arranged.

Comedy was to be the keynote. After all, our efforts might be mistaken if we attempted to be serious, and if we *did* happen to be funny—well, we were supposed to be, weren't we? So we chose the hackneyed theme of the heiress who must marry by a certain hour—introducing the villain "determined to marry the girl, by gad!"—and all that.

A Veritable Adonis

For the hero we chose a veritable Adonis—black marcelled locks, a "neat-line" moustache and the most charming "Colgate" smile. Had he a girl? He vaguely murmured that he had—rather too vaguely, I thought.

It was finally decided to have one big day out and get all the outdoor shots done in the fine weather and leave the interior scenes until the late autumn. We selected a spot in the wilds of Hertfordshire (yes, there are wilds even in Herts), and started off bright and early one morning with a lorry full of props and three private cars conveying the cast—on location.



The villain in

I had been informed that the villain was a most serious character. We had not been the number of motoring parties that they themselves right on numerous small boys' competition as to nearest the cameraman ranged themselves all in the hope, I presume, of directing the picture." He was directing (sic) and the cameras most obtained without if unwanted.

Just the

Our opening scene was a house which was a close-up of the bride-to-be. Some had spotted "just



The detective's office was certainly a work of art!

This interesting article appears in the January

HOME MOVIES

SEND POSTCARD TO-DAY FOR SPECIMEN COPY "Home Movies" is obtainable at all Newsagents, Bookstalls and Dealers, or by post 7½d. (Subscription rates: Inland and Abroad 7½d per annum, Canada 7½d per annum), from George Newnes, Ltd., 8-11, Southampton Street, Strand, London, W.C.2.

THE STANDARD IS RISING...



To keep up with Radio Progress only the best components are good enough. Write for free leaflets indispensable to constructors who are satisfied only with the finest results.

1. The Potentiometer. Price 3/- to 8/-. Leaflets Ref. Nos. W79-81.
2. The DWA Coil. Price 9/9. Leaflets Ref. No. W65.
3. The Band Pass Filter. Prices 12/- and 12/6 Leaflet Ref. No. W73.
4. The LF-Transformer. Prices 6/9 and 10/-. Leaflet Ref. No. W76.

Every type of component is made by "Lewcos" and stocked by all reputable dealers.

Lewcos

REGD.

RADIO COMPONENTS

THE LONDON ELECTRIC WIRE COMPANY AND SMITHS, LIMITED, CHURCH ROAD, LEYTON, LONDON, E.10

P.W. Gift Stamp No. 17

Printed by NEWNES & PEARSON PRINTING CO., LTD., Exmoor Street, Ladbroke Grove, W.10, and published by GEORGE NEWNES, LTD., 8-11, Southampton Street, Strand, W.C.2. Sole Agents for Australia and New Zealand: GORDON & GORON, LTD., South Africa: CENTRAL NEWS AGENCY, LTD. *Practical Wireless* can be sent to any part of the world, post free, for 17/4 per annum; six months, 8/8. Registered at the General Post Office for Transmission by Canadian Magazine Post.