

RADIO RELAY SYSTEMS

Practical Wireless

3^D_I

Published every Wednesday by
**GEORGE
NEWNES
LTD.**

Vol. 3. — No. 67.
DECEMBER 30th, 1933.

Registered at the G.P.O. as a Newspaper.

EDITED BY F. J. CAMM.

Making an

ALL-PURPOSE TEST METER

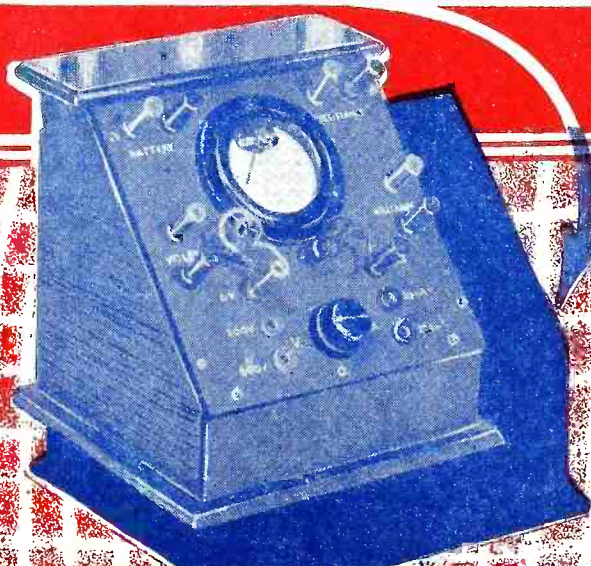

FIT A FILT

PRICE

2/6

REFILLS 1/6

The

GREATEST THING YOU CAN POSSIBLY GIVE YOUR HOME THIS CHRISTMAS!

INTER-COMMUNICATION WITH ALL THE PEOPLES OF THE WORLD!



At last the day of All-World Radio has arrived, and you can build with your own hands the first receiver to give you not only England and Europe, but America and Australia direct. The Lissen All-Wave All-World "Skyscraper" 4 tunes from 12 to 2,100 metres. It brings two complete new wavelength ranges within reach of the ordinary listener—stations and programmes which before he was never able to receive—Ultra Short and Short-Wave transmissions from the ends of the earth. And remember you get these stations through Double-Balanced Pentode Output giving brilliant reproduction on a Moving-Coil Speaker—as much power as a Mains Set from ordinary high-tension batteries.

Lissen have made this All-Wave All-World Radio available to Home Constructors because it brings back the thrill of conquest to hear America and Australia direct on a set you have built yourself, it makes you an enthusiast to realise what a wonderful thing you have created.

Build with your own hands a set which will receive **ULTRA SHORT** and **SHORT** waves as well as ordinary broadcast programmes

When you see the Great Free Chart of the All-Wave All-World "Skyscraper" 4, which tells you how to build it, and how to work it, and why it gives such marvellous results, you will agree at once that it will be wise of you to build for yourself rather than buy a factory-assembled receiver which cannot give you these new and intriguing short-wave stations. The FREE CHART simplifies everything; there are pictures of every part, with every wire numbered, every hole lettered, every terminal identified. **YOU CAN'T GO WRONG!** But get the Chart and see for yourself—then build the Lissen All-Wave All-World "Skyscraper" 4, the SET THAT SPANS THE WORLD!

KIT COMPLETE WITH VALVES £5.12.6

To LISSEN, LTD., Publicity Dept., ISLEWORTH. Please send me FREE copy of All-Wave All-World "Skyscraper" Chart.

Name

Address

P.W. 2134

POST COUPON CHART FREE

LISSEN

4
"SKYSCRAPER"

NEXT WEEK! BUILDING A PORTABLE TELEVISION RECEIVER

Practical Wireless

EDITOR:
F. J. CAMM

Technical Staff:
W. J. DELANEY
H. J. BARTON CHAPPLE,
Wh.Sch., B.Sc., A.M.I.E.E.
FRANK PRESTON
W. B. RICHARDSON

Vol. III, No. 67
Dec. 30th, 1933

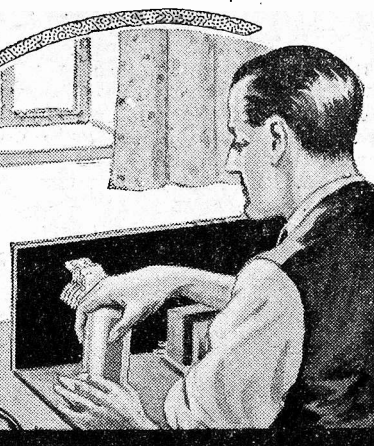

ROUND *the* WORLD of WIRELESS

Collieries Band Concert

SWANNICK Collieries Band, which won the Junior Championship at the Crystal Palace this year, give a programme for Midland Regional listeners on January 4th. E. Skidmore conducts the band, which was founded thirty years ago. The players are drawn entirely from the colliery employees. Several part-songs will be sung by the Newlands Quartet.

Another Sims Reeves Recital

FRANK TITTERTON'S heroic efforts to revive the songs of his brilliant predecessor in vocal art, Sims Reeves, continue unabated, and on December 30th he is to give another of these Sims Reeves recitals in the National programme. Titterton started singing professionally after the war, during which he served in the Tank Corps, "and," he says, "I required a tank almost to myself, even at that time." His girth has since increased still more, and now, paradoxically, he uses one of the smallest cars on the market in order to get about all over the country to fulfil his numerous engagements. When he is driving there is scarcely room for anyone else in the car.

"The Streets of London"

STORIES of life in the 'eighties have a singular fascination for the modern age. There certainly seems to be less appeal about the 'sixties or the 'seventies; and even the 'nineties are not associated in the minds of most people with the same air of romanticism as the decade when Queen Victoria's Jubilee was registered, an event universally celebrated with as much fervency as the Diamond Jubilee ten years later. It is to the 'eighties, then, that Barbara Burnham and Mark H. Lubbock have gone for their programme of December 29th, "The Streets of London," which will be heard by National listeners. It is a drama of low and high life in eight scenes. A banking house in Cheapside, a mansion in Park Lane, a tenement in Seven Dials; and a cottage in Highgate are among the scenes to be included in this novel programme. The Theatre Orchestra will play.

You May Now Hear Manila

KZRM, the main broadcasting station operating at Manila (Philippine Islands), is now relaying the programmes of its medium-wave transmitter on 49.3 metres (6,085 kc/s). They have been picked up in the British Isles between G.M.T. 22.00 and midnight.

"Songs from the Shows"

A NEW series of "Songs from the Shows" will start in January. The first theatre to be dealt with will be the Adelphi, and the cast will include those popular microphone "stars," Anona Winn,

artists new to the microphone. Thus the programmes will cater for the large number of people who write to Broadcasting House, saying that they work all night and thus never hear any of the programmes which they want to hear.

Primitive Time Signals

IN Great Britain we are given the exact time by means of the "six pips" automatically supplied by the Greenwich Observatory, but many Continental stations still transmit signals at odd hours, taking the time from an electric studio clock. In Germany, except at certain periods of the day, the announcer strikes a gong and tells his hearers the number of minutes past the hour. A similar method has been used in France, but is gradually being replaced by clock carillons or so-called Westminster chimes, imitating Big Ben.

Eiffel Tower Will Not Close Down Yet

SO far as can be foreseen, only that part of the Lucerne Plan dealing with medium-wave stations will be brought into operation on January 15th, 1934; the "long-wave" stations will probably remain on their usual channels. Broadcasts from the Eiffel Tower, therefore, are expected to continue until further notice. Later, if agreement can be reached amongst the interested nations, alterations may be made in the wavelengths of transmitters working on channels between 1,000 and 2,000 metres.

Radio Splendid

IF on one night you leave your receiver tuned to North National and then return to the set towards 1.30 a.m., on twirling the condenser very slightly upwards—until the set is tuned to 302.8 metres, to be exact—you should easily capture a broadcast from LR4, Radio Splendid, Buenos Aires. At 2 a.m. you will hear a time signal consisting of ten flute-like notes followed by one long blast. As a rule the station, which announces regularly in Spanish and English, concludes its dance music transmissions by playing the opening bars of Jessel's *Parade of the Ten Soldiers*.

SERVICE!

Every PRACTICAL WIRELESS RECEIVER is made only from parts which are available to the public. Only those parts actually used by our designers are specified—no alternatives.

Every PRACTICAL WIRELESS RECEIVER is Guaranteed to give the results we claim under a Free Advice Guarantee.

All readers' queries are accurately, promptly and helpfully answered FREE OF CHARGE, and without onerous restrictions.

Because of the unparalleled reader service we render, PRACTICAL WIRELESS has set an entirely new standard in radio journalism and become the

LEADING CONSTRUCTORS' WEEKLY

George Baker, Reginald Purdell, and Olive Groves, with, perhaps, a famous Adelphi name or two. Stanford Robinson will conduct the orchestra, and the deviser of the "Songs from the Shows" series since their beginning, John Watt, will compère. An innovation will be that two performances will be given, one evening performance, probably on the Friday or Saturday night, and one afternoon performance, a Saturday matinée. The latter may replace "First Time Here," the present 4.30 tea-time entertainment by

ROUND the WORLD of WIRELESS (Continued)

Additional B.B.C. Studios

AN old skating rink in the immediate vicinity of Maida Vale, London, is likely to become in the near future an important branch of Broadcasting House. A portion of the building will be converted to utilise it for large orchestral concerts such as those given in the past at the No. 10 (Wharf) studio near Waterloo Bridge. Arrangements will also be made to incorporate at the Maida Vale branch other smaller studios. It is expected that the building will also be required for the variety and vaudeville hours when the short lease of St. George's Hall, recently acquired by the B.B.C. for this purpose, comes to an end.

Listen to Buenos Aires

TWO Argentine stations which are now being well heard are, LR3 Radio Nacional on 315.8 metres and LR4, Radio Splendid on 303 metres; their power is respectively 18 and 15 kilowatts. For the purpose of identification it will assist readers to know that most announcements are made in both Spanish and English. Talks are usually given between 10 and 11 p.m., followed by a concert, and at 1 a.m. strains from an Argentine tango band may be picked up. The news bulletin is broadcast at about 3 a.m. shortly before the stations close down. The best time to make a search is between midnight and 3 a.m. G.M.T.

U.S.S.R. and United States

TESTS in trans-Atlantic telephony are now being regularly carried out between Moscow and New York. The Russian station RNE on 25 metres (12,000 kc/s) may be heard calling WQP, Rock Point, the latter replying on 21.58 metres (13,900 kc/s). An attempt will shortly be made to relay a concert from Moscow or Leningrad to the United States. The tests are usually carried out towards 1.30 p.m. G.M.T., the English language being used on both sides.

Poland Holds Musical Broadcast Record

OF all the European stations Warsaw is the one which holds the record for the greatest proportion of musical broadcasts made in the course of the week's wireless transmissions. Of the programmes given out by this studio, 68 per cent. is devoted to orchestral, vocal, or instrumental music. Gramophone records are not much used for the broadcasts, although their popularity in Poland for home entertainment is no less than it is in other countries.

Radio-Paris Temporarily Closed Down

FOLLOWING the transfer of the Remy St. Honoré high-power transmitter to the French State network, Radio-Paris suspended its broadcasts from December 8th to 17th. No doubt failure to receive concerts on 1,724 metres during this period must have greatly puzzled listeners, as notice was only given of this measure to the Press after the station had closed down. As it is now being worked by a totally different organisation, the time schedule

INTERESTING and TOPICAL PARAGRAPHS

will be completely altered; for the first week or so a skeleton programme has been devised, but the station will shortly take over its regular duties as the high-power channel of the P.T.T. network.

NEW POST OFFICE RESEARCH STATION

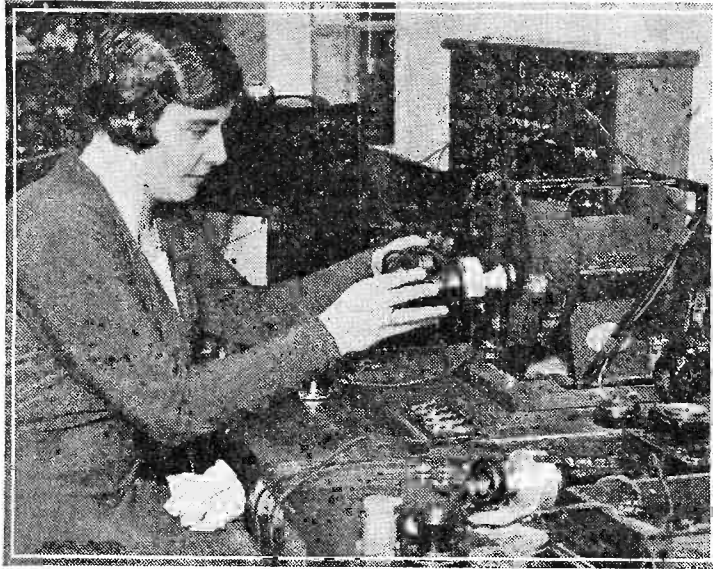

Testing the efficiency of head-phones at the new P.O. Research Station at Dollis Hill.

Spain's Radio Mushrooms

OWING to the indefinitely postponed reorganization of the broadcasting system in Spain, a large number of small transmitters have started up in various parts of the country with a view to an attempt to give radio listeners some kind of wireless entertainment. Most of these

SOLVE THIS!

Problem No. 67.

Jones constructed a receiver which employed a variable-mu H.F. stage and got very satisfactory results. In order to increase selectivity he removed the tuning coil and fitted band-pass coils of the type which required connecting direct to earth. As he used a ganged condenser this also had to be earthed, and he was at a loss to know how to apply the necessary bias voltage to the H.F. valve. He suddenly thought of fitting a grid leak between the arm of the control potentiometer and the grid of the H.F. valve, and he, therefore, fitted up this arrangement but found that it had no effect. Why? Three books will be awarded for the first three correct solutions opened. Address your attempts to The Editor, PRACTICAL WIRELESS, Geo. Newnes, Ltd., 8-11, Southampton Street, Strand, London, W.C.2. Envelopes should be marked Problem No. 67, and should be posted to reach us not later than January 1st, 1934.

SOLUTION TO PROBLEM No. 66.

The secondary of the transformer in Brown's receiver had become internally disconnected thus producing an open-grid circuit. Consequently no grid-bias was being applied to the output valve.

The following three readers successfully solved Problem No. 65, and books have accordingly been forwarded to them:—Mr. C. Weir, 3, Almsford Road, Salford 6. Mr. G. H. Hudd, 89, Penrhys Road, Ystrad Rhondda, Glam. Mr. V. Webb, 12, Halesowen Road, Halesowen.

stations are worked by private and local associations. In addition to those already mentioned in these columns, something like twenty-five others have been launched on the ether during the past few weeks. As most of them, in power, do not exceed 150—200 watts and operate on channels between 200 and 218 metres, but few of the transmissions can be picked up in the British Isles.

Mexican Station Logged

CONDITIONS have been so favourable lately for the reception of trans-Atlantic transmissions in the early morning hours that a broadcast from Mexico was clearly heard on a recent date. The station logged was XED, Reynosa (Nuevo Laredo), on 310.9 m. (965 kc/s). The transmission was in Spanish and English, dance music being given at the time. The call picked up was XED *Companhia Internacional Diffusoria de Reynosa*, Mexico, the latter word being pronounced: *Mayheeco*. In the latest lists the power of the transmitter is given as 10 kilowatts.

Budapest on Short Waves

PENDING the construction of a special transmitter to be utilised solely for the purpose, the main portion of the Budapest evening programmes is now being put out almost nightly through one of the Szekesfeher-

var short-wave stations. The transmitter is HAT2, working on 43.86 metres. It has been well heard between 9.0 and 10.30 p.m. G.M.T. on this side of the Channel.

Russian Stations Exchange Wavelengths

SINCE the advent of the Moscow Noghinsk 500 kilowatt transmitter, alterations have been made in the wavelengths of two high-power transmitters. Leningrad, previously on 1,000 metres, has exchanged channels with Moscow (T.U.) hitherto working on 1,304 metres. This frequency separation was desirable for the former transmitter in view of the fact that another station at Leningrad works on 857 metres.

New Station at Pretoria

THE South African Government has decided to erect a high-power broadcasting station at Roberts Heights, not only for the transmission of programmes, but also to be used for commercial purposes.

The World's Playground

OF the North American broadcasting stations one of the best heard on this side of the Atlantic is WPG, Atlantic City (New Jersey), on 272.6 metres (just below the Turin condenser reading). As a rule its signals can be picked up from 1 a.m. onwards. The studio is in the Columbia Broadcasting Network, taking a large portion of its programmes from WABC, New York, and the fact is mentioned in the call. Atlantic City is the "Brighton" of New York.

(Continued on page 752)

RADIO RELAYS

Radio Relay, or Re-diffusion, Stations are Now Actively in Operation in Various Parts of the Country, and although Readers may Not be Interested in Obtaining Their Broadcast Programmes from These Sources, they will find it Most Instructive to Study the Principles upon which These Stations Operate. By BERNARD DUNN.

FOR the last few years there has been a gradual increase in the number of relay or re-diffusion stations coming into operation, and the writer knows for a fact that there are now several thousands of subscribers to these "community" receivers. There might be some readers who are unaware of the existence of these stations, and therefore a brief description of their purpose will not be out of place. The idea is that a receiving station is set up near to a town and this station receives the broadcast programmes, passes the signals through powerful amplifiers, and distributes them to a number of subscribers. Every subscriber must have a broadcast licence, and pays a certain weekly fee to the company responsible for the distribution of programmes. The average fee for a single programme is about 1s. 3d. per week, when the subscriber buys his own speaker, whilst a slight extra charge is made if a speaker is had on loan.

The whole scheme is simply an enlargement of that whereby programmes are supplied to speakers in various rooms in a house from a central receiver, but, of course, there are many

more factors involved and many more difficult problems to consider. This point will readily be appreciated when it is explained that very often the distance between the receiving station and the subscriber is as much as three miles, whilst there might be 2,000 subscribers to a single station. The problems become still more involved when two or more alternative programmes are to be made available to every subscriber, and various forms of "balanced" circuits are necessary to prevent interference between the lines carrying them.

Special Loud-speakers

Fig. 1 shows the general arrangement of receiver, amplifier, supply lines and loud-

speakers however, that special permanent magnet moving-coil speakers having a speech coil resistance of 4,000 or 5,000 ohms are employed, and thus 500 of them in parallel would have a final resistance of something like 10 ohms, even neglecting the resistance of the supply lines.

Safety Fuses

At first it might be considered that the fuses would be unnecessary, but it must be remembered that the current flowing through the lines attains a value of several amperes and that a short-circuit might be definitely harmful to the apparatus. But that is not all, because if a single loud-speaker were short-circuited the supply lines would be shorted, with a result that every speaker would be silenced. When the fuse is in circuit a short can only put one speaker out of use, and all the others can operate normally.

Amplifier Details

The receiver is a perfectly ordinary one, generally a superbet, but the amplifier must be capable of supplying a tremendous output since it is found that at least 1 watt (1,000 milliwatts) must be allowed for each speaker in the circuit. Rather than build a single amplifier to supply, say, 1,000 watts, however, it is more usual to employ four or five, each supplying a portion of the total output. Each amplifier feeds a particular "line," so that any failure due to a valve filament or other cause can affect only a comparatively few subscribers. In any case a replacement can be made in a very short

(Continued on page 752)

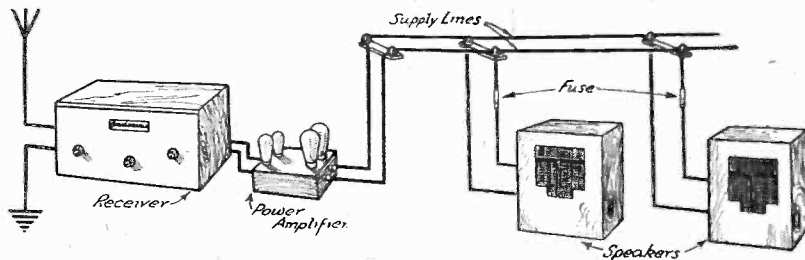

Fig. 1.—This sketch shows the general principles of the radio relay, or re-diffusion, service.

speakers for the simplest form of re-diffusion service. It will be seen that all the speakers are in parallel and that a fuse is included in the circuit of each. Another point is that all the speakers are fed by a two-wire system, it being contrary to regulations to make use of an earth-return and a single wire such as is generally done when using choke-capacity output filters.

The reader will probably wonder how it is possible to choose an output transformer to match the resultant impedance of all the speakers in parallel; obviously if these had speech coils of about 7 ohms, as is common in normal wireless practice, the output transformer would require to have a ratio of thousands to one, which it would be impossible to provide. The fact is,

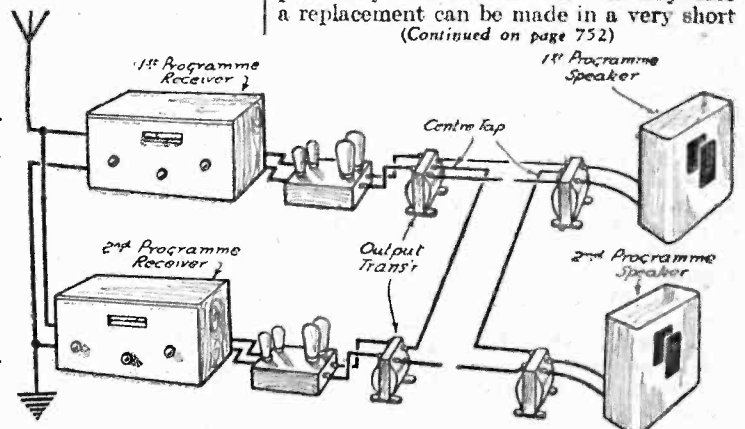

Fig. 2.—This sketch shows how two programmes can be distributed by using only three supply wires.

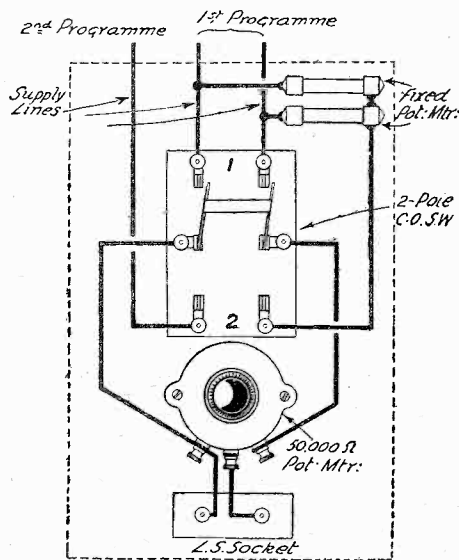

Fig. 3.—The connections and components used in the subscribers' switch for a three-wire two-programme service are shown above. A fixed potentiometer takes the place of a centre-tapped transformer connected as shown in Fig. 2.

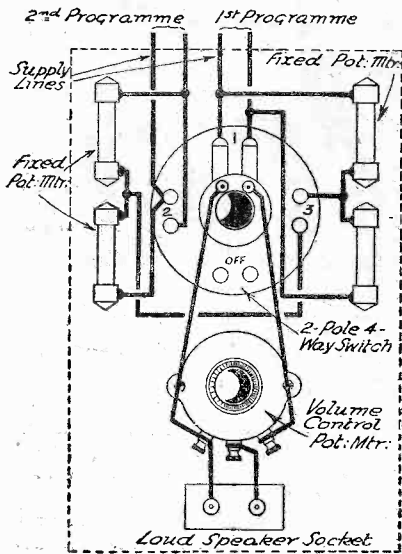

Fig. 5.—The wiring and components in the switch box for a four-wire three-programme service are shown here.

(Continued from page 751)

time, since it is usual to have at least one amplifier in reserve.

This is not the correct place to describe the amplifiers in detail, but it might be mentioned that the usual circuit arrangement, and one which has proved particularly satisfactory, is one in which four valves are used in two-stage push-pull. The first two valves are usually super-power ones designed to handle about 8 watts each, whilst those used in the output stage are transmitting valves capable of handling anything up to 150 watts each. These latter valves require an anode voltage of between 1,000 and 2,000; and this is obtained from a generator, which is found to be considerably better than stepping up the mains supply by means of huge transformers. It might be mentioned in passing that the total anode current consumption of a single amplifier is often as high as 1 ampere, whilst the signal current fed to the speaker supply lines can be anything from a quarter of an ampere to several amps.

Supply Lines

The supply lines are generally in the form of overhead wires similar to telephone wires, being supported on insulated brackets in the same way. No very especial care need be taken in arranging and erecting them when only a single programme service is in use, but when multiple programmes are being sent out, great care is necessary to arrange the wires in balanced loops to avoid interaction. With this end in view the positions of the wires are reversed at intervals, whilst artificial loading and other palliatives have sometimes to be resorted to so that interference may be avoided.

The wires are generally taken through a hole in the roof of the house, the safety fuse being fitted as near as possible to the point of inlet. The equipment at the receiving end is very simple, consisting (in the case of a single-programme service) of nothing more than a wooden switch box upon which are mounted the volume control potentiometer and speaker plug socket. When a multiple-programme service is provided a change-over switch must also be fitted on the switch box, and this has to be wired so that the volume control is operative on every programme.

Re-diffusing Multiple Programmes

Since two wires are required for a single programme it would seem that four would be needed for the distribution of two programmes, six for three, and so on. Actually, however, this is not the case, because there are various so-called "phantom" circuits in which one supply wire can be made to carry two signals. A common arrangement, by means of which two programmes can be transmitted on three wires, is illustrated in Fig. 2. In this case the first programme is transmitted in the usual way along a single pair of lines, but the second one is sent out quite differently. One side of the "second programme" output transformer at the amplifier end is connected to a centre-tap on the secondary of the "first programme" transformer, the other end feeding straight to the speaker line. At the listening end a special transformer is required for the speaker taking the first programme, and the centre-tapping on its primary supplies the second connection for the other speaker. This method has the disadvantage that transformers are required for the loudspeakers, and that adds to the expense. In a simplification of the latter arrangement, which is being used rather widely, the speaker transformers are dispensed with and a fixed potentiometer is connected across the "first programme" lines, a connection being taken from its centre-tapping to the "second programme" speaker. Switch-box connections for the system just outlined are shown in Fig. 3.

The "two-programme" system described above gives the basis of a more complicated one by means of which any number of programmes can be sent out. At least, that is true theoretically, but in practice it is

found very difficult to deal successfully with more than three alternative programmes. Fig. 4 shows the general arrangement of a four-wire-three-programme system where centre-tapped potentiometers are employed for balancing purposes. Slightly better results are often to be obtained by using transformers of the kind shown in Fig. 2, but expense rules them out as being rather impracticable. It will be seen from Fig. 4 that interference between different programmes is practically impossible since the potential existing between each pair of lines is equal in respect to the third programme. At the same time there is the full signal voltage of the third programme between the two pairs of lines, and therefore these must be kept well apart. Also the leads-in inside the house must be screened from each other, or so arranged that there can be no inductive coupling between them.

The internal connections of a house supplied with a three-programme service are shown in Fig. 5, where it can be seen that a two-pole four-way switch is employed to change from one programme to another and to switch the speaker out of circuit. The switch is so arranged that the volume control remains in circuit on every programme. A method which may be used as an alternative if the volume control is attached to the speaker itself is to fit three alternative sockets into which the speaker plug may be inserted.

ROUND THE WORLD OF WIRELESS

(Continued from page 750)

Using Gramophone Needles

THERE is an idea among gramophone users that it is quite in order to play both sides of a 10in. record with the same needle. There is absolutely no difference between this and playing one side of two different records, as the opposite faces have nothing whatever in common.

Make Sure before you Dismantle a Set

AN experienced engineer, who should have known better, took a portable set to pieces because it would not receive the local station, and did not discover until some time afterwards that the trouble was not in the set, but was due to the screening effect of a very large mirror which backed the sideboard upon which the receiver stood.

Those Midget Terminals

AT this time of year the large manufacturers start to think about next year's programme. Perhaps, if we all wish together hard, somebody might design a component with terminals a little larger than the midgets used at present, so that they could be properly tightened with the fingers, instead of stripped with the pliers.

Innsbrück on a Shipping Wavelength

TESTS are now being carried out by the Austrian relay station at Innsbrück on 578 metres, a channel allotted to this transmitter by the Lucerne Plan. Although the wavelength is one which would suit the authorities well, it is necessary to make sure that the broadcasts do not interfere with the telegraphy work of ships in the Mediterranean. If no complaints are made in this respect Innsbrück will increase its power to 2 kilowatts.

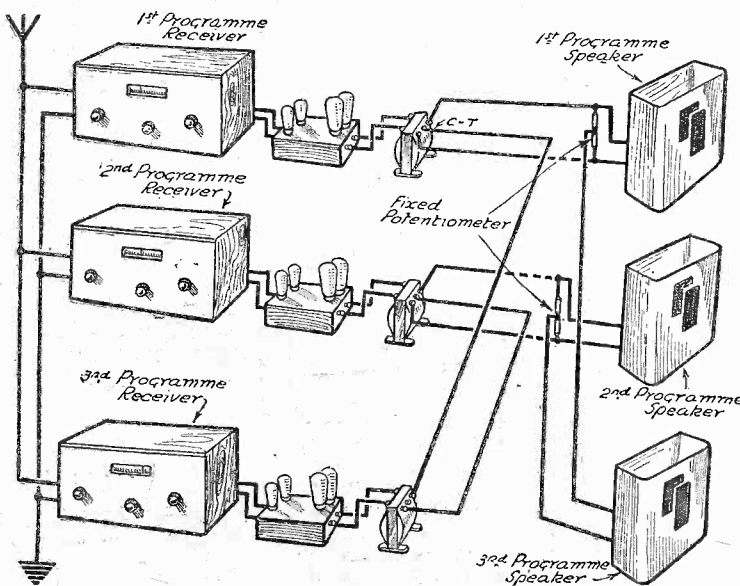
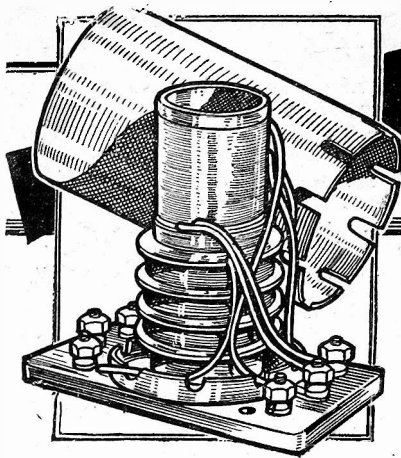

Fig. 4.—The general arrangement of a four-wire three-programme service is illustrated in this sketch.

MAKING YOUR OWN Screened Coils



In this Fourth Article of the Series, the Author Describes the Construction of Oscillator Coils and Intermediate-frequency Transformers for Superheterodyne Receivers.

By FRANK PRESTON.

SUPERHETERODYNE receivers are justly popular at the present time, and most amateurs now realize that such sets are no more difficult to construct

The difference is generally made to be 110 kilocycles, and this is the figure which will be taken as a basis in the present design. To obtain that difference the oscillator coil is made to tune to a lower range of frequencies (or wavelengths) than those encompassed by the preceding tuning coils. In other words, the tuned winding of the oscillator coil contains fewer turns; the "reaction" winding, incidentally, is almost the same size although it can usually be made rather smaller with advantage.

Details of the windings for an oscillator coil complying with the conditions already laid down are clearly shown in the dimensioned drawing at Fig. 1. It will be evident from this that the medium-wave winding consists of seventy-five turns wound side by side, and the long-wave one of 240 turns placed in two similar sections arranged on the

systoflex sleeving, and the screening can is earthed by means of a soldering tag fitted under the clamping nut of terminal number 5. The connections for the oscillator coil in a battery-operated superhet of the kind using a separate oscillator valve (which is generally better in home-constructed battery sets) are given in the circuit at Fig. 2. It should be pointed out, however, that the coil detailed can successfully be employed in almost any type of superhet, either mains or battery-operated, and the connections and arrangements of windings are more or less standard ones such as are of necessity employed by most coil manufacturers. For this reason the coil can be fitted into almost any average circuit without difficulty arising.

It would be possible, if sufficient testing and calibrating apparatus were available, to tune the oscillator coil with the third (oscillator) section of a superheterodyne gang condenser, but as such apparatus will not be in the possession of most readers, the suggestion is made that a separate tuning condenser of .0005 mfd. capacity should be used. By doing this, all difficulties of trimming will automatically be avoided, whilst the separate tuned circuits will always be correctly adjusted, with a result that optimum results will be secured.

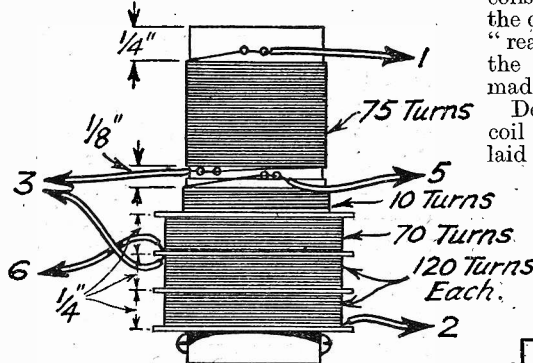

Fig. 1.—Constructional details of the oscillator coil described are given in the above drawing.

and operate than are "straight" ones of the more usual types. Despite this, the home constructor is very liable to gain the impression that the coils required for superhets are involved and complicated components which can only be made in well-equipped factories. This is by no means the case, for they are actually identical in construction with the ordinary coils employed in sets of any other kind. Once this idea is grasped any reader will find not the slightest difficulty in making an oscillator coil and also the necessary intermediate-frequency transformers. In order that the work may be tackled with every confidence, I am going to describe how the latter components can be made from almost the same materials as were used for the various coils dealt with in the previous three articles under the above heading.

An Oscillator Coil

The oscillator coil can be considered as the opposite of a tuned grid coil with reaction, since it contains similar windings which are connected in the reverse order. That is, the tuned winding is wired in the anode circuit of the oscillator valve, whilst the "reaction" winding is connected in the grid circuit and is untuned. It is, of course, the object of the oscillator valve to produce oscillations which shall differ in frequency by a certain fixed amount from the frequency of the signals being received.

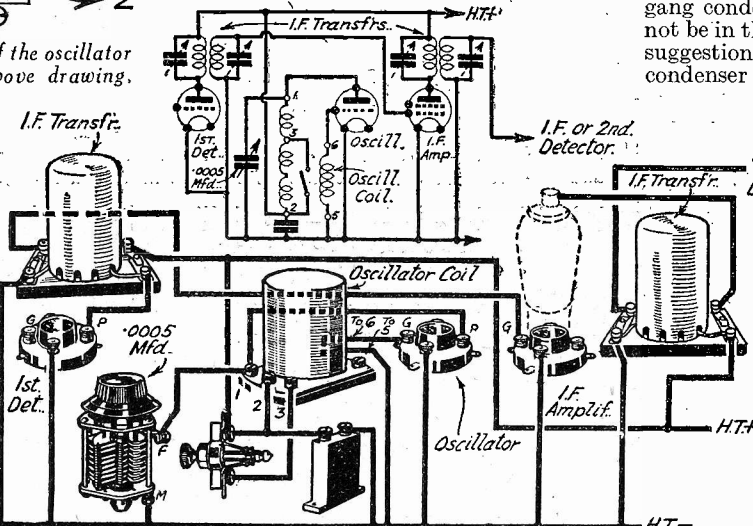

Fig. 2.—This skeleton circuit gives the connections for the oscillator coil and I.F. transformer described.

coil former. In order to obtain correct coupling on both wavebands, the reaction winding is arranged in two parts, one of which is wound as side-by-side turns comparatively near to the medium-wave winding and the other of seventy turns placed in a slot next to the long-wave sections. All the turns are of 34-gauge d.c.c. or enamelled wire and are put on in the same direction. It is unnecessary here to detail the method of construction, since that subject was adequately dealt with in the first article of this series. Suffice it to say that the coil is again mounted on an ebonite baseplate measuring about 3in. by 2in. with six terminals arranged in exactly the same positions as before. Leads to the terminals are made by passing the ends of the windings through suitable lengths of

An Intermediate-frequency Transformer

An intermediate-frequency transformer of the band-pass type can be made with the greatest of ease, and all the necessary winding details are shown in Fig. 3. The lin. diameter paxolin former previously specified is fitted with six of the washers supplied with it so that four winding sections are provided; two of these will

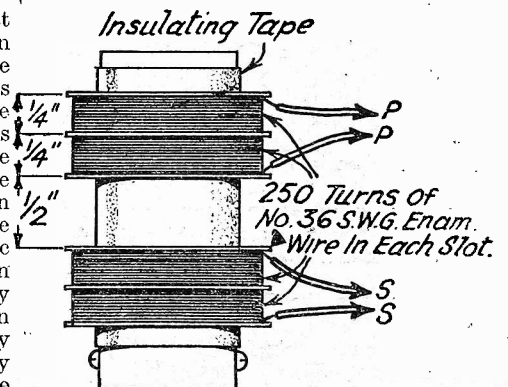

Fig. 3.—Principal dimensions and winding particulars for the I.F. transformer.

(Continued from previous page)

take the primary, and two the secondary windings. The same idea is made use of for positioning the washers as was previously used. First, a strip of insulating tape $\frac{1}{4}$ in. wide is wound twice round the former, and then a washer is pressed closely against it. A second strip of similar width is then wound on at the other side of the washer, after which a second washer is fitted. Another strip of insulating tape and a third washer complete the winding sections for the primary.

So as to give correct spacing between the primary and secondary windings a $\frac{1}{4}$ in. wide strip of insulating tape is wound round the tube just touching the third washer. After that, another set of three washers can be fitted in exactly the same way as the first three were arranged. The "U" mounting bracket must, of course, be attached to the lower end of the former, as it was in the previous coils, and then the windings can be put on. Start with the primary and anchor the end of the wire in a pair of small holes made in the paxolin tube, wind on 250 turns in the first slot, pass over to the second slot and complete the winding by putting on another 250 turns, so making 500 in all. The "finishing" end of the wire can be anchored by passing it through two holes made in the former, or by running a spot of sealing wax on to it. When the primary is finished the secondary can be wound in exactly the same manner, and using the same number of turns.

The Ebonite Base

Finally comes the job of making the ebonite base and also two small and simple pre-set condensers which are necessary for accurate trimming; details of this part of the work are clearly shown in Fig. 4. It can be seen that the ebonite measures $\frac{1}{2}$ in. long by 2 in. wide, and is drilled with eleven holes. Seven of the holes are to take terminals, and are $\frac{7}{64}$ in. diameter, and counter-bored $\frac{3}{16}$ in. to receive the rounded heads of the terminals, two are $\frac{1}{4}$ in. to take the mounting screws, whilst the remaining two holes are drilled $\frac{7}{64}$ in., and are then tapped out to 4 B.A. There will be no difficulty in tapping out the latter pair of holes if a 4 B.A. tap and holder are available, but even if they are not, there should be no difficulty in forming the thread by forcing a screw through the holes. The matter will further be simplified if one or two flats are carefully filed on the screw

by means of a fine file; these will improve the cutting abilities of the improvised tap and prevent binding.

Trimming Condenser

After the base has been prepared the pre-set condensers should be made according to the dimensioned drawing at Fig. 4. A strip of hard springy brass $\frac{1}{2}$ in. wide, as well as a piece of thin mica or celluloid, is required. Two pieces of brass, each $1\frac{1}{2}$ in. long, are needed for each condenser and these are drilled according to the dimensions given. One piece has a $\frac{7}{64}$ in. hole $\frac{1}{2}$ in. from the end and a $\frac{3}{16}$ in. hole $1\frac{1}{2}$ in. from the same end, whilst the other also has a $\frac{7}{64}$ in. hole $\frac{1}{2}$ in. from the end, but has a slot $\frac{3}{16}$ in. long by $\frac{1}{8}$ in. wide $\frac{1}{2}$ in. away from the

terminal; finally a $\frac{1}{4}$ in. round or cheese-headed brass screw, with a washer under its head, should be passed through the slot in the top brass plate, also through the larger holes in the mica and lower plate, into the tapped hole in the base.

When both pre-set condensers have been assembled the connections can be made to them from the ends of the windings. The two leads from the primary go to one condenser, whilst these from the secondary go to the other.

In mounting the finished intermediate-frequency transformer on the receiver chassis it will be essential to place spacers, consisting of a number of washers or of short lengths of brass tubing on the holding-down screws in order to allow the pre-set condenser adjusting screws to work without fouling the baseboard.

The transformer described can be connected in any superheterodyne circuit where an intermediate frequency of 110 kilocycles is employed and the connections are perfectly standard. That is, the primary terminals are joined to the anode of the first detector (or I.F.) valve and H.T. positive respectively, whilst the secondary terminals are connected to earth and to the grid of the following valve. A skeleton circuit showing the first detector, oscillator, and first I.F. valves is given at Fig. 2, from which the connections for both the transformers and oscillator coil can easily be obtained. After connecting up the primary and secondary sections, all the I.F. transformers must, of course, be

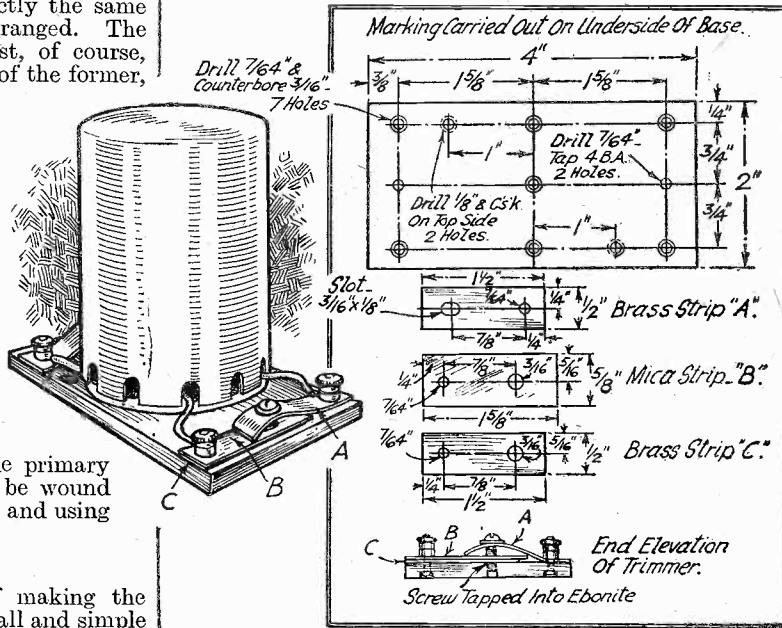

Fig. 4.—Full constructional details of the I.F. transformer and pre-set trimming condensers are given in this drawing.

hole. The slot can be made by drilling a $\frac{1}{4}$ in. hole and then extending it by means of a small file, or by holding the metal in a vice and pressing the drill against the side of the hole, so cutting away some of the metal. Two holes must also be made in the mica (or celluloid) as shown, this being done most successfully by means of punches made from iron wire or nails. The process of assembling the condensers is as follows: fit the bolt of one terminal through its hole in the base and place the lower brass plate in position with the mica directly over it; next bend the other strip of brass so that it bows upward in the middle; now attach this under the clamping nut of the second

matched up by adjusting the pre-set trimmers by means of a long insulated screwdriver. At least two, and often three, intermediate-frequency transformers are required for every superhet, and it need scarcely be mentioned that it is absolutely essential that they should all be very accurately matched. With this end in view the turns should carefully be counted as they are wound. For the same reason the plates of the pre-set condensers should be made as nearly as possible of identical dimensions. If these points are watched it is most unlikely that any difficulty will present itself. Further details regarding ganging sets of coils will be given in a later article.

The "Neutron"

WE have become accustomed to electrons and protons, the former being negative charges of electricity, and the latter positive charges. Now we have had thrust upon us the neutron, which we are led to understand is a charge that is neither. Can we hope that this is the end, as there would seem to be nothing that can be added to a positive charge, a negative charge, and no charge at all, although it is a charge all the same.

Disconnecting the Pick-up Plug

MOST commercial receivers have a pick-up plug and socket for use when reproducing gramophone records, and many listeners who do not possess a pick-up leave the plug in the socket to

PRACTICAL PARS

prevent losing it. While this practice may make no difference on the local station, or even on those stations that tune in at the top of the dial, it is to be strongly deprecated as it will mis-gang the receiver, and reduce volume considerably on those low-wave stations such as Fécamp.

Changing Over to a Variable-Mu

WHEN replacing a battery screen-grid valve it is an excellent opportunity to change over to a variable-mu type. This naturally necessitates the fitting of a potentiometer for volume control, three point switch, and so on, which the owner

may not be in a position to fit at the particular time that replacement is necessary. This is no reason why the old screen grid should not be replaced by a variable-mu type, as it will give similar performance without any additional components or alterations until the owner feels disposed to add the variable control, and gain the extra advantage of the variable-mu characteristic.

Electrical Zero

THE resistance of a conductor decreases as the temperature is lowered. It is thought that a current, once started in a loop, would go on running round for ever if the metal could be reduced to the "electrical zero," as it is believed that the loop would have no resistance.

Making MICROPHONE TRANSFORMERS

MICROPHONES have recently become extremely popular with wireless-set users as a means of providing entertainment in various novel and interesting ways, and this fact explains the reason why there are now so very many different types of instruments on the market at such reasonable prices. Previous articles in PRACTICAL WIRELESS have dealt with the problem of choosing a microphone and with the method of connecting it to the receiver, but many readers who already have a microphone, taken from an old telephone installation or made at home, have written to ask for further information.

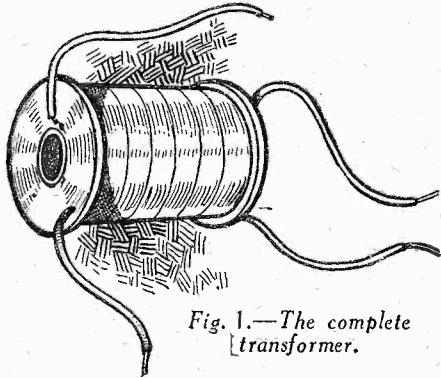

Fig. 1.—The complete transformer.

The point which has troubled most of these inquirers has been in regard to the use of a transformer between the microphone and the pick-up terminals of the set. Some cannot decide what type of transformer is required, whilst others do not appreciate the need for a transformer and inquire if it is really essential. As a matter of fact, a transformer is essential—quite essential—because the resistance of any ordinary type of microphone is very low, being in the region of but a few ohms. If such a low-resistance component were connected across the grid circuit of a valve it would act as a short-circuit, with a result that the valve would be prevented from functioning at all. On the other hand, if a resistance were wired in series with the microphone to increase the grid circuit resistance, the output from the microphone would be reduced to so great an extent that it could not operate the valve. Additionally, a direct current (generally taken from a small dry battery or accumulator) must be passed through the microphone, and this could not be done if the high resistance were in circuit. The only way to combine the requirements of high grid-circuit resistance and low microphone resistance is to employ a transformer with a low resistance primary and a high resistance (or more correctly, impedance) secondary. Besides giving the effects mentioned above, the transformer performs another important duty by increasing, or stepping

In this Article the Writer Describes One or Two Very Simple Methods by which the Constructor Can Make His Own Microphone Transformer.

up, the comparatively small fluctuating voltages passing through the primary and the microphone; this naturally results in a greater signal voltage being applied to the grid of the amplifying valve, and a consequent increase in output volume.

Transformer Requirements

The actual requirements of the transformer depend to a certain extent upon the particular microphone employed, but in nearly every case the principal need is for a primary having a resistance of no more than about 5 ohms and a secondary

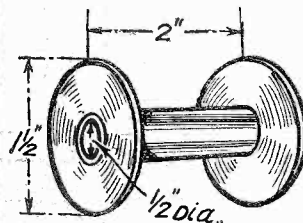

Fig. 2.—Details of the winding spool.

having an impedance, at average speech frequencies, of upwards of 50,000 ohms. These conditions are fulfilled by making transformers according to the particulars

which are to be given, the component in this case having a step-up ratio of 100 to 1. There are, of course, innumerable ways of making an efficient transformer, but the simplest and least expensive is to employ a core consisting of a bundle of soft iron wires fitted into a suitable bobbin containing the correct windings. A sketch of a component made according to the particulars just given is shown at Fig. 1. In making the transformer, a winding spool or bobbin must first be prepared, and details of this are given in Fig. 2. The first requirement is a cardboard tube about 1/2 in. internal diameter and 2 in. long, and if a suitable ready-made tube is not available it can be made quite easily by winding a 2 in.-wide strip of paper on to a wooden rod. Whilst the paper is being wound on, glue or shellac varnish should liberally be applied to it. When the adhesive has properly set, the tube should be perfectly rigid, and then a pair of 1 1/2 in. diameter cardboard end cheeks should be fitted. If a hole

is punched in the middle of these so that they fit tightly on to the tube no further strengthening should be required, but if they fit fairly slackly it is best to apply "tacky" glue and to give the whole bobbin a few coats of thin shellac varnish. After varnishing, the bobbin should be "baked" by placing it in a warm oven.

The Windings

The next step is to put on the windings. The primary comes first, and consists of 100 turns of 24-gauge d.c.c. wire. Start by making two holes through one of the end cheeks, and anchor the wire in these. After winding the correct number of turns, the other end of the wire can be anchored in the same way as before. Then cover the primary with a layer of empire cloth or insulating tape, taking care that it fits well up against the end cheeks. One hundred times as many turns are required for the secondary, and they are of 38-gauge enamelled wire. This wire is very thin, and the end must be soldered to a short length of flex anchored through a couple of holes in an end cheek, after which winding may be commenced. Attempt to keep the turns fairly even and approximately in layers, and after about every 2,000 turns insulate with a layer of thin waxed paper or oiled silk. It is rather a tedious task to wind on and count 10,000 turns, but the process is considerably simplified if the bobbin can be fitted on to a wooden rod which is gripped in the chuck of a hand-drill held in a vice. In that case it is most expedient to find the gearing ratio of the drill and to count the revolutions of the handle rather than the number of turns put on to the bobbin. It will be more helpful to know, however, that the

(Continued on page 758)

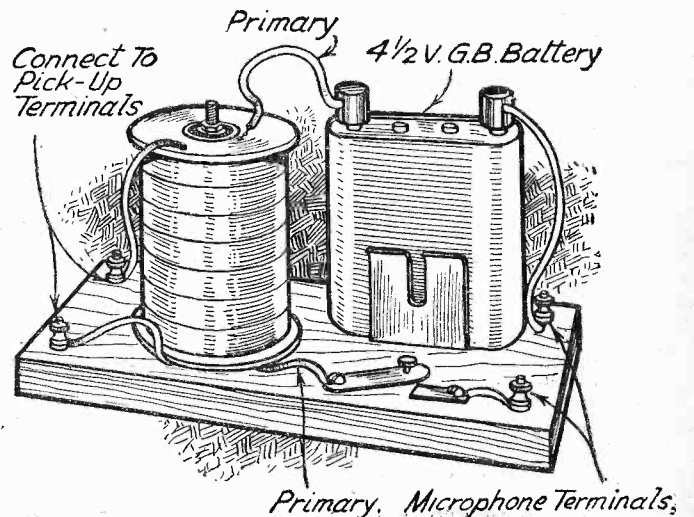

Fig. 3.—This sketch shows how a very convenient microphone unit (consisting of a transformer, battery, and switch) can be made.

**VARIABLE-MU
SCREENED-GRID CIRCUIT**

MOVING COIL SPEAKER

SINGLE DIAL TUNING

● Vivid, true-to-life reproduction—magnificent “all-Europe” performance—dignified cabinet design. These are the three great features which have made the Cossor Radio Console an outstanding example of moderately priced radio. Let your ears convince you of its superb tone—hear a Cossor Radio Console working at your local wireless shop.

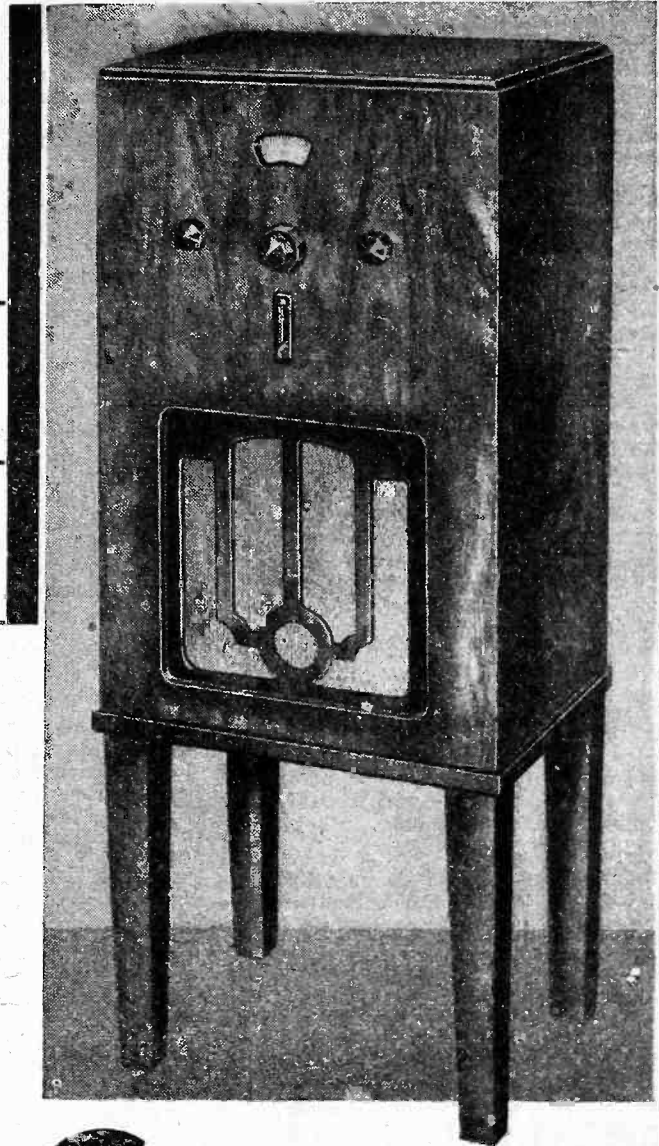

COSSOR CLASS "B" BATTERY CONSOLE Model 3456

Complete Receiver, as illustrated, with Cossor 220 VS Variable-Mu Screened Grid, Cossor 210 HL Detector, Cossor 215 P Driver and Cossor 220 B Class "B" Output Valves. Single-dial tuning, selectivity control and combined volume control and "on-off" switch. Wavechange switch for 200-530 and 900-2000 metres. Handsome walnut finished Console Cabinet, 2 ft. 11 in. high, 1 ft. 2 in. wide, 11 in. deep, giving ample accommodation for batteries. Permanent Magnet Moving Coil Loud Speaker of the latest type. Gramophone Pick-up Plug and Socket. **PRICE £9.19.0**

Price does not include Batteries or Accumulator. Hire Purchase Terms: 20/- deposit and 10 monthly payments of 20/-.

COSSOR ALL-ELECTRIC CONSOLE (for A.C. Mains) Model 3468

Specification similar to Battery Model 3456, but operating from Electric Light Supply. Complete with four Cossor A.C. Mains Valves viz.: M.V.S.G. (Met.) Variable-Mu S.G., 41 M.H. (Met.) Detector, 41 M.F. Output and 442 B.U. Rectifier. Mains Energised Moving Coil Speaker. Illuminated tuning-dial. For A.C. Mains only, 200/250 volts adjustable, 40/100 cycles. **PRICE £10.15.0**

Hire Purchase Terms: 25/- deposit and 10 monthly payments of 21/-.

COSSOR ALL-ELECTRIC CONSOLE (for D.C. Mains) Model 3469

As Model 3468, but for operation on D.C. Mains. Supplied complete with three Cossor D.C. Mains Valves viz.: D.V.S.G. (Met.) Variable-Mu S.G., D.H.L. (Met.) Detector and D.P. Power Output. For D.C. Mains only, 200/250 volts (adjustable). **PRICE £10.15.0**

Hire Purchase Terms: 25/- deposit and 10 monthly payments of 21/-.

Prices do not apply in I.F.S.

Legs are detachable on all Console Models and the receivers can be used as table models with legs detached.

**COSSOR
RADIO CONSOLES**

To A. C. COSSOR LTD., Melody Dept., Highbury Grove, London, N.5.

Please send me free of charge, your 20-page Catalogue of Radio Receivers B.20.

Name.....

Address.....

PRAC. 30/12/38

MAKING MICROPHONE TRANSFORMERS*(Continued from page 756)*

weight of wire required for the full 10,000 turns will be slightly over four ounces, and therefore, provided a four-ounce reel of 38-gauge wire is obtained, there will be no need whatever to count the turns, especially since the exact number is by no means critical.

Fitting the Core

When the winding has been completed the wire should be covered with a few layers of insulating tape to protect the fine wire from injury. After that the core must be fitted, and this will consist of a bundle of soft iron wires 2in. long. Suitable wire can be obtained from most ironmongers, being sold by weight in lengths of about 9in. to 10in., for use by florists and butchers. It is essential that the wire should be really soft, and if any doubt exists in regard to this it should be tied in a bundle, placed in a low fire on going to bed, and left until morning; this will anneal it perfectly. Cut the wire into suitable lengths and then fit it into the wound bobbin, packing it as tightly as possible to prevent any possibility of vibration.

The finished transformer can be mounted on a small board by means of brass straps, or by using the method illustrated in Fig. 3.

In the latter instance a length of 4 B.A. screwed brass rod is fitted through the middle of the core and is used to mount the component in an upright position on a baseboard or on the chassis of the amplifier.

A Neat Microphone Unit

The complete unit shown in Fig. 3 is a convenient little microphone accessory, consisting of the transformer just described, a 4.5-volt G.B. battery for operating the microphone, and a simple on-off switch. The drawing is almost self-explanatory, but it might be mentioned that the switch is made from a couple of strips of brass attached to the hard-wood baseboard by means of two screws. The longer brass strip is made to pivot so that it can make or break contact with the smaller strip. By using this idea the microphone can permanently be left connected to the terminals arranged for it, whilst the other terminals are joined directly to the pick-up terminals of the receiver or amplifier. It is, of course, necessary to "open" the switch contacts when the microphone is out of use, so that the dry battery is not run down unnecessarily.

Other Forms of Construction

If an old and burnt-out L.F. trans-

former is available, a slightly better component than that described above can be made by using the core stampings and winding spool. The core clamps should first be removed, and then the core stampings are withdrawn and the spool unwound. After that, the spool should be rewound, using 50 turns of 24-gauge d.c.c. wire for the primary and 5,000 turns of 38-gauge enamelled wire for the secondary. The method of winding is exactly as described above, whilst information in regard to the method of reassembling the core stampings can be obtained from the article dealing with the construction of L.F. and smoothing chokes published in the issue of PRACTICAL WIRELESS dated December 23rd. It should be pointed out that the reason for employing only half as many turns in this case is that the iron core is "closed," so giving a similar inductance and impedance with fewer turns of wire.

When it is desired to make a transformer of the "closed core" type and an old L.F. transformer is not to hand, it can be done by obtaining three dozen No. 5 stallo stampings and making a winding spool and clamps to fit it as explained in the previous article just referred to.

UNIVERSAL MAINS RECEIVERS*(Continued from page 755)*

a greater number of valves is employed and the set is to work from 110 volt mains the lower voltage ones must be used.

The Series Resistance

For our present purpose let us assume that the 20-volt valves are being used. When three are connected in series a total of only 60 volts will be required to heat them, and, therefore, the difference in voltage between this and that of the mains must be dissipated by the resistance R. It will now be clear why the latter resistance is tapped at a number of points, each of which is marked with a particular voltage figure. If it is assumed that the highest voltage ever to be applied to the set will be 250, the maximum voltage to be eliminated by R will be 250-60, or 190. The total value of the resistance can then be calculated by dividing 190 by the heater current, which is .18 amp. (Ohm's law, of course). As a result of this simple calculation the resistance required is found to be just about 106 ohms, and by making other similar calculations the value required

between the end of the resistance and the various tappings can readily be found. After that, a component can be made up from Eureka resistance wire and an asbestos former, or it can be bought ready-made from Messrs. Bulgin or some other firm of manufacturers.

If D.C. valves of the type taking a heater voltage of 16, and a current of .25 amp., were to be used, the above calculation would be slightly modified, since the total voltage required by the three valves in series would be only 48 and the current would be .25 amp.

In Fig. 2 it will be seen that a 25-ohm variable resistance is wired in series with the tapped one used for voltage-dropping, and the purpose of this is to regulate the heater current to the exactly correct value when the set is connected to mains of a voltage different to that provided for by any of the tappings. The correct setting of the resistance can be determined with sufficient exactness from the position of the slider, but if desired, an ammeter may be inserted in series with it and an adjustment made so that the current flowing is just right.

Component Values

The approximate values of all the important components are shown in Fig. 2, and extensive use is made of electrolytic condensers for smoothing purposes.

In order that the electrolytics may easily be distinguished from the ordinary paper and mica components they are marked with positive and negative signs to indicate the correct polarity. It should also be noticed that two 1-amp. safety fuses are included in the mains leads to prevent damage in case of accidental short-circuits. Additionally, as a further safety measure, a 2 mfd. fixed condenser is inserted in series with the earth lead; the object of this is to prevent a short-circuit of the mains fuses when working on

D.C. mains whose positive is earth-connected, or when the A.C. supply is so connected that the "live" side is joined to the earth line.

Safety Measures

There are certain precautions which must be taken in building and using any type of universal mains receiver, because the set is always in direct contact with the supply leads. The main precaution is to ensure that all controls are well insulated, and that grub screws in the knobs are well sunk to prevent the possibility of touching them. An additional safeguard is to fill in the grub screw-holes with sealing wax or other insulating material. It is also important that a fixed condenser should be included in both the aerial and earth leads so that the actual wires going away from the set to aerial and earth are ("electrically") quite "dead." Fuses should be a standard fitting in any receiver, but they are more than ever important in a universal mains instrument.

When connecting the set to A.C. mains it does not matter which way round the plug is fitted, but when D.C. mains are used it is absolutely essential that correct polarity should be obtained. Just as is the case with a normal D.C. receiver, no results will be obtained if the positive and negative leads are reversed. In addition to this, where electrolytic smoothing condensers are employed they would be in danger of being damaged if they were subject to the wrong supply polarity for any length of time. To check this latter point it is best, where possible, to determine the positive and negative sides of the mains and to mark the sockets in some way so that they can easily be recognized later. Of course, it is possible to determine the proper connections by trial and error methods, because the set will fail to operate if the leads are reversed, although the valve heaters will show a light. If the set has repeatedly to be connected and disconnected, it might be better to employ ordinary smoothing condensers in place of the electrolytics shown, or otherwise to fit a simple polarity indicator to the set.

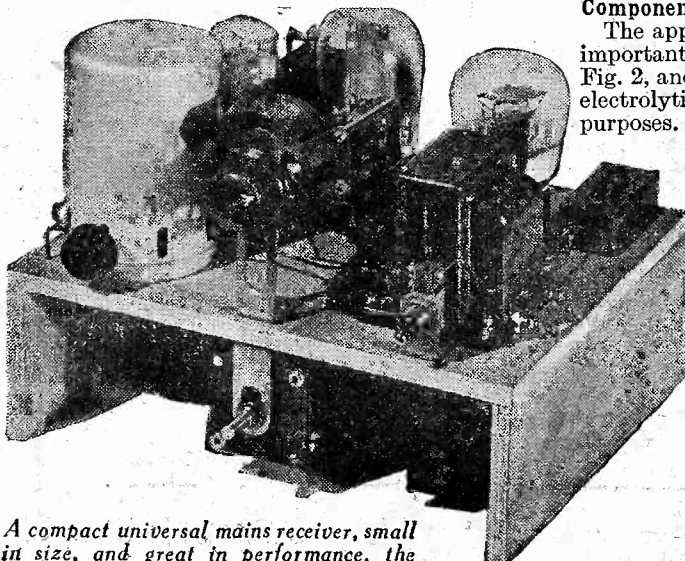

A compact universal mains receiver, small in size, and great in performance, the "A.C.-D.C. Two."



READERS' WRINKLES



Making Soldering Flux
SOLDERING flux of sorts has been responsible for many breakdowns. If you use flux which has an acid content you must be prepared for trouble at some time or other, especially where it is used

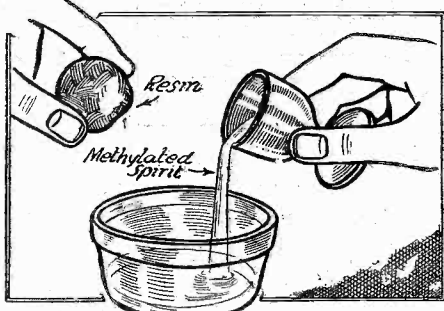

Soldering flux made with resin and methylated spirit.

on thin wires. By making your own flux you can be sure that no acid exists. The only precaution to be taken is that the wire be well cleaned, a procedure which is generally done by the acid in the purchased flux. Get a knob of resin the size of a walnut, break up small and place in a container having sufficient methylated spirit to fill an ordinary egg cup. When the resin has dissolved the flux will be ready for use. Apply to the joint to be made and solder in the ordinary way.—W. G. HILL (JUN.) (Dagenham).

An Efficient Lead-in Insulator
IN endeavouring to find an ideal lead-in that would give an infinity reading under most severe conditions, I have used the arrangement shown in the accompanying sketch. The glass bottles were easily cut by tying a methylated-spirit-soaked string around the bottle in the desired position, lighting the string, and when almost burned out, plunging the bottle into cold water, when a crack appears around the bottle. A gentle tap all round does the rest. The lead-in rod was made from 2B.A. studding and wing-nuts.—R. E. NEWITT (Balham).

Aerial Selectivity Unit
The following is a brief description of what may be called an aerial selectivity unit, which has been found very effective in reducing, and in many instances entirely eliminating, interference and

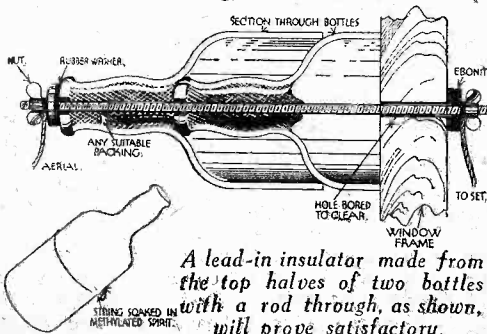

A lead-in insulator made from the top halves of two bottles with a rod through, as shown, will prove satisfactory.

THAT DODGE OF YOURS!

Every Reader of "PRACTICAL WIRELESS" must have originated some little dodge which would interest other readers. Why not pass it on to us? We pay £1-10-0 for the best wrinkle submitted, and for every other item published on this page we will pay half-a-guinea. Turn that idea of yours to account by sending it in to us addressed to the Editor, "PRACTICAL WIRELESS," George Newnes, Ltd., 8-11, Southampton Street, Strand, W.C.2. Put your name and address on every item. Please note that every notion sent in must be original. Mark envelopes "Radio Wrinkles." Do NOT enclose Queries with your Wrinkle.

heterodyning from other unwanted stations. The performance of this unit has been equally effective on both long- and medium-wave bands. Two variometers are used, the rotor and stator of each being wound with 200 turns of 40-gauge enamel wire, and both stators being wound approximately

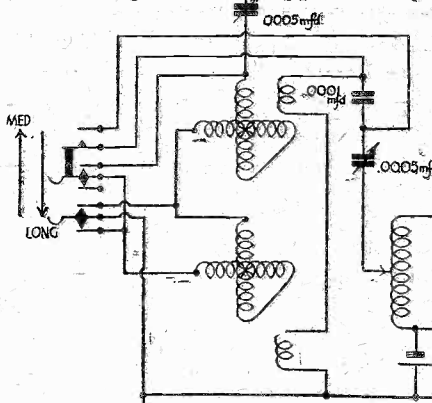

1 in. apart on the same former, which has a diameter of 2 1/2 in. The aerial series condenser has a maximum capacity of .0005 mfd., and is of miniature type (mica dielectric). The variometers are connected in parallel for medium wave, and in series for the long-wave band, the change being made by means of a Kellogg type key-switch, which is indicated in the diagram. The coupling from the unit to first stage of the receiver is by means of two windings i.e. 15 turns of 26-gauge wire, which are wound over each stator and connected in series. One of the remaining outer ends is taken direct to earth, and the other end through a .0001 fixed condenser and also a .0005 variable. These are in series with each other, but it will be seen from the diagram that the .0001 fixed condenser is short-circuited when the unit is operating on medium waves, this being done by means of the two remaining springs on the key-switch.

It will be found that the .0005 variable condenser in the coupling coil circuit, besides aiding selectivity, acts as an excellent volume control. The great advantage of this unit is that most stations are received with very little loss of volume.—V. D. BROOKER (Chelmsford).

A Slow-Motion Remote Control Device

IN short-wave receivers particularly, a good slow-motion control, with anti-hand-capacity control, is essential. The arrangement illustrated may be made up to operate on the standard 3 in. ebonite dials. A large socket, such as the Clix No. 14, is mounted on the panel close against one part of the dial. A plug to fit the socket is then provided with a rubber ring such as may be obtained for one penny for umbrellas. Through the upper part of the plug a piece of stiff wire is passed, projecting about 1/4 in. on either side. A

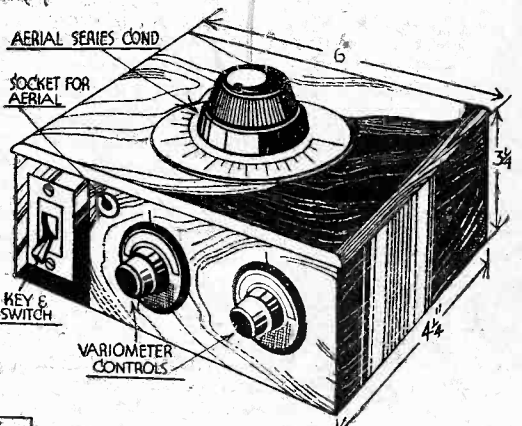

Above is shown the finished aerial selectivity unit and (left) the circuit diagram.

piece of ebonite tubing having an internal diameter to form a fairly comfortable fit over the plug end is next obtained, and a saw-cut made for a depth of about 1/4 in. at one end to accommodate the cross wire. A small spring tool-clip from the popular stores is next screwed on the panel or inside the cabinet lid to accommodate the ebonite handle when not required. In use, the handle is removed and placed over the cross wire and rotated, during which it is pressed slightly so that the rubber ring presses on the edge of the dial.—D. LANIER (Hendon).

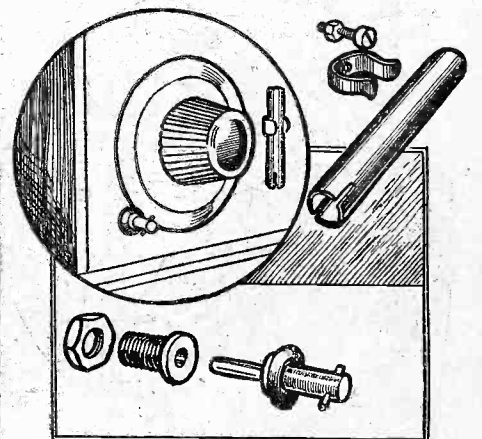

Details of the slow motion remote control device.

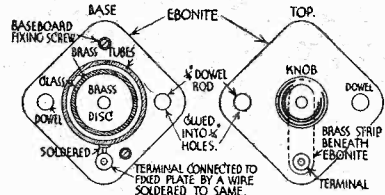
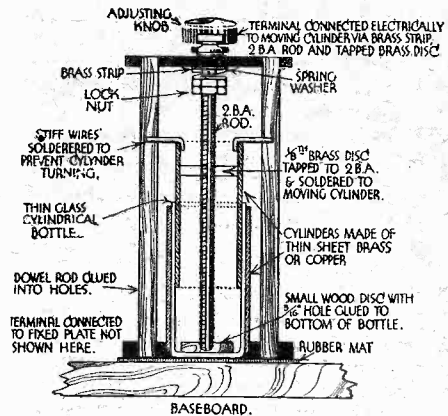

Constructional details for making a tubular condenser.

A Tubular Variable Condenser

THE useful tubular variable condenser shown in the accompanying diagrams is quite easy to make. Although intended for base-board mounting, it is easily adapted for panel mounting, if necessary, by reversing the upper terminal, fixing a bent brass bracket to each ebonite square to support the condenser, and making the 2 B.A. rod a little longer.

A cylindrical-shaped glass bottle is used for the dielectric, a piece of thin sheet brass is placed around the glass, the ends of both being placed in a hole cut to the required size in the ebonite base, and fixed with strong adhesive. An elastic band keeps the top pressed close to the bottle, or adhesive may be used for the purpose.

Another piece of thin brass sheet is bent to shape and slipped in the glass. A disc of 1/8 in. brass is then made with a central hole drilled and tapped 2 B.A. This disc is soldered inside the tube, as shown in the diagram.

The 2 B.A. rod is fitted with a knob, spring washer, and two nuts. The upper terminal is connected to the 2 B.A. rod by a brass strip, as shown.

The diagram clearly explains the fitting

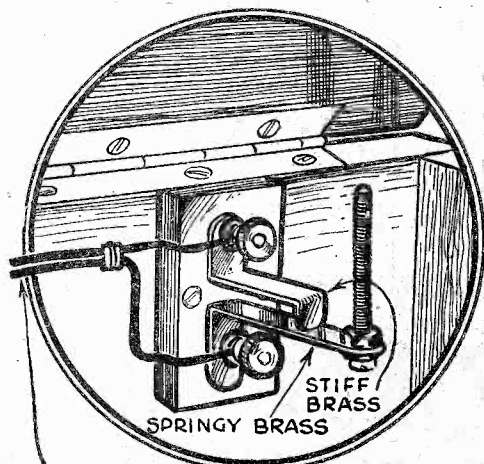

An automatic switch for a radiogram.

of the dowel rod pillars, which are just over twice the height of the bottle.

By rotating the knob the capacity of the condenser is altered with a slow-motion effect. The component will be found very useful, especially in short-wave experimental work.—C. E. GREAVES (Birtley).

An Illumination Refinement

THERE are several devices upon the market for dial lighting and "wave-range" indicators. They are mostly mechanical appliances actuated by cams controlled from the coil bases, etc.

The accompanying sketches show a simpler and cheaper substitute to give a similar effect.

The controls for this arrangement may easily be constructed by the provision of additional contacts placed at the rear of the wave-change-over push-pull switch. The diagrams are self-explanatory—the contact strips being detailed in Figs. 1 and 2, and the connections in Fig. 3. Furthermore, a few more applications may be made of this principle. Suppose an enthusiast has a triple-wave set and a dual reading dial carrying two (long and medium) illuminating bulbs; it is a good scheme to provide facilities to light both these lamps as a visual short-wave indication. This facility is easily catered for by adding the connections shown chain-dotted in Fig. 3.—W. A. HARRISON (Aintree).

Automatic Switch for Radiogram

THE accompanying sketch should make the construction quite clear. The

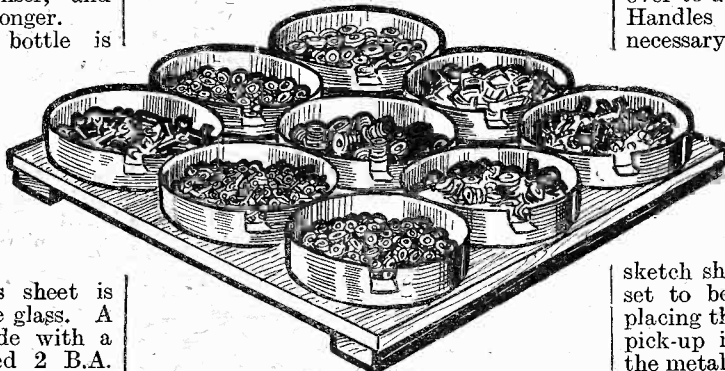

A handy container for odd nuts and bolts, etc. Tabs are cut and bent to allow a small label to be stuck on.

materials required are an odd bit of ebonite 1 1/2 in. by 1 in., two terminals from an old component, a small nut and bolt, a strip of stiff brass 1 1/2 in. by 1/4 in., and a strip of springy brass 2 in. long (from an old torch battery). Drill a hole 1/4 in. from each end of the springy brass, put the bolt through one hole and lock it tight by its nut. Bend the other end at right-angles 1/4 in. from the end, drill hole 1/4 in. from one end of stiff brass strip, and bend this at right-angles at this end; also bend it at right-angles in opposite direction 1/4 in. from the other end. The switch can now be wired in series with a screw-in bulb holder, which can be placed at any convenient place in cabinet. Connection can be made either to a dry battery or across the filament terminals of one of the valve holders.

When the lid is closed it bears on top of the bolt and the contact is broken, but on opening the lid the contacts are closed, thus completing the circuit.—S. C. DUFFETT (Kettering).

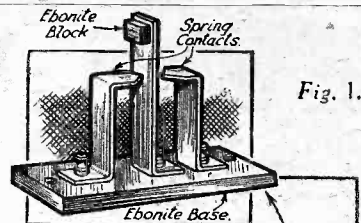

Fig. 1.

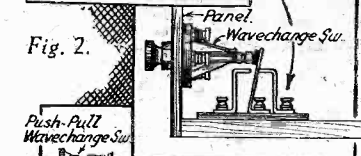

Fig. 2.

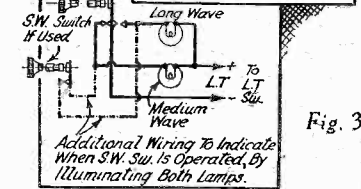

Fig. 3.

A cheap and simple lamp for dial lighting and wave-range indicators.

A Useful Dodge for Storing Small Parts

FOR storing and keeping handy the multitude of wireless bits and pieces, such as nuts, bolts, washers, etc., I have adopted the following simple plan. I collected a dozen round 2oz. tobacco tins and fixed them on a board, as shown in sketch, by means of a wood screw through the bottom of each tin. For identifying the various sections, the side of each tin is slotted in a convenient place and bent over to allow a small label to be stuck on. Handles may be fixed to the board, if necessary. I also make use of this idea for holding wood screws, nails, etc., and find it saves a lot of time.—L. A. GINGER (Barnes).

Radiogram Switching Device

MANY people who possess a radiogram forget to switch off after using the pick-up. The accompanying sketch shows a method which enables the set to be switched off automatically by placing the pick-up on the rest. When the pick-up is placed on the rest it forces the metal rod down, thus breaking the circuit. The two leads, A and B, are connected in parallel with the L.T. switch.—W. G. VINCENT (Walforth).

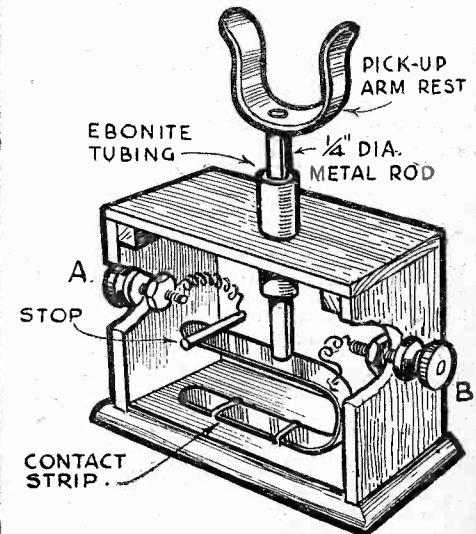

A switch for automatically switching off the radiogram, worked by simply placing the pick-up arm on the rest.

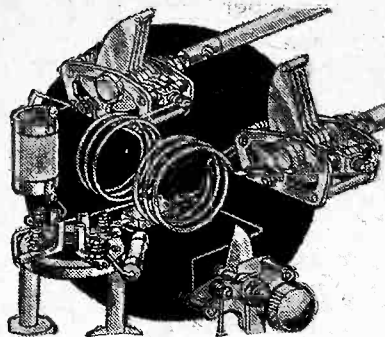

Short Wave Section

NOTES ON SHORT-WAVE SUPERHET. RECEIVERS

By MANDER BARNETT

IN previous notes on short-wave matters I have made reference to the superheterodyne type of receiver for short-wave reception, and I propose at this point

Adding a Pentode Output Stage

Such a receiver, of course, is not of very much practical value, but by adding a power pentode output stage, a useful and

with selectivity, and we require to use the superheterodyne system mainly for the increase in signal strength available and for the added ease of tuning, which this system does provide in a way which no other type of receiver can, and this is a very important point for short-wave reception, as any amateur who has had any experience at all of short-wave work will know.

A short-wave superheterodyne receiver does not need to be a costly affair, and a very satisfactory model for loud-speaker operation need not have more than five valves—if A.C. operation is required, this can often be cut down to four, taking advantage of the superior characteristics of mains valves. In a battery model, these valves may take the sequence of (a), combined first detector and oscillator, (b), intermediate frequency amplifier (hereafter referred to as the I.F. amplifier), (c), the second detector, (d), the first L.F. amplifier, and (e), the power output stage. We can thus bring the number of valves down to a reasonable figure, and the final results from five valves arranged in this manner will certainly be vastly superior to those to be obtained from a "straight" receiver using the same number of valves.

If an even more powerful receiver is required, further amplifying stages can be added between (b) and (c) in the sequence referred to above, or high-frequency amplifiers can be added at signal frequency ahead of the first valve on the lines of a normal high-frequency amplifier for short-wave work.

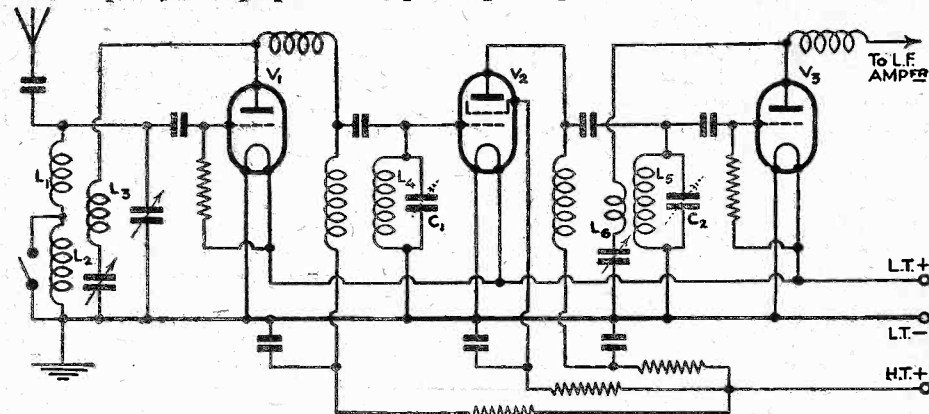

to go rather more closely into the short-wave superheterodyne question, as it is a matter worthy of the serious attention of all amateurs who have any interest at all in short-wave reception. The construction of a short-wave superheterodyne receiver can well be the starting-point for an amount of really interesting work for those amateurs who have perhaps already built one or two short-wave receivers of the straight type. Due, no doubt, to an amount of prejudice to this type of receiver in the past, many people have got hold of the idea that a superheterodyne receiver is necessarily a costly affair owing partly to the fact that a large number of valves is supposed to be necessary. Present-day practice, however, proves this to be wrong and actually, indeed, the very simplest form of superheterodyne receiver need have but two valves. Now, that may sound rather startling at first, but it is nevertheless quite correct, the valves being used in the sequence of (a) combined first detector and oscillator and (b) second detector—that is, the bare superheterodyne principle is used without employing any amplifying stages, either at high, low, or intermediate frequency, other than the amount of amplification which is given by these two valves themselves.

extremely selective receiver can be made on these lines for use on the medium and long-wave bands, selectivity being the chief feature. However, for short-wave work, we are not particularly concerned

Reception on 100 Metres

For satisfactory reception up to about 100 metres, one valve and one tuned

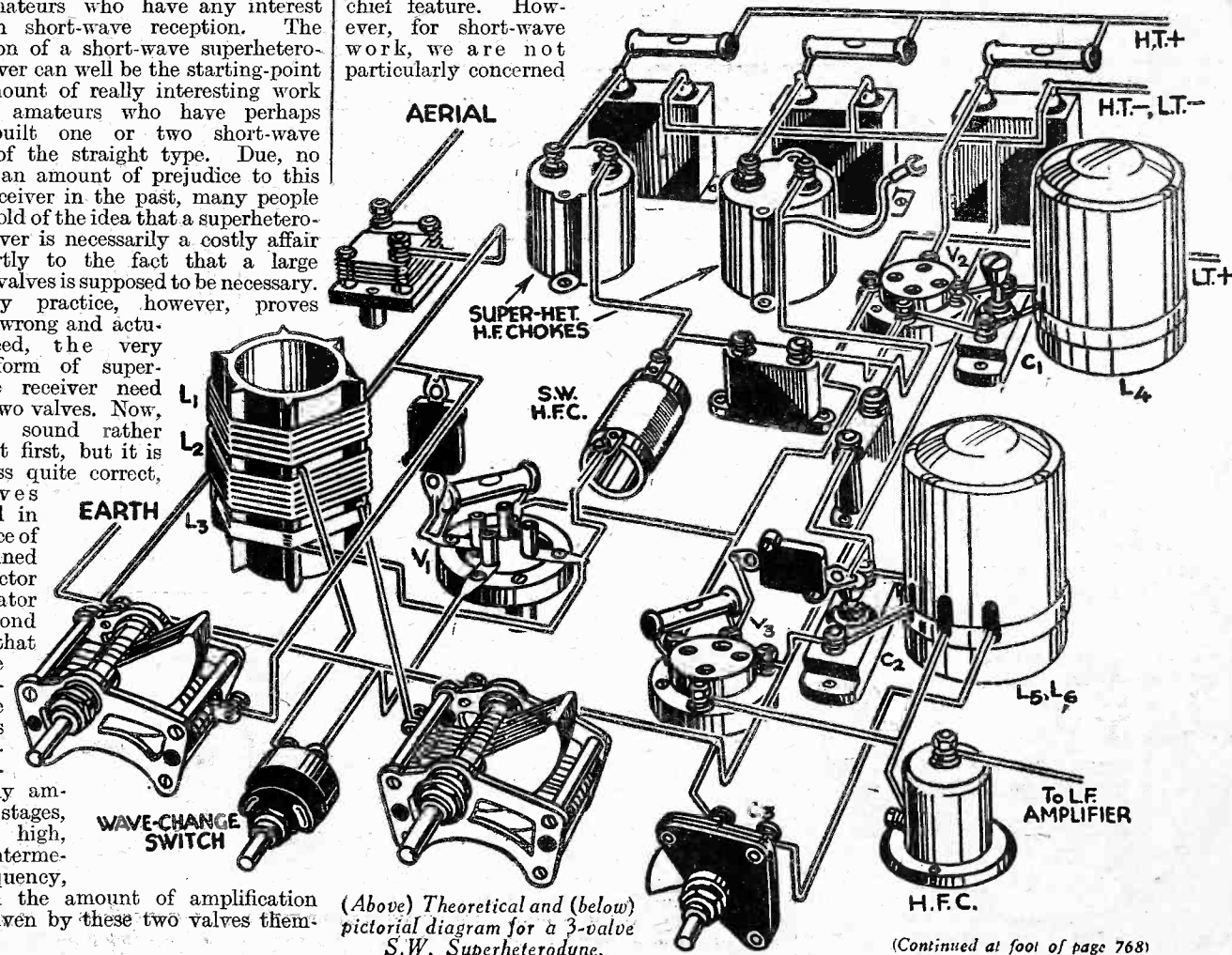

(Above) Theoretical and (below) pictorial diagram for a 3-valve S.W. Superheterodyne.

(Continued at foot of page 768)

Where the CURRENTS FLOW

IN the first instalment, the circuit of a fairly simple receiver was traced through and the complex nature of the currents flowing through the various parts of the network were examined. The circuit chosen, while representative of a large number of standard sets, could not, of course, permit of an exhaustive analysis of the current distribution in every type of receiver—those, for example, operated from A.C. mains or from D.C. mains; those employing straight or variable- μ high-frequency stages; super-hets; sets with automatic volume control; and the hundred and one other special features the various permutations of which make the difference between one design and another.

Complex Nature

This week I shall deal with two further aspects of the complex nature of the currents flowing in radio circuits. You have probably noticed that in most circuits a single connecting wire, or, perhaps, a certain component, may actually form a part of two or even more different circuits. A very simple example of this is the low-tension network of a battery-operated receiver, such as is shown in skeletonized form in Fig. 1.

Here, F_1 , F_2 , and F_3 are the valve filaments, and B is the low-tension accumulator. It is clear that the circuit of F_1 can be considered as the filament itself plus the low-tension leads and the battery B. Similarly, the circuit of F_2 consists of F_2 , part of the low-tension wiring, and the battery; and the circuit of F_3 is composed of F_3 , part of the wiring, and the battery. So you see, the battery is common to all three circuits.

Now suppose that for some reason, variations of voltage were produced in that part of the network which is common to all three circuits, that is to say, in the battery. Obviously, corresponding current variations would take place in each of the filament circuits. There is very little chance of serious variation of this sort occurring in the low-tension network of a battery set, but there are innumerable other places in a set where effects of this kind may take place, and may give rise to serious trouble.

An Example

Here is a very common example. Fig. 2 shows the essential anode circuit connections of a 3-valve battery or H.T. eliminator set, from which it will be noted that the high-tension supply unit is common to all three circuits. The anode current of V_1 consists of a direct current with both radio-frequency and audio-frequency components. The anode current of the detector

Part 2.

Some Further Aspects of the Complex Nature of the Currents Flowing in Various Radio Circuits.

By H. BEAT HEAVYCHURCH

valve V_2 is a direct current with audio-frequency variation, while the anode current of V_3 is also a direct current, with a very large audio-frequency component. All these complex currents will flow simultaneously in the high-tension supply unit, and because the H.T. source possesses a far from negligible resistance, the variations in load current will cause voltage variations—in other words, an alternating voltage will be developed

the other valves. These variations will then be transferred *via* the inter-valve couplings to the grid circuits of the succeeding valves, and will be amplified therein, finally appearing as a spurious signal voltage at the grid of the output valve which, in turn, causes still greater variation in the anode current of that valve, resulting in increased voltage variations in the high-tension supply.

From a Ticking to a Howl

Thus the whole cycle starts again, with the result that the "back-coupled" voltage eventually upsets the stability of the set, and the low-frequency oscillations developed are made manifest in the speaker by noises which will range from slight ticking sounds to a popping reminiscent of a motor-boat, or even to a full-throated howl, according to the electrical characteristics of the circuit.

Fortunately, it is not difficult to avoid the troubles due to "back coupling," as it is termed. The cure is "decoupling."

It is a recognized electrical law that if a current is passed through a circuit possessing impedance, a voltage drop occurs across that impedance, and the voltage drop is proportional to the strength of the current and to the value of the impedance. Further, if the current is passed through two impedances in series, the total voltage drop across the pair will be divided between them in the proportion of their impedances. Thus, if a high and a low impedance are connected in series, the voltage drop across the high impedance will be very great compared with that across the low impedance.

This principle can be applied to decoupling circuits in which there is a risk of instability due to back coupling. The method consists in connecting in the circuit to be decoupled a resistance or choke having a high impedance to alternating current, and by-passing this to earth by a condenser having a relatively low impedance to alternating currents.

Harmful Voltage

A typical example is shown in Fig. 3, in which the variations in (Continued on page 764)

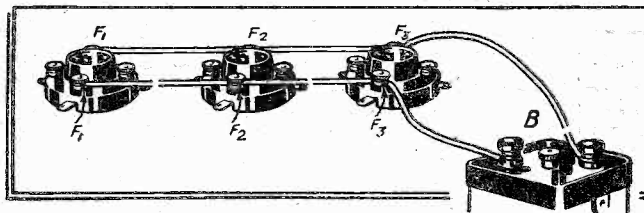

Fig. 1.—Skeleton filament network of a battery-operated receiver.

across the resistance of the high-tension unit.

As the actual values of the anode currents of the early stage valves are small, and

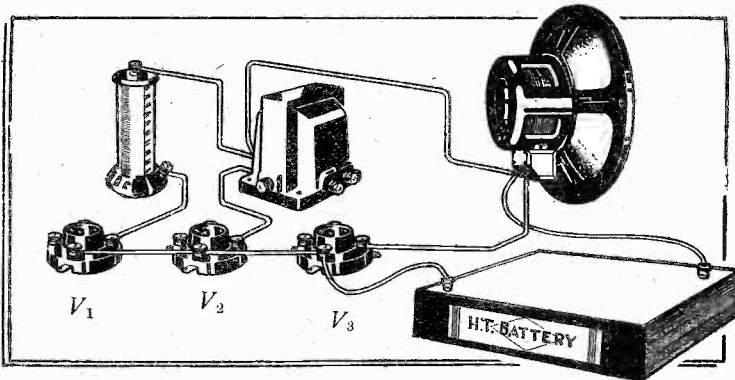

Fig. 2.—The skeleton anode network of a three-valve battery set.

their variations at radio frequency or audio frequency are not very great, the voltage fluctuations in the total anode feed caused by them may not be serious. But the audio-frequency pulsations in the anode current of the output valve form a fairly large percentage of the total rectifier load, and give rise to really substantial audio-frequency voltage variations, which will appear also in the high-tension feed currents of all

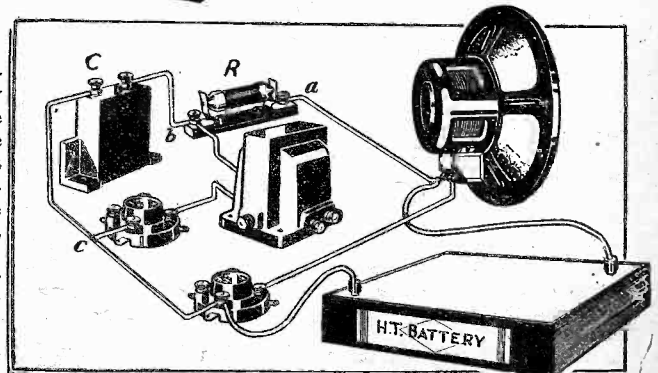

Fig. 3.—Simple decoupling by resistance R and condenser C.

Making an All-Purpose Test Meter

In this Article the Author Explains its Construction and Operation.

By DAVID SUTTON



EVERY serious radio experimenter needs a good-quality testing set, for to-day efficient radio reception is more than ever a matter of exact design and adjustment. The instrument here described was built to provide a handy means of measuring the various currents and voltages

The 2-milliamp range will be found extremely useful for checking the screen currents of high-frequency valves; 20 milliamps is a useful range for the average battery receiver, while the 200-milliamp range is amply large for any work likely to be undertaken by the amateur.

A simple application of Ohm's law enabled the values of the volt-range line resistances to be determined as follows: 30,000 ohms for the 6-milliamp range;

Two views of the completed meter.

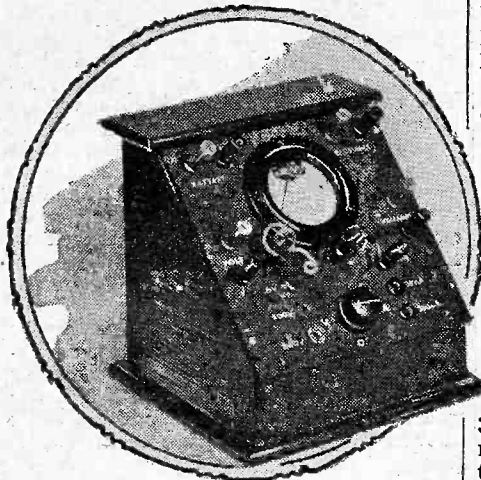

100,000 ohms for the 200-volt range, and 300,000 ohms for the 600-volt range. These resistors are of the popular 1-watt metallized type. Standard samples can be used if great accuracy is not desired, but the writer considered it worth while to pay a few pence extra for resistors guaranteed accurate to 1 per cent. of the rated values.

The 2-milliamp range is the normal range of the instrument, while shunts of one-

in radio receivers of all sorts, both in connection with "fault tracing" and for those precise preliminary adjustments which are essential if sets of modern design are to be operated at maximum efficiency. Provision is also made for taking fairly accurate measurements of resistances up to about 75,000 ohms.

Before describing the test set in detail it may be well to indicate the considerations which governed the choice of the instrument proper. It was decided at the outset that a fairly high standard of accuracy was essential, and therefore a good quality moving-coil milliammeter was selected.

Moreover, in order to avoid erroneous low readings when measuring the voltage of batteries on load, it was obvious that a low-range milliammeter, taking a maximum drain of, say, 2 milliamps should be employed in conjunction with line resistances for the voltmeter ranges.

Components Incorporated

The actual instrument selected is a 2in. dial flush-mounting moving-coil milliammeter giving a full scale deflection with 2 milliamps, but actually having two scales, one graduated 0-2 and the other 0-6. This double scale immediately suggested the following ranges: 6, 200 and 600 volts, and 2, 20 and 200 milliamps. These ranges are extremely convenient in practice, for the 6-volt range is just right for low-tension battery testing; 200 volts covers high-tension measurements in all battery sets and most mains receivers, while the 600-volt range is useful when dealing with the larger high voltage output valves employed in powerful mains sets, and small public address gear.

ninth and one ninety-ninth of the instrument resistance are used as multipliers for the 20- and 200-milliamp ranges. The instrument specified has an internal resistance of exactly 90 ohms, so that the shunts must be of 10 and 0.9 ohms respectively.

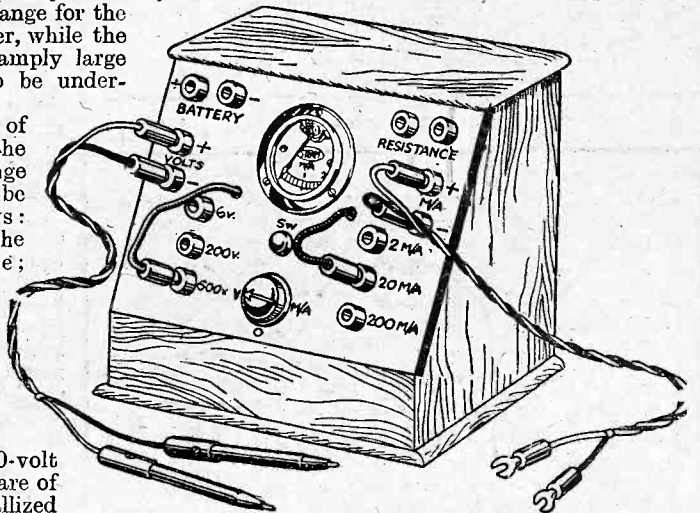

These can be purchased with the instrument, thus saving considerable trouble, or the constructor can make his own if he prefers.

For resistance measurements, provision is made for connecting the milliammeter in series with a dry cell and with the resistance under test, and the accompanying table will enable the value of the resistance to be found from the milliammeter reading. In order to avoid risk of damaging the meter when measuring low resistances, a limiting resistance is included in the ohm-meter circuit. This resistance is of 660 ohms, which, with the instrument resistance of 90 ohms, makes 750 ohms permanently in circuit and limits the current to 2 milliamps when using a 1½-volt dry cell. The resistance table takes account of this limiting resistance, that is to say 750 ohms have been subtracted from the values found by calculation.

Theoretical Circuit

Fig. 1 shows the theoretical circuit of the test set. It will be observed that a double-pole, double-throw switch, S1, permits the instrument to be changed over from the milliamp range to the volt range. This useful provision allows milliamp and volt readings to be made in rapid succession without disconnecting the milliamp leads. This switch has also an "off" position and should always be moved to this position when taking resistance measurements, especially if any apparatus is connected to either the volt or milliamp terminals.

Choice of voltage and milliamp ranges are made by two selector plugs on short

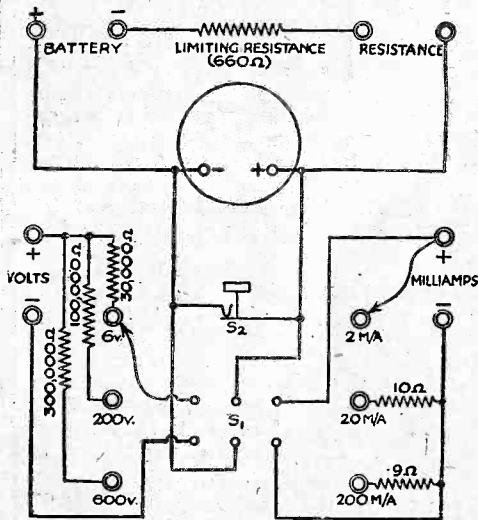

Fig. 1.—Diagram of connections.

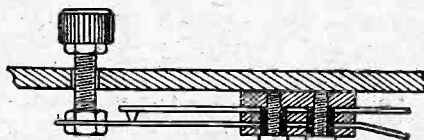

Fig. 2.—Detail of safety switch.

(Continued overleaf)

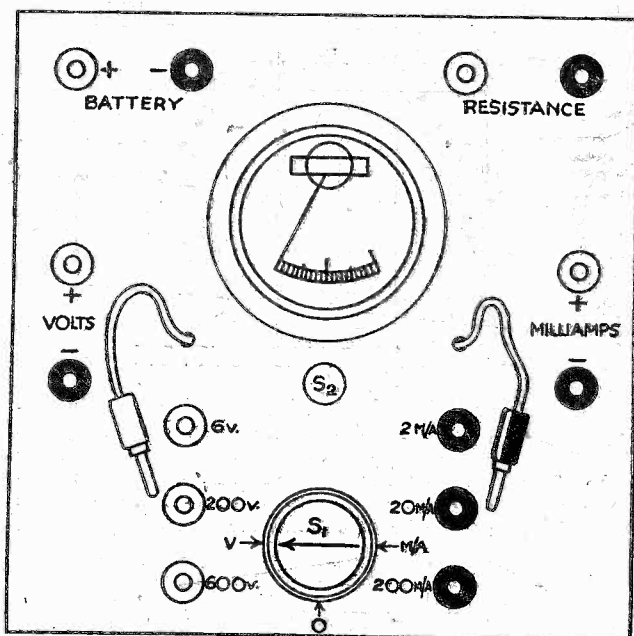

Fig. 3.—Panel layout.

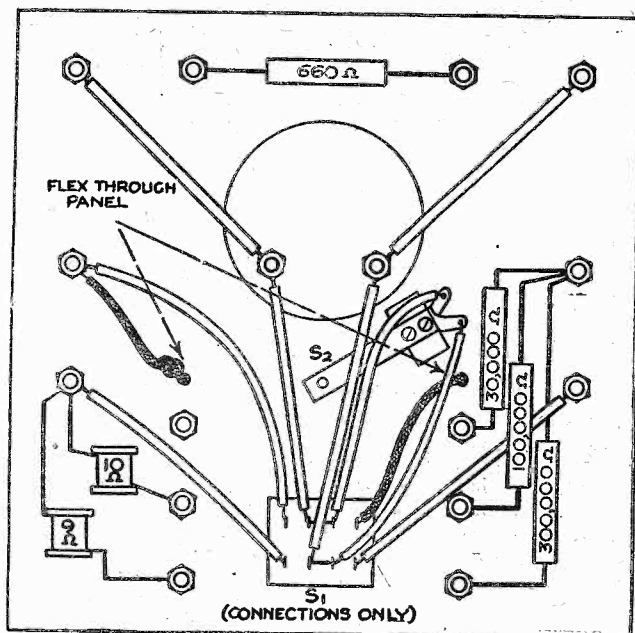

Fig. 4.—Back of panel connections.

(Continued from previous page)

flexible leads which must be inserted into the appropriate sockets.

The switch S2 is a safety switch which normally short-circuits the instrument. When taking a reading the switch must be depressed, thus breaking the short circuit. This gives a final opportunity for examining the connections and settings of the switch and it avoids the risk of passing excessive current through the instrument when changing from one milliamp range to another, as when the selector plug is withdrawn for this purpose the instrument is left temporarily with no shunt in circuit.

ESSENTIAL COMPONENTS

- One milliammeter, moving-coil type, 0-2 milliamps and scaled 0-2 and 0-6 (Sifam, Type R.T.R.)
- Two shunts for above instrument, 10 ohms and 0.9 ohms (Sifam).
- Four 1-watt metallized resistors—660 ohms, 30,000 ohms, 100,000 ohms and 300,000 ohms (Erie).
- Fourteen bushed sockets, 7 red and 7 black (Clix).
- Ten plugs to match, 5 red and 5 black (Clix).

No particular type of change-over switch is specified. The writer used an old Igranic anti-capacity switch which happened to be handy. Care must be taken that the switch makes very good contact, especially on the milliamp range, for high contact resistance will seriously upset the accuracy of the readings when using the multiplying shunts.

The shorting switch was home made, using two of the contacts of an old telephone switch. The construction is indicated in the detail sketch, Fig. 2. The contacts are bent so that they normally make contact. A long brass stud is bolted to the bottom contact strip and passes through a hole drilled in the panel, terminating in a small knob which, when depressed, displaces the bottom contact downwards and breaks the circuit.

Panel Layout

The panel layout is shown in Fig. 3. A panel 6½ ins. square just accommodates the whole of the apparatus nicely, but the actual size to be used will, of course, depend upon the constructor's taste in cabinets. For the instrument illustrated, an old sloping-panel box, which originally housed a crystal receiver, was used, a form of cabinet which is very convenient because the slope of the panel brings the instrument to the best angle for reading.

The actual wiring is simplicity itself, and the back-of-panel sketch reproduced at Fig. 4 is self-explanatory. The whole of the connecting wires are covered in systoflex; joints at the various switches are soldered, but all others are screwed connections, with the exception of the shunts, which are soldered to short

lengths of stout tinned copper wire attached to the terminal sockets. The shunts are wound on small ivory bobbins, and are supported in the set by threading the bobbins on the systoflex of two convenient connecting wires.

Using the Instrument

For voltmeter readings the test leads or prods should be connected to the two sockets marked "Volts" at the left-hand side of the panel, the selector plug (red) inserted in the socket marked with the appropriate range, the switch S1 turned to the left, and the switch S2 depressed at the instant of taking the reading.

For milliamp readings the terminals on the right-hand edge of the panel and the black selector plugs must be used, while the switch S1 must be turned to the right.

When using the instrument for measuring resistances, the switch S1 should first be turned to the central position marked "O." A single 1½-volt dry cell should be connected to the sockets marked "Battery" at the top left-hand corner of the panel,

(Continued on page 768)

WHERE THE CURRENTS FLOW—

(Continued from page 762)

the anode current of the output valve transfer corresponding variations to the anode circuit of the previous valve through the common resistance of the high-tension unit. There is, however, a high resistance, R, in the anode circuit of the previous valve, and the condenser, C, connected between this resistance and the high-tension negative wire.

The harmful alternating voltage can be considered as existing between the points "a" and "c"; and because the impedance of R between "a" and "b" is much greater than the impedance of the condenser, C, between "b" and "c," the alternating voltage will exist chiefly between "a" and "b" while the voltage fluctuations across "bc" (i.e., across the valve and its anode load), due to back coupling, will be negligible.

Another frequent source of back coupling is the automatic grid bias arrangements of an alternating-current all-mains set, especially one in which the anode current of all the receiving valves flows through the bias resistance of the output valve. The smoothing of the grid-bias voltage is very essential to prevent unwanted modulation of the anode currents in early valve stages, and it is also desirable to decouple the grid circuits in the way indicated in Fig. 4, to prevent unwanted alternating voltages being transferred to the grids of these valves.

A Current Diversion

There are several conditions under which high-frequency voltages are transferred to portions of the circuit where they can cause instability. Usually, this is the result of high-frequency components being allowed to circulate in parts of the audio-

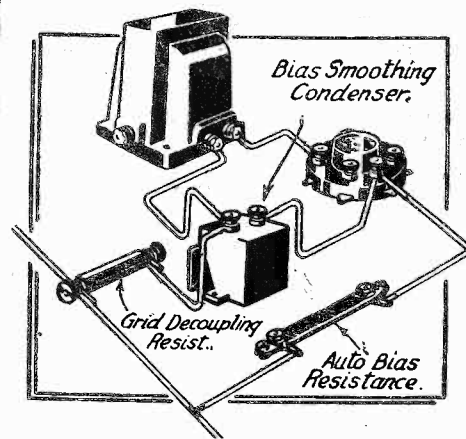

Fig. 4.—Smoothing auto grid bias and good decoupling arrangements.

frequency network, where they are re-amplified, and then, if by any peculiarity of the layout of the set they can be re-transferred to the aerial circuit, or to any other radio frequency portion of the wiring of the set, they will be re-amplified to an extent which may cause instability.

Trouble of this kind can be prevented by diverting all high-frequency currents from the low-frequency amplifier. Most receivers have an H.F. choke in the anode circuit of the detector valve in order to divert the high-frequency portion of their anode currents through the reaction condenser. A further condenser, of about .0003 microfarads capacity, may be connected from the end of this choke to the filament or cathode, or, alternately, across the primary winding of the low-frequency transformer.

PERFECT POWER PUREST TONE

from



WIRELESS BATTERIES AND

ACCUMULATORS

DO YOU RUN A COLUMBIA 380?

If so, the Ever Ready Batteries made specially for this set are: H.T./W 1180; G.B./9 v. Winner; L.T./2130. If not, simply ask your dealer for the Ever Ready List, showing all popular makes with their special Ever Ready batteries. Your set will be powered perfectly by its appropriate Ever Ready batteries.

THE EVER READY CO. (GREAT BRITAIN) LTD.,
Hercules Place, Holloway, London, N.7.

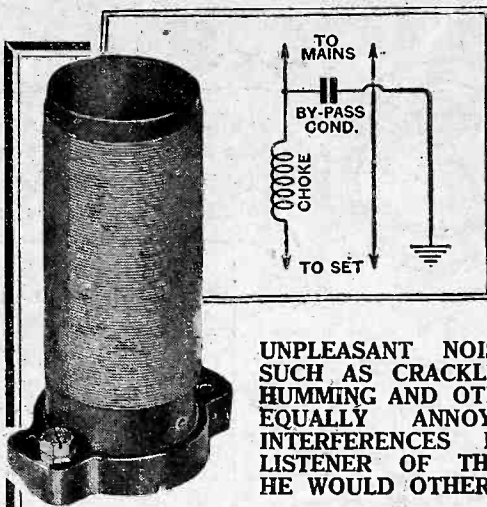

STOP THOSE NOISES!

UNPLEASANT NOISES, SUCH AS CRACKLING, HUMMING AND OTHER EQUALLY ANNOYING INTERFERENCES DEPRIVE THE LISTENER OF THE ENJOYMENT HE WOULD OTHERWISE RECEIVE.

"GOLSTONE" INTERFERENCE SUPPRESSING DEVICES

"GOLSTONE" MAINS H.F. CHOKES

(For A.C. and D.C. Supplies) as illustrated W.H.F., 3/6

INTERFERENCE COMPENSATORS. HIGH-VOLTAGE CONDENSERS SCREENED AERIAL DOWN LEADS. IMPEDENCE MATCHING DEVICES. SCREENED TRANSMISSION LINES. SCREENED TUBINGS are some of the wide range manufactured. Obtainable from all First-Class Radio Stores. See the name "GOLSTONE" on each component before purchasing and refuse substitutes. If any difficulty write direct.

Let "GOLSTONE" Technical Department solve your Interference Problems. Send Postcard for "Interference Elimination" Form and descriptive Folders.

FREE
Large 56-page
1933/34 RADIO
CATALOGUE sent
FREE on request.

Ward & Goldstone
PENDLETON MANCHESTER LTD.

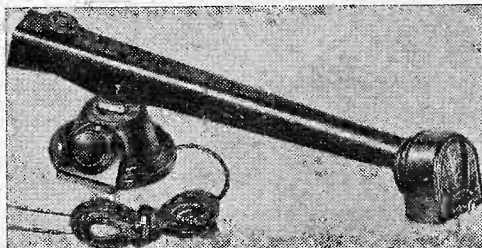

PRICE with volume control and connecting leads **22/6**
If your dealer does not stock Universe 1934 Pick-ups, write us for catalogue, stating dealer's name and address.

UNIVERSE 1934 PICK-UP

"STIFFER" MODEL. Output nearly 4 volts, average 2 volts. Base used in any position. Pick-up reel cannot go out of adjustment (pat. applied for). Ball-catch swivel head for easy needle changing. Weight on record adjustable. Moulded in smart brown bakelite case. Fully guaranteed.

The "Broadcaster and Wireless Retailer" says
**"NATURAL TONE
— ENTIRELY RELIABLE"**

COSMOCORD LTD. DEPT. P UNIVERSE WORKS, ENFIELD MIDDX



Why pay twice as much for valves that are no better—often not as good? "362" will give you the very best possible results, no matter what circuit you are using. They are ENTIRELY BRITISH, NON-MICROPHONIC, FULLY GUARANTEED, and there are types equivalent to all the good makes. Send for "362" post free direct.

Post Free from

3/6

"362" BATTERY TYPE VALVES:—H., HL. & L., 3/6. Power, 4/-. Super-Power, 4/6. S.G., 7/6. Var-Mu, 7/6. "Class B" 9/- Pentode type, 10/- (Metalised 3d. extra)

"362" Patent UNBREAKABLE TOLEDO BATTERY TYPE VALVES:

HL., 4/6. Power, 5/6. Super-Power, 6/- S.G., 10/- Var-Mu, 10/-

"362" "CLASS B" KIT. Absolutely complete with "Class B" Valve, 7-pin valveholder, Input & Output Transformers, with full instructions, 28/6. With M.O. Loudspeaker, 50/-

AS GOOD AS THE BEST BUT COST 50% LESS

Cash with order. Cheques and P.O.'s must be crossed and made payable to:—
THE 362 RADIO VALVE CO., LTD. (Dept. W.), Stoneham Road, London, E.5

CHOOSING AND USING A BATTERY ELIMINATOR

By J. NORMAN

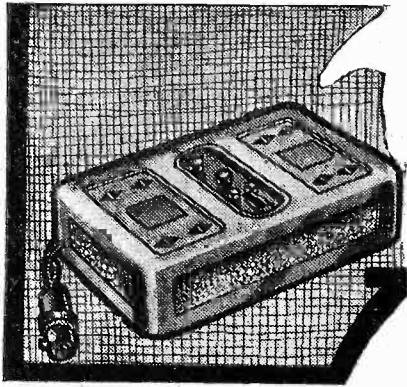

In This Article the Author Discusses the Important Points to be Considered in Choosing an Eliminator for Use with Various Types of Receivers.

DESPITE the popularity of all-mains receivers there are still thousands of set users who prefer receivers of the battery-operated type, or who have to use battery sets which were bought some years ago. At the same time, such listeners naturally wish to run their sets in the most economical and reliable way, which means that the high-tension supply (and perhaps also the low-tension) should be obtained from the electric supply mains. There is, of course, no difficulty whatever in operating a set originally designed as a battery model entirely from the mains supply, all that is necessary being a reliable eliminator of

and voltage required. The set will have battery valves, and since these take a maximum anode voltage of 150, such a voltage will be adequate for the eliminator. As the current output is entirely dependent upon the type of receiver in use the only satisfactory method of deciding what it should be is to measure the H.T. current consumption of the set whilst it is in use. This can be done quite easily by inserting a milliammeter in series with the negative lead from the high-tension battery. There is one point to be remembered in this respect, however, which is that the voltage of the eliminator will be appreciably higher than that of the battery, and, consequently, the current consumption will be greater when the eliminator is in use. In most cases it will be sufficiently accurate to increase the measured current by fifty per cent. in order to decide upon the correct rating of the eliminator.

obsolete pattern, and decoupling is not provided, it will be essential to feed the detector valve (and possibly the first L.F. one, if two L.F. stages are employed) from a separate tapping point. In such instances it is better to choose a unit which has a variable tapping (not a screen-grid one), giving a voltage of from about 30 to 80 at about 4 to 2 milliamps. This tapping will be correctly decoupled inside the eliminator, and no further consideration need be given to that point.

Where the set has separate H.T. leads for both the detector and first L.F. or detector and H.F. valves the eliminator should have the variable tapping mentioned above and also a fixed tapping which will supply a voltage of about 90 at 5 milliamps.

S.G. Voltage Supply

Yet another variable tapping will be required if the receiver employs a screen-grid or variable-mu valve, due to the fact that the screening grid must be fed from a separate voltage source. Moreover, this tapping must not be like that for the detector valve since the variable voltage output must be derived from a potentiometer rather than from a variable resistance. Every make of eliminator can be obtained in a type provided with an S.G. tapping, and the appropriate socket is invariably marked "S.G."; it should provide an output of from 30 to 80 volts at about 1.5 milliamps.

It is only occasionally that an eliminator will be called for to give all the various outputs mentioned above, but one can generally be chosen to provide the actual tappings required.

Eliminators for Class B

When the set is of a type employing a Class B or Q.P.-P. output stage, quite a

(Continued on facing page)

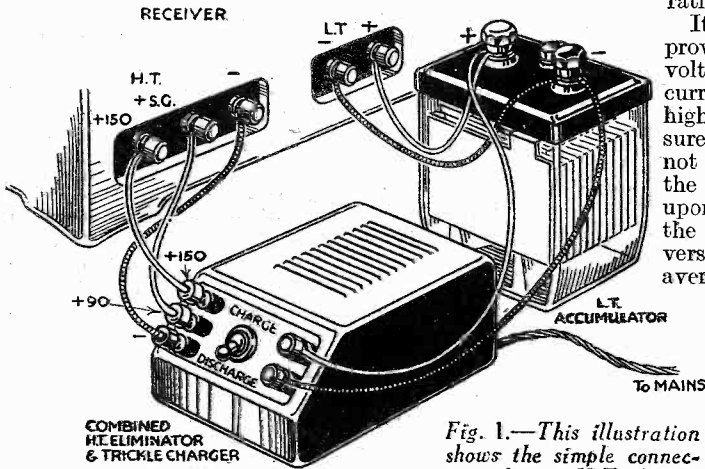

Fig. 1.—This illustration shows the simple connections for an H.T. eliminator of the type fitted with an L.T. trickle charger.

suitable pattern. Moreover, it is in nearly every case considerably less expensive to convert a battery set to an all-mains one by employing an eliminator in conjunction with it than to attempt to convert the set to work with A.C. valves. This scarcely ever necessitates any alteration to the normal wiring of the set, and gives results which are perfectly satisfactory and reliable. It also prevents the possibility of a particularly interesting programme item being missed due to the accumulator or high-tension battery suddenly running down.

The choice of eliminators on the market is so extremely wide that the amateur who proposes to buy a new eliminator is likely to be confused and to have extreme difficulty in deciding just which unit he should buy. In addition to this, it is quite an easy matter to purchase an eliminator of a type totally unsuited for use with the set for which it is intended, or to buy one that will be useless at a later date should the set be changed for one of a newer type.

Eliminator Output

Once it has been decided to buy an eliminator, the first question which must be decided is in regard to the output current

Voltage Tappings

Having settled the question of the maximum output, the problem of lower-voltage tappings must be considered. In the case of any modern battery receiver in which the detector valve is adequately decoupled, it will be quite unnecessary to use any tappings, and if a unit is chosen which is already provided with alternative tapping points these may simply be ignored. On the other hand, if the set is of a somewhat

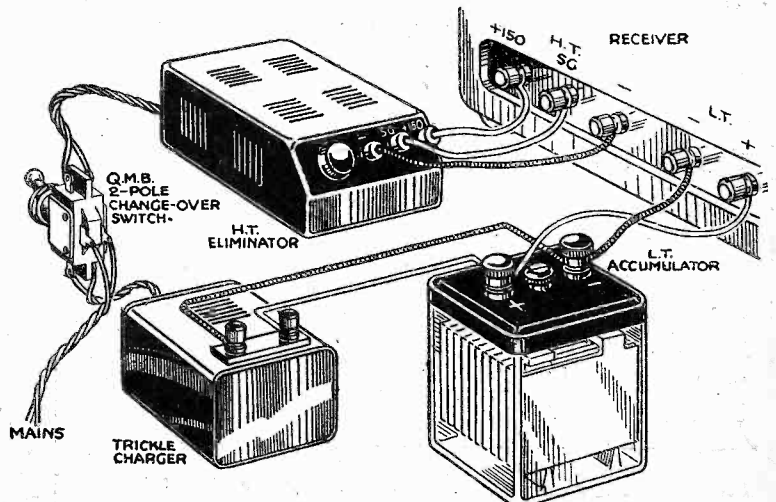

Fig. 2.—When a separate H.T. eliminator and trickle charger are employed the units should be wired up as shown above.

(Continued from previous page)

different kind of unit is called for, due to the fact that the current consumption of such an amplifier constantly varies between some 3 and 35 milliamps., despite the fact that the average consumption may be no more than 10 milliamps. or so. Because of this, the voltage of an ordinary eliminator would constantly be changing inversely with the current. Now, the chief reason for the variation of voltage with the current is the resistance of the rectifier (in the case of an A.C. unit), and also of the smoothing choke and decoupling resistances. This objection can be overcome in three ways; one is to employ a rectifier of lower resistance, another is to cut down the resistance of the smoothing choke and resistance network, and the third is to make use of a neon stabilizer. Valve rectifiers are normally of sufficiently low resistance in their standard form, whilst metal rectifiers of special low-resistance types are now being made especially for use with Class B eliminators. The neon stabilizers referred to are voltage-regulating devices which are connected between the negative and positive H.T. output terminals, in which position they act rather like tremendously large fixed condensers, "absorbing" a certain amount of current when the voltage across them exceeds a certain figure, and passing a negligible current under low-voltage conditions.

All the three different methods briefly described are made use of by various manufacturers, with a result that any one of them can supply an eliminator suitable for Class B working. Such eliminators are always described as being intended for Class B use, but they can, of course, be used with any kind of set taking up to the maximum current output. As a matter of fact, eliminators of this type have many uses in sets not fitted with Class B output, since they give a uniform voltage regardless of the current drain. Due to this, they can be used with every success in conjunction with sets requiring a current of only 15 milliamps. or so, and yet they are perfectly suitable for use later on with a more powerful type of set requiring an H.T. current of any value up to the maximum; this is naturally a great advantage.

Perhaps it should be mentioned at this stage that most D.C. eliminators of standard type can satisfactorily be used with Class B sets, due to the fact that the only resistance in circuit between the main positive supply and the anodes of the Class B valve is that of the smoothing choke, which in many cases is very low. This does not always apply, and, therefore, intending purchasers should check this point by consulting the makers' catalogue.

Trickle Charging

When buying any kind of eliminator it is always a great advantage to choose one which, in addition to the H.T. tappings required, is fitted with a trickle charger by means of which the accumulator can always be kept fully charged. By following this course the battery receiver is really converted into a completely mains-driven one and requires no attention whatever, apart from the occasional "topping-up" of the accumulator with distilled water to compensate for evaporation. It would appear that many amateurs consider the idea of using a combined eliminator-trickle charger rather complicated, and needing a rather elaborate switching system to change over the accumulator from "charge" to "discharge." This is by no means the case, and many combined eliminators are

(Continued on page 768)

CUTTING OUT STATIC

A Few Practical Hints on the Elimination of Various Kinds of Electrical Interference. By E. PARKER.

THE increase in use, during the past few years, of electrical appliances both in the home and elsewhere, has brought with it an increase in the associated evil—interference. There must be many listeners who have been introduced to this bug-bear during the last few

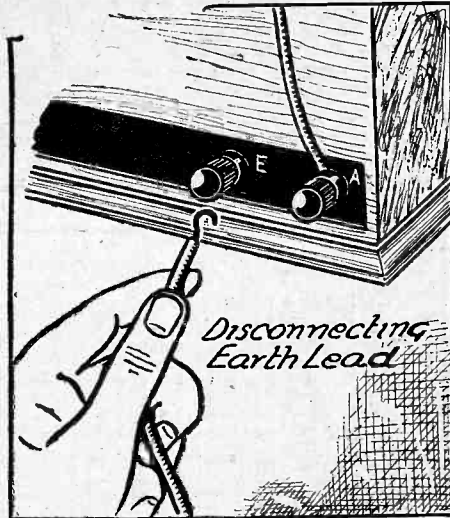

Fig. 1.—The earth lead often introduces noises into a receiver.

months, and to these the following remarks may be of some use.

Interference can be caused by practically any electrical mechanism, from a tiny motor to a power station and, note this carefully, the now-common neon sign is by no means innocent of this trouble, particularly the smaller varieties.

It is practically impossible to cure the interference at the receiver end, the cure must be applied at the root of the trouble; so all we can hope to do is to eliminate at least some of the noise at the receiver end. A temporary measure of relief can often be obtained by disconnecting the earth lead and using the set with the aerial only or, for permanency, try another earth, preferably a buried one. This is because a great deal of electrical apparatus is earthed; consequently, interference reaches the set through this source, so if the water pipes of the house run near the earth of the apparatus, and if you are using these pipes for an earth, interference is a certainty.

Further relief can often be obtained by altering the position of the aerial. I have two aerials, one running diagonally across the room and the other a vertical aerial, parallel to the outside wall of the house, and I find that the latter picks up a great deal less interference than the former

from an electric motor about thirty yards away.

If you are using an outdoor aerial, why not try an indoor one? Or, alternatively, alter the position of the present one? If an aerial is running parallel with tramlines or with a power-cable, interference can be very easily picked up. Trams are a noted sort of trouble, and one reason can easily be seen any evening. Just watch the trolley-arm as it runs along the overhead wire; the sparks you will see mean trouble for the majority of sets in the immediate neighbourhood, so keep your aerial well away from trams if at all possible.

If the trouble is caused in your own house, there may be several ways out of the difficulty. One method is to "silence" the apparatus itself. In the case of an electric motor, possibly in a vacuum cleaner, sewing-machine or similar apparatus, the commonest cure is to connect two condensers in series across the brushes, the centre point of the condensers being connected to earth. The condensers should be of good make, and each capable of standing the full mains voltage. The capacity of these condensers is not critical—one to two microfarad will usually be sufficient, but do not use "shoddy" condensers.

"Shielded Lead-in"

Perhaps the interference is being picked up from the house wiring; in that case relief can probably be obtained by fitting a "shielded lead-in." This particular wire consists, in principle, of a copper conductor held centrally in a metal-shielded casing. When fitted, this metal shielding is connected to earth, signals from the aerial coming to the set via the central copper conductor. There are several examples of this type of lead-in now on the market, and there is certainly nothing to be lost by fitting it, the only point to remember being that the length used should be kept within reasonable limits.

An alternative to fitting the shielded lead-in is to have a greater length of supporting cable (or rope) between the point of suspension nearest the house and the lead-in. This means that the point where the lead-in leaves the aerial, assuming that it is one of the usual types, is moved farther from the house, with the result that the lead-in forms more of an angle with the house than when in the previous position.

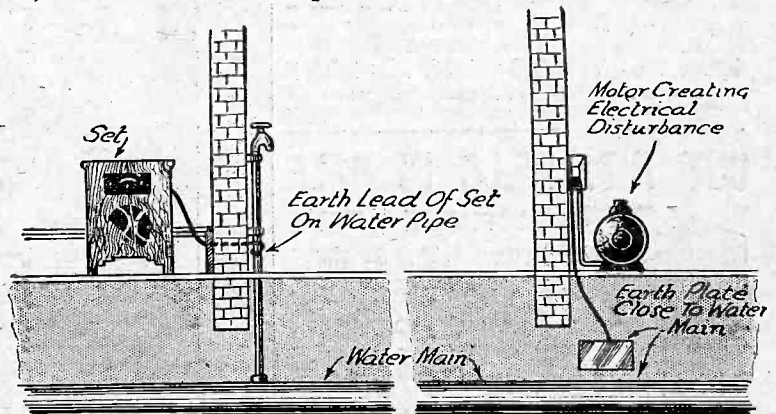

Fig. 2.—The water mains also often form a ready means of bringing in interference.



GET THEM ONE AT A TIME WITH AN **AIRCLIPSE**

There will be an amazing improvement in selectivity immediately you fit the AIRCLIPSE in place of your present aerial. Not another gadget, not a condenser, but an auto-inductive aerial that filters incoming signals, bringing in each programme separately sharp and clear. Unusually masts and wires are dispensed with entirely. Fits inside or outside the set. Makes any set "portable."

Another delighted purchaser writes: "I purchased an Airclipse with the usual misgiving, and am pleased to find that I was wrong. Selectivity is certainly improved, and as regards clarity of tone, I was agreeably surprised."

AIRCLIPSE
5/ AUTO-INDUCTIVE AERIAL
DROV PAT. 9377/33
Of all radio dealers or direct from:—



AIRCLIPSE LTD., 182, Vauxhall Bridge Road, London, S.W.1
Telephones: Victoria 5022.

IF YOUR RECEPTION IS GOOD

SUPERIAL
THE AERIAL WHICH MADE BROADCASTING POPULAR
ELECTRON'S SUPER AERIAL

WILL MAKE IT PERFECT



The most selective and powerful aerial ever devised. Extra heavy rubber insulation abolishes masts, poles, insulators and separate leads-in. The first and only efficient indoor or invisible aerial. Don't be misled into buying inferior imitations. SUPERIAL is strong, cheap, efficient and lightning proof. £100 Free Lightning Insurance—send in your Form to-day. From all Dealers.

100 ft 3/6: 75 ft 2/6: 50 ft 1/9: 25 ft 1/4
THE NEW LONDON ELECTRON WORKS LTD 6 EAST HAM LONDON E.6

CUT H.T. BILLS IN HALF

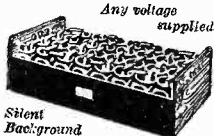

IMPROVE TONE

Why put up with the constant expense of dry batteries and poor results when they are running down? Install a Standard Wet H.T. Battery and end the problem for good. Supplies abundant pure current year in, year out, annual replenishment at small cost all that is necessary. Maintains voltage amazingly—recharges itself when not in use. A real investment. 120v. 12,500 m.a. £2 complete. Carriage paid. Write for details.

ALL STANDARD BATTERY SPARES SUPPLIED.
THE WET H.T. BATTERY CO. (Pr.),
26, LISLE STREET, LONDON, W.C.2. Gerrard 6121.

CHOOSING AN ELIMINATOR

(Continued from page 767)

provided with the necessary (two-pole-change-over) switch and a pair of leads for connecting to the accumulator terminals. With this idea it is only necessary to connect up the H.T. leads to the set in the normal way and join two pairs of leads to the accumulator. Of the latter two sets of leads, one is that from the L.T. terminals on the set, whilst the other is that from the unit. In order to make the arrangement quite clear it is shown in a simple sketch at Fig. 1.

If an eliminator of the ordinary type, intended for H.T. only, is at present in use it is a perfectly simple matter to use a trickle charger of any type with it by

connecting up the units as shown in Fig. 2. When the double-pole change-over switch is in one position the mains are connected to the H.T. eliminator, and the accumulator is joined up to the appropriate terminals on the set. By operating the switch knob, however, the mains supply is transferred from the H.T. unit to the trickle charger, and the accumulator is automatically put "on charge" without any other alteration being called for. It should be mentioned, incidentally, that the set should be switched off by means of its switch before charging of the accumulator is commenced, since if this were not done there might be some chance of damaging the valve filaments due to the application of an excessive voltage to them.

UNIVERSAL TESTING SET

(Continued from page 764.)

and the resistance to be tested should be connected between the sockets marked

1 Milli-amp. Reading	2 Resistance with 1.5v. battery	3 Resistance with 7.5v. battery	4 Milli-amp. Reading	5 Resistance with 1.5v. battery	6 Resistance with 7.5v. battery
0.1	14,250	74,000	1.1	610	6,100
0.2	6,750	36,700	1.2	500	5,500
0.3	4,250	24,000	1.3	400	5,000
0.4	3,000	18,000	1.4	320	4,600
0.5	2,600	14,000	1.5	250	4,250
0.6	1,750	11,500	1.6	190	4,000
0.7	1,400	10,000	1.7	130	3,600
0.8	1,125	8,600	1.8	83	3,400
0.9	900	7,600	1.9	40	3,200
1.0	750	6,700	2.0	—	3,000

"Resistance" at the top right-hand corner of the panel. Press the safety switch

knob S2, and note the reading of the milliammeter, using the 2-milliamp scale. Then turn to the table and against the milliamp reading in columns (1) or (4) read the value of the unknown resistance in column (2) or (5). If the resistance so found is so high that the milliamp reading is too small to be read accurately a 7½-volt grid battery can be substituted for the 1½-volt cell, when the resistance values corresponding to the various milliamp readings will be as shown in column (3) or (6).

It is very important not to use the 7½-volt battery unless the resistance under test is known to be over 3,000 ohms. Otherwise, excessive current will pass through the instrument and may cause serious damage.

SHORT WAVE SECTION

(Continued from page 761)

circuit can very satisfactorily do service for both the first detector and oscillator stages, provided that a fairly low I.F. is used. The output from this valve is fed

directly to the I.F. amplifier, and it should be noted here that it is not essential to use any of the accepted types of I.F. transformers as used in superheterodyne receivers of the medium and long-wave types. We can instead use almost any type of fairly compact tuning coil which is capable of being tuned to about 2,000 metres when used with a pre-set condenser of .0005 mfd. capacity. The diagram on page 761 indicates a receiver of this type, and the coils L4, 5 and 6 are those referred to here. It will be appreciated, of course, that these coils must be shielded. The two I.F. coils are brought into step by means of the pre-set condensers C1 and C2 which, when once set, will not require further adjustment, unless further changes are made in some other part of the receiver equipment.

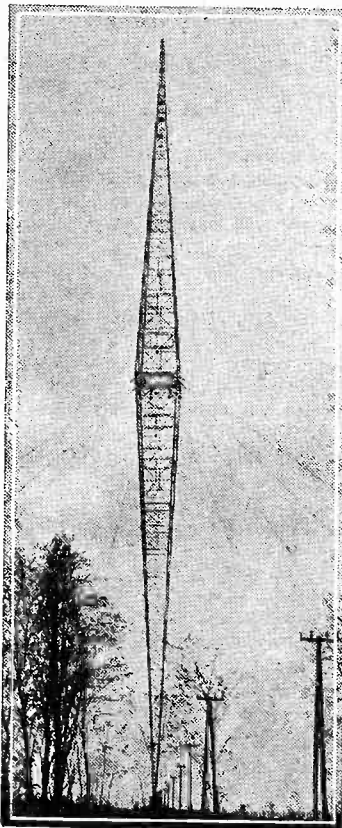

New Budapest aerial mast. See paragraph on this page.

Unique Budapest Wireless Mast

THE photograph on the left shows the new aerial mast of the Hungarian station at Lakihe, near Budapest. The mast is of unusual and unconventional design, and tapers from the base to its widest point, the centre, and again from there to the top, where it comes to a point. This mast is 314 metres high and is of American design.

The Pentagrid

THE pentagrid is already on the English market, and it is probable that the triode-pentode will not be long in following it, but where is all this going to end, and what is more important, is it leading anywhere? The old and much despised bi-grid is about three years old and the wonderful (?) pentagrid is to kill it completely, but when all is said and done, is there much difference in them from the point of view of those who use receivers for listening to broadcasts rather than to lecture about them?



THE BEGINNER'S SUPPLEMENT

THE EASY ROAD TO RADIO

PREVENTING H.F. LEAKAGE

Some Suggestions for Keeping Stray High-Frequency Current Out of the Low-Frequency Circuit. By G. W. DAVEY.

EVERY reader must by now have learnt sufficient about wireless to know the difference between the terms H.F. and L.F. or, that is to say,

those of you who are suspicious of the behaviour of your sets can check up on them. First, instability may be caused. Besides feed-back in the anode-circuits,

the most common cause of instability, stray H.F. is a very likely offender. Secondly, overloading of the valves: for besides carrying the normal L.F. load, they would have imposed on them an extra

H.F. content, and so overload more easily. Again, generally bad quality, "fuzzy" top notes, hissing sibilants, violins that sound like flutes, and a certain harshness of tone, all would indicate to the expert that H.F. has strayed into the L.F. side.

Having decided upon a little more rigid tightening up of the barrier to H.F. from the L.F. circuits, we must look into the various schemes we can employ.

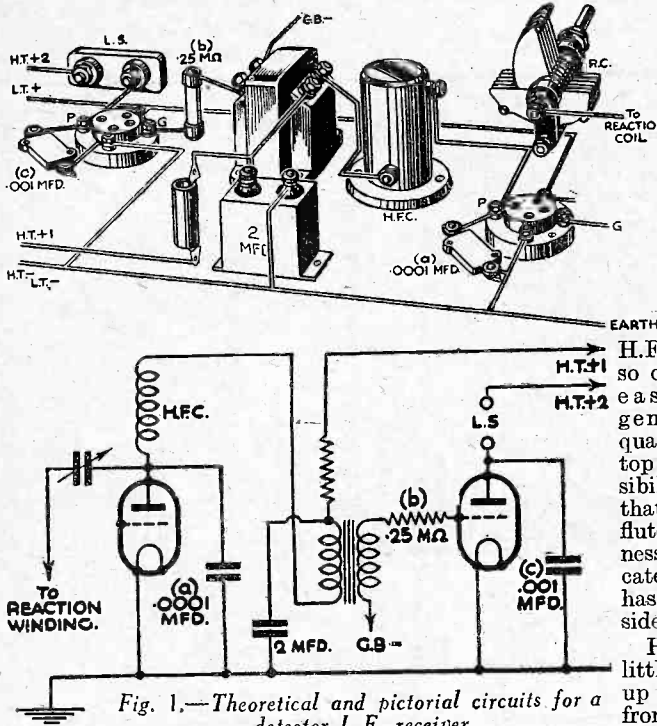

Fig. 1.—Theoretical and pictorial circuits for a detector-L.F. receiver.

high frequency and low frequency. Roughly speaking, H.F. currents are the currents which are received by the aerial, are tuned, passed into the high-frequency stages, if any, and so on to the detector, where they are detected, or turned into low-frequency currents. Of course, we know that many low frequencies are referred to as "high," those round about 10,000 cycles, for instance, but such frequencies are low compared with those known as "high frequencies."

The detector, then, can be looked upon as the dividing line between high and low frequencies in a wireless set, and it is, for efficient working, essential that the H.F. and L.F. should be kept strictly to their own spheres of work. This more particularly applies to H.F., which is very prone to stray into the L.F. circuits unless rigidly excluded.

A Few Symptoms

Let us briefly run over a few of the symptoms which suggest that H.F. is getting into the L.F. circuits, so that

Some Remedies

In Fig. 1 a diagram is given of a typical detector and L.F. side of a set. The first barrier to H.F. we have inserted is the H.F. choke which, as its name implies, should choke back the H.F. currents. Now, if this choke is a poor one quite a lot of H.F. will leak past it, besides which, if we are stopping the H.F. here we should provide an alternative path for it. This path in most sets nowadays is provided by means of a differential reaction condenser. Where ordinary reaction is fitted there should be a path back to earth for the H.F. through a .0001 mfd. condenser marked (a) in Fig. 1. A real "de Luxe" arrangement for stopping H.F. at the detector anode is indicated in Fig. 2.

A condenser of .00005 mfd. capacity is connected between earth and either side of the H.F. choke.

With R.C. coupling there is a direct

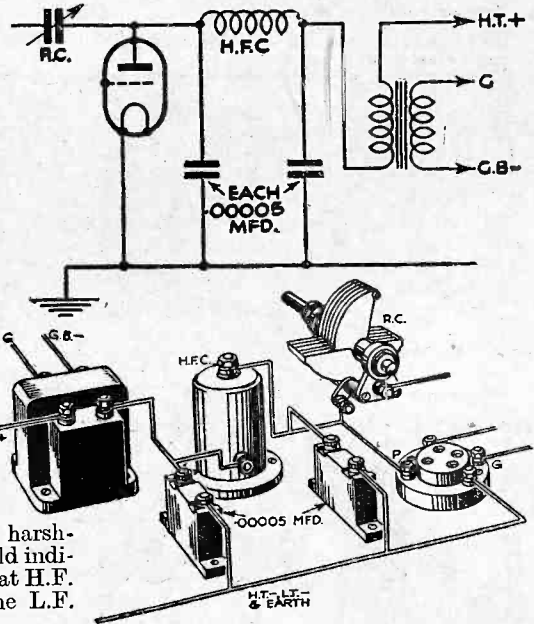

Fig. 2.—These circuits show how an H.F. "stopper" circuit can be arranged.

path for H.F. currents through the coupling condenser to the grid of the L.F. valve and the following hint is of primary importance with such couplings. It may so happen, however, that the capacity between the windings of the L.F. transformer may be sufficiently large to allow an H.F. leakage, in which case the idea is equally applicable. It is to insert a resistance of between 100,000 and 250,000 ohms in the lead from the coupling component to the grid of the L.F. valve.

Stray H.F. in Phone Leads

The next suggestion is of particular use in short-wave sets where stray H.F. in the phone leads can cause hand and body capacity effects. It is also of good use in portable sets as also in any others where it is deemed an improvement. It is a condenser (c) in Fig. 1, of .001 mfd. capacity connected between the plate of the output valve and earth. A special refinement is to put an H.F. choke in each loud-speaker lead as well. In superhets special care must be taken to keep the H.F. in its place, and chokes of extra high inductance should be used.

TOPICAL TECHNICALITIES.

Rectification.

Rectification is the name given to the process of changing alternating current into direct current. It has previously been explained under this heading that the voltage and polarity of alternating current constantly change from maximum to zero and from positive to negative, respectively, whilst a D.C. supply is at a uniform voltage and constant polarity. The object of rectification, therefore, is principally to render the current of constant polarity, and this object may be achieved in various ways. All are similar in principle, though varying slightly in their methods of application. Any device used for rectification is called a rectifier, and operates by reason of its property of allowing current to flow through it in one direction only. To take a simple analogy, a rectifier can be considered as the electrical counterpart of the mechanical valve which allows fluids or gases to pass through it in one direction only. The simplest type of rectifier is the valve, and this will easily allow a current to flow from its filament or cathode to the anode, but does not permit of a current flow in the reverse direction. When A.C. is applied to the valve, current flows only when the cathode receives the negative half-cycle, there being no current passing on the alternate half-cycle.

WHEN ERECTING

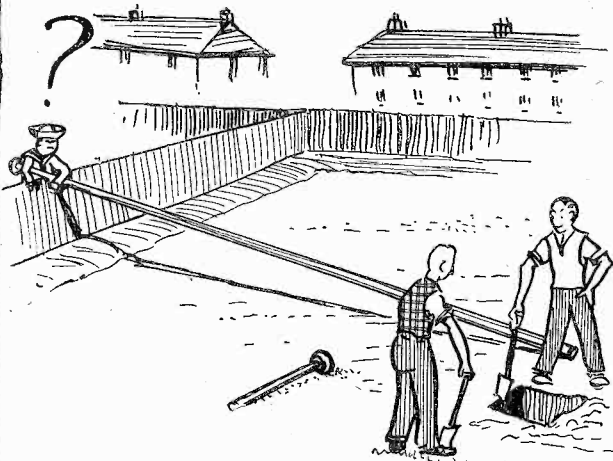

A WIRELESS MAST

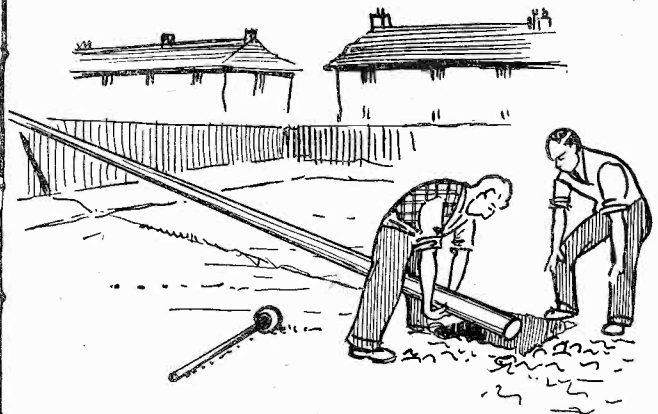

ALWAYS

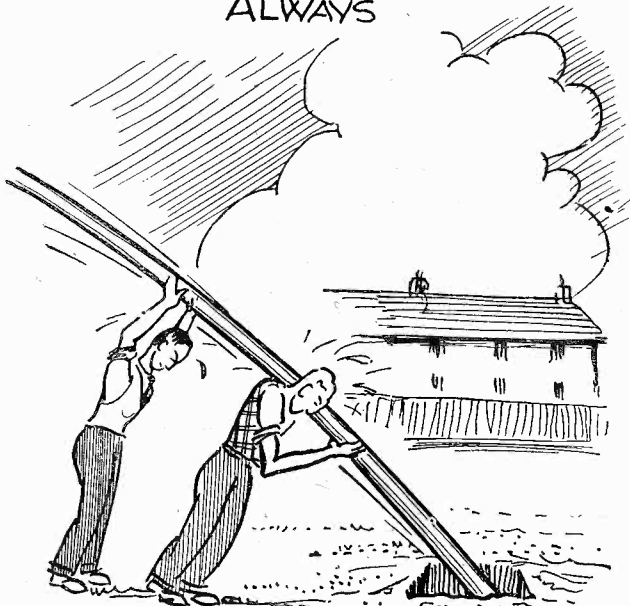

BE CAREFUL

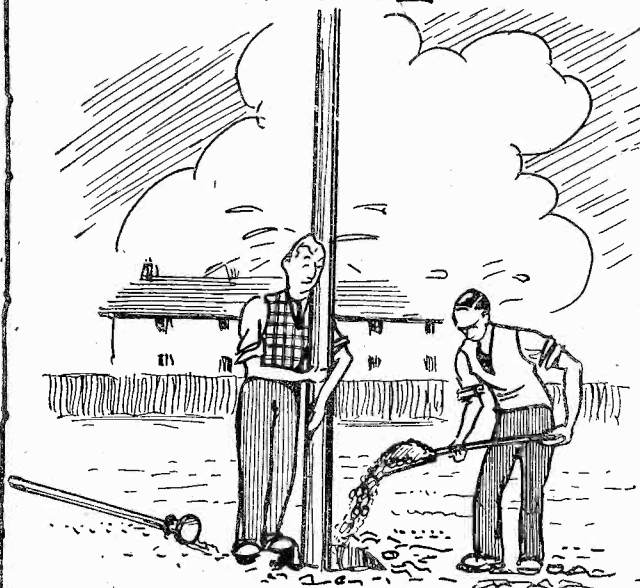

NOT TO INCLUDE

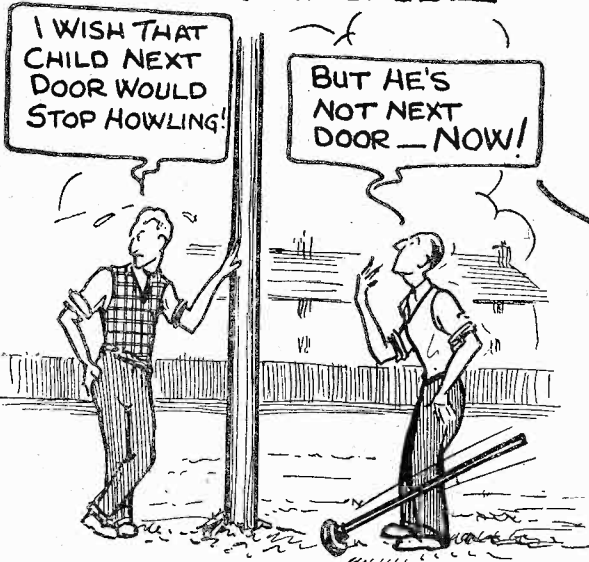

A STOWAWAY!

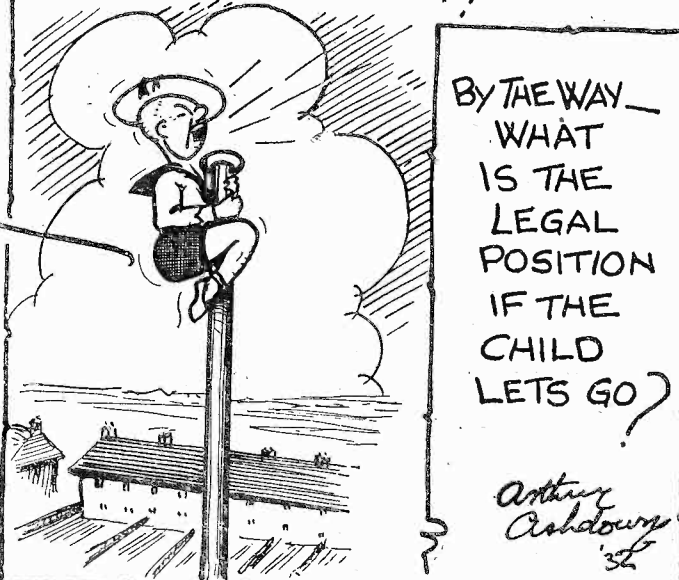

RADIO RAMBLINGS

By JACE

Gettings from my Notebook



Safety-fuse Connections

I WAS recently asked to investigate what, on first appearances, seemed to be a rather intricate difficulty in connection with a battery receiver said to have been built to a design published in PRACTICAL WIRELESS. The owner of the set found that when he switched on the set was quite "dead" so far as signals were concerned, but, peculiarly enough, the fuse showed a fairly bright light. He at first thought that there must be a high-resistance short-circuit somewhere in the set, and had, therefore, thoroughly examined the wiring in addition to testing all the components. During the course of his tests the fuse was accidentally short-circuited, when signals could be received in the normal manner. Apart from this, however, no clue as to the peculiar behaviour could be traced. What would you have said the difficulty was due to? The answer is pretty easy, really, because the low-tension negative lead had been joined to the wrong side of the fuse, with a result that when the switch contacts were closed the fuse was in series with the valve filaments. The fuse acted as a series resistance of sufficiently high value to prevent the valves from functioning. On the other hand, though, the resistance of the valve filaments was low in comparison, and they, therefore, passed quite sufficient current to light up the fuse bulb. It is surprising how such little points as this can often give so much trouble.

Electrical Interference

COMPLAINTS are still received from listeners who find interference-free reception at certain hours of the day quite impossible, due to the fact that some form of electrical device in the neighbourhood happens to be in use. This electrical interference, or man-made static (as the Americans prefer to call it) business is becoming increasingly important, and it seems quite time that the powers that be should institute some regulation whereby interference would be made a punishable offence. After all, it is by no means impossible in these days to design electrical apparatus in such a way that it is practically non-radiating, whilst existing apparatus can almost invariably be "silenced" by fitting suitable condensers, or, better still, by making use of one of the many disturbance suppressors now on the market and obtainable at quite a low price. It should also be pointed out that the Post Office engineers are only too willing to give assistance by locating the source of interference and offering to fit the necessary "silencing" equipment for the bare cost of the parts.

In case of trouble due to interference, all that the listener has to do is to obtain a form from the Post Office, give brief replies to the simple questions printed thereon, and return it to the Engineering

Department connected with the local P.O. Almost immediately upon receipt the Post Office send out experienced engineers to go into the matter and suggest the most suitable remedies. Before calling in the P.O., however, it is best to make sure that the interference is not being created by loosely-fitting electric lamps, defective switches or domestic appliances such as carpet sweepers, hair driers and the like. When the origin of the disturbance is found to be due to a particular piece of apparatus in the house the remedy is fairly obvious. A fault in the lighting system can be rectified by the local electrician, whilst disturbance suppressors for any kind of motor can now be bought from any radio dealer. Certain manufacturers make a wide range of suppressors of all types, each of which is suitable for some particular form of interference. These firms will also supply a questionnaire, the replies to which will enable them to say exactly what type of unit will be most suitable for the particular case.

A Very Neat Iron-core Tuning Unit

A NEAT and compact tuning unit, the "Colpak," which is fitted with three type "G" Ferrocart iron-core coils, has recently been tested in our laboratories. The unit is assembled on an aluminium chassis measuring 6½ in. by 7½ in. by 1½ in., and all the necessary terminals are mounted on the side, where they are readily accessible. The coils are arranged as an aerial band-pass filter, followed by a tuned-grid coil with reaction, and are tuned by means of a screened three-gang condenser. The latter is not provided with a dial and drive, so that the user may obtain one of the full-vision drives now on the market in any pattern which he prefers. A very complete switch assembly is provided, and this is operated by a single knob which can be turned into one of four positions to give "Gramophone Pick-up," "Long Waves," "Medium Waves" and "Off"; the knob is clearly marked to show which position it is in. By making use of this excellent tuning unit the constructor can build any set of the single screened-grid type with the greatest of ease, and by using only a few additional components. As the coils and tuning condenser are perfectly balanced and matched, the preliminary adjustments which remain for the constructor to make are of a particularly simple nature, since it is only necessary to compensate for the capacity between connecting wires, by operating the trimmer condensers which are conveniently placed on top of the gang condenser. By adjusting these when the receiver is first made the entire task of matching will be completed, and all subsequent tuning can easily be carried out by the single knob. The "Colpak" described can be obtained for use in either battery or mains receivers, and the particular type required should be stated when ordering.

A Neon Potential Divider

THE neon stabilizer is fairly well known as a device for maintaining the output voltage of an eliminator constant irrespective of the current drain, and now we learn of a modification of this idea. A new form of neon has recently been evolved which really performs the work of several stabilizers, one each of which is connected in the positive tappings from an eliminator. This latest development is known as a glow-gap potential divider, due to the fact that it operates on the multiple output leads instead of on one only. In principle the new device is similar to the neon stabilizer, but, in addition to the normal anode and cathode, it contains a number of other electrodes which are situated between the main anode and cathode. In consequence of this, the total voltage drop across the component is divided into various steps by the various intermediate electrodes. Each of the intermediate electrodes can be employed to feed a particular valve anode, and the various voltages obtained remain constant, whether or not the current fluctuates or remains at a uniform figure.

A New Television Transmitter

NEWS comes from Chicago that Dr. Zworykin, a scientific investigator, has evolved a new instrument for television transmission which he has called an "Iconoscope." The device is particularly interesting and consists of a combination of a photo-cell of large dimensions and a cathode-ray tube. The cathode ray is produced in the usual manner by an emission of electrons by a filament, and the ray is directed in the appropriate direction by means of anodes or deflecting plates, on to the large photo-cell (or really a bank of small cells) which replaces the normal fluorescent screen. The object to be televised is focused on to the outside of the screen, with a result that the small cells become charged proportionately to the intensity of the incident light. Then, as the electron beam or ray passes over the cells the latter are discharged and the current impulses so obtained are amplified and passed on to the transmitter. For reception, an ordinary cathode-ray receiver is employed and the transmitting process is actually reversed.

H.T. Eliminator Output

THE discharge rate of an eliminator varies considerably with the current, and, as a consequence, the voltage from a tapping intended to be taken to a screen-grid valve may be much higher than the normal value. For instance, when the eliminator is giving a total of 25 milliamps. the voltage of the screen-grid tap may be 65 and the output voltage of the power tapping 120, which is about right for normal working. If, however, the current is reduced to, say, 15 milliamps., the voltage at the screen-grid tapping may rise to about 85, which would cause instability in some sets.

In mains units having fixed tappings it is as well to arrange for the voltages to be brought down if necessary. Usually a bigger power-valve will have the desired effect of increasing the load and reducing the pressure, but if this is not a desirable change a resistance can be connected between the power-output tap and the negative terminal. An "artificial" load, which will produce the same effect as a larger power-valve, might take the form of a resistance in parallel with the H.T. supply.

FACTS & FIGURES

Components tested in our Laboratories

BY THE PRACTICAL WIRELESS TECHNICAL STAFF.

NEW FERRANTI VALVE HOLDERS

AN interesting new Ferranti line, in the shape of chassis-mounting valve-holders, has recently been placed on the market, and we have received samples in 4-, 5- and 7-pin types. These holders can only be described as excellent components well in keeping with the tradition of the firm of Ferranti. They consist of a neat moulding into which are fitted the necessary sockets, the latter being of a new spring type with which perfect contact with the valve pins is assured. In every case the holders are of the soldering-tag type, a special feature being that the tags are long

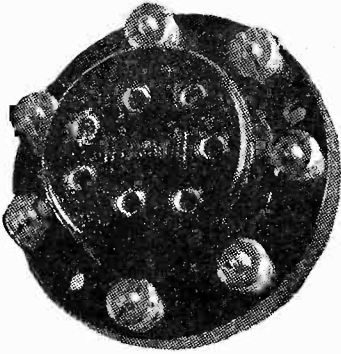

The Ferranti baseboard-mounting 7-pin valve-holder.

and project well away from the sockets. This feature is one which will specially be appreciated by the constructor, particularly when using the 7-pin component. With most varieties of 7-pin holders it is by no means an easy matter to make connection to all the seven sockets without running the risk of causing a short-circuit, but no such difficulty can possibly arise in connection with the Ferranti components under review. We have thoroughly tested holders of every type submitted and found them entirely satisfactory in every way. Valves fitted them perfectly and no undue pressure was required to press the valve pins right "home," despite the fact that the spring sockets are amply strong to make true contact and are so designed that their efficiency cannot become impaired by long usage. Incidentally, we might add that these holders are identical with those used in all Ferranti receivers, which are renowned for their trouble-free service. The prices are 9d., 1s. 3d. and 1s. 9d. respectively for the 4-pin, 5-pin and 7-pin types.

TWO NEW RECTIFIER VALVES

THERE are certain advantages to be gained by using rectifier valves of the indirectly-heated type, especially in conjunction with sets which employ an indirectly-heated valve in the output stage. The chief advantage is that, since the rectifier and receiving valve cathodes heat up at the same rate, perfect safety for the smoothing condensers and allied equipment is obtained without having to make use of a thermal delay switch. In addition, indirectly-heated valves are slightly more robust than those having a filament and are thus better able to withstand a certain amount of vibration such as is often caused in a powerful receiver due to the proximity of the loud-speaker.

Bearing the above points in mind, it is particularly interesting to observe that Messrs. Mullard, one of the pioneer valve firms, have now introduced a pair of indirectly-heated rectifiers which are "companions" to their

popular D.W.2 and D.W.3 types. The new valves are styled the I.W.2 and I.W.3, the "I" and "D" standing for "indirectly" and "directly" (heated) respectively. They have characteristics almost identical with those of the two directly-heated counterparts, being, in fact, slightly different only in respect to the L.T. current which they consume. Both are full-wave valves, and the I.W.2 has a maximum rectified output of 250 volts at 60 milliamps when a voltage of 250 is applied to each anode. The heater consumes 1.2 amps. at 4 volts, or .2 amp. more than the D.W.2. The I.W.3 is capable of providing an output of 350 volts at 120 milliamps, whilst its heater requires 4 volts at 2.4 amps.; this latter figure is .4 amp. more than is taken by the D.W.3. Despite the slightly higher L.T. current consumption, these valves can in nearly every case be substituted for their directly-heated counterparts without any modification being called for. A slightly heavier load will naturally be placed upon the mains transformer but, provided that this component is of sound manufacture and has good "regulation," it will easily be capable of dealing adequately with the slight overload. It should be added that the indirectly-heated rectifiers are exactly the same price as the others with which they have been compared, namely, 12s. 6d. and 15s. for the I.W.2 and I.W.3 respectively.

SIEMENS BATTERIES FOR COSSOR RECEIVERS

OWNERS of Cossor battery receivers, type Nos. 335, 341, 342, 344, 3,456, 735 and 634 will be interested to learn that Messrs. Siemens, by arrange-



Siemens new battery for Cossor receivers.

ment with Messrs. A. C. Cossor, have introduced two new "Full of Power" double-capacity batteries specially designed to fit the cabinets of the new Cossor receivers mentioned. The smaller battery, type No. 1,172, measures 10½ ins. long by 8½ ins. wide by 3 ins. deep and will fit exactly into the cabinet of all the above receivers except the No. 634. This battery is of 120 volts rating and is listed at 15s. 6d. A type No. 1,175 is made for the Cossor No. 634 receiver, and this gives 120 volts as well as supplying 9 volts for grid bias purposes. It is somewhat larger than the model previously described, being 12½ ins. long by 8½ ins. wide by 3 ins. deep, and is retailed at 20s. Owners of the new Cossor receivers will know that these batteries can be purchased with every confidence and in the knowledge that they are officially approved of by the makers of their set. The type No. 1,172 battery is illustrated on this page.

SOME INTERESTING MAINS UNITS

WE have just taken the opportunity of testing some of the high-grade mains units made by Messrs. Mains Power Radio, Ltd., and are of the opinion that these should be known to our readers. The range is a wide one and embraces every type of eliminator normally required for battery sets. There are three units for D.C. use, and these cost from so little as £1 1s. to £2. The smallest gives an output of 18 to 20 milliamps and has three fixed positive tapings, one of which gives 120 to 150 volts, another, 75 to 90 volts for a detector or first L.F., and the third, 75 to 90 volts for screening grid supply. A second unit, called the type No. D.C.2, has three similar tapings but, supplying up to 25 milliamps, it will operate receivers having up to five valves. The largest (type D.C.3) unit gives a maximum voltage of 185 at 25 milliamps and has two lower-voltage tapings just the same as those on the smaller models. This eliminator can be used with practically

any receiver, including one using a small Class B valve in the output stage.

The A.C. models give similar output to those provided by the D.C. ones just mentioned and are sold for £1 19s. 6d., £2 10s. and £3 respectively. None of them are designed for Class B use, however, but they can be used with receivers of the more normal type, taking up to the rated current outputs. An interesting feature of the A.C. units is that any of them can be obtained fitted with a trickle charger for charging a 2-volt accumulator for an extra charge of £1 2s. 6d.

Additionally, a trickle charger alone is included in the list and this is suitable for charging a 2-volt accumulator at ½ amp. The price of the charger is £1 9s. 6d.

On test we found these M.P.R. units extremely good, both mechanically and electrically. They are soundly constructed and housed in attractive frosted metal containers, which provide complete protection and a full measure of safety.

COMBINED DRIVER AND CLASS B VALVE

OUR congratulations are due to the High Vacuum Co., Ltd. (makers of the popular "Hivac" valves) who are, so far as we know, the first to introduce a combined driver and Class B valve. This valve should go a long way towards still further increasing the popularity of Class B amplification, since it makes for economy both in prime cost and running expenses, besides simplifying construction and effecting a saving in space. This latest valve, called the "Hivac" "Driver + B," is a true combination of the "Hivac" types L.210 and B.220 valves, and though giving a maximum undistorted output of 1.25 watts, its filament consumes only .2 ampere, or the same as that of an ordinary small power valve. Its quiescent anode current is only 2.5 milliamps in all, this figure rising to a maximum of 32 milliamps at full load. The new valve is illustrated on this page, and it can be seen that, in addition to the seven-pin contacts on its base, there is a terminal mounted on top of the glass envelope. Six of the pins are identical in regard to their connections with those on a plain Class B valve of standard type, whilst the seventh pin, which is normally not used, is connected to the grid of the driver section. The driver anode is joined to the terminal on the cap. Priced at 15s. 6d., this valve is sure to prove popular with constructors.

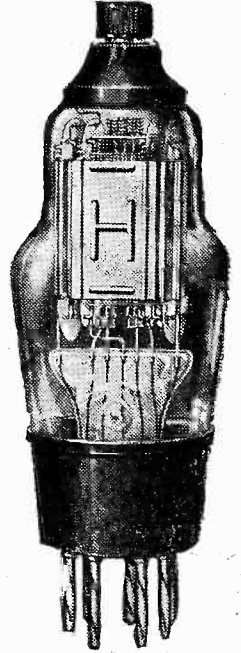

This illustration gives some idea of the new combined Hivac valve.

BELLING LEE INTERFERENCE AID

WE have already drawn attention to the ingenious and useful Disturbance Suppressor which is manufactured and sold by Messrs. Belling and Lee. We have now received some additional literature from this firm which shows that they are really making a strong endeavour to assist the listener who suffers from interference, and this additional assistance is in the form of a printed questionnaire which is enclosed with each Suppressor, and which is also obtainable by any reader who is not certain whether or not to purchase one of these devices to alleviate or entirely remove any form of disturbance which he may experience on his particular receiver. The questionnaire, in addition to a number of queries relating to the apparatus and residence, etc., lists no fewer than thirteen well-known forms of interference suppressors. By filling up this form and sending it to Messrs. Belling and Lee they will do all in their power to assist a listener in fitting some device which will enable them to obtain good reception free from interference. There are twenty-two questions, and any reader may obtain a copy of this sheet upon application to Messrs. Belling and Lee. An interesting booklet dealing with the question of interference, and dealing also with the results which have been obtained in varying circumstances with this Suppressor, is also being published by Messrs. Belling and Lee and should be studied by all listeners who wish to know more about this subject.

**HAVE YOU RESERVED
OUR POCKET TOOL KIT?**

If so, you should claim it without delay!

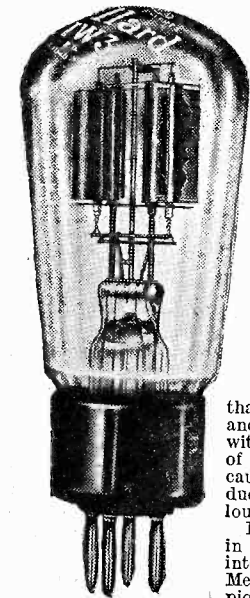

The new Mullard indirectly-heated rectifier, type I.W.3.

PRACTICAL LETTERS FROM READERS

The Editor does not necessarily agree with opinions expressed by his correspondents. All letters must be accompanied by the name and address of the sender (not necessarily for publication).

"Wireless Constructor's Encyclopædia"

in Fiji

SIR,—I would like to thank you for the copy of the "Wireless Constructor's Encyclopædia" and to express my appreciation of it. Although I have not yet had the opportunity of reading it completely through, I am sure that I shall find it of the utmost value.

I read with interest in my last copy of PRACTICAL WIRELESS your preliminary remarks on "all-wave tuning coils," and hope that we shall soon be favoured with data for their construction. Wishing your paper every success.—G. F. FLEMDUS (Suva, Fiji).

[A series of articles on "Making Your Own Screened Coils" commenced in the issue of PRACTICAL WIRELESS for December 9th.—Ed.]

Another Reader's Congratulations

SIR,—I thank you very much for the tool kit received safely. It is certainly the finest kit obtainable at anywhere near the price, and I do not know of another kit so adaptable. PRACTICAL WIRELESS is to be heartily congratulated on producing such a fine gift.—F. N. BEDWELL (Stratford-on-Avon).

"A Great Book"

SIR,—I wish to thank you for the "Wireless Constructor's Encyclopædia" which has just come to hand. It is indeed a very fine book, written in simple language, so that beginners can easily understand it, in fact the beginner finds something here to fascinate him, and the more advanced man finds just the information he wants. It is truly a great book.—J. M. L. LAWRIE (Dundee).

"A Splendid Kit"

SIR,—I take this opportunity of acknowledging the receipt of your Presentation Kit of Tools. I should like to thank you very much indeed for such a splendid kit, and I can assure you, sir, that I think it is the most practical and efficient gift idea thought of up to the present. I have shown it to some friends of mine (wireless "fans," needless to say), and they are, like me, of the opinion that it is an excellent and compact little tool kit. I have been a reader of PRACTICAL WIRELESS for some time now, and have found your articles and illustrations most interesting and instructive. I have been building sets, and experimenting with sets, for something like nine years now, but I have never found any of the wireless publications so interesting or lucid in detail as PRACTICAL WIRELESS. More power to your elbow!—GEORGE M. BUTCHART (Glasgow).

"Delighted With It"

SIR,—I have received my PRACTICAL WIRELESS pocket tool kit safely, and wish to express my thanks for same. I am delighted with it, and shall find it very useful. I am pleased to be one of the lucky recipients.—HORACE DOWDS (Belfast).

"In Very Good Condition"

SIR,—I beg to acknowledge receipt of PRACTICAL WIRELESS kit of radio tools for which I thank you. They appear to be in very good condition, and should provide excellent help in my repairs and construction work in the future. I read PRACTICAL WIRELESS with very great interest.—MARTIN T. FORD (Wells).

Six- or Seven-valve A.C. Mains Superhet

Wanted

SIR,—I enjoy your paper very much, but would be grateful if you would give us particulars and diagrams of a 6- or 7-valve A.C. mains superhet short-wave set with automatic volume control suitable for the Indian Empire broadcast. Battery sets are of little value here on account of the moist climate conditions. Atmospheric, too, make reception at times unbearable, and one is glad to shut down the set. Fading is another of our difficulties, hence the request for automatic volume control. I am sure your Eastern readers would very much appreciate such a design, and no doubt some of your home readers would also be interested.—GORDON HARROWER, F.R.C.S. (Singapore).

CUT THIS OUT EACH WEEK

DO YOU KNOW?

—THAT a new television transmission system has been developed in which cathode-ray tubes and photo-electric cells are combined to produce greater detail than normally obtainable.

—THAT a new multi-valve is now on the market in which a Class B valve and its Driver are contained in one glass envelope.

—THAT it is not essential to use an intermediate frequency of 110 kc/s in a super-heterodyne receiver.

—THAT the frequency above mentioned is chosen only because it affords least interference.

—THAT the permanent magnet system used in a modern moving-coil loud-speaker has a flux density equivalent to many of mains-energised types.

—THAT the normal average flux density is in the neighbourhood of 10,000 lines per sq. cm. A power auditorium type of speaker may have a strength of 70,000 lines per sq. cm.

—THAT a combined reaction condenser and variable-mu potentiometer is now on the market.

NOTICE.

The Editor will be pleased to consider articles of a practical nature suitable for publication in PRACTICAL WIRELESS. Such articles should be written on one side of the paper only, and should contain the name and address of the sender. Whilst the Editor does not hold himself responsible for manuscripts, every effort will be made to return them if a stamped and addressed envelope is enclosed. All correspondence intended for the Editor should be addressed: The Editor, PRACTICAL WIRELESS, Geo. Newnes, Ltd., 8-11, Southampton Street, Strand, W.C.2.

Owing to the rapid progress in the design of wireless apparatus and to our efforts to keep our readers in touch with the latest developments, we give no warranty that apparatus described in our columns is not the subject of letters patent.

ELECTRIFY YOUR SET!

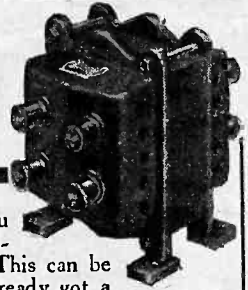

Do you realise you can make your set all-electric for 12/6? This can be done, if you have already got a mains unit for your H.T. supply. Just scrap your Battery Valves and replace them with A.C. Valves, and then incorporate a Heayberd L.T. Transformer. Described below are the three models.

Type.	Output.	Price.
723	2+2v. 3 amps.	12/6
727	2+2v. 5 amps.	17/6
731	2+2v. 10 amps.	22/6

POST NOW

I enclose 3d. in stamps for 36p. booklet, showing me how to build the mains unit for my particular purpose.

Mr.

Address



HEAYBERD & CO.,
10, FINSBURY ST.,
LONDON, E.C.2.

ADD 50/- WEEKLY TO YOUR EARNINGS BY CHARGING ACCUMULATORS IN YOUR SPARE TIME.

Complete Plant incorporating Westinghouse Rectifiers, to charge 105 cells weekly.

Trade price £4/4/0 or 8/- monthly. A.C. Mains only. Send for descriptive booklet.

MAINS' POWER RADIO, Ltd., Romford, Essex.

RADIO ON EASY TERMS EPOCH CLASS 'B' SPEAKER

SIMPLY CONNECT TO YOUR SET WITHOUT ANY ALTERATION AND GET MAINS VOLUME AT VERY LOW USE OF H.T.

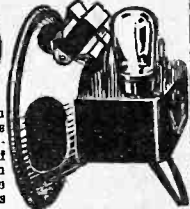

The EPOCH Class "B" Combination Speaker combines a complete Class "B" Adaptor and a high-class Cobalt P.M. Speaker. Send only 5/-; if satisfied pay further 5/- at once, then 8 monthly payments of 7/8. (Cash in 7 days, 62/-) Complete with Class "B" Valve and full Instructions.

E. J. HERAUD, Ltd. (Dept. P.39), NUMBER ONE, EDMONTON, LONDON, N.18. Satisfaction or Money Back Guaranteed.

7 DAYS' FREE APPROVAL!

H.T. ELIMINATORS AND TRICKLE CHARGERS.

BRITISH THROUGHOUT. 2 YEARS' GUARANTEE. A.C. models incorporate Westinghouse metal rectifier and a special power supply for illuminating tuning dials. Trickle charger 15s. 0d. extra.

Catalogue free from actual manufacturers:

D.C.	V.M.C. RADIO COMPANY, 154, Holmleigh Road, LONDON, N.16. No Trade Discounts.	A.C.
15/-		30/-

Micromesh THE MODERN VALVE

Literature and prices on request.

Standard Telephones and Cables, Ltd.,

St. Chad's Place, 364, Gray's Inn

Road, London, W.C.1. Terminus 6255

Moving-coil versus Moving-iron Speakers

SIR.—As a retail branch manager, I am constantly being confronted with the fallacy, upon explaining the advantage of a moving-coil speaker from the frequency point of view, that conversion to this type of loud-speaker incurs additional battery expense. If you could find room in your valuable paper for this letter I think it would clear up a very confusing point.

Consumption from batteries is, of course, governed entirely by the valves employed in any receiver, and not at all by the amount of volume obtained, *except* in the case of the new type valves, where consumption is at a minimum during an interval in the programme and at a maximum when full volume is obtained.

These valves, known as "Class B," are, as most readers know, two separate "high-mag." valves in one glass bulb, working on a push-pull principle, each valve amplifying alternate half-cycles from the incoming signal applied to the grid.

Getting back to our point, the average moving-coil loud-speaker is not as sensitive as a good quality balanced-armature unit, and will therefore not give equivalent volume when compared upon the same radio signal.

This may have led to the fallacy before mentioned, and has probably arisen from the fact that upon replacing a moving-iron unit with one of the moving-coil type there is a noticeable loss of signal strength. When reconnecting a moving-iron loud-speaker, the leads must, of course, go to the proper terminals, otherwise it will become demagnetized, and consequently, the volume will decrease. With compliments and sincerest wishes for a prosperous and successful season.—E. G. PEARSE (Liverpool).

issued by this firm. Amongst the apparatus dealt with in the leaflets are various types of power amplifiers, heavy duty speakers, radio-gramophone equipment, microphones, and receivers. The address is Dalton Street, West Norwood, London, S.E.27.

MULLARD VALVE GUIDE

THE new season's Mullard Master Valve Guide is a very useful book of pocket size, giving the operating data and characteristics of the complete range of Mullard valves. The application of each valve is simply explained and useful hints concerning such matters as grid-bias voltage, operating notes, and so forth are included for each type. The technical appendix, which occupies thirty-four pages, includes a useful article with many diagrams on automatic grid bias, an authoritative article on the operation of rectifier valves, a handy method of calculating the correct ratios for output transformers, a guide to the standard connections to the new seven-pin base, and many other informative articles. Copies of the handy book can be obtained from the Publicity Dept., Mullard Wireless Service Company, 111, Charing Cross Road, London, W.C.2.

RADIO CLUBS AND SOCIETIES

Club Reports should not exceed 200 words in length and should be received First Post each Monday morning for publication in the following week's issue.

THE NEW ZEALAND DX CLUB

Now we want to ask a special favour of all members and non-members. A special short-wave station list with time schedule is being prepared, and any member who has any up-to-date schedules of America and Continental stations is asked to kindly send them in, together with a stamped addressed envelope, when a copy will be posted to them when ready. Lists will be published once a fortnight, and can be had by anyone enclosing 1½d. stamp. All communications for membership should be addressed to Leslie W. Orton, "Kingsthorpe," Willowbank, Uxbridge, or Mr. Stephen Cullen, 33, Dilston Grove, London, S.E.16.

SLADE RADIO

The third annual dinner, and also the 300th meeting of this Society was held at the Imperial Hotel quite recently. Dr. C. H. Harcourt, the chairman and founder, and also Mrs. Harcourt were present, together with a large number of members and friends. During the evening the Challenge Cup was presented to Mr. J. Walley and replicas to Messrs. S. Phillips and G. T. Peck.—Hon. Sec., 110, Hillaries Road, Gravelly Hill, Birmingham.

NEW LEEDS RADIO CLUB

A new club has been formed in Leeds for youths interested in radio, and would welcome new members. Lectures are frequently given on all subjects from crystal and one-valve sets to short-wave work and television, and are accompanied with demonstrations. Persons interested are invited to call or write to the Hon. Sec., E. H. Page, 6, Bridle Path Crescent, Crossgates, Leeds.

ANGLO-AMERICAN RADIO AND TELEVISION SOCIETY

The Uxbridge Branch held its second meeting on December 13th. An enjoyable time was spent by all present. Several stations were tuned in upon the branch receiver, whilst gramophone records of WOR, WTIC, WIOD, WGY, WPG, WJZ, 2XAF, 3XAU, 9XF, 1XAZ, etc., were played over. These records are of actual reception. The making of gramophone records with the aid of an acoustic gramophone was demonstrated, Rome, London and members being recorded in this way. This was done by inserting an aluminium disc upon the turntable of the gramophone, and shouting into the horn whilst the needle in the soundbox was placed against the revolving disc. There is no charge for joining this Branch, and all interested are invited to write to Leslie W. Orton, "Kingsthorpe," Willowbank, Uxbridge, for details.

We are notified by the Connecticut State College that they are putting over a DX concert, dedicated to the A.-A.R. and T.S., I.R.S., and DX listeners in general, on January 6th, 1934. The concert will be broadcast between 9.30 and 10.30 a.m., and the station will operate upon 600 kc/s, using the call letters WCAC. Reports should be addressed to Wm. J. Van Bynum, Connecticut State College, Storrs, Conn., U.S.A., or to L. W. Orton at the address given above.

SMETHWICK WIRELESS SOCIETY

At a recent meeting of the Smethwick Wireless Society, Mr. C. D. Gwinn, B.Sc., of the Telegraph Condenser Co., Ltd., gave a lecture on "Electric Condensers." He dealt in detail with the construction and properties of the three main types—paper (inductive and non-inductive), mica and electrolytic. An interesting series of lantern slides was shown, illustrating the actual processes of manufacture.—Hon. Sec., Mr. E. Fisher, 33, Freeth Street, Oldbury, Nr. Birmingham.

REPLIES TO BROADCAST QUERIES

RECEIVER (Stockton-on-Tees): GZHS, in the latest lists, is advertised as an amateur transmitter: G. W. Hale, 1, Bijou Villas, Grand Drive, Raynes Park, London, S.W.20; G5PL, J. A. Philpot, 21, Casino Avenue, Herne Hill, London, S.E.24; VU2DX, India. Further information regarding the latter can be obtained from: John G. MacIntosh, Dinjan T. E. Rangagora P.O., Assam, India. F. WILFORD (Eston): We can trace the following call-signs: WQP, Rocky Point (New York), 21.58 m.; GBB, Rugby, 22.08 m.; W2AOE, Dana A. Griffin, 3, Oakridge Avenue, Summit, New Jersey, U.S.A.; F8VL, Caradec, 177, Rue Croix-Nivert, Paris, 15, France; F8FG, Jillon, Rue Laplace-Chalette (Loire), France; FYH, Oran (Algeria); GMQ, Ongar (England), 21.85 m.; G2UC, E. J. Nock-Winstone, 1, Auriol Road, London, W.14; G6FG, N. Hendry, Hertford House, Sanderson Road, Newt castle-on-Tyne; G6US, N. E. Read, 32, Earls Court Road, London, W.8. For further information regarding the British amateurs, we advise you to write to The Radio Society of Great Britain, 53, Victoria Street, S.W.3.

CATALOGUES RECEIVED

To save readers trouble, we undertake to send on catalogues of any of our advertisers. Merely state, on a postcard, the names of the firms from whom you require catalogues, and address it to "Catalogue," PRACTICAL WIRELESS, Geo. Neveles, Ltd., 8/11, Southampton St., Strand, London, W.C.2. Where advertisers make a charge, or require postage, this should be enclosed with applications for catalogues. No other correspondence whatsoever should be enclosed.

NUVOLIAN SPEAKERS

A FINE range of these high-class speakers is given in a folder we have received from Nuvolian Electric, Ltd. The speakers are well known for their beauty of tone, largely due to the use of a patent cone which is moulded in one piece with the speech-coil former. By a special device an annular recess is compressed in the speech-coil former part of the cone to accommodate the speech-coil windings, with the result that with a gap of given width, a gain in clearance is obtained in the magnet gap. The speech coil end of the cone is reinforced by a special process which makes possible the more even reproduction of both bass and top, resulting in a remarkable brilliance of tone.

There are several permanent magnet models, ranging in price from 22s. 6d. to 42s. 6d., and also the P7 mains-energized speaker, capable of handling up to 5 watts without distortion. This speaker is made in three sizes, priced at 22s. 6d., 25s., and 30s. respectively. Well-finished cabinets of modern design to suit the speakers are also listed at very reasonable prices. The address is Meredith Works, Park Crescent, Clapham Park Road, London, S.W.4.

FERRANTI RADIO PRODUCTS

THE excellence of Ferranti electrical apparatus is well known, and this excellence extends to every radio component produced by this firm. A complete range of these products, together with prices, is given in a thirty-four page pamphlet just issued by Ferranti, Ltd., Hollinwood, Lancashire. Included in the list are L.F. transformers, mains transformers, fixed and variable condensers, speakers, valves, test sets, receivers, and a fine range of high-grade radio meters.

TANNOY COMPONENTS

TANNOY PRODUCTS are well known for their power amplifiers and other radio apparatus, particulars of which are given in a loose-leaf folder

THE A.C.—D.C.2 NEW PENTODE.

IN PRACTICAL WIRELESS dated September 2nd, we described a Universal receiver bearing the above name. The valve employed in the output stage of this receiver was an Ostar Ganz PT.3, and in the original model was fitted with a five-pin base and a side terminal. The stock of these valves has now been exhausted, and the latest supplies bear a 7-pin base. In order to assist readers who are constructing this receiver and who may obtain the new type of valve the accompanying illustration shows the new holder together with a diagram of the old pattern valve, and the numbering on these two sketches has been made to agree. Thus when wiring the circuit from the blue-print the connections which are taken to the original valve should

be joined to the terminals on the new valve which bear identical markings. It should be noticed that the suppressor grid must also be connected direct to the cathode.

In some cases it has been found that the particular mains which are in use are rather noisy and this gives rise to hum troubles. In such cases the expedient of changing round the 8 and the 1 mfd. condenser should be tried. At present the 8 mfd. condenser is used as a smoothing device across the pentode biasing resistance, whilst the 1 mfd. is joined across the receiver side of the smoothing choke. Reversal of these two connections may result in an improvement in the cases referred to.

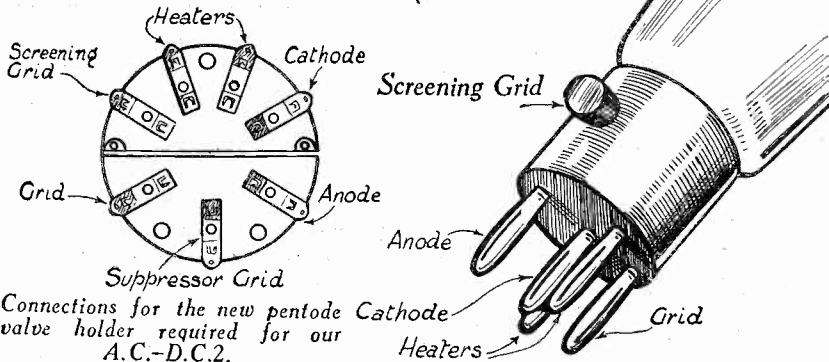

LET OUR TECHNICAL STAFF SOLVE YOUR PROBLEMS

REPLIES TO



If a postal reply is desired, a stamped addressed envelope must be enclosed. Every query and drawing which is sent must bear the name and address of the sender. Send your queries to the Editor, PRACTICAL WIRELESS, Geo. Newnes, Ltd., 8-11, Southampton St., Strand, London, W.C.2.

The coupon on this page must be attached to every query.

QUERIES and ENQUIRIES by Our Technical Staff

SPECIAL NOTE.

We wish to draw the reader's attention to the fact that the Queries Service is intended only for the solution of problems or difficulties arising from the construction of receivers described in our pages, from articles appearing in our pages, or on general wireless matters. We regret that we cannot, for obvious reasons—

- (1) Supply circuit diagrams of complete multi-valve receivers.
- (2) Suggest alterations or modifications of receivers described in our contemporaries.
- (3) Suggest alterations or modifications to commercial receivers.
- (4) Answer queries over the telephone.

Please note also that all sketches and drawings which are sent to us should bear the name and address of the sender.

SCREENED PRIMARY WINDING

"In an advertisement for a mains transformer recently I noticed that the term 'screened primary' was used. As I understand that a transformer operates by virtue of induction from the primary winding to the secondary winding, I am rather at a loss to understand how a transformer can transform when the primary is screened from the secondary. I should, therefore, be glad of your remarks regarding this point."—S. C. (Gloucester).

You are quite correct in your understanding of the working of a transformer, but you have omitted to differentiate between low-frequency and high-frequency currents. The transformer operates at low frequencies, and to screen low-frequency oscillations it is essential to use iron screening shields. The point with which we are concerned in a mains transformer, however, is the prevention of instability due to H.F. currents finding their way either from the mains leads to the receiver, or in the opposite direction, and, therefore, a thin copper sheet, or, alternatively, a small winding of copper wire is arranged between primary and secondary windings, and when this is connected to earth H.F. currents are short-circuited and thus instability from this cause is prevented. Naturally, if the primary was enclosed in an iron box which was earthed, the transformer would not function.

MICROPHONE DESIGN

"Owing to the recent microphone articles which you have published I have been looking into the mike problem, and think I have discovered a new idea. You have shown how the carbon granules alter the resistance between the two poles of the microphone in order to convert to speech or music, and I tried to make one of these instruments up. My experiments were not very successful and I was thinking round the arrangement when I decided that the granules were not necessary. All that is required, to my mind, is two poles with some variation between them, and I, therefore, tried using two very thin copper sheets with air separation, and I arranged these like a condenser. By speaking on to the top plate the capacity is varied owing to the movement, and this ought to work. I was not able to get any results, and should like to know where my idea has gone wrong."—G. H. (Hampstead).

Your idea is quite sound, and the arrangement which you made up is known as a "condenser microphone." It is used extensively in America and has certain applications in wireless practice on this side of the Atlantic. The method of using it, however, is not exactly the same as in the case of the ordinary microphone, and you must include the device so that the capacity variation, as distinct from a resistance variation, will produce results. For instance, if an oscillating valve has the condenser microphone connected in its grid circuit, variations in capacity will vary the frequency of the oscillation and produce the required effects. Alternatively, the device may be used to link together two valves, the coupling between them serving to vary the total effect. You will find, however, that the carbon type of instrument will

prove most suitable for home use and, in addition to its greater sensitivity, it may be used without any critical circuit modifications.

D.C. POLARITY

"I have made up the A.C.-D.C. 2 which you recently described, and I find that this suffers from some peculiar form of trouble. Some nights when I plug in I get very good results, but on some evenings it refuses to work altogether. I plug in and the set seems absolutely dud, no signals or reaction being obtainable anywhere. I have tried all through the evening with the same results and have given up in disgust, but the next day when I try it out it goes right away. I should be very glad if you could give me some idea as to where this trouble might originate."—S. K. (Surbiton).

We see from your address that you are on D.C. mains, and this is no doubt the cause of your trouble. When you insert the plug into the mains socket you must do so in order to obtain the correct polarity, and when once you have found which way round the plug should go you must mark it in some way so that it is always inserted in that position. If you do not do this you will find that the plug may have to be turned round when you fit it sometimes, and it is this which is preventing your signals on some evenings.

DATA SHEET No. 67.

Cut this out each week and paste it in a notebook.

MISCELLANEOUS VALVES NOW OBTAINABLE						
Type	Reference No.	Filament Volts	Amps	Anode Volts	Base Price	Maker
Bi-Grid	210 DG	2.0	.1	100	5-pin 20/-	Cossor
	41 MDG	4.0	1.0	200	19/-	
or	DG 2	2.0	.2	100	20/-	Marconi & Osram
	SS 210 DG	2.0	.1	30	19/-	
Double	SS 4 DG AC	4.0	1.0	200	19/-	Six Sixty
	DG 210	2.0	.12	100	4-pin 15/-	
Grid	DG 4100	4.0	1.0	100	5-pin 17/-	Tungsram
	DG 2018	20.0	.18	100	17/-	
Bar-retter for D.C. Sets	200/25	—	—	—	4-pin —	Lissen Osram
	251	—	—	—	4-pin 12/6	
	180 R	—	—	—	5/6	Tungsram
Heptode Frequency Changer	VET 4	4.0	1.0	200	7-pin 20/-	Ferranti
Special Diode Rectifier	CE 2	2.0	1.5	1,000	4-pin 15/-	Ediswan

FAULTY SWITCH

"My three-valve battery switch has now been working for nearly two years, but it has become erratic in its behaviour. When I wish to listen-in I find that I have to pull the switch very hard, and sometimes it does not work very loud. Is the valve worn out, or is the switch responsible for the trouble. It appears to be all right, but I do not know very much about the mechanical side of these switches."—T. B. A. (Newark).

The switch can be the cause of a lot of trouble, especially if it has been in use for a long period. You will probably find that the pear-shaped metal part at the top has become corroded, or the small springs into which it fits are weak and do not press tightly on the plunger. The best thing would be to purchase a new switch and fit this in place of the present one, noting the method of connection. Alternatively, you can remove the plunger by unscrewing the ebony knob, and then press the two springs inwards and carefully clean the contact faces with fine emery. Do not be tempted to oil or grease the switch to make it work easier.

REDUCING MAINS OUTPUT

"I have been given a very neat mains unit for Christmas, but it gives 200 volts, and my set only wants 150 volts. How can I reduce the output without damaging the unit, and get the required voltage."—E. C. F. (Dover).

In order not to damage the unit, it is preferable to connect a resistance across the output, external to the unit. You will, of course, have to ascertain the total output of your set in milliamps and endeavour to find a resistance which, together with the receiver, will result in a voltage drop of such a value that the total drain on the unit will not be in excess of that for which it is designed. That is to say, if the unit is rated at 200 volts 60 milliamps, you must arrange that the total drain of set and resistance does not exceed 60 milliamps. This is necessary to ensure that 200 volts is obtained at the positive terminal, and also that the rectifier is not damaged.

THE BEST INSTRUMENT

"I am thinking of taking radio really seriously in the new year, and, therefore, will buy some sort of measuring instrument as a start off. What would you advise me to get? A voltmeter, milliammeter, or a combined instrument? I want something which will not have to be thrown away when I really understand the subject, and one which will help me to understand many of the mysteries of the subject."—P. O. (Highbury).

Undoubtedly, the best thing for you to do is to buy a really good milliammeter. This will enable you to take various readings as the valves are functioning, and so help you to understand the mysteries of anode current, etc., and with the aid of shunts it will also be able to measure voltages. An instrument really 0 to 2 milliamps will prove highly desirable as this may be converted to read higher currents by the simple expedient of short-circuiting it with various resistances, according to the range desired. Do not get a cheap instrument as it will not prove so accurate on the various ranges, and will also lead to troubles eventually.

BATTERY BIAS FOR MAINS VALVE

"I have built up a mains set, and it is nearing completion, but I am in doubt about one point. I bought some second-hand valves, and the H.F. and detector valves are standard and bear markings, but the output valve (a pentode) has had the name rubbed away from the glass, or it was badly engraved. Consequently I do not know what make it is or what bias to give it. How can I find out the best value for the bias, or other values to ensure that I work it at its best point?"—Q. L. K. (Hornsey).

Provided that your mains unit does not deliver more than 200 or 250 volts you may be certain that you will not be applying too much H.F. to a standard mains valve. With regard to the heater supply, also, this will no doubt be quite in order at 4 volts. The grid bias is the only really doubtful value and this would best be ascertained by connecting the cathode of the valve to earth, and joining a standard grid bias battery between the earth line and the G.B. terminal of the L.F. transformer. This would enable you to adjust the bias to obtain best results, and the value of the required resistor could then be ascertained by measuring the anode current of the valve and dividing this (expressed as a fraction of an amp.) into the grid bias voltage. The answer will be the ohmic value of the resistor, which may then be joined in the cathode lead in the ordinary way. The G.B. terminal of the transformer will, of course, then have to be joined to earth.

WIRE FOR COILS

"There is a little point regarding the wire used for tuning coils which I should like advice upon. I am told that cotton-covered wire is not very suitable, because of some property contained in the cotton. Could you please tell me if this is correct?"—A. B. (Rhyll).

The only real difficulty in connection with using cotton-covered wire for coil construction is that cotton absorbs moisture very readily, and therefore if the coil is likely to be placed in a damp position the moisture might cause a high-resistance short between adjacent turns.

FREE ADVICE BUREAU COUPON

This coupon is available until January 6, 1934, and must be attached to all letters containing queries.

PRACTICAL WIRELESS, 30/12/33.

PRACTICAL WIRELESS

Miscellaneous Advertisements

Advertisements are accepted for these columns at the rate of 3d. per word. Minimum charge 3/-.

PREMIER Supply Stores, 20, High Street, Clapham S.W.4. See our advt. on Page 748 of last week's issue.

THE following valves are guaranteed unused and perfect, and any valve differing from the makers' characteristics will be exchanged; and all latest types. A.C./Pens. P.T.4s. A.C.S.G./V.M.s. Pen. 4Vs. M.V.S.G.s. A.C.S.2/Pens. M.M.4V.s. P.T.625s. V.M.S.4s. D.C.2/Pens. D.P.T.s. P.M.24M.s. M.P.T.4s. V.M.4V.s. A.C.S.1/V.M.s. P.M.24B.s. D.C.28.G./V.M.s. 11/-; M.S.4s. M.S.4B.s. A.C.S.G.s. S.4V.A.s. S.4V.B.s. M.S.G./L.A.s. D.S.B.s. A.C.S./2s. D.C.2S.G.s. 9/6; U.14s. 10/-; "Class B" P.M.2B. P.D.220. 220.B. 8/6. M.L.4s. A.C./P.s. P.M.24s. 8/-; A.C./H.L.s. 164V.s. 354V.s. A.C./H.L.s. 41M.H.L.s. U.10s. U.U.60/250s. M.H.4s. M.H.L.4s. 7/6; V.S.2s. 215S.G.s. 220S.G.s. P.M.12s. P.M.12A.s. 9/-; 442B.U.s. D.W.3s. 8/6; 215 P.s. 220P.s. L.P.2s. 4/9; P.2s. 6/6; P.T.2s. P.M.22A.s. 9/-; H.L.210s. H.210s. L.210s. L.2s. 3/9. All Types of Brand New American Valves in Stock, first-class makes: 247s, 235s, 224s, 236s, 237s, 238s, 239s, 245s, 244s, 12/-; 227s, 226s, 280s, 9/6; 242s, 232s, 11/-; U.X.250s, 16/-; 281s, 14/6. Carriage Paid. Cash with Order or c.o.d.—Ward, 45, Farringdon St., E.C.1.

EVERYTHING to make your own transformers (mains and push-pull), chokes and coils. Lists free.—Lumen Electric Coy., 9, Scarisbrick Ave., Litherland, Liverpool, 21.

ERICSSON 3/1 L.F. Transformers, List price, 17s. 6d. New and guaranteed. Our price, 2s. 3d. post free U.K.—Pioneer Radio, Coptic St., London, W.C.1.

REPAIRS TO ANY MAKE RADIO APPARATUS. 24 Hours service, guaranteed laboratory tested. Transformers, loud-speakers from 4/-. Eliminators, Mains Transformers, etc. New cones fitted to Moving-Coil speakers. Estimates free. Wates Volt/Amp meters a speciality. 3/6, other makes quoted for. Repair Dept. C. WEEDON POWER LINK RADIO CO., 185, Earlham Grove, London. E.7. Maryland 4344.

CHARGING WITHOUT MAINS!—Thousands are charging their own accumulators, why don't you? "Tonic" trickle-charger kits keep 2-volt accumulators fully charged. Ideal for remote districts. From 7/-, postage 9d. Full particulars, stamp.—Williams, Netherend, Cradley, Nr. Birmingham.

THE Exchange Specialists. Get your New Kits, Speakers, Radio Sets or Components from us. Your Old Set, Speaker or Components taken in part payment. Absolute satisfaction assured.—Rad-Auto-Gram Co., 39, Tulketh Street, Southport.

CHAL Electric offers Brand New Set Manufacturers' surplus Moving Coil Speakers. Magnavox Type D.C.144, 7-in. cones 100/190 D.C. (2500 ohms) (40/76 M.A.) and 190/280 D.C. (6500 ohms) (29/43 M.A.) at 19/- each. 152 Type, 9-in. cones same voltages at 26/- each. ROLAS F.6 (voltages as in Magnavox), 7 1/2-in. cones at 18/-; F.7 9-in. cones same voltages at 25/-. Permanent Magnets, F.6 P.M., list 49/6, at 28/-; F.7 P.M., list £3, at 33/-. State if Power or Pentode Transformer. All fitted Humbeckers. Also number of Class "B". State requirements. All goods Carr. Paid. Cash with order or C.O.D. Chal Electric, No. 6, Conduit Street, London, W.1. Regent 6240.

TELEVISION Guaranteed Receivers from £3, leading makers components. Constructor's Handbook, 1s.—Bennett Television, Jesmond House, Redstone Copse, Redhill.

WANTED good Modern Wireless Parts, Sets, Eliminators, Meters, Valves, Speakers, etc. Spot Cash Waiting. Send or bring. We pay more than any other Dealer. Open 9-8.—University Radio, 142, Drummond St., H-mstead Rd., N.W.1.

TELEVISION Constructors Guide, 1/3, illustrated catalogue free, notes 1d.—Ancl Cine Co., 16, Highbury Terrace, Nr. Highbury Station.

Piano Tone RADIO GRAM CABINETS as supplied to B.B.C. 65/- POLISHED CABINET FOR 35/- No Middle Profits! Famous maker offers finest Radio Furniture. As supplied to B.B.C. a quality and value impossible to better. Beautifully hand polished! GUARANTEED Piano-Tone acoustically. DIRECT—on FREE TRIAL (or 10/- monthly.) LIST FREE! From makers PICKETT'S Piano Tone Cabinet (P.R.) Works, Albion Road, Bexleyheath, near London.



The Pilot

the world-famous figure-head—always to be associated with PETO-SCOTT Radio-by-Mail Service—wishes a happy and prosperous New Year to his many thousands of customers throughout the World, with specially cordial greetings to those friends who have been regular customers since the inception of PETO-SCOTT in 1919.

PETO-SCOTT CO. LTD. 77 CITY ROAD, LONDON, E.C.1

Telephone: Clerkenwell 9406/7 EST. 1919 West End Showrooms: 62 High Holborn, London, W.C.1

EASY TERMS PROMPT DELIVERY Any Amplion, Blue Spot, Baker, Celestion, Epoch, R. & A. Rola, Sonochorde, Grampian, Igranic, Lamplugh, Magnavox, Ormond, W.B. or Ferranti Moving Coil Speaker Supplied. Send 5/- only and pay the balance by monthly instalments. No references. Entirely private and confidential. KITS, PARTS, SETS, ELECTRIC CLOCKS ON EASY TERMS. Write for Catalogue and state requirements. TURNADE AND PARTNERS, LTD. Ludgate House, Fleet St., London, E.C.4. Telephone: Central 1903.

FRONT OF PANEL MILLED NUT FIT THIS ELECTRIC CLOCK TO YOUR SET! NO MAINS NEEDED! KEEPS CORRECT TIME! NO WINDING! Works off small battery lasting 12 months, or can be plugged into G.B. battery without affecting reception. Uses practically no current. Fits into hole 3 1/2 in. dia. in any panel up to 1/2 in. thick. Easy to fit—no screws required. Only 1/2 in. from front of panel to back of case. Swiss movement. Hands set from front. Nickel-plated bezel. Useful addition to any set. RIVERSIDE MFG. Co., Ltd., Dept. 21, Crisp Road, Hammersmith, W.6. Telephone: Riverside 6392. COMPLETE WITH BATTERY POSTAGE 6D

GRIPSO PATENT NAMED PLUGS & SPADES LISTS FROM MAKERS THE GRIPSO COY. 28 VICTORIA ST., LONDON, S.W.1. RADIO SUPPLIES Send your list of Radio needs for our quotation. Kits, Parts, Sets, etc. Everything in Radio stocked, prompt delivery, 7 days' approval. Catalogue free. Taylex & Standard Wet H.T. replacements stocked. N. TAYLOR, 9, GROVE RD., BALHAM, S.W.12

SOUTHERN RADIO'S Wireless Bargains.—Set manufacturers' guaranteed surplus. VARIABLE Condensers.—Lotus 2-gang 0.0005, complete with dial, knob, escutcheon, S/G; Lotus Dyblock Single Variable 0.0005 Condensers with dial, knob escutcheon, 4/9, (list 9/56; Hydra block condensers, new, 16 mfd., 2+2+8+2+1+1 1,000 volt test. 7/- each; 4 mfd., 2/6; 2 mfd., 1/9; 1 mfd., 1/-. Block condensers 1,500 volt, with terminals 20 mfd. (2+2+2+2+2+2+2+2+2+1+1) 12/9; 10 mfd. (2+2+2+2+1+1) 3/3. RADIOPHONE Volume Controls and Switch. 50,000 and 10,000 ohms, 3/3 each (list 10/6). HELLESENS 8 mfd., Electrolytic Condensers, 3/6 each, 4 mfd., 3/- each. SPEAKERS.—Permanent magnet, 28/- (listed 49/6); D.C. mains energised, 2,500 to 6,500 ohms, complete with humbucking coils and transformers, 16/6 (list 39/6); Magnavox D.C. speakers, M.C. latest type "154" all voltages, 17/6 each. G.E.C. Stork speakers, complete in magnificent cabinet, 19/6 (listed £3/15); Ormond speakers, complete in cabinets, 10/- (listed 25/-); Blue Spot, 100 U, 13/6 (list 37/6). READY Radio "303" A Kits, complete with cabinet, M.C. speaker, less valves, £2/5; with 3 Mullard valves (P.M.I.L.F., P.M.2D.X., P.M.2), £3/5 (list £6/17/6). READY Radio Meteor "A" 3-Valve Screen Grid Kit, complete with cabinet, M.C. speaker, less valves, £3/7/6; with 3 Mullard valves (P.M.12A., P.M.2D.X., P.M.2A.), £4/10 (list £8/7/6). READY RADIO ST.400 Kits, as specified by R Scott Taggart, £2/19/6 each (list £4/17/6); all kits brand new in original sealed cartons. R.T.H. Senior Pick-ups, 1934, complete with volume control, 28/6 each (list 37/6). Blue Spot Pick-ups, with volume control, Model "88," 26/- each (listed 63/-). Ferranti Chokes, C.T., 20 Hys., 50 m.a., 6/8 each (list 35/-); H.M.V. volume controls, 1/6 each (list 12/6). Dubille 4 mfd. condensers (2+1+1), 1,000 volt, 2/9 each. 4.5 mfd. (2.25+2.25), 1,000 volt., 3/- each. Lumophon D.C. Moving Coil Speakers with terminals, 11/6 each (list 39/6). Mains Switches, 3 amp., 250 volt, 8d. each, 7/6 doz. Edison Bell Centre Tapped Inductance Coils, all values from 20 upwards, 9d. each, 7/6 doz. assorted. Amplion Loudspeaker Units, 2/3 each (list 12/6). Every article perfectly new. ALL Goods guaranteed Now and Perfect and sent Carriage Paid. PLEASE Note.—We have opened branches at 271-275, High Rd., Willesden Green, N.W.10, and at 46, Lisle Street, W.C.2, where callers are cordially invited to inspect our large stocks of wireless bargains. Please send all post orders to 323, Euston Rd., N.W.1. SOUTHERN RADIO, 323, Euston Rd., London, N.W.1 (near Warren St. Tube). Phone: Museum 6324.

RADIOMART BIRMINGHAM.—New and revised list of surplus manufacturers' surplus and bankrupt stocks. The largest selection in country. No rejects or standard goods. No misrepresentation. Send stamp and save pounds.—The Square Dealers, 19, John Bright Street, Birmingham.

"PRACTICAL WIRELESS" MAINS TRANSFORMER for Mr. Camm's A.C. Three. For any mains input 250-0-250 v. 60 m/a. 2-0-2 v. 1 amp. and 2-0-2 v. 3 amps for 10/6 Usual price 21/-.

HOME BROADCASTER. Why not be your own Announcer and give your voice a microphone opportunity? OUR NEW LESDIX No. 11 SUPER MICROPHONE in bakelite case is a marvel for speech and music reproduction on your radio set. 5/6 For hand or stand.

PHONES, PHONES, PHONES 120-ohm Sullivan Headphones, W.D. model, at a tenth of cost. For circuit testing, fault spotting, broadcast listening, microphone experiments, line signals, Morse reading, A.C. Bridge work, condenser calibration for use with H.R. transformer. All one type and new. Aluminium body and headbands. Maker's price to-day is 15/- Our price 2/6 per pair, 3d. postage or 4/6 for 2 pairs post free.

ELECTRADIX RADIOS, 218, UPPER THAMES ST., E.C.4. Phone: City 0191.

PLASTAPE The "Modern Aerial" for the "Modern Set" AMPLION (1932) LTD. AERIALS, EARTHS, EXTENSION WIRES

ADVERTISEMENT INDEX

Aircelipse, Ltd.	Page 768
"Amateur Gardening" Books	Back Cover
Amplion (1932), Ltd.	776
Cosmocord, Ltd.	765
Cossor, A. C., Ltd.	757
Electradix Radios	776
Ever Ready Co. (Gt. Britain), Ltd.	765
Graham Farish, Ltd.	Front Cover Strip
Gripso Co.	776
Heayberd, F. C., & Co.	773
Heraud, E. J., Ltd.	773
Lissen, Ltd.	Inside Front Cover
Mains Power Radio, Ltd.	773
New London Electron Works	768
Peto Scott, Ltd.	776
Picketts	776
Riverside Mfg. Co., Ltd.	776
Standard Telephones & Cables, Ltd.	773
Taylor, N.	776
362 Radio Valve Co., Ltd.	765
Turnadge & Partners	776
V.M.C. Radio Co.	773
Ward & Goldstone, Ltd.	765
Wet H.T. Battery Co.	768



A "William" Book makes an ideal Gift for old and young alike.

Ask your Newsagent or Bookseller to show you other titles in this popular series.

Latest Title

WILLIAM—THE REBEL
By RICHMAL CROMPTON

Obtainable at all Booksellers or by post 2/6 from George Newnes, Ltd., 8-11, Southampton Street, Strand, London, W.C.2.

PRACTICAL HANDBOOKS

Clearly written and fully illustrated.

This series covers a wide field and will prove of the greatest value to everyone interested in models and how to make them; woodwork and other crafts.

ACCUMULATORS

An up-to-date handbook dealing with every type of accumulator, methods of charging them at home, care and maintenance, also explains how to erect a charging station.

TWENTY-FIVE TESTED WIRELESS CIRCUITS

All the sets described have been designed to meet modern needs. They range from simple crystal receivers to a seven-valve super-heterodyne, and all the sets have been made and tested before inclusion.

SIMPLE ELECTRICAL APPARATUS

An excellent little book for those who wish to make simple and useful electrical appliances, such as galvanometers, electric motors, dynamos and Leyden jars.

THE HANDYMAN'S ENQUIRE WITHIN

Hundreds of practical ideas and hints of value to the man who is clever with his hands.

NEWNES'

HOME MECHANIC BOOKS

Ask your Newsagent to show you other titles in this popular series.

Obtainable at all Newsagents and Bookstalls, or by post 1/- each from George Newnes, Ltd., 8-11, Southampton St., Strand, W.C.2.

Geo. Newnes, Ltd.

NEWNES'

PRACTICAL AND HELPFUL WIRELESS BOOKS

Will prove of the utmost value to everybody who wants to understand wireless from A to Z

Latest Titles

THE WIRELESS CONSTRUCTOR'S ENCYCLOPEDIA 5/-
By post 5/6

By F. J. CAMM (*Editor of "Practical Wireless"*). 2nd Edition. Written in plain language by one of the most accomplished designers and writers on wireless construction. The whole subject is fully covered, and the volume is remarkable for the number of practical illustrations it contains, there are hundreds of circuits, wiring diagrams and layouts. Wireless terms and definitions are clearly explained. No matter in which branch of radio you are interested, you will find everything adequately dealt with here.

THE ELEMENTS OF WIRELESS 3/6
By RALPH STRANGER. By post 3/10

The Author starts with elementary principles, covers the whole field of wireless reception, both from the theoretical and practical points of view, and finishes with a complete survey of a four-valve wireless receiver, explaining its working from the aerial terminal to the loud-speaker.

FIFTY TESTED WIRELESS CIRCUITS 2/6
By F. J. CAMM (*Editor "Practical Wireless"*). By post 2/10

This handbook contains every modern circuit, complete with instructions for assembling, component values, and notes on operation.

DICTIONARY OF WIRELESS TERMS 2/6
By RALPH STRANGER. By post 2/10

The author, who is a master of lucidity, has produced in his "*Wireless Dictionary*" a valuable and fully-explained synopsis of technical terms that everybody can understand. An indispensable boon to every wireless enthusiast who reads technical books and journals.

Other Titles

THE OUTLINE OF WIRELESS 8/6
By RALPH STRANGER. (*Omnibus size.*) By post 9/-

A comprehensive work on wireless that everybody can understand. Specially written for the "man in the street," and covers the whole subject of wireless reception from A to Z. Fourth Edition. 816 pages.

THE MATHEMATICS OF WIRELESS 5/-
By RALPH STRANGER. By post 5/4

This book is essential for the wireless amateur who desires to gain a fuller knowledge of his subject. Written by one who has the gift of explaining abstruse subjects in a simple fashion. Fully illustrated.

WIRELESS, THE MODERN MAGIC CARPET 3/6
By RALPH STRANGER. (*Fifth Edition.*) By post 3/10

Wireless simply explained at the beginning and seriously treated at the end.

FINDING FOREIGN STATIONS 3/6
By R. W. HALLOWS. (*Long Distance Wireless Secrets.*) By post 3/10

A book which will be eagerly welcomed by all wireless enthusiasts. It will solve your difficulties and enable you to obtain the best possible results of which your set is capable.

WIRELESS STEP BY STEP 2/6
By "DICTRON." (*Tenth Edition.*) By post 2/10

A book which shows the wireless enthusiast how to obtain the maximum enjoyment from his wireless set.

RADIO PLAYS 2/6
By L. DU GARDE PEACH. By post 2/10

Millions of wireless listeners who have been thrilled by such plays as "The Path of Glory," and "The Mary Celeste" can now read them in book form. Mr. du Garde Peach has written some of the most successful plays ever broadcast.

Obtainable at all Booksellers, or by post from **GEORGE NEWNES, LTD.**, 8-11, Southampton Street, Strand, London, W.C.2.

Geo. Newnes, Ltd.

Practical New Year Gifts for Gardening Friends

THERE can be no better choice of gift for a garden-loving friend than a really good gardening book. Here are works written by men whose names are famous in Horticulture. Collingridges have specialised in gardening books for half a century, and each of those mentioned represents the best of its class.

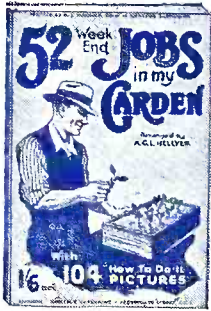

10/6

Postage 9d. extra.

7/6

Postage 6d. extra.

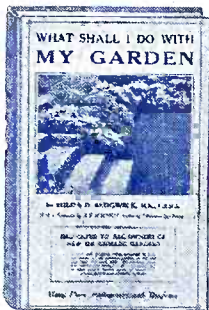

5/-

Postage 6d. extra.

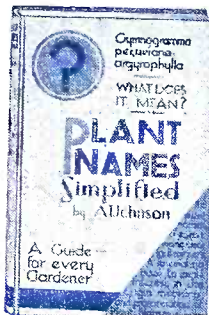

3/6

Postage 6d. extra.

2/6

Postage 6d. extra.



2/-

Postage 3d. extra.

1/6

Postage 3d. extra.

- Flower Garden T. W. Sanders
- Amateur's Greenhouse A. J. Macself
- Encyclopædia of Gardening T. W. Sanders
- French Intensive Gardening A. J. Macself
- Fruit and its Cultivation T. W. Sanders
- Popular Hardy Perennials T. W. Sanders
- Rock Gardens and Alpine Plants T. W. Sanders
- Roses and their Cultivation T. W. Sanders
- Vegetables and their Cultivation T. W. Sanders
- Alphabet of Gardening T. W. Sanders
- Carnations for Amateurs J. L. Gibson
- Chrysanthemums for Amateurs A. J. Macself
- Garden Foes T. W. Sanders
- Grapes, Peaches, and Melons T. W. Sanders
- Orchids for Amateurs T. W. Briscoe
- What Shall I do with My Garden H. Sedgwick
- Plant Names Simplified A. T. Johnson
- Special Manures for Garden Plants A. J. Macself
- Wild Flowers through the Seasons S. Hibberd
- Bulbs and their Cultivation A. J. Macself
- Flower Beds S. Ashmore
- Garden Doubts and Difficulties H. Smith
- Gay Gardens from Seed S. B. Williams
- Hardy Border Plants T. W. Briscoe
- Simple Fruit Growing P. K. Bear
- Simple Gardening A. J. Macself
- Simple Greenhouse Management J. S. Dakers
- Simple Pruning N. Catchpole
- Simple Rose Growing A. G. L. Hellyer
- Simple Rock Gardening A. J. Macself
- Amateur Gardening Month by Month T. W. Sanders
- 52 Week-end Jobs in My Garden A. G. L. Hellyer
- 101 Things about Gardening H. A. Smith
- Gladioli and Dahlias C. W. J. Unwin
- Sweet Peas for All Purposes A. J. Macself
- Tomatoes and How to Grow Them F. R. Castle

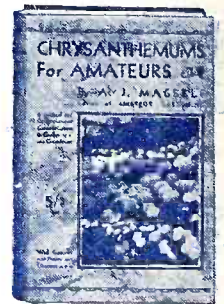

The practical and beautifully illustrated series of Books listed above offers helpful usefulness to Gardeners beyond all comparison.

THERE ARE NO BETTER BOOKS ON GARDENING

OBTAINABLE BY RETURN OF POST FROM COLLINGRIDGES, PUBLISHERS OF THE BEST GARDENING BOOKS
"AMATEUR GARDENING" OFFICES, 148-9, ALDRSGATE STREET, LONDON, E.C.1

P. W. Gift Stamp No. 66

Printed by NEWNES & PEARSON PRINTING CO., LTD., Exmoor Street, Ladbroke Grove, W.10 and published by GEORGE NEWNES, LTD., 8-11, Southampton Street, Strand, W.C.2. Sole Agents for Australia and New Zealand: GORDON & GOTCH, LTD., South Africa: CENTRAL NEWS AGENCY, LTD. Practical Wireless can be sent to any part of the world, post free, for 17/4 per annum; six months, 8/8. Registered at the General Post Office for Transmission by Canadian Magazine Post.

P. W. Gift Stamp
"Popular Mechanics" No. 10