

Tips, guides and reports for people repairing televisions and electronic equipment

# TELEVISION



## AND HOME

## PAIR

NOVEMBER 2003 £3.20

Report from the  
**IFA Berlin Show**



## TV interference from TETRA

### A flexible CCTV security system

Satellite, Audio, Monitor, TV, VCR and DVD faults



## Thanks to Eldor, finding the right transformer is child's play...

With most of Europe's leading TV manufacturers including Alba, Beko, Daewoo, Philips, Samsung and Toshiba, to name but a few, choosing Eldor as their supplier of Line Output Transformers and Classic, as Eldor's sole European distributor, finding the transformer you need is as easy as 1, 2, 3...

- 1... Locate the label on the original transformer.
- 2... Make a note of the Eldor part number shown on the label.
- 3... Locate this number on your Eldor look-up card and order the Classic part number listed from your usual Classic distributor.

If you don't yet have a copy of the Eldor look-up card phone your Classic distributor with the Eldor part number and tell them you want an original Eldor part.

For more information on the entire Classic range or details of a distributor near you, call 01635 278678, visit us on the web; [www.classic-electronics.co.uk](http://www.classic-electronics.co.uk) or email us at [sales@classic-electronics.co.uk](mailto:sales@classic-electronics.co.uk)



Technical helpline 01635 278678



Eldor part number  
format xxxx.xxxx  
with or without the  
final alpha character

Safety Approved

# CONTENTS

November 2003

Vol. 54, No. 01

## 3 Comment

Companies that wax and wane.

## 4 Teletopics

The European HDTV system. Flat TV update. Business news. Flat CRTs from LG.Philips. Video recording devices. DAB update. Sharp's 'wireless TV'.

## 6 A flexible CCTV system

Simple inexpensive off-the-shelf CCTV kits are readily available but lack individual expansion capabilities and flexibility. Ian Rees has devised a system that should fulfil the needs of small-to-medium sized installations, with some added innovations found only in dedicated PC or professional systems.

## 12 At the Internationale Funkausstellung



The 2003 IFA exhibition featured the latest developments in digital TV, flat-screen technology, DVD players and recorders, camcorders with various storage systems and domestic networking. George Cole was there to report for us.

## 16 The TETRA problem

TETRA is an international standard for digital mobile communications. The police and other emergency services in the UK are gradually adopting TETRA systems. They are high-powered, and can cause UHF TV interference problems. Bill Wright describes the situation and the remedies that can be used.

## 25 Servicing the Sharp DA100 (50Hz) and DA50W chassis

Part 3 of this series, by Alex Towers, deals with the dynamic focus, EW correction and field output stage circuitry and outlines line and field timebase fault-finding procedures.

## 32 Letters

DTT redundant? Fire hazard. Reliability. Polarity protection. Vintage radio repairs.

## 33 Help wanted

## 34 DX and Satellite Reception

Terrestrial DX and satellite TV reception reports. Broadcasting news. LNB-dish matching. Interference from PLT. Roger Bunney reports.

## 38 Audio faults

Hints and tips on repairing professional and consumer equipment.

## 40 Monitors

Guidance on repairing monitors and related equipment

## 44 VCR clinic

## 45 Test Case 491

## 46 TV fault finding

## 50 Web service

Useful websites for TV professionals, technicians and enthusiasts.

## 54 Satellite notebook

High-definition TV tests. Digital channel update. BBC1 regional oddities. Update at 34.5°W. Unusual test cards. Digibox fault reports.



## 57 Next month in Television

## 58 What a life!

TV and VCR faults. Band III converters. Warm sets. Donald Bullock's servicing commentary.

## Editor

John A. Reddihough

## Deputy Editor

Tessa Winford

## Advertisement Sales

Reuben Gurunlian

01322 611 292

Fax 01322 616 376

## Publishing Director

Tony Greville

Note that we are unable to answer technical queries over the telephone and cannot provide information on spares other than that given in our Spares Guide.

## Disclaimer

We work hard to ensure that the information presented in *Television* is accurate. However, *Television's* publisher - Highbury Business Communications - will not take responsibility for any injury or loss of earnings that may result from applying information presented in the magazine. It is your responsibility to familiarise yourself with the laws relating to dealing with your customers and suppliers, and with safety practices relating to working with electrical/electronic circuitry - particularly as regards electric shock, fire hazards and explosions.

**Next issue, dated  
December, on sale  
November 19**

# WILTSGROVE LTD

35/38 River Street, Digbeth, Birmingham B5 5SB

TEL: 0121 772 2733 - FAX: 0121 766 6100

## ONLINE CATALOGUE!

<http://www.wiltsgrove.co.uk>

visit our website to search your required product

Make/Model, Product Category,  
Manufacturers part number,  
Key Word search or Our Order Code

e-mail: [sales@wiltsgrove.co.uk](mailto:sales@wiltsgrove.co.uk)

<http://www.wiltsgrove.co.uk>

Opening Times: 9:00am - 6:00pm (Monday to Saturday)

VALID UNTIL THE END OF NOVEMBER 2003

### 14" BLACK & WHITE MONITOR

#### SPECIFICATION:

Input Voltage	AC 110V / 230V / 240V
Power Consumption	35 Watts
Signal Input	BNC - 75 Ohm (switchable) Video, Composite
Input Impedance	BNC Connector, 75 Ohm / High Switchable
Colour	Black
Resolution	1000 TV Lines
Linearity	Horizontal 10% Max Vertical 10% Max
CRT	14"
Operating Temperature	-10°C to +60°C
Dimensions (WxDxH)mm	318 x 340 x 315
Weight	10.20Kgs



£72.50

Order code: AV-1051

### 14" HIGH RES COLOUR MONITOR

#### SPECIFICATION:

Power Type	14" Diagonal
Scanning Frequency	NTSC H 15.734 KHz V 60 Hz PAL H 15.625 KHz V 50Hz
Screen Colour	Intensity, colour and saturation control
Video Signal Input	1.0Vp-p / 75 Ohms
Video Impedance	75 Ohms / High Switchable
Horizontal Resolution	NTSC 450 TV Lines PAL 500 TV Lines
Audio	Built-in passive speakers
Sound Input	400mV 1k ohm
Sound Output	2W
Speaker Impedance	8 Ohms
Power Source	AC 110V / 230V / 240V
Power Consumption	35W
Dimensions (WxHxD)mm	356 x 335 375
Weight	Approx. 14.8 kg



£129.95

Order code: AV-1056

### 4 WAY CAMERA SWITCHER

#### SPECIFICATION:

Input Voltage	AC 110V / 230V / 240V
Video Inputs	1.0 Vp-p / 75 ohms - 4 inputs
Video Output	1.0 Vp-p / 75 ohms - 2 outputs
Video Gain	From Attenuation to amplifier, 0.8 to 1.4 Vpp
Video Bandwidth	20MHz ± 5%
Max Video Input	2.0 Vpp
Choke Test Result at Input	Better than 400p
Switch Interval	Approx. 1 to 15 sec
Channel Selection	Buttons / Push / Encoder
Power Consumption	3W Max
Video Connector	BNC
Position & Power Lamp	Long Life LED
Operating Temperature	-10 to +60°C
Construction	Steel, with gray enamel finish
Dimensions (WxDxH)mm	215x140x40
Weight	Approx. 0.82Kgs



£39.95

Order code: AV-1071

### BLACK & WHITE BULLET CAMERA

#### SPECIFICATION:

Video Pick Off Device	1/4" BNC Interface Transfer CCD
Scanning System	2:1 Interlace (NTSC Standard) / 2:1 Interlace (PAL Standard)
	525 Lines/60 Fields/30 Frames / 625 Lines/50 Fields/25 Frames
Scanning Frequency	15.734KHz (H) / 59.94Hz (V) (NTSC) 15.625KHz (H) / 50Hz (V) (PAL)
Effective Pixels	768(H) x 494(V) / NTSC 752(H) x 582(V) PAL
Input Lens	8.8mm (2" x 1/8") (M12)
Video Output	1.0Vp-p NTSC Comp / 1.0Vp-p PAL Comp
Electronics	Super-Resolution / Low Noise Processor
Sync System	INT Only
Resolution	525 Lines/60 Fields/30 Frames
Gamma	γ=0.45
Bit Rate	30FPS / 30FPS
Power Source	DC 12V 200mA 4.5W
Lens	8.8mm Bullet
Minimum Illumination	0 Lux
Dimensions (WxDxH)mm	58 x 38 x 48
Lens Type	Regular Lens



#### FEATURES:

- Built-in 6 LEDs to observe the security area under dark of 0 Lux
- Can be used under water of 30m
- Extremely low power Consumption

£39.95

Order code: AV-1540

### 4 CH COLOUR DUPLEX MULTIPLEXER

#### SPECIFICATION:

<b>VIDEO SIGNAL</b>	TV System	NTSC / PAL
	Digital Memory	72x4Mbit / 72x4Mbit
	Main Input	4 Channels / 1 MUX
	Video Input Signal	1.0Vp-p 75 Ohms
	Video Output	4 Channels/2 monitors / VCR
	Video Output Signal	1.0Vp-p 75 Ohms
	Scale	Yes
<b>ELECTRICAL</b>	Power Supply	100-240V, 50/60Hz (Free Voltage)
	Power Consumption	Approx. 10W
<b>VIDEO FEATURES</b>	Colour Format	Y, C, Colour
	Recording Quality	1 - 5 sec
	Export Mode	Normal / Black Line
<b>CONNECTOR</b>	Video Input	4 BNCs
	Video Output	4 BNCs
	Monitor Output	2 BNCs
	VCR Input	1 BNC + 1Y/C
	VCR Output	1 BNC + 1Y/C
	Alarm In/Out	25 Pin D-Sub
	Power Jack	DC Jack
<b>MECHANICAL</b>	Dimensions (WxDxH)	44 x 88 x 30 (mm)
	Weight	4.2kg (plus necessary cable)
<b>ALARM FEATURE</b>	Alarm Inputs	4 Inputs (NO/NC selectable)
	Alarm Outputs	1 Relay Output (3A max)
	Multiple Alarm Display	Sequence
	Alarm Duration	1 - 60 sec
	Video Loss Indicate	Alarm with Blue Screen
<b>ENVIRONMENTAL</b>	Operating Temperature	0°C - 50°C
	Humidity	30 - 80% (relative, non-condensing)



#### FEATURES:

- High Quality Digital Processing
- 4 Channel Camera Input
- Duplex Operation: Recording & Monitoring
- Freeze Picture on playback mode or live mode
- Fully compatible with Time Lapse VCR / S-VHS & other VCR
- Digital Motion Detection
- Display Mode (1h / 4CH)

£229.00

Order code: AV-6022

### DVR STAND ALONE 4 CHANNEL

#### SPECIFICATION:

Operation Mode	Fixed Frame / CCD
Resolution	720 x 480
Display Mode	Single Channel / 2:1 / 4:1 / Full Screen / 2:1 / 4:1 / Full Screen / Auto
Recording Speed	720 x 240 1-10 Frames/sec (adjustable) 360 x 240 1-15 Frames/sec (adjustable)
Audio Recording / Live Audio	1 ch
Compression	MJPEG
System Division Mode	1 - 4 Division
Camera Input	4 CH BNC (NTSC/PAL)
Video Output	Composite Video / 4:1 / 2:1
Playback Function	Playback - forward reverse Fast Forward Fast Reverse Forward one frame Zoom in
POD	HD/SD MODE
Search Mode	Date, Time, Camera
Operating Temperature	0°C - 50°C
Power Supply	AC 100V - 240V, 50/60Hz DC 12V/4A
Power Consumption	20W
Dimension (W x D x H)mm	313 x 255 x 44
Weight	1.7kg



#### FEATURES:

- Up to 30 frames per second video display
- Simultaneously recording live view display
- Automatically detects NTSC/PAL
- Tapeless recording replaces conventional time-lapse recorder
- Four set input and one set output alarm connection Automatically recording, after being triggered
- Highly stable non-PC based proprietary system
- Automatically returns the original operation when power recovery from failure

£429.00

Order code: AV-6070

### 1/4" COLOUR WEATHER-PROOF BULLET CAMERA

#### SPECIFICATION:

Pick Up Device	1/4" Colour Interface Transfer CCD
Picture Elements	NTSC/EIA 510 (H) x 492 (V) PAL/CCIR 500 (H) x 582 (V)
Sync System	1 Line
Horizontal Resolution	330 TV Lines
Linearity	Horizontal 10% Max / V 10%
Auto White Balance	2500°K - 9500°K
AGC	Yes
Gamma Characteristics	0.45
Electrical Noise	Shot Noise (1000Hz) 1.0Vp-p (1000Hz) 1.0Vp-p
Power Source	DC 12V ± 10%
Power Consumption	2.5W Max
S/N Ratio	More than 48dB
Video Output	Composite 1.0Vp-p 75 Ohms
Minimum Illumination	0.5 LUX / 75 ohms
Storage Temperature	-10°C to +60°C



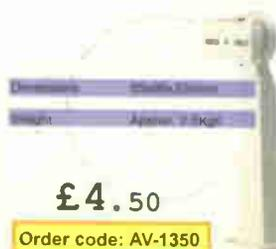
£64.95

Order code: AV-1420

### BOTH ITEMS REQUIRED FOR COMPLETE SET

BRACKET for CAMERA HOUSING

CAMERA HOUSING - OUTDOOR



Dimensions (WxDxH)mm	30x30x30
Weight	Approx. 1.5kg

£4.50

Order code: AV-1350



Dimensions (WxDxH)mm	110x100x100
Weight	Approx. 1.5kg

Order code: AV-1365 £29.75

\*\*TRADE ONLY\*\*

\* PRICES SUBJECT TO AVAILABILITY, VAT & CARRIAGE.  
\* PRICES MAYBE CHANGED WITHOUT PRIOR NOTICE.

Freefax Orderline: **0500 55 05 05**

# Companies that wax and wane

When I was young large companies seemed to me to be pretty permanent fixtures – despite the depression and war years. After all, they owned giant mills, steel plants, Atlantic liners, coal mines or what have you: not the sorts of things one might expect to come into and out of use over a relatively short period of time. Yet the mills have closed, UK steelmaking has declined dramatically, the liners have long since given way to aircraft, and the pits are no longer active. The fields of electrical and electronic manufacturing are similarly affected by change. Who, back in the Seventies, would have thought that the mighty Thorn Electrical Industries would fade away? Once Sir Jules departed it seemed to do just that. Interestingly, Philips has proved its survival capability to date, though the going has been tough at times. More recently we have had the extraordinary business of the internet company bubble. Some of these companies shot up to a huge size on paper only to shrivel away within months.

Boards, when they are not busy fiddling the books, can have a very difficult time. Companies have to evolve to maintain a role in the ever-changing economy. Sometimes they succeed brilliantly, sometimes they make disastrous mistakes – Marconi springs to mind as an example of the latter.

Recent reports suggest that several well-known companies may be faltering. Nokia, the world's largest mobile phone maker, has announced a restructuring. The company has an unusual background – it started off in the forestry industry, then evolved into electronics. Forestry has long since gone, and since 1992, when the mobile phone boom started, the company has concentrated on this area. But mobile phones have become cheap, commodity items, and sales have been flagging. The industry is now placing increased emphasis on data services. So Nokia is to be reorganised, with three divisions: mobile phones and networks, multimedia and 'enterprise solutions'. The latter will target business customers. Multimedia will concentrate on imaging, gaming and entertainment services, including camera-phones – the company is about to launch the N-gage portable gaming unit, which has wireless connectivity (bluetooth) built in so that interactive games can be played. Nokia's mobile phone-PC combination comes under enterprise solutions. This may provide some sort of indication as to the way in which things are going.

Motorola's problems appear to be more serious – its chairman and chief executive Chris Galvin has just resigned. So have other major company officers. Motorola was founded in 1928 by Chris Galvin's grandfather Paul, and was for many years famed for its car radios. In the early days of ICs it became a major manufacturer of chips for consumer electronics. It is still heavily involved in the semiconductor field, but this part of the business has been loss-making for some time. More recently it has concentrated on mobile phones, but has found

it hard to compete with Nokia – its market share has dropped from 26 to under 15 per cent. Other, more successful divisions include wireless services and products. There have been delays in introducing new mobile phones and phone-cameras, some with colour screens, including the V810 clam-shell phone-camera that's intended as a leading new product, marking a shift of emphasis from engineering to design. There have been suggestions that the company might be broken up. It has cut 56,000 jobs, about a third of the workforce, in recent years.

Eastman Kodak, for long synonymous with photographic film, aims to reinvent itself as a giant in the digital imaging field – after making a rather belated start. The example of Polaroid, inventor of instant prints, is not helpful: it became bankrupt in 2001. Kodak will have its work cut out to succeed in fields that are dominated by the likes of Canon, Sony, Olympia, Nikon, Xerox, Hewlett-Packard and Epson. But it has launched several initiatives, including digital cameras, the Ofoto internet site, and a joint flat-panel display venture with Sanyo.

Intel has already had one narrow escape when, in the eighties, it moved from D-RAM to microprocessor chip manufacture, a field it has come to dominate. Since the early nineties it has grown in size by a factor of ten. But the semiconductor industry has been through huge upheavals during the last decade and Intel's chief



Cover: Our cover photographs this month show some of the highlights of IFA 2003 (see page 12), including Panasonic's DMR-E100H combined DVD-RAM recorder with 80GB hard disk and an SD Memory Card slot, one of Sony's DVD-RW/R camcorders and a Philips LCD TV Model 42PF9965.

executive, Craig Barrett, feels that the coming decade will bring "major, major dislocation", with Asia as the centre of this convulsion. Intel is responding by moving much of its R&D work overseas. As Craig Barrett has put it, "essentially all PC and handheld design work is now done in Taipei (Taiwan), so I put my engineers where the action is".

Is nothing sacred? How about Microsoft and IBM? The latter has had its problems in recent times, while Microsoft is facing increased competition from the likes of Linux. Its proneness to email viruses has not done it any favours. But we shall see. One thing is certain: free markets are fearsome taskmasters.

## COPYRIGHT

© Highbury Business Communications, 2003. All rights reserved. No part of this publication may be reproduced, stored or transmitted in any form or by any means without the written permission of the publishers.

All reasonable precautions are taken by *Television* to ensure that the advice and data published are reliable. We cannot however guarantee it and we cannot accept legal responsibility for it.

## CORRESPONDENCE

All correspondence regarding advertisements should be addressed to the Advertisement Manager, *Television*, Highbury Business Communications, Nexus House, Azalea Drive, Swanley, Kent, BR8 8HU. Editorial correspondence should be addressed to *Television*, Editorial Department, Highbury Business Communications, Nexus House, Azalea Drive, Swanley, Kent, BR8 8HU.

## INDEXES AND BINDERS

Indexes for Vols. 38 to 52 are available at £3.50 each from SoftCopy Ltd., who can also supply a fifteen-year consolidated index on computer disc. For further details see page 697.

Binders that hold twelve issues of *Television* are available for £6.50 each from Modern Bookbinders, Pringle Street, Blackburn, BB1 1SA. Telephone: 01254 59 371. Make cheques payable to "Television Binders".

## Newstrade Enquires

Distributed by COMAG

Telephone: 01895 444055

ISSN 0032-847X

## SUBSCRIPTIONS

Highbury Subscription Services, Link House, 8 Bartholomew's Walk, Ely, Cambridge CB7 4ZD. Telephone 01353 654 431 Fax 01353 654 400 Email hbc.subs@highbury-wyvern.co.uk Please notify change of address.

## Subscription rates:

UK 1 year £33.80, 2 years £54.00, 3 years £71.00.  
Republic of Ireland 1 year £38.95, 2 years £62.00, 3 years £81.85.  
Mainland Europe 1 year £49.00, 2 years £78.40, 3 years £102.90.  
Rest of World 1 year £63.50, 2 years £101.00, 3 years £133.00.  
Cheques should be made payable to *Television*.

## BACK NUMBERS

If available issues are £4.00 each.



**HIGHBURY**  
Business Communications

A SUBSIDIARY OF HIGHBURY HOUSE COMMUNICATIONS PLC

# TELETOPICS

## The European HDTV system

An official statement on 13 September announced that Europe's first high-definition service, Euro 1080, will start broadcasting on 1 January 2004. Transmission will be via satellite, to households and theatres.

Programming will include the European and the World Soccer Championships and the Olympic Summer or Winter Games. The first programme, scheduled to start at 11 a.m., will be the New Year's Concert from Vienna.

Some 2.5m HDTV sets are expected to have been sold in the US during 2003. Japan is ever farther ahead, with more than 6m households being able to watch HD television. Many broadcasters throughout the world are currently transmitting HDTV, including NBC, Channel 7 Australia, NHK Japan, Korean BS, China CTV and TV Globo Brazil. Europe lags behind in sticking with standard-definition TV,

despite having developed the HD-MAC system back in the Eighties.

Euro 1080 will launch with two channels, the Main Channel and the Event Channel. The former will broadcast free-to-air via satellite to households and small venues (sports bars, hotel chains, airports etc.) a four-hour rolling programme consisting of live and delayed live content, the footprint extending from Norway to Portugal and Greece, covering more than thirty countries. The latter will distribute event programmes to 'Event Cinemas', i.e. theatres equipped with an electronic projection system and a 5.1 surround sound system. Content will range from big events to specific regional programming. Euro 1080 will co-produce HD content with public broadcasters, production houses and record companies, and also exchange

programmes with HDTV services worldwide. It also plans to acquire rights from owners of major events.

Anyone with a 60cm dish pointed at the satellite will be able to receive the Euro 1080 signal. Viewers will also have to purchase an HDTV set-top box and display in order to see the pictures at their best. There have so far been no announcements of prices or manufacturers of such equipment. Connections will involve linking the new STB to the dish with the existing satellite receiver linked to an IF loop output. The HDTV STB will provide component, composite and S video outputs.

It will also be possible to distribute the HDTV signals via a coaxial cable network, with the cable service operator being able to include the digital HDTV stream with any existing data stream. Cable operators who have upgraded their networks to carry DVB TV can multiplex the HDTV transport stream with other channels.

The HDTV multiplexed signal occupies a 7MHz channel bandwidth and uses QAM 256 modulation with a bit rate of 40Mbits/sec. The display parameters are 1,920 pixels x 1,080 lines, with 50Hz interlaced frames.

Central play-out and post-production for the service will be located at Hove, Belgium. Euro 1080 is using Panasonic D5 HD and DVCPRO-HD as tape formats for production, post-production and content recording. Other equipment such as cameras, vision mixers and video servers is being supplied by Thomson. Sound will be available in Dolby Digital form.

Test transmissions are already taking place and can be viewed, as Hugh Cocks reports in Satellite Notebook (see page 54).



**LG.Philips has introduced two new TV picture tubes, the Cybertube+ SuperSlim range. Depth has been reduced significantly to make them competitive with flat-panel displays.**

**The 32in. tube is the world's first real-flat widescreen, slim-line CRT, measuring just 35cm from front to back (see above). This has been achieved by increasing the deflection angle to 125°. The photo shows the significantly shallower**

**profile of the glass envelope over much of its rear surface area. The tube will enable manufacturers to produce sets with the cost and performance advantages of CRT technology while being little deeper than a plasma model. Only minor chassis modifications are required to cater for the new tube.**

**The other tube in the range is a 21in., 110° real-flat 4:3 screen type that uses a hybrid coil. The 38cm depth knocks 13cm off that of a conventional 21in. tube.**

**The company has also demonstrated a 36in. real-flat widescreen high-definition picture tube that uses its unique HF rectangular deflection yoke and an improved high-resolution gun.**

## Flat TV update

Sony has announced that it will boost its flat-panel TV range substantially and is aiming for a 30 per cent share of the market. The company is reorganising its Japanese manufacturing facilities and plans to increase its flat-panel range from seven models last year to 27 in time for the Christmas sales season. Sony has held talks with Samsung about a joint venture to produce LCD panels – at present Sony relies on Hitachi and LG.Philips for its supplies. Sony does not have its own LCD production technology.

Samsung forecasts that global sales of flat-screen PC monitors will exceed those of CRT models for the first time next year, while sales of flat-screen TV sets could outnumber

those of CRT sets within five years.

"Explosive" growth is expected next year as prices fall: the price of a 32in. Samsung LCD set is forecast to fall from about \$4,000 by the end of this year to something like \$3,000 next year as increased production leads to economies of scale. At present the price of an LCD TV set is on average about five times that of a CRT set.

Sharp, the world's leading LCD TV manufacturer with a market share of about 60 per cent, forecasts that demand will double from 1.4m sets last year to 3m this year and 8m in 2005, when the company is to cease producing CRT sets. It forecasts that in 2007 fifty per cent of the TV market will consist of flat-panel sets, with 37 per cent LCD. The company is rapidly converting its European TV centre at Barcelona from CRT to LCD

TV production and has plans for a second European plant.

Taiwan's largest LCD manufacturer, AU Optronics, is to invest US\$2.35bn in a sixth-generation manufacturing complex, the first phase in an expansion plan that will involve over US\$5bn. AUO will be producing 32, 37 and 42in. TV-suitable LCD panels in the new plant, which is scheduled to come on-line late next year.

DisplaySearch Taiwan forecasts that the LCD TV market will take off strongly in the second half of next year, doubling from 4.2m units this year to 8.4m in 2004. Another market report suggests that sales will reach 30.7m units by 2007. There has already been a warning of future over-supply and price wars.

Dell has announced that it might enter the TV market with LCD sets.

## Business news

Last month we reported that electrical/electronics retailer PowerHouse had been placed in administrative receivership. As we went to press it was announced by the administrators that the chain has been sold to a New Zealand retailer, Pacific Retail Group, which will buy the 142 PowerHouse stores, infrastructure and brand, saving over 2,000 jobs. PRG has a 33 per cent share of the NZ market and has branched out into lingerie retailing.

Parts of BoxClever, the TV rental group, have been placed in administrative receivership, including Endeava which provides servicing and logistics back-up, including call-centre support. Endeava employs most of BoxClever's 4,000 staff and runs its 160 outlets. The aim seems to be to restructure the loss-making units and sell them on.

Annual results from Dixons were better than expected, with turnover up from £4.888bn to £5.761bn for the year to May 3 and pre-tax profit only marginally down at £279m compared to £282m. The company reports strong sales of laptop PCs and digital cameras and camcorders during the 18 weeks to September 6. Sales of extended warranties have stabilised after a big fall last year, the result of bad publicity arising from the Competition Commission probe. Margins on extended warranty sales are higher than on actual product, and Dixons is the market leader in this field.

Amstrad returned to profit (£3.8m) during the year to June 30 as a result of increased sales of digiboxes to BSkyB. The Em@iler business (Amserve) continued to make a loss

but is expected to break even this fiscal year, following a halving of the price of the unit last Christmas. Over 255,000 Em@ilers have now been sold: the bigger the user base the greater the possibility of generating significant revenue, which comes from phone and on-line charges and advertising.

## Audio developments

Warner Music, in conjunction with Sony, intends to launch combined CD and DVD music-video discs early next year. They will have a music album on the CD side and DVD music-video material on the other side. The technology is being supported by Universal Music, EMI and BMG.

Toshiba has developed the Gigabeat G20, a compact audio player based on a 1.8in., 20GB hard disk that can store over 300 hours of music recorded at 128kbits/sec – equivalent to 5,000 four-minute pieces of music or 500 CDs. The unit weighs just 138g. A small lithium-ion battery provides more than eleven hours of continuous playback between charges. The player is compatible with two types of software: Windows Media Audio 9, which is now pre-installed in new Windows PCs; and Toshiba Audio Application, which comes with the player. WMA, MP3 and WVA format audio can be stored and played. A CD compressed to 60MB can be downloaded in approximately 30 seconds via the USB2 connector.



*NEC has developed a working prototype mobile phone that can receive terrestrial digital TV transmissions. It uses a portable aerial and incorporates a UHF tuner and an OFDM decoder chip that was developed for wideband CDMA mobile phones. Its disadvantage at present is battery life while in the TV mode. This is about an hour. NEC considers that a life of one hour talk-time and one hour TV time will be required for the product to be a viable commercial proposition. The company is working on improvements that include better receivers, lower power consumption and the development of digital TV/mobile internet applications. The prototype was demonstrated at Telecom 2003, which was held in Geneva during October.*

## Sharp's wireless TV

Sharp has launched the world's first 'wireless TV'. The Aquos Mobile Model LC15L1E is a 15in. LCD set that can operate completely free of cables and leads. It uses a 2.4GHz spread-spectrum video/audio transmission system with a range of 30cm as a link between the screen and other equipment, to source DVD, VCR and broadcast TV material, and has a battery that provides over two hours' operation. It also has two scart sockets and an aerial socket. The price is about £1,200.

Sharp Microelectronics Europe has launched a megapixel CCD sensor module that can be used to add a camera feature to a slimline mobile phone. The LZOP3721 is claimed to be the smallest and slimmest of its type, measuring just 13.5 x 11 x 9.7mm.

## Video recording

Samsung has launched a range of camcorders, Models IT Cam 5, 7 and 9, that use a 1.5GB hard disc as the storage device. Use of MPEG-4 compression enables several hours of video to be recorded on the disc. Top of the range Model IT Cam 9 has an LCD screen for monitoring and playback, a Memory Stick slot and a USB2.0 connector for fast downloads to a PC. Prices range from £500-£700 depending on specification.

Thomson has launched a hand-held video recorder, Model RD2780, that can record video material, MP3 music or JPEG

files on a 20GB hard disc and has a 3.5in. colour screen. It can record directly from a TV set. Use of MPEG-4 compression enables up to 80 hours of video to be stored on the disc. Price is about £500.

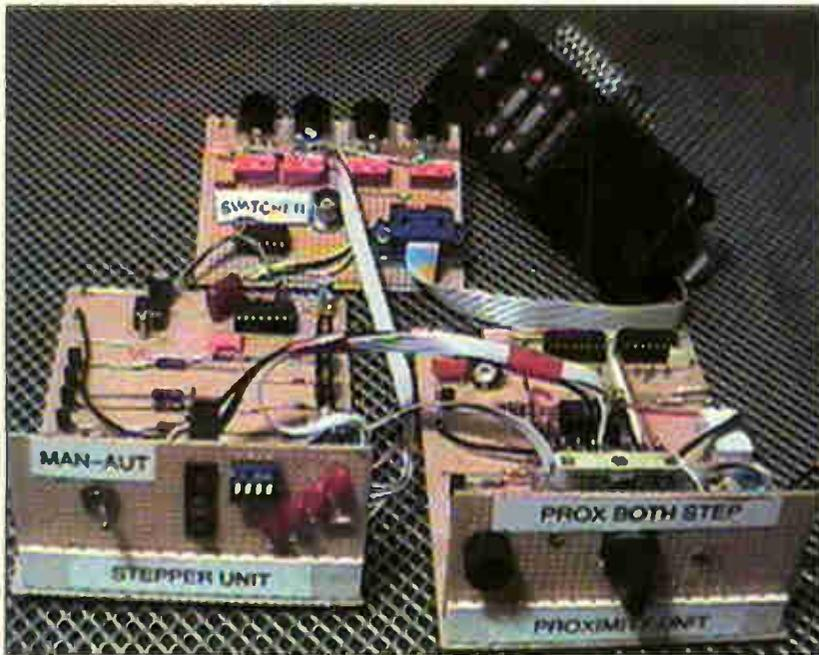
Kane Wireless has launched the Vision Station, which consists of a TV tuner for installation in a PC and software that enables programmes to be recorded on memory cards that can be played back via a PDA such as an iPaq or XDA. Use of compression technology from Essential Viewing enables programmes to be stored on the PC's hard disc in a very small space. The system is on sale at Argos and Carphone Warehouse for about £300.

## DAB update

The world's first 5.1-channel surround-sound broadcasting system is being tested in a six-month trial in the central London area. Capitol Radio is using Microsoft's Windows Media Audio 9 format, which can compress 5.1 audio into a 128kbits/sec internet protocol stream. NTL Broadcast is providing the trial multiplex, in the L band (1.4GHz). Reception involves use of a PC. RadioScape and Imagination Technologies (Pure) are providing receiving equipment. The RadioScape receiver consists of two PCI-bus cards, while the Pure Model DRX-702ES can feed 5.1 sound to the PC via its USB socket.

Earlier this year RadioScape, NTL and Microsoft demonstrated video via DAB. UK digital radio company Perstel has demonstrated a prototype receiver with a 7in. colour LCD screen. There is so far no broadcaster commitment to DAB video in the UK, but German broadcasters have expressed interest in transmitting the 2006 Football World Cup in this format.

Sony has announced that it will launch portable DAB radio receivers early next year.



**Simple inexpensive off-the-shelf CCTV kits are readily available but lack individual expansion capabilities and flexibility. Ian Rees has devised a system that should fulfil the needs of small-to-medium sized installations, with some added innovations found only in dedicated PC or professional systems**

# A flexible CCTV system

**S**imple, inexpensive off-the-shelf CCTV kits are widely available from DIY stores. The cheapest domestic systems consist of a small CCD camera, 20m of multicore cable, a power supply and a scart plug for connection to a TV set or VCR. Multi-camera switching systems with a monitor can be purchased for use with larger domestic or small commercial premises. Some systems

include a PIR detector that can trigger a domestic VCR. The main disadvantages of these kits are their lack of individual expansion capability and flexibility.

This article describes a flexible CCTV system that should fulfil the needs of most small-to-medium sized installations, with some added innovations found only with dedicated PC-based or professional systems. It features a complete integrated control system, but individual circuit sections can be made to operate alone. In its basic form it can accept inputs from two-thirty cameras for splitting and viewing with one-three independent video monitors.

## Basic block diagram and operating modes

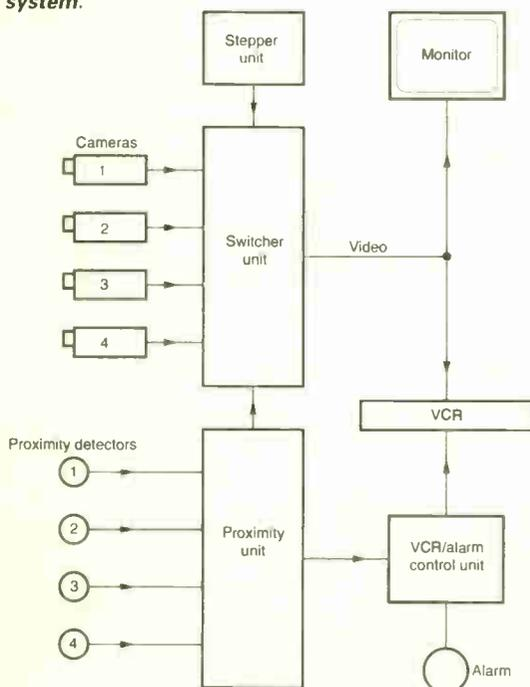
Fig. 1 shows the complete system in block diagram form. It's built using inexpensive and readily available parts. No rocket science is involved, so the system is simple to understand and readily adaptable. For simplicity, only four cameras and proximity detectors are shown in Fig. 1. There are three possible modes of operation: automatic stepping, proximity control and manual switching.

The stepper controls the switcher unit so that the camera outputs are fed in sequence to the monitor and VCR. The automatic stepping sequence has variable dwell times for each camera. If required, indi-

vidual cameras can be deselected from the sequence. The proximity unit allows better site monitoring by using proximity detectors that are mounted in the field of view of the cameras. Proximity detectors 1-4 can be pressure mats, active/passive infra-red, VOX or gate switches etc. A short audio warning alarm is sounded when the VCR records an event under the control of the proximity unit. In the automatic mode sequential and proximity camera switching can be done independently or together. When done together the sequence switching continues until a proximity sensor is activated. The associated camera is then selected, triggering the alarm and VCR. After a preset time the VCR is turned off and the sequenced switching continues.

The ability of the proximity unit to follow activity from camera to camera can be a considerable advantage in comparison with sequence-only systems. The proximity unit can be used with a domestic VCR. Because only the event is recorded, not the periods in between, a domestic VCR can record large amounts of action in the long-play mode. The short beep tone produced by the audio alarm when an event is detected is very useful. The alarm sound relieves an observer from the need to watch the monitor(s) continually. It can be used even if no recordings are required, to draw attention to activity on the site.

**Fig. 1: Basic block diagram of the flexible CCTV security system.**





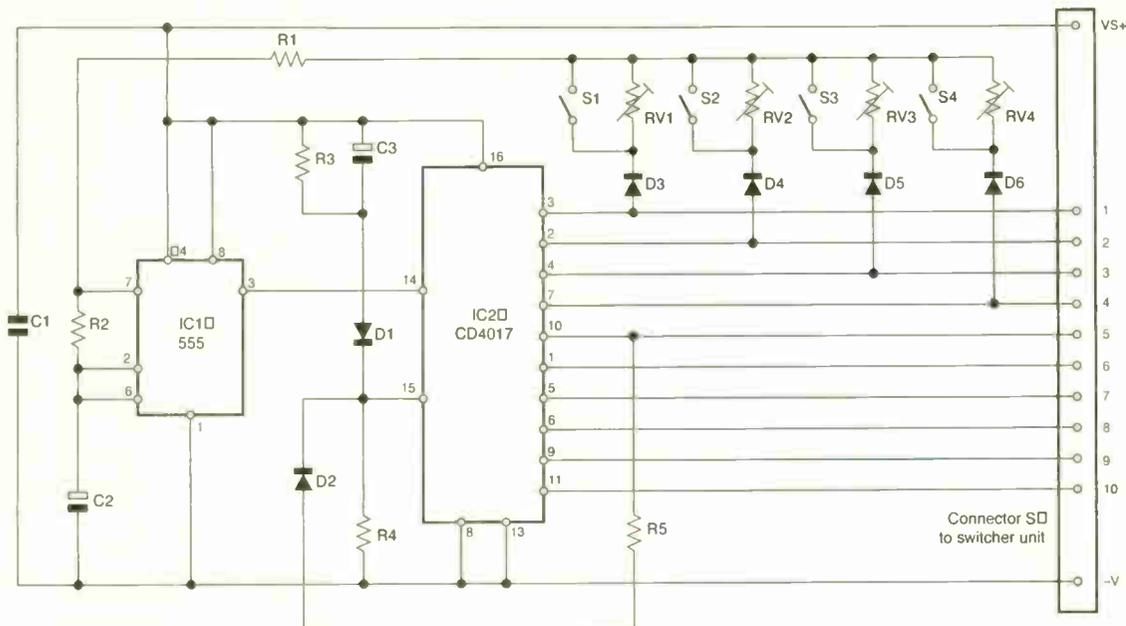


Fig. 2: The stepper unit circuit.

### The stepper unit

Fig. 2 shows the stepper unit circuit. It generates a sequence of outputs that's used by the switcher unit to select the cameras. The 555 timer chip IC1 and CD4017 decade-counter chip IC2 produce timed switching pulses that are continuously adjustable up to 250 seconds at each step by presets RV1-4.

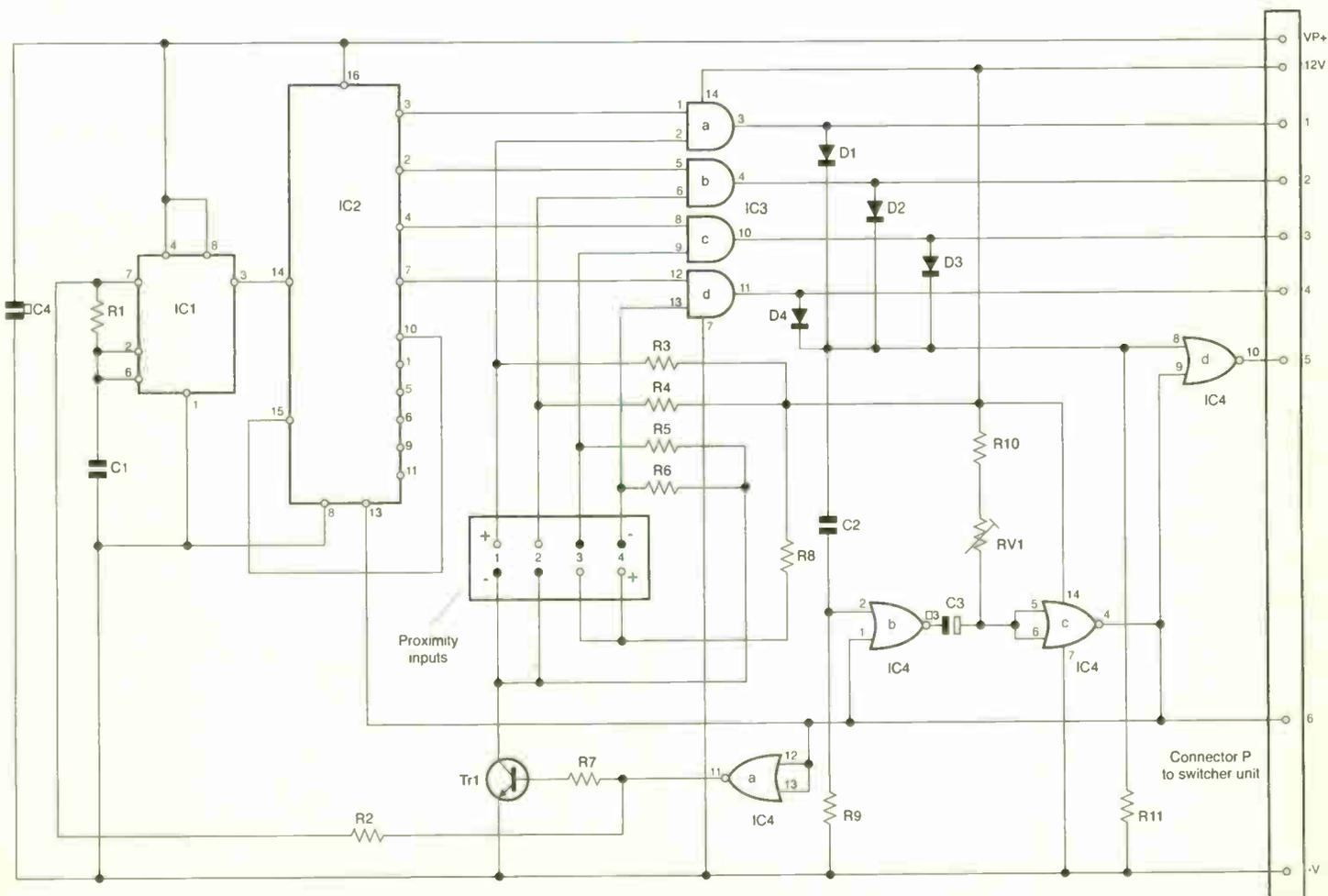
When closed, switches S1-4 bypass the relevant timing step: they are used to move quickly across an installed camera that may not be required at the time.

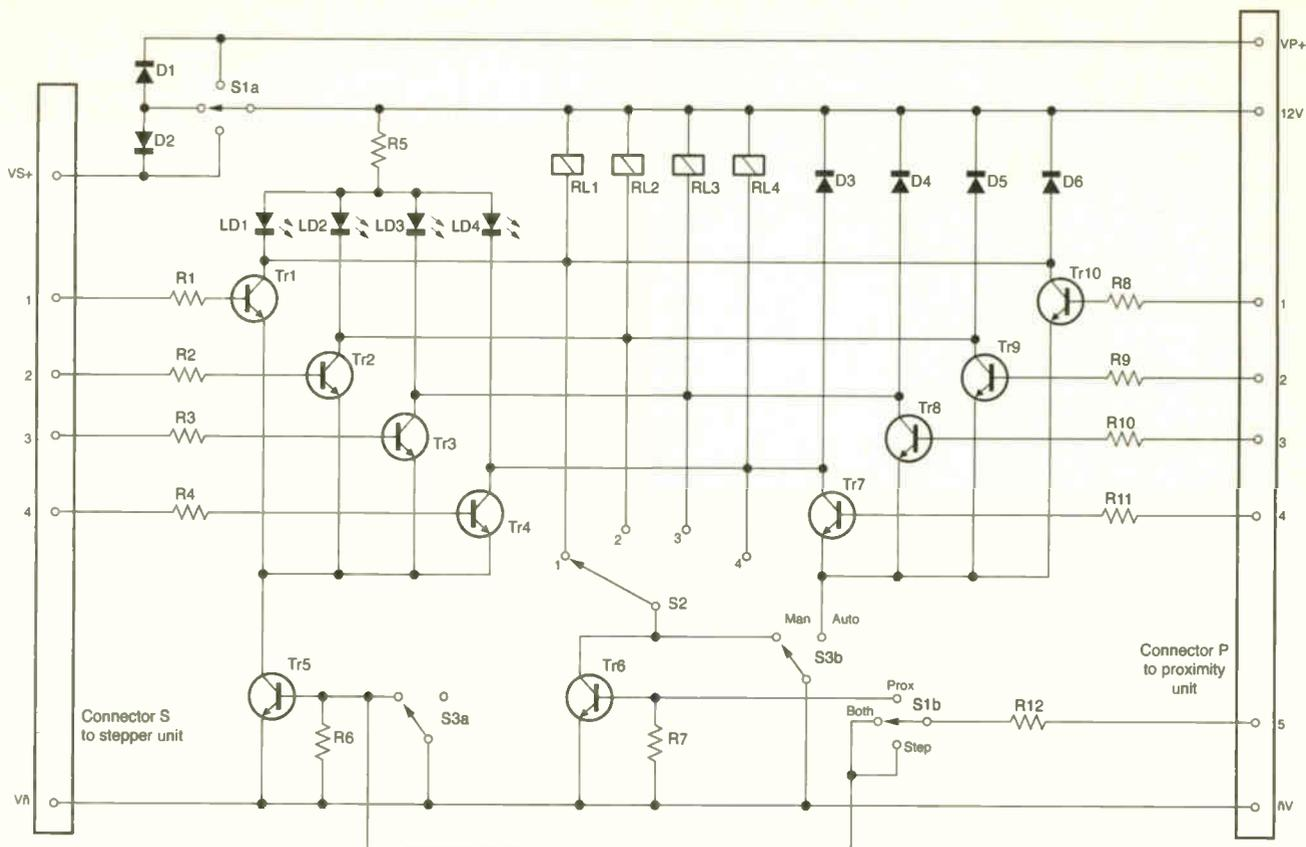
When the supply (VS+) is connected to the circuit C3 charges and IC2 is reset, as pin 15 is taken high. Pin 3, the first in the count chain, provides an output at pin 1 of connector S to a relay driver transistor

in the switcher unit. All the other outputs, at pins 2-10 of connector S, are low. The timing cycle is set by RV1 and the associated components.

The first clock pulse from pin 3 of IC1 moves the counter along one. Pin 2 of IC2 is then high, providing a drive output to the relay driver transistor connected to pin 2 of connector S. Pin 3 and all the other out-

Fig. 3: The proximity unit circuit.





**Fig. 4: The stepper unit circuit.**

put pins of IC2 are now low. RV2 now provides the adjustable dwell-timing period and thus the relevant camera output on time.

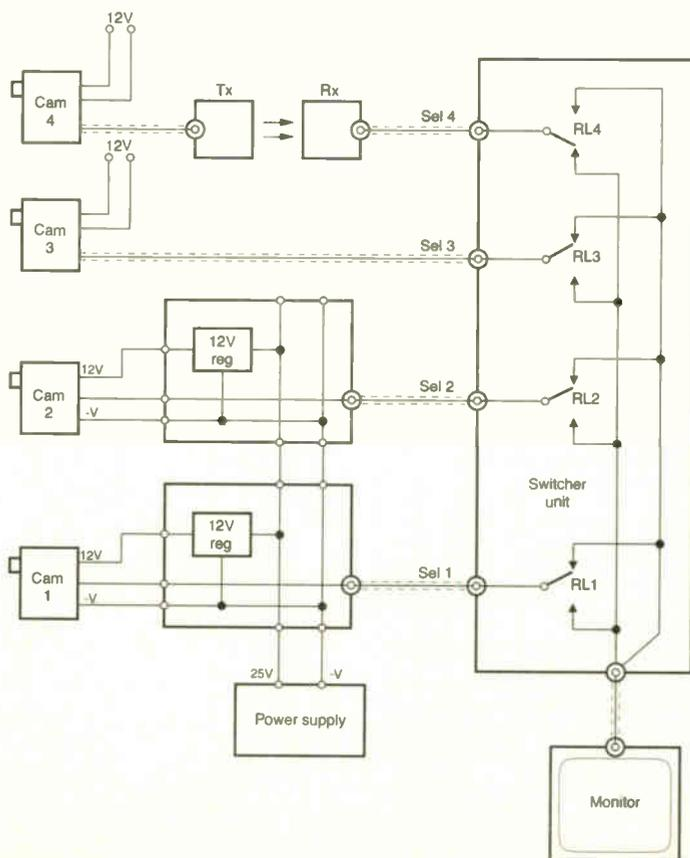
Up to ten sequential outputs can be obtained from the CD4017 decade-counter chip, after which it

will automatically recycle. In the four-camera version shown, a reset is forced at the unused fifth step by connecting pin 10 of IC2 via R5 and D2 to pin 15. A 2-9 drive sequence can be set up by using this forced-reset method.

### The proximity unit

The proximity unit circuitry, shown in Fig. 3, can also control up to ten inputs. But to simplify matters only four inputs are shown. The clock chip IC1 and counter IC2 use a similar circuit arrangement to that in Fig. 2. The 555 chip runs at about 500Hz. It drives pin 14 of the counter chip whose outputs are used, in conjunction with the and gates in IC3, to scan the proximity detector inputs.

As shown, proximity inputs 1 and 2 are configured for normally-closed detectors such as infra-red beam-break or PIR units. Pressure mats and gate/door switches can be used with the normally-open inputs 3 and 4. A check with Table 1 shows that a high output is obtained only when both inputs of an and gate in IC3 are high. When the cycling output from IC2 coincides with a high from the proximity input, the output from the relevant and gate goes high. The rising edge of the high is passed via D1, D2, D3 or D4 and C2 to trigger the monostable timer formed by IC4b/c. The timer turns off Tr1 and freezes the scan of IC1, IC2, holding a high output to the switcher unit from IC3 via connector P. The relevant relay driver in the switcher unit then selects the camera associated with the proximity input. The dwell-time is adjustable between 10-60 seconds by RV1. With Tr1 turned off, the normally-earthed ends of the proximity inputs go high for the duration of the timed period. This



**Fig. 5: Video switching with a four-camera system.**

ensures that IC3 continues to provide an output after the proximity input stops.

Nor gate IC4d produces a low during this period. It's used either to turn off the stepper unit or default camera of the proximity unit depending on the position of switch S1a/b in Fig. 4. Audio alarm and VCR switching are controlled by IC4's complimentary outputs at pins 5 and 6 of connector P. At the end of the timing period IC4b/c revert to their original state, returning control to the stepper unit or proximity default. Only one camera is selected at a time, and any new proximity inputs received during the freeze period are ignored. The same process occurs whichever proximity input is triggered.

Take care when wiring the proximity inputs, and note that the '-' terminals are above chassis earth potential (-V) when Tr1 turns off. If the '-' terminal is accidentally shorted to -V earth none of the proximity inputs will select and hold. Simultaneous proximity triggers that might cause more than one camera to be selected are automatically sorted by the scanning action to provide a single output.

### The switcher unit

I always feel that I should use solid-state devices in my circuits, but make no apologies for using relays in this part of the system. Miniature relays are simple, robust and reliable. They have not got the extended service life of solid-state devices, but fitting them in sockets can ameliorate this. I have in fact never had to replace any electromagnetic relays in long-standing systems where they have been employed.

Fig. 4 shows the switcher unit circuitry, which receives inputs from the stepper and proximity units. Two sets of driver transistors control the four relays. This may seem a bit unnecessary, but the arrangement works very well and makes function switching simple.

The three-position function switch S1 enables the cameras to be controlled by the stepper or proximity unit or both together. When proximity is used alone and not triggered a default camera needs to be selected, otherwise the monitor screens will be blank. Selection is done by Tr6, which works in conjunction with the manual switch S2. When Tr6 is turned on at the end of a proximity freeze cycle (S1a/b in the prox position) S2 selects the default camera. With S1 set at its centre (both) position the stepper and proximity units run together. As long as there are no

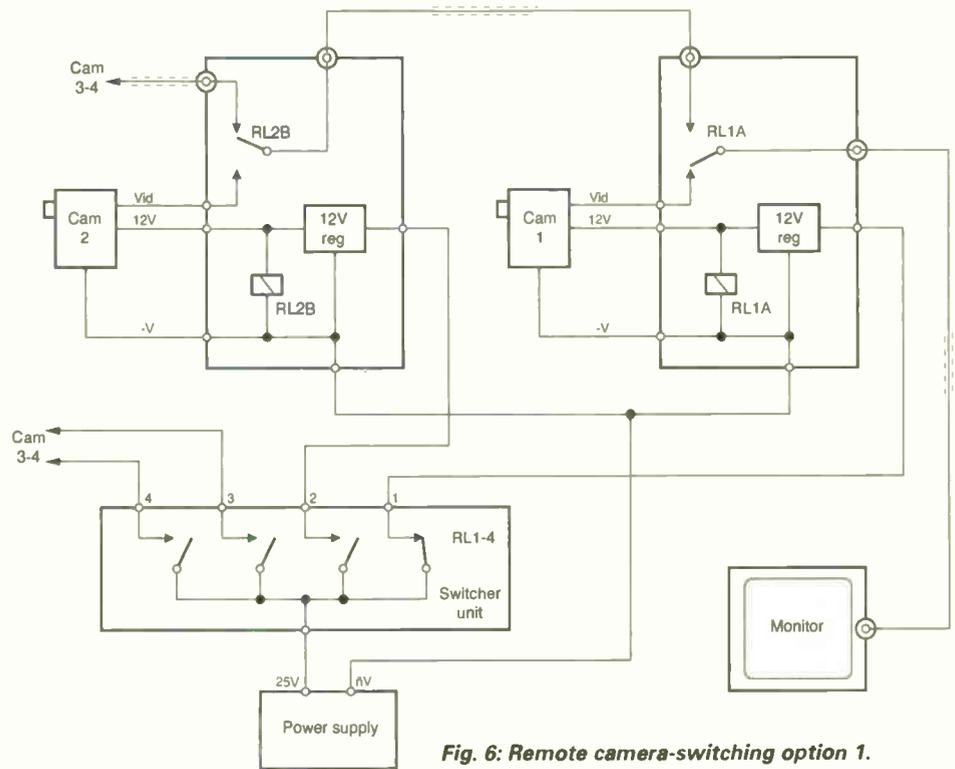


Fig. 6: Remote camera-switching option 1.

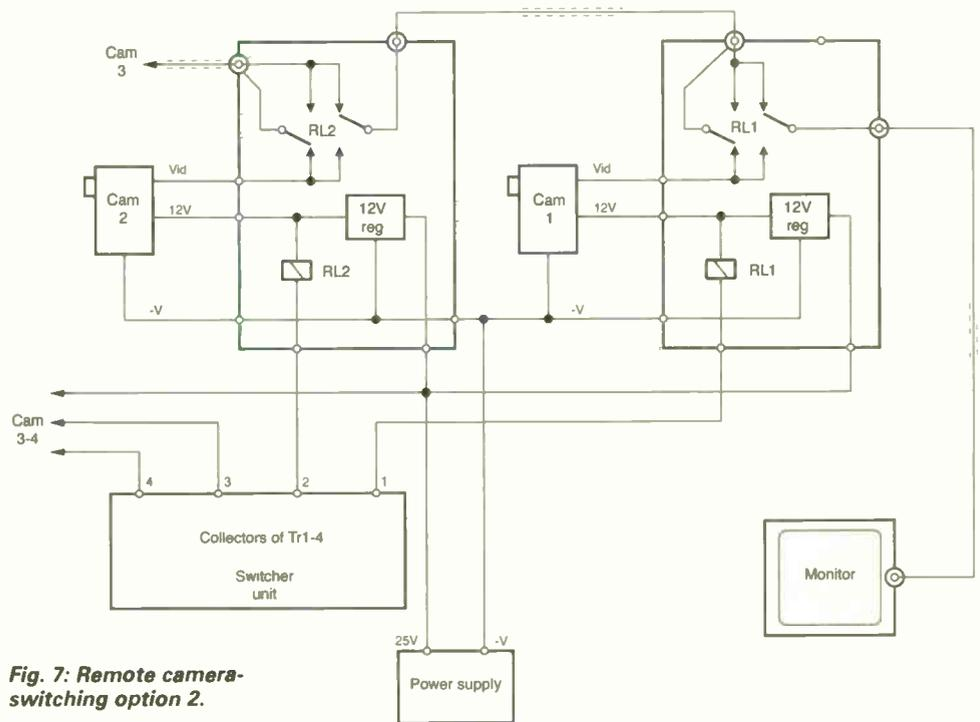


Fig. 7: Remote camera-switching option 2.

proximity inputs the cameras will be controlled by the stepper unit. If a proximity input is received, the proximity unit takes over, interrupting the stepper cycle by turning off Tr5 (through the gate action of IC4d in Fig. 3) and switching on the required camera as described above. The stepper action continues once the proximity unit's freeze period has been completed.

LED indicators L1-4 show which

Table 1: Truth tables for IC3 and IC4 (Fig. 3).

And gate IC3			Nor gate IC4		
Inputs		Output	Inputs		Output
a	b		a	b	
L	L	L	L	L	H
L	H	L	L	H	L
H	L	L	H	L	L
H	H	H	H	H	L

Fig. 8: The power supply circuit.

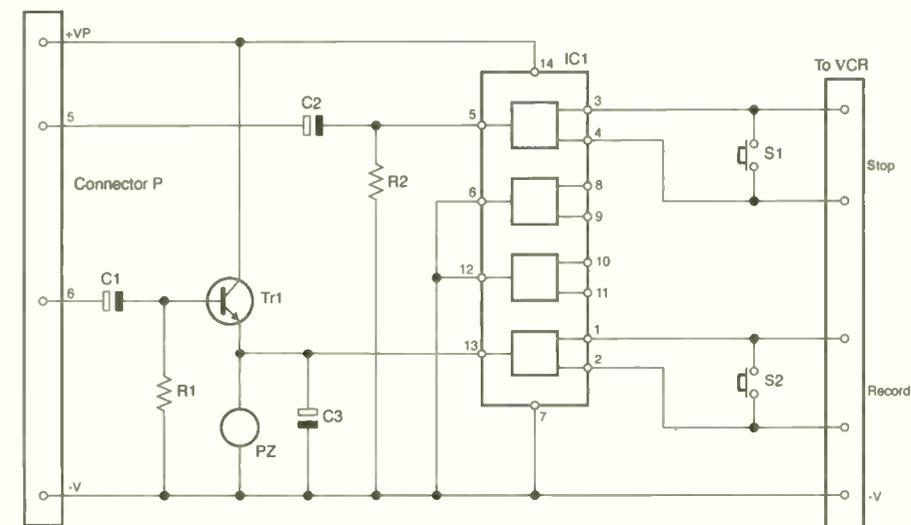
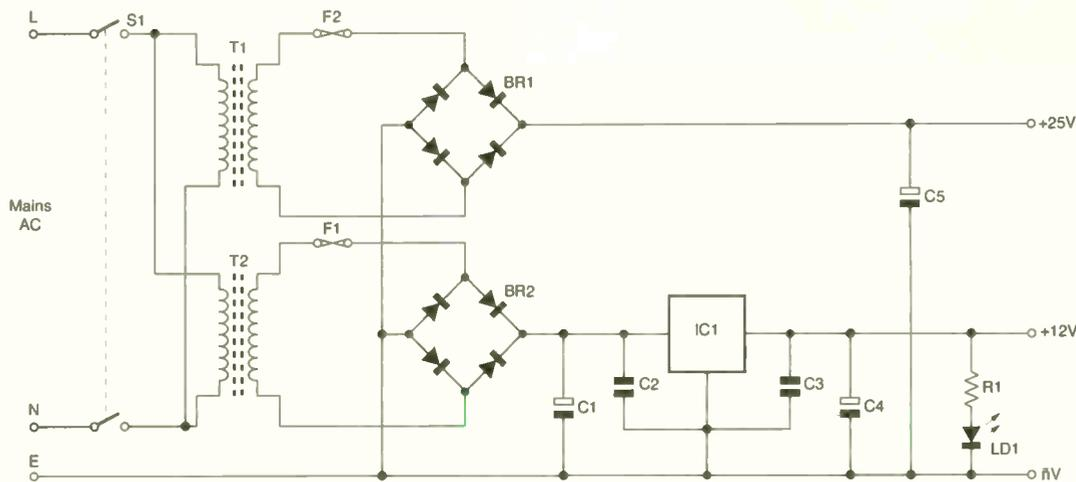


Fig. 9: The VCR control and audio alarm circuit.

camera is activated. With the auto/manual switch S3 set to manual, cameras can be selected directly using switch S2. Note that if the relays have suppression diodes built-in, D3-6 will not be required.

### Signal switching

The supply of power to the cameras and sending images to the monitor(s) and VCR(s) can be carried out in a variety of ways. Fig. 5 shows how a four-camera system using a variety of camera types can be selected for video signal only.

A 25V DC line from the power supply feeds cameras 1 and 2. Assuming that the CCD cameras are 12V DC types, local L7812 12V IC regulators reduce the supply for these cameras. This method compensates for the voltage drop along the DC supply cables. Camera 3 is shown using its own 12V power supply derived from the mains. Where a location is difficult to cable, a 2GHz RF link can be used, as shown for camera 4. Composite video outputs are selected by relay contacts RL1-4. Unselected video inputs are muted to prevent crosstalk between cameras. Reed relays are best, but sub-miniature

mechanical types have proved to be satisfactory.

The disadvantage of this cabling arrangement is the large number of coaxial lines that have to be run individually and terminated at the switcher. If they are many in number they can be difficult to conceal. The position of the security room or office is never at a convenient location, so a considerable amount of time and energy may be required to expand or modify the system later.

A good way of simplifying the problem is to use remote switching, as shown in Figs. 6 and 7. Remote switching uses one video feed daisy-chained via the cameras in the system. One additional multicore telephone-type cable can supply both power and control to the cameras.

In Fig. 6 switcher unit relays RL1-4 now supply the switched 25V DC feed to the selected camera. Each camera has a local routing relay (RL1A, RL2B etc.) connected to the output from its L7812 12V stabiliser. When one of these relays is selected, its contacts connect the camera's video output to the coaxial line. All cameras on the feed line other than the one selected are then isolated. The line down to the moni-

tor(s) is maintained via the normally-closed contacts in the de-energised relays in the video line. As only one camera at a time is switched on, minimum power is drawn by the system and crosstalk is eliminated.

An irritating problem with simple systems is the time taken for the monitor's field scanning to roll into lock when cameras are live-switched. Careful adjustment of the monitor's field hold can minimise but not eliminate the problem. Methods usually employed with better cameras and systems are not always available with cheaper CCD units. Some systems use signal blanking at changeover, increasing the time available for the monitor's field timebase to lock. The short time required for a camera to produce a picture when first switched as in Fig. 6 can give a similar inferior effect, masking the field-sync problem by turning a shortcoming into an advantage. Ensure that any cameras used in this way are able to produce a viewable and locked image quickly at cold switch-on.

If supply switching is not practical because of the cameras used, the arrangement shown in Fig. 7 can be used with the cameras powered all the time. The switcher unit relays RL1-4 are now located at or near the camera. Each relay coil is connected directly to the switcher unit via the control cable. The relay contacts connect the signal from the selected camera to the coaxial feed and mute signals from the unselected cameras. Miniature double-pole relays are used, the second pole muting unselected signals farther along the chain. Depending on line transmission, mismatching and other losses, muting may or may not be required.

In practice a mixture of remote and local camera control can be used for optimum flexibility.

## Power supply

The power supply requirements are simple, see Fig. 8. It is best to use separate supplies for the cameras and control electronics. Transformer T1 and fuse F2 are selected to match the current requirements of the cameras in the system. One of my early installations that used a single power supply started to malfunction when an extra camera was fitted – the increased current drain reduced the voltage just enough to upset the stepper-unit timing. Fortunately it was possible to power the camera locally from the mains, which corrected the problem.

It is important to include capacitors C2 and C3 in Fig. 8. They must be soldered as close as possible to the input and output pins of the regulator IC1, to prevent instability. Instability in IC1 will usually result in low output when the stabiliser is on load. It's best to solder the capacitors carefully to the legs of the IC. Although not shown in Figs. 5, 6 and 7, similar capacitors should be fitted to the stabilisers here.

The upper input voltage limit of the stabiliser specified is 30V DC. A heatsink may be required if it runs hot. Overheating will make it shut down. The lower input voltage level should not be less than 15V if stabilisation is to be efficient. The L7812 is rated at 1A. If more current is required (up to 2A) an L78S12 should be used.

## VCR control and alarm unit

Slow-scan VCRs are currently still expensive at about £400 while domestic ones are available at less than £50. This system's ability to record short bursts of event action triggered by proximity detectors makes the use of a domestic VCR very attractive. With a standard three-hour VHS tape used in the long-play mode and the proximity dwell timing set to 60 seconds, 360 event recordings can be made before tape rewind ( $60 \times 60 \times 6 = 21,600$  seconds/ $60 = 360$  events). Even allowing for false triggering, this is still a considerable recording period. A four-hour tape would increase the recording time, but these are prone to damage and tangling in cheap VCRs.

The employment of staff to watch one or more video monitors continuously is not practical with a small installation. Use of the proximity unit to trigger an audio alarm immediately draws attention to the monitor(s) when an event has been detected.

Fig. 9 shows the circuit of the control/alarm unit. IC1 is a CD4066

quad bilateral switch chip that's used to control the VCR record and stop. The rising edge of the trigger output from the proximity unit charges C1 and briefly biases Tr1 on. This transistor then supplies voltage to the piezo-sounder PZ and pin 13 of IC1. With a positive voltage at pin 13 of IC1, the impedance between pins 1 and 2 changes from high to low. This change is used to operate the VCR's record function. A hardwire connection can be made across the record-button switch on the VCR or the remote-control unit. When the timed-record period ends, pin 5 of connector P goes high charging C2. Pin 5 of IC1 then briefly lowers the impedance between pins 3 and 4 and the VCR stop function operates, in the same way as for record. Press-button switches S1 and S2 are included to check the VCR link and provide a convenient means of checking or

setting the record and stop functions.

Hardwiring directly to a VCR is usually simple, but connection to a remote-control unit can be tricky and requires care. If you don't want to modify the remote-control unit supplied with the VCR, a cheap universal type could be bought. The only solderable connection points likely to be found will be at the control IC. Trace the print back from the record and stop button pads to the IC. A good light, optical magnification and a fine-pointed soldering iron are required for this task. A four-way flat ribbon cable is best for the link. Leave the remote-control unit powered by its own battery.

## Next month

In Part 2 next month we'll consider cameras, proximity detectors, system expansion, construction and installation. ■

## Components list

### Stepper unit

R1	470Ω
R2	1kΩ
R3	470kΩ
R4	2.2kΩ
All 0.25W 5%	
RV1-4	1MΩ linear presets
C1, C4	0.1μF 100V ceramic
C2	100μF 25V electrolytic
C3	1μF 25V electrolytic
IC1	555 timer
IC2	CD4017
D1-6	1N4148
S1-4	1-pole 1-way switches (4-way DIP switch OK)

### Proximity unit

R1	1kΩ
R2, R10	100kΩ
R3-6	10kΩ
R7	18kΩ
R8	6.8kΩ
R9	15kΩ
All 0.25W 5%	
RV1	1MΩ linear preset
C1, C2	47nF 100V Mylar
C3	100μF 25V electrolytic
C4	0.1μF 100V ceramic
IC1	555 timer
IC2	CD4017
IC3	CD4081
IC4	CD4001
D1-4	1N4148
Tr1	BC547B

### Switcher unit

R1-4	18kΩ
R5	1kΩ
R6, R7	2.2kΩ

R8-12	18kΩ
All 0.25W 5%	
D1, D2	BY133
D3-6	1N4148 (see text)
Tr1-10	BC547B
LD1-4	5mm red LEDs
RL1-4	12V 700Ω relays (see text)
S1	2P 3W switch
S2	1P 4W switch (see text)
S3	2P 2W switch

### Power supply

R1	1kΩ 0.25W 5%
C1	1,000μF 40V electrolytic
C2, C3	0.1μF 100V ceramic
C4	47μF 16V electrolytic
C5	2,200μF 40V electrolytic
IC1	L7812 (see text)
BR1, BR2	3A bridge rectifiers
LD1	0.5mm LED
T1	240V/16V mains TX (see text)
T2	240V/16V 1A mains TX
F1	500mA 20mm fuse
F2	See text
S1	DP mains on/off switch

### VCR control and audio alarm unit

R1	3.3kΩ
R2	22kΩ
Both 0.25W 5%	
C1	33μF 25V electrolytic
C2	22μF 16V electrolytic
C3	1μF 16V electrolytic
IC1	CD4066
PZ	12V piezo buzzer
	2.7kHz 10mA
S1, S2	Normally-open momentarily-close push-button switches



## at the Internationale Funkausstellung

**The 2003 IFA featured the latest developments in digital TV, flat screen technology, DVD players and recorders, cam-corders with various storage systems and domestic networking. George Cole was there to report for us**

**T**he Internationale Funkausstellung (IFA) is held in Berlin every two years and has become the world's largest consumer electronics show. Unlike most other electronic shows it's open to the public. So the exhibition halls are full of people interested in the latest developments in consumer electronics. At this year's show there were 1,007 exhibitors spread over 160,000 square metres of floor space. Major attractions included flat-screen TV sets, DVD recorders and networked products.

### Digital TV

On August 4 Berlin and Brandenburg became the world's first DTT-only region

when the analogue TV transmitters were switched off for the last time. The digital switchover took place just six years after Germany's first DTT tests were carried out and eighteen months after a Memorandum of Understanding was signed between public and commercial broadcasters and the Media Institution of Berlin and Brandenburg, which co-ordinated the switchover. The German government aims to end all analogue TV transmissions in 2010.

The Panasonic TX32DTX30C is the company's first IDTV set released in Germany for free-to-air (FTA) transmissions. Its features include a 32in. Quinrix 16:9 CRT, 100Hz scanning, a 500-page teletext memory and three scart sockets. Pioneer unveiled an FTA digital set-top box, Model DBR-TF100GB, and plans to launch an IDTV set for Continental markets. The DBR-TF100GB has two scart sockets, an RF loop-through/modulator module and a newly designed user interface that Pioneer plans to adopt across its entire range. Nokia's MediaMaster Models 260S and 260T are digital STBs for satellite and terrestrial reception respectively. They include an 80GB hard drive on which up to 40 hours of TV programming can be recorded: it's also possible to transfer to it more than 3,000 images from camera-phones using a

*The Panasonic TX32DTX30C is the company's first IDTV set released in Germany for free-to-air (FTA) transmissions.*





*The Pioneer DV565A is a versatile player that can also handle DVD-Audio and SACD discs and JPEG images stored on a CD.*

wired or a wireless Bluetooth connection.

Pace's digital STB offerings included Models DC210 and DS201. They use Pace's new common hardware system that enables a cable, satellite or terrestrial front-end to be added as required. The Puma is an integrated dual-decoder and twin-tuner satellite STB with an optional 20GB hard drive that enables it to be used as a personal video recorder (PVR). The Samsung SPVR-7400CI is a digital PVR with 80GB hard drive and two common interface (CI) slots. Humax showed the PVR8000, a PVR with a smart removable hard drive, making it easy for owners to upgrade to a larger-capacity drive.

The German market is also a target for Multimedia Home Platform (MHP) products. MHP is a specification developed by the Digital Video Broadcasting (DVB) project to add features such as interactivity and internet links to digital TV broadcasts. Sony had a large display of MHP sets, all with CRTs, including Model DVP-NS430S which includes a slot for a Memory Stick card. The Humax CI8140 is an MHP-compliant STB that also includes a Dolby Digital optical output socket. Samsung and Nokia also showed MHP set-top boxes.

### TV sets

On some stands, for example Philips, it was hard to find a CRT model. Philips will have launched thirteen non-CRT TV models by the end of the current year, with ten screen sizes. They include five models (50PF9965, 42PF9965, 37PF9965, 32PF9965 and 30PF9965 – the first two digits indicating the screen size) that incorporate the company's Pixel Plus technology. Model 30PF9965 has an LCD screen, the other models having plasma screens. Pixel Plus is a digital processing technology that provides enhanced resolution. Philips held an interesting demonstration that compared Pixel Plus with rival digital-enhancement technologies developed by Sharp, Sony, Panasonic and Samsung. Both LCD and plasma products were compared and certainly, on the evidence, Pixel Plus provided the best pictures from a subjective point of view. But the demonstration also highlighted how difficult it can be to make definitive comparisons, as the sets may have different display rates, e.g. 75Hz or 100Hz and interlaced or progressive scanning. Philips

also showed two small-screen LCD sets and three portable LCD models, with screen sizes from 13 to 20in.

Sony's offerings included for LCD Wega models, KLV-15SR2, KLV-21SR2, KLV-17HR2 and KLV-23HR2 – the latter has a Memory Stick card slot. The SR2 models provide XGA (1,024 x 768) resolution while the HR2 models feature WXGA (wide XGA, i.e. 1,280 x 720) resolution. All models include a composite/component video processor that converts an analogue signal to digital form then processes it to reduce noise. A digital comb filter improves Y/C separation while Sony's Digital Reality Creation (DRC) technology provides enhanced resolution.

Panasonic displayed a number of LCD TV sets including the TX-22LT3F, a 16:9 model with integrated tuner. It uses Panasonic's Real Mach panel technology that provides a contrast ratio of 400:1. Sharp's massive stand was heavily populated with LCD sets. One of the highlights was Model LC15L1E (Aquos Mobile), a TV set that operates without a TV aerial or a power socket. The 15in. LCD set uses a lithium-ion battery for power and an AV transmission system to pick up and deliver sound and pictures. Samsung had on show a 54in. LCD TV with a contrast ratio of 800:1; the TFT-LCD module is only 2in. thick.

JVC's LCD TV sets included Models LT32C31, LT26C31, LT23E31 and LT17E31, which all incorporate the company's DIST (Digital Image Scaling Technology). Grundig was showing its Tharus range of LCD and plasma sets. The company also offers the Megalogic system, a TV guide and teletext function to the 2.5 specification, and Teleweb that enables teletext pages to be surfed as if one is using the internet instead of the conventional approach of entering combinations of page numbers.

There were also lots of plasma screens around, including the Pioneer Models PDP-504HDE and PDP-434HDE (the first two digits indicate the screen size in inches) that incorporate the company's Pure Digital image-processing technology. The images I saw certainly looked clean and sharp. Both models incorporate a multimedia viewer that can read JPEG images stored on a memory card. Thomson showed a 50in. plasma set, Model 50WB03, which uses the company's Hi-pix technology to multiply the number of pixels per line by 1.5 to create a sharper picture. Panasonic's plasma Models TH42PA20E and TH37PA20E feature the company's Real Mach technology. Model PD42V31 from JVC includes DIST technology and a 3D sound system.

Samsung showed a 70in. plasma display panel with 2.07 million pixels (1,920 x 1,080 scanning), twice the resolution of today's panels. It expects this to be used for public display systems rather than the living room. The LG stand displayed 71 and 60in. plasma displays and a 52in. TCD TV set.

Other TV products of interest included the Thomson Model TW610S, a 61in. projection set with a built-in DVD player, and a TV recorder from the German company Metz. The latter has a 160GB hard drive that can store up to 200 hours of programming and functions such as live pause. In addition by subscribing to a special service users can set the TV's timer via the internet.

Philips gave a glimpse of the future with a PolyLED display. The company's research stand showed a 2 x 3in. full-colour prototype with a resolution of 176 x 220 pixels. Unlike a TFT display, PolyLED doesn't require a backlight and thus consumes less power. Construction basically consists of two glass plates that sandwich the PolyLEDs. Philips envisages



*Philips DVDR 70*

that the technology will be used initially in portable products such as mobile phones but also has plans for in-car systems. The two biggest problems at present are scaling up production and increasing the lifetime, which is currently a few thousand hours – the target is 8,000 hours by 2005. Philips also showed its Mirror TV. This combines a 17-30in. LCD screen with polarising technology that enables almost 100 per cent of the light to be passed through a reflective surface. The screen can therefore be flipped between a TV display and a mirror. Philips sees considerable potential in the hotel market, and the demonstration room was set up like a hotel living room and bathroom. You could shave while watching the morning news in a corner of the mirror. A domestic version is expected possibly in 2005.

## DVD

It was hard to spot a VCR on any of the stands: DVD is fast becoming the format of choice for watching video material at home, with more than half of European homes (53 per cent) now having a DVD player. This has been helped by the falling cost of DVD players. In a keynote speech Gerard Kleisterlee, president of Philips, pointed out that in 2001 DVD players were at the cutting edge of technology and commanded a fair price premium but, since then, the price has fallen by a factor of ten. In some cases DVD players are given away free with other products, such as large-screen TV sets. The good news is that manufacturers are still developing DVD products with added features.

The Pioneer DV565A is a versatile player that can also handle DVD-Audio and SACD discs and JPEG images stored on a CD. It reads CD Audio, Video CD and Super VCD discs, and DVD-R and DVD-RW discs recorded in the Video Mode.

The Samsung Model DVD-HD935 is claimed to be the world's first HDTV-compliant DVD player. It uses scaling-up technology to increase the video resolution to 720 x 1,080 (lines). Faroudja's DCDi de-interlacing picture technology improves movement within the picture and sharpens outlines.

Star Media showed an interesting player, Model DivX5000. DivX is a form of video compression that's widely used on the

internet. It's based on MPEG-4 technology and enables up to two hours of video to be stored on a CD-R disc. DivX picture quality is surprisingly good. The system is also used by some digital cameras and camcorders to record video clips that can be sent over the internet. Star Media emphasised that the DivX5000 can play DVD discs from all regions. The company also showed DVD players with progressive-scan PAL outputs.

The Thomson Model DTH7500 is a combined DVD player and 80GB hard drive that can store up to 80 hours of video. Other features include live pause, a front USB connection, a generic memory-card reader and JPEG reader: digital photos or MP3 music files can be transferred from a PC to the DTH7500's hard drive.

The LG Latrion is a combined 29in. TV set, DVD player and VCR.

There was a stand devoted to DVD-Audio, with a selection of players and discs. The format seems to have a higher profile in Germany than in the UK. I came across a number of DVD-Audio (and SACD for that matter) discs in record shops. According to the DVD-Audio Council, whose members include JVC, Panasonic, Sharp and Toshiba, there are not more than 500 DVD-Audio titles available worldwide.

## DVD recorders

If IFA is anything to go by, it looks as if consumers, retailers and service engineers will have to learn to live with several recordable DVD formats. There is little sign of the market consolidating, and there were giant stands devoted to all the major recordable formats and their respective associations. Many companies that support one format are also members of a rival DVD association however. So it's no surprise that there is much consumer confusion over recordable DVD.

The DVD+RW Alliance, which has more than sixty members including Philips, Sony, Thomson, Dell, HP and TDK says that 80 per cent of the consumer DVD records sold in Europe are +RW machines. A new x8 recording speed was announced for +R discs.

Sony announced two new dual-format DVD recorders, Models RGR-GX7 and

RGR-GX3, which record on both DVD+RW and DVD-RW discs. Sony has also developed two DVD-RW camcorders – apparently because the -RW specifications were finalised first.

Philips launched five new DVD recorders, the DVDR70, 75, 77 and 80 separates and the LX9000R, a DVD recorder and home-entertainment system – it includes a 5.1-channel speaker system with Dolby Digital, DTS and MPEG multi-channel sound. Model DVDR77 provides an 8-hour recording time on a single disc and has a memory-card feature that can read almost all the types of memory cards used by digital cameras, enabling JPEG images to be transferred to DVD discs. Another feature converts JPEG images into DVD-compatible slide shows that can be played by almost all DVD players and PC DVD drives. The DVDR80 includes the Guide Plus+ on-screen guide, which enables users to make a timed recording simply by selecting the programme from an on-screen menu and pressing a button.

Yamaha's Model DRX2 plays all types of DVD discs except DVD-RAM, and also plays CD-R/RW discs. It offers six recording modes that provide recording times between 1-6 hours, including linear PCM audio in the two-hour mode.

Benq, a company with manufacturing operations in the Far East including Malaysia and Taiwan, had on show what is claimed to be the world's slimmest DVD recorder, Model JH300, which is just 5.9cm high. It's a DVD+RW machine that includes a progressive-scan output. It will be launched in NTSC markets first.

The Humax Model DRP560, a sleek silver box with an orange trim, is a DVD+RW recorder that can also play back DVD-R and DVD-RW discs (the latter in the video mode). It has six recording modes.

The RW Products Promotion Initiative (RWPPPI) represents the DVD-RW and DVD-R formats. It has 58 member companies, including Pioneer, Samsung, Sony, LG and NEC. Pioneer is the main driver behind the -RW format, so it was no surprise that the company's press event had a lot to say about the format. Evidence that DVD-RW has better compatibility with standard DVD-Video players was quoted. The DVD+RW Alliance had made



The JVC DR-M1 DVD-RAM recorder is also compatible with DVD-R and DVD-RW discs



the same claim for its format less than half an hour previously!

Pioneer's flagship product is Model DVR-5100H-S, a DVD recorder with an 80GB hard drive that can store up to 102 hours of video programming. It has four modes, Fine (17 hours), SP (34 hours), LP (68 hours) and EP (10-2 hours). The company's previous recorder, Model DVR-77H, used eleven LSI chips. These have been replaced with a single LSI chip that has four million gates. A high-speed copying system can transfer EP recordings on to a blank disc at x24 speed. Once a DVD-R/RW disc has been formatted in Video Mode, the DVR-5100H-S creates a menu of thumbnail images that show what has been recorded on the disc. Pioneer was asked why it had launched a DVD burner that can also record on DVD+RW discs. A company spokesman explained that Pioneer makes a lot of drives for OEM manufacturers, who have demanded that the DVD drives are compatible with a variety of recordable DVD formats. He stressed that the company has no intention of launching a consumer product with DVD+RW operation.

The Sharp Models DV-HR350S and DV-HR300S are combined DVD-RW and hard disk recorders.

The Recordable DVD Council (RDVDC) is an association of more than ninety companies, including Panasonic, Toshiba, Hitachi and Samsung, that support the DVD-RAM format. To add to the confusion there's yet another group, the RAM Promotion Group (RAMPG), whose members include Hitachi, Panasonic, Toshiba and JVC. Using the slogan 'Real DVD', the RDVDC had much to say about the compatibility of DVD-RAM products with other types of DVD discs. But this compatibility is essentially one-way, as almost all DVD-Video players can't play DVD-RAM discs, even ones without a protective caddy. This is because DVD-RAM uses a different recording format, land-and-groove with zoned constant linear velocity (ZCLV). While this enables DVD-RAM to provide hard-disk type features such as random access, the price paid is lack of compatibility.

Panasonic released a brochure listing all the European DVD products that are compatible with DVD-RAM discs, but only five are consumer DVD-Video players – four from Panasonic and one from JVC. The Panasonic DMR-E100H is a combined DVD-RAM recorder with an 80GB hard drive. It also has an SD Memory Cared slot. The Panasonic SC-HT1000 is a DVD-RAM home-theatre system with 5.1-channel sound and DVD-Audio compatibility.

The JVC DR-M1 DVD-RAM recorder is also compatible with DVD-R and DVD-RW discs. It incorporates a block noise reduction circuit and Hadamard noise reduction for reducing 'mosquito noise'. Other features include a progressive-scan PAL output, a timebase corrector and on-



*Panasonic has developed a range of camcorders that record on an SD Memory Card. The D-snap range consists of Models SV-AV100,*

disc timer programming. The latter writes timer data on disc, enabling the timer to be set simply by inserting a programmed disc. The DR-M1 is also part of JVC's QP-ES9AL home-theatre system.

### Blu-ray

I found a number of Blu-ray recorders at the show. This format could be the next step after recordable DVD, using a blue laser and 27GB discs that can store up to two hours of high-definition video. Philips and JVC had prototype Blu-ray recorders on their stands while Sony and LG showed production recorders, Models BDZ-S77 and BD-VDR respectively.

### Camcorders

A number of tapeless camcorders were shown at IFA. The Hitachi Models DZ-MV350E and DZ-MV380E, also the Panasonic Model VDR-M30, use 8cm DVD-RAM and DVD-R discs. The Sony Models DCR-DVD100 and DCR-DVD200 use 1.4GB DVD-RW and DVD-R discs that can store up to 60 minutes of video. They also have a x10 zoom and a high-speed USB 2.0 connection for transferring images to a PC.

One product that turned a lot of heads was the Samsung ITCAM7, which incorporates a 1.5GB hard drive to store moving video, still images, music and data files. It can thus be used as a camcorder, digital camera, portable MP3 player or even as a portable hard drive. Video is compressed in MPEG-4 form and can be played back at 25 frames/second with VGA (640 x 480) resolution. You can connect it to a TV set, VCR or PC.

Panasonic has developed a range of camcorders that record on an SD Memory

Card. The D-snap range consists of Models SV-AV100, SV-AS10 and SV-AV20. They record both MPEG-2 and MPEG-4 video and can store up to 20 minutes of MPEG-2 video on a 512MB card. The following recording modes are available with the D-snap range: MPEG-2 fine mode at 6Mbps/sec and standard mode at 3Mbps/sec; and MPEG-4 super fine (320 x 240) at 1Mbps/sec, normal (176 x 144) at 30kbits/sec, or economy (176 x 144) at 100kbits/sec. The SD Memory Card has a maximum data transfer rate of 10Mbps/sec – 1GB cards are under development.

As the D-snap range uses an SD card instead of tape or a disc, the camcorders are extremely small. Model SV-AV100 measures 3.32 x 8.89 x 6.49cm (credit-card size) and weighs 156g. Model SC-AS10 weighs just 56g, making it lighter than a pack of cards. How do you go about servicing such a tiny device? When a D-snap camcorder is placed in a base station images can be transmitted to a TV set or sent via a USB link to a PC.

### Home networks

Home networking and system convergence were major themes at this year's IFA. Many companies showed systems that are designed to link various domestic entertainment devices to each other and/or the internet.

LG's home network involved a living room, kitchen and study, with a wall-mounted plasma screen as the main display. Philips has extended its Connected Home concept. This involves a broadband internet connection to a 'Connected Planet' which uses WiFi wireless technology to distribute digital content such as music and video around the home. Users thus have access to information and entertainment anywhere and anytime via various devices.

Philips' new products included the Streamium MX6000I, a DVD home entertainment system with WiFi access to content stored on a PC or on-line. In fact there were quite a few WiFi hotspots dotted around the IFA, and people were using laptop PCs to log on to the internet from a variety of places. Philips' Portable Blue is a tiny optical disc about the size of a 10p piece: it can store up to 1GB of data, using blue-laser technology.

Thomson's Oz server stores music, video and images and distributes them around the home using 5GHz RF technology. JVC also demonstrated a 5GHz home-distribution system.

The Broadband Box, a Swedish company, demonstrated a product with the same name. It's a combined PC, DVD recorder, digital TV recorder, audio library, radio, photo album and internet terminal, all contained in a large silver and maroon box, with a broadband connection for downloading digital content from the internet. It's an impressive product. But whether consumers will want to put all their digital eggs in one basket remains to be seen. ■

# The TETRA problem

**TETRA is an international standard for digital mobile communications. The police and other emergency services in the UK are gradually adopting TETRA systems. They are high-powered, and can cause UHF TV interference problems. Bill Wright describes the problem and the remedies that can be used**



*Photo 1: TETRA 'tyre marks' on a TV screen. Reception was with a vertically-polarised log-periodic aerial and a single-stage UHF/VHF masthead amplifier, 3km from the TETRA mast which was 15° off-axis from the TV transmitter. The TETRA field strength was 15dB stronger than that of the analogue TV channels.*

**T**ETRA stands for TERrestrial Truncked RADio. It's an international standard for digital mobile communications and, in the UK, the police and other emergency services are gradually adopting TETRA systems. TETRA bears some resemblance to the digital mobile phone networks, but the cells are generally larger and the transmission powers higher. The introduction of any new transmission system is likely to cause some degree of interference to existing services. But the problems that TETRA is causing to TV reception seem to be much more widespread than anyone anticipated. There are deep political issues involved with the implementation of TETRA and, in many districts where a TETRA mast has appeared, there is local feeling that the Home Office, having committed billions to the scheme, is riding roughshod over responsibility for TV interference problems. This is not the place to go into that, so I will simply describe the technical problem and suggest remedies.

The frequencies allocated for police and fire service TETRA use in the UK are 380-385MHz (mobile) and 390-395MHz (fixed). The company that operates TETRA, O2 Airwave, is building a network using these frequencies – the process should be more or less complete by the end of the year.

## **TETRA and TVI**

There is nothing particularly pernicious about these transmissions. TETRA interference has become noteworthy simply because the transmitters are new, quite high-powered, and are often in residential areas. Most of the normal TVI (TV interference) remedies apply when dealing with TETRA interference. But, as the interfering signals are digital, some familiar TVI symptoms such as audio breakthrough will not be

present. And as the base stations transmit continuously the interference does not stop and start like, for example, TVI from a taxi base station. Apart from these points, my comments here about TETRA interference apply equally to any strong interfering transmissions, especially to those between 300-450MHz.

TETRA interference problems are most likely to arise when one or more of the following conditions apply:

- (1) The TETRA mast is within a few km.
- (2) The TV aerial is vertically polarised.
- (3) The TV aerial is of the group A (chs. 21-35) or wideband type.
- (4) A masthead amplifier, particularly a two-stage one, is in use.
- (5) The TV field strength is poor.

Since TETRA transmitter aerials are flat panels that are designed to radiate most power towards the target area, the field strength in areas very close to the mast might be rather less than expected. But areas on high ground 2-3km from a mast, on the other side of a valley for example, can be pretty well swamped with signal.

Interference problems are uncommon when the TETRA field strength is relatively low, unless a masthead or distribution amplifier is in use. At locations where the field strength is very high however interference is quite common, even where the TV field strength is good and the aerial is connected to the TV set directly, with no signal amplification.

If the interfering field strength is very high, the unwanted signal can enter either via the aerial or directly into the TV set or VCR. This is really an EMC (electromagnetic compatibility) shortcoming with the TV set or VCR. The symptoms can be very peculiar, and may not look like TVI. More or less anything is possible, though a common symptom is faint patterning – even when the TV set is working with a scart input. I'm generalising from experience with only a small sample, but the very cheap 'supermarket special' TV sets seem to be more susceptible to the problem than others. If you come across a set that works perfectly on your bench but persistently misbehaves in the customer's home, have a good look around the immediate neighbourhood for a transmission mast. Since TETRA often shares a site with cellphone and other transmissions, the mast will probably not be new. Look for new panel arrays. These will often be mounted below the cellphone panels, on arms that position them away from the mast. Some TETRA transmission sites are atop blocks of flats, so TV sets on the higher floors

of adjacent high-rise blocks may be in a very strong interfering field (the occupiers will be as well – there are contentious health concerns about this).

TETRA transmissions are properly engineered of course, and the out-of-band radiation should be minute. Nevertheless the second harmonic coincides with UHF TV ch. 60. So, if you encounter strange problems with this channel, TETRA could be the culprit.

### Masthead amplifiers

Normally it's the fundamental frequency that causes the trouble, because 400MHz is well within the passband of most aerial amplifiers. Thus the vast majority of problems arise when some sort of aerial amplifier is in use. If you think about it, use of a masthead amplifier means that the TV signals are likely to be on the low side, so a fairly-close TETRA transmitter could produce a field strength 30-40dB higher than that of the TV signals. Even allowing for the fact that the aerial is pointing at the TV transmitter rather than the TETRA mast, and isn't designed for 400MHz reception, it is quite likely that the masthead amplifier will be presented with enough input signal to cause overloading. In its resulting non-linear condition, the amplifier will add interference to TV channels that have no obvious relationship to the interfering frequency.

The effects vary. DTT (Digital Terrestrial Television) often withstands this interference surprisingly well, and remains unaffected when the analogue channels are quite badly affected. But reception will be impossible beyond the point where the DTT carrier-to-noise ratio falls off the edge of the 'digital cliff'.

Because the TETRA signal is digital, the familiar telltale signs of breakthrough are not present with analogue TV reception. The word 'breakthrough' implies that the interfering carrier's modulation is visible or audible in recognisable form at the TV set, and this doesn't happen with TETRA. There are no disembodied voices whispering "you go round the back while I watch the front" or suchlike police chat coming from the customer's TV set. Interference to analogue reception can be mistaken for that caused by an oscillating masthead amplifier, but a closer examination of the screen will often suggest the real cause of the trouble.

The appearance of the patterning varies a great deal, depending on the relative strength of the interference, but Photo 1 is fairly typical. The distinctive white horizontal bars, each made up of diagonal stripes, have given rise to the description 'tyre marks'. This effect is presumably the result of the pulsed nature of the TETRA signal. There may well be cross-modulation, with one TV channel appearing faintly behind another.

In a really severe case TETRA can wipe out the TV signal completely. But the first time I encountered TETRA interference the symptoms were much less dramatic. There was slight cross-modulation, and some rather vague patterning on the screen. At first I wondered whether the masthead amplifier had some weird fault. When I connected the aerial lead to the spectrum analyser I saw, as expected, a huge spike some way below the UHF TV band. Thinking that the amplifier was oscillating, I disconnected its power supply as a check. This should kill any such oscillation of course. But to my surprise the spike, though greatly reduced, was still present. When a small screwdriver was used as the aerial the spike was very tall. I climbed on to the roof and soon found that the signal, at 392MHz, came from the direction of an innocuous-

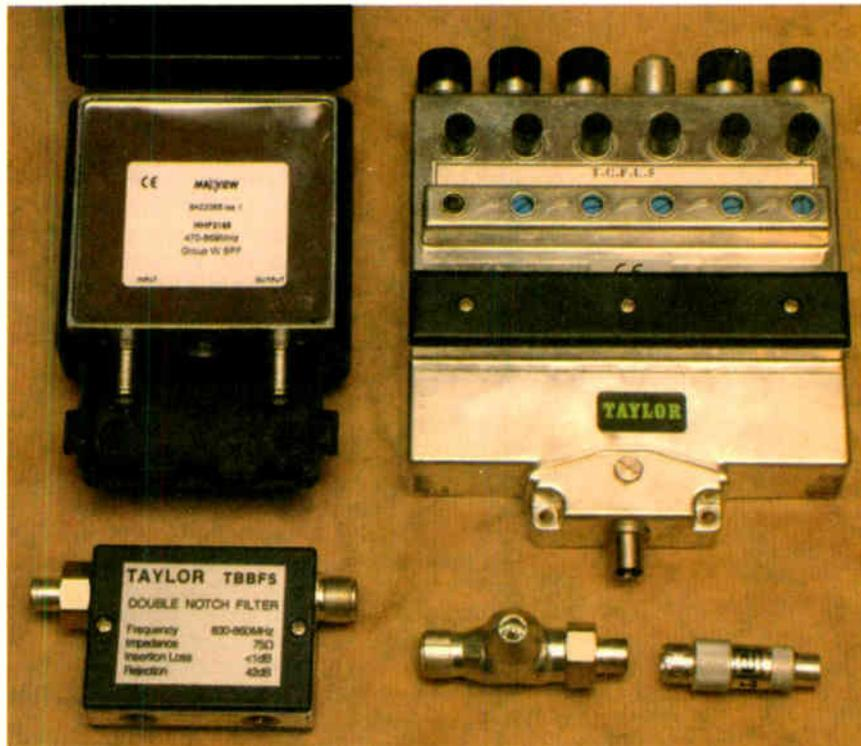


Photo 2: Various types of filter. Clockwise from the top left bandpass, channel-pass/leveller, high-pass, single-notch and double-notch.

looking cellphone mast about 3km away.

A two-stage masthead amplifier is much more likely to be affected than a single-stage one. Two-stage amplifiers have a gain of about 25dB, single-stage ones about 14dB. Quite often the extra gain provided by a two-stage amplifier is unnecessary, and the only thing you need to do to get rid of the interference is to fit a single-stage one instead. The rule-of-thumb I use for assessing whether a two-stage masthead amplifier is required is simple. Assuming that the downlead losses are less than 3dB, I would consider the use of a two-stage amplifier only when the weakest analogue channels are below  $-8\text{dBmV}$  ( $52\text{dB}\mu\text{V}$ ) at the aerial terminals.

If TETRA or other signals below the UHF TV spectrum are causing problems, it's best to use a UHF-only masthead amplifier. These incorporate a high-pass filter that can provide a good degree of protection against interference at 400MHz.

It's also important to use a fully-screened masthead amplifier. Most if not all the major manufacturers now have fully-screened products available. Some of the more 'vintage' masthead amplifiers are poor performers by modern standards, and are very susceptible to strong out-of-band or in-band interference. Maximum output levels are often rather low, which means that the cross-modulation threshold is easily exceeded by unwanted transmissions.

### Filters

Having sorted out the masthead amplifier, if there is one, the next thing you have to consider when faced with strong out-of-band interference is the use of filters. Fortunately lots of these are available. Four basic types are relevant: bandpass, channel-pass/leveller, notch (single or double) and high-pass – see Photo 2.

A bandpass filter passes only the specified frequency range. A high-pass filter rejects everything below its cut-off frequency. A notch filter rejects a spot frequency. A channel-pass filter passes only the

channels specified. There are pros and cons with each type, but whichever type is used it must normally be inserted before the first amplifier in the system. All filters lose a little bit of the wanted signal as well, and with the filter in front of the masthead amplifier the carrier-to-noise ratio will inevitably be degraded, if only slightly. This is unavoidable, but in a marginal reception area it's a good reason for not fitting a filter if this can be avoided. In a difficult case where it's felt that the slight loss before amplification introduced by the filter is unacceptable, it might be possible to use a low-gain amplifier before the filter. Further amplification to overcome cable or distribution losses can follow the filter.

In many cases a bandpass filter will do the trick, with no further complications. They are also known as 'group-pass filters'. Since the filter will normally be before the masthead amplifier it will usually be outdoors, so it must be built into a weatherproof housing. Fringe and Maxview amongst others have such filters. The Maxview MHF range is fully-screened and has F connectors. It includes types for channels 21-37, 21-42, 21-68, 35-53, 35-68 and 48-68. To reject TETRA at 400MHz, use the filter designed for the highest possible group of channels. Through loss with the wanted channels is less than 1dB while the rejection at 400MHz is better than 25dB.

High-pass filters are most familiar to us as in-line CB filters. Examples are the Antiference TVI and TVI-U. These filters' cut-off frequency is generally not high enough to reject TETRA signals.

Notch filters come into their own when a distribution system carries VHF-FM and DAB radio as well as TV. A notch filter tuned to the exact TETRA frequency should be fitted in-line with each aerial feed prior to the amplifiers. Aerials for DAB can receive a lot of TETRA signal, but fortunately a double-notch filter can provide very high rejection – as much as 40dB is possible. Accurate tuning is difficult without a spectrum analyser.

Taylor Bros (Oldham) can supply notch filters for any frequency. Alternatively bandpass filters are available from Taylor Bros for VHF-FM (type TBP2) and DAB (type TBP3). These are indoor units which are intended to be fitted just in front of the distribution amplifier. In the unlikely event that a masthead amplifier is used for VHF-FM or DAB, the filter can be fitted into a standard ABS electrical junction box. A 120 x 180 x 50mm box with a rubber seal on the lid is ideal.

It is unlikely that you would need to resort to channel-pass filters with a simple domestic installation. On the other hand the majority of distribution systems would benefit from having such a filter at the aerial input, even when out-of-band interference isn't a problem. But if the aerial receives TETRA or any other unwanted signal at significant strength a channel-pass filter/leveller is a must. By 'significant strength' I mean about 6dB lower than the digital TV multiplexes. Since TETRA often appears at the aerial terminals at higher strength than even the analogue TV channels, it is very likely in areas with TETRA coverage that a distribution system will need a channel-pass filter/leveller. We now take this for granted, the only exceptions being small systems with twenty or fewer outlets in places where the TV signals are very strong, at about 20dBmV or more. Filters for five analogue channels and six digital multiplexes can cost as much as £150. Believe me, we wouldn't use them if there was a cheaper alternative that works as well.

### **Aerial work**

Don't start adding filters and changing masthead

amplifiers without giving the aerial a cursory glance at the very least. A bit of aerial work can pay dividends both technically and financially, the latter because customers seem to see more value in shiny things on the chimney than in boxes in the loft or your time.

The fundamental requirement is to improve the ratio between the wanted and unwanted transmissions as much as possible. First I'll state the obvious: the aerial should be pointed at the TV transmitter accurately, and should be sited as advantageously as possible. If raising the aerial or moving it to another chimney gives better line-of-site to the transmitter without improving the view towards the TETRA mast, it's worth doing the work. Apart from alleviating the TETRA problem, there will be a general improvement in reception. Don't waste your time putting the aerial off-beam from the transmitter in the hope of 'nulling out' the interference: it doesn't work.

TV aerials designed to work right down to the bottom of the UHF TV spectrum (470MHz) seem to function surprisingly well at 400MHz, even exhibiting directional properties and gain! If possible, avoid the use of wideband aerials. These are often installed unnecessarily nowadays, thanks largely to a widespread misconception that they are always needed for DTT reception. If all the analogue and digital TV signals required are in group B or C/D, the low-frequency response of a wideband aerial merely contributes to troublesome interference such as that from TETRA. The inferior performance of a wideband in comparison with a grouped aerial can also make a difference.

As a desperate last resort, it might be possible to improve the signal-to-interference ratio by relocating the TV aerial to a spot that's screened from the TETRA mast. Unfortunately 400MHz signals aren't attenuated by buildings and trees as much as UHF TV ones, so this might not be all that effective.

Most VHF-FM aerials have to be installed horizontally, which helps avoid TETRA interference. Unfortunately DAB aerials have to be installed vertically.

### **In conclusion**

The electromagnetic spectrum has become ever more crowded over the years. During my time as an aerial installer I have seen all sorts of innovations that have caused UHF TV reception problems. In the late Seventies and early Eighties there was the CB craze. Then we had the illegal high-powered cordless phones. Meanwhile many of the CB fanatics migrated to amateur radio and started to transmit lots of watts at 144MHz and 432MHz, usually in the middle of crowded housing estates. Next illegal video senders became popular – I could write a book about the trouble they caused. Low-powered RSL radio stations have sprung up all over in recent years, cellphone masts adorn every bit of high ground, and we now have five analogue channels and six digital multiplexes competing for space in the UHF TV spectrum, with the old channel-spacing rules thrown to the winds. No wonder we have interference problems!

We must remember though that the majority of these problems are not caused by the interfering transmitter but are the result of poor EMC (electromagnetic compatibility) at the receiving end. Poor amplifier design, the wrong type of amplifier, cheap coaxial cable, poor TV set design and an inadequate aerial installation can all open the door to interference.

Ensuring good EMC performance has become an important part of installers' work over the years. TETRA is just the latest challenge. I'm sure it won't be the last!

# Grandata Ltd

distributor of electronic components

## Specials Offers and New Arrivals !!

### High Quality Fully Shielded Foil Wrapped Scart Lead

Length : 1.5m Width : 12mm

Box of 25

Price : £ 30.00 + vat

Box of 50

Price : £ 50.00 + vat

**Order Code : PLG26**



### Fully Shielded 21 Pin Connected Scart Lead

Length : 1.5m Width : 8mm

Box of 50

Price : £ 30.00 + vat

Box of 100

Price : £ 55.00 + vat

**Order Code : PLG23**



### New Arrival !!

#### Jaeger 2003 / 2004 Semiconductor Comparison Book

This A5 sized book contains vital information on 41,400 types of components.

Transistors , Diodes , Thyristors , IC's all covered with details of :  
Design  
Brief data / description  
Construction type...etc

**Order Code : BOOK04**

**Price : £ 23.00 - No VAT**  
(plus £ 2.00 + vat for Postage)

### Coax Fly Lead Plug to Socket

Length : 2m

Box of 50

Price : £ 15.00 + vat

Box of 100

Price : £ 25.00 + vat

**Order Code : COXCABLE**



### 2 Phono to 2 Phono Cable

Length : 1.2m

Box of 25

Price : £ 12.50 + vat

Box of 50

Price : £ 20.00 + vat

**Order Code : PLG33**



### Scart Plug to Scart Sockets 5 way splitter

Length : 0.4m

Box of 10

Price : £ 20.00 + vat

**Order Code : PLG44**



### Switched Scart to 3 Phono and S-Video Sockets

Box of 10

Price : £ 10.00 + vat

Box of 20

Price : £ 17.00 + vat

**Order Code : PLG85**



## Aerial Installation Accessories

### SLx Aerial Amplifiers

Now with built in Digital ByPass Operates with Sky™ DigiEye

Class leading noise figure of 4dB or less

6dB signal amplification on all models

Description	Order Code	Price
2 Way - No Bypass	SLX2	£ 8.00 + vat
2 Way - With Bypass	SLX2B	£ 9.25 + vat
4 Way - No Bypass	SLX4	£ 13.00 + vat
4 Way - With Bypass	SLX4B	£ 14.00 + vat
6 Way - No Bypass	SLX6	£ 18.00 + vat
6 Way - With Bypass	SLX6B	£ 19.00 + vat
8 Way - No Bypass	SLX8	£ 18.50 + vat
8 Way - With Bypass	SLX8B	£ 20.00 + vat



Integrated Digital By Pass

### SLx Masthead Amplifiers

UHF TV antenna pre amplifier designed for the professional aerial installer

15dB gain masthead amplifier ideal for majority of domestic installations

26dB gain masthead amplifier for longer cable runs (loss of more than 3dB) or if connected to passive splitters

Requires 12V DC power supply via download either via dedicated power supply unit or from a distribution amplifier with line powering

15dB Amp Order Code : 27830R  
Price : £ 4.30 + vat

26dB Amp Order Code : 27831R  
Price : £ 4.50 + vat

SLx Masthead Amp PSU  
Order Code : 27832R  
Price : £ 5.00 + vat

Postage for 2+ £ 5.00 + vat



### Coax Plug Aluminium



Order Code : PLG51

Bag of 10

Price : £ 1.25 + vat

Bag of 100

Price : £ 9.00 + vat

### Screw Type Coax Plugs



Order Code : PLG62

Bag of 10

Price : £ 1.60 + vat

Bag of 100

Price : £ 12.50 + vat

### Twist On F Connectors



Order Code : PLG101

Bag of 10

Price : £ 1.00 + vat

Bag of 100

Price : £ 6.00 + vat

### Coax Coupler Socket to Socket



Order Code PLG54

Bag of 10

Price : £1.50 + vat

### Coax Coupler Plug to Plug



Order Code PLG55

Bag of 10

Price : £1.50 + vat

### Y Splitter Inductive 3 way



Order Code YSPLITTER

Price : 40p + vat

Bag of 10

Price : £ 3.00 + vat

K.P. House , Unit 15 , Pop In Commercial Centre , Southway , Wembley , Middlesex . HA9 0HB England

Tel : (020) 8900 2329

Fax : (020) 8903 6126

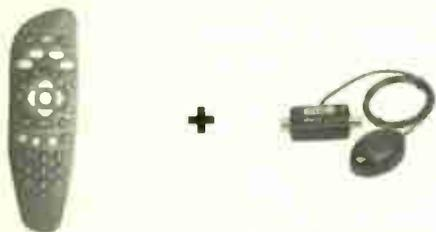
Email : sales@grandata.co.uk

# Grandata Ltd

distributor of electronic components

## Digital Satellite Accessories

### Sky™ Digital Remote & TV Link Eye Combination



Order Code : SKYPACK1

Price : £ 16.00 + vat each

5 +

£ 14.50 + vat each

### Sky™ Digital Remote Controls



Order Code : RCKSKY

1 +

£ 7.95 + vat each

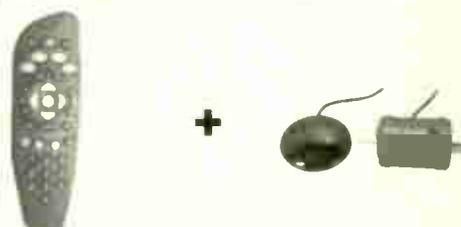
5 +

£ 7.45 + vat each

10 +

£ 6.95 + vat each

### Sky™ Digital Remote & SLx Link Eye Combination



Order Code : SKYPACK2

Price : £ 13.00 + vat each

5 +

£ 11.50 + vat each

### SLx Link Eye

Allows control of Sky™ Digibox via the signal feed for second TV

Order Code : 27833R

1 - 9

£ 6.50 + vat each

10 - 24

£ 5.50 + vat each



### Sky™ Digital TV Link Eye

Order Code : TVLINKEYE

Price

£ 10.75 + vat

5 +

£ 7.99 + vat each

10+

£ 6.99 + vat each



### SLx Amp By Pass Kit

For use with aerial amplifiers and Sky™ Digibox

Allows for operation of Link Eye in conjunction with a distribution amplifier

Order Code : 27829R

Price : £ 5.00 + vat



## Satellite Repair / Mod Kits

### Amstrad DRX100

Tuner Repair Kit

Order Code  
SATKIT35

Price  
£ 1.40 + vat

### Amstrad DRX100

Power Supply Reliability Kit

Order Code  
SATKIT36

Price  
£ 12.00 + vat

### Amstrad DRX100

Power Supply Repair Kit

Order Code  
SATKIT37

Price  
£ 13.50 + vat

### Grundig GDS200

Digital Satellite Receiver Repair Kit

Early psu  
MODEL : DSO - 0385 REV C

Order Code: SATKIT34A  
Price : £ 10.00 + vat

### Grundig GDS200/300

Digital Satellite Receiver Repair Kit

LATER psu TYPE REV 03  
DSO - 0375 REV A  
DSO - 0385 REV 5

Order Code: SATKIT34B  
Price : £ 10.00 + vat

### Digital Satellite Receivers Fan Kit

Suitable for

Amstrad DRX100 , DRX200  
Grundig GDR200 , GDS200  
Pace Digibox

plus many more analogue makes and models

Order Code : FANKIT1

Price : £ 10.00 + vat

### Panasonic Digital Satellite Receiver Fan Kit

Suitable for Panasonic TU-DSB20/30 , TU-DSB31/35

Order Code : FANKIT2

Price : £ 15.00 + vat

### Grundig Digital Satellite Receivers Reliability Kit

These kits contain capacitors that are generally of higher specification than those fitted by the manufacturers.

**New Arrivals !!**

#### GDS200

Early PSU  
DSO0385 Rev C

Kit Contains 9 capacitors

Code : RELKIT34A  
Price: £ 4.00 + vat

#### GDS200 / GDS300

Later PSU  
DSO0375 Rev A  
DSO0385 Rev F

Kit Contains 11 capacitors

Code : RELKIT34B  
Price: £ 4.00 + vat

#### GDS200 / GDS300

Later PSU  
Rev 03

Kit Contains 13 capacitors

Code : RELKIT34C  
Price: £ 4.00 + vat

#### GDS200 / GDS300

Samsung PSU  
PSSH370601B

Kit Contains 12 capacitors

Code : RELKIT34D Price: £ 4.00 + vat

#### GDS300

Samsung PSU  
PSSH370603B

Kit Contains 13 capacitors

Code : RELKIT34E Price: £ 4.00 + vat





# Grandata Ltd

distributor of electronic components

**KONIG ELECTRONIC**

## Konig Remote Controls

**KONIG ELECTRONIC**

Part No.	Code	Part No.	Code	Part No.	Code	Part No.	Code	Part No.	Code	Part No.	Code	Part No.	Code
<b>AKAI</b>		<b>FERGUSON...continued</b>		<b>HITACHI...continued</b>		<b>NOKIA</b>		<b>PHILIPS...continued</b>		<b>SHARP...continued</b>		<b>TOSHIBA...continued</b>	
CT2582E	IR9700	68L52	IR9639	C24W5511T	IR9983	3126	IR9157	RC9020	IR9434	RRMCG0662PESA	IR9487	1480RBW	IR9953
CT2585	IR9700	A10R	IR9259	C2514	IR9476	3126F	IR9157	RC9030	IR9434	RRMCG0739BMA5A	IR9711	1480TB	IR9953
CT2885	IR9700	A14R	IR9259	C2545T	IR9677	C1	IR9161	RC9057	IR9556	RRMCG0833PESA	IR9487	1480TBW	IR9953
IR16	IR9700	A36R	IR9677	C2546TN	IR9677	C2	IR9161	RC9067	IR9556	RRMCG0898CESA	IR9487	1480TBV	IR9953
RC556	IR9397	B51F	IR9639	C2547TN	IR9677	C3	IR9161	RC9070	IR9556	RRMCG1014BMA5A	IR9711	1480TBZ	IR9953
RC556	IR9397	B51NX	IR9639	C2556TN	IR9677	C4	IR9161	RC9076	IR9434	RRMCG1023BMA5A	IR9711	1510RBT	IR9952
RC85	IR9700	B59F	IR9639	C2567TN	IR9677	CM1	IR9569	RC9133	IR9710	RRMCG1031BMA5A	IR9788	1510RDT	IR9952
<b>AMSTRAD</b>		B59N	IR9639	C2567TN2	IR9983	D1	IR9161	<b>SAMSUNG</b>		RRMCG1036BMA5A	IR9711	1510RT	IR9952
SRD550	IR9386	B59NX	IR9639	C2567TN2	IR9983	D2	IR9161	CX5312W	IR9432	RRMCG1046BMA5A	IR9788	1559RB	IR9952
SRX510	IR9386	B68F	IR9639	C2586TN	IR9983	E1	IR9161	CX5325W	IR9432	RRMCG1048BMA5A	IR9788	1559RBT	IR9952
AE6001	IR9352	B68NX	IR9639	C2659H	IR9142	E2	IR9161	CX532WT	IR9432	RRMCG1050BMA5A	IR9788	1559RBT	IR9952
<b>B &amp; O</b>		C59NX	IR9639	C2660	IR9142	EM2	IR9700	CX534WT	IR9432	RRMCG2799CESA	IR9487	1559RBT	IR9952
Beolink 100	IR9843	C68NX	IR9639	C2861	IR9142	ES5	IR9701	RM104	IR9432	SV2044G	IR9487	1559RBT	IR9952
<b>BEKO</b>		D51ND	IR9639	C2846TN	IR9677	FS10	IR9573	RM109	IR9546	SV2044S	IR9487	1559RBT	IR9952
RC51321	IR9398	D59F	IR9639	C2847TN	IR9677	FS11	IR9573	<b>SANYO</b>		SV2145G	IR9487	1559RBT	IR9952
RC51331	IR9398	D59N	IR9639	C2856TN	IR9677	FS4/1	IR9573	4AAU1U0092	IR9459	SV2145S	IR9487	1559RBT	IR9952
RC61331	IR9398	D68N	IR9639	C2856TN	IR9677	FS4/2	IR9573	JXA	IR9457	SV2277S	IR9487	1559RBT	IR9952
<b>BLAUPUNKT</b>		D78N	IR9639	C2886TN	IR9983	FS5	IR9506	JXCL	IR9530	SV2277S1	IR9487	1559RBT	IR9952
8669493	IR9188	E51N	IR9639	C28W410TN	IR9983	FS5/1	IR9506	JXCR	IR9530	SV2877S	IR9487	1559RBT	IR9952
1532	IR9503	E59R8	IR9639	C28W510TN	IR9983	FS9	IR9506	JXFF	IR9457	SV2877S1	IR9487	1559RBT	IR9952
1570-46	IR9516	RCU1734	IR9584	CBP1476R	IR9142	RC1	IR9157	JXGA	IR9139	RM604	IR9974	1559RBT	IR9952
8627 105 463	IR9188	RCU1742	IR9584	CBP1646R	IR9142	RC2	IR9157	JXGE	IR9139	RM607	IR9974	1559RBT	IR9952
8668813000	IR9516	RCU1785	IR9584	CBP2067	IR9142	IRM1	IR9535	JXGT	IR9460	RM609	IR9974	1559RBT	IR9952
1556-46	IR9516	RCU1789	IR9584	CBP2216	IR9142	IRM2	IR9535	JXGW	IR9460	RM615	IR9511	1559RBT	IR9952
1563-46	IR9516	RH880	IR9594	CBP2226	IR9142	IR3	IR9535	JXJG	IR9460	RM620	IR9511	1559RBT	IR9952
1616	IR9504	RH885	IR9325	CBP226	IR9142	RCN610	IR9752	JXLB	IR9460	RM625	IR9511	1559RBT	IR9952
1627	IR9503	RHT01	IR9259	CL2156TAN	IR9983	RCN620	IR9752	JXLG	IR9460	RM630	IR9511	1559RBT	IR9952
1632	IR9503	RHT10	IR9639	CL24W1TAN	IR9983	RCN624	IR9757	RC238	IR9974	RM631	IR9511	1559RBT	IR9952
1654-46	IR9516	RHT30	IR9639	CL2567TAN	IR9983	SM1	IR9491	RC254	IR9974	RM633	IR9511	1559RBT	IR9952
1616	IR9504	T49F	IR9639	CL2586TAN	IR9983	SM2	IR9491	RC258	IR9530	RM634	IR9511	1559RBT	IR9952
1632	IR9503	T49M	IR9639	CL2867TAN	IR9983	<b>PANASONIC</b>		RC305	IR9974	RM635	IR9511	1559RBT	IR9952
1632	IR9503	T51N	IR9639	CL2886TAN	IR9983	02280227	IR9835	RC307	IR9457	RM636	IR9511	1559RBT	IR9952
1M32	IR9503	T59F	IR9639	CL28W1TAN	IR9983	91005926	IR9835	RC308	IR9457	RM637	IR9511	1559RBT	IR9952
1M55-16	IR9516	T59N	IR9639	CL28W2TAN	IR9983	EUR50100	IR9826	RC317	IR9457	RM641	IR9321	1559RBT	IR9952
1M63-16	IR9516	T68N	IR9639	CL32W2TAN	IR9983	EUR51920	IR9835	RC318	IR9457	RM641A	IR9321	1559RBT	IR9952
1M70-16	IR9516	T742	IR9584	CLE871A	IR9602	EUR51921	IR9835	RC321	IR9457	RM650	IR9321	1559RBT	IR9952
1P32	IR9503	T752	IR9584	CLE871B	IR9602	IR3592	IR9826	RC612	IR9457	RM651	IR9321	1559RBT	IR9952
1Q16	IR9504	T758	IR9584	CLE874A	IR9602	TC1485DR	IR9826	RC625	IR9457	RM652	IR9321	1559RBT	IR9952
1R32	IR9504	T789	IR9594	CLE874B	IR9602	TC14S1R	IR9834	RC628	IR9457	RM653	IR9321	1559RBT	IR9952
TC106	IR9406	T78DPL	IR9639	CLE876	IR9476	TC150E	IR9562	RC642	IR9530	RM654	IR9321	1559RBT	IR9952
TC110 PIP	IR9248	CLE876C	IR9476	CLE876C	IR9476	TC150E	IR9562	RC645	IR9530	RM655	IR9321	1559RBT	IR9952
TC143	IR9406	CLE876D	IR9476	CLE876D	IR9476	TC150E	IR9562	RC645	IR9530	RM656	IR9321	1559RBT	IR9952
TC144	IR9504	CLE876E	IR9476	CLE876E	IR9476	TC150E	IR9562	RC645	IR9530	RM657	IR9321	1559RBT	IR9952
TC190	IR9529	CLE876F	IR9476	CLE876F	IR9476	TC150E	IR9562	RC645	IR9530	RM658	IR9321	1559RBT	IR9952
TC192	IR9529	CLE876G	IR9476	CLE876G	IR9476	TC150E	IR9562	RC645	IR9530	RM659	IR9321	1559RBT	IR9952
TC194	IR9529	CLE876H	IR9476	CLE876H	IR9476	TC150E	IR9562	RC645	IR9530	RM660	IR9321	1559RBT	IR9952
<b>CROWN</b>		105-068	IR9403	CLE876I	IR9476	TC150E	IR9562	RC645	IR9530	RM661	IR9321	1559RBT	IR9952
RC51331	IR9398	105-209B	IR9862	CLE902A	IR9677	TC150E	IR9562	RC645	IR9530	RM662	IR9321	1559RBT	IR9952
RC61331	IR9398	105-210A	IR9862	CLE902B	IR9677	TC150E	IR9562	RC645	IR9530	RM663	IR9321	1559RBT	IR9952
2190T	IR9397	105-219J	IR9854	CLE903A	IR9677	TC150E	IR9562	RC645	IR9530	RM664	IR9321	1559RBT	IR9952
<b>DAEWOO</b>		105-224V	IR9854	CLE903B	IR9677	TC150E	IR9562	RC645	IR9530	RM665	IR9321	1559RBT	IR9952
DMQ1414	IR9397	105-229H	IR9854	CLE921A	IR9983	TC150E	IR9562	RC645	IR9530	RM666	IR9321	1559RBT	IR9952
DMQ141A 1	IR9840	105-230C	IR9854	CLE921B	IR9983	TC150E	IR9562	RC645	IR9530	RM667	IR9321	1559RBT	IR9952
DMQ20A 1	IR9840	38T1	IR9854	CLE922A	IR9982	TC150E	IR9562	RC645	IR9530	RM668	IR9321	1559RBT	IR9952
DMQ2195	IR9840	CB20E40X	IR9854	CLR876E	IR9476	TC150E	IR9562	RC645	IR9530	RM669	IR9321	1559RBT	IR9952
DMQ2595	IR9840	CBT2190E	IR9854	CP2546	IR9677	TC150E	IR9562	RC645	IR9530	RM670	IR9321	1559RBT	IR9952
DMQ2895	IR9840	CBT4902E	IR9854	CP2546TAN	IR9677	TC150E	IR9562	RC645	IR9530	RM671	IR9321	1559RBT	IR9952
<b>FERGUSON</b>		CBT9905	IR9403	CP2556TAN	IR9983	TC150E	IR9562	RC645	IR9530	RM672	IR9321	1559RBT	IR9952
22H3	IR9584	VS068K	IR9862	CP2841TA	IR9677	TC150E	IR9562	RC645	IR9530	RM673	IR9321	1559RBT	IR9952
22B5	IR9584	CUC503	IR9614	CP2856TA	IR9983	TC150E	IR9562	RC645	IR9530	RM674	IR9321	1559RBT	IR9952
22H3	IR9584	CUC5200	IR9614	CP2856TAN	IR9983	TC150E	IR9562	RC645	IR9530	RM675	IR9321	1559RBT	IR9952
22H3	IR9584	CUC5301	IR9529	CP2856TAN	IR9983	TC150E	IR9562	RC645	IR9530	RM676	IR9321	1559RBT	IR9952
2422	IR9584	CUC5302	IR9529	CP2856TAN	IR9983	TC150E	IR9562	RC645	IR9530	RM677	IR9321	1559RBT	IR9952
2422	IR9584	CUC5310	IR9614	CP2856TAN	IR9983	TC150E	IR9562	RC645	IR9530	RM678	IR9321	1559RBT	IR9952
2422	IR9584	RC300	IR9614	CP2856TAN	IR9983	TC150E	IR9562	RC645	IR9530	RM679	IR9321	1559RBT	IR9952
2423	IR9584	TP500VT	IR9500	CP2856TAN	IR9983	TC150E	IR9562	RC645	IR9530	RM680	IR9321	1559RBT	IR9952
2433	IR9584	TP590VT	IR9509	CP2856TAN	IR9983	TC150E	IR9562	RC645	IR9530	RM681	IR9321	1559RBT	IR9952
2445	IR9584	TP600VT	IR9509	CP2856TAN	IR9983	TC150E	IR9562	RC645	IR9530	RM682	IR9321	1559RBT	IR9952
2452	IR9584	TP610	IR9509	CP2856TAN	IR9983	TC150E	IR9562	RC645	IR9530	RM683	IR9321	1559RBT	IR9952
2453	IR9584	TP621	IR9299	CP2856TAN	IR9983	TC150E	IR9562	RC645	IR9530	RM684	IR9321	1559RBT	IR9952
2463	IR9584	TP630	IR9509	CP2856TAN	IR9983	TC150E	IR9562	RC645	IR9530	RM685	IR9321	1559RBT	IR9952
2475	IR9584	TP650	IR9509	CP2856TAN	IR9983	TC150E	IR9562	RC645	IR9530	RM686	IR9321	1559RBT	IR9952
26H3	IR9584	TP661	IR9509	CP2856TAN	IR9983	TC150E	IR9562	RC645	IR9530	RM687	IR9321	1559RBT	IR9952
28132	IR9584	TP662	IR9509	CP2856TAN	IR9983	TC150E	IR9562	RC645	IR9530	RM688	IR9321	1559RBT	IR9952
31K2	IR9584	TP663	IR9509	CP2856TAN	IR9983	TC150E	IR9						



# Grandata Ltd

distributor of electronic components

## Transistors / Linear IC's

Part No.	Price	Part No.	Price	Part No.	Price	Part No.	Price	Part No.	Price	Part No.	Price	Part No.	Price	Part No.	Price		
BU208A	£0.75	IRF5450	£5.00	MJE1350	£0.80	STK4191	£9.00	STK5461	£3.00	STR371	£4.00	TDA2450-3	£10.00	TD4665	£2.50	UD8136	£2.00
BU2506DF	£0.90	IRF5740	£3.00	MJE1351	£0.80	STK4191 X	£14.00	STK5466	£5.00	STR380	£3.50	TDA2460-2	£0.70	UD4670	£4.75	UD8138A	£1.30
BU2506DX	£1.00	IRF5840	£3.00	MJE16206	£4.50	STK419-130	£15.00	STK5467	£4.00	STR381	£3.90	TDA2501	£3.00	UD4671	£5.00	UD8139B	£2.00
BU2508A	£1.00	IRF610	£0.80	MJE18004	£1.75	STK419-140	£16.00	STK5468	£3.00	STR383	£4.10	TDA2506T	£8.00	UD4680	£3.50	UD8139	£2.00
BU2508AF	£1.10	IRF611	£1.20	MJE18006	£2.00	STK4192	£7.00	STK5471	£9.00	STR384	£3.50	TD2507	£4.50	UD4681	£4.50	UD8140	£2.00
BU2508AX	£1.30	IRF620	£1.00	MJE18008	£1.75	STK4197 II	£9.50	STK5472	£3.75	STR40090	£3.50	TD2510	£4.50	UD4685	£2.75	UD8143	£1.60
BU2508D	£1.30	IRF630	£0.75	MJE18204	£2.50	STK4199 II	£10.50	STK5473	£4.80	STR40115	£6.00	TD2514A	£5.00	UD4686	£5.00	UD8145	£1.20
BU2508DF	£1.20	IRF634	£1.25	TK0025	£4.20	STK4199II	£10.50	STK5474	£5.00	STR4090A	£6.50	TD2515	£4.50	UD4687	£5.00	UD8146	£2.00
BU2508DX	£1.50	IRF640	£1.50	TK0039	£6.00	STK4200	£4.00	STK5476	£3.50	STR41090	£3.30	TD2520-1	£9.00	UD4700A	£7.50	UD8153	£10.00
BU2520AF	£1.70	IRF640F	£2.00	TK0086	£10.00	STK4204 II	£10.90	STK5477	£4.50	STR4142	£4.50	TD2521	£8.00	UD4710H	£7.00	UD8170	£1.70
BU2520AX	£1.40	IRF630S	£2.00	TK1039	£4.60	STK4204I	£10.50	STK5478	£2.50	STR4211	£3.15	TD2522	£12.00	UD4714C	£3.50	UD8171	£2.30
BU2520DF	£2.25	IRF642	£2.00	TK1040	£6.40	STK4211 II	£10.00	STK5479	£3.00	STR4311H	£9.50	TD2523	£8.50	UD4716C	£4.50	UD8172	£2.00
BU2520DX	£2.00	IRF644	£2.00	TK1049	£7.00	STK4211 V	£8.00	STK5481	£4.70	STR4400	£8.00	TD2525	£4.50	UD4720	£6.60	UD8173	£1.75
BU2522AX	£1.50	IRF650	£2.00	TK1050	£6.50	STK4221 II	£12.00	STK5482	£2.85	STR441	£9.50	TD2530	£3.00	UD4725	£7.50	UD8174	£2.00
BU2525A	£3.25	IRF710	£1.50	TK1060	£7.00	STK4231 II	£10.50	STK5483	£4.40	STR4415	£4.75	TD2538	£2.00	UD4780	£6.00	UD8175	£7.00
BU2525AF	£2.20	IRF720	£0.85	TK2025	£6.20	STK4231 V	£14.00	STK5486	£4.50	STR442	£16.00	TD2549	£3.00	UD4800	£3.00	UD8177	£3.00
BU2525AX	£1.90	IRF730	£1.25	TK2028	£5.00	STK4241	£10.50	STK5487	£5.25	STR450A	£7.00	TD2558	£4.00	UD4810	£5.00	UD8177F	£3.50
BU2525D	£2.40	IRF740	£0.90	TK2029	£6.00	STK4241 V	£12.50	STK5488	£4.80	STR451	£8.00	TD2560Q	£7.00	UD4850	£4.75	UD8179S	£7.50
BU2525DF	£1.75	IRF740F	£3.00	TK2030	£10.00	STK4272	£5.00	STK5490	£4.50	STR4511	£5.50	TD2560-3	£14.00	UD4851	£3.25	UD8180	£12.50
BU2527AF	£4.00	IRF820	£0.90	TK2038	£7.00	STK4273	£5.50	STK5491	£4.00	STR4512	£4.00	TD2574V	£3.50	UD4852	£3.25	UD8205	£12.50
BU2527AX	£2.50	IRF830	£0.85	TK2048	£9.50	STK4274	£5.00	STK5492	£4.15	STR4524	£4.75	TD2576A	£9.00	UD4854	£5.00	UD8212	£3.50
BU2527DF	£2.00	IRF830F	£1.60	TK2058 IV	£18.00	STK4274	£5.00	STK5493	£3.00	STR453	£5.00	TD2577A	£2.00	UD4855	£6.00	UD8214B	£10.50
BU2527DX	£2.00	IRF840	£0.85	TK2101	£10.50	STK430	£5.00	STK5494	£4.00	STR454	£13.00	TD2578A	£7.00	UD4856	£5.00	UD8215H	£3.00
BU2532AL	£3.25	IRF940F	£1.75	TK2110	£5.50	STK4301	£5.00	STK5495	£3.50	STR455	£5.50	TD2579A	£2.10	UD4858	£3.50	UD8217	£2.25
BU2708AF	£2.00	IRF9140	£10.00	TK2139	£6.75	STK4311	£6.50	STK5496	£3.00	STR456	£4.70	TD2579B	£3.25	UD4860	£2.00	UD8303	£2.50
BU2708AX	£2.00	IRF9230	£4.00	TK2155	£9.00	STK433	£4.00	STK5497	£4.00	STR457	£6.00	TD2652	£48.00	UD4861	£3.50	UD8304	£4.00
BU2708DF	£2.00	IRF9510	£1.50	TK2230	£4.70	STK4332	£3.65	STK5498	£3.00	STR470	£3.00	TD2653A	£4.50	UD4866	£2.75	UD8305	£5.00
BU2708DX	£2.00	IRF9511	£1.50	TK3102 II	£5.30	STK4352	£3.75	STK6324B	£5.00	STR50020	£3.50	TD2710-1	£4.00	UD4880	£4.50	UD8305A	£5.00
BU2720AX	£2.00	IRF9520	£1.50	TK3106	£25.00	STK4352	£5.00	STK6327	£12.00	STR50092	£5.50	TD4918A	£17.00	UD4918A	£17.00	UD8310	£6.00
BU2720DF	£2.00	IRF9530	£1.25	TK3122 III	£7.25	STK436	£4.30	STK6328A	£4.00	STR50103A	£2.60	TD4930	£5.00	UD4930	£5.00	UD8350Q	£2.75
BU2720DX	£2.00	IRF9531	£2.00	TK3152 II	£9.00	STK4362	£4.50	STK6431	£6.00	STR50112A	£6.50	TD4935	£3.00	UD4935	£3.00	UD8351	£2.00
BU2722AF	£3.30	IRF9540	£1.75	TK3156	£5.00	STK437	£6.00	STK6607	£4.00	STR50113	£5.00	TD4940	£2.00	UD4940	£2.00	UD8354Q	£2.75
BU2725AF	£2.00	IRF9541	£2.00	TK350-030	£7.00	STK4372	£4.90	STK6712BIV	£5.50	STR5015	£5.00	TD4941	£2.80	UD4941	£2.80	UD8356	£2.00
BU2725DF	£2.00	IRF9610	£0.95	TK392-040	£12.00	STK439	£5.00	STK6722	£6.50	STR50213	£4.00	TD4942	£2.00	UD4942	£2.00	UD8360N3	£8.00
BU2727AF	£2.00	IRF9620	£0.85	TK401-050	£8.00	STK4392	£5.00	STK6732	£10.00	STR50330	£4.75	TD4950	£1.00	UD4950	£1.00	UD8361AN3	£8.00
BU2727DF	£2.00	IRF9622	£2.00	TK401-080	£9.00	TK441	£6.80	STK6822	£7.50	STR51041	£5.00	TD4951	£4.50	UD4951	£4.50	UD8361N3	£9.00
BU2727DX	£2.00	IRF9630	£1.30	TK401-120	£10.00	TK4412	£4.50	STK6825	£6.50	STR51213	£5.00	TD49510	£3.00	UD49510	£3.00	UD8362AN	£12.00
BU2727AF	£2.00	IRF9640	£2.30	TK401-140	£12.00	TK443	£7.00	STK6922	£10.00	STR51424	£7.00	TD49521	£7.50	UD49521	£7.50	UD8362AN3	£7.50
BU506DF	£1.00	IRFBC20	£1.10	TK4017	£4.00	TK4432	£6.00	STK6932	£4.50	STR53041	£4.00	TD49560	£6.00	UD49560	£6.00	UD8362BN3	£8.50
BU508AF	£0.60	IRFBC30	£1.20	TK4019	£4.80	TK457	£4.70	STK6962	£2.75	STR54041	£3.20	TD49561	£3.00	UD49561	£3.00	UD8362N3	£12.00
BU508APH	£0.60	IRFBC40	£2.10	TK402-040	£7.00	TK459	£5.60	STK6972	£3.00	STR5412	£2.80	TD49561A	£3.00	UD49561A	£3.00	UD8362N4	£9.00
BU508AXI	£0.90	IRFBE30	£2.25	TK402-070	£7.00	TK460	£6.60	STK6981B	£5.00	STR55044	£4.50	TD49562A	£2.60	UD49562A	£2.60	UD8362N5	£12.00
BU508D	£0.75	IRFD120	£1.00	TK402-070	£7.00	TK461	£6.00	STK6982	£6.00	STR56041	£5.00	TD49563	£3.50	UD49563	£3.50	UD8362N6	£16.00
BU508DF	£0.85	IRFD120	£1.20	TK402-071	£7.00	TK463	£9.50	STK6982H	£6.00	STR58041	£2.50	TD49563A	£4.00	UD49563A	£4.00	UD8366N3	£11.50
BU508DR	£1.30	IRFD220	£1.00	TK402-090	£8.00	TK465	£9.00	STK7216	£4.20	STR59041	£2.00	TD49564	£3.25	UD49564	£3.25	UD8370	£11.50
BUH1015	£4.25	IRF1120	£3.00	TK4021	£3.80	TK473	£8.20	STK7217	£2.50	STR60001	£5.25	TD49565	£2.20	UD49565	£2.20	UD8372A	£16.50
BUH1215	£4.50	IRFBC40	£1.00	TK402-100	£9.00	TK4793	£8.00	STK7225	£5.00	STR6008X	£5.75	TD49566	£2.80	UD49566	£2.80	UD8374	£10.00
BUH515	£2.00	IRFBC40G	£2.00	TK402-100	£9.00	TK4803	£10.00	STK7226	£17.00	STR6020	£2.70	TD49566A	£3.00	UD49566A	£3.00	UD8375A	£12.50
BUH515D	£2.75	IRFP054	£4.00	TK402-120	£9.00	TK4813	£8.00	STK7233	£7.00	STR61001	£4.75	TD49567	£3.50	UD49567	£3.50	UD8376	£15.00
BUH517	£2.50	IRFP064	£5.00	TK4024 II	£5.50	TK4833	£8.50	STK7251	£5.00	STR7001	£6.75	TD49568	£3.00	UD49568	£3.00	UD8380	£2.00
BUH517D	£1.75	IRFP140	£2.50	TK4025	£5.30	TK4843	£7.20	STK7253	£6.50	STR80145	£4.00	TD49569	£3.75	UD49569	£3.75	UD8424	£4.00
BUH715	£4.25	IRFP150	£2.40	TK4026	£4.80	TK4853	£17.00	STK730-060	£6.50	STR81145	£3.75	TD49570	£2.00	UD49570	£2.00	UD8425	£5.00
BUL30	£1.25	IRFP240	£3.00	TK4026B	£4.80	TK4863	£7.00	STK730-080	£6.00	STR81159	£4.00	TD49571	£6.75	UD49571	£6.75	UD8432	£5.50
BUL381	£1.50	IRFP250	£2.80	TK4026V	£5.00	TK4873	£11.00	STK7308	£7.00	STR8124	£10.00	TD49572	£2.00	UD49572	£2.00	UD8433	£6.00
BUL381D	£1.25	IRFP340	£2.50	TK4028	£5.50	TK488-010	£8.00	STK7309	£4.00	STR83145	£5.00	TD49573	£3.50	UD49573	£3.50	UD8440	£3.00
BUT11A	£0.35	IRFP350	£3.25	TK4032 II	£5.10	TK488-050	£8.00	STK7310	£3.00	STR83159	£7.00	TD49574	£5.00	UD49574	£5.00	UD8443	£3.50
BUT11AF	£0.35	IRFP360	£8.00	TK4034 X	£9.25	TK4893	£10.00	STK73405 II	£5.50	TD41420	£8.00	TD49575	£8.00	UD49575	£8.00	UD8451	£3.25
BUT11AX	£0.50	IRFP450	£2.70	TK4036	£4.70	TK4913	£9.00	STK73410 II	£3.50	TD41470	£12.00	TD49576	£3.50	UD49576	£3.50	UD8453	£3.50
BUT12	£0.80	IRFP460	£4.00	TK4036V	£8.00	TK501	£5.50	STK73410 II	£5.00	TD41514A	£3.25	TD49577	£3.00	UD49577	£3.00	UD8461	£9.50
BUT12A	£0.80	IRFP9140	£14.50	TK4038	£6.80	TK50322	£3.50	STK7348	£4.00	TD41548	£4.20	TD49578	£4.00	UD49578	£4.00	UD8501	£3.75
BUT12AF	£0.90	IRFP9240	£3.00	TK4040 II	£6.50	TK5314	£4.75	STK7356	£4.25	TD41541A	£5.00	TD49579	£0.85	UD49579	£0.85	UD8505	£11.00
BUT18	£0.80	IRFP40	£3.00	TK4042 II	£8.00	TK5315	£5.00	STK7358	£4.40	TD41541A	£4.00	TD49580	£3.00	UD49580	£3.00	UD8560Q	£4.25
BUT18A	£0.80	IRFP50	£4.50	TK4046	£9.50	TK5323	£6.00	STK7359	£4.25	TD41546T	£10.50	TD49581	£3.00	UD49581	£3.00	UD8561Q	£5.25
BUT18AF	£0.65	IRFP60</															

# Grandata Ltd

distributor of electronic components

## Line Output Transformers

Part No	Code	Price	Part No	Code	Price	Part No	Code	Price	Part No	Code	Price	Part No	Code	Price
<b>ALBA</b>			<b>HITACHI..continued</b>			<b>PANASONIC..continued</b>			<b>PHILIPS..continued</b>			<b>THOMSON..continued</b>		
3714002	LOT02	£12.00	2433453	LOT82	£12.50	TLF 14568 F	LOT40	£15.00	AT 2079 / 21	LOT395	£12.00	10588080.P2	LOT1505	£19.00
043714002J	LOT02	£12.00	2433751	LOT01	£13.00	TLF 14584 F	LOT41	£17.00	AT 2079 / 24	LOT392	£15.00	151128140	LOT1505	£19.00
43700000	LOT02	£12.00	2433752	LOT01	£13.00	TLF 14586 F	LOT42	£17.00	AT 2079 / 40	LOT773	£11.50	1512814	LOT1505	£19.00
<b>AMSTRAD</b>			2433891	LOT23	£12.50	<b>PHILIPS</b>			AT 2079 / 99	LOT276	£14.00	15128140	LOT1505	£19.00
1810951	LOT55	£14.00	2433892	LOT84	£14.50	3119 108 31260	LOT90	£12.50	AT 2079/30 01	LOT106	£12.50	153144.6	LOT1505	£19.00
3714002	LOT02	£12.00	2433893	LOT23	£12.50	3119 108 31290	LOT73	£11.50	AT 2079/30102	LOT106	£12.50	15314460	LOT1505	£19.00
043714002J	LOT02	£12.00	2433952	LOT33	£10.00	3119 108 31440	LOT433	£16.00	<b>SAISHO</b>			1532873 A	LOT1505	£19.00
43700000	LOT02	£12.00	2434002	LOT226	£14.50	3119 108 31441	LOT433	£16.00	3714002	LOT02	£12.00	3233500	LOT244	£14.50
AM152591	LOT55	£14.00	2434141	LOT33	£10.00	3119 108 31442	LOT433	£16.00	043714002J	LOT02	£12.00	3233900	LOT244	£14.50
<b>FERGUSON</b>			2434274	LOT44	£10.50	3119 198 62930	LOT57	£11.00	43700000	LOT02	£12.00	40011200	LOT244	£14.50
00 D-3-508-002	LOT381	£15.50	2434393	LOT405	£22.50	3122 138 62930	LOT57	£11.00	7140021	LOT02	£12.00	40148300	LOT244	£14.50
06 D-3-083-001	LOT82	£12.50	2434593	LOT44	£10.50	3122 138 36072	LOT111	£15.00	<b>SHARP</b>			<b>TOSHIBA</b>		
06 D-3-083-002	LOT82	£12.50	2436201	LOT90	£12.50	3122 138 36072	LOT111	£15.00	RTRNF 1220 CEZZLOT39	£18.50	1810951	LOT55	£14.00	
06 D-3-084-001	LOT23	£12.50	23236465	LOT392	£15.00	3122 138 36920	LOT57	£11.00	RTRNF 2001 CEZZLOT338	£17.50	2433751	LOT01	£13.00	
06 D-3-087-001	LOT23	£12.50	2433891H	LOT23	£12.50	3122 138 36923	LOT57	£11.00	RTRNF 2006 CEZZLOT308	£13.50	23236098	LOT288	£14.00	
06 D-3-088-001	LOT84	£14.50	45150504	LOT362	£16.00	3122 138 37050	LOT132	£15.00	RTRNF 2023 CEZZLOT310	£15.00	23236198	LOT288	£14.00	
06 D-3-093-001	LOT204	£16.00	<b>MATSUI</b>			3122 138 37620	LOT90	£12.50	<b>SONY</b>			23236201	LOT395	£12.00
06 D-3-508-003	LOT276	£14.00	00070	LOT438	£16.00	3122 138 37771	LOT129	£14.00	1-439-286-00	LOT46	£13.00	23236245	LOT389	£12.00
06 D-3-512-001	LOT204	£16.00	20071	LOT438	£16.00	3122 138 37992	LOT1116	£19.00	-439-286-11	LOT46	£13.00	23236255	LOT289	£15.00
29201-022-01	LOT63	£17.00	20072	LOT438	£16.00	3122 138 38040	LOT73	£11.50	1-439-286-12	LOT46	£13.00	23236425	LOT288	£14.00
773197	LOT304	£15.50	20073	LOT438	£16.00	3122 138 38123	LOT395	£12.00	1-439-286-13	LOT46	£13.00	23236427	LOT395	£12.00
D 059 / 37	LOT200	£14.00	20074	LOT438	£16.00	3128 138 20200	LOT433	£16.00	1-439-286-13	LOT46	£13.00	23236428	LOT289	£15.00
<b>GOODMANS</b>			20075	LOT438	£16.00	3128 138 20201	LOT433	£16.00	1-439-332-41	LOT100	£15.00	23236424	LOT129	£14.00
1142.5057	LOT1164	£15.00	3714002	LOT02	£12.00	3128 138 20202	LOT433	£16.00	1-439-332-42	LOT101	£14.50	TFB 4090 AC	LOT395	£12.00
1142.5077	LOT1164	£15.00	3221008	LOT438	£16.00	3138 108 30100	LOT106	£12.50	1-439-332-52	LOT100	£15.00	TFB 4124 AE	LOT392	£15.00
1142.5079	LOT1164	£15.00	043714002J	LOT02	£12.00	3138 108 30101	LOT106	£12.50	1-439-363-11	LOT268	£14.00	TFB 4124 AF	LOT392	£15.00
1142.5081	LOT1164	£15.00	043221088P	LOT438	£16.00	3138 108 30102	LOT106	£12.50	1-439-363-21	LOT268	£14.00	<b>We are stockist of both Konig and HR Diemen LOPT's This is just a selection of the LOPT's that we stock....Please call on 020 8900 2329 for copy of our LOPT catalogue</b>		
1152-5016	LOT1934	£19.00	43700000	LOT02	£12.00	40348-08	LOT1577	£18.00	1-439-387-11	LOT311	£14.50			
1179.0387	LOT1147	£16.00	7140021	LOT02	£12.00	40348A-08	LOT1577	£18.00	1-439-387-21	LOT311	£14.50			
1192.0527	LOT1147	£16.00	<b>MITSUBISHI</b>			40348A-09	LOT1577	£18.00	1-439-416-11	LOT255	£16.00			
1352.5008	LOT1167	£15.00	731003	LOT51	£15.50	4812 140 10246	LOT111	£15.00	1-439-416-12	LOT255	£16.00			
1352.5008E	LOT1167	£16.00	334 P 18506	LOT51	£15.50	4812 140 10349	LOT106	£12.50	1-439-416-21	LOT255	£16.00			
1352.5016	LOR1934	£19.00	<b>OREGA</b>			4812 140 10369	LOT90	£12.50	1-439-416-23	LOT255	£16.00			
1352.5027	LOT1270	£16.00	40153201	LOT349	£17.50	4812 140 10421	LOT90	£12.50	1-439-416-41	LOT255	£16.00			
1352.5033	LOT1270	£16.00	<b>ORION</b>			4822 140 10246	LOT111	£15.00	1-439-416-51	LOT255	£16.00			
<b>HINARI</b>			<b>PANASONIC</b>			4822 140 10274	LOT123	£14.50	<b>THOMSON</b>					
3714002	LOT02	£12.00	TLF 14512 F	LOT39	£18.50	4822 140 10306	LOT57	£11.00	105009.8	LOT1505	£19.00			
043714002J	LOT02	£12.00	TLF 14520 F	LOT40	£15.00	4822 140 10349	LOT106	£12.50	10500980	LOT1505	£19.00			
43700000	LOT02	£12.00	TLF 14521 F	LOT39	£18.50	4822 140 10381	LOT128	£13.00	10500980.P1	LOT1505	£19.00			
CF 124 B	LOT67	£14.50	TLF 14567 F	LOT39	£18.50	4822 140 10384	LOT127	£15.50	10531460	LOT1505	£19.00			
CF 124 E	LOT67	£14.50	<b>PHILIPS</b>			4822 140 10406	LOT73	£11.50	105660.6	LOT1505	£19.00			
<b>HITACHI</b>			<b>PANASONIC</b>			4822 140 10544	LOT433	£16.00	105660060	LOT1505	£19.00			
2424593	LOT44	£10.50	TLF 14512 F	LOT39	£18.50	4822 140 10566	LOT433	£16.00	105660606	LOT1505	£19.00			
2432461	LOT169	£15.00	TLF 14520 F	LOT40	£15.00	AT 2076 / 10	LOT57	£11.00	105660606.P2	LOT1505	£19.00			
2432761	LOT169	£15.00	TLF 14521 F	LOT39	£18.50	AT 2077 / 81	LOT121	£15.00	105880.8	LOT1505	£19.00			
			TLF 14567 F	LOT39	£18.50	AT 2078 / 21	LOT395	£12.00	10588080	LOT1505	£19.00			
						AT 2079 / 15	LOT129	£14.00						

## CD Pick Ups and Mechanisms

Part No	Price	Part No	Price	Part No	Price
CDM12.1 Mechanism	£14.00	KSS 213 B	£8.75	OPTIMA 6 S	£11.50
KHM220AAA		KSS 213 C	£9.50	OPTIMA 5	£11.50
DVD Laser	£ 40.00	KSS 213 D	£16.00	RCTRTH8151	£20.00
KSS 210A Original	£11.00	KSS 213 F	£12.00	RCTRTH8112	£14.00
KSS 210A Replacement	£9.50	KSS 240 A	£30.00	RCTRTH8147 Mech	£ 10.00
KSS 210 B	£15.00	NKS 240 A			
		Replacment for KSS240A	£20.00		

Check out our Online Catalogue at

[www.grandata.co.uk](http://www.grandata.co.uk)

This advertisement is just a selection of our stock.

Please contact us if you cannot find the part you are looking for.

\* Please add £1 p+p and VAT to all orders (Unless Otherwise stated) \* All components are brand new

\* We accept payment by Access , Switch , Visa , Cheque and Postal Order

\* All prices quoted are subject to availability and may be changed without prior notice

E & OE

K.P. House , Unit 15 , Pop In Commercial Centre , Southway , Wembley , Middlesex . HA9 0HB England

Tel : (020) 8900 2329

Email : [sales@grandata.co.uk](mailto:sales@grandata.co.uk)

Fax : (020) 8903 6126

Website : <http://www.grandata.co.uk>

# Servicing the Sharp DA100 (50Hz) and DA50W chassis

Part 3 of this series, by Alex Towers, deals with the dynamic focus, EW correction and field output stage circuitry and outlines line and field timebase fault-finding procedures

**W**e ended last month with the operation of the basic line drive and output stage circuitry. Before we start on fault-finding in this area we should take a look at the focus-modulation circuits used in larger-screen models, since these are linked to the line-scan current path.

## Dynamic focusing

Because of their larger screen size, 66cm and 76cm models employ a focus-modulation circuit. It's driven by the line-scan current waveform. The function of the focus modulator is to ensure that the picture is kept in focus at the edges of the display. When the beams are deflected to the edges of the screen they become distorted, as the distance they travel is greater than at the centre of the screen.

Fig. 24 shows the circuit used in GF models. The primary winding of transformer T1602 is connected in series with the line-scan current path, prior to the chassis return via the scan-correction capacitor C613. The signal generated in the secondary winding is fed to the slider of the focus control potentiometer, and is thus superimposed on the DC focus voltage.

This basic arrangement is used in both FW and GF models. Because of the different type of screen with FW models however a rather more complex focus-modulation circuit is used, see Fig. 25. With FW models the screen is not truly flat, the curvature affecting the time taken by the beams to reach the screen to a greater extent than with a flat screen. Focus correction in both the horizontal and vertical directions is therefore required. Horizontal correction is carried out as with GF models, but vertical correction is added, see Fig. 25. The EW drive signal is fed via R1610 and C1605 to pin 2 of IC1601, whose output at pin 1 drives Q1602 and Q1601. The latter adjusts the waveform produced by T1602's secondary winding.

Fig. 26 shows the focus-modulator PCB in FW models.

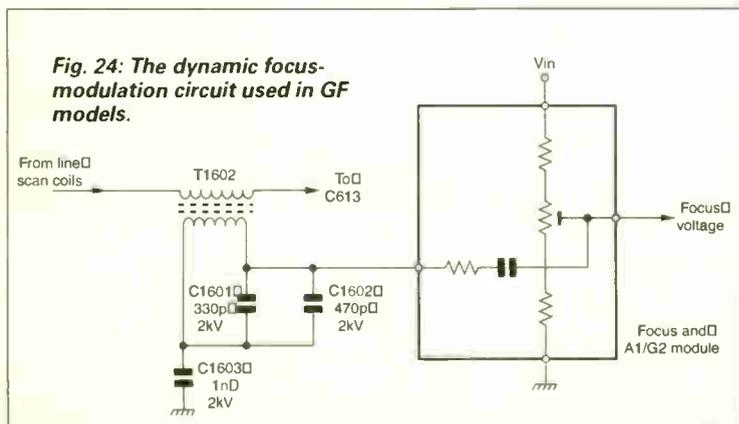


Fig. 24: The dynamic focus-modulation circuit used in GF models.

## Line output stage faults

If the negative supply used to switch off the line output transistor Q601 is too low it won't turn off rapidly. A large voltage will be developed across its collector-emitter junctions during the switch-off period, while current is still being drawn. The power generated has to be dissipated by the transistor itself, which will get very hot and will eventually fail. The usual cause of this problem is C607, which can fall in value or become leaky. As a result, the negative switch-off supply falls. If this has not already been done, it's advisable to fit a 105°C capacitor in this position.

For intermittent failure of the line output transistor it's advisable to replace C607, D610 and D611. Dry-joints can also cause this problem. The areas most commonly affected are the line scan coils' chassis return circuit (C613, R613 and the associated components) and the scan coil connector itself. Sometimes C613 or R613 become open-circuit, the result being loss of line scanning with the possibility that the output transistor becomes short-circuit or leaky. C613 can fail under load, so it's best to check it by substitution. C528, C632 and C615 can also be responsible for intermittent failure of the line output transistor.

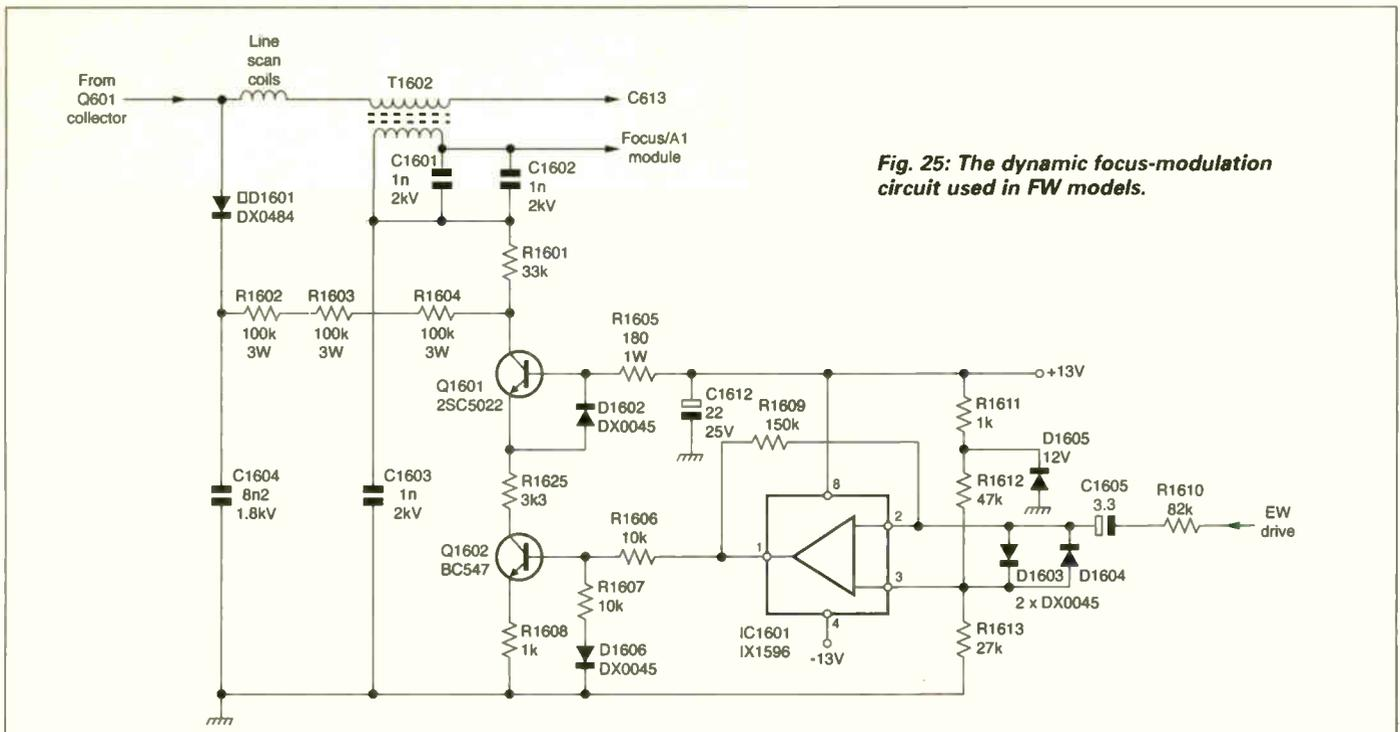
Note that the correct type of line output transistor must be used. An incorrect type will result in erratic operation or premature failure of the device. The Sharp part number for Q601 is RH-TX0144BMZZ.

You could find that the line drive is missing even though the main microcontroller chip IC1001 has gone through the boot-up sequence. The line drive signal comes from pin 50 of the video/deflection processor chip IC801. IC1001 produces a line mute output at pin 57 – this is rather misleadingly referred to as HOUT. The mute can be released to enable the line output stage to start up by short-circuiting the base-emitter junction of Q607 (2SC2412) or temporarily disconnecting link wire JL2, see Fig. 27.

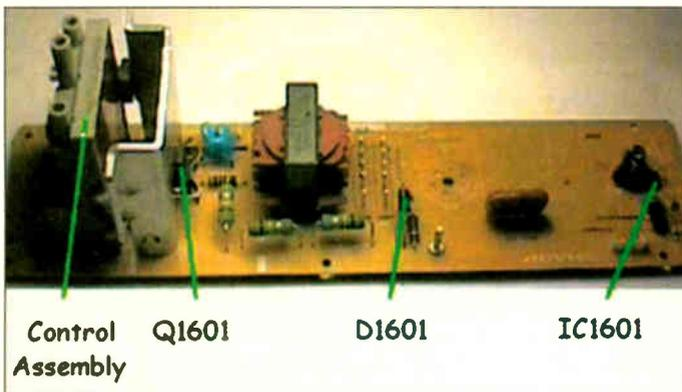
If D1601 on the focus-modulator PCB (66 and 76cm models only) becomes leaky or short-circuit, the result will be an over-large picture as the EHT drops to about 20kV.

## EW correction

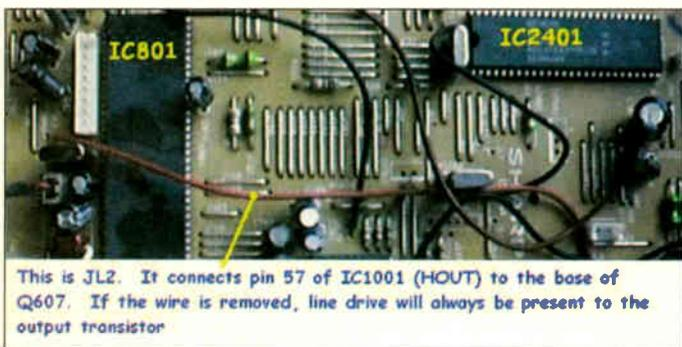
In addition to the normal EW correction required with a 4:3 aspect ratio, 110° deflection tube a widescreen set requires a change of correction for different scanning modes. There are generally three basic modes with widescreen sets, 4:3, 14:9 and 16:9, but in addition the latter can have three variants, full, panorama and cinema. The full mode is used to stretch a 4:3 format picture which contains fast-moving action, for example motor racing: so it doesn't matter greatly if the horizontal linearity is not constant across the screen. The panorama mode is similar but for slow-action or even stationary displays, for example news programmes, where any variation in linearity would be noticeable. To overcome this problem the linearity



**Fig. 25: The dynamic focus-modulation circuit used in FW models.**



**Fig. 26: Photo of the FW focus-modulator PCB.**



**Fig. 27: Location of link wire JL2.**

while a parabolic EW signal from pin 32 of the video/deflection processor chip IC801 is fed to the non-inverting input. The result is a pulse-width modulated output at line frequency, with the width of the pulses determined by the parabolic EW signal. This output is fed to Q506, which is biased for class D operation, is then low-pass filtered and is finally used to drive the diode modulator (D603/604 and C601/610). The low-pass filter consists of L603 and C610. In addition the output from the filter is fed via C611 to coil L604. The centre tap of this coil is connected to the line linearity circuit, while the other end is connected to chassis. Thus the line linearity can be adjusted by the parabolic EW signal.

Fig. 29 shows the print side of the EW circuit and Fig. 30 the component side.

### Fault-finding in the EW correction circuit

It is important to establish in which part of the circuit the fault lies. Check the control output at pin 32 of IC801. There should be a parabolic waveform here, at a base frequency of 50Hz. It will change shape depending on the amount of correction applied. So it is important to enter the service mode (see later) and ensure that none of the adjustments are at minimum or maximum.

If this waveform is present and changes as adjustments are made, the cause of the fault will be in the drive or output circuitry. Faults that can be experienced in this area include:

(1) R519 (usually 100kΩ), which is connected to the 150V supply, can go high in value or open-circuit. It's mounted on the component side of the PCB. The part number is VRD-RA2HD104J. Note that the value is sometimes 150kΩ. Check the value before fitting a replacement, as incorrect value will result in poor EW geometry performance.

(2) Q506 (2SD2391), which is a surface-mounted device, can be leaky, short-circuit, open-circuit or can overheat. The part number is RH-TX0151BMZZ. If it has to be replaced, the following should also be changed: L603/4, D502-4, D516 and C528.

The resistance of L603 and L604 can fall – L603 is normally 8Ω. The part numbers are L603 RCLIP0286BMZZ and L604 RCLIP0284BMZZ. Clamp diodes D502-4, part number RH-DX0551BMZZ, can be intermittently faulty. Clamp diode D516, part number RH-EX0837BMZZ, can also be intermittently faulty – it's not shown in the GF circuit diagram but is fitted to the chassis. The reservoir capacitor C528 (10μF, 63V) can become leaky. Its part number is VCEAGA1JW106M.

is kept constant at the centre of the screen, the sides of the picture being stretched to fill the screen. The cinema mode is for use with pictures that are in true 16:9 format. When setting the geometry, the set must be put in the 'full' mode.

Fig. 28 shows the basic EW correction and line scan circuitry used in these sets. It's centred on transistor Q506, which operates slightly differently from a conventional EW diode-modulator driver in that it is turned on to increase rather than reduce the width. This enables the circuit to work more efficiently, and as a result the transistor does not become overly hot in operation.

IC503 is a switching amplifier. Integrated line-frequency pulses from the line driver circuit are fed to the inverting input via Q501,

(3) The EW modulator diodes D603 and D604 can go open- or short-circuit. Part numbers are D603 RH-DX0299BMZZ and D604 RH-DX0302BMZZ.

(4) A dry-joint can be present at C601 and/or C610.

If the waveform at pin 32 of IC801 is not present, is severely distorted or the adjustment range is poor, the cause of the fault could be the EEPROM chip IC1003 or the video/deflection processor chip IC801. In this case it is recommended that IC1003 is first blanked (see later). If this does not cure the problem, IC801 is probably defective.

Sometimes it may not be possible to set the geometry correctly in all modes after blanking the EEPROM. In this case ensure that the EPROM (IC1002) is the correct type – see Part 1. When the correct EPROM has been fitted, the EPROM will have to be blanked to enable the correct data to be downloaded to it.

Replacement EPROMs have been produced to provide minimal geometry adjustments. If the picture geometry is still poor after carrying out this procedure, the fault will lie elsewhere in the EW circuitry.

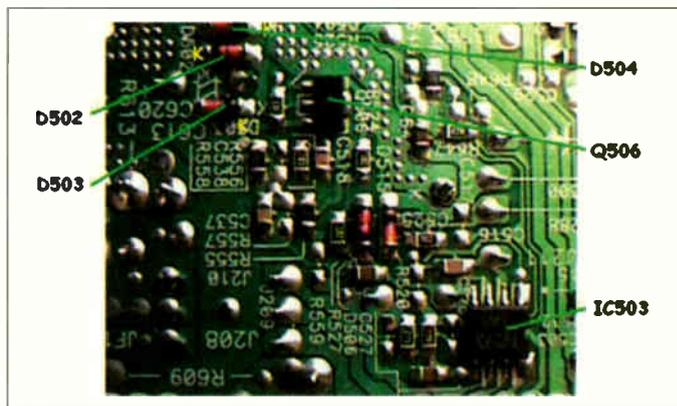
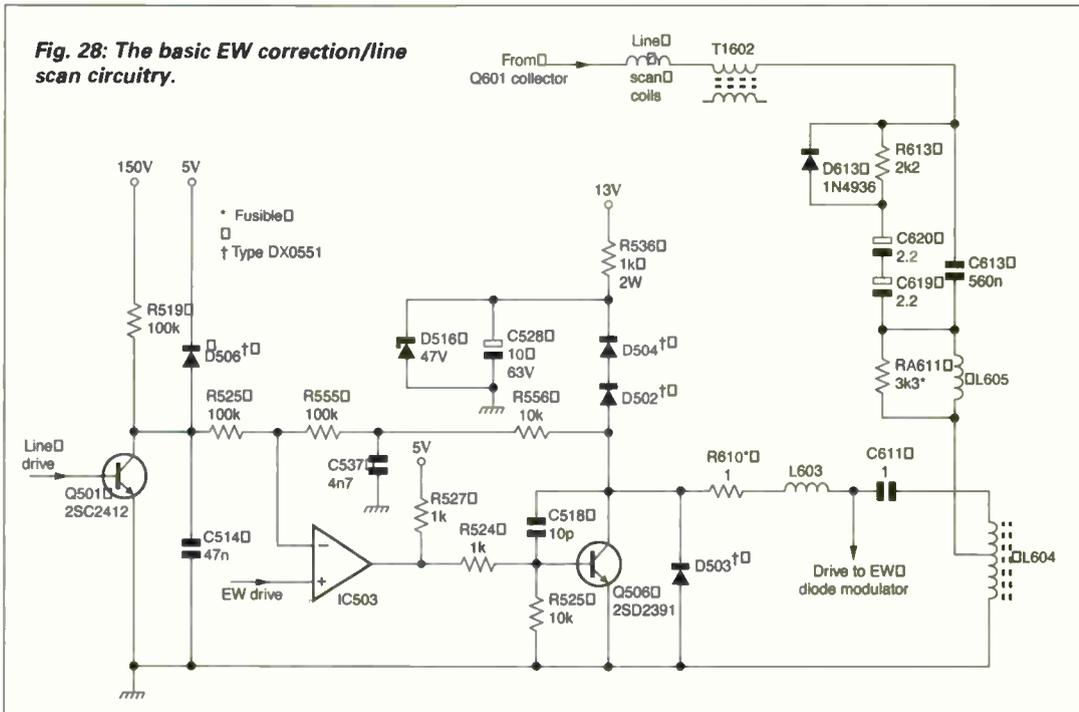
### The CRT PCB

Two types of CRT PCB are used, one for 66cm and 76cm sets and the other for the 56cm Model 56FW53H. The major difference is that there is no scan-velocity modulator or picture-rotation circuitry in the 56cm model, so the PCB is smaller. Note that the RGB output chip IC1801 can be one of three types, see Part 1. Fig. 31 shows the 66cm and 76cm PCB, Fig. 32 the 56FW53H PCB.

It's possible for the grey-scale to wander, the picture brightness ramping up or down. If the A1/G2 voltage is set correctly, check IC1801 by substitution.

Picture smearing will occur if the reference voltage at pin 2 of IC1801 (type TEA5101A or TDA6019JF) is about 10V instead of about 11.5V. This normally shows in the red display. If the voltage is below 9V the picture will blank. In both cases Q912 (TX0130) or its associated components can be the cause. This transistor can run hot (especially with GF modules, because the transistor draws more current). If you suspect that the transistor could fail because of this, a 68Ω, 0.5W resistor can be added between its collector and emitter. It is easiest to fit this resistor on the print side of the PCB.

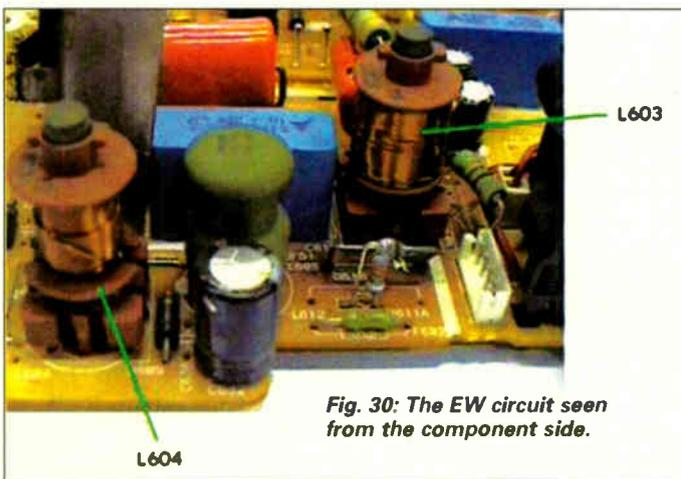
**Fig. 28: The basic EW correction/line scan circuitry.**



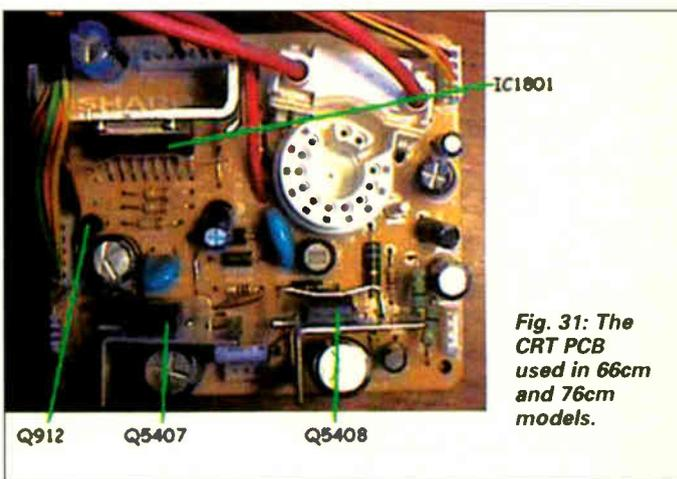
**Fig. 29: The EW circuit seen from the print side.**

### Class D output stages

Sharp used discrete-component class D output stages for a number of years to minimise dissipation. Subsequently a specially-designed IC was introduced for the purpose. This device is ideal for TV audio and field output stages, where high efficiency (low energy use) is required. The TDA7480 IC is for use in audio and field output circuits, while the TDA7481 version is used to drive the sub-woofer in sets with Dolby Pro-Logic. Table 3 shows the pin details for the TDA7480, with voltages when used in the field output stage

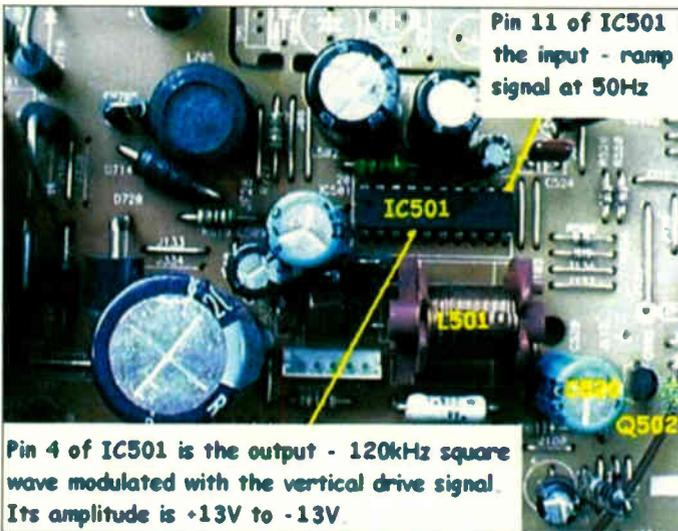
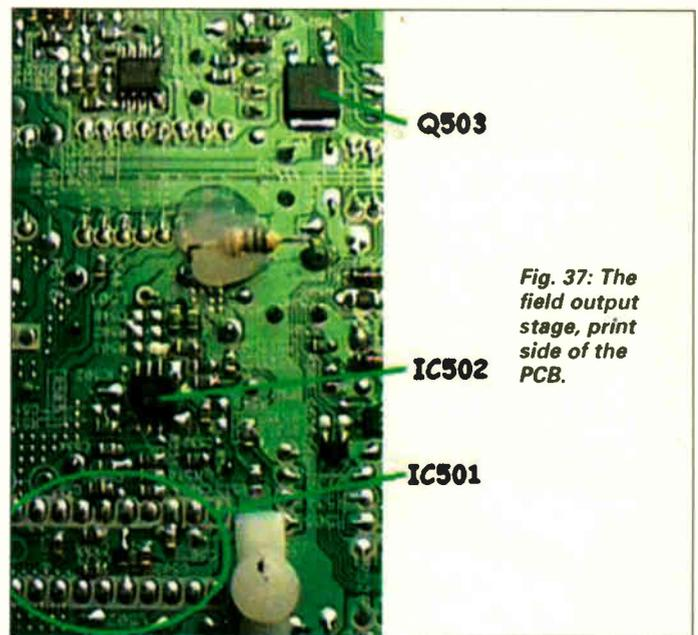
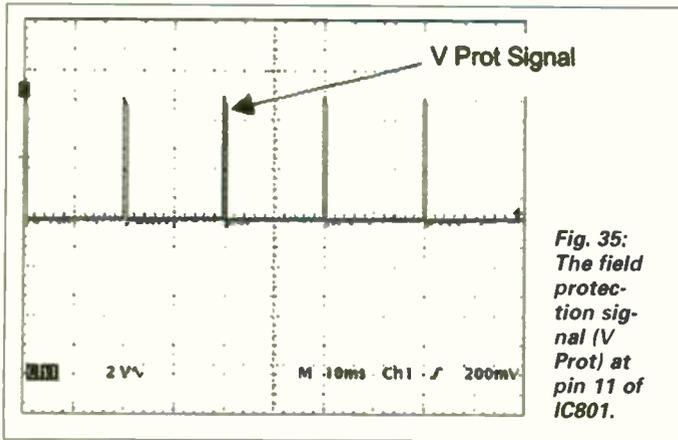


**Fig. 30: The EW circuit seen from the component side.**



**Fig. 31: The CRT PCB used in 66cm and 76cm models.**





usual cause is that Q502 and/or Q503 is leaky or short-circuit. In this case the 25V supply will probably be low.

Red, green and blue lines may be seen at the top of the screen. This normally means that the automatic grey-scale correction lines generated during the field flyback period are not being blanked correctly. Adjustment of the A1/G2 setting on the line output transformer will normally cure this problem. It is possible for the fault to be caused by incorrect operation of the field flyback circuit however. First check that the +25V supply generated by D510/C520 is not low (below 18V) and that there is no excessive ripple here. If there is a problem in this area, the flyback circuit is unable to generate a high enough pulse to send the beams back to the top of the screen. It is not unusual to find that C520 or the feed resistor R530 (10Ω, shown as R617 in Fig. 22) is faulty.

If there is severe vertical distortion or a very small picture, pin 12 (mute) of IC501 may not be at 5V. At any voltage less than 2.7V the IC's output will be attenuated by 70dB. The cause could be failure of C511 or R509.

Foldover at the bottom of the screen when the set has been operating for about fifteen minutes can be caused by failure of the 100nF surface-mounted capacitor C505. Replace it with a capacitor from Sharp, part no. VCKYTV1HF104Z.

### Next month

Next month we'll continue with the operation of the audio circuitry and fault finding in this section of the receiver.

stage is not working and blanks its RGB outputs.

Fig. 36 shows the field output stage from the component side and Fig. 37 the layout on the print side of the PCB.

### Field timebase faults

Most field-scan faults are caused by software corruption or output IC failure. If the EEPROM gets corrupted it can cause severe vertical distortion, no drive, or foldover at the top of the screen. An EEPROM problem can be solved by blanking it, using the blanking OTP (see later). As the audio and field output ICs are the same, a substitution check will prove whether the field output IC is faulty.

When a 56FW53H set is fitted with a Thomson tube, check that EEPROM location F7 on page 0C is 0D. This location controls the field blanking point and, if set incorrectly, can cause red, blue and green lines to flash intermittently at the top of the screen. The setting can be incremented to 0E, 0F or 10 if necessary. 10 is the maximum allowable value – any higher setting will result in an unstable blanking level. If the symptom persists with a setting of 10, there's a fault elsewhere in the chassis.

Field collapse produces the blank-screen symptom. To avoid a line being burnt on the screen in this event IC801 monitors, at pin 11, the field flyback pulses. It blanks the screen when these pulses are missing, by shutting down its RGB outputs. When the blank-screen symptom is present, check for 50Hz pulses at an amplitude of 5V at pin 11 of IC801. They may be missing or corrupted because of a fault in the flyback circuit. The

**Table 3: TDA7480 pin details**

Pin(s)	Nominal voltage	Function
1-3	-13.1V	Negative supply
4	0V	PWM output
5	-2.5V	Anode of internal bootstrap diode
6	9.9V	Connection to external bootstrap capacitor
7	0V	No connection
8	0V	Connection to external feedback integrating capacitor
9	-11.8	Connection to external frequency-setting resistor
10	0V	Signal earth
11	0V	Input
12	5V	Standby/mute control
13	0V	No connection
14	14.1V	Positive signal supply
15	-2.5V	Reference voltage
16	14.1V	Positive power section supply
17-20	-13.1V	Negative supply

# atlas LCR

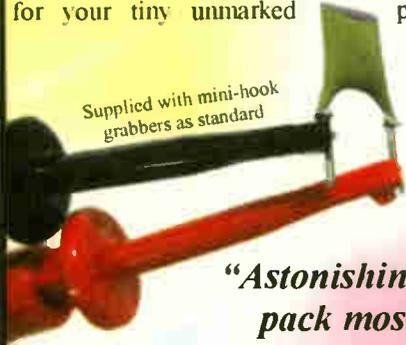
Passive Component Analyser  
(Model LCR40)

# £79

fully inclusive UK price

Just clip on the test leads and press test. The Atlas LCR will automatically identify the type of component, apply the appropriate test level and frequency, display the component's value and more!  
Probes are detachable too, so you can use the optional SMD tweezers for your tiny unmarked passives - fantastic.

- Automatic component identification (Inductor, Capacitor or Resistor)
- Component value measurement
- Auto frequency (DC, 1kHz, 15kHz, 200kHz)
- Inductor DC resistance measurement
- Non-volatile probe compensation memory
- Detachable probes allowing use of optional test prods. SMD tweezers, etc...
- Hands free mode with value hold



Supplied with mini-hook grabbers as standard

**Inductance range: 1µH to 10H**  
**Capacitance range: 1pF to 10,000µF**  
**Resistance range: 1Ω to 2MΩ**  
**Basic accuracy: 1%**  
**Test signals: 1V, 3mA max**

*"Astonishingly, this little unit seems to pack most of the punch of a large and very expensive automated LCR bridge into its tiny case."*

Andy Flind - EPE Magazine March 2003



Accessories:

- Carry case
  - Tweezer Probes
  - Crocodile Probe Set
  - Large Grabber Probes
- (more available soon)

# atlas DCA

Semiconductor Analyser  
(Model DCA55)

# £60

fully inclusive UK price

**NOW MEASURES TRANSISTOR LEAKAGE!**



enclosure colours may vary

**Check and identify your semi's**

- Bipolar transistors,
- Darlington transistors,
- Diode protected transistors,
- Resistor shunted transistors,
- Enhancement mode MOSFETs,
- Depletion mode MOSFETs,
- Junction FETs,
- Low power triacs and thyristors,
- Diodes and diode networks,
- LEDs (+bicolours)

- Automatic component identification
- Pinout identification
- Transistor gain measurement
- MOSFET gate threshold measurement
- PN junction characteristics measurement
- Shorted Junction identification
- Transistor leakage measurement
- Just connect the part anyway round and press the button!
- Auto power on/off

NPN bipolar  
Darlington

Diode protection  
between C-E

Resistor shunt  
between B-E

Current gain  
Hfe=126

Enhancement mode  
N-Ch MOSFET

Gate Threshold  
Vgs=3.47V

RED GREEN BLUE  
Ball Point

0.77V

0.2

*"It's the kind of instrument that should be on every engineer's and enthusiasts bench."*

EPE Magazine  
March 2000



# atlas PACK £129!

LCR40 and DCA55 Pack

fully inclusive UK price

Why not order both analysers at the same time and take advantage of our special offer, saving you £10!

Visit [www.peakelec.co.uk](http://www.peakelec.co.uk) to download the data sheets, user guides and copies of independent reviews. You can pay using a cheque, postal order, credit or debit card and even pay securely online. Please contact us for your volume requirements.

Also available from Farnell, Maplin, Rapid and CPC (prices vary)

**PEAK**  
electronic design ltd

Atlas House, Kiln Lane  
Harpur Ind. Est., Buxton  
Derbyshire, SK17 9JL, UK

[www.peakelec.co.uk](http://www.peakelec.co.uk)  
[sales@peakelec.co.uk](mailto:sales@peakelec.co.uk)

Tel. 01298 70012 Fax. 01298 70046





# NEED A CHEAP TUBE?

BRAND NEW PHILIPS  
W66ECK/ESF  
AT £145.00

*Other types available.*

NEW TUBES BOUGHT FOR  
CASH.

Visit [www.dlec.co.uk](http://www.dlec.co.uk)

Tel: 01474 361276/327677

Fax 01474 335228

E-mail: [sales@dlec.co.uk](mailto:sales@dlec.co.uk)

D'Lec Components Ltd  
3 Manor Court, Sole Street  
Cobham, Kent DA13 9BU

# Nunar Electronic Calls & Orders

Following the success of the highly acclaimed F4 Service Management in the early 1990's the powerful software Nunar allows you to use your existing F4 customer records to create a new database for organising service calls and processing customer orders.

Nunar works independently from F4 and can also work in conjunction with any computerised system you are using. It provides five different search methods to instantly locate your customers. All details are then used to create a service call or customer order. Customers are located by either of the following fields:

Owner ID    Postcode    Address    Name    Telephone

The postcode and telephone searches for example locate and transfer all details from your customer database, this avoids duplicating details when booking in. A professional image is portrayed when customers are located from their telephone number. When using caller display this enables you to have customer information on screen before answering the telephone.

She boasts an infinite user entry when used on a network and is tailored to fit your exact requirements. Please contact us for more information.

**Logik Business Solutions**  
**17 Marsworth, Stafford**  
**Tel: 01785 222082**  
**Mob: 07748 916526**

## ALDER COMPONENTS (HECKMONDWIKE) LIMITED

127A WESTGATE, HECKMONDWIKE  
WEST YORKSHIRE WF16 0EW  
TEL: (01924) 411089 FAX: (01924) 411104



Calder Components stock an extensive range of spares and components for the TV, aerial, satellite and video repair trade. We offer a friendly service usually with next day delivery and do not charge for postage and packing. We have a comprehensive range of parts in stock.

### Our specialist areas are: REMOTE CONTROLS

We stock a wide range of models including both originals and equivalents. BSKyB remotes a speciality with attractive prices for large orders.

### PACE DIGIBOX SPARES

We hold a comprehensive stock of top selling spares including PSU kits, tuners, IC's, etc plus BSKyB remote controls. We also stock panels and covers for digiboxes and remotes. A full catalogue and price list is available on request.

### LOPTX'S

We can provide a vast range of LOPTX's. Currently we have a special offer on the following:

Eldor	1192.1327	at £9.20 each
Eldor	1192.0797	at £9.50 each
Eldor	1142.1615	at £10.00 each
Orega	1034.2010	at £10.00 each
Orega	1036.9690	at £13.50 each

Volume discounts are available for large orders of the above.

All orders or enquiries are welcome by either telephone or fax on the above numbers.

# REMOTES DIRECT

All makes and models

Replacement and Originals remote  
controls available.

**!!!!!!At a fraction of the cost!!!!!!**

*Please contact for instant quote*

**ROB or MARK**

**Tel: 01257 793527**

**E-mail: [infrared@btconnect.com](mailto:infrared@btconnect.com)**

*Or check out our website and  
order on-line*

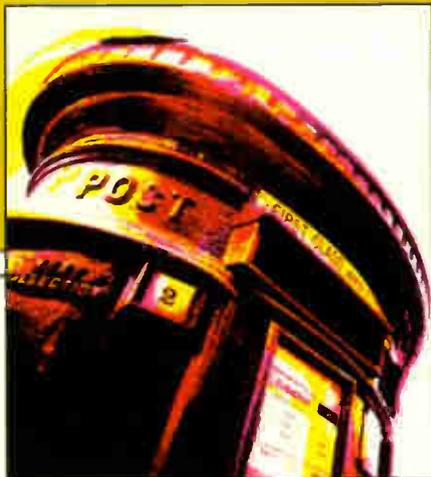
**Website:**

**[www.remotesdirect.co.uk](http://www.remotesdirect.co.uk)**

Also available a wide range of  
satellite equipment

**And various other electronics!!!!!!!**

# LETTERS



## DTT redundant?

I had to laugh when I read the item headed 'Aerials for DTT' in Teletopics (September). After all the misleading publicity about how good DTT is, someone has finally admitted that "because the characteristics of DTT reception differ significantly from those of analogue TV reception, it's much more difficult to ensure that an aerial installation will be satisfactory". Those of us in the trade always knew this.

Where do Monkey and Johnny Vegas fit into this? According to them, when it was still ITV Digital, all you had to do for super digital pictures was to pick up a box from your local dealer and glue it to the end of your existing aerial. Over much of the country this simply didn't work. Since the reworking and renaming of the service, it has been improved technically and the signal is more robust. Yet the Digital TV Group still says that the aerial system is of paramount importance for the system to work – you can get problems because of co-channel interference, multipath reception, marginal signal strength and overloading. Perhaps my memory is becoming foggy, but weren't all these problems going to disappear as a result of DTT's marvellous error-correction systems and the extreme robustness of the digital signal?

We already have a perfectly good digital TV delivery system, via Astra. Once you've bought your DTT box then paid out anything up to £150 to get your aerials sorted out, you can receive a service that's of limited technical capability because of bandwidth limitations and can, for the same reason, never be expanded to include the premium channels. You might as well go for Astra.

Satellite broadcasting is superior: the signals can be received relatively easily

Send letters to "Television", Highbury Business Communications, Nexus House, Azalea Drive, Swanley, Kent, BR8 8HU or e-mail [t.winford@highburybiz.com](mailto:t.winford@highburybiz.com) using subject heading 'Television Letters'.

Please send plain text messages. Do NOT send attachments. Be sure to type your full name, address, postcode, telephone and e-mail address (if any).

Your address and telephone number will not be published but your e-mail address will unless you state otherwise.

Please send ONLY text intended for the letters page. Correspondence relating to subscriptions and other matters must be sent to the office address given above.

and cheaply almost anywhere. We now have a sorry mess of a broadcasting system. All that was needed was a little co-operation between all parties. Once again the politicians got it wrong.

*Geoff Darby,  
Earls Barton, Northampton.*

## Fire hazard

When I took the back off a Bush Model WS6671 (Vestell 11AK19 chassis) recently I noticed, printed on the top right-hand side of the PCB, the words 'risk of fire'. Too true! The fault was a dry-joint at C613 (12nF) in the EW diode-modulator circuit, and the associated fusible resistor R629 (2.7Ω) had in turn been fried. This seems to be something of a design muck up. Had the genius who was responsible thought about it, a fusible resistor that's designed to go open-circuit in the event of an overload in the circuit it protects is likely to get hot and should therefore be mounted on long leads in mid air, not close to the PCB. As a result R629 burnt a hole in the board the size of the Grand Canyon, and carbonised some of the board as well.

All was not lost as I persevered, cleaning up the PCB with a fibre pen, and mounted the replacement fusible resistor in mid air. Otherwise the set would have been consigned to the skip. So yet another big waste was avoided.

The EW coil was also damaged, and it took some time to obtain a replacement. I was told that there is quite a demand for it.  
*Ray Withey,  
Edinburgh.*

## Reliability

During the Seventies and Eighties I was a regular contributor to this magazine. I've long since left the trade, but still buy the magazine regularly. Recent reports on the demise of the service industry as we knew it, because of the greater reliability of modern sets and the 'throw-away' approach that cheap new equipment has brought about, led me to relate the following story.

Way back in 1979 a friend of mine bought two 'nearly new' Philips sets fitted with the G11 chassis. By nearly new I mean

that they had been in use for about six months in a hotel. New owners and a change of regime meant that they were no longer required. So my friend snapped them up for his own use. I gave them the once-over at the time, and also carried out a little experiment that I'll come to shortly.

Twenty four years on the sets both remain in daily use and work perfectly. I had replaced the notorious HT reservoir electrolytic capacitor in both sets. In one set I'd had to replace the TDA2600 field timebase chip, the two EW modulator diodes, and attend to dry-joints all over the place. But both sets have their original CRTs and line output transformers, also the original line output transistors and power supply thyristor rectifiers. Even the troublesome beam-limiter transistors on the power panel are the same.

Why? Maybe because of the little experiment I mentioned earlier. At the time I decided to see how low the nominally 152V HT voltage could be set without materially affecting the performance of the sets. I found that it could be reduced to 142V with no noticeable effect on picture quality. There was a slight reduction in both the width and the height. This was only to be expected, and was easily corrected by slight adjustment of the appropriate timebase presets.

Although it has always been said that under-running a receiver is as detrimental as over-running it, I can only assume that the de-stressing effect of my adjustments was the reason for this remarkable longevity. Either that or an amazing coincidence – remember that we're talking about G11s!

I would be interested in any opinions readers may have about this.

*Steven Knowles,  
Enfield, Middx.*

## Polarity protection

With reference to Jim Littler's letter (October) concerning protection against reverse-polarity battery connection, a simpler solution is to add a bridge rectifier to the battery input of any device that's to be used with a car or truck battery. I have done this many times – and have watched

with amusement the expressions on people's faces when I have swapped the battery connections over and the piece of equipment still works!

Fig. 1 illustrates this.

David Mawtus,  
Scarborough, North Yorkshire.

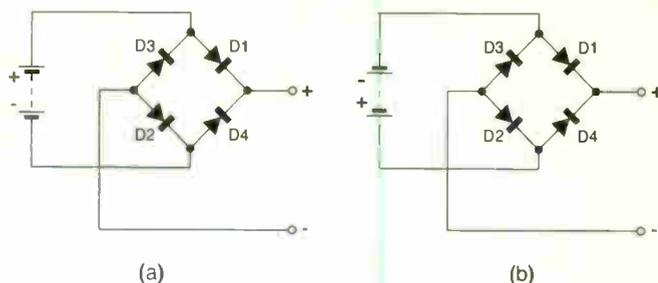
### Vintage radio repairs

I was very interested to read Pete Roberts' article on the Bush Model VTR103 transistor radio in the October issue. More on vintage radio please!

You can always recognise the VTR103 with its red pip at the end of the telescopic FM aerial. I have one in my collection (cream coloured front and back with brown broxine sides). It works on all three bands but the VHF quality is not so good. I might replace the AF115 transistor in the VHF mixer/oscillator stage with an AF125, as Pete suggests, to see if this provides any improvement. I don't think anyone has interfered with the VHF alignment!

The large, circular Perspex tuning knob on the front of the VTR103, TR82 and the original MB60 valve mains/battery model was always difficult to remove. I usually

**Fig. 1: Addition of a bridge rectifier between a battery and the equipment it powers. It doesn't matter which way round the battery is connected. In (a) diodes D1 and D2 provide the connection, in (b) diodes D3 and D4 do the job.**



try to place an old cloth under and around the knob and try to get an even 'pull' on it. Don't bend the pointer in the process! If any damage to the knob does occur, a replacement can be found from a scrap DAC70 or VHF90C valve radio. It's a good idea to put some vaseline on the control shaft and on the inside of the control knob, where the shaft goes in, so that the knob can more easily be removed should the need arise. Like Pete, I've never had to replace those Hunts Mouldseal capacitors in these transistor radios. The only time that I replace them is in valve radios.

The backs of these transistor sets often suffer from damage. They are usually held by a coin-screw that gives access to the battery, but people try to lever the back off with a screwdriver. Hence pieces of missing plastic around the sides of the back. In addition some previous owners drill out holes in order to install various sockets, which never get used, in the back of these sets. The back looks very tatty in this condition. So I fill the spaces with epoxy resin and try to match the original colour.

Mike Horne,  
[www.mikesradio.freeservers.com](http://www.mikesradio.freeservers.com)

# HELP WANTED

The help wanted column is intended to assist readers who require a part, circuit etc. that's not generally available. Requests are published at the discretion of the editor. Send them to the editorial department or email to [t.winford@highburybiz.com](mailto:t.winford@highburybiz.com)

**Wanted:** Remote-control unit for the Manhattan 9000 stereo satellite receiver, also operating instructions. Willing to pay for these or does anyone know where I might purchase them? Phone Mike Commelford on 0771 525 8580 (Chesterfield).

**Wanted:** Line output transformers (oil-filled) for the Murphy Models V290C and V320A, which date from around 1956-58. I am also looking for a Murphy Model V410 or V430. Full costs paid. Phone Trevor Goodenough on 01563 540 444 or email [trevor@goodenough.freeserve.co.uk](mailto:trevor@goodenough.freeserve.co.uk)

**For disposal:** A Commodore Vic 20 computer with cassette deck, manuals, tapes

and power supply. Believed to be working but needs good clean and some TLC. Free for collection (Bishops Stortford). If interested, please email David Martin at [dandjmartin@ntlworld.com](mailto:dandjmartin@ntlworld.com)

**Wanted:** Service manual for the Technics SA-DV170 stack audio system incorporating a carousel DVD player. I have sorted out the power connection problem but one channel of the base unit, which also contains the power supply, is dead. Can anyone help? D. Housley, 30 Arncliffe Drive, Heelands, Milton Keynes, Bucks. MK13 7LH.

**Wanted:** Old half-inch diameter ferrite rods. Must be six inches or more long. Willing to pay very good money for them. Peter Tankard, 16A Birkendale Road, Sheffield, S6 3NL. Phone 07931 463 823 (mobile) 9 a.m. to 10.30 p.m.

**Wanted:** A TMP47C834N R165 microcontroller IC for the Philips TV Model 14PT156A/05. G.T. Singleton. 59 Garstang Road, Catterall, Preston, Lancs, PR3 0HD. Phone 01995 606 864.

**Wanted:** Circuit diagram (photocopy OK) for the Schneider Model STV2801, or any information on the power supply and line output circuitry. The set is lifeless and I suspect a power fault. IC102 could be faulty but the number cannot be seen. Donald Bills, 46 Blewitt Street, Pensnett, Brierley Hill, Dudley, DY5 4AN.

**Wanted:** For spares. Quad 303 and 405 power amplifiers, 33 and 44 preamplifiers and FM2 and FM3 tuners. Working or non-working. Phone Mike on 01758 613 790.

**Wanted:** Can someone out there help or at least point me in the right direction? I have a DVD player that provides S-video and composite video outputs, but the TV input

I wish to use expects to see YUV or Y/Cr/Cb. The only converter I can find listed is a semi-professional multiple switched input device that also gives an RGB output but is far too expensive at almost £300. It will obviously do what I want, but has too many extra bits I would never use - I need simple S-video in to YUV out. I'm sure I can't be unique in requiring such a device! Phone Mike Harris on 0161 485 1621 (Cheshire) or (mobile) 07966 377 684, or email [mike.harris@ukonline.co.uk](mailto:mike.harris@ukonline.co.uk)

**Wanted:** Tigan loudspeaker cloth, large size. Phone Steve Beeching on 01636 626 895 or email [steve@grovefarm.force9.co.uk](mailto:steve@grovefarm.force9.co.uk)

**Wanted:** Manual (photocopy OK) for the Telequipment S54A oscilloscope. Your price paid! Phone Steve (M.D. Stevenson) on 01702 522 929.

**Wanted:** Working teletext PCB for the ITT Compact 80-R-DST chassis, a remote-control unit for the Sony Betamax VCR Model SL-C30UB, and a tuning tool for the Ferguson TX90 chassis (it operates the AFC). Phone Mark on 01268 414 654.

**Wanted:** Remote-control IC type  $\mu$ PD550-25 for the Hitachi music centre Model SDT900. I know it's an oldie, but someone out there must have one. Please have a good look! Phone Stan (Stanley Swales) on 01924 829 653 (Wakefield, West Yorkshire).

**Wanted:** Spare parts for the Bush MB60 valve mains/battery radio, and control knobs for the Pye Fenman II valve radio (they suffer from brittleness and don't come away from the set easily!). Please email Mike Horne at [mike@jhorne62.freeserve.co.uk](mailto:mike@jhorne62.freeserve.co.uk)



# DX and Satellite Reception

**Terrestrial DX and satellite TV reception reports. Broadcasting news. LNB-dish matching. Interference from PLT. Roger Bunney reports**



People blocked the main routes out of New York during the power outage in NE America in early August. This shot, from WCBS, was received via NSS-7 (21.5°W).

**D**uring August there was a remarkable spell of hot weather, broken by colder weather from the north with rain from the 28th. The very settled high-pressure system from the 4th produced the best tropospheric propagation for some years. A noteworthy feature was the first Band III DAB-DX!

Tropospheric conditions improved from about the 3rd, giving sustained reception from Scandinavia, Denmark, Germany, France and the Benelux countries in all TV bands. On several days Band III and the UHF bands were jammed with signals. Highlights were reception of SVT-1 Vannas (Sweden) ch. E2 and YLE Tervola (Finland) ch. E3 while, of particular interest, Cyril Willis (King's Lynn) achieved the first recorded Band III DAB-DX, with reception from many stations in the Benelux countries and UK regionals at up to about 200 miles. So we now know that terrestrial digital DX is possible. After two weeks of excellent reception, the opening began to falter on the 16th.

Sporadic E conditions were also very active. Here's the SpE log:

- 3/8/03 TVE (Spain) ch. E3; RTP (Portugal) chs. E2-4.
- 4/8/03 TVE E3.
- 5/8/03 TVE E2. 3; RTP E3; RAI (Italy) IA.
- 6/8/03 NRK (Norway) E2. 3; SVT (Sweden) E2-4.
- 7/8/03 RAI IA; Tele A (Italy) E2-; C+ (Canal Plus, France) L2.
- 8/8/03 MTV (Hungary) R1; RTP E3.
- 9/8/03 NRK E3; RAI IA; TVE E2.
- 10/8/03 RAI IA. B; HRT (Croatia) E4.
- 14/8/03 RAI IA, B; BT (Belarus) R1; RTP E3; RTL (RTL Klub, Hungary) R2.
- 15/8/03 UT (Ukraine) R2; MTV R1; RTP E2. 3; TVE E2-4.
- 16/8/03 MTV R1.
- 17/8/03 NRK E4; RTL KL R2; MTV R1; RAI IA, B; TVE E2; TVE-IZ (Izana, Canary Is) E3; HRT E4; Dubai E2.
- 18/8/03 NRK E2-4; YLE (Finland) E4.
- 19/8/03 BT R1; C+ L2.
- 20/8/03 RTL KL R2; UT R2; RTP E2; TVE E2. 3.

During several late-evening spells of SpE reception from Spain the signals fell to a low but viewable level for some hours. On the 20th TVE ch. E2 produced late-evening signals that rose to very high levels with severe hum, almost like Auroral propagation. Odd. All in all an excellent month.

## Satellite sightings

During the late afternoon on August 4 there was the largest power outage in NE America for years, affecting an area from Ohio to New York and the Great Lakes to Pennsylvania. When I checked NSS-7 (21.5°W) for breaking news I found very fragmented reports via CNN Newsource at 11:563GHz H (SR 6.109, FEC 3/4). There were live helicopter-camera shots that showed a mass of home-going New Yorkers blocking the freeways, roads etc., and pictures from the WCBS and WNYW TV stations. These were interrupted several times for studio inserts to provide updating reports. I assume from the CNN NY bureau as there was an NY 1 corner ident logo. Between these news inserts studio technicians and on-screen presenters attempted to gauge the power-loss area, with phoned-in reports from affiliated stations. When I rotated the dish to 12.5°W (Atlantic Bird-1) there was a total absence of signals – the outage had closed down the teleport. But later in the evening the GlobeCast downlinks returned. The CNN uplink teleport is at Atlanta, Georgia, which was outside the blackout region.

Less than an hour before the East Coast blackout President Bush was seen at the US Marine Corps Miramar Airbase, California, where he made a patriotic speech to marines recently returned from Iraq. The speech was carried by CNN Newsource.

The major bombing at the UN's Baghdad HQ on the 19th brought several satellite uplinks there into operation. APTN was running at both 10-961 and 10-964GHz V (4,167.5/6) via Eutelsat W1 (10°E). Content concentrated on rescue work, with numerous

live reports back to networks in Europe and the US. ITN's Martin Giessler for example used the 10.964GHz channel. A couple of days earlier an American news package via Eutelsat W2 (16°E) at 12.533GHz H (5,632, 3/4) featured a large water main that had been damaged by an explosion, flooding the surrounding area. The same day an oil pipeline was blown up.

Eutelsat W1 is a major carrier of news and sports. Interesting that a rare N. Korean feed was seen on the 3rd. At the time the Israeli Satlink facility was present at 12.741GHz V (5,632, 3/4) with a threshold-level signal (1,425). At the end of a programme with Chinese-script captions a fluttering N. Korean flag (star in the middle) was seen, followed by colour bars then a blank screen. It seems to have been a relay of the main Pyongyang TV channel and, I suspect, was carried for the final Satlink network news broadcast. Satlink continued with a carrier, and later fed APTN footage from Jerusalem and Ramallah.

On the 9th it was the Mey Highland Games with Prince Charles and Camilla in attendance. Their appearance was the main reason for a sat truck to be present, since the sporting events were very parochial – tug of war, tossing the caber, and an odd game that required each contestant to hurl a large weight above his head while standing under a jumping-frame cross bar, then avoiding the weight crashing down on his head a few seconds later! There was a pleasant and happy crowd in that distant Caithness field. Seen via Eutelsat W1, the APTN UP4 feed, at 10.970GHz V (4,167, 5/6).

One evening in middle of the month I checked the Atlantic Bird-1 GlobeCast transponder at 11.014GHz H (20,145, 3/4) and found that the Channel 1 circuit carried a 'GlobeCast Miami FI' ident. A check on the signal level with the RSD information menu showed a normal 70 per cent level, but the inlaid serial ident on the level bar alternated between the usual 'standard hop', 'hop 3', 'hop 4' and 'hop 8'. Very odd. Another oddity has been the transmission identified as 'Service 1' from Europe\*Star-1 (45°E) at 12.678GHz V (6,109, 3/4). It carries the serial ident 'NDS Network', so it's obviously a TV feed. Although I've monitored the carrier on most days I've never seen video content.

HellasSat (39°E), which was launched to provide coverage of the 2004 Olympic Games in Greece, provides regular transmissions at 10.976GHz V (5,632, 3/4). Alan Richards (Nottingham) came across a Euro-political discussion here, with interpreters and four audio subcarriers for different languages. The transmission ended with a Greek-language documentary on the Olympics and a news update on construction progress at the venues for the various events. The service ident was unusual – 'Mountain 1'. Alan also found French-language content from Ethiopia, Mozambique, Cameroon and the Congo via the Atlantic Bird-2 (8°W) GlobeCast transponder at 11.501GHz H (6,111, 3/4) during each weekday evening in mid-July. All rare sightings.

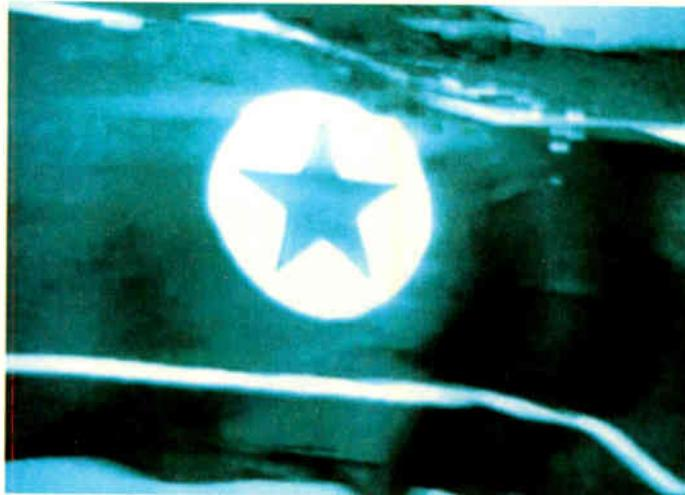
The Montenegro downlink via Atlantic Bird-3 (5°W) has been affected by jamming. Check at 12.642GHz H (3,885, 7/8).

Edmund Spicer (Littlehampton) viewed a major NASA press conference via the Atlantic Bird-1 GlobeCast channel 1 feeder following publication of the damning official report on the Columbia shuttle disaster. The NASA chief answered questions from its staff and interested parties. Clearly things will change.

## News

The 2003 NAB convention revealed considerable broadcaster interest in the use of MPEG-4 video compression, which can be almost twice as efficient as MPEG-2. Recently developed bridging technology enables the two to be used together as deemed best, probably MPEG-2 for in-house purposes and MPEG-4 for transmission and broadband video applications.

Microsoft is increasing its presence in the broadcasting field with the Windows Media 9 system that was introduced last year, including the H264 and WM9 software packages. WM9 is already being used by Associated Press for rapid compilation and transmission of despatches to the newsroom from battle zones etc. via satellite phone. Panasonic is using WM9 for digital content manage-



**Closedown of Pyongyang TV (N. Korea), seen via Eutelsat W1 (10°E).**

ment in sports and archiving. Tandberg TV is exploiting it for encoding video and audio, achieving remarkable quality with bit rates less than half that required for the equivalent quality with MPEG-2.

There's clearly a move to the use of increased signal compression in the broadcasting world.

Peter Merrett of Sciteq Pty Ltd., Australia, reports in the NZ trade magazine *SatFACTS* on a digital satellite receiver fitted with a new low-threshold tuner developed by Sharp. It achieved a signal level of 50 per cent compared with 20 per cent, going into pixellation, with a standard tuner. Sharp produces an extremely wide range of satellite tuners for digital equipment.

## DXer's SPECIAL 14" TV



£299.00

Overnight delivery by insured courier £12.00

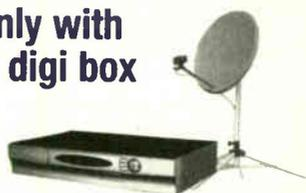
- Direct channel entry/readout
- Direct frequency entry 40-860MHz
- Multistandard
- Low noise tuner
- 12v DC and mains operation
- Remote control
- Scart connection
- Auto scanning of RF channels
- Auto scanning of frequencies 40-860MHz
- Cable tuner
- Video squelch (removed in tuning mode)
- Six teletexts
- Covers systems BG/LL/DKK PAL and SECAM, NTC via the scart

---

### FREE BBC VIEWING IN EUROPE

**Perfect reception only with the latest THOMSON digi box**

- The correct digi box + the correct dish + the correct LNB = perfect reception anywhere
- Watch the BBC wherever you like, in Europe etc
- Digital satellite systems from only £399.00
- All dish systems are supplied with LNB, cable and plugs
- You can receive FREE viewing of BBC1,2,3,4, children's BBC, BBC24 hour news and all the BBC radio stations plus many more
- ITV1, Channels 4 and 5 available by subscription arranged by ourselves
- Increase your dish size with our new enhanced imported LNBs



**Tripods £49.95**

**Digital system with 88cm dish — £438.95**

**with 1.1m dish — £478.95**

ALL PRICES INC VAT

---

Overnight delivery in the UK for all items by insured courier £12.00

---

FULLY COMPREHENSIVE 35 PAGE CATALOGUE AVAILABLE BY RETURN OF POST FOR £1.50

---

AERIAL TECHNIQUES LTD Tel: 01202-423555 Fax: 01202-425055  
59 Watcombe Road, Southbourne, Bournemouth, Dorset BH6 3LX, UK  
E-mail: atech@dircon.co.uk www.aerial-techniques.com  
Est 1979 Callers by Appointment please







Edmund Spicer took this photo of the BT TES-43 satellite truck at Littlehampton.

Radio Marti and TV Marti, the US government-backed broadcasters to Cuba via a balloon at some 10,000ft above Key West, Florida, are to start broadcasting via satellite in order to overcome jamming. Ku-band downlinking capacity has been leased aboard the Hispasat satellite at 30°W.

The Russian ORT TV channel is being made available to US cable operators by Ascent Media Network, via Intelsat. The channel is received in London, sent via transatlantic fibre-optic cable to the New York AMNS switching centre, then on to International Channel Networks, Colorado for distribution.

### LNB-dish matching

Recently Roy Carmen mentioned that the performance, i.e. signal output level, of his 1m Triax dish seemed to be the same as that of his 1.2m Channel Master dish, though the claimed performance of the two LNBFs used is similar – an LNBF is an LNB with integrated feedhorn. I am wondering whether the cause could be poor LNB-dish matching with the larger dish. I use a 1.2m Channel Master dish myself and am happy with it – apart from the fact that it becomes rather grubby and requires an annual clean off. My main concern in dish selection was a smooth polar response with minimal secondary lobes. Trying for example to receive low-level signals from Eutelsat 2F1 (21.5°E) with its inclined orbit (2.3° drift) is a challenge, being next to the Astra 1 powerhouse at 19.2°E. The polar response of the Channel Master dish seems to be excellent.

I've seen many glowing references to Triax equipment. Certainly the company's terrestrial aerials are first class, and its dishes are also said to be excellent. Roy has always tended to try the latest, lowest-noise LNBFs as they appear on the market, to optimise performance with a smallish dish. Inevitably these are LNBFs. Most dishes used for reception from Hot Bird are up to 70-80cm in diameter, perhaps slightly larger in the far north. It occurs to me that LNBFs might be optimised for use with smaller rather than larger dishes. For optimum performance the feedhorn must 'see' the surface of the dish with minimal overlap, as overlap introduces noise. Conversely low-cost LNBFs may not see the whole surface of a larger dish, thus failing to produce maximum possible output. My own Channel Master dish uses a dedicated Channel Master feedhorn and flange assembly – the LNB is bolted on to the rear C120 flange of the feedhorn. This is referred to as an LNB+F. It ensures – I hope! – that the feed and dish match.

While Roy and I were considering the dish v. LNB(F) situation, an article on testing and evaluating LNBFs for digital signal reception appeared in *SatFACTS* (May 2003 issue). It included a small section on "lowering the noise wall". I quote from it: "In marginal

reception situations you have only two choices – to get more signal or reduce the noise wall." This means use a higher-gain (larger) dish or improve the noise performance with a lower-noise LNB. The article points out that many people, when using an offset dish, neglect to use an LNBF whose 'feed pattern' is designed to see the physical shape of the dish correctly. A shaped dish requires a 'shaped feed pattern'. In theory a dish and LNBF should be sold as a matched pair. Otherwise the LNBF used may have been designed for a dish with a different shape, thus reducing the performance and polar response. In the UK dishes and LNBFs tend to be sold separately, which could explain why the expected performance is not achieved.

Bill Wright ([www.wrightsaerials.tv](http://www.wrightsaerials.tv)) has carried out a few tests with a cheap 0.6dB noise LNB and signal analyser and found that ground noise was on average 7dB higher than sky noise. The comparison was with the LNB pointing at the sky and then at the ground, buildings etc. Aiming it at a tree produced similar readings to ground noise. These measurements were made at night: solar radiation might increase the noise during the day.

An LNB that sees beyond the edge of a prime-focus dish will pick up ground noise. Ground noise is less with an offset dish, as the LNB is aimed upwards. But in either case a response with minimal side lobes is important. Offset feeds are usually flared to optimise pick-up efficiency. Bill also comments that commercial dishes have a non-reflective skirt around the rim, perhaps to minimise man-made and thermal noise.

### Interference from PLT

The following is not relevant to DX-TV or satellite reception. But many readers are in the trade, while others DX on the MW and SW bands, and may thus experience the problem.

Perhaps 18-24 months ago I mentioned concern in amateur radio circles about a new form of communication, PLT (Power Line Telecommunications) – sending data to houses, offices etc. via power lines. The EMC column in the June 2003 issue of the RSGB journal *RadCom* discusses two types of PLT, Ascom and Mainnet. Ascom uses up to three carrier frequencies, 2.4, 4.8 and 8.4MHz, with a 1MHz bandwidth. Mainnet uses a single carrier with a wider bandwidth, 4.25-6MHz. With both systems the sidebands tail off slowly, so the bandwidth is far in excess of the nominal one.

Dave Lauder, who has written the EMC column in *RadCom* for many years, has warned that PLT would cause serious disruption to amateur radio and SW transmissions if adopted. The government seems to be encouraging it. PLT trials have been carried out at Crieff in Scotland, and have been threatened for the Winchester, Hants area. Ominously, there was a mention of PLT tests recently in the business section of my local paper. It's now the end of August and I suspect that the Winchester tests have begun.

White noise and a sharp buzzing, with a rapid pulsing noise (several pulses per second), have become audible on the MW band from about 750kHz, increasing in level with frequency. By 1,400kHz the noise can be heard on weaker MW signals. At 1,600kHz a communications receiver measures S7 on the S meter scale. At 1,820kHz the reading rises to S9, and remains at this level up to 2,600kHz when it drops to S7. Tuning higher, I find that the noise falls to S6 but increases to S8-9 from 4,400kHz through to 6,200kHz, with white noise plus buzzing. It falls to S7 at 7,000kHz, then tails off into general SW noise from 7,300kHz.

Being involved in MW-DX I am aware of general MW conditions and know that this is a new and wideband form of interference. It clearly affects MW broadcasts, which is disturbing. The RSGB website that covers the Crieff PLT tests has sound clips of the Ascom system. These show a close resemblance to what I am hearing at my location. I have reported the problem to the RSGB and am making representations to the local electricity supply company. But big business interests are involved! I'll report further as things develop.

The following RSGB site contains the Crieff information: [http://www.qsl.net/rsgb\\_emc/crieff](http://www.qsl.net/rsgb_emc/crieff)

# Export Enquiry Only

Genuine Returns

**Tv's ,Vcr's ,Dvd's ,Audio, Small Appliances  
Iron's , Toasters Etc Container load Available!!  
LARGE QUANTITY!!**

Also Available for UK Market

Products from

**SONY HITACHI TOSHIBA PANASONIC DAEWOO  
BEKO SVA MORPHY RICHARDS PHILIPS KINGAVON  
& TRADEX**

**Call- 07836 520036**

**All prices are subject to VAT, carriage and availability. Prices subject to change without prior notice!**

## Tv's

- Beko 14" Remote Tv From **£34.99**
- Beko 14" Text Tv From **£39.99**
- Beko 28" 4:3 Text Tv From **£99.99**
- Beko 28" Wide Text Tv From **£125.00**
- Daewoo 14" Tv/Vcr Combi From **£69.99**
- Basic Dvd From **£49.99**
- Basic Vcr From **£24.99**

## C28W540N

- 66cmV Screen (28" tube)
- Nicam Digital Sound
- 10 page text
- 2x 12w RMS
- 2 Scart sockets
- Hitachi on screen display
- Pure Flat Tube
- Nicam Stereo

**£249.99**

## Vcr's

### HITACHI VTFX240EUK



- Nicam
- Video plus
- Movie text
- Lp/sp
- 6 Head
- Silver

**£44.99**

### HITACHI VTMX210EUK



- Tape Navigation
- Commercial advance
- Movie text
- Ntc playback
- mono silver

**£34.99**

## Cv810 Bagless Cylinder Cleaners



**£17.99**

## Dvd's

### HITACHI HTD-K150 DVD THEATER SYSTEM



- DVD Player with built in Receiver
- Playback on DVD/VCD/CD
- Ability to Read MP3/CD-R/CD-RW
- DTS Dolby Digital AM/FM Digital
- 5 Speaker Surround System
- 2x Auxiliary inputs Stylishly designed
- Satellite and Centre Speakers Sleep
- Timer Full Remote Control
- Multiregional

**£139.99**

### DVP325EUK



- Plays DVD, DVD-R, CD, CD-R, CD-RW discs
- Compatible playback of Mp3 audio files on CD
- enables accurate reading of disc formats Dolby Digital Sound
- Controls DVD and other brand TVs

**£79.99**

## Audio COMPACT DIGITAL AUDIO

### TradeX TX121CDB



- AM/FM STEREO TUNER
- TOP LOADING PROGRAMMABLE CD PLAYER
- LCD DISPLAY
- SOFT EJECT CASSETTE DOOR
- AUTO STOP CASSETTE MECHANISM
- ONE TOUCH RECORDING
- AUTOMATIC RECORDING LEVEL CONTROL
- STEREO HEADPHONE JACK
- ACDC OPERATION
- USE MP3S URVED SIZE BATTERIES (BATTERIES NOT INCLUDED)

**£25.99**

## Technics



### SB-HDV600

Wood Grain Speaker System

Set of 2

**Only £19.99**

**Trade  
Electronix**  
INFO@TRADEELECTRONIX.CO.UK

## INTERCOM CAMERA SYSTEM



- Bell camera and full Accessories included
- Additional camera sold separate
- Infra Red Camera for Night vision
- Built in Mic for sound
- optional electric door latch
- A/B switch
- Two Way speech
- 250 metre cable
- High quality Video

**Brand New!  
£39.99**

## SB-PT96 SATELLITE SPEAKER SYSTEM

SET OF 3  
**Technics**  
The science of sound



**Only £9.50**

## Panasonic NNE252W COMPACT MICROWAVE



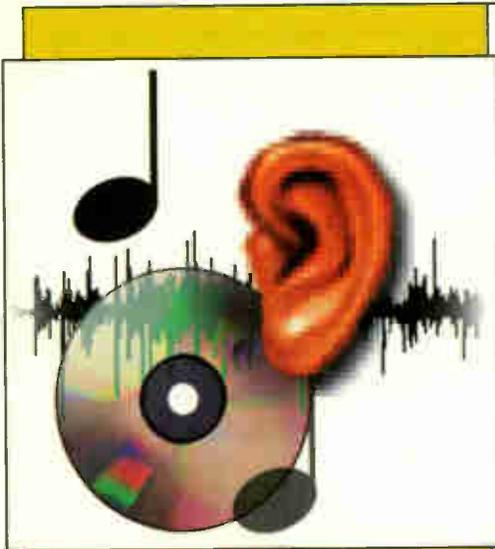
- Auto Weight Cook
- Auto Weight Reheat
- Auto Weight Defrost
- Child Lock
- Touch Button
- 800W (I.E.C.)
- 19 litre Capacity
- Acrylic Lining
- 5 Power Levels
- 12hr Timer
- 2 Stage Memory

**Brand New!  
£39.99**

**30/34 River street Digheth B'ham B5 5SA Tel:0121 773 3300 Fax 0121 773 2300**

All Stock is Graded Stock unless otherwise stated

www.TradeElectronix.co.uk



# AUDIO FAULTS

Reports from  
**Geoff Darby Charles Coultas  
and Chris Bowers**

We welcome fault reports from readers – payment for each fault is made after publication. See page 40 for details of where and how to send reports.

## Yamaha CRXM5

If one of these comes in and you suspect the laser unit, be very careful how you quote for the job. I would suggest that you allow a good two hours for labour if the laser unit is type KSS580.

There are two reasons for this. First the laser unit is not very easy to get at. You will spend twenty minutes or so getting to the point where the changer is out and you can see the deck itself. Secondly and much more importantly, you have to change the laser unit to type KSS710A. Although this is physically similar to the KSS580 in general mechanical terms, its connections and electrical characteristics are entirely different. So it comes with a kit of parts and two large sheets of modification instructions and diagrams.

The modifications involve removal of links from the PCB, removal of a number of surface-mounted resistors, replacement of others with resistors of different value, print cuts, and the addition of standard carbon resistors and a lot of wires across the back of the board. All this is after you've actually removed the main board of course.

In all fairness the instructions are fairly comprehensive, though a little misleading in places. For success you must follow the numbered instructions completely blindly. Do not attempt to figure out what you are doing by referring to the modified circuit diagram, as this will mislead you. All the resistors you are told to remove in the first couple of steps are still in the circuit diagram, but are shown with new values, in red. This is not correct. They should just be removed, and left removed, as the instructions say.

When it comes to the print cuts and adding the wires and external resistors, refer to the print layout supplied for help with interpreting instructions like "short the No 10 pin of PN801 to the No 9 pin cut above (the +side of C823)". You'll need good eyes or a magnifier to see the modifications clearly on the print layout. But they are there, and are correct. The procedure is not helped by instructions like "remove chip resistor R830 (silkscreened as R832)". Yes, R830 and R832 are marked incorrectly on the board but are shown correctly in the circuit diagram! One of them has to be removed and the value of the other has to be changed, so make sure you get them the right way round. Also one of the carbon resistors that has to be fitted has a value of 100Ω. The resistor supplied has this value, but its packet is incorrectly marked 100kΩ.

Finally there is a problem with the flexiprint connection tail from the replacement laser unit. It's upside down in comparison with the original, so it has to be twisted over before it can be inserted into the connector that joins it to the long white flexiprint which goes up to the main board. Be careful to do this close to the connector. Otherwise, even though the tail comes round a piece of plastic that should isolate the moving part from the fixed part, the twist can migrate up to the transition point and make the laser run stiff on its tracks.

Once I'd carried out these modifications a further twenty minutes were required to reassemble everything. I was then rewarded with a fully working unit. I dread to think what I would have done had it not worked. You certainly wouldn't want to put the original laser unit back, and such a situation would probably leave you seriously concerned as to whether your original diagnosis had been incorrect or you had made an error in fitting the modification kit. **G.D.**

## Sony STR-DB940

This gigantic AV amplifier arrived on the bench with a note to say that it "makes a buzz from the sub". I soon discovered that the output to the sub had quite a high level of treble on it intermittently instead of being pure sub (bass). This odd behaviour could be instigated by slight movement of the flexiprint between the main PCB and the 'vol' sub-PCB.

No amount of cleaning of the connectors

or foil tails at the flexiprint's ends would correct the problem. I was loath to believe that the cable itself was faulty, as it was quite thick and had never been stressed with tight bends near its ends. Eventually however I decided to order a replacement. When this had been fitted the problem was no longer present. **G.D.**

## Sony HCD-MD313

This CD/MD player/radio/amplifier was brought in because 'no disc' was displayed when a CD was inserted. Without thinking too much about it, I suspected the optical block and ordered a replacement. But when it was fitted the fault was still there. I then noticed, as I should have done before, that the CD wasn't rotating. So maybe the optics had been OK after all.

Investigation into why the motor was not rotating led nowhere. The motor worked all right when it was tested with a 1.5V battery, and the sled and focus seemed to be working normally. I replaced the motor/focus/sled drive IC, but this made no difference.

Much delving around with the scope didn't help, but I then found that focus search was missing. I sat back and thought about the problem. Perhaps the disc doesn't spin until some positive result is obtained from the focus search. When I scoped the output from the focus-coil drive IC it was cycling up and down but the lens wasn't. A little further investigation showed that the flexible, flat cable to the optical unit was damaged. I also realised that I had forgotten to remove the solder short that protects the laser when the optical unit is in transit! I probably damaged the flat cable with all the messing about I subjected the drive to.

A new flat cable and removal of the solder short put matters right. **C.C.**

## Sony MZ-R90

There was no recording with this MiniDisc unit. A look inside revealed the cause: the overwrite head didn't come down because of a defect with the HC gear, reference 113. A new gear, part no. 4-222-215-01, restored normal operation. **C.B.**

## Sony ICF-SW7500

This small LCD radio produced an IC-type cracking noise after five-six minutes with FM operation only. A look inside, on the B side of the main board, revealed that the small surface-mounted electrolytic capacitor C69 (220μF, 4V) had started to leak on to the board. A quick board clean up and replacement of the capacitor, part no. 1-126-246-11, restored normal FM sound. **C.B.**

## Sony MZ-R900

This silver MiniDisc player had a broken LCD module. I've had this problem several times. You have to fit a replacement module, part no. 1-804-171-11. Units with serial numbers CED325801-326000 are prone to this fault. **C.B.** ■



# Rocket science?

Buying spares doesn't  
have to be...

We purchase from many suppliers, both UK and abroad  
so that you don't have to.

- ✓ Run by T.V. engineers for T.V. Engineers.
- ✓ You speak to experienced engineers with in-depth knowledge of TV/Video trade.
- ✓ CLASSIC<sup>®</sup> distributors and trade counter. Cards, Switch and Accounts.
- ✓ We stock parts that engineers advise us to stock, with regular updates.
- ✓ Free or low £1.00 p&p on orders means:
- ✓ YOU CAN EASILY AFFORD TO ORDER MORE THAN ONCE A DAY!!!



Engineers countrywide have already found our compact catalogue an invaluable aid...  
to order your free copy today...

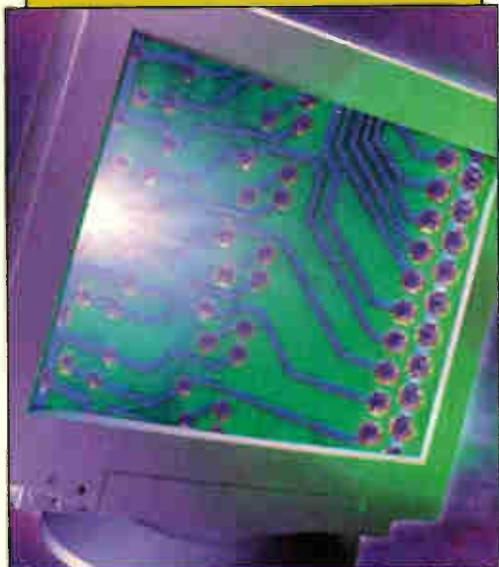
Ring Mike on 0114 273 9622

## IrwinElectronics

*"The television engineer's wholesaler"*

*Unit 200, JC Albyn Complex, Burton Rd., SHEFFIELD S3 8BX*

Online you can place orders at [www.IrwinElectronics.co.uk](http://www.IrwinElectronics.co.uk)



# MONITORS

Fault reports from  
Gerry Mumford  
and  
Ian Field

We welcome fault reports from readers – payment for each fault is made after publication.

Reports can be sent by post to:

Television Magazine Fault Reports,  
Highbury Business Communications  
Nexus House,  
Azalea Drive, Swanley, Kent BR8 8HU

or e-mailed to:  
t.winford@highburybiz.com

## Taxan EV760TC095

This dead monitor produced the usual clicking sound of the trip action. Checks in the line output stage revealed that D104 (BY329-1200) in the EW diode modulator circuit was leaky. When the monitor was tested after fitting a replacement it powered on very briefly, with a massive burst of EHT, then started to trip again. This time the line output transistor Q106 (2SC5048) had gone short-circuit. The massive burst of EHT before its demise gave the game away: the real cause of the fault was the line output stage tuning capacitor C105 (6.2nF, 2kV) which was open-circuit and, when removed, was seen to have a slightly bulged appearance. Once these two items had been replaced the EHT was down to its correct level and the monitor produced a good display. G.M.

## Viewsonic M70 (Model VCDS21503-1E)

This monitor powered up with light from the green LED but no display. There was no EHT and a quick visual inspection revealed that C556 (100µF, 200V) on the secondary side of the power supply was leaking electrolyte. Replacement of this capacitor cured the fault.

Since the first occasion we've had many more of these monitors with this fault but, deceptively, the capacitor has always looked OK – especially in the Taxan variant that uses an almost identical chassis. G.M.

## Viglen AX1595

This monitor was dead with a blown up power supply. The items one usually has to replace in this event are the 2SK2545 chopper FET Q301, the UC3842 controller chip IC301 and the 15V, 500mW zener diode ZD301. In this case we also had to replace the mains bridge rectifier diodes D301-4 (unmarked, use type 1N4007) and the current-sensing resistor, which consists of five 1Ω, 0.5W resistors connected in parallel (R306-R310). Once the replacements had been fitted we had a working unit with a good display. G.M.

## Elonex/AST TE1438A

The complaint with this monitor was no blue. It had received previous attention which, to say the least, didn't help. Whoever had last removed the screening plate from the CRT base PCB hadn't bothered to unsolder the lugs! A vague attempt had been made to reattach the plate, but it fell off as I eased the CRT base connector off. I then noticed that the pads for Q205 in the green emitter-follower pair circuit had been pushed off the PCB. As I unsoldered the transistor the tracks fell off completely.

Once the missing tracks had been

replaced with stout wire, and the PCB had been cleaned for closer inspection, I found that the blue cathode pin on the CRT base receptacle had pushed its solder pad off the PCB. The heater pins' pads had also lifted, but not severed the tracks.

The damaged solder lands for the screening plate's lugs were repaired by binding tinned-copper wire along the edge of each slot. The best way to describe this repair method is that it's like the 'blanket stitch' without the fancy loop! After cleaning off the green varnish, you anchor a length of tinned copper wire at one end of the slot and repeatedly thread the wire around the edge of and through the slot, pulling it tight, so that it runs along the edge like a 'layer-wound' coil. Solder the tail end down at the end, to secure the turns and restore the integrity of the earth track if this has been broken.

Depending on the thickness of the tinned-copper wire used, the legs of the screening plate might be a tight fit. They can usually be eased in if heat from a soldering iron is applied at the same time. I.F.

## Apricot XJ52023

Sometimes a monitor comes in simply because a switch has been mis-set. This 17in. monitor spent some time making clicking noises before it started up and produced a distorted blank raster. So I decided to try the two slide-switches at the back: sync on/off and power saving on/off. When the sync on/off switch was moved from off to on the 'fault' completely disappeared.

The only difference the power-saving switch makes is that in the on position removal of either the H or V sync pulses shuts the monitor down, while in the off position removal of either the H or V sync pulses simply blanks the raster. The situation is no different whether the 15-pin sub-D or 5 x BNC input is used.

I am puzzled as to why a monitor would have a switch to cut off the sync input. As I don't have the manual I've no clue as to what purpose it might serve. To prevent a repeat performance I considered gluing the switch in the on position, but instead opted for a sort of compromise. I cut the sync switch lever flush with the screening plate and concealed it with tape. Thus it's not impossible to operate the switch should the need arise, but anyone intending to do so will first have to remove the tape.

I cut the power-management switch lever down to about half its length to reduce the chance of inadvertent operation. It's unlikely to stop the monitor working but could cause erratic operation while the PC is booting up and initialising the sync-ratio registers on its video output card. I.F. ■

## \*PERIFELEC

### MC 30 A Spectrum Analyser



- Synthesized satellite cable and TV field strength meter with panoramic reception on 14 cm (5.5") screen and digital carriers measurement.
- Complete microprocessor and IspLSI logic control.
- Continuous frequencies from 46 to 860 MHz and from 920 to 2150 MHz on 4 bands.
- Selectable 4, 1 and 0,2 MHz spectrum band-width, picture measurement 1 MHz.
- Display of picture of selected synthesized channel.
- FM (Radio) LA', B/G, L, D/K/K', MN TV standards and Ku and C satellite standards.
- Possibility of 32 programs memorized per frequency band.
- Display (2 Lines of 16 characters).
- Range of measurement of signal strength from 20 to 120 dBµV, manual or automatic attenuator.
- Battery life about 1 hour 20 minutes, weight 5,8 Kg.

- Display of full-band and 4 possible expanded spectrums.
- Channels and frequency plans of cable and TV standards memorized
- Frequency, signal strength in dBµV or bargraph, displayed on a digital display (2 lines of 16 characters).
- Voltage of remote power supply in 14v or 18v and 22 KHz in satellite + DiSeq C™ v1.2 switching

The panoramic field strength meter MC30A combines in one instrument all the functions necessary for installing and checking TV or satellite reception, both analogue and digital. The visualization of the spectrum and the picture allows the carrying out of all the necessary adjustments with this one instrument. The high technology used in the MC30A allows a range of possibilities unheard of in a instrument in this price category.

### Lacuna Digital Satellite Meter

A custom designed, small lightweight ABS case, created with the installer in mind



- Signal strength and BER will be displayed together
- Identifies the chosen satellite
- Signal strengths and BER settings calibrated facility for recalibration by distributor
- Removable 'F' connector
- LNB short circuit protection and LNB power supply
- Compatible with all satellite transmissions ie Ku and C band, DVB and DSS

### NEW Lacuna Terrestrial Digital Meter

Small, lightweight custom designed for terrestrial digital installations

- Identifies transmitter
- Measures signal strength, carrier/noise and BER
  - UHF / VHF
- Analogue and digital measurement
- Removable 'F' connector
- 4 line LCD with backlight
- Weight including batteries 600g
- 12v line power facility



Full catalogue of meters available, please phone for details.

### COASTAL AERIAL SUPPLIES

Unit X2, Rudford Industrial Estate, Ford, Arundel BN18 0BD  
Telephone: 0870 2641990 Fax: 0870 264 1991

Perifelec  
Sole Import  
Distributors

# FRUSTRATED!

## Looking for ICs TRANSISTORS?

A phone call to us could get a result. We offer an extensive range and with a World-wide database at our fingertips, we are able to source even more. We specialise in devices with the following prefix (to name but a few).



2N 2SA 2SB 2SC 2SD 2P 2SJ 2SK 3N 3SK 4N 6N 17 40 AD  
ADC AN AM AY BA BC BD BDT BEV BDW BDX BF  
BFR BFS BFT BFW BFX BFY BLY BLX BS BR BRX BRY BS  
BSS BSV BSW BSX BT BTA BTB BRW BU BUK BUT BUY  
BUW BUX BUY BUZ CA CD DX CXA DAC DG DM DS  
DTA DTC GL GM HA HCF HD HEF ICL ICM IRF J KA  
KIA L LA LB LC LD LF LM M M5M MA MAB MAX MB  
MC MDA J MJE MJF MM MN MPS MP5A MP5H MP5U  
MRF NJM NE OM OP PA PAL PIC PN RC S SAA SAB  
SAD SAJ SAS SDA SG SI SL SN SO STA STK STR STRD  
STRM STRS SV1 T TA TAA TAG TBA TC TCA TDA TDB  
TEA TIC TIP TIPL TEA TL TLC TMF TMS TPU U UA  
UAA UC UDN ULN UM UPA UPC UPD VN X XR Z ZN  
ZTX + many others

We can also offer equivalents (at customers' risk).  
A LARGE RANGE OF ELECTRONIC COMPONENTS ON  
OUR CD ROM - LIST AVAILABLE ON REQUEST  
Mail, phone, Fax, Credit Card orders & callers welcome.



Connect

## Cricklewood Electronics Ltd

40-42 Cricklewood Broadway, London NW2 3ET

Tel: 020 8452 0161 Fax: (020) 8208 1441

www.cricklewoodelectronics.co.uk

E-mail: sales@cricklewoodelectronics.com

# Sky Digital Satellite Tuner Repairs

We also repair Power Supplies, Complete Set Top Box's  
UHF Tuners and Modulators

For more information and latest prices  
See our web site

[www.mces.co.uk](http://www.mces.co.uk)

## MCES Digital

15 Lostock Road Davyhulme Manchester M41 0ES

E-mail: [sales@mces.co.uk](mailto:sales@mces.co.uk)

Phone: 0161 746 8037

Fax: 0161 746 8136

# TUBES

## NEW LOWER PRICES:-

14" Philips/Orion	34EAC, 34AGT, 34JLL	£30
24" Philips widescreen	W56ECK, W56ESF	£160
24" Thomson widescreen	W56EGV	£160
26" Panasonic standard	66ECF	£55
26" Philips standard	66EAK	£75
26" Thomson standard	66ECY, 66EDN, 66EHJ	£55
28" Thomson widescreen	W66EGV, W66EJU	£85
28" LG widescreen	W66QBD	£85
28" Philips widescreen	W66ECK, W66ESF	£160
29" Philips standard	68ESF	£135
32" Thomson widescreen	W76EDX	£120
32" Philips widescreen	W76ESF	£245

All prices include carriage but are subject to VAT

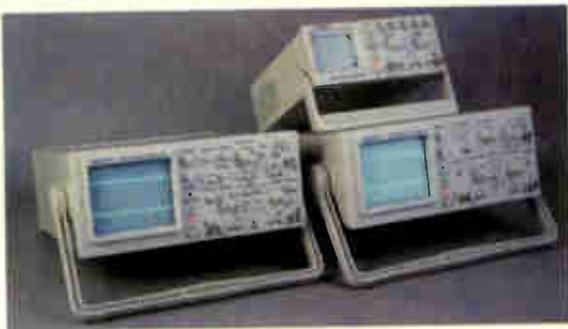
We also de-scratch tubes

## EXPRESS TV

The Mill, Mill Lane,

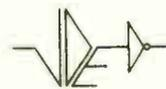
Rugeley, Staffs WS15 2JW

Tel: 01889 577600 Fax: 01889 575600



## 20% discount for TV readers

digimess® oscilloscopes from £109.00 inc vat & del



**Vann Draper**  
**Electronics Ltd**  
 The test & measurement specialists  
[www.vanndraper.co.uk](http://www.vanndraper.co.uk)

Test equipment from Grundig, digimess®

Vann Draper is offering over 20% discount to readers of *Television magazine* on their new range of digimess® analogue oscilloscopes, prices shown below include discount.

The range consists of a 10MHz single channel as well as 20, 40 and 60MHz dual channel types. Triggering modes are Auto, Norm and TV, with the 40 and 60MHz versions also including PP Auto triggering. Z axis inputs & input delay lines are provided on the 20, 40 and 60MHz types and all models are supplied complete with mains lead, operating manual and a 1 year guarantee.

Model number	M010	M020	M040	M060
Price (inc vat & del)	£109.00	£289.00	£459.00	£649.00
B/W & no of CH's	10MHz single	20MHz dual	40MHz dual	60MHz dual
Accelerating voltage	1.3kV	2kV	14kV	14kV
Screen size 8 x 10	1 div = 6mm		1 div = 10mm	
Vertical (3%)	5mV - 5V/div		5mV - 5V/div	
Vertical mode	CH1, CH2, ALT, ADD, CHOP, INVERT CH2			
Horizontal (3%)	0.1S - 0.1uS/div		0.5S - 0.2uS/div	
Dims (cm) & wt	22x27x9, 3kg		32x42x13, 6.5kg	

To order, simply post the coupon to: **Vann Draper Electronics Ltd, Stenson House, Stenson, Derby DE73 1HL.** Or Tel 01283 704706 Fax 01283 704707  
 Email [sales@vanndraper.co.uk](mailto:sales@vanndraper.co.uk) Web [www.vanndraper.co.uk](http://www.vanndraper.co.uk)

Use this coupon for your order

Please supply me:

(Qty) ... (Model) ... (Price) ...  
 (Qty) ... (Model) ... (Price) ...

Name:

Address:

Tel No:

Total £

Cheques payable to Vann Draper Electronics Ltd or debit my Visa, Mastercard or Switch card:

Card type:

Card No:

Expiry date:

Switch iss No:

Signature:

Overseas readers can still obtain this discount but carriage charges vary according to country. Please telephone, fax, email or write to Vann Draper.



## S.V.G.A II

**NEW!** SVGA II now has a slimline case, 9 display outputs at 640\*480, 800\*600 & 1024\*768. Colourbars, crosshatch, dot, black, red, green, blue, white and flashing white patterns. Test and set-up computer monitors without a PC.

15 way D type output, runs on 8-12V DC adapter and be built in a couple of hours.

**New lower kit price of only £29.50.**

Can be supplied in PC Bone or Black case. Software upgrade available for original SVGA generator.



## MULTIGEN VIDEO GENERATOR

From the Author of SVGA generator and Videogen comes a new all in one unit. Ten display outputs in PAL, NTSC & VGA of testcard, colourbars, grayscale, crosshatch, centering, red, green, blue, white and flashing white.

PAL 625 lines 50Hz - NTSC 515 lines 60 Hz, Composite & S Video outputs - VGA 640\*480 60 Hz, 15 way D - AUDIO 1 KHz Phono output.

Unit can be powered via 8-12V DC adapter, 2 AA alkaline or rechargeable batteries that are recharged via adapter.

**Full kit of parts to build the Multigen, £58 or £62 including 1.6A/hr NiMH Batteries.**

Based on a 50 mips Ubicom Scenix micro running software routines to create fully interlaced test patterns. An Analogue devices AD722 chip performs the RGB conversion giving a 1Volt signal into 75 ohm termination. A DC-DC converter power supply enables just 2 AA cells to power the Multigen. Audio tone output is a sinewave generated by a Wien bridge oscillator circuit with a buffered output. The kit comes with a high quality double sided PCB with ready programmed micro and AD722 chip ready soldered. All components including case, self adhesive overlay, drill template and full construction details are supplied in the kit. Only soldering of components to PCB and drilling, filling of plastic end panels is required to construct Multigen. The unit can be built in three to four hours. Visit our Website for circuit diagrams, layout details and actual screen shots of the different patterns produced.

**Note: Micro can be re-programmed onboard for future software upgrades.**  
 Now available in PC Bone or Black case, please state when ordering.



Please add £2 postage to all orders, £3 for overseas orders. Send cheque, Postal Orders or International Money Orders to  
 J Harding, 43 Jonathan road, Trentham, Stoke-on-Trent, Staffs, ST4-8LP England.

Coming soon, **D-GEN** a PAL 512\*288 digital pattern generator with 3:4 / 16:9 Testcards & Scart RGB output.  
 For more information on these two kits and future products, send S.A.E. or

Visit our website "<http://www.videocorner.co.uk>" or Email us at "[roy@videocorner.co.uk](mailto:roy@videocorner.co.uk)"

# Repair SMDs on PCBs *in seconds* with the NEW Hot Jet 'S'

Desoldering and soldering of SMDs by hot air and without contact is the fast and efficient way for the modern repair workshop. And now, Welwyn Tool can offer the complete package - a range of hot air tools, SMD Rework Stations, nozzles to suit all SMD requirements, free demonstrations and free colour instructional brochure ... all available from Distributors nation-wide.

For further information, please ask for Reference No. TMS

## WELWYN TOOL CO. LTD.

4 SOUTH MUNDELLS,  
WELWYN GARDEN CITY  
HERTS AL7 1EH.  
TEL: (01707) 331111.  
FAX: (01707) 372175.



PUT HOT AIR TO WORK FOR YOU

## ONLINE SHOPPING CHEAPER AND EASIER

[www.elclondon.co.uk](http://www.elclondon.co.uk)

TV, VIDEO SPARES AND ELECTRICAL ITEMS



ELC EAST LONDON COMPONENTS  
63 PLASHET GROVE, LONDON E6 1AD.  
TWO MINUTES WALK FROM UPTON PARK TUBE STATION  
TEL: 020 8472 4871 FAX: 020 8503 5926  
E-mail: [sales@elclondon.co.uk](mailto:sales@elclondon.co.uk)



## Electronicworld TV AND VIDEO LTD

Our HUGE product range has HUNDREDS of models, most of which are NEARLY NEW. You'll find EXCELLENT QUALITY with the very latest style in HOME ENTERTAINMENT and the ultimate range of PREMIUM BRANDS. Our prices, we believe CAN'T BE BEATEN.



**TVRUS** Electrical Goods at UNBEATABLE Prices... vsp SECURITY



See our new awesome web site. Just click on the wholesale link to view just a small sample of our stock.



<http://www.tvrus.co.uk>

All prices are Exclusive of VAT  
**BIRMINGHAM**  
208 Bromford Lane, Erdington, Birmingham B24 8DL  
Tel: 0121 327 3273 Fax: 0121 322 2011  
**LONDON**  
221 Kenton Road, Middlesex HA3 0HD  
Tel: 020 8907 9387  
**PRESTON**  
Unit 434 Rangle Road, Walton Summit, Preston PR5 8AR  
Tel: 01772 316066





## VCR CLINIC

Reports from  
**Bob Flynn**  
**Graham Richards**  
**Andrew Duggan**  
**Gary Laidler**  
**John Coombes**  
**J.S. Ogilvie**  
**M.J. Abbott**  
 and  
**Mark Tyerman**

We welcome fault reports from readers – payment for each fault is made after publication. See page 40 for details of where and how to send reports.

### Ferguson FV62 (R2000 mechanism)

There was no wind or rewind, though sometimes these functions would start then stop. All other functions were OK. The cause was traced to wear on the main brake lever (item K156) – it was worn underneath, where it contacts the clutch unit. Replacement cured the fault. The Ferguson part no. is 70420433. **B.F.**

### Sony SLV-SE700 (S mechanism)

This VCR was dead with the input fuse blown. The cure was to replace the four 1N4005L bridge-rectifier diodes and the 2SK3047 chopper FET, which was very leaky. The TDA16846 chopper control IC was OK. **B.F.**

### Hitachi VTM230E

The half-loading arm (item 256) was sticking on the cam gear underneath it. The reason for this was not obvious, but was found to be that the pinch roller was not secure on its shaft because the plastic sleeve had a split in it. **B.F.**

### Toshiba V856B

The playback picture had spots in the background, the same as you get when the deck earthing is poor. Replacing CP051 (1 $\mu$ F, 50V) in the power supply cured this fault and also improved the display brightness. While I had the power supply out I also replaced CP041 (220 $\mu$ F, 10V) which causes dim displays, and CP007 (10 $\mu$ F, 50V) and CP008 (100 $\mu$ F, 25V) which cause no-power problems. **B.F.**

### Saisho VR1200HQ/Matsui VX820

If the machine is dead with no clock display, though the standby LED lights briefly, go straight to the clock PCB and remove the five or six blobs of brownish glue, especially the one near the reset chip IC602. For no tuning check whether D2584 is open-circuit. **G.R.**

### Sony SLV315

For full display illumination that's possibly intermittent, with maybe a whistling sound, remove the rewind/forward wind rotary-control assembly and dismantle it carefully. Clean the tracks and pins and reassemble. **G.R.**

### GoldStar RC7031

This Nicam/VideoPlus VCR produced just a blue screen, with an occasional negative-looking picture appearing in the E-E mode. A check on the electrolytics C707 (4.7 $\mu$ F) and C727 (220 $\mu$ F) proved that they were faulty. The repair was completed by replacing the video coupling capacitor C710

(47 $\mu$ F) and the 12V supply decoupling capacitor C711 (47 $\mu$ F). **G.R.**

### Sony SLV-SE70

There was no RF output/loop-through and no AV output. The cause was traced to Q607, which was dry-jointed. It's mounted on the print side of the PCB, near the power supply plug/socket CN600. **G.R.**

### Ferguson FV81LV

The clock display could hardly be seen and dimmed even more when a function was selected. CP041 (220 $\mu$ F, 10V) in the display heater feed circuit was virtually open-circuit. While I had the power supply out I replaced the 10 $\mu$ F and 100 $\mu$ F electrolytics on the primary side as a precaution. **G.R.**

### Akai VS66EK

The complaint was tape jammed with the loading motor running, also patterning in the E-E mode. After clearing the mechanism jam I scoped the 6V supply and found that there was lots of noise present. Replacement of the following electrolytic capacitors restored normal life to this machine: C1 (2,200 $\mu$ F, 35V), C6 (100 $\mu$ F, 25V), C15 (220 $\mu$ F, 35V), C24 and C25 (both 47 $\mu$ F, 25V). **G.R.**

### Sanyo VHRH900E

This VCR was brought in with a tape partially loaded. When the tape had been removed the machine appeared to work normally. It was put on soak test, and after some time failed again. The tape was once more removed but this time, while the deck was finishing the loading cycle, it seemed to slow down. A new loading motor cured the problem. As a precaution, a new mode switch was also fitted. **A.D.**

### Samsung SV209B

This machine chewed tapes and was very noisy in the FF/rewind modes. Removal of the gearing and idler assembly required some care. I then found that the centre gear was cracked.

This VCR uses the same deck as the **Toshiba V209UK** and other models. The centre gear is part no. BY730111. It's available from SEME. **A.D.**

### Toshiba V703

This VCR's display was very dim. The customer wanted it fixed for sentimental reasons. Fortunately the state of C810/C813 gave the game away. They were leaking badly but hadn't damaged the print. **G.L.**

### Hitachi VTM620

The complaint with this machine was that the E-E sound was missing at switch on.

The owner explained that it used to come on after a minute but now took ten minutes. So out with the hairdryer and freezer, which led me to the culprits – C407 and C411. G.L.

### Philips Turbo deck

If tape playback is very jittery and the take-up spool is very jerky, fit service kit 1. It contains the changing gear, double gear and gear pulley. J.C.

### Panasonic NVSD200 (K deck)

If one of these machines won't accept a tape, or intermittently won't do so, check the take-up sensor for dry-joints. J.C.

### Samsung SV421

Tape chewing can be caused by a worn pinch roller of faulty mode switch. In this case however the idler assembly was tight. J.C.

### Toshiba V631UK

A 'clicking noise' was the complaint with this machine. It seems to be quite a common problem with a number of Toshiba VCRs or, in some cases, the symptom may be a jammed mechanism that prevents loading. The cause of all this is a

guide post that breaks off – the symptom depends on where the post lands. Its part no. is AC61-00122A. J.C.

### Panasonic NVHD625 (K deck)

If there are loading problems or no FF/rewind etc. check the main lever unit, part no. VXL2307. It has a habit of cracking at one end. While you have the machine apart, check the loading-motor coupler (part no. VDP1434 or SEME VDC7540) for any signs of cracking. If in doubt, replace it. Also clean the mode switch. This will sort the machine out. J.S.O.

### Sharp VCM27HM

This machine produced a blue screen in the playback mode, but the picture was OK in the FF/rewind search modes. On close inspection I could see that the top edge of the tape was being creased, as a result of which it rode up on the audio/control head. A replacement pinch roller put this machine back in working order. J.S.O.

### Panasonic NVHD100

If there is no display check Q1701 (2SD973A-R) on the front display PCB. It tends to burn out. A BC337 can be

used as a replacement. J.S.O.

### Sharp VCA63HM

If the power supply is squealing replace C913 (47µF). J.S.O.

### Philips VR6547/05

The complaint with this VCR, which is fitted with a JVC deck, was tape chewing. The cause was a faulty clutch assembly. This can be obtained from CPC under order code VS1D469. The Konig 1493 will fit, but the pulleys have to be swapped. M.J.A.

### Toshiba V720UK

This machine wouldn't play tapes because there was no take-up. The boss on the gear centre assembly was cracked. Part no. is BY730111. M.J.A.

### Goodmans TVC146

The fault with this TV/VCR combi unit was no power. I found that the power switch SW08 was dry-jointed, ready in fact to fall off the board. M.T.

### Ferguson FV44

This VCR had a very dim display. Replacement of C28 cured the fault. M.T.

## Test Case 491

Test Case Rentals does not claim to have the richest clientele in the world. The situation is quite the opposite in fact, and prepayment meters, bread-and-butter TV sets and a diminishing number of VCRs are the stock-in-trade: exotica such as plasma screens figure hardly at all in the inventory. There are a few score Sony SLV-SE720Gs amongst the VCRs rented out, and the common problem that arises with them, data corruption in the EEPROM, is well known to the workshop crew.

The effects of this fault, apparently brought on by incorrect marking and insertion of an electrolytic capacitor during production, are most often lack of any display on the front-panel indicator, incorrect functions when the on-board control keys are used, and various picture and sound problems during playback. The cure is to replace the now-faulty capacitor, C701, which is usually distressed and bulging as a result of its reverse-voltage ordeal, and to reduce the value of resistors R668 and R669 from 10kΩ to 4.7kΩ. In some cases it is also necessary to replace IC701 on the motherboard, though we haven't had to do this so far. Then, once the option bytes in the memory chip have been programmed correctly, all should be well. This has been our experience – until now!

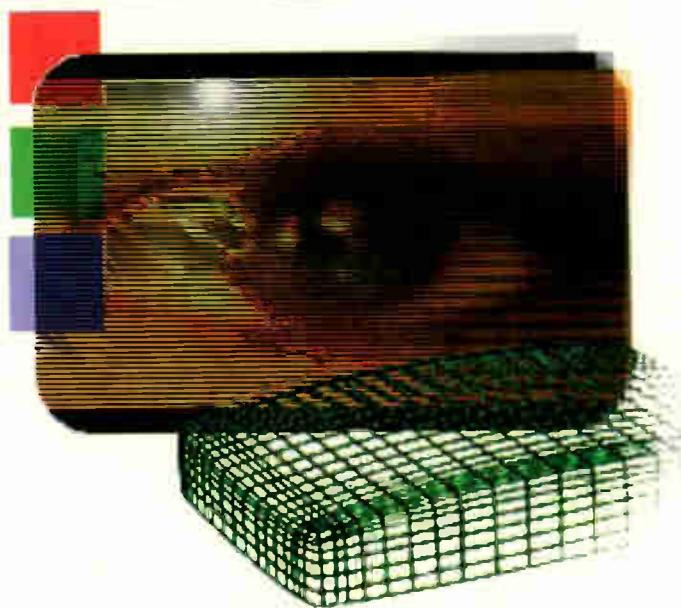
Sage was not at all fazed then when a similar Model SLV-SE820G came in with the familiar symptoms described above. After replacing the capacitor and the two resistors he reassembled the machine, fired it up and pressed the record key, smartly followed by a five-second dwell on the zapper's menu key. The TV screen then produced the options display, in which the selected bytes appear highlighted. As is often the case, only two or three of them were shown in this way, and Sage set

about programming the numbers. Having had to use them a number of times before, he had them listed in his little bench-side notebook: 3-14 inclusive, 19, 27, 33-35, 40, 41, 45, 47, 51, 60, 61, 63, 66, 69 and 72.

These were all banged in and then memorised with a stab on the zapper's menu key. The machine was next switched off and on again to reboot, after which the auto-setting of the head-switching point was invoked by keying 'test' (a concealed button behind the VCR's front panel) then SP/LP on the zapper – with an alignment tape playing. This setting is also stored in the EEPROM. All done then! Sage checked the picture and sound with his *Snow White* tape, made a quick test recording, then turned to the paperwork . . .

The machine went back to the customer next day, and no more was heard of it until after the weekend. Then Sage was summoned to the reception counter, to be confronted by the Sony machine's owner. He was brandishing the VCR in one hand and its instruction book in the other. Sage had mucked the VCR up, it was alleged. Since the machine had been returned, its dial-timer had not worked! Sage, muttering apologies, crept back to his bench with the machine, then consulted the instruction book to discover what the dial-timer was supposed to do. Set a timed recording, that's what. It did nothing at all when it was tried.

Sage was convinced that the cause was simply failure to reconnect the front-panel's ribbon cable during reassembly. Was this the case, or had the little jog-control mechanism been damaged perhaps? Sage delivered the machine in person later that day. What had ailed it? For the solution (think first!) turn to page 57.



## TV FAULT FINDING

Reports from  
**Michael Dranfield**  
**Philip Salkeld**  
**Glyn Dickinson**  
**Les Mainstone**  
**Andrew T. Duggan**  
**Martin Cole**  
**Ian Turnbull**  
**Jerry Fedorak**  
**Dave Husband**  
**Martyn S. Davis and**  
**Steve Hague**

We welcome fault reports from readers – payment for each fault is made after publication. See page 40 for details of where and how to send reports.

### **Grundig 28EKB-T70-1020A (Professional 2500 chassis)**

This newish set was dead. When it was switched on from standby the green LED lit up but nothing else happened. Not having seen one of these sets before I was quite pleased to find a large, blackened dry-joint at the line scan coils socket. But the set remained dead after resoldering this joint, and the power supply was up and running. Scope checks around the line driver FET (TL1) showed that gate drive was present but there was nothing at the transistor's drain. Nor was there any voltage at the drain connection to the driver transformer. At this point I was stuck, not knowing the set. Fortunately the local Grundig dealer lent me a manual, and I then found that a surface-mounted BAV203 diode (DL2) between pin 3 of the driver transformer and chassis was short-circuit. M.D.

### **Ferguson ICC5 chassis**

As this old set used to provide such excellent pictures its owner gave the go-ahead for repair at up to £40. The picture was very ragged, as if there was a dried up electrolytic capacitor across the HT supply. But I found that tweaking the EW potentiometer cured the trouble. Unfortunately the picture then lacked width, so it was obviously not a power supply problem. Further investigation showed that CG01 (10 $\mu$ F, 50V), which is

connected to pin 6 of the TDA4950 EW chip IC01, had dried out.

A replacement capacitor cured the raggedness, but the EW control now did nothing. At this point I noticed that with the new 10 $\mu$ F capacitor fitted the TDA4950 chip was getting very hot. A replacement IC restored normal operation. M.D.

### **JVC AV28WFR1EKS**

The problem with this set was field collapse. But there was a wavy instead of a straight line across the screen. The last time I'd seen this symptom was with a set fitted with the Thorn 9000 chassis! The cause had been a dry-joint at the earthy end of the field scan plug/socket: the field collapse was being modulated by the line scan coils.

But no dry-joints could be found this time, and a resistance check showed that the field scan coils were open-circuit. It seemed that a new tube would be needed but, with nothing to lose, I decided to heat up the solder joints on the yoke and flow some fresh solder on. This provided a complete cure. Also a good tip from the customer – a 24-can case of Stella lager – who thought he was going to have to shell out for a new tube! M.D.

### **Thomson 32WX65US (ICC19 chassis)**

There was no luminance though the OSD was OK. A scope check showed that the luminance signal was missing at pin 4 of IV001, so the cause of the problem was on the digital signal module, which is difficult to get at. The luminance signal passes through five ICs and a handful of surface-mounted transistors on this module. It's not easy to carry out scope checks on the module, but I eventually found that there was a luminance input at pin 26 of IV601 (TDA9143) but no output at pin 12. A replacement IC cured the fault. M.D.

### **Toshiba 28W93B (C8SS chassis)**

This set was stuck in standby though 125V was present at the HT fuse F470 in the power supply. After finding nothing wrong in the line output stage I returned to the power supply to check the LT rails and found that there was no voltage at pin 21 of plug 813A. Tracing back from this I discovered that R430 (56 $\Omega$ , 0.5W) was open-circuit and that there was a short-circuit at the emitter of Q430. The cause of the trouble was the 0.01 $\mu$ F disc ceramic capacitor from this point to chassis, C431. It was short-circuit. A new capacitor and resistor restored normal operation. P.S.

### **Goodmans 285NS**

These sets always seem to come in dead because the line output transformer has



been arcing, as a result of which the output transistor blows. SEME can supply the transformer, under code no. HR7927. On this occasion however the set was still dead once these items had been replaced. There was HT at C805, the mains bridge rectifier's reservoir capacitor, and at pin 1 of the STR5707 chopper chip 1801, but there were no other supplies. I decided to carry out a resistance check between pins 2 and 4 of 1801, and discovered that they were short-circuit. A replacement restored normal working order. P.S.

### **Tatung T28NE51 (E chassis)**

I was called out to this set, the complaint being no sound. When I tried the remote-control unit I found that the green cursor which shows the volume level remained at zero. The brightness, contrast etc. all varied. So the sound was locked. To release it you press vol+ on the set and at the same time press the mute button on the remote-control unit. After doing this the sound returned and could be adjusted normally. P.S.

### **Beko 16328NX**

This oldish set had a vertical shift problem, i.e. a black line that was well up from the bottom of the screen. Use of freezer revealed the culprit, which was R725 (150k $\Omega$ , 0.5W). A long soak test after fitting a replacement confirmed that this resistor had been the cause of the fault. P.S.

### **Samsung C16844N**

In most cases replacement of the TDA8350Q field and EW output IC will cure field faults in these sets. However you will sometimes find a side effect, flyback lines at the top of the picture. To clear this fault replace R307 (10 $\Omega$ , 1W). P.S.

### **Beko NR28426NDS**

If you come across a dead set and the cause is not the sand-filled fuse, go straight to the BU508D line output transistor T504. You will find that it's short-circuit. Don't replace it until you have fitted a new line output transformer (TR502), because this will have been arcing. As this set was in warranty the replacements had to be ordered direct from Beko. P.S.

### **Grundig ST82-774 (CUC7890 chassis)**

This monster seemed to be dead apart from the fact that the front display was illuminated. Investigation showed that the HT and LT supplies were present. When I moved to the line output stage I found that there was no drive. These sets use a

TDA8140 line driver chip, IC526. Checks here showed that there was an input from the line generator at pin 7 (what a relief!) but no drive output at pin 1. A replacement IC restored normal operation. The next problem was to get the set off the bench. What a weight! P.S.

### **Philips Anubis AA-5 chassis**

The report with this 21in. set said "crackling then dead". Seeing a dreaded triangle on the line output transformer's label I replaced it. The result was a tripping set, though all the supply voltages were correct. Line drive was present, but at very low amplitude – the TDA8361E jungle chip had been dealt a mortal blow. A replacement restored the EHT, and revealed field collapse! A new TDA3654 IC brought the picture back. I wonder how loud that "crackling" had been?

Note that this chassis differs from the Anubis A, which has a different jungle chip. G.D.

### **Grundig ST70-755/9 (CUC6460 chassis)**

This set was dead though there was 330V at the mains bridge rectifier's reservoir capacitor C626 (220 $\mu$ F). This item is followed by a DC Wickman fuse, Si624 (1.6A), which was open-circuit. I also noticed that there was a bad dry-joint at C648 (470pF, 1.6kV), which is in parallel with the chopper transistor T644. I replaced the latter (IRFBC40) and IC631 (TDA4605/03), also C648 and, as a precaution, C633 (100 $\mu$ F, 25V) and C661 (1 $\mu$ F, 63V). A new fuse completed the repair and, at switch on, the set sprang to life. L.M.

### **Philips 29PT727B (GR2.4 AA chassis)**

This set had a faulty line output transistor (BU2520AF) and transformer. I gave the customer an estimate, which was accepted. Fortunately it allowed some leeway for unforeseen eventualities. When the transistor and transformer arrived they were fitted and the EW modulator diodes D6546 (BY228) and D6547 (BYW95C) were replaced. After a quick check around the line output stage for anything else amiss I switched the set on. Result, a flashing front LED.

After the customary expletive, I isolated the line output stage and provided the power supply with a dummy load. It declared itself very happy. So attention was redirected to the line output stage, where I found that F1534 (315mA) was open-circuit. This led me back to the EW drive circuit, which is on the CRT base panel, and opened a can of worms.

Tr7533 (BD440) was short-circuit, so this and the two surface-mounted transistors Tr7530 and Tr7537 (both type BC848B) were replaced. I also replaced two diodes, D6560 (LL4148) and D6561 (BZX79-C68), which provide a feed to the protection circuit. The BZX79-C68 diode had tested OK with my equipment. After that the set was fired up, voltage checks were carried out and the set was boxed up. After five hours on the soak test bench it died again, with a thin squealing sound. At this stage I contemplated a plumbing course.

Off came the back and out came the chassis. This time I found that the bulky scan-correction capacitor C2550 (680nF, 250V) was the culprit, with a short-circuit reading. I assume that it had failed as a result of stress from the previous problems. L.M.

### **Samsung C15337AN (US60A chassis)**

This set, with its excellent, usually trouble-free chassis, arrived with a note to say that it did odd things at odd times, sometimes flashing and the text not working. Two of the diodes in the mains bridge rectifier circuit, D801 and D802 (type 1N4003), showed signs of overheating, so replacements were fitted. They are on the larger of the two PCBs. When the set was switched on it produced a blank raster, with no signs of any audio or video. I was suspicious of the two 12V regulators IC801 and IC802, but replacements made no difference. The culprit turned out to be the 5V regulator IC804 (MC7805). Once this had been replaced the set worked and, after retuning, behaved itself with normal text. L.M.

### **Grundig CUC2030 chassis**

"Turns itself off when my back's turned" claimed the elderly lady customer. When I took the back off and removed the chassis I noticed a number of dry-joints on the secondary side of the power supply. These were repaired and the set was switched on. All the supply-line voltages were checked and found to be correct, so the chassis went back into the cabinet. When the set was switched on it was dead! Out came the chassis again and, after much twisting and tapping, a dry-joint was found at C53009. Dealing with this cured the erratic shut down. L.M.

### **Philips 25PT4494/05 (L6.3 AA chassis)**

At switch on this set produced a raster but no sound. The front and remote controls produced no response, and there were no

signs of any graphics. A check on the outputs at the secondary side of the power supply showed that the 5V rail was at only 0.2V. This led to a check on transistor Tr7505 (BC337-40) which was open-circuit. A replacement cured the fault. L.M.

### **Daewoo DVT1482P**

This combi unit was dead with no illumination from the standby LED. After some attempts the LED did light, but when Power was pressed the unit just tripped and died. While making a few checks in the power supply I noticed that C811 (100 $\mu$ F, 16V) was almost touching the heatsink for the chopper transistor Q801. As a result it had dried up. A replacement solved the problem. A.T.D.

### **Bush 1433 (11AK20M chassis)**

This set was dead with a short-circuit chopper transistor – Q801, type 2SK2750. Checks revealed that in addition the following were either blown or short-circuit: R851 (0.33 $\Omega$ ), R801 (2.2 $\Omega$ , 5W), R819 (0.47 $\Omega$ ), R812 (1k $\Omega$ , surface-mounted) and D808 (BA159). Just in case, I decided to replace the MC44603AP chopper control chip IC801 as well. After that the set ran perfectly. A.T.D.

### **Philips L01.1E chassis**

If you get a loud mechanical noise as soon as the set is switched on from the mains, the degaussing coil is vibrating/rattling on the CRT's rimband. To cure the fault all that's required is a spot of hot-melt glue to keep the coil away. M.C.

### **Hitachi C32WF523-311**

This flat-screen set would switch to standby after a few seconds. Checks revealed the cause to be loss of the first anode supply, because of a fault within the CRT. The tube fitted was an LG type W76QDD259X. I.T.

### **Philips 25PT4521 (MD1.1 chassis)**

There was no picture because of field scan failure. I found that the -15V supply, which is derived from the line output transformer, was missing with circuit protector CP1463 (800mA) open-circuit. The cause of this was transistor Tr7440 (BC327), which was short-circuit, and diode D6440 (1N4148), which was leaky. These two components are mounted on a small sub-panel. I.T.

### **LG KE14U73**

Very intermittently this combi unit's picture would disappear with motorboating on sound. In the fault condition all the main supply voltages dropped significantly. The cause was a

dry-joint at R811 in the current-sensing part of the power supply. I.T.

### **Hitachi C2142N**

The complaint with this set was loss of red, because of failure of the TDA6108 RGB output chip. A modified CRT base PCB is available from Hitachi to prevent repeated failure. The part no. is VS20089197. I.T.

### **Panasonic TX21GVI**

The sound would sometimes disappear when a cassette was inserted in this combi unit. The cause was traced to dry-joints at C613 in the audio circuit on the VCR PCB. I.T.

### **Proline 28N1**

This set was stuck in standby. When the remote-control unit was used to bring it out of standby the power supply would whistle then go back to standby. Cold checks in the power supply revealed that C25 was dry-jointed. Once it had been resoldered the set came back to life with good results. J.F.

### **Minato ST1411**

This 14in. colour portable was dead. Checks in the power supply revealed that R502 (100k $\Omega$ ), one of the start-up resistors, was open-circuit. In addition there was a dry-joint at C506. Once these points had been attended to everything was OK. J.F.

### **Grundig W70-2030**

This one-year old widescreen set was brought in because it was dead. The standby LED at the front would sometimes light up. Visual checks in the power supply area revealed the cause of the trouble, dry-joints with arcing at plug R629 to the transformer (mounted at the corner of the cabinet). Normal operation was restored by resoldering the plug. J.F.

### **Wharfedale 550S (PT92 chassis)**

Two of these sets required attention on the same day. The first one produced a rustle of EHT at switch on then shut down. Checks in the line output stage revealed a diode that looked as if it had nipped outside and spent too long in the sunshine. Sure enough it read 22 $\Omega$ . That was the easy one.

Set two seemed to have a blanking fault – the picture was cutting out about once a second, though the sound and teletext were OK. So I dusted off the scope and ordered a service manual. After much wasted time checking waveforms and voltages I decided to enter the service mode (press sub-page on the remote-control unit and volume down on the set)

to find out what was inside the micro. I discovered an item marked CL (cathode drive level), for which the manual suggested a setting of 4. It was actually at 8. To be on the safe side I set the level to 3. After that all was well.

Note that this chassis is used in the **Bush Model 2876T** amongst others. D.H.

### **Philips 25PT4523 (MD1.2E chassis)**

This set was dead with its input fuses blown. It didn't take long to spot the cause. A small, blue high-voltage capacitor, C2540, had blown itself in half. This 220pF capacitor is connected in parallel with the chopper transistor. Its failure had taken out the big cement resistor and two of the mains bridge rectifier diodes.

For good measure I replaced the chopper FET, all four mains bridge rectifier diodes, all three HV capacitors and the large 1 $\Omega$  anti-surge resistor. I was then rewarded with the satisfying sound of EHT rustling up and a working set. M.S.D.

### **Philips 32PW9544 (MD2.25E chassis)**

There was a degree of urgency associated with the repair of this large, expensive dead set. When the customer arrived to report the fault she apparently became hysterical then abusive – to the extent that the police had to be called in. She then phoned our various managers to offer them her views, and followed this with a four-page letter to our MD. So it was a chance for me, the lowly engineer, to shine and retrieve the situation.

On investigation I found that the chopper FET was short-circuit and the control IC had a short-circuit diode and open-circuit resistor connected to pin 3, which drives the FET. The following items were replaced: Tr7541 (STW9NA60), IC7520 (MC44604), D6524 (BYV10-20), R3524 (10 $\Omega$ ), R3546 and R3547 (both 0.39 $\Omega$ ). Once this had been done there was the sound of EHT to confirm that the repair was successful. Phew! M.S.D.

### **Hitachi C2142 (11AK19 chassis)**

I have not come across this model before – it didn't look like a Hitachi set. The reported fault was no sound. When I took the back off I was a little surprised to find a Vestel 11AK19 chassis. Not that I mind: it's relatively predictable, and easy to work on. A few quick checks revealed that pin 2 of the TDA2614 audio output chip was being held low. This is the mute pin, which is controlled by transistor Q100 (BC548B). When it was tested this transistor proved to be leaky. A replacement restored the sound. S.H. ■

# SPARES & REPAIRS

**SPECIALISTS IN ALL MAKES AND MODELS OF SATELLITE EQUIPMENT**  
 ECHOSTAR / TECHNOMATE / HUMAX / MANHATTAN  
 GRUNDIG / PANASONIC / PACE / AMSTRAD

**SAME DAY COLLECTION FROM MAINLAND UK ADDRESSES - BOOK BEFORE 1PM**

**LARGE SELECTION OF REFURB BOXES COMPLETE WITH 12 MONTHS WARRANTY AND NEW ACCESSORIES**

**SPARE PARTS FOR DIGIBOXES - NEW AND USED - POWER SUPPLY UNITS, TUNERS, MODEMS, RF SOCKETS, BGA'S AND CHIPS**

**WE ALSO STOCK COSMETICS FOR ALL DIGIBOXES**

**EXCLUSIVE TO SDS!**



**SILVER PACE 2200 DIGIBOXES**

**DISCOUNTS ON QUANTITIES**



**1 HOWARD AVENUE  
 BARNSTAPLE  
 DEVON  
 EX32 8QA**

**TEL: 01271 325888  
 FAX: 01271 329163  
 chrissds@hotmail.com**

# Economic Devices

PO Box 73, Oakengates TF2 8WR

Tel ++44 (0)1952 273130

Fax ++44 (0)1952 405478

**Remote Controls from £5.95 each**

Stock held for over **53000** different models

**SEMICONDUCTORS**  
**Over 34,000** types of transistors, IC's, diodes etc. or equivalents stocked

**We take your hassle** Some suppliers just won't help. We will work really hard to find those difficult parts - just ask and let our 'no holds barred' enquiry hound work for you.!!!

**...and look at the special offers.....**

**BUT11A @ 29p each BUT11AF @ 41p each**  
**BU508A @ 45p each Fully wired scart lead @ 99p**

**a slight inconvenience.... you must buy more than one.**

BU208A	X 5	75p ea	TEA2018A	X 5	99p ea
BU508A	X 5	79p ea	UC3842	X 5	59p ea
BU508AF	X 5	85p ea	CNX62A	X 5	29p ea
BU508D	X 5	89p ea	S2000AF	X 5	84p ea
BUT11A	X 5	29p ea	TDA3353B	X 5	55p ea
BUT11AF	X 5	47p ea	TDA3354	X 5	82p ea
Phillips type 1.2 volt	Back up battery	X 5			59p ea
Phillips type 2.4 volt	Back up battery	X 5			120p ea
Scart - Scart lead 1.5m	Fully wired	X 2			89p ea
Positor PT37, TH98009	(White)	X 5			59p ea
Thom TX100 Chassis	110 DGR LOPTX	each			£11.24
Phillips CP90 Chassis	LOPTX	each			£11.63

**...and now ask about our value for money full price list. Remember £1.50 post & handling**

All major credit cards accepted

**www.telepart.co.uk**

The web page where you can look up the price and order of Video, TV, VCR and Satellite. Web search by model for video parts, remote controls, LOPT's etc. overseas enquiries particularly welcome

**New CCTV catalogue out NOW**  
 cameras, monitors, switches  
 quads, multiplexers, the lot.

## Campion Electronics Ltd.

**SUPPLIERS OF QUALITY EX-RENTAL TV'S**

and video equipment to independent retailers across the UK and EIRE.

**FREE DELIVERY SERVICE**  
 to most areas of UK

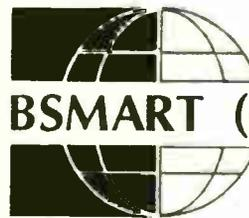
**WORLDWIDE EXPORT SERVICE**  
 Large stock of TVs suitable for export  
 Experts in UHF/VHF conversion

Visit our large warehouse at:

**Units 1 & 2 Tenat Works,  
 Worcester Rd, Kidderminster,  
 Worc, DY10 1JR**

**Tel: (01562) 746000 (2 Lines)**

**Just 20 miles from Birmingham City Centre**



**BSMART (CRAWLEY) LTD**

**Largest selection of**

**MAJOR MANUFACTURERS  
 NEW "B"  
 GRADE PRODUCTS**

**T.V. VIDEO AUDIO  
 MICROWAVE OVENS**

**Contact Paul Bean**

**BSMART (CRAWLEY) LTD.  
 10/11 LLOYDS COURT, MANOR ROYAL,  
 CRAWLEY, SUSSEX RH10 2QX**

**Tel: (01293) 618000**

**Fax: (01293) 400133**

# WEB SERVICE

To reserve your web site space telephone  
 Tel: 01322 611292 Fax: 01322 616376  
 E-MAILS [r.gurunlian@highburybiz.com](mailto:r.gurunlian@highburybiz.com)



## Alban Electronics

<http://www.albanelectronics.co.uk>

Alban stocks, supplies and provides technical support for a range of terrestrial/cable/satellite and analogue/digital TV equipment. PROMAX (manufacturers electronic test equipment including signal level meters, spectrum analysers, BER/CSI/MER analysers for QPSK, QAM & COFDM, optical fibre light sources and power meters, 16:9 test pattern generators), ALCAD (manufacturers of R.F. wide band and adjacent channel amplifiers, aerials for MATV, SMATV & IRS systems) and ANTARES (cascadeable multi-switches). ALBAN has a complete after sales repair and calibration service that is fully supported by the manufacturers, in addition provides a free system design service using only reliable high quality components.

## Alltrade Aerials & Satellite Ltd

<http://www.alltrade.co.uk>  
 Leading distributor to the trade



Full e-commerce site with over 1500 products with in-stock quantities!! We supply everything associated with Digital/Analogue Terrestrial & DTH/Motorised Satellite reception. All Antennas. All Brackets. All Cables. All Connectors. All Amplifiers. We provide a free MATV/SMATV planning service as well.  
 Phone 0845 075 0751 Fax 01273 425700

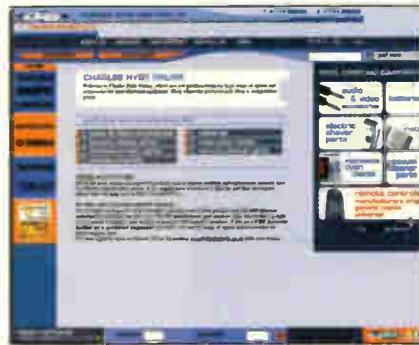
## Cricklewood Electronics

<http://www.cricklewoodelectronics.co.uk>

Cricklewood Electronics stock one of the widest ranges of components, especially semiconductors including ICs, transistors, capacitors, resistors. all at competitive prices.

## Charles Hyde & Son Ltd

<http://www.charleshyde.co.uk>



Search for both original and copy spare parts in our extensive database covering Akai, Alba, Bush, Ferguson, Goldstar, Hitachi, LG, Matsui, Nokia, Saisho, Sanyo, Sony, Sharp, Thomson, Panasonic, Philips, Samsung, Tascam, Teac, Toshiba, Yamaha and many more. In addition huge ranges of Lasers, Lopts, Remote controls and Semiconductors may be accessed.



## Dönberg Electronics

<http://www.donberg.ie>

<http://www.donberg-electronics.com>

<http://www.electronic-spare-parts.com>

As the leading distributor for the TV, Video and Audio trade in Ireland, we supply over 2000 shops & service dept with Audio-Video and TV spares, Semiconductors, Test Equipment, Service Manuals, Remote Controls etc. At present we stock over 35,000 different lines. We hold agencies for: Panasonic, Sharp, Mitsubishi, Sanyo, Beko, Ersa, Muter, Diemen HR, Philex, PRF, König-electronics. We specialise in parts for all continental sets and obsolete semiconductors.

## J W Hardy Communications

<http://www.jwhardy.co.uk>



R.F. Network Specialist.  
 Shop online - for R.F.network components. We supply a full range of TV, radio reception equipment to receive analogue/digital signals from both

terrestrial and satellite sources. We provide a free planning service for your R.F. networks, MATV and SMATV etc

### Irwin Electronics

<http://www.irwinelectronics.co.uk>

As Classic Distributors we complement our existing mail and trade counter business with our website. You can order parts on-line quickly and easily. We intend to explore alternative ways of assisting engineers to run their business successfully.

### MMWafercards

<http://www.mmwafercards.com>

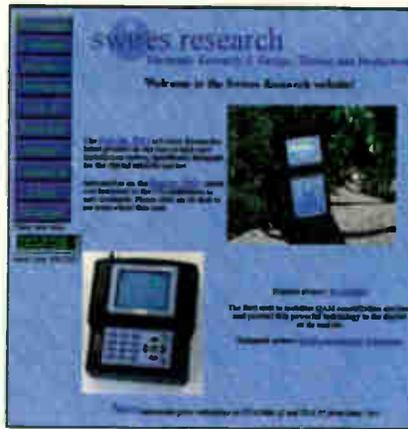


Smartcards and programmers for all access-controlled applications. Incorporating [www.satstore.co.uk](http://www.satstore.co.uk) The Enthusiasts Satellite Store. Tel 01386 48731 Fax 01386 765875

### M.C.E.S.

<http://www.mces.co.uk>

The MCES site gives details of our range of service including Tuners, Video Heads, RF & IF Modules plus latest prices offers.



### Swires Research

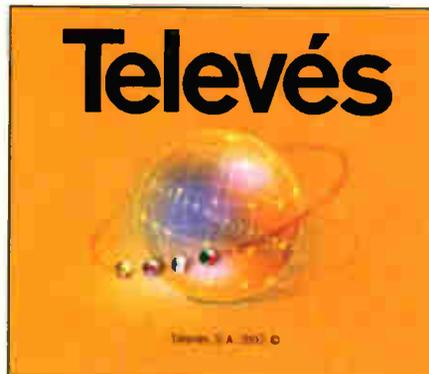
<http://www.swires.com>

Swires Research produce high quality instruments for the television industry, including portable signal level meters and spectrum analysers for digital and analogue RF signal measurements.

### Televés

<http://www.televés.com>

Televés website was launched as an easier way to keep in contact with our World-wide Network of Subsidiaries



and Clients. This site is constantly updated with useful information/news plus you can download info on our range: TV Aerials & accessories, Domestic and Distribution amplifiers, Systems Equipment for DTT and Analogue TV, Meters and much more.

### Wiltsgrove

<http://www.wiltsgrove.co.uk>



**WILTSGROVE LTD** founded in 1984, is renowned as a leading supplier of Audio, Video, TV, Spare parts and Accessories.

We are now pleased to announce the launch of our ONLINE CATALOGUE:

<http://www.wiltsgrove.co.uk>

Our easy to use search engine will allow you to find the products you require via:

- Make / Model.
- Product Category.
- Key Word search.
- Manufacturers part number.
- Our Order Code.

All orders before 5pm will be dispatched the same day.

**Tel:** (0121) 772 2733

**Fax:** (0121) 766 6100

**Email:** [sales@wiltsgrove.co.uk](mailto:sales@wiltsgrove.co.uk)

## Make sure of your copy of *Television*

It can be difficult finding a copy of *Television* at local newsagents. The number of magazines being published keeps increasing, which means that newsagents have less shelf space for the display of individual titles. Specialist magazines in particular get crowded out.

There's a solution to the problem. Most newsagents provide "shop-save" and/or home-delivery services. There's no charge for a shop save. You simply ask your newsagent to order a copy for you: it will be kept on one side each month ready for you to collect. Home-delivered copies are ordered in the same way, but generally incur a delivery charge.

A newsagent can order any magazine for you, whether or not the shop normally stocks it.

If you buy your copies of *Television* from a newsagent and want to make sure you get every issue, just ask at the counter.



# Installation Engineers **Bang & Olufsen**

wish to appoint a number of Installation Engineers to work with our exclusive stores throughout **Yorkshire\*** and the **Midlands\***

### The position

As an Installation Engineer your primary role will be to:

- Professionally install Audio Visual products to the highest standards in our customers homes
- Install multiple room BeoLink systems, distributing audio and video sources around the home
- Provide technical assistance to our Sales staff
- Extend the experience beyond the point of installation

### Qualifications

We are looking for engineers with installation experience who understand and share the values of our brand. Above all we are seeking outgoing individuals who are focused on delivering excellence for our discerning customers

### What we offer

An excellent salary package.

In addition to comprehensive product & installation training, we offer a challenging and rewarding role where you will have an opportunity to demonstrate the competences of the World's leading home electronics brand.

### Applications

If you feel you have the qualities & capabilities we are looking for to take up this exciting opportunity then please send your written application and CV to:

Mr Nick Hayes  
Bang & Olufsen  
Freeport NEA5589  
LINCOLN  
LN5 7BR

[www.bang-olufsen.com](http://www.bang-olufsen.com)



\* Recruiting in **SHEFFIELD - LEEDS - LEICESTER - PETERBOROUGH**

BANG & OLUFSEN



# COLOUR TRADE

**POSSIBLY  
LARGEST & OLDEST  
EST. IN  
THE UK EST FOR  
30 YEARS**

Wholesaler Distributors & Expert Agents of  
Domestic Electronics & Appliances

**FULL RANGE OF FACTORY  
GRADED TV's DVD / VIDEOS  
HI-FI SMALL & LARGE  
DOMESTIC GOODS**

## TECHNICAL SUPPORT

*Now Available*

**TV's, DVD's, VCR & AUDIO**

*Over 40 years of genuine experience*

Experts on:-

Thomson • Sanyo • Beko • LG • Tatung • Ferguson  
Bush • Funai • Pacific • Dansai • Samsung & more

# 0907 076 70 80

Call cost 60p min

### MAIN DEALER

- Thompson
- Sanyo
- Beko



**Tel: 0121 359 7020 Fax: 0121 359 6344**

Phoenix House, 190 Bridge St. West, Newtown, Birmingham B19 2YT

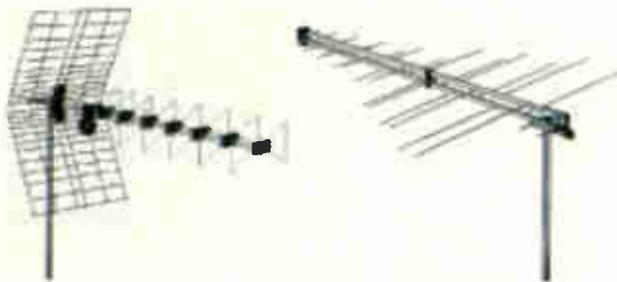
Email: [inquiries@colourtrade.com](mailto:inquiries@colourtrade.com)

# MTD

Your connection to the digital future

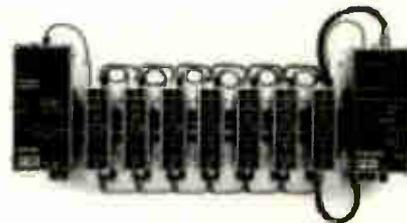
## MTD proudly announces the complete range of Fracarro products

### Aerials



A wide range of aerials including the CAI benchmarked BLU420

### Channelised Amplifiers



The leading K Series channelised amplifiers for distribution of digital and analogue signals



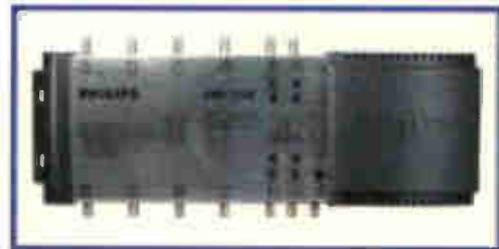
Test Equipment for digital and analogue

### Philips GII: The leading IRS Range



### Dishes

A wide range of satellite dishes, including the Penta HQ range



## FRACARRO

Martin Turner Direct Ltd

Unit 16C, Severn Bridge Ind Est, Caldicot,  
Monmouthshire. NP26 5PT

E-mail: [enquiries@martinturnerdirect.co.uk](mailto:enquiries@martinturnerdirect.co.uk)

Company registration No. 2885911

## PHILIPS

Tel: 01291 421422

Fax: 01291 422701

[www.martinturnerdirect.co.uk](http://www.martinturnerdirect.co.uk)



view and make recordings of the transmissions (see Photos 1-3). Recordings of the signal on a hard disk gobble a massive 180MB a minute, which didn't give much viewing time when transferred to a standard 680MB CD! I found that playback of the CD was possible only with a fairly recent PC, using the Windows Mediaplayer or the Elecard software mentioned in the September issue article. Attempts at playing the disc with a PC that had less than a 2GHz processor resulted in picture and sound dropout. Definition with a computer monitor is very good, especially if the monitor is large and can



Photo 1: Euro 1080 HDTV test transmission.

## SATELLITE NOTEBOOK

**Reports from  
Hugh Cocks  
Christopher Holland  
and  
Michael Dranfield**

24.000Mbits/sec, they either crash under the data onslaught or show intermittent pixellated blocks on the screen. The best results I have obtained so far with a conventional receiver have been with an old Nokia 9600 box, which showed a zoomed-in top-left portion of the picture in 625-line format, though with intermittent picture and sound dropout.

PC-based satellite-receiver systems work much better. Using the TechSat PC card system described in the September issue and a fast computer I was able to

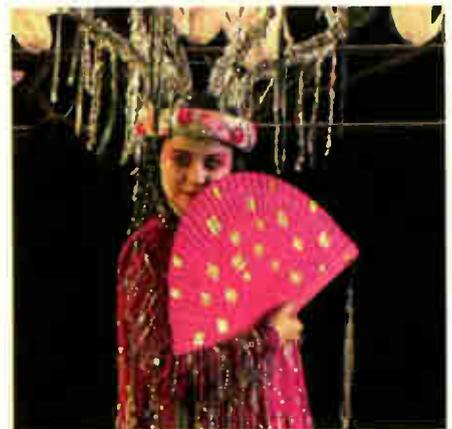


Photo 2: Euro 1080 HDTV test transmission.

### High-definition TV tests

The European 1,080-line high-definition TV system is due to start a regular transmission schedule at the beginning of next year. More information can be found on the internet at [www.euro1080.tv](http://www.euro1080.tv)

There are 25 frames per second, with a horizontal definition of about 1,900 lines. Tests are currently being carried out via the Astra 1 slot (19.2°E), at 12.168GHz V (symbol rate 27,500, FEC 3/4). Conventional MPEG-2 satellite receivers will tune in the signal but because of the large amount of data transmitted to achieve this definition, about



Photo 3: Euro 1080 HDTV test transmission.





**Photo 4:** White line dashes at the top left-hand corner of the screen with BBC1 regional transmissions, seen when these are displayed in the letterbox mode.



**Photo 5:** Nigerian NTA 2 caption received via Intelsat 903.



**Photo 6:** Nigerian NTA 2 news reader received via Intelsat 903.

be set to the highest-definition possible.

Some experimentation with the receiving software was necessary. The Prog DVB program mentioned in the previous article would record perfectly well but displayed some blocks with live pictures. DVB Viewer however gave the best-quality live pictures but wouldn't record properly! The programs sometimes had to be opened and closed once or twice for live pictures to be displayed, because an 'error' message appeared on the screen instead. The software was obviously not entirely happy about handling this amount of data.

At the time of writing this report the transmissions consist of an approximately one-hour long demonstration tape that shows clips of various live orchestral and operatic performances, with the Astra and Euro 1080 logos in the top right-hand corner. No doubt dedicated HDTV receivers will soon be available, if not already at a cost, and possibly fantastic picture quality will be achieved if the

**Table 1: Latest digital channel changes at 28.2°E**

Channel and EPG no.	Sat	TP	Frequency/pol
Arrow Radio (911)	2B	32	12.324GHz V
BBC1 Channel Is (958*)	2D	50	10.847GHz V
Factory Outlet (670)	2B	33	12.344GHz H
Paramount 2 (128)	2A	11	11.914GHz H
Pop Plus (620)	EB	C6	11.426GHz V
Vectone Urdu** (828)	EB	C10	11.644GHz H

TP = transponder. EB = Eurobird. 2A/B/D = Astra 2A/B/D.

\*BBC1 Channel Is will be on EPG 101 with viewing cards registered with in the region.

\*\* Plus three Vectone test channels.

output is fed to say a large-screen plasma TV display. H.C.

### Digital channel update

The latest channel additions at 28.2° are listed in Table 1. Where allocated, the EPG number is shown in brackets after the channel name.

ATN TV (EPG no. 827) via Eurobird transponder D12S has returned to the EPG after being off-air for several months.

RTE Radio 1 has been given EPG no. 910. This is the stereo version, which has been available for over a year via Astra 2D transponder 43 (10.744GHz H) using the digibox add-channels facility. The mono version of RTE Radio 1 (EPG no. 892) via Astra 2B transponder 32 (12.344GHz H) has been renamed RTE Europe, probably because of the much wider footprint of Astra 2B compared to Astra 2D. RTE Radio 1 has also recently started up via the good old-fashioned LW band, with a high-powered transmitter at 252kHz.

Ekushey TV (EPG no. 814) and Total Rock Radio (EPG no. 885) have ceased transmissions. C.H.

### BBC1 regional oddities

I've noticed that the BBC1 English regional variations all have a small time delay compared with BBC1 London when transmitting national programmes. This is no doubt because the London output is sent to the regional studio and then returned.

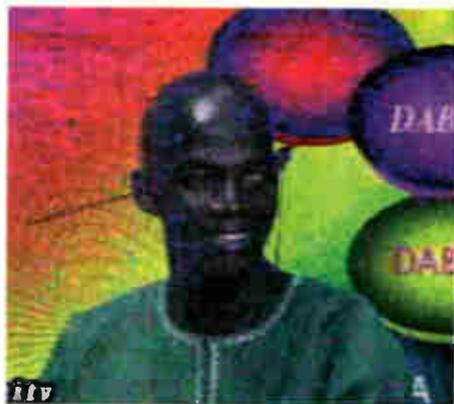
When the digibox video output is set to 'letterbox' the regions all have a series of white line dashes at the top left-hand corner of the screen (see Photo 4). These seem to be the same whichever region is selected. The dashes are not present with BBC1 London, Scotland, Wales and Northern Ireland. I've also noticed that when a non-digibox receiver is used in the letterbox mode the dashes appear briefly after channel selection and are then suppressed. C.H.

### Update at 34.5°W

The C-band channels available via Intelsat



**Photo 7:** Nigerian Minaj transmission via Intelsat 903.



**Photo 8:** Nigerian MITV transmission via Intelsat 903.



**Photo 9:** Snell & Wilcox widescreen test pattern with GTV 9 Melbourne identification received via Eutelsat W3.

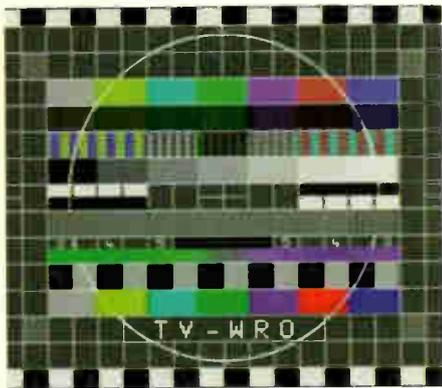


Photo 10: TVP (Poland) test pattern with Wroclaw identification received via Eutelsat W3.



Photo 11: British Telecom/NewSkies Satellites caption received via Eutelsat W3.

903 at 34.5°W were listed here about a year ago. Since then a Nigerian multiplex has become available at quite a reasonable signal strength. The frequency is 3.890GHz, with left-hand circular polarisation, a symbol rate of 16,300 and 3/4 FEC. TV channels are NTA 2 (see photos 5-6), MITV (see Photo 8) and Minaj (see Photo 7). Radio stations in the package are Cool FM, Ray FM, Rhythm FM and Star FM.

The MITV photo is of appalling quality. The signal appears to be picked up off-air at low strength complete with ghosts, the result being intermittent dropouts with the digital signal transmitted. It has been like this since I first started to take a look some weeks ago, with no attempt to improve the signal at the uplink site! H.C.

### Unusual test cards

Continuing our series of unusual test cards and captions, Photo 9 is a very rare shot of a Snell & Willcox widescreen test pattern from the Australian TV station GTV 9 in Melbourne. It was transmitted prior to a Eurovision newsfeed via Eutelsat W3 (7°E).

Photo 10 is from state broadcaster TVP (Poland), again transmitted prior to a Eurovision newsfeed via W3, this time from the regional city of Wroclaw. I recall this Polish test card being transmitted via the terrestrial TVP network many years ago.

Photo 11 shows a British Telecom/NewSkies Satellites caption, again via W3.

The transmissions were at 11.043GHz, with vertical polarisation, a symbol rate of 6,665 and 7/8 FEC. H.C.

### Pace 2200

This was a later version of the 2200 fitted with the ZIF tuner. It produced the 'no satellite signal received message'. The dealer who sent it to me said he had fitted a new tuner, but it looked more like a used than a new one. My first step was to check the installation menu, to confirm that the settings were all correct. I then removed the tuner and plugged it into my test rig. This confirmed that it was OK, so I refitted it and checked the tuning, 3.3V and 5V supplies, the serial clock and data lines, and the LNB supply. Everything seemed to be in order, but the digibox still didn't work.

I then realised that the 22kHz tone was missing from the LNB supply, though it was set to 'on' in the menu. The tone is generated by a pulse-width modulator within the ST20 housekeeping microcontroller chip U600, the tone output being at pin 142. It was present here. I continued scope checks through to C102 (470pF) and found that it was missing at the output side of this capacitor. But a replacement capacitor made no difference.

The tone is switched on and off by toggling pin 1 of U600. Time was wasted here. The tone is on when this pin is high (1.53V) and off when it's low (0V). But the change is not instantaneous: it takes place three seconds after you press 'select' with the remote-control unit. Very naughty!

Anyway U600 was OK, so it was back to the output side of C102. This is connected to the collector of the LNB switch-off transistor Q138 and the LM358M 22kHz tone amplifier chip U103. Clearly one or other of these items was deleting the tone. Replacing Q138 made no difference: replacing U103 made D101 (BAS16) go up in smoke. I also found that D107 (15V zener diode) and the 2SK2414 FET Q103 were leaky. Replacing all these items (U103, D101, D107 and Q103) finally restored normal operation. M.D.

### Panasonic TU-DSB30

The picture produced by this digibox was covered in red and green blocks, which

indicates a failed SDRAM chip. There are two to choose from, IC302 and IC303. I decided to check their temperatures using a laser-sighted digital thermometer. This showed that IC302 was running 2°C hotter than the other chip. A replacement (KM416S1120DT-G8) SDRAM in the IC302 position cured the problem.

I first used this trick about ten years ago, to locate a faulty RAM chip in an Atari computer that had eight of them in parallel. M.D.

### Amstrad DRX100

This digibox was stuck in standby with no LNB voltage present. Its owner said he had fitted a power-supply capacitor kit some eighteen months previously. Checks showed that the cause of the problem was with the 3.3V supply, where the voltage was low at 2.2V. The value of the 1,000µF, 16V reservoir capacitor C12 had fallen to 12µF, with an ESR of 12Ω. All the capacitors were green in colour and made by 'Nover'. The quality of the kit capacitors that had been fitted was in fact probably worse than that of the originals.

Replacement capacitor kits were originally produced by SatCure, but have been copied by other firms that have undercut prices by using poor-quality components. I recommend purchasing capacitor kits from SatCure, which supplies low-ESR capacitors rated for high ripple current. M.D.

### Pace 2500S5

Unlike the 2500S3, this model has the ZIF front-end on the main board. The MAX2115 ZIF chip is unfortunately prone to failure. This particular digibox produced the 'no satellite signal received' message, and the cause was traced to the ZIF chip.

Replacement is far from easy. You have to use a soldering station to remove the screening can after removing the LNB socket. The replacement chip measures only 6mm square and has 48 solder pads underneath. Unlike BGA chips, which come with pre-attached solder balls, the MAX2115 has bare pads. An exact amount of solder has to be applied to the PCB, then the chip is sat on top and taken up to reflow. This requires great skill and care to get it right. It's not my favourite job. M.D.

### Amstrad DRX100

This digibox had a familiar symptom – it produced the 'no satellite signal received' message – but this time the tuner's local oscillator was running and it was producing Q and I outputs. The OSD said a signal was being received, but with no quality.

The cure was to replace the BMC4200KEF QPSK channel decoder chip U100. M.D. ■

## Solution to Test Case 491

– see page 45 –

Home electronic and also electrical equipment is increasingly processor-controlled and software-driven. Few problems arise when the codebook and command set are burnt into a rugged ROM chip of some sort. EEPROMs used for the purpose are not so reliable however – their grip on the contents seems to be less firm!

With the user, factory and installation settings stored in a memory chip and acted upon by a microcontroller chip, we have in effect a mini computer. It has software, an operating system and peripherals, e.g. a deck mechanism. PCs do the right thing only when they are programmed correctly, and this was the problem with the Sony SLV-SE820G VCR. Sage had entered the right codes, but for the wrong model – the less-sophisticated SLV-SE720G. Thus the machine in question was suffering from some sort of an identity crisis and, in its new role as an SLV-SE720G, wouldn't have anything to do with its jog-timer knob – you don't have one of these with the SE720G!

Sage got out the SE820G data and found that its code table is somewhat different. He soon had the correct bytes entered – 3-15 inclusive. 19, 23, 27, 29, 32-35, 40, 41, 45, 47-50, 60, 61, 63, 64, 66, 69 and 72. After that the machine's functions and features could all be used.

This sort of thing is becoming increasingly common with modern equipment, along with software updates, not all of which can be transmitted over the air. So be wary!

## NEXT MONTH IN TELEVISION

### Mobile phones and their repair

Mobile phones are part of everyday life for most people nowadays. Chris Archer outlines their history, how they operate, and then describes dismantling and repair procedures for some common models. The aim is to provide enough basic information to enable you to attempt repairs rather than consigning faulty phones to the bin.

### Maintaining PA amplifiers

Here's a useful sideline, looking after the PA amplifiers used by local bands. Geoff Darby has been involved in this work for some time and explains the sort of problems you get and how to deal with them.

### Tackling the Vestel 11AK33 chassis

This chassis is used in various recent Hitachi and Wharfedale models. Tripping is a common fault condition which must be dealt with the right way. Alan Dent tells you how to go about it and describes some other fault conditions you might encounter.

### Putting the triac to work

The triac is a useful semiconductor device that's not as widely used as it deserves to be. J. LeJeune describes its origin, mode of operation and how to make use of it.

## PLUS ALL THE REGULAR FEATURES

## TELEVISION INDEX & DIRECTORY 2003

### Plus hard-copy index and reprints service

Here's the essential repair information you need! The Television Index & Directory 2003, in CD-ROM form, contains the text of nearly 15,000 high quality fault reports on TVs, VCRs, Camcorders, DVD players, Monitors, Satellite TV units, Audio equipment and CD players, searchable by make and model, plus the text of 180 Test Cases and over 200 major servicing articles, from fifteen years of Television magazine. It also contains a full fifteen year index of Television, a Spares Guide, a directory of Trade and Professional Organisations, an International TV Standards guide, a satellite TV Channel Finder, a TV transmitter list and a compendium of internet resources for service engineers. The software is quick and easy to use, and runs on any PC with Windows 95, 98, ME, NT, XP or 2000.

Television Index & Directory 2003 CD-ROM, £199

Television Index & Directory 2003 CD-ROM upgrade, £46 (to qualify for this upgrade you need to have purchased a previous version of the Television Index on floppy disk or on CD-ROM)

A six-month update of the index and fault reports will be available in May 2003. If you wish to take advantage of this, £10 should be added to your order.

Television Index only, 1988–2002, £36

Television Index only upgrade from previous versions, £16

**Hard-copy indexes** of Television magazine are available for Volumes 38 (1988) to 52 (2002) at £3.50 per volume.

**Reprints of articles** from Television back to 1988 are also available, at the flat rate of £3.50 per article — you can order through our web site, or write to the address below.

The above prices include UK postage and VAT where applicable. Add an extra £1 postage for non-UK EC orders, or £5 for non-EC overseas orders, although Channel Island residents do not need to add any extra postage. Cheques should be made payable to SoftCopy Ltd. Access, Visa or MasterCard Credit Cards are accepted. Allow up to 28 days for delivery (UK).

**SoftCopy Limited, 1 Vineries Close, Cheltenham, GL53 ONU, UK**

**Telephone 01242 241 455, Fax 01242 241 468**

**e-mail: sales@softcopy.co.uk web site:**

**http://www.softcopy.co.uk**

Published on the third Wednesday of each month by Highbury Business Communications, Nexus House, Azalea Drive, Swanley, Kent. BR8 8HU. **Highbury Business Communications** is a division of **Highbury Communications PLC**. **Typesetting** by Impress, Unit 2, Parkway, Southgate Way, Orton Southgate, Peterborough PE2 6YN. **Printed** in England by Polestar (Colchester) Ltd., Newcomen Way, Severalls Industrial Park, Colchester, Essex CO4 4TG. **Distributed** by Comag, Tavistock Road, West Drayton, Middlesex UB7 7GE (tel. 01895 444 055). **Sole Agents** for Australia and New Zealand. Gordon and Gotch (Asia) Ltd.; South Africa, Central News Agency Ltd. **Television** is sold subject to the following conditions, namely that it shall not, without the written consent of the Publishers first having been given, be lent, resold, hired out or otherwise disposed of by way of Trade at more than the recommended selling price shown on the cover, excluding Eire where the selling price is subject to currency exchange fluctuations and VAT, and that it shall not be lent, resold, hired or otherwise disposed of in a mutilated condition or in any unauthorised cover by way of Trade or affixed to or as part of any publication or advertising, literary or pictorial matter whatsoever.



# WHAT A LIFE!

## TV and VCR faults. Band III converters. Strange customers and warm sets. Donald Bullock's servicing commentary

We were due to return to Spain earlier in the month but, by way of getting their pound of flesh, Steven and Paul thought up a wheeze that would keep me in the workshop for a couple more days. They decided to go on an extended tench fishing exercise. It's my own fault I suppose. I became addicted to the sport at fourteen or so and I guess they are just taking after me. Of course they are nowhere near as good at it as I am!

### Enter Shiner

I had scarcely taken my coat off when Shiner Albright danced in. He's a 'ten per center' – he will take this or fetch that for anybody, saying that he does it out of the goodness of his heart. So he might, and no one says a word against him. But he always insists on a ten per cent discount from the shop, and charges the customer ten per cent on the price he should have paid to the shopkeeper. A handy way of getting by. He's also a natural charmer, with a quiet and casual gift of the gab. People queue up to have him help them.

He brings us a lot of jobs, so we can't complain. This time he brought in a Sharp VCM29HM VCR and a Toshiba TV set, Model 2151TB.

"For two of my good friends, Donald" he said. Then he heard cups chinking, but didn't let on. It was Greeneyes making the tea. He's always full of compliments for the ladies, and Greeneyes falls for his charm. He dropped his voice and smiled at her.

"There wouldn't be a cup of that nectar for poor old Shiner, would there?" he asked.

There was of course.

### The Toshiba TV

When he'd danced off I put the Toshiba set on the bench and plugged it in. After five seconds it clicked off. So I tried it again, and once more it tripped. I removed the back and looked around the chassis for dry-joints. There was a beauty at the mains bridge rectifier's reservoir capacitor. I felt good as I speedily dealt with it and tried again.

I didn't feel so good when the set tripped off once more. I had to do a bit of thinking. Then I reached for the meter to check the HT output from the power supply. It should have been about 115V, but the reading was way out at 145V. No wonder.

I decided to check the electrolytics on the primary side of the power supply and soon found that C817 (22 $\mu$ F, 100V) had fallen to about 2 $\mu$ F. It's the reservoir for the STR58041 chopper chip's -42V supply. The set worked perfectly once a replacement had been fitted.

### The VCR

Then I got round to the Sharp VCR. Apparently it kept chewing tapes and seizing up. When I opened it I found that there was a large amount of tape debris, all saturated with oil. After cleaning out the debris and mopping up the oil I carefully degreased the deck. In so doing I noticed that the left-hand spool was stiff, because the back-tension band was sticking to it. A new one put that right.

When Shiner breezed back I'd prepared the bills, taking care to add the ten per cent that he would want subtracted. He paid up happily after deducting his ten per cent, as he always does.

"Er, Shiner" I commented, "you didn't accidentally drop a teeny spot of oil in the recorder's works by any chance, did you?"

"Well, in a manner of speaking, just the tiniest drop" he replied, "but I want to thank you for doing these two so quickly. One is my granny's, the other

belongs to my aunt Rosie. You've made them both happy, Donald. Now it just so happens that I have another couple of jobs for you."

### More TVs

He ran out then returned with a giant Goodmans TV, Model GTV69W3BLU4. We know it, the chassis being the Vestel 11AK19PRO. From where I was the set seemed to run in on its own two legs.

"Dead as a dodo" he said as he put it down. "It belongs to my uncle Herbie." Then he danced out again and returned with a widescreen Sharp set, Model 66FW54H (DA100 chassis).

"Cracking and banging and all sorts" he announced. "Belongs to my late younger brother's wife." He winked at me, clicked his tongue then put on a devout face.

The Goodmans set had a short-circuit line output transistor, type BU2508AF. A replacement restored the picture, but the width was poor and there was severe EW distortion. It didn't take long to establish that the BUK444-200A EW driver FET was short-circuit. I fitted a PNQ20T in its place as this is more up to the job. But the bowing remained. After checking the various capacitors in the circuit, including the scan-corrector C630 that gives a lot of trouble, I turned my attention to the EW modulator diodes. The capacitors had both been OK, but D611 (BY299P) was open-circuit. A replacement completed the repair, and the picture was perfect.

Not bad I thought, now for the Sharp set. There was a lot wrong with this one, which was arcing badly. The HT reservoir capacitor C720 (100 $\mu$ F, 200V) had blown off its top, and the BUH515 line output transistor Q601 was short-circuit. R623 (1 $\Omega$ , 2W safety type) in the HT feed to the line output stage had gone open-circuit, and I assume that there had been excessive HT.

The MOC8106 optocoupler IC705 in the power supply is the prime suspect in this event, and turned out to be faulty. So were R765 and R766 (both 100 $\Omega$ ) in the feed to pin 1 of the optocoupler. They all live on the copper side of the board.

There were a number of faults on the CRT base PCB. The TEA5101A RGB output chip IC1801 had to be replaced, also Q5407 (2SA1837) and Q5408 (2SC4793) in the scan velocity-modulator output stage. R5425 (470Ω, 1W) in the supply to this stage was open-circuit.

It took some time to replace these various items. I then switched the set on, somewhat gingerly, and breathed a sigh of relief when it behaved perfectly. To prevent a recurrence of this sort of thing Sharp recommends adding a 170V avalanche diode in parallel with C720, with its cathode to the positive side. The part number is RH-EX0875BMZZ.

### Band III converters

Last month I mentioned that Bill and Hilary Wright were looking for a picture of a Band III converter, the first type of set-top box, that used to sit on top of BBC-only sets in the Fifties, after the start of ITV transmissions. I was doubtful whether there would be much response – they soon became obsolete, as the setmakers devised their own Band I/III tuners for fitting inside their sets. And what a mixed bag of tuners they introduced! Some were quite good and tidy, others were good but clumsy, and some were an absolute headache. The worst, to my mind, were the Ultra ‘trombone’ ones. They remain etched in my memory!

To my surprise however there was a good response. It’s clear that many readers have collections of vintage radio and TV sets and other brown goods items. I received photos from two readers, Bob Webb of Burton upon Trent and Dave Higgison of Doncaster. One was of a brand new, unused converter made by Champion! Dave mentions that it was potentially lethal, because it has a two-pin 5A mains connector into which the TV set could be plugged. Nothing wrong with that but, instead of fitting a shrouded socket, there’s a two-pin unshrouded live plug! My thanks to Bob and Dave.

### Emails

I am also grateful to those who have sent me emails on various points. Keep it up! You can reach me at [donald@wheatleypress.com](mailto:donald@wheatleypress.com)

Greeneyes is also very grateful to a reader we recently met and is about to settle in Spain. It wasn’t long before *Television* was mentioned and, when this column came up, Greeneyes confirmed that I was the guilty scribbler. He stepped back, looked at me carefully, then said:



“Coo, but that picture at the top of the column is an old one of you, isn’t it?”

In fact of course I’m much younger and more handsome than the picture makes out. I think someone else walked in front of the camera as it was clicked . . .

### Strange types

Dave Smith of Leigh, Lancashire tells me about some of the strange types who have wandered into his TV and electronics shop. One was an old lady who came in and studied a large card display of control knobs. She declined assistance and eventually turned away, showing some upset. Dave approached her again and it transpired that she thought she was in an ironmongers and wanted a brass doorknob.

Another time a tall, intelligent-looking chap slapped his money on the counter and asked for a packet of rubber goods. Dave explained that they didn’t sell them, and that he should try the chemists opposite.

“But,” the chap persisted, “I naturally assumed that you would be the best place to try, this being an electronics shop. After all each one is electrically tested, isn’t it?”

Then there was the chap who bought a radio kit and brought it back, saying it didn’t work. It looked neat and tidy but when Dave investigated he found that a fine-nozzled tube of grey Bostick had been used instead of solder!

Darren Henwood of Romford, Essex mentions the oddball who came into his TV shop and plonked a pair of well-worn shoes down. “I’d like these soled and heeled please” he said.

### Warm sets

Peter Nutkins of Charmouth, Dorset called at our place in Spain last year. He commented on the fact that customers often complain that their sets, after being repaired, get too warm. He

*The first sort of set-top box, a Band III converter that dates from the mid Fifties.*

recalled an incident in his early days in the trade when a customer with a Bush TV22 complained that it got too warm. Peter reassured him that he was mistaken, then placed the palm of his hand on the side of the Bakelite cabinet. It was red hot!

When he looked inside he soon found the reason for the heat. In an effort to suppress some slight mains-borne interference someone had added an RC circuit that consisted of a large wire-wound resistor in series with an even larger paper capacitor. This had been fitted to the side of the cabinet, on a tag strip, and wired across the mains input. The capacitor had gone short-circuit and the resistor was indeed red hot.

Another case involved a Bush TV53. This model had a strip of gold-coloured metal trim along the bottom of the tube’s implosion screen. The owner phoned repeatedly to complain that she got shocks from the trim while adjusting the controls. He explained that this wasn’t possible, as there was no connection between the trim and anything live.

Eventually she threatened legal action and he called to discuss the matter. In fact she was right! While it was true that there was no physical connection of anything live to the metal trim, a fault condition made it fleetingly and painfully ‘live’. The EY51 EHT rectifier was going short-circuit intermittently. As a result the EHT would momentarily collapse and induce a charge in the metal. Profuse apologies and a new EY51 restored good customer relations.

Peter did not mention it, but I wonder why the lady didn’t notice the effects of spasmodic EHT collapse on her picture? Too busy getting shocks maybe. ■



Colour CCTV camera, 8mm lens, 12V d.c. 200mA 582x628 Resolution 380 lines Automatic aperture lens Mirror function PAL Back Light Compensation MLR, 100x40x40mm. Ref EE2 £69

Built-in Audio .15lux CCD camera 12V d.c. 200mA 480 lines s/n ratio >48db 1V P-P output 110mm x 60mm x 50mm. Ref EE1 £99



Metal CCTV camera housings for internal or external use. Made from aluminium and plastic they are suitable for mounting body cameras in. Available in two sizes 1 - 100 x 70 x 170mm and 2 - 100 x 70 x 280mm. Ref EE6 £22 EE7 £26 multi-position brackets. Ref EE8 £8

Excellent quality multi-purpose TV/TFT screen, works as just a LCD colour monitor with any of our CCTV cameras or as a conventional TV. Ideal for use in boats and caravans 49.7MHz-91.75MHz VHF channels 1-5, 168-25MHz-222.75MHz VHF channels 6-12, 471.25MHz-869.75MHz, Cable channels 112-325MHz-166.75MHz Z1-Z7, Cable channels 224-25MHz-446.75MHz Z8-Z35 5" colour screen. Audio output 150mW. Connections, external aerial, earphone jack, audio/video input, 12V d.c. or mains. Accessories supplied Power supply, Remote control, Cigar lead power supply, Headphone Stand/Bracket, 5" model £139 Ref EE9, 6" model £149. Ref EE10



Self-cocking pistol plier 002 crossbow with metal body. Self-cocking for precise string alignment Aluminium alloy construction High tec fibre glass limbs Automatic safety catch Supplied with three bolts Track style for greater accuracy. Adjustable rear sight 50lb drawweight 150ft sec velocity Break action 17" string 30m range £21.65 Ref PLCR002

Fully cased IR light source suitable for CCTV applications. The unit measures 10 x 10 x 150mm, is mains operated and contains 54 infra-red LEDs. Designed to mount on a standard CCTV camera bracket. The unit also contains a daylight sensor that will only activate the infra-red lamp when the light level drops below a preset level. The infra-red lamp is suitable for indoor or exterior use, typical useage would be to provide additional IR illumination for CCTV cameras. £49. Ref EE11



Mains operated and designed to be used with any CCTV camera causing it to scan. The clips can be moved to adjust the scan angle, the motor reversing when it detects a clip. With the clips removed the scanner will rotate constantly at approx 2-3rpm. 75 x 75 x 80mm £23. Ref EE12

Colour CCTV Camera measures 60x45mm and has a built-in light level detector and 12 IR LEDs 0.2 lux 12 IR LEDs 12V d.c. Bracket Easy connect leads £69. Ref EE15



A high quality external colour CCTV camera with built-in infrared LEDs measuring 60 x 60 x 60mm Easy connect leads colour Waterproof PAL 1/4in. CCD 542 x 588 pixels 420 lines 0.05 lux 3-6mm F2 78 deg lens 12V d.c. 400mA Built-in light level sensor. £99. Ref EE13

Colour pinhole CCTV camera module with audio. Compact, just 20x20x20mm, built-in audio and easy connect leads PAL CMOS sensor 6-9V d.c. Effective Pixels 628x582 Illumination 2 lux Definition >240 Signal/noise ratio >40db Power consumption 200mW £35. Ref EE21



A small colour CCTV camera measuring just 35 x 28 x 30mm. Supplied complete with bracket, microphone and easy connect leads. Built-in audio. Colour 380 line resolution PAL 0.2 lux +18db sensitivity. Effective pixels 628 x 582 Power source 6-12V d.c. Power consumption 200mW £36. Ref EE16

Complete wireless CCTV system with video. Kit comprises pinhole colour camera with simple battery connection and a receiver with video output. 380 lines colour 2.4GHz 3 lux 6-12V d.c. manual tuning Available in two versions, pinhole and standard. £79 (pinhole) Ref EE17, £79 (standard). Ref EE18



Small transmitter designed to transmit audio and video signals on 2.4GHz. Unit measures 45 x 35 x 10mm. Ideal for assembly into covert CCTV systems Easy connect leads Audio and video input 12V d.c. Complete with aerial Selectable channel switch £30. Ref EE19



2.4GHz wireless receiver Fully cased audio and video 2.4GHz wireless receiver 190x140x30mm, metal case, 4 channel, 12V d.c. Adjustable time delay, 4s, 8s, 12s, 16s. £45. Ref EE20

The smallest PMR446 radios currently available (54x87x37mm). These tiny handheld PMR radios not only look great, but they are user friendly & packed with features including VOX, Scan & Dual Watch. Priced at £59.99 PER PAIR they are excellent value for money. Our new favourite PMR radios! Standby - 35 hours Includes: - 2 x Radios, 2 x Belt Clips & 2 x Carry Strap £59.95 Ref ALAN1 Or supplied with 2 sets of rechargeable batteries and two mains chargers £84.99. Ref Alan2



Beltronics BEL550 Euro radar and GATSO detector Claimed Detection Range: GATSO up to 400m. Radar & Laser guns up to 3 miles. Detects GATSO speed cameras at least 200 metres away, plenty of time to adjust your speed £319. Ref BEL550

TheTENS mini Microprocessors offer six types of automatic programme for shoulder pain, back/neck pain, aching joints, Rheumatic pain, migraines headaches, sports injuries, period pain. In fact all over body treatment. Will not interfere with existing medication. Not suitable for anyone with a heart pacemaker. Batteries supplied. £19.95 Ref TEN327 Spare pack of electrodes £5.99. Ref TEN327X



Dummy CCTV cameras These motioned cameras will work either on 2 AA batteries or with a standard DC adapter (not supplied) They have a built-in movement detector that will activate the camera if movement is detected causing the camera to 'pan' Good deterrent. Camera measures 20cm high, supplied with fixing screws. Camera also has a flashing red l.e.d. built in. £9.95. Ref CAMERAB

INFRA-RED FILM 6" square piece of flexible infra-red film that will only allow IR light through. Perfect for converting ordinary torches, lights, headlights etc to infra-red output only using standard light bulbs Easily cut to shape. 6" square £15. Ref IRF2 or a 12" sq for £29 IRF2A



#### GASTON SEALED LEAD-ACID BATTERIES



1-3AH 12V @ £5 REF GT1213  
3-4AH 12V @ £8 REF GT1234  
7AH 12V @ £8 REF GT127  
17AH 12V @ £18 REF GT1217

All new and boxed, bargain prices. Good quality sealed lead-acid batteries

SOLAR PANEL 10 watt silicon solar panel, at least 10 year life, 365 x 26mm, waterproof, ideal for fixing to caravans, boat, motorhomes etc. Nicely made unit with fixing holes for secure fittings. Complete with leads and connectors. Anodised frame. Supplied with two leads, one 3M lead is used for the clip with two croc clips, the other lead is used to connect extra panels. Panels do NOT require a blocking diode, they can be left connected at all times without discharging the battery. £84.99. REF PAN  
8A solar regulator 12V, 96 watt, 150mm x 100mm x 25mm £28. REF SOLREG2



High-power modules (80W+) using 125mm square multi-crystal silicon solar cells with bypass diode. Anti-reflection coating and BSF structure to improve cell conversion efficiency: 14%. Using white tempered glass, EVA resin, and a weatherproof film along with an aluminium frame for extended outdoor use, system Lead wire with waterproof connector. Four sizes, 80W 12V d.c. 1200 x 530 x 35mm, £287. REF NE80. 123W 12V d.c., 1499 x 662 x 46mm, £439. REF NDL3. 125W 24V, 1190 x 792 x 46mm, £439. REF NEL5 and 165W 24V, 157 x 826 x 46mm, £593.

**BULL GROUP LTD**  
UNIT D, HENFIELD BUSINESS PARK,  
HENFIELD, SUSSEX BN5 9SL  
TERMS: CASH, PO, CHEQUE PRICES + VAT  
WITH ORDER PLUS £5.50 P&P (UK) PLUS VAT.  
24 HOUR SERVICE £7.50 (UK) PLUS VAT.  
OVERSEAS ORDERS AT COST PLUS £3.50  
Tel: 0870 7707520 Fax 01273 491813  
Sales@bullnet.co.uk  
www.bullnet.co.uk

THE TIDE CLOCK. These clocks indicate the state of the tide. Most areas in the world have two high tides and two low tides a day, so the tide clock has been specially designed to rotate twice each lunar day (every 12 hours and 25 minutes) giving you a quick and easy indication of high and low water. The Quartz tide clock will always stay calibrated to the moon. £21 REF TIDEC



LINEAR ACTUATORS 12-36V D.C. BUILT-IN ADJUSTABLE LIMIT SWITCHES. POWER COATED 18in. THROW UP TO 1,000lb. THRUST (400lb. RECOMMENDED LOAD). SUPPLIED WITH MOUNTING BRACKETS DESIGNED FOR OUTDOOR USE. These brackets originally made for moving very large satellite dishes are possibly more suitable for closing gates, mechanical machinery, robot wars etc. Our first sale was to a company building solar panels that track the sun! Two sizes available, 12in. and 18in. throw. £29.95. REF ACT12, £34.95 REF ACT18.



POWERSAFE DEEP CYCLE BATTERIES  
12V 51AH. NOW ONLY £29.95 EACH  
YUASA 6V 100AH NOW ONLY £19 EACH



BRAND NEW MILITARY ISSUE DOSE METERS (radiation detectors). Current NATO issue. Standard emergency services unit. Used by most of the world's military personnel. New and boxed. £69. REF SIEM69

NIGHT VISION SYSTEM. Superb hunting rifle sight to fit most rifles, grooved for a telescopic sight. Complete with infra-red illuminator. Magnification 2-7x. Complete with rubber eye shield and case. Opens up a whole new world! Russian made. Can be used as a hand held or mounted on a rifle. £99. REF PN1



These Samarium magnets measure 57mm x 20mm and have a threaded hole (5/16th UNF) in the centre and magnetic strength of 2-2 gauss. We have tested these on a steel beam running through the offices and found that they will take more than 170lb. (77kg) in weight before being pulled off. With keeper. £19.95. REF MAG77.

Peltier Effect heat pump. Semiconductor thermoelectric device which works on the Peltier effect. When supplied with a suitable electric current, can either cool or heat. Also when subject to an externally applied temperature gradient can produce an electric current. Ideal for cooling or controlling the temperature of sub assemblies. Each module is supplied with a comprehensive 18-page Peltier design manual featuring circuit designs, design information etc., etc. The Peltier manual is also available separately. Maximum watts 56-2 40 x 40mm Imax, 5-5A Vmax, 16-7 Tmax (c-dry N2), 72. £29.95 (inc. manual. REF PELT1. Just manual £4 REF PELT2.



New transmitter, receiver and camera kit. £69. Kit contains four channel switchable camera with built-in audio, six IR l.e.d.s and transmitter, four channel switchable receiver, 2 power supplies, cables, connectors and mounting bracket £69. Wireless Transmitter. Black and white camera (75 x 50 x 55mm). Built-in 4 channel transmitter (switchable). Audio built-in 6 IR l.e.d.s. Bracket/stand. Power supply 30m range Wireless Receiver 4 channel (switchable). Audio/video leads and scart adapter. Power supply and manual. £69. REF COP24.



This miniature Stirling Cycle Engine measures 7in. x 4 1/4in. and comes complete with built-in alcohol burner. Ref flywheels and chassis mounted on a green base, these all-metal beauties silently running at speeds in excess of 1,000 r.p.m. attract attention and create awe wherever displayed. This model comes completely assembled and ready to run. £97. REF SOL!



SHOP ONLINE  
WWW.BULLNET.CO.UK

# P.J.HILL TV. VCR. SPARES FLYBACK TRANSFORMERS BY ELDOR, OREGA, TERMAL, CLASSIC ALSO BUDGET RANGE.

Enquire by No's off old transformer & model No. For Akai, Akora, Alba, Aiwa, Bush, Beko, Daewoo, Ferguson, Formentii, Goodmans, Grundig, Hinari, ITT, JVC, Matsui, Net, Orion, Panasonic, Philips, Samsung, Sanyo, SEG, Sharp, Sony, Thomson, Tatung, Toshiba, etc

## REMOTE CONTROL BY CLASSIC

Video heads & spares, CD Lasers, belts, mains switches, semi conductors, valves, switch mode transformers (including Matsui 2196N) service kits, T/V, VCR & satellite resistors, capacitors, valves, tuners, triplers etc.

ASK ABOUT OUR SERVICE MANUAL LIBRARY FOR TV VIDEO & MICROWAVE & AUDIO.

MOST CREDIT & DEBIT CARDS

**P.J.HILL**  
**classic**  
DISTRIBUTOR

**E7 NORTHWAY TRADING EST,  
NORTHWAY LANE, TEWKESBURY,  
GLOS, GL20 8JH,  
TEL: 01684 296902  
FAX: 01684 294317**



## VIDEO DISPLAY (EUROPE) LIMITED

Video Display (Europe) Ltd, Unit 5, Old Forge Trading Est  
Sudley Road, Lymington, West Midlands DY9 8EL  
United Kingdom  
Tel 44 (0) 1384 894777 Fax: 44 (0) 1384 895788  
ad@img.euro.com

**Data & Display  
Components**

### SPECIAL OFFERS

**TEKTRONIX 2445A 4 Ch  
150MHz Delay, Cursors etc  
Supplied with 2 Tektronic probes** **ONLY £425**

**TEKTRONIX 2232 Digital Storage Scope Dual Trace  
100 MHz 100ms with probe** £525

**H.P. 54501A Digitizing Oscilloscope 100MHz, 4Ch** £425

**CIRIUS CRL254 Sound Level Meter with Calibrator  
80-120dB LEO** £95

**BECKMAN HD110 Handheld 3 1/2 digit DMM, 28  
ranges with battery, leads and carrying case** £30

**WAYNE KERR B424 Component Bridge** £50

**RACAL 9300 True RMS Voltmeter 5Hz-20MHz  
usable to 60MHz 10v-316v** £50

**RACAL 9300B as above** £75

**H.P. 3312A Function Gen 0.1Hz-13MHz AM/FM  
Sweep/Tri/Gate/Burst etc** £300

**FARNELL AMM255 Automatic Mod Meter 1.5MHz-  
2GHz Unused** £300

**FARNELL DSG1 Low Frequency Syn Sig Gen  
0.001Hz to 99.99kHz, Low Distortion TTL/Square/  
Pulse Outputs etc** £95

**FLUKE 8600A Handheld True RMS DMM 4 1/2 digit  
As new £150 Used £95**

**H.P. 3310A Function Gen 0.005Hz-5MHz Sine/Sq/Tri/  
Ramp/Pulse** £125

**FARNELL FLM4 Sine/Sq Oscillator 10Hz-1MHz  
distortion TTL Output Amplitude Meter** £95

**H.P. 545A Logic Probe with  
and 547A Current Tracer** £95

**FLUKE 77 Multimeter 3 1/2 digit 1000V  
15kV Series II** £70

**HEME 1000 LCD Clamp Meter 200A In Carrying  
Case** £100

**BLACK STAR ORION PAL-TV VIDEO Colour Item  
Generator from £125**

**THURLBY/THANDAR TG2100 Function Generator  
0.002Hz-2MHz TTL etc** £95

**THURLBY/THANDAR PSU 0.1-30V 0-2A Twice  
(Late version)** £200

**Racal 9008 ONLY  
Automatic Modulation Meter AM/FM  
1.5MHz-2GHz** **£95**

**Datron 1061A  
High Quality 5 1/2 digit Bench Multimeter  
True RMS/4 wire Current Converter** **£225**

### JUST IN

**H.P. 8640A SIGNAL GENERATOR AM/FM** £250

**500KHz-512MHz**

**KENWOOD CS4025 Oscilloscope Dual Trace 20MHz** £125

**LEADER LB0523 Oscilloscope Dual Trace 35MHz** £140

**GOULD OS300 Oscilloscope Dual Trace 20MHz** £95

**NATIONAL PANASONIC VP7705A Distortion Analyser** £125

**KENWOOD VT176 Millivoltmeter 2Channel** £50

**KENWOOD FL140 Wow & Flutter Meter** £50

**KENWOOD FL180A Wow & Flutter Meter** £50

**BIRD 43 Watt Meter** £75

**Elements for the above** £25

**MARCONI 893C AF Power Meter, Sine Measurement,  
Unused £100 Used £60**

**MARCONI 893B No-Sine** £30

**MARCONI 2610 True RMS Voltmeter Autorange  
25MHz** £195

**GOULD J3B Sine/Sq Osc. 10Hz-100kHz Low Distortion** £125

**AVO 8 Mk6 in Ever Ready Case, with leads and  
Others Avos** £80

**GOODWILL GVT427 Dual Ch. Auto Range  
Ranges Freq 10Hz-1MHz** £100-£125

**SOLARTRON 7150 DMM 4 1/2 digit True RMS - IEEE** £95

**SOLA 7150 PLUS** £100

**QUALITY RACAL CO** £50

**Counter 50MHz** £50

**Counter 10Hz-520MHz** £75

**Counter 10Hz-560MHz** £50

**AIM 9343M Logic Analyser** £200

**Automeasurements Ltd** £100

**HUNTRON M1000** £100

**MARCONI 893C AF Power Meter, Sine Measurement,  
Unused £100 Used £60**

**FARNELL AP60/150** £2000

**FARNELL AP100/90** £2000

**H.P. 60128 DC PS** £1000

**FARNELL AP60/50** £1000

**FARNELL H60/50 0-60V 0-50A** £750

**FARNELL H60/25 0-60V 0-25A** £400

**Power Supply HPS3010 0-30V, 0-10A** £140

**FARNELL Dual PSU XA35-2T 0-35V 0-2A Twice OMD  
Display** £180

**FARNELL L30-2 0-30V, 0-2A** £80

**FARNELL L30-1 0-30V, 0-1A** £60

**Many other Power Supplies available**

**Isolating Transformer 240V In/Out 500VA** £40

### Farnell DTV 12-14 OSCILLOSCOPE

Dual Trace 12 MHz TV. Coupling. ONLY £75

### FARNELL LFI Sine/Sq OSCILLATOR

10Hz-1MHz. ONLY £75

### OSCILLOSCOPES

**TEKTRONIX TDS350 Dual Trace 200MHz 1GS  
unused** £400

**TEKTRONIX TDS320 Dual Trace 100MHz 500MS  
used** £200

**TEKTRONIX TDS310 Dual Trace 50MHz 200MS  
used** £150

**LECROY 9400A Dual Trace 175MHz SG/S** £500

**HITACHI VC6523 Dual Trace** £500

**PHILIPS PM3092 2-20MHz 200MS** £500

**PHILIPS PM3082 2-20MHz 200MS** £500

### OSCILLOSCOPES AVAILABLE

**TEKTRONIX TDS350 Dual Trace 200MHz 1GS  
unused** £400

**TEKTRONIX TDS320 Dual Trace 100MHz 500MS  
used** £200

**TEKTRONIX TDS310 Dual Trace 50MHz 200MS  
used** £150

**LECROY 9400A Dual Trace 175MHz SG/S** £500

**HITACHI VC6523 Dual Trace** £500

**PHILIPS PM3092 2-20MHz 200MS** £500

**PHILIPS PM3082 2-20MHz 200MS** £500

### OSCILLOSCOPES AVAILABLE

**TEKTRONIX TDS350 Dual Trace 200MHz 1GS  
unused** £400

**TEKTRONIX TDS320 Dual Trace 100MHz 500MS  
used** £200

**TEKTRONIX TDS310 Dual Trace 50MHz 200MS  
used** £150

**LECROY 9400A Dual Trace 175MHz SG/S** £500

**HITACHI VC6523 Dual Trace** £500

**PHILIPS PM3092 2-20MHz 200MS** £500

**PHILIPS PM3082 2-20MHz 200MS** £500

### OSCILLOSCOPES AVAILABLE

**TEKTRONIX TDS350 Dual Trace 200MHz 1GS  
unused** £400

**TEKTRONIX TDS320 Dual Trace 100MHz 500MS  
used** £200

**TEKTRONIX TDS310 Dual Trace 50MHz 200MS  
used** £150

**LECROY 9400A Dual Trace 175MHz SG/S** £500

**HITACHI VC6523 Dual Trace** £500

**PHILIPS PM3092 2-20MHz 200MS** £500

**PHILIPS PM3082 2-20MHz 200MS** £500

### OSCILLOSCOPES AVAILABLE

**TEKTRONIX TDS350 Dual Trace 200MHz 1GS  
unused** £400

**TEKTRONIX TDS320 Dual Trace 100MHz 500MS  
used** £200

**TEKTRONIX TDS310 Dual Trace 50MHz 200MS  
used** £150

**LECROY 9400A Dual Trace 175MHz SG/S** £500

**HITACHI VC6523 Dual Trace** £500

**PHILIPS PM3092 2-20MHz 200MS** £500

**PHILIPS PM3082 2-20MHz 200MS** £500

### H.P. 6063B DC Electronic Load 3-240V/0-10A 250W

**H.P. 66312A PSU 0-20V/0-2A** P.O.A. £400

**H.P. 66311B PSU 0-15V/0-3A** £400

**H.P. 66309D PSU Dual 0-15V 0-3A/0-12V 0-1.5A** £750

**H.P. 6632B PSU 0-20V/0-5A** £500

**H.P. 6623A PSU Triple Output ranging from  
0-2V 0-5A to 0-20V 0-4A** £850

**Agilent 34401A DMM 6 1/2 digit** £400/£450

**Agilent 34402A DMM 5 1/2 digit** £275

**Agilent 45 DMM 3 1/2 digit** £400

**KETTLERLEY 2010 6 1/2 digit** £950

**KETTLERLEY 6170 3 1/2 digit** £1250

**H.P. 4338B 1000V Meter** £1500

**RACAL 9300 2.6 GHz** £500

**RACAL 9300 3GHz** £850

**RACAL 9300 3GHz Function Gen/ARB.** £900/£1000

### OSCILLOSCOPES AVAILABLE

**TEKTRONIX TDS350 Dual Trace 200MHz 1GS  
unused** £400

**TEKTRONIX TDS320 Dual Trace 100MHz 500MS  
used** £200

**TEKTRONIX TDS310 Dual Trace 50MHz 200MS  
used** £150

**LECROY 9400A Dual Trace 175MHz SG/S** £500

**HITACHI VC6523 Dual Trace** £500

**PHILIPS PM3092 2-20MHz 200MS** £500

**PHILIPS PM3082 2-20MHz 200MS** £500

### SPECTRUM ANALYSERS

**H.P. 8720C Microwave Network Analyser 50Hz - 20GHz** £12500

**H.P. 8561B 50Hz - 6.5GHz** £5000

**H.P. 8560A 50Hz - 2.9GHz Synthesised** £5000

**H.P. 8594E 9kHz - 2.9GHz** £4500

**H.P. 8591E 1MHz - 1.8GHz 75 ohm** £2750

**H.P. 853A with 8559A 100kHz - 21GHz** £1750

**H.P. 8558B with Main Frame 100kHz - 1500MHz** £750

**H.P. 3585A 20Hz - 40MHz** £2500

**H.P. 3580A 5Hz - 50kHz** £600

**ADVANTEST R4131B 10kHz - 3.5GHz** £2750

**EATON/Aitech 757 0.001 - 22GHz** £2750

**MARCONI 2382 100Hz - 400MHz High Res** £5000

**MARCONI 2370 30Hz - 110MHz** from £500

**H.P. 182 with 8557 10kHz - 350MHz** £500

**H.P. 141T Systems**

**8553 1kHz - 110MHz** £500

**8554 500kHz - 1250MHz** £750

**8555 10MHz - 18GHz** £1500

**H.P. 8443 Tracking Gen/Counter 110MHz** £250

**H.P. 8444 Opt 059** £750

**B & K 2033R Signal Analyser** £650

**H.P. 8754A Network Analyser 4MHz - 1300MHz** £1250

**H.P. 3577A Network Analyser 5Hz - 200MHz** £3000

**H.P. 53310A Modulation Domain Analyser Dpt  
001/003** £5000

**ONO SOKKI Portable FFT Analyser** £1500

### RADIO COMMUNICATORS TEST SETS

**MARCONI 2955/2955R** from £1000

**Rohde & Schwarz CMT 0.1 - 1000MHz** £1500

**Schlumberger 4040** £750

### USED EQUIPMENT - GUARANTEED. Manuals supplied.

This is a VERY SMALL SAMPLE OF STOCK. SAE or telephone for lists. Please check availability before ordering. CARRIAGE all units £16. VAT to be added to total of goods and carriage.

### STEWART OF READING

110 WYKEHAM ROAD, READING, BERKS RG6 1PL  
Telephone: (0118) 9268041 Fax: (0118) 9351696  
www.stewart-of-reading.co.uk



Callers welcome 9am-5.30pm Monday to Friday (other times by arrangement)

# ADVERTISERS INDEX

Aerial Techniques.....	35	Kudos Marketing.....	63
Alban Electronics .....	OBC	Logik Business Solutions.....	31
Bang & Olufsen.....	52	Martin Turner Direct.....	53
B Smart .....	49	M.C.E.S.....	41
Blundell Production Equipment .....	IBC	Multigen .....	42
Bull Electrical.....	60	Peak Electronic Design .....	30
Calder Components.....	31	PJ Hill.....	61
Campion Electronics .....	49	Remotes Direct .....	31
Coastal Aerial Supplies.....	41	Stewart of Reading.....	61
Colourtrade.....	52	Satellite & Digital Services.....	49
Cricklewood Electronics Ltd .....	41	TW Electronics .....	IFC
D'Lec Components .....	31	Trade Electronix .....	37
East London Components .....	43	Urwin Electronics .....	39
Economic Devices .....	49	Vann Draper Electronics Ltd.....	42
Electronic World T.V. & Video .....	43	Video Display Europe Ltd.....	61
Express TV .....	41	Welwyn Tools.....	43
Grandata Ltd .....	19-24	Wiltsgrove .....	2
Horizon Global Electronics .....	62		
Instore Electrics.....	62		
JPG Electronics .....	62		



## What a Lovely Pair!



### HORIZON DIGITAL TERRESTRIAL METER

#### HDTM

- Signal Strength and BER displayed together
- Pre and post BER displayed on sub menu
- 10 pre programmed transmitters (via website) or all channel step through
- Audible tune-in, with back light
- 7 or 8 MHz channels
- 2K and 8K mode
- Automatic Transmission and constlation
- VHF (band3) and UHF bands
- RF input range 167-862 MHz
- Input dynamic range -72dBm~-20dBm
- Input connector BNC. Input imp75 ohms. Loop through
- External power for mast amplifiers, etc.
- Built in universal charger 80-250 V Ac. Intelligent charger (CE approved) with delta V delta T detection. Fast charge, then Trickle
- Run time with full charge: Minimum 5 hours from 2.5 Ah battery
- Figure of 8 mains input connector. 2.1 mm Female PSU plug for external charge via supplied car charger
- Computer interface: Serial port (Com 1-4) for upgradeable software on transmitters.

### HORIZON DIGITAL SATELLITE METER

#### HDSMV2

- Signal Strength and BER displayed together
- 32 Transponders or 16 satellites, horizontal & vertical
- Audible tune-in, with back light
- DVB, C&Ku band, Mpeg, V Sat compatible
- Input dynamic range -65dBm~-25dBm
- Input connector F-female. Input imp 75 ohms
- Symbol Frequency rate from 1 Msps ~ 45Msps
- Universal charger 80 V ~ 250 V Ac. Intelligent Charger (CE approved) with delta V delta T detection Fast charge, then Trickle
- Run time with full charge (single LNB): Minimum 3 hours from 2.4Ah battery
- Figure of 8 mains input connector. 2.1 mm Female PSU plug for external charge via car charger
- LNB short circuit protection 500 mA automatic limiter
- RF input range 950- 2150 MHz
- Computer interface: Serial Port (COM 1,2,3 or 4) for upgradeable software on satellite settings.

[www.horizonhge.com](http://www.horizonhge.com)

Speed up your installations call NOW on +44 (0)20 8281 3777  
or email [sales@horizonhge.com](mailto:sales@horizonhge.com) for a reliable solution





**WATCH SLIDES ON TV  
MAKE VIDEOS OF  
YOUR SLIDES  
DIGITISE YOUR  
SLIDES  
(using a video capture card)**



"Liesegang diatv" automatic slide viewer with built in high quality colour TV camera. It has a composite video output to a phono plug (SCART & BNC adaptors are available). They are in very good condition with few signs of use. For further details see [www.diatv.co.uk](http://www.diatv.co.uk)  
.....£91.91+ vat = £108.00

Board cameras all with 512x582 pixels 8.5mm 1/3 inch sensor and composite video out. All need to be housed in your own enclosure and have fragile exposed surface mount parts. They all require a power supply of between 10 and 12v DC 150mA.

47MIR size 60x36x27mm with 6 infra red LEDs (gives the same illumination as a small torch but is not visible to the human eye).....£37.00 + vat = £43.48

30MP size 32x32x14mm spy camera with a fixed focus pin hole lens for hiding behind a very small hole.....£35.00 + vat = £41.13

40MC size 39x38x27mm camera for 'C' mount lens these give a much sharper image than with the smaller lenses.....£32.00 + vat = £37.60

Economy C mount lenses all fixed focus & fixed iris  
VSL1220F 12mm F1.6 12x15 degrees viewing angle.....£15.97 + vat = £18.76

VSL4022F 4mm F1.22 63x47 degrees viewing angle.....£17.65 + vat = £20.74

VSL6022F 6mm F1.22 42x32 degrees viewing angle.....£19.05 + vat = £22.38

VSL8020F 8mm F1.22 32x24 degrees viewing angle.....£19.90 + vat = £23.38

Better quality C Mount lenses  
VSL1614F 16mm F1.6 30x24 degrees viewing angle.....£26.43 + vat = £31.06

VWL813M 8mm F1.3 with iris 56x42 degrees viewing angle.....£77.45 + vat = £91.00

1206 surface mount resistors E12 values 10 ohm to 1M ohm 100 of 1 value £1.00 + vat 1000 of 1 value £5.00 + vat

866 battery pack originally intended to be used with an orbitel mobile telephone it contains 10 1.6Ah sub C batteries (42x22dia the size usually used in cordless screwdrivers etc.) the pack is new and unused and can be broken open quite easily.....£7.46+vat = £8.77



Please add 1.66 + vat = £1.95 postage & packing per order

**JPG ELECTRONICS**

Shaws Row, Old Road, Chesterfield, S40 2RB

Tel 01246 211202 Fax 01246 550959 Mastercard/Visa/Switch

Callers welcome 9:30 a.m. to 5:30 p.m. Monday to Saturday



**ELECTRICS LIMITED**

171 HAREHILLS LANE, LEEDS LS8 3QE

Tel: 0113 240 1114. Tel/Fax: 0113 240 7275.

Mobile: 07976 403134

Email: [sales@instoreleeds.freeserve.co.uk](mailto:sales@instoreleeds.freeserve.co.uk)

**MANUFACTURES GRADED PRODUCTS  
ALL PRICES PLUS VAT:  
ALL PRODUCTS FULLY GUARANTEED**

\*  
PHILIPS 32PW6506 32" WIDESCREEN REAL FLAT,  
FM RADIO, 50HZ **£349.00**

\*  
PHILIPS 32PW9527 32" WIDESCREEN REAL FLAT,  
DOLBY, 100HZ, PIXEL PLUS **£549.00**

\*  
PHILIPS LX3000 DVD PLAYER 5.1 SURROUND  
SOUND SYSTEM, 75W RMS **£139.00**

\*  
PHILIPS 14" TV/VCR COMBI FROM **£84.00**  
PHILIPS 14" PORTABLES FROM **£59.00**

\*  
PHILIPS VCR'S FROM **£39.00**  
PHILIPS AUDIO SYSTEMS FROM **£44.00**

\*  
**FURTHER OFFERS AVAILABLE  
PLEASE CALL FOR A PRICE LIST  
CREDIT CARDS WELCOME: NEXT DAY DELIVERY**

**SPARES DIRECT**



**Why go any-  
where else for  
Panasonic  
spares?**

From phones to cameras, home cinema systems to DVD players, Panasonic brings ideas to life. If you service or repair any of our products, we can make your life easier too, thanks to the new Panasonic Spares Direct website.

Specially developed for smaller companies who only need parts or advice occasionally but still want genuine discounts on guaranteed spare parts, it's now open for business.

Register on the subscription-based site now and for just £24 for a year's access you'll find the most competitive prices, online technical information and repair manuals, special offers and immediate part number identification.

It's fast, it's easy, it's trouble-free and it's the only place you need to visit when you need to service or repair any Panasonic product.

So why call us for spares when you can now visit us 24 hours a day?

Visit [www.panasonic-spares-direct.co.uk](http://www.panasonic-spares-direct.co.uk) for more information.

**Panasonic**

Panasonic CS UK  
Willoughby Road, Bracknell, Berkshire, RG12 8FP

[www.panasonic-spares-direct.co.uk](http://www.panasonic-spares-direct.co.uk)

# Service Link

TELEPHONE 01322 611292

FAX 01322 616376

## FOR SALE

### EX RENTAL TVs, VCRs, PORTABLES

**Combi Washing  
Machines, Fridge  
Freezers etc.**

For stock list call

**Barry McDonald  
01622 719313  
or 07836 789528**

### CLOSED DOWN SERVICE CENTRE

Everything like large quantity of  
CTV, VCR, Camcorders, Audio and  
Hi-Fi service manuals for Sony,  
Panasonic, JVC, Toshiba etc.  
Books and lots more plus test  
equipment, meters etc.  
Spare parts and cabinets, lots of  
made test leads.  
New audio video leads accessories.  
Please call Matt 07958 471033

### ICC17 LOPTX Kit

Widescreen Special  
*Ferguson W7023U etc.*  
*Thomson 24WK23U etc*  
*Pt no. 10608670P1*

**ONLY £24.95!**

**IrwinElectronics**  
Telephone 0114 273 9622

### SKY - DIGIBOXES

SALES - PERFECT COMPLETE  
SILVER PANASONICS  
£95 INCLUSIVE PRICES  
Other models £65  
Faulty Boxes £20  
Minimum 3 boxes  
Plus carriage.  
K.T.V. Warehouse,  
Tucking Mill, Camborne,  
Cornwall TR14 8NP.  
Tel: 01209 718043 11am-4pm

## FOR SALE

### ? STOP

LOPT'S. REMOTES  
ALL TV COMPONENTS

TIDMAN MAIL ORDER LTD  
236 SANDYCOMBE RD  
KEW RICHMOND  
SURREY TW9 2EQ  
(1/2 MILE FROM KEW BRIDGE)  
PHONE: 020-8948-3702

### PHOTOGRAPHIC SERVICES

### BENCH ENGINEER REQUIRED

TO REPAIR ANALOG AND DIGITAL  
CAMCORDERS ETC

- Minimum experience 5 years
- Able to work to component level
- Location Kent
- Performance pay 20-35k +  
healthcare

Contact Trevor on Tel: 01732 761270  
E-mail address: trev4dnh@aol.com

### PROJECTOR SPARES

### VIDIKRON

projector spare parts and  
service information.

PROJECTSPARES  
Tel: 01444 831769  
Fax: 01444 831580  
E-mail:  
projectspares@btinternet.com

### REPAIRS

### Trade repairs to Sky digiboxes

Pace, Amstrad, Grundig, Panasonic,  
(including Fluid Ingress).  
All makes repaired at a fair fixed price.

**Scan Digital Services**

For details  
Give Alan a ring on  
Tel/Fax: 01633 25 40 50  
E-Mail: alan@scansat.globalnet.co.uk

## SERVICE DATA

### NEED HELP NOW?

Then ring the

### ★ ELECTRON TECHNICAL HELPLINE ★

Genuine help available to all  
repairers of

T.V. - V.C.R - SAT - AUDIO  
(Inc Valves)

Over 30 years experience and  
vast data base

**0906 470 1706**

Calls cost 60p per minute

Hours of Business Mon to Fri  
9.00 am - 12.30pm : 2.15pm - 5.30pm  
Sat. Morn 9am - 12.30pm

### TV/VCR CIRCUITS (WE DO NOT STOCK AUDIO OR MONITOR INFORMATION)

TEL A.T.V. on  
**0114 285 4254**

CTV Circuits ..... from £5.00  
VCR Circuits ..... from £7.00  
CTV Manuals ..... from £10.50  
VCR Manuals ..... from £14.50

User instructions also available  
(P/P add £2.50 to each order)

**419 LANGSETT ROAD  
SHEFFIELD S6 2LL**

MANUAL COLLECTIONS PURCHASED.  
(POST 1995)

### SERVICE MANUALS

Have you ever turned away work  
for want of a Service Manual?  
Have you ever bought a Service  
Manual and never used it more  
than once?

Then why not join ...

### THE MANUALS LIBRARY

For details and membership  
application form write,  
phone or fax:

**HARVEY ELECTRONICS**

43 Loop Road, Beachley, Chepstow,  
Mons, NP16 7HE

Tel: 01291 623086 Fax: 01291 628786

Visa: Mastercard accepted

## SERVICE DATA

Service Information **FES** Circuit Diagrams

TV's, VCR's, SATELLITE  
CAMCORDERS, AUDIO &  
HI-FI's

Prices are from £5.50 + £2.75 P&P  
add a further £5.50 per item  
in the same order

note: some items priced individually

**we now supply universal  
tv/video remotes at competitive  
prices**

Payment by credit card, PO or cheque

Tel: Fax 01206 211570

e-mail: colin@fryerns.fsbusiness.co.uk



2 The Lodge  
Easthorpe Green  
Marks Tey, Colchester  
CO6 1HA

### SERVICE INFO

TV - VIDEO - AUDIO

Prices- any make/model

CTV	s/man	10.00
VCR	s/man	15.00
CTV	circs	5.00
VCR	circs	7.00

Other items POA

All prices include p/p.  
Do not add any VAT

**AMTel**

Huna,  
Caithness KW1 4YL  
**01955 611313**  
[www.amtel.org.uk](http://www.amtel.org.uk)

### WANTED

### BEST CASH PRICES PAID

FOR VALVES KT88,  
PX4 AND MOST  
AUDIO/OTHER  
TYPES.

**Tel: 01403 784961**

Billington Export Ltd  
Sussex RH14 9EZ  
Fax 01403 783519  
Email: sales@bel-tubes.co.uk  
Visitors by appointment

For a FREE consultation on how best to market your products/services  
to a professional audience contact REUBEN on 01322 611292

DOWNLOAD FREE SAMPLE CHAPTERS AT [www.newnespress.com](http://www.newnespress.com)

## DVD PLAYERS AND DRIVES

**K. F. Ibrahim**

**£24.99**

- ▼ The engineer's guide to DVD technology
- ▼ Fully up-to-date coverage of video, PC and audio applications

This book is a comprehensive guide to the technology and its application, with a special focus on design issues and pitfalls, maintenance and repair. The

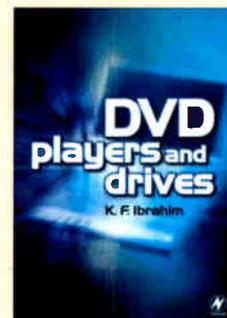
principles of DVD technology are introduced from the basics, and DVD applications are illustrated by genuine technical information in the form of block diagrams and circuit schematics. All current forms of DVD player and writer are introduced, including equipment types that are only just appearing on the market.

**CONTENTS:** Introduction; DVD discs; Digital processing; Video encoding; Audio encoding; The DVD player; Microprocessors for DVD systems;

**NEW**

Signal processing; Servo control; Microprocessor control; The power supply and user interface; DVD writers; DVD drives for Personal Computers; Testing and fault diagnosis; Glossary; Appendices, including DVD specifications and standards; Index

August 2003 336pp 234 x 156mm 150 illustrations Paperback ISBN 0750657367



## CLOSED CIRCUIT TELEVISION

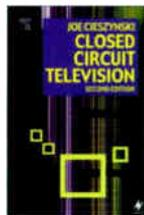
**CCTV Installation, Maintenance and Operation**

**Second Edition**

**Joe Cieszynski**

**£24.99**

**NEW**



- ▼ Concise and accessible, ideal quick reference for on-the-job use

- ▼ Provides a thorough guide to the technical side of CCTV and is fully dual-standard for PAL and NTSC systems

CCTV is an essential guide for professionals involved in the installation and maintenance of CCTV systems, system design, specification and purchasing and the management of CCTV systems. This book provides a thorough guide to the technical side of the subject from cameras and monitors, video recording, cabling and transmission through to installation and maintenance.

**CONTENTS:** The CCTV industry; Signal transmission and cabling; Light and lenses; Lighting technology; Television fundamentals; The camera; Monitors; Video recording; Switchers; Telemetry and integrated alarm systems; Motion detection; Commissioning and maintenance; Ancillary equipment; Glossary; Index

September 2003 320pp 156 x 234mm 150 illustrations Paperback ISBN 0750657286

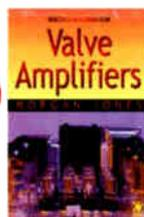
## VALVE AMPLIFIERS

**Third Edition**

**Morgan Jones**

**£29.99**

**NEW**



- ▼ The definitive modern guide to tube amplifiers for home and professional audio applications

"Valve Amplifiers is an extremely well-written book, containing a wealth of information that all audio designers and builders will find useful." - Glass Audio

**Valve Amplifiers** has been widely recognised as the most complete guide to valve amplifier design, modification, analysis, construction and maintenance written for over 30 years. Design principles and construction techniques are provided so readers can devise and build from scratch designs that actually work. Practical aspects, including safety, and other essentials of design are addressed throughout in the familiar context of current best practice in electronic design, using only currently available components.

**CONTENTS:** Preface; Circuit analysis; Basic building blocks; Distortion; Component technology; Power supplies; The power amplifier; The pre-amplifier; Appendix; Index

August 2003 640pp 156 x 234mm 300 illustrations Paperback ISBN 0750656948

## NEWNES PC TROUBLESHOOTING POCKET BOOK

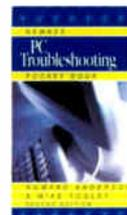
**Third Edition**

**Howard Anderson**

**Mike Tooley**

**£17.99**

**NEW**



- ▼ All the essential data for PC fault-finding and upgrading

This book provides a concise and compact reference that describes, in a clear and straightforward manner, the principles and practice of faultfinding and upgrading PCs and peripherals. The book is aimed at anyone who is involved with the installation, configuration, maintenance, upgrading, repair or support of PC systems. It also provides non-technical users with sufficient background information, charts and checklists to enable the diagnosis of faults and help to carry out simple modifications and repairs. In order to reflect rapid changes in computer technology (both hardware and software) this new edition has been completely revised and rewritten.

**CONTENTS:** PC fundamentals; System architecture and construction; Processor types and families; Support devices; Semiconductor memory; The parallel printer interface; The serial communications ports; The PC expansion bus; Floppy disk drives; Hard disk drives; Viruses; Displays; DOS system configuration; Windows troubleshooting; Tools and test equipment; Reference section; Diagnostic software; Index

August 2003 256pp 110 x 190mm 60 illustrations Hardback ISBN 0750659882

## NEWNES GUIDE TO TELEVISION AND VIDEO TECHNOLOGY

Third Edition

Eugene Trundle

£17.99

**BESTSELLER**



'A truly accessible guide to TV technology and the Digital revolution. Essential information for all servicing students and professionals.' - Electronic Servicing & Technology

'Newnes Guide to Television and Video Technology is essential reading for service engineers and electronic servicing students.' - Digital Broadcasting, 2001

The third edition of the **Newnes Guide to Television & Video Technology** is the definitive guide to analogue and digital TV technology. Eugene Trundle explores the fundamentals of Digital TV (satellite, cable and terrestrial) and Digital Video, as well as providing a thorough grounding in analogue systems.

**CONTENTS:** Basic television; The PAL system; Transmission and reception; Colour decoding; The TV receiver; Teletext; PAL-Plus, MAC and enhanced TV; Digital TV; Satellite TV; Cable TV; Development of video tape recording; Video tape; Signal processing; Signal processing; Servo systems and motor drive; System control for VCRs; The complete VCR; Tape formats compared; DVD players; Index

February 2001 464pp 138 x 216mm  
Paperback 291 illustrations ISBN  
0750648104

## NEWNES GUIDE TO DIGITAL TV

Second Edition

Richard Brice

£24.99



▼ A uniquely concise and readable guide to the technology of digital television

**Newnes Guide to Digital Television** provides a down-to-earth guide to all aspects of digital TV, encompassing the electronics of the equipment, broadcast applications, installations and servicing, and the different transmission methods - terrestrial, satellite and cable. It provides an overview of digital TV for specialists in any one area as well as an introduction for those who want to gain a basic grasp of the technology. The second edition has been updated with all the key developments, and includes new and expanded sections on digital video interfaces, DSP, DVD, video servers, automation systems, HDTV, 8-VSB modulation and the ATSC system.

**CONTENTS:** Foundations of television; Digital video and audio coding; Digital signal processing; Video data compression; Audio data compression; Digital audio production; Digital video production; The MPEG multiplex; Broadcasting digital video; Consumer digital technology; The future; Index

October 2002 304pp 234 x 156mm 4  
illustrations Paperback ISBN 0750657219

## VIDEO DEMYSTIFIED

Third Edition

Keith Jack

£50.00



CD Rom



▼ Provides international coverage

'*Video Demystified* is a one-of-a-kind book. Anyone who designs multimedia or digital-video products will most certainly benefit from reading it.' - Electronics Handbook

This book contains expanded coverage of digital video processing technologies, video compression, digital video interfaces, and the MPEG1 and MPEG2 standards. Also included within the book are two CDs, which provide video test files for MPEG1, MPEG2, H261, and H263 and an electronic version of the book. This is by far the most informative analogue and digital video reference available.

Included is a list of references at the end of each chapter, along with a 50-page glossary at the end of book.

**CONTENTS:** Introduction to video; Colour spaces: rgb, yuv, yiq, ycbr, photoycc, his, hls, and hsv; chromaticity; non-rgb space considerations; Gamma correction; Video signals overview: Analog video interfaces: Digital video interfaces: Digital video processing: Sdtv-Hdtv Ntsc, Pal, and secam overview: Ntsc ntsc and pal digital encoding and decoding: Smpte 314m; Aaux; Vaux; IEEE digital television; Atsc; Dvb; Index

May 2001 784pp 180 x 234mm Paperback  
2 CD ROMS ISBN 1878707566

## DICTIONARY OF VIDEO AND TELEVISION TECHNOLOGY

Keith Jack

Vladimir Tsatsoulin

£29.99



CD Rom

▼ Provides comprehensive and up-to-date information, including coverage of test and measurement procedures

▼ Electronic version of the book accompanies text

'It gives concise but thorough explanations of essential concepts and terms in video and television and is the most complete dictionary covering this fast-paces field.' -Electronic Engineering Times

This up-to-date reference contains virtually all the terminology commonly used in modern global video and television technology, with thorough definitions aimed at the engineering level. It covers all international video standards, digital and analogue video signals, data compression, video conferencing, encoding/decoding—indeed, every term associated with video/television technology.

**CONTENTS:** Contains thousands of terms and their definitions in alphabetical order

November 2002 322pp 178 x 228mm  
Paperback with CD-ROM ISBN 187870799X

## SERVICING TV, SATELLITE AND VIDEO EQUIPMENT

Eugene Trundle

£21.99

▼ Written by a practising service engineer

▼ Includes a symptom index for easy reference and new material on the latest Digital TV and Video equipment



'A genuinely practical hands-on guide for service engineers, including a section on the latest digital equipment.' The Engineers Journal

Based on many years of practical bench and field experience, the book wastes little space on theoretical principles and circuit description where it is well covered elsewhere: here the emphasis is on the practical business of fault diagnosis and repair. Includes a symptom index for easy reference and new material on the latest Digital TV and Video equipment.

**CONTENTS:** Test and diagnostic equipment; Power supplies; Line timebase; Field timebase; Luminance and decoder; Tuners and vision receivers; Audio receiver section; TV control systems; Picture tubes; Teletext decoders; Video deck mechanics; System control in VCRs; Servos and motors; VCR luminance section; VCR chroma stages; VCR audio servicing; Camera section, clock; Display and timer circuits; Dealing with intermittent faults; Repair techniques; Safety; BEAB and BS415; Digital TV; Symptom index

November 2001 336pp 189 x 246mm  
Paperback ISBN 0750655070

## VIDEO AND CAMCORDER SERVICING AND TECHNOLOGY

Fifth Edition

Steve Beeching

£20.99



This book provides fully up-to-date coverage of the whole range of current home video equipment, analogue and digital. It is the key to successful servicing of VCRs and camcorders and cover the new generation of video equipment: DVD and hard disk recording (MPEG2).

As well as traditional VCRs the scope of **Video and Camcorder Servicing and Technology** includes the full range of video cameras designed for home use and editing systems, and the latest DVD and hard-disk equipment.

'It furnishes readers with everything they need to know about troubleshooting and repairing traditional VCRs, video cameras designed for home use and editing systems, and the latest DVD equipment.' Poptronics

**CONTENTS:** Magnetism and magnetic recording; Azimuth tilt technique; Frequency modulated recording and playback; Motor control and servomechanisms; Colour recording and playback; Systems control; Long play; Hi fi audio; Still pictures and slow motion; Camcorders; Digital camcorders; MPEG and D-VHS; Editing; PDC and IEEE1394; Soldering and desoldering; Index

April 2001 320pp 189 x 246mm 150  
illustrations Paperback ISBN 0750650397

## NEWNES TV AND VIDEO ENGINEER'S POCKET BOOK

Third Edition

Eugene Trundle

£17.99

**BESTSELLER**

'A gem of a book... can be used by service engineers throughout the world.' Elektor Electronics



This well-known book is an essential tool for every service engineer, and an extremely useful reference source for a wide range of engineers, students, sales and installation staff. The third edition has been thoroughly updated to include digital and other new technologies, with new chapters on digital camcorders and VCRs, digital television, Dolby sound systems, and home cinema.

**CONTENTS:** Components and assemblies; Television and video waveforms and standards; Satellite TV; TV signal processing; Teletext and viewdata; Nicam stereo sound; Timebase circuits; Power supply systems; Video on magnetic tape; Video recorder signal processing; Servo systems; Video recorder deck control; Audio record and playback; Control systems; Test equipment and fault diagnosis; Digital TV; Digital Camcorders and VCRs; Dolby sound systems and home cinema; Reference data; Index

October 1999 503pp 105 x 190mm 1 illustration Hardback ISBN 0750641940

## PRACTICAL ELECTRONIC FAULT FINDING AND TROUBLESHOOTING

Robin Pain

£21.99

'Robin Pain has put down in words (almost entirely free of maths) the experience of many years practical work on audio, radio, TV and computer equipment.' Electronics Education



It isn't enough to be able to design. It isn't even enough to be able to debug. To be a real faultfinder, you must be able to get a feel for what is going on in the circuit you are examining. In this book Robin Pain explains the basic techniques needed to be faultfinder.

**CONTENTS:** Voltage, current and resistance; Capacitance, inductance and impedance; Diodes, transistors, op amps and negative feedback; Analogue fault finding techniques; Audio frequency; Radio frequency; Digital fault finding techniques; Discrete logic; Serial interfaces; Parallel interfaces; Microprocessor systems; Memory; Addressing; Microprocessor action; I/O control; CRT control; Dynamic RAM; Microprocessor systems: Fault finding techniques; Fault finding; Memory problems; Appendices; Index

April 1996 240pp 156 x 234mm 1 illustration Paperback ISBN 0750624612

## AUDIO AND HI-FI HANDBOOK

Revised Edition

Ian Sinclair

£31.99

▼ A handy reference tool for anyone involved in audio design, manufacture, installation and use

▼ A comprehensive - and comprehensible - guide to audio electronics

Written by a team of experts and specialist contributors, this comprehensive guide has proved to be an invaluable resource for professional designers and service engineers. The third edition includes new chapters on servicing, Nicam stereo and digital satellite radio. For the first time in paperback, this revised edition features a completely new chapter on the most recent digital developments, CD-R/RW, HDCD, Internet audio, MP3 players and DAM-CD.

**CONTENTS:** Sound waves and acoustics; Studio acoustics; Microphones; Sound synthesis; Introduction to digital principles; Compact disc technology; Other digital systems (DAT, NICAM, DCC, MD); DVD audio standards; MP3 music on the internet; Nicam and satellite radio; Analogue tape recording; Noise reduction systems; The LP record; Disc reproduction; Tuners and radio receivers; Preamps and inputs voltage amplifiers/controls; Valve amplifiers; Loudspeakers; Loudspeaker enclosures; Headphones; Public address; In-car audio; Servicing; Interconnections; Index

October 2000 480pp 189 x 246mm Paperback ISBN 0750649755

## NEWNES DICTIONARY OF ELECTRONICS

S W Amos

R S Amos

£12.99

▼ A concise glossary for electronics, TV, radio and computing

▼ Includes a handy appendix of acronyms

The **Newnes Dictionary of Electronics** has become an essential item on the bookshelves of electronics engineers, managers, technicians, students and enthusiasts. The book is in a convenient compact format that makes it an ideal working dictionary. The definitions are clear and concise, supported by numerous illustrations and circuit diagrams.

'The **Newnes Dictionary of Electronics** has become an essential item on the bookshelves of electronics engineers, managers, technicians, students and enthusiasts. The definitions are clear and concise, supported by numerous illustrations and circuit diagrams.' EPN

**CONTENTS:** Listing of electronics terms  
March 2002 389pp 138 x 216mm 300 illustrations Paperback ISBN 0750656425



## NEWNES SERVICE ENGINEER'S POCKET BOOK

Geoff Lewis

Ian Sinclair

£14.99

▼ Written by two well known and experienced authors

▼ Information is well organised and presented in the handy Pocket Book format

This Pocket Book aims to provide the service engineer with all the necessary information to carry out work on domestic electronics equipment. Packed full of data, tables of standard values, formulae and charts, this useful and portable little book will be both an essential reference for all those working in consumer electronics and a handy revision aid for students.

**CONTENTS:** General faultfinding; The workshop; Basic circuits; Power supplies; Aerials, feeders and propagation; Audio systems; Television and teletext receivers; Satellite television systems; Video recorders and cameras; Television distribution systems or Community Area Television (CATV); Index

April 1998 256pp 90 x 190mm 1 illustration Hardback ISBN 0750634480



## PC SYSTEMS, INSTALLATION AND MAINTENANCE

Second Edition

R. P. Beales

**NEW**

£19.99

▼ Updated throughout to cover new technologies and latest developments in the field

▼ Additional website resources feature colour figures to download, appendices and web links

Written in a straightforward, easy to read style, Rob Beales provides the knowledge and techniques needed to build, troubleshoot, and maintain personal computer systems. Updated throughout in line with current technologies this is THE PC hardware handbook for students, IT support staff, small business users and home office users covering the set-up, running and maintenance of PC systems.

**CONTENTS:** PC hardware technology: The PC defined; The system-unit; Peripherals; Networks; assembling, Configuring and upgrading; Building a complete PC system. Systems support: Routine maintenance and troubleshooting; Health & safety; Glossary

September 2003 448pp Paperback 111 illustrations ISBN 0750660740



### FURTHER INFORMATION

All publication dates, prices and other details are correct at time of going to press but may be subject to change without further notice.

Enquiries about late publication dates should be addressed to:

Ian Seager

Newnes, Linacre House, Jordan Hill, Oxford OX2 8DP, UK

Tel: +44 (0)1865 314464

Fax: +44 (0)1865 314572

For more information on these and other Newnes books please go to [www.Newnespress.com](http://www.Newnespress.com)

## MULTIFUNCTION PERIPHERALS FOR PCS

Technology, Troubleshooting and Repair

Marvin Hobbs

£25.99

This resource explains how multifunction peripherals work in theory and in practice, with lots of hands-on examples and important troubleshooting and repair tips. -Poptronics



Multifunction devices combine the essentials of a fax machine, printer, scanner, and copier into one peripheral for small and home offices. As the market for this equipment grows, the need for skilled repair and maintenance increases.

Unfortunately the service documentation supplied by the manufacturers is completely inadequate making the repair jobs even harder and more expensive. Marvin Hobbs teaches you how multifunction peripherals work in theory and in practice with lots of hands-on examples and important troubleshooting and repair tips you don't want to miss.

**CONTENTS:** Diagnostics and maintenance; Ink jet Printers in MFD machines; Laser and LED printers in MFD machines; Thermal printers; Scanners; Fax function; PC software for printer control; Standards and protocol; Consumables; Glossary; Abbreviations; References

February 2000 232pp 178 x 254mm 234 illustrations Paperback ISBN 0750671254

## ELECTRONIC CLASSICS

Collecting, Restoring and Repair

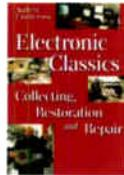
Andrew Emmerson

£21.99

▼ A highly popular type of 'modern antique'

▼ Covers technical aspects of classic valve-based circuitry

▼ The most complete work for vintage audio and TV enthusiasts, dealers and repairers



"What an amazing collection of information!... This is a book which should be in every vintage radio enthusiast's reference library. Radiobygones

This highly readable book encompasses all aspects of buying, collecting, restoring, repairing, sourcing parts, professional services, clubs and societies, etc. Covering the technical side as well as collecting, this book offers the most comprehensive coverage available. The most complete work for vintage audio and TV enthusiasts, dealers and repairers.

**CONTENTS:** Repairing and restoring; First-line repairs; Electrical components; Cabinet and chassis; Finishing off a set; Buyer's guide - where to find parts; Service data - where to find it; Professional services directory; Clubs and societies; Recommended reading; Museums and other places to see professional restorations; Keeping track of your collection; What's it worth; Patronising dealers; Buying at auctions and antique fairs; Collector's luck; Safety; References; Index

August 1998 400pp 156 x 234mm 1 illustration Paperback ISBN 0750637889

## TELEVISION IC DATA FILES

Second Edition

John Edwards

£18.99

▼ Over 30% new material

The second edition covers over 70 ICs not included previously, making this book an essential update for the many service engineers who have discovered that John Edwards books are a vital workshop tool. However, the purpose of the book remains to cover the devices most frequently found faulty in television sets in production since the late 1980s, so all the key ICs will still be found here.

**CONTENTS:** A collection of television ICs files presented in alphabetical/numerical order

January 2000 256pp 156 x 234mm Paperback ISBN 0750645814



## VCR IC DATA FILES

John Edwards

£20.99

Due to the increasing complexity of television and video equipment there is a growing need for service information that is current, accurate, affordable and readily available. The purpose of this book is to provide the workshop technician and the field engineer with a valuable and convenient method of fault finding without the need to consult workshop manuals which are often expensive or indeed out of stock.

**CONTENTS:** A collection of VCR ICs files presented in alphabetical/numerical order

July 1998 448pp 156 x 234mm 1 illustration Paperback ISBN 0750639938



## TELEVISION MICROPROCESSOR IC DATA FILES

John Edwards

£19.99

▼ Comprehensive cover of most commonly used ICs

▼ Convenient reference for working engineer

Complementing the first volume in this series, Television IC Data Files, the most popular microprocessor ICs used in televisions are covered here. Each device is presented graphically with the relevant data information given against each pin to enable the engineer to quickly compare voltage measurements and signal in/out data on a faulty device, with those in the book. All the measurements and signal data in the book were taken under actual working conditions.

**CONTENTS:** A collection of television microprocessor ICs presented in alphabetical/numerical order

March 1997 240pp 156 x 234mm Paperback ISBN 0750633352



# TELEVISION

## TV FAULT FINDING GUIDE

Peter Marlow

£20.99

▼ Real repair and troubleshooting info - not just cribs from manufacturers' data sheets

Peter Marlow's TV Fault Finding Guide is a distillation of the most used fault reports from 11 years of Television magazine. Arranged by make and model the information is extremely easy to access, and the book is a convenient size for the bench or to carry with you. Unlike other fault guides, this one is based on top quality information from leading authorities, and genuine repair case studies. This is real-life servicing information, not just a compilation of manufacturers' manuals.

**CONTENTS:** Introduction; A-Z of manufacturers and models

March 2000 400pp 156 x 234mm Paperback ISBN 0750646330



## VCR FAULT FINDING GUIDE

Peter Marlow

£20.99

▼ Approximately 2,000 reports on 193 models from 35 different manufacturers

▼ Instant on-the-spot diagnosis and repair advice

This book is an essential repair and troubleshooting tool from an experienced Television magazine author. Unlike other fault guides, this one is based on top quality information from leading authorities, and genuine repair case studies. This is real-life servicing information, not just a compilation of manufacturers' manuals. This will undoubtedly become one of the service engineer's most useful tools.

**CONTENTS:** Introduction; A-Z of manufacturers and models

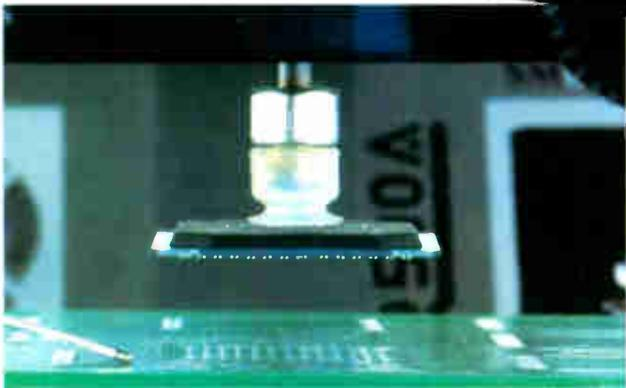
March 2000 464pp 156 x 234mm Paperback ISBN 0750646349



Why not register to receive our monthly eNews. We will send you details on our latest publications, regular discounts, free sample chapters, relevant information and more. To subscribe either fill in the form overleaf and tick the box or alternatively go to [www.newnespress.com](http://www.newnespress.com)

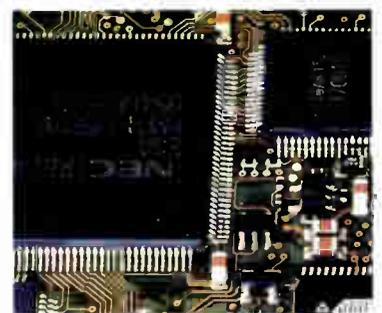
# IR500 printed circuit board re-work station

"A printed  
circuit board



re-work station,  
that requires no  
special nozzles, is

user friendly & makes selective  
removal & replacement  
of all types of components  
easy, without damage"



# BLUNDELL

PRODUCTION EQUIPMENT

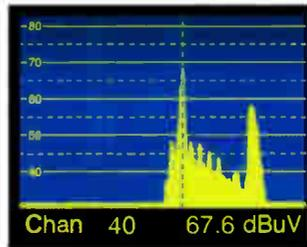
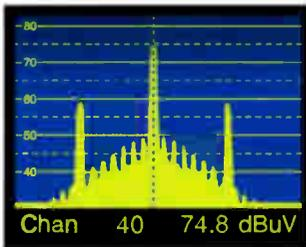
tel: 024 7647 3003  
[www.blundell.co.uk](http://www.blundell.co.uk)  
[sales@blundell.co.uk](mailto:sales@blundell.co.uk)

203 Torrington Ave, Coventry  
West Midlands, CV4 9UT, UK

# TELEVISION TEST PATTERN GENERATORS

The new **GV 998** is a digital pattern generator offering more advanced features at again a realistic price. Those features include :

- ◆ MPEG-2 format Transport Stream generation
- ◆ Video and audio included in the TS
- ◆ Video and audio inputs
- ◆ Generation of a variable frequency sound carrier for decoding verification
- ◆ Multistandard and multisystem analogue TV signal generation
- ◆ Possibility to edit different fields of the TS database to present the name of the service provider
- ◆ Remote control via a personal computer
- ◆ Moving video patterns to check MPEG-2 decoders



## PROMAX GV SERIES

- ◆ Choice of 12 instruments
- ◆ NICAM and Teletext
- ◆ 4:3 and 16:9 Formats
- ◆ Full field and VITS
- ◆ Computer Controlled
- ◆ Front panel memories
- ◆ Own Company Logo
- ◆ Computer Monitor testers
- ◆ Hand Held Models
- ◆ Multi Standard, PAL, NTSC, SECAM
- ◆ High Quality Construction
- ◆ Attractive Price Levels
- ◆ Full After Sales Service
- ◆ Available from Stock



FOR TELEVISION PATTERN GENERATORS, THERE'S NO WIDER CHOICE THAN WITH PROMAX



## SELECTED ITEMS FROM THE PROMAX RANGE OF TEST EQUIPMENT



**MS 250**

Analogue and Digital Satellite Detector.



**PRODIG 1**

Satellite Dish Installer's Meter Does more than just BSkyB



**PRODIG 2**

Analogue & Digital Aerial Meter Measures digital channel power and C/N



**MC 377+**

Analogue & Digital, Satellite & Terrestrial Measures channel power and C/N



**PROLINK 3 + 4 SERIES**

Satellite & Terrestrial, Analogue & Digital, Spectrum Analyser with BER (optional on P3)

# Alban

ALBAN ELECTRONICS LIMITED

THE PROMAX SERVICE CENTRE

6 Caxton Centre, Porters Wood, St. Albans, Hertfordshire, AL3 6XT.

TEL: 01727 832266 FAX: 01727 810546

WEB: [www.albanelectronics.co.uk](http://www.albanelectronics.co.uk)

EMAIL: [info@albanelectronics.co.uk](mailto:info@albanelectronics.co.uk)

SALES + SERVICE + CALIBRATION



TELECOMMUNICATIONS TEST EQUIPMENT  
AE 767 Spectrum Analyser



**NEW!**  
THE NEW ALBAN WEB SITE ...  
[www.albanelectronics.co.uk](http://www.albanelectronics.co.uk)  
FOR ALL THE LATEST NEWS AND INFORMATION FROM ALBAN

**NEW!**