

**THE No.1 MAGAZINE FOR ELECTRONICS TECHNOLOGY & COMPUTER PROJECTS**

**EVERYDAY**

**MARCH 2005**

**PRACTICAL**

# **ELECTRONICS**

**£3.10**

## **PIC TOOLKIT TK3 SIMULATOR & PIC18F UPGRADE**

**Mini simulator providing initial software testing**

## **HEADPHONE AMPLIFIER**

**A stand-alone or add-on project**

**CAT FLAP**  
**Give your cat the key to the door**

**BINGO BOX**  
**Versatile number generator & checker**



[www.epemag.co.uk](http://www.epemag.co.uk)

World Radio History



Colour CCTV camera, 8mm lens, 12vdc200ma a 582X628 Res 380 lines Automatic aperture lens Mirror function PAL Back Light Comp MLR, 100x40x40mm ref EE2 £75.90

Built in Audio 15lux CCD camera 12vdc 200ma 480 lines s/n ratio >48 db 1v P-P output 110x60x50mmref EE1 £108.90



Metal CCTV camera housings for internal or external use Made from aluminium and plastic they are suitable for mounting body cameras in Available in two sizes 1. 100x70x170mm and 2. 100x70x280mm Ref EE6 £22 EE7 £26 Multi position brackets Ref EE8 £8.80



Excellent quality multi purpose TV/TFT screen, works as just a LCD colour monitor with any of our CCTV cameras or as a conventional TV ideal for use in boats and caravans 49.75mhz-91.75mhz VHF channels 1-5, 168.25mhz-222.75mhz VHF channels 6-12, 471.25mhz-869.75mhz, Cable channels 112.325mhz-166.75mhz Z1-Z7, Cable channels 224.25mhz-446.75mhz Z8-Z35 5" colour screen, Audio output 150mW, Connections, external aerial, earphone jack, audio/video input, 12vdc or mains, Accessories supplied Power supply Remote control Cigar lead power supply Headphone Stand/bracket 5" model £139 Ref EE9.



Self cocking pistol plier 002 crossbow with metal body. Selfcocking for precise string alignment Aluminium alloy construction High tec fibre glass limbs Automatic safety catch Supplied with three bolts Track style for greater accuracy Adjustable rear sight 50lb draw weight 150lt sec velocity Break action 17" string 30m range £23.84 Ref PLCR002



Fully cased IR light source suitable for CCTV applications. The unit measures 10x10x150mm, is mains operated and contains 54 infra red LEDs. Designed to mount on a standard CCTV camera bracket. The unit also contains a daylight sensor that will only activate the infra red lamp when the light level drops below a preset level. The infrared lamp is suitable for indoor or exterior use, typical useage would be to provide additional IR illumination for CCTV cameras £53.90 ref FF11



Colour CCTV Camera measures 60x45mm and has a built in light level detector and 12 IR leds 2lux 12 IR leds 12vdc Bracket Easy connect leads £75.90 Ref EE15



High quality external colour CCTV camera with built in infra red LEDs measuring 60x60x60mm Easy connect leads colour Waterproof PAL 1/4" CCD 542x588 pixels 420 lines .05 lux 3.6mm F2.78 deg lens 12vdc 400ma Built in light level sensor £\*08.90 Ref EE13



A small colour CCTV camera just 35x28x30mm Supplied with bracket, easy connect leads. Built in audio. Colour 380 line res, PAL 0.2lux +18db sensitivity Effective pixels 628x582 6-12vdc Power 200mw £39.60 Ref EE16



Peltier module. Each module is supplied with a comprehensive 18 page Peltier design manual featuring circuit designs, design information etc etc. The Peltier manual is also available separately Maximum watts 56.2 40x40mm Imax 5.5A Vmax 16.7 Tmax (c-dry N2) 72 £32.95 (inc manual) REF PELT1, just manual £4.40 ref PELT2



GASTON SEALED LEAD ACID BATTERIES  
1.3AH 12V @ £5.50 GT1213  
3.4AH 12V @ £8.80 GT1234  
7AH 12V @ £8.80 GT127  
17AH 12V @ £19.80 GT1217

COMPAG 1000mA 12vdc power supplies, new and boxed 2 metre lead DC power plug 2.4mmx10mm £5.25 each, 25+ £3.50 100+£2.50

All new and boxed, bargain prices Good quality sealed lead acid batteries



1.2ghz wireless receiver Fully cased audio and video 1.2ghz wireless receiver 190x140x30mm metal case, 4 channel, 12vdc Adjustable time delay, 4s. 8s, 12s 16s. £49.50 Ref EE20

The smallest PMR446 radios currently available (54x87x37mm). These tiny handheld PMR radios look great, user friendly & packed with features including VOX, Scan & Dual Watch. Priced at £59.99 PER PAIR they are excellent value for money. Our new favourite PMR radios! Standby: - 35 hours Includes: - 2 x Radios, 2x Belt Clips & 2 x Carry Strap £59.95 Ref ALAN1 Or supplied with 2 sets of rechargeable batteries and two mains chargers £93.49 Ref Alan2

The TENS mini Microprocessors offer six types of automatic programme for shoulder pain, back/neck pain, aching joints, Rheumatic pain, migranes headaches, Sports injuries, period pain. In fact all over body treatment. Will not interfere with existing medication. Not suitable for anyone with a heart pacemaker. Batteries supplied. £21.95 Ref TEN327 Spare pack of electrodes £6.59 Ref TEN327X

Dummy CCTV cameras These motorised cameras will work either on 2 AA batteries or with a standard DC adapter (not supplied) They have a built in movement detector that will activate the camera if movement is detected causing the camera to "pan" Good deterrent Camera measures 20cm high, supplied with fixing screws. Camera also has a flashing red led. £10.95 Ref CAMERAB

INFRA RED FILM 6" square piece of flexible infra red film that will only allow IR light through Perfect for converting ordinary torches, lights headlights etc to infrared output using standard light bulbs. Easily cut to shape. 6" square £16.50 ref IRF2 or a 12" sq for £34.07 IRF2A

THE TIDE CLOCK These clocks indicate the state of the tide, Most areas in the world have two high tides and two low tides a day, so the tide clock has been specially designed to rotate twice each lunar day (every 12 hours and 25 minutes) giving you a quick and easy indication of high and low water. The Quartz tide clock will always stay calibrated to the moon. £23.10 REF TIDEC

LINEAR ACTUATORS 12-36VDC BUILT IN ADJUSTABLE LIMIT SWITCHES POWDER COATED 18" THROW UP TO 1,000 LB THRUST (400LB RECOMMENDED LOAD) SUPPLIED WITH MOUNTING BRACKETS DESIGNED FOR OUTDOOR USE These brackets originally made for moving very large satellite dishes are possibly more suitable for closing gates, mechanical machinery, robot wacs etc. Our first sale was to a company building solar panels that track the sun! Two sizes available, 12" and 18" throw. £32.95 REF ACT12,

Samarium magnets are 57mm x 20mm and have a hole (5/16th UNF) in the centre and a magnetic strength of 2.2 gauss. We have tested these on a steel beam running through the offices and found that they will take more than 170lbs (77kgs) in weight before being pulled off. With keeper £21.95 REF MAG77

New transmitter, receiver and camera kit. £69.00  
Kit contains four channel switchable camera with built in audio, six IR leds and transmitter, four channel switchable receiver, 2 power supplies, cables, connectors and mounting bracket. £69.00 Wireless Transmitter Black and white camera (75x50x55mm) Built in 4 channel transmitter (switchable) Audio built in 6 IR Leds Bracket/stand Power supply 30 m range Wireless Receiver 4 channel (switchable) Audio/video leads and scart adapter Power supply and Manual £69.00 ref COP24

This miniature Stirling Cycle Engine measures 7" x 4-1/4" and comes complete with built-in alcohol burner. Red flywheels and chassis mounted on a green base, these all-metal beauties silently running at speeds in excess of 1,000 RPM attract attention and create awe wherever displayed. This model comes completely assembled and ready to run. £106.70 REF SOL1

High-power modules using 125mm square multi crystal silicon solar cells with bypass diode Anti reflection coating and BSF structure to improve cell conversion efficiency: 14%. Using white tempered glass, EVA resin, and a weatherproof film along with an aluminum frame for extended outdoor use. system Lead wire with waterproof connector. 80 watt 12v 500x1200 £315.17, 123w 12vdc 1499x662x46 £482.90 165 w 24v 1575x826x46mm £652.30

**BULL GROUP LTD**  
UNIT D HENFIELD BUSINESS PARK  
HENFIELD SUSSEX BN5 9SL  
TERMS: CASH, PO, CHEQUE PRICES+VAT  
WITH ORDER PLUS £5.50 P&P (UK) PLUS VAT.  
24 HOUR SERVICE £7.50 (UK) PLUS VAT.  
OVERSEAS ORDERS AT COST PLUS £3.50  
Tel: 0870 7707520 Fax 01273491813  
Sales@bullnet.co.uk  
www.bullnet.co.uk



Ultra-compact, lightweight, easy to use and comfortable to hold, the new NVMT is unique for a night scope in offering a tactile, suregrip plastic bodyshell and, for extra protection/grip, partial rubber armouring. Currently the top of the range model, the NVMT G2+ features a 'commercial' grade Gen 2+ Image Intensifier Tube (IIT). The NVMT has a built-in, powerful Infrared (IR) Illuminator for use in very low light/total darkness. Powered for the scope and IR is provided by 1 x 3V Lithium CR123A battery (not supplied). A green LED next to the viewfinder indicates when the Image Intensifier Tube is switched on while a red LED indicates when the IR Illuminator is switched on. Type Gen Weight Size Lens Mag 2x, Weight 400g, 125x82x35mm angle of view 30 deg, built in infra red, rang 3 - 400m, supplied with batteries £849 Ref COB24023.

55 - 200 WATT INFRA RED TORCHES  
Search guard 1 infrared torch Plastic bodied waterproof infrared rechargeable lamp. 100mm diameter lens, 200mm body length. 55 watt bulb, 1,000,000 candle power (used as an indication of relative power) Supplied complete with a 12v car lighter socket lead/charger and a 240v mains plug in charger. £49 REF sguard 1. Also available, 70watt @ £59, 100 watt @ £79, 200 watt @ £99.



B2 AIR RIFLE Available in .177 and .22-19" Tapered Rifled Barrel-Adjustable Rear Sight- Full Length Wooden Stock- Overall Length 43" approx Barrel Locking Lever - Also available in CARBINE Grooved for Telescopic Sight model with 14" barrel - no front sight for use with scope Weight approximately 6lbs. Extremely Powerful .22 £28.90, .177 £24.70, pellets (500) £2.55, sights 4x20 £6.80, 4x28 £15.32 Other models available up to £250 www.airpistol.co.uk

12V SOLAR PANELS AND REGULATORS  
9 WATT £58.75  
15 WATT £84.25  
22 WATT £126.70  
Regulator up to 60 watt £21.25  
Regulators up to 135 watt £38.25

The combination of multi-crystal cells and a high-reliability module structure make this series of solar panels the ideal solar module. For large scale power generation hundreds or even thousands of modules can be connected in series to meet the desired electric power requirements. They have a high output, and highly efficient, extremely reliable and designed for ease of maintenance. Separate positive negative junction boxes and dual by-pass diodes are a few examples of some of its outstanding features. Supplied with an 8 metre cable. Perfect for caravans, boats, etc. Toughened glass.



LOCK PICK SETS 16, 32 AND 60 PIECE SETS  
This set is deluxe in every way! It includes a nice assortment of balls, rakes, hooks, diamonds, two double ended picks, a broken key extractor, and three tension wrenches. And just how do you top off a set like this? Package it in a top grain leather zippered case. Part LP005 - Price £45.00  
This 32 piece set includes a variety of hooks, rakes, diamonds, balls, extractors, tension tools... and comes housed in a zippered top grain leather case. If you like choices, go for this one! Part: LP006 - Price £65.00  
If you want run toward the biggest pick set you can find, here it is. This sixty piece set includes an array of hooks, rakes, diamonds, balls, broken key extractors, tension wrenches, and even includes a warded pick set! And the zippered case is made, of course, of the finest top grain leather. First Class! Part: LP007 - Price £99.00

Mamod steam roller, supplied with fuel and everything you need (apart from water and a match!) £85 REF 1312 more models at www.mamodspares.co.uk

Mamod steam roller, supplied with fuel and everything you need (apart from water and a match!) £130 REF 1318 more models at www.mamodspares.co.uk

PEANUT RIDER STIRLING ENGINE This all metal, black and brass engine with red flywheel is mounted on a solid hardwood platform. comes complete with an alcohol fuel cell, extra wick, allen wrenches, and Owner's Manual. Specifications: Base is 5-1/4" x 5-1/4", 4" width x 9" height, 3/4" stroke, 3-1/2" flywheel £141.90  
**SHOP ONLINE**  
**WWW.BULLNET.CO.UK**

ISSN 0262 3617  
PROJECTS ... THEORY ... NEWS ...  
COMMENTS ... POPULAR FEATURES ...

VOL. 34. No. 3 MARCH 2005

Cover illustration: Alfred Pasiaka/Science Photo Library

# EVERYDAY PRACTICAL ELECTRONICS

INCORPORATING ELECTRONICS TODAY INTERNATIONAL

[www.epemag.co.uk](http://www.epemag.co.uk)  
EPE Online: [www.epemag.com](http://www.epemag.com)

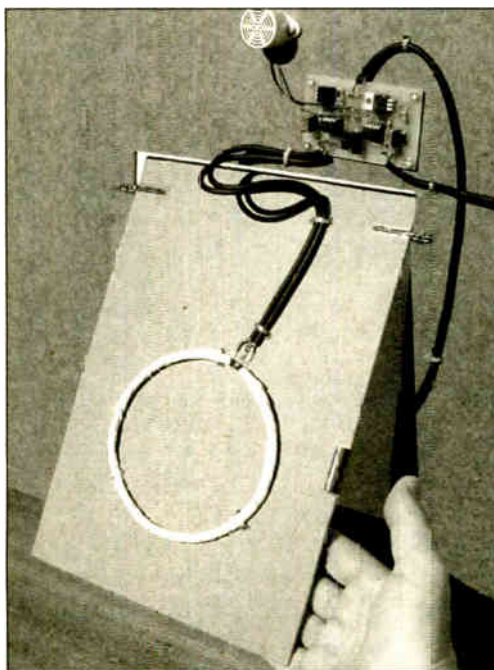

© Wimborne Publishing Ltd 2005. Copyright in all drawings, photographs and articles published in EVERYDAY PRACTICAL ELECTRONICS is fully protected, and reproduction or imitations in whole or in part are expressly forbidden.

Our April 2005 issue will be published on Thursday, 10 March 2005. See page 147 for details

## Projects and Circuits

- CAT FLAP** by Thomas Scarborough 156  
Electronically deter stray moggies from invading your cat's private door
- INGENUITY UNLIMITED - Sharing your Ideas with others** 162  
NiCad Battery Discharger; Slumber Alarm; Audio Illusions; Pico Prize Winners
- STEREO HEADPHONE MONITOR** by Terry de Vaux-Balbirnie 168  
Usable as an add-on for last month's Sound Card Mixer or as a stand-alone unit
- PIC ELECTRIC MK2 - 2** by John Becker 172  
Describing the software which monitors the cost of running your mains electrical appliances
- BINGO BOX** by David Coward 180  
PIC those random numbers without a traditional bag!
- SMART KARTS - 6 SK-3 Push and Grab Software** by Owen Bishop 193  
Discussing the third set of software routines for our PIC-based buggy

## Series and Features

- CIRCUIT SURGERY** by Alan Winstanley and Ian Bell 166  
The basics of square waves, and of handling crimped connectors
- TECHNO TALK** by Andy Emmerson 176  
Even telephone systems are prone to virus infection
- PIC N' MIX** by Andrew Jarvis 178  
High level languages - a first visit to the C side!
- NET WORK - THE INTERNET PAGE** surfed by Alan Winstanley 190  
Topical news on eBay and related frauds
- PRACTICALLY SPEAKING** by Robert Penfold 206  
A novice's guide to front panel labelling without a PC
- TK3 SIMULATOR AND PIC18F UPGRADE** by John Becker 208  
Detailing the latest additions to our PIC assembly and programming toolkit

## Regulars and Services

- PIC RESOURCES CD-ROM** Invaluable to all PICkers! 150
- EDITORIAL** 155
- NEWS** - Barry Fox highlights technology's leading edge  
Plus everyday news from the world of electronics 160
- SHOPTALK** with David Barrington 188  
The *essential* guide to component buying for EPE projects
- PLEASE TAKE NOTE** 188
- READOUT** John Becker addresses general points arising 199
- CD-ROMS FOR ELECTRONICS** 202  
A wide range of CD-ROMs for hobbyists, students and engineers
- BACK ISSUES** Did you miss these? 215
- BACK ISSUE CD-ROMS** single-source shopping for issues you've missed 216
- DIRECT BOOK SERVICE** 217  
A wide range of technical books available by mail order, plus more CD-ROMs
- ELECTRONICS MANUALS** 220  
Essential CD-ROM reference works for hobbyists, students and service engineers
- PRINTED CIRCUIT BOARD AND SOFTWARE SERVICE** 221  
PCBs for EPE projects. Plus EPE project software
- ADVERTISERS INDEX** 224

Readers Services • Editorial and Advertisement Departments 155

## NEW FROM FED – FEDPIC Key - USB In Circuit Programmer / Debugger



FEDPIC Key – Ultra-Miniature USB In Circuit Serial Programmer and Debugger

Pricing £60.00

**Description :** Our new in-circuit programmer/debugger for PIC's operates on the PC USB port, requires no additional power supply and the programmer application runs under Windows '98, ME, 2000 or XP.

**Programs :** 12Cxxx, 12Fxxx, 16Fxxx, 18Cxxx and 18Fxxx devices and flash upgradeable for future devices.

**Operates** on a simple 6 pin SIL connector and includes the FED In Circuit Debugger. FEDPIC Key Debugger has the same functionality as our standard ICD described below, but runs 3 times faster !

## FED – PIC and AVR – ANSI C Compiler products

### Visual Development for the FED C Compilers WIZ-C for PIC, AVIDICY for AVR

- An application designer for the FED PIC or AVR C Compilers FULLY including the PIC or AVR C Compiler
- Drag a software component on to your design & set up the parameters using check boxes, drop down boxes and edit boxes (see shot below)
- Connect the component to the device pins using the mouse
- Select your own C functions to be triggered when events occur (e.g. Byte received, timer overflow etc.)
- Simulate, Trace at up to 10x the speed of other simulators
- Generate the base application automatically and then add your own functional code in C or assembler
- WIZ-C supports over 80 PICS - 16F87x, 16F627/8, 16C55x, 16C6x, 16F8x, 16C7xx 18Cxx, 18Fxxx, 12F629/676 etc.
- AVIDICY supports normal and Mega range devices
- Demonstration download available :

[www.fored.co.uk/CDemo.htm](http://www.fored.co.uk/CDemo.htm)

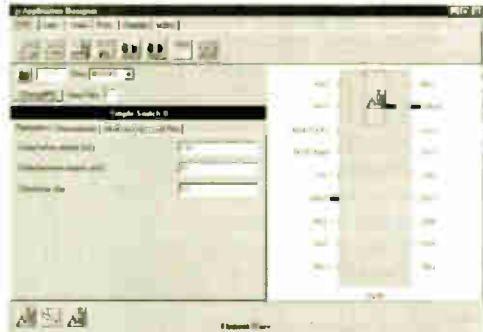

Screen shot (left) shows push button element connected to a PIC. Parameters may be set to control debounce and repeat. C function may be specified to call when the button is pressed

### FED ANSI C Compiler for PIC and AVR

- C Compiler designed to ANSI standards
- Supplied with library routines for C standard functions and many interface applications including I2C, LCD, LED's, timers, EEPROM, IRDA, Dallas 1 Wire, Hex Keypad, Maths, asynchronous serial interfacing, clocked data etc.
- With complete development/simulation environment including LCD/Keypad/LED/RS232 terminal
- View your simulation on a logic analyser application showing waveforms, timing or analogue results
- Profiler shows execution count, execution time and average time for functions and code blocks
- Smart linker – efficiently tiles routines throughout memory to minimise long jumps and page setting bits
- Supports the FEDPIC Key and FED In Circuit Debugger for PIC devices 16F87x and 18Fxx devices – See web site for more details.

### WIZ-C and C Compiler Pricing :

AVR or PIC C Compiler	£60.00
AVR or PIC C Compiler Professional	£90.00
AVIDICY or WIZ-C	£70.00
AVIDICY or WIZ-C Professional	£100.00

WIZ-C products are provided with introductory tutorial, full extensive manuals provided on CD.

All prices may be **reduced by £20.00** if the product is purchased at the same times as WIZ-ASM, serial or USB programmer, or our Development board.

## In Circuit Debugger board (or use the new FEDPIC Key)

Supports 16F87x and 18Fxxx

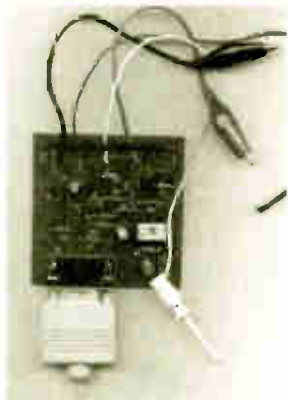

- CD and FEDPIC Key, allow real hardware to be examined & programs to be debugged and to be run in real time on your application
- The FED ICD requires only one data I/O pin on the PIC which can be chosen from any of ports B, C or D.
- Can program and re-program applications in circuit
- Up to 13 breakpoints (18F version)
- Run, Animate, single step and step over, run to cursor line, set PC to any value in the program
- Trace execution in the original C or Assembler source files
- View and change values of PIC special function registers, W and the ports.
- Standard serial interface to PC

## Programmers and Development Board (See web pages)

**USB Programmer** - 40 pin multi-width ZIF socket. Same range of devices as our serial programmer (below).

Price : £90/kit

**PIC Programmer** - Handles serially programmed PIC devices in a 40 pin multi-width ZIF socket. 16C55X, 16C6X, 16C7X, 16C8x, 16F62x, 16F8X, 12C508, 12C509, 16C72XPIC 14000, 16F87X, 18Cxxx, 18Fxxx, 12F6xx etc.

Also In-Circuit programming.

Operates on PC serial port

Price : £45/kit, £50/built & tested

**Development Board** – For ALL 40 pin PICS from 16cxxx, 16Fxxx and 18C/Fxxx. Includes In-Circuit Programmer – NO separate programmer required. LCD interface, hex keypad, LED's and Driver, 32 I/O pins on header, I2C EEPROM, 2 Serial Interfaces, Will run FED PIC BASIC (supplied free on CD ROM), 1A 5V regulator etc.

The CD-ROM is supplied with FED PIC BASIC and Compiler

Price : £35/kit, £45/built & tested, CD - £5.00.

Manual on CD-ROM or download free from our web site

Forest Electronic Developments  
12 Bulcowne Walk, Sway,  
LYMINGTON, Hampshire. SO41 4DU  
Email - [info@fored.co.uk](mailto:info@fored.co.uk)  
Web Site - <http://www.fored.co.uk>  
0159C-881511 (Voice/Fax)



Prices Please add £3.00 for P&P and handling to each order and then EU residents add VAT at 17.5%. Cheques/POs payable to Forest Electronic Developments, phone with credit card details or order using Credit card or Switch from our secure web site

# NEXT MONTH

## SAFETY INTERFACE

*A flexible safety interface for a PIC/logic/PC to mains controller*

The advent of the PIC micro-controller has revolutionised electronics in recent years. The number of components needed for a control circuit has dropped dramatically, and controlling devices that operate at low voltages is relatively straightforward. Controlling mains powered devices, however, is generally not so straightforward, primarily for safety reasons.

This project will enable the constructor to experiment in regulating power to, or simply switching on and off, mains powered equipment, via a PIC or logic circuit, or if used with EPE's Serial Interface, a PC in safety.

## BACK TO LOGIC BASICS

In this short series of articles we illustrate how useful circuits can be simply designed just around a CMOS logic gate or two. We start off with a brief refresher on a few CMOS devices, and follow with a Freezer Door Alarm project to build. During the series we also present:

Water Level Detector; Burglar Alarm; Animal Scarecrow; Digital Lock; Door Chime; Electronic Dice; Kitchen Timer; Electronic Room Thermometer; Daily Reminder; Whistle Switch; Parking Radar; Telephone Switch; Noughts and Crosses Engima; Weather Vane. The designs are based on low cost components, have printed circuit boards and are well suited to construction by "early starters" to electronics. All are battery powered.

## SIMPLE 550Hz TO 30MHz RADIO RECEIVER

*Updating the Spontaflex circuit of Sir Douglas Hall KCMG, MA*

Sir Douglas, who died last year, was an "inveterate experimenter with radio" whose ingenuity inspired and delighted a generation of electronics enthusiasts in the '60s. This receiver is an updated version of perhaps his most famous circuit and is presented with an add-on i.c. amplifier to give a more powerful output. The highly sensitive tuner section uses just two transistors in a reflex design which wrings the last ounce of performance from the devices. The set will receive a.m. and s.s.b. signals.

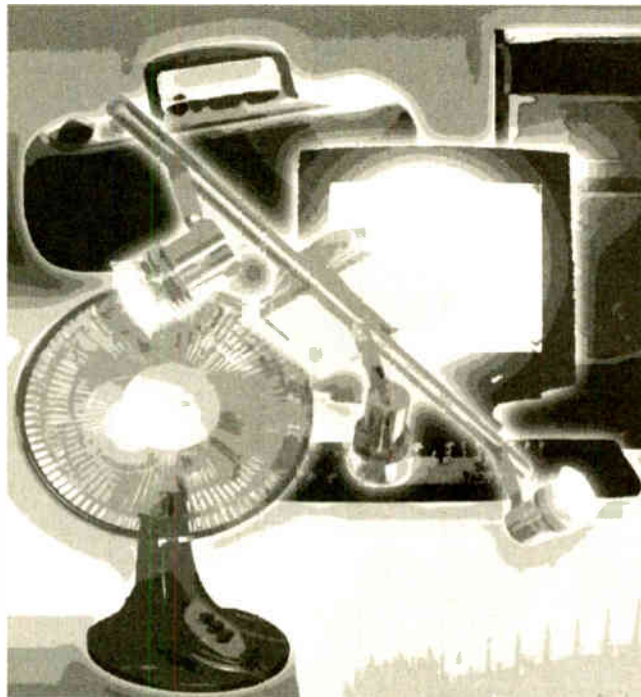

## PIC 18F MICROCONTROLLER FAMILY INTRODUCTION

This article is an introduction to Microchip's new PIC18F series of high-end microcontrollers, with special reference to the PIC18Fxx2 family. At present this comprises the four devices PIC18F242, PIC18F252, PIC18F442 and PIC18F452.

In many ways these 18F devices are similar to, and backwards compatible with, their 16F counterparts. They have been enhanced in quite a number of ways, and the good news is that, for readers familiar with the 16F series, there isn't a steep learning curve before you can start using them.

Programs written for a 16F can usually be ported to run on a similar 18F with only a modest amount of work – it's not a rewrite job, although there are a few nasty pitfalls to avoid that we'll discuss. You can learn about a number of the new features gradually, and only when you need them.

# NO ONE DOES IT BETTER

EVERYDAY  
PRACTICAL  
ELECTRONICS

**DON'T MISS AN  
ISSUE – PLACE YOUR  
ORDER NOW!**

Or take out a subscription and save money  
See page 191

**APRIL 2005 ISSUE ON SALE THURSDAY, MARCH 10**



Quasar Electronics Limited  
PO Box 6935, Bishops Stortford,  
CM23 4WP  
Tel: 0870 246 1826  
Fax: 0870 460 1045  
E-mail: sales@quasarelectronics.com

Add £2.95 P&P to all UK orders or 1st Class Recorded – £4.95.  
Next day (insured £250) – £7.95. Europe – £6.95. Rest of World – £9.95  
(order online for reduced price UK Postage).  
We accept all major credit/debit cards. Make cheques/POs  
payable to Quasar Electronics Limited.  
Prices include 17.5% VAT. MAIL ORDER ONLY.  
Call now for our FREE CATALOGUE with details of over 300  
high quality kits, projects, modules and publications.



# QUASAR 0871 CREDIT CARD SALES 717 7168

Helping you make the right connections

## PIC & ATMEL Programmers

We have a wide range of low cost PIC and ATMEL Programmers. Complete range and documentation available from our web site.

### Programmer Accessories:

40-pin Wide ZIF socket (ZIF40W) £15.00  
18VDC Power supply (PSU010) £19.95  
Leads: Parallel (LDC136) £4.95 / Serial (LDC441) £4.95 / USB (LDC644) £2.95

### NEW! USB 'All-Flash' PIC Programmer

USB PIC programmer for all 'Flash' devices. No external power supply making it truly portable. Supplied with box and Windows Software. ZIF Socket and USB Plug A-B lead not incl.



Kit Order Code: 3128KT – £34.95

Assembled Order Code: AS3128 – £44.95

### Enhanced "PICALL" ISP PIC Programmer

Will program virtually ALL 8 to 40 pin PICs plus certain ATMEL AVR, SCENIX SX and EEPROM 24C devices. Also supports In System Programming (ISP) for PIC and ATMEL AVRs. Free software. Blank chip auto detect for super fast bulk programming. Requires a 40-pin wide ZIF socket (not included)

Assembled Order Code: AS3144 – £54.95

### ATMEL 89xxx Programmer

Uses serial port and any standard terminal comms program. 4 LEDs display the status. ZIF sockets not included. Supply: 16VDC.



Kit Order Code: 3123KT – £29.95

Assembled Order Code: AS3123 – £34.95

### NEW! USB & Serial Port PIC Programmer

USB/Serial connection. Header cable for ICSP. Free Windows software. See website for PICs supported. ZIF Socket and USB Plug A-B lead extra. 18VDC.

Kit Order Code: 3149KT – £34.95

Assembled Order Code: AS3149 – £49.95

### Introduction to PIC Programming

Go from a complete PIC beginner to burning your first PIC and writing your own code in no time!

Includes a 49-page step-by-step Tutorial Manual, Programming Hardware (with LED bench testing section), Win 3.11-XP Programming Software (will Program, Read, Verify & Erase), and a rewritable PIC16F84A that you can use with different code (4 detailed examples provided for you to learn from). Connects to PC parallel port.



Kit Order Code: 3081KT – £14.95

Assembled Order Code: AS3081 – £24.95

### ABC Maxi AVR Development Board

The ABC Maxi board has an open architecture design based on Atmel's AVR AT90S8535 RISC microcontroller and is ideal for developing new designs.



#### Features:

8Kb of In-System Programmable Flash (1000 write/erase cycles) • 512 bytes internal SRAM • 512 bytes EEPROM • 8 analogue inputs (range 0-5V) • 4 Opto-isolated Inputs (I/Os are bi-directional with internal pull-up resistors) • Output buffers can sink 20mA current (direct i.e.d. drive) • 4 x 12A open drain MOSFET outputs • RS485 network connector • 2-16 LCD Connector • 3-5mm Speaker Phone Jack • Supply: 9-12VDC.

The ABC Maxi STARTER PACK includes one assembled Maxi Board, parallel and serial cables, and Windows software CD-ROM featuring an Assembler, BASIC compiler and in-system programmer.

Order Code ABCMAXISP – £79.95

The ABC Maxi boards only can also be purchased separately at £59.95 each.

## Controllers & Loggers

Here are just a few of the controller and data acquisition and control units we have. See website for full details. Suitable PSU for all units: Order Code PSU445 – £8.95

### Rolling Code 4-Channel UHF Remote

State-of-the-Art. High security. 4 channels. Momentary or latching relay output. Range up to 40m. Up to 15 TXs can be learned by one Rx (kit includes one Tx but more available separately). 4 indicator LEDs.



Rx: PCB 77x85mm, 12VDC/6mA (standby).

Two & Ten Channel versions also available.

Kit Order Code: 3180KIT – £41.95

Assembled Order Code: AS3180 – £49.95

### Computer Temperature Data Logger

Serial port 4-channel temperature logger. °C or °F. Continuously logs up to 4 separate sensors located 200m+ from board. Wide range of free software applications for storing/using data. PCB just 38x38mm. Powered



by PC. Includes one DS1820 sensor and four header cables.

Kit Order Code: 3145KT – £19.95

Assembled Order Code: AS3145 – £26.95

Additional DS1820 Sensors – £3.95 each

Most items are available in kit form (KT suffix) or pre-assembled and ready for use (AS prefix).

### NEW! DTMF Telephone Relay Switcher

Call your phone number using a DTMF phone from anywhere in the world and remotely turn on/off any of the 4 relays as desired. User settable Security Password, Anti-Tamper. Rings to Answer, Auto Hang-up and Lockout. Includes plastic case. 130 x 110 x 30mm. Power: 12VDC.



Kit Order Code: 3140KT – £39.95

Assembled Order Code: AS3140 – £49.95

### Serial Port Isolated I/O Module



Computer controlled 8-channel relay board. 5A mains rated relay outputs and 4 opto-isolated digital inputs (for monitoring switch states, etc). Useful in a variety of control and sensing applications. Programmed via serial port (use our new Windows interface, terminal emulator or batch files). Serial cable can be up to 35m long. Includes plastic case 130 x 100 x 30mm. Power: 12VDC/500mA.

Kit Order Code: 3108KT – £54.95

Assembled Order Code: AS3108 – £64.95

### Infra-red RC 12-Channel Relay Board



Control 12 on-board relays with included infra-red remote control unit. Toggle or momentary. 15m+ range. 112 x 122mm.

Supply: 12VDC/0.5A.

Kit Order Code: 3142KT – £41.95

Assembled Order Code: AS3142 – £51.95

### PC Data Acquisition & Control Unit

Monitor and log a mixture of analogue and digital inputs and control external devices via the analogue and digital outputs. Monitor pressure, temperature, light intensity, weight, switch state, movement, relays, etc. with the appropriate sensors (not supplied). Data can be processed, stored and the results used to control devices such as motors, sirens, relays, servo motors (up to 11) and two stepper motors.



#### Features

- 11 Analogue Inputs – 0-5V, 10 bit (5mV/step)
- 16 Digital Inputs – 20V max. Protection 1K in series, 5-1V Zener
- 1 Analogue Output – 0-2.5V or 0-10V. 8 bit (20mV/step)
- 8 Digital Outputs – Open collector, 500mA, 33V max
- Custom box (140 x 110 x 35mm) with printed front & rear panels
- Windows software utilities (3-1 to XP) and programming examples
- Supply: 12V DC (Order Code PSU203)

Kit Order Code: 3093KT – £69.95

Assembled Order Code: AS3093 – £99.95

## Hot New Kits This Summer!

Here are a few of the most recent kits added to our range. See website or join our email Newsletter for all the latest news.

### NEW! EPE Ultrasonic Wind Speed Meter



Solid-state design wind speed meter (anemometer) that uses ultrasonic techniques and has no moving parts and does not need

calibrating. It is intended for sports-type activities, such as track events, sailing, hang-gliding, kites and model aircraft flying, to name but a few. It can even be used to monitor conditions in your garden. The probe is pointed in the direction from which the wind is blowing and the speed is displayed on an LCD display.

#### Specifications

- Units of display: metres per second, feet per second, kilometres per hour and miles per hour
- Resolution: Nearest tenth of a metre
- Range: Zero to 50mph approx.

Based on the project published in Everyday Practical Electronics, Jan 2003. We have made a few minor design changes (see website for full details). Power: 9VDC (PP3 battery or Order Code PSU345).

Main PCB: 50 x 83mm.

Kit Order Code: 3168KT – £34.95

### NEW! Audio DTMF Decoder and Display



Detects DTMF tones via an on-board electret microphone or direct from the phone lines through the onboard audio transformer. The

numbers are displayed on a 16-character, single line display as they are received. Up to 32 numbers can be displayed by scrolling the display left and right. There is also a serial output for sending the detected tones to a PC via the serial port. The unit will not detect numbers dialled using pulse dialling. Circuit is microcontroller based.

Supply: 9-12V DC (Order Code PSU345).

Main PCB: 55 x 95mm.

Kit Order Code: 3153KT – £17.95

Assembled Order Code: AS3153 – £29.95

### NEW! EPE PIC Controlled LED Flasher

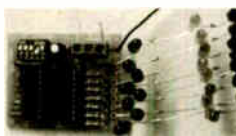

This versatile PIC-based LED or filament bulb flasher can be used to flash from 1 to 160

LEDs. The user arranges the LEDs in any pattern they wish. The kit comes with 8 superbright red LEDs and 8 green LEDs. Based on the Versatile PIC Flasher by Steve Challinor, EPE Magazine Dec '02. See website for full details. Board Supply: 9-12V DC. LED supply: 9-45V DC (depending on number of LED used). PCB: 43 x 54mm. Kit Order Code: 3169KT – £10.95

Most items are available in kit form (KT suffix) or assembled and ready for use (AS prefix)

## FM Bugs & Transmitters

Our extensive range goes from discreet surveillance bugs to powerful FM broadcast transmitters. Here are a few examples. All can be received on a standard FM radio and have adjustable transmitting frequency.

### MTTX' Micro-Miniature 9V FM Room Bug



Our best selling bug! Good performance. Just 25 x 15mm. Sold to detective agencies worldwide. Small enough to hide just about anywhere.

Operates at the 'less busy' top end of the commercial FM waveband and also up into the more private Air band.

Range: 500m. Supply: PP3 battery.

Kit Order Code: 3051KT – £8.95

Assembled Order Code: AS3051 – £14.95

### HPTX' High Power FM Room Bug

Our most powerful room bug.

Very Impressive

performance. Clear and stable output signal thanks to the extra circuitry employed.

Range: 1000m @ 9V. Supply: 6-12V DC (9V PP3 battery clip supplied). 70 x 15mm.

Kit Order Code: 3032KT – £9.95

Assembled Order Code: AS3032 – £17.95

### MTTX' Miniature Telephone Transmitter



Attach anywhere

along phone line.

Tune a radio into the signal and hear

exactly what both parties are saying.

Transmits only when phone is used. Clear, stable signal. Powered from phone line so completely maintenance free once installed.

Requires no aerial wire – uses phone line as antenna. Suitable for any phone system worldwide. Range: 300m. 20 x 45mm.

Kit Order Code: 3016KT – £7.95

Assembled Order Code: AS3016 – £13.95

### 3 Watt FM Transmitter



Small, powerful FM transmitter. Audio preamp stage and three RF stages deliver 3 watts of RF power. Can be used with the electret

microphone supplied or any line level audio source (e.g. CD or tape OUT, mixer, sound card, etc). Aerial can be an open dipole or Ground Plane. Ideal project for the novice wishing to get started in the fascinating world of FM broadcasting. 45 x 145mm.

Kit Order Code: 1028KT – £22.95

Assembled Order Code: AS1028 – £34.95

### 25 Watt FM Transmitter

Four transistor based stages with a Philips BLY89 (or equivalent) in the final stage. Delivers a mighty 25 Watts of RF power.

Accepts any line level audio source (input sensitivity is adjustable). Antenna can be an open dipole, ground plane, 5/8, J, or YAGI configuration. Supply 12-14V DC, 5A. Supplied fully assembled and aligned – just connect the aerial, power and audio input. 70 x 220mm.

Order Code: 1031M – £124.95



**QUASAR**  
electronics

Helping you make the right connections!

**CREDIT  
CARD  
SALES**  
0871  
717  
7168

## Electronic Project Labs

Great introduction to the world of electronics. Ideal gift for budding electronics expert!

### 500-in-1 Electronic Project Lab

This is the top of the range and is a complete electronics course taking you from beginner to 'A' level standard and beyond! It contains all the parts and instructions to assemble 500 projects. You get three comprehensive course books (total 368 pages) – *Hardware Entry Course*, *Hardware Advanced Course* and a micro-computer based *Software Programming Course*. Each book has individual circuit explanations, schematic and assembly diagrams. Suitable for age 12 and above. Order Code EPL500 – £149.95

**30, 130, 200 and 300-in-1 project labs also available – see website for details.**



## Number 1 for Kits!

With over 300 projects in our range we are the UK's number 1 electronic kit specialist. Here are a few other kits from our range.

- 1046KT – 25W Stereo Car Booster £29.95
- 3087KT – 1W Stereo Amplifier £4.95
- 3105KT – 18W BTL mono Amplifier £9.95
- 3106KT – 50W Mono Hi-fi Amplifier £19.95
- 3143KT – 10W Stereo Amplifier £10.95
- 1011-12KT – Motorbike Alarm £12.95
- 1019KT – Car Alarm System £11.95
- 1048KT – Electronic Thermostat £9.95
- 1080KT – Liquid Level Sensor £6.95
- 3003KT – LED Dice with Box £7.95
- 3006KT – LED Roulette Wheel £8.95
- 3074KT – 8-Ch PC Relay Board £29.95
- 3082KT – 2-Ch UHF Relay £26.95
- 3126KT – Sound-Activated Relay £7.95
- 3063KT – One Chip AM Radio £10.95
- 3102KT – 4-Ch Servo Motor Driver £15.95
- 3155KT – Stereo Tone Controls £8.95
- 1096KT – 3-30V, 5A Stabilised PSU £32.95
- 3029KT – Combination Lock £6.95
- 3049KT – Ultrasonic Detector £13.95
- 3130KT – Infra-red Security Beam £12.95
- SG01MKT – Train Sounds £6.95
- SG10 MKT – Animal Sounds £5.95
- 1131KT – Robot Voice Effect £9.95
- 3007KT – 3V FM Room Bug £6.95
- 3028KT – Voice-Activated FM Bug £12.95
- 3033KT – Telephone Recording Adpt £9.95
- 3112KT – PC Data Logger/Sampler £18.95
- 3118KT – 12-bit Data Acquisition Unit £52.95
- 3101KT – 20MHz Function Generator £69.95

**No.1  
FOR  
KITS**

**www.quasarelectronics.com**

Secure Online Ordering Facilities • Full Product Listing, Descriptions & Photos • Kit Documentation & Software Downloads

# EPE PIC RESOURCES CD-ROM V2

**VERSION 2 NOW AVAILABLE**



**Version 2 includes the EPE PIC Tutorial V2 series of Supplements (EPE April, May, June 2003)**

**ONLY £14.45**  
INCLUDING VAT and P&P

The CD-ROM contains the following Tutorial-related software and texts:

- EPE PIC Tutorial V2 complete series of articles plus demonstration software, John Becker, April, May, June '03
- PIC Toolkit Mk3 (TK3 hardware construction details), John Becker, Oct '01
- PIC Toolkit TK3 for Windows (software details), John Becker, Nov '01

Plus these useful texts to help you get the most out of your PIC programming:

- How to Use Intelligent L.C.D.s, Julyan Ilett, Feb/Mar '97
- PIC16F87x Microcontrollers (Review), John Becker, April '99
- PIC16F87x Mini Tutorial, John Becker, Oct '99
- Using PICs and Keypads, John Becker, Jan '01
- How to Use Graphics L.C.D.s with PICs, John Becker, Feb '01
- PIC16F87x Extended Memory (how to use it), John Becker, June '01
- PIC to Printer Interfacing (dot-matrix), John Becker, July '01
- PIC Magick Musick (use of 40kHz transducers), John Becker, Jan '02
- Programming PIC Interrupts, Malcolm Wiles, Mar/Apr '02
- Using the PIC's PCLATH Command, John Waller, July '02
- EPE StyloPIC (precision tuning musical notes), John Becker, July '02
- Using Square Roots with PICs, Peter Hemsley, Aug '02
- Using TK3 with Windows XP and 2000, Mark Jones, Oct '02
- PIC Macros and Computed GOTOs, Malcolm Wiles, Jan '03
- Asynchronous Serial Communications (RS-232), John Waller, unpublished
- Using I<sup>2</sup>C Facilities in the PIC16F877, John Waller, unpublished
- Using Serial EEPROMs, Gary Moulton, unpublished
- Additional text for EPE PIC Tutorial V2, John Becker, unpublished

NOTE: The PDF files on this CD-ROM are suitable to use on any PC with a CD-ROM drive. They require Adobe Acrobat Reader – included on the CD-ROM

**Order on-line from**  
[www.epemag.wimborne.co.uk/shopdoor.htm](http://www.epemag.wimborne.co.uk/shopdoor.htm)  
or [www.epemag.com](http://www.epemag.com) (USA \$ prices)  
or by Phone, Fax, Email or Post.

## EPE PIC RESOURCES V2 CD-ROM ORDER FORM

Please send me ..... (quantity) EPE PIC RESOURCES V2 CD-ROM

Price £14.45 each – includes postage to anywhere in the world.

Name .....

Address .....

.....

.....

..... Post Code .....

I enclose cheque/P.O./bank draft to the value of £ .....

Please charge my Visa/Mastercard/Amex/Diners Club/Switch/Maestro

£ .....

Card No. ....

Card Security Code ..... (The last 3 digits on or just under the signature strip)

Valid From ..... Expiry Date .....

Switch Issue No. ....

**SEND TO: Everyday Practical Electronics,  
Wimborne Publishing Ltd.,**

**408 Wimborne Road East, Ferndown, Dorset BH22 9ND.**

Tel: 01202 873872. Fax: 01202 874562.

Email: [orders@epemag.wimborne.co.uk](mailto:orders@epemag.wimborne.co.uk)

Payments must be by card or in £ Sterling – cheque or bank draft drawn on a UK bank.

Normally supplied within seven days of receipt of order.

Send a copy of this form, or order by letter if you do not wish to cut your issue.

**BECOME A PIC WIZARD WITH THE HELP OF EPE!**



# SQUIRES

## MODEL & CRAFT TOOLS

A COMPREHENSIVE RANGE OF MINIATURE HAND AND POWER TOOLS AND AN EXTENSIVE RANGE OF

## ELECTRONIC COMPONENTS

FEATURED IN A FULLY ILLUSTRATED

704 PAGE MAIL ORDER CATALOGUE

# 2005 ISSUE

## SAME DAY DESPATCH FREE POST AND PACKAGING

Catalogues: FREE OF CHARGE to addresses in the UK.  
Overseas: CATALOGUE FREE, postage at cost charged to credit card

## SHOP EXTENSION NOW OPEN

Squires, 100 London Road,  
Bognor Regis, West Sussex, PO21 1DD



TEL: 01243 842424  
FAX: 01243 842525



## FRUSTRATED!

### Looking for ICs TRANSISTORS?

A phone call to us could get a result. We offer an extensive range and with a world-wide database at our fingertips, we are able to source even more. We specialise in devices with the following prefix (to name but a few).



2N 2SA 2SB 2SC 2SD 2P 2SJ 2SK 3N 3SK 4N 6N 17 40 AD ADC AN AM AY BA BC BD BDT BDV BDW BDX BF BFR BFS BFT BFX BFY BLY BLX BS BR BRX BRY BS BSS BSV BSW BSX BT BTA BTB BRW BU BUK BUT BUW BUX BUZ BUZ CA CD CX CXA DAC DG DM DS DTA DTC GL GM HA HCF HD HEF ICL ICM IRF J KA KIA L LA LB LC LD LF LM M M5M MA MAB MAX MB MC MDAJ MJE MJF MM MN MPS MP5A MP5H MP5U MRF NJM NE OM OP PA PAL PIC PN RC S SAA SAB SAD SAJ SAS SDA SG SI SL SN SO STA STK STR STRD STRM STRS SV T TA TAA TAG TBA TC TCA TDA TDB TEA TIC TIP TIPL TEA TL TLC TMP TMS TPU U UA UAA UC UDN ULN UM UPA UPC UPD VN X XR Z ZN ZTX + many others

**PLEASE VISIT OUR WEB SITE AT**  
[www.cricklewoodelectronics.com](http://www.cricklewoodelectronics.com)  
We Stock a Massive Range of Components

Mail, phone, Fax Credit Card orders and callers welcome



Connect

## Cricklewood Electronics Ltd

40-42 Cricklewood Broadway London NW2 3ET  
Tel: 020 8452 0161 Fax: 020 8208 1441

## PLEASE ENSURE YOU TELEPHONE TO CHECK AVAILABILITY OF EQUIPMENT BEFORE ORDERING OR CALLING.

### MISCELLANEOUS CLEARANCE STOCK

<b>OSCILLOSCOPES</b>	<b>POWER SUPPLY</b> Model 12030 0-20V 0-30A - On Wheels	£95
TEKTRONIX 465B Dual Trace 100 MHz Delay fitted into 19in rack frame	HARMER SIMMONS 5025/110 Input 240V 10A Output 50V 25A	£100
HP 1740A Dual Trace 100 MHz delay (rd lock)	CENTRONIX M100 Regavoit input 240V 250 VA Output 240V 1000VA	£90
HP 1740A Dual Trace 100 MHz Delay	DRANETZ 606 Line Distribution Analyser	£35
HP 1741 Dual Trace 100 MHz Analogue Storage	WAYNE KERR B801 Radio Frequency Bridge	£25
HP 1744A Dual Trace 100 MHz Analogue Storage	FEEDBACK TFA607 Transfer Function Analyser	£25
PHILIPS PM3264 4 Ch. 100 MHz	WAVETEK S2 Data Multimeter	£60
GOULD OS3000A Dual Trace 40 MHz	GOULD SG200 RF Signal Generator	£20
TRO CS1040 Dual Trace 40 MHz	CHATLLOW Force Meter	£15
GOLDSTAR OS9020P Dual Trace 20 MHz	ALFRED E105 Variable Attenuator 4-9GHz	£20
WATSU SS5702 Dual Trace 20 MHz	CALMETRIC 6 Decade Resistance Box	£15
KIKUSUI COS5020 Dual Trace 20 MHz	SULLIVAN C8710 Precision 5 Decade Capacitor Box	£20
<b>POWER SUPPLIES</b>	MARCONI 6033/3 Waveguide	£20
FARNELL L30BT 0-30V 0-1A Twice	MARCONI 2169 Pulse Modulator	£20
FARNELL L30AT 0-30V 0-500MA Twice	MARCONI 2400A Frequency Meter 80MHz	£30
FARNELL L730-1 0-30V 0-1A Twice Scruffy	MARCONI 6950 RF Power Meter - No head	£35
FARNELL L302 0-30V 0-2A Scruffy	MARCONI 6960 RF Power Meter - No head - Digital	£50
FARNELL L30-1 0-30V 0-1A Scruffy	HP X382A Variable Attenuator Waveguide	£20
FARNELL L30B 0-30V 0-1A	HP X316A Counter	£50
FARNELL L30AT 0-30V 0-500MA	HP 8750A Storage Normalizer	£60
FARNELL C1 0-50V 0-1A - 2 Meters	HP 907A Coaxial Sliding Load	£20
Farnell TOP51 5V 1A or 1-5V 200MA	PROGRAMMA T92 Timer	£20
COUTANT LB500 2 0-30V 0-5A - 2 Meters	RACAL 9009 Modulation Meter	£40
COUTANT LQ750 2 0-30V 0-2A - 2 Meters	RACAL 9009A Modulation Meter	£50
COUTANT LQ7200 0-15V 0-2A - Twice	TEXCAN SAS5 102dB in 10dB steps	£15
COUTANT LQ7100 0-30V 0-1A Twice	BIRD Attenuator etc in box 30dB	£15
COUTANT LQ750 2 0-30V 0-500MA	BIRD B341-200 Coaxial Attenuator 20dB 40W 50ohm	£25
WEIR 781 0-30V 2A or 0-15V 4A	BIRD 31 Wattmeter 6 & 30W 50ohm 30-50MHz	£40
WEIR 782 0-30V 2A or 0-15V 4A	TELOMIC TTF95-5-SEE Tunable Band Pass Filter	£20
WEIR 431D 0-30V 1A - 5V 4A	TELOMIC 190-SEE Tunable Band Reject Filter 125-250	£15
WEIR 400 0-30V 0.3A - 10V 1A	TELOMIC 95-SEE Tunable Band Reject Filter 60-126	£15
WEIR 460 0-60V 0.3A - 20V 1A	HELPER INST CM11 Snapper	£30
HP 6266B 0-40V 0-5A 2 Meters	HELPER INST S103 Snapper 3	£30
HP 6266B 0-10V 0-20A 2 Meters	SXP100 Parallel to Serial Converter	£10
HP 6111A 0-20V 0-1A	MICROMASTER LV	£40
HP 6235A +6V 1A +19V 200MA	DATAMAN S3 Programmer	£50
KINGSBILL 36V2C 0-36C 0-2A	RS 428-103 Logic Pulsar	£20
MARCONI TP2158 0-30V 0-2A Twice	GLOBAL S01 Shortcircuit	£25
LAMBDA 422FM 0-40V 0-1A Twice + 2 Meters	RS 160-7127 Conductivity Meter	£35
LAMBDA LK345A FM 0-60V 0-10A 2 Meters	EAGLE DC30 Probe 30kHz DC	£5
SYSTEM DOWNER SHR40-2 0-40V 0-2A - 2 Meters	AVO T20AMP Shunt for AVO 8	£5
GRENSON SRL60-4 0-60V 0-4A	SOUTHERN CALIFORNIA BTRM-S-10 2000.0 MHz	£50
SORENSEN BP14 +5V 2.5A & +/- 15V 1.5A	MOTOROLA R2001D Communication System Analyser	£250
RS 815-991 2 x 5v 2.5A or 2 x 1.5V 1.5A or 2 x 5V 1A	WESTON 1149 Standard Cell 1.01859 ABS Volts at 20C	£10
RS 208-197 Line Voltage Conditioner - Output 240V 0.65A	MURHEAD A-6-B Resistance Box	£10
POWER CONVERSION PLC1000 Line Cond. 1000VA	RACAL 9917A UHF Frequency Meter 10Hz-560 MHz	£45
HARLWY AUTOMATION PPS3200 System Power Supply	RACAL 9917 UHF Frequency Meter 10Hz-560 MHz	£40
POWERLINE LAB807 0-300V 0-0.75A	RACAL 9915M UHF Frequency Meter 10Hz-520 MHz	£30

RACAL 9901 Universal Counter Timer DC-50 MHz	£15
RACAL 9900 Universal Counter Timer 30 MHz DC-30 MHz±15	£15
WAVETEK 136 VCG/CA Generator	£20
HP 435A Power Meter - No lead no head	£15
HP 8015A Pulse Generator	£30
HP 403B AC Voltmeter	£15
DH-LOG PRA15 Phase Rotation Indicator	£10
RAYWORLD D2000 Digital Indicator	£10
HP 3720A HP/IB Extender	£10
HATFIELD 2115 Attenuator 75ohm 100dB	£10
HATFIELD 2115S Attenuator 75ohm 100dB	£10
HATFIELD 2118R Attenuator 75ohm 100dB	£10
HATFIELD 2135 Attenuator 600ohm 100dB	£20
TEKTRONIX 1103 Tekprobe Power Supply	£10
SYSTEM DOWNER 6243A Freq Counter 20Hz-1250 MHz±35	£35
LEVILL TG301 Function Generator 1 MHz Sine/Sq/Tri	£30
SOLARTRON 7045 Digital Multimeter	£30
HP 8040A Leveling Amplifier	£15
HP 3455A Digital Voltmeter	£50
FEEDBACK PM610 Digital Frequency Meter	£25
EARNELL T88 True RMS RF Millivoltmeter	£40
THURLBY 1503 Digital Multimeter	£15
SULLIVAN 8666 Milliohmmeter	£15
KAL Tunable Bank Reject Filter	£15
BARR & STROUD EF4-02 Bank Pass Filter 1Hz-100KHz	£15
BARR & STROUD EF4-02 LP/HP Filter 1Hz-100KHz	£15
FLUKE 8810A Digital Multimeter	£30
FLUKE 8502A Digital Multimeter	£25
ELECTRONIC VISUAL EV4840 TV Waveform Monitor	£20
TRACER NORTHERN TN1750	£30
WRS-275 UV Exposure Unit	£10
MICRODYNE CORP. Receiver	£50
VARIAN V2L-6941F1 Travelling Wave Tube Amplifier	£50
MOORE READ SFC5001 AUXJC Static Frequency Converter	£20
720 Volts 400 Hz	£50
BRAGER 2131 Multi Gas Detector	£10
PHILIPS PM8237 Multiport Data Recorder	£20
INDEUCO 4417 Signal Conditioner X 2	£10
PULSTEX 132 DC Current Calibrator	£30
PM1038-014 Display with 1038-N10 Network Analyser	No
Heads	£50
NEGERO MUMAZK Wind Up 1000V Mohm	£30
NETROM 2501 Pal Tester	£15
SULLIVAN AC1012 4 Decade Resistance Box 0.05%	£10
BRANDENBURGH 020 Static Freq Converter 110/240V input	£40
0-60KHz Output 115V 400Hz 20VA	£40
NARDA 708 Attenuator	£10
ANALOGUE ASSOCIATES X800 Audio Amplifier 800watt (400w	£30
per Channel no DC Protection)	£30
W&G PC62 PCM Channel Generator	£30
SIVERS LAB 12400 - 18000 MHz	£10
SIVERS LAB 5212 2500 - 4000 MHz + C264	£10
CHOPICO VS10 DC Standard 10V	£30

### EXTRA SPECIAL OFFERS

H.P. 8560A Spectrum Analyser, 50Hz-2.0GHz	£3,250
H.P. 8568B Spectrum Analyser, 1MHz-22GHz	£1,500
MARCONI 2382 Spectrum Analyser, 20MHz-400MHz	£1,250
TEKTRONIX 2465A Oscilloscope, 4-ch, 350MHz	£750
TEKTRONIX 2246 Oscilloscope, 4-ch, 100MHz	£375
H.P. 8640A AM/FM Signal Gen, 500kHz-512kHz	£175

### SPECIAL OFFERS

OSCILLOSCOPES	
LECROY 9400A dual trace, 170MHz, 5GS	£500
LECROY 9400 dual trace, 125MHz	£400
TEKTRONIX 468 dual trace, 100MHz, digital storage	£300
TEKTRONIX 475 dual trace, 200MHz, delay sweep	£250
TEKTRONIX 465B dual trace, 100MHz, delay sweep	£250
TEKTRONIX 465 dual trace, 100MHz, delay sweep	£175
PHILIPS PM317 dual trace, 50MHz, delay sweep	£150
THURLBY PL3200MD 0-30V 0-2A twice digital PSU	£160
H.P. 66512A 0-20V 0-2A Communications PSU	£200
H.P. 6626A Precision High Resolution PSU 8 outputs	
0-7V 0-15A or 0-50V 0-0.5A twice; 0-15V 0-0.2A	£500
0-0.5V 0-2A twice	
CIRRUS CR254 Sound Level Meter with calibrator	£70
80-120dB LED	£95
WAYNE KERR B404 Component Bridge	£50
RACAL 9300 True RMS Voltmeter, 5Hz-20MHz usable to	
50MHz, 10V-316V	£50
RACAL 9300B True RMS Voltmeter, 5Hz-20MHz usable to	
50MHz, 10V-316V	£70
AVO DA116 Digital Avometer with battery and leads	£20
FARNELL LF84 Sine/Sq Oscillator, 10Hz-1MHz	£75
low distortion TTL output amplitude meter	£80
FARNELL J38 Sine/Sq Oscillator, 10Hz-100kHz, low dist	£30
FLUKE 1000 LCD Clamp Meter, 0-100mA, in carrying case	£35
HEME 77 Multimeter 3 1/2 digit handheld with battery & leads	£45
KENWOOD VT176 2-Channel Multimeter	£50
FLUKE 700 Multimeter	£50
KENWOOD FL140 Wow and Flutter Meter	£75
KENWOOD FL180A Wow and Flutter Meter	£75
KENWOOD FL180 Wow and Flutter Meter, in-carrying case	£125
KENWOOD 6960B Power Meter with 650Ω load, 10MHz-20GHz±450	
SOLARTRON 7150 DMM 6 1/2 digit True RMS IEEE	£75
SOLARTRON 7150 Plus As 7150 + temp. measurement	£100
IEEE Cables	£5
H.P. 3312A Function Gen. 0-1Hz-13MHz, AM/FM	
Sine/Sq/Tri/Burst etc	£200
H.P. 3310A Function Gen. 0.005Hz-8MHz, Sine/Sq/Tri	
Ramp/Pulse	£80
RACAL 9008 Automatic Modulation Meter, ±5MHz-2GHz	£30
ISOLATING Transformer, input 250V output 500VA, unused	£80
RACAL 1792 Receiver	£25

## STEWART of READING

17A King Street, Mortimer, Near Reading RG7 3RS  
Telephone: (0118) 933 1111. Fax: (0118) 933 2375



www.stewart-of-reading.co.uk

Open 9am-5.00pm Monday to Friday (other times by arrangement)

### Used Equipment - GUARANTEED. Manuals supplied

This is a VERY SMALL SAMPLE OF STOCK. SAE or Telephone for lists.  
Please check availability before ordering.  
CARRIAGE all units £16. VAT to be added to Total of Goods and Carriage

**MAIL ORDER ONLY • CALLERS BY APPOINTMENT**

### EPE PROJECT PICS

Programmed PICs for \*EPE Projects  
 12C508/9 - £3.90; 16F627/8 - £4.90  
 16C84/16F84/16C71 - £5.90  
 16F876/877 - £10.00  
 All inc. VAT and Postage  
 (\*Some projects are copyright)

### EPE MICROCONTROLLER P.I. TREASURE HUNTER

The latest MAGENTA DESIGN - highly stable & sensitive - with I.C. control of all timing functions and advanced pulse separation techniques.

- High stability drift cancelling
- Easy to build & use
- No ground effect, works in seawater



- Detects gold, silver, ferrous & non-ferrous metals

- Efficient quartz controlled microcontroller pulse generation.
- Full kit with headphones & all hardware

**KIT 847 ..... £63.95**

### PIC PIPE DESCALER

- SIMPLE TO BUILD
- HIGH POWER OUTPUT
- AUDIO & VISUAL MONITORING
- SWEPT FREQUENCY

An affordable circuit which sweeps the incoming water supply with variable frequency electromagnetic signals. May reduce scale formation, dissolve existing scale and improve lathering ability by altering the way salts in the water behave. Kit includes case, P.C.B., coupling coil and all components. High coil current ensures maximum effect. L.E.D. monitor.



**KIT 868 ..... £22.95 POWER UNIT.....£3.99**

### MICRO PEST SCARER

Our latest design - The ultimate scarer for the garden. Uses special microchip to give random delay and pulse time. Easy to build reliable circuit. Keeps pets/pests away from newly sown areas, play areas, etc. uses power source from 9 to 24 volts.

- RANDOM PULSES
- HIGH POWER
- DUAL OPTION



Plug-in power supply £4.99

**KIT 867. .... £19.99**

**KIT + SLAVE UNIT. .... £32.50**

### WINDICATOR

A novel wind speed indicator with LED readout. Kit comes complete with sensor cups, and weatherproof sensing head. Mains power unit £5.99 extra.

**KIT 856. .... £28.00**

## ★ TENS UNIT ★

### DUAL OUTPUT TENS UNIT

As featured in March '97 issue.

Magenta have prepared a FULL KIT for this excellent new project. All components, PCB, hardware and electrodes are included. Designed for simple assembly and testing and providing high level dual output drive.

**KIT 866. . Full kit including four electrodes £32.90**

Set of 4 spare electrodes £6.50

### 1000V & 500V INSULATION TESTER



Superb new design. Regulated output, efficient circuit. Dual-scale meter, compact case. Reads up to 200 Megohms.

Kit includes wound coil, cut-out case, meter scale, PCB & ALL components.

**KIT 848. .... £32.95**

## EPE TEACH-IN 2000

Full set of top quality NEW components for this educational series. All parts as specified by EPE. Kit includes breadboard, wire, croc clips, pins and all components for experiments, as listed in introduction to Part 1.

\*Batteries and tools not included.

### TEACH-IN 2000 -

**KIT 879 £44.95**

**MULTIMETER £14.45**

### SPACEWRITER

An innovative and exciting project. Wave the wand through the air and your message appears. Programmable to hold any message up to 16 digits long. Comes pre-loaded with "MERRY XMAS". Kit includes PCB, all components & tube plus instructions for message loading.

**KIT 849 ..... £16.99**

### 12V EPROM ERASER

A safe low cost eraser for up to 4 EPROMS at a time in less than 20 minutes. Operates from a 12V supply (400mA). Used extensively for mobile work - updating equipment in the field etc. Also in educational situations where mains supplies are not allowed. Safety interlock prevents contact with UV.

**KIT 790 ..... £29.90**

### SUPER BAT DETECTOR

1 WATT O/P, BUILT IN SPEAKER, COMPACT CASE  
 20kHz-140kHz  
 NEW DESIGN WITH 40kHz MIC.

A new circuit using a 'full-bridge' audio amplifier i.c., internal speaker, and headphone/tape socket. The latest sensitive transducer, and 'double balanced mixer' give a stable, high performance superheterodyne design.

**KIT 861 ..... £34.99**

ALSO AVAILABLE Built & Tested... £48.99



### 68000 DEVELOPMENT TRAINING KIT

- NEW PCB DESIGN
- 8MHz 68000 16-BIT BUS
- MANUAL AND SOFTWARE
- 2 SERIAL PORTS
- PIT AND I/O PORT OPTIONS
- 12C PORT OPTIONS



**KIT 621**

**£99.95**

- ON BOARD 5V REGULATOR
- PSU £6.99
- SERIAL LEAD £3.99

### Stepping Motors

MD100...Std 100 step...£9.99

MD200...200 step...£12.99

MD24...Large 200 step...£22.95



### MOSFET MkII VARIABLE BENCH POWER SUPPLY 0-25V 2.5A

Based on our Mk1 design and preserving all the features, but now with switching pre-regulator for much higher efficiency. Panel meters indicate Volts and Amps. Fully variable down to zero. Toroidal mains transformer. Kit includes punched and printed case and all parts. As featured in April 1994 EPE. An essential piece of equipment.



Kit No. 845 ..... £64.95

### ULTRASONIC PEST SCARER

Keep pets/pests away from newly sown areas, fruit, vegetable and flower beds, children's play areas, patios etc. This project produces intense pulses of ultrasound which deter visiting animals.

- KIT INCLUDES ALL COMPONENTS, PCB & CASE
- EFFICIENT 100V TRANSDUCER OUTPUT
- COMPLETELY INAUDIBLE TO HUMANS
- UP TO 4 METRES RANGE
- LOW CURRENT DRAIN



**KIT 812. .... £15.00**

### SIMPLE PIC PROGRAMMER

**KIT 857... £12.99**

Includes PIC16F84 chip disk, lead, plug, p.c.b., all components and instructions

Extra 16F84 chips £3.84  
 Power Supply £3.99

## PIC LCD DISPLAY DRIVER

16 Character x 2 Line display, pcb, programmed PIC16F84, software disk and all components to experiment with standard intelligent alphanumeric displays. Includes full PIC source code which can be changed to match your application.

**KIT 860.....£19.99**

- Learn how to drive the display and write your own code.
- Ideal development base for meters, calculators, counters, timers — just waiting for your application!
- Top quality display with industry standard driver, data and instructions

## PIC STEPPING MOTOR DRIVER

PCB with components and PIC16F84 programmed with demonstration software to drive any 4 phase unipolar motor up to 24 Volts at 1 Amp. **Kit includes 100 Step Hybrid Stepping Motor** Full software source code supplied on disc.

Use this project to develop your own applications. PCB allows 'simple PIC programmer' 'SEND' software to be used to reprogram chip.

**KIT 863.....£18.99**

## 8 CHANNEL DATA LOGGER

From Aug/Sept '99 EPE. Featuring 8 analogue inputs and serial data transfer to PC. Magenta redesigned PCB - LCD plugs directly onto board. Use as Data Logger or as a test bed for developing other PIC16F877 projects. Kit includes lcd, prog. chip, PCB. Case, all parts and 8 x 256k EEPROMs

**KIT 877.....£49.95**

## PIC16F84 MAINS POWER CONTROLLER & 4 CHANNEL LIGHT CHASER / DIMMER

- Zero Volt Switching
- Opto-isolated 5 Amp HARD FIRED TRIACS
- 12 Way keypad Control

- With program source code disk.
- Chase Speed and dimming potentiometer controls.
- Reprogram for other applications

**KIT 855.....£39.95**

## PIC TUTOR 1 EPE MARCH APRIL MAY '98 PIC16F84 STARTER SERIES

The original PIC16F84 series by John Becker. Magenta's Tutor board has individual switches and leds on all portA and PortB lines, plus connectors for optional 4 digit seven segment led display, and 16 x 2 intelligent lcd. Written for newcomers to PICs this series. Disk has over 20 tutorial programs. Connect to a PC parallel port, send, run, and experiment by modifying test programs - Then Write and Program your Own

**KIT 870... £27.95, Built...£42.95**

16x2 LCD..£7.99. LED display..£6.99. 12VPSU..£3.99

## SUPER PIC PROGRAMMER

Magenta's original parallel port programmer. Complete with WINDOWS 95 - 2K software. Use standard Microchip .HEX files. Includes Disassembler. Read/Prog/Verify 18,28, and 40 pin PICs. 16F84/876/877, 627/8, + 16xx OTPs.

**KIT 862... £29.99** Power Supply £3.99

## ICEBREAKER

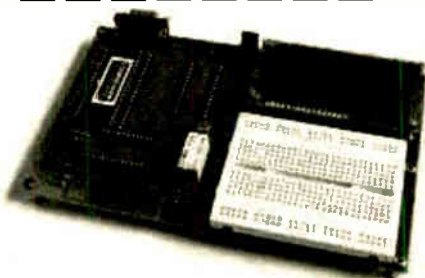

## PIC Real Time In-Circuit Emulator

- ICEbreaker uses PIC16F877 in-circuit debugger.
- Links to standard PC Serial port (lead supplied).
- Windows (95 to XP) Software included
- Works with MPASM assembler
- 16 x 2 LCD display, Breadboard, Relay, I/O devices and patch leads

Featured in *EPE Mar'00* Ideal for beginners & experienced users.

Programs can be written, downloaded, and then tested by single-stepping, running to breakpoints, or free run at up to 20Mhz. Full emulation means that all ports respond immediately - reading and driving external hardware. Features include: Run; set Breakpoint; View & change registers, EEPROM, and program memory; load program; 'watch window' registers.

**KIT 900...£34.99** With serial lead & software disk, PCB, Breadboard, PIC16F877, LCD, all components and patch leads.  
POWER SUPPLY - £3.99 STEPPING MOTOR 100 Step £9.99

## Introducing: BrainiBorg!

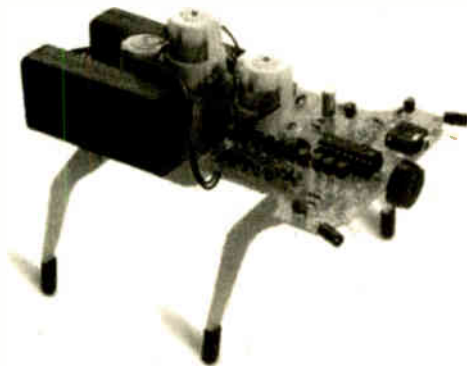

A super walking programmable robot with eyes that sense obstacles and daylight: **BrainiBorg** comes with superb PC software CD (*WIN95+ & XP*) and can be programmed to walk and respond to light and obstacles on any smooth surface.

CD contains illustrated constructional details, operating principles, circuits and a superb **Educational Programming Tutorial**.

Test routines give real-time 'scope traces of sensor and motor signals. Connects to PC via **SERIAL** port with the lead supplied.

Kit includes all hardware, components, 3 motor/gearboxes. Uses 4 AA batteries (*not supplied*). *An Ideal Present!*

**KIT 912** Complete Kit with CD rom & serial lead **£49.99**

**KIT 913** As 912 but built & tested circuit board **£58.95**

## EPE PIC Tutorial

*EPE Apr/May/June '03 and PIC Resources CD*

- Follow John Becker's excellent PIC toolkit 3 series.
- Magenta Designed Toolkit 3 board with printed component layout, green solder mask, places for 8,18, 28 (wide and slim), and 40 pin PICs. and Magenta extras.
- 16 x 2 LCD, PIC chip all components and sockets included.

**KIT 880** (with 16F84) **£34.99**, built & tested **£49.99**

**KIT 880** (with 16F877) **£39.99**, built & tested **£55.99**

## EPE TEACH-IN 2004

**THE LATEST NOV 03 SERIES** All parts to follow this new Educational Electronics Course. Inc. Breadboard, and wire, as listed on p752 Nov. Issue.

**Additional Parts** as listed in 'misc.' Section (less RF modules, Lock, and Motor/g.box)

Reprints: £1.00 per part.

**KIT 920.....£29.99** **KIT921.....£12.99**

## MAGENTA BRAINIBOT I & II

- Full kit with ALL hardware and electronics.
- As featured in *EPE Feb '03* (KIT 910)
- Seeks light, beeps, and avoids obstacles
- Spins and reverses when 'cornered'
- Uses 8 pin PIC chip
- ALSO KIT 911 - As 910 PLUS programmable from PC serial port leads and software CD included.



**KIT 910....£16.99** **KIT 911....£24.99**

# MAGENTA

All prices include VAT. Add £3.00 p&p. Next day £6.99

Tel: 01283 565435 Fax: 01283 546932 email: sales@magenta2000.co.uk

122004



**Station Road, Cullercoats,  
Tyne & Wear, NE30 4PQ**

Prices Exclude Vat @ 17.5%  
UK Carriage £2.50 (less than 1kg)  
£5.50 greater than 1kg

Cheques / Postal orders payable to  
ESR Electronic Components.  
PLEASE ADD CARRIAGE & VAT TO ALL ORDERS



See Next / Last Months Ad. for  
**ELECTRONIC COMPONENTS**

**PCB Production - Development**

**0.1" Copper Stripboard**

Size	T-racks/Holes	Price
25 x 64mm	9T / 25H	£0.24
64 x 95mm	24T / 37H	£0.87
95 x 127mm	36T / 50H	£1.41
127 x 152mm	45T / 63H	£1.95
152 x 178mm	54T / 72H	£2.49
178 x 203mm	63T / 81H	£3.03
203 x 229mm	72T / 90H	£3.57
229 x 255mm	81T / 99H	£4.11
255 x 281mm	90T / 108H	£4.65
281 x 307mm	99T / 117H	£5.19
307 x 333mm	108T / 126H	£5.73
333 x 359mm	117T / 135H	£6.27
359 x 385mm	126T / 144H	£6.81
385 x 411mm	135T / 153H	£7.35
411 x 437mm	144T / 162H	£7.89
437 x 463mm	153T / 171H	£8.43
463 x 489mm	162T / 180H	£8.97
489 x 515mm	171T / 189H	£9.51
515 x 541mm	180T / 198H	£10.05
541 x 567mm	189T / 207H	£10.59
567 x 593mm	198T / 216H	£11.13
593 x 619mm	207T / 225H	£11.67
619 x 645mm	216T / 234H	£12.21
645 x 671mm	225T / 243H	£12.75
671 x 697mm	234T / 252H	£13.29
697 x 723mm	243T / 261H	£13.83
723 x 749mm	252T / 270H	£14.37
749 x 775mm	261T / 279H	£14.91
775 x 801mm	270T / 288H	£15.45
801 x 827mm	279T / 297H	£15.99
827 x 853mm	288T / 306H	£16.53
853 x 879mm	297T / 315H	£17.07
879 x 905mm	306T / 324H	£17.61
905 x 931mm	315T / 333H	£18.15
931 x 957mm	324T / 342H	£18.69
957 x 983mm	333T / 351H	£19.23
983 x 1009mm	342T / 360H	£19.77
1009 x 1035mm	351T / 369H	£20.31
1035 x 1061mm	360T / 378H	£20.85
1061 x 1087mm	369T / 387H	£21.39
1087 x 1113mm	378T / 396H	£21.93
1113 x 1139mm	387T / 405H	£22.47
1139 x 1165mm	396T / 414H	£23.01
1165 x 1191mm	405T / 423H	£23.55
1191 x 1217mm	414T / 432H	£24.09
1217 x 1243mm	423T / 441H	£24.63
1243 x 1269mm	432T / 450H	£25.17
1269 x 1295mm	441T / 459H	£25.71
1295 x 1321mm	450T / 468H	£26.25
1321 x 1347mm	459T / 477H	£26.79
1347 x 1373mm	468T / 486H	£27.33
1373 x 1399mm	477T / 495H	£27.87
1399 x 1425mm	486T / 504H	£28.41
1425 x 1451mm	495T / 513H	£28.95
1451 x 1477mm	504T / 522H	£29.49
1477 x 1503mm	513T / 531H	£30.03
1503 x 1529mm	522T / 540H	£30.57
1529 x 1555mm	531T / 549H	£31.11
1555 x 1581mm	540T / 558H	£31.65
1581 x 1607mm	549T / 567H	£32.19
1607 x 1633mm	558T / 576H	£32.73
1633 x 1659mm	567T / 585H	£33.27
1659 x 1685mm	576T / 594H	£33.81
1685 x 1711mm	585T / 603H	£34.35
1711 x 1737mm	594T / 612H	£34.89
1737 x 1763mm	603T / 621H	£35.43
1763 x 1789mm	612T / 630H	£35.97
1789 x 1815mm	621T / 639H	£36.51
1815 x 1841mm	630T / 648H	£37.05
1841 x 1867mm	639T / 657H	£37.59
1867 x 1893mm	648T / 666H	£38.13
1893 x 1919mm	657T / 675H	£38.67
1919 x 1945mm	666T / 684H	£39.21
1945 x 1971mm	675T / 693H	£39.75
1971 x 1997mm	684T / 702H	£40.29
1997 x 2023mm	693T / 711H	£40.83
2023 x 2049mm	702T / 720H	£41.37
2049 x 2075mm	711T / 729H	£41.91
2075 x 2101mm	720T / 738H	£42.45
2101 x 2127mm	729T / 747H	£42.99
2127 x 2153mm	738T / 756H	£43.53
2153 x 2179mm	747T / 765H	£44.07
2179 x 2205mm	756T / 774H	£44.61
2205 x 2231mm	765T / 783H	£45.15
2231 x 2257mm	774T / 792H	£45.69
2257 x 2283mm	783T / 801H	£46.23
2283 x 2309mm	792T / 810H	£46.77
2309 x 2335mm	801T / 819H	£47.31
2335 x 2361mm	810T / 828H	£47.85
2361 x 2387mm	819T / 837H	£48.39
2387 x 2413mm	828T / 846H	£48.93
2413 x 2439mm	837T / 855H	£49.47
2439 x 2465mm	846T / 864H	£50.01
2465 x 2491mm	855T / 873H	£50.55
2491 x 2517mm	864T / 882H	£51.09
2517 x 2543mm	873T / 891H	£51.63
2543 x 2569mm	882T / 900H	£52.17
2569 x 2595mm	891T / 909H	£52.71
2595 x 2621mm	900T / 918H	£53.25
2621 x 2647mm	909T / 927H	£53.79
2647 x 2673mm	918T / 936H	£54.33
2673 x 2699mm	927T / 945H	£54.87
2699 x 2725mm	936T / 954H	£55.41
2725 x 2751mm	945T / 963H	£55.95
2751 x 2777mm	954T / 972H	£56.49
2777 x 2803mm	963T / 981H	£57.03
2803 x 2829mm	972T / 990H	£57.57
2829 x 2855mm	981T / 999H	£58.11
2855 x 2881mm	990T / 1008H	£58.65



**Solderless Breadboard**

Tie Points & Size Power Rails  
390 81 x 60mm 2 £2.75  
840 175 x 67mm 2 £4.86  
740 175 x 55mm 1 £4.03  
640 175 x 42mm 0 £3.08  
Many other sizes available,  
also jump wires & matrix board.



**PCB Production - Drafting Materials**

**A4 Artwork Film (per 10 sheets)**

Clear Manual Film £1.25  
Clear Laser Film £1.75  
White HQ Laser Film £4.62

**Ethc Resist Pens**

"Dialo" Pen £2.98  
"Stagelite" Fine Pen £0.88

**Ethc Resist Transfers**

Seno mixed DIL pads £2.24  
Seno mixed Rnd pads £2.24  
Alfac mixed pads £1.84  
Transfer Spatular £1.25



We carry the full range of Seno & Alfac PCB transfers,  
see our catalogue for full details.

**Soldering Irons**

We carry in stock a wide range of soldering iron and  
soldering accessories. Irons from 12 to 100 Watts.  
20W 240V Basic £3.74  
25W 240V Ceramic £14.05  
30W 240V Basic £4.68

**Desolder Pumps**

Basic 1x5 x 18mm £2.85  
Antistat c 195mm £3.92  
Antex Mini 198mm £6.02  
Antex Pro 210mm £10.26



**Digital Multimeter**

Model: 121-120  
Price: £11.47  
A highly featured digital multimeter for professional  
use. Offers 30 ranges and 8  
functions including tempera-  
ture, capacitance, diode,  
continuity and hFE measure-  
ment. Large 3.5 digit LCD  
display with automatic polari-  
ty indicator. Supplied  
with shielded test leads, K  
type temperature probe and  
shock proof rubber holster.

**Technical Specifications**

DC voltage 200mV - 1000V  
±0.5%  
AC volts 2V - 700V (±0.8%)  
DC current 2mA - 20A (±1.2%)  
AC current 200mA - 20A  
(±1.8%)  
Resistance 200 Ohms - 20M  
Ohms (±0.8%)  
Capacitance 2000pF - 20 F (±2.5%)  
Temperature 0 C - 100 C (±1.5%)  
Frequency 20kHz (±1%)  
Max display 1999  
Power supply 9V (PP3 battery)  
Dimensions 68 x 173 x 40 mm



**CCTV - Complete Systems**

We carry the full range of  
MicroMark Black & White and  
Colour CCTV systems for the  
home or office.  
These complete easy install sys-  
tems are supplied complete with  
power supply, cables and all fix-  
ings. Simple plug-in connections,  
for use with any TV or Video with  
a scart socket.



**Black & White Systems  
from £22.97**

**CCTV - Black & White Module**

A miniature CMOS camera module  
with a 3.6mm F2 Lens, video output &  
power via connectors provided.  
**Specs (660-800)**  
Power: 12Vdc 50mA  
Video System: CCIR  
Pixels: 352 x 288  
Min Illumination: 0.5Lux  
Video Output: 1Vpp, 75Ω  
Dims: 35 x 35 x 28mm 20g **£17.93**



**PCB Production - Processing Equipment**

We carry a large range of the photographic & chemical  
processing equipment for PCB production, a full list with  
full technical specifications is available in our catalogue  
or visit our web site.

**UV Exposure units**

2 x 8W Tubes, 6 min timer  
229 x 159mm working area  
Model 332-002 £88.78  
4 x 15W Tubes, 7 1/2 min timer  
330 x 260mm working area  
Model 332-004 £194.51



**Chemical Processing**

Low cost plastic tray £1.80  
Process tanks feature electrically  
operated pumps and/or heaters  
with thermostat control, suitable  
for boards upto 370 x 260mm.  
Universal Tank with heater  
Model 333-007 £161.60  
Bubble etch Tank with heater  
& bubble pump.  
Model 333-004 £198.50  
Any of these items carriage £5.50

**PCB Production - Tools**

**Drill Bits**

HSS parallel shank bits available in sizes from 0.3mm to  
2.0mm  
0.3-0.95mm in 0.05mm steps £0.60ea £4.00/10  
1.0-2.0mm in 0.1mm steps £0.40ea £3.60/10  
HSS Reduced shank (2.35mm) bit available in sizes from  
0.6mm to 1.7mm in 0.1mm steps £0.84ea £7.60/10  
Reground Tngsten carbide reduced shank (3.2mm) avail-  
able in sizes from 0.6 to 1.6mm in 0.1mm steps £1.90

**Drilling Machines**

Expo reliant 12V drill, 3.8mm capacity, 8400rpm £12.78  
Minicraft MX1 230V,  
8000 - 21000rpm with  
chuck & collet.  
Model EPE270-390  
Normal price £48.51



**\*\* SPECIAL OFFER PRICE £31.02 \*\***

**Servisol Products**

**Aerosols**

200ml Switch Cleaner	£1.96
200ml Freezer	£3.97
400ml Foam Cleanser	£2.13
400ml Cleaner / lubricant	£2.79
75ml Vide Head Cleaner	£1.94
200ml Aero Klene	£2.85
200ml Aero Duster	£4.66
250ml Cold Clean	£3.14
200ml Label remover	£3.52
400ml Isopropyl alcohol	£3.36
<b>Tubes</b>	
25g Heatsink Compound	£2.60
50g Silicone grease	£2.50



**NEW CATALOGUE  
OUT NOW**  
available from [www.esr.co.uk](http://www.esr.co.uk)

**Educational Kits**

These kits are an ideal way to start you interest in elec-  
tronics. They feature re-useable components which are  
attached via springs & wires and easy step by step  
guides to make a range of exciting projects. The 300-in-1  
features a breadboard for more complex circuits.



**Panel Meters**

High quality analogue panel meters, class 2, zero point  
correction, mirror scale and prewired for panel illumina-  
tion. Meter size 46 x 60mm, Cutout size: 38mm Ø

Range	Int Ω	Price
0-50 A	6k5	£13.18
0-100 A	1k0	£16.80
0-500 A	430Ω	£32.29
0-1mA	200Ω	£55.20
0-10mA	21k	
0-50mA	1k2	
0-100mA	05k65	
0-500mA	0212	
0-1A	60mΩ	
0-3A	20mΩ	
0-5A	12mΩ	
0-15A	4mΩ	
0-10V	10k	
0-15V	15k	
0-30V	30k	
±50 A	1k9	

All meters £5.89 each  
6V Lamps £1.23 /pair

**CCTV - Colour Module**

A miniature colour CMOS camera module  
with a 3.6mm F1.2 Lens, video output &  
power via connectors provided.  
**Specs (660-842)**  
Power: 12Vdc 150mA  
Video System: PAL  
Pixels: 628 x 582  
Min Illumination: 3Lux  
Video Output: 1Vpp, 75Ω  
Dims: 28 x 28 x 28mm 20g **£36.33**



**PCB Production - Laminates**

**Copper clad - paper**

Single sided low cost paper composite board

100 x 160mm Board	£0.44
100 x 220mm Board	£0.62
160 x 233mm Board	£1.02
220 x 233mm Board	£1.70
8" x 12" 8arg	£1.40

**Copper clad - glass fibre**

Single & Double 1.6mm 305g/m<sup>2</sup>

100 x 160mm Single	£0.85
100 x 220mm Single	£1.25
160 x 233mm Single	£2.29
220 x 233mm Single	£2.88
8" x 12" Single	£3.44
100 x 160mm Double	£0.88
100 x 220mm Double	£1.25
160 x 233mm Double	£2.70
220 x 233mm Double	£2.90
8" x 12" Double	£3.50



**Photoresist Coated**

1.6mm 35 micron Pre-coated with a high quality photo-  
resist layer. Available in low cost paper composite or  
Glass fibre, Single & Double sided. Other sizes also  
available.

Size
------

# EVERYDAY PRACTICAL ELECTRONICS

THE No.1 MAGAZINE FOR ELECTRONICS TECHNOLOGY & COMPUTER PROJECTS

**VOL. 34 No. 3 MARCH 2005**

**Editorial Offices:**  
EVERYDAY PRACTICAL ELECTRONICS EDITORIAL  
WIMBORNE PUBLISHING LTD., 408 WIMBORNE ROAD EAST,  
FERNDOWN, DORSET BH22 9ND  
Phone: (01202) 873872. Fax: (01202) 874562.

Email: enquiries@epemag.wimbome.co.uk  
Web Site: www.epemag.co.uk  
EPE Online (downloadable version of EPE): www.epemag.com  
EPE Online Shop: www.epemag.wimbome.co.uk/shopdoor.htm  
See notes on Readers' Technical Enquiries below – we regret lengthy technical enquiries cannot be answered over the telephone.

**Advertisement Offices:**  
EVERYDAY PRACTICAL ELECTRONICS ADVERTISEMENTS  
MILL LODGE, MILL LANE,  
THORPE-LE-SOKEN, ESSEX CO16 0ED  
Phone/Fax: (01255) 861161 Email: epeads@aol.com

## Availability – Export

Once again I feel compelled to write about the availability of *EPE*. Unfortunately all the export copies of last month's issue were lost in a warehouse fire at Thurrock in Essex. The fire actually forced the closure of the M25 motorway and caused major traffic problems for two days. Over 120 fire appliances attended over a period of five days. Fortunately no one was injured.

So, if you normally buy your magazine from a bookstall outside of the UK you would have missed out on the February issue – all *subscription* copies were, however, supplied as normal. If you need a February '05 copy we have a few in stock – see the *Back Issues* page (page 215). When these are all gone the alternative is to download a copy from our *EPE Online* web site at [www.epemag.com](http://www.epemag.com), the price there is \$5 (US) for one issue or \$10.99 (US) for a one year subscription (12 downloadable issues), which represents an incredible bargain. You could also subscribe to the printed issue to make sure of future copies – see page 191.

## Availability – UK

Sometimes it is also not that easy to get copies of *EPE* in the UK, though we have not had any delays in publishing or missed issues in the last 20 years; so don't believe anyone who tells you anything different. With so many magazines now being published most newsagents can only carry a limited range and even the larger stores have a limit to the number of magazines they stock. This means that to ensure a copy of *EPE* each month you might need to order a copy from your newsagent, either to be "shop saved" for you or delivered to your home.

There is of course another alternative and that is to take out a subscription. We offer subscriptions for six months, one year or two years and all of them represent a saving against the cover price. In fact, if you pay for two years in advance you will actually save £17.40 and that is without any cover price increases. (With a paper price increase looming we may soon be forced to increase the cover price, but we will hold out as long as possible.)

You will find a subscription order form on page 191.

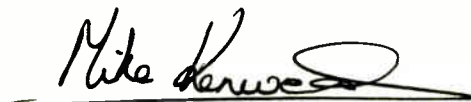

## AVAILABILITY

Copies of *EPE* are available on subscription anywhere in the world (see opposite), from all UK newsagents (distributed by COMAG) and from the following electronic component retailers: Omni Electronics and Yebo Electronics (S. Africa). *EPE* can also be purchased from retail magazine outlets around the world. An Internet on-line version can be purchased and downloaded for just \$10.99US (approx £7) per year available from [www.epemag.com](http://www.epemag.com)

## SUBSCRIPTIONS

Subscriptions for delivery direct to any address in the UK: 6 months £16.50, 12 months £31, two years £57; Overseas: 6 months £19.50 standard air service or £28.50 express airmail, 12 months £37 standard air service or £55 express airmail, 24 months £69 standard air service or £105 express airmail. To subscribe from the USA or Canada see the last magazine page. Online subscriptions, for downloading the magazine via the Internet, \$10.99US (approx £7) for one year available from [www.epemag.com](http://www.epemag.com). Cheques or bank drafts (in £ sterling only) payable to *Everyday Practical Electronics* and sent to EPE Subs. Dept., Wimborne Publishing Ltd, 408 Wimborne Road East, Ferndown, Dorset BH22 9ND. Tel: 01202 873872. Fax: 01202 874562. Email: subs@epemag.wimbome.co.uk. Also via the Web at: <http://www.epemag.wimbome.co.uk>. Subscriptions start with the next available issue. We accept MasterCard, Amex, Diners Club, Maestro or Visa. (For past issues see the *Back Issues* page.)

## BINDERS

Binders to hold one volume (12 issues) are available from the above address. These are finished in blue p.v.c., printed with the magazine logo in gold on the spine. Price £6.95 plus £3.50 p&p (for overseas readers the postage is £6.00 to everywhere except Australia and Papua New Guinea which cost £10.50). Normally sent within seven days but please allow 28 days for delivery – more for overseas.

Payment in £ sterling only please. Visa, Amex, Diners Club, Maestro and MasterCard accepted. Send, fax or phone your card number, card expiry date and card security code (the last 3 digits on or just under the signature strip), with your name, address etc. Or order on our secure server via our UK web site. Overseas customers – your credit card will be charged by the card provider in your local currency at the existing exchange rate.



**Editor:** MIKE KENWARD

**Deputy Editor:** DAVID BARRINGTON

**Technical Editor:** JOHN BECKER

**Business Manager:** DAVID J. LEAVER

**Subscriptions:** MARILYN GOLDBERG

**Administration:** FAY KENWARD

**Editorial/Admin:** (01202) 873872

**Advertisement Manager:**

PETER J. MEW, (01255) 861161

**On-Line Editor:** ALAN WINSTANLEY

**EPE Online** (Internet version) **Editors:**

CLIVE (MAX) MAXFIELD and ALVIN BROWN

## READERS' TECHNICAL ENQUIRIES

**E-mail:** techdept@epemag.wimbome.co.uk

We are unable to offer any advice on the use, purchase, repair or modification of commercial equipment or the incorporation or modification of designs published in the magazine. We regret that we cannot provide data or answer queries on articles or projects that are more than five years old. Letters requiring a personal reply *must* be accompanied by a **stamped self-addressed envelope** or a **self-addressed envelope and international reply coupons**.

## PROJECTS AND CIRCUITS

All reasonable precautions are taken to ensure that the advice and data given to readers is reliable. We cannot, however, guarantee it and we cannot accept legal responsibility for it. A number of projects and circuits published in *EPE* employ voltages than can be lethal. **You should not build, test, modify or renovate any item of mains powered equipment unless you fully understand the safety aspects involved and you use an RCD adaptor.**

## COMPONENT SUPPLIES

**We do not supply electronic components or kits for building the projects featured, these can be supplied by advertisers (see *Shoptalk*). We advise readers to check that all parts are still available before commencing any project in a back-dated issue.**

## ADVERTISEMENTS

Although the proprietors and staff of EVERYDAY PRACTICAL ELECTRONICS take reasonable precautions to protect the interests of readers by ensuring as far as practicable that advertisements are *bona fide*, the magazine and its Publishers cannot give any undertakings in respect of statements or claims made by advertisers, whether these advertisements are printed as part of the magazine, or in inserts.

The Publishers regret that under no circumstances will the magazine accept liability for non-receipt of goods ordered, or for late delivery, or for faults in manufacture.

## TRANSMITTERS/BUGS/TELEPHONE EQUIPMENT

We advise readers that certain items of radio transmitting and telephone equipment which may be advertised in our pages cannot be legally used in the UK. Readers should check the law before buying any transmitting or telephone equipment as a fine, confiscation of equipment and/or imprisonment can result from illegal use or ownership. The laws vary from country to country; readers should check local laws.

# Cat Flap

Thomas Scarborough

Using your cat's magnetic attraction to keep stray moggies, and other unwelcome intruders, from invading his/her kingdom



**C**ATS are not very brave. The author's work-desk is situated next to a window where the household cat jumps in and out. Occasionally, working late at night, a foreign cat will poke its nose through the window. On noticing the author (before the author has noticed the cat) the cat will sometimes retreat in such panic that it strikes the window with a bang. It is this characteristic of the cat – its extreme nervousness on entering unfamiliar terrain – that is exploited in this design.

The project described here is a Cat Flap with a difference, both conceptually and electronically. The flap itself swings freely, and is not released with a catch, as is usually the case. This simplifies the design a great deal.

An "authorised" cat may walk freely in and out of the flap. However, if a foreign cat (or perhaps a rat or a mongoose – depending on where you live!) opens the flap, even to a crack, it is surprised by whatever might meet the constructor's fancy – perhaps an ultrasonic shriek, or a spotlight – but nothing that might harm the cat. Bearing in mind a cat's timidity, this is bound to keep a foreign cat at bay.

Having said this, the circuit has been so

designed that it may also be used as a "stock standard" cat flap, whereby a flap releases when the "authorised" cat comes near, yet remains locked to foreign cats. The only drawback here is the additional work required to manufacture a mechanical catch for the flap.

## In Concept

The core consideration of this design was how to distinguish a foreign cat from one's own. The obvious solution was to tag one's own cat, and to detect the tag. A common solution is a magnet – except that a magnet does not typically offer good range unless it is combined with a sophisticated (and often pricey) sensor.

Some traditional cat flaps use reed switches, in combination with a magnet on the cat's collar. However, the author could not see how such devices should work reliably with (typically) less than 3cm (1.18in.) range. Either a greater range was required, or another method of detection.

The solution was found in a novel detector using a coil with a Faraday shield, located on or in the flap. This detects a small neodymium magnet up to about 20cm (7.90in.). Even half this range would be adequate to detect a cat approaching the flap. The magnet is of course attached to the cat's collar.

As soon as the cat approaches the flap, the circuit detects the magnet attached to the cat's collar and a simple timer is triggered. The purpose of the timer is to disable a reed switch on the side of the cat flap.

Consider what happens if the reed switch is *not* disabled – that is, if a *foreign* cat pokes its nose through the flap. In this case, the reed switch activates whatever surprise the constructor might wish to have in store for the cat. However, if the reed switch is first disabled through the timer, a cat is able to walk freely through the flap – until the timer resets.

A reed switch of course is activated by a magnet, and to avoid any conflict with the magnet on the cat's collar, the switch's activating magnet is mounted on the flap, so that when the flap moves, so does the magnet. Therefore the magnet remains stationary in relation to the flap, and remains undetected by the coil which is also mounted on the flap.

## Circuit Description

The full circuit diagram for the Cat Flap is shown in Fig.1. The circuit exploits a few simple scientific facts. If magnetic field lines approach a conductor at 90 degrees to the conductor, a current is

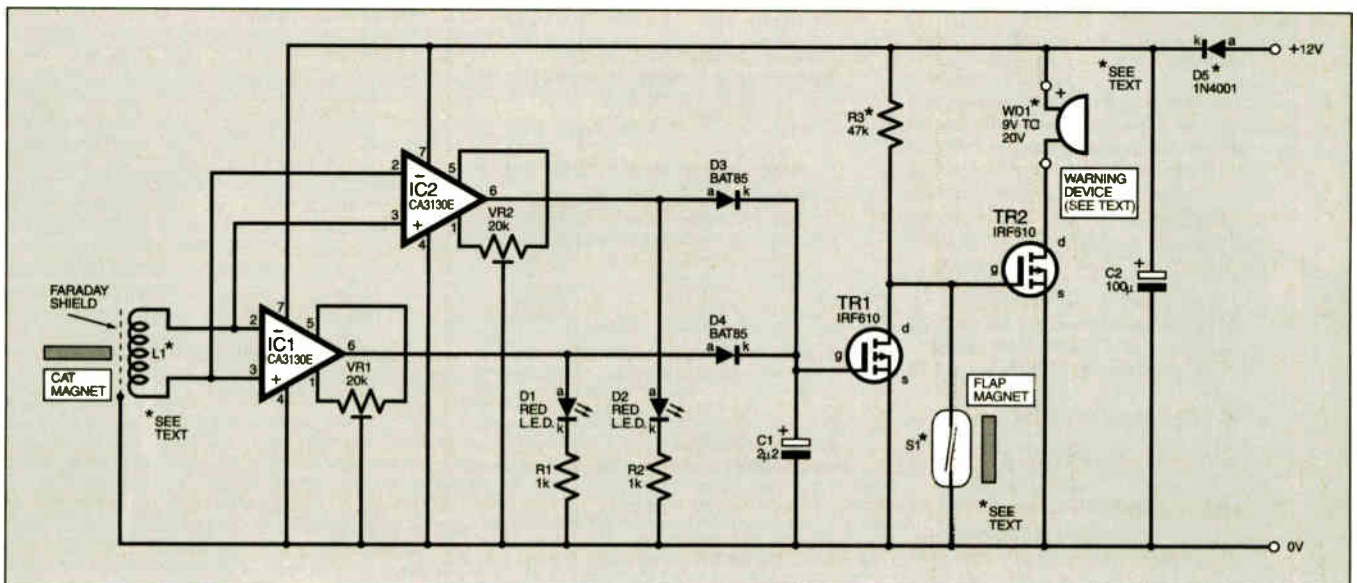

Fig. 1. Complete circuit diagram for the magnet-activated Cat Flap

generated in the conductor. Further, the greater the length of the conductor, the larger the current that is generated. Therefore, as a magnet's North or South pole approaches sensing coil L1, so a potential difference is created across the inverting (pin 2) and non-inverting (pin 3) inputs of IC1 and IC2.

Coil L1 is wired to the inputs of IC1 and IC2 in a complementary fashion, and this is because the current flows in different directions in the coil, depending on which magnetic pole approaches the coil. If only one i.c. were used in the circuit, the cat would only be detected moving in one direction – unless, of course, it should walk backwards through the flap!

Preset potentiometers VR1 and VR2 are offset adjustments, and bias the internal circuitry of IC1 and IC2 so that their outputs are ordinarily *just* held "low". With extremely light 5pA internal biasing at its inputs, the CA3130E does not require further external biasing in this application.

A Faraday shield is added to coil L1 to preclude any capacitive coupling, and this is described in more detail below. In view of the extreme sensitivity of the circuit, coil L1 must be wired to the printed circuit board (p.c.b.) through screened wires.

## Surprise, Surprise

When a magnet approaches coil L1, the output (pin 6) of either IC1 or IC2 will go "high", thus charging capacitor C1, and causing transistor TR1 to conduct for sev-

eral seconds. Light emitting diodes (l.e.d.s) D1 and D2 give a visual indication of the status of the outputs of IC1 and IC2, to confirm that preset potentiometers VR1 and VR2 are suitably adjusted.

Diodes D3 and D4 isolate the outputs of IC1 and IC2 from each other, and serve to maintain the charge on capacitor C1. The value of C1 may be altered to change the timing period.

Ordinarily, the gate of MOSFET TR2 is held "low" through reed switch S1, which is closed when the flap is closed (i.e. flap magnet holding switch contacts together). However, when the flap is opened (removing magnet), S1 opens, so that only resistor R3 and MOSFET TR1 are left in circuit.

Everything now depends on the potential at the junction of R3 and TR1. If an "authorised" cat has just triggered IC1 or IC2 (by the influence of the "cat magnet" on the field coil L1), thereby charging capacitor C1, TR1 will conduct, and TR2's gate (g) will be held "low".

However, in the absence of an "authorised" cat, TR1 will fail to conduct, and TR2's gate will be taken "high" through resistor R3. Transistor TR2 thereby conducts, triggering whatever surprise one might have in store for the cat. This "surprise" is wired between the drain (d) of TR2 and the positive supply line. Note that S1 need not necessarily be a reed switch. This

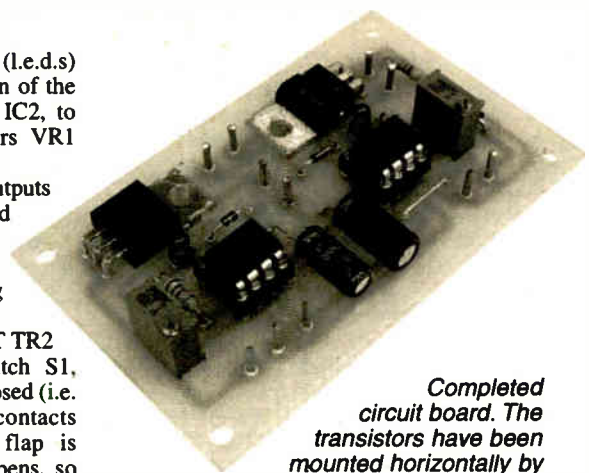

*Completed circuit board. The transistors have been mounted horizontally by carefully bending their leads prior to soldering*

may also be a pressure switch or a broken beam, or anything that should best suit one's requirements.

If a "stock standard" cat flap is preferred, components R3, S1, and TR2 are removed from the circuit, and a solenoid is wired in place of R3, to release a catch on the flap. In this case, one needs to bear in mind that a solenoid generates a fairly strong electromagnetic field, so that this will need to be mounted some distance from coil L1 – about 30cm (11.8in.) should be adequate.

A diode should be wired across the solenoid – cathode to the +12V line – to reduce the back e.m.f. generated when TR1 switches off.

## COMPONENTS

Approx Cost  
Guidance Only  
excl. cat flap, case & batts

**£16**

### Resistors

R1, R2 1k (2 off)  
R3 47k

All 0.25W 5% carbon film

### Potentiometers

VR1, VR2 20k 25-turn cermet preset, top-adjust (2 off)

### Capacitors

C1 2μ2 radial elect. 16V  
C2 100μ radial elect. 16V

### Semiconductors

D1, D2 3mm red l.e.d. (2 off)  
D3, D4 BAT85 signal diode (2 off)  
D5 1N4001 50V 1A rect. diode (or suitably rated for load – see text)  
TR1, TR2 IRF610 power MOSFET, or equivalent (2 off)  
IC1, IC2 CA3130E CMOS op.amp (2 off)

### Miscellaneous

S1 reed switch, normally open contacts, with magnet  
L1 70 turns 30s.w.g. (0.315mm) enamelled copper wire wound on 120mm diameter former = 30 metres

See  
SHOP  
TALK  
page

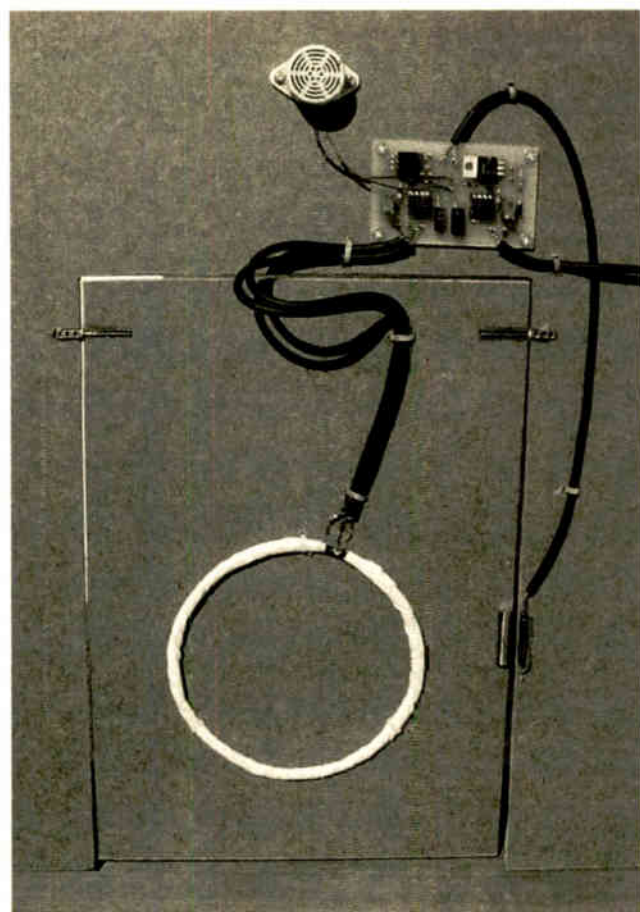

Printed circuit board available from the *EPE PCB Service*, ABS plastic case (if required); battery clip or power socket (if required); 8-pin dual-in-line (d.i.l.) socket (2 off); screened microphone cable (about 1 metre); small neodymium magnet (preferred) for cat's collar, see text; suitable external alarm circuit, i.e. miniature buzzer – see text; materials for cat flap; cable ties; solder pins; solder, etc.

Note that the circuit should not be mounted too close to any heavy electrical equipment, e.g. a dish-washer, since this may also trigger the circuit. If in doubt, test the circuit in situ before fixing it permanently. Alternatively, reduce the circuit's sensitivity through adjustment of presets VR1 and VR2 (see later).

No special supply decoupling is required, particularly in view of the fact that its most sensitive component, coil L1, is isolated from the rest of the circuit. A regulated 12V power supply is suggested for the sake of stability. A 9V supply would also suit.

Diode D5 is included for supply reverse polarity protection. This should be suitably rated for the load (warning device) wired in to the circuit. No on-off switch is used, since the circuit is likely to be used on a continuous basis.

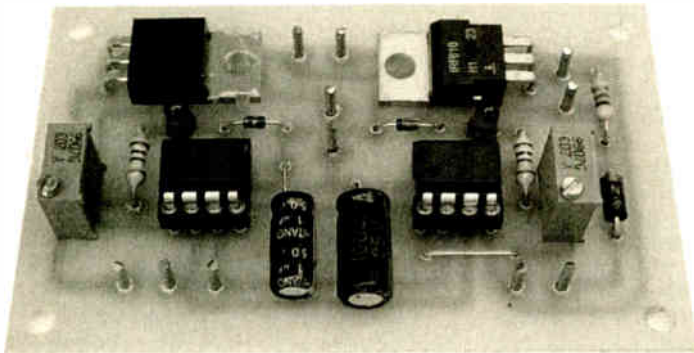

number of turns, the wire gauge, and the diameter of the coil may all be changed a fair deal without significantly influencing the circuit. However, more turns will increase the sensitivity of the circuit. The completed coil should be wrapped tightly in insulating tape.

Now a Faraday shield is required, which, in this instance, takes the form of a tin-foil wrapping for the coil which goes all the way around it, *excepting* a small section about 5mm (0.2in.) or 10mm (0.4in.) wide. That is, a small section of the coil insulating tape is left exposed underneath the Faraday shield.

The Faraday shield now needs to be connected to the p.c.b., and for this purpose, a bare wire may be wrapped around the shield. This is later soldered to the screen of a screened cable, and taken to the p.c.b. The Faraday shield (baking-foil) is similarly wrapped with insulating tape.

### In A Flap

A suggested cat flap construction assembly is shown in the photographs. Alternatively, you can purchase a ready-made unit from a local Pet shop or DIY superstore and adapt it to yours needs.

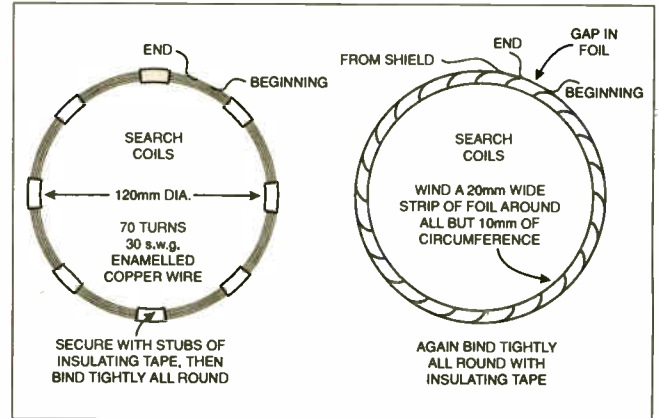

Fig.3. Suggested winding procedure for the cat sensing coil. The winding sequence is shown on the opposite page

### Construction

The Cat Flap circuit is built on a small single-sided printed circuit board (p.c.b.) measuring just 77mm (3in.) x 47mm (1.85in.). The topside component layout and full-size underside copper foil master pattern are shown in Fig.2. This board is available from the *EPE PCB Service*, code 491.

Note that no relay is included on the p.c.b. This is for two reasons. First, the external circuit (e.g. an ultrasonic alarm) might not require this. But secondly, if a relay were to be mounted too close to coil L1, its electromagnetic field could upset the circuit, and additional circuitry would be required to "blank it out". If a relay is used, mount it some distance from coil L1, and use a diode across its coil to suppress back-e.m.f. (the cathode of the diode is wired to its positive terminal).

Begin construction by soldering in position the eleven solder pins, the two 8-pin dual-in-line (d.i.l.) sockets and resistors R1 to R3. Position and solder presets VR1 and VR2, electrolytic capacitors C1 and C2, then diodes D3 to D5 on the board. Light emitting diodes D1 and D2 may be soldered directly to the p.c.b., or mounted elsewhere by means of sheathed wires.

Next, solder MOSFETS TR1 and TR2 on the board, double-checking the pin connections are correct. Note that their pins should be carefully bent over so that the bodies of the transistors lie parallel with the p.c.b., see Fig.2.

Before inserting IC1 and IC2 in their d.i.l. sockets and testing the circuit, we need to wind coil L1 and complete the construction of the mechanical flap.

### Sensing Coil Details

In the prototype, coil L1 was 70 turns of 30s.w.g. enamelled copper wire, wound on a 120mm (4.7in.) former. However, this is not critical, and the

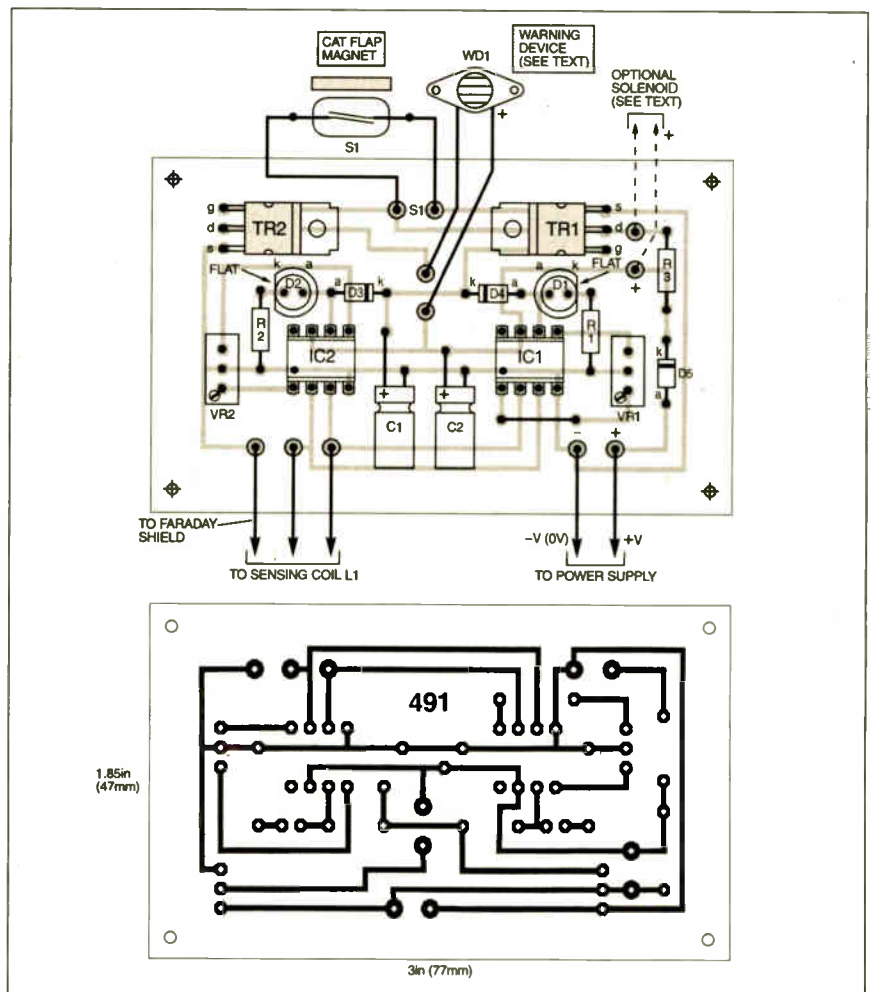
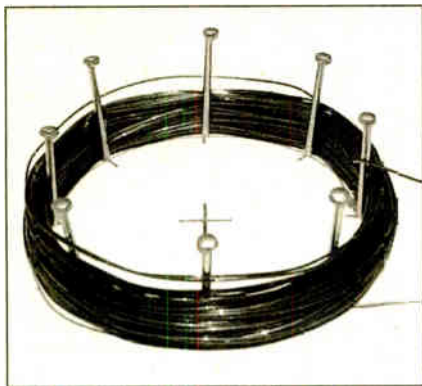
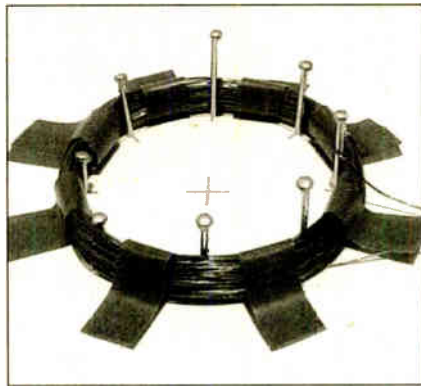

Fig.2. Cat Flap printed circuit board component layout, wiring detail and full-size underside copper foil master pattern. Note that screened cable must be used to wire the coil and Faraday shield to the p.c.b.





Enamelled copper wire (30s.w.g.) wound around guide pins (former)



Strips of insulating tape used to hold the coil windings together



Taped-up coil and the Faraday shield awaiting final connecting wire



Tin-foil Faraday shield, awaiting final covering of insulating tape

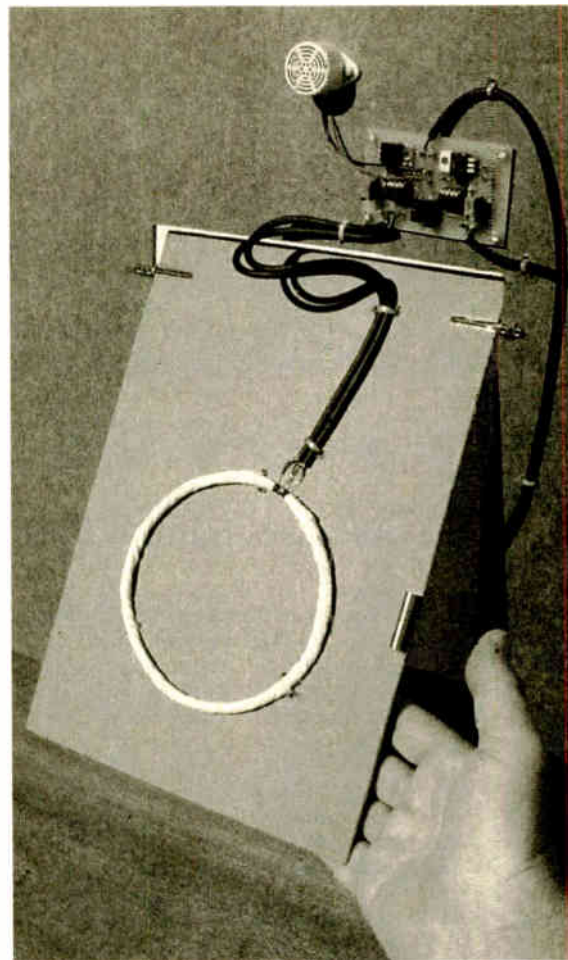

Cat Flap arrangement showing components mounted on and around the flap. The flap needs to swing freely in both directions.

The flap needs to be able to swing freely in both directions. At one or the other edge of this flap, on the fixed frame which surrounds it, mount reed switch S1 (on the right edge of the flap in the photo). Wire this to the p.c.b. by means of screened audio cable, with the screen being soldered to the p.c.b. 0V copper track as shown in Fig.2. An attendant magnet is mounted on the flap as shown, so that when the flap is closed, reed switch S1 contacts are held closed, and when the flap is opened, they are released and revert to being open.

### Coil Mounting

Next, mount coil L1 on the flap as shown in the photograph, so that this swings with the flap. Coil L1 needs to be wired to the p.c.b. by means of twin-core screened "figure-8" cable (two separate screens), or with two separate screened cables as in the photograph. Leave a loop of cable where the top of the flap meets the frame, so that the wire flexes easily as the flap opens and closes.

Wire up the external circuit (a simple buzzer is shown in the photograph). Wire up the 12V power supply, again using screened cable, observing the correct polarity. Finally, insert IC1 and IC2 in the d.i.l. sockets, checking their orientation. Take anti-static precautions – that is, before handling, ensure that your body has been discharged to earth. If desired, an ABS plastic case may be used to house the circuit board.

### Lock-Out

If a "standard" cat flap is preferred, omit components R3, S1, and TR2 from the p.c.b., and wire a solenoid across the solder pads to the left of resistor R3's position in

Fig.2. Bear in mind again that this will need to be mounted some distance from the sensing coil L1. For this purpose, a long actuating shaft will be required to move the flap's catch.

As a suggestion, a section may be cut out of the flap so that the flap swings freely past the catch when the catch is lifted. When the catch drops, it will hold the flap.

Current consumption is about 2.2mA on standby, rising to about 10mA when an "authorised" cat is detected. To this is added the current required by the external warning circuit should a foreign cat (or any other animal) poke its nose through the flap.

### Setting-Up and Use

It need hardly be said that the circuit may be used in many applications beyond a Cat Flap. Examples would be a magnetic lock, a device to detect a model train passing over a track, or a circuit which detects magnetisation in metal objects.

Setting-up is "a snap". Attach the power supply. Turn preset potentiometers VR1 and VR2 anticlockwise until l.e.d.s D1 and D2 just extinguish. Then turn them further back (anticlockwise) a further quarter turn, so that the circuit will not spuriously trigger.

A neodymium magnet is to be preferred for attaching to the cat's collar. This needs to be

mounted with either of its magnetic poles at approximately 90 degrees to the sensing coil L1.

When a magnet approaches coil L1 from either side, i.e.d. D1 or D2 will illuminate. If the flap is opened immediately after this, the external circuit will remain inactive. Failing this, it will be activated.

All that now remains is to find the household cat and attach the magnet to his or her collar. Not only should you be happy, but your cat also, whose home is now a safe haven, free from marauders. □

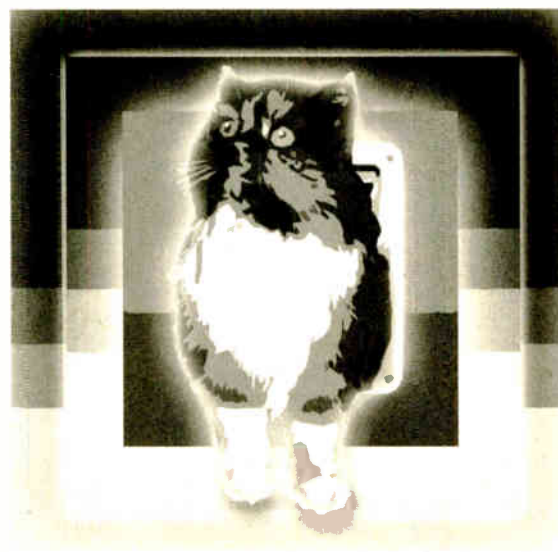

## DISASTROUS

**Power Line Communication could prevent essential amateur radio assistance at times of disaster. Barry Fox reports the concerns**

**T**HE Tsunami disaster, and before that the hurricanes in the Caribbean and the 9/11 terrorist attacks on New York and Washington, have all highlighted the value of shortwave amateur radio in an emergency situation. In each case hams were able to communicate, over long distances with low powered SW transmitters, long after power supplies, phone lines and cellphones had gone down, preventing Internet access.

The Amateur Radio Service is now warning that unless there is tighter control on interference from the new "powerline" technologies being planned to satisfy the world's appetite for ever-faster Internet connections, there may be no such emergency links in the future.

"A few dB of extra interference noise and I would not have been able to hear the Sri Lankan signal", said Hilary Clayton-Smith, a consultant on electromagnetic compatibility for the International Amateur Radio Union, and herself a keen radio operator who was monitoring emergency traffic after the Tsunami struck.

"I doubt reception would have been possible in a PLC-enabled age" (Power Line Communications). "It is nonsense to say in the case of an emergency there would not be any mains power and so no PLC interference. The signals need to be received in an area outside the disaster area, where there may well be PLC".

### Power Line Communications

The US government gave the green light to Broadband over Power Line in October 2004; in Europe the European Commission is close to allowing Power Line Communications. The names are different but the technology is the same. Broadband data is sent into the home, and around the home, as a high frequency signal piggy-backed on the existing low frequency mains supply.

The powerline systems can deliver up to 5Mbps over the "last mile" from the streets and into the home – with 10Mbps promised later. So PLC provides welcome commercial competition for the phone and cable companies. It is cheaper and more convenient than laying fibre, or using satellites, or transmitters on balloons and airships.

But the mains is a hostile environment with ever-changing patterns of interference being fed back into the supply from mechanical switches, electronic control circuits, electric motors in power tools and appliances, and central heating thermostats. So the powerline data must be spread wide over many high frequency carriers to ensure that something always gets through the

interference. The frequencies used range up to 30MHz – which by unhappy coincidence is the radio band that travels best round the world. And unfortunately the mains wiring works like a broadcast antenna and radiates the data signal to cause interference in the radio band below 30MHz.

### Protected Status

The amateur band is protected against interference by the International Telecommunications Union. So the US government's Federal Communications Commission changed Part 15 of its rules on wireless transmission to allow data up to 80MHz on power lines, provided that the operators use electronic filters on their equipment to "notch" out frequencies which are proven to cause interference.

The Consumer Electronics Association, whose members sell the equipment consumers use with broadband connections "applauds" the FCC's decision because "it will advance consumer use of new technologies and products". Only one of the Commissioners, Michael Copps, was unhappy with the decision. Copps warned that the FCC must "work hard to monitor, investigate and take quick action" over interference, not let cases "take years to resolve".

### Signal Notching

The European Commission, CENELEC (the European Committee for Electrotechnical Specification) and COCOM (the EC's Communications Committee), have spent the last two years trying to agree on draft rules for "notching" to balance "technical, social and economic" factors against the "importance" of services which suffer interference.

But who will decide what's "important", and how will they judge importance, ask hams. Jonathan Stott of the BBC's R&D centre at Kingswood Warren in Surrey agrees with the FCC and EC decisions to abandon any attempt at setting emission limits. "A level high enough to permit PLC operations offers no protection to reception of broadcasting. A level low enough to protect reception of broadcasting will prevent PLC operations."

But Stott warns that simple notching will cause unforeseen problems. "There is risk that the PLC operators will become sensors – it would be an absolute gift to the regimes in countries where freedom of expression and uncensored access to the internet is non-existent. Countries may choose to jam broadcasts".

### Two-Way Option

So Stott's team at Kingswood Warren has thought laterally. If a PLC system can radiate interference in the broadcast bands, it must also pick up broadcast signals.

According to the BBC's new plan, all PLC equipment would have to "listen" for any radio broadcasts in the vicinity, and automatically switch to different data frequencies for as long as the broadcast continued. But this will only happen if the system providers are forced to build intelligent listening and self-adjustment into their modems.

Technical details of the PLC systems on offer (Main.net of Reston, Virginia; Ascum in Berne Switzerland; DS2 in Valencia, Spain) are often sparse because the technology is proprietary and still on trial and developing ([www.ascum.com/](http://www.ascum.com/); [www.ds2.es/](http://www.ds2.es/); and [www.powerline-plc.com/](http://www.powerline-plc.com/)).

BBC researchers analysed the signals that leak from trial set-ups and found that Main.net data is spread over a wide frequency band, much like a 3G phone system; Ascum uses four 1MHz carrier bands at 2.4, 4.8, 8.4 and 10.8MHz; and DS2 and an industry standard system called HomePlug use OFDM (orthogonal frequency division multiplexing) like European digital radio and TV, to put the data on many narrow carrier waves.

### Surface Wave Exploitation

There is now a dark horse in the race, from Corridor Systems of Santa Rosa, California. Corridor relies on the "surface wave" effect. When very high frequency signals are launched straight down a cable they tend to stay inside the cable, near the surface. Overhead power lines are used to carry data on frequencies ranging from 800MHz and 10GHz. This is far above the frequencies used for conventional PLC and safely above the amateur bands.

The signals get from the overhead cables into homes by local radio transmitters, like Wi-Fi hotspots, which are fixed to the cables near homes that want to buy data. Corridor is so confident that its system causes no interference that it recently published full technical details and an open letter to the FCC with test results (<http://www.corridor.biz/pdf/031201-fcc-letter.pdf>)

Corridor has so far satisfied critics in the radio community that its claims are justified. The FCC has approved the system by saying that because it works above 80MHz it need not comply with the special requirements for systems below 80MHz (notching and listing service areas on a database).

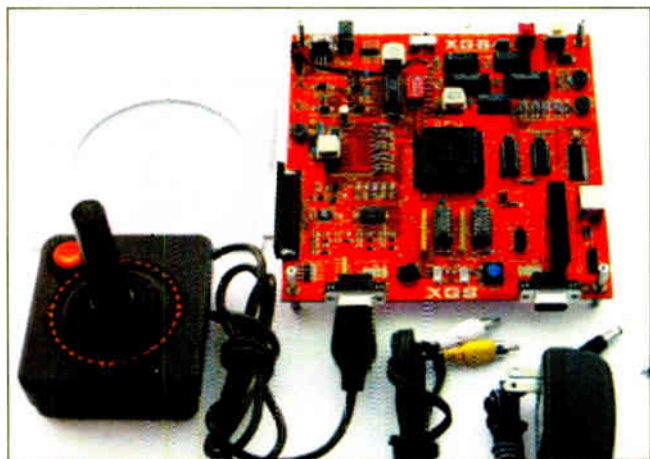

### XGameStation

The XGameStation is the world's first video game system development kit designed for education. The kit comes with an assembled XGameStation console, joystick, controller, cables, CD containing all system software and tools necessary to develop the system. An extensive eBook explains how the system was designed and how it works from the ground up.

Everything from basic digital logic to computer engineering to circuit board design to firmware and low-level software is covered. The kit is aimed at everyone from seasoned engineers to absolute electronics newbies. It is designed to teach students and hobbyists how to develop hardware that can be used for video game applications.

Andre LaMothe, CEO and Chief Scientist of Nurve Networks LLC, says that "like all revolutionary ideas, the XGameStation is equal parts fantasy and reality. On the one hand it addresses a real problem that has existed for years – that no hobbyist game programmer or hardware hacker has a unified, inexpensive platform they can actually build, take apart, and own exclusively. On the other hand, it will power a next-generation synergy of hardware, software, imagination and creativity of unparalleled proportions".

For more information contact Nurve Networks LLC, Dept EPE, 402 Camino Arroyo West, Danville, California 94506, or browse [www.xgamestation.com](http://www.xgamestation.com).

### Radio Anorak

*Astonishing – we have come across a "radio powered-jacket for kids on the go". Wild Planet, a toy maker known for its spy gear and adventure gadgets has teamed up with clothing retailer GAP to produce "Hoodio", a fleece jacket with a waterproof FM radio control panel sewn into one sleeve, a detachable power pack hidden in a pocket, and removable speakers built into the hood.*

*Hoodio is to be sold at GapKids stores in the UK, USA, Canada and France, as we go to press the web site states a US price of \$29.99. Be aware that the web site cautions that the Hoodio may obstruct your side vision and what you can hear around you.*

*For more information browse [www.wildplanet.com](http://www.wildplanet.com).*

### Ground Transient Terminator

The Ground Transient Terminator (GTT) technology developed by ECM Electronics and 9 Corporation, could well find beneficial use by those professionals who are plagued by electrical transient and surge problems.

Ground transients are one of the most frequent problems and can cause significant disruption to the operation of microprocessor-based equipment. Current microprocessors expect to see less than 0.5V between neutral and ground lines. If the micro sees more than 0.5V, system lock-ups, communication errors, reduced operating productivity, unreliable data, fragmented hard drives and damage to equipment may be seen, causing operational problems that cannot be duplicated or explained.

The GTT is the first device that can be safely placed between case ground and equipment in order to eliminate ground transients, helping prevent the problems from occurring. It is a passive filter that works by opposing changes in electron flow on the ground wire. This slows the damaging rise and fall time of a transient voltage waveform, rather than clipping it off, controlling frequency instead of amplitude.

For more information contact ECM Electronics Ltd, Dept EPE, Penmaen House, Ashington, London Road, Pulborough, W.Sussex. Tel: 01903 892810; Fax: 01903 892738. Email: [ecm@ecmelectronics.co.uk](mailto:ecm@ecmelectronics.co.uk). Web: [www.ecmelectronics.co.uk](http://www.ecmelectronics.co.uk). Also browse: [www.9corp.com](http://www.9corp.com).

# YOU WON'T GET YOUR FINGERS BURNT

It may surprise you but buying an Antex soldering iron costs less than you think in the long run. British made to exacting standards, they last significantly longer than imported brands. And with a wide range of thermally balanced soldering irons, you can pick up a "fixed temperature" or "in-handle" temperature model that will suit your needs perfectly.

None of which will burn a hole in your pocket.

If your hobby demands the best iron for the job but you don't want to get your fingers burnt by the cost, visit our website or your electronics retailer for the coolest models around.

Pick up an

**ANTEX**

Not just any old iron.



[www.antex.co.uk](http://www.antex.co.uk)

2 Westbridge Industrial Estate Tavistock  
Devon PL19 8DE Tel 01822 613565

# INGENUITY UNLIMITED

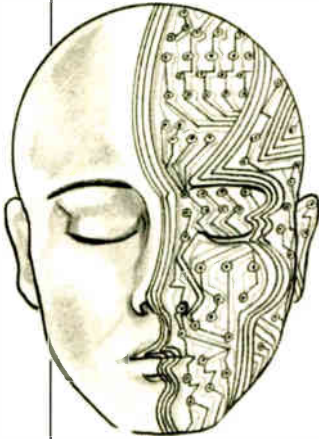

Our regular round-up of readers' own circuits. We pay between £10 and £50 for all material published, depending on length and technical merit. We're looking for novel applications and circuit designs, not simply mechanical, electrical or software ideas. Ideas *must be the reader's own work* and **must not have been published or submitted for publication elsewhere**. The circuits shown have NOT been proven by us. *Ingenuity Unlimited* is open to ALL abilities, but items for consideration in this column should be typed or word-processed, with a brief circuit description (between 100 and 500 words maximum) and full circuit diagram showing all component values. **Please draw all circuit schematics as clearly as possible.**

Send your circuit ideas to: *Ingenuity Unlimited*, Wimborne Publishing Ltd., 408 Wimborne Road East, Ferndown Dorset BH22 9ND. (We do not accept submissions for *IU* via E-mail.) Your ideas could earn you some cash and a prize!

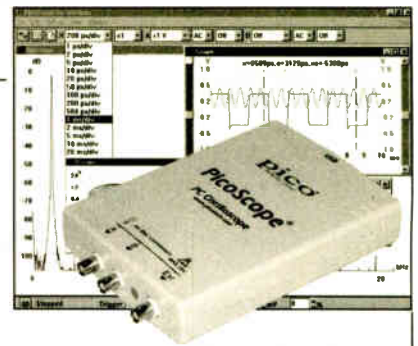

## WIN A PICO PC BASED OSCILLOSCOPE WORTH £599

- 5GS/s Dual Channel Storage Oscilloscope ●
- 50MHz Spectrum Analyser
- Multimeter ● Frequency Meter
- USB Interface

If you have a novel circuit idea which would be of use to other readers then a Pico Technology PC based oscilloscope could be yours. Every 12 months, Pico Technology will be awarding a PicoScope 3205 digital storage oscilloscope for the best IU submission. In addition, a DrDAQ Data Logger/Scope worth £59 will be presented to the runner up.

## NiCad Battery Discharger – Useful Flattery

**W**HEN faced with a set of partially discharged NiCad batteries it is not certain how long you need to recharge them for, so it is best to completely discharge them before giving them a full charge.

The circuit diagram shown in Fig.1 was built to discharge either a single battery to 1V, or a set of four batteries to 4V final voltage at a rate of about 25mA to 30mA, then switch itself off. It is based on a two-transistor latch circuit which

turns itself off when the current flowing through it falls to a predetermined value. Its operation is as follows:

### Circuit Details

With a single battery connected and switch S1 pressed, the current flows through resistor R2, meter ME1, and transistors TR1 and TR2. When S1 is released, the circuit latches, each transistor providing the required base current for the other.

Current continues to flow through the circuit with slowly reducing battery voltage, until the minimum latching current is reached. At this point the current through TR1 is no longer sufficient to provide the required voltage across resistor R3 to keep transistor TR2 turned on. Consequently, the latch turns itself off and the battery is discharged no further.

The value of the minimum latching current is determined by resistor R3, and a value of 47Ω gives about 15mA. As the latch is current-controlled, the "unlatch" voltage is determined by the

series resistance values. Bearing in mind that about 0.8V is developed across the latch itself, so a resistance of 13Ω (R2 and ME1 in series) gives an unlatch voltage of 0.8V + 0.195V = 0.995V.

### Four Cells

For use with four NiCads in series, i.e.d. D1 and resistor R1 are used in series with the basic circuit to provide an additional 3V drop at 15mA, giving an unlatch voltage of 4V.

The unlatch voltages can be trimmed by adjusting the values of resistors R1 and R2, so if you choose to use a multimeter in place of meter ME1, trim resistor R2's value to retain the correct unlatch voltages. Meter ME1 should have a minimum f.s.d. of 30mA, and an internal resistance of about 3Ω.

The transistors I used were BC237 (*npn*) and BC307 (*pnp*), though other similar devices should work fine.

P.A. Tomlinson, Hull

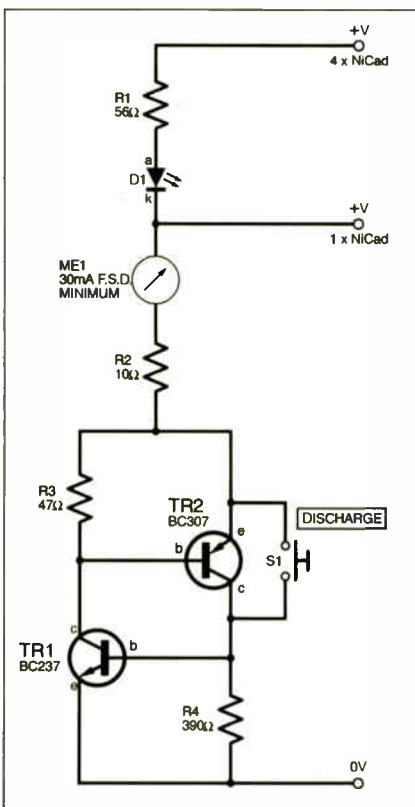

Fig.1. NiCad Battery Discharger circuit diagram

## PICO PRIZE WINNERS

Once more it's time to decide the lucky winners of superb PC-based Oscilloscopes, generously donated to *Everyday Practical Electronics* by Pico Technology, to whom we extend our appreciation for sponsoring the column again. For more information about Pico's range of PC-based test equipment visit their web site at <http://www.picotech.com>, or see their advertisement elsewhere in this issue.

*EPE* Editor Mike Kenward and Technical Editor John Becker considered all *Ingenuity Unlimited* entries published over the last twelve months, and the lucky prizewinners were finalised as follows:

**Winner** – receives a superb PicoScope3205 Digital Storage Oscilloscope worth £599: *Manual Bit-Stream Selector* by Godfrey Manning, Edgware, Middlesex (*EPE* August 2004)

**Runner-Up** – a Pico DrDAQ Data Logger/Scope worth £59: *Mouse Trapped Indicator* by C. Embleton, Darlington, Co. Durhamm (*EPE* May 2004)

# Slumber Alarm - Wake-Up Call

THE circuit diagram shown in Fig.2 was produced to prevent an elderly woman falling asleep on public transport and missing her destination. The problem was caused by the combined soporific effects of the warm environment she was in, the road or rail vibrations she was subjected to, and the side-effects from prescribed medication.

During a journey the Slumber Alarm delivers a tone in the person's ear via an earpiece (the prototype used one half of a personal stereo headset) and ideally the person presses the Reset button (S4) muting the tone. Approximately ten seconds later the tone sounds again; the person having to cancel the tone again.

This continues throughout the journey keeping the wearer alert; although they could still fall asleep for the reasons mentioned earlier. If the Reset switch is not pressed (because the person is sleeping) eventually the tone will sound at a greatly increased volume awakening the person in time to alight at their destination; or perhaps one stop further on.

The output signal (pin 3) from the low power 7555 timer/oscillator IC1 feeds 1Hz pulses to l.e.d. D1 and the Clock input (pin

14) of IC2, a 4017B decade counter, which counts up from zero. When output Q9 (pin 11) of IC2 goes high, as ten seconds elapse, IC3a inverter sets latch IC3b/IC3c. With switch S2 set at Normal, this enables oscillator IC4a/IC4b generating the "wake-up" tone which is fed to Volume control VR2, transistor TR2 and earpiece LS1.

Pressing and releasing Reset switch S4 resets IC2 via inverter IC3d and resets the latch (IC3b/IC3c) muting the tone. Counter IC2 now resumes counting and ten seconds later the tone is heard again.

If Reset S4 is not pressed the tone sounds continuously (which may or may not awaken the sleeper) and because IC2 is still enabled it continues counting. Eventually, IC2's output Q8 (pin 9) goes high again and along with IC3b's output (remaining high from before) it is decoded by IC4a/IC4b switching on transistor TR1, thus bypassing VR2, and increasing the tone's volume - awakening the person wearing the alarm.

## Setting Up

To commission the circuit, ensure switch S3 is set to Soft, adjust Volume control VR2 to midway and connect a 9V battery

(B1). Operate On/Off switch S1 and check that l.e.d. D1 is flashing at approximately 1Hz. Now set switch S2 to Demo/Test enabling the oscillator, resetting/disabling IC2 and the latch and connecting transistor TR1 base (b) to switch S3. As TR1 is biased off so VR2 is not short circuited, therefore, the tone heard in the earpiece is at soft volume.

Insert the earphone (LS1) in the person's ear and adjust VR2 until the volume is acceptable; the volume level may be adjusted later to compensate for road or rail noise. Reposition the earphone near but not in the ear and set preset VR1 to its mid-track position. Set switch S3 Loud and adjust preset VR1 until the tone from the earphone is very loud yet tolerable for the person to wear it in their ear momentarily.

Finally, set switches S2 to Normal, S3 to Soft and S1 to Off. Using a dab of adhesive or hot melt glue on preset VR1's adjuster control, secure its wiper in position.

The Slumber Alarm in now ready for use. - Happy Snoozing!

**Chris Embleton,  
Darlington, Co. Durham.**

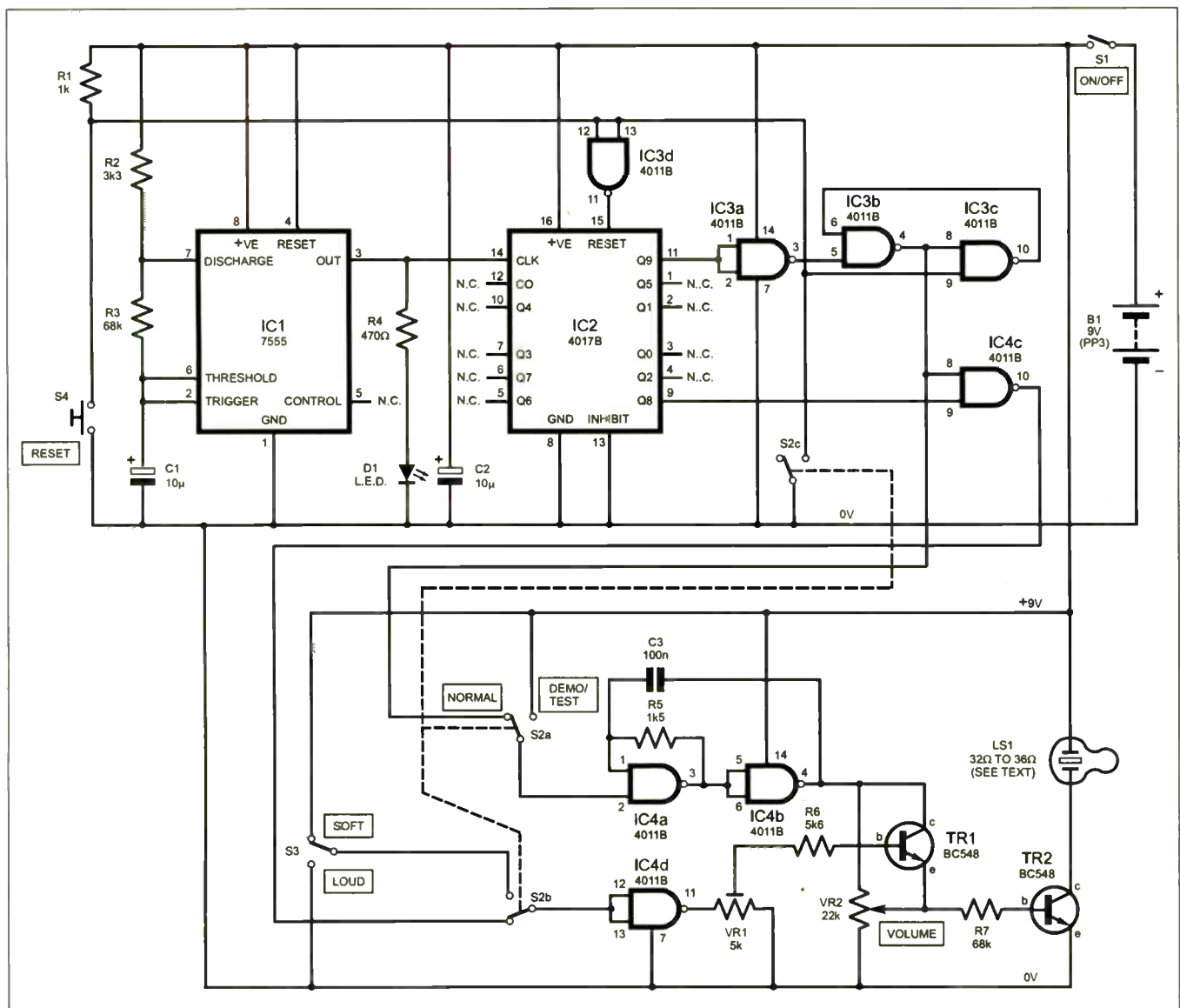

Fig.2. Circuit diagram for the wake-up call Slumber Alarm

## Audio Illusion – Ears a Ping-Pong

**T**HE circuit pictured in Fig.3 is a revamped version of one which appeared in *IU* some years ago. It is a classic auditory illusion that has had psychologists and neuroscientists puzzled for decades. Unlike the original circuit, which required three oscillators, this circuit uses just one. Also, it perfectly fulfils the theoretical requirements of the illusion by automatically generating the three frequencies required.

In the classic illusion, a two-tone “siren” plays into stereo headphones. The two tones are separated by one octave, and alternate at roughly 4Hz. However, the siren is played out-of-phase into each ear-piece. If all were well, each ear would hear a two-tone siren, as they ought to do. However, in reality the mind perceives a two-tone “ping-pong” effect, which jumps from ear to ear. What has the mind done with the missing tones? Further, if one reverses the headphones, the tones fail to reverse with the headphones, but “stay where they were”.

A single oscillator-divider IC1 provides the two audio tones through its outputs Q4 and Q5. One of these tones (from Q5) is exactly half the frequency of the other (Q4), so that these are separated by exactly one octave as required. Output Q13 switches an electronic version of a d.p.d.t. relay, comprising IC2 and the inverter formed around transistor TR1 and resistor R3. Thus the two tones are played out-of-phase. The effect is the same whether headphones or loudspeakers are used.

*Thomas Scarborough,  
Cape Town, Rep. S. Africa*

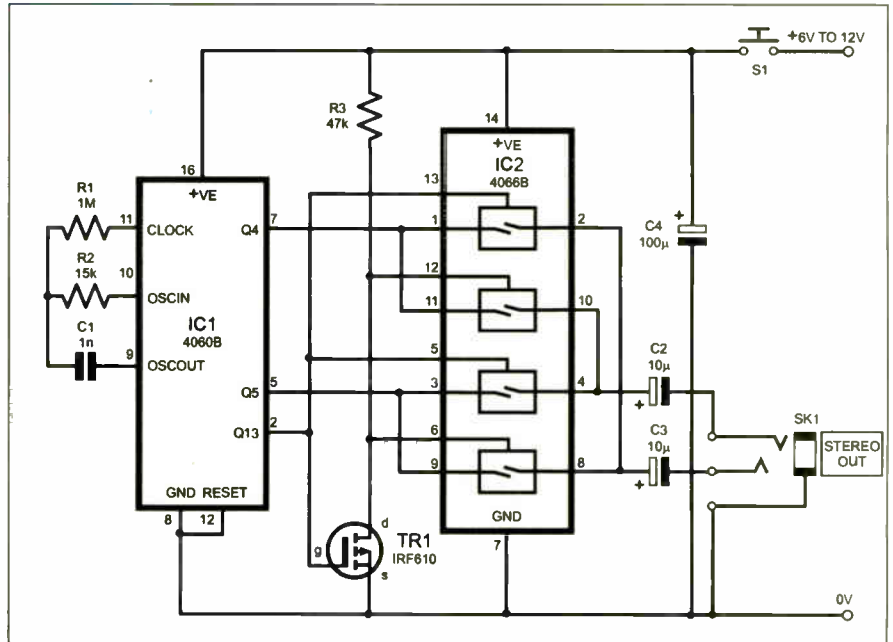









Fig.3. Circuit diagram for creating an audio illusion

### INGENUITY UNLIMITED BE INTERACTIVE

IU is your forum where you can offer other readers the benefit of your Ingenuity. Share those ideas, earn some cash and possibly a prize.



# Professional Security Products

 <p><b>Colour Night Vision Camera</b> – Fully weatherproof with 10m IR range. 1/4" CCD with automatic IR switching, 380 TV lines Resolution &amp; 12v operation. <b>Only £69.00</b></p>	 <p><b>Miniature Colour Camera</b> – with wide angle lens &amp; audio 1/3" C-Mos, 330 TV lines Resolution, 6-12v operation &amp; only 20 x 31mm. <b>Only £35.00</b></p>	 <p><b>Video Receiver</b> – Mini 2.4Ghz A/V receiver with antenna. 4 Channel selection, RCA output &amp; 12v operation. <b>Only £69.00</b></p>
 <p><b>Colour Pinhole Bullet Camera</b> Fully weatherproof with Pinhole lens. 1/4" CCD, 380 TV lines Resolution, 12v operation &amp; only 21.5 x 62.5mm. <b>Only £69.00</b></p>	 <p><b>Colour Pinhole PCB Camera.</b> 1/4" CCD, 380 TV lines Resolution, 12v operation &amp; only 22 x 26mm. <b>Only £59.00</b></p>	 <p><b>GSM Alarm</b> – Alerts you by SMS when an alarm has been triggered. 2 inputs &amp; 2 outputs, up to 5 mobile numbers can be stored and operates between 6-15v. <b>Only 199.00</b></p>
 <p><b>Colour Bullet Camera</b> – Fully weatherproof with standard lens. 1/4" CCD, 420 TV lines Resolution, 12v operation &amp; only 20 x 74mm. <b>Only £65.00</b></p>	 <p><b>Hi-Power Video Transmitter</b> – Mini 2.4Ghz A/V transmitter with built on microphone. 4 Channel selection &amp; 12v operation. <b>Only £35.00</b></p>	<p><b>More Products Available on</b> <b>WWW.SPSTOREUK.COM</b></p>

\*\*\*\*\* ALL PRICES EXCLUDE P&P and VAT \*\*\*\*\*

- Bitz Technology Ltd •
- 344 Kilburn Lane • London W9 3EF •
- Tel: +44 (0) 208 968 0227 • Fax: +44 (0) 208 968 0194 •
- E-Mail: [info@spystoreuk.com](mailto:info@spystoreuk.com) • Web: [www.spystoreuk.com](http://www.spystoreuk.com) •





# New Power Products From B.K. Electronics

## A new range of 12V and 24V to 230V Inverters with soft start



A Complete range of regulated inverters to power 220V and 240V AC equipment via a car, lorry or boat battery. Due to their high performance (>90%) the inverters generate very little heat. The high stability of the output frequency (+/-1%) makes them equally suitable to power sensitive devices. These inverters generate a modified sine wave, which are considerably superior to the square waves which are produced by most other inverters. Due to this superior feature they are capable of powering electrical equipment such as TV,s, videos, desktop & notepad computers, microwave ovens, electrical lamps, pumps, battery chargers, etc.

★ Soft start (Minimises shutdown when used with inductive loads) ★ Reverse polarity protection ★ Battery low/high shutdown ★ Short Circuit, overload and overtemp protection

 <p><b>150W</b></p> <p><b>Part No. 12V</b> 651.620 <b>Part No. 24V</b> 651.623</p> <p>Continuous Power 150W Peak Power 450W Output Voltage 230V AC AC Frequency 50Hz Efficiency 90% Stability +/-10% Dimensions 165x91x58mm Weight 850g</p> <p><b>£26.48</b></p>	 <p><b>300W</b></p> <p><b>Part No. 12V</b> 651.626 <b>Part No. 24V</b> 651.629</p> <p>Continuous Power 300W Peak Power 1000W Output Voltage 230V AC AC Frequency 50Hz Efficiency 90% Stability +/-10% Dimensions 190x91x58mm Weight 1.1kg</p> <p><b>£34.43</b></p>	 <p><b>600W</b></p> <p><b>Part No. 12V</b> 651.632</p> <p>Continuous Power 600W Peak Power 1800W Output Voltage 230V AC AC Frequency 50Hz Efficiency 90% Stability +/-10% Dimensions 242x91x58mm Weight 1.7kg</p> <p><b>£69.09</b></p>	 <p><b>1000W</b></p> <p><b>Part No. 12V</b> 651.638</p> <p>Continuous Power 1000W Peak Power 3000W Output Voltage 230V AC AC Frequency 50Hz Efficiency 90% Stability +/-10% Dimensions 393x242x80mm Weight 3.1kg</p> <p><b>£141.47</b></p>
--	---	--	---

### 300W Pure Sine Wave Inverter



**Part No. 12V** 651.650  
Continuous Power 600W  
Peak Power 1000W  
Stability +/-10%  
Efficiency 90%

**Price £122.06**

THD <4%  
Dimensions 80x242x255mm  
Weight 2.8kg  
Temperature Range -15 to +50 Deg C

A pure sine wave inverter for supplying 230V AC from a 12V car battery. A pure sine wave is required for example field lab use.

- ★ Generates pure sine wave
- ★ Cooling Fan
- ★ Low Voltage alarm below 10.5V DC
- ★ Automatic turn off when voltage below 10V
- ★ Protected against short circuit and overheating

### 1500W 12 or 24V to 230V Inverter



**Part No. 12V** 651.602  
**Part No. 24V** 651.605

Continuous Power 600W  
Peak Power 1800W  
Output Voltage 230V AC

**Price £246.75**

AC Frequency 50Hz  
Efficiency 90%  
Stability +/-10%  
Dimensions 242x91x58mm  
Weight 1.7kg

- ★ The inverter gives an audible warning signal when the battery voltage is lower than 10.5V (21 for the 24V versions). The inverter automatically shuts off when the battery voltage drops below 10V (20V for the 24V versions)
- ★ Protection - Input short circuit and over heating (55 Deg C)
- ★ Modified sine wave
- ★ Remote lead available

### Regulated PSU Adjustable 0-20V / 2A



Regulated power supply with a variable output voltage ranging from 0V to 30V at 2 amp max.

- ★ Housed in a solid case
- ★ Fixed mains lead
- ★ Illuminated mains switch
- ★ Output via red(+) and black(-) 4mm sockets
- ★ Fitted with 2 panel meters for analogue display of Voltage and current

Power Supply 230V AC 50Hz, Output Voltage 0 to 20VDC, Output Current 2A Max, Dimensions 110x240x150mm, Weight 2.8kg **Pt.No.650.673**

Only £24.48

### Regulated PSU Adjustable 0-30V / 10A



Regulated power supply with a variable output voltage 0 to 30V and current limiting up to 10 Amps

- ★ Voltage and current limiting provided by "coarse" and "fine" rotary controls
- ★ The unit has short and "FOLDBACK" overload protection
- ★ Output via red(+) and black(-) and green(ground) 4mm sockets
- ★ Output voltage and current are indicated by two clear 3-digit green LED displays

Power Supply 230V AC 50Hz, Output Voltage 0 to 30VDC, Output Current 0 to 10 Amps, Dimensions 160x260x355mm, Weight 12 **Pt.No.650.682**

Only £157.92

### Regulated PSU Adjustable 0-30V / 3A

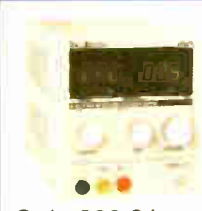

Regulated power supply with a variable output voltage 0 to 30V and current limiting up to 3 Amps

- ★ The unit has short and "FOLDBACK" overload protection
- ★ Housed in a solid case
- ★ Power switch fitted
- ★ Output via red(+) and black(-) 4mm sockets
- ★ Output voltage and current are indicated by two high precision LED displays

Power Supply 230V AC 50Hz (150W), Output Voltage 0 to 30VDC, Output Current 0 to 3 Amp, Dimensions 155x213x285mm, Weight 3.7kg **Pt.No.650.676**

Only £82.91

### Triple Output Regulated PSU Adjustable 2x30V / 0-3 Amps Plus 5V at 3 Amp Fixed



Regulated power supply with with dual variable voltages from 0 to 30V DC and a fixed 5V at 3A output

- ★ The setting of the output voltages can be coupled (master/slave)
- ★ Series and parallel switchable output
- ★ The unit has short and "FOLDBACK" overload protection
- ★ Output via red, black and green terminals
- ★ Output voltage and current are indicated by two clear 3-digit green LED displays

Only £157.92

Power Supply 230V AC 50Hz, Output Voltages 2 x 0 to 30VDC 1 x 5V fixed, Output Current 2 x 0 to 3 Amps 1 x 3A fixed, Dimensions 160x260x355mm, Weight 12kg **Pt.No.650.685**

### Regulated PSU Adjustable 0-50V / 3A



Regulated power supply with a variable output voltage 0 to 50V and current limiting up to 3 Amps

- ★ The unit has short and "FOLDBACK" overload protection
- ★ Housed in a solid case
- ★ Power switch fitted
- ★ Output via red(+) and black(-) 4mm sockets
- ★ Output voltage and current are indicated by two high precision LED displays

Power Supply 230V AC 50Hz (175W), Output Voltage 0 to 30VDC, Output Current 0 to 3 Amp, Dimensions 155x213x285mm, Weight 3.7kg **Pt.No. 650.679**

Only £94.75

### 13.8V Fixed Voltage PSU's

A complete range of fixed voltage regulated power supplies all short circuit and "FOLDBACK" protected housed in sturdy cases

Model Number	650.652	650.654	650.657	650.660	650.663	650.667
Continuous Current	3A	5A	7A	9A	12A	15A
Maximum Current	5A	7A	10A	15A	20A	25A
Peak Surge Current	7A	9A	12A	17A	22A	27A
Output Voltage	13.8V DC	13.8V DC	13.8V DC	13.8V DC	13.8V DC	13.8V DC
Price	£18.70	£23.96	£32.81	£40.26	£57.46	£67.17



DELIVERY CHARGES:- ALL ABOVE ITEMS CHARGED AT £8.00 PER ORDER. ORDERS FROM SCHOOL, COLLEGES, GOVT., PLCs ETC. PRICES INCLUSIVE OF V.A.T. SALES COUNTER. CREDIT CARD ORDERS ACCEPTED BY POST PHONE OR FAX. E&OE



**B.K. ELECTRONICS** Ad-5  
UNIT 1 COMET WAY, SOUTHEND-ON-SEA, ESSEX. SS2 6TR.  
TEL.: 01702-527572 FAX.: 01702-420243  
Web:- <http://www.bkelec.com> E-Mail [sales@bkelec.com](mailto:sales@bkelec.com)

# Circuit Surgery

Alan Winstanley and Ian Bell

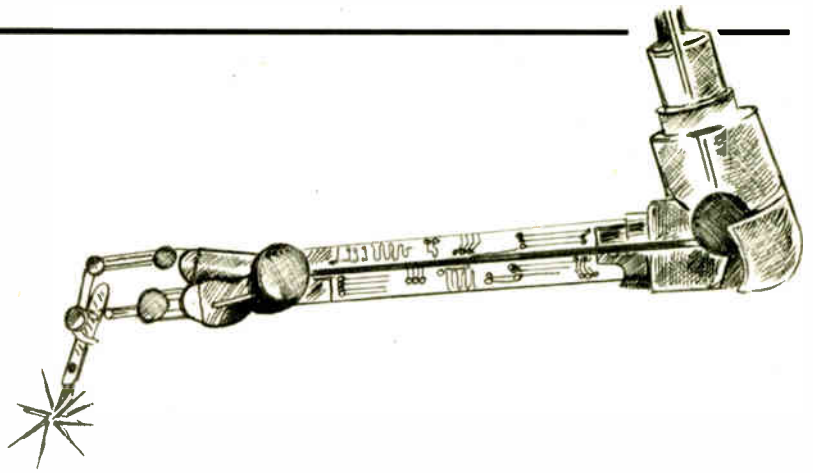

We return to basics this month, looking at square waves and offering advice for dealing with crimped connectors

## Being Square

"I'm currently reading a book called *Getting Started In Electronics* in which there are some terms and definitions relating to electronics. The bit that's puzzled me is the meaning of "Square Wave – a signal which oscillates between two fixed voltages."

"That's it! I'm confused because I understand a sinewave but never quite understood the meaning or application of a so-called square wave and the reference to a fixed voltage. What does a square wave do? Please can you help. Thanks from Geoff," in the EPE Chat Zone ([www.epemag.co.uk](http://www.epemag.co.uk)).

After our three-part primer on the PC USB (Universal Serial Bus), it's back to basics in *Circuit Surgery* with an introduction to some of the most common waveforms and signals that are present in many electronic circuits.

Waveforms are the product of both analogue and digital electronic circuits. Analogue waveforms can be thought of as being comprised of "wavy lines" and may be, for example, an audio output from a microphone or loudspeaker, or a.m. or f.m. radio signals. A digital signal is recognisable by clearly defined step changes of level: personal computers and PIC microcontroller logic circuits are full of these digital signals.

Sometimes, we need to convert one sort of signal to the other, for which an analogue-to-digital converter (ADC) or digital-to-analogue converter (DAC) circuit will be used. Examples of signal conversion are found in audio CD systems, which process digitised forms of analogue signals (the original music) and outputs them as "wavy lines" to an audio amplifier, to be played over some headphones or loudspeakers.

In Fig. 1 some square wave signals have been drawn. The first thing to point out is that a square wave does not have to be "square shaped"! They can be rectangular, or they can be brief "blips". They

merely represent a step change from one level to another and back again: they can be a stream of pulses, or "ons" and "offs".

Another point is that they don't necessarily have to represent voltage (symbol  $V$ ): they can relate to current (symbol  $I$ ) or some other physical phenomenon. In microelectronics though, square waves are most often seen when discussing voltage signals, logic levels and pulse trains.

In Fig. 1a a square wave is shown that plots voltage against time. The shaded area represents the square wave, and it is either "low" at 0V, or "high" at a voltage labelled  $V_1$ . We can put more interesting labels on this square wave. If the "on" time is  $t_1$  as shown, and the "off" time is  $t_2$  then the **period** of this square wave is  $T = (t_1 + t_2)$ . If  $t_1$  is say 0.05 seconds (50 milliseconds) and  $t_2$  is 0.02 seconds (20 milliseconds), the period is 0.07 seconds.

The frequency  $f$  of a waveform is the reciprocal of the period in seconds, i.e.  $f = 1 / T$  (Hz).

Frequency is the same as the number of cycles per second and is measured in Hertz (Hz.) Our square wave has a frequency of  $1 / 0.07 = 14$  Hz.

In Fig. 1b another square wave is shown, but this time the "high" period  $t_1$  is much shorter than the "low" period  $t_2$ . If  $t_1$  is now 20 milliseconds and  $t_2$  is 50 milliseconds then the frequency of the square wave is still the same!

The "on" time  $t_1$  may be referred to as the **mark** and the "off" time  $t_2$  as the **space**. The mark-to-space ratio indicates the waveform's **duty cycle**. A 100% duty cycle would mean that the voltage would be permanently high at  $V_1$ . A 50% duty cycle means that the voltage is on for 50% of the time.

## On Duty

The term *duty cycle* often appears in other areas. When buying a computer printer, for example, the printer's "duty cycle" rating indicates the intended rate of usage, usually in sheets of paper printed per month. This helps you to choose a printer that will cope with the likely demand. A heavy-duty printer might have a duty cycle of 150,000 pages per month; my Deskjet 1220C inkjet has a duty cycle of 5,000 pages per month.

Cheap domestic waste paper shredders have appalling duty cycle ratings as befits their price, often requiring a "rest" (that's the "space" in the square wave of shredding operation) after a few minutes of use (the "mark"). If you exceed the rated duty cycle, or feed through too many sheets at a time, the motor will overheat and trip out. In this context a duty cycle of 10% means that it must rest for 90% of the session. By uprating the motor, cutters and power supply, the duty cycle could be improved towards a

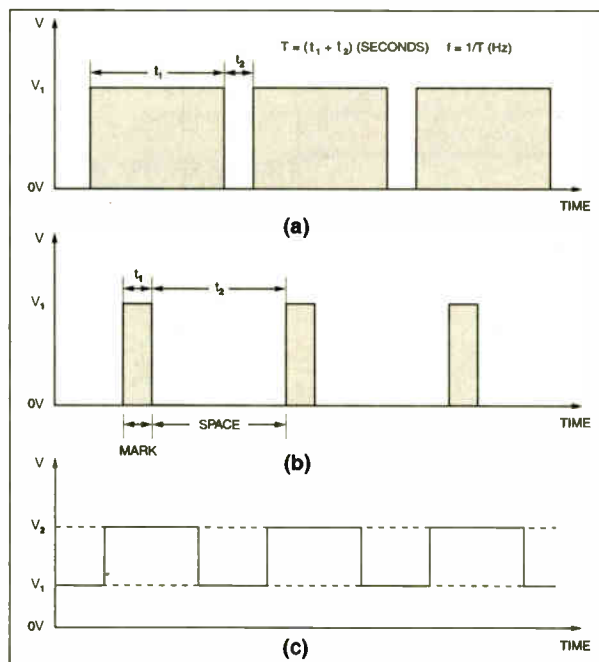

Fig. 1. Some examples of square wave: a) showing the total period  $T = (t_1 + t_2)$ ; b) illustrating the mark/space ratio and c) showing square waves do not have to cycle between zero and another level



theoretically unstopable 100% "continuously rated".

As mentioned earlier, a square wave will step between one level and another, but this doesn't have to be from zero to some other level. In Fig 1c a square wave is shown that has been level-shifted from 0V and is superimposed on a higher voltage. It now cycles (oscillates) between two levels,  $V_1$  and  $V_2$  but can still be classed as a square wave. The principles of calculating frequency and duty cycle are the same.

In our examples the square wave oscillates between two fixed levels, which means that we can class them as **binary** signals. These are at the root of operation of logic circuits and PIC projects.

In binary circuits the voltage levels are strictly specified. A classic TTL logic circuit would use square wave signals of 0V (logic low) and +5V (high), though a tolerance is permissible on these values that allows for consistent operation between different chips. Data sheets tell us what these *threshold* values are, and designers have to ensure that digital circuits operate correctly at them. Modern low power circuits use lower threshold values, e.g. +3.3V.

In practical electronic circuits, square waves are not perfectly shaped. It takes a finite amount of time to switch between low and high states, and if we enlarge a square wave sufficiently (say, by measuring them and changing the time base of an oscilloscope) then eventually we can see that it starts to take on a "trapezoidal" shape rather than the perfect square. Therefore, of interest to advanced circuit designers are the *rise time* and *fall time* of a pulse or a square wave, which relates to how fast the leading edge and trailing edge of the square wave can change from one state to the other. In most hobby circuits this doesn't matter, but when clock frequencies in modern personal computers are reaching the gigahertz (1,000,000,000 cycles per second) level then it becomes critical.

## Sine of the Times

A familiar sinewave is shown in Fig.2. Unlike a square wave, which *switches* between two thresholds, a sinewave *swings* between two **peak voltages**. The example swings around the 0V axis between  $+V_{pk}$  and  $-V_{pk}$ . This is like the domestic mains voltage supply. The frequency is calculated the same way, using  $f = 1/T$ . A standard 50Hz mains sinewave has a period  $T$  of 20 milliseconds.

Why is the mains voltage a sinewave and not a square wave? Electricity is produced at power stations by means of huge "electromagnets" spinning around inside generators. The output voltage therefore rises as the rotating electromagnet approaches the surrounding coils, before the magnet moves away again and then actually reverses in polarity. The sinewave reflects this rising, falling and reversing of the generator coils by having a *positive* and *negative* cycle.

The British mains supply is officially labelled as 230V a.c., though in reality it is more like 240V a.c.; this value is termed the

r.m.s. (root mean square) voltage and if we multiply this by 1.414 – the square root of 2 – we can calculate the approximate peak voltage of 339V a.c., giving us a **peak-to-peak voltage** of 678V a.c.

To round off this simple introduction, Fig 2 also shows a sawtooth (b) and triangle (c) waveforms. These might be seen in timing or synchronising circuits. The classic 555 timer chip produces a square wave output and its RC timing network can be a useful source of a sawtooth waveform. A.R.W.

## A Source of Mystery

*"I am in the USA and have recently downloaded the Dec 2004 issue of your online magazine (www.epemag.com) and would like to try out the Super Vibration Switch project. However, I am finding it very difficult to locate the required components. I would like to know if there is a store that you could recommend?"*

*"Any information you can offer would be helpful. Also, in the same project, can metal film resistors be substituted for the carbon film resistors? Thank you, from Fred Adams, USA" (by email).*

One source in the USA I can suggest is Digi-Key Corporation ([www.digikey.com](http://www.digikey.com)) based in Minnesota. They have a downloadable catalogue, and UK readers may be interested to know that there is a UK freephone number available. Prices are available in Pounds Sterling and are said to include duty and brokerage fees.

Unfortunately it is hard these days to design a project assuming that all components can be sourced from one store. We do specify sources for any unusual parts in our *Shoptalk* column. Part of the deal of modern hobby electronics is that it may be necessary to deal with a number of suppliers (vendors), though we know this can impact on the construction cost due to multiple postage charges incurred. Try gathering together some catalogues, or check over *EPE* advertisers' web sites to see what's on offer, and group orders for

projects together to save postage. Order extra regular parts for "stock" as well.

It is perfectly alright to use metal film types in place of the carbon film ones we mentioned in the Parts List. We specify ordinary carbon film types as these are "vanilla flavour" resistors that are used universally in normal applications. Metal film types are of a higher quality, and have uses in low noise projects or ones where closer tolerances are needed on component values. A.R.W.

## Crimping or Soldering

One of my favourite TV programs is *American Chopper*, a piece of theatre about a US custom motorcycle factory ([www.orangecountychoppers.com](http://www.orangecountychoppers.com)) run by its cantankerous owner, helped by his long suffering sons. My eyes lit up (as did the bike's headlight, in fact) in a recent programme when they were wielding a soldering iron and doing some wiring up on their latest bike. Which leads to my next reader's question:

*"I have just been told that you should never solder crimped spade connectors after they have been crimped. At UWE I was told this should not be done, yet I have now been told that I should! What is your view? Many thanks, Philip." (by email).*

In my view, crimped wires do not need to be soldered "for luck". The good folks of OCC were seen to be twisting and soldering some motorcycle wires together rather than using crimp connectors. In another programme on satellite TV, I groaned when I saw a huge battery terminal wire being crimped and soldered – it was for a home built 4x4. On a custom bike intended mainly for show, then it doesn't matter much, but there are good reasons why soldering can be inferior to crimping an electrical joint – and why the two shouldn't be mixed.

The factor affecting reliability here is vibration, and it doesn't take an Orange County chopper to cause work-hardening metal fatigue on soldered joints that have to flex in use. Many devices vibrate – computer power supplies have a fan, and disk drives vibrate as well. When a multistranded wire is soldered (whether crimped or not), then the solder turns it into a brittle solid-core wire.

Vibration causes the wire to flex, which as we all know will eventually fracture the joint. Strain reliefs are used in many connectors that need to be soldered, to improve reliability. Even the crimps of a spade terminal often include some form of strain relief to grab the insulation and grip it firmly, to avoid fracture.

If you look under the bonnet (hood) of a car, almost all wiring is terminated in crimped connections. Apart from helping the cost and speed of assembly, this is done when terminals are too large for ordinary soldering (the 12V battery, starter motor etc.) or if the wire is going to be subject to vibration or stress. Using the proper tools and connectors, crimping allows good, consistent and reliable joints to be made every time. A.R.W.

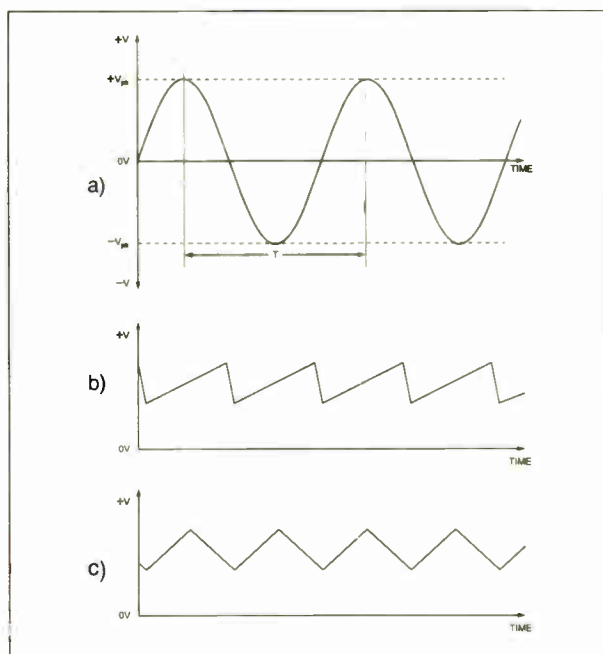

Fig.2. A sinewave (a) has a period  $T$  and swings from  $+V_{pk}$  to  $-V_{pk}$ . Example waveform (b) is referred to as a sawtooth and (c) is a triangle wave.

# Stereo Headphone Monitor

by Terry de Vaux-Balbirnie



Usable as an add-on for last month's Sound Card Mixer or as a stand-alone unit

**T**HIS circuit was designed to be built into the *Sound Card Mixer* (Feb '05). With it, the user may monitor the output using a pair of headphones and make accurate adjustments while recording is in progress. Some readers will not need this facility because their configuration already allows headphone monitoring. This is why the circuit was not included as part of the original design.

Equally useful to some readers is the ability to use the circuit as a self-contained unit. This will allow listening to the sound output from any Line level source, such as an electronic musical instrument, using headphones.

If the *Sound Card Mixer* has been constructed in the specified sloping-front case, there will be ample space inside to accommodate this new circuit and it may share its power supply. The additional current depends on various factors but it is likely to be in the region of 10mA to 15mA. The total current requirement of the Mixer will then rise to some 55mA. This will reduce the life of the battery pack so, for long periods of use, a larger set of batteries may be used. If these will not fit inside the case, they could be sited externally.

## Stereo Amplifier

The Stereo Headphone Monitor is just a small stereo power amplifier. It provides sufficient output to operate a pair of standard headphones having an impedance of 32 ohms approximately. The unit is fitted with a volume control which allows the sound to be adjusted to a comfortable listening level. Using this does not affect the signal passing to a sound card or other device.

When built into the *Sound Card Mixer*, you could use headphones having a boom microphone attached. This would be ideal for commentaries and "voice overs". The advantages of adopting this method are that the hands are kept free and a constant speaking distance is maintained with the microphone.

## Circuit Description

The full circuit diagram for the Stereo Headphone Monitor is shown in Fig.1. Integrated circuits IC1 and IC2 are the actual amplifiers. Two are required – one for each channel. These can provide

325mW into an 8Ω load. However, since headphones have a much greater impedance than this, the available output will be reduced. This does not matter because only a very small output is sufficient to fully load the headphones.

The circuit comprises two sections and a small number of components common to both. The part centred around IC1 is associated with the Left channel while that based on IC2 is responsible for the Right. Since these parts are identical, only a description of the left channel is needed. Note that components in the left channel (and those common to both) are labelled with single figures – for example, C1, C2, and C3 while in the right one, the corresponding components are prefixed with a "1" – C11, C12, C13, etc.

## Power Supply

The power supply may consist of a 6V or 9V battery. If used as a stand-alone unit, four AA size alkaline cells would be satisfactory. Current flows via diode D1 to charge capacitor C5. Sudden surges of current occur on the sound peaks and batteries alone might not be able to provide these, especially when they are nearing the end of their life. This would result in distortion. The capacitor holds a reserve of charge which will provide any instantaneous current demands.

Diode D1 gives supply reverse-polarity protection and also isolates the power supply from that of the *Sound Card Mixer* if this is shared with it. The positive supply feed is made to IC1 pin 6. Pin 2 (the inverting input) is connected to 0V together with the actual 0V connection, pin 4.

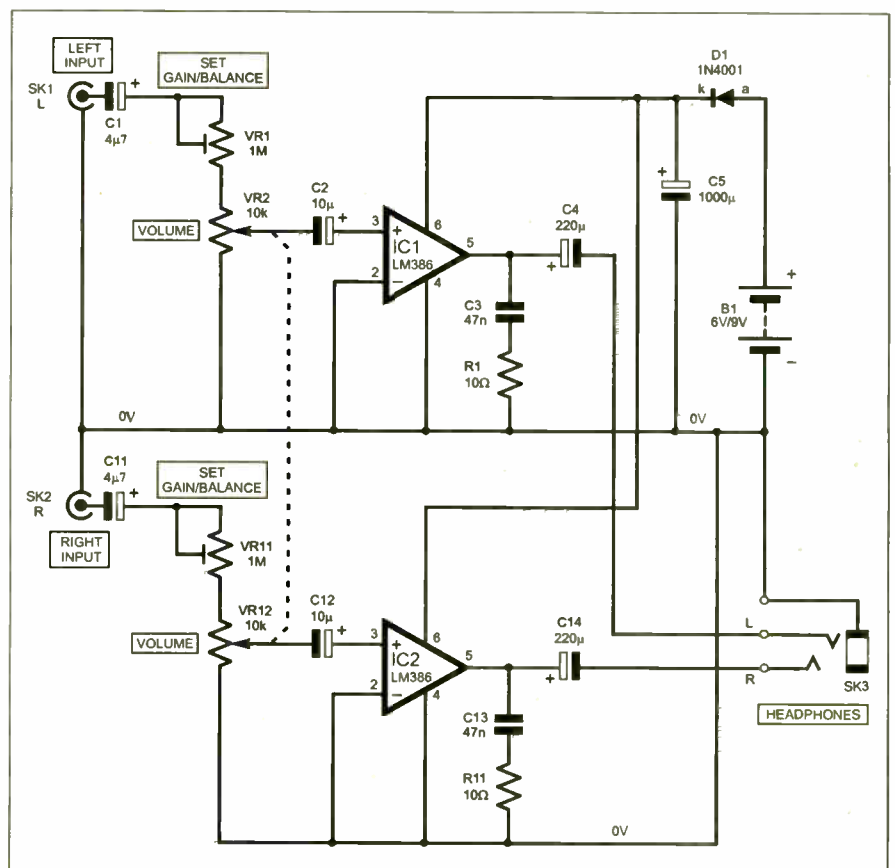

Fig.1. Complete circuit diagram for the Stereo Headphone Monitor.

The signal input is made to IC1 pin 3 (the non-inverting input). However, a line level signal would be too high and must first be reduced. This is carried out using a potential divider arrangement. The incoming a.c. (audio) signal flows through capacitor C1, preset potentiometer VR1 and rotary Volume control VR2 to the 0V line.

## To the Maximum

Suppose VR1 is adjusted to maximum resistance (1M $\Omega$ ). With VR2 at its minimum setting, the voltage at its sliding contact (wiper) will be zero. When VR2 is set to maximum, the signal voltage will be divided by 100 approximately. With preset VR1 adjusted to less than maximum resistance, a smaller amount of attenuation (reduction) is provided.

## COMPONENTS

### Resistors

R1, R11 10 $\Omega$  (2 off) 0.25W  
5% carbon film

### Capacitors

C1, C11 4 $\mu$ 7 radial elect.  
35V (2 off)  
C2, C12 10 $\mu$  radial elect.  
16V (2 off)  
C3, C13 47n ceramic disc,  
5mm pitch (2 off)  
C4, C14 220 $\mu$  radial elect.  
16V (2 off)  
C5 1000 $\mu$  radial elect.  
16V

See  
SHOP  
TALK  
page

### Potentiometers

VR1, VR11 1M carbon preset  
vertical (2 off)  
VR2/VR12 10k min. dual-  
ganged rotary  
carbon, p.c.b  
mounting, with  
5mm matrix pin  
spacing, log.  
(see text)

### Semiconductors

D1 1N4001 50V 1A  
rectifier diode  
IC1, IC2 LM386N-1 power  
amplifier (2 off)

### Miscellaneous

SK1, SK2 phono socket  
(2 off) (see text)  
SK3 3.5mm stereo jack  
socket (see text)  
B1 AA-size alkaline  
cells (see text)  
(4 off)

Printed circuit board, available from the *EPE PCB Service*, code 490; metal case (see text); control knob; 8-pin d.i.l. sockets (2 off); PP3-type battery connector; connecting wire; solder, etc.

Approx. Cost  
Guidance Only

£11

Preset VR1 will be adjusted at the end so that, when VR2 is at maximum, there is minimal distortion combined with sufficient volume. VR1 and VR11 will also be adjusted at the end of construction so that there is a balance (equality) in the volume between the left and right channels.

Note that VR2 (left Volume control) is one section of a dual (ganged) potentiometer. This is really two units controlled by a single spindle. The other section, VR12, is used as a Volume control for the right channel.

The signal "tapped off" by VR2's wiper is applied to IC1 input pin 3 via capacitor C2. There is a small bias (standing voltage) on this pin which is set automatically by internal components. This allows both the positive and negative parts of the input signal waveform to be amplified by swinging above and below this voltage.

The output appears at pin 5 and the signal flows via capacitor C4 to the left-hand headphone output. Capacitor C3 connected in series with resistor R1 stabilise the amplifier and prevent any oscillation that might otherwise occur.

## Construction

Construction of the Stereo Headphone Monitor is based on a single-sided printed circuit board (p.c.b.). This board is available from the *EPE PCB Service*, code 490. The component layout and actual size copper master track pattern are shown in Fig.2.

Begin construction by soldering the two 8-pin i.c. sockets in position then add the fixed resistors and preset potentiometers (VR1/VR11). Follow with the capacitors – most of these are electrolytic and care must be taken to place them with the correct polarity as indicated. Add diode D1, taking care over its polarity.

Solder Volume control potentiometer VR2/VR12 in place. It would be better

if this is a logarithmic (log) type because it provides an improved physiological response (angle of rotation against perceived change in volume). However, an ordinary linear (lin) unit would be satisfactory.

## Assembly

Adjust presets VR1/VR11 to approximately mid-track position. Solder pieces of stranded connecting wire to the power supply and the input and output pads. Using coloured wires will help to avoid errors. Insert the i.c.s into their sockets. The completed p.c.b. is shown in the photograph.

The circuit panel is very small and light so may be mounted using the potentiometer bush fixing alone. If the circuit is to be used as an add-on unit for the *Sound Card Mixer*, decide on a suitable position for it inside the case. Remove the existing p.c.b. to prevent damage and move any wiring out of the way.

Drill holes for the potentiometer bush and headphone jack socket. In the prototype, the socket was mounted at the front of the unit because this avoids trailing wires.

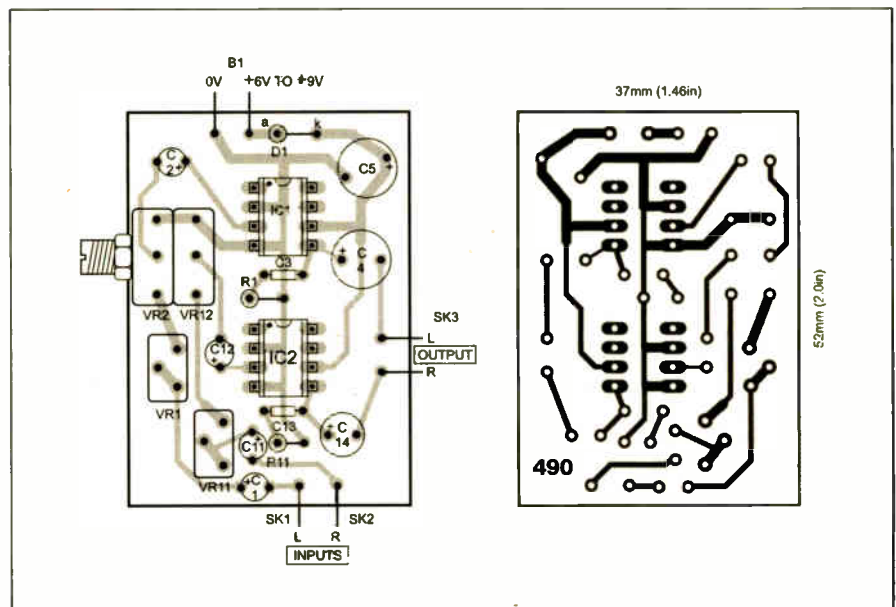
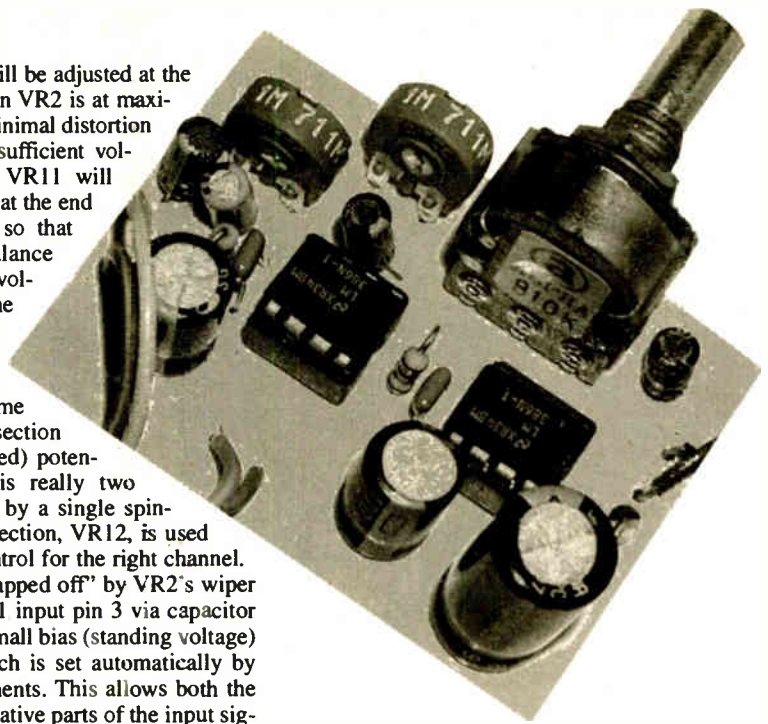
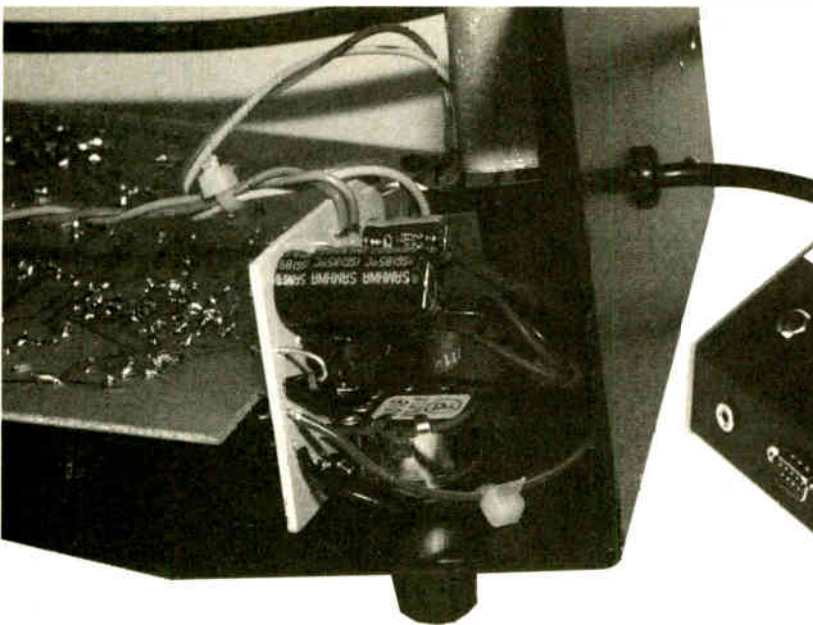

Fig.2. Printed circuit board top side component layout, wiring details and full-size underside copper master for the Stereo Headphone Monitor



The Stereo Headphone Monitor circuit board mounted at the rear of last month's Sound Card Mixer project



The knob on the top/back of last month's Sound Card Mixer is the volume control for the Headphone Monitor. The Headphone socket can be seen on the front edge of the case

### Interwiring

If the unit is to be built into the *Sound Card Mixer* case, refer to Fig.3. This shows the connections needed to the existing wiring. The supply positive feed is made to the on-off switch (so that the switch controls both sections). The 0V connection is made to the rear solder tag. There are

already connections made here so it will be best to desolder them, twist all the wires together and solder the joint again. Make sure this work is sound.

The left and right Monitor's input connections are made to the *Sound Card Mixer's* output wires (see Fig.3). In the prototype, the wires were cut at a conven-

ient place and the new ones soldered to them. Heat shrinkable sleeving should be used to insulate the joints.

For the output (Headphone) socket SK3, use a 3.5mm stereo jack type (or as appropriate for the headphones used). The socket used in the prototype made an automatic sleeve connection with the metal case (0V). If this type is used, scrape away the paint around the hole on the inside of the case so that good electrical contact is made. If the socket is fully insulated and does not make a 0V connection in this way, the sleeve connection will need to be hard-wired to a 0V point (to the solder tag at one of the phono sockets for instance).

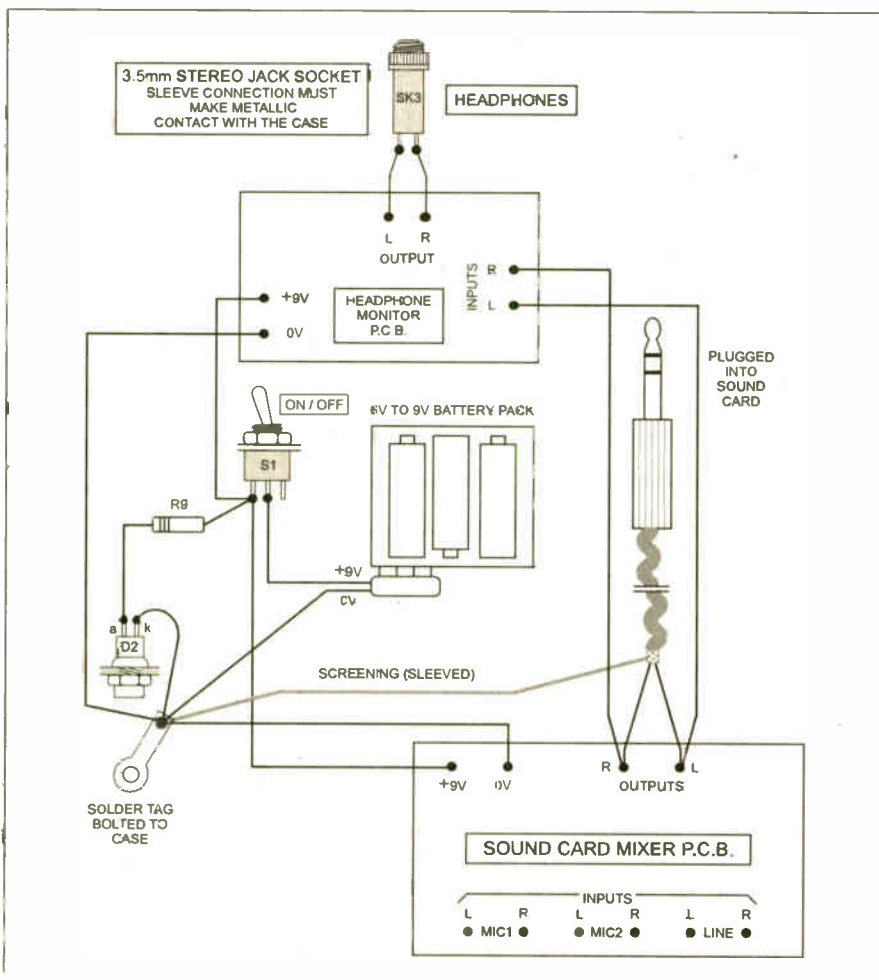

Fig.3. Interwiring between the Headphone Monitor and last month's Sound Card Mixer's components and circuit board

### Free Standing

If the Monitor circuit is constructed as a free-standing unit, choose a suitable metal box large enough to accommodate the circuit panel, battery pack, on-off switch, phono input sockets and headphone jack socket. Drill the fixing holes for these parts and attach them. Make sure the soldered joints on the underside of the p.c.b. are kept several millimetres clear of the base of the box. This will prevent any short circuits with the metalwork.

Refer to Fig.4 which shows the internal wiring. The sleeve connections of the phono sockets, that of the headphones socket, the "0V" wire on the p.c.b. and the battery "0V" ("negative") wire, are inter-connected and must make metallic contact with the case ("earth") via a solder tag.

The sleeve connections of uninsulated "single hole fixing" phono sockets make an automatic connection with the metalwork. These are usually supplied with a solder tag and, fitted to one socket, may be used for all the 0V connections. Scrape away any paint around the fixing hole to make sure a good contact is made. If any of the sockets do not make the "earth" connection automatically, you will need to hard-wire them to a separate solder tag. Make sure this makes good electrical contact with the metal case.

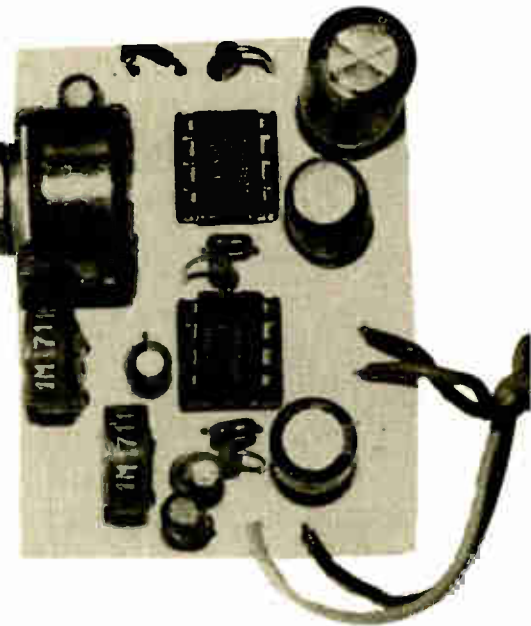
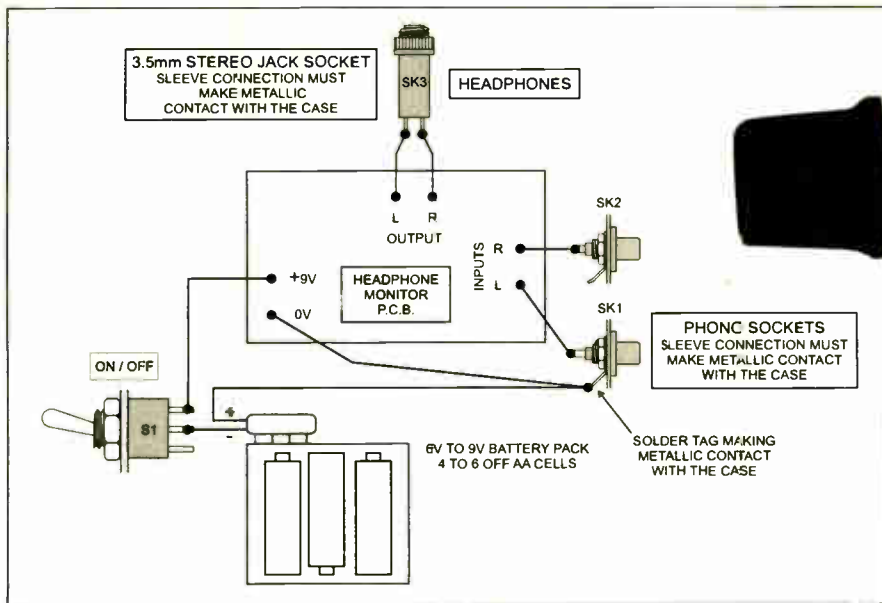

Fig.4. Interwiring for the "stand-alone" version of the Headphone Monitor. The sleeve connections for the jack socket and phono sockets must make a good "earth" (0V) with the metal case

The completed Headphone Monitor circuit board ready for mounting in a suitable metal case

### Testing and Listening

Turn the Volume control to minimum (full anticlockwise rotation). Plug the headphones into the jack socket. Apply a Line level signal to the input and switch on the supply. A suitable signal may be obtained from a tape deck, CD player or possibly a camcorder's audio output.

Listen cautiously to the headphones in

case there are any surprise loud noises. Advance the volume control and check the sound quality. If it is very weak despite the Volume control being set to the maximum, reduce the settings of presets VR1/VR11 equally by clockwise rotation of the sliding contacts (as viewed from the left-hand edge of the p.c.b.). You may need to remove the circuit panel to do this, or you

might be able to do it with it in place using a thin screwdriver.

If the sound becomes very distorted as the volume is turned up, decrease the settings. Aim for maximum undistorted sound when the volume control is turned fully clockwise. Presets VR1/VR11 should also be individually adjusted for an equal volume between left and right channels. □

## EPE Availability

Many newsagents do not have the room for a vast range of magazines so to make sure they get you a copy of *EPE* please fill in the form below and hand it to your newsagent. *EPE* is distributed on a sale or return basis.

**It's a switched-on issue next month! - ORDER YOUR COPY NOW!**  
**★ Simple Radio Receiver ★ Safety Interface ★**  
**Plus - Back to Logic Basics Part One**



### NEWSAGENTS ORDER FORM

Please reserve/deliver a copy of *Everyday Practical Electronics* for me each month

Signed .....

Name and Address .....

Post Code .....

*Everyday Practical Electronics* is published on the second Thursday of each month and distributed S.O.R. by COMAG. Make sure of your copy of *EPE* each month - cut out or photostat this form, fill it in and hand it to your newsagent.

# PIC Electric MK2

John Becker - Part 2

Monitor the cost of running your mains electrical appliances

**L**AST MONTH we described the circuit diagram and construction of this mains power monitoring design. We conclude now by describing its testing and setting-up and then discuss its optional use with a PC.

## Control Board Tests

Connect the Control board to the Sensor board. Check that the +5V supply line is still correct. If so, the d.i.l. i.c.s, including the pre-programmed PIC, can be inserted and the l.c.d. connected. Again check that the +5V line is correct. Adjust preset VR1 until the l.c.d. screen display is clearly visible.

At the moment of power connection to the unit, the PIC software enters an initialisation routine setting various "housekeeping" factors, including the setting of the l.c.d. into 4-bit 2-line mode. On completion, the screen briefly displays an opening message and states the number of serial memory chips installed, either none or one with PIC-Electric, e.g.:

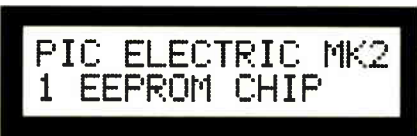

The program then goes into its main monitoring routine with the screen displaying voltage, plus current and wattage for the two channels (even if only one sensor is installed). The following is an example display when Channel 1 has a load connected to its sensor:



At this time, the voltage value will be present but the current and watts values should be zero. It is worth noting that in the UK the mains a.c. supply voltage is permitted to vary within a 6% range of the nominal value of 230V a.c.

The reading on your screen, though, will likely be different from the true a.c. voltage present. So too will the amps

and watts value(s) differ from those that actually exist when an appliance is connected to a sensor. PIC-Electric needs "tuning" via the switches before the correct values are displayed, as described in a moment.

Press and release Step switch S3, to display the second l.c.d. screen, as described above. An example is:



in which the running cost for Channel 1 at this moment is 507 (pence, or whatever your local currency is – it does not matter to the software what your currency is called, as long as it is a decimal currency). Channel 2 has so far not clocked up any reportable cost. The elapsed time since PIC Electric had power applied is 17 minutes and 36 seconds. The last memory address at which sample data has been stored is 432 (out of 32768).

Pressing S3 again re-displays screen 1.

## Fine Tuning

Each time PIC-Electric is powered-up, part of the initialisation routine fetches certain correction and value factors from its internal EEPROM. Until changed, the values are those used by the author with the prototype.

There are two paths through which the values can be changed. In path one, mains frequency synchronisation can be adjusted, plus the voltage and amperage correction factors. In path two the cost per unit of electricity used can be set, and selection of whether PIC-Electric is to be used on a 50Hz or 60Hz mains supply (this affects internal timing factors). It is not necessary to specify the local mains a.c. supply voltage (230V/110V) standard.

The essential factor to change first is the local mains frequency, 50Hz or 60Hz. This can only be done, though, following the setting of the local electricity unit cost (although you may use the author's default setting for the time-being if you prefer).



To enter this correction path, press Reset switch S4 and hold it pressed. Now press switch S1 (Up) and hold it pressed, then release S4 and then briefly after release S1. The following default message is displayed (showing the local cost of the author's electricity units as 8.37 pence per kilowatt hour):



With this screen showing, the integer cost per unit (8 in this case) can be changed. Pressing S1 increases the value (maximum range 999). Pressing S2 (Down) decreases it (minimum value 0). Having set the desired value (see your latest electricity bill), press Step switch S3, to display the message PRICE DECIMALS on line 2.

Now the decimal values can be changed (from 37 in this instance) using S1 and S2. The range is 00 to 99, cyclically rolling-over at the extremes.

Having set this value, press S3 again to enter the mains frequency selection mode, in which line 1 shows the existing frequency selection, with line 2 blank:



Only S2 changes the setting, slowly alternating between 50Hz and 60Hz for as long as S2 is pressed. Release S2 when the desired frequency is shown. Switch S2 may be re-pressed if necessary.

This frequency value selection is used by the PIC software in its clock counting routine, determining the number of mains cycles that should be counted before updating the seconds counter. It is also used to set the delays between synchronously reading the upper and lower peaks of the sensors' output voltage levels.

Pressing S3 again causes the cost and frequency values to be stored in the PIC's EEPROM, where they remain until

changed another time, even when power is disconnected. The message STORED is shown until the switch is released, following which the PIC ELECTRIC MK2 title is shown.

## Taking Samples

The 50Hz (or 60Hz) signal at PIC pin RA4 is monitored for change by the software. RA4 is a Schmitt Trigger input triggered when an input signal crosses intermediate upper or lower thresholds. Each time the signal crosses the upper threshold, the software starts a timer. At the time-out, there is a timed delay after which the voltage at ADC pin RA1 is read, synchronously with one waveform peak relating to the current monitored via Channel 1.

A second synchronous delay then occurs on the opposite peak of this waveform and the voltage value is read. A similar pair of delays follow for reading Channel 2's current via ADC pin RA3. Then the voltage at ADC input pin RA0 is read, from whose value the a.c. mains voltage is assessed.

It will be seen from the graph in Fig.7 why the delays are required. The initial trigger threshold at RA4 occurs before the peak of the 50Hz/60Hz mains cycle. The first delay sets the timing between that trigger threshold and the waveform's upper peak, at which the first PIC sample is taken. The second delay is set to synchronise the next PIC sample reading with the lower peak of the waveform. Between them, these two readings give the peak-to-peak value of the waveform, from which the current drawn via sensor X1 is assessed.

The following two delays are timed for the next waveform cycle to be monitored at its peaks, for assessing Channel 2's current.

## Adjusting Synchronisation

Synchronisation of the sample taking in relation to the trigger point is determined by a value held in the PIC's EEPROM. Until changed, that value is the one used by the author, but individual versions of PIC-Electric Mk2 may benefit from adjustment to it due to normal differences in the tolerance of the associated components. Adjustment is simple.

To enter this correction path, press Reset switch S4 and hold it pressed. Press Down switch S2 and hold it pressed, then release S4 and briefly after release S2. On screen line 2 will be shown the message CHANGE SYNC. The PIC now monitors the amperage value for Channel 1. In this mode, the sampling rate is increased to about five times faster than normal to speed up the software's response to the switch presses about to be made.

With no appliance load plugged into Channel 1, Line 1 should show a value of 000A, but maybe flickering to 001A as well.

Plug in an appliance drawing a known amount of power, say a 60W table lamp. The value displayed on Line 1 will change to reflect the current being drawn by it, approximately 0.24A with the prototype and a nominally 60W lamp. The displayed value may be slightly unstable due to noise on the mains supply line.

Switches S1 (Up) and S2 (Down) are now used to change the synchronisation timing value upwards or downwards. All

that is necessary is to observe the screen value by pressing one or other switch and holding it pressed. It does not matter which switch is used at this moment, but S1 is suggested.

With switch S1 pressed, the screen value should change upwards or downwards, but be aware that the apparent response rate is quite slow, so be patient. If the value falls below the starting number, release S1 and press S2 to reverse the direction of change.

The idea is to use the switches until the displayed value is at the highest number that can be achieved. Let the value rise to just beyond its peak and start falling again. Now use the other switch until the peak value is again achieved, then finally release that switch. The value shown is the optimum when the synchronisation point is central to the upper peak of the waveform, as shown in Fig.7.

## More Scope

A facility to use a dual-channel oscilloscope to monitor the waveform and synchronisation point has been provided, although its use will not significantly affect the accuracy of the adjustment as provided by the above technique.

Clip one scope channel probe to test point TP3 and adjust the scope's display amplitude and sampling rate so that three or four complete a.c. waveforms are displayed on its screen. Clip the other scope channel's probe to test point TP10, and set the scope's sync setting to that channel, for positive edge triggering. Adjust the amplitude setting for scope channel 2 so that the two waveforms are superimposed.

It may be seen that the a.c. waveform is not truly sinusoidal, due to the presence of the bridge rectifier, but may be more like a flat-peaked triangle wave. Scope channel 2's waveform will consist of two cycles of a squarewave, followed by a single cycle gap, followed by two more cycles of a squarewave, etc.

The rising edge of the pulses occurs on the rising edge of the a.c. waveform, or near to its upper flat peak. The falling edges of the pulses will be in a similar position in relation to the falling edge of the a.c. waveform.

Using switches S1 and S2, the pulse edges will be seen to slowly shift their position relative to the a.c. waveform. The optimum position is when they are central to the a.c. waveform peaks.

## Adjusting Volts Reading

When satisfied with the synchronisation setting, press switch S3. The screen now changes to show a nominal voltage value on the upper line and the message CHANGE VOLTS on the lower.

The displayed value now needs to be adjusted until it corresponds with the actual mains a.c. voltage value present at the input to the unit. Set your multimeter to a range suited to monitoring

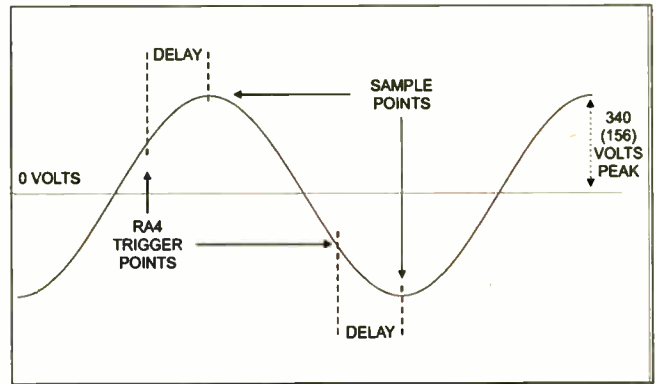

Fig.7. Waveform sampling logic

a.c. mains voltages. Observing normal mains safety practice, clip its leads to the mains input test points TP8 and TP9. Note the reading.

Now use switches S1 and S2 to adjust the unit's screen value until it shows the same voltage. The rate of change is faster than for the synchronisation change. Release the switch being used when the values match.

## Adjusting AMPS Reading

When the volts reading has been set, press switch S3 (Step) to enter the amps setting screen. Its lower line will show CHANGE AMPS, with the upper line showing three values, in order of amps, volts and watts.

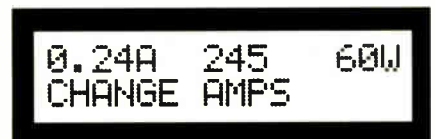

The amps and volts values will be those set in the previous two modes. The watts value is the result of those values being multiplied. Using switches S1 and S2 again will be seen to adjust the amps and watts values, but not the volts value (although it is possible that this may change independently if the a.c. mains supply voltage changes).

There are two techniques for tuning the unit to the correct amperage value.

If you have the facilities for monitoring a.c. mains current, note the real-time value of the current actually been used by the appliance connected to the unit. Then adjust the unit's amps display to match.

Otherwise, assume that the stated wattage of the appliance is correct, i.e. that a 60W lamp is actually drawing 60 watts (unlikely, but probably close enough). Then adjust the display until that wattage value is shown.

Again, once satisfied, press switch S3. The settings established in these three modes are now recorded to the PIC's EEPROM, for immediate use and future recall. The message SYNC STORED is displayed briefly once S3 is released, and the unit then enters the normal monitoring mode.

The correction values may be changed again at any time if you wish, by the same techniques.

From here on, further presses of S3 then alternate the display between its two screens as described earlier.

Switches S1 and S2 have no effect during normal monitoring.

Pressing Reset switch S4 in monitoring mode has three effects: it resets the clock and cumulative cost counters to zero, and causes a Start flag to be set into the serial memory at its present count address (as discussed previously).

## Clearing Serial Memory

As said, sample data is recorded continuously to the serial memory while the unit is powered, the address counter eventually rolling over to zero and restarting upwards, overwriting previous data.

The serial memory may be cleared whenever you want. Again, two switches are used, to prevent inadvertent clearing before you are ready! To start the clearance process, first press Reset switch S4, hold it pressed, now press S3, hold it pressed, then release S4, and then release S3.

This action cause the screen display to change to CLEARING EEPROM on Line



1, with the clearance progress shown on Line 2, as in the following example:

The count value changes in steps of 256 during the clearance progress, until the full 32768 bytes have been cleared to zero. The chip number does not change in this design as only one memory chip is used.

Clearance is quite slow as various timing factors are involved in the process. It takes about two and a half minutes to fully clear the chip.

Once clearance has been completed, the address count is set to zero and normal monitoring mode is again entered.

## PC Software

Recorded data can only be downloaded and viewed via a PC screen using the specially written software referred to earlier.

To run the program, open the PIC-Electric Mk2 folder and double-click on PICelect.exe. The first time that the program is run it creates several additional files to which it refers each time the program is subsequently loaded. These include various settings which may be changed by the user from within the program, plus details of file data paths accessed via the Directory function.

Following this brief procedure, a nearly full-screen display on which graph data will later be drawn is shown. It also has various control buttons.

First note the two "radio" buttons towards the top right, labelled COM1 and COM2. Connect a standard serial port cable (the same type as you use with a modem) into the COM port socket that you wish to use, and into the PIC Electric Mk2 connector at the other end. Set the screen COM port choice accordingly.

## Download Data

The next button of immediate interest is the Download Data button. It is via this option that monitored data recorded by the PIC is downloaded.

Note that the data in the PIC's serial memory is unaffected by the download and remains

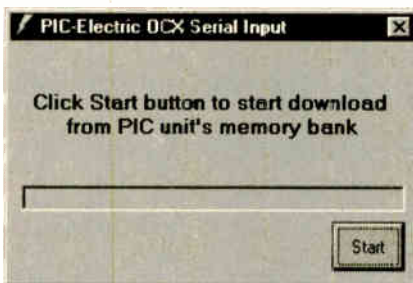
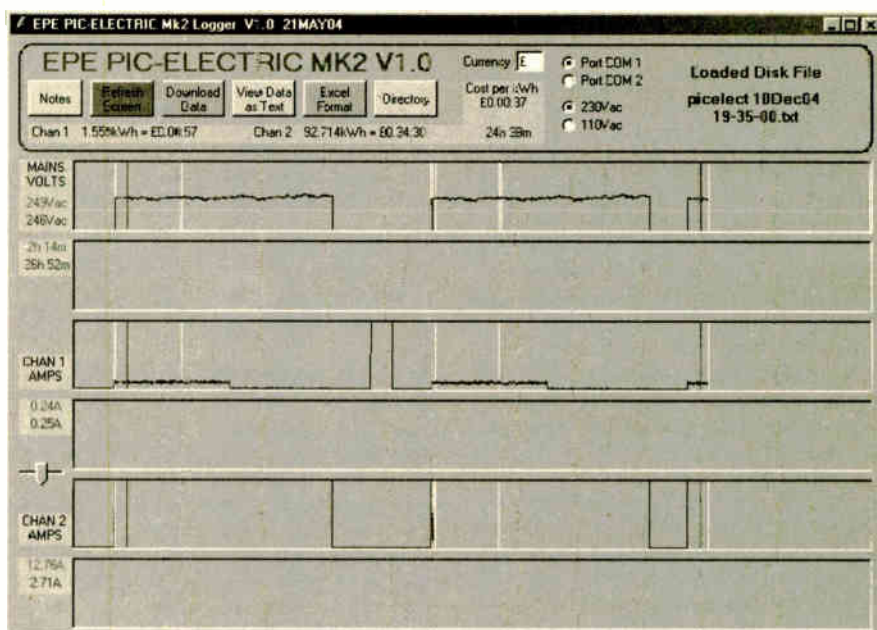

intact. Further recordings may be made to the memory following a download, and the whole batch input as a block at a later time.

Assuming that you have first reset the serial memory, and have already been recording data for a while, click on the Download button to reveal the Download screen.

To start the download, click on the sub-screen's Start button. The PC sends a handshake command (the letter "G", for Go), the PIC acknowledges by sending back the letter "R" for Received, and starts to output the stored serial memory data to the PC, in blocks of 1024 bytes. Data is transferred at 9600 Baud, 8 bits, no parity.

On receipt of each data block the PC and PIC again exchange "G" and "R" and another block is sent. This continues until the PIC has output all 32K bytes of its memory. A bargraph on the PC screen shows the download progress, and the PIC unit's screen displays the message OXC DATA TO PC. At the end of the data transfer, the PIC resumes sampling, recording and output to the l.c.d. as usual.

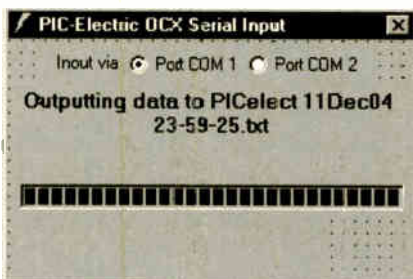

Once the PC recognises that a time-out has passed during which it has received no data, it exits Receipt mode and outputs the received

data to two text (TXT) files in the same folder as the other PIC-Electric files are held.

These are named with prefixes of "PIClectOrigData" and "PIClect", followed by a unique date and time identity, as applies at the time of the download.

The first file contains the original data as received from the PIC, but now in ASCII text format compiled from the binary format in which the PIC sends it.

The second file comprises "processed" data in which each pair of twin-byte values of the recorded data are combined into one decimal value with a fixed length of five characters, followed by a comma. It is this file that the PC uses when it displays the waveforms generated from the data.

This file can be viewed as text data by clicking the Main screen's View Data as Text button. The data is input to either Windows Notepad or Wordpad, depending on its length.

Text file viewing is only available once the complete cycle has been completed. Once the text files have been stored to disk, the program automatically hides the Download screen and plots the processed data onto it as waveforms relating to the data values. The speed of this depends on the speed at which your PC operates.

The graphing area consists of six "picture" windows. The top pair are for the volts display, the next pair for Channel 1 amps data, and the bottom pair for Channel 2 amps data.

Data plotting commences at the left of each of the top pairs, continues to the far right and follows on into the second of the pairs, and again through to the far right. The entire set of data is displayed.

There are several informative labels above and to the left of the display area. Three labels state the function of each display window pair. Each pair has two additional labels which are updated when the mouse is clicked on any selected point in the windows.

## Selective Analysis

Clicking the mouse left button in a window causes a vertical red line to be drawn at that point, and in the other two equivalent windows for the other display pairs. Clicking the mouse right button causes a



blue line to be similarly drawn. Re-clicking either mouse button shifts the appropriate line to the new position.

The labels at the left of the window pairs show the recorded values for the positions indicated by the vertical coloured lines, each label text having the same colour as the line. The values are suffixed by "V" or "A" as appropriate to the window pair.

On a label below the volts values, the elapsed recording time at the vertical lines is displayed, in the same colours as the lines, in hours and minutes. The left of the upper window of each pair is taken as zero time. The far right of the lower window is the maximum elapsed time since zero hours. It is at this point that the most recent sample value is plotted.

Immediately below the control buttons at the top left of the screen two other labels display the elapsed time between the coloured vertical markers, and the cost of the electricity used during that time.

The timings do not take into account any periods during which the unit is unpowered. Vertical white lines on the screen indicate where these breaks occurred.

## Costings

The cost per unit of power (1kWh) is that set into the PIC as described earlier and downloaded at the same time as the sample data. It cannot be changed on the PC screen. This value is also stored in the text file of the downloaded data. (In reality, you could actually change that value in the file if you wished, and for the new value to be used when that file is re-imported for display.)

The costs are displayed as (for instance) pounds, pence and hundredths of a pence, e.g. £9:27:03 – nine pounds, 27.03 pence.

Above the cost per unit label is a "cosmetic option" facility. It shows the "£" symbol as appropriate to UK readers (and some other countries). The symbol may be changed to suit other currencies, e.g. to a dollar symbol, "\$". The selection available, though, depends on the capabilities of your keyboard and the PC's character generator.

Click on the box, change the symbol, then click on the word SAVE that is now shown beside it. On doing so, the symbol is saved to disk on your PC, for recall next time the program is run.

Following the symbol change, all cost displays will now be prefixed with that symbol.

## Scaling

PIC-Electric Mk2 has been designed for use on both 110V a.c. and 230V a.c. mains voltages. Whilst no change is required to the PIC unit in this respect, the PC screen display can be tailored to give better resolution of the recorded voltage variations that occur naturally with any mains supply. Two radio buttons (below the COM buttons) select the options, and the chosen one is stored to disk for future recall.

The first difference between the options is that the horizontal yellow lines in the voltage windows are positioned differently. They indicate the vertical windows position at which the nominal standard of 230V a.c. or 110V a.c. occurs.

Secondly (and most importantly),

with the 230V a.c. selection, only voltages between 200V a.c. and 300V a.c. are plotted. Any values above or below those extremes are not displayed. With the 110V a.c. setting, the display limit is 0V a.c. to 150V a.c.

Between the amps labels is a slider button. This has three positions and sets an amp amplification factor which is applied to the scaling of the amps displays, allowing better viewing of low current values. The settings are  $\times 1$ ,  $\times 10$  and  $\times 100$ .

## Directory Use

The Directory button allows previously recorded data files to be selected for display. The Directory screen is similar to those used with the author's other VB6 programs. Full details of its use can be read via the Notes button seen near the top when that sub-screen is displayed.

In brief, folder paths are selected via the left-hand path menu, and files within a selected path selected by double-clicking on a named file in the right-hand list. This causes the Directory sub-screen to close and the file data to be loaded. If a file name is only clicked once, it is not actually selected, but is just highlighted and a return to the Main screen can be made by using the Exit button.

All path files are pre-selected for a prefix of "PICelect". You may also add your own filter to this prefix via the text box provided, allowing file names that only conform to the prefix and filter characters to be listed, allowing selection by date, for example. The filter function can be turned on and off via its click box.

A history of the folder paths accessed is recorded to disk when new ones are selected. This is recalled each time the program is loaded and a particular path can be selected via the dropdown History option.

The name of the loaded disk file is shown at the top right of the main screen.

## Refresh Button

The PC screen waveform display is "volatile" in that if the screen is minimised, using the normal Windows button for this, when it is restored the waveforms will no longer be shown. Click the Refresh Screen button to cause them to be redrawn.

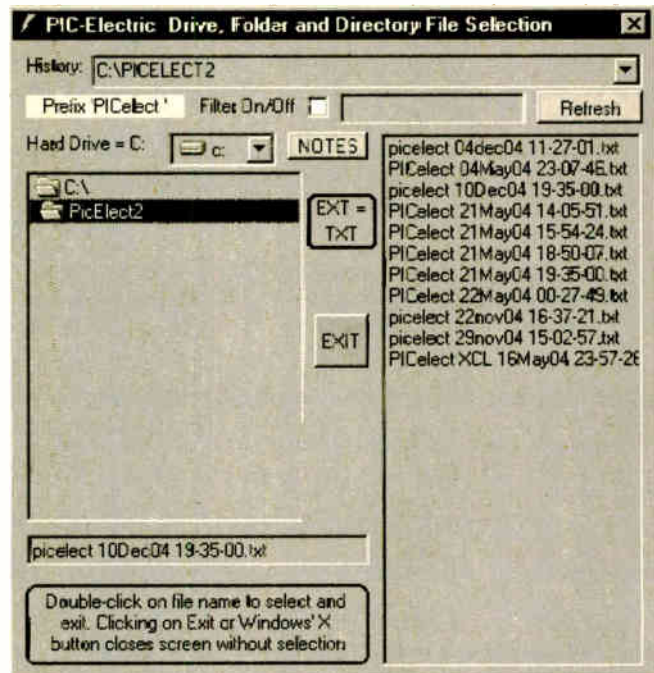

Example of the Directory screen through which files prefixed "PICelect" can be selected for input.

## Main Screen Notes

Clicking the Notes button on the main screen displays a sub-screen with a few useful comments about the main screen – such things as hovering the mouse over the buttons and labels, causing a "Tooltip Text Box" to appear and briefly describe the function of the button or label. Click OK to close the sub-screen.

## Graphical Analysis

The Excel Format button converts loaded data files to a format suited for use with Windows Excel graphing software. This format is in four columns, oldest sample at the top, newest at the bottom. The columns are in order of Start Flag (as discussed earlier), volts, amps Channel 1, amps Channel 2.

Excel, or variants of it, is available as standard on many PCs and is believed to be part of the Windows Office suite. As well as offering graphing facilities, Excel provides for mathematical expressions to be computed. These options allow the data to be examined in more substantial detail than the PIC-Electric program can offer.

Brief information about using Excel was given in the author's *Earth Resistivity* article (May '03) Part 2, page 363. Excel's own Help file, though, taught the author all he knows about it. Read it and experiment to find what Excel can do!

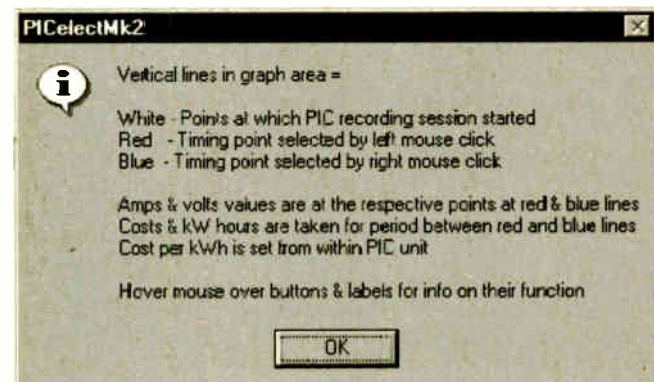

## RESIDENT EVIL

**Forget about the Ghost in the Machine – what if the spook is malware? What might happen when viruses contaminate the telephone network? Mark Nelson has heard some alarming reports.**

**E**VEN people with minimal interest in the inner workings of the telephone system have a vague awareness that the network is controlled by computers. There's a natural follow-on from this: anything that affects computers could therefore affect the telephone system. And if telephones could be crippled by viruses, that's pretty bad news.

Bad news, because up to now telephones have been remarkably resilient to the kind of outages that beset computers. Telephone handsets themselves are generally line-powered, so they are unaffected by mains electricity failures, whilst the power supply at exchanges is derived from storage batteries with diesel generator back-up.

The processors that control the electronic switching fabric of digital exchanges are protected from outside influences, meaning that hackers and crackers simply cannot nuzzle them. Up to now there have been no reports of public exchanges being reprogrammed maliciously, mainly because the processors used are highly proprietary and outsiders have no access to the code used.

### Well Documented

This is an accurate description of the public switched telephone network but is less appropriate to the internal systems used in business, manufacturing and public utilities. Many telephones, particularly those connected as Voice over Internet Protocol (VoIP) devices to data networks (LANs), rely for power on mains adapters and some of the smaller private switches (PABXs) are totally dependent on the mains (which as we know, can and does fail).

The software used on commercial PABXs is well documented (you can buy programming manuals on the Internet) and most switches have a programming port for the specific purpose of remote updates by modem to their code. The telephone numbers of these "back door" ports are generally easy to guess, the passwords are frequently unaltered from the default and there have been many instances of unauthorised alterations going undetected until a massive phone bill is received.

According to Cardiff-based telecomms consultant Richard Cox, the phone pirates' method is alarmingly simple. "It only works because people don't take the most basic security precautions", he says. "Infiltrators break in via these 'maintenance ports' and set up their own re-routing facilities on direct inward dialling lines. The hackers can do this because owners often do not change the password code from the default settings of 000 or 111; once logged on, they can make the changes

they want and even change the passwords to lock out the legitimate system manager.

"The maintenance ports are normal ex-directory phone lines and discovering these is not as difficult as it might seem. The likely exchange prefixes can be determined by logical survey, then the actual number obtained with the aid of a scanning program and a phone-connected PC."

### New Threat

This kind of interference is the direct action of humans and has been going on for more than ten years. The new threat concerns the possibility of telephones being crippled by viruses, or rather the telephone system as a whole rather than individual handsets. In point of fact we have already had telephones affected by viruses; "crippled" is too strong a word but there are several recorded incidents of mobile handsets infected by malware, mostly of the harmless proof-of-concept variety. But it's perfectly clear that any device that's processor-controlled can have its method of operation altered if someone manages to reprogram the processor.

Earlier I mentioned that public exchanges were relatively immune to unauthorised manipulation and this is likely to remain the case. The vulnerability applies particularly to business users who operate "converged" networks that combine voice and data over the same infrastructure.

A virus that can bring down a data network can also cripple voice calls because speech is encoded as the same kind of IP packet as data. And when firms deploy the VoIP systems, mentioned above, on their networks and also provide direct dialling facilities from the public network, they are particularly at risk.

### Compromised by Complacency

Whilst IT managers are well aware of external threats to data security, far fewer realise that on converged systems voice is also vulnerable. Reports in the trade press bear witness to this concern. Ian Shepherd of Telindus states that IP voice networks have already been compromised because of complacency.

"Where you have taken an existing IP infrastructure and added voice, then organisations are getting viruses and denial of service attacks. We know that this happens. If you get something nasty, it will be the voice that goes down first. We are not seeing directed attacks focussed on SIP or H.323 (the two main VoIP protocols in use) but this will come."

How will it come, though? Where does the threat enter the system? Joseph Seanor, Security Managing Consultant with systems provider Avaya, explains it

will be by viruses. The first point of vulnerability is the servers on which IP voice switches run. Many of these use the Windows operating system and are connected to the Internet in order to receive updates to Windows. The other place where viruses can enter the system is in the office: a user brings a virus-infected laptop computer to work, then hooks it up to the VoIP phone line in his office instead of using the network connection.

### More Insidious

• Losing your enterprise voice network, even temporarily, is bad news for any organisation but at least the failure will be self-evident. A second risk, where calls are intercepted by persons unknown, is more insidious simply because it might go undetected. As VoIP blogger Tom Keating says on his website (<http://blog.tmcnet.com/blog/tom-keating>), "Imagine for a moment working for a stock exchange company; you could install a network sniffer program that captures VoIP streams. Knowing the IP address of a particular IP phone, you can filter the traffic and tap into someone's VoIP conversation."

To counter this threat major equipment managers such as Cisco and Alcatel are now developing add-on modules for encrypting voice traffic. Alcatel's product, developed by defence contractor Thales, uses a hardware encryption system rather than software in order to avoid affecting quality of service (any delay to speech packets results in undesirable break-up, as on a bad mobile call).

Also unlikely to be detected, at least initially, are Denial of Service (DoS) attacks, and even if they are generic bandwidth starvation attacks, targeting your network as a whole rather than voice in particular, the system will still feel the pain. This in turn means that network managers must monitor calls effectively to know when the system is performing above or below user expectations, not necessarily a simple inexpensive exercise.

No doubt all these issues are no more than teething troubles but they do illustrate that new technologies certainly bring new problems. But now let's change the subject and close with a report that has to be a sign of the times. The last manufacturer of audiotape in America has closed down.

That's right: surprising its workers and everybody else for that matter, Quantegy (whose tape was formerly known as Ampex and before that, Irish) shut down its factory in Opelika, Alabama without notice. Pundits reckon it may signal the end of tape recording, as well it may.



**the atlas SCR**

- Automatically analyse Thyristors and Triacs.
- Automatically identify all three leads.
- Automatic test currents from 100µA to 100mA!

SCR100  
**£99**

atlas SCR  
model SCR100

LCR40  
£69.00

DCA55  
£49.00

SCR100  
£99.00

Passive components, semiconductors,  
power devices, network cabling  
**Choose your perfect analyser**

**New Low Prices!**

limited time only

**the atlas LCR**

- Automatically identify Inductors, Capacitors and Resistors.
- Inductors from 1µH to 10H.
- Capacitors from 1pF to 10,000µF.
- Resistors from 1Ω to 2MΩ
- 1% Basic accuracy.
- Automatic frequency selection.



LCR40  
**£69**

"Star Pack"  
LCR and DCA  
in carry case  
£118.00

Carry cases  
£15.00

SMD Tweezer  
Probes for LCR  
£19.00

Spare Battery  
£1.75

accessories & carry cases



Semiconductor Analysis

ESR Measurement



model ESR60  
available December 2004

£49



model DCA55

Cat5 Cable Testing



model UTP05

£79

[www.peakelec.co.uk](http://www.peakelec.co.uk)

all prices include UK Delivery and VAT

Don't just test it...  
**...Analyse it!**

# PIC N' MIX ANDREW JARVIS

Our periodic column for your PIC programming enlightenment

## High Level Languages – A First Visit to the C Side!

**M**ORE often than not recently, it seems that every project I attempt uses a different PIC, and program writing is taking longer than it used to. Largely, I think this is because the memory available to me is increasing, which does invite larger and more complex designs.

Reusing existing code helps but is not always straightforward, especially when porting it between PIC families with different instruction sets and some inevitable device dependencies that creep in. Essentially, what is needed is reduced development effort and portability, or put more simply – a high level programming language.

### Crafty Code

A language like C should allow us to produce a program code that is independent of any one PIC type (or indeed micro-controller type) and that is expressed in a more intuitive, English-like style. Ultimately though, it will be translated into many assembler instructions in a way that we cannot control.

This translation creates a fear of so called “code bloat” – inefficient compiler generated code that wastes precious memory. It’s easy to spot – as is sometimes the case when compiled code is reverse engineered and passed off as assembler. You see code positioned erratically or unused, flags tested unnecessarily and too much jumping around. Not the sort of things a human would do.

As assembler programmers, we are in total control of our chosen device. Each line of our carefully, if slowly, crafted code maps one-to-one with a PIC instruction so that we know exactly what it is doing at any time. (Well, OK, most of the time then!)

Once we start to use a high level language, we rely on the compiler vendors to do an efficient job with our code – guided by as many hints as we can give them along the way. In practice, true portability won’t be achieved anyway because of variations between compiler vendors and their different adoption of standards. Some things that we could do in assembler just won’t be possible, but most should be a lot easier.

### Catch 22

There’s usually a trade off between power and portability – consider the instruction based timing loops of *PIC n’ Mix* July ‘04. (If you missed it, we looked at ways of generating precise delays using detailed knowledge of instruction cycles). This sort of thing is not easy with C, we

### LISTING 1

```
delay1 equ 0x20
delay2 equ 0x21

org 0 ; reset vector
goto start

start
banksel TRISIO ; bank 1
clrf TRISIO ; set as outputs

call 0x3FF ; OSCCAL
movwf OSCCAL

banksel GPIO ; bank 0
clrf GPIO ; reset GPIO
movlw 0x07
movwf CMCON ; set digital IO

clrf delay1 ; init delay
clrf delay2 ; loop counters

movlw 0x01

loop
xorwf GPIO, F ; toggle

wait
decfsz delay1, F ; inner loop
goto wait
decfsz delay2, F ; outer loop
goto wait
goto loop ; start over
```

have no idea of knowing which particular instructions a compiler will generate when code is compiled.

But then if we are after portability – why would we want to produce code that has a dependency on the underlying instruction set? Much better we write our code firmly in the problem domain and let the compiler worry about how it translates into the specific requirements of a PIC.

Nonetheless, most C compilers will actually provide extensions that let us mix C code with assembler, so you can in fact still write instruction based, PIC dependant code. And one reason you might do so is to write an accurate delay routine.

There isn’t space here to offer anything like a full “C for PICs” type tutorial. If you have experience of assembler but not C, then it shouldn’t be too difficult to tag along, reading it is much easier than writing it! If your interest is sparked there are many good references you can follow up. Start with the definitive *The C Programming Language* by Kernighan and Ritchie, and [www.microchip.com](http://www.microchip.com) is an excellent PIC resource where you can find lots of sample code and links to other sites of interest.

### Hi-Tech PICC Lite

Hi-Tech PICC Lite is a great introduction to the C programming language for PICs. “Lite” inevitably means “limited” in some way, but as you will see, nothing that prevents us creating hobby projects for the more popular PICs. The compiler can be downloaded from the Hi-Tech website: [www.htsoft.com/downloads/demos.php](http://www.htsoft.com/downloads/demos.php). The manual is a separate download: [www.htsoft.com/downloads/manuals.php](http://www.htsoft.com/downloads/manuals.php).

The MicrochipC website given above also offers an interesting “Frequently Asked Questions for Hi-Tech C”, which could save a lot of time. The 362-page PICC manual contains a great description of the general compilation process, in addition to documenting the language, extensions and error messages. It is an excellent resource for students and hobbyists.

The best news is that it’s all free (Professional C compilers for PICs are normally in the “hundreds of pounds” bracket). Second best is that it will only compile for about 10 PICs, but they include 16F84(A), 16F627(A), 16F877(A) and 12F629/675. Sound familiar? The latter three have recently been added to *Toolkit TK3*, which makes PICC Lite a good choice for *EPE* readers.

Other compilers, like the ones from Microchip (C17 and C18), will only target the 17 or 18 series devices respectively (which it is generally acknowledged are much more suited to C programming for a number of reasons, including their greater memory and stack sizes).

### Good News Wizard

If you are familiar with the Microchip MPLAB IDE, there’s more good news – PICC Lite integrates seamlessly. Creating a new C project is as simple as starting the Project Wizard, selecting a PIC, then choosing the Hi-Tech PICC toolsuite. You can build, simulate and debug C code in just the same way as you did for the Microchip MPASM toolsuite.

It is strongly recommended to use this free IDE with PICC Lite (and MPASM too!), though its size can be a deterrent if you don’t have access to a fast internet connection. The full install for version 7.00 weighs in at 25MB. If this is too much, there is a command line alternative for PICC, which is documented in the manual, and also an unsupported “DOS style” text based IDE called HTLPIC, which has a useful C library reference off the help menu.

*TK3* users will have to break out of the MPLAB to program the PIC. The hex file

## LISTING 2

```
unsigned char delay1;
unsigned char delay2;

void main(void)
{
    TRISIO = 0;
    OSCCAL = _READ_OSCCAL_DATA();
    GPIO = 0;
    CMCON = 7;

    for (;;)
    {
        GPIO ^= 0x01;
        while (--delay1 > 0)
        {
            while (--delay2 > 0);
        }
    }
}
```

generated by the linker can be found in the project folder you chose from the project wizard, or as otherwise set in the PICC Linker tab of the build options for your project. Select this file from *TK3* then Send Hex from the main screen as usual. Don't forget to make sure the correct PIC type is set.

Since there's no room for a C tutorial, we'll turn the whole thing on its head for a bit of fun and see what the compiler produces. Listing 1 shows the first example of the flashing I.e.d. code from *PIC n' Mix* July '04, mentioned earlier – and chosen here because I wanted to compare the output from the compiler against the smallest complete assembler program that I could remember writing previously. It's slightly updated to target the 12F629, which wasn't supported by *TK3* at the time.

Compare it to Listing 2, which is a C equivalent. Variables *delay1* and *delay2* are declared as externals so that they will be initialised to zero by default (automatics are not). Special function registers can be accessed with no regard to correct bank settings, and the iterations are controlled by an infinite for loop. The real interesting part though, is *OSCCAL*.

There was first the question of how to express `call 0x3FF` in C without resorting to mixing in some assembler – which

would be easy enough to do in this case with the *ASM* directive. Then looking through the 12F include file the following macro definition was found which sent me running for Kernighan and Ritchie muttering about how we were trying to make life easier!

```
define _READ_OSCCAL_DATA()
(* (unsigned char(*)())0x3FF)()
```

We know that 0x3FF is the address of a (very small) function that returns the *OSCCAL* calibration value with a simple *retlw* instruction. The "unsigned char" is the most efficient data type on the mid-range PIC because it maps directly onto 8-bit bytes, in this case the literal value returned in the W register. The macro is therefore casting the address into the desired type, i.e. a pointer to a function that has no arguments and returns an unsigned char, before then calling it.

Listing 3 is the assembler that the PICC compiler creates from the C code in Listing 2 (with maximum optimisation set). It was generated by the Hex to MPASM facility of *TK3*, but it would be just as easy to use the *-S* compile flag of the PICC compiler, or to import the HEX file into MPLAB.

The label *Jump1005* is the equivalent of our original *start* label in Listing 1. It is interesting to note that the optimiser has not stopped the unnecessary bank select bit (*STATUS<5>*) switching between *TRISIO* and *OSCCAL*, probably because of the subroutine call to 0x3FF, which of course could leave *STATUS* in an unknown state – when writing the assembler of Listing 1 we had the benefit of knowing that it would not.

It's also worth a reminder that this is the Lite version of the compiler. Although Level 9 was set for the global optimiser, the manual does state that for PICC Lite, there is little advantage in using levels above three. There's a couple of differences with the timing loops too, but they remain essentially the same. The first half of Listing 3 looks to be startup code, including the section from label *Jump10* which initialises the two-loop counter variables to zero, as we expected, using indirect addressing.

## LISTING 3

```
List P = PIC12F629, R=DEC;
include P12F629.inc
```

```
REG20      EQU H'20'
REG21      EQU H'21'

ORG 0

JUMP0      clrf STATUS
JUMP1      movlw 0
JUMP2      movwf PCLATH
JUMP3      goto JUMP4
JUMP4      movlw 32
JUMP5      movwf FSR
           movlw 34
           call JUMP13
           clrf STATUS
           goto JUMP1005
JUMP10     xorwf FSR,W
           clrf INDF
           incf FSR,F
           xorwf FSR,W
           btfss STATUS,Z
           goto JUMP10
           retlw 0

ORG 1005

JUMP1005   bsf STATUS,5
           clrf TRISIO
           bcf STATUS,5
           call 0x3FF
           bsf STATUS,5
           movwf OSCCAL
           bcf STATUS,5
           clrf GPIO
           movlw 7
           movwf CMCON

JUMP1015   movlw 1
           xorwf GPIO,F
           goto JUMP1020

JUMP1018   decfsz REG21,F
           goto JUMP1018

JUMP1020   decfsz REG20,F
           goto JUMP1018
           goto JUMP1015
```

Next time – some more PICC and a look at the library functions. We'll *printf()* to an LCD, *getch()* from a keyboard and mix in John Becker's PS/2 interfacing code of *EPE* August 2004.

# Radio Bygones

The leading UK magazine for vintage radio enthusiasts

ARTICLES on restoration and repair, history, circuit techniques, personalities, reminiscences and just plain nostalgia – you'll find them all. Plus features on museums and private collections and a full-colour photo-feature in every issue.

ITS MOSTLY about valves, of course, but 'solid-state' – whether of the coherer and spark-gap variety or early transistors – also has a place.

FROM THE DAYS of Maxwell, Hertz, Lodge and Marconi to what was the state-of-the-art just a few short years ago...

THERE IS ALSO a selection of free readers' For Sale and Wanted advertisements in every issue.

## Radio Bygones covers it all!

THE MAGAZINE is published six times a year, and is only available by postal subscription. It is not available at newsagents.

TO TAKE OUT a subscription, or to order a sample copy, please contact:

RADIO BYGONES, Wimborne Publishing Ltd.,

408 Wimborne Road East, Ferndown, Dorset BH22 9ND.

Tel: 01202 873872. Fax 01202 874562.

Web sites: [www.radiobygones.co.uk](http://www.radiobygones.co.uk) or [www.radiobygones.com](http://www.radiobygones.com)

Now Also Available to  
**BUY ONLINE**  
[www.radiobygones.com](http://www.radiobygones.com)  
Log on, pay by credit card  
and download the magazine to  
your PC  
**ONLY \$9.99 (US dollars)**  
**FOR 6 ISSUES**  
A free issue is  
available

# Bingo Box

David Coward



PIC power helps pick those numbers without a traditional bag!

**M**OST people will have played Bingo or similar Lottery style games since their early years. Methods abound for the selection of random numbers – usually between 1 and 89 – ranging from wooden balls in bags to the washing-machine-like Lotto creations as seen on television.

This project applies modern PIC-based electronics to the traditional game, resulting in a gadget that is completely fair, requires no set-up time and, most importantly in family circles, removes all arguments about who should be the “caller”!

## Basic Bingo

The basic Bingo Box is simply constructed on a single printed circuit board (p.c.b.) containing two 7-segment displays, a few pushbutton switches (most importantly the “Bingo” button) and a keypad. Once “Bingo” has been called (or “pressed” in fact) the keypad is used to validate the potential winner’s numbers.

The Bingo Box provides for manual and automatic number generation. In this latter mode, a number is generated automatically after a pre-programmable delay of up to 99 seconds. A “rewind and replay” function is also provided, as is the ability to change the range for which numbers are generated – useful for quick games!

The project also demonstrates and applies a number of techniques previously featured in *EPE* projects, including large 7-segment l.e.d. displays. Most fun of all (and very useful for school/club bingo evenings) the Bingo Box can control the enormous electrically operated 7-segment mechanical displays described in John Becker’s *PIC Big Digit Display* article, May '02 (for which at the time of writing, the parts are still readily available). These devices can be driven from an expansion p.c.b. enabling constructors to customise the Bingo Box to their own specific requirements.

## Bingo Circuit

The circuit diagram for the basic Bingo Box is shown in Fig.1. At its heart is a PIC16F877 microcontroller, IC1, clocked at 20MHz as set by crystal X1. The PIC drives display module X2, a 10mm com-

mon anode dual 7-segment l.e.d. display.

This multiplexed display’s segments are controlled by PIC PORTB, RB1 to RB7, via buffer resistors R1 to R7. PORTC pins RC0 and RC1 control the display’s multiplexed selection via transistor drivers TR1 and TR2, whose bases are buffered by resistors R8 and R9.

To illuminate a segment, the software turns on the appropriate transistor via PORTC and loads the segment pattern into PORTB. This technique has been used many times in previous *EPE* projects. Provided that the multiplex rate is fast

enough, no flickering is apparent.

Light emitting diodes D1 to D4, which provide various game indications, are connected to PORTA, RA1 to RA4, via current limiting resistors R15 to R18.

Piezo sounder WD1 is used to provide audio feedback on key presses and produces tones to indicate right and wrong numbers at the checking stage. It is controlled by pin RA0. As it is a high impedance device, an additional driver and limiting resistors are not needed.

It is intended that power for the circuit is supplied by a 12V battery, via switch S7. This

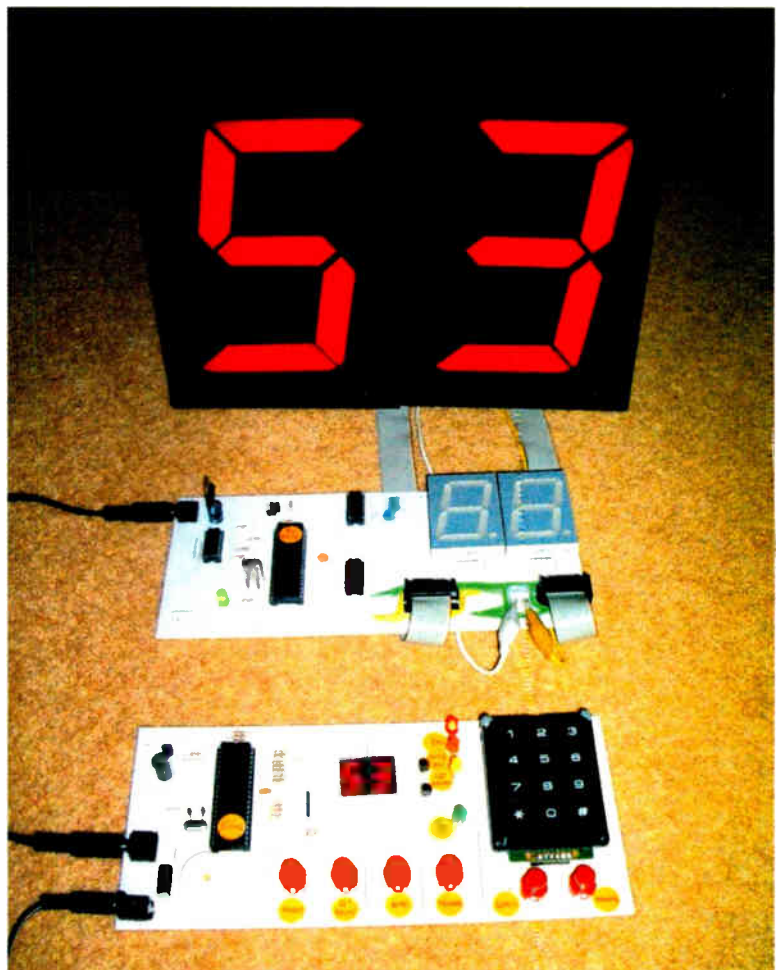

Two large “big-digit” mechanical 7-segment displays connected to the volt-display interface board, which is also linked to the main Bingo Box p.c.b. a g e



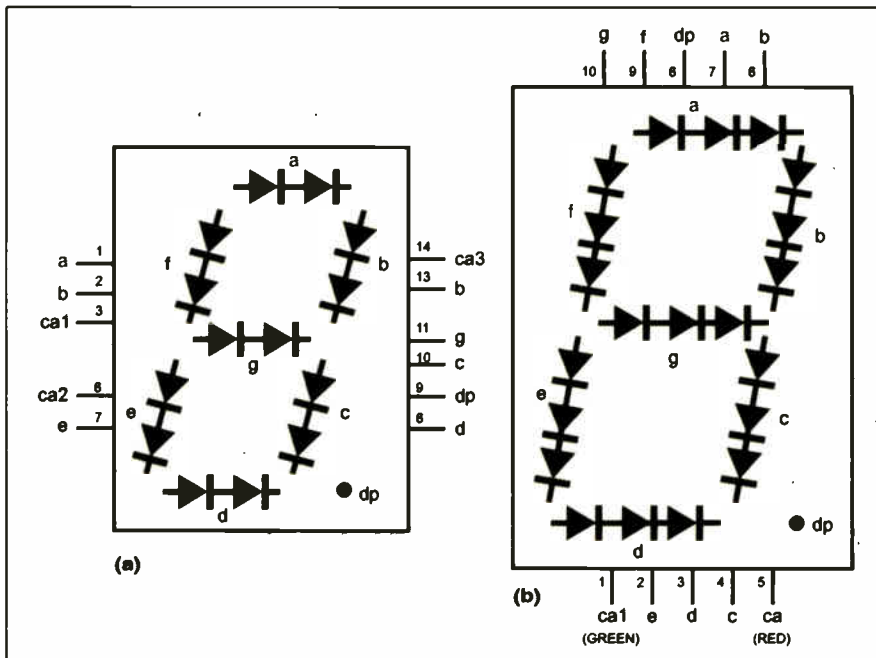

Fig.3. Showing the usual number of l.e.d.s that make up two popular sizes of 7-segment display: (a) 25mm (1in.), groups of two and (b) 55mm (2.2in.) groups of three

resistors and so can be directly connected to PIC ports without additional buffering. The driver outputs can be used to control common anode style displays of the type used in the Big Digit extension about to be described.

There are several ways to provide a current source for the multiplexed displays. Simple transistor drivers of the type used to drive the displays in the basic Bingo Box are one possibility. But as greater currents are needed for the larger displays, an L293DN motor driver is used as the current source – a configuration also seen in a number of previous EPE projects.

## Absolutely Massive Displays

The use of ULN2004A and L293DN devices is identical to the driver configuration used in the *Big Digit Display* (May '02) and so it is only a matter of software design to produce a device capable of driving both large l.e.d. displays (where the segments are driven in a continuous loop using multiplexing techniques) and the mechanical Big Digits (where the segments are pulsed on or off).

The circuit diagram of the Big Display driver is shown in Fig.5. PIC16F877 microcontroller IC1 is used to control the displays. It is clocked at 4MHz, as set by crystal X1.

The large 7-segment l.e.d. displays have their segments controlled by PORTB, whose outputs are buffered by the 7-way ULN2004A current sink IC2, the output currents of which are buffered by resistors R2 to R8.

The value of these resistors sets the brilliance of the display. A value of 470Ω was found to be adequate for most types of l.e.d., but can be reduced or increased depending on the brightness required. Check the l.e.d. datasheet for the maximum current that it can take.

PORTA selects which digit is activated during the multiplexed cycle. Via buffer resistors R12 to R15, pins RA0 to RA3 control the drivers within IC4, which in turn control the common anodes of the display. IC4 is enabled by biasing its control pins 1 and 9 high via resistor R9.

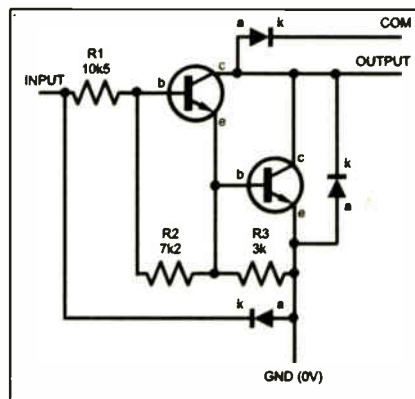

Fig.4. Single stage schematic diagram for the ULN2004A Darlington array

The mechanical Big Digits require push-pull control of their segments. They are turned on by IC2 and off by IC3. The latter is controlled by PORTD. Digit selection is again controlled by IC4, but by the other pair of its drivers. Connection to the digit segments is via connectors 1 and 2, and TB1.

The software has been written to drive either the large 7-segment l.e.d. display or the "mechanical" Big Digits, but not both at the same time. The logic level on pin RA4 determines which software routine is selected. For the Big Digit display, pin RA4 is held high via resistor R10. For the l.e.d. display, the pin is taken low by connecting jumper pins JP1.

The main p.c.b. is connected to the Big Digit driver via socket SK1. The connecting lead provides the power and the serial data from PIC pin RE0 in the main unit.

## Power Supply

A 12V d.c. power supply is required for this design if the Big Digits are to be used. If only l.e.d. displays are used, a lower supply is acceptable, down to, no less than, 7V. Voltage regulator IC5 provides a stabilised +5V supply for the PICs.

The raw power can be supplied from a

mains-powered battery eliminator, but should not fall below 12V under load if the mechanical Big Digits are used.

## Construction

Component and track layout details for the Bingo Box and the big Digit Display are shown in Fig.6 and Fig.7 respectively. These boards are available from the EPE PCB Service, codes 492 (Main) and 493 (Display).

Before beginning construction of the Big Digit board, decide which size of digit you would like to use. The p.c.b. makes provision for two sizes of 7-segment l.e.d. as well as the mechanical Big Digits via connectors 1 and 2, and TB1. Note that IC3 is only required if the board is to drive the mechanical displays.

The 55mm on-board displays used in the prototype contain both red and green l.e.d.s, the selection of which is determined by connecting the appropriate common anode. For green displays, links LK2 and LK4 should be inserted, whilst red displays require LK1 and LK3.

Assemble the boards in the preferred order of ascending component size, using sockets for all the dual-in-line i.c.s, and correctly observing the orientation of all polarity sensitive components. The use of pin-strip sockets for the 7-segment l.e.d.s is advisable.

Keypads normally come with pre-attached pins. It is advisable to use an appropriate socket for this too rather than solder the pins to the p.c.b. All switches and push-buttons (including the keypad) are shown as p.c.b. mounted types to ease construction. However, these can be mounted off-board if required and connected using suitable flying-leads. In particular, it might be a good idea to use a remotely mounted heavy-duty pushbutton for switch S2 on the Bingo Box ("Bingo!") ... but this is left to the constructor's discretion!

The segments of the mechanical displays can be connected to the p.c.b. using a wiring harness as described in the original article. However, for ease of disconnection, IDC cable can be used to make the connections, as shown in Fig.8. The common anode drives for the displays are via the 2-way screw terminal connector, TB1.

## Testing

The p.c.b.s can both be tested in the same way. After construction, check that all power voltages are correct at the i.c. sockets (with the i.c.s omitted at this stage). Ensure that the output of regulator IC5 is +5V (within a few millivolts).

After this, two wander leads can be used to test the displays. With reference to the appropriate circuit diagram, one end of the first wander lead is plugged in to pin 11 or 32 of the PIC (IC1) with the other end inserted into the port pin associated with the anode of a display. This will be RC0 (pin 15) or RC1 (pin 16) for the Master p.c.b. and RA0 (pin 2) or RA3 (pin 5) for the Big Digit board.

For the master board, a lead plugged into IC1's pin 12 or 31 (0V) can then be touched briefly to each PORTB pin that connects to a display. One l.e.d. segment should light up for each touch. The big digit l.e.d. display can be tested using the same principle, except that the second



# BINGO BOX – CIRCUIT BOARD CONSTRUCTION

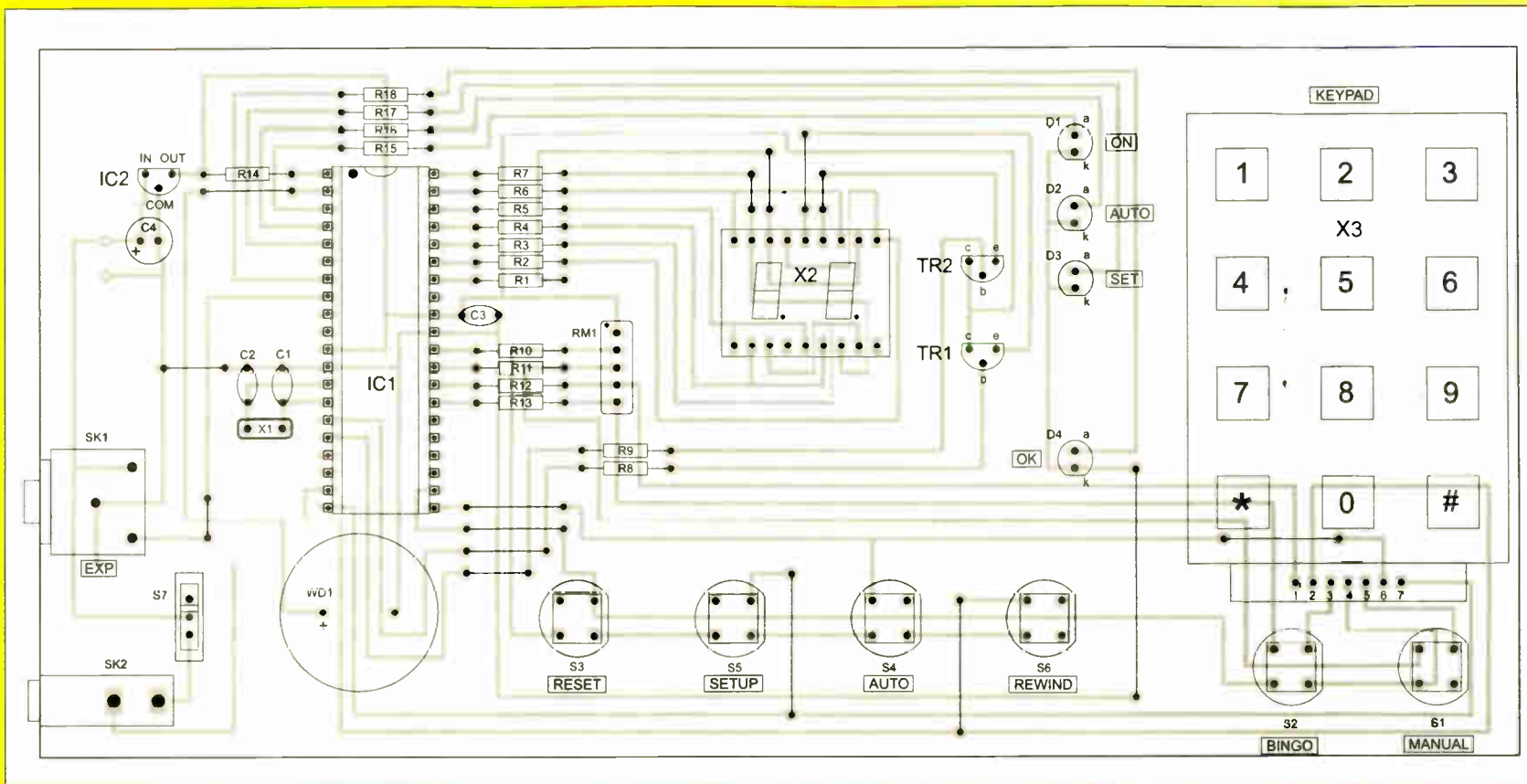
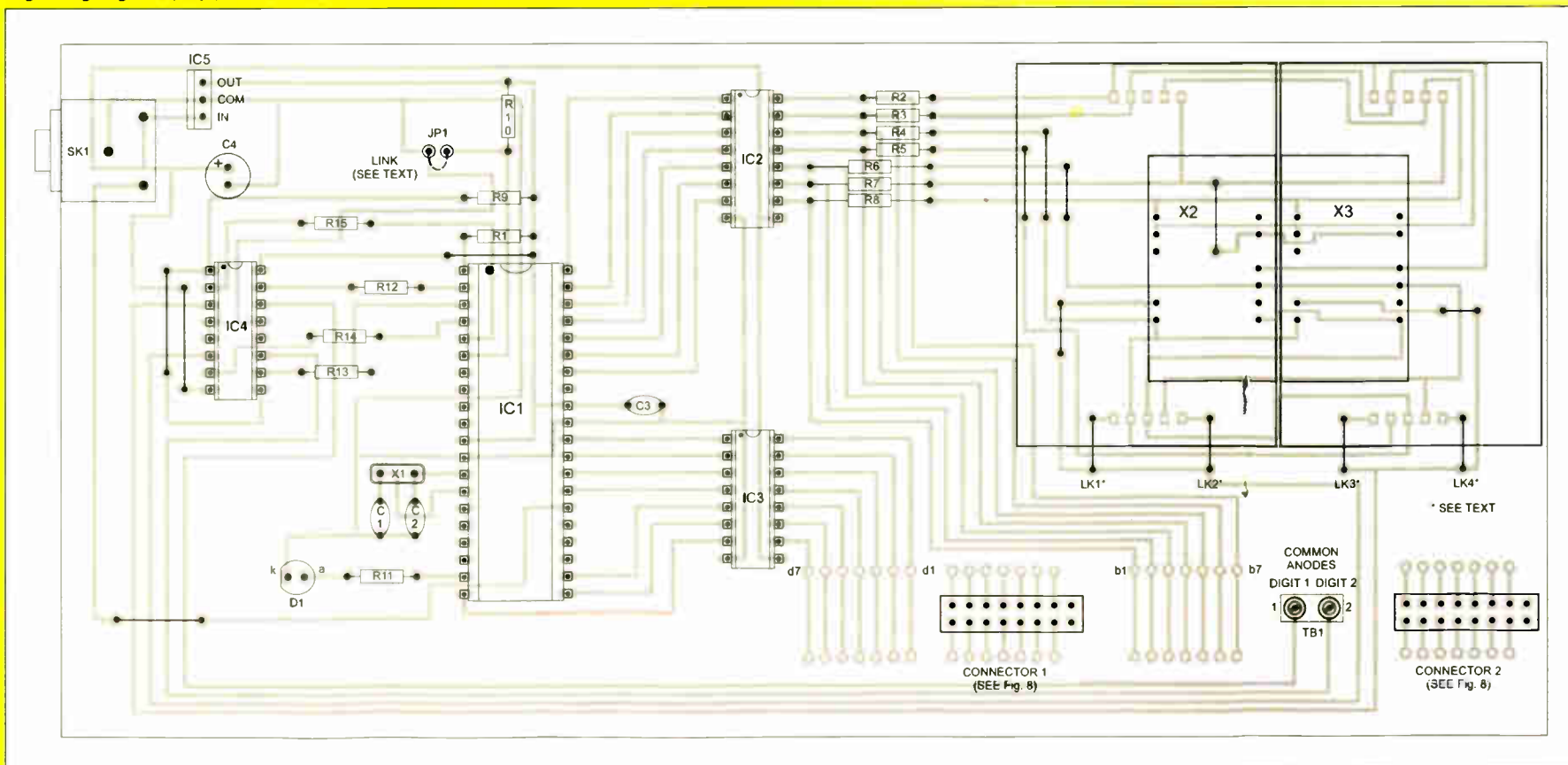

Fig.6. Printed circuit board component layout for the basic Bingo Box

Fig.7. Big Digit Display printed circuit board component layout



## COMPONENTS Approx Cost Guidance Only **£29** excl. PCB & Display Case

BINGO BOX		IC2	
<b>Resistors</b>		<b>Miscellaneous</b>	
R1 to R7, R15 to R18	150Ω (11 off)	S1 to S6	push-to-make switch, p.c.b. mounting (6 off)
R8, R9	1k (2 off)	S7	s.p.s.t. toggle switch, s.i.l., p.c.b. mounting
R10 to R13	4k7 (4 off)	SK1	2.5mm power jack socket, p.c.b. mounting
RM1	47k 4-way commoded s.i.l. module	WD1	piezoelectric buzzer, p.c.b. mounting
R14	10k	X1	20MHz crystal
All 0.25W 5% carbon film unless marked.		X2	dual 7-segment common anode l.e.d.
<b>Capacitors</b>		X3	4 x 3 pushbutton keypad
C1, C2	22p ceramic 5mm pitch (2 off)	Printed circuit board, available from the EPE PCB Service, code 492 (Main); 40-pin d.i.l. socket; 2 x 9 way s.i.l. sockets; case to suit; connecting wire; solder, etc.	
C3	100n ceramic disc, 5mm pitch		
C4	100μ radial elect. 16V		
<b>Semiconductors</b>			
D1 to D4	5mm l.e.d., colours to suit (4 off)		
TR1, TR2	BC548 npn transistor (2 off)		
IC1	PIC16F877-20 microcontroller preprogrammed (see text)		

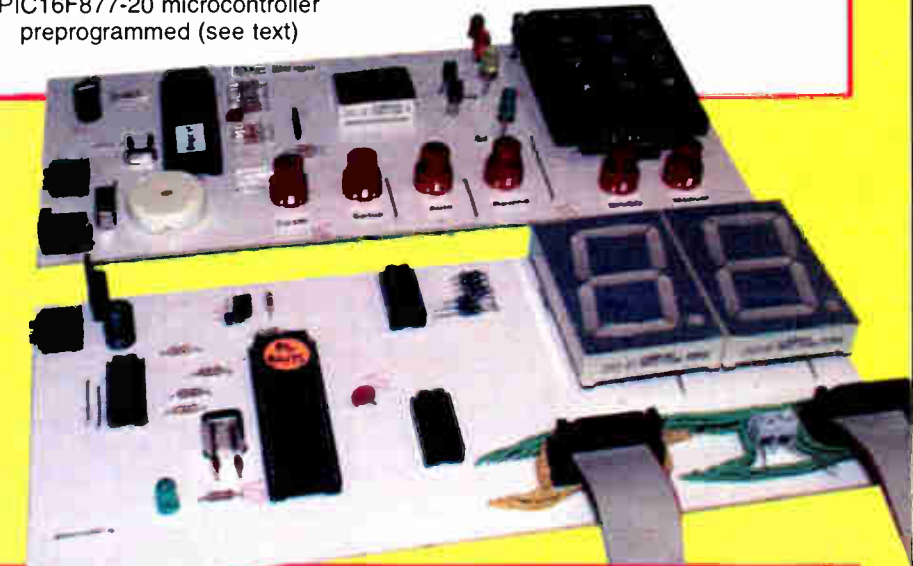

## COMPONENTS Approx Cost Guidance Only **£30** excl. Big Digits (optional)

BIG DIGIT DISPLAY		IC2, IC3	
<b>Resistors</b>		<b>Miscellaneous</b>	
R1	10k	IC4	L293DN motor driver
R2 to R8	470Ω (7 off)	IC5	7805 +5V 1A voltage regulator
R9, R10	1k (2 off)	ST1	3.5mm stereo jack socket, p.c.b. mounting
R11	150Ω	CON1, CON2	16-way IDC p.c.b. header plug (see text) (2 off)
R12 to R15	4k7 (4 off)	TB1	2-way terminal block
All 0.25W 5% carbon film.		X1	4MHz crystal
<b>Capacitors</b>		X2, X3	common anode 7-segment l.e.d., (2 off) (see text)
C1, C2	22p ceramic disc, 5mm pitch (2 off)	Printed circuit board, available from the EPE PCB Service, code 493 (Big Digit); 16-pin d.i.l. socket (3 off); 40-pin socket; case to suit; 16-way IDC cable and 16-way IDC p.c.b. leader plug (2 off) if required – see text; connecting wire; solder, etc.	
C3	100n ceramic disc, 5mm pitch		
C4	100μ radial elect. 6V		
<b>Semiconductors</b>			
D1	red l.e.d., 5mm		
IC1	PIC16F877-4 microcontroller, preprogrammed (see text)		

Fig.8. Interwiring links for connecting the mechanical displays to the Big Digit Display board

The full-size underside copper foil master pattern for the basic Bingo Box printed circuit board is shown below

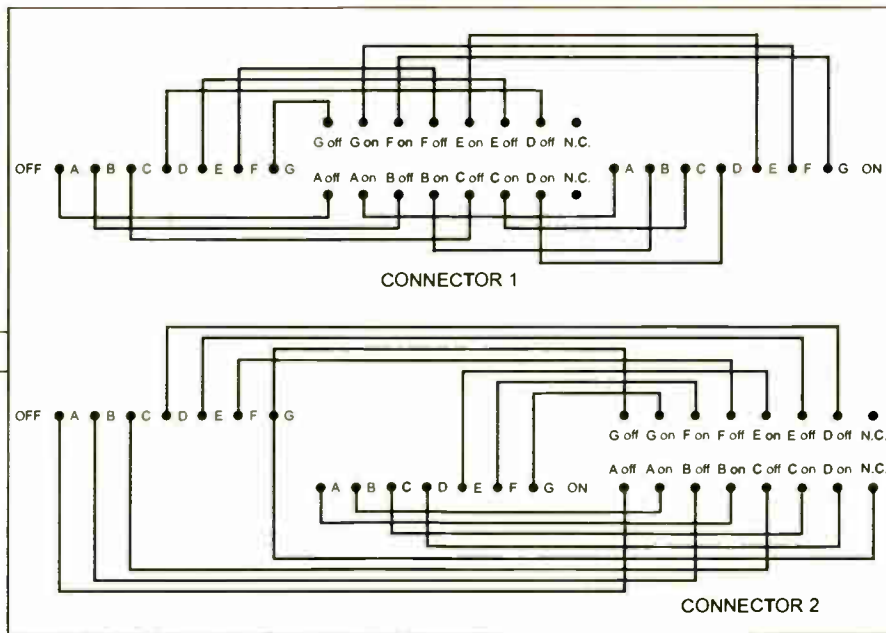
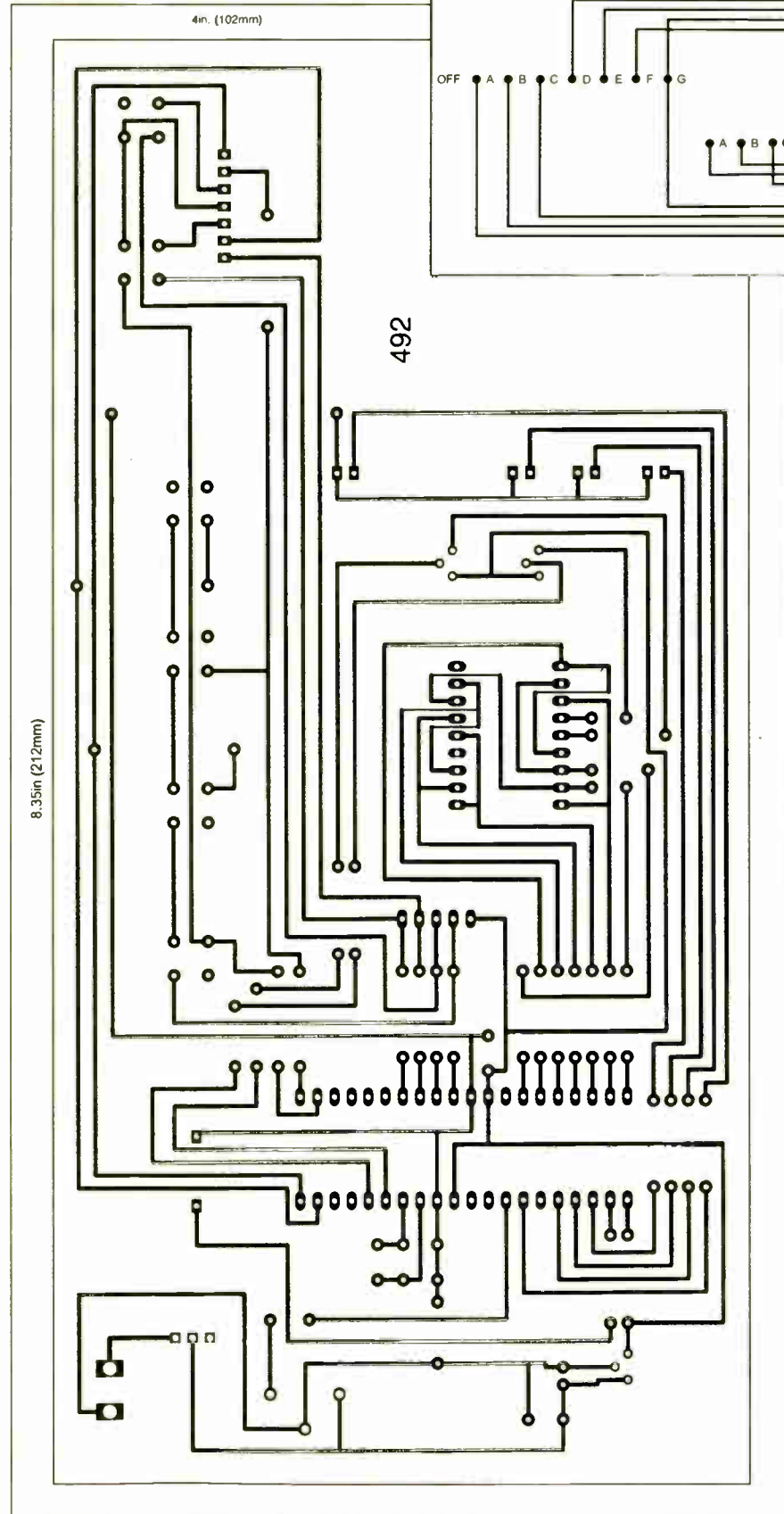

wander lead must also connect to a +5V supply pin instead of to 0V.

If the mechanical displays are used, the test sequence is carried out on PORTA and PORTD. With the common anode connected as described above, a brief touch of a wander lead between the +5V supply and PORTA socket pin will result in a segment turning on. A similar brief touch to the corresponding PORTD pin will turn it off again. Note that care must be taken to ensure that the contact is *very brief*, otherwise over-heating and damage may occur within the display or driver chip.

Always ensure that the power is off before making any changes to the p.c.b.s. It must also be off when plugging in the inter-board connector – the mechanical design of the socket is such that the positive supply voltage could be applied directly to the PORTC serial input. As the voltage is well in excess of the +5V permissible for the PIC, the PIC could die.

### In Use

On power-up, the master Bingo Box display will show “- -”, the On I.e.d. (D1) illuminates and the default time delay for the automatic mode is set at five seconds. This is the standby mode. To change the delay, which is the time between numbers being generated in automatic mode, press switch S5 (Setup), then enter the time in seconds using the keypad and press Setup again to store the time.

To change the number range, enter setup mode as described above and then press the “#” key. Now use the keypad to enter the maximum number in the range followed by the “#” key again. After this, pressing Setup returns the unit to standby mode. Note that 00 is not a permitted number!

To start producing numbers automatically, press S4 (Auto). Numbers will now be generated after the preset time interval. L.E.D. D2 will illuminate to show that the mode is automatic and a short tone is generated via buzzer WD1 for approximately one second before each new number is displayed. In manual mode, each press of S1 (Manual) generates a new number. Number generation

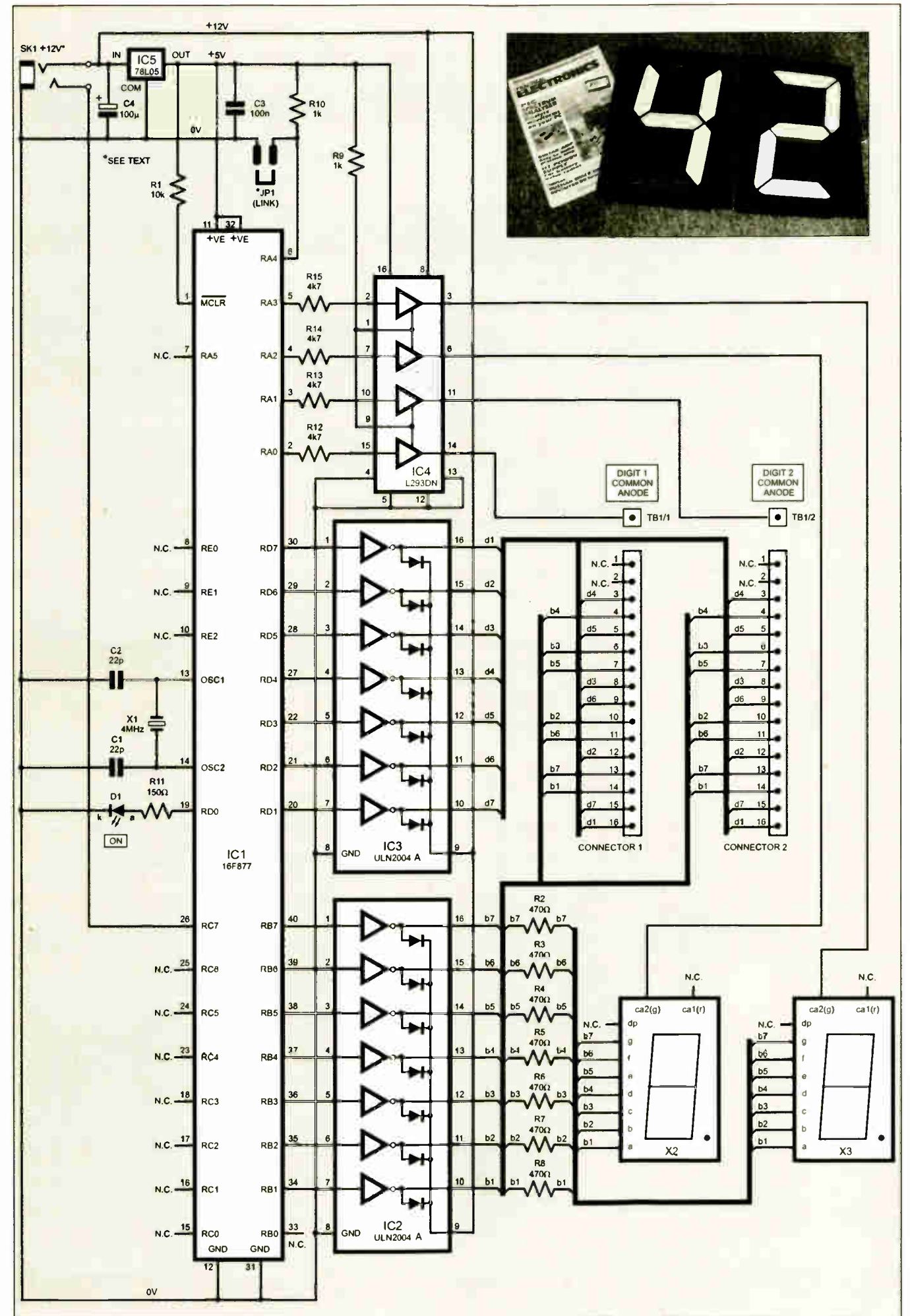

Fig.5. Complete circuit diagram for the Big Digit display driver stages

stops when all numbers in the defined range have been generated.

If someone believes they have a "Bingo!" situation, they should press the Bingo button S2. The on-board display

will show "- -" and l.e.d. D1 (On) will flash. The player should then enter their numbers via the keypad signifying the end of each 2-digit number with the "#" key. If it is a valid number, l.e.d. D4

(OK) will light and a high frequency beep will be heard.

If the number has not been called, a low frequency sound will be produced and the machine will go into a standby mode, waiting for either the Auto or Manual keys to be pressed. During checking, it is usual for any externally mounted displays to show the last number generated.

The Rewind key (S6) replays the last 10 numbers at the rate of one every two seconds and the Reset key (S3) clears all memory ready for another game. This will also reset the Big Display board if it is connected.

## Bingo Software

The software is written in WIZ-C. As usual, all source code together with compiled hex files is available for download from the *EPE* web site, via [www.epemag.co.uk](http://www.epemag.co.uk). Preprogrammed PICs can be obtained as given in this month's *Shoptalk*. The C source code is fully commented.

For your general interest – WIZ-C has an application designer style front-end in which basic devices are visually connected to PICs using "drag and drop" functionality. The basic devices used in the Bingo Box are a keypad, an asynchronous serial interface, an EEPROM and a variety of timers and output ports. The WIZ-C software creates the basic code required to drive these devices and, where required, provides "events" which user routines can process. An example of an event is a key press or a timer overflow.

The use of an application designer considerably speeds up the development cycle and removes much stress from the programmer – although the PIC world is divided between assembler purists, who like to control the behaviour of the silicon on each and every clock cycle, and those who simply want to build things in the shortest possible time!

It is not the purpose of this article to debate the relative merits of each, so C source, ASM and hex files are all provided! The assembler generated by the compiler is not directly TASM or MPLAB compatible, but those with the keypad difficulties mentioned earlier may find it useful in modifying the software to suit their pinout arrangement.

## Random Generation

The most unusual aspect of the software is the random number generation. Given that all PICs begin in a similar state, and given the same set of conditions and stimuli will end up in the same state, how is it possible to generate randomness?

There is much debate about this matter, but the Bingo Box uses time as a variable and re-seeds the random number generator at arbitrary intervals during program execution. In practice, the number sequence does appear to be truly random!

## Acknowledgement

John Becker's various PIC designs previously published in *EPE* for driving multiple l.e.d.s and Big Displays are gratefully acknowledged. □

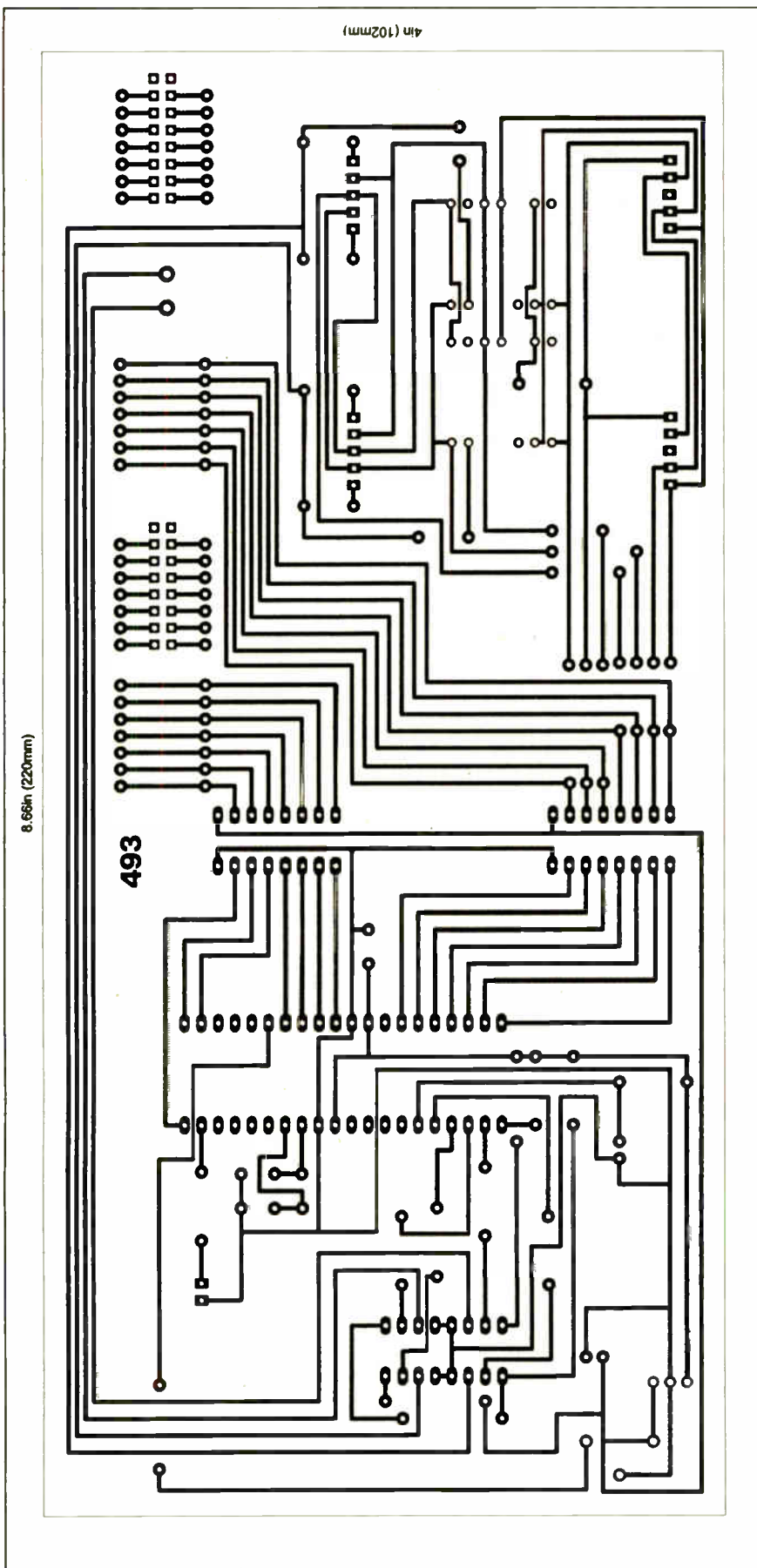

Full-size copper foil for the Big Digit p.c.b.

# SHOP TALK

with David Barrington

## Cat Flap

Although it is to be preferred, it is not absolutely necessary to use neodymium magnets for the cat's collar called up in the *Cat Flap* project. Almost any fairly strong small bar magnet should produce results. In fact, the only "neodymium" magnets we have come across when scouring listings have been disc types.

For the flap magnet you could purchase one of the many encapsulated types advertised for alarm circuits. These are usually sold with an accompanying reed switch in a matching package. The reed switch needs to be one with "normal open" contacts.

A source for the specified IRF610 MOSFET seems to be rare and the only one we have come across so far is **Cricklewood** (☎ 0208 452 0161 or [www.cricklewoodelectronics.com](http://www.cricklewoodelectronics.com)), specify by type number. We understand that transistors TR1 and TR2 are not at all critical in this circuit and components advertisers should be able to offer suitable alternative/equivalent devices.

As suggested by the author, readers should keep to the specified CA3130E op.amp as, apart from the preset potentiometers, no further input biasing is needed. Small quantities of 30 s.w.g. enamelled copper wire can be obtained from **JAB** (☎ 0121 682 7045 or [www.jabdog.com](http://www.jabdog.com)), mail order only.

The small printed circuit board is available from the *EPE PCB Service*, code 491 (see page 221). One small observation we would make is that the completed circuit board should be housed in a small plastic case. Even though it is mounted on the inside of the door, a wet moggie's fur could cause havoc with the electronics! Maybe the coil should also be covered with some thin plastic sheet?

## Headphone Monitor

We do not expect any buying problems to be encountered when shopping for parts for the *Headphone Monitor* project. Like most volume controls, you should specify that you require a *logarithmic* (*log.*) type when ordering the dual-ganged (stereo) rotary potentiometer.

Whether you chose to build this little stereo power amplifier as a stand-alone unit or incorporate it in last month's *Sound Card Mixer* project, it must be housed in a metal case/console for extra screening. If added to the Mixer and run for prolonged periods from the same supply, the power supply may need upgrading. If used as a stand-alone monitor/amplifier, four AA size alkaline cells should be sufficient.

If you wish to use the same miniature, metal bodied, 3.5mm stereo jack socket as used in the model, this came from **Maplin** (☎ 0870 429 6000 or [www.maplin.co.uk](http://www.maplin.co.uk)), code FK03D. Note that the sleeve connection of any jack socket used must make a good "ground" (0V) connection to the metal case. The LM386N power amp i.c. is stocked by most of our components advertisers.

The printed circuit board is available from *EPE PCB Service*, code 490 (see page 221)

## Bingo Box

With such a variety of 7-segment displays on the market now, and most stocked in one form or another by our components advertisers, readers should have no trouble in finding a suitable display device for the *Bingo Box* project. The ones mounted on the author's p.c.b.s are manufactured by **Kingbright** and are stamped: series DA56-11EWA (2001-43) dual display for Main board; and series SBA18-11EGWA (2003-43) for the Display p.c.b. Note that common anode devices are needed. The 3 × 4 matrix keypad should be readily available.

For the optional off-board "giant" displays, bulk purchasing has enabled **Display Electronics** (☎ 0208 653 3333 or [www.distel.co.uk](http://www.distel.co.uk)) to offer the "British Rail" giant 10 inch 7-segment electromechanical display at a very reasonable price; claimed to be less than 30 per cent of the original. A single display module (code RW44) costs just £29.95 plus VAT and £99 plus VAT for four units (code PH26). A carriage charge may need to be added to these prices.

It is important that constructors specify the suffix D when ordering the L293DN stepper motor driver i.c. The D denotes it is a 16-pin device and has diode protection. Do not use other L293 device types as they may not have the same characteristics and could be 20-pin versions. The one used in the prototype was purchased from **Rapid Electronics** (☎ 01206 751166 or [www.rapidelectronics.co.uk](http://www.rapidelectronics.co.uk)), code 82-0192.

The six pushbutton switches used are the 4-terminal "click-effect" types with a polarising flat on one side. Each switch contact is connected internally to two pins (terminals), hence the polarising flat, for ease of track layout on p.c.b. You can, of course, use other switches but you will probably need extra link wires to complete the circuit connections.

For those readers unable to program their own PICs, fully programmed PIC16F877 microcontrollers can be purchased from **Magenta Electronics** (☎ 02083 565435 or [www.magenta2000.co.uk](http://www.magenta2000.co.uk)) for the inclusive price of £10 each (overseas add £1 for p&p). You will need two PICs, one for each board, a 20MHz version for the Main p.c.b. and a 4MHz version for the Big Digit p.c.b.

The software, including source code files, is available on a 3.5in. PC-compatible disk (Disk 8) from the *EPE Editorial Office* for a sum of £3 each (UK), to cover admin costs (for overseas charges see page 221). The software is also available for *Free* download via [www.epemag.co.uk](http://www.epemag.co.uk).

The printed circuit boards can be obtained from the *EPE PCB Service*, codes 492 (Main) and 493 (Display) see page 221.

## PLEASE TAKE NOTE

### Speed Camera Watch (Jan '05)

To clarify the connections between the GPS module and p.c.b., we have been advised that the colour coding is: red to JP5-1; green to JP5-2 (unused); yellow to JP5-3 (unused); blue to JP5-4; white to JP5-5; black to JP5-6.

## electronic surveillance equipment

No gimmicks, gadgets or fantasy performance claims, just high quality equipment direct from the company who for over 25 years have designed, developed and manufactured covert audio surveillance equipment for the entire industry, from private individuals to government departments. If you have a requirement, speak to us....*last*.

- ◆ Full range of covert audio surveillance products
- ◆ Professional quality UHF crystal equipment
- ◆ Cost effective VHF FM equipment
- ◆ SENSIBLE prices from a long established, discreet and reputable company
- ◆ Excellent service and advice from experienced staff
- ◆ Everything designed, developed and manufactured by us in-house and under our control
- ◆ We are dedicated to surveillance products... we make *nothing* else
- ◆ Latest surface mount technology on all modules for maximum performance and micro size
- ◆ We ship worldwide and accept cards, cash and cheques

Phone, fax or e-mail [sales@suma-designs.co.uk](mailto:sales@suma-designs.co.uk) for our free 2005 illustrated catalogue of audio surveillance equipment, or visit us on-line at [www.suma-designs.co.uk](http://www.suma-designs.co.uk).

suma  
designs

The Workshops, 95 Main Road,  
Baxterley, Warwickshire, CV9 2LE UK  
Tel/Fax: 01827 714476  
[www.suma-designs.co.uk](http://www.suma-designs.co.uk)

# PicoScope 3000 Series PC Oscilloscopes

The PicoScope 3000 series oscilloscopes are the latest offerings from the market leader in PC oscilloscopes combining high bandwidths with large buffer memories. Using the latest advances in electronics, the oscilloscopes connect to the USB port of any modern PC, making full use of the PCs' processing capabilities, large screens and familiar graphical user interfaces.

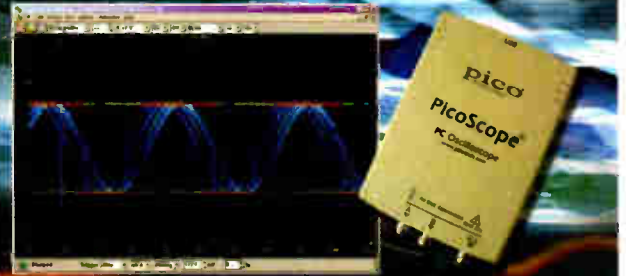

- High performance: 10GS/s sampling rate & 200MHz bandwidth
- 1MB buffer memory
- High speed USB 2.0 interface
- Advanced display & trigger modes
- Compact & portable
- Supplied with PicoScope & PicoLog software

PicoScope:	3204	3205	3206
Bandwidth	50MHz	100MHz	200MHz
Sampling rate (repetitive)	2.5GS/s	5GS/s	10GS/s
Sampling rate (single shot)	50MS/s	1COM/s	200MS/s
Channels	2+Ext trigger	2+Ext trigger Sig gen	2+Ext trigger Sig gen
Oscilloscope timebases	5ns/div to 50s/div	2ns/div to 50s/div	1ns/div to 50s/div
Timebase accuracy	50ppm	50ppm	50ppm
Spectrum ranges	0 to 25MHz	0 to 53MHz	0 to 100MHz
Buffer memory size	256KB	512KB	1MB
Resolution / accuracy		8 bits / 3%	
Ranges		±100mV to ±20V	
PC Connection		USB2.0 (USB1.1 compatible)	

Tel: 01480 396395

[www.picotech.com/scope249](http://www.picotech.com/scope249)

**pico**  
Technology Limited

## For rapid development of electronic systems...

**E-BLOCKS**

E-blocks are small circuit boards each of which contains a block of electronics typically found in an electronic system. E-blocks can be programmed in C. Assembly and are tightly integrated with Flowcode which instantly converts flow charts into PICmicro code.

**NEW**

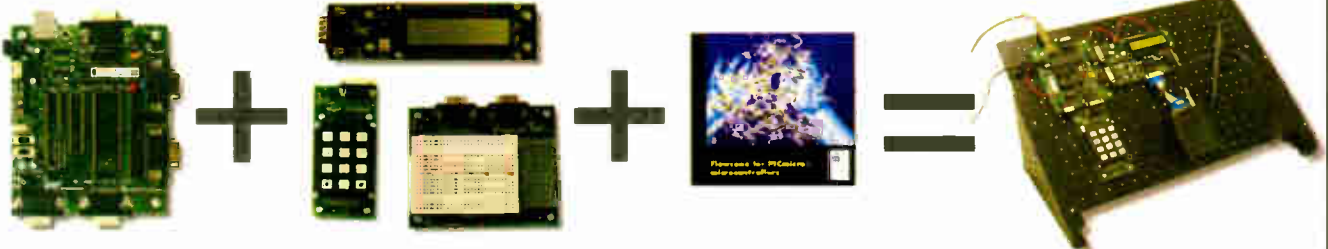

Low cost USB PIC programmers  
(Starting at £27, model shown £35)

plus a wide range of add-on boards and accessories...

..... plus incredibly easy to use software based on flow charts ..

... equals extremely rapid system development: like this mobile text messaging system built from E-blocks.

## ...and solutions for learning and development...

Hands on training courses



training courses in PICmicro(R) programming, CPLD programming and ECAD

Resources for learning CPLD programming



Complete courses in electronics and programming



Equipment for datalogging, control and PC 'scopes



...and more at:

**m**  
**mm**

...see [www.matrixmultimedia.co.uk](http://www.matrixmultimedia.co.uk)

Matrix Multimedia Limited  
sales@matrixmultimedia.co.uk  
t. 0870 700 1831 f. 0870 700 1832

# SURFING THE INTERNET

# NET WORK

## ALAN WINSTANLEY

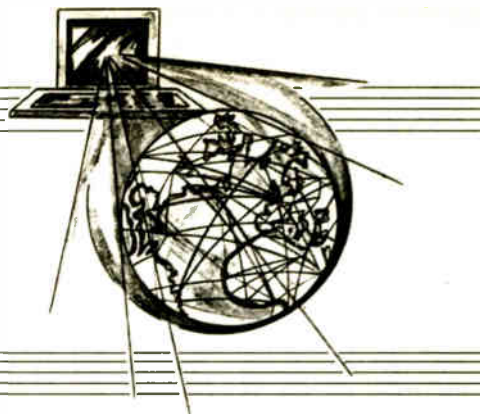

**I**n last month's *Net Work* I outlined some practical tips to help you avoid getting your fingers burnt on eBay. I am postponing the promised item on "phishing" fraud. Instead, here's more topical news and feedback on eBay and related frauds.

### Cashback Fraud

Whilst the vast majority of eBay transactions are successful, it is wise to keep one's feet superglued to the ground when placing a bid or selling an item. Both cowboy sellers and cowboy customers exist on eBay just as they do in real life. The latest form of fraud doing the rounds involves sellers receiving strange offers to buy the item for sale, and actually the buyer offers to pay a whole lot more for the item than is being asked for!

Due to a little-known loophole in UK banking regulations, it is one of the worst scams around, because there is a nasty sting in the tail that may not be felt until weeks after the event when your money disappears for good. It affects anyone selling items, whether on the Internet, in eBay or in, say, car sales magazines, or any other form of media, especially when the item for sale is quite valuable.

My thanks to *EPE* reader Bryan Staines who emailed to say:

"I auctioned my Norton motorcycle on eBay making the bidders clearly aware that the payment conditions would be cash on collection only. I received a winning bid but was suspicious as the bidder was based in Singapore (showing a yahoo.sg mail address), however I mailed him (he had an English name) and asked for his requirements regarding collecting the motorcycle.

"He said he had a client in the U.K. that owed him money and he would arrange for his client to make a personal cheque out to me, for me to deduct the value of the Norton, and to transfer the remainder to him via Western Union Transfer. I immediately replied stating that this was not acceptable and that I assumed the transaction was now null and void, needless to say I have not had a reply.

"It reinforces your comment of *Caveat Emptor*. My congratulations to you on your excellent *Net Work* column."

A few points here: firstly, anyone can set up a Yahoo, Geocities or Hotmail email address in a trice, so dealing with someone having such an address should set alarm bells ringing. The mention of Western Union in the same breath is also a huge warning sign. The chances are that the money transfer is an attempt to convert a fraudulent money order or cheque into hard cash. The web site <http://the-law.com> contains many useful forum messages on eBay fraud. Also read <http://tinyurl.com/59w65> if you have time!

### Generating a Loss

Shortly afterwards, regular reader Dave Preston emailed with a similar story:

"Recently I sold some unwanted test equipment on eBay, and one item in particular, a nearly new TGR1040 1GHz RF Generator, has been causing me some problems. Twice previously, it has attracted bids but not enough to warrant its reserve of £950. However, on a recent attempt to sell it, after Day One I had a reply from someone wanting to buy it. After an email to find out more, I got the following reply:

'Hello, thanks so much for your fast response... The bank draft/money order that will be issued will include the money for the sales of your item + the shipping cost and my commission.

'I would like to restate clearly that this item will be shipped to Africa and I have a shipping agent who would take good care of this. You will be required to cash the bank draft/ Money Order and deduct the funds for the sales of your item and have the excess funds sent to the shipper via Western Union Money Transfer at one of their outlets around you in order to schedule the pick up of the item.

'All necessary transfer papers will be duly signed by the shipper on behalf of my client when the shipping agents comes for the pick up of the item. I will be willing to entertain more of your questions that might arise and you are free to mail me. If you really show willingness and would really want to sell this item fast, please provide your contact details so that I can have it forwarded to my client for immediate payment issuance.'

### Accredited View

Dave asked for my views on this transaction. This type of "cashback fraud" is one of the nastiest forms of Internet scams around at the moment. The criminals supposedly send you "excess funds", from which you deduct the amount of your sale to keep. You forward the surplus (the cashback amount) to a "shipping agent" using Western Union. You send the goods. Then, the original payment bounces, due to a little-known loophole in the way UK banks operate. You lose everything.

The London Metropolitan Police web site has useful data on this "cashback fraud", see

[http://www.met.police.uk/fraudalert/cashback\\_fraud.htm](http://www.met.police.uk/fraudalert/cashback_fraud.htm) (or, <http://tinyurl.com/44c23>).

Also explained on the excellent legal web site *Out-Law.com* (in an article at <http://tinyurl.com/5jmrg>): "Under the clearing system used by the banks, while cheques may appear to clear within a matter of days, the banks are entitled to reclaim the value of the cheque if it later turns out to be stolen or issued fraudulently, often weeks later. This means that the victim is then out of pocket to the tune of the refund and the item he thought he was selling."

A stolen identity may be used to pay you, perhaps with a stolen cheque or money order, but in the case of cashback fraud, you will lose the goods you sent out, you will lose all monies including the "surplus" funds that you helpfully mailed out via Western Union but worst of all, as the Police mentions, you will not be reimbursed by the banks for any of your losses.

Sometimes, greed and naivety take over when deals seem too good to be true. The Internet offers rich pickings for villains who will defraud you without mercy, and there is no doubt that Internet fraud in many forms will soar in coming years. With ID theft increasingly rife, some think that eBay singularly fails to protect its customers adequately enough against fraud and has a lot to answer for. You can email the writer at [alan@epemag.demon.co.uk](mailto:alan@epemag.demon.co.uk)

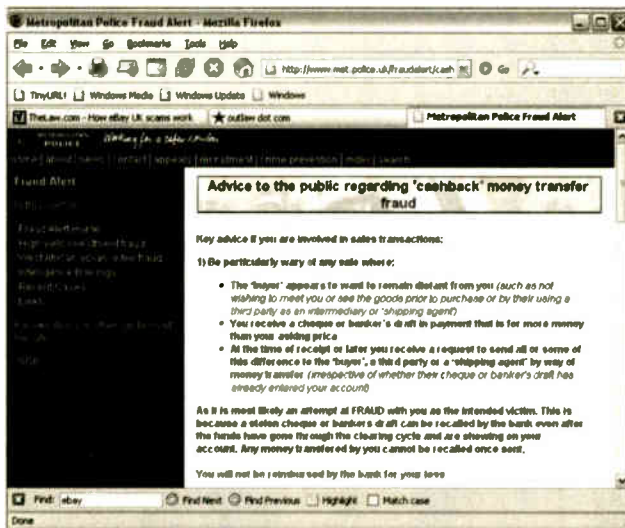

# EVERYDAY PRACTICAL ELECTRONICS

www.epemag.co.uk  
EPE Online: www.epemag.com

## Subscribe and SAVE 51p

an issue over UK  
newstand prices on a  
one year subscription.

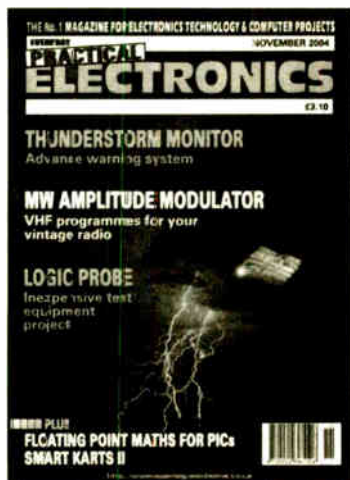

## Plus:

- Avoid the price rises for the duration of the subscription.
- Your issue posted to you in time to arrive before publication date (UK).
- No more searching newsagents shelves for your copy.

### Annual subscription rates:

6 Months: UK £16.50, Overseas £19.50 (standard air service),  
£28.50 (express airmail)  
1 Year: UK £31.00, Overseas £37.00 (standard air service),  
£55 (express airmail)  
2 Years: UK £57.00, Overseas £89.00 (standard air service),  
£105 (express airmail)

To: Everyday Practical Electronics,  
Wimborne Publishing Ltd., 408 Wimborne Road East, Ferndown,  
Dorset BH22 9ND  
Tel: 01202 873872 Fax: 01202 874562  
E-mail: subs@epemag.wimborne.co.uk  
Order from our web site at:  
www.epemag.co.uk

### Maestro TAKE ADVANTAGE NOW! SUBSCRIPTION ORDER FORM



To subscribe from the USA or Canada  
see the last magazine page

I enclose payment of £ .....  
(cheque/PO in £ sterling only),  
payable to Everyday Practical Electronics



My card number is: .....  
Please print clearly and check that you have the number correct

Signature .....

Card Security Code ..... (The last 3 digits on or just under  
the signature strip)

Card Ex. Date ..... Maestro Issue No. ....

Subscriptions can only start with the next available issue.  
For back numbers see the Back Issues page.

01/05

Name .....

Address .....

Post code ..... Tel. ....

If you do not wish to cut your issue, send a letter or copy of this form.

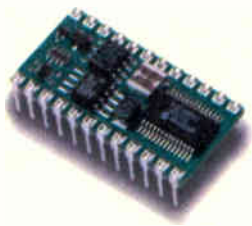

BS2-IC



BS2-SX

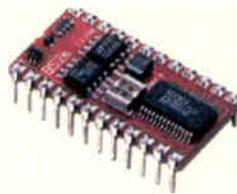

BS2E-IC

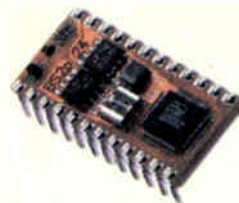

BS2P/24

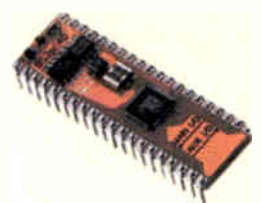

BS2P/40

**Parallax BASIC Stamps - still the easy way to get your project up and running!**

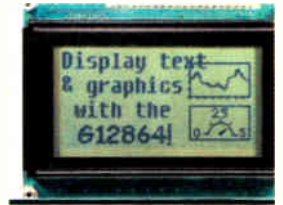

**Serial Alphanumeric and Graphic Displays, Mini-Terminals and Bezel kits**

# www.milinst.com



Animated Head



3-Axis Machine



Six-Legged Walkers



Robotic Arms



Bipeds

**Robotic models for both the beginner and the advanced hobbyist**

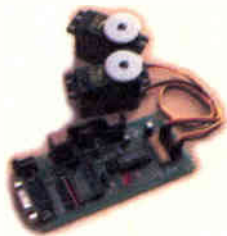

Servo Drivers

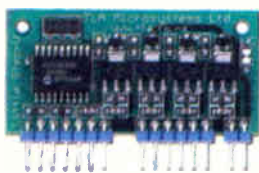

Motor Drivers



On-Screen Displays



DMX Protocol

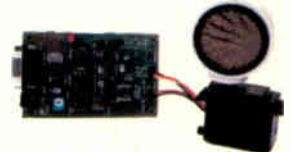

U/Sound Ranging

**Animatronics and Specialist Interface-Control Modules**



Quadravox MP3 & Speech Systems



SensoryInc Voice Recognition

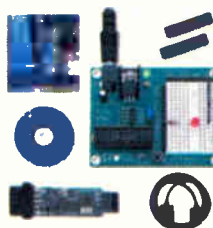

Parallax Ubicom Tool Kits



Tech-Tools PIC & Rom Emulators



BASICMicro PIC BASIC Compilers

## Development Tools

Milford Instruments Limited Tel 01977 683665, Fax 01977 681465, sales@milinst.com



# Smart Karts

Owen Bishop

## Part 6 – SK-3 Push and Grab Software

**L**AST month we described the circuits and construction of the third incarnation of our mobile robot, calling it SK-3. This month we describe how to make SK-3 wield its pusher and grabber via its software. The software comprises four sub-programs that are selected by switches S1 and S2. The first two are for the SK-3 with its pusher attached, the other two are for use with the grabber.

### Sub-routines

For previous Smart Kart versions, each of the four sub-programs has been self-contained, except that they all call the same delay sub-routine, **Pause2**. This month's programs have several quite long routines in common so we are setting these up as sub-routines that can be called from any of the four programs. This should make it easier and quicker for you to write your own programs, if you decide to do so. Here is a list of the sub-routines, stating what each does and what (if any) values it returns.

**Pushdown:** Lowers the pusher to the surface, then raises it just clear

**Pushup:** Calls **Pushdown:** then raises the pusher well clear of the surface

**Ready:** Initialises the robot; takes up any slack in the winch cord, raises the pusher or jaws clear of the surface

**Jopen:** Open the jaws to their widest extent. Not applicable to the pusher

**Detect:** Samples the Red-On and LDR signals. Returns with values in the register **object:** 01 = sensor swamped by bright light, 02 = no object detected, 03 = object detected. This sub-routine is described in more detail later

**Grabbit:** Assumes that **Ready:** and **Jopen:** have been called, so jaws are wide open. Closes jaws until they have gripped an object or the jaws are in contact with each other. Returns with values in the working register, **W:** 00 = no object grabbed, 01 = object grabbed. Not applicable to the pusher

**Circulate:** Action described later under "Deal the Pack"

**Pickup:** Detects and picks up an object, calling **Takeit:** to close the jaws

**Raster:** Scans an area about 30cm square, looking for an object. Returns when

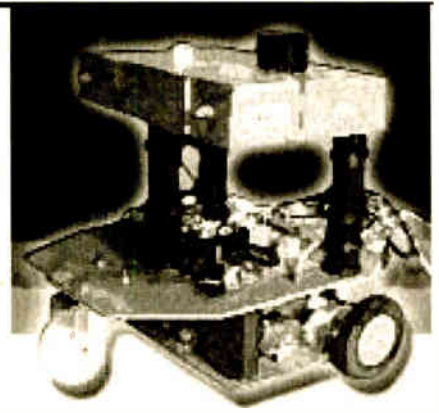

an object is found or when 20 scans have been completed

**Takeit:** Closes the jaws on an object presented to them

**Pause2:** Provides a delay up to about eight seconds, the length depending on the value in register **W** when the sub-routine is called

### Clean Sweep

When running the sub-program **Behave1:** the robot uses its pusher to sweep an area clear of small objects. The program is selected by switching off both Select switches, S1 and S2. Group A inputs of the Distribution board are used throughout the program.

Although the program has an extremely simple action – sweeping blindly to and fro to clear the area – you are able to modify the robot's behaviour while the program is running and so teach it how best to do its work. The light sensor is not required in this program.

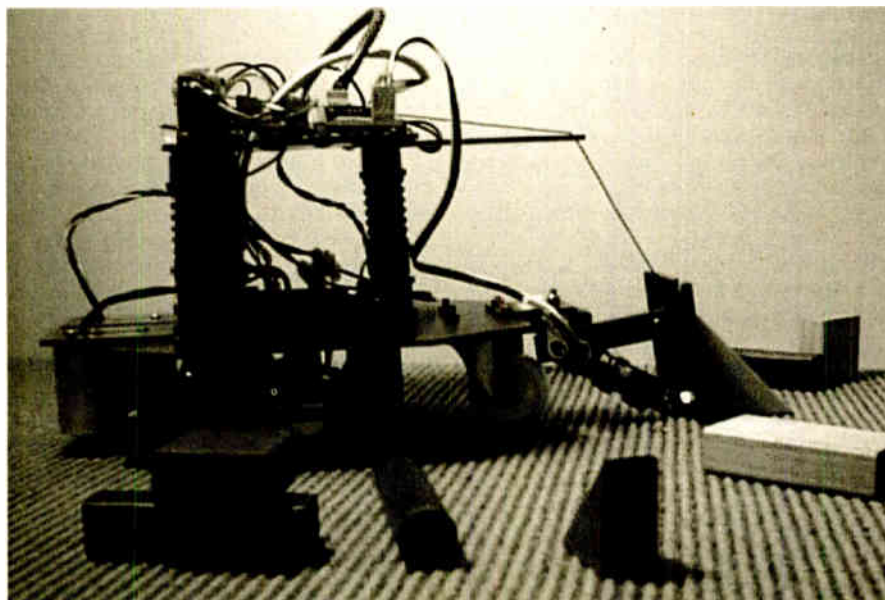

Clearing an area using SK-3's rear mounted pusher attachment

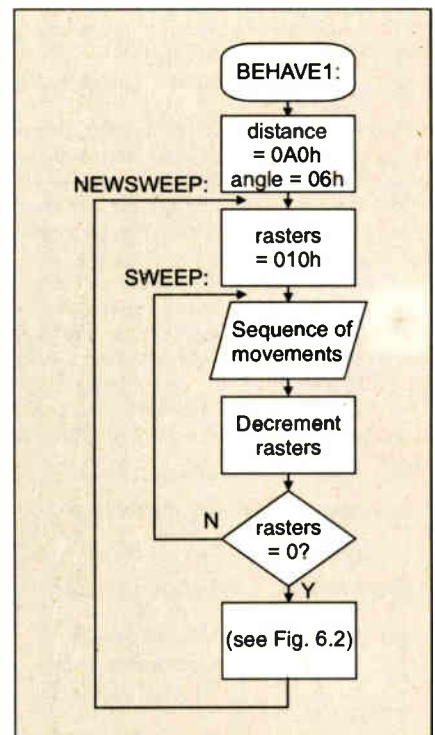

Fig.6.1. Outline flowchart of Behave1:

The robot performs a repeating series of sweeps across the area. It lowers its pusher and then reverses (pusher leading) a fixed distance, pushing objects before it, spins left through a small angle and stops. For the return journey it raises the pusher and moves forward (pusher behind) the same distance, and spins right through an equally small angle. This brings it back to a position slightly to the right of its original position, but it is still facing in the same direction. In this way, it sweeps the area from left to right.

Unfortunately, a problem with robots of this type is that wheel slippage may upset this neat scheme. It depends on the kind of wheels and their frictional grip on the surface. Wheels with spongy rubber tyres are the best but are not easily obtainable in a suitable size. But try it with the wheels you have, as the teaching aspect of this program is of interest and mirrors the kind of program used in some industrial robots.

### Start-Up

The program begins by initialising three variables (Fig.6.1). **Distance** controls the length of each sweep, **angle** controls the angles turned through at the ends of each sweep, and **Rasters** is the number of sweeps attempted.

The first half of the program, which begins at label **Newsweep:**, follows the pattern of many of the programs that we have already studied. It consists of a sequence of routines for sending the code for a particular action to Port A (for the drive motors) or to Port B (for the winch motor). An example is the spin left routine in Listing 2.1 in *EPE* Nov '04.

In the case of the winch motor, code 010h raises the pusher and code 020h lowers it. At the end of the sequence, **rasters** is decremented. If **rasters** has not reached zero the program loops back to repeat the sequence.

### Operator Link

If **rasters** has been reduced to zero, the program drops through to the sequence illustrated in Fig.6.2. This gives the operator the opportunity to change the value of angle, to vary the spacing between successive sweeps. The operator communicates instructions to the robot by means of the infrared sensors. These are used in other programs for line-following and similar tasks but now we put them to a novel use.

The long delay is to give the operator time to insert a piece of black card beneath one or both of the sensors. The input from the sensors is read at the end of the delay. First we read the left sensor input at RB7. The input is high (bit set) if the surface below it is white (or light in colour). It is low (bit clear) if the surface is black (black card beneath). Here is the extract from the assembler code for taking a decision based on the state of RB7:

```

btfss portb, 7 ; skip if left sensor
                ; is on white
goto setangle ; to change angle
goto newsweep ; repeat sweeps,
              ; angle unchanged
setangle:
movlw 03h ; load small change of
          ; angle into W

```

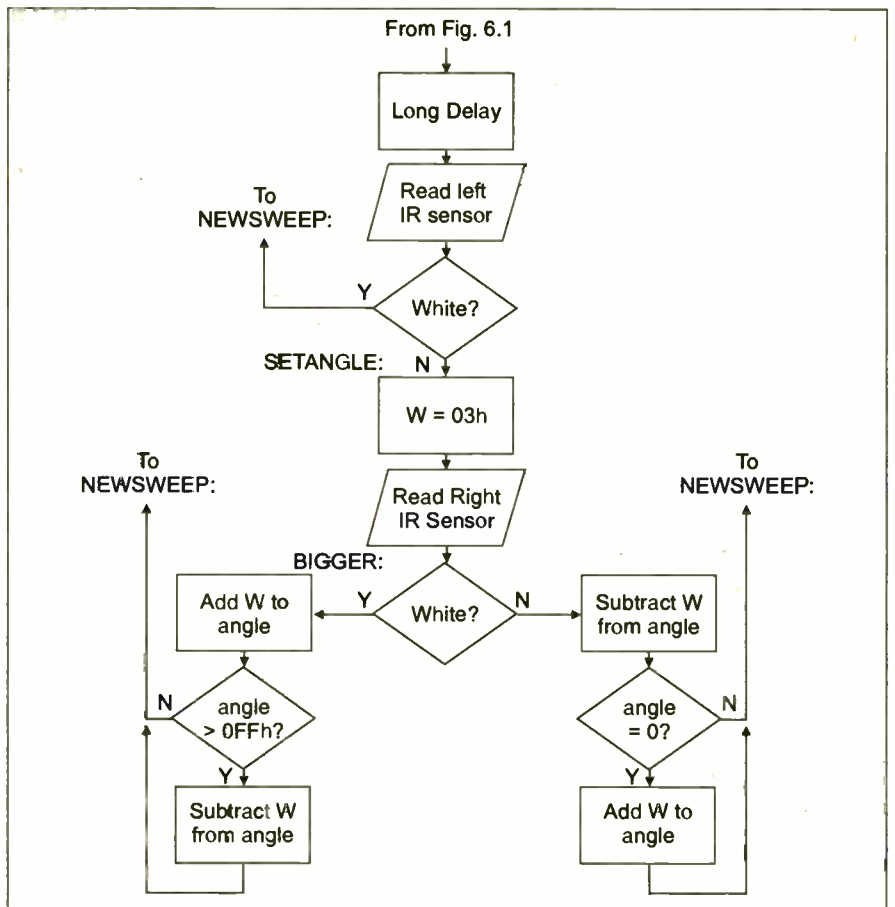

Fig.6.2. Detailed flowchart of the sensing routines of Behave1:

The effect of this is to loop back to **Newsweep:** to repeat the sweeps unchanged if the card under the left sensor is white, or to alter the angle if the card is black.

After **Setangle:** the program reads the input from the right sensor, at RB6. Depending on the input at RB6, the value previously stored in **W** (03h, see extract) is either added to or subtracted from **distance**. Given a low input (black), **distance** is reduced by 03h; given a high input (white) **distance** is increased by 03h.

Before the PIC loops back to **Newsweep:** there are sequences in both branches of the program to restore the value of **angle** should it ever be reduced to zero or increased beyond 0FFh. If it is reduced to zero, the Zero flag (bit 2 in the **Status** register) is set. The program tests this bit and acts accordingly. If **angle** is increased above the maximum (0FFh), the Carry flag (**Status** bit 0) is set. The program tests this bit and if necessary restores **angle** to its previous value.

Summing up, the area is prepared by scattering it with toy bricks or other objects. The robot is placed at the edge of the area, pusher facing toward the area. It sweeps back and forth across the area 20

times, pushing the objects out of the area. Then it pauses for about 10 seconds.

Assuming that the surface is white or light-coloured, you can alter the variable angle by placing (or not placing) a piece of black card beneath the IR sensors (Table 6.1). Increasing angle increases the spacing distance between adjacent sweeps.

The robot then repeats the sweeping action, with changed spacing if so instructed. This can be repeated with changed spacing any number of times.

### Random Demolition

The Random Demolition program (**Behave2:**) might well be called "Bull in a China Shop". Another name might be "Monte Carlo Walk", for the robot is made to wander around in a very erratic and random (actually pseudo-random) way. The program is selected by setting switch S1 on and S2 off.

Before running the program, prepare the area by scattering it with objects to be demolished. If you are using toy bricks, now is your chance to construct structures that look sturdy but are easily toppled. Place these in a row with about 10cm gap between them. Put SK-3 about

Table 6.1: Changing the angle

White/Black state	RB7 (left)	RB6 (right)	Action
On white surface	1	1	<b>angle</b> not changed (no black card) spacing unchanged
Black card beneath both sensors	0	0	Increased <b>angle</b> gives both sensors increased spacing
Black card beneath left sensor only	0	1	Decreased <b>angle</b> gives left sensor only decreased spacing

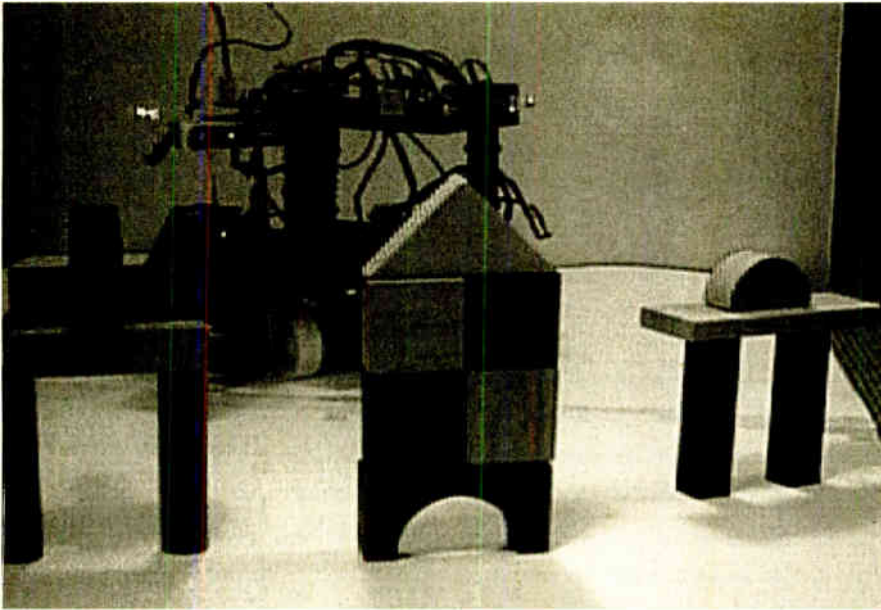

Smart Kart SK-3 ready for a devastating "demolition" charge in Behave2: mode

10cm from the line, with its pusher toward the buildings. As an alternative to bricks, you could scatter the area with skittles and make a game of it.

This program uses the light sensor to detect the objects. We mounted the sensor on the end of the cord support, aimed downward to a point about 20cm in front of the pusher. The program's flowchart is shown in Fig.6.3. It begins by lifting the pusher well above the surface, as it is not being used at this stage. Then a random number is generated, using a routine similar to, though simpler than, the random number routine described for SK-1, in its maze-running program (*EPE* Nov '04).

The random number is held in the variable **random**. While the program runs it may take any of the values between binary 0000001 (01h) and binary 1111111 (FFh). The value is sent to Port A to control the drive motors. Port A has only five bits, so the upper three bits are ignored. Bit 4 goes to RB4 which is used to select Group A or Group B inputs. The state of bit 4 is not relevant during this part of the program, so can be ignored.

This leaves the lower four bits (RB3 to RB0) with which to control the motors. Of the 16 possible binary combinations of 0 and 1, we have normally used only seven. For example, 1010 drives both motors forward. A motor stops if its two inputs are both low, or if they are both high, as can be verified by studying Part 1 Fig.3.

This means, for example, that codes 0001 and 1101 both stop the right motor and drive the left motor in reverse. Similarly, codes 0000, 0011, 1100 and 1111 all stop both motors. So any of the 16 possible groups that are sent to the motors can have some effect in driving or stopping the robot.

After the code has been sent to the motors, **Pause2:** is called and the motors run (or do not run) for about one second. Then a new random number is generated and

the robot performs another movement. The effect of all this is to make the robot move about irregularly but, on average, not travel very far from its original position.

### Detective

The Demolition program relies on the **Detect:** subroutine to tell the robot when there is an object within range of its pusher or grabber. This subroutine is called after each random movement. **Detect:** is used also by the two grabber programs. The sensor (or light probe), was described in Part 5 (Fig.5.2).

A flashing beam of red light from l.e.d. D2 is directed ahead of the pusher or grabber (ahead, that is, when the robot is running in reverse). If an object is present the beam is reflected back, and falls on the LDR. Blue l.e.d. D1 is there for visual effect and plays no part in detection.

To detect an object reliably, we make use of two signals:

- Red-On: low when the l.e.d. D2 is off, high when it is on
- LDR: low when light falls on it, high when there is little shown or no light

The waveforms in Fig.6.4 show the

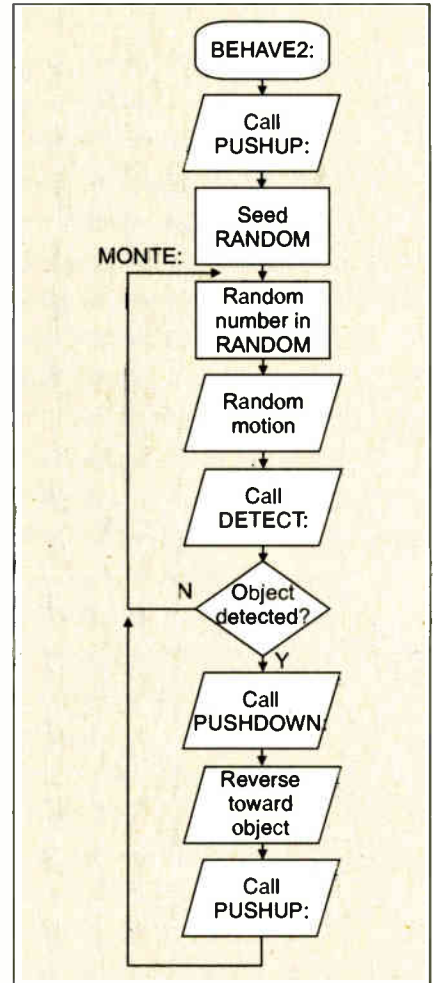

Fig.6.3. Flowchart of Behave2:

signals as the l.e.d. flashes. There are three possible outcomes:

- If an object is present, both signals alternate and are opposite in phase
- If the sensor happens to be directed toward a bright room light or a sunny window, the LDR signal is permanently low. We say that the sensor is "swamped". Under this condition, it is not possible to know whether there is an object present or not
- If there is no object present (and no swamping), LDR is permanently high.

To differentiate between these three results we sample the signals at two stages, as indicated by the dashed lines in Fig.6.4. If an object is present, the LDR signal is the inverse of Red-on at both stages. Table 5.1 in Part 5 shows that the Red-on and LDR signals are both sent to Port B pin RB3. Red-on is selected as one of the Group A inputs; LDR is selected as a Group B input. As shown in the flowchart of Fig.6.5, **Detect:** begins by selecting Group A (output RA4 high) and reading the Red-on signal at RB3.

The first requirement is that the program should be synchronised with the flashing of the l.e.d. The program waits for Red-on to go low (D2 off), then waits for it to go high (D2 on). Group B inputs are then enabled and, after a delay to allow the voltage to settle, the

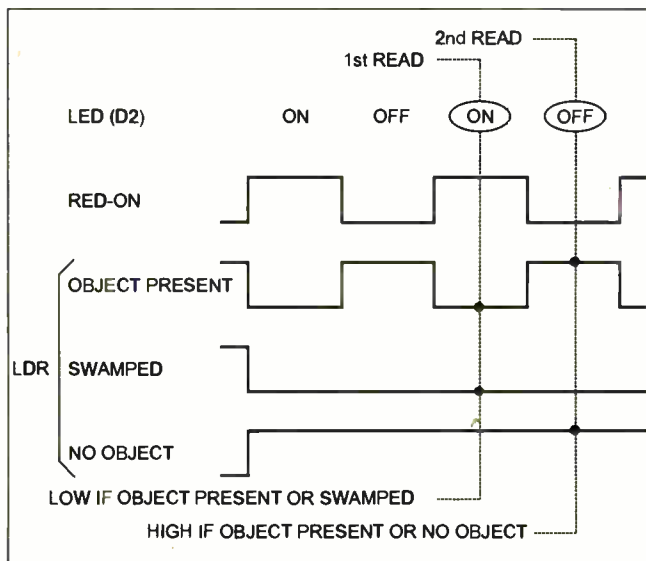

Fig.6.4. Timing diagram of the Detect: subroutine

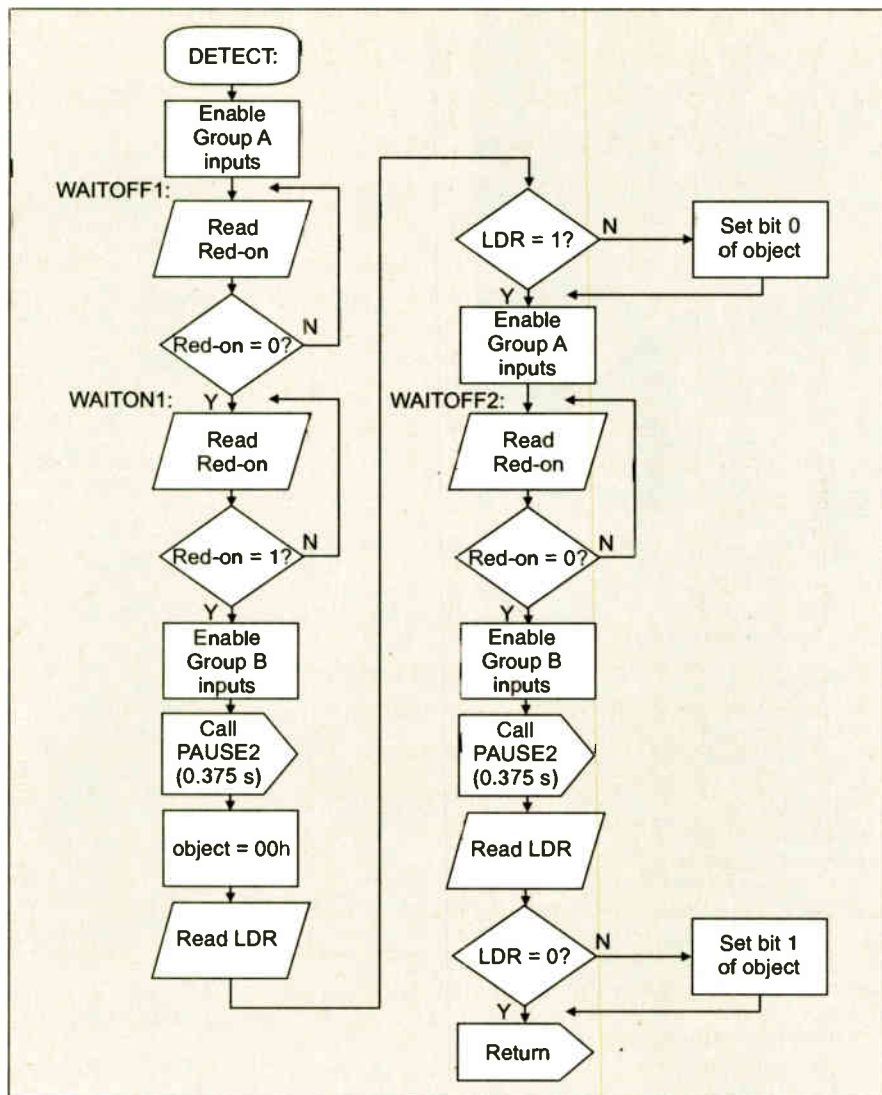

Fig.6.5. Flowchart of the Detect: subroutine

program resets the variable **object** and reads the output from the LDR. This is the first read shown in Fig.6.4. If no light is detected, LDR is high and the program enables Group A again. Otherwise, if there is reflection from an object or the LDR is swamped, bit 0 of **object** is set to 1.

Now the program waits for Red-on to go low, when it samples LDR again. This is the second read in Fig.6.4. Bit 1 of **object** is set if the LDR detects no light (either an object is present but not illuminated, or there may be no object and the LDR is not swamped). The final result is that if an object is definitely detected and the LDR is not swamped, **Detect:** returns with both bits of **object** set (**object** = 3).

On return from this subroutine, **object** is tested using a short routine:

```
movlw 0FDh           ; Put FDh into W (effectively -3)
addwf object, W     ; Add object to W, which gives |
                    ; zero if object = 3
btfsc status, Z    ; Test zero flag
goto found         ; If Z = 1, object detected
; continue with program ; If Z = 0, no object detected
```

Although we normally test for the value 03h, it is also possible to test for two other values (01h and 02h) in **object**, as explained in the list of subroutines at the beginning of this article. It is not normally possible to return 00h.

## Charge!

Returning to the flowchart of **Behave2:** (Fig.6.3), we can see what happens on

*Smart Kart SK-3 getting to grips with some "building bricks" that are wanted at another location.*

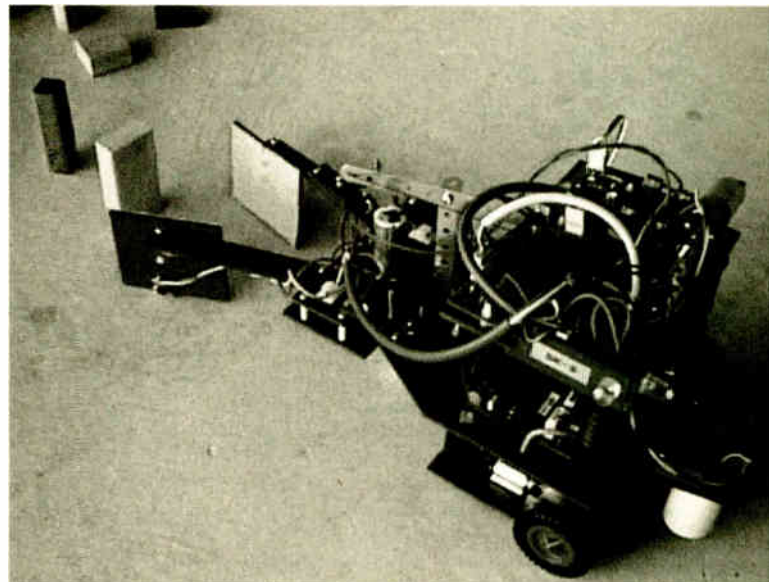

return from **Detect:**. If no object is detected the program simply loops back to **Monte:** and the robot continues its Monte Carlo Walk.

If an object is detected, the robot lowers the pusher and charges toward the object and beyond, demolishing it on its way through, like skittles!

## Search and Eliminate

The Search and Eliminate routine, **Behave3:**, is selected by switching S1 off and S2 on before pressing the Reset button. The routine's flowchart is shown in Fig.6.6.

It begins by calling **Ready:** and **Jopen:** to make the robot ready for action. Then it calls **Raster:** in which SK-3 runs forward and backward to search for an object. On its backward runs, it stops eight times to call **Detect:**, repeating for 20 runs. It returns from **Raster:** as soon as it detects an object within reach of its jaws, or after it has completed 20 runs.

On its return, the program examines the contents of **object**. This holds the value 03h if an object has been detected, as explained previously.

If an object is detected, the program continues by calling **Grabbit:** to operate the jaws. It assumes that the jaws are already wide open and raised a few millimetres above the surface. It does not test for an object because it is assumed that **Detect:** has already been called.

Its first action is to reverse the robot a few centimetres closer to the object, to obtain a better grip. The next stage is to select Group B and switch on the jaws motor to close the jaws. While the jaws are closing it reads the input from microswitch S4. This is one of the limit switches mounted on the gearbox.

When the jaws eventually come together, S4 closes and gives a high output. If the input from this switch is low, it means that the jaws have not reached their closed positions. The program also reads switch S5, which is the microswitch on the pressure jaw. Its output goes low when there is pressure on the jaw, indicating that the jaws are gripping an object.

The flowchart in Fig.6.7 shows the part of **Grabbit:** that uses the two microswitches. The PIC waits in a loop,

reading the input from S4 and S5 until either the jaws are closed but empty, or an object is gripped. If there is nothing in the jaws, the motor is stopped and the program returns with 00 in W. If an object is gripped, the motor is allowed to run a little more to tighten the grip, and then stopped. The program raises the jaws and returns with 01 in W.

If an object is successfully grabbed, the robot runs a zigzag course away from the site, drops the object, lowers the jaws to rest on the surface (a safety precaution in real life), and the program ends. However, two things may happen to prevent the program reaching its end. The robot may fail to find an object or, having found one, may fail to grab it firmly.

In the first event, the program goes to **Waiting:**, where it enters a loop. This loop is based on the assumption that no, or very few, objects are available. SK-3 stays in one place with its jaws open, waiting for an object to be placed between them. It waits indefinitely but, as soon as we give it an object, it tries to grab it, and the program continues as before.

If it fails to grab the object, the program enters another loop at **Nextgo:**. This loop assumes that there are plenty of objects but they are difficult to pick up. The loop gives the robot five tries at the **Raster:** routine, looking for other objects. If it still fails to find one it goes to the **Waiting:** loop where it waits to be given one.

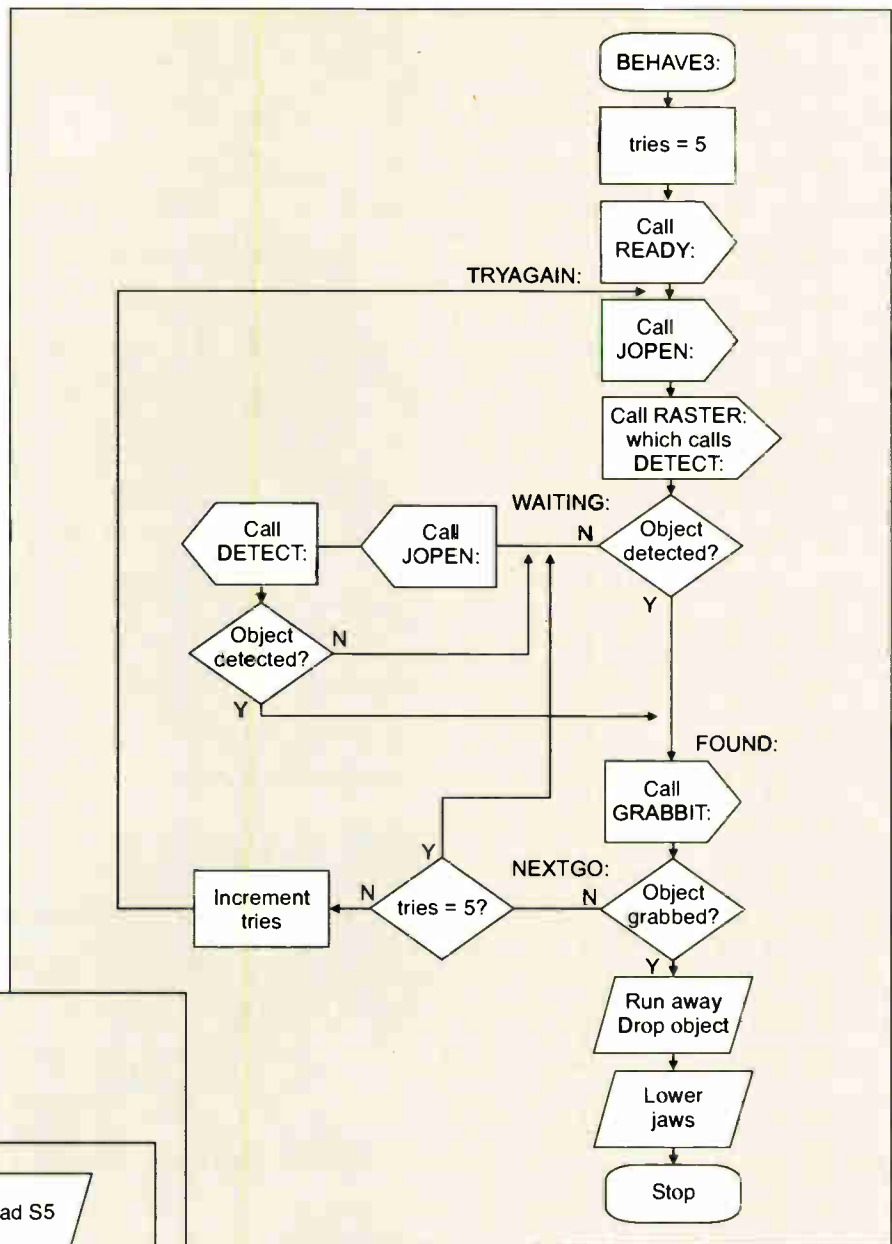

Fig.6.6. Flowchart of the Behave3: program

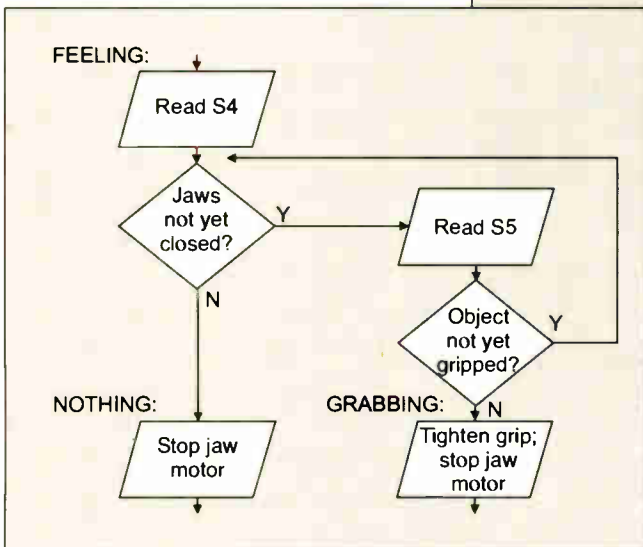
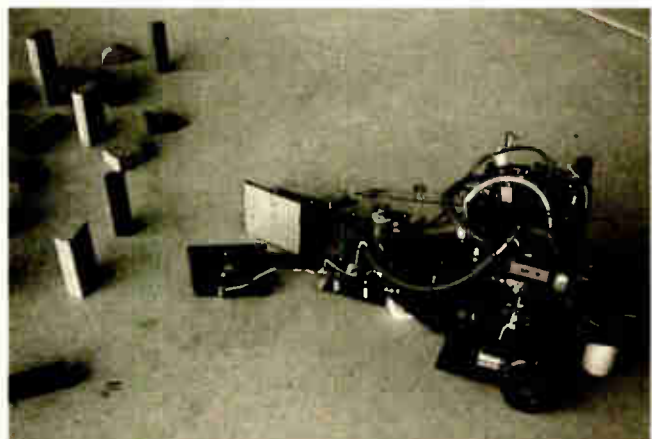

Fig.6.7. Flowchart of part of the Grabbit: subroutine

This program needs a large flat area. Scatter small objects (such as toy building bricks) in the central region of the area, about 10cm apart. Place SK-3 with its jaws facing the cluster of objects (see photo below) and switch on.



Seen from above, the grabber comprises a motor-driven gearbox and two arms. The upper arm in the photo is the pressure-sensitive arm



On the floor of the author's garage, SK-3 prepares to steal a brick

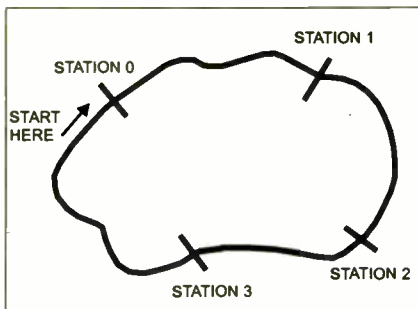
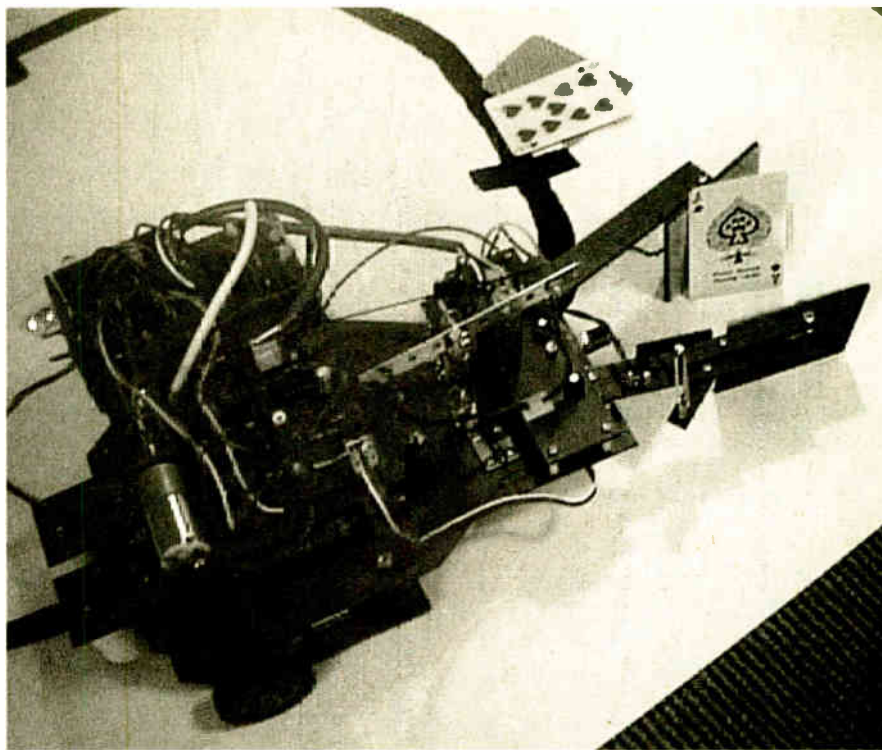

Fig.6.8. A possible path for the Behave4: program. Paint the path about 20-25 mm wide on white card, using black acrylic paint. Radius of bends should be at least 70mm. The stations are painted as transverse blocks



Smart Kart SK-3 about to "deal" an ace to a player's station at the gaming table.

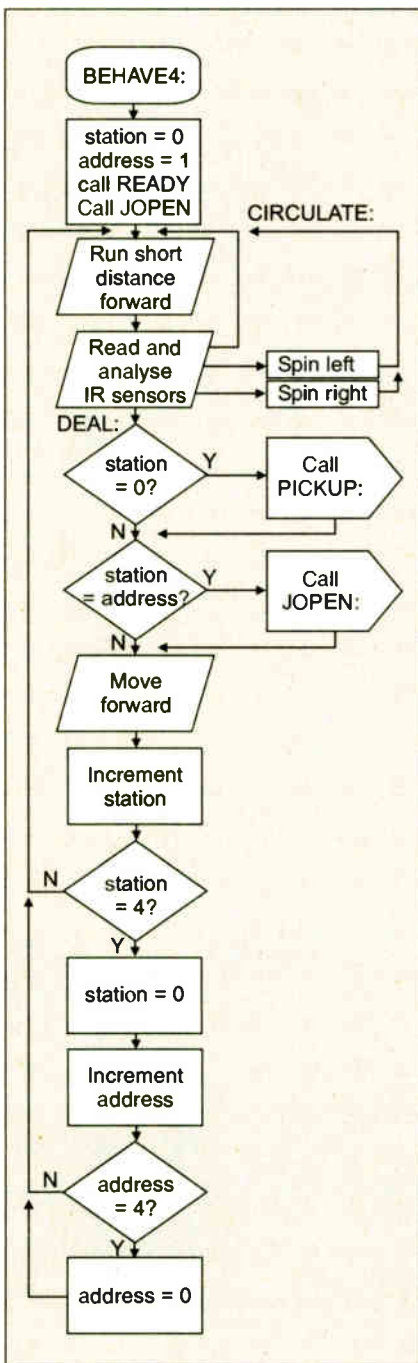

Fig.6.9. Flow chart of the Deal the Pack Behave4: program



Close-up of one of the two, front-mounted, infra-red line sensors.

### Deal the Pack

Both Select switches S1 and S2 are turned on to enable the Deal the Pack routine. The program is based on the Line Runner With Stations program (Behave2:) described for SK-1 (Part 2). This uses the two infra-red sensors to guide the robot along a path that is a closed loop, see "line-runner map", shown in fig.6.8.

When running this program the robot behaves like a person dealing a pack of cards. When it is at Station 0 (the dealer's station), the robot is given a playing card and then distributes it to one of the stations, including Station 0. On successive rounds it drops a card at each station in turn.

The program (Fig.6.9) is the same as the line-follower up to the point at which the robot reaches a station. There, instead of the previous routine (Break:) we have a new one called Deal:. This uses two

variables, **station** and **address**, to keep track of the robot's activities.

A lap takes the robot once round the track from Station 0 and back to Station 0. The **station** variable is the number of the station at which the robot is going to stop next. The **address** variable is the number of the station at which it is going to drop the card.

### Let's Play

There are two simple rules for the Deal the Pack Behave4: program:

- Pick up a card when **station = 0**
- Drop the card when **station = address**

Assuming that SK-3 is circulating clockwise, it drops the card at Station 1 in loop 1, at Station 2 in loop 2, at Station 3 in loop 3 and at Station 0 in loop 4. Then it repeats.

The **Pickup:** subroutine calls **Ready:**, **Jopen:** and **Detect:**, waiting in a loop until an object is placed between the jaws. Then it calls **Grabbit:** to grasp the object. On returning from **Grabbit:** it does not check to find out if an object is grabbed. With a very thin object, such as a card, it is not possible to tell. So the robot relies on the operator to place the object accurately and check that it is firmly held.

To drop the card at the station the program simply calls **Jopen:**. The robot then moves forward a short distance to clear the station but, before proceeding to the next station, **station** and **address** are updated. They are ready to tell the robot what to do at the next station.

Using a painted path similar to Fig.6.8, place the robot on the path where it says Start Here. It should be facing forward, that is with its jaws facing away from Station 0. Run the program. Feed the robot with an object every time it comes to Station 0. It has an insatiable appetite!

### Next Month

Next month, in part 7, our buggy gets into *Son et Lumiere* and PICs up the art of cybernetic singing and dancing!

# READOUT

Email: john.becker@wimborne.co.uk

**John Becker addresses some of the general points readers have raised. Have you anything interesting to say? Drop us a line!**

All letters quoted here have previously been replied to directly.

## WIN AN ATLAS LCR ANALYSER WORTH £79

An Atlas LCR Passive Component Analyser, kindly donated by Peak Electronic Design Ltd., will be awarded to the author of the *Letter Of The Month* each month.

The Atlas LCR automatically measures inductance from 1 $\mu$ H to 10H, capacitance from 1pF to 10,000 $\mu$ F and resistance from 1 $\Omega$  to 2M $\Omega$  with a basic accuracy of 1%.



## ★ LETTER OF THE MONTH ★

### Locating GPS and Rugby

Dear EPE,

Although I won't be constructing the *Speed Camera Watch* (Jan '05), I have been interested in GPS (which it uses) for a long time. However, GPS instruments are too expensive for me to experiment with, so the latest article was very useful in pointing to an affordable module, and gave me a good start with a lot of the groundwork already done.

I took up electronics as a hobby when nearing retirement, after ten early years as an electronics engineer – it was all valves then – and thirty years teaching computer programming, and have subscribed to *EPE* since 1996. I had to learn about op.amps and transistors, and a lot of that came from *EPE*. I am also now a radio ham, licensed in 2000, and have built an Elecraft K2 as my HF rig, but its output goes to a loudspeaker driven by *EPE* audio amplifier circuits, and I used an oscillator from an *EPE* series to learn to send Morse.

My signal generator is from *EPE* Oct '96, and I have *Icebreaker* and *Toolkit TK3*. My hi-fi is turned on and off for

recording programmes while I am out, by the radio-controlled clock from *EPE* Nov '97. My latest project was to adapt the receiver from a pair of wireless earphones to drive a loudspeaker instead, and, you've guessed it, it's an *EPE* audio amplifier that drives the speaker.

While I was still working, in the nineties, I heard of the Rugby transmissions and tried to find out about a receiver. One of the articles sent to me by NPL (National Physical Laboratory) was from long ago and written by one John Becker. I didn't build it but I learned a lot from it.

**Harry Weston, via email**

*Thanks for this Harry. I've a feeling we shall see more designs that use the GPS Module referred to. Rugby – there's nostalgia, I had great fun with producing that design for EPE, in the late 80s I think. It was built entirely around standard logic chips, even the receiver! My more recent one used a Maplin receiver module, and I fed its output into a PIC, which did all the decoding.*

*More power to your continued enjoyment of us and your electronics!*

(We agree, we don't like cheap insulated screwdriver testers either.)

Not only is it against accepted codes of practice to use non-approved electrical equipment, it is also illegal to sell or make available for supply any equipment that is not CE approved and suitably marked. Trading Standards officers are now well equipped to deal with this aspect.

There is still nothing to stop *EPE* readers from making mains-operated plug-in equipment, or making their own tests and checks on domestic wiring, or indeed making minor electrical repairs of their own. It would be a very sad day if it should be deemed illegal for a hobbyist to solder up a transformer and plug it into the mains.

Where necessary, *EPE* dispenses strong warnings to caution readers against making wiring modifications when they do not have competence, and they should consult a qualified electrician where in doubt. Readers have always been left to use their judgment about this and this formula has worked perfectly for 40-odd years.

**Alan Winstanley**

### Electrical Installations

Dear EPE,

As one of the qualified jobsworth electricians mentioned in the letter from George Chatley (Feb '05) I would just like to add my voice to his comments. The Building Regulations have been amended to cover all electrical work carried out in a domestic property. They apply when building work is undertaken and the new *Part P* covers electrical work. These regulations require that:

1. Reasonable provision should be made in the design, installation, inspection and testing of electrical installations.

2. Sufficient information should be provided so that people wishing to operate, maintain or alter electrical equipment can do so with reasonable safety. Any major work carried out will have to be self-certificated by a competent person.

The work covered is major works involving rewiring or anything requiring a new circuit. Minor works like adding an additional light or socket or replacing accessories are not notifiable, but you will need to read the approved document to see what is covered. Any major work carried out which is subject to the provisions of *Part P* will have to be notified to the local authority and would normally have to be inspected by the local building control department.

But, to avoid the need for the building control department to appoint special agents, they will accept certificates of compliance from "Competent Firms",

### A Shocking State

Dear EPE,

I realise that your publication is not aimed at electrical issues but I wish to draw attention to the Oct '02 *Circuit Surgery* section headed "A Shocking State". The remark that there are "plenty of low cost voltage testers available" will in my opinion only increase the risk of serious injury or death to members of the public who have little or no knowledge of the dangers.

The use of *non-approved* voltage testers for safe isolation of supplies is against all safety codes of practice, the inherent danger of multimeters is well known within the electrical trade, and the use of mains tester screwdrivers to check for the presence of lethal voltages is definitely not on. Any instrument that requires yourself to be part of the circuit under test is asking for trouble.

A vast number of these devices are purchased from unproven sources, i.e. boot-fairs and market stalls, and are of unknown origin. Malfunction of these can cause the full mains voltage to appear at the metal end cap. The non-contact type, which operate on the presence of a magnetic field, can give false information.

There is a correct procedure for safe isolation which requires an approved voltage

tester to GS38 standard, which must be proved to function both before and after checking the circuit in question. The obvious solution, however, is to leave it to the professionals, which from 1st January 2005 carries the force of the law, up to a point.

From 1st January *no person* may carry out the majority of electrical work on domestic premises without holding a particular self-certification qualification, unless such work is authorised by the local council's department who will come and test the installation afterwards, at cost to yourselves.

Failure to comply can result in a fine up to £5000, and this is to be extended to cover DIYers. Further information on domestic electrical work can be found initially at [www.partp.com](http://www.partp.com).

**Martyn Briggs, Lecturer (Electrotech), Chelmsford College, via email**

*Circuit Surgeon Alan Winstanley replies:*

Your point is taken about the use of cheap non-approved mains testing equipment, and we would always encourage readers to put quality first when choosing such items. There are, however, a number of low cost CE-approved testers available.

which means appropriately approved electrical contractors are able to certificate the work. Approved contractors have to be registered with an approved body like the NICEIC or ECA (National Inspection Council for Electrical Installation Contracting, and Electrical Contractors Association).

As most house-holders would not have any idea in regard to design or the regulations (BS 7671) which cover all electrical installation work, or even have the relevant test instruments required (which are expensive) for testing, you can see why they could not be called "competent".

Visit the NICEIC web site for further information [www.niceic.org.uk](http://www.niceic.org.uk) and click on the *Part P* link. The main implication of this is that failure to comply with the requirement will be a criminal offence and that local authorities will have the power to have the work removed if it does not comply.

Can I just add that I have been reading your mag since the early 70s and have built quite a lot of projects over the years with some actually still in use. Keep up the good work.

Peter Goater, via email

*Thank you Peter, that's useful info.*

## MORE ON REGS

Dear EPE,

Regarding George Chatley's letter, "Shorting-out DIY?", Feb '05, as a Qualified Electrical Engineer and now Practising Handyman, I feel compelled to calm him, and hopefully enlighten your other readers to the law.

First of all, if you intend to do electrical work in your home, visit the government web site at:

[www.odpm.gov.uk/stellent/groups/odpm\\_buildreg/documents/page/odpm\\_breg\\_033480.hcsp](http://www.odpm.gov.uk/stellent/groups/odpm_buildreg/documents/page/odpm_breg_033480.hcsp)

And this next link will show you if you do, or do not need to notify:

[www.niceic.org.uk/partp/notification.html](http://www.niceic.org.uk/partp/notification.html)

The new rules affect anyone doing electrical work in the home, including DIYers and should be read and understood. Nobody likes being told what to do, least of all me, who has been doing electrical and electronic installations and design and testing for 20 years, but there are always good reasons for changes in building regulations. Practically, the Building Regs have been changed to prevent the home owner from "cowboy" builders.

The rules will not stop you changing a socket or a switch or adding a bit of wire in the attic for your soldering iron. What they will do, however, is help to ensure that if anyone gets killed or injured by your or a cowboy's electrics, they will have some legal tool against you or that person for not following the regulations.

Having said that, I must point out that for any place containing water, i.e. bathroom, kitchen, utility room or outside, there are special requirements, zones and specifications for enclosures and positioning of equipment and cable and earthing. For these areas you are bound to get an electrical contractor, or you must contact your local building control department who will be pleased to advise you on a correct course of action. Visit

[www.niceic.org.uk/](http://www.niceic.org.uk/) before you decide to do anything yourself.

From an electronics point of view, which is what I am interested in at home, there are British Standards for just about everything manufactured, to safe guard the public and users of equipment from injury or death. When I design anything electronic at home I try to make it in a way which would be able to be sold in a shop, especially if another member of my family is going to use it.

We should take the change in the electrical regs as a warning. As electronics enthusiasts we should all try to conform our electronics DIY projects to a reasonable safety and harmonious standard.

Terry Middlebrook, via email

*Thank you Terry for your useful comments as well.*

## Mains Projects Safety

Dear EPE,

I notice in *PIC Electric Mk2* (Feb '05) that you again stress the safety procedures to be followed when building and testing mains powered circuits – this cannot be stated too often. However, we are all fallible and it is all too easy to forget whether the circuit is powered or not as we dive in with our multimeters, scope probes (and fingers!). Even having a low voltage i.e.d. to show the circuit is on assumes that the transformer, rectifier, etc. are working (and that the i.e.d. is the right way round!).

When I build any mains powered circuit I always build in a 230V neon across the mains lead at the first point where it enters the circuit or the enclosure. This ensures that I can tell at a glance if the circuit is live and has saved me from several nasty "belts" over the years. It only costs a few pence and could be a life saver.

Roger Redman, via email

*Thanks for that Roger. My own view is that there is nothing to beat the sight of the mains plug's naked pins beside you on the workbench, then you know it's unplugged! Useful though neons may be, even they can fail.*

## Universal NiMH Charger?

Dear EPE,

How about a project for a universal NiMH charger? When I bought my Sony CyberShot digital camera, I got a charger and two Sony 2100mAh NiMH batteries in the box. Soon afterwards, I bought two (non-Sony) 1800mAh NiMH backup batteries. Although the Sony charger could charge them, they only lasted for two to three photo shots. I then bought a charger with four 2300mAh NiMH batteries. The problem with this charger is that it only shows that it is busy charging the batteries, but not when the charge is completed. NiMH batteries should not be overcharged, but with this new charger I have no idea if a set of batteries has been charged.

So now I have enough batteries, but I have to take along two chargers. Could *EPE* present a proper charger project that can charge AA NiMH batteries from, say, 1800mAh to 3200mAh?

Pieter Kruger, Bloemfontein, South Africa

*Well readers – are any of you sufficiently expert in battery chargers that you might offer us your own design which would suit Pieter, and other readers too?*

## Speed Camera Watch

Dear EPE,

I am intrigued by the letter from Robert Talbot, Member of the Institute of Advanced Motorists, in the Feb '05 issue. I drive approximately 50,000 miles a year in the UK with my job and I can tell you not all speed cameras are located to be clearly visible nor are they all now yellow. If you get off the M1 at J24 and take the road out of Kegworth in Leicestershire towards the A6 to Loughborough, you will find a camera on the opposite side of the road on the exit of a sharp blind bend. So they do end up on blind bends.

Also, on the A1 southbound near Grantham, there is a camera a few yards behind a road sign! Were it not for the graduations on the road you would be unlikely to know it was there before you had passed it, especially in the dark and rain. I could go on.

Mr Talbot might have had a point had he referred to the (slight!) distraction that may ensue when using the electronic unit while travelling, but he is incorrect about speed camera practice.

Kevin Bell, via email

*Thank you Kevin.*

## Challenging!

Dear EPE,

I refer to George Chatley's letter in *Readout* Jan '05 and take up arms and rush to John's Becker's defence. Perhaps George is picking just one small part of the whole spectrum of technology and saying you have no ideas in that small part. *EPE*, commendably, does not try to spread itself too thin, so it is easy to pick a part in the overall picture to which you have made no contribution.

To me your innovation is twofold, what I might call, to borrow from PIC terms, direct and indirect innovation. Direct innovation is the articles which are in their own right innovative, and there are plenty of those. Of course, the editorial policy is to maintain reader interest by publishing articles about projects which are do-able. Without reader interest, *EPE* dies and we would all be the losers.

Indirect innovation is what has mostly kept me coming to the table. I learn about PICs, for example, in tutorial type articles, which might or might not be direct innovation in their own right, but which spur me on to do my own innovative stuff, using the tools learnt from *EPE*. The knowledge thereby gained enables me to move quickly up a learning curve to do the things which are my prime interest.

Long live *EPE* and all the best to you for 2005.

John Waller, Plainfield, USA,  
via email

*Thank you John. We too believe that people learn from studying how others tackle problems, even if they don't actually build the published designs.*



# DrDAQ Data Logger

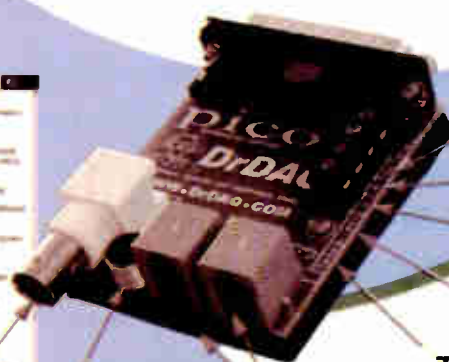

- Low cost- under £60
- Built in sensors for light, temperature and sound (level and waveforms)
- Use DrDAQ to capture fast signals
- Outputs for control experiments
- Supplied with both PicoScope (oscilloscope) and PicoLog (data logging) software

External sensors: Humidity  
Temperature  
O2 In Air  
Reed Switch

For more information on DrDAQ, please visit:

[www.picotech.com/drdaq113](http://www.picotech.com/drdaq113)

## PC Oscilloscopes

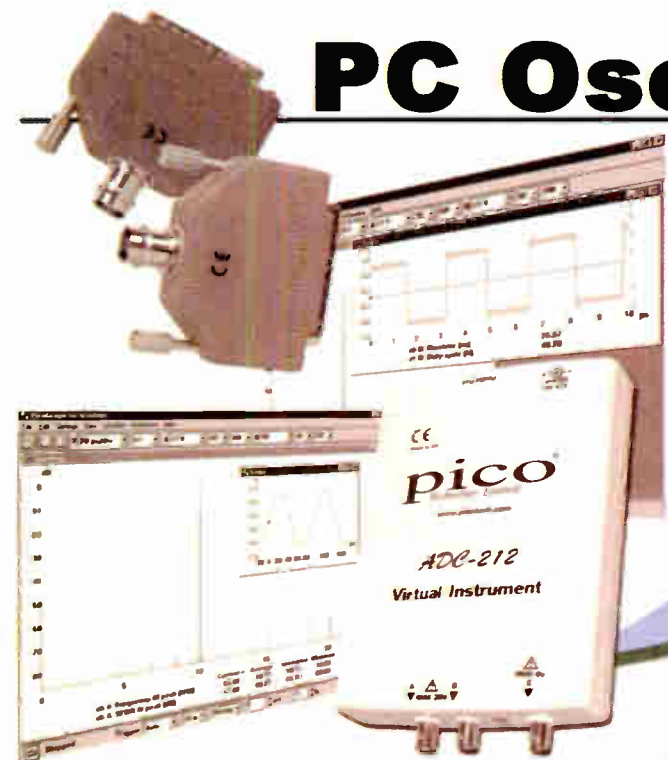

- Scope and spectrum analyser functions
- A fraction of the cost of benchtop scope
- Save multiple setups, for ease of use
- Save, print and e-mail your traces
- FREE technical support for life
- FREE software and upgrades
- Automated measurements

For more information on our scopes, please visit:

[www.picotech.com/scope244](http://www.picotech.com/scope244)

Tel: 01480 396395 Fax: 01480 396296 E-mail: [sales@picotech.com](mailto:sales@picotech.com)

# EPE IS PLEASED TO BE ABLE TO OFFER YOU THESE ELECTRONICS CD-ROMS

## ELECTRONICS PROJECTS



Logic Probe testing

*Electronic Projects* is split into two main sections: **Building Electronic Projects** contains comprehensive information about the components, tools and techniques used in developing projects from initial concept through to final circuit board production. Extensive use is made of video presentations showing soldering and construction techniques. The second section contains a set of ten projects for students to build, ranging from simple sensor circuits through to power amplifiers. A shareware version of Matrix's CADPACK schematic capture, circuit simulation and p.c.b. design software is included.

The projects on the CD-ROM are: Logic Probe; Light, Heat and Moisture Sensor; NE555 Timer; Egg Timer; Dice Machine; Bike Alarm; Stereo Mixer; Power Amplifier; Sound Activated Switch; Reaction Tester. Full parts lists, schematics and p.c.b. layouts are included on the CD-ROM.

## ELECTRONICS CAD PACK

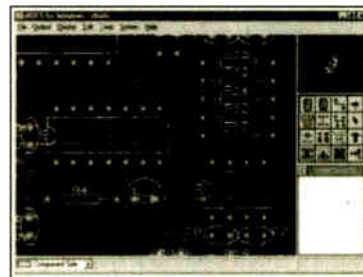

PCB Layout

Electronics CADPACK allows users to design complex circuit schematics, to view circuit animations using a unique SPICE-based simulation tool, and to design printed circuit boards. CADPACK is made up of three separate software modules. (These are restricted versions of the full Labcenter software.) **ISIS Lite** which provides full schematic drawing features including full control of drawing appearance, automatic wire routing, and over 6,000 parts. **PROSPICE Lite** (integrated into ISIS Lite) which uses unique animation to show the operation of any circuit with mouse-operated switches, pots, etc. The animation is compiled using a full mixed mode SPICE simulator. **ARES Lite** PCB layout software allows professional quality PCBs to be designed and includes advanced features such as 16-layer boards, SMT components, and an autorouter operating on user generated Net Lists.

## ELECTRONIC CIRCUITS & COMPONENTS V2.0

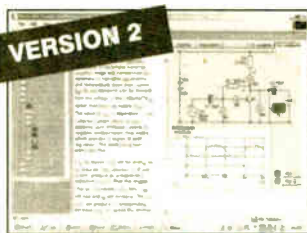

Circuit simulation screen

Provides an introduction to the principles and application of the most common types of electronic components and shows how they are used to form complete circuits. The virtual laboratories, worked examples and pre-designed circuits allow students to learn, experiment and check their understanding. Version 2 has been considerably expanded in almost every area following a review of major syllabuses (GCSE, GNVQ, A level and HNC). It also contains both European and American circuit symbols. Sections include: **Fundamentals:** units & multiples, electricity, electric circuits, alternating circuits. **Passive Components:** resistors, capacitors, inductors, transformers. **Semiconductors:** diodes, transistors, op.amps, logic gates. **Passive Circuits. Active Circuits. The Parts Gallery** will help students to recognise common electronic components and their corresponding symbols in circuit diagrams. Included in the Institutional Versions are multiple choice questions, exam style questions, fault finding virtual laboratories and investigations/worksheets.

## ANALOGUE ELECTRONICS

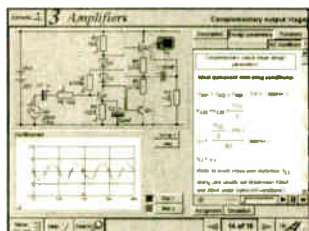

Complimentary output stage

*Analogue Electronics* is a complete learning resource for this most difficult branch of electronics. The CD-ROM includes a host of virtual laboratories, animations, diagrams, photographs and text as well as a SPICE electronic circuit simulator with over 50 pre-designed circuits.

Sections on the CD-ROM include: **Fundamentals** – Analogue Signals (5 sections), Transistors (4 sections), Waveshaping Circuits (6 sections), **Op.Amps** – 17 sections covering everything from Symbols and Signal Connections to Differentiators. **Amplifiers** – Single Stage Amplifiers (8 sections), Multi-stage Amplifiers (3 sections), **Filters** – Passive Filters (10 sections), Phase Shifting Networks (4 sections), Active Filters (6 sections), **Oscillators** – 6 sections from Positive Feedback to Crystal Oscillators. **Systems** – 12 sections from Audio Pre-Amplifiers to 8-Bit ADC plus a gallery showing representative p.c.b. photos.

## DIGITAL ELECTRONICS V2.0

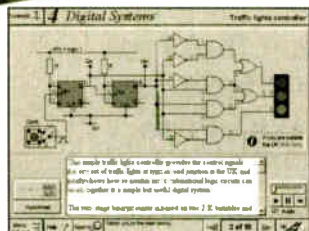

Virtual laboratory – Traffic Lights

*Digital Electronics* builds on the knowledge of logic gates covered in *Electronic Circuits & Components* (opposite), and takes users through the subject of digital electronics up to the operation and architecture of microprocessors. The virtual laboratories allow users to operate many circuits on screen.

Covers binary and hexadecimal numbering systems, ASCII, basic logic gates, monostable action and circuits, and bistables – including JK and D-type flip-flops. Multiple gate circuits, equivalent logic functions and specialised logic functions. Introduces sequential logic including clocks and clock circuitry, counters, binary coded decimal and shift registers. A/D and D/A converters, traffic light controllers, memories and microprocessors – architecture, bus systems and their arithmetic logic units. Sections on Boolean Logic and Venn diagrams, displays and chip types have been expanded in Version 2 and new sections include shift registers, digital fault finding, programmable logic controllers, and microcontrollers and microprocessors. The Institutional versions now also include several types of assessment for supervisors, including worksheets, multiple choice tests, fault finding exercises and examination questions.

## ANALOGUE FILTERS



Filter synthesis

*Analogue Filters* is a complete course in designing active and passive filters that makes use of highly interactive virtual laboratories and simulations to explain how filters are designed. It is split into five chapters: **Revision** which provides underpinning knowledge required for those who need to design filters. **Filter Basics** which is a course in terminology and filter characterization, important classes of filter, filter order, filter impedance and impedance matching, and effects of different filter types. **Advanced Theory** which covers the use of filter tables, mathematics behind filter design, and an explanation of the design of active filters. **Passive Filter Design** which includes an expert system and filter synthesis tool for the design of low-pass, high-pass, band-pass, and band-stop Bessel, Butterworth and Chebyshev ladder filters. **Active Filter Design** which includes an expert system and filter synthesis tool for the design of low-pass, high-pass, band-pass, and band-stop Bessel, Butterworth and Chebyshev

## ROBOTICS & MECHATRONICS

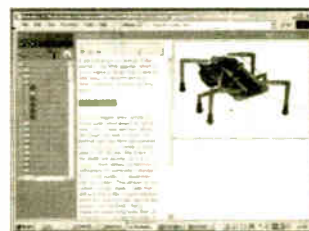

Case study of the Millford Instruments Spider

Robotics and Mechatronics is designed to enable hobbyists/students with little previous experience of electronics to design and build electromechanical systems. The CD-ROM deals with all aspects of robotics from the control systems used, the transducers available, motors/actuators and the circuits to drive them. Case study material (including the NASA Mars Rover, the Millford Spider and the Furby) is used to show how practical robotic systems are designed. The result is a highly stimulating resource that will make learning, and building robotics and mechatronic systems easier. The Institutional versions have additional worksheets and multiple choice questions.

- Interactive Virtual Laboratories
- Little previous knowledge required
- Mathematics is kept to a minimum and all calculations are explained
- Clear circuit simulations

## PRICES

Prices for each of the CD-ROMs above are:

(Order form on third page)

Hobbyist/Student .....£45 inc VAT  
 Institutional (Schools/HE/FE/Industry).....£99 plus VAT  
 Institutional 10 user (Network Licence) .....£249 plus VAT  
 Site Licence.....£499 plus VAT

(UK and EU customers add VAT at 17.5% to "plus VAT" prices)

# PICmicro TUTORIALS AND PROGRAMMING

## HARDWARE

### VERSION 2 PICmicro MCU DEVELOPMENT BOARD

*Suitable for use with the three software packages listed below.*

This flexible development board allows students to learn both how to program PICmicro microcontrollers as well as program a range of 8, 18, 28 and 40-pin devices. For experienced programmers all programming software is included in the PPP utility that comes with the development board. For those who want to learn, choose one or all of the packages below to use with the Development Board.

- Makes it easier to develop PICmicro projects
- Supports low cost Flash-programmable PICmicro devices
- Fully featured integrated displays – 13 individual l.e.d.s, quad 7-segment display and alphanumeric l.c.d. display
- Supports PICmicro microcontrollers with A/D converters
- Fully protected expansion bus for project work
- All inputs and outputs available on screw terminal connectors for easy connection

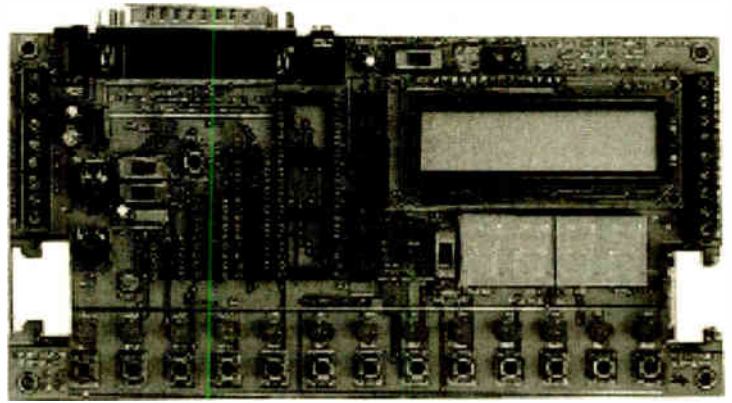

**£145 including VAT and postage**

**12V 500mA plug-top PSU (UK plug) £7**

**25-way 'D' type connecting cable £5**

## SOFTWARE

*Suitable for use with the Development Board shown above.*

### NEW V3

#### ASSEMBLY FOR PICmicro V3 (Formerly PICtutor)

Assembly for PICmicro microcontrollers V3.0 (previously known as PICtutor) by John Becker contains a complete course in programming the PIC16F84 PICmicro microcontroller from Arizona Microchip. It starts with fundamental concepts and extends up to complex programs including watchdog timers, interrupts and sleep modes. The CD makes use of the latest simulation techniques which provide a superb tool for learning: the Virtual PICmicro microcontroller. This is a simulation tool that allows users to write and execute MPASM assembler code for the PIC16F84 microcontroller on-screen. Using this you can actually see what happens inside the PICmicro MCU as each instruction is executed which enhances understanding.

- Comprehensive instruction through 45 tutorial sections
- Includes Vlab, a Virtual PICmicro microcontroller: a fully functioning simulator
- Tests, exercises and projects covering a wide range of PICmicro MCU applications
- Includes MPLAB assembler
- Visual representation of a PICmicro showing architecture and functions
- Expert system for code entry helps first time users
- Shows data flow and fetch execute cycle and has challenges (washing machine, lift, crossroads etc.)
- Imports MPASM files.

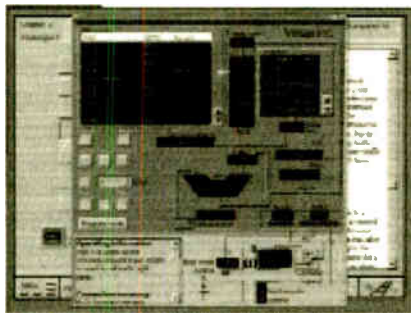

Virtual PICmicro

#### 'C' FOR PICmicro VERSION 2

The C for PICmicro microcontrollers CD-ROM is designed for students and professionals who need to learn how to program embedded microcontrollers in C. The CD contains a course as well as all the software tools needed to create Hex code for a wide range of PICmicro devices – including a full C compiler for a wide range of PICmicro devices.

Although the course focuses on the use of the PICmicro microcontrollers, this CD-ROM will provide a good grounding in C programming for any microcontroller.

- Complete course in C as well as C programming for PICmicro microcontrollers
- Highly interactive course
- Virtual C PICmicro improves understanding
- Includes a C compiler for a wide range of PICmicro devices
- Includes full Integrated Development Environment
- Includes MPLAB software
- Compatible with most PICmicro programmers
- Includes a compiler for all the PICmicro devices.

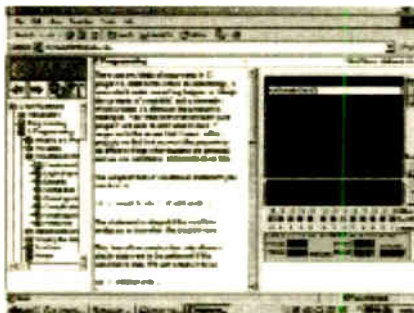

Minimum system requirements for these items: Pentium PC running Windows 98, NT, 2000, ME, XP; CD-ROM drive; 64MB RAM; 10MB hard disk space.

#### FLOWCODE FOR PICmicro V2

Flowcode is a very high level language programming system for PICmicro microcontrollers based on flowcharts. Flowcode allows you to design and simulate complex robotics and control systems in a matter of minutes.

Flowcode is a powerful language that uses macros to facilitate the control of complex devices like 7-segment displays, motor controllers and l.c.d. displays. The use of macros allows you to control these electronic devices without getting bogged down in understanding the programming involved.

Flowcode produces MPASM code which is compatible with virtually all PICmicro programmers. When used in conjunction with the Version 2 development board this provides a seamless solution that allows you to program chips in minutes.

- Requires no programming experience
- Allows complex PICmicro applications to be designed quickly
- Uses international standard flow chart symbols (ISO5807)
- Full on-screen simulation allows debugging and speeds up the development process
- Facilitates learning via a full suite of demonstration tutorials
- Produces ASM code for a range of 18, 28 and 40-pin devices
- Professional versions include virtual systems (burglar alarm, buggy and maze, plus RS232, IrDa etc.).

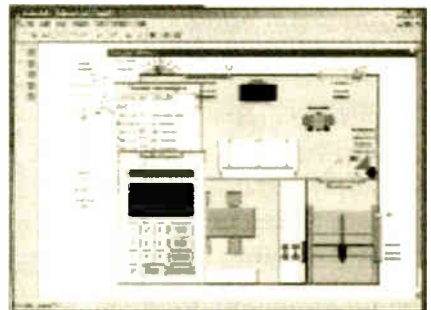

Burglar Alarm Simulation

## PRICES

Prices for each of the CD-ROMs above are:

*(Order form on next page)*

*(UK and EU customers add VAT at 17.5% to "plus VAT" prices)*

Hobbyist/Student  
Flowcode V2 Hobbyist/Student  
Institutional (Schools/HE/FE/Industry)  
Flowcode Professional  
Institutional/Professional 10 user (Network Licence)  
Site Licence

£45 inc VAT  
£57 inc VAT  
£99 plus VAT  
£99 plus VAT  
£300 plus VAT  
£599 plus VAT

# TEACH-IN 2000 – LEARN ELECTRONICS WITH EPE

EPE's own *Teach-In* CD-ROM, contains the full 12-part *Teach-In* series by John Becker in PDF form plus the *Teach-In* interactive software (Win 95, 98, ME and above) covering all aspects of the series. We have also added Alan Winstanley's highly acclaimed *Basic Soldering Guide* which is fully illustrated and which also includes *Desoldering*. The *Teach-In* series covers: Colour Codes and Resistors, Capacitors, Potentiometers, Sensor Resistors, Ohm's Law, Diodes and L.E.D.s, Waveforms, Frequency and Time, Logic Gates, Binary and Hex Logic, Op.amps, Comparators, Mixers, Audio and Sensor Amplifiers, Transistors, Transformers and Rectifiers, Voltage Regulation, Integration, Differentiation, 7-segment Displays, L.C.D.s, Digital-to-Analogue. Each part has an associated practical section and the series includes a simple PC interface (Win 95, 98, ME ONLY) so you can use your PC as a basic oscilloscope with the various circuits.



Sine wave relationship values

A hands-on approach to electronics with numerous breadboard circuits to try out.

**£12.45** including VAT and postage. Requires Adobe Acrobat (available free from the Internet – [www.adobe.com/acrobat](http://www.adobe.com/acrobat)).

**FREE WITH EACH TEACH-IN CD-ROM** – *Electronics Hobbyist Compendium* 80-page book by Robert Penfold. Covers Tools For The Job; Component Testing; Oscilloscope Basics.

**FREE BOOK WITH TEACH-IN 2000 CD-ROM**

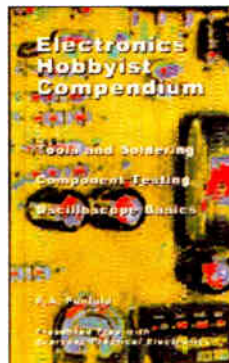

# DIGITAL WORKS 3.0

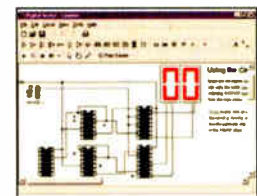

Counter project

*Digital Works Version 3.0* is a graphical design tool that enables you to construct digital logic circuits and analyze their behaviour. It is so simple to use that it will take you less than 10 minutes to make your first digital design. It is so powerful that you will never outgrow its capability ● Software for simulating digital logic circuits ● Create your own macros – highly scalable ● Create your own circuits, components, and i.c.s ● Easy-to-use digital interface ● Animation brings circuits to life ● Vast library of logic macros and 74 series i.c.s with data sheets ● Powerful tool for designing and learning. **Hobbyist/Student £45 inc. VAT. Institutional £99 plus VAT. Institutional 10 user £249 plus VAT. Site Licence £599 plus VAT.**

## ELECTRONICS IN CONTROL

Two colourful animated courses for students on one CD-ROM. These cover Key Stage 3 and GCSE syllabuses. **Key Stage 3:** A pictorial look at the Electronics section featuring animations and video clips. Provides an ideal introduction or revision guide, including multi-choice questions with feedback. **GCSE:** Aimed at the Electronics in many Design & Technology courses, it covers many sections of GCSE Electronics. Provides an ideal revision guide with Homework Questions on each chapter. Worked answers with an access code are provided on a special website.

**Single User £29 inc. VAT. Multiple User £39 plus VAT**  
**Student copies (available only with a multiple user copy) £6 plus VAT**  
*(UK and EU customers add VAT at 17.5% to "plus VAT" prices)*

## MODULAR CIRCUIT DESIGN

Contains a range of tried and tested analogue and digital circuit modules, together with the knowledge to use and interface them. Thus allowing anyone with a basic understanding of circuit symbols to design and build their own projects. Version 3 includes data and circuit modules for a range of popular PICs; includes PICAXE circuits, the system which enables a PIC to be programmed without a programmer, and without removing it from the circuit. Shows where to obtain free software downloads to enable BASIC programming. Essential information for anyone undertaking GCSE or "A" level electronics or technology and for hobbyists who want to get to grips with project design. Over seventy different Input, Processor and Output modules are illustrated and fully described, together with detailed information on construction, fault finding and components, including circuit symbols, pinouts, power supplies, decoupling etc.

**Single User £19.95 inc. VAT. Multiple User £34 plus VAT**  
*(UK and EU customers add VAT at 17.5% to "plus VAT" prices)*

**VERSION 3**

## ELECTRONIC COMPONENTS PHOTOS

A high quality selection of over 200 JPG images of electronic components. This selection of high resolution photos can be used to enhance projects and presentations or to help with training and educational material. They are royalty free for use in commercial or personal printed projects, and can also be used royalty free in books, catalogues, magazine articles as well as worldwide web pages (subject to restrictions – see licence for full details). Also contains a **FREE** 30-day evaluation of Paint Shop Pro 6 – Paint Shop Pro image editing tips and on-line help included!



**Price £19.95 inc. VAT**

Minimum system requirements for these CD-ROMs: Pentium PC, CD-ROM drive, 32MB RAM, 10MB hard disk space. Windows 95/98/NT/2000/ME/XP, mouse, sound card, web browser.

### Please send me: **CD-ROM ORDER FORM**

- Electronic Projects
- Electronic Circuits & Components V2.0
- Analogue Electronics
- Digital Electronics V2.0
- Filters
- Electronics CAD Pack
- Robotics & Mechatronics
- Assembly for PICmicro V2
- 'C' for PICmicro V2
- Flowcode V2 for PICmicro
- Digital Works 3.0

- Version required:
- Hobbyist/Student
  - Institutional
  - Institutional/Professional 10 user
  - Site Licence



- PICmicro Development Board V2 (hardware)
- Development Board UK plugtop power supply
- Development Board 25-way connecting lead

- Teach-In 2000 + FREE BOOK
- Electronic Components Photos
- Electronics In Control – Single User
- Electronics In Control – Multiple User
- Modular Circuit Design – Single User
- Modular Circuit Design – Multiple User

Note: The software on each version is the same, only the licence for use varies.

Full name: .....

Address: .....

.....Post code: .....Tel. No: .....

Signature: .....

I enclose cheque/PO in £ sterling payable to WIMBORNE PUBLISHING LTD for £ .....

Please charge my Visa/Mastercard/Amex/Diners Club/Switch: £ .....

Valid From: .....Card expiry date: .....

Card No: .....Switch Issue No. ....

Card Security Code ..... (The last 3 digits on or just under the signature strip)

## ORDERING

**ALL PRICES INCLUDE UK POSTAGE**

Student/Single User/Standard Version price includes postage to most countries in the world  
 EU residents outside the UK add £5 for airmail postage per order

**Institutional, Multiple User and Deluxe Versions** – overseas readers add £5 to the basic price of each order for airmail postage (do not add VAT unless you live in an EU (European Union) country, then add 17½% VAT or provide your official VAT registration number).

Send your order to:  
**Direct Book Service**

**Wimborne Publishing Ltd**  
 408 Wimborne Road East  
 Ferndown, Dorset BH22 9ND

To order by phone ring

**01202 873872. Fax: 01202 874562**

Goods are normally sent within seven days

E-mail: [orders@wimborne.co.uk](mailto:orders@wimborne.co.uk)

Online shop:

[www.epemag.wimborne.co.uk/shopdoor.htm](http://www.epemag.wimborne.co.uk/shopdoor.htm)

# Easy, Safe, Fast...

Get Your **FREE UK Pounds Sterling Priced Catalogue** - all 424 pages!  
Just fill out the catalogue request form at [www.jaycarelectronics.co.uk/catalogue](http://www.jaycarelectronics.co.uk/catalogue)

**Check our website!**

- All of our 6,000+ products with search facilities.
- 128-bit secure on-line ordering - safe & secure.
- Over 3,500 product datasheets & application notes.
- And we're from Australia, so you can trust us!
- Postage and Packing includes airmail to the UK, and is £5.00 for orders up to £49.99. See our website for all freight charges.



Moreinfo?

[www.jaycarelectronics.co.uk](http://www.jaycarelectronics.co.uk)



**FREE 424 page Catalogue**

**Performance Electronics for Cars Book**

B5-5080 £6.35 plus post & packing

Australia's leading electronics magazine, Silicon Chip, has developed a range of projects for performance cars. There are 16 projects in total, ranging from devices for remapping fuel curves, to nitrous controllers, and more! The book includes all instructions, components lists, colour pictures, and circuit layouts. There are also chapters on engine management, advanced systems, DIY modifications, and more. Over 150 pages! All of the projects described are available in kit form, exclusively from Jaycar. Check out our website for all the details.



**JUST ONE OF OUR MANY GREAT PRE-BUILT & TESTED CONSUMER PRODUCTS!**

**Map Reading Made Easy!**

XC-0375 £5.50 plus post and packing

The digital map distance calculator is truly a great device. All you have to do is program the scale of your map, then roll the wheel tip along the intended route. It will then display the **ACTUAL REAL WORLD DISTANCE** in miles (or kilometres) on the LCD. It is light and compact at around 5-inches long.



**Theremin Synthesiser Kit**

KC-5295 £13.05 plus post & packing

**The Theremin**

is a weird musical instrument that was invented early last century but is still used today. The Beach Boys' classic hit "Good Vibrations" featured a Theremin.

Kit includes a machined, silk-screened, and pre-drilled case, circuit board, all electronic components, and clear English instructions.

This product is also available pre-built and fully tested - Cat. AM-4025 £27.25.



**50MHz Frequency Meter Kit with LCD Display**

KC-5369 £20.30 plus post & packing

If you want a great value frequency meter, then this project is for you.

It features autoranging operation for ease of use, switching between its three ranges. High resolution of 0.1Hz up to 150Hz, 1Hz between 150Hz and 16MHz, and 10Hz above 16MHz. It can be powered by a 9V battery or wall adaptor (not included) and the case measures just 5 1/8" x 2 5/8" x 1". Kit includes laser cut & silk screened case, circuit board, electronic components, & clear English instructions.



**Fuel Mixture Display Kit for Cars**

KC-5195 £4.35 plus post & packing

Using this simple kit will give you a good indication of how rich or lean your car's engine is running.

It uses the factory EGO (exhaust gas, oxygen) sensor to indicate the fuel mixture on a series of LEDs. If your engine does not have an EGO sensor, one can be obtained from an automotive junk yard. Kit includes circuit board, all electronic components, and clear English instructions.



**10 Amp 12VDC Motor Speed Controller Kit**

KC-5225 £6.95 plus post & packing

This project allows you to take control of DC motors, or dim incandescent lights. Control the speed of a fuel injection or water pump on your car, and a whole lot more. With the components supplied, it can handle up to 10 amps. By fitting an optional extra MOSFET transistor, it can handle up to 20 amps. Kit includes circuit board, all electronic components, and clear English instructions. Optional extra MOSFET transistor - ZT-2450 £2.15.

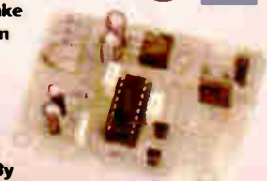

**We Stock...**

Electronic Components

Electronic Project Kits

Test & Measurement Equipment

Power Products and Accessories

Audio & Video Equipment & Accessories

Computer & Telecoms Accessories

Security & Surveillance Equipment

**Explanation of icons used for kits**

Indicates an approximate construction time for each project for a competent constructor. It does not however, include any installation etc that may be required.



Indicates that the assembly is initially built in a workshop. Requires basic electronics and soldering skills.

Requires a good knowledge of electronics to understand its operation, and troubleshooting techniques may be required.



Log on to [www.jaycarelectronics.co.uk/catalogue](http://www.jaycarelectronics.co.uk/catalogue) for your **FREE** catalogue!

**0800 032 7241**

(Monday - Friday 09.00 to 17.30 GMT + 10 hours only) For those that want to write: 100 Silverwater Rd Silverwater NSW 2128 Sydney Australia

**Jaycar**  
Electronics

# PRACTICALLY SPEAKING

*Robert Penfold looks at the Techniques of Actually Doing It!*

**T**HE subject of using a computer and a printer to produce professional looking front panels has been covered in previous *Interface* articles, and elsewhere in *EPE*. It is probably fair to say that the computer approach is by far the best. Whether you need to produce complete panels or individual labels, just about anything is possible with the aid of a PC, a printer, and some cheap graphics software.

Text can be tiny, huge or anywhere in between. Even a standard Windows installation has a wide range of fonts available, with many more available for little or nothing. With an inkjet printer you can even produce designs in full glorious colour.

If you have access to suitable equipment, it is certainly worth trying the computerised approach to producing front panels. However, not everyone has access to a PC and a printer, and some prefer a more hand-crafted method.

What alternative methods are available? The range of options seems to be somewhat reduced compared to a few years ago. This is probably due to the widespread use of computers in the graphic arts industry, and the consequent decline in the manufacture of traditional graphic arts materials.

## Direct Approach

In days of yore, the two normal choices were high quality plastic panels made using a simple photographic process, or rub-on transfers applied direct to the front panel. The panel making systems could produce some top quality results that were very hard-wearing, but none of them are produced today. Dry transfers offered a cheaper and simpler solution to neat panels, but they are now increasingly difficult to obtain and expensive.

Many of the lettering sheets that are available from local stationers have quite large letters, at around 5mm to 12mm high. A letter height of around 2.5mm to 4mm is needed for labelling control functions, although a somewhat larger size can be used on larger projects.

Sheets of Letraset are still produced (see [www.letraset.com](http://www.letraset.com)), and some fonts are available in smaller sizes. These are professional products, and the letter heights are in point sizes (one point is equal to approximately 0.35mm). A point size of 10 is about right for labelling control functions, but 12 point lettering is also usable. Unfortunately, professional lettering sheets are expensive, although they are quite large and should last for many projects.

Assuming that suitable transfers can be obtained and provided due care is taken, it is possible to produce some quite professional looking results using this method. There is some skill involved

though, as each letter has to be positioned very accurately. The smaller the lettering, the more precisely each letter has to be positioned. It is therefore advisable to use the largest text size that will not look out of place. A magnifier on a flexible arm can be very useful when building projects, and it is more than a little useful for an intricate task such as this.

## Rub-Down

The transfers must be added before the controls and other components are fitted to the panel, so that there is a flat surface to work on. Ideally the panel should be removed from the case, but this is not possible with most types of case. If the panel cannot be removed, it is best to clamp the case in place so that you at least have a firm surface to work on. With a separate panel it is a good idea to fix it to the worktop using double-sided tape. This will prevent the panel from sliding around while you are trying to work on it.

A problem with rub-on transfers is that they tend to rub off again. Professional transfers are expensive but generally provide much better adhesion. No transfers will stick reliably unless the panel is clean and free from grease. Various cleaning fluids are available for this type of thing, but note that some of these dissolve or discolour some plastics.

It is essential to try any cleaning fluid on the back of a panel first, to check that there are no ill effects. Simply rubbing a panel thoroughly with a piece of kitchen towel should be sufficient unless it is heavily contaminated with grease or dirt.

## Some Guidelines

Some transfer systems have guides that are intended to make it easier to get the letters aligned vertically, and some also help with the spacing between letters. These systems are not necessarily that helpful in practice, and when working on a small panel they can be difficult to implement at all.

In most cases it will be necessary to work "by eye", but it can be helpful to mark a horizontal guideline for each row of letters. However, make sure that you use something that does not permanently mark the panel and can be easily removed

without damaging the lettering. Using a small piece of insulation tape as a guide is often more practical than using a pen or pencil to mark a line.

Neat results are dependent on getting each word placed accurately. Whatever method you use to label panels, this is something where being mathematical about the task often produces odd-looking results. The best position for each word is the one that looks the best, but where appropriate, make sure that the words in a row are of accurate vertical alignment. Again, a guideline marked on the panel will make this task much easier.

When judging the best position for each word it is more than a little helpful to temporarily place the control knobs on the panel. Remember that with some types of case the edges of the front panel are obscured once it is fitted into the main unit. The lettering must be kept reasonably well clear of any "no-go" areas of this type.

Bear in mind that some letters are wider than others. If a word has six letters it is not safe to assume that the centre line will be half way between the third and fourth letters. In the word "INPUT" for example, the "I" is narrower than the other letters. The centreline is not straight through the middle of the letter "P", but is just to the right of this.

The convention is to use only uppercase letters for labels, as this makes words easier to read, but you are allowed some artistic license. However, using only uppercase letters makes life easier because they are more uniform in width than the lowercase variety.



*Fig. 1. The Dymo Mini labeller on the left costs less than an electronic labeller such as the unit from Brother on the right, but the difference in cost is less than one might expect.*

## To the Point

Two common errors when applying dry transfers are to use a tool that has too sharp a point and to press too hard. Only moderate pressure is needed in order to transfer the letters from the backing sheet to the panel, and anything more can distort the letters. Using a tool that is too pointed will also distort the letters. A pencil with the point sandpapered to a well rounded shape will do the job quite well.

Dry transfers are not very hard wearing, and I suppose that this is also true of most other types of lettering. The simplest way of providing a protective covering is to spray the finished panel with a clear lacquer, or alternatively brush on some clear nail polish. Shops that sell art supplies have sprays that are intended for fixing pastel and charcoal drawings, and any of these should work well in this application.

Covering the whole panel with self-adhesive transparent plastic gives the ultimate in hard-wearing panels. Use a piece of plastic that is slightly too large and then trim it down to precisely the right size.

The main problem when using a plastic covering is that it can be difficult to get the plastic to lay perfectly flat at the first attempt. Small air bubbles can be pricked with a pin and pressed flat. Anything more major will require the plastic to be peeled off and a fresh attempt then has to be made. Unfortunately, some of the lettering is likely to come away with the plastic, ruining the panel. The thicker plastic materials give the best results and are easier to use, but they too can be difficult to obtain these days.

## Labels

An easier approach to labelling panels is to make an individual adhesive label for each word, and then add them to the panel. With this method it is possible to add the labels once the project has been completed in other respects. In fact this is probably the best time to add them.

One way to make the labels is to use dry transfers on a self-adhesive plastic material. Actually, it is not essential to use plastic, and the material used does not have to be self-adhesive. Any good quality paper can be used provided it is quite thin. Any general purpose adhesive can be used to stick the labels in place, but Scotch Spray Mount is probably the best choice for this type of thing as it allows the labels to be easily repositioned.

By far the easiest way of making labels is to use a label making machine. The simplest type is the Dymo mini labeller, which has been produced in various forms for many years. The labels are produced on 6mm wide strips of self-adhesive plastic, which produces letters of just the right size for adding legends to projects.

The gadget itself costs under a fiver, and the tapes are quite cheap. On the down side, the quality of the labels is not very good. They are produced using a simple embossing system that produces quite crude results. This form of lettering is still better than nothing

though. It is probably the best option for those who prefer something simple and straightforward at a "rock bottom" price.

## Upmarket

Going slightly upmarket, the cheaper electronic labelling machines are capable of very high quality results. Like the simple Dymo labeller, they produce the labels on ribbons of self-adhesive plastic, but they mainly use a simple thermal printing process that produces very "crisp" results. The ribbons have various widths from about six to 20 millimetres. Some labelling machines only take the larger tapes, and are of little use in the current context. One that will take six or eight millimetre tapes is required.

A basic electronic labelling machine is unlikely to provide a wide range of fonts, but there are usually a few "frills" such as bold text, two-line printing, and the option of adding an outline around the lettering. An electronic labeller that has a Spartan specification should still be capable of producing good quality labels almost instantly.

The labels usually stick very reliably to metal and plastic panels, but this is something of a mixed blessing. Repositioning labels without making them a bit tatty at the edges can be difficult, because it is difficult to tear them away from the panel.

However, if necessary it only takes a few seconds to print out a replacement label. The ribbons are not particularly cheap, but the cost per label is very low since each ribbon should be sufficient to produce dozens or even hundreds of labels.

The difference in cost between a simple labeller and a basic electronic unit is less than one might expect, with some available for under a tenner. On the other hand, the difference in the quality of the results is vast. If you can afford the small additional outlay it is definitely worth buying an electronic labelling machine. You will probably find the labeller useful as a household gadget as well.

As pointed out previously, the tapes for electronic labellers can be quite expensive, so take this into account before buying a labeller that is not supplied complete with one or two suitable tapes. A couple of tapes could easily cost more than the labeller itself.

## Stencil

Most stationers still sell stencils, and they are even available from some supermarkets. Together with a pen of the type designed to write on almost anything, a stencil can be used to mark lettering directly onto most plastic and metal panels. Using an ordinary fibre-tip pen and a



Fig.2. The label from the Dymo Mini (top) is not as good as one from an electronic labelling machine (bottom). Results are adequate though, and can be improved if due care is taken when stamping the letters and handling the tapes

stencil, it is possible to make paper or card overlays that can be glued to front panels. Marking the panel directly usually produces the most clearly defined lettering, because a plastic or metal panel does not absorb and spread the ink. Spreading of the ink can be a major problem when using some combinations of pen and paper.

A problem with marking directly onto a panel is that the pen usually has a tendency to periodically dry up and stop writing. This is due to the spirit-based inks they use. Minimise this problem by keeping the top of the pen in place except when it is actually being used. On the plus side, the lettering produced using this method is remarkably resilient, and it is far tougher than lettering produced using dry transfers.

On the down side, this makes it difficult to remove a letter if a mistake is made. A solvent that will remove the erroneous letter is also quite likely to dissolve a plastic panel. Correcting mistakes on a card or paper overlay is not possible, so you have to get it right first time.

The biggest problem with stencils is that they are mostly available for lettering of about ten millimetres or more in height. At smaller sizes they become increasingly impractical due to the need for pens having ultra-fine tips.

Using stencils effectively requires a fair amount of skill, since getting the letters positioned accurately first time is far from easy. However, I have seen some very neat results produced using this method.



Fig.3. Using stencils it is possible to add lettering direct to a panel. Small lettering is not a practical proposition though

# TK3 Simulator and PIC18F Upgrade

John Becker



Detailing the latest additions to EPE's PIC assembly and programming toolkit

**T**HIS article describes the latest facilities that have been added to the author's *EPE PIC Toolkit TK3* PIC assembly and programming software, now released as version V3.00.

The first addition is a quite sophisticated Mini Simulator through which your own software routines can be put through initial testing procedures, allowing potential bugs to be eliminated prior to downloading the code to a PIC.

The second enhancement is the expansion of the assembly, programming and disassembly routines to allow members of the recently introduced PIC18Fxx2/xx8 family to be handled. These devices have more commands and abilities than the more familiar PIC16Fxx devices, but have significantly different assembly and programming requirements.

## Mini Simulator

For some years the author resisted the temptation to write PC software which would allow a PIC's assembly code (ASM) to be tested in advance of sending its associated HEX file to a PIC. The main reason for resisting was that it was felt the writing of such a program would be highly time-consuming and difficult.

However, Richard Hinckley, in his *PIC Breakpoint* article of Oct '03, illustrated a technique for displaying on a PC screen the code values held by PIC registers in a semi-realtime situation. Impressed by the usefulness of this display, the author began wondering if a similar display might be used to show register value changes while the PC did the actual processing of the assembly code, rather than the PIC itself.

One hot day last UK summer, when it was more comfortable to stay indoors, a brief test program was written in which register values were displayed on screen in boxes similarly positioned as in Richard's *Breakpoint*. The results were encouraging, and more readily accomplished than had been anticipated.

So the tests continued, maturing into more specific functions, all related to the full suite of 30+ codes as recognised by a PIC16F device, such as the F84, F628 and F877 etc, which TK3 has long been able to handle.

Eventually, the Simulator reached the point at which many useful programming

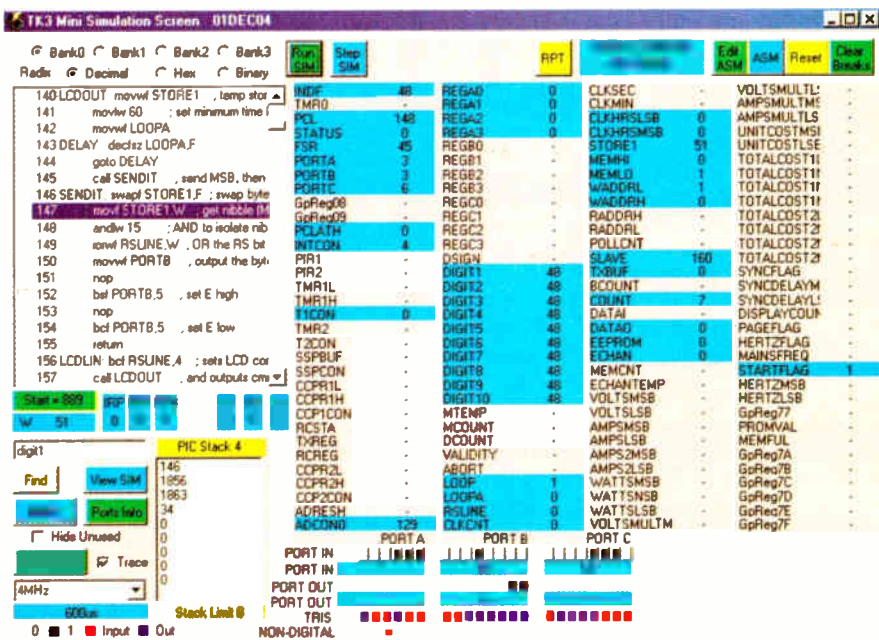

functions had been added, in addition to the basic step-by-step simulation. At that point, by chance *EPE* reader John Waller, with whom the author regularly email chats about PICs and other matters, expressed an interest in trying the Simulator with the software he was writing. This was for a model train semaphore signals controller he was developing.

There ensued a lively exchange of emailed ideas and Simulator code developments, effectively resulting in the software described below.

## Preparing for Simulation

To use Simulation mode, the assembly (ASM) code that you have written is first assembled (through *TK3*) in the normal way, generating the usual HEX code. In doing so, though, it also generates another file having the same base name, but suffixed with *.SIM*. To this file are written the ASM commands, along with the HEX code values, and their command count addresses. These values are stored in the file in strict order of the same addresses as the PIC would see them. Also stored to this file are the equated register names and their address numbers.

Consequently, during simulation, all the

branches, GOTOs and CALLS are to the same addresses as the PIC would see them, and the registers have the same values written to and read from them as when the PIC is running in real life. The Simulator thus allows a full check to be made of what is occurring as each command is processed.

When assembly has been completed, the actual HEX file is ignored at this time. Instead, the Mini Sim button on *TK3*'s main screen is clicked, and the Simulator function is launched. This loads the SIM file, displaying the commands in a List Box, and storing the HEX codes to a memory array.

Simultaneously, any register values and their equated names actively used in the

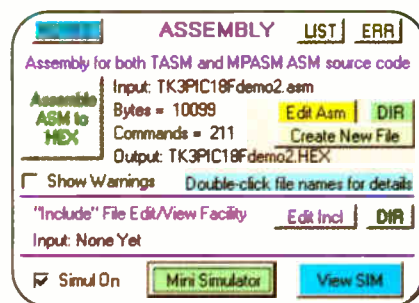



ASM file are allocated in numerical register order to the main Sim screen area. Here there are 128 zones arranged in columns, numerically ordered from top to bottom, left to right.

The register names are shown to the left of each column, and their current values to their right. Any zone which does not have an allocated register name is allocated a default name, prefixed as GPRreg (general purpose register), followed by its address number in hexadecimal (e.g. GPRreg4B).

If the PIC in question has registers which are unavailable (e.g. register address 07 is unused in the PIC16F84), the name is shown as n/a (not available). Until register values have actually been set while running the simulation, their value boxes remain empty except for a hyphen symbol.

## Bank Blocks

There can be more than 128 registers involved for any PIC, and any whose addresses are greater than 127 (remember that zero is an address in this context) are stored "behind" the screen, in numerical order in temporary storage arrays.

Any group of 128 registers and their values can be called up for display instead of the first 128 registers block by means of the Bank selection buttons at the top left of the screen. The buttons behave "exclusively" so that only one Bank can be displayed at a time.

The selected Banks correspond to the allocated Banks for the PIC16Fxx family. Not all of these PICs have four Banks available, in which case, only those available can be selected. The PIC16F84, for instance, has only two Banks, whereas the PIC16F877 has four. Conversely, the 18F family have more than four banks (16 for the 18Fxx2/xx8 devices), and they can be selected in groups via another button when in 18F mode.

Note that when assembling an ASM file, unless it has the PIC type embedded in it (near the top of its code, in the form: LIST = P16F84) you *must* set the PIC type correctly via the usual *TK3* main screen option.

## Running a Simulation

Two buttons, Run Sim and Step Sim, on the Sim screen allow the program to be cycled through each command in order, and its associated HEX command value processed accordingly. The numerical results of each command are displayed in the dedicated register boxes as appropriate.

Normally the register boxes are uncoloured, but become coloured (light blue) when they are accessed. This aids good visibility. Additionally, the captions in each box show in red while they are currently accessed, reverting to black when the next register is selected.

In Run mode, the sequence starts at the first command listed (or as selected), and the program automatically processes each command in order as it is encountered, amending values and branching to other segments of the code as instructed, as would a real PIC.

The main difference to a PIC is that you can stop the simulation at any point and examine the current status of the registers. To do this directly with a PIC, Richard's *PIC Breakpoint* program is needed.

The processing speed is also different.

When Run mode is started, the program steps through the commands at a rate determined by the Sim program's internal timer interrupt.

When clicked to start running, the Run button's caption changes to Stop and its green colour changes to red. Click the button to stop automatic running.

Run mode is of particular benefit when it is the results of processing one or more code routines that are more significant than the immediate results of each command, as provided by Step Mode.

In Step mode, the process is identical to that in Run mode, except that each click of the Step button simply steps the simulation sequence on by one command, then waiting for the next click before stepping on again. This allows the results of each command to be examined at leisure.

Note that a particular line in the program is executed as soon as the simulation steps into it. For example, if you are simulating a timing loop, and you want to check a particular action occurs correctly when TMR2H reaches a particular value, then that value must be set into TMR2H *before* stepping into the line where TMR2H is read.

## Selective Simulation

In either Run or Step mode, the starting point for the simulation can be set at any command. Alongside the Listed commands are small tick-boxes. To select any command as the start point, left-click on the selected command's box, then right-click at the same point. This action stores the starting point to memory, and is also confirmed in the small green box below the List screen. Clicking Run or Step now causes the simulation to start at that point.

Run mode can be terminated at any point beyond the start point (or even before it if commands there are branched to from a command further down the list). To select a stop (break) point, left-click on the required box, but do not right-click it.

When Run commences at the start point, the sequence of commands is processed until the break point is reached. Run mode then terminates and reverts to Step mode.

To repeat the simulation sequence from the designated start point, click the RPT button.

The start point can be changed in the same way as it was set. You may have several break points set simultaneously, each set by left-clicking on its tick box. When Run mode is again clicked following a break, the sequence then continues until the next break is reached, and so on. The break points only have significance for Run mode – in Step mode, each command is processed as an individual action.

Break points can be deleted by left-clicking on the ticked box. The tick changes state on an alternating cycle. It is important to note that it is the *box* which must be clicked, not the line itself. The latter *may* appear to work sometimes, but the tick behaviour can be erratic (a VB6 problem). Do not double-click a box.

All start and break points can be cancelled by clicking on the Clear Breaks button.

Neither the RPT nor the Clear Breaks button affect the register values. To clear the registers back to zero (null) values, click the Reset button. This also resets the register box colours to neutral grey. Note that break points are unaffected by Reset.

By default, the register values are displayed in decimal. They can, though, be displayed in any radix, decimal, hexadecimal or binary. Three buttons below the Bank buttons select the radix mode.

## Changing Register Values

Any displayed register can have its value changed manually when in Step mode. To do so, click on the register, at which a selection of other boxes appears at the top of the screen. The screen then displays the register name, its value in decimal in a text box, and as a binary value in eight tick boxes. Clicking any tick box changes its logic state and the resulting new byte is shown in the text box. Alternatively, you may change the text box value by keying in a new value, from 0 to 255. Values must be in decimal.

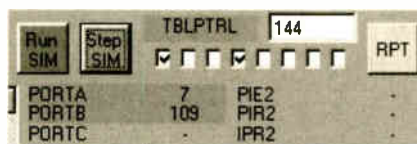

Clicking the register name to the left of the text box (or pressing Enter) causes the new value to be stored back to the selected register. At this point the Change option closes and is removed from screen. Clicking Run or Step also performs the same action.

## Flag Bits

In addition to register values being displayed, so too are the Status register flag bits in their own boxes, below the List screen. The flags displayed are for the C, DC and Z bits (plus IRP, RPI, RP0 for non-18F devices, plus N and OV for 18F), with their status shown in binary (1 or 0).

These bits can be changed manually by clicking on them, causing them to alternate between states. The displayed value of these bits is responded to when the simulation is running.

## W Register

The W register value has been allocated its own box, to the left of the Status flag bits. This is constantly updated while the simulation is in progress. It too may be changed manually, in the same way as for the other registers.

## Tooltip Texts

Visual Basic 6 (VB6), in which this program has been written, allows "Tooltip Text Boxes" to be allocated. These are normally allocated with text at the time that the program is written. However, they can be given texts while the program is running and advantage of this has been taken. If you hover the mouse cursor over any register value box, that value will be displayed in a yellow box in decimal, hex and binary, irrespective of the radix mode selected.

Hovering the mouse over any register name will cause that register's address to be displayed in hex. Hovering it over the flag boxes causes the full value within the Status register to be displayed in all three radix forms. Hovering it over the W box shows that value in all three radix modes.

Many other on-screen function buttons have Tooltip Texts, displaying a brief description of what that button does.

Furthermore, hovering the mouse over the List screen commands causes the full text of that line to be shown (within the length limits imposed by VB6); useful on the List screen when long command lines are truncated.

## Word Find

A Find command button has been provided below the List screen. Above the button is a text box. Key in any word (or phrase) which might occur in the commands listed, click Find (or press Enter) and the routine will find it for you if it exists, highlighting the line in which it occurs. If it is not found, a message display will tell you so. Further clicking of Find will display other occurrences of the word until the end of the list is reached. Re-clicking Find will then start the search from the top.

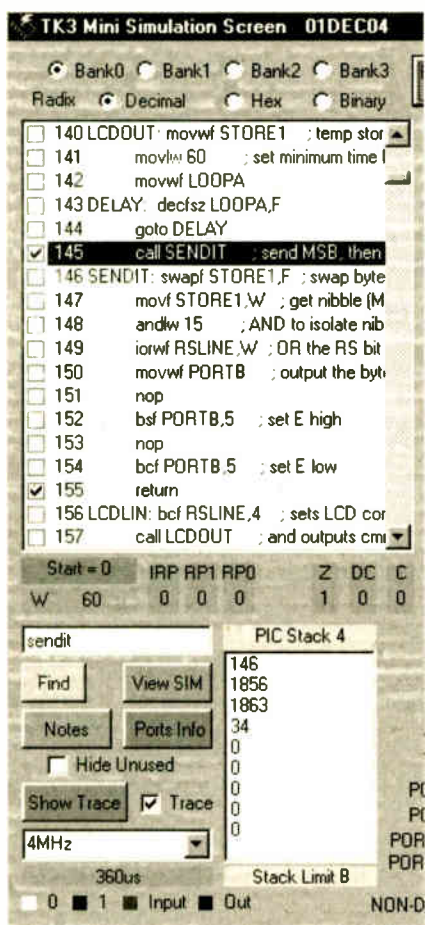

## PIC Stack

PICs have a Stack register which keeps track of return addresses when CALL commands are actioned. In the PIC16F family, this register cannot be read from or written to directly. It has a limit of eight addresses and can be inadvertently overwritten if this count is exceeded in a complex program having nested sub-calls. Such overwriting invariably causes a major program crash.

The Simulator keeps track of the Stack status and displays it in a separate list box a little below the command list box. The values shown are the addresses, in reverse calling order (last in, first out) and in decimal, to which the program jumps when a

RETURN or RETLW command is performed. The values are one greater than the address from which the CALL was made.

When a return is made, the return address is "popped" from the stack, and return addresses below it are rippled back up the stack. This is a particularly useful facility as complex programs can generate many "nested" calls and unwary program writers can cause the stack to overflow, with the eighth address being lost, and consequent mayhem in the program!

## Ports

The Ports are different to other registers in that they are effectively two registers, one for data output to the world, the other for input from it, as determined by the setting of their TRIS (data direction) registers.

The basic function of a PIC16F Port pin is illustrated in the schematic drawing shown when the Ports Info button is clicked. Microchip state that: "Reading a port register reads the status of the pin, whereas writing to it will write to the port latch. All write operations are read-modify-write operations, so a write to a port implies that the port pins are first read, then this value is modified and written to the port data latch."

At the bottom of the screen, the PORT IN buttons in the first line represent the data logic levels available to be input when the relevant TRIS bit is set for input, alternating between High and Low logic when clicked, black or white respectively. In some respects they can be regarded as external switches connected to the pins. The blue boxes below them show the equivalent numerical value of the input logic bits.

The small PORT OUT boxes represent

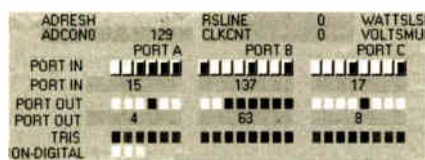

the logic levels available to be output to the world from the data latch. The value is that determined by reads from the input pins and that set by data writes to a port (re-read Microchip's statement if this is not immediately clear). The data actually output is modified by whether relevant TRIS pins are set for input or output. The blue PORT OUT boxes show the equivalent numerical value of the data latch contents. On the main body of the screen, the register boxes for the Ports show the same data latch value.

The second-from-bottom line of boxes shows the TRIS bits, red for input mode, and blue for output mode.

With some PICs, pins can be selected for analogue or digital mode, as set by CMCON in an F628 for instance. For this to work, of course, the PIC type and configuration value must be included in the ASM file in the conventional manner (see discussion of 18F demo program later). When a simulation for such PICs is being run, an additional line of boxes at the bottom shows the analogue/digital status.

## Missing Labels

Any Labels written into an ASM file are only repeated in the SIM file if they have a

command associated with them. The SIM file is created at the same time as the HEX file and records only those statements for which a code value and address are given. Any line without such is ignored.

The SIM screen list box is arranged in strict numerical order of addresses as the PIC would see them and any additional lines would throw the program count correctness and Calls/Gotos>Returns etc would not be implemented properly. The only way round this is for you to add NOP at any label without a command where the label needs to be shown in the SIM list.

## Command Timings

Each command actioned takes one or two PIC cycles (as listed in the data sheet), which occur at one quarter of the PIC's clock (e.g. crystal) rate. The simulator keeps track of the command cycles and displays them at the bottom left of the screen. By default they are in relation to a 4MHz crystal rate (1 cycle = 1 microsecond).

You may change this rate via the Combo box above the cycle counter display. The choices are 32768Hz, 3.2768MHz, 4MHz, 10MHz, 20MHz. No provision has been made to add to the choices. Click on the box's arrow and select from the list displayed. The choice is not stored for future recall when next the program is run, reverting to 4MHz.

## Hide Unused

Normally, the screen displays all registers associated with a PIC Bank. You may "hide" unused registers by clicking on the Hide Unused tick box at the bottom left. Re-click to re-display them all.

## Edit and Assembly Buttons

The Edit button calls up the same Edit facility as accessed via TK3's main screen, allowing the ASM code to be modified. Exiting the Edit function returns you to the Sim screen, where an ASM button is now shown. Click it to start code assembly in the normal way.

On completion of the assembly, that sub-screen offers the same options as usual, plus the option to re-enter the Simulation screen. (It has proved impossible to offer an automatic assembly entry from the Simulation screen following exit from Edit – as is provided via the main screen's function using the Enter key.) The Edit and Assembly buttons are hidden during automatic simulation (Run) mode.

## Trace Button

The Trace tick box allows you to make a record of the commands actioned while in automatic Run mode. On starting the run, a file is opened (TK3Trace.txt) and each command actioned has its code line output to the text file, along with its address value. On stopping auto-run, the file is closed and can then be examined via the Show Trace button.

The recording always starts from the current line selected. The recording facility is not available when single-stepping a program, or when the Trace box is unticked. The record is always overwritten when a new run is started.

## Simulation Inhibit

The simulation facility can be inhibited via the main screen. To the left of the Mini

Sim button is a tick box. Click the box to hide the tick, this also hides the Mini Sim button. Re-click the tick box to reactivate the option.

The benefit of turning off the Simul option is that it prevents .SIM files being created during the assembly process. If you are changing the ASM file name for each new version of that code (as is recommended, by using a suffix number for example), your disk drive could become "well-populated" by SIM files that you do not need. This inhibit option prevents SIM files from being created when you do not want them.

## Simulating HEX Files

If you only have a HEX file for a particular program and wish to simulate it, first convert the HEX file to an ASM file via *TK3*'s Hex Disassembly option. Then assemble the resulting ASM file to create the required SIM file). Remember that you must set the PIC Type for the PIC being disassembled.

## Sim File Examination

The Sim file may be examined via the main screen or sim screen View Sim buttons. This is for information only and has no practical purpose.

## Limitations

This mini simulator does not attempt to match the facilities of more sophisticated commercial simulators. It basically shows the behaviour of the commands in a program and the effects that they have upon the registers accessed. The following are not supported:

Interrupts  
Access to Data Eeprom  
PortB pullups  
Sleep  
Analogue inputs and other special I/O functions (e.g. RS232)  
Timers, including WatchDog, with the exception that a mock creation of a TMR0 rollover is generated in response to the simulator's own internal timer

The program has a limit of 8000 PIC commands, 512 registers (4 Banks) for non-18F devices, and 4096 registers (16 Banks) for 18Fs.

All code changes must be made through the normal Edit/Assemble functions, they cannot be changed from within the simulator screen.

Whilst the simulator was originally designed for the PIC16F family, most aspects should also function with the 12F and 18F families. However, with the 18F family facilities, there are several other limitations, some known, others yet to be discovered.

Of the known 18F limitations (in addition to the 16F ones), table read and write commands (TBLRD, TBLWT) cannot (as yet) be processed correctly.

As a final comment on the simulator, it was originally written with the expectation that it would be used to check short code routines before implementing them into a larger program. Although it has been proved that some longer programs can be simulated, it is not guaranteed that all can be. If you wish to make helpful suggestions about improving this simulator, contact the author as stated later.

## TK3 MPASM Link

Since early versions of *TK3*, an on-screen link to Microchip's MPASM assembler has been provided for those who have MPASM installed. This has been slightly upgraded in that *TK3* and MPASM can now exchange file names via two click-buttons. Using these buttons, any file name selected through *TK3* can be placed in MPASM's assembly program (via its .INI file, line 2), and vice versa.

Should you ever find that *TK3*'s assembler cannot perform a less common function, but which is available through MPASM, don't hesitate to assemble your ASM code through MPASM. The HEX file created through MPASM is totally compatible with *TK3* and can be programmed into the PIC through *TK3* (provided *TK3* can handle the PIC type involved).

Similarly, any HEX file generated by *TK3* is believed to be totally compatible with any programmer designed for use with MPASM-type files. This is not necessarily true of ASM files created through *TK3*. *TK3* recognises a number of command structures (as used with the TASM dialect) which MPASM does not. Such differences are explained in the Notes files readable through *TK3*. To translate an ASM file having these different command structures to suit MPASM's requirements, use *TK3*'s Conversion facility.

## Disassembly Functions

*TK3*'s Disassembly functions have also been enhanced with V3.00. These now allow a greater variety of methods through which PIC contents and HEX files can be examined and translated to "English".

---

# PIC18Fxxx Family Facilities

---

**F**OLLOWING determined persuasion by a number of readers, in the summer of 2004 the author embarked upon the task of upgrading *TK3* to handle the fairly recently introduced PIC18Fxxx family. These have a host of extra facilities not offered by the more familiar 16F8x, 16F87x and 16F62x families. Malcolm Wiles will be formally introducing the 18F family to you next month.

In terms of *TK3*, the upgrade requirements were to add recognition of the extra commands, and to amend the programming algorithm to 16-bit instead of 14-bit. At first sight this appeared to be a straight-forward though lengthy upgrade.

Restructuring *TK3* to handle 18F commands as well as the existing 16F and 12F commands proceeded fairly readily, although it was soon recognised that splitting the Assembly routine into two separate functions would be preferable, avoiding many "IF 18F THEN ... ELSE ...END IF" statements.

By September, that split with all its implications and accessory routine procedure amendments had been finalised. Time to amend the Programming to send 16-bit as well as 14-bit hex values. Fortunately, it seemed, Microchip's datasheet had provided examples of the programming structures

needed to send and read back 16-bit words to/from 18F devices. These were followed and tested.

Disaster – they did not work, or if they did they were unreliable in their repeatability. Browsing Microchip's data in all directions did not reveal solutions, but it did reveal documentation anomalies and ambiguities. Microchip's technical department were of no help, simply sending an automated reply to a querying email telling the author to browse their web site for information; which had already been done anyway, to no avail.

## Battle Lines

By mid-October, the author recognised that this was a battle he might not win (not often that happens!). However, Malcolm Wiles, professional programmer and knowledgeable in the C language and its derivatives, provided the author with his C++ routines which *did* successfully program 18Fs.

Analysing Malc's commands clarified the Microchip ambiguities (although Malc too had earlier had trouble interpreting their published data in several areas). It also revealed a previously unknown problem with VB6, the software in which *TK3* is written. Any value written in hexadecimal form representing a two-byte decimal

value of 32K or greater is translated by VB6 to a *negative* value comprising three bytes.

Many of the formatting commands required in the PIC programming routines are expressed in Microchip's documentation as hex values from 0000 to in excess of 7FFF (32767 decimal), well beyond VB6's "negative" boundary. Consequently, *TK3*'s software, which sends decimal values in serial bit streams to the PIC, was sending the wrong format commands. Malc's software helped reveal this problem (C++ does not suffer the same value problem), as well as clarifying Microchip's requirements.

*TK3* 18F programming success was achieved in mid November! This included sending programming commands, configuration values and EEPROM data, and reading back data from all locations.

Following extensive bench and field testing, *TK3* with 18F facilities was released to the world in Jan '05 as V3.00! However, the current version should be treated as a "beta" version still under field trials. If you spot anything which is not as it should be, please tell the author via *EPE*.

This request particular applies to the 18F simulation which has had less opportunity to be tested "for real".

## PIC18F Differences

As Malcolm will explain next month, there are several differences between 18F and 16F devices in the way in which code must be written.

Also be aware that MPASM (as at V3.50) no longer recognises the following shorthand commands when assembly 18F code:

CLRC, CLRDC, CLRZ, SETC, SETDC, SETZ, SKPC, SKPDC, SKPZ, SKPNC, SKPNDC, SKPNZ.

If you wish to use these valuable commands with MPASM, they must be defined at the head of your program. *TK3* continues to recognise them for all PIC types.

## Example PIC18F Program

The program extracts in Listing 1 to 9 show examples of some 18F programming routines which you should find useful. They illustrate how an alphanumeric l.c.d. can be controlled by an 18F, and how this PIC's data EEPROM can be written to and read from. There are some other aspects which are also worth highlighting, including the use of FSR and INDF.

The demo is simply aimed at getting you started with 18Fs. The author finds the use of an l.c.d. is vital when debugging a program (irrespective of simulations) and so seems an essential first facility you might also need when writing for 18F. Similarly regarding EEPROM use, which is a facility the author often uses (partly as a debugging aid), so again seems an elementary tool to which you should have immediate access.

The full demo program from which these extracts have been taken is supplied with *TK3* Version V3.00 as file TK3PIC18FDEMO2.asm.

### Listing 1

```
List P = PIC18F252, R=DEC;
```

```
include P18F252.inc
```

```
__config H'300000', H'00'
__config H'300001', H'22'
__config H'300002', H'08'
__config H'300003', H'00'
__config H'300004', H'00'
__config H'300005', H'00'
__config H'300006', H'80'
__config H'300007', H'00'
__config H'300008', H'0F'
__config H'300009', H'C0'
__config H'30000A', H'0F'
__config H'30000B', H'E0'
__config H'30000C', H'0F'
__config H'30000D', H'40'
```

```
A equ 0
```

```
CBLOCK
```

```
LOOP
LOOPA
CLKCNT
STORE
STORE
RSLINE
TEST
TEST2
TEST3
TEST4
```

```
ENDC
```

## List P Directive

Some of you may not be familiar with the List P directive as in Listing 1 line 1, **List P = PIC18F252 R=DEC**. This instructs the assembly program that the code which it is about to assemble is for a PIC18F252. Any PIC program can have a similar statement made at this point, detailing the intended PIC type. The assembler, whether *TK3* or MPASM etc, will then know which procedures it is to follow in order to correctly assemble the program for that PIC.

The directive **R=DEC** simply tells the assembler that any value encountered which does not have a prefix of, say, H', B', \$, %, etc, is to be taken as a decimal value. It is worth noting that the author has never needed a radix other than decimal, and the statement can just be copied as shown for your own programs (or even omitted).

## Include Directive

Line 2 has the statement **include P18F252.inc**. This tells the assembler it is to use the register equates values given in the Microchip "include" file for the same PIC type. This saves you having to key in your own list of the required special function registers (SFRs) and their allocated addresses (e.g. PORTB EQU xx, etc).

The "include" file name is prefixed by "P", followed by the PIC type. MPASM "include" (.INC) files for the entire PIC range can be downloaded from Microchip's website. They are also included with Microchip software such as MPLAB and MPASM. A selection of those for the PICs which *TK3* recognises are included with *TK3*'s software.

## Configuration

Next follow 14 configuration statements. The 18F family have more complex configuration arrangements than, for example, the 16F family with which you will be familiar. *TK3* has been given a dedicated config screen through which 18F config values are established. You click on the required functions you wish to set or reset, either through their allocated boxes, or via the List sub-screen and its tick boxes.

Having made your selection, click on the Copy Output button. This copies all 14 config values to the Windows clipboard. You then open the ASM text file for the

program being developed and paste the values into it, which are correctly formatted in the style shown in Listing 1.

When the program is assembled, the config values are placed into the HEX file and automatically programmed into the PIC when the HEX code is sent to it. The config screen also allows you to readback config values from the PIC, and to send the values directly to the PIC, although there is rarely any need for the latter to be done separately.

It is stressed that you *must* have the 18F family datasheet in order to fully understand the functions of the config options.

## Erasure and Code Protection

It is worth commenting that the program and data EEPROM contents of a PIC18F are automatically erased when the PIC is reprogrammed. Simultaneously, the config values are reset to their defaults, and all code protection values are cleared. Config can be written to or read from regardless of any code protection which may be on.

## Access and Banked

As Malcolm explains next month, PIC18F devices have Access and Banked addresses. Their function is somewhat analogous to using the BANK0/BANK1 (PAGE0/PAGE1) directives of the 16F family, but more subtle. Any command which causes a PIC register to be written to or read from should indicate whether that register is in the Access or Banked bank. This is done through *TK3* by the use of "A" or "B" as part of the command (MPASM also allows the use of the suffix ACCESS or BANKED, but *TK3* does not).

Normally you will only work with registers in the Access bank and so letter "A" will be the suffix, as is shown throughout Listing 1. If you omit to add the suffix, *TK3* will remind you, but assemble as though "A" had been used.

A full list of the 18F commands recognised by *TK3* can be read via the Show PIC Codes button at the bottom right of the main screen. The codes also show which suffixes are needed with each command, e.g. ADDWF requires f,d,a, in other words, it needs the file name, destination F or W, and the Access bit (A or B).

## CBLOCK Directive

Recognition of the CBLOCK/ENDC directives is a fairly recent addition to *TK3*.

This is an MPASM structure which allows you to allocate your own named registers without giving them specific EQU XX values. The register names you want are simply listed following the CBLOCK statement. The list is terminated by the ENDC directive.

During assembly, each register is given a consecutive address starting from the value given as part of the

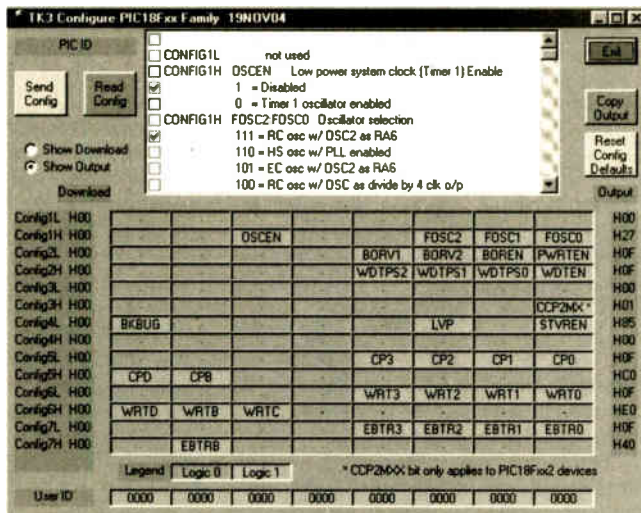

CBLOCK statement. In the case of Listing 1, there is no value given, and the value is taken as zero (18F registers can start from 0, unlike 16F registers which typically start at H'0C' or H'20' depending on PIC type). For non-18F PICs, *TK3* allocates the relevant number even if it is omitted – unlike MPASM, which always treats an unspecified CBLOCK value as 0.

## ORG and TRISx

As with other PIC families, the assembler/programmer must be told the PIC memory location (address) from which it must start to place the commands. With 18Fs, the first available working location is after the Interrupt location at H'18'. See the datasheet for details of the locations up to H'18'. Do not specify location 5 as the starting address for 18Fs, which is what you would probably do with 16F devices.

Unlike 16Fs, 18Fs do not require the use of BANK1/BANK0 directives when setting the TRISx values. They are simply set as shown in Listing 2 at the label START.

### Listing 2

```

org      0
goto    START
org      0008h
retfie

org      0018h
retfie

START    clrf PORTA,A
         clrf PORTB,A
         clrf TRISA,A
         clrf TRISB,A
         movlw B'11000110'
         movwf T0CON,A

```

## Timer 0

Timer 0 with the 18Fs is set similarly to the same timer in 16Fs, except that register T0CON is the one used to set the timer's prescaler ratio. The value shown in Listing 2 (B'11000110') sets the timer prescaler to 1:64.

## PCL Counter and Tables

Accessing Tables through the PCL program counter (as required for 16F devices) is not needed with the 18F family. Instead, tabled values are read through the setting of table pointers and versatile TBLRD commands, and there is no limit to the length of tables. Examples of 18F table access are shown in Listings 3 to 5, where the tables are at labels TABLCD, MESSAG and MESSAG2. Malcolm will explain table use more fully next month. Apart from this change to any table use, alphanumeric l.c.d.s are controlled in same way as for other PICs.

It is still possible to use PCL for tables, but a crucial point to note is that 18F PCL behaves differently to 16F PCL. This difference requires a change to any loop which calls PCL-governed tables, in that the loop counter must be *doubly* incremented following each call to the table. If it were to be only singly incremented (in the more familiar manner) each line in the table would be accessed twice.

Double incrementing for PCL-accessed tables is essential in order to access each line both consecutively and

### Listing 3

```

LCDSET  clrf    RSLINE
        movlw  UPPER TABLCD
        movwf  TBLPTRU,A
        movlw  HIGH TABLCD
        movwf  TBLPTRH,A
        movlw  LOW TABLCD
        movwf  TBLPTRL,A
        movlw  8
        movwf  LOOP,A

LCDST2  tblrd*+
        movf   TABLAT,W,A
        rcall  LCDOUT
        decfsz LOOP,F,A
        bra   LCDST2
        call  PAUSIT

```

incrementally. The loop count thus has to be twice the length you might normally expect, i.e. for an 8-line table access, a loop of 16 counts must be set. The knock-on effect is that tables are limited to 128 lines instead of the normal 256.

Malcolm stresses that it is preferable not to use PCL for 18F table access.

In Listing 3, the l.c.d is initialised to 2-line 4-bit mode, then a tabled 8-character message (MESSAG) is sent to l.c.d screen line 1. The routine is written to suit the standard l.c.d pinout order on *TK3*'s p.c.b.

## Data EEPROM Writing

Next, for the sake of demonstration, values in the third table (MESSAG2) are sent for storage in the PIC's data EEPROM as in Listing 5. This is a subject which gave the author much grief many years back when he began investigating PIC16C devices, Microchip's datasheet then being erroneous.

The 18F datasheet in this respect is not totally explicit either, and a certain amount of experimentation had to be done before writing to the data EEPROM was successful. Reading from it was straightforward. But with both routines, knowledge gained from other PICs was invaluable for getting the 18F to function correctly.

When writing to the EEPROM, the value to be written is first placed in a temporary register (STORE, or other name of your choosing), the address at which the value is to be stored in the EEPROM is then loaded into W, and the

### Listing 4

```

;LCD initialisation table

TABLCD  db B'00110011', B'00110011'
        db B'00110010', B'00101100'
        db B'00000110', B'00001100'
        db B'00000001', B'00000010'

; end initialisation table

MESSAG  db 'R', 'E', 'A', 'D', ' ', 'E', 'P', 'E'

MESSAG2 db 'H', 'I', 'J', 'K', 'L', 'M', 'N', 'O'

org     H'F00000'
de     'A','B','C','D','E','F','G','H','I'
end

```

### Listing 5

```

PRMMSG  movlw  UPPER MESSAG2
        movwf  TBLPTRU,A
        movlw  HIGH MESSAG2
        movwf  TBLPTRH,A
        movlw  LOW MESSAG2
        movwf  TBLPTRL,A
        bsf   RSLINE,4,A
        movlw  8
        movwf  LOOP,A
        movwf  LOOPA,A

PRMMS2  tblrd*+
        movff  TABLAT, STOREI
        movf   LOOPA,W,A
        rcall  SETPRM
        movf   LOOPA,F,A
        decfsz LOOP,F,A
        bra   PRMMS2

```

### Listing 6

```

SETPRM  movwf EEADR,A
        movf  STOREI,W,A
        movwf EEDATA,A
        bcf  EECON1,EEPGD,A
        bcf  EECON1,CFGSA,A
        bsf  EECON1,WREN,A
        bcf  INTCON,GIE,A
        movlw H'55'
        movwf EECON2,A
        movlw H'AA'
        movwf EECON2,A
        bsf  EECON1,WR,A

CHKWRT  btfsz PIR2,EEIF,A
        goto CHKWRT
        bcf  EECON1,WREN,A
        bcf  PIR2,EEIF,A
        bcf  EECON1,WREN,A
        return

```

SETPRM routine called. A somewhat "black-art" set of commands follows, which should be copied parrot-fashion into your own programs. All you need to concern yourself with is the loading of STORE and W. See Listing 6.

## Data EEPROM Reading

When reading the EEPROM, simply load W with the EEPROM address from which to read the data, then call GETPRM.

See Listings 7 and 8. The routine is exited with W holding the value from the specified location. Again, copy the routine as it is into your own program.

Having placed eight extra values into the EEPROM (at its locations 8 to 15) in Listing 5, the first eight values (at locations 0 to 7 – set there as discussed next) are read back in Listing 7 and displayed at the right of screen line 1. The

## Listing 7

```
GETEEPROM    clrf LOOP,A
              movf LOOP,W,A
              call GETPRM
              call LCDOUT
              incf LOOP,F,A
              btfss LOOP,3,A
              goto GETEEPROM
              call LCD21
              movlw 8
              movwf LOOP,A

GETEEPROM2   movf LOOP,W,A
              call GETPRM
              call LCDOUT
              incf LOOP,F,A
              btfss LOOP,4,A
              goto GETEEPROM2
              movlw ''
              call LCDOUT
```

## Listing 8

```
GETPRM       movwf EADDR,
              bcf EECON1,EEPGD,A
              bcf EECON1,CFG5,A
              bsf EECON1,RD,A
              movf EEDATA,W,A
              return
```

new EEPROM values are read and displayed on screen line 2.

Note in the full program the way in which the screen line is selected (call LCD21). It is suggested that you experiment with the table messages (but don't amend TABLCD), and those DB and DE-prefixed values at the end of Listing 4.

## Embedded Data EEPROM Values

The DE-prefixed values at the end of Listing 4 are the values which the assembler loads into the HEX file for subsequent automatic placing into the PIC's data EEPROM, at locations 0 to 7 in this case. You will see the ORG value of H'F00000' – a very large value for a PIC you might think. Fortunately, it is not an address value as such, but merely a value which the assembler knows means that subsequent values are for the EEPROM.

Be aware that MPASM treats pairs of values in a DE line as a single value compacted into one word (two bytes), and individual DE values also as two bytes but with the second having a value of zero. TK3 treats all data values as two bytes with the second as zero, and when reading the EEPROM this zero value is "unseen".

TK3 may have this function changed in a future version as it consumes more EEPROM than desirable.

## FSR and INDF

The use of indirect addressing through FSR and INDF is also different with 18F devices. Practical examples are shown in Listing 9. For an understanding of the logic behind the commands, it essential to read the 18F datasheet, noting that there are several indirect addressing registers in addition (but similar) to those in the examples.

## Listing 9

```
movlw 5 ; load 4 consecutive registers
movwf TEST
movlw 6
movwf TEST2
movlw 4
movwf TEST3
movlw 8
movwf TEST4 ; this reg not accessed by routine below
lfsr FSR1,TEST ; load FSR1 with address of 1st reg (TEST)
movf POSTINC1,W ; read 1st reg and inc FSR counter
iorlw 48
call LCDOUT ; show REG contents as decimal
movf POSTINC1,W ; read 2nd reg and inc FSR counter
iorlw 48
call LCDOUT ; show REG contents as decimal
movf INDF1,W ; read 3rd reg but don't inc FSR counter
iorlw 48
call LCDOUT ; show REG contents as decimal
movf POSTDEC1,W ; read 3rd reg again and decrement FSR counter
iorlw 48
call LCDOUT ; show REG contents as decimal
movf INDF1,W ; read 2nd reg but don't dec/inc FSR counter
iorlw 48
call LCDOUT ; show 2nd REG contents as decima
```

## Obtaining TK3 V3.00

The software for TK3 V3.00, which includes the Simulation, 18F facilities and the demonstration program (TK3PIC18FDEMO2.ASM), is available via the *EPE* web site at [www.epemag.co.uk](http://www.epemag.co.uk). Click the usual Downloads button on the home page, and then access the PIC Microcontrollers path and select folder *Toolkit TK3*. Download all files within that folder into a new folder on your PC, under whatever name you choose. It is suggested that you do not delete the earlier *TK3* folder, just rename it.

Note that what used to be sub-folders named Disk 1 and Disk 3 have now been combined into one folder named Disk1-3. This holds the standalone (*Toolkit3.exe*) file, all the associated text files etc, and the *TK3 VB6* source code. The original Disk 3 held only the source code and is no longer required on its own (or available).

If you have not downloaded *TK3* before and do not have *VB6* installed on your PC, you *must* use the files in folder Disk 2. These are Microsoft "runtime" files required for use with the standalone *Toolkit3.exe*.

Where files are zipped, unzip them all into the same folder holding the rest of *TK3*'s files. Winzip is the suggested unzip facility, and should be part of any PC's software. If you do not have it installed, it may be download free from [www.winzip.com](http://www.winzip.com).

Unless you are already familiar with PIC18F devices, wait until you've read Malc's introduction to them next month before putting them to use. There are certain other critical differences which you need to appreciate. You should also obtain the Microchip datasheet (DS39564) for the 18Fxx2/xx8 devices, from [www.microchip.com](http://www.microchip.com). It is over 300 pages, but is essential to understanding the devices.

## Acknowledgements

The author wishes to thank John Waller for the active field testing he did over several weeks with the Simulator and a PIC16F62x program he was working on, making many invaluable suggestions which were then implemented. John's project for a model railway signal control will be published in a few months time.

Malcolm Wiles is also warmly thanked for his invaluable help with getting *TK3* to program 18F PICs and for clarifying 18F table use. In places Microchip's documentation is less than clear and Malc clarified a number of points which, for some time, presented the author with seemingly insurmountable hurdles. Malc is currently offering advice on further improvements in respect of 18F devices. Updated *TK3* software embodying Malc's suggestions will be released when appropriate.

Malc's *Introduction to the PIC18F Family* will be published next month, in the April '05 issue.

Several other readers, too numerous to mention individually, have also assisted in various ways in the upgrade to *TK3 V3.00*. Very many thanks for your help too!

Don't forget that *TK3* now embodies Richard Hinckley's *PIC Breakpoint*, and several contributions by Andrew Jarvis to add more PIC types and associated software tools to *TK3*'s repertoire. And Ian Stedman has contributed a *TK3* FAQ file which is in the *TK3* folder on the Downloads site. Joe Farr is currently developing a *TK3* interface for Proton+ Software. Thanks guys!

Practical example projects using 18F devices are in the pipeline.

If you wish to provide the author with feedback about *TK3*, you can do so via his *EPE* email address:

[john.becker@wimborne.co.uk](mailto:john.becker@wimborne.co.uk). □

We can supply back issues of *EPE* by post, most issues from the past three years are available. An *EPE* index for the last five years is also available at [www.epemag.wimbome.co.uk](http://www.epemag.wimbome.co.uk) or see order form below. Alternatively, indexes are published in the December issue for that year. Where we are unable to provide a back issue a photocopy of any *one article* (or *one part* of a series) can be purchased for the same price. Issues from Nov. 98 are available on CD-ROM – see next page – and issues from the last six months are also available to download from [www.epemag.com](http://www.epemag.com). Please make sure all components are still available before commencing any project from a back-dated issue.

## DID YOU MISS THESE?

### NOV '03

**PROJECTS** • PIC Random L.E.D. Flasher • Cardboard Clock • Practical Radio Circuits-6 (S.S.B. and Direct Conversion Receiver) • Anyone At Home?

**FEATURES** • Teach-In 2004 – Part 1 • Ingenuity Unlimited • Practically Speaking • Techno Talk • Circuit Surgery • New Technology Update • Net Work – The Internet Page.

### DEC '03

**PROJECTS** • PIC Nim Machine • Practical Radio Circuits-7 (Superhet Tuner) • PIC Virus Zapper Mk2 • Christmas Cheeks.

**FEATURES** • Teach-In 2004 – Part 2 • Electrotherapy • Circuit Surgery • Ingenuity Unlimited • Techno Talk • High-Speed Decimal To Binary For PICs • Interface • Network – The Internet.

### JAN '04

**PROJECTS** • Car Computer • Practical Radio Circuits-8 (Dual-Conversion SW Receiver) • Bedside Nightlight • PIC Watering Timer.

**FEATURES** • GPS to PIC and PC Interface • Practically Speaking • Teach-In 2004 – Part 3 • Ingenuity Unlimited • Techno Talk • Circuit Surgery • New Technology Update • Net Work – The Internet Page.



### FEB '04

**PROJECTS** • PIC LCF Meter • Sonic Ice Warning • Jazzy Necklace • PIC Tug-of-War.

**FEATURES** • Surface Mount Devices • Circuit Surgery • Teach-In 2004 – Part 4 • Interface • Ingenuity Unlimited • Techno Talk • Net Work – The Internet Page.

### MAR '04

**PROJECTS** • Bat-Band Convertor • Emergency Stand-by Light • MIDI Health Check • PIC Mixer for RC Planes.

**FEATURES** • Teach-In 2004 – Part 5 • New Scientist CD-Rom Review • Circuit Surgery • Techno Talk • Ingenuity Unlimited • Practically Speaking • Net Work – The Internet Page.

### APRIL '04

**PROJECTS** • EPE Experimental Seismograph Logger 1 • Infra-Guard Monitor • Loft Light Alarm • PIC Moon Clock.

**FEATURES** • USB To PIC Interface • Ingenuity Unlimited • Teach-In 2004 Part 6 • Interface • Techno Talk • Circuit Surgery • New Technology Update • Net Work – The Internet Page • Pull-Out – Semiconductor Classification Data.

### MAY '04

**PROJECTS** • Beat Balance Metal Detector • In-Car Laptop PSU • Low-Frequency Wien Oscillator • EPE Experimental Seismograph Logger-2.

**FEATURES** • Coping With Lead-Free Solder • Teach-In 2004 – Part 7 • Ingenuity Unlimited • Techno Talk • Circuit Surgery • Practically Speaking • Pic-N-Mix • Net Work – The Internet Page.

### JUNE '04

**PROJECTS** • PIC Quickstep • Crafty Cooling • MIDI Synchronome • Body Detector Mk2.

**FEATURES** • Clinical Electrotherapy • Ingenuity Unlimited • Teach-In 2004 – Part 8 • Interface • Circuit Surgery • Techno Talk • PIC-N-Mix • Net Work – The Internet Page.



### JULY '04

**PROJECTS** • Portable Mini Alarm • Bongoo Box • Hard Drive Warbler • EPE PIC Magnetometry Logger-1.

**FEATURES** • Making Front Panel Overlays • Practically Speaking • Teach-In 2004 – Part 9 • Ingenuity Unlimited • Circuit Surgery • Techno Talk • PIC-N-Mix • Net Work – The Internet Page.

### AUG '04

**PROJECTS** • EPE Scorer • Keyring L.E.D. Torch • Simple F.M. Radio • EPE PIC Magnetometry Logger - 2.

**FEATURES** • PIC To PS/2 Mouse and Keyboard Interfacing • Techno Talk • Circuit Surgery • Teach-In 2004 – Part 10 • Interface • Ingenuity Unlimited • PIC-N-Mix • Net Work – The Internet Page.

### SEPT '04

**PROJECTS** • EPE Wart Zapper • Radio Control Failsafe • Rainbow Lighting Control • Alphamouse Game.

**FEATURES** • Light Emitting Diodes – Part 1 • High Speed Binary-To-Decimal For PICs • Practically Speaking • Ingenuity Unlimited • Techno-Talk • Circuit Surgery • PIC-N-Mix • Network – The Internet Page

### OCT '04

**PROJECTS** • EPE Theremin • Smart Karts – Part 1 • Volts Checker • Moon and Tide Clock Calendar.

**FEATURES** • Light Emitting Diodes – 2 • Circuit Surgery • Interface • Ingenuity Unlimited • Techno Talk • PIC-N-Mix • Network – The Internet Page • ROBOTS – Special Supplement

### NOV '04

**PROJECTS** • Thunderstorm Monitor • M.W. Amplitude Modulator • Logic Probe • Smart Karts - 2. **FEATURES** • Light Emitting Diodes-3 • Floating Point Maths for PICs • Ingenuity Unlimited • PE 40th Anniversary • Circuit Surgery • Techno Talk • PIC-N-Mix • Net Work – The Internet Page.

### DEC '04

**PROJECTS** • Super Vibration Switch • Versatile PIC Flasher • Wind Direction Indicator • Smart Karts - 3.

**FEATURES** • Light Emitting Diodes-4 • Ingenuity Unlimited • Circuit Surgery • Interface • PIC 'N' Mix • Techno Talk • Net Work – The Internet Page • INDEX Vol. 33.



### JAN '05

**PROJECTS** • Speed Camera Watch • Gate Alarm • Light Detector • Smart Karts - 4.

**FEATURES** • Practically Speaking • 32-Bit Signed Integer Maths for PICs • Ingenuity Unlimited • Circuit Surgery • Techno Talk • PIC 'N' Mix • Picoscope 3205 Review • Net Work – The Internet Page

### FEB '05

**PROJECTS** • PIC Electric MK2 Pt1 • Sneaky • Sound Card Mixer • Smart Karts - 5.

**FEATURES** • Interface • Circuit Surgery • Ingenuity Unlimited • Techno Talk • PIC 'N' Mix • E-Blocks and Flowcode V2.0 Reviews • Net Work – The Internet Page

## BACK ISSUES ONLY £3.50 each inc. UK p&p.

Overseas prices £4 each surface mail, £5.50 each airmail.

We can also supply issues from earlier years: 1999 (except Feb., May, Aug., Sept., Dec.), 2000 (except Feb., Mar., July, Oct.), 2001 (except May, Aug. to Nov.), 2002 (except Feb., June, Aug. to Nov.), 2003 (except June) Where we do not have an issue a photocopy of any *one article* or *one part* of a series can be provided at the same price.

### ORDER FORM – BACK ISSUES – PHOTOCOPIES – INDEXES

- Send back issues dated .....
- Send photocopies of (article title and issue date) .....
- Send copies of last five years indexes (£3.50 for five inc. p&p – Overseas £4 surface, £5.50 airmail)

Name .....

Address .....

.....Tel: .....

I enclose cheque/P.O./bank draft to the value of £ .....

Please charge my Visa/Mastercard/Amex/Diners Club/Switch £ ..... Switch Issue No. ....

Card No. ....

Valid From ..... Card Expiry Date ..... Card Security Code .....

(The last 3 digits on or just under the signature strip)

SEND TO: Everyday Practical Electronics, Wimborne Publishing Ltd., 408 Wimborne Road East, Ferndown, Dorset BH22 9ND.

Tel: 01202 873872. Fax: 01202 874562.

E-mail: [orders@epemag.wimbome.co.uk](mailto:orders@epemag.wimbome.co.uk) On-line Shop: [www.epemag.wimbome.co.uk/shopdoor.htm](http://www.epemag.wimbome.co.uk/shopdoor.htm)

Payments must be in £ sterling – cheque or bank draft drawn on a UK bank. Normally supplied within seven days of receipt of order.

Send a copy of this form, or order by letter if you do not wish to cut your issue.

MO2/05

# STORE YOUR BACK ISSUES ON MINI CD-ROMS

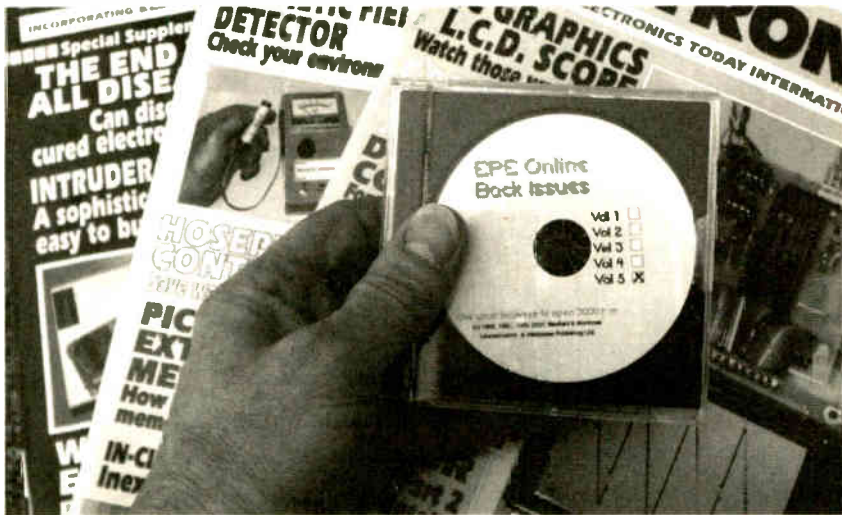

**VOL 11  
NOW AVAILABLE**

**ONLY  
£14.45** each  
including VAT  
and p&p

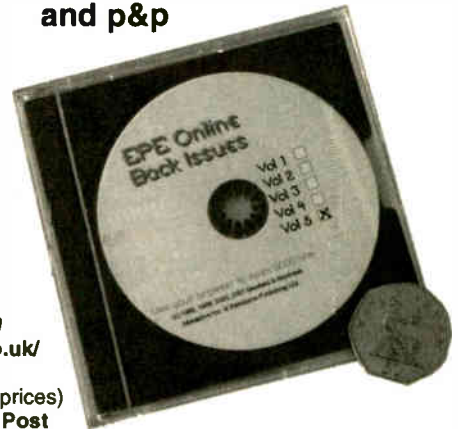

A great way to buy *EPE* Back Issues – our mini CD-ROMs contain back issues from our *EPE Online* website plus bonus articles, all the relevant PIC software and web links. Note: no free gifts are included. All this for just £14.45 each including postage and packing.

- VOL 1:** BACK ISSUES – January 1999 to June 1999  
Plus some bonus material from Nov and Dec 1998
- VOL 2:** BACK ISSUES – July 1999 to December 1999
- VOL 3:** BACK ISSUES – January 2000 to June 2000
- VOL 4:** BACK ISSUES – July 2000 to December 2000
- VOL 5:** BACK ISSUES – January 2001 to June 2001
- VOL 6:** BACK ISSUES – July 2001 to December 2001
- VOL 7:** BACK ISSUES – January 2002 to June 2002
- VOL 8:** BACK ISSUES – July 2002 to December 2002
- VOL 9:** BACK ISSUES – January 2003 to June 2003
- VOL 10:** BACK ISSUES – July 2003 to December 2003
- VOL 11:** BACK ISSUES – January 2004 to June 2004

Order on-line from  
[www.epemag.wimbome.co.uk/  
shopdoor.htm](http://www.epemag.wimbome.co.uk/shopdoor.htm)  
or [www.epemag.com](http://www.epemag.com) (USA \$ prices)  
or by phone, Fax, E-mail or Post

NOTE: These mini CD-ROMs are suitable for use on any PC with a CD-ROM drive. They require Adobe Acrobat Reader (available free from the Internet – [www.adobe.com/acrobat](http://www.adobe.com/acrobat))

## WHAT IS INCLUDED

All volumes include the *EPE Online* editorial content of every listed issue, plus all the available PIC Project Codes for the PIC projects published in those issues.

Note: Some supplements etc. can be downloaded free from the Library on the *EPE Online* website at [www.epemag.com](http://www.epemag.com). No advertisements are included in Volumes 1 and 2; from Volume 5 onwards the available relevant software for *Interface* articles is also included.

## EXTRA ARTICLES – ON ALL VOLUMES

**BASIC SOLDERING GUIDE** – Alan Winstanley's internationally acclaimed fully illustrated guide. **UNDERSTANDING PASSIVE COMPONENTS** – Introduction to the basic principles of passive components. **HOW TO USE INTELLIGENT L.C.D.s**, by Julyan Ilett – An utterly practical guide to interfacing and programming intelligent liquid crystal display modules. **PhyzyB COMPUTERS BONUS ARTICLE 1** – Signed and Unsigned Binary Numbers. By Clive "Max" Maxfield and Alvin Brown. **PhyzyB COMPUTERS BONUS ARTICLE 2** – Creating an Event Counter. By Clive "Max" Maxfield and Alvin Brown. **INTERGRAPH COMPUTER SYSTEMS 3D GRAPHICS** – A chapter from Intergraph's book that explains computer graphics technology. **FROM RUSSIA WITH LOVE**, by Barry Fox – Russian rockets launching American Satellites. **PC ENGINES**, by Ernest Flint – The evolution of Intel's microprocessors. **THE END TO ALL DISEASE**, by Aubrey Scoon – The original work of Rife. **COLLECTING AND RESTORING VINTAGE RADIOS**, by Paul Stenning. **THE LIFE & WORKS OF KONRAD ZUSE** – a brilliant pioneer in the evolution of computers. A bonus article on his life and work written by his eldest son, including many previously unpublished photographs.

Note: Some of the EXTRA ARTICLES require WinZip to unzip them.

## BACK ISSUES MINI CD-ROM ORDER FORM

Please send me ..... (quantity) BACK ISSUES CD-ROM VOL 1  
Please send me ..... (quantity) BACK ISSUES CD-ROM VOL 2  
Please send me ..... (quantity) BACK ISSUES CD-ROM VOL 3  
Please send me ..... (quantity) BACK ISSUES CD-ROM VOL 4  
Please send me ..... (quantity) BACK ISSUES CD-ROM VOL 5  
Please send me ..... (quantity) BACK ISSUES CD-ROM VOL 6  
Please send me ..... (quantity) BACK ISSUES CD-ROM VOL 7  
Please send me ..... (quantity) BACK ISSUES CD-ROM VOL 8  
Please send me ..... (quantity) BACK ISSUES CD-ROM VOL 9  
Please send me ..... (quantity) BACK ISSUES CD-ROM VOL 10  
Please send me ..... (quantity) BACK ISSUES CD-ROM VOL 11  
Price £14.45 each – includes postage to anywhere in the world.

Name .....

Address .....

..... Post Code .....

I enclose cheque/P.O./bank draft to the value of £ .....

Please charge my Visa/Mastercard/Amex/Diners Club/Maestro

£ .....

Card No. ....

Card Security Code ..... (The last 3 digits on or just under the signature strip)

Valid From ..... Expiry Date .....

Maestro Issue No. ....

SEND TO: **Everyday Practical Electronics,  
Wimbome Publishing Ltd.,  
408 Wimborne Road East, Ferndown, Dorset BH22 9ND.**  
Tel: 01202 873872. Fax: 01202 874562.  
E-mail: [orders@epemag.wimbome.co.uk](mailto:orders@epemag.wimbome.co.uk)

Payments must be by card or in £ Sterling – cheque or bank draft drawn on a UK bank.

Normally supplied within seven days of receipt of order.



# DIRECT BOOK SERVICE

NOTE: ALL PRICES INCLUDE UK POSTAGE

FREE *Electronics Hobbyist Compendium* book with Teach-In 2000 CD-ROM



## EPE TEACH-IN 2000 CD-ROM

The whole of the 12-part *Teach-In 2000* series by John Becker (published in *EPE* Nov '99 to Oct 2000) is now available on CD-ROM. Plus the *Teach-In 2000* interactive software (Win 95, 98, ME and above) covering all aspects of the series and Alan Winstanley's *Basic Soldering Guide* (including illustrations and Desoldering).

*Teach-In 2000* covers all the basic principles of electronics from Ohm's Law to Displays, including Op.Amps, Logic Gates etc. Each part has its own section on the interactive software where you can also change component values in the various on-screen demonstration circuits.

The series gives a hands-on approach to electronics with numerous breadboard circuits to try out, plus a simple computer interface (Win 95, 98, ME only) which allows a PC to be used as a basic oscilloscope.

ONLY **£12.45** including VAT and p&p

Order code Teach-In CD-ROM

## Circuits and Design

### PREAMPLIFIER AND FILTER CIRCUITS

R. A. Penfold

Provides circuits and background information for a range of preamplifiers, plus tone controls, filters, mixers, etc. The use of modern low noise operational amplifiers and a specialist high performance audio preamplifier i.c. results in circuits that have excellent performance, but which are still quite simple. All the circuits featured can be built at quite low cost. The preamplifier circuits featured include: Microphone preamplifiers (low impedance, high impedance, and crystal). Magnetic cartridge pick-up preamplifiers with R.I.A.A. equalisation. Crystal/ceramic pick-up preamplifier. Guitar pick-up preamplifier. Tape head preamplifier.

Other circuits include: Audio limiter. Passive tone controls. Active tone controls. PA filters (highpass and low-pass). Scratch and rumble filters. Loudness filter. Mixers. Volume and balance controls.

92 pages

Temporarily out of print

### DOMESTIC SECURITY SYSTEMS

A. L. Brown

This book shows you how, with common sense and basic do-it-yourself skills, you can protect your home. It also gives tips and ideas which will help you to maintain and improve your home security, even if you already have an alarm. Every circuit in this book is clearly described and illustrated, and contains components that are easy to source. Advice and guidance are based on the real experience of the author who is an alarm installer, and the designs themselves have been rigorously put to use on some of the most crime-ridden streets in the world.

The designs include all elements, including sensors, detectors, alarms, controls, lights, video and door entry systems. Chapters cover installation, testing, maintenance and upgrading.

192 pages

Order code NE25

£20.99

### MICROCONTROLLER COOKBOOK

Mike James

The practical solutions to real problems shown in this cookbook provide the basis to make PIC and 8051 devices really work. Capabilities of the variants are examined, and ways to enhance these are shown. A survey of common interface devices, and a description of programming models, lead on to a section on development techniques. The cookbook offers an introduction that will allow any user, novice or experienced, to make the most of microcontrollers.

240 pages

Order code NE26

£23.99

### A BEGINNER'S GUIDE TO TTL DIGITAL ICs

R. A. Penfold

This book first covers the basics of simple logic circuits in general, and then progresses to specific TTL logic integrated circuits. The devices covered include gates, oscillators, timers, flip/flops, dividers, and decoder circuits. Some practical circuits are used to illustrate the use of TTL devices in the "real world".

142 pages

Order code BP332

£5.45

### PRACTICAL ELECTRONICS CALCULATIONS AND FORMULAE

F. A. Wilson, C.G.I.A., C.Eng., F.I.E.E., F.I.E.R.E., F.B.I.M.

Bridges the gap between complicated technical theory, and "cut-and-try" methods which may bring success in design but leave the experimenter unfulfilled. A strong practical bias - tedious and higher mathematics have been avoided where possible and many tables have been included.

The book is divided into six basic sections: Units and Constants, Direct-Current Circuits, Passive Components, Alternating-Current Circuits, Networks and Theorems, Measurements.

256 pages

Order code BP53

£5.49

## Computing & Robotics

### WINDOWS XP EXPLAINED

N. Kantaris and P. R. M. Oliver

If you want to know what to do next when confronted with Microsoft's Windows XP screen, then this book is for you. It applies to both the Professional and Home editions.

The book was written with the non-expert, busy person in mind. It explains what hardware requirements you need in order to run Windows XP successfully, and gives an overview of the Windows XP environment.

The book explains: How to manipulate Windows, and how to use the Control Panel to add or change your printer, and control your display; How to control information using WordPad, Notepad and Paint, and how to use the Clipboard facility to transfer information between Windows applications; How to be in control of your filing system using Windows Explorer and My Computer; How to control printers, fonts, characters, multimedia and images, and how to add hardware and software to your system; How to configure your system to communicate with the outside world, and use Outlook Express for all your email requirements; How to use the Windows Media Player 8 to play your CDs, burn CDs with your favourite tracks, use the Radio Tuner, transfer your videos to your PC, and how to use the Sound Recorder and Movie Maker; How to use the System Tools to restore your system to a previously working state, using Microsoft's Website to update your Windows set-up, how to clean up, defragment and scan your hard disk, and how to backup and restore your data; How to successfully transfer text from those old but cherished MS-DOS programs.

268 pages

Temporarily out of print

### INTRODUCING ROBOTICS WITH LEGO MINDSTORMS

Robert Penfold

Shows the reader how to build a variety of increasingly sophisticated computer controlled robots using the brilliant Lego Mindstorms Robotic Invention System (RIS). Initially covers fundamental building techniques and mechanics needed to construct strong and efficient robots using the various "click-together" components supplied in the basic RIS kit. Explains in simple terms how the "brain" of the robot may be programmed on screen using a PC and "zapped" to the robot over an infra-red link. Also, shows how a more sophisticated Windows programming language such as Visual BASIC may be used to control the robots.

Detailed building and programming instructions provided, including numerous step-by-step photographs.

288 pages - large format

Order code BP901

£14.99

### MORE ADVANCED ROBOTICS WITH LEGO MINDSTORMS - Robert Penfold

Covers the Vision Command System

Shows the reader how to extend the capabilities of the brilliant Lego Mindstorms Robotic Invention System (RIS) by using Lego's own accessories and some simple home constructed units. You will be able to build robots that can provide you with 'water service' when you clap your hands, perform tricks, 'see' and avoid objects by using 'bats radar', or accurately follow a line marked on

the floor. Learn to use additional types of sensors including rotation, light, temperature, sound and ultrasonic and also explore the possibilities provided by using an additional (third) motor. For the less experienced, RCX code programs accompany most of the featured robots. However, the more adventurous reader is also shown how to write programs using Microsoft's VisualBASIC running with the ActiveX control (Spirit.OCX) that is provided with the FIS kit.

Detailed building instructions are provided for the featured robots, including numerous step-by-step photographs. The designs include rover vehicles, a virtual pet, a robot arm, an 'intelligent' sweet dispenser and a colour conscious robot that will try to grab objects of a specific colour.

298 pages

Order code BP902

£14.99

### PIC YOUR PERSONAL INTRODUCTORY COURSE

SECOND EDITION John Morton

Discover the potential of the PIC microcontroller through graded projects - this book could revolutionise your electronics construction work!

A uniquely concise and practical guide to getting up and running with the PIC Microcontroller. The PIC is one of the most popular of the microcontrollers that are transforming electronic project work and product design.

Assuming no prior knowledge of microcontrollers and introducing the PICs capabilities through simple projects, this book is ideal for use in schools and colleges. It is the ideal introduction for students, teachers, technicians and electronics enthusiasts. The step-by-step explanations make it ideal for self-study too; this is not a reference book - you start work with the PIC straight away.

The revised second edition covers the popular reprogrammable EEPROM PICs: P16C84/16F84 as well as the P54 and P71 families.

270 pages

Order code NE36

£15.99

### INTRODUCTION TO MICROPROCESSORS

John Crisp

If you are, or soon will be, involved in the use of microprocessors, this practical introduction is essential reading. This book provides a thoroughly readable introduction to microprocessors, assuming no previous knowledge of the subject, nor a technical or mathematical background. It is suitable for students, technicians, engineers and hobbyists, and covers the full range of modern microprocessors.

After a thorough introduction to the subject, ideas are developed progressively in a well-structured format. All technical terms are carefully introduced and subjects which have proved difficult, for example 2's complement, are clearly explained. John Crisp covers the complete range of microprocessors from the popular 4-bit and 8-bit designs to today's super-fast 32-bit and 64-bit versions that power PCs and engine management systems etc.

222 pages

Order code NE31

£21.99

The books listed have been selected by *Everyday Practical Electronics* editorial staff as being of special interest to everyone involved in electronics and computing. They are supplied by mail order direct to your door. Full ordering details are given on the last book page.

FOR A FURTHER SELECTION OF BOOKS SEE THE NEXT TWO ISSUES OF EPE

All prices include UK postage

### NEWNES INTERFACING COMPANION

Tony Fischer-Cripps

A uniquely concise and practical guide to the hardware, applications and design issues involved in computer interfacing and the use of transducers and instrumentation.

Newnes Interfacing Companion presents the essential information needed to design a PC-based interfacing system from the selection of suitable transducers, to collection of data, and the appropriate signal processing and conditioning.

Contents: Part 1 - Transducers; Measurement systems; Temperature; Light; Position and motion; Force, pressure and flow. Part 2 - Interfacing; Number systems; Computer architecture; Assembly language; Interfacing; A to D and D to A conversions; Data communications; Programmable logic controllers; Data acquisition project. Part 3 - Signal processing; Transfer function; Active filters; Instrumentation amplifier; Noise; Digital signal processing.

320 pages

Order code NE38

£26.99

# Testing, Theory and Reference

## THE AMATEUR SCIENTIST CD-ROM

The complete collection of The Amateur Scientist articles from *Scientific American* magazine. Over 1,000 classic science projects from a renowned source of winning projects. All projects are rated for cost, difficulty and possible hazards.

Plus over 1,000 pages of helpful science techniques that never appeared in *Scientific American*.  
Exciting science projects in: Astronomy; Earth Science; Biology; Physics; Chemistry; Weather... and much more! The most complete resource ever assembled for hobbyists, and professionals looking for novel solutions to research problems. Includes extensive Science Software Library with even more science tools.  
Suitable for Mac, Windows, Linux or UNIX. 32MB RAM minimum, Netscape 4.0 or higher or Internet Explorer 4.0 or higher.  
Over 1,000 projects



Order code AS1 CD-ROM £19.95

## BEBOP BYTES BACK (and the Bebop Computer Simulator) CD-ROM

Clive (Max) Maxfield and Alvin Brown

This follow-on to *Bebop to the Boolean Boogie* is a multimedia extravaganza of information about how computers work. It picks up where "Bebop I" left off, guiding you through the fascinating world of computer design... and you'll have a few chuckles, if not belly laughs, along the way. In addition to over 200 megabytes of mega-cool multimedia, the CD-ROM contains a virtual microcomputer, simulating the motherboard and standard computer peripherals in an extremely realistic manner. In addition to a wealth of technical information, myriad nuggets of trivia, and hundreds of carefully drawn illustrations, the CD-ROM contains a set of lab experiments for the virtual microcomputer that let you recreate the experiences of early computer pioneers. If you're the slightest bit interested in the inner workings of computers, then don't dare to miss this!  
Over 800 pages in Adobe Acrobat format

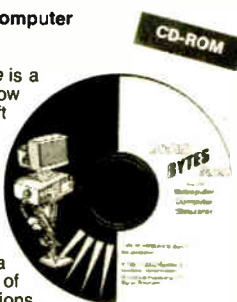

Order code BEB2 CD-ROM £21.95

## DIGITAL ELECTRONICS – A PRACTICAL APPROACH With FREE Software: Number One Systems – EASY-PC Professional XM and Pulsar (Limited Functionality)

Richard Monk

Covers binary arithmetic, Boolean algebra and logic gates, combination logic, sequential logic including the design and construction of asynchronous and synchronous circuits and register circuits. Together with a considerable practical content plus the additional attraction of its close association with computer-aided design including the FREE software.

There is a 'blow-by-blow' guide to the use of EASY-PC Professional XM (a schematic drawing and printed circuit board design computer package). The guide also conducts the reader through logic circuit simulation using Pulsar software. Chapters on p.c.b. physics and p.c.b. production techniques make the book unique, and with its host of project ideas make it an ideal companion for the integrative assignment and common skills components required by BTEC and the key skills demanded by GNVQ. The principal aim of the book is to provide a straightforward approach to the understanding of digital electronics.

Those who prefer the 'Teach-In' approach or would rather experiment with some simple circuits should find the book's final chapters on printed circuit board production and project ideas especially useful.  
250 pages

Temporarily out of print

## OSCILLOSCOPES – FIFTH EDITION

Ian Hickman

Oscilloscopes are essential tools for checking circuit operation and diagnosing faults, and an enormous range of models are available.

This handy guide to oscilloscopes is essential reading for anyone who has to use a 'scope for their work or hobby; electronics designers, technicians, anyone in industry involved in test and measurement, electronics enthusiasts... Ian Hickman's review of all the latest types of 'scope currently available will prove especially useful for anyone planning to buy – or even build – an oscilloscope.

The contents include a description of the basic oscilloscope; Advanced real-time oscilloscope; Accessories; Using oscilloscopes; Sampling oscilloscopes; Digital storage oscilloscopes; Oscilloscopes for special purposes; How oscilloscopes work (1): the CRT; How oscilloscopes work (2): circuitry; How oscilloscopes work (3): storage CRTs; plus a listing of Oscilloscope manufacturers and suppliers.  
288 pages

Order code NE37 £22.99

## SCROGGIE'S FOUNDATIONS OF WIRELESS AND ELECTRONICS – ELEVENTH EDITION

S. W. Amos and Roger Amos

Scroggie's Foundations is a classic text for anyone working with electronics, who needs to know the art and craft of the subject. It covers both the theory and practical aspects of a huge range of topics from valve and tube technology, and the application of cathode ray tubes to radar, to digital tape systems and optical recording techniques.

Since *Foundations of Wireless* was first published over 60 years ago, it has helped many thousands of readers to become familiar with the principles of radio and electronics. The original author Sowerby was succeeded by Scroggie in the 1940s, whose name became synonymous with this classic primer for practitioners and students alike. Stan Amos, one of the fathers of modern electronics and the author of many well-known books in the area, took over the revision of this book in the 1980s and it is he, with his son, who have produced this latest version.

400 pages

Temporarily out of print

## PRACTICAL ELECTRONIC FAULT FINDING AND TROUBLESHOOTING Robin Pain

To be a real fault finder, you must be able to get a feel for what is going on in the circuit you are examining. In this book Robin Pain explains the basic techniques needed to be a fault finder.

Simple circuit examples are used to illustrate principles and concepts fundamental to the process of fault finding. This is not a book of theory, it is a book of practical tips, hints and rules of thumb, all of which will equip the reader to tackle any job. You may be an engineer or technician in search of information and guidance, a college student, a hobbyist building a project from a magazine, or simply a keen self-taught amateur who is interested in electronic fault finding but finds books on the subject too mathematical or specialised.

The fundamental principles of analogue and digital fault finding are described (although, of course, there is no such thing as a "digital fault" – all faults are by nature analogue). This book is written entirely for a fault finder using only the basic fault-finding equipment: a digital multimeter and an oscilloscope. The treatment is non-mathematical (apart from Ohm's law) and all jargon is strictly avoided.  
274 pages

Order code NE22 £25.99

## ELECTRONIC TEST EQUIPMENT HANDBOOK

Steve Money

In most applications of electronics, test instruments are essential for checking the performance of a system or for diagnosing faults in operation, and so it is important for engineers, technicians, students and hobbyists to understand how the basic test instruments work and how they can be used.

The principles of operation of the various types of test instrument are explained in simple terms with a minimum of mathematical analysis. The book covers analogue and digital meters, bridges, oscilloscopes, signal generators, counters, timers and frequency measurement. The practical uses of these instruments are also examined.  
206 pages

Order code PC109 £9.95

## DIGITAL GATES AND FLIP-FLOPS

Ian R. Sinclair

This book, intended for enthusiasts, students and technicians, seeks to establish a firm foundation in digital electronics by treating the topics of gates and flip-flops thoroughly and from the beginning.

Topics such as Boolean algebra and Karnaugh mapping are explained, demonstrated and used extensively, and more attention is paid to the subject of synchronous counters than to the simple but less important ripple counters.

No background other than a basic knowledge of electronics is assumed, and the more theoretical topics are explained from the beginning, as also are many working practices. The book concludes with an explanation of micro-processor techniques as applied to digital logic.  
200 pages

Order code PC106 £9.95

## UNDERSTANDING ELECTRONIC CONTROL SYSTEMS

Owen Bishop

Owen Bishop has produced a concise, readable text to introduce a wide range of students, technicians and professionals to an important area of electronics. Control is a highly mathematical subject, but here maths is kept to a minimum, with flow charts to illustrate principles and techniques instead of equations.

Cutting edge topics such as microcontrollers, neural networks and fuzzy control are all here, making this an ideal refresher course for those working in industry. Basic principles, control algorithms and hardwired control systems are also fully covered so the resulting book is a comprehensive text and well suited to college courses or background reading for university students.

The text is supported by questions under the headings Keeping Up and Test Your Knowledge so that the reader can develop a sound understanding and the ability to apply the techniques they are learning.  
228 pages

Order code NE35 £20.99

## HOW ELECTRONIC THINGS WORK – AND WHAT TO DO WHEN THEY DON'T Robert Goodman

You never again have to be flummoxed, flustered or taken for a ride by a piece of electronics equipment. With this fully illustrated, simple-to-use guide, you will get a grasp on the workings of the electronic world that surrounds you – and even learn to make your own repairs.

You don't need any technical experience. This book gives you: Clear explanations of how things work, written in everyday language. Easy-to-follow, illustrated instructions on using test equipment to diagnose problems. Guidelines to help you decide for or against professional repair. Tips on protecting your expensive equipment from lightning and other electrical damage. Lubrication and maintenance suggestions.

Covers: colour TVs, VCRs, radios, PCs, CD players, printers, telephones, monitors, camcorders, satellite dishes, and much more!  
394 pages

Order code MGH3 £21.99

## VINTAGE RADIOS – COLLECTING ● SERVICING ● RESTORING

Tony Thompson

The essential guide to collecting, repairing and restoring vintage valve radios. These receivers are becoming ever more popular as collectibles, this is a good thing because it means that a very large piece of technological history is being reclaimed when at one time many thought it lost forever. If you look around, you will find plenty of valve radio sets just waiting for a loving restoration. They may not yet be the most highly prized, and they are unlikely to be in top condition, but they can be yours and, if you develop the skills outlined in this book, you will possess radio receivers to be proud of.

The book covers radio history, styling, faultfinding, chassis and cabinet restoration, types of set.  
124 pages spiral bound

Order code TT1 £13.50



All prices include UK P&P



# Project Building

## ELECTRONIC PROJECT BUILDING FOR BEGINNERS

R. A. Penfold

This book is for complete beginners to electronic project building. It provides a complete introduction to the practical side of this fascinating hobby, including the following topics:

Component identification, and buying the right parts; resistor colour codes, capacitor value markings, etc; advice on buying the right tools for the job; soldering; making easy work of the hard wiring; construction methods, including stripboard, custom printed circuit boards, plain matrix boards, surface mount boards and wire-wrapping; finishing off, and adding panel labels; getting "problem" projects to work, including simple methods of fault-finding.

In fact everything you need to know in order to get started in this absorbing and creative hobby.

135 pages

Temporarily out of print

## BUILDING VALVE AMPLIFIERS

Morgan Jones

The practical guide to building, modifying, fault-finding and repairing valve amplifiers. A hands-on approach to valve electronics - classic and modern - with a minimum of theory. Planning, fault-finding, and testing are each illustrated by step-by-step examples.

A unique hands-on guide for anyone working with valve (tube in USA) audio equipment - as an electronics experimenter, audiophile or audio engineer.

Particular attention has been paid to answering questions commonly asked by newcomers to the world of the vacuum tube, whether audio enthusiasts tackling their first build, or more experienced amplifier designers seeking to learn the ropes of working with valves. The practical side of this book is reinforced by numerous clear illustrations throughout.

368 pages

Order code NE40

£21.99

# Theory and Reference

## ELECTRONICS MADE SIMPLE

Ian Sinclair

Assuming no prior knowledge, *Electronics Made Simple* presents an outline of modern electronics with an emphasis on understanding how systems work rather than on details of circuit diagrams and calculations. It is ideal for students on a range of courses in electronics, including GCSE, C&G and GNVQ, and for students of other subjects who will be using electronic instruments and methods.

Contents: waves and pulses, passive components, active components and ICs, linear circuits, block and circuit diagrams, how radio works, disc and tape recording, elements of TV and radar, digital signals, gating and logic circuits, counting and correcting, microprocessors, calculators and computers, miscellaneous systems.

199 pages

Order code NE23

£13.99

## GETTING THE MOST FROM YOUR MULTIMETER

R. A. Penfold

This book is primarily aimed at beginners and those of limited experience of electronics. Chapter 1 covers the basics of analogue and digital multimeters, discussing the relative merits and the limitations of the two types. In Chapter 2 various methods of component checking are described, including tests for transistors, thyristors, resistors, capacitors and diodes. Circuit testing is covered in Chapter 3, with subjects such as voltage, current and continuity checks being discussed.

In the main little or no previous knowledge or experience is assumed. Using these simple component and circuit testing techniques the reader should be able to confidently tackle servicing of most electronic projects.

96 pages

Order code BP239

£5.49

## PRACTICAL ELECTRONIC FILTERS

Owen Bishop

This book deals with the subject in a non-mathematical way. It reviews the main types of filter, explaining in simple terms how each type works and how it is used.

The book also presents a dozen filter-based projects with applications in and around the home or in the constructor's workshop. These include a number of audio projects such as a rhythm sequencer and a multi-voiced electronic organ.

Concluding the book is a practical step-by-step guide to designing simple filters for a wide range of purposes, with circuit diagrams and worked examples.

188 pages

Order code BP299

£5.49

## ELECTRONIC PROJECTS FOR EXPERIMENTERS

R. A. Penfold

Many electronic hobbyists who have been pursuing their hobby for a number of years seem to suffer from the dreaded "seen it all before" syndrome. This book is fairly and squarely aimed at sufferers of this complaint, plus any other electronics enthusiasts who yearn to try something a bit different.

The subjects covered include:- Magnetic field detector, Basic Hall effect compass, Hall effect: audio isolator, Voice scrambler/descrambler, Bat detector, Bat style echo location, Noise cancelling, LED stroboscope, infra-red "torch", Electronic breeze detector, Class D power amplifier, Strain gauge amplifier, Super hearing aid.

138 pages

Order code BP371

£5.45

## PRACTICAL FIBRE-OPTIC PROJECTS

R. A. Penfold

While fibre-optic cables may have potential advantages over ordinary electric cables, for the electronics enthusiast it is probably their novelty value that makes them worthy of exploration. Fibre-optic cables provide an innovative interesting alternative to electric cables, but in most cases they also represent a practical approach to the problem. This book provides a number of tried and tested circuits for projects that utilize fibre-optic cables.

The projects include:- Simple audio links, F.M. audio link, P.W.M. audio links, Simple d.c. links, P.W.M. d.c. link, P.W.M. motor speed control, RS232C data links, MIDI link, Loop alarms, R.P.M. meter.

All the components used in these designs are readily available, none of them require the constructor to take out a second mortgage.

132 pages

Order code BP374

£5.45

## ELECTRONIC MUSIC AND MIDI PROJECTS

R. A. Penfold

Whether you wish to save money, boldly go where no musician has gone before, rekindle the pioneering spirit,

or simply have fun building some electronic music gadgets, the designs featured in this book should suit your needs. The projects are all easy to build, and some are so simple that even complete beginners at electronic project construction can tackle them with ease. Stripboard layouts are provided for every project, together with a wiring diagram. The mechanical side of construction has largely been left to the individual constructors to sort out, simply because the vast majority of project builders prefer to do their own thing.

None of the designs requires the use of any test equipment in order to get them set up properly. Where any setting up is required, the procedures are very straightforward, and they are described in detail.

Projects covered: Simple MIDI tester, Message grabber, Byte grabber, THRU box, MIDI auto switcher, Auto/manual switcher, Manual switcher, MIDI patchbay, MIDI controlled switcher, MIDI lead tester, Program change pedal, Improved program change pedal, Basic mixer, Stereo mixer, Electronic swell pedal, Metronome, Analogue echo unit.

138 pages

Order code PC116

£5.45

## VIDEO PROJECTS FOR THE ELECTRONICS CONSTRUCTOR

R. A. Penfold

Written by highly respected author R. A. Penfold, this book contains a collection of electronic projects specially designed for video enthusiasts. All the projects can be simply constructed, and most are suitable for the newcomer to project construction, as they are assembled on stripboard.

There are faders, wipers and effects units which will add sparkle and originality to your video recordings, an audio mixer and noise reducer to enhance your soundtracks and a basic computer control interface. Also, there's a useful selection on basic video production techniques to get you started.

Circuits include: video enhancer, improved video enhancer, video fader, horizontal wiper, improved video wiper, negative video unit, fade to grey unit, black and white keyer, vertical wiper, audio mixer, stereo headphone amplifier, dynamic noise reducer, automatic fader, pushbutton fader, computer control interface, 12 volt mains power supply.

124 pages

Order code PC115

£5.45

## BOOK ORDERING DETAILS

All prices include UK postage. For postage to Europe (air) and the rest of the world (surface) please add £2 per book. For the rest of the world airmail add £3 per book. CD-ROM prices include VAT and/or postage to anywhere in the world. Send a PO, cheque, international money order (£ sterling only) made payable to Direct Book Service or card details, Visa, Mastercard, Amex, Diners Club or Maestro to:

**DIRECT BOOK SERVICE, WIMBORNE PUBLISHING LTD.,  
408 WIMBORNE ROAD EAST, FERNDOWN, DORSET BH22 9ND.**

Books are normally sent within seven days of receipt of order, but please allow 28 days for delivery - more for overseas orders. *Please check price and availability (see latest issue of Everyday Practical Electronics) before ordering from old lists.*

For a further selection of books see the next two issues of *EPE*.

Tel 01202 873872 Fax 01202 874562. Email: [dbs@wimborne.co.uk](mailto:dbs@wimborne.co.uk)

Order from our online shop at: [www.epemag.co.uk](http://www.epemag.co.uk)

## BOOK ORDER FORM

Full name: .....

Address: .....

..... Post code: ..... Telephone No: .....

Signature: .....

I enclose cheque/PO payable to DIRECT BOOK SERVICE for £ .....

Please charge my card £ ..... Card expiry date.....

Card Number ..... Switch/Maestro Issue No.....

Card Security Code ..... (the last three digits on or just under the signature strip)

Please send book order codes: .....

Please continue on separate sheet of paper if necessary  
If you do not wish to cut your magazine, send a letter or copy of this form

# ELECTRONICS MANUALS ON CD-ROM £29.95 EACH

## ELECTRONICS SERVICE MANUAL

## THE MODERN ELECTRONICS MANUAL

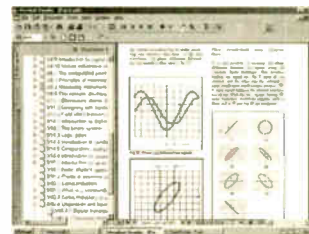
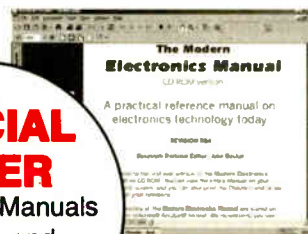
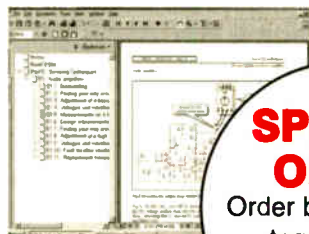

**SPECIAL OFFER**  
Order both Manuals together and **SAVE £10**

**Everything you need to know to get started in repairing electronic equipment**

- Around 900 pages • Fundamental principles • Troubleshooting techniques • Servicing techniques • Choosing and using test equipment • Reference data • Manufacturers' web links
- Easy-to-use Adobe Acrobat format • Clear and simple layout
- Vital safety precautions • Professionally written • Supplements

**SAFETY:** Safety Regulations, Electrical Safety and First Aid.  
**UNDERPINNING KNOWLEDGE:** Electrical and Electronic Principles, Active and Passive Components, Circuit Diagrams, Circuit Measurements, Radio, Computers, Valves and Manufacturers' Data, etc.  
**PRACTICAL SKILLS:** Learn how to identify Electronic Components, Avoid Static Hazards, Carry Out Soldering and Wiring, Remove and Replace Components.  
**TEST EQUIPMENT:** How to Choose and Use Test Equipment, Assemble a Toolkit, Set Up a Workshop, and Get the Most from Your Multimeter and Oscilloscope, etc.  
**SERVICING TECHNIQUES:** The Manual includes vital guidelines on how to Service Audio Amplifiers. The Supplements include similar guidelines for Radio Receivers, TV Receivers, Cassette Recorders, Video Recorders, Personal Computers, etc.  
**TECHNICAL NOTES:** Commencing with the IBM PC, this section and the Supplements deal with a very wide range of specific types of equipment – radios, TVs, cassette recorders, amplifiers, video recorders etc.  
**REFERENCE DATA:** Diodes, Small-Signal Transistors, Power Transistors, Thyristors, Triacs and Field Effect Transistors. Supplements include Operational Amplifiers, Logic Circuits, Optoelectronic Devices, etc.

**The essential reference work for everyone studying electronics**

- Over 800 pages • In-depth theory • Projects to build
- Detailed assembly instructions • Full components checklists • Extensive data tables • Manufacturers' web links
- Easy-to-use Adobe Acrobat format • Clear and simple layout • Comprehensive subject range • Professionally written • Supplements

**BASIC PRINCIPLES:** Electronic Components and their Characteristics; Circuits Using Passive Components; Power Supplies; The Amateur Electronics Workshop; The Uses of Semiconductors; Digital Electronics; Operational Amplifiers; Introduction to Physics, including practical experiments; Semiconductors and Digital Instruments.

**CIRCUITS TO BUILD:** The Base Manual describes 12 projects including a Theremin and a Simple TENS Unit.

**ESSENTIAL DATA:** Extensive tables on diodes, transistors, thyristors and triacs, digital and linear i.c.s.

**EXTENSIVE GLOSSARY:** Should you come across a technical word, phrase or abbreviation you're not familiar with, simply look up the glossary and you'll find a comprehensive definition in plain English.

The Manual also covers **Safety** and provides web links to component and equipment **Manufacturers and Suppliers.**

Full contents list available online at: [www.epemag.wimborne.co.uk](http://www.epemag.wimborne.co.uk)

**Supplements:** Additional CD-ROMs each containing approximately 500 pages of additional information on specific areas of electronics are available for £19.95 each. Information on the availability and content of each Supplement CD-ROM will be sent to you.

**Presentation:** CD-ROM suitable for any modern PC. Requires Adobe Acrobat Reader which is included on the CD-ROM.

Wimborne Publishing Ltd., Dept Y03, 408 Wimborne Road East, Ferndown, Dorset BH22 9ND. Tel: 01202 873872. Fax: 01202 874562.

**PLEASE** send me

THE MODERN ELECTRONICS MANUAL CD-ROM

ELECTRONICS SERVICE MANUAL CD-ROM

I enclose payment of £29.95 (for one Manual) or £49.90 for both Manuals (saving £10 by ordering both together).

**FULL NAME** ..... (PLEASE PRINT)

**ADDRESS** .....

.....

..... **POSTCODE** .....

**SIGNATURE** .....

I enclose cheque/PO in UK pounds payable to Wimborne Publishing Ltd.

Please charge my Visa/Mastercard/Amex/Diners Club/Switch/Maestro

Card No ..... Switch/Maestro Issue No .....

Valid From ..... Expiry Date .....

Card Security Code ..... (The last 3 digits on or just under the signature strip)

**ORDER FORM**

Simply complete and return the order form with your payment to the following address:

**Wimborne Publishing Ltd,**  
**Dept. Y03,**  
**408 Wimborne Road East, Ferndown,**  
**Dorset BH22 9ND**

Price includes postage to anywhere in the World

We will happily exchange any faulty CD-ROMs but since the content can be printed out we do not offer a refund on these items.

**Your CD-ROM(s) will be posted to you by first class mail or airmail, normally within four working days of receipt of your order**

# PCB SERVICE

Printed circuit boards for most recent *EPE* constructional projects are available from the PCB Service, see list. These are fabricated in glass fibre, and are fully drilled and roller tinned. All prices include VAT and postage and packing. Add £1 per board for airmail outside of Europe. Remittances should be sent to The PCB Service, *Everyday Practical Electronics*, Wimborne Publishing Ltd., 408 Wimborne Road East, Ferndown, Dorset BH22 9ND. Tel: 01202 873872; Fax 01202 874562; Email: [orders@epemag.wimborne.co.uk](mailto:orders@epemag.wimborne.co.uk). On-line Shop: [www.epemag.wimborne.co.uk/shopdoor.htm](http://www.epemag.wimborne.co.uk/shopdoor.htm). Cheques should be crossed and made payable to *Everyday Practical Electronics* (Payment in £ sterling only).  
**NOTE: While 95% of our boards are held in stock and are dispatched within seven days of receipt of order, please allow a maximum of 28 days for delivery – overseas readers allow extra if ordered by surface mail.**  
**Back numbers or photostats of articles are available if required – see the Back Issues page for details. We do not supply kits or components for our projects.**  
**Please check price and availability in the latest issue.**  
**A large number of older boards are listed on our website.**  
 Boards can only be supplied on a payment with order basis.

PROJECT TITLE	Order Code	Cost
★ EPE PIC Met Office	AUG '03 402	£10.46
Alarm System Fault Finder	404	£4.44
Radio Circuits-3 Regen. Radio	405	£5.07
Tuning Capacitor Board	406	£4.28
Radio Circuits-4 Varicap Tuner	SEPT '03 412	£4.44
Coil Pack – General Coverage	413	£5.07
Coil Pack – Amateur Bands	414	£4.75
★ PIC-A-Colour – Software only	–	–
Spooky Bug (Top Tenner)	OCT '03 409	£5.07
Radio Circuits-5 Crystal Marker	415	£4.44
Super Regen. Receiver	419	£5.07
Buffer Amplifier	420	£4.44
★ Serial Interface for PICs and VB6	416	£5.23
★ PIC Breakpoint – Software only	–	–
Anyone At Home – Logic Board	NOV '03 421	Pair £6.35
– Relay Board	422	–
Radio Circuits-6 Direct Conversion SW Receiver	423	£6.02
★ PIC Random L.E.D. Flasher	424	£4.60
★ PIC Virus Zapper Mk2	DEC '03 425	£5.72
Radio Circuits-7 SW Superhet Tuner/Mixer	426	£5.70
Christmas Cheeks (double-sided)	427	£4.44
★ PIC Nim Machine – Software only	–	–
Bedside Nightlight (Top Tenner)	JAN '04 417	£4.44
Sound Trigger	418	£4.60
Timing/Lamp	428	£5.71
Radio Circuits-8 Dual Conversion SW Rec. – I.F. Amp	429	£4.45
– Signal-Strength Meter	430	£4.75
– B.F.O./Prod. Detector	431	£7.61
★ Car Computer (double-sided)	–	–
★ PIC Watering Timer – Software only	–	–
★ GPS to PIC and PC Interface – Software only	–	–
Jazzy Necklace	FEB '04 432 pair	£5.40
Sonic Ice Warning	433	£5.39
★ LCF Meter	434	£5.00
★ PIC Tug-of-War	435	£5.00
Bat-Band Converter	MAR '04 436	£4.76
★ MIDI Health Check – Transmitter/Receiver	437 pair	£7.61
Emergency Stand-by Light	438	£5.55
★ PIC Mixer for RC Planes – Software only	–	–
★ Teach-In '04 Part 5 – Software only	–	–
Infra-Guard	APR '04 439	£5.07
★ Moon Clock	442	£5.71
★ Teach-In '04 Part 6 – Software only	–	–
★ EPE Seismograph Logger	–	–
Control Board	440	–
Sensor Amp. Board	441 pair	£6.50
In-Car Lap-Top PSU	MAY '04 443	£4.60
Beat Balance Metal Detector	444	£4.60
Teach-In '04 Part 7 – Transmitter	445	£4.91
Receiver	446	£4.75
Moisture	447	£4.44
★ PIC Quickstep	JUNE '04 448	£5.71
Body Detector MkII	449	£4.91
★ Teach-In '04 Part 8 – Software only	–	–
★ MIDI Synchronome – Software only	–	–
Hard Drive Warbler	JULY '04 450	£4.60
★ Bongo Box	451	£6.02
Portable Mini Alarm – Sensor	452	£5.23
– Counter	453	£5.07
★ Teach-In '04 Part 9	–	–
PIC Combination Lock Alarm Monitor	454	£5.07
★ EPE Magnetometry Logger	455	£5.71
Keyring L.E.D. Torch	AUG '04 456	£4.12
★ Teach-In '04 Part 10 – PIC Curtain or Blind Winder	457	£5.39
Simple F.M. Radio – F.M. Tuner	458	£5.07
– Tone Control	459	£4.75
– Audio Power Amp (TDA2003)	347	£4.60
– Power Supply	460	£5.39
★ EPE Scorer	461	£6.66
– Control Board	462	£7.93
– Display Board	463	£5.55
– Slave Board	–	–
★ PIC to Mouse/Keyboard – Software only	–	–

PROJECT TITLE	Order Code	Cost
EPE Wart Zapper	SEPT '04 464	£4.60
★ Radio Control Failsafe	465	£4.76
★ AlphaMouse Game	466	£4.60
★ Rainbow Lighting Controller – Software only	–	–
★ Moon and Tide Clock Calendar	OCT '04 467	£5.55
Volts Checker	468	£4.20
★ Smart Cards – Software only	–	–
Logic Probe	NOV '04 469	£4.76
Thunderstorm Monitor	470	£5.39
MW Amplitude Modulator	–	–
– V.F.O./Buffer	471	£4.76
– Modulator/PA	472	£5.07
– Power Supply	473	£4.76
Super Vibration Switch	DEC '04 474	£4.75
Wind Direction Indicator	475	£6.18
★ PIC Flasher Mk2	–	–
– Control Board	476	£4.75
– Transmitter	477	£4.44
– Multipurpose Board	478	£4.75
– Simple Cyclor	479	£4.44
– Luxeon V Controller	480	£4.44
– Power Supply	473	£4.76
Light Detector	JAN '05 481	£4.44
★ Camera Watch	482	£6.03
Gate Alarm – Oscillator	483	£4.92
– Delay/Timer	484	£4.92
★ Sneaky – Transmitter	FEB '05 485	£4.60
– Receiver	486	£4.91
★ PIC Electric Mk2 – Control	487	£5.87
– Sensor	488	£5.71
Sound Card Mixer	489	£7.29
Headphone Monitor	MAR '05 490	£5.71
EPE Cat Flap	491	£6.02
Bingo Box – Main	492	£9.04
– Big Digit Display	493	£10.31

## EPE SOFTWARE

Software programs for *EPE* projects marked with a single asterisk ★ are available on 3.5 inch PC-compatible disks or free from our Internet site. The following disks are available: **PIC Tutorial V2** (Apr-June '03); **EPE Disk 3** (2000); **EPE Disk 4** (2001 – excl. PIC Toolkit TK3); **EPE Disk 5** (2002); **EPE Disk 6** (2003 – excl. Earth Resistivity and Met Office); **EPE Disk 7** (2004); **EPE Disk 8** (Jan 2005 to current cover date); **EPE Earth Resistivity Logger** (Apr-May '03); **EPE PIC Met Office** (Aug-Sept '03); **EPE Seismograph** (Apr-May '04); **EPE Magnetometry Logger** (July-Aug '04); **EPE Teach-In 2000**; **EPE Spectrum**; **EPE Interface Disk 1** (October '00 issue to current cover date). **EPE Toolkit TK3** software is available on the **EPE PIC Resources CD-ROM**, £14.45. Its p.c.b. is order code 319, £8.24.  
 ★★ The software for these projects is on its own CD-ROM. The 3.5 inch disks are £3.00 each (UK), the CD-ROMs are £6.95 (UK). Add 50p each for overseas surface mail, and £1 each for airmail. All are available from the *EPE PCB Service*. All files can be downloaded free from our Internet FTP site, accessible via our home page at: [www.epemag.co.uk](http://www.epemag.co.uk).

## EPE PRINTED CIRCUIT BOARD SERVICE

Order Code	Project	Quantity	Price
.....			
Name .....			
Address .....			
.....			
Tel. No. ....			
I enclose payment of £..... (cheque/PO in £ sterling only) to:			
 		 <b>Everyday Practical Electronics</b> MasterCard, Amex, Diners Club, Visa or Switch/Maestro	
Card No. ....			
Valid From .....		Expiry Date .....	
Card Security Code ..... Switch/Maestro Issue No .....			
(The last 3 digits on or just under the signature strip)			
Signature .....			
NOTE: You can also order p.c.b.s by phone, Fax, Email or via our Internet site on a secure server: <a href="http://www.epemag.wimborne.co.uk/shopdoor.htm">http://www.epemag.wimborne.co.uk/shopdoor.htm</a>			

Everyday Practical Electronics reaches twice as many UK readers as any other UK monthly hobby electronics magazine, our sales figures prove it. We have been the leading monthly magazine in this market for the last twenty years.

If you want your advertisements to be seen by the largest readership at the most economical price our classified and semi-display pages offer the best value. The prepaid rate for semi-display space is £10 (+VAT) per single column centimetre (minimum 2.5cm). The prepaid rate for classified adverts is 40p (+VAT) per word (minimum 12 words).

All cheques, postal orders, etc., to be made payable to Everyday Practical Electronics. VAT must be added. Advertisements, together with remittance, should be sent to Everyday Practical Electronics Advertisements, Mill Lodge, Mill Lane, Thorpe-le-Soken, Essex CO16 0ED. Phone/Fax (01255) 861161.

For rates and information on display and classified advertising please contact our Advertisement Manager, Peter Mew as above.

## BOWOOD ELECTRONICS LTD

Suppliers of Electronic Components

Place a secure order on our website or call our sales line  
All major credit cards accepted

Web: [www.bowood-electronics.co.uk](http://www.bowood-electronics.co.uk)

Unit 1, McGregor's Way, Turnoaks Business Park,  
Chesterfield, S40 2WB. Sales: 01246 200222

Send 60p stamp for catalogue

## The Versatile, Programmable On Screen Display System [www.STV5730A.co.uk](http://www.STV5730A.co.uk)

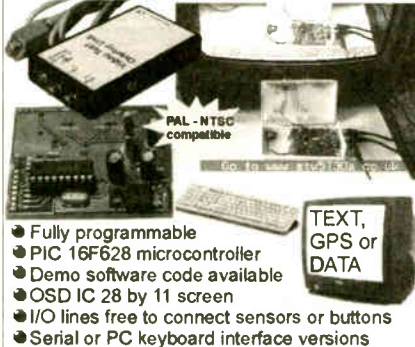

PAL - NTSC compatible

TEXT, GPS or DATA

- Fully programmable
- PIC 16F628 microcontroller
- Demo software code available
- OSD IC 28 by 11 screen
- I/O lines free to connect sensors or buttons
- Serial or PC keyboard interface versions

## X-10® Home Automation We put you in control™

Why tolerate when you can automate?

An extensive range of 230V X-10 products and starter kits available. Uses proven Power Line Carrier technology, no wires required.

Products Catalogue available Online.

Worldwide delivery.

Laser Business Systems Ltd.

E-Mail: [info@laser.com](mailto:info@laser.com)

<http://www.laser.com>

Tel: (020) 8441 9788

Fax: (020) 8449 0430



## TOTALROBOTS

ROBOTICS, CONTROL &  
ELECTRONICS TECHNOLOGY

High quality robot kits and components  
UK distributor of the OOPic microcontroller

Secure on-line ordering

Rapid delivery

Highly competitive prices

Visit [www.totalrobots.com](http://www.totalrobots.com)

Tel: 0208 823 9220

## Component Kits!

£4.99

CAP-001 93pcs Electrolytic  
Capacitor Kit (1-2200uF 10-63V)

£9.99

RES-001 1000pcs Metal Film  
Resistor Kit (100-1M 0.25W 1%)

£4.99

CAP-002 100pcs Polyester  
Capacitor Kit (1-470nF 63V)

£4.99

CAP-003 240pcs Ceramic  
Capacitor Kit (22pF-100nF 50V)

Mail order P&P: £2.50 (Free P&P orders over £20)

[www.fastcomponents.co.uk](http://www.fastcomponents.co.uk)

Tel: 0870 750 4468 Fax: 0870 137 6005  
Winchester House, Winchester Rd,  
Walton-on-Thames, Surrey, KT12 2RH

## TRANSFORMERS

- Custom Wound
- 1 Phase to 50kVA
- 3 Phase to 100kVA
- A.C. and D.C. Chokes
- H.T. up to 5kV
- Transformer Kits
- Coils up to 1m Dia.
- Transformer Rectifiers
- Toroidals
- Motor Generators

Visit [www.jemelec.com](http://www.jemelec.com) for details  
or request our free leaflet

Jemelec, Unit 16, Vanguard Trading Estate, Storrth Lane,  
Chesterfield, S40 2TZ

Tel: 0870 787 1769

## BTEC ELECTRONICS TECHNICIAN TRAINING

VCE ADVANCED ENGINEERING  
ELECTRONICS AND ICT  
HNC AND HND ELECTRONICS  
NVQ ENGINEERING AND IT  
PLEASE APPLY TO COLLEGE FOR  
NEXT COURSE DATE  
FULL PROSPECTUS FROM

LONDON ELECTRONICS COLLEGE  
(Dept EPE) 20 PENYWERN ROAD  
EARLS COURT, LONDON SW5 9SU  
TEL: (020) 7373 8721

## Miscellaneous

**MICRO CHIP DEVICES** for home and business. Projects and Products on Microchip and 1-wire technologies. Visit our WEB site at: [www.microchipdevices.com](http://www.microchipdevices.com)

**ELECTRONICS ENGINEERS REQUIRED** for basic to advanced project design and/or construction work. If you have one or two days a week free and could use some extra cash then please email your information and contact details to Chris at [cm1999@hotmail.co.uk](mailto:cm1999@hotmail.co.uk)

**VALVES AND ALLIED COMPONENTS IN STOCK.** Phone for free list. Valves, books and magazines wanted. Geoff Davies (Radio), tel. 01788 574774.

**KITS, TOOLS, COMPONENTS.** S.a.e. catalogue: Sir-Kit Electronics, 52 Severn Road, Clacton, CO15 3RB.  
[www.geocities.com/sirkituk](http://www.geocities.com/sirkituk)

## Computer Software

**FREE DOWNLOADABLE SOFTWARE:** Electronics, Electrical and Computing V8.2. Computer Science V8.2 and GCSE Maths V8.2. Still selling at £120 each on CDROM is now available to download and fully install to your hard drive COMPLETELY FREE OF CHARGE. Latest update includes the new Web Links feature. Visit [www.eptsoft.com](http://www.eptsoft.com) for details.

## EPE BINDERS

KEEP YOUR MAGAZINES SAFE -  
RING US NOW!

This ring binder uses a special system to allow the issues to be easily removed and re-inserted without any damage. A nylon strip slips over each issue and this passes over the four rings in the binder, thus holding the magazine in place.

The binders are finished in hard-wearing royal blue p.v.c. with the magazine logo in gold on the spine. They will keep your issues neat and tidy but allow you to remove them for use easily.

The price is £6.95 plus £3.50 post and packing. If you order more than one binder add £1 postage for each binder after the initial £3.50 postage charge (overseas readers the postage is £6.00 each to everywhere except Australia and Papua New Guinea which costs £10.50 each).

Send your payment in £'s sterling cheque or PO (Overseas readers send £ sterling bank draft, or cheque drawn on a UK bank or pay by card), to Everyday Practical Electronics, Wimborne Publishing Ltd, 408 Wimborne Road East, Ferndown, Dorset BH22 9ND. Tel: 01202 873872. Fax: 01202 874562.

E-mail: [editorial@epemag.wimborne.co.uk](mailto:editorial@epemag.wimborne.co.uk)

Web site: [www.epemag.co.uk](http://www.epemag.co.uk)

Order on-line from

[www.epemag.wimborne.co.uk/shopdoor.htm](http://www.epemag.wimborne.co.uk/shopdoor.htm)

We also accept card payments. Mastercard, Visa, Amex, Diners Club or Maestro. Send your card number and card expiry date plus Maestro Issue No. with your order.

## VVT TRANSFORMERS

Transformers and Chokes for all types of circuits including specialist valve units  
Custom design or standard range  
High and low voltage

Variable Voltage Technology Ltd

Unit 3, Sheat Manor Farm, Chillerton,  
Newport, Isle of Wight, PO30 3HP

Tel: 0870 243 0414 Fax: 01983 721572

email: [sales@vvt-cowes.freemove.co.uk](mailto:sales@vvt-cowes.freemove.co.uk)

[www.vvttransformers.co.uk](http://www.vvttransformers.co.uk)

ANDRE LAMOTHE'S  
**XGAMESTATION**  
 LEARN STEP-BY-STEP HOW TO DESIGN  
 AND BUILD YOUR OWN VIDEO GAME CONSOLE!  
 Design inspired by the Atari 800/2600,  
 Sinclair ZX Spectrum, Apple II & Commodore 64!

Complete Package eBook Integrated IDE

**SX52 CPU  
80 MIPS!**

**OPEN SOURCE!**

**FEATURES:**

- Great for Hobbyists AND Students!
- Complete Software Development Kit!
- eBook on Designing the XGS Console!
- Parallax SX-Key Compatible!
- Fully Assembled XGS Micro Edition Unit!
- The Fun Way to Learn Embedded Systems!

**PAL & NTSC  
COMPATIBLE!**

**WWW.XGAMESTATION.COM**  
 SUPPORT@NURVE.NET | PH 925.736.2098(USA)



National College of Technology

## DISTANCE LEARNING COURSES

Electronic Circuits  
 Digital Circuits  
 Mathematics

Electronic Testing & Fault Finding  
 Programmable Logic Controllers  
 Mechanics & Mechanisms

These courses lead to a **BTEC QUALIFICATION** and are suitable for beginners and those with more experience, needing to update their skills.

Register **NOW** and learn at your own pace with tutor support available to help you succeed.

For more information please telephone

**08456 345 445**

or visit our web site

[www.oakcad.co.uk/nct.aspx](http://www.oakcad.co.uk/nct.aspx)



National College of Technology is part of the OakCAD Training Group.

**N. R. BARDWELL LTD (Est. 1948)**

100	Signal Diodes 1N4148	£1.00	80	Assd. capacitors 1nF to 1µF	£1.00
75	Rectifier Diodes 1N4001	£1.00	200	Assd. disc. ceramic capacitors	£1.00
50	Rectifier Diodes 1N4007	£1.00	50	Assd. SMD Presets (sm. stand, cermet)	£1.00
10	W01 Bridge Rectifiers	£1.80	50	Assd. RF chokes (inductors)	£1.00
10	555 Timer I.C.s	£1.30	25	Assd. grommets	£1.00
4	741 Op Amps	£1.30	8	Assd. di. switches	£1.00
50	Assorted Zener Diodes 400mW	£1.00	8	Assd. push-button switches, multi-bank, multi-pole	£1.00
12	Assorted 7-segment Displays	£1.00	30	Assd. di. sockets up to 40 way	£1.00
35	Assorted I.C.s, var. shapes, colours & sizes	£1.30	10	TV coax plugs, plastic	£1.00
25	3mm I.e.d.s. red or green or yellow	£1.30	40	metres very thin connecting wire, red	£1.00
25	3mm I.e.d.s. red or green or yellow	£1.30	20	1in. glass reed switches	£1.00
75	5mm I.e.d.s. green, 6-5mm legs	£1.00	100	Any one value ¼W 5% cf resistors range 1R to 10M	£0.45
50	Anal I.e.d.s. 2mcd red Diode Package	£1.00	10	7812 Voltage Regulators	£1.00
25	Assd. High-Brightness I.e.d.s. var. cols	£1.00	300	Assd. resistors, ¼W/½W, mostly on tapes	£1.00
25	BC182L Transistors	£1.00			
25	BC121 Transistors	£1.30			
30	BC237 Transistors	£1.30			
20	BC327 Transistors	£1.30			
30	BC328 Transistors	£1.00			
30	BC547 Transistors	£1.00			
20	BC547B Transistors	£1.00			
30	BC548 Transistors	£1.00			
30	BC549 Transistors	£1.30			
25	BC557 Transistors	£1.00			
30	BC558 Transistors	£1.00			
25	BC559 Transistors	£1.00			
20	2N3904 Transistors	£1.00			
100	1nF 50V wkg Axial Capacitors	£1.00			
80	Assd. capacitors electrolytic	£1.30			

288 Abbeydale Road, Sheffield S7 1FL  
 Phone (local rate): 0845 166 2329  
 Fax: 0114 255 5039  
 e-mail: [sales@bardwells.co.uk](mailto:sales@bardwells.co.uk)  
 web: [www.bardwells.co.uk](http://www.bardwells.co.uk)  
 Prices include VAT, Postage £1.85  
 44p stamp for lists or disk  
 POs, Cheques and Credit Cards accepted  
 SEE OUR WEB PAGES FOR MORE  
 COMPONENTS AND SPECIAL OFFERS

[www.epemag.com](http://www.epemag.com)

Get your magazine "instantly" anywhere in the world - buy from the web.

TAKE A LOOK, A FREE ISSUE IS AVAILABLE

A one year subscription (12 issues) costs just \$10.99 (US)

[www.epemag.com](http://www.epemag.com)

## Europe's Largest Surplus Store

20,000,000 Items on line NOW !  
 New items added daily

Established for over 25 years, UK company Display Electronics prides itself on offering a massive range of electronic and associated electro-mechanical equipment and parts to the Hobbyist, Educational and Industrial user. Many current and obsolete hard to get parts are available from our vast stocks, which include:

- ◆ 6,000,000 Semiconductors
- ◆ 5,000 Power Supplies
- ◆ 25,000 Electric Motors
- ◆ 10,000 Connectors
- ◆ 100,000 Relays & Contactors
- ◆ 2000 Rack Cabinets & Accessories
- ◆ 4000 Items of Test Equipment
- ◆ 5000 Hard Disk Drives

We Ship Worldwide

Surplus Wanted

[www.distel.co.uk](http://www.distel.co.uk)

Display Electronics  
 29 / 35 Osborne Road  
 Thornton Heath  
 Surrey UK CR7 8PD

Telephone  
**[44] 020 8653 3333**  
 Fax [44] 020 8653 8888

## Watch Slides on TV.

Make videos of your slides. Digitise your slides (using a video capture card)  
 "Liesgang diatv" automatic slide viewer with built in high quality colour TV camera. It has a composite video output to a phono plug (SCART & BNC adaptors are available). They are in very good condition with few signs of use. More details see [www.diatv.co.uk](http://www.diatv.co.uk).  
 £91.91 + VAT = £108.00



Board cameras all with 512 x 582 pixels 8.5mm 1/3 inch sensor and composite video out. All need to be housed in your own enclosure and have fragile exposed surface mount parts. They all require a power supply of between 10V and 12V DC 150mA.  
 47MIR size 60 x 36 x 27mm with 6 infra red LEDs (gives the same illumination as a small torch but is not visible to the human eye) £37.00 + VAT = £43.48  
 30MP size 32 x 32 x 14mm spy camera with a fixed focus pin hole lens for hiding behind a very small hole £35.00 + VAT = £41.13  
 40MC size 39 x 38 x 27mm camera for 'C' mount lens these give a much sharper image than with the smaller lenses £32.00 + VAT = £37.60  
 Economy C mount lenses all fixed focus & fixed iris  
 VSL1220F 12mm F1.6 12 x 15 degrees viewing angle £15.97 + VAT £18.76  
 VSL4022F 4mm F1.22 63 x 47 degrees viewing angle £17.65 + VAT £20.74  
 VSL6022F 6mm F1.22 42 x 32 degrees viewing angle £19.05 + VAT £22.38  
 VSL8020F 8mm F1.22 32 x 24 degrees viewing angle £19.90 + VAT £23.38

## Better quality C Mount lenses

VSL1614F 16mm F1.6 30 x 24 degrees viewing angle £26.43 + VAT £31.06  
 VWL813M 8mm F1.3 with iris 56 x 42 degrees viewing angle £77.45 + VAT = £91.00  
 1206 surface mount resistors E12 values 10 ohm to 1M ohm  
 100 of 1 value £1.00 + VAT 1000 of 1 value £5.00 + VAT

866 battery pack originally intended to be used with an orbital mobile telephone it contains 10 1-6Ah sub C batteries (42 x 22 dia. the size usually used in cordless screwdrivers etc.) the pack is new and unused and can be broken open quite easily  
 £7.46 + VAT = £8.77



Please add £1.66 + vat = £1.95 postage & packing per order

## JPG Electronics

Shaws Row, Old Road, Chesterfield, S40 2RB.

Tel 01246 211202 Fax 01246 550959

Mastercard/Visa/Switch

Callers welcome 9.30 a.m. to 5.30 p.m. Monday to Saturday

## SHERWOOD ELECTRONICS

### FREE COMPONENTS

Buy 10 x £1 Special Packs and choose another one FREE

SP1	15 x 5mm Red LEDs	SP133	20 x 1N4004 diodes
SP2	12 x 5mm Green LEDs	SP134	15 x 1N4007 diodes
SP3	12 x 5mm Yellow LEDs	SP135	5 x Miniature slide switches
SP5	25 x 5mm 1 part LED clips	SP136	3 x BFY50 transistors
SP6	15 x 3mm Red LEDs	SP137	4 x W005 1.5A bridge rectifiers
SP7	12 x 3mm Green LEDs	SP138	20 x 2-2/63V radial elect. caps.
SP8	10 x 3mm Yellow LEDs	SP140	3 x W04 1.5A bridge rectifiers
SP9	25 x 3mm 1 part LED clips	SP142	2 x CMOS 4017
SP10	100 x 1N4148 diodes	SP143	5 Pairs min. crocodile clips (Red & Black)
SP11	30 x 1N4001 diodes	SP146	10 x 2N3704 transistors
SP12	30 x 1N4002 diodes	SP147	5 x Stripboard 9 strips x 25 holes
SP18	20 x BC182 transistors	SP151	4 x 8mm Red LEDs
SP20	20 x BC184 transistors	SP152	4 x 8mm Green LEDs
SP23	20 x BC549 transistors	SP153	4 x 8mm Yellow LEDs
SP24	4 x CMOS 4001	SP154	15 x BC548 transistors
SP25	4 x 555 timers	SP156	3 x Stripboard, 14 strips x 27 holes
SP26	4 x 741 Op.Amps	SP160	10 x 2N3904 transistors
SP28	4 x CMOS 4011	SP161	10 x 2N3906 transistors
SP29	3 x CMOS 4013	SP165	2 x LF351 Op.Amps
SP33	4 x CMOS 4081	SP166	20 x 1N4003 diodes
SP34	20 x 1N914 diodes	SP167	5 x BC107 transistors
SP36	25 x 10/25V radial elect. caps.	SP168	5 x BC108 transistors
SP37	12 x 100/35V radial elect. caps.	SP172	4 x Standard slide switches
SP39	10 x 470/16V radial elect. caps.	SP173	10 x 220/25V radial elect. caps
SP40	15 x BC237 transistors	SP174	20 x 22/25V radial elect. caps
SP41	20 x Mixed transistors	SP175	20 x 1/63V radial elect. caps.
SP42	200 x Mixed 0.25W C.F. resistors	SP177	10 x 1A 20mm quick blow fuses
SP47	5 x Min. PB switches	SP178	10 x 2A 20mm quick blow fuses
SP49	4 x 5 metres stranded core wire	SP181	5 x Phono plugs - esstd colours
SP102	20 x 8-pin DIL sockets	SP182	20 x 4-7/63V radial elect. caps.
SP103	15 x 14-pin DIL sockets	SP183	20 x BC547 transistors
SP104	15 x 16-pin DIL sockets	SP187	15 x BC239 transistors
SP105	4 x 74LS00	SP189	4 x 5 metres solid core wire
SP109	15 x BC557 transistors	SP192	3 x CMOS 4066
SP112	4 x CMOS 4093	SP193	3 x 10mm Yellow LEDs
SP115	3 x 10mm Red LEDs	SP197	6 x 20 pin DIL sockets
SP116	3 x 10mm Green LEDs	SP198	5 x 24 pin DIL sockets
SP118	2 x CMOS 4047	SP199	5 x 2.5mm mono jack plugs
SP124	20 x Assorted ceramic disc caps	SP200	5 x 2.5mm mono jack sockets
SP126	6 x Battery clips - 3 ea. PP3 + PP3		
SP130	100 x Mixed 0.5W C.F. resistors		
SP131	2 x TL071 Op.Amps		

### RESISTOR PACKS - C.Film

RP3	5 each value - total 365 0.25W	£3.20
RP7	10 each value - total 730 0.25W	£4.45
RP10	1000 popular values 0.25W	£6.35
RP4	5 each value-total 345 0.5W	£4.10
RP8	10 each value-total 690 0.5W	£6.75
RP11	1000 popular values 0.5W	£8.60

2004 Catalogue now available £1 inc. P&P or FREE with first order.

P&P £1.50 per order. NO VAT

Cheques and Postal Orders to:

**Sherwood Electronics,**  
 7 Williamson St., Mansfield,  
 Notts. NG19 6TD.

## ADVERTISERS INDEX

ANTEX	161
N. R. BARDWELL	223
B.K. ELECTRONICS	Cover (iv)/165
BITZ TECHNOLOGY	164
BULL GROUP	Cover (ii)
CRICKLEWOOD ELECTRONICS	151
DISPLAY ELECTRONICS	223
ESR ELECTRONIC COMPONENTS	154
FOREST ELECTRONIC DEVELOPMENTS	146
JAYCAR ELECTRONICS	205
JPG ELECTRONICS	224
LABCENTER	Cover (iii)
MAGENTA ELECTRONICS	152/3
MATRIX MULTIMEDIA	189
MILFORD INSTRUMENTS	192
NATIONAL COLLEGE OF TECHNOLOGY	223
NURVE NETWORKS LLC	223
PEAK ELECTRONIC DESIGN	177
PICO TECHNOLOGY	189/201
QUASAR ELECTRONICS	148/9
SHERWOOD ELECTRONICS	224
SQUIRES	151
STEWART OF READING	151
SUMA DESIGNS	188

ADVERTISEMENT MANAGER: PETER J. MEW

ADVERTISEMENT OFFICES:

EVERYDAY PRACTICAL ELECTRONICS, ADVERTISEMENTS,  
 MILL LODGE, MILL LANE, THORPE-LE-SOKEN,  
 ESSEX CO16 0ED. Phone/Fax: (01255) 861161

For Editorial address and phone numbers see page 155

## EPE SUBSCRIPTIONS

SAVE 51p AN ISSUE OVER UK NEWSTAND PRICES  
 ON A UK ONE YEAR SUBSCRIPTION

Subscriptions for delivery direct to any address in the UK: 6 months £16.50, 12 months £31, two years £57; Overseas: 6 months £19.50 standard air service or £28.50 express airmail, 12 months £37 standard air service or £55 express airmail, 24 months £69 standard air service or £105 express airmail.

Cheques or bank drafts (in £ sterling only) payable to *Everyday Practical Electronics* and sent to *EPE Subs. Dept.*, Wimborne Publishing Ltd., 408 Wimborne Road East, Ferndown, Dorset BH22 9ND. Tel: 01202 873872. Fax: 01202 874562. Email: [subs@epemag.wimborne.co.uk](mailto:subs@epemag.wimborne.co.uk). Also via the Web at <http://www.epemag.wimborne.co.uk>. Subscriptions start with the next available issue. We accept MasterCard, Amex, Diners Club, Switch or Visa. (For past issues see the Back Issues page.)

## ONLINE SUBSCRIPTIONS

Online subscriptions, for downloading the magazine via the Internet, \$10.99US (approx. £7) for one year available from [www.epemag.com](http://www.epemag.com).

## USA/CANADA SUBSCRIPTIONS

To subscribe to *EPE* from the USA or Canada please telephone Express Mag toll free on 1877 363-1310 and have your credit card details ready. Or fax (514) 355 3332 or write to Express Mag, PO Box 2769, Plattsburgh, NY 12901-0239 or Express Mag, 8155 Larrey Street, Anjou, Quebec, H1J 2L5.

Email address: [expsmag@expressmag.com](mailto:expsmag@expressmag.com).

Web site: [www.expressmag.com](http://www.expressmag.com).

USA price \$60(US) per annum, Canada price \$97(Can) per annum - 12 issues per year.

*Everyday Practical Electronics*, periodicals pending, ISSN 0262 3617 is published twelve times a year by Wimborne Publishing Ltd., USA agent USACAN at 1320 Route 9, Champlain, NY 12919. Subscription price in US \$60(US) per annum. Periodicals postage paid at Champlain NY and at additional mailing offices. POSTMASTER: Send USA and Canada address changes to *Everyday Practical Electronics*, c/o Express Mag., PO Box 2769, Plattsburgh, NY, USA 12901-0239.



# PROTEUS

**The Complete Electronics Design System**



## Schematic & PCB Layout

- Powerful & flexible schematic capture.
- Auto-component placement and rip-up/retry PCB routing.
- Polygonal gridless ground planes.
- Libraries of over 8000 schematic and 1000 PCB parts.
- Bill of materials, DRC reports and much more.

## Mixed Mode SPICE Circuit Simulation

- Berkeley SPICE3F5 simulator with custom extensions for true mixed mode and interactive simulation.
- 6 virtual instruments and 14 graph based analysis types.
- 6000 models including TTL, CMOS and PLD digital parts.
- Fully compatible with manufacturers' SPICE models.

## Proteus VSM - Co simulation and debugging for popular Micro-controllers

- Supports PIC, AVR, 8051, HC11 and ARM micro-controllers.
- Co-simulate target firmware with your hardware design.
- Includes interactive peripheral models for LED and LCD displays, switches, keypads, virtual terminal and much, much more.
- Provides source level debugging for popular compilers and assemblers from Crownhill, IAR, Keil, and others.

# VSM

Virtual System Modelling

## New Features in Version 6

- Drag and drop toolbars.
- Visual PCB packaging tool.
- Improved route editing.
- Point and click DRC report.
- Multiple design rules (per net).
- Multiple undo/redo.

**Call Now for Upgrade Pricing**

labcenter

Electronics  
53-55 Main Street, Grassington, BD23 5AA

Tel: 01756 753440  
Fax: 01756 752857

Contact us for  
**Free Demo CD**



**www.labcenter.co.uk**  
**info@labcenter.co.uk**



# POWER AMPLIFIER MODULES-LOUDSPEAKERS-MIXERS 19 INCH STEREO AMPLIFIERS-ACTIVE CROSS/OVERS.

- \* PRICES INCLUDE V.A.T.
- \* PROMPT DELIVERY

## OMP MOS-FET POWER AMPLIFIERS HIGH POWER, TWO CHANNEL 19 INCH RACK

10,000's  
SOLD  
TO PRO  
USERS



### THE RENOWNED MXF SERIES OF POWER AMPLIFIERS

FOUR MODELS:- MXF200 (100W + 100W) MXF400 (200W + 200W)  
MXF600 (300W + 300W) MXF900 (450W + 450W)

ALL POWER RATINGS ARE R.M.S. INTO 4 OHMS, WITH BOTH CHANNELS DRIVEN  
FEATURES:- \* Independent power supplies with two toroidal transformers  
\* Twin L.E.D. Vu Meters \* Level controls \* Illuminated on/off switch \* Jack / XLR inputs  
\* Speaker Outputs \* Standard 775mv inputs \* Open and Short circuit proof \* Latest Mos-Fets  
for stress free delivery into virtually any load \* High slew rate \* Very low distortion \* Aluminium  
cases \* MXF600 & MXF900 fan cooled with D.C. Loudspeaker and thermal protection.

USED THE WORLD OVER IN CLUBS, PUBS, CINEMAS, DISCOS ETC

SIZES:-

MXF200 W19" D11" H3 1/2" (2U)  
MXF400 W19" D12" H5 1/2" (3U)  
MXF600 W19" D13" H5 1/2" (3U)  
MXF900 W19" D14" H5 1/2" (3U)

PRICES:- MXF200 £175.00 MXF400 £233.85  
MXF600 £329.00 MXF900 £449.15  
SPECIALIST CARRIER DEL £12.50 Each



## XLS200 Active Bass System

Price £279.00+ £8.00 Carriage

We have been designing and manufacturing 5 star award winning subs since 1992



Features

- \* Uses a Peerless XLS10, one of the worlds best subwoofer drive units
- \* True 200W RMS 400W Peak
- \* Simultaneous high and low level connections
- \* Solid construction 25mm baffle and back and 18mm MDF sides with real wood veneers
- \* Four fantastic finishes
- \* Compact size only 390D x 295H x 295W mm
- \* Over engineered for sonic excellence weighs in at 20kg

At about a cubic foot the XLS200 can be easily hidden from view, but you will certainly know it is there. With the easy to setup controls it will take only minutes to get up and running showing it's punch, agility and power. Due to its rigid sealed box enclosure and powerful 200W amplifier coupled to an extremely high quality 250mm drive unit the XLS200 sounds absolutely stunning from the off, with music that is underpinned by masses of low end extension. Movies will come to life too, as you hear the effects as well as feel them.

- \* Free Accessories worth £40.00. 10M Speakon High Level Lead - 5M High Quality Gold Phono to Phono Lead and a set of spikes
- \* Pay no extra for real wood veneers



Strength & Depth in the knowledge that we have supplied over 100,000 subs

For further details look on our website at :-  
<http://www.bkelec.com/new>



## 100 WATT ACTIVE SUB BASS AMPLIFIER PANEL



AN ACTIVE SUB BASS AMPLIFIER WITH A TRUE 100W RMS OUTPUT. SUPERB CONSTRUCTION WITH THE FACILITIES TO INTEGRATE SEAMLESSLY INTO MOST HI-FI OR HOME CINEMA SETUPS. USE THIS PANEL PLUS ONE OF OUR LOUSPEAKERS TO MAKE YOUR OWN SUB WOOFER THAT WILL MATCH OR BEAT MOST COMMERCIALY AVAILABLE SUB WOOFERS.

FEATURES:- \* 100W RMS INTO 8 OHMS \* HIGH AND LOW LEVEL INPUTS \* TOROIDAL TRANSFORMER \* SHORT CIRCUIT PROTECTION \* D.C. SPEAKER PROTECTION \* FREQUENCY ROLL OFF, LOWER 10Hz, UPPER 60Hz TO 240Hz (FULLY ADJUSTABLE) \* AC3 COMPATIBLE FILTER CAN BE BYPASSED FOR 5-1 FORMATS. \* AIRTIGHT CONSTRUCTION \* TENS OF THOUSANDS OF OUR PANELS ALREADY IN USE. \* COMPLETE WITH LEADS

SPECIFICATIONS:- \* POWER 100W RMS @ 8 OHMS \* FREQ RESP. 10Hz 15KHz -3dB \* DAMPING FACTOR >200 \* DISTORTION 0.05% \* S/N A WEIGHTED >100dB \* SUPPLY 230V A.C. \* WEIGHT 2.7Kg \* SIZE H254 X W254 X D94mm

THERE ARE 2 VERSIONS OF THE ABOVE PANEL AVAILABLE :-BSB100/8 8 OHM VERSION BSB100/4 4 OHM VERSION BOTH PANELS ARE PRICED AT £117.44 + £5.00 P&P INCL. V.A.T. CHECK WEBSITE FOR PANELS UP TO 500W



DELIVERY CHARGES:- PLEASE INCLUDE AS ABOVE, A MINIMUM CHARGE OF £8.00 TO A MAXIMUM AMOUNT OF £30.00. OFFICIAL ORDERS FROM SCHOOLS, COLLEGES, GOVT. PLCs ETC. PRICES INCLUSIVE OF V.A.T. SALES COUNTER. CREDIT CARD ORDERS ACCEPTED



## RF REMOTE CONTROLLED MAINS SWITCHES



RF Remote controlled mains switches suitable for use around the home where the operation of mains equipment up to 1KW can be controlled with the touch of one button. Ideal for equipment that has the wall socket obstructed like Hi-Fi and AV systems, or for lights. Kit comprises of one RF remote control and three sockets. The RF remote can control an additional two sockets making five in all and the sockets are programmable from 1 to 5 via a selector switch on the back of the socket. Sockets also come with an override switch to turn the power on and off without the aid of the remote control.

### Features

- \* Remote controller can control up to 5 switches
- \* Up to 20 metre range
- \* Adjustable codes
- \* Manual On/Off
- \* Extra socket and remote available



Kit comprises of 3 mains switches and one RF remote control

Order No. 350.112

Price £19.95

Additional Socket £6.66ea Order No.350.112A

Additional Remote £6.66ea Order No. 350.112B

## OMP MOS-FET POWER AMPLIFIER MODULES

SUPPLIED READY BUILT AND TESTED

These modules now enjoy a world-wide reputation for quality, reliability and performance at a realistic price. Four models are available to suit the needs of the professional and hobby market. ie. Industry, Leisure, Instrumental and Hi-Fi etc. When comparing prices, NOTE that all models include toroidal power supply, integral heatsink, glass fibre P.C.B. and drive circuitry to power a compatible Vu meter. All models are open and short circuit proof

### THOUSANDS OF MODULES PURCHASED BY PROFESSIONAL USERS

**OMP/MF 100 Mos-Fet** Output Power 110 watts R.M.S. into 4 ohms, frequency response 1Hz - 100kHz -3dB, Damping Factor >300, Slew Rate 45V/uS, T.H.D. typical 0.002%, Input Sensitivity 500mV, S.N.R. 110dB, Size 300 x 123 x 60mm.  
Price:- £43.85 + £4.00 P&P

**OMP/MF 200 Mos-Fet** Output Power 200 watts R.M.S. into 4 ohms, frequency response 1Hz - 100kHz -3dB, Damping Factor >300, Slew Rate 50V/uS, T.H.D. typical 0.001%, Input Sensitivity 500mV, S.N.R. 110dB, Size 300 x 155 x 100mm.  
Price:- £67.35 + £4.00 P&P

**OMP/MF 300 Mos-Fet** Output Power 300 watts R.M.S. into 4 ohms, frequency response 1Hz - 100kHz -3dB, Damping Factor >300, Slew Rate 60V/uS, T.H.D. typical 0.001%, Input Sensitivity 500mV, S.N.R. 110dB, Size 330 x 175 x 100mm.  
Price:- £84.75 + £5.00 P&P

**OMP/MF 450 Mos-Fet** Output Power 450 watts R.M.S. into 4 ohms, frequency response 1Hz - 100kHz -3dB, Damping Factor >300, Slew Rate 75V/uS, T.H.D. typical 0.001%, Input Sensitivity 500mV, S.N.R. 110dB, Fan Cooled, D.C. Loudspeaker Protection, 2 Second Anti Thump Delay, Size 385 x 210 x 105mm.  
Price:- £137.85 + £6.00 P&P

**OMP/MF 1000 Mos-Fet** Output Power 1000 watts R.M.S. into 2 ohms, frequency response 1Hz - 100kHz -3dB, Damping Factor >300, Slew Rate 75V/uS, T.H.D. typical 0.001%, Input Sensitivity 500mV, S.N.R. 110dB, Fan Cooled, D.C. Loudspeaker Protection, 2 Second Anti Thump Delay, Size 422 x 300 x 125mm.  
Price:- £264.00 + £12.00 P&P

NOTE: MOS-FET MODULES ARE AVAILABLE IN TWO VERSIONS. STANDARD - INPUT SENS 500mV/BANDWIDTH 100kHz OR PEC (PROFESSIONAL EQUIPMENT COMPATIBLE) - INPUT SENS 775mV, BANDWIDTH 50kHz ORDER STANDARD OR PEC

## WRIST WATCH STYLE 8 CHANNEL PMR 2 WAY RADIOS



A pair of uniquely styled 2 way PMR personal radios ideal for short range communications, no licence required. Each wrist watch radio is capable of transmitting up to 5 Km without obstructions and have a built in thermometer and stopwatch function., they can also tell the time!!! The set comprises two wrist watches, rechargeable batteries, and a double fast charger. These must be the smallest PMR radio's available

- \* Range up to 5 Km unobstructed
- \* Watch / Stopwatch and Thermometer function
- \* Baby Monitor Function
- \* High gain antenna
- \* Supplied in pairs
- \* Supplied with rechargeable batteries, 2 hands free sets and a double fast charger

Order No. 270.538

Price £46.67 Per Pair

Specifications:- Batteries supplied Li-ion, Frequency 446Mhz (PMR), Output power 0.5W ERP, Channels 8 + 38 CTCSS sub channels

# B.K. ELECTRONICS

REF D10

UNIT 1 COMET WAY, SOUTHEND-ON-SEA, ESSEX. SS2 6TR.  
TEL.: 01702-527572 FAX.: 01702-420243  
Web:- <http://www.bkelec.com> E-Mail [sales@bkelec.com](mailto:sales@bkelec.com)