

THE No.1 MAGAZINE FOR ELECTRONICS TECHNOLOGY & COMPUTER PROJECTS

EVERYDAY

FEBRUARY 2005

PRACTICAL **ELECTRONICS**

£3.10

SOUND CARD MIXER

Improves live PC recordings

PIC-ELECTRIC Mk 2

Highly versatile electricity use/cost monitor and logger

SNEAKY

Covert signalling for magic tricks



PLUS

E-BLOCKS AND FLOWCODE REVIEW



9 770262 361126

www.epemag.co.uk



Colour CCTV camera, 8mm lens, 12vdc200ma a 582X628 Res 380 lines Automatic aperture lens Mirror function PAL Back Light Comp MLR, 100x40x40mm ref EE2 £75.90

Built in Audio .15lux CCD camera 12vdc 200ma 480 lines s/n ratio >48 db 1v P-P output 110x60x50mm ref EE1 £108.90



Metal CCTV camera housings for internal or external use. Made from aluminium and plastic they are suitable for mounting body cameras in. Available in two sizes 1-100x70x170mm and 2-100x70x280mm Ref EE6 £22 EE7 £26 Multi position brackets Ref EE8 £8.80



Excellent quality multi purpose TV/TFT screen, works as just a LCD colour monitor with any of our CCTV cameras or as a conventional TV ideal for use in boats and caravans 49.75mhz-91.75mhz VHF channels 1-5, 168.25mhz-222.75mhz VHF channels 6-12, 471.25mhz-869.75mhz, Cable channels 112.325mhz-166.75mhz Z1-Z7, Cable channels 224.25mhz-446.75mhz Z8-Z35 5" colour screen, Audio output 150mW, Connections, external aerial, earphone jack, audio/video input, 12vdc or mains, Accessories supplied Power supply Remote control Cigar lead power supply Headphone Stand/bracket, 5" model £139 Ref EE9.



Self cocking pistol picr002 crossbow with metal body. Selfcocking for precise string alignment Aluminium alloy construction High tec fibre glass limbs Automatic safety catch Supplied with three bolts Track style for greater accuracy Adjustable rear sight 50lb draw weight 150ft/sec velocity Break action 17" string 30m range £23.84 Ref PLCR002



Fully cased IR light source suitable for CCTV applications. The unit measures 10x10x150mm, is mains operated and contains 54 infra red LEDs. Designed to mount on a standard CCTV camera bracket. The unit also contains a daylight sensor that will only activate the infra red lamp when the light level drops below a preset level. The infra red lamp is suitable for indoor or exterior use, typical useage would be to provide additional IR illumination for CCTV cameras. £53.90 ref FF11



Colour CCTV Camera measures 60x45mm and has a built in light level detector and *21R leds .2lux 12 IR leds 12vdc Bracket Easy connect leads £75.90 Ref EE15



A high quality external colour CCTV camera with built in infra red LEDs measuring 60x60x60mm Easy connect leads colour Waterproof PAL 1/4" CCD5-42x588 pixels 420 lines .05 lux 3.6mm F2.78 deg lens 12vdc 400ma Built in light level sensor. £108.90 Ref EE13



A small colour CCTV camera just 35x28x30mm Supplied with bracket, easy connect leads. Built in audio. Colour 380 line res, PAL 0.2lux+18db sensitivity Effective pixels 628x582 6-12vdc Power200mw £39.60 Ref EE16



Peltier module. Each module is supplied with a comprehensive 18 page Peltier design manual featuring circuit designs, design information etc etc. The Peltier manual is also available separately Maximum watts 56.2 40x40mm Imax 5.5A Vmax 16.7V Tmax (c-dry N2) 72 £32.95 (inc manual) REF PELT11, just manual £4.40 ref PELT2



COMPAQ 1000mA 12vdc power supplies, new and boxed, 2 metre lead DC power plug 2.4mmx10mm £5.25 each, 25+ £3.50 100+£2.50



3km Long range video and audio link complete with transmitter, receiver, 12.5m cables with pre fitted connectors and aerials. Achieve up to 3km. Cameras not included Ideal for stables, remote buildings etc. Mains power required £299



Complete wireless CCTV system with video. Kit comprises pinhole colour camera with simple battery connection and a receiver with video output. 380 lines colour 2.4ghz 3lux 6-12vdc manual tuning Available in two versions, pinhole and standard. £79 (pinhole) Ref EE17, £86.90 (standard) Ref EE18



GASTON SEALED LEAD ACID BATTERIES
1.3AH 12V @ £5.50 GT1213
3.4AH 12V @ £8.80 GT1234
7AH 12V @ £8.80 GT127
17AH 12V @ £19.80 GT1217

All new and boxed, bargain prices. Good quality sealed lead acid batteries



1.2ghz wireless receiver Fully cased audio and video 1.2ghz wireless receiver 190x140x30mm metal case, 4 channel, 12vdc Adjustable time delay, 4s, 8s, 12s 16s. £49.50 Ref EE20

The smallest PMR446 radios currently available (54x87x37mm). These tiny handheld PMR radios look great, user friendly & packed with features including VOX, Scan & Dual Watch. Priced at £59.99 PER PAIR they are excellent value for money. Our new favourite PMR radios! Standby: - 35 hours Includes: - 2 x Radios, 2x Belt Clips & 2 x Carry Strap £59.95 Ref ALAN1 Or supplied with 2 sets of rechargeable batteries and two mains chargers £93.49 Ref Alan2

The TENS mini Microprocessors offer six types of automatic programme for shoulder pain, back/neck pain, aching joints, Rheumatic pain, migraines headaches, sports injuries, period pain. In fact all over body treatment. Will not interfere with existing medication. Not suitable for anyone with a heart pacemaker. Batteries supplied. £21.95 Ref TEN327 Spare pack of electrodes £6.59 Ref TEN327X

Dummy CCTV cameras These motorised cameras will work either on 2 AA batteries or with a standard DC adapter (not supplied) They have a built in movement detector that will activate the camera if movement is detected causing the camera to 'pan' Good deterrent. Camera measures 20cm high, supplied with fixing screws. Camera also has a flashing red led. £10.95 Ref CAMERAB

INFRA RED FILM 6" square piece of flexible infra red film that will only allow IR light through. Perfect for converting ordinary torches, lights headlights etc to infrared output using standard light bulbs Easily cut to shape. 6" square £16.50 ref IRF2 or a 12" sq for £34.07 IRF2A

THE TIDE CLOCK These clocks indicate the state of the tide. Most areas in the world have two high tides and two low tides a day, so the tide clock has been specially designed to rotate twice each lunar day (every 12 hours and 25 minutes) giving you a quick and easy indication of high and low water. The Quartz tide clock will always stay calibrated to the moon. £23.10 REF TIDE C

LINEAR ACTUATORS 12-36VDC BUILT IN ADJUSTABLE LIMIT SWITCHES POWDER COATED 18" THROW UP TO 1,000 LB THRUST (400LB RECOMMENDED LOAD) SUPPLIED WITH MOUNTING BRACKETS DESIGNED FOR OUTDOOR USE These brackets originally made for moving very large satellite dishes are possibly more suitable for closing gates, mechanical machinery, robot wars etc. Our first sale was to a company building solar panels that track the sun! Two sizes available, 12" and 18" throw. £32.95 REF ACT12,

Samarium magnets are 57mm x 20mm and have a hole (5/16th UNF) in the centre and a magnetic strength of 2.2 gauss. We have tested these on a steel beam running through the offices and found that they will take more than 170lbs (77kgs) in weight before being pulled off. With keeper. £21.95 REF MAG77

New transmitter, receiver and camera kit. £69.00 Kit contains four channel switchable camera with built in audio, six IR leds and transmitter, four channel switchable receiver, 2 power supplies, cables, connectors and mounting bracket. £69.00 Wireless Transmitter Black and white camera (75x50x55mm) Built in 4 channel transmitter (switchable) Audio built in 6 IR Leds Bracket/stand Power supply 30 m range Wireless Receiver 4 channel (switchable) Audio/video leads and scart adapter Power supply and Manual £69.00 ref COP24

This miniature Stirling Cycle Engine measures 7" x 4-1/4" and comes complete with built-in alcohol burner. Red flywheels and chassis mounted on a green base, these all-metal beauties silently running at speeds in excess of 1,000 RPM attract attention and create awe wherever displayed. This model comes completely assembled and ready to run. £106.70 REF SOL1

High-power modules using 125mm square multi-crystal silicon solar cells with bypass diode Anti reflection coating and BSF structure to improve cell conversion efficiency: 14%. Using white tempered glass, EVA resin, and a weatherproof film along with an aluminum frame for extended outdoor use. system Lead wire with waterproof connector. 80 watt 12v 500x1200 £315.17, 123w 12vdc 1499x662x46 £482.90 165 w 24v 1575x826x46mm £652.30

BULL GROUP LTD
UNIT D HENFIELD BUSINESS PARK
HENFIELD SUSSEX BN5 9SL
TERMS: CASH, PO, CHEQUE PRICES+VAT
WITH ORDER PLUS £5.50 P&P (UK) PLUS VAT.
24 HOUR SERVICE £7.50 (UK) PLUS VAT.
OVERSEAS ORDERS AT COST PLUS £3.50
Tel: 0870 7707520 Fax 01273491813
Sales@bullnet.co.uk
www.bullnet.co.uk



Ultra-compact, lightweight, easy to use and comfortable to hold, the new NVMT is unique for a night scope in offering a tactile, suregrip plastic body shell and, for extra protection/grip, partial rubber armouring. Currently the top of the range model, the NVMT G2+ features a 'commercial grade' Gen2+ Image Intensifier Tube (IIT). The NVMT has a built-in, powerful Infrared (IR) Illuminator for use in very low light/total darkness. Power for the scope and IR is provided by 1 x 3V Lithium CR123A battery (not supplied). A Gen LED next to the viewfinder indicates when the Image Intensifier Tube is switched on while a red LED indicates when the IR Illuminator is switched on. Type Gen Weight Size Lens Mag 2x, Weight 400g, 125x82x35mm angle of view 30 deg, built in infra red, rang 3 - 400m, supplied with batteries £849 ref COB24023.

55 - 200 WATT INFRA RED TORCHES Searchguard 1 infrared torch Plastic bodied waterproof Infrared rechargeable lamp. 100mm diameter lens, 200mm body length. 55 watt bulb, 1,000,000 candle power (used as an indication of relative power) Supplied complete with a 12v car lighter socket lead/charger and a 240v mains plug in charger. £49 REF sguard 1. Also available, 70watt @ £59, 100 watt @ £79, 200watt @ £99.



B2 AIR RIFLE Available in .177 and .22+19" Tapered Rifled Barrel Adjustable Rear Sight Full Length Wooden Stock Overall Length 43" approx Barrel Locking Lever • Also available in CARBINE Grooved for Telescopic Sight model with 14" barrel - no front sight with scope. Weight approximately 6lbs Extremely Powerful .22 £28.90, .177 £24.70, pellets (500) £2.55, sights 4x20 £6.80, 4x28 £15.32 Other models available up to £250. www.airpistol.co.uk

12V SOLAR PANELS AND REGULATORS
9 WATT £58.75
15 WATT £84.25
22 WATT £126.70
Regulator up to 60 watt £21.25
Regulators up to 135 watt £38.25

The combination of multi-crystal cells and a high-reliability module structure make this series of solar panels the ideal solar module. For large-scale power generation hundreds or even thousands of modules can be connected in series to meet the desired electric power requirements. They have a high output, and highly efficient, extremely reliable and designed for ease of maintenance. Separate positive negative junction boxes and dual by-pass diodes are a few examples of some of its outstanding features. Supplied with an 8 metre cable. Perfect for caravans, boats, etc. Toughened glass.



LOCK PICK SETS 16, 32 AND 60 PIECE SETS This set is deluxe in every way! It includes a nice assortment of balls, rakes, hooks, diamonds, two double ended picks, a broken key extractor, and three tension wrenches. And just how do you top off a set like this? Package it in a top grain leather zippered case. Part: LP005 - Price £45.00
This 32 piece set includes a variety of hooks, rakes, diamonds, balls, extractors, tension tools ... and comes housed in a zippered top grain leather case. If you like choices, go for this one! Part: LP006 - Price £65.00
If you want to run toward the biggest pick set you can find, here it is. This sixty piece set includes an array of hooks, rakes, diamonds, balls, broken key extractors, tension wrenches, and even includes a warded pick set! And the zippered case is made, of course, of the finest top grain leather. First Class Part: LP007 - Price £99.00

Mamod steam roller, supplied with fuel and everything you need (apart from water and a match!) £85 REF 1312 more models at www.mamodspares.co.uk
Mamod steam roller, supplied with fuel and everything you need (apart from water and a match!) £130 REF 1318 more models at www.mamodspares.co.uk

PEANUT RIDER STIRLING ENGINE This all metal, black and brass engine with red flywheel is mounted on a solid hardwood platform, comes complete with an alcohol fuel cell, extra wick, allen wrenches, and Owner's Manual. Specifications: Base is 5-1/4" x 5-1/4", 4" width x 9" height, 3/4" stroke, 3-1/2" flywheel £141.90
SHOP ONLINE
WWW.BULLNET.CO.UK

ISSN 0262 3617
 PROJECTS ... THEORY ... NEWS ...
 COMMENTS ... POPULAR FEATURES ...

VOL. 34. No. 2 FEBRUARY 2005

Cover illustration: Oscar Burriel/Science Photo Library

EVERYDAY
PRACTICAL
ELECTRONICS

INCORPORATING **ELECTRONICS TODAY INTERNATIONAL**

www.epemag.co.uk

EPE Online: www.epemag.com



Projects and Circuits

- PIC ELECTRIC MK2** by John Becker 84
 Monitor the cost of running your mains electrical appliances
- SNEAKY** by Mike Boyden 94
 A covert communication system for magicians and spies!
- SOUND CARD MIXER** by Terry de Vaux-Balbirnie 107
 Bring "life" to your computerised live recordings
- INGENUITY UNLIMITED - Sharing your ideas with others** 114
 Digital Stop Clock; Light and Heat Sensor
- SMART KARTS - 5 Pushing and Grabbing** by Owen Bishop 128
 Our mobile robot morphs into SK-3 and gains a grabber and pusher

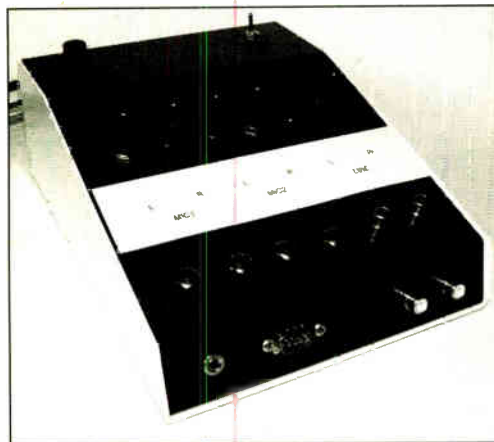

Series and Features

- TECHNO TALK** by Andy Emmerson 90
 Wireless Internet services via tethered balloons - or just pie in the sky?
- PIC N' MIX** by Andrew Jarvis 100
 Read the script - free development software!
- CIRCUIT SURGERY** by Alan Winstanley and Ian Bell 102
 Continuing our short series on the Universal Serial Bus (USB) with a suggested circuit
- E-BLOCKS AND FLOWCODE V2.0 REVIEWS** by Robert Penfold 117
 Two systems which teach the easy understanding of electronics through dedicated modules under readily reprogrammable software control
- INTERFACE** by Robert Penfold 122
 Simple digital to analogue conversion for PCs
- NET WORK - THE INTERNET PAGE** surfed by Alan Winstanley 127
 Beware of eBay scammers

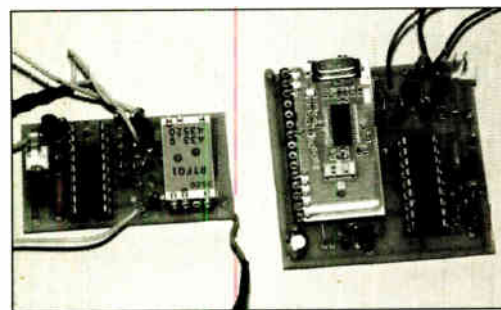

Regulars and Services

- BACK ISSUE CD-ROMS** single-source shopping for issues you've missed 78
- BACK ISSUES** Did you miss these? 79
- EDITORIAL** 83
- NEWS** - Barry Fox highlights technology's leading edge 91
 Plus everyday news from the world of electronics
- READOUT** John Becker addresses general points arising 105
- CD-ROMS FOR ELECTRONICS** 124
 A wide range of CD-ROMs for hobbyists, students and engineers
- SHOPTALK** with David Barrington 136
 The *essential* guide to component buying for *EPE* projects
- DIRECT BOOK SERVICE** 137
 A wide range of technical books available by mail order, plus more CD-ROMs
- ELECTRONICS MANUALS** 140
 Essential CD-ROM reference works for hobbyists, students and service engineers
- PRINTED CIRCUIT BOARD AND SOFTWARE SERVICE** 141
 PCBs for *EPE* projects. Plus *EPE* project software
- ADVERTISERS INDEX** 144

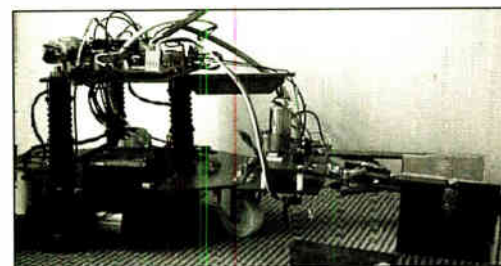

© Wimborne Publishing Ltd 2005. Copyright in all drawings, photographs and articles published in EVERYDAY PRACTICAL ELECTRONICS is fully protected, and reproduction or imitations in whole or in part are expressly forbidden.

Our March 2005 issue will be published on Thursday, 10 February 2005. See page 75 for details

Readers Services • Editorial and Advertisement Departments 83

PLEASE ENSURE YOU TELEPHONE TO CHECK AVAILABILITY OF EQUIPMENT BEFORE ORDERING OR CALLING.

MISCELLANEOUS CLEARANCE STOCK

OSCILLOSCOPES	POWER SUPPLY Model 12030 0-20V 0-30A - On Wheels £95
TEKTRONIX 465B Dual Trace 100 MHz Delay fitted into 18in rack frame	HARMER SIMMONS 5025/110 Input 240V 50A Output 50V 25A £100
HP 1740A Dual Trace 100 MHz delay (no lock)	CENTRONIC M100 Regenerat Input 240V 250 VA Output 240V 1000VA £50
HP 1740A Dual Trace 100 MHz Delay	DRANETZ 606 Line Distribution Analyser £38
HP 1741 Dual Trace 100 MHz Analogue Storage	WAYNE KERR 8601 Radio Frequency Bridge £25
HP 1744A Dual Trace 100 MHz Analogue Storage	FEEDBACK TFA807 Transfer Function Analyser £25
PHILIPS PM3264 4 ch. 100 MHz	WAVETEK 63 Data Multimeter £80
GOULD O83000A Dual Trace 40 MHz	GOULD SG200 RF Signal Generator £20
TRIO CS1040 Dual Trace 40 MHz	CHATILLON Force Meter £18
GOLDSTAR O99020P Dual Trace 20 MHz	ALFRED I105 Variable Attenuator 4-8GHz £20
IWATSU S58702 Dual Trace 20 MHz	CAMMETRIC 5 Decade Resistance Box £15
KIKUSUI C085020 Dual Trace 20 MHz	SULLIVAN C8710 Precision 5 Decade Capacitor Box £20
POWER SUPPLIES	MARCONI 60333 Waveguide £20
FARNELL L30BT 0-30V 0-1A Twice	MARCONI 2185 Pulse Modulator £20
FARNELL L30AT 0-50V 0-500MA Twice	MARCONI 2430A Frequency Meter 80MHz £30
FARNELL LT30-1 0-30V 0-1A Twice Scruffy	MARCONI 6950 RF Power Meter - No head £35
FARNELL L30-2 0-30V 0-2A Scruffy	MARCONI 6980 RF Power Meter - Digital £50
FARNELL L30-1 0-30V 0-1A Scruffy	HP X362A Variable Attenuator Waveguide £20
FARNELL L30B 0-30V 0-1A	HP 8315A Counter £50
FARNELL L30AT-0-50V 0-500MA	HP 8750A Storage Normalizer £20
FARNELL C1 0-50V 0-1A - 2 Meters	HP 907A Co-axial Sliding Load £20
Farnell TOPS1 5V 1A ±15V 200MA	PROGRAMMA TM2 Timer £20
COUTANT LB500 2 0-30V 0-5A - 2 Meters	RACAL 9009 Modulation Meter £40
COUTANT LA200 2 0-3V 0-2A - 2 Meters	RACAL 9009A Modulation Meter £50
COUTANT LGT200 0-15V 0-2A - Twice	TEXCAN 8450 102dB in 10dB steps £15
COUTANT LGT100 0-30V 0-1A Twice	BIRD Attenuator etc in box 30dB £15
COUTANT LGT5050 0-50V 0-500MA	BIRD 8341-200 Coaxial Attenuator 20dB 40W 50ohm £25
WEIR 781 0-30V 2A or 0-15V 4A	BIRD 81 Wattmeter 6 & 30W 50ohm 30-50MHz £40
WEIR 782 0-30V 2A or 0-15V 4A	TELENIC TTP95-5EE Tunable Band Pass Filter £20
WEIR 4310 0-30V 1A - 5V 4A	TELENIC 190-3EE Tunable Band Reject Filter 125-250 £18
WEIR 400 0-0V 0.3A - 10V 1A	TELENIC 95-3EE Tunable Band Reject Filter 60-128 £18
WEIR 460 0-0V 0.3A - 20V 1A	HELPER INST CML1 Snadder £20
HP 6256B 0-40V 0-5A 2 Meters	HHELPER INST S103 Snadder 3 £30
HP 6256B 0-10V 0-20A 2 Meters	SXP100 Parallel to Serial Converter £10
HP 6111A 0-20V 0-1A	MICROMASTER LV £40
HP 8235A ±6V 1A ±15V 200MA	DATAMAN S3 Programmer £50
KINGSHILL 36VDC 0-36C 0-2A	RS 424-103 Logic Pulser £5
MARCONI TP2158 0-30V 0-2A Twice	GLOBAL S01 Shortcircuit £20
LAMBDA 422FM 0-40V 0-1A Twice 4 Meters	RS 180-7127 Conductivity Meter £35
LAMBDA LK345A FM 0-60V 0-10A 2 Meters	EAGLE DC30 Probe 30KΩ DC £5
BYSTRON DOWNER SHR40-2 0-40V 0-2A - 2 Meters	AVO 100AMP Shunt for AVO 8 £5
BORENBON SRL6-4 0-60V 0-4A	SOUTHERN CALIFORNIA BTRM-S-10 2000.0 Mhz £30
GRENSON BP14 ±5V 2.5A & ±7.5V 0.5A	MOTOROLA R20101 Communication System Analyser £260
RS 613-991 2 x 5v 2.5A or 2 x 12V 1.5A or 2 x 5V 1A	WESTON 1149 Standard Cell 1.0155 ABS Vols at 20C £10
RS 206-197 Line Voltage Conditioner - Output 240V 0.65A £40	MURHEAD A-6-B Resistance Box £10
POWER CONVERSION PLC1000 Line Cond. 1000VA £50	RACAL 9917A UHF Frequency Meter 10Hz-560 MHz £45
HARLYN AUTOMATION IPP38200 System Power Supply £90	RACAL 9917 UHF Frequency Meter 10Hz-560 MHz £40
POWERLINE LAB807 0-300V AC 0.75A	RACAL 99159M UHF Frequency Meter 10Hz-520 MHz £30

RACAL 9901 Universal Counter Timer DC-50 MHz	£15
RACAL 9900 Universal Counter Timer 30 MHz DC-30 MHz	£15
WAVETEK 136 VCG/VCA Generator	£20
HP 435A Power Meter - No lead no head	£30
HP 8015A Pulse Generator	£10
HP 403B AC Voltmeter	£15
DH-LOG PR415 Phase Rotation Indicator	£10
MATWOOD D2000 Digital Indicator	£10
HP 3720A HP1B Extender	£10
HATFIELD 2115 Attenuator 75ohm 100dB	£10
HATFIELD 2118R Attenuator 75ohm 100dB	£10
HATFIELD 2118R Attenuator 75ohm 10dB	£10
HATFIELD 2135 Attenuator 60ohm 100dB	£20
TEKTRONIX 1103 Tekprobe Power Supply	£10
BYSTRON DOWNER 6243A Freq Counter 20Hz-1250 MHz	£35
LEVELL 10301 Function Generator 1 MHz Sine/Sq/Tri	£30
SOLARTRON 7045 Digital Multimeter	£40
HP 8404A Levelling Amplifier	£15
HP 3455A Digital Voltmeter	£50
FEEDBACK FIM10 Digital Frequency Meter	£25
FARNELL TMS True RMS RF Millivoltmeter	£40
THURLBY PL320QMD 0-30V 0-2A twice digital PSU	£200
H.P. 9828A Precision High Resolution PSU, 4 outputs	£15
0-7V 0-15A or 0-5V 0-0.5A twice; 0-18V 0-2A or 0-50V 0-2A twice	£500
CIRRIUS CRL264 Sound Level Meter with calibrator	£95
80-120dB LED	£80
WAYNE KERR 8424 Component Bridge	£95
RACAL 9300 True RMS Voltmeter, 5Hz-20MHz usable to 60MHz, 10V-316V	£50
RACAL 9300B True RMS Voltmeter, 5Hz-20MHz usable to 60MHz, 10V-316V	£75
AVO DA118 Digital Avometer with battery and leads	£20
FARNELL LPM4 Sine/Sq Oscillator, 10Hz-1MHz, low distortion TTL output amplitude meter	£75
FARNELL J38 Sine/Sq Oscillator, 10Hz-100kHz, low dist.	£50
HEME 1000 LCD Clamp Meter, 0-1000A, in carrying case	£35
FLUKE 77 Multimeter 3 1/2 digit handheld with battery & leads	£45
KENWOOD VT178 2-Channel Multimeter	£50
KENWOOD FL140 Wow and Flutter Meter	£75
KENWOOD FL180A Wow and Flutter Meter	£125
MARCONI 6960B Power Meter with 8620 head, 10MHz-20GHz	£150
SOLARTRON 7150 DMH 6 1/2-digit True RMS IEEE	£75
SOLARTRON 7150 Plus As 7150 - temp. measurement	£100
IEEE Cables	£5
H.P. 3312A Function Gen, 0.1Hz-13MHz, AM/FM Sweep/Sq/Tri/Burst etc	£200
H.P. 3310A Function Gen, 0.005Hz-8MHz, Sine/Sq/Tri Ramp/Pulse	£90
RACAL 9008 Automatic Modulation Meter, 1-5MHz-2GHz	£90
ISOLATING Transformer, Input 250V, output 500VA, unshielded	£30
RACAL 1792 Receiver	£35

EXTRA SPECIAL OFFERS

H.G.R. 8580A Spectrum Analyser, 50Hz-2.9GHz	£3,250
H.P. 8598B Spectrum Analyser, 10MHz-22GHz	£1,500
MARCONI 2382 Spectrum Analyser, 200kHz-400MHz	£1,250
TEKTRONIX 2465A Oscilloscope, 4-ch, 350MHz	£750
TEKTRONIX 2246 Oscilloscope, 4-ch, 100MHz	£375
H.P. 8640A AM/FM Signal Gen, 500kHz-512MHz	£176

SPECIAL OFFERS

OSCILLOSCOPES	
LECROY 9400A dual trace, 170MHz, 50/S	£500
Leeroy 9400 dual trace, 125MHz	£400
TEKTRONIX 468 dual trace, 100MHz, digital storage	£250
TEKTRONIX 475 dual trace, 200MHz, delay sweep	£250
TEKTRONIX 468B dual trace, 100MHz, delay sweep	£250
TEKTRONIX 465 dual trace, 100MHz, delay sweep	£175
PHILIPS PM127 dual trace, 50MHz, delay sweep	£150
H.P. 8312QMD 0-30V 0-2A twice digital PSU	£180
H.P. 9828A Precision High Resolution PSU, 4 outputs	£200
0-7V 0-15A or 0-5V 0-0.5A twice; 0-18V 0-2A or 0-50V 0-2A twice	£500
CIRRIUS CRL264 Sound Level Meter with calibrator	£95
80-120dB LED	£80
WAYNE KERR 8424 Component Bridge	£95
RACAL 9300 True RMS Voltmeter, 5Hz-20MHz usable to 60MHz, 10V-316V	£50
RACAL 9300B True RMS Voltmeter, 5Hz-20MHz usable to 60MHz, 10V-316V	£75
AVO DA118 Digital Avometer with battery and leads	£20
FARNELL LPM4 Sine/Sq Oscillator, 10Hz-1MHz, low distortion TTL output amplitude meter	£75
FARNELL J38 Sine/Sq Oscillator, 10Hz-100kHz, low dist.	£50
HEME 1000 LCD Clamp Meter, 0-1000A, in carrying case	£35
FLUKE 77 Multimeter 3 1/2 digit handheld with battery & leads	£45
KENWOOD VT178 2-Channel Multimeter	£50
KENWOOD FL140 Wow and Flutter Meter	£75
KENWOOD FL180A Wow and Flutter Meter	£125
MARCONI 6960B Power Meter with 8620 head, 10MHz-20GHz	£150
SOLARTRON 7150 DMH 6 1/2-digit True RMS IEEE	£75
SOLARTRON 7150 Plus As 7150 - temp. measurement	£100
IEEE Cables	£5
H.P. 3312A Function Gen, 0.1Hz-13MHz, AM/FM Sweep/Sq/Tri/Burst etc	£200
H.P. 3310A Function Gen, 0.005Hz-8MHz, Sine/Sq/Tri Ramp/Pulse	£90
RACAL 9008 Automatic Modulation Meter, 1-5MHz-2GHz	£90
ISOLATING Transformer, Input 250V, output 500VA, unshielded	£30
RACAL 1792 Receiver	£35

STEWART of READING

17A King Street, Mortimer, Near Reading RG7 3RS
 Telephone: (0118) 933 1111. Fax: (0118) 933 2375
www.stewart-of-reading.co.uk



Open 9am-5.00pm Monday to Friday (other times by arrangement)

Used Equipment - GUARANTEED. Manuals supplied
 This is a VERY SMALL SAMPLE OF STOCK. SAE or Telephone for lists.
 Please check availability before ordering.
CARRIAGE all units £16. VAT to be added to Total of Goods and Carriage



DISTANCE LEARNING COURSES

Electronic Circuits
 Digital Circuits
 Mathematics

Electronic Testing & Fault Finding
 Programmable Logic Controllers
 Mechanics & Mechanisms

These courses lead to a **BTEC QUALIFICATION** and are suitable for beginners and those with more experience, needing to update their skills.

Register **NOW** and learn at your own pace with tutor support available to help you succeed.

For more information please telephone

08456 345 445

or visit our web site

www.oakcad.co.uk/nct.aspx



National College of Technology is part of the OakCAD Training Group.

GSM Telemetry Solution

- GSM technology with no range limitations -



The GSM alarm will send an SMS (text) message to the pre-programmed mobile numbers every time an input is triggered. Inputs can be anything from door openings or temperature changes etc....

You can also control connected devices by simply calling or send an SMS to the unit, i.e. open or close doors.

Features:

- Just insert a sim card and your ready.
- Alerts you by SMS when an input has been triggered.
- Up to 5 mobile numbers can be programmed to receive the alerts.
- GSM Dual Band, will alert you where ever you are.
- 2 Inputs & 2 Relay Outputs, all controlled via SMS.
- Small & compact, easy to conceal.
- Status information via LED's.

Specifications:

- GSM Dual Band 900/1800 Mhz
- Supply Voltage: 6-15V
- Dimensions: 100x53x25mm
- Weight: 100g

Special Price: £199.00*
 *All prices exclude P&P and VAT.

Bitz Technology Ltd
 344 Kilburn Lane, London W9 3EF
 Tel: +44 (0) 208 968 0227 Fax: +44 (0) 208 968 0194
 E-Mail: info@spystoreuk.com

NEXT MONTH

CAT FLAP

A versatile detector that will sense the presence of a magnet worn by the cat at a distance of around 20cm. The design can then be used to trigger a deterrent for strays and/or unlock the cat flap for the magnet-wearing moggy.

A simple design employing an easily constructed coil with a Faraday shield plus a handful of p.c.b. mounted components.

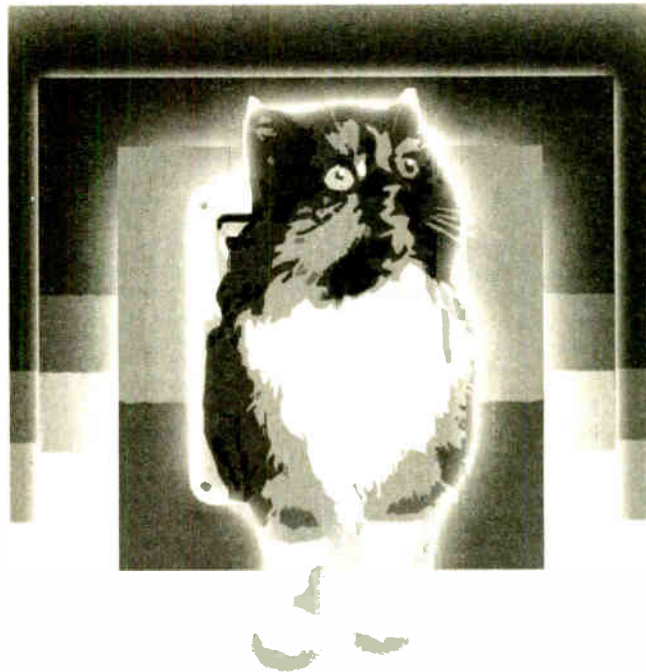

PIC BINGO

Most people will have played Bingo or similar lottery style games since their early years. Methods abound for the selection of random numbers – usually between 1 and 90 – ranging from wooden balls in bags to the washing-machine like Lotto creations as seen on television. This project applies modern PIC-based electronics to the traditional game, resulting in a gadget that is completely fair, requires no set-up time and, most importantly in family circles, removes all arguments about who should be the “caller.”!

PIC Bingo provides for manual and automatic number generation. In automatic mode, a number is generated automatically after a pre-programmed delay of up to 99 seconds. A “rewind and replay” function is also provided, as is the ability to change the range for which numbers are generated – useful for other games – and to check the numbers on the winning card.

The project also demonstrates and applies a number of techniques previously featured in EPE projects, including large seven-segment l.e.d. displays and, most fun of all (and very useful for school/club bingo evenings), the enormous seven-segment displays described in the PIC Big Digit Display article from May 2002. These devices are driven from an expansion p.c.b. enabling constructors to customise the project to their specific requirements.

TK3 SIMULATOR AND PIC18F UPGRADE

Describing the latest facilities that have been added to the EPE PIC Toolkit TK3 PIC assembly and programming software, now released as version V3.00.

The first addition is a quite sophisticated Mini Simulator through which your own software routines can be put through initial testing procedures, allowing potential bugs to be eliminated prior to downloading the code to a PIC.

The second enhancement is the expansion of the assembly, programming and disassembly routines to allow members of the recently introduced PIC18Fxx2/xx8 family to be handled. These devices have more commands and abilities than the more familiar PIC16Fxx devices, but have significantly different assembly and programming requirements.

NO ONE DOES IT BETTER

EVERYDAY
PRACTICAL
ELECTRONICS

**DON'T MISS AN
ISSUE – PLACE YOUR
ORDER NOW!**

Or take out a subscription and save money
See the last magazine page for prices

MARCH 2005 ISSUE ON SALE THURSDAY, FEBRUARY 10



Quasar Electronics Limited
PO Box 6935, Bishops Stortford,
CM23 4WP
Tel: 0870 246 1826
Fax: 0870 460 1045
E-mail: sales@quasarelectronics.com

Add £2.95 P&P to all UK orders or 1st Class Recorded – £4.95.
Next day (insured £250) – £7.95. Europe – £6.95. Rest of World – £9.95
(order online for reduced price UK Postage).
We accept all major credit/debit cards. Make cheques/POs
payable to Quasar Electronics Limited.
Prices include 17.5% VAT. MAIL ORDER ONLY.
Call now for our FREE CATALOGUE with details of over 300
high quality kits, projects, modules and publications.

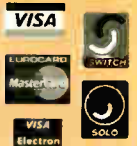

QUASAR 0871 CREDIT CARD SALES 717 7168
electronics

Helping you make the right connections!

PIC & ATMEL Programmers

We have a wide range of low cost PIC and ATMEL Programmers. Complete range and documentation available from our web site.

Programmer Accessories:

40-pin Wide ZIF socket (ZIF40W) £15.00
18VDC Power supply (PSU010) £19.95
Leads: Parallel (LDC136) £4.95 / Serial (LDC441) £4.95 / USB (LDC644) £2.95

NEW! USB 'All-Flash' PIC Programmer

USB PIC programmer for all 'Flash' devices. No external power supply making it truly portable. Supplied with box and Windows Software. ZIF Socket and USB Plug A-B lead not incl.



Kit Order Code: 3128KT – £34.95

Assembled Order Code: AS3128 – £44.95

Enhanced "PICALL" ISP PIC Programmer

Will program virtually ALL 8 to 40 pin PICs plus certain ATMEL AVR, SCENIX SX and EEPROM 24C devices. Also supports In System Programming (ISP) for PIC and ATMEL AVRs. Free software. Blank chip auto detect for super fast bulk programming. Requires a 40-pin wide ZIF socket (not included)

Assembled Order Code: AS3144 – £54.95

ATMEL 89xxx Programmer

Uses serial port and any standard terminal comms program. 4 LEDs display the status. ZIF sockets not included. Supply: 16VDC.



Kit Order Code: 3123KT – £29.95

Assembled Order Code: AS3123 – £34.95

NEW! USB & Serial Port PIC Programmer

USB/Serial connection. Header cable for ICSP. Free Windows software. See website for PICs supported. ZIF Socket and USB Plug A-B lead extra. 18VDC.

Kit Order Code: 3149KT – £34.95

Assembled Order Code: AS3149 – £49.95

Introduction to PIC Programming

Go from a complete PIC beginner to burning your first PIC and writing your own code in no time!

Includes a 49-page step-by-step Tutorial Manual,

Programming Hardware (with LED bench testing section), Win 3.11-XP Programming Software (will Program, Read, Verify & Erase), and a rewritable PIC16F84A that you can use with different code (4 detailed examples provided for you to learn from). Connects to PC parallel port.

Kit Order Code: 3081KT – £14.95

Assembled Order Code: AS3081 – £24.95



ABC Maxi AVR Development Board

The ABC Maxi board has an open architecture design based on Atmel's AVR AT90S8535 RISC microcontroller and is ideal for developing new designs.

Features:

8Kb of In-System Programmable Flash (1000 write/erase cycles) • 512 bytes internal SRAM • 512 bytes EEPROM
• 8 analogue inputs (range 0-5V)
• 4 Opto-isolated Inputs (I/Os are bi-directional with internal pull-up resistors)
• Output buffers can sink 20mA current (direct i.e.d. drive) • 4 x 12A open drain MOSFET outputs • RS485 network connector • 2-16 LCD Connector
• 3.5mm Speaker Phone Jack
• Supply: 9-12VDC.

The ABC Maxi STARTER PACK includes one assembled Maxi Board, parallel and serial cables, and Windows software CD-ROM featuring an Assembler, BASIC compiler and in-system programmer.

Order Code ABCMAXISP – £79.95

The ABC Maxi boards only can also be purchased separately at £59.95 each.



NEW! DTMF Telephone Relay Switcher

Call your phone number using a DTMF phone from anywhere in the world and remotely turn on/off any of the 4 relays as desired. User settable Security Password, Anti-Tamper, Rings to Answer, Auto Hang-up and Lockout. Includes plastic case. 130 x 110 x 30mm. Power: 12VDC.

Kit Order Code: 3140KT – £39.95

Assembled Order Code: AS3140 – £49.95



Serial Port Isolated I/O Module



Computer controlled 8-channel relay board. 5A mains rated relay outputs and 4 opto-isolated digital inputs (for monitoring switch

states, etc). Useful in a variety of control and sensing applications. Programmed via serial port (use our new Windows interface, terminal emulator or batch files). Serial cable can be up to 35m long. Includes plastic case 130 x 100 x 30mm. Power: 12VDC/500mA.

Kit Order Code: 3108KT – £54.95

Assembled Order Code: AS3108 – £64.95

Controllers & Loggers

Here are just a few of the controller and data acquisition and control units we have. See website for full details. Suitable PSU for all units: Order Code PSU445 – £8.95

Rolling Code 4-Channel UHF Remote

State-of-the-Art. High security.

4 channels. Momentary or latching relay output. Range up to 40m. Up to 15 TXs can be learned by one Rx (kit includes one Tx but more available separately). 4 indicator LEDs.

Rx: PCB 77x85mm, 12VDC/6mA (standby).

Two & Ten Channel versions also available.

Kit Order Code: 3180KIT – £41.95

Assembled Order Code: AS3180 – £49.95



Computer Temperature Data Logger

Serial port 4-channel temperature logger. °C or °F. Continuously logs up to 4 separate sensors located 200m+ from board. Wide range of free software applications for storing/using data. PCB just 38x38mm. Powered

by PC. Includes one DS1820 sensor and four header cables.

Kit Order Code: 3145KT – £19.95

Assembled Order Code: AS3145 – £26.95

Additional DS1820 Sensors – £3.95 each



Infra-red RC 12-Channel Relay Board



Control 12 on-board relays with included infra-red remote control unit. Toggle or momentary. 15m+ range. 112 x 122mm.

Supply: 12VDC/0.5A.

Kit Order Code: 3142KT – £41.95

Assembled Order Code: AS3142 – £51.95

PC Data Acquisition & Control Unit

Monitor and log a mixture of analogue and digital inputs and control external devices via the analogue and digital

outputs. Monitor pressure, temperature, light intensity, weight, switch state, movement, relays, etc. with the appropriate sensors (not supplied). Data can be processed, stored and the results used to control devices such as motors, sirens, relays, servo motors (up to 11) and two stepper motors.

Features

- 11 Analogue Inputs – 0-5V, 10 bit (5mV/step)
- 16 Digital Inputs – 20V max. Protection 1K in series, 5-1V Zener
- 1 Analogue Output – 0-2.5V or 0-10V, 8 bit (20mV/step)
- 8 Digital Outputs – Open collector, 500mA, 33V max
- Custom box (140 x 110 x 35mm) with printed front & rear panels
- Windows software utilities (3.1 to XP) and programming examples
- Supply: 12V DC (Order Code PSU203)

Kit Order Code: 3093KT – £69.95

Assembled Order Code: AS3093 – £99.95



Most items are available in kit form (KT suffix) or pre-assembled and ready for use (AS prefix).

Hot New Kits This Summer!

Here are a few of the most recent kits added to our range. See website or join our email Newsletter for all the latest news.

NEW! EPE Ultrasonic Wind Speed Meter

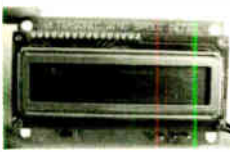

Solid-state design wind speed meter (anemometer) that uses ultrasonic techniques and has no moving parts and does not need

calibrating. It is intended for sports-type activities, such as track events, sailing, hang-gliding, kites and model aircraft flying, to name but a few. It can even be used to monitor conditions in your garden. The probe is pointed in the direction from which the wind is blowing and the speed is displayed on an LCD display.

Specifications

- Units of display: metres per second, feet per second, kilometres per hour and miles per hour
- Resolution: Nearest tenth of a metre
- Range: Zero to 50mph approx.

Based on the project published in *Everyday Practical Electronics*, Jan 2003. We have made a few minor design changes (see website for full details). Power: 9VDC (PP3 battery or Order Code PSU345).

Main PCB: 50 x 83mm.
Kit Order Code: 3168KT – £34.95

NEW! Audio DTMF Decoder and Display



Detects DTMF tones via an on-board electret microphone or direct from the phone lines through the onboard audio transformer. The

numbers are displayed on a 16-character, single line display as they are received. Up to 32 numbers can be displayed by scrolling the display left and right. There is also a serial output for sending the detected tones to a PC via the serial port. The unit will not detect numbers dialled using pulse dialling. Circuit is microcontroller based.

Supply: 9-12V DC (Order Code PSU345).
Main PCB: 55 x 95mm.
Kit Order Code: 3153KT – £17.95
Assembled Order Code: AS3153 – £29.95

NEW! EPE PIC Controlled LED Flasher



This versatile PIC-based LED or filament bulb flasher can be used to flash from 1 to 160

LEDs. The user arranges the LEDs in any pattern they wish. The kit comes with 8 superbright red LEDs and 8 green LEDs. Based on the *Versatile PIC Flasher* by Steve Challinor, *EPE Magazine* Dec '02. See website for full details. Board Supply: 9-12V DC. LED supply: 9-45V DC (depending on number of LED used). PCB: 43 x 54mm.
Kit Order Code: 3169KT – £10.95

Most items are available in kit form (KT suffix) or assembled and ready for use (AS prefix)

FM Bugs & Transmitters

Our extensive range goes from discreet surveillance bugs to powerful FM broadcast transmitters. Here are a few examples. All can be received on a standard FM radio and have adjustable transmitting frequency.

MMTX' Micro-Miniature 9V FM Room Bug



Our best selling bug! Good performance. Just 25 x 15mm. Sold to detective agencies worldwide. Small enough to hide just about anywhere.

Operates at the 'less busy' top end of the commercial FM waveband and also up into the more private Air band. Range: 500m. Supply: PP3 battery.
Kit Order Code: 3051KT – £8.95
Assembled Order Code: AS3051 – £14.95

HPTX' High Power FM Room Bug

Our most powerful room bug.



Very impressive performance. Clear and stable output signal thanks to the extra circuitry employed. Range: 1000m @ 9V. Supply: 6-12V DC (9V PP3 battery clip supplied). 70 x 15mm.
Kit Order Code: 3032KT – £9.95
Assembled Order Code: AS3032 – £17.95

MTTX' Miniature Telephone Transmitter



Attach anywhere along phone line. Tune a radio into the signal and hear

exactly what both parties are saying. Transmits only when phone is used. Clear, stable signal. Powered from phone line so completely maintenance free once installed. Requires no aerial wire – uses phone line as antenna. Suitable for any phone system worldwide. Range: 300m. 20 x 45mm.
Kit Order Code: 3016KT – £7.95
Assembled Order Code: AS3016 – £13.95

3 Watt FM Transmitter



Small, powerful FM transmitter. Audio preamp stage and three RF stages deliver 3 watts of RF power. Can be used with the electret

microphone supplied or any line level audio source (e.g. CD or tape OUT, mixer, sound card, etc). Aerial can be an open dipole or Ground Plane. Ideal project for the novice wishing to get started in the fascinating world of FM broadcasting. 45 x 145mm.
Kit Order Code: 1028KT – £22.95
Assembled Order Code: AS1028 – £34.95

25 Watt FM Transmitter

Four transistor based stages with a Philips BLY89 (or equivalent) in the final stage. Delivers a mighty 25 Watts of RF power. Accepts any line level audio source (input sensitivity is adjustable). Antenna can be an open dipole, ground plane, 5/8, J, or YAGI configuration. Supply 12-14V DC, 5A. Supplied fully assembled and aligned – just connect the aerial, power and audio input. 70 x 220mm.
Order Code: 1031M – £124.95



QUASAR
electronics

Helping you make the right connections!

**CREDIT
CARD
SALES
0871
717
7168**

Electronic Project Labs

Great introduction to the world of electronics. Ideal gift for budding electronics expert!

500-in-1 Electronic Project Lab

This is the top of the range and is a complete electronics course taking you from beginner to 'A' level standard and beyond! It contains all the parts and instructions to assemble 500 projects. You get three comprehensive course books (total 368 pages) – *Hardware Entry Course*, *Hardware Advanced Course* and a micro-computer based *Software Programming Course*. Each book has individual circuit explanations, schematic and assembly diagrams. Suitable for age 12 and above.
Order Code EPL500 – £149.95
30, 130, 200 and 300-in-1 project labs also available – see website for details.



Number 1 for Kits!

With over 300 projects in our range we are the UK's number 1 electronic kit specialist. Here are a few other kits from our range.

- 1046KT – 25W Stereo Car Booster £29.95
- 3087KT – 1W Stereo Amplifier £4.95
- 3105KT – 18W BTL mono Amplifier £9.95
- 3106KT – 50W Mono Hi-fi Amplifier £19.95
- 3143KT – 10W Stereo Amplifier £10.95
- 1011-12KT – Motorbike Alarm £12.95
- 1019KT – Car Alarm System £11.95
- 1048KT – Electronic Thermostat £9.95
- 1080KT – Liquid Level Sensor £6.95
- 3003KT – LED Dice with Box £7.95
- 3006KT – LED Roulette Wheel £8.95
- 3074KT – 8-Ch PC Relay Board £29.95
- 3082KT – 2-Ch UHF Relay £26.95
- 3126KT – Sound-Activated Relay £7.95
- 3063KT – One Chip AM Radio £10.95
- 3102KT – 4-Ch Servo Motor Driver £15.95
- 3155KT – Stereo Tone Controls £8.95
- 1096KT – 3-30V, 5A Stabilised PSU £32.95
- 3029KT – Combination Lock £6.95
- 3049KT – Ultrasonic Detector £13.95
- 3130KT – Infra-red Security Beam £12.95
- SG01MKT – Train Sounds £6.95
- SG10 MKT – Animal Sounds £5.95
- 1131KT – Robot Voice Effect £9.95
- 3007KT – 3V FM Room Bug £6.95
- 3028KT – Voice-Activated FM Bug £12.95
- 3033KT – Telephone Recording Adpt £9.95
- 3112KT – PC Data Logger/Sampler £18.95
- 3118KT – 12-bit Data Acquisition Unit £52.95
- 3101KT – 20MHz Function Generator £69.95



www.quasarelectronics.com

Secure Online Ordering Facilities ● Full Product Listing, Descriptions & Photos ● Kit Documentation & Software Downloads

STORE YOUR BACK ISSUES ON MINI CD-ROMS



**VOL 11
NOW AVAILABLE**

**ONLY
£14.45** each
including VAT
and p&p

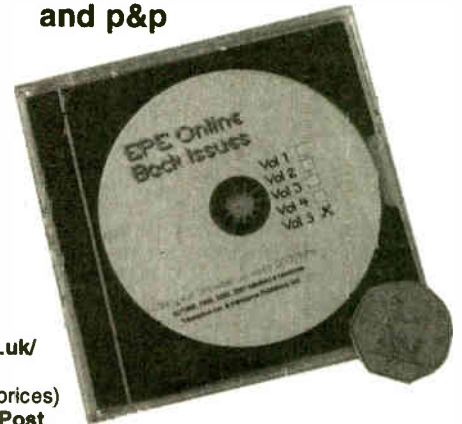

A great way to buy **EPE Back Issues** – our mini CD-ROMs contain back issues from our **EPE Online** website plus bonus articles, all the relevant PIC software and web links. Note: no free gifts are included. All this for just £14.45 each including postage and packing.

- VOL 1: BACK ISSUES** – January 1999 to June 1999
Plus some bonus material from Nov and Dec 1998
- VOL 2: BACK ISSUES** – July 1999 to December 1999
- VOL 3: BACK ISSUES** – January 2000 to June 2000
- VOL 4: BACK ISSUES** – July 2000 to December 2000
- VOL 5: BACK ISSUES** – January 2001 to June 2001
- VOL 6: BACK ISSUES** – July 2001 to December 2001
- VOL 7: BACK ISSUES** – January 2002 to June 2002
- VOL 8: BACK ISSUES** – July 2002 to December 2002
- VOL 9: BACK ISSUES** – January 2003 to June 2003
- VOL 10: BACK ISSUES** – July 2003 to December 2003
- VOL 11: BACK ISSUES** – January 2004 to June 2004

Order on-line from
[www.epemag.wimborne.co.uk/
shopdoor.htm](http://www.epemag.wimborne.co.uk/shopdoor.htm)
or www.epemag.com (USA \$ prices)
or by phone, Fax, E-mail or Post

NOTE: These mini CD-ROMs are suitable for use on any PC with a CD-ROM drive. They require Adobe Acrobat Reader (available free from the Internet – www.adobe.com/acrobat)

WHAT IS INCLUDED

All volumes include the **EPE Online** editorial content of every listed issue, plus all the available **PIC Project Codes** for the PIC projects published in those issues.

Note: Some supplements etc. can be downloaded free from the Library on the **EPE Online** website at www.epemag.com. No advertisements are included in Volumes 1 and 2; from Volume 5 onwards the available relevant software for **Interface** articles is also included.

EXTRA ARTICLES – ON ALL VOLUMES

BASIC SOLDERING GUIDE – Alan Winstanley's internationally acclaimed fully illustrated guide. **UNDERSTANDING PASSIVE COMPONENTS** – Introduction to the basic principles of passive components. **HOW TO USE INTELLIGENT L.C.D.s**, by Julian Ilett – An utterly practical guide to interfacing and programming intelligent liquid crystal display modules. **Phyzyb COMPUTERS BONUS ARTICLE 1** – Signed and Unsigned Binary Numbers. By Clive "Max" Maxfield and Alvin Brown. **Phyzyb COMPUTERS BONUS ARTICLE 2** – Creating an Event Counter. By Clive "Max" Maxfield and Alvin Brown. **INTERGRAPH COMPUTER SYSTEMS 3D GRAPHICS** – A chapter from Intergraph's book that explains computer graphics technology. **FROM RUSSIA WITH LOVE**, by Barry Fox – Russian rockets launching American Satellites. **PC ENGINES**, by Ernest Flint – The evolution of Intel's microprocessors. **THE END TO ALL DISEASE**, by Aubrey Scoon – The original work of Rife. **COLLECTING AND RESTORING VINTAGE RADIOS**, by Paul Stenning. **THE LIFE & WORKS OF KONRAD ZUSE** – a brilliant pioneer in the evolution of computers. A bonus article on his life and work written by his eldest son, including many previously unpublished photographs.

Note: Some of the **EXTRA ARTICLES** require WinZip to unzip them.

BACK ISSUES MINI CD-ROM ORDER FORM

- Please send me (quantity) BACK ISSUES CD-ROM VOL 1
- Please send me (quantity) BACK ISSUES CD-ROM VOL 2
- Please send me (quantity) BACK ISSUES CD-ROM VOL 3
- Please send me (quantity) BACK ISSUES CD-ROM VOL 4
- Please send me (quantity) BACK ISSUES CD-ROM VOL 5
- Please send me (quantity) BACK ISSUES CD-ROM VOL 6
- Please send me (quantity) BACK ISSUES CD-ROM VOL 7
- Please send me (quantity) BACK ISSUES CD-ROM VOL 8
- Please send me (quantity) BACK ISSUES CD-ROM VOL 9
- Please send me (quantity) BACK ISSUES CD-ROM VOL 10
- Please send me (quantity) BACK ISSUES CD-ROM VOL 11

Price **£14.45 each** – includes postage to anywhere in the world.

Name

Address

..... Post Code

I enclose cheque/P.O./bank draft to the value of £

Please charge my Visa/Mastercard/Amex/Diners Club/Maestro

£

Card No.

Card Security Code (The last 3 digits on or just under the signature strip)

Valid From Expiry Date

Maestro Issue No.

**SEND TO: Everyday Practical Electronics,
Wimborne Publishing Ltd.,
408 Wimborne Road East, Ferndown, Dorset BH22 9ND.
Tel: 01202 873872. Fax: 01202 874562.
E-mail: orders@epemag.wimborne.co.uk**

Payments must be by card or in £ Sterling – cheque or bank draft drawn on a UK bank.

Normally supplied within seven days of receipt of order.

We can supply back issues of *EPE* by post, most issues from the past three years are available. An *EPE* index for the last five years is also available at www.epemag.wimborne.co.uk or see order form below. Alternatively, indexes are published in the December issue for that year. Where we are unable to provide a back issue a photocopy of any *one article* (or *one part* of a series) can be purchased for the same price. Issues from Nov. 98 are available on CD-ROM – see next page – and issues from the last six months are also available to download from www.epemag.com. Please make sure all components are still available before commencing any project from a back-dated issue.

DID YOU MISS THESE?

OCT '03

PROJECTS ● RC Car Wars ● Serial Interface for PICs and VB6 ● Practical Radio Circuits-5 (Super Regen. Receiver) ● Spooky Bug.
FEATURES ● PIC Breakpoint ● Ingenuity Unlimited ● Interface ● Techno-Talk ● New Technology Update ● Net Work – The Internet Page.

NOV '03

PROJECTS ● PIC Random L.E.D. Flasher ● Cardboard Clock ● Practical Radio Circuits-6 (S.S.B. and Direct Conversion Receiver) ● Anyone At Home?
FEATURES ● Teach-In 2004 – Part 1 ● Ingenuity Unlimited ● Practically Speaking ● Techno Talk ● Circuit Surgery ● New Technology Update ● Net Work – The Internet Page.

DEC '03

PROJECTS ● PIC Nim Machine ● Practical Radio Circuits-7 (Superhet Tuner) ● PIC Virus Zapper Mk2 ● Christmas Cheeks.
FEATURES ● Teach-In 2004 – Part 2 ● Electrotherapy ● Circuit Surgery ● Ingenuity Unlimited ● Techno Talk ● High-Speed Decimal To Binary For PICs ● Interface ● Network – The Internet.



JAN '04

PROJECTS ● Car Computer ● Practical Radio Circuits-8 (Dual-Conversion SW Receiver) ● Bedside Nightlight ● PIC Watering Timer.
FEATURES ● GPS to PIC and PC Interface ● Practically Speaking ● Teach-In 2004 – Part 3 ● Ingenuity Unlimited ● Techno Talk ● Circuit Surgery ● New Technology Update ● Net Work – The Internet Page.

FEB '04

PROJECTS ● PIC LCF Meter ● Sonic Ice Warning ● Jazzy Necklace ● PIC Tug-of-War.
FEATURES ● Surface Mount Devices ● Circuit Surgery ● Teach-In 2004 – Part 4 ● Interface ● Ingenuity Unlimited ● Techno Talk ● Net Work – The Internet Page.

MAR '04

PROJECTS ● Bat-Band Converter ● Emergency Stand-by Light ● MIDI Health Check ● PIC Mixer for RC Planes.
FEATURES ● Teach-In 2004 – Part 5 ● New Scientist CD-Rom Review ● Circuit Surgery ● Techno Talk ● Ingenuity Unlimited ● Practically Speaking ● Net Work – The Internet Page.

APRIL '04

PROJECTS ● EPE Experimental Seismograph Logger 1 ● Infra-Guard Monitor ● Loft Light Alarm ● PIC Moon Clock.
FEATURES ● USB To PIC Interface ● Ingenuity Unlimited ● Teach-In 2004 Part 6 ● Interface ● Techno Talk ● Circuit Surgery ● New Technology Update ● Net Work – The Internet Page ● Pull-Out – Semiconductor Classification Data.

MAY '04

PROJECTS ● Beat Balance Metal Detector ● In-Car Laptop PSU ● Low-Frequency Wien Oscillator ● EPE Experimental Seismograph Logger-2.
FEATURES ● Coping With Lead-Free Solder ● Teach-In 2004 – Part 7 ● Ingenuity Unlimited ● Techno Talk ● Circuit Surgery ● Practically Speaking ● Pic-N'-Mix ● Net Work – The Internet Page.



JUNE '04

PROJECTS ● PIC Quickstep ● Crafty Cooling ● MIDI Synchronome ● Body Detector Mk2.
FEATURES ● Clinical Electrotherapy ● Ingenuity Unlimited ● Teach-In 2004 – Part 8 ● Interface ● Circuit Surgery ● Techno Talk ● PIC-N'-Mix ● Net Work – The Internet Page.

JULY '04

PROJECTS ● Portable Mini Alarm ● Bongo Box ● Hard Drive Warbler ● EPE PIC Magnetometry Logger-1.
FEATURES ● Making Front Panel Overlays ● Practically Speaking ● Teach-In 2004 – Part 9 ● Ingenuity Unlimited ● Circuit Surgery ● Techno Talk ● PIC-N'-Mix ● Net Work – The Internet Page.

AUG '04

PROJECTS ● EPE Scorer ● Keyring L.E.D. Torch ● Simple F.M. Radio ● EPE PIC Magnetometry Logger-2.
FEATURES ● PIC To Ps/2 Mouse and Keyboard Interfacing ● Techno Talk ● Circuit Surgery ● Teach-In 2004 – Part 10 ● Interface ● Ingenuity Unlimited ● PIC-N'-Mix ● Net Work – The Internet Page.

SEPT '04

PROJECTS ● EPE Wart Zapper ● Radio Control Failsafe ● Rainbow Lighting Control ● Alphamouse Game.
FEATURES ● Light Emitting Diodes – Part 1 ● High Speed Binary-To-Decimal For PICs ● Practically Speaking ● Ingenuity Unlimited ● Techno-Talk ● Circuit Surgery ● PIC-N'-Mix ● Network – The Internet Page

OCT '04

PROJECTS ● EPE Theremin ● Smart Karts – Part 1 ● Volts Checker ● Moon and Tide Clock Calendar.
FEATURES ● Light Emitting Diodes – 2 ● Circuit Surgery ● Interface ● Ingenuity Unlimited ● Techno Talk ● PIC-N'-Mix ● Network – The Internet Page ● ROBOTS – Special Supplement

NOV '04

PROJECTS ● Thunderstorm Monitor ● M.W. Amplitude Modulator ● Logic Probe ● Smart Karts - 2.
FEATURES ● Light Emitting Diodes-3 ● Floating Point Maths for PICs ● Ingenuity Unlimited ● PE 40th Anniversary ● Circuit Surgery ● Techno Talk ● PIC-N'-Mix ● Net Work – The Internet Page.



DEC '04

PROJECTS ● Super Vibration Switch ● Versatile PIC Flasher ● Wind Direction Indicator ● Smart Karts - 3.
FEATURES ● Light Emitting Diodes-4 ● Ingenuity Unlimited ● Circuit Surgery ● Interface ● PIC-N' Mix ● Techno Talk ● Net Work – The Internet Page ● INDEX Vol. 33.

JAN '05

PROJECTS ● Speed Camera Watch ● Gate Alarm ● Light Detector ● Smart Karts - 4.
FEATURES ● Practically Speaking ● 32-Bit Signed Integer Maths for PICs ● Ingenuity Unlimited ● Circuit Surgery ● Techno Talk ● PIC 'N' Mix ● Picoscope 3205 Review ● Net Work – The Internet Page

BACK ISSUES ONLY £3.50 each inc. UK p&p.

Overseas prices £4 each surface mail, £5.50 each airmail.

We can also supply issues from earlier years: 1999 (except Feb., May, Aug., Sept., Dec.), 2000 (except Feb., Mar., July, Oct.), 2001 (except May, Aug. to Nov.), 2002 (except Feb., June, Aug. to Nov.), 2003 (except June) Where we do not have an issue a photocopy of any *one article* or *one part* of a series can be provided at the same price.

ORDER FORM – BACK ISSUES – PHOTOCOPIES– INDEXES

- Send back issues dated
- Send photocopies of (article title and issue date)
- Send copies of last five years indexes (£3.50 for five inc. p&p – Overseas £4 surface, £5.50 airmail)

Name

Address

Tel:

I enclose cheque/P.O./bank draft to the value of £

Please charge my Visa/Mastercard/Amex/Diners Club/Switch £ Switch Issue No.

Card No.

Valid From Card Expiry Date Card Security Code

(The last 3 digits on or just under the signature strip)

SEND TO: Everyday Practical Electronics, Wimborne Publishing Ltd., 408 Wimborne Road East, Ferndown, Dorset BH22 9ND.

Tel: 01202 873872. Fax: 01202 874562.

E-mail: orders@epemag.wimborne.co.uk On-line Shop: www.epemag.wimborne.co.uk/shopdoor.htm

Payments must be in £ sterling – cheque or bank draft drawn on a UK bank. Normally supplied within seven days of receipt of order.

Send a copy of this form, or order by letter if you do not wish to cut your issue.

M02/05

MAIL ORDER ONLY • CALLERS BY APPOINTMENT

EPE PROJECT PICS

Programmed PICs for *EPE Projects

12C508/9 - £3.90; 16F627/8 - £4.90

16C84/16F84/16C71 - £5.90

16F876/877 - £10.00

All inc. VAT and Postage

(*Some projects are copyright)

EPE MICROCONTROLLER P.I. TREASURE HUNTER

The latest MAGENTA DESIGN - highly stable & sensitive - with I.C. control of all timing functions and advanced pulse separation techniques.

- High stability drift cancelling
- Easy to build & use
- No ground effect, works in seawater



- Detects gold, silver, ferrous & non-ferrous metals

- Efficient quartz controlled microcontroller pulse generation.
- Full kit with headphones & all hardware

KIT 847£63.95

PIC PIPE DESCALER

- SIMPLE TO BUILD
- HIGH POWER OUTPUT
- AUDIO & VISUAL MONITORING
- SWEPT FREQUENCY

An affordable circuit which sweeps the incoming water supply with variable frequency electromagnetic signals. May reduce scale formation, dissolve existing scale and improve lathering ability by altering the way salts in the water behave. Kit includes case, P.C.B., coupling coil and all components. High coil current ensures maximum effect. L.E.D. monitor.



KIT 868 £22.95 POWER UNIT.....£3.99

MICRO PEST SCARER

Our latest design - The ultimate scarer for the garden. Uses special microchip to give random delay and pulse time. Easy to build reliable circuit. Keeps pets/pests away from newly sown areas, play areas, etc. uses power source from 9 to 24 volts.

- RANDOM PULSES
- HIGH POWER
- DUAL OPTION



Plug-in power supply £4.99

KIT 867.....£19.99

KIT + SLAVE UNIT.....£32.50

WINDICATOR

A novel wind speed indicator with LED readout. Kit comes complete with sensor cups, and weatherproof sensing head. Mains power unit £5.99 extra.

KIT 856.....£28.00

★ TENS UNIT ★

DUAL OUTPUT TENS UNIT

As featured in March '97 issue.

Magenta have prepared a FULL KIT for this, excellent new project. All components, PCB, hardware and electrodes are included. Designed for simple assembly and testing and providing high level dual output drive.

KIT 866. . Full kit including four electrodes £32.90

Set of 4 spare electrodes £6.50

68000 DEVELOPMENT TRAINING KIT

- NEW PCB DESIGN
- 8MHz 68000 16-BIT BUS
- MANUAL AND SOFTWARE
- 2 SERIAL PORTS
- PIT AND I/O PORT OPTIONS
- 12C PORT OPTIONS

KIT 621

£99.95

- ON BOARD 5V REGULATOR
- PSU £6.99
- SERIAL LEAD £3.99

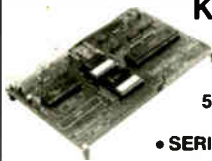

Stepping Motors

MD100...Std 100 step...£9.99

MD200...200 step...£12.99

MD24...Large 200 step...£22.95



MOSFET MKII VARIABLE BENCH POWER SUPPLY 0-25V 2.5A

Based on our Mk1 design and preserving all the features, but now with switching pre-regulator for much higher efficiency. Panel meters indicate Volts and Amps. Fully variable down to zero. Toroidal mains transformer. Kit includes punched and printed case and all parts. As featured in April 1994 EPE. An essential piece of equipment.



Kit No. 845£64.95

ULTRASONIC PEST SCARER

Keep pets/pests away from newly sown areas, fruit, vegetable and flower beds, children's play areas, patios etc. This project produces intense pulses of ultrasound which deter visiting animals.

- KIT INCLUDES ALL COMPONENTS, PCB & CASE
- EFFICIENT 100V TRANSDUCER OUTPUT
- COMPLETELY INAUDIBLE TO HUMANS
- UP TO 4 METRES RANGE
- LOW CURRENT DRAIN



KIT 812.....£15.00

EPE TEACH-IN 2000

Full set of top quality NEW components for this educational series. All parts as specified by EPE. Kit includes breadboard, wire, croc clips, pins and all components for experiments, as listed in introduction to Part 1.

*Batteries and tools not included.

TEACH-IN 2000 -

KIT 879 £44.95

MULTIMETER £14.45

SPACEWRITER

An innovative and exciting project. Wave the wand through the air and your message appears. Programmable to hold any message up to 16 digits long. Comes pre-loaded with "MERRY XMAS". Kit includes PCB, all components & tube plus instructions for message loading.

KIT 849£16.99

12V EPROM ERASER

A safe low cost eraser for up to 4 EPROMS at a time in less than 20 minutes. Operates from a 12V supply (400mA). Used extensively for mobile work - updating equipment in the field etc. Also in educational situations where mains supplies are not allowed. Safety interlock prevents contact with UV.

KIT 790£29.90

SUPER BAT DETECTOR

1 WATT O/P, BUILT IN SPEAKER, COMPACT CASE 20kHz-140kHz NEW DESIGN WITH 40kHz MIC.

A new circuit using a 'full-bridge' audio amplifier i.c., internal speaker, and headphone/tape socket. The latest sensitive transducer, and 'double balanced mixer' give a stable, high performance superheterodyne design.



KIT 861£34.99

ALSO AVAILABLE Built & Tested... £48.99

SIMPLE PIC PROGRAMMER

KIT 857... £12.99

Includes PIC16F84 chip disk, lead, plug, p.c.b., all components and instructions

Extra 16F84 chips £3.84 Power Supply £3.99

PIC LCD DISPLAY DRIVER

16 Character x 2 Line display, pcb, programmed PIC16F84, software disk and all components to experiment with standard intelligent alphanumeric displays. Includes full PIC source code which can be changed to match your application.

KIT 860.....£19.99

- Learn how to drive the display and write your own code.
- Ideal development base for meters, calculators, counters, timers --- just waiting for your application!
- Top quality display with industry standard driver, data and instructions**

PIC STEPPING MOTOR DRIVER

PCB with components and PIC16F84 programmed with demonstration software to drive any 4 phase unipolar motor up to 24 Volts at 1 Amp. **Kit includes 100 Step Hybrid Stepping Motor**. Full software source code supplied on disc.

Use this project to develop your own applications. PCB allows simple PIC programmer 'SEND' software to be used to reprogram chip.

KIT 863.....£18.99

8 CHANNEL DATA LOGGER

From Aug/Sept '99 EPE. Featuring 8 analogue inputs and serial data transfer to PC. Magenta redesigned PCB - LCD plugs directly onto board. Use as Data Logger or as a test bed for developing other PIC16F877 projects. Kit includes lcd prog. chip, PCB, Case, all parts and 8 x 256k EEPROMs

KIT 877.....£49.95

PIC16F84 MAINS POWER CONTROLLER & 4 CHANNEL LIGHT CHASER / DIMMER

- Zero Volt Switching
- Opto-Isolated 5 Amp HARD FIRED TRIACS
- 12 Way keypad Control
- With program source code disk.
- Chase Speed and dimming potentiometer controls.
- Reprogram for other applications

KIT 855.....£39.95

PIC TUTOR 1 EPE MARCH APRIL MAY '98 PIC16F84 STARTER SERIES

The original PIC16F84 series by John Becker. Magenta's Tutor board has individual switches and leds on all portA and PortB lines, plus connectors for optional 4 digit seven segment led display, and 16 x 2 intelligent lcd. Written for newcomers to PICs this series. Disk has over 20 tutorial programs. Connect to a PC parallel port, send, run, and experiment by modifying test programs - *Then Write and Program your Own*

KIT 870... £27.95, Built...£42.95

16x2 LCD..£7.99. LED display..£6.99. 12VPSU..£3.99

SUPER PIC PROGRAMMER

Magenta's original parallel port programmer. Complete with WINDOWS 95 - 2K software. Use standard Microchip .HEX files. Includes Disassembler. Read/Prog/Verify 18,28, and 40 pin PICs. 16F84/876/877, 627/8, + 16xx OTPs.

KIT 862... £29.99 Power Supply £3.99

ICEBREAKER

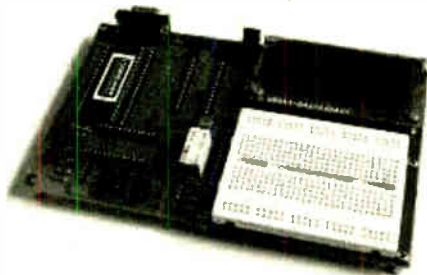

PIC Real Time In-Circuit Emulator

- ICEbreaker uses PIC16F877 in-circuit debugger.
- Links to standard PC: Serial port (lead supplied).
- Windows (95 to XP) Software included
- Works with MPASM assembler
- 16 x 2 LCD display, Breadboard, Relay, I/O devices and patch leads.

Featured in EPE Mar'00 Ideal for beginners & experienced users.

Programs can be written, downloaded, and then tested by single-stepping, running to breakpoints, or free run at up to 20Mhz.

Full emulation means that all ports respond immediately - reading and driving external hardware.

Features include: Ruri; set Breakpoint; View & change registers, EEPROM, and program memory; load program; 'watch window' registers.

KIT 900...£34.99 With serial lead & software disk, PCB, Breadboard, PIC16F877, LCD, all components and patch leads.

POWER SUPPLY - £3.99 STEPPING MOTOR 100 Step £9.99

Introducing: BrainiBorg!

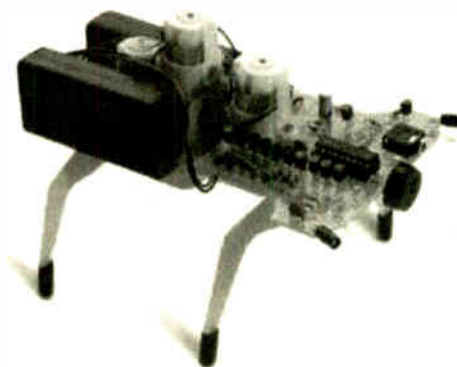

A super walking programmable robot with eyes that sense obstacles and daylight: **BrainiBorg** comes with superb PC software CD (WIN95+ & XP) and can be programmed to walk and respond to light and obstacles on any smooth surface.

CD contains illustrated constructional details, operating principles, circuits and a superb Educational Programming Tutorial.

Test routines give real-time 'scope traces of sensor and motor signals. Connects to PC via SERIAL port with the lead supplied.

Kit includes all hardware, components, 3 motor/gearboxes. Uses 4 AA batteries (not supplied). *An Ideal Present!*

KIT 912 Complete Kit with CD rom & serial lead **£49.99**

KIT 913 As 912 but built & tested circuit board **£58.95**

EPE PIC Tutorial

EPE Apr/May/Jun '03 and PIC Resources CD

- Follow John Becker's excellent PIC toolkit 3 series.
- Magenta Designed Toolkit 3 board with printed component layout, green solder mask, places for 8, 18, 28 (wide and slim), and 40 pin PICs. and Magenta extras.
- 16 x 2 LCD, PIC chip all components and sockets included.

KIT 880 (with 16F84) **£34.99**, built & tested **£49.99**

KIT 880 (with 16F877) **£39.99**, built & tested **£55.99**

EPE TEACH-IN 2004

THE LATEST NOV 03 SERIES *Additional Parts* as listed in 'misc.' Section (less RF modules, Lock, and Motor/g.box) Inc. Breadboard, and wire, as listed on p752 Nov. Issue.

Reprints: **£1.00 per part.**

KIT 920.....£29.99 **KIT921.....£12.99**

MAGENTA BRAINIBOT I & II

- Full kit with ALL hardware and electronics.
- As featured in EPE Feb '03 (KIT 910)
- Seeks light, beeps, and avoids obstacles
- Spins and reverses when "cornered"
- Uses 8 pin PIC chip
- ALSO KIT 911 - As 910 PLUS programmable from PC serial port leads and software CD included.



KIT 910....£16.99 **KIT 911....£24.99**

MAGENTA

All prices include VAT. Add £3.00 p&p. Next day **£6.99**

Tel: 01283 565435 Fax: 01283 546932 email: sales@magenta2000.co.uk

022005



Station Road, Cullercoats, Tyne & Wear, NE30 4PQ

Prices Exclude Vat @17.5%. UK Carriage £2.50 (less than 1kg) £5.50 greater than 1kg Cheques / Postal orders payable to ESR Electronic Components.

PLEASE ADD CARRIAGE & VAT TO ALL ORDERS



See Next / Last Months Ad. for COMPONENT ACCESSORIES

Table listing electronic components such as 4000 Series resistors, 74HC series logic chips, and RAM modules with their respective part numbers and prices.

Table listing electronic components including A/D Converters, Bridge Rectifiers, uControllers, PIC Series, Voltage Regulators, Thyristors, Diodes, Transistors, and Diac components.

Table listing electronic components including Ceramic Mini Disc capacitors, Mylar Film capacitors, Resistor networks, Preset Resistors, and Potentiometers.

Table listing electronic components including various types of capacitors (Ceramic, Mylar, Film) and their specifications.

Table listing electronic components including various types of capacitors (Ceramic, Mylar, Film) and their specifications.

Table listing electronic components including various types of capacitors (Ceramic, Mylar, Film) and their specifications.

Table listing electronic components including various types of capacitors (Ceramic, Mylar, Film) and their specifications.

Quality Components No surplus or redundant stock. All from leading manufacturers.

Quality Service Sameday despatch on all stock items. Friendly helpful staff.

Fast Delivery Nextday service for all small (<1kg) orders at no extra charge. 3 day service for orders >1kg

No Minimum Order what you need, no pack quantities or min order value.

Quantity Discounts Available We offer discounts for all items subject to quantity required, phone, fax or email for a quote.

New Catalogue Out Now Free with all orders or via the internet. New Switch Section

Tel: 0191 2514363 Fax: 0191 2522296 Email: sales@esr.co.uk http://www.esr.co.uk

EVERYDAY PRACTICAL ELECTRONICS

THE No.1 MAGAZINE FOR ELECTRONICS TECHNOLOGY & COMPUTER PROJECTS

VOL. 34 No. 2 FEBRUARY 2005

Editorial Offices:

EVERYDAY PRACTICAL ELECTRONICS EDITORIAL
WIMBORNE PUBLISHING LTD., 408 WIMBORNE ROAD EAST,
FERNDOWN, DORSET BH22 9ND
Phone: (01202) 873872. Fax: (01202) 874562.

Email: enquiries@epemag.wimbome.co.uk

Web Site: www.epemag.co.uk

EPE Online (downloadable version of EPE): www.epemag.com

EPE Online Shop: www.epemag.wimbome.co.uk/shopdoor.htm

See notes on Readers' Technical Enquiries below – we regret lengthy technical enquiries cannot be answered over the telephone.

Advertisement Offices:

EVERYDAY PRACTICAL ELECTRONICS ADVERTISEMENTS
MILL LODGE, MILL LANE
THORPE-LE-SOKEN, ESSEX CO16 0ED
Phone/Fax: (01255) 861161 Email: epeads@aol.com

Historic Bunkum

The more we investigate the past the more we realize that much of the history of technology that has been popularly accepted over the last 100 years or so is actually pure bunkum! Take for instance the invention of the transistor by Bell Labs in 1947 – they in fact repeated existing technology – see Andy Emmerson's *Who Really Invented The Transistor* article published in our January 2003 issue. Or the "invention" of radio by Marconi when in fact Tesla had demonstrated remote control by radio in 1893. See the article *Nikola Tesla – Overlooked Radio Pioneer* by Lorin Knight G2DXX in our sister publication *Radio Bygones* in the August/September 2002 issue.

Maybe you thought Edison invented the voice recording system in 1877 – not so, a French scientist called Leon Scott invented a recording machine twenty years earlier. See Andrew Emmerson's reply to a letter from a reader in the USA in this issue.

In the past we have also looked at the "invention" of the computer and at present our article on *The Life And Works of Conrad Zuse* (available as an extra on our Back Issue CDROMs) perhaps describes the earliest working computer – unless of course you know different?

Putting It Right

Suffice to say that we are always keen to update the record on such inventions – I was going to use the term "set the record straight" but who knows if what I have indicated above are the final definitive versions of events? Time will tell if further previous "inventions" come to light.

How we get such information into mainstream teaching, public awareness and update the history books and encyclopedias is, of course, another challenge. But the more people we tell the better chance we have. So next time you find a quiz answer or book reference with the "wrong" answer why not take the trouble to inform the perpetrators that, whilst their answer conforms to popular belief, it is in fact basically incorrect.

We live and learn!

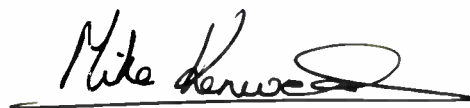

AVAILABILITY

Copies of *EPE* are available on subscription anywhere in the world (see opposite), from all UK newsagents (distributed by COMAG) and from the following electronic component retailers: Omni Electronics and Yebo Electronics (S. Africa). *EPE* can also be purchased from retail magazine outlets around the world. An Internet on-line version can be purchased and downloaded for just \$10.99US (approx £7) per year available from www.epemag.com

SUBSCRIPTIONS

Subscriptions for delivery direct to any address in the UK: 6 months £16.50, 12 months £31, two years £57; Overseas: 6 months £19.50 standard air service or £28.50 express airmail, 12 months £37 standard air service or £55 express airmail, 24 months £69 standard air service or £105 express airmail. To subscribe from the USA or Canada see the last magazine page. Online subscriptions, for downloading the magazine via the Internet, \$10.99US (approx £7) for one year available from www.epemag.com.

Cheques or bank drafts (in £ sterling only) payable to Everyday Practical Electronics and sent to EPE Subs. Dept., Wimborne Publishing Ltd, 408 Wimborne Road East, Ferndown, Dorset BH22 9ND. Tel: 01202 873872. Fax 01202 874562. Email: subs@epemag.wimbome.co.uk. Also via the Web at: <http://www.epemag.wimbome.co.uk>. Subscriptions start with the next available issue. We accept MasterCard, Amex, Diners Club, Maestro or Visa. (For past issues see the *Back Issues* page.)

BINDERS

Binders to hold one volume (12 issues) are available from the above address. These are finished in blue p.v.c., printed with the magazine logo in gold on the spine. Price £6.95 plus £3.50 p&p (for overseas readers the postage is £6.00 to everywhere except Australia and Papua New Guinea which cost £10.50). Normally sent within seven days but please allow 28 days for delivery – more for overseas.

Payment in £ sterling only please. Visa, Amex, Diners Club, Maestro and MasterCard accepted. Send, fax or phone your card number, card expiry date and card security code (the last 3 digits on or just under the signature strip), with your name, address etc. Or order on our secure server via our UK web site. Overseas customers – your credit card will be charged by the card provider in your local currency at the existing exchange rate.



Editor: MIKE KENWARD

Deputy Editor: DAVID BARRINGTON

Technical Editor: JOHN BECKER

Business Manager: DAVID J. LEAVER

Subscriptions: MARILYN GOLDBERG

Administration: FAY KENWARD

Editorial/Admin: (01202) 873872

Advertisement Manager:

PETER J. MEW, (01255) 861161

On-Line Editor: ALAN WINSTANLEY

EPE Online (Internet version) Editors:

CLIVE (MAX) MAXFIELD and ALVIN BROWN

READERS' TECHNICAL ENQUIRIES

E-mail: techdept@epemag.wimbome.co.uk

We are unable to offer any advice on the use, purchase, repair or modification of commercial equipment or the incorporation or modification of designs published in the magazine. We regret that we cannot provide data or answer queries on articles or projects that are more than five years old. Letters requiring a personal reply *must* be accompanied by a **stamped self-addressed envelope or a self-addressed envelope and international reply coupons.**

PROJECTS AND CIRCUITS

All reasonable precautions are taken to ensure that the advice and data given to readers is reliable. We cannot, however, guarantee it and we cannot accept legal responsibility for it.

A number of projects and circuits published in *EPE* employ voltages than can be lethal. You should not build, test, modify or renovate any item of mains powered equipment unless you fully understand the safety aspects involved and you use an RCD adaptor.

COMPONENT SUPPLIES

We do not supply electronic components or kits for building the projects featured, these can be supplied by advertisers (see *Shoptalk*). We advise readers to check that all parts are still available before commencing any project in a back-dated issue.

ADVERTISEMENTS

Although the proprietors and staff of EVERYDAY PRACTICAL ELECTRONICS take reasonable precautions to protect the interests of readers by ensuring as far as practicable that advertisements are *bona fide*, the magazine and its Publishers cannot give any undertakings in respect of statements or claims made by advertisers, whether these advertisements are printed as part of the magazine, or in inserts.

The Publishers regret that under no circumstances will the magazine accept liability for non-receipt of goods ordered, or for late delivery, or for faults in manufacture.

TRANSMITTERS/BUGS/TELEPHONE EQUIPMENT

We advise readers that certain items of radio transmitting and telephone equipment which may be advertised in our pages cannot be legally used in the UK. Readers should check the law before buying any transmitting or telephone equipment as a fine, confiscation of equipment and/or imprisonment can result from illegal use or ownership. The laws vary from country to country; readers should check local laws.

PIC Electric MK2



John Becker - Part 1

Monitor the cost of running your mains electrical appliances

PIC-ELECTRIC Mk2 is a considerably more sophisticated version of a design published in *EPE* about nine years ago. Whereas the original basically monitored the cost of running a single mains a.c. electrical appliance in real-time, the Mk2 provides data logging facilities for two appliances, each independently connected to its own logging path. It has the features shown in the panel opposite.

It must be noted that this design should only be built by those who are suitably qualified or supervised. Mains electricity can kill!

Current Sensors

As with the original *PIC-Electric*, Hall Effect current transducers are used in this design, notated as X1 and X2 in Fig.1 (you may omit X2 if you do not want two channels). With these transducers, alternating current (a.c.) measurement is carried out by measuring the magnetic field that is generated by a current-carrying conductor. The schematic drawing illustrating the principle is shown in Fig.2.

Features

- PIC16F876 microcontrolled
- 230V/110V 50Hz/60Hz compatible
- 2-channel monitoring – second channel optional
- L.C.D. display of real-time values for:
Mains a.c. voltage, up to 250V a.c., including 110V a.c.
Appliance load current, up to 25A per channel
Appliance power consumption, up to 6kW per channel
Cumulative cost since start of monitoring, to 999.99 units
User selected cost per kWh value, any decimal currency
Elapsed time since unit's power-up
- Optional on-board serial logging memory for:
Mains a.c. voltage
Appliance load current, 2 channels
- Logging capacity approximately 68 hours at 1-minute sampling rate
- Cyclic recording, 0 to maximum memory, roll-over to 0, continue, etc
- Output of recorded data to PC-compatible computer, Windows 95 upwards
- Specially written PC program for data storage to disk for subsequent display and analysis
- Stand-alone program, written in Visual Basic 6, but does not need VB6 to be installed on PC
- Data files compatible with Windows Excel graphing and analysis software

Basically, the device consists of a ferro-magnetic former around which are wound two coils. The primary coil is tapped and the number of turns through which the current flows can be selected according to the maximum current to be monitored. In PIC-Electric Mk2, the primary winding is connected so that

only one coil turn is used, allowing a theoretical maximum of 25A to be drawn through the sensor.

Within the gap between the legs of the magnetic former is a Hall Effect semiconductor device. This is placed at right angles to the magnetic field generated by current passing through the primary coil. The resulting voltage generated across the semiconductor is linearly proportional to the magnetic field, and hence to the current flowing in the circuit.

The device can be used to measure alternating or direct currents (a.c. or d.c.). Its output does not depend on a changing magnetic field, only on the instantaneous strength of the field. The bandwidth of the device is from d.c. to 150kHz.

The voltage generated across the semiconductor is processed by an internal amplifier and fed through the secondary winding of the transducer, generating an output current. An output current of 25mA is generated by a 25A primary current flowing through the sensor, to within $\pm 0.6\%$. By feeding the current through a known-value resistor, typically 100 Ω to



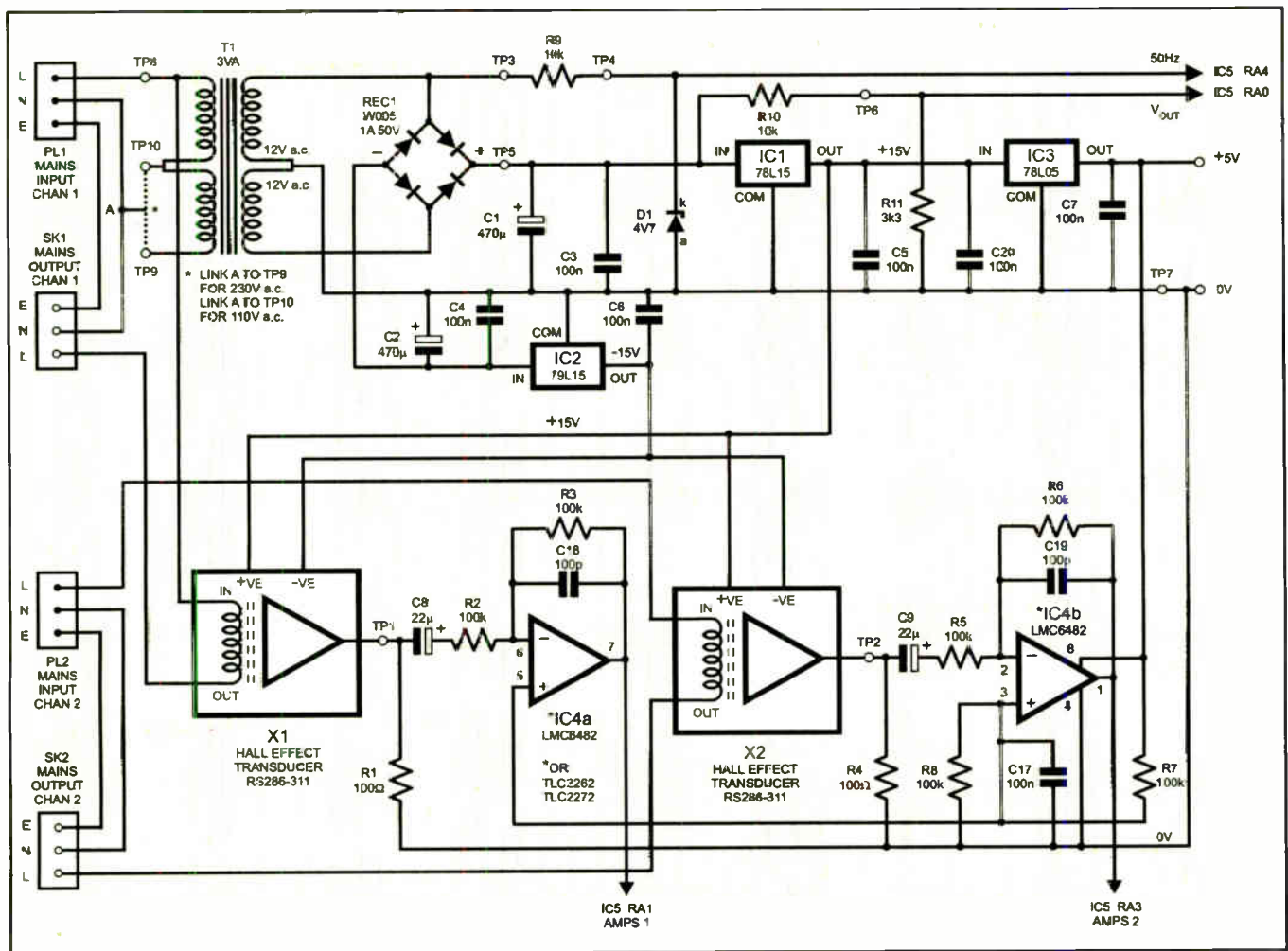

Fig.1. Circuit diagram for the PIC Electric Mk2 power supply and current sensors.

190Ω, the current can be converted to an equivalent output voltage.

When connected for 25A maximum current, the resistance of the primary coil is only 0.3 milliohms, and so imposes very little insertion loss between the mains power source and the appliance being monitored. The isolation between the primary coil and the sensor's output is 2.5kV r.m.s. at 50Hz for one minute.

The sensor also requires a dual d.c. supply voltage of ±15V, consuming about 10mA, plus the output current.

Power Supply

Referring to Fig.1, mains a.c. electrical power is brought into the circuit via a standard mains plug and cable.

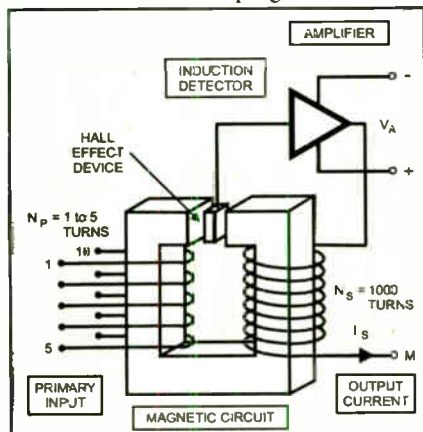

Fig.2. Hall effect current sensor and transducer functional diagram.

Initially it powers transformer T1, and may be 230V a.c. or 110V a.c., depending on which primary windings of the transformer are used. The twin secondary windings each output a nominal 12V a.c. This is bridge rectified by REC1 to provide a dual-rail supply of about ±18V d.c.

Capacitor C1 smooths the positive rail voltage, which is then regulated down to +15V by IC1. The negative rail is smoothed by C2 and regulated down to -15V by IC2. This ±15V supply is required to power the current sensors, X1 and X2. Capacitors C3 to C6 help to maintain the "quietness" of the supply rails.

The nominal 12V a.c. output on one secondary winding is also attenuated by resistor R9 and Zener diode D1 to provide a 0V to 4.7V peak-to-peak output signal. This is used as a synchronisation signal by the control circuit (Fig.3, IC5 pin RA4).

From capacitor C1, the rectified but unregulated voltage is also fed to the potential divider formed by resistors R10 and R11. The d.c. voltage at their junction is that used by the controller to assess the equivalent mains a.c. voltage (via IC5 pin RA0) – any change in the latter will cause an equivalent change in the rectified voltage.

The +15V output from IC1 is regulated down to +5V by IC3 for use by the control circuit, with decoupling provided by capacitors C7 and C6.

Sensing Circuits

The two mains a.c. live (L) lines are fed to the inputs of the two transducers, X1 and X2. Their outputs are connected separately to the live terminal of the appliances being monitored, via connectors SK1 and SK2 respectively.

Taking sensor X1 as the example, current drawn by the appliance causes an output current to flow from the sensor's output, as described above. Resistor R1 provides the load across which the equivalent sensor output voltage is generated. The maximum a.c. voltage that can be developed here is approximately ±2.5V for a 25A appliance current.

Because the PIC operates from a 0V/5V supply, the a.c. voltage from the sensor, which swings above and below 0V, is capacitively coupled to the op.amp stage around IC4a. A rail-to-rail op.amp is used, powered from the -5V supply line. In the presence of an output signal from the sensor, the op.amp's output swings above and below the midway level of 2.5V, as set by resistors R7 and R8. As discussed presently, the upper and lower peaks of the waveform are synchronously monitored for amplitude by the PIC.

Sensor channel two, comprising X1 and IC4b, functions in the same way as channel one.

Control Circuit

The main control circuit is shown in Fig.3. At its heart is the PIC16F876 microcontroller IC5, which is operated

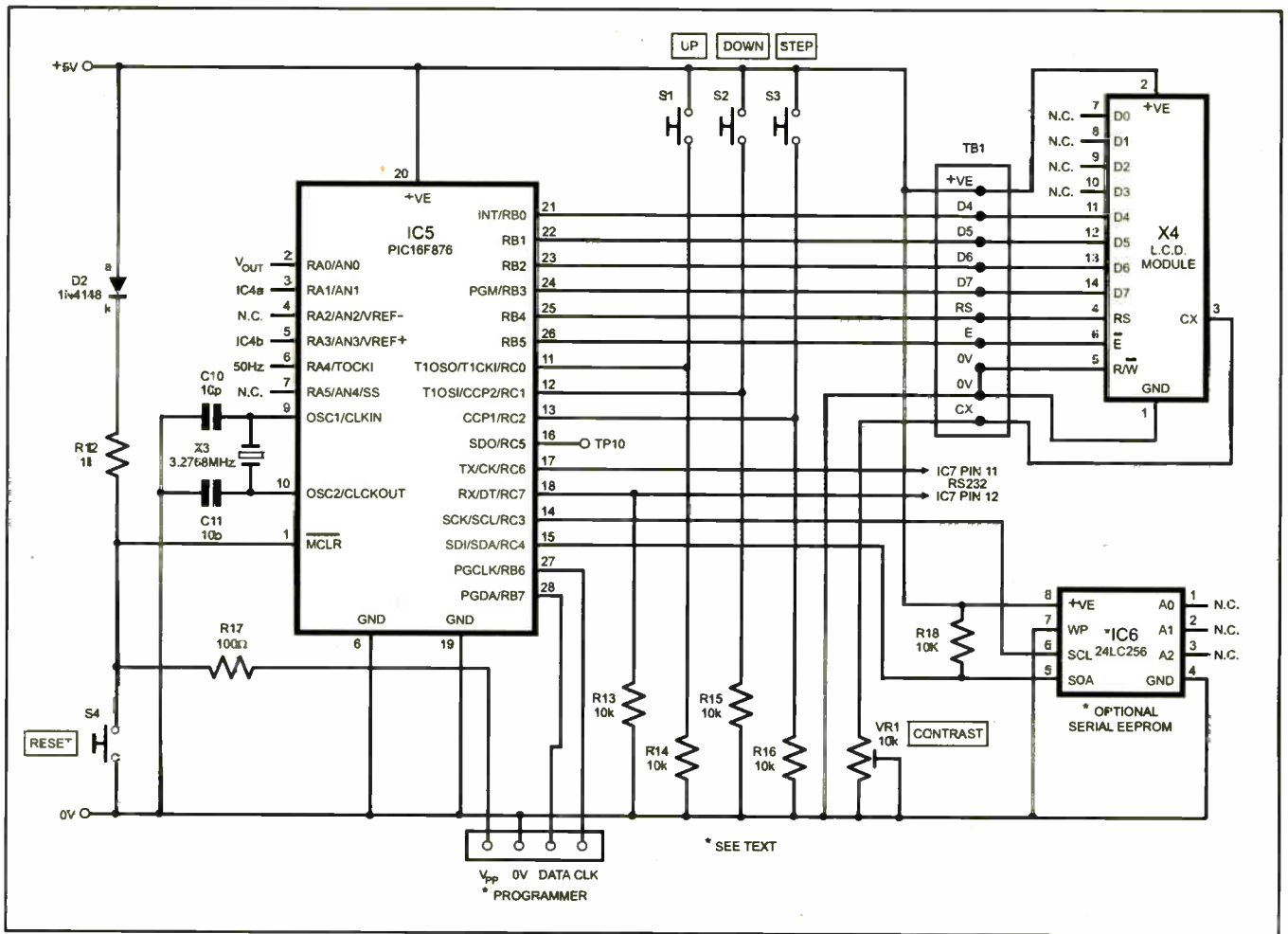

Fig.3. Main control diagram for PIC Electric Mk2.

at 3.2768MHz as set by crystal X3. Via Port B, the PIC controls the 2-line by 16 characters per line alphanumeric liquid crystal display (l.c.d.) X4, which is used in standard 4-bit mode. Its screen contrast is set by preset VR1. The switches, S1 to S4, will be discussed at relevant points later in the text.

PIC pins RA0, RA1 and RA3 are used in analogue-to-digital conversion (ADC) input mode. Pin RA4 is used as a Schmitt trigger digital input, into which is fed the 50Hz (or 60Hz) mains frequency signal via R9/D1 in Fig.1.

The rising edges of the mains frequency waveform trigger a clock counter. Every one second (50 or 60 pulses, depending on mains frequency) a clock counter (hours, minutes, seconds) is updated. At this point the PIC synchronously reads the analogue voltage levels on the three allocated inputs, converting each to a 10-bit digital value. The value on RA0 represents the equivalent voltage present at the mains supply. The values on RA1 and RA3 respectively represent the appliance current detected by the sensors.

At this moment, however, these values are just numbers as generated by the PIC's ADC conversion. Correction factors are then applied which convert the numbers to meaningful voltage and current values.

The three resulting values are then further processed to establish the wattage values that the current and voltage readings represent. From this value a cost factor in relation to the wattage is calculated, according to the value previously entered via switches into the PIC's non-volatile memory (EEPROM - electrically

erasable read-only memory). This value is the cost per kilowatt-hour (kWh) as charged by your local electrical supply company.

These results are then processed in relation to the elapsed time (from the clock counter) since the unit was connected to the mains power, and "running cost" totals determined.

Results are output to the l.c.d., which is used in 2-screen mode, i.e. there are two display screens available for viewing, as selected by switch S3.

The first screen displays both appliance current values at the left, channel 1 on line 1, channel 2 on line 2, each suffixed with "A" for amps. Both values are followed by the prevailing wattage values, suffixed with "W". At the top right of line 1 is shown the present equivalent a.c. mains voltage value and below it the letter "V".

Screen 2 displays the real-time running cost for each channel, respectively on lines 1 and 2. At the right of line 2 is shown the elapsed time since monitoring started, counting up at one-second intervals. The clock's maximum hours count display is 999, after which it rolls over to zero and counts up again.

At the right of line 1 is shown the present address count of the optional external memory, discussed next.

Examples of several screen displays will be shown next month in Part 2.

External Memory

PIC Electric Mk2 has been provided with a data recording facility for those who would like to keep track of facts and figures. It is stressed, however, that the design

does not need to be used as a logger. It is perfectly suited to using on its own as a "here and now" monitor for use around the home from time-to-time.

A single serial non-volatile memory chip is provided for data logging, IC6 in Fig.3. It is a Microchip type 24LC256, as used in several previous EPE logging designs. It has 256 kilobits (32-kilobytes) of 8-bit memory.

In other designs, eight of these memories can be run in parallel, with a 3-bit address value determining which one is to be accessed in response to coded commands from the PIC. In this application, the memory is used on its own and its address-setting pins (A0 to A2) are left unconnected (they are biased low within the device).

The memory is controlled by PIC pins RC3 (clock) and RC4 (data). Data is transferred serially in response to the clock signals. The data pin is bidirectional (read/write) and is provided with a pull-up resistor (R18) for use during data read.

Data is recorded to the memory at one-minute intervals, in blocks of eight bytes at a time, allowing 4096 (4K) sample groups to be recorded, just over 68 hours-worth of samples. The memory is accessed cyclically, recording to memory bytes from 0 to 32K, then rolling over to zero, and then recording over the previous memory locations, up to 32K again, and so on.

To maintain program simplicity in respect of the rollover point, the number of bytes used for each sample has been set at

the "round" binary number of 16, which divides evenly into 32768 (32K). At each minute interval two bytes for the voltage are recorded, two bytes each for both current channels, with two bytes left over. To one of these is recorded a "flag" which indicates at what point in the memory count the unit has been switched on. The other is set to zero and ignored.

When each batch of samples is recorded at one minute intervals, the present memory count is also recorded to the PIC's own internal non-volatile memory. This memory, and the main 32K serial memory, retain data even after power has been disconnected.

Each time power is re-applied, the PIC's internal memory is read for various correction values, and also for the latest memory address from which to continue the recording count. The above marker "flag" is set at this point.

When the serial memory is downloaded to a PC (which may be done at any time), the screen displays waveforms relative to the recorded volts and amps values, and also shows marker lines indicating the start of each powered session, as recorded by the "flag".

Also, when the memory is downloaded, the current memory address count is copied to the PC so that the data can be shown in the correct time sequence - oldest data first, newest last (at screen right).

RS232 Interface

The RS232 serial interface circuit is shown in Fig.4. This circuit's components may be omitted if the logging facility provided by IC6 is not required.

The interface allows the logged data to be copied to a PC computer, according to the industry-standard RS232 protocol and voltage levels. It is used in bidirectional mode to allow the PIC and PC to exchange handshake signals to main the correct data synchronisation. Data exchange is set at 9600 Baud, 8-bits, no parity.

Resources

Software, including source code files, for the PIC unit and PC interface is available on 3.5inch disk from the Editorial office (a small handling charge applies - see the *EPE PCB Service* page) or it can be downloaded free from the *EPE* Downloads page, accessible via the home page at www.epemag.co.uk. It is held in the PICs folder, under PIC-Electric Mk2. Download all the files within that folder.

This month's *Shoptalk* provides information about obtaining pre-programmed PICs.

The PIC program source code (ASM) was written using *EPE Toolkit TK3* software (also available via the Downloads page) and a variant of the TASM dialect. The run-time assembly is supplied as an MPASM HEX file, which has configurations embedded in it (crystal XT, WDT off, POR on, all other values off).

The PC interface software was written under Visual Basic 6 (VB6), but you do not need VB6 to be installed on your PC in order to run it.

Whether or not VB6 is installed, copy all of the PIC-Electric files (except the PIC files if you prefer) into a new folder called C:\PIC Electric Mk2, or any name of your choosing, on Drive C (the usual hard drive letter).

If you do not have VB6, you also need three other files, *comdlg32.ocx*, *Mscmmct1.ocx* and *Msvbm60.dll*, held on our 3.5inch disk named Interface Disk 1, and in the Interface folder on our Downloads page (they are also included with the *TK3* software, in Disk 2). These files must be copied into the same folder as the other PIC-Electric Mk2 files.

These three files are not supplied with the PIC-Electric software as they are common to several *EPE* VB6 projects and amount to about 1MB of data.

Additionally, the VB6 source code makes use of Joe Farr's excellent *Serial Interface for PICs* (Oct '03) software. In order to access (and perhaps modify for your own purposes) the PIC-Electric VB6 source code files, you need to have Joe's software installed on your PC as well (see his published text). This is also available via our Downloads page.

Without Joe's software installed, if you try to access the PIC-Electric source code, it will crash.

Note that you should not attempt to "instal" the PIC-Electric VB6 files via Explorer or other similar PC facility. Use Windows' own normal Copy facility.

Construction

There are two printed circuit boards for this design - one for the power supply and sensors, and one for the control circuit.

COMPONENTS

Resistors

R1, R4, R17	100Ω (3 off)
R2, R3, R5 to R8	100k (6 off)
R9, R10, R13 to R16, R18	10k (7 off)
R11	3k3
R12	1k
All 0.25w 5% carbon film	

See
SHOP
TALK
page

Potentiometer

VR1	10k preset, round
-----	-------------------

Capacitors

C1, C2	470μ radial elect. 25V (2 off)
C3 to C7, C17, C20	100n ceramic disc, 5mm pitch (7 off)
C8, C9	22μ radial elect. 16V (2 off)
C10, C11	10p ceramic disc, 5mm pitch (2 off)
C12 to C16	1μ radial elect. 16V (5 off) - see text
C18, C19	100p ceramic disc, 5mm pitch

Semiconductors

D1	4V7 400mW Zener diode
D2	1N4148 signal diode
REC1	W005 1A 50V bridge rectifier
IC1	78L15 +15V 100mA regulator
IC2	79L15 -15V 100mA regulator
IC3	78L05 +5V 100mA regulator
IC4	LMC6482 dual op.amp, rail-to-rail
IC5	PIC16F876 micro controller, pre-programmed (see text)
IC6	24LC256 serial EEPROM (optional - see text)
IC7	MAX232 RS232 interface (optional - see text)

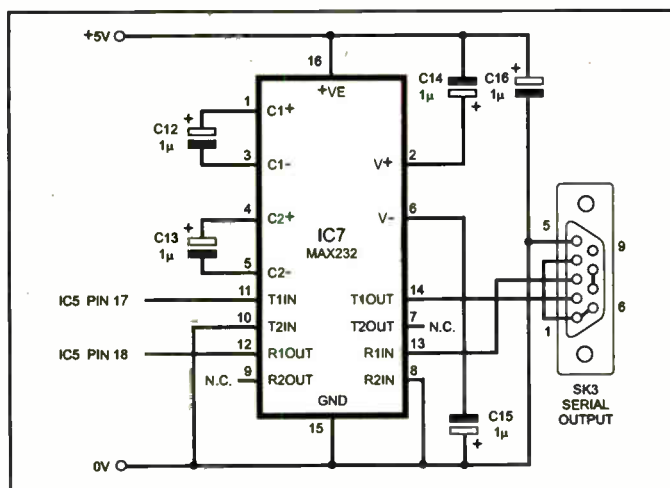

Fig.4. Optional serial interface circuit.

Miscellaneous

S1 to S4	min s.p. push-to-make switch (4 off)
T1	min. mains transformer, 2 x 120V a.c. primaries 2 x 12V secondaries, 1.5VA per secondary, p.c.b. mounting
X1, X2	Hall effect current transducer RS286-311 (X2 optional - see text)
X3	3.2768MHz crystal
X4	2-line x 16-character (per line) alphanumeric l.c.d.

Printed circuit boards, available from the *EPE PCB Service* code 487 (Control) and 488 (Sensor); metal case, minimum 190mm x 110mm x 60mm; 8-pin d.i.l. socket (2 off); 16-pin d.i.l. socket; 28-pin d.i.l. socket; mains screw-terminal block strip, to suit; mains cables, plugs and sockets, to suit; connecting wire; solder, etc.

Approx. Cost
Guidance Only

£75

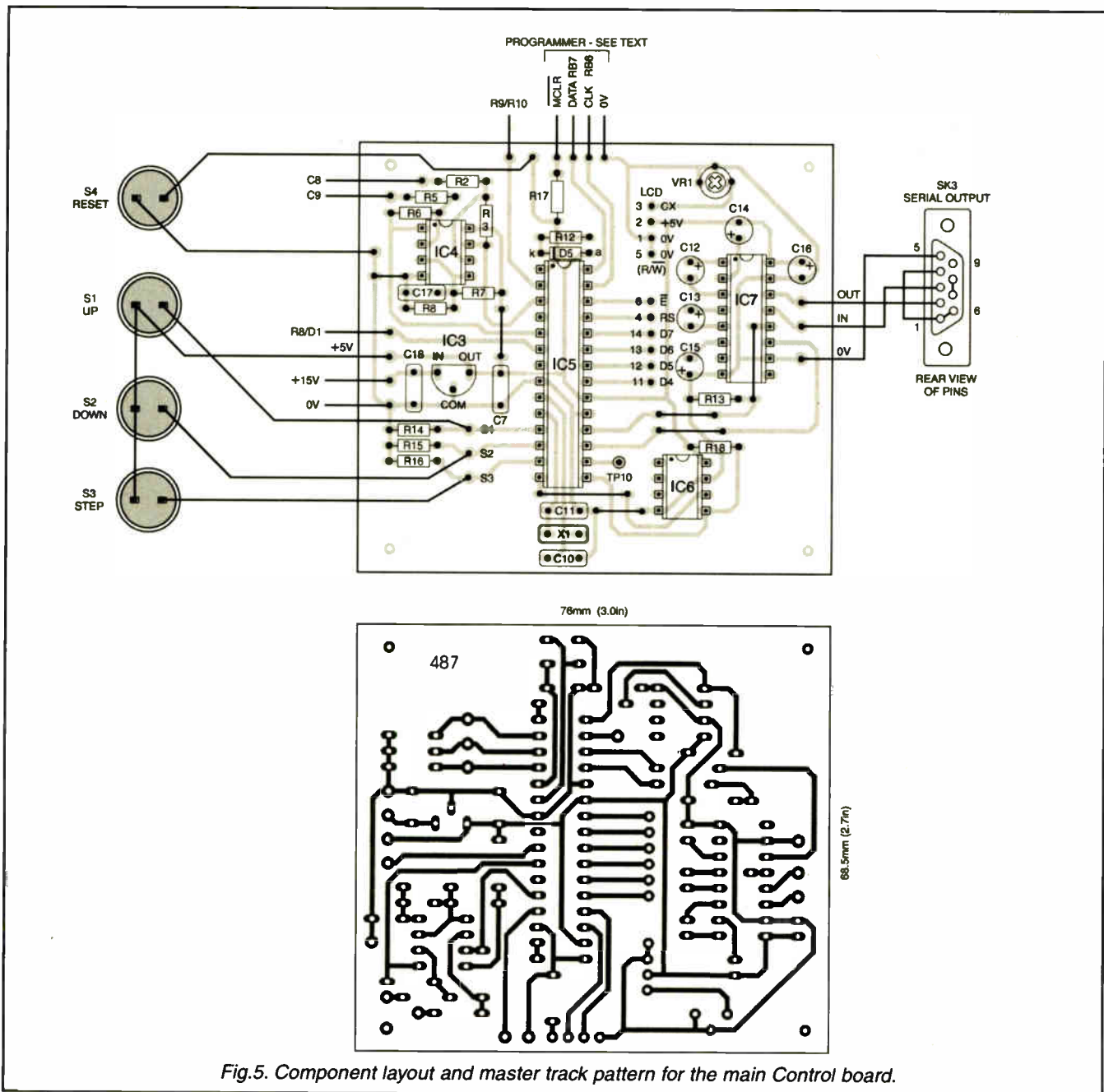

Fig. 5. Component layout and master track pattern for the main Control board.

These boards are available as a pair from *EPE PCB Service*, codes 487 (Control) and 488 (Sensor). Their component and track layout details are shown in Fig. 5 and Fig. 6.

It is again stressed that this mains powered design should only be built by those who are suitably qualified or supervised.

As usual, assemble the boards in order of ascending component size, starting with the few on-board link wires. Correctly observe the polarity of electrolytic capacitors and semiconductors. Do not insert the dual-in-line (d.i.l.) i.c.s into their sockets, or insert sensors X1 and X2, or connect the l.c.d., until valid operation of all aspects of the power supply has been proved.

Enclosure and Wiring

The unit should be housed in a good-quality metal box suitable for enclosing mains powered circuits. Locking cable grommets should be used for the mains input and output cable holes, drilled at one

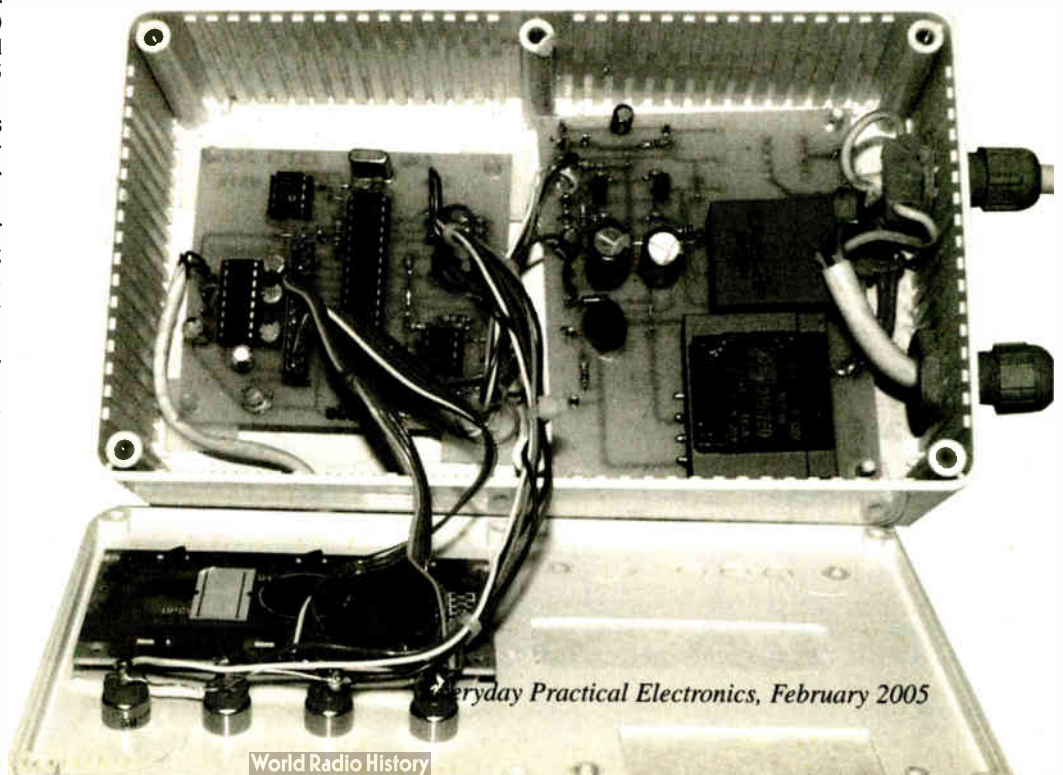

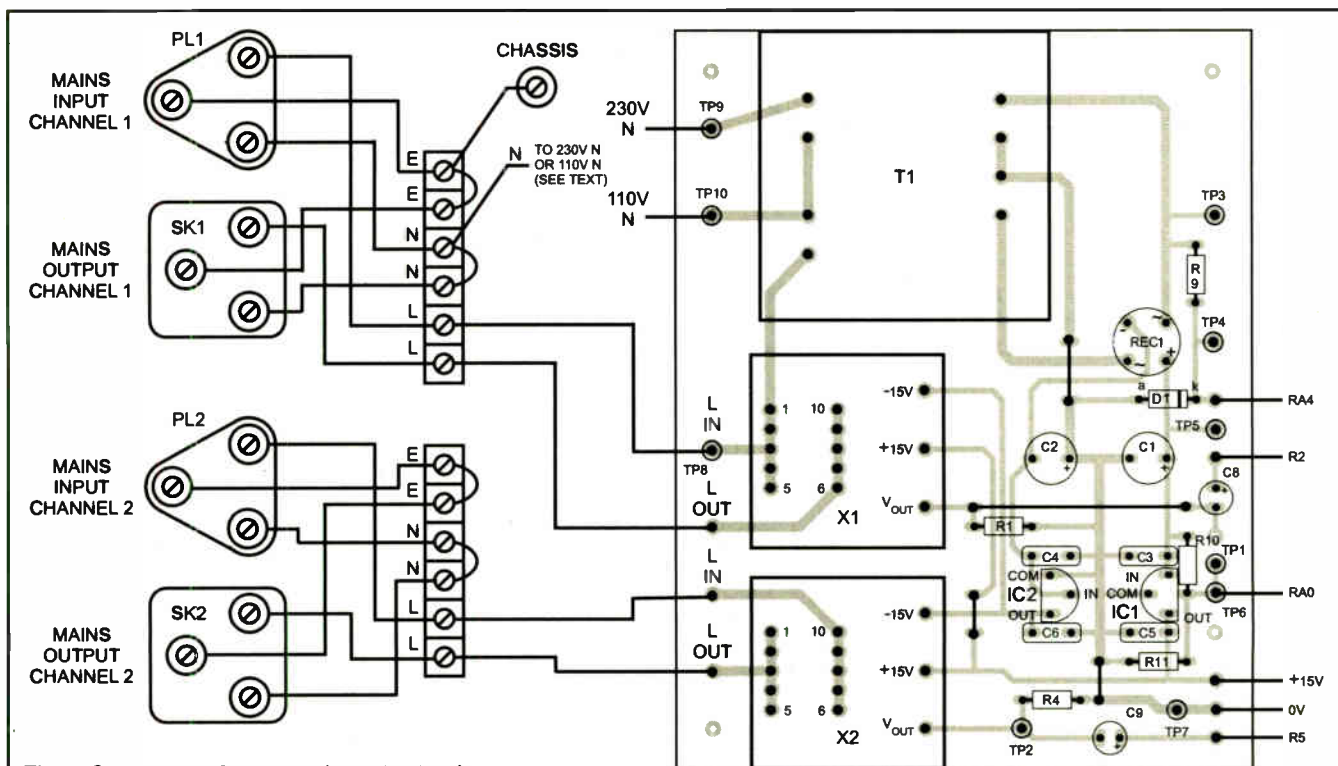

Fig. 6. Component layout and master track layout pattern for the Sensor board

end of the case. A slot needs cutting in the lid for the l.c.d. and holes drilled for the switches. The serial connector SK3, if used, should be mounted at the opposite end of the case to the mains cables.

Ventilation holes were not found necessary with the prototype, but if they are preferred, ensure that they do not allow objects to be inserted that could come into contact with the mains connections. The latter should also be covered with insulating tape to prevent inadvertent electrical contact with them.

The mains power cables should be of a size appropriate to the current which they are expected to carry. Although the sensors are capable of monitoring 25A of current, the limit for normal domestic power cables and connectors in the UK is 13A. The plugs and sockets used with the cables should be chosen to suit the supply standard of the country in which this design is to be used. Use suitably-rated terminal strip connectors on the inside of the case.

The neutral (N) connection to the p.c.b. for channel 1 should be made to the point designated for the supply voltage rating in your locality. The metal box must have a wired connection between it and the earth (E) lead of the mains input cable for channel 1.

Note that the mains-carrying tracks on the p.c.b. should be reinforced with suitably-rated solid connecting wire to allow the maximum permissible current to be conducted through them.

Power Supply Test

Normal mains safety procedures must be observed with all the tests now described. The power must be disconnected when making changes to the assembly.

With the sensors, d.i.l. i.c.s and l.c.d. omitted, apply power to the unit. Monitor

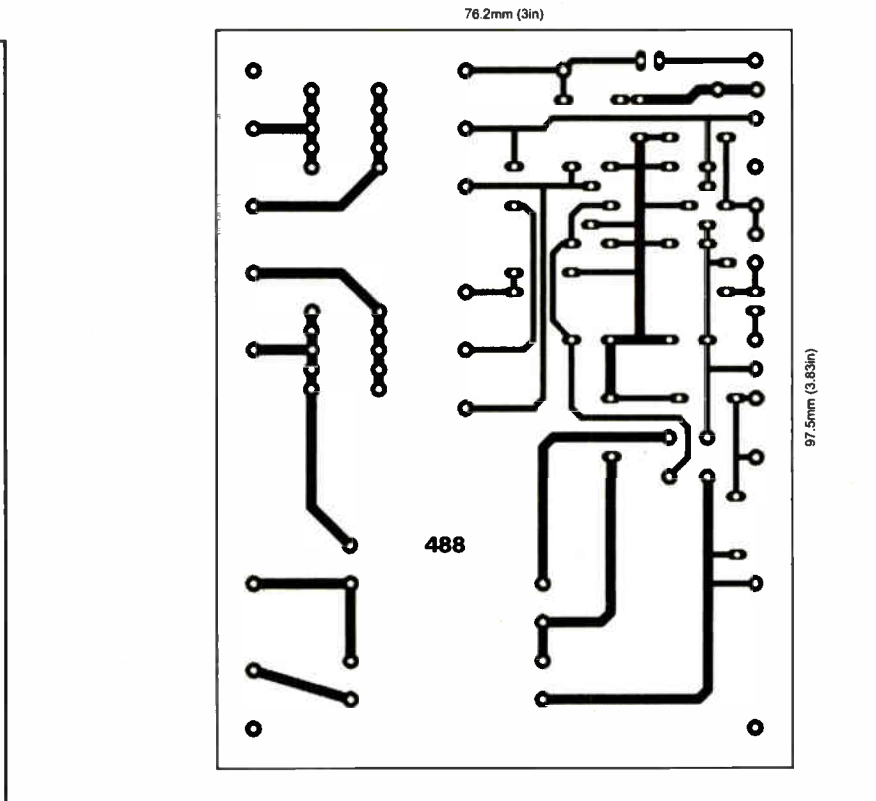

the output voltage at regulators IC1, IC2 and IC3, which should respectively be at +15V, -15V and +5V (within a few per cent) with reference to the 0V line. DO NOT take any readings with reference to mains neutral or mains earth unless specifically stated.

Additionally check that the voltage at test point TP6 is below the maximum allowable limit of +5V. If an oscilloscope is available, check that the 50Hz (or 60Hz) waveform at TP4 is swinging between 0V and about 4.7V.

If any voltage readings are incorrect, immediately disconnect the power and find out why.

When the power supply has been proved, the sensor(s) may be inserted and soldered into position. As said above, reinforce the p.c.b. tracks to suit the maximum current expectation.

With power re-applied, but without an appliance being monitored, check that the ±15V supply lines are still correct.

Next Month

In Part 2 next month we conclude by describing PIC Electric's testing, alignment and optional use with a PC and customised software.

PIE IN THE SKY?

Look to the sky - Is it a bird or a plane? It's certainly not Superman but a new wireless Internet service using tethered balloons and circling aeroplanes as antenna platforms. According to Andrew Emmerson it's pure science fiction and another example of ignoring the lessons of history.

LAST December saw the announcement that £2.1 million from the European Union's Framework Programme was to be devoted to a hare-brained scheme to make broadband Internet available to all by means of solar powered aircraft. Had the announcement's date been the first of April, I would have smiled at this wizard wheeze but sadly these mischief makers are for real.

Stratospheric Broadband

Their project goes by the name of Capanina and brings together some 13 partners from across Europe and Japan. Under the banner "stratospheric broadband", the declared intention is to develop broadband capability from aerial platforms as a cost-effective solution and viable alternative to cable and satellite.

The Capanina proposal is based around aircraft or airships operating as "High Altitude Platforms" (HAPs) located permanently in the sky. Placing these HAPs at an altitude of 20 kilometres – well above the flight path of normal aeroplanes but below satellites – will, the proponents claim, provide a cheaper and more efficient solution than those currently available, as HAPs do not require underground cabling or masts.

The fact that most countries are already well provided with cabling and antenna structures is ignored in their sales pitch, which instead concentrates on their goal of delivering broadband connections to rural areas across Europe – the areas where there is least demand for this service – within the next four years.

"The opportunities offered by HAPs are exciting as they could deliver broadband connections which are 2,000 times faster than a traditional modem and 200 times faster than today's 'wired' ADSL broadband", says Peter Walters, FP6UK National Contact Point for the programme. "Demand for fast communication is increasing all over the world, and this technology offers an innovative way of delivering broadband inexpensively to people at home, in the office or on the move."

Failed Projects

Innovative it may be but convincing it's not. In fact there's nothing in the programme to demonstrate either a commercial case or practical feasibility. The roster of failed sky-platform projects is not exactly short either. In 2003 York-based telecomms firm SkyLINC declared it would build a network of base stations for delivering broadband to rural communities from tethered balloons 1-5km up.

A year previously a startup company in the USA called SkyTower Telecommunications

announced it would launch solar-powered "Helios" unmanned aeroplanes that would circle for six months, transmitting bargain-priced broadband Internet, 3G cellular and high-definition TV service.

Before this, Angel Technologies (1992), SkyStation International (1996), Platforms Wireless International (1996), RotoStar (1997) and Space Data Corporation (1997) all announced similar schemes involving helium blimps or high-altitude aircraft. And surprise, surprise, not one of these has come to fruition.

Lost in Space

The money sunk and lost without trace on all those projects belonged to private investors, who presumably could afford to throw good money after bad. What makes the Capanina project different from all previous incarnations of the same idea is that public money is involved. And £2.1 million is not exactly small change.

Worse, not one of these schemes demonstrates that its proponents have researched the practicalities. Tethered balloons – aerostats to give them their "technical" name – require, well, tethering and the height at which they must fly (but not fly away) means you will need some pretty strong guy wires to keep them in place. Mechanical problems to overcome arise from megalightning, gales and icing, both on the ropes and on the aerial platforms (blimps or drones).

Even if these hurdles are not insuperable, the hazard to aircraft trying to avoid the tethers will be far more difficult to overcome. Whilst costs per customer may be lower than satellite or landline connection, it is only fair to say that these schemes will need many more balloons or aircraft than they would satellites for the same coverage and they will find the stratosphere a harsher environment than outer space.

There is plenty of case history to demon-

strate the impracticality of these schemes too; the idea of transmitting from airborne platforms such as aeroplanes or tethered balloons has never found much favour. There have been some remarkable plans in the past (see panel), even a few successful experiments, but generally the schemes have never really fulfilled the expectations of their architects.

Stratovision

The only successful projects of transmitting from aeroplanes have been American, first "Stratovision" transmitting educational TV to schools in the 1950s and then over Vietnam with televisual entertainment to troops during the ill-fated war of the 1960s. Radio Caroline proposed commercial television over northern England but it never managed to get off the ground. Technically these schemes were feasible but also very expensive.

Success with tethered balloons has been far more patchy and about the only scheme that worked has been TV Marti, beaming propaganda television from an aerostat over Cudjoe Key (Florida) to the Cubans (whose government has been very successful at jamming the signal in the Havana area, using both helicopter-borne jammers and scores of small units mounted on utility poles).

Other schemes have turned out complete failures; probably the most recent attempt to use sky-hooks was the ill-fated "pop pirate" radio ship *Laser 558*, anchored off the British coast in the North Sea. A tethered balloon intended to hold aloft the antenna wires lasted only a short while; the motion of the ship and arc currents from the aerial soon put paid to this ingenious scheme.

The last word just has to go to Internet commentator Lloyd Wood, who likens the whole concept to the secret Cloudbase headquarters of children's telefantasy series Captain Scarlett; the truth is always less believable than fiction!

A Brief History

Britain's balloon came first! After the last war there was great pressure to extend the previously London-only television service to the rest of the country. Unfortunately there was neither sufficient finance nor manufacturing or manpower resources to achieve this by conventional means.

Arthur C. Clarke had already described his scheme for broadcasting using artificial satellites, however, and it may have been this which inspired the Post Office's scheme for an aerial suspended from a tethered balloon! Conceived in 1947, the most direct inspiration may have been the sight of the wartime balloon barrage of the London skyline during the war years.

The designer, John Bray, died only recently and in his memoirs he wrote: "The proposal was to use frequencies above 1000MHz (at which useful gain and directivity could be achieved by aeriols of practicable size). Full coverage of the whole of the United Kingdom could have been provided by six such systems at heights of about 5,000ft. Since the aerial system was wholly passive and could have a wide frequency bandwidth it could be used simultaneously for broadcasting and for picking up signals from a similar system up to about 150 miles away, or from mobile units for outside broadcast purposes."

Oyez, OLED TV Screening Shortly!

An alternative to LCD screens is imminent, and partly thanks to printer company Epson. Barry Fox reports

EPSON is now promising that OLED TV screens, made from Organic Light Emitting Diodes, can be made for half the price of an LCD screen of the same size – and be ready for sale by 2007. The surprise claim came out of the European Business and Technology Forum in London hosted by Seiji Hanaoka, Executive Vice President and Chief Technology Officer of the Seiko Epson Corporation.

Epson's Strategy

With press flown in from around Europe, the promise was to "present Epson's business strategy and vision of digital imaging in tomorrow's world." Much of the event was little more than a sales pitch for Epson's ink jet printers and LCD projectors, because 80% of all LCD projectors use Epson panels – with 0.9in (2.29cm) projector panels promised for May 2005.

The LCD screen market is sewn up by Philips, Samsung, LG, Sony and Sharp. So Shoichi Iino, General Manager of the OLED Development Division, was not undermining Epson's current business by promising big things from OLEDs. "It is the display technology of the future" said Iino confirming that LCD development would continue, with Epson and Sanyo now in partnership.

"OLED is thin, beautiful and affordable. OLED has superior speed, contrast and viewing angle to LCD". The colour chemicals are applied as lines of spots by an inkjet printer – with ± 15 micron accuracy, to give 200 pixels per inch. OLED target lifetime is 10,000 hours, with end of OLED lifetime defined as a brightness loss of 20%.

"We will hit that target by 2007," claimed Iino. "We have built a 40in (101.6cm) XGA panel and its lifetime is 2,000 hours. OLED panels can be thin, and large or small. They are thinner and simpler than LCD or plasma. The cost will theoretically be 50% less than LCD because there is no backlight or polarizing panels."

Moving Greetings

A slide suggested that OLEDs will be used to make greetings cards with moving pictures – but there was no practical demonstration. Iino also regretted that he could not show the 40in prototype because "it was too big to fit in my suitcase". But transport problems had not prevented Epson from bringing in many more prototype products, including a miniature 12.3gm helicopter robot controlled by Bluetooth, and three smaller OLED screens.

Nick Butler, MD Epson UK, promised OLEDs for home entertainment by 2007, but small screens only. A working 2.1in (5.3cm) OLED Active Matrix screen with 262,144 colours and power drain of 150mW, looked very impressive, with bright pictures and good colours, and no smear on moving video. A 5.5in (14cm) version with similar specification and drawing 2W looked equally impressive.

A 12.5in (31.7cm) screen was housed in a case, which vibrated slightly to the touch suggesting the presence of a fan inside. There were no specification details for this larger screen. The 12.5in pictures were equally impressive, though, even on a sequence showing fireworks against a dark sky. But the prototypes were very obviously prototypes, with ribbon cables attached.

Future Confident?

Says Sarah Carroll of market analysts Understanding & Solutions: "OLED does offer significant cost savings. However the life of the product is still a very significant issue and they themselves are talking about commercial introduction in 2007, which is a lifetime in this business – and allows LCD and plasma to gain further ground."

Subwoofers for Audiophiles and Savings



B.K. Electronics, whose colour ads have graced our back covers for many years, have told us that their XLS200 subwoofers are now offered direct to the public, and that savings of up to £300 can be made compared to similarly specified subwoofers.

B.K. have manufactured at least

100,000 award winning and highly acclaimed subwoofers for OEMs (original equipment manufacturers) such as Rel Acoustics and Rega etc. It is with this depth of experience in designing and building quality subwoofers that B.K. now offer the XLS200 to the public.

The XLS200 uses a Peerless XLS10 drive unit that is amongst the world's best and highly regarded drive units, coupled with the BSBP200 sub-bass amplifier to give precise control and flexibility. There are two versions available to suit most tastes, the XLS200 which is forward firing, and the XLS200-DF which is downward firing.

Further information on these subwoofers can be found on B.K.'s website at www.bkelec.com/new/. The company's other contact details are, B.K. Electronics, Dept. EPE, Unit 1, Comet Way, Southend-on-Sea, Essex. Tel: 01702 527572. Fax: 01702 420243.

Watching While Training

Train delays should now be a lot easier to bear. British company Goodmans is now selling a vest pocket video player that lets people watch movies on the move without the need to carry a DVD player.

The £200 GPDR1 uses MPEG-4 compression to record two hours of video in a 256MB memory card at 320Kbps. The video can be copied from a TV set, VCR or DVD. Goodmans believe that because the device only makes a temporary recording to solid state memory, and can only show video on its own 6.4cm l.c.d. colour screen, it does not need to incorporate the copy protection circuitry used in video disc or tape recorders, to stop them recording movies.

Because there is no disc to spin – as in an iPod or portable DVD player – rechargeable batteries last at least two hours.

The GPDR1 also records 10 hours of MP3 music or shows over 3000 JPEG still pictures. If the train is really late, it works as a dictation machine for recording many long angry letters.

Barry Fox

MAPLIN FOR BIG BOYS?

Maplin is now rivaling the Innovations catalogues for enticing hyperbole. A recent Big Boys Toys catalogue offers a "full function calculator with a dark secret", for £20. The calculator comes with a pair of wireless headphones. Put the calculator on a conference table, or living room table, go into another room and listen on the headphones to whatever is being said.

What intrigues most, however, is a whole gaggle of "Shocking" gismos. Previously Maplin had sold a fly swatter, like a tennis racket, that fries insects with a high voltage spark. Now a pen, cigarette lighter and Roulette wheel all have one thing in common; they contain a hidden electric shock coil. The pen, which is "great fun for the office", shocks when you press the top; the lighter delivers a belt when the flame lights; and the Roulette wheel rewards the unlucky loser with a nasty surprise.

Each of these Shocking Big Boys Toys comes with the same warning: "This is not a toy - do not play if you suffer from epilepsy, a heart condition or any similar related illness". So it will pay to be wary of anyone in the home, pub or office who casually asks you about epilepsy or heart disease - or generously offers a free calculator.

Barry Fox

Crystal Cold Audio

Here's an intriguing innovation, as outlined in a press release recently received, which says:

With the never-ending search for a purer quality of sound with the music and Hi-Fi Industry, the technological boundaries are being pushed as never before. Rising to the challenge for crystal clear sound, Cryogenic Treatment Services ... are proving a specialist cryogenic process for improving the performance of cables, circuit boards and other electronic equipment.

Although relatively new to the music and Hi-Fi Industry, the cryogenic treatment of cables and circuit boards is gradually being considered by many as an important factor in assisting with the reproduction of a pure and transparent sound signal.

For more information contact Cryogenic Treatment Services Ltd, Dept EPE, Mansfield i-Centre, Hamilton Way, Mansfield, NG18 5BR. Tel: 01623 600830. Web: www.195below.co.uk.

electronic surveillance equipment

No gimmicks, gadgets or fantasy performance claims, just high quality equipment direct from the company who for over 25 years have designed, developed and manufactured covert audio surveillance equipment for the entire industry, from private individuals to government departments. If you have a requirement, speak to us....*last*.

- ◆ Full range of covert audio surveillance products
- ◆ Professional quality UHF crystal equipment
- ◆ Cost effective VHF FM equipment
- ◆ SENSIBLE prices from a long established, discreet and reputable company
- ◆ Excellent service and advice from experienced staff
- ◆ Everything designed, developed and manufactured by us in-house and under our control
- ◆ We are dedicated to surveillance products... we make *nothing* else.
- ◆ Latest surface mount technology on all modules for maximum performance and micro size
- ◆ We ship worldwide and accept cards, cash and cheques

Phone, fax or e-mail sales@suma-designs.co.uk for our free 2005 illustrated catalogue of audio surveillance equipment, or visit us on-line at www.suma-designs.co.uk.

suma
designs

The Workshops, 95 Main Road,
Baxterley, Warwickshire, CV9 2LE UK
Tel/Fax: 01827 714476
www.suma-designs.co.uk

YOU WON'T GET YOUR FINGERS BURNT

It may surprise you but buying an Antex soldering iron costs less than you think in the long run. British made to exacting standards, they last significantly longer than imported brands. And with a wide range of thermally balanced soldering irons, you can pick up a "fixed temperature" or "in-handle" temperature model that will suit your needs perfectly.

None of which will burn a hole in your pocket.

If your hobby demands the best iron for the job but you don't want to get your fingers burnt by the cost, visit our website or your electronics retailer for the coolest models around.

Pick up an

ANTEX
Not just any old iron.



www.antex.co.uk

2 Westbridge Industrial Estate Tavistock
Devon PL19 8DE Tel 01822 613565

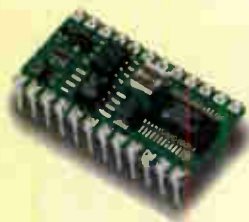

BS2-IC

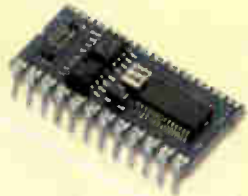

BS2-SX

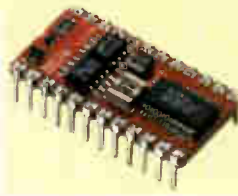

BS2E-IC

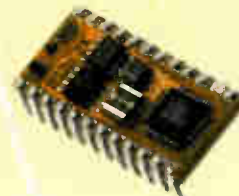

BS2P/24

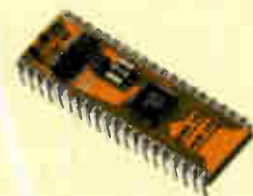

BS2P/40

Parallax BASIC Stamps - still the easy way to get your project up and running!

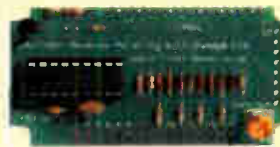
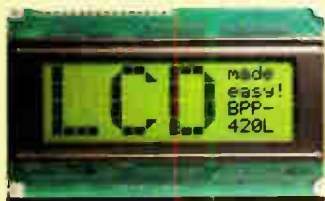

**Serial Alphanumeric and Graphic Displays,
Mini-Terminals and Bezel kits**

www.milinst.com



Animated Head



3-Axis Machine



Six-Legged Walkers



Robotic Arms



Bipeds

Robotic models for both the beginner and the advanced hobbyist

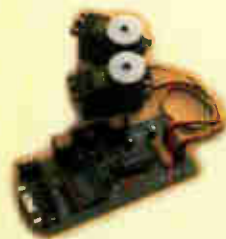

Servo Drivers

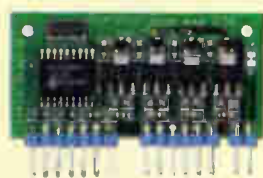

Motor Drivers



On-Screen Displays



DMX Protocol



U/Sound Ranging

Animatronics and Specialist Interface-Control Modules



Quadvox
MP3 & Speech Systems



SensoryInc
Voice Recognition

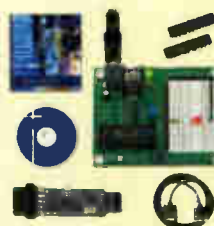

Parallax
Ubicom Tool Kits



Tech-Tools
PIC & Rom Emulators

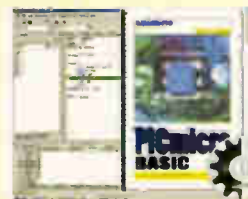

BASICMicro
PIC BASIC Compilers

Development Tools

Milford Instruments Limited Tel 01977 683665, Fax 01977 681465, sales@milinst.com

Sneaky

by Mike Boyden



A covert communication system for magicians and spies

FOR a number of years the author has used simple magical tricks to entertain friends at parties and gatherings. The art of confounding an audience is a unique pleasure and all the more fun when the audience is in close proximity to the deception and the group is still unable to work out how the trick works. The author is also interested in electronics and as a consequence of combining these two hobbies, Sneaky was developed.

Sneaky is basically a two-unit one-way radio communication system. One unit, the Slave, is worn by the magician and the other unit, the Master, is worn by the assistant. The transmission path is unidirectional, that is, data can only be passed from the

Master to the Slave. Exactly how the Sneaky pair are used in front of an audience is explained later.

Experimenting

Initial experiments were conducted using widely available low-power radio links, operating in the UHF band. The devices at first appeared to fit the overall design requirements being physically small, having low electrical power needs, requiring no operating licence and obtainable at a reasonable price.

Although these units can operate over distances of approximately 100m, the initial results were disappointing, due to reliability issues. It was only when these units

were given an improved signalling system, overseen by a PIC microcontroller, that a fully functional system became a practical proposition. The final system has been tested at a number of gatherings and found to work reliably, whilst remaining undetected.

Sneaky Master

The circuit diagram for the Master transmitting unit is shown in Fig. 1. It comprises a 433MHz low-power f.m. transmitter, IC2, coupled to a PIC16F628 microcontroller, IC1, operating at 4MHz, as set by crystal (or ceramic resonator) X1. Using a crystal-controlled frequency helps to maintain good synchronisation between the asynchronous transmissions.

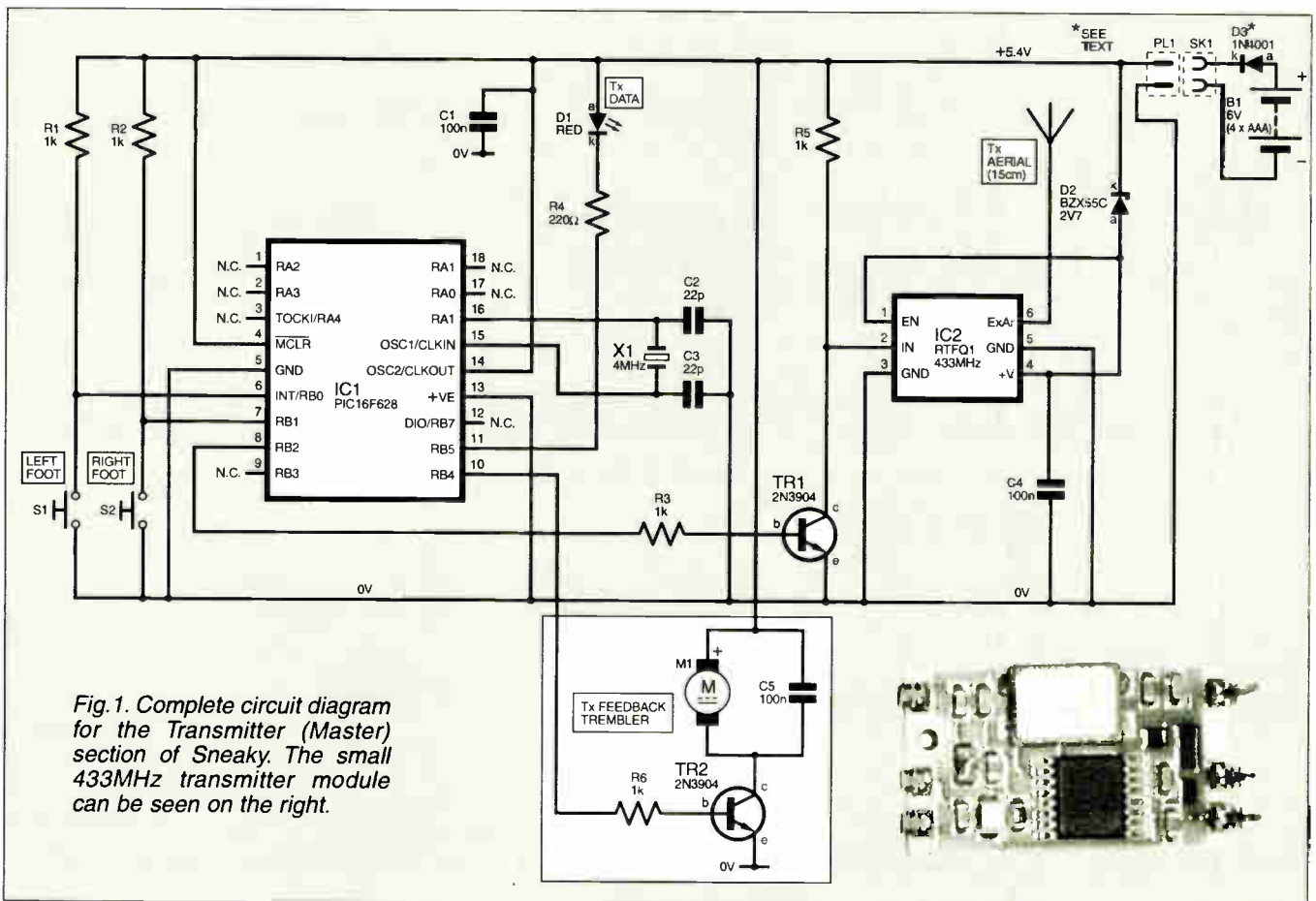

Fig. 1. Complete circuit diagram for the Transmitter (Master) section of Sneaky. The small 433MHz transmitter module can be seen on the right.

Covert signalling is accomplished by means of pushbutton switches, S1 and S2. These are operated by the assistant's right and left feet and coupled to the PIC by thin wires passing inside the assistant's trousers.

When the PIC detects a switch press, it outputs a coded stream of pulses from its pin RB2. The format of the pulse stream depends on which switch is pressed. The pulses are fed via buffer resistor R3 to transistor TR1, whose collector output feeds them to the transmitter module, IC2.

So that the assistant knows that a foot switch has been correctly pressed, a "trembler" is used as the covert signalling device. These units are simply small motors that vibrate when energised. When the PIC is outputting data to the transmitter, its pin RB4 turns on trembler motor M1 via transistor TR2. Resistor R6 buffers the PIC's output line, and capacitor C5 decouples the voltage across the motor.

While transmission is taking place, Tx Data I.e.d. D1 is turned on by PIC pin RB5. Resistor R4 is the I.e.d.'s ballast resistor.

The transmitter is powered at 3.3V, a voltage which *must not* be exceeded. In this design the battery-provided 6V supply is dropped to 3.3V by the insertion of Zener diode D2 between it and the transmitter.

Sneaky Slave

The circuit diagram for Sneaky's Slave Receiver is shown in Fig.2. The 433MHz receiver module is notated as IC2. The data output pulses from IC2's pin 14 are first buffered by resistor R8 and transistor TR3, and then fed to pin RB1 of the second PIC16F628 microcontroller, IC1.

The PIC decodes the pulse train and, depending on the code, activates one of the two trembler motors, M1 or M2, via pins RA3 and RA4, resistors R1 and R2, and transistors TR1 and TR2. Resistor R3 is required to positively bias pin RA4 as this is an open-collector output. This PIC is also controlled at 4MHz, as set by crystal X1.

An important design requirement for the

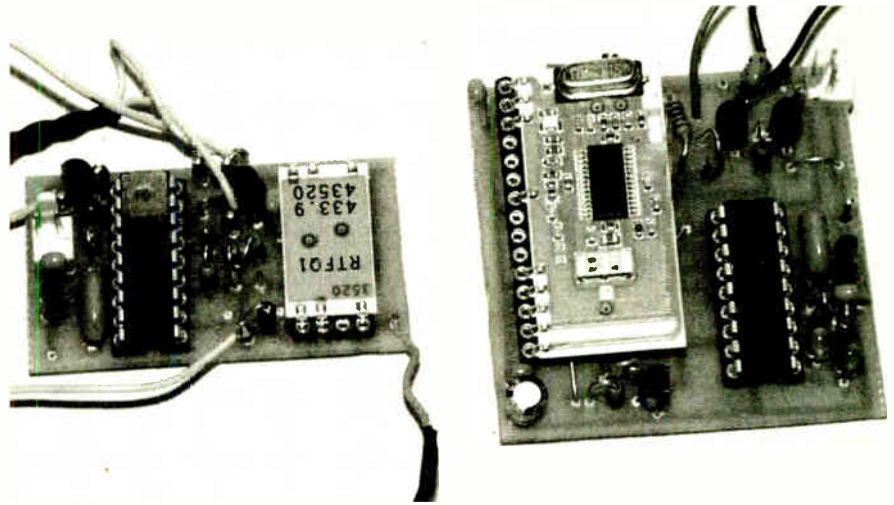

The Prototype transmitter and receiver circuit boards that make up Sneaky

receiver is that any loss of signal is reported to the wearer immediately. This is one of the tasks managed by the PIC and two independent checks make sure that the loss of the r.f. (radio frequency) link or data transmission errors are quickly signalled.

The receiver module IC2 generates an output voltage (RXSL) at pin 13, relative to the received signal strength. This is fed to PIC pin RA2, which is used in comparator mode. The software monitors this input and compares it with a reference voltage at pin RA1, also used in comparator mode.

The reference voltage is set by preset potentiometer VR1. The voltage across VR1 is regulated at approximately 3.0V by Zener diode D1 and resistor R4. Preset VR1 is set so that the voltage at its wiper, and thus RA1, represents the minimum received signal strength below which the link quality is deemed to be unacceptable.

Tests showed that RXSL should be about 2.5V for a fully functional link, dropping to 1.0V for an unacceptable link. Consequently, setting a voltage of approximately 1.5V at the wiper of VR1 includes a safety margin before a "signal loss" error

is indicated. Should the RXSL voltage fall below the reference voltage, then the error condition is signalled by fully turning on both the right and left tremblers whilst the fault condition persists.

When data is *not* being received, Rx Error I.e.d. D2 is turned on by PIC pin RB5, ballasted by resistor R5. When it is being correctly received, Rx Data I.e.d. D3 is turned on by RB4, ballasted by R6.

Power Supply

To eliminate the possibility of a unit becoming inadvertently turned off, there are no power switches in the prototypes.

The battery power leads are connected directly to the p.c.b.s by means of locking plugs. Each power lead also contains a diode (D3 and D4 in Fig.1 and Fig.2) respectively, which is used to reduce the 6V supply to approximately 5.4V.

Magical PICs

Although there are two boards, each PIC uses the same software (see later). PIC pin RB7 on each PIC is used to detect into which board the device is plugged, and this

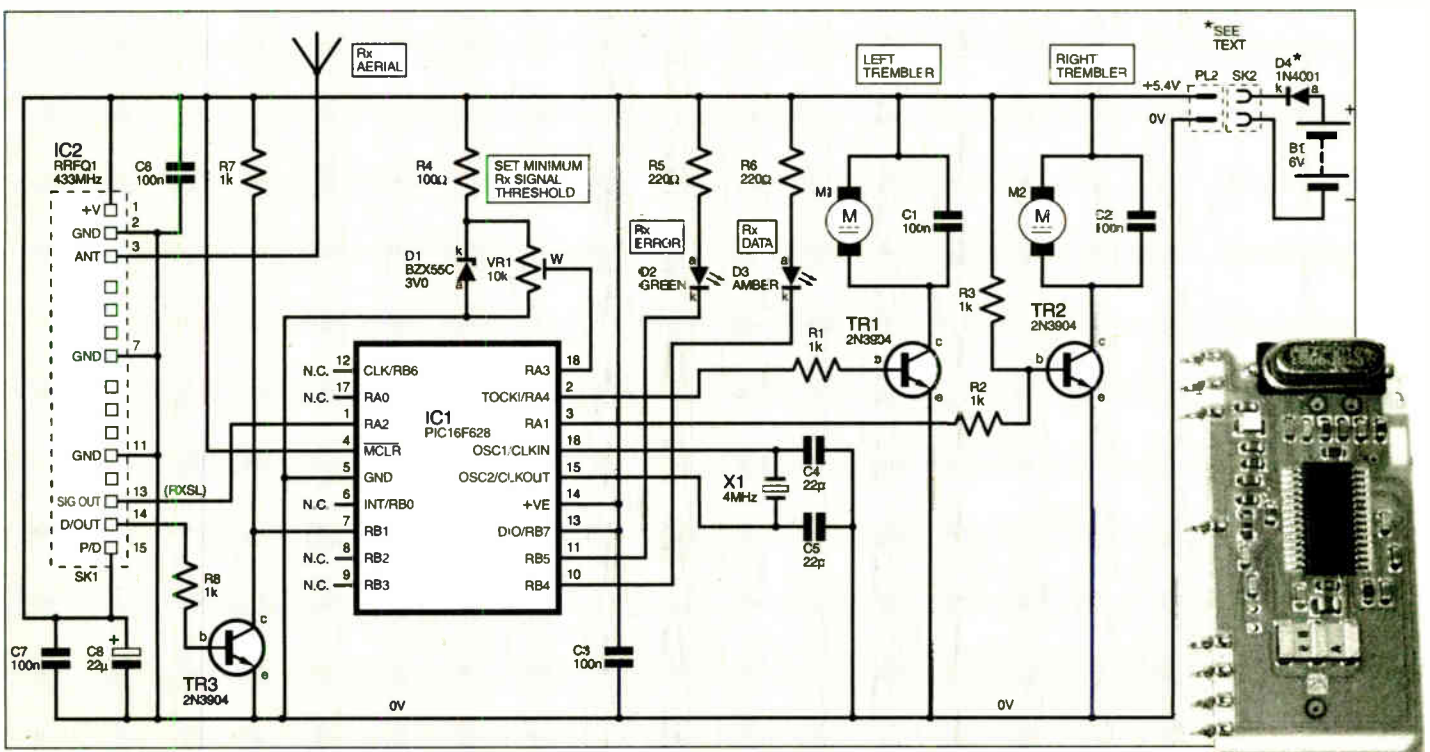

Fig.2. Full circuit diagram for Sneaky's Receiver (Slave) unit. The receiver module is shown on the right.

enables the relevant code routine to be automatically executed.

When power to the transmitter unit is switched on, the PIC initialises itself for asynchronous communication at 2400 Baud. It then continuously sends the ASCII code for letter "Z", see Fig.5, unless a footswitch press is detected. This continuous transmission can be thought of as the system's "heartbeat" and is used by the receiver to check the presence of the transmitter.

If footswitch activation is detected, then the switch closure is debounced and either the ASCII code for "A" or "B", is transmitted, indicating which switch was pressed.

COMPONENTS

TRANSMITTER (MASTER)

Resistors

R1 to R3,
R5, R6 1k (5 off)
R4 220Ω

See
SHOP
TALK
page

All 0.25W 5% carbon film or better.

Capacitors

C1, C4, C5 100n ceramic disc,
5mm pitch (3 off)
C2, C3 22p ceramic disc,
5mm pitch (2 off)

Semiconductors

D1 5mm red l.e.d.
D2 BZX55C 2V7
Zener diode
D3 1N4001 rectifier
diode
TR1, TR2 2N3904 npn
transistor (2 off)
IC1 PIC16F628 micro
controller, prepro
grammed (see
text)
IC2 RTFQ1 433MHz
transmitter
module

Miscellaneous

S1, S2 single-pole
normally-open
click switch (2 off)
M1 6V d.c. trembler
motor (see text)
X1 4MHz crystal (or
ceramic resonator)
PL1/SK1 2-way, p.c.b. mount
ing, keyed pin-
header (male) and
matching 2-pin
(female) socket
B1 6V battery pack
(4 x AAA)

Printed circuit board, available from the *EPE PCB Service*, code 485 (Trans); 18-pin d.i.l. socket; s.i.l. socket strip for TX module; metal case, size and type to choice; multi-strand connecting wire, including 15cm piece for aerial; heatshrink sleeving; solder pins; solder etc.

Approx. Cost
Guidance Only

£18

Excl. case & batteries

On receipt of characters "A" or "B", the appropriate trembler is activated for about one second. Invalid switch combinations, e.g. both pressed together, are ignored.

Once the letters "A" or "B" are sent then the repetitious "heartbeat" character transmission is resumed. Its receipt is continually verified by the receiver's PIC and any unexpected absence triggers a fault alarm condition. This alerts the wearer that a loss of communication with the master has occurred, and a move to a better location to recover the link can be made.

Construction

Component and track layout details for the Transmitter and Receiver are shown in Fig.3 and Fig.4 respectively. These boards are available from the *EPE PCB Service* codes 458(Trans.) and 486(Rec.).

Assemble the boards in the suggested order of ascending component size. Use sockets for both PICs, the transmitter and the receiver. A single-in-line (s.i.l.) socket cut to length is suitable for the latter devices. Do not insert any of these four devices on their boards until after the assembly has been fully checked. Observe the correct orientation of all polarity-sensitive components, such as the electrolytic

capacitors and all semiconductor devices.

The tremblers in the prototype were originally adapted from 3V cassette recorder motors. A blob of solder placed onto the brass motor shaft, created the necessary eccentric rotation and hence vibration. However, a source of commercial tremblers is given in *Shoptalk*, but the connections to these units need to be made more rugged.

Once the solder connections have been made and tested, the entire trembler unit should be enclosed in 20mm heatshrink sleeving, with the wires trapped underneath. By applying heat, the sleeve will shrink tightly around the trembler and wires, thereby improving durability.

First Test

As previously said, the transmitter sup-

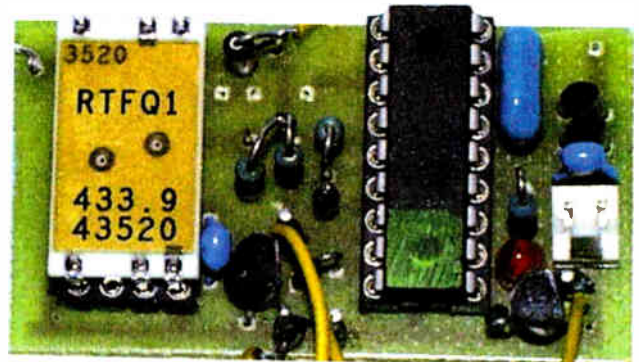

Completed prototype Transmitter board.

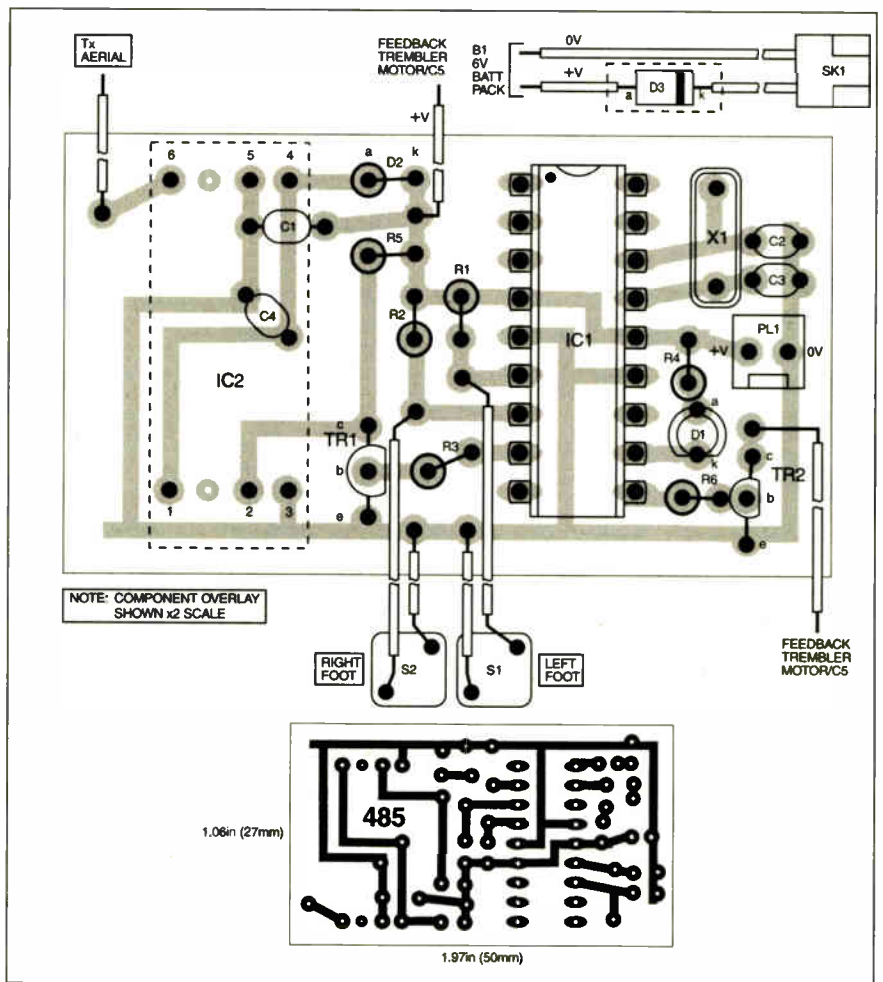
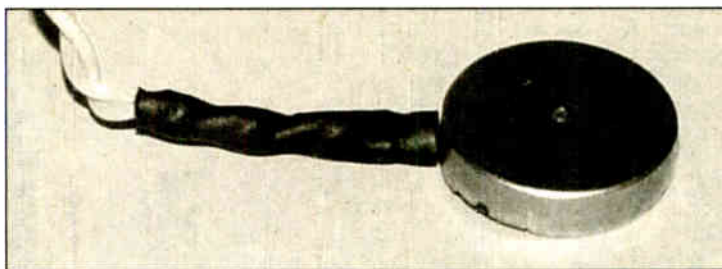
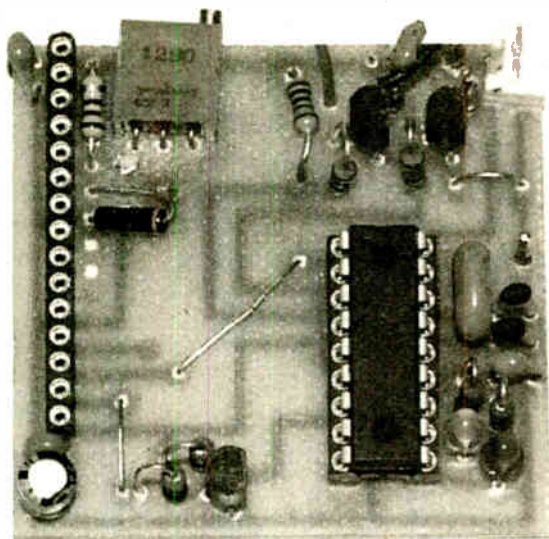

Fig.3. Printed circuit board component layout (shown twice size), wiring and full-size underside copper foil master for the assistance (Master) transmitter.



One of the trembler motors

(Left) Prototype receiver circuit board. Preset VR1 and Zener diode D1 have been laid flat to make room for the receiver module

COMPONENTS

RECEIVER (SLAVE)

Resistors

R1 to R3, R7, R8 1k (5 off) **See SHOP TALK page**
 R4 100Ω
 R5, R6 220Ω (2 off)
 All 0.25W 5% carbon film or better.

Potentiometer

VR1 10k 18- to 25-turn cermet preset, top adjust

Capacitors

C1 to C3, C6, C7 100n ceramic disc, 5mm pitch (5 off)
 C4, C5 22p min. ceramic, 5mm pitch (2 off)
 C8 22μ radial elect. 16V

Semiconductors

D1 BZX55C 3V0 Zener diode
 D2 5mm green l.e.d.
 D3 5mm amber l.e.d.
 D4 1N4001 rect. diode
 TR1 to TR3 2N3904 npn transistor (3 off)
 IC1 PIC16F628 microcontroller, preprogrammed (see text)
 IC2 RRFQ1 433MHz receiver module

Miscellaneous

M1, M2 6V trembler motor (2 off)
 X1 4MHz crystal (or ceramic resonator)
 PL1/SK1 2-way, p.c.b. mounting, keyed pin-header (male) and matching 2-pin (female) socket
 B1 6V battery pack (4 x AAA)

Printed circuit board, available from the *EPE PCB Service*, code 486 (Receiver); 18-pin d.i.l. socket; s.i.l. socket strip for Rx module; metal or plastic case, size and type to choice; multistrand connecting wire, including 15cm piece for aerial; heatshrink sleeving; solder pins; solder etc.

Approx. Cost
 Guidance Only

£19

Excl. case & batteries

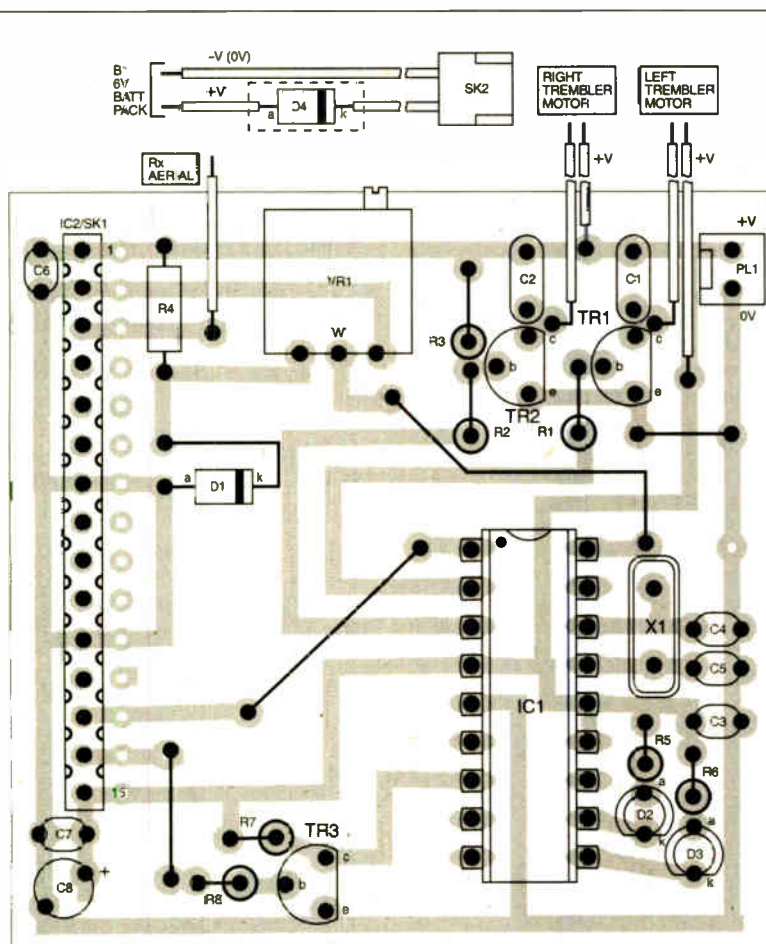

NOTE: COMPONENT OVERLAY SHOWN :2 SCALE.

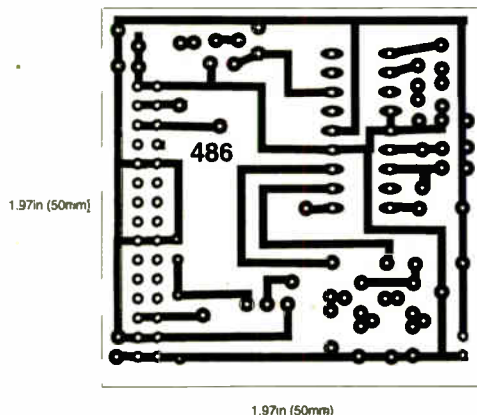

Fig.4. Slave (Magician) receiver printed circuit board component layout (twice size), wiring and full-size copper foil master. The receiver module (IC2) is plugged into s.i.l. socket SK1.

ply voltage of 3.3V must not be exceeded. Before inserting the transmitter module, temporarily connect a 1kΩ resistor between the allocated p.c.b. pads for the transmitter's pin 5 (+VE) and pin 4 (0V). If the voltage at the junction of this resistor and the anode (a) of Zener diode D2 exceeds significantly 3.3V (i.e. greater than say 3.5V), the fault must be traced and corrected – the most likely reason is that the diode is inserted the wrong way round.

When satisfied with all checks of the boards, insert the preprogrammed PICs, transmitter and receiver modules. Ensure that the pins of the latter modules tally with the p.c.b. pads to which tracking is connected. The module should be inserted *gently* as the ceramic substrate is brittle and will not withstand physical abuse.

The receiver module should be *carefully* bent over slightly to reduce the overall height. The component side should appear uppermost.

Enclosures

The test models were enclosed in two ancient tobacco tins, but modern enclosures can be used! Whilst the Receiver can be built into a plastic case, the Transmitter should be built into a metal one and an earth wire taken from a 0V point on the p.c.b. and securely connected to the case. This connection will enhance the transmitter's effectiveness. Its aerial should pass through a generous hole in the case and hang to a length of about 15cm.

Clearly mark the pushbuttons and tremblers so as to avoid the channels becoming inadvertently swapped over when Sneaky is being fitted at a later date.

Setting Up

Sneaky's receiver should be the first unit to be set up. Apply power and adjust preset VR1 to give approximately 1.5V at its wiper (and at PIC pin 18). The receiver tremblers should be activated, signalling an error condition (no "heartbeat" detected and poor signal strength). Also, Rx Error l.e.d. D2 should be on.

Next, apply power to the transmitter and place it about 2m away from the receiver. The tremblers should stop trembling and the Rx Error l.e.d. turn off. This demonstrates that the "heartbeat" is being correctly detected and the received signal level is acceptable.

Pressing the transmitter pushswitches should flash the transmitter Tx Data l.e.d. and activate the transmitter's feedback trembler. At the receiver, the Rx Data l.e.d. should flash and the respective receiver trembler should turn off for about 0.5 seconds. The Rx Error l.e.d. should be off.

A little testing will establish under what conditions Sneaky will provide reliable communications. On the prototype, the voltage range of receiver signal strength recorded was 1V with transmitter turned off and 2.5V with the transmitter placed 2m away from the receiver, and 2V at a range of about 16m.

This voltage difference is an indication of the safe working range of the two units and should be set with some margin of safety included. The prototype operated reliably over a distance of up to about 16m, through four household walls, which is an

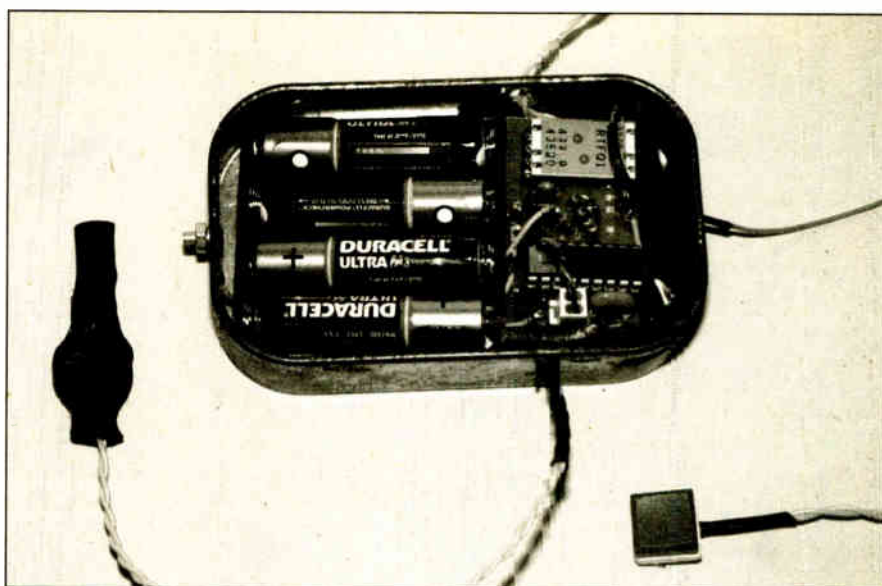

Component positioning inside the prototype transmitter's metal case. A trembler motor, encased in heat shrink sleeving, is shown on the left and a "toe/foot" switch on the right.

excellent result, given the less-than-ideal aerial arrangements.

When used in very close proximity (less than 1m), the received signal strength error warning would sometimes trigger, so very close proximity of magician and assistant should be avoided.

Art of Deception

The prototype units are retained against the body by means of 4cm elastic bands sewn to small cotton pockets. The pockets should be designed to retain the units against the natural curves of the body, while at the same time being comfortable.

Suitable locations were found to be either behind the calf muscle or at the base of the spine. The tremblers were simply pushed underneath the retaining elastic

band, see Fig.5. The aerial is allowed to hang down, disguised inside the trouser. Female magicians may favour locating the unit at the base of the spine and concealing the aerial in the waistband.

The pushbutton switches can be secured to the ball of a big toe with a little p.v.c. tape, as the sock is pulled over the foot. If the "click" of the button cannot be felt, then the toe of the sock can be cut away, thus improving the feel of the button against the sole of the shoe. If two-channel signalling is required, then the wire to the other button is passed across the trousers at the waist band and down the left leg to the left foot.

Being sneaky, Sneaky will work best when it is thought of as a part of a performance that is used to entertain an audience and all performances are more pol-

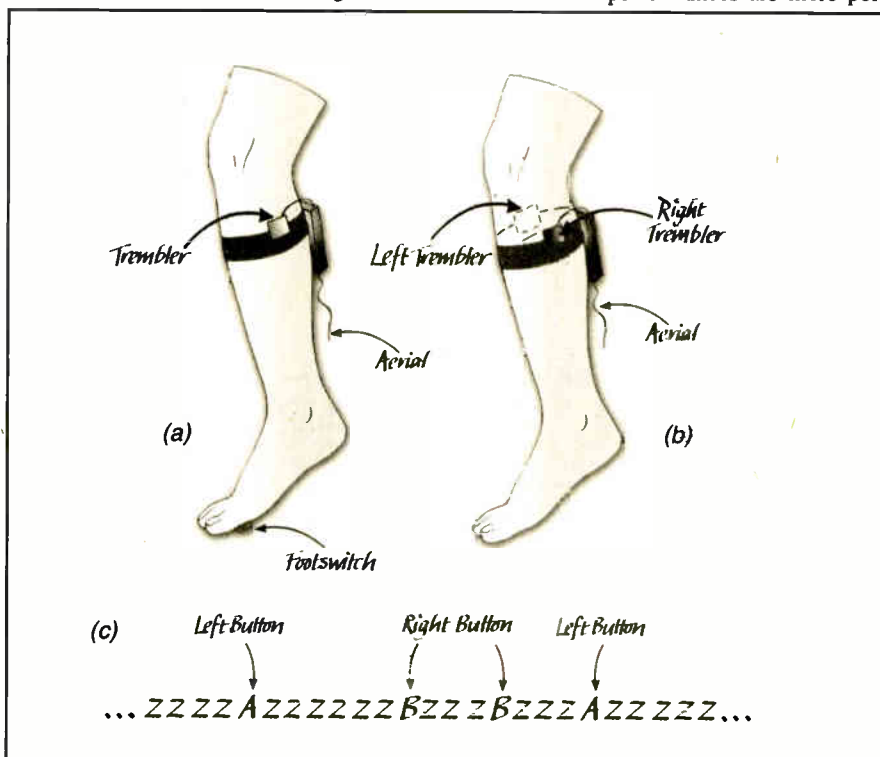
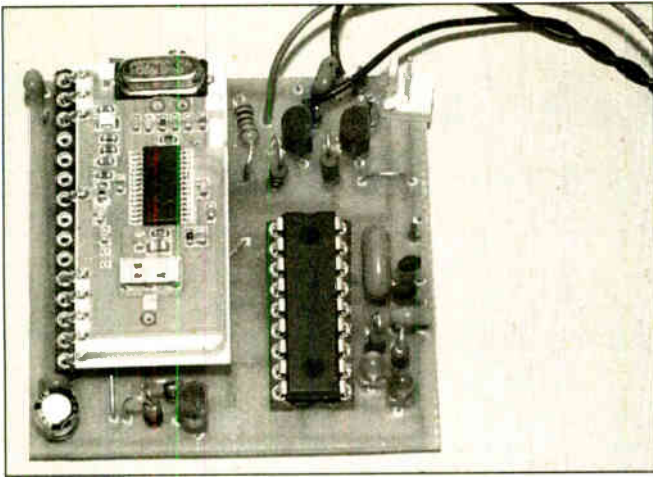

Fig.5. One suggestion for concealing the two units and tremblers: a) Master (assistant) and b) Slave (Magician). The "heartbeat" sequence transmission code is shown at c)



Layout of components on the receiver circuit board. The pins of the receiver module have been carefully bent to reduce the overall height of the board.

ished if they are well rehearsed. Magicians will emphasise the importance of planning when entertaining an audience – after all, your audience don't know what is going to happen or how the trick is done, so the initiative is with the magician and assistant.

Have a number of signals prearranged with a variety of meanings, so that there is no obvious communication between magician and assistant. If things go wrong, have a distraction plan already devised.

The following describes a method by which Sneaky has been used, but the variations are endless and will provide great fun for trickster and audience alike (with apologies to *The Sting*):

...The Set Up

The trick is set up between two people, namely the magician (who wears the slave unit) and the accomplice (who wears the master unit). The magician and accomplice should preferably arrive at the venue at different times and appear not to know each other.

The units should be turned on and a number of tests carried out to check range and reliability. Checks should be made inside and outside the venue – the importance of this will become apparent later.

...The Hook

The magician can show off some little tricks and make it known that he/she is quite the amateur entertainer. Later on in the evening, four objects are placed on a table in one room and the magician is allowed to view the selection. The items are given a number by the magician, say a vase is number 1, a pencil is number 2, a pepper pot is number 3 and a shoe is number 4.

The magician now goes to the next room. He declares that if a person points to an object on the table, he will "read the mind" of that person and state which object was pointed at. The assistant stands in the room where the objects are being selected.

...The Shut-Out

A few people are asked to try their luck, but no attempt is made by the assistant to signal the selection to the magician. The eager audience, previously built up by the magician will slowly lose interest, but just as the audience fades away, it is time to pull them back, but very gently at first.

...The Sting

When all appears to have gone flat, a person is finally selected in "desperation". The assistant watches the selection made and now signals this to the magician by means of Sneaky. One pulse indicates object 1, two pulses object 2, and so on.

Slowly, it will become clear that this person must have the right "mental telepathy" as he/she is getting it correct 100 percent of the time. People will start to call their friends to witness a remarkable event.

To maintain audience interest, the items for selection can be changed to, say, four cards – Ace of Hearts, Ace of Diamonds etc. or the names of four people or symbols marked onto a piece of paper, i.e. square, circle, diamond etc. The variations on this trick are almost unlimited.

The wonderment in the audience will build up as people look for the deception. On one occasion, the author completely stopped a party with this trick and was instructed to "read the minds" of party goers from the house next door, where, of course the trick still worked because basic range checks had already been carried out with the assistant.

The duration of this trick should not be over extended, as one audience became increasingly suspicious and "frisked" the Magician, nearly detecting Sneaky.

One or Two Channels?

Signalling up to approximately six items can be made using Sneaky in the single channel configuration (i.e. right foot switch in the master and right trembler in the slave). Sending each pulse with a regular rhythm will assist the magician with counting, but anything more than six signals can lead to confusion for both sender and recipient.

It is therefore advised to use the two channels option for signalling, say, a playing card. In this situation the left foot can signal suit (Clubs = one pulse etc) and if the card is low (Ace to six = one pulse) or high (seven to King = two pulses). The right foot signals the card value. For example nine Clubs = one pulse followed by two pulses on the left foot, then three pulses on the right foot. Although this sounds cumbersome, reliable and speedy signalling was accomplished after only two weeks practice.



The receiver and transmitter p.c.b.s housed in ancient tobacco tins. The tins should be lined with insulation tape to avoid any "short circuits" across the copper tracks.

Continually pressing either of the buttons will result in a regular pulsating of the respective trembler at about 1Hz and this could be used as another category of signal.

This unit is suited to a simple "selection" type of trick, but really the variations are only limited by the ingenuity of EPE amateur magicians. But remember that this is a performance and, for all performers, the "buzz" of entertaining people is addictive and worth all the rehearsal time.

Never give away the secrets of your magic. This rule allows others to entertain (and be entertained) by a live performer – a rare thing in these days of recorded mass entertainment.

Resources

Software, including source code files, for the Sneaky is available on 3.5-inch disk from the Editorial office (a small handling charge applies – see the *EPE PCB Service* page). It can also be downloaded free from the *EPE Downloads* page, accessible via the home page at www.epemag.wimborne.co.uk. It is held in the PICs folder, under Sneaky. Download all the files within that folder.

This month's *Shoptalk* provides information about obtaining pre-programmed PICs, and the sourcing of components. □



PIC N' MIX

ANDREW JARVIS

Our periodic column for your PIC programming enlightenment

Read the Script, Free Development Software!

THERE are few subjects that stir more passionate debate than the relative merits of your favourite programming language or development tool. If you enjoy putting together PIC projects, then it's likely you'll have a battle on two fronts – not only do you have to select the assembler (or compiler) of choice for the PIC device but, as many *EPE* projects demonstrate, there is often the PC side to consider as well.

Looking at PC software is actually a bit of a departure for *Pic N' Mix*, but while attempting not to stray too far off territory, I did want to share one particular technique that can be useful for rapid development. You may have noticed that numerous PIC designs published by *EPE* use Visual Basic for the PC application software. VB, as it is popularly known, is a favourite because it is powerful, yet simple to learn and has provided an acceptable migration path for BASIC lovers raised on earlier platforms.

One criticism levelled at VB is that it is difficult to know which version to get, or indeed how to get it. Then there's the .NET framework, which adds an unnecessary layer of complexity and some compatibility issues into the mix, so why bother at all?

The language debate usually reaches common ground where good software is offered at no cost. That is why assembly is so popular for the PIC – *TK3* supports TASM and MPASM, or alternatively there's the GPUTILS assembler and Microchip's own popular MPASM assembler and MPLAB IDE – all free. There are of course others, which you may know about.

What may be less obvious is that anyone using a Windows PC already has a free VB development system, of sorts. If you didn't know this, you've just discovered Visual Basic Script Edition (VBScript).

What's the Script?

For many people, VBScript is a language for scripting HTML to create dynamic web pages in the context of a Web browser. However, when combined with the Windows Script Host (WSH) integrated into most Windows platforms (or available for free download), scripts may be run natively within the OS, which to you and I means you can double-click them or run them at the command line. In turn, this opens up Windows Script as a viable test-bed for PIC related development on the PC, and is a great introduction for those who are anxious about purchasing a more complete development system.

Just how viable is perfectly illustrated when VBScript combines with other components to create something altogether

more useful. As an example, we'll demonstrate using scripting with the *EPE* Serial ActiveX control supplied with Joe Farr's October '03 article *Serial Interface for PICs and VB6*.

If you need to download or upgrade your scripting capability go to www.msdn.microsoft.com/scripting and choose Microsoft Windows Script 5.6 for your Windows platform. This will install the latest (at the time of writing) VBScript and WSH for you. It's unlikely you'll need to do this if you're running a more recent version of Windows like 2000 or XP.

Test Run

A quick test can be performed to be sure you are up and running properly before attempting anything more complex. Create a script (i.e. a new text file) with your favourite text editor and enter the following line:

```
WScript.Echo("Pic n' Mix Shows How!")
```

Save it with the extension `.vbs`, then double-click the file to see the message. If you prefer the command line, start an MS-DOS command prompt, change to the directory where you saved the script and enter "cscript", followed by the script name. (Alternatively, you can right-click the file and choose "Open in MS-DOS window".)

Incidentally, you may have realised by now that the "favourite programming language" debate is looming again. I could just have easily described this process with JScript (Microsoft's implementation of JavaScript), which is also supported by the WSH. Indeed, if your passion is for C, or C++ over VB then you will probably find this scripting flavour much easier to learn, and you can do most of everything described here with the different syntax and a file extension of `.js`.

Something for Nothing

Sample 1 from Joe's *Serial Interfacing* article (the simple loopback test) has been reconstructed as VBScript comprising two files, `EPESerial.wsf` and `Sample1.vbs` available from the usual Downloads click-link on the *EPE* website, via www.epemag.co.uk. To run it, be sure you have the Serial control installed (it's also available from the Downloads site if you don't already have it), and that you have the interface connected and set up correctly for Sample 1. Type the following at a Command Prompt in the directory to which

you copied the scripts:

```
cscript //job:sample1 eserial.wsf
```

If you get an error along the lines of "Cannot find the type library" then it is likely you haven't installed the Serial OCX.

The new sample is basically very similar to the original, but there are a few fundamental differences. VBScript has only one data type, the Variant, so you won't see the usual references to integral types like Integer and Boolean. This lack of strict type checking makes "Option Explicit" almost essential to stop the interpreter creating new variables when you inevitably misspell the name of one in your script files.

Also, the *EPE* Serial control is instantiated by using its textual programmatic identifier (ProgID) instead of by dragging the control onto a form as you would do using the Visual Basic IDE. The same "CreateObject" method also connects the Serial OCX events. The Windows Script File (*.wsf) is required to allow the use of named constants like "sio19200". Error handling is largely different and has been omitted for simplicity.

Using the Serial control in this way is a tribute to the beauty of component based, language neutral, reusable software. It's yet another way of getting something for nothing – perhaps in the future *EPE* will release more controls of the calibre of the Serial OCX.

Scripture Lessons

Of course, VBScript is not limited just to readers who constructed the Serial Interface or installed the ActiveX control. Apologies to readers for whom this example has less value, but it is hoped that it's still a useful exercise to see how such scripts may be put together and adapted for your own projects. A free Script Debugger is also available from the Microsoft link given previously.

For more documentation on the script technologies and an extensive language reference for both VBScript and JScript, download "Microsoft Windows Script 5.6 Documentation" from the Microsoft address given earlier. A word of caution is merited, though, before you attempt anything too ambitious with scripting. VBScript is not a replacement for a powerful development system like VB6. It is an interpreted subset of the language with limited functionality for direct access to the operating system. You can't build and run the *EPE* projects with it, but it can be a useful tool, it is free, and most importantly, you might have some fun with it.

We'll continue this next month.



the atlas SCR

- Automatically analyse Thyristors and Triacs.
- Automatically identify all three leads.
- Automatic test currents from 100µA to 100mA!

SCR100
£99

atlas SCR
model SCR100

LCR40
£69.00

DCA55
£49.00

SCR100
£99.00

Passive components, semiconductors,
power devices, network cabling
Choose your perfect analyser

New Low Prices!

limited time only

the atlas LCR

- Automatically identify Inductors, Capacitors and Resistors.
- Inductors from 1µH to 10H.
- Capacitors from 1pF to 10,000µF.
- Resistors from 1Ω to 2MΩ
- 1% Basic accuracy.
- Automatic frequency selection.



LCR40
£69

"Star Pack"
LCR and DCA
in carry case
£118.00

Carry cases
£15.00

SMD Tweezer
Probes for LCR
£19.00

Spare Battery
£1.75

accessories & carry cases



Semiconductor Analysis

ESR Measurement
model
ESR60



available December 2004

model
DCA55



£49

Cat5 Cable Testing



model
UTP05

£79

www.peakelec.co.uk

all prices include UK Delivery and VAT

Don't just test it...
...Analyse it!

Circuit Surgery

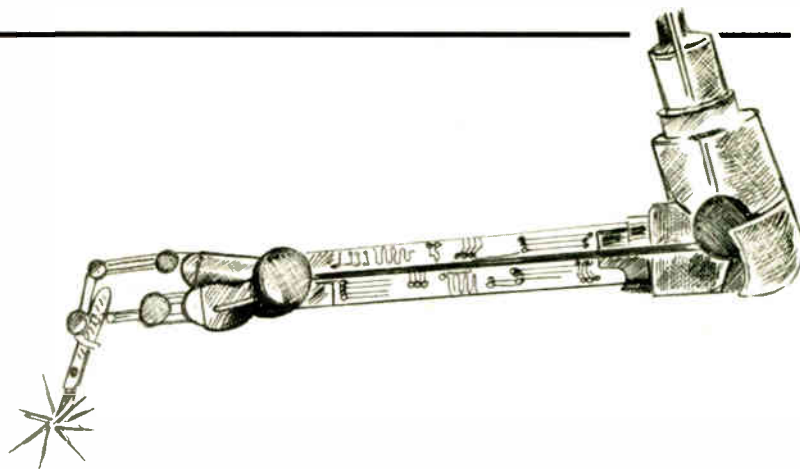

Alan Winstanley and Ian Bell

We round off our brief introduction to the PC Universal Serial Bus, with a suggested circuit

OVER the last couple of months we have looked at some of the internal details of the Universal Serial Bus (USB), looking at pinouts and power requirements, plus the basic concepts behind USB data itself. Hopefully this has given some insight into how it works, at least at the electrical level.

There is a lot more to USB than we have described – in particular we have not discussed much about other aspects such as software drivers needed on the PC, nor the protocols via which communication between the PC and potentially several simultaneously active USB devices can be managed.

Even with our brief overview, you have probably realised that USB is complex and therefore building a USB compliant circuit from scratch is not easy. Unfortunately, applications and software such as a fully-worked USB-based PIC programmer go

beyond the scope of *Circuit Surgery*. Does this mean the hobbyist has to give up on USB? Hopefully not, as there are a number of chips that can do most of the work for you.

One such chip is the surface-mounted FT232BM from Future Technology Devices International Ltd. (FTDI). The FT232BM device is a USB UART (Universal Asynchronous Receiver/Transmitter) which provides conversion between USB and basic serial data of the form used by RS232 (as used by the PC serial port). The FT232BM does not handle full conversion to RS232 – for this you need to add an RS232 level converter chip such as the Maxim MAX213CA1. Conversion to other serial standards such as RS422 and RS485 are also easy using appropriate level converter chips.

Simple USB Circuit

For many possible USB projects, full conversion to RS232 will not be required because the FT232BM inputs and outputs serial digital data in a form that can be directly connected to a device such as a PIC using either a 3.3V or 5V supply, or powered via the USB bus. An example of a circuit like this is shown in Fig. 1.

Even though it is a surface mount device, this should not deter the experienced hobbyist or experimenter who is capable of p.c.b. design or soldering to a reasonable level of accuracy using a very fine soldering iron.

The PIC's on-chip UART (or other device) can connect directly to the UART in the FT232BM. Serial data from the PIC is then sent via USB to the PC. Similarly, data from the PC is

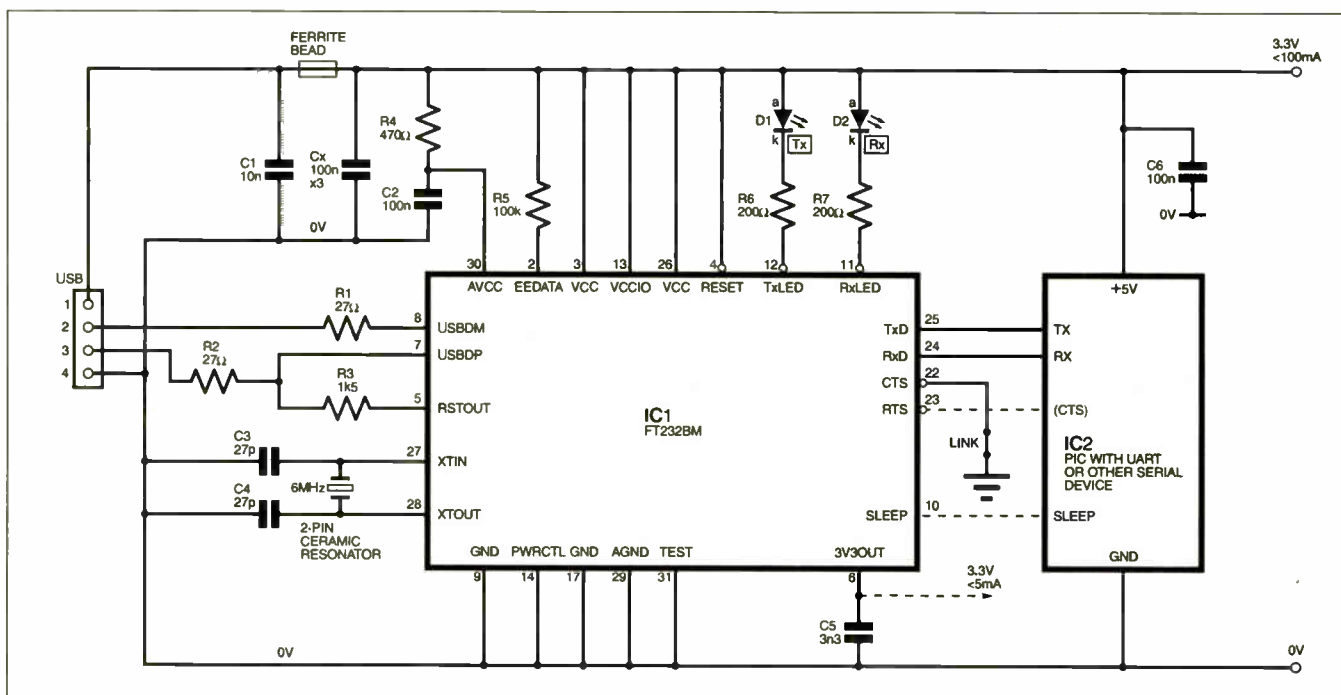

Fig.1. Basic bus powered USB circuit using the FT232BM to provide a serial interface to a device such as a PIC.

received on the USB link by the FT232BM and sent serially to the PIC or other device.

The simplest serial link can be implemented using just two lines, Receive (RXD) and Transmit (TXD), to and from the FT232BM and external device. The other (RS232) serial protocol signals Request to Send (RTS), Clear to Send (CTS), Data Terminal Ready (DTR), Data Set Ready (DSR), Data Carrier Detect (DCD) and Ring Indicator (RI) are all provided on separate pins of the FT232BM and can be used if required.

The FT232BM also provides an Enable Transmit Data output pin for RS485 protocol, and it provides two outputs which can directly drive i.e.d.s to indicate transmit and receive activity. They can drive separate i.e.d.s or they can be wired together to drive a single i.e.d.

The circuit in Fig. 1 shows the FT232BM configured for USB bus-powered operation. As we discussed in our first USB article, there is a limit to the amount of current available from the USB bus. Although USB can supply 500mA the basic circuit in Fig. 1 should not be used for supply currents above 100mA. This is because all USB devices should draw no more 100mA at initial connection.

Power Compliance

For high power bus-powered circuits it is necessary to use the PWREN output pin of the FT232BM to control power consumption. This pin goes low once the USB connection has been established, and can be used to enable the higher power circuitry. Also remember that a bus-powered hub can only supply 100mA to a device connected to it.

Another power requirement for strict compliance with the USB standard is that the USB device must be able to go into suspend mode in which it draws less than 500µA. This can be implemented using the SLEEP output pin of the FT232BM to suspend activity in the rest of the circuit (e.g. put a PIC into sleep mode, or power down an RS232 driver chip). The SLEEP pin goes low during USB suspend.

For projects that exceed a 500mA supply requirement, or have their own power anyway, the FT232BM can be configured for self-powered operation by a small change to the USB interface

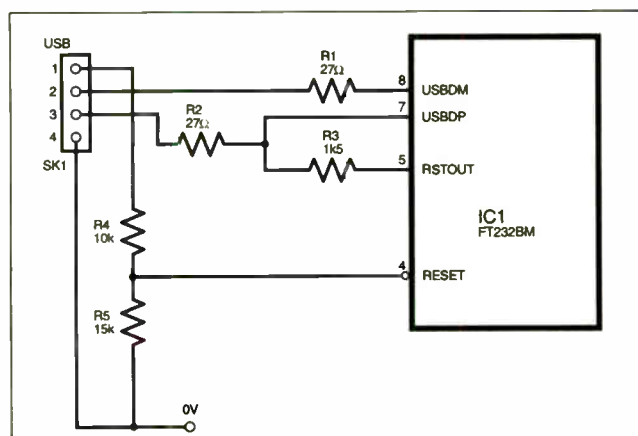

Fig.2. USB connections to the FT232BM for self-powered circuits

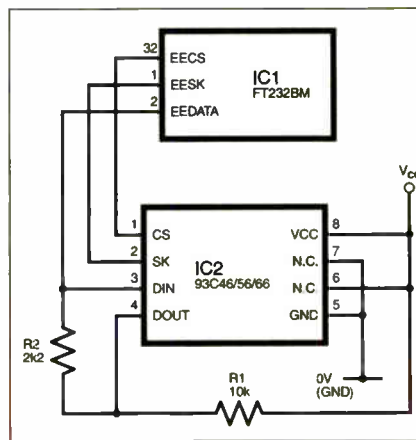

Fig.3. Using an EEPROM to configure the FT232BM.

circuit, as shown in Fig. 2. Here the USB 5V pin is no longer connected to the circuit's supply.

The basic circuit in Fig. 1 will provide a working USB connection to a microcontroller, such as a PIC or other device. However, it does not make full use of all the FT232BM's features. In order to have full control over the configuration of the FT232BM you need to connect an EEPROM containing the configuration data as shown in Fig. 3. The EEPROM data includes Vendor Identifier, Product Identifier Serial Number and Power Description (required for high power devices).

Default USB data is provided by the FT232BM (to the PC) if no EEPROM is present, but without an EEPROM the FT232BM does not provide a serial number. This number allows multiple FT232BMs to be connected without causing conflicts, but means that the device's identification (from the PC's point of view) will change if it is plugged into a different port.

The EEPROMS used can be 93C46, 93C56 or 93C66. The latter two store more data than is required by the FT232BM and this spare space may be used by other parts of the circuit (e.g. a PIC) if access to the EEPROM is correctly controlled (this is explained in detail in the data sheet for the device).

The FT232BM has several power supply pins. There are two V_{CC} (4.35V to 5.25V) pins providing power to the chip core and non-UART interface pins. The V_{CCIO} pin (3.0V to 5.25V) supplies the UART interface (the Tx/Rx i.e.d.s must also be connected to this supply). There are two ground (GND) pins and also an analogue supply and ground AV_{CC} and AGND which power the internal clock multiplier, and finally there is a 3.3V (3V3V_{OUT}) output from an internal regulator. The main purpose of this regulator is to supply the USB transceiver, but a small current (<5mA) may be used by external circuitry.

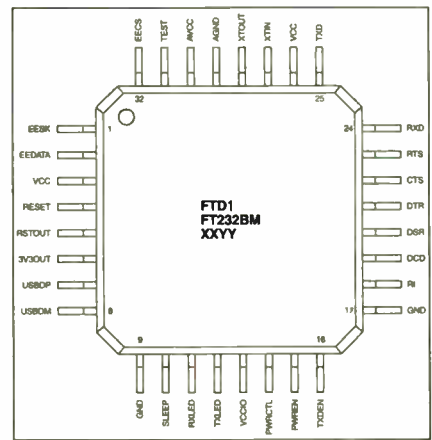

Fig.4. Pinouts for the FT232BM.

Software Drivers

In order to use the FT232BM, software drivers have to be installed on the PC. These are available from the FTDI web site (as are instructions on installation and usage)

To make use of the full features of the FT232BM use the "Direct Drivers" that allows the EEPROM attached to the FT232BM to be programmed with configuration data. You can download a utility from FTDI that programs the EEPROM via the FT232BM over the USB link.

In their simplest form, the drivers create a virtual COM port which can then be used just like any other. So all the software you have written for old serial COMs ports should simply work – just set the COM port number to the virtual port created by the driver.

Similarly, the standard serial program HyperTerminal (found in Windows Communications programs) can be used to test small amounts of data transfer to and from your USB project (particularly if you use text-based data) without having to write any software first.

Resources

Further information can be found on the FTDI web site at www.ftdichip.com. The Site also has a link to FTDI's worldwide sales network.

Hopefully I have given you a taste of what's involved and some useful pointers for further experimentation. I.M.B.

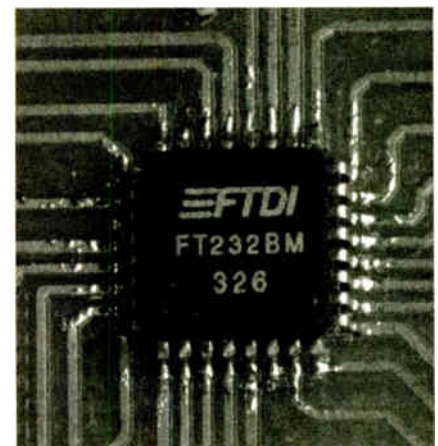

The FT232BM is a surface mount device in an LQFP-32 package with 0.8mm pitch pins. With care it can be soldered by hand, as was the example in this photo.

New Power Products From B.K. Electronics

A new range of 12V and 24V to 230V Inverters with soft start



A Complete range of regulated inverters to power 220V and 240V AC equipment via a car, lorry or boat battery. Due to their high performance (>90%) the inverters generate very little heat. The high stability of the output frequency (+/-1%) makes them equally suitable to power sensitive devices. These inverters generate a modified sine wave, which are considerably superior to the square waves which are produced by most other inverters. Due to this superior feature they are capable of powering electrical equipment such as TV,s, videos, desktop & notepad computers, microwave ovens, electrical lamps, pumps, battery chargers, etc.

★ Soft start (Minimises shutdown when used with inductive loads) ★ Reverse polarity protection ★ Battery low/high shutdown ★ Short Circuit, overload and overtemp protection



£26.48

Part No. 12V 651.620
Part No. 24V 651.623
Continuous Power 150W
Peak Power 450W
Output Voltage 230V AC
AC Frequency 50Hz
Efficiency 90%
Stability +/-10%
Dimensions 165x91x58mm
Weight



£34.43

Part No. 12V 651.626
Part No. 24V 651.629
Continuous Power 300W
Peak Power 1000W
Output Voltage 230V AC
AC Frequency 50Hz
Efficiency 90%
Stability +/-10%
Dimensions 190x91x58mm
Weight 1.1kg



£69.09

Part No. 12V 651.632
Continuous Power 600W
Peak Power 1800W
Output Voltage 230V AC
AC Frequency 50Hz
Efficiency 90%
Stability +/-10%
Dimensions 242x91x58mm
Weight 1.7kg



£141.47

Part No. 12V 651.638
Continuous Power 1000W
Peak Power 3000W
Output Voltage 230V AC
AC Frequency 50Hz
Efficiency 90%
Stability +/-10%
Dimensions 393x242x80mm
Weight 3.1kg

300W Pure Sine Wave Inverter



Part No. 12V 651.650
Continuous Power 600W
Peak Power 1000W
Stability +/-10%
Efficiency 90%

651.650
1000W
+/-10%
90%

A pure sine wave inverter for supplying 230V AC from a 12V car battery. A pure sine wave is required for example field lab use.

- ★ Generates pure sine wave
- ★ Cooling Fan
- ★ Low Voltage alarm below 10.5V DC
- ★ Automatic turn off when voltage below 10V
- ★ Protected against short circuit and overheating

Price £122.06

THD <4%
Dimensions 80x242x255mm
Weight 2.8kg
Temperature Range -15 to +50 Deg C

1500W 12 or 24V to 230V Inverter



Part No. 12V 651.602
Part No. 24V 651.605
Continuous Power 600W
Peak Power 1800W
Output Voltage 230V AC

- ★ The inverter gives an audible warning signal when the battery voltage is lower than 10.5V (21 for the 24V versions). The inverter automatically shuts off when the battery voltage drops below 10V (20V for the 24V versions)
- ★ Protection - Input short circuit and over heating (55 Deg C)
- ★ Modified sine wave
- ★ Remote lead available

Price £246.75

AC Frequency 50Hz
Efficiency 90%
Stability +/-10%
Dimensions 242x91x58mm
Weight 1.7kg

Regulated PSU Adjustable 0-20V / 2A



Only £24.48

Regulated power supply with a variable output voltage ranging from 0V to 30V at 2 amp max.

- ★ Housed in a solid case
- ★ Fixed mains lead
- ★ Illuminated mains switch
- ★ Output via red(+) and black(-) 4mm sockets
- ★ Fitted with 2 panel meters for analogue display of Voltage and current

Power Supply 230V AC 50Hz, Output Voltage 0 to 20VDC, Output Current 2A Max, Dimensions 110x240x150mm, Weight 2.8kg Pt.No.650.673

Regulated PSU Adjustable 0-30V / 10A



Only £157.92

Regulated power supply with a variable output voltage 0 to 30V and current limiting up to 10 Amps

- ★ Voltage and current limiting provided by "coarse" and "fine" rotary controls
- ★ The unit has short and "FOLDBACK" overload protection
- ★ Output via red(+) and black(-) and green(ground) 4mm sockets
- ★ Output voltage and current are indicated by two clear 3-digit green LED displays

Power Supply 230V AC 50Hz, Output Voltage 0 to 30VDC, Output Current up to 10 Amps, Dimensions 160x260x355mm, Weight 12kg Pt. No.650.682

Regulated PSU Adjustable 0-30V / 3A



Only £82.91

Regulated power supply with a variable output voltage 0 to 30V and current limiting up to 3 Amps

- ★ The unit has short and "FOLDBACK" overload protection
- ★ Housed in a solid case
- ★ Power switch fitted
- ★ Output via red(+) and black(-) 4mm sockets
- ★ Output voltage and current are indicated by two high precision LED displays

Power Supply 230V AC 50Hz (150W), Output Voltage 0 to 30VDC, Output Current 0 to 3 Amp, Dimensions 155x2133x285mm, Weight 3.7kg Pt.No.650.676

Triple Output Regulated PSU Adjustable 2x30V / 0-3 Amps Plus 5V at 3 Amp Fixed



Only £157.92

Regulated power supply with with dual variable voltages from 0 to 30V DC and a fixed 5V at 3A output

- ★ The setting of the output voltages can be coupled (master/slave)
- ★ Series and parallel switchable output
- ★ The unit has short and "FOLDBACK" overload protection
- ★ Output via red, black and green terminals
- ★ Output voltage and current are indicated by two clear 3-digit green LED displays

Power Supply 230V AC 50Hz, Output Voltages 2 x 0 to 30VDC 1 x 5V fixed, Output Current 2 x 0 to 3 Amps 1 x 3A fixed, Dimensions 160x260x355mm, Weight 12kg Pt. No.650.685

Regulated PSU Adjustable 0-50V / 3A



Only £94.75

Regulated power supply with a variable output voltage 0 to 50V and current limiting up to 3 Amps

- ★ The unit has short and "FOLDBACK" overload protection
- ★ Housed in a solid case
- ★ Power switch fitted
- ★ Output via red(+) and black(-) 4mm sockets
- ★ Output voltage and current are indicated by two high precision LED displays

Power Supply 230V AC 50Hz (175W), Output Voltage 0 to 30VDC, Output Current 0 to 3 Amp, Dimensions 155x2133x285mm, Weight 3.7kg Pt.No. 650.679

13.8V Fixed Voltage PSU

A complete range of fixed voltage regulated power supplies all short circuit and "FOLDBACK" protected housed in sturdy cases

Model Number	650.652	650.654	650.657	650.660	650.663	650.667
Continuous Current	3A	5A	7A	9A	12A	15A
Maximum Current	5A	7A	10A	15A	20A	25A
Peak Surge Current	7A	9A	12A	17A	22A	27A
Output Voltage	13.8V DC	13.8V DC	13.8V DC	13.8V DC	13.8V DC	13.8V DC
Price	£18.70	£23.96	£32.81	£49.26	£57.46	£67.17

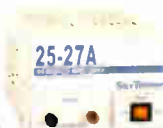

DELIVERY CHARGES:- ALL ABOVE ITEMS CHARGED AT £8.00 PER ORDER. ORDERS FROM SCHOOL COLLEGES, GOVT. PLCs ETC. PRICES INCLUSIVE OF V.A.T. SALES COUNTER. CREDIT CARD ORDERS ACCEPTED BY POST PHONE OR FAX. E&OE



B.K. ELECTRONICS

Ad-5

UNIT 1 COMET WAY, SOUTHEND-ON-SEA, ESSEX. SS2 6TR.

TEL.: 01702-527572 FAX.: 01702-420243

Web:- <http://www.bkelec.com> E-Mail sales@bkelec.com

READOUT

WIN AN ATLAS LCR ANALYSER WORTH £79

Email: john.becker@wimborne.co.uk

John Becker addresses some of the general points readers have raised. Have you anything interesting to say? Drop us a line!

All letters quoted here have previously been replied to directly.

An Atlas LCR Passive Component Analyser, kindly donated by Peak Electronic Design Ltd., will be awarded to the author of the *Letter Of The Month* each month.

The Atlas LCR automatically measures inductance from $1\mu\text{H}$ to 10H , capacitance from 1pF to $10,000\mu\text{F}$ and resistance from 1Ω to $2\text{M}\Omega$ with a basic accuracy of 1%.



★ LETTER OF THE MONTH ★

Electromagnetic Pulses

Dear EPE,

Mike Kenward's *Editorial* (Jan '05) brought back memories of a time when I was involved in the building and testing of an EMP (electromagnetic pulse) simulator. There is nothing secret or technical in the design, although I won't reveal the location where I worked. All countries that produce defence electronics will have a simulator of some sort. Size varies with application. The US have a massive bridge built entirely of wood (no metal fasteners) onto which they can roll B52 bombers. Another spans a cliff-lined inlet into which the largest aircraft carriers will fit.

The one I worked on would have been able to take a reasonable size truck. The method of producing EM pulses consisted of a high voltage generator/store which was triggered through an oil bath capacitor, onto an adjustable spark gap (built in a sealed container which was filled with SF6 gas). This then passed through a series of about 10 steel wires which fanned out and over the equipment to be tested, before converging back down to a large resistor network to earth. The voltage was only half a megavolt, larger systems run up to tens of megavolts. Although the voltage was modest, care had to be taken in construction in order to negate corona effect and its losses.

The tricky part comes in getting the speed of rise-time of the pulse. It is this that can kill electronics by beating protection responses. We were given a target of one nanosecond rise-time. After trying a couple of capacitors and varying the pressure of the SF6 gas and the spark gap,

a calculated speed of 1.2 nanosecs was achieved. Had we more modern measuring equipment, the results may have been different. The capacitors took about a week to build and installing them meant the removal/replacement of about 2000 litres of transformer oil.

I know the system worked as my transistor radio got fried during one of the tests. I don't know a lot more about the subject other than the above. I joined another project shortly after and don't know if minimum rise-time was beaten. However, I do know how to switch one million amps!!

It's probably easier and cheaper to explode a nuclear device to produce a large EM pulse than find another method.

It has been some time since I last wrote. I have changed profession (I seem to do this every 16 or so years, so this should be the last) and have spent the last 13 months getting "up to speed". I now work as an electro-mechanical technician, servicing and repairing 650 volt generating and UPS (universal power supply) systems for the railway. This opportunity arose just as I was building an inverter system to run a three-phase lathe in my shed. They had to stop me when they asked if I knew anything about UPS systems! A lot of the information I gleaned from articles and projects in *EPE*. I'm forever grateful.

Graham Card, via email

How nice to hear from you again Graham, and with a fascinating tale to tell! Thank you. And you've also convinced me not to try generating EMPs with a PIC! Very best wishes with the new job.

Smart Karts

Dear EPE,

I was delighted to receive the October edition of *EPE* and find the *Smart Kart* article in it. I run Hobby Electronics courses for "mature age" students and we have been tinkering with simple mobile buggies using op.amps and 555 timers. But the *Smart Kart* will be our main construction project for next year. Many thanks for a great magazine.

Tony Lee, Old Reynella, S. Australia, via email

Thanks Tony, that's good to know. We expected that Owen Bishop's imaginative robot would find use in many educational ways. It really is a "fun" design as well.

Clear L.E.D.s

Dear EPE,

I would like to say how much I have enjoyed reading Anthony H. Smith's series of articles on l.e.d.s and related circuits (Sept '04 to Jan '05). Even though I have an HND in Electrical & Electronics Eng. (after many years of study at night-school) I often struggle to understand many articles on electronics, never having had the chance to work in the industry. However, I found Anthony Smith's articles refreshing and a model of clarity.

David R. Smith, via email

Thank you for your kind words David. We know that many readers have benefitted from Tony's excellent series.

Speed Camera Watch

Dear EPE,

Regarding Mike Hibbett's *Speed Camera Watch* (Jan '05), rather than spend time and effort on designing a device to alert himself of the presence of a camera, perhaps he might consider changing his driving habits and observe the speed limits.

I fear, however, that this is not likely to happen as he admits often to being unaware of his speed and many times in the same spot.

Cameras are placed so as to be easily visible (not near sharp bends) and are sign-posted and painted bright yellow to alert drivers in plenty of time, reminding us to obey the law or be prosecuted for behaving irresponsibly.

And I think your magazine is behaving irresponsibly in publishing this article which, despite its disclaimer, encourages the law-breaker.

Robert Talbot, Member of the Institute of Advanced Motorists, via email

Editor Mike replies:

I cannot see how this encourages the law breaker. No doubt you have never drifted over the speed limit but I am afraid that most of us are human and occasionally do so. As you say cameras are obvious to alert drivers in plenty of time, this device just adds to that time. I don't think Mike suggested that cameras were placed near sharp bends, simply that the unit could also remind you of a bend etc.

If this device helps to keep drivers within the law then it must be a good thing. Indeed, some Police forces have advocated the use of such detectors. As we said on the front cover, this is an early warning system. I guess our opinions must differ on this one but I certainly do not feel we have in any way acted irresponsibly.

Mike Kenward

Time-Warp?

Dear EPE,

I enjoyed the November issue as usual, but feel that a few comments are in order:

Andy Emmerson (*Techno Talk*) includes Abraham Lincoln in the list of individuals whose voices may be recovered from early recordings by the application of the latest digital technologies. Unfortunately, President Lincoln was murdered in 1865, twelve years before the first audio recording was made. Therefore, I suspect that Mr Lincoln's voice is still beyond the reach of our technology.

The story "News... Valve Centenary" suggests that Fleming's valve delayed the imminent development of semiconductor

technology. But, is this assertion plausible? The 43 years between the valve's invention and the first transistor, produced an explosion of scientific and technical knowledge and skill.

Yet, in 1947 the Bell Labs team that developed the transistor was just barely able to make it work even though they had the best materials, the latest equipment, the brightest people, and buckets of money. In fact, they gave up on their first design, a field effect device, because they were unable to produce sufficiently pure semiconductor materials. The point-contact transistor was the best they could do.

More years of R&D, especially in materials science, were needed to produce the silicon junction transistor. And, still more years of R&D after that before semiconductors could handle a significant amount of power. Rather than impeding progress, Fleming's valve was the very development which opened the door and enabled all that followed.

Herman Respass, Shelby Township, Michigan, USA, via email

Editor Mike replied to Herman:

Thanks for your interesting response, which I have sent on to Andy Emmerson for his comments. On the subject of semiconductor development I take the points you have made but should also point out that "crystals" with three contacts were being used to "amplify" before Fleming invented the valve and no doubt development of that area of technology would have speeded up semiconductor electronics.

To which Herman replied:

I have seen some early crystal circuits (galena and cat-whisker) with three contact points. Some of them were called amplifiers or amplified output receivers. The ones I've seen so far were really voltage doublers. The crystals formed two diodes. Although true amplification did not occur, these circuits could provide significantly louder output than single diode circuits. The increased loudness sometimes gave the impression of amplification to early experimenters.

However, there are certainly many things in this world which I have never seen. Maybe this is an opportunity for me to learn something new. If you would point me to a source of information, I would appreciate it.

And Andy responded:

At first sight Mr Respass has got to be right; Lincoln did indeed die before Edison disclosed his tinfoil recording system. But Edison was by no means the first person to record sound, a fact that I didn't have space to mention in my article.

Under the heading "Sound recorded in 1857", a web page reports: "For years, a rumor has titillated enthusiasts of phonograph history - the speculation that Abraham Lincoln made a sound recording. Indeed, it is known that in 1857, a French scientist named Leon Scott invented a proto-phonograph that recorded, but could not play back, sounds. According to the Lincoln rumor, the 16th president spoke

into a similar device in 1863. However, Lincoln fans shouldn't get too excited. For now, there's absolutely no proof that Lincoln actually took time off during the Civil War to speak into anyone's recording device, experts say."

Nevertheless, Scott is reputed to have recorded Lincoln in the White House on his Phonograph and at this point in time, who is qualified to prove or disprove this? His machine certainly exists and is preserved in the Smithsonian Institution. If you follow the thread on this subject at <http://palimpsest.stanford.edu/byform/mailling-lists/arsclist/2004/07/msg00193.html> you will see that a working phonograph had already been constructed in 1791.

Very few devices were actually "invented" by the person who took the credit in history; they merely improved the prior inventions of others. Leon Scott's Phonograph is described at <http://history.acusd.edu/gen/recording/scott.html>, where you can also see a photo of one of his machines.

As for Mr Respass' comment about "the 43 years between the valve's invention and the first transistor", I don't think he has read about Lossev's "oscillating crystals" nor seen my article on pre-1947 crystal triodes (*Who Really Invented the Transistor?* Jan '03). Working transistors were produced long before Bell Labs re-invented them and embezzled the credit for a pre-existing technology!

Andy Emmerson

Windication

Dear EPE,

Can I thank Mike Feather for his *Wind Direction Indicator* (EPE Dec 2004). It is always of interest to see how other designers approach a problem, and it is a relief to see a proper electronic design that doesn't rely on software in a PIC. There are a couple of comments I would like to make though.

Firstly, I don't think the suggested shaft encoder is going to last very long in a weather-exposed environment. I can find no specification for the switch contact plating, and at the price I don't think it's likely to be gold. If a sensor is going to be in service for the long term and not just a few months, a non-contact encoder is required (for example, brew your own optical encoder with a clear plastic wheel, some l.e.d.s, and a few phototransistors).

My other point is that the decode and display circuit can be reduced to one i.c.! While the use of a 74LS86 to convert Gray code to binary is very interesting and educational, it really isn't necessary. Just feed the Gray code directly into the binary inputs of the 74LS154 decoder, and sort it out by putting the l.e.d.s in Gray-code order around the display.

Ken Wood, via email

Thanks Ken, your comments are appreciated. Somehow, though, I suspect those switch contacts may remain functional for longer than you might think. Assuming that they are kept moving by the wind, there should be a degree of self-cleaning that takes place. On the electronics circuit board, though, it might be worth while

coating it with "conformal" spray to protect it from moisture and possible degradation of tracks and joints.

In a wind sensor I did some 10 years back I did use opto-coupling, in conjunction with a linear optosensor chip that had been newly introduced at that time. It was, though, a more complex solution than Mike used. We liked the simplicity of what Mike achieved, whilst one chip could have been saved, it would have made the board more complex.

Shorting-Out DIY?

Dear EPE,

I hear that as from January nobody will be able to alter anything electrical like wiring in their own house without getting it checked and passed by a qualified jobsworth electrician. That is if you can find one of these rare individuals with the necessary bit of paper and who will even consider visiting at less than a £200 call out charge.

I have in my time had more than enough of the "you can't do that 'cos I say so" brigade to last me many lifetimes. If this is a fact then you may as well pull down the shutters on the mag 'cos sooner or later a clown will be accusing you of aiding and a betting.

George Chatley, via email

I don't know what implications this might have George, either in terms of what I do in my own home, or what significance it might have if any for EPE and other mags in our field.

For a start, how on earth do they enforce this restriction? Do they intend that DIY stores should stop selling electrical cable, sockets, junction boxes etc? Since buying my first house 40 years ago I have always made electrical changes and upgrades as I have seen fit, and without "professional" intervention, with one exception. That was when I had a heavy-current potter's kiln installed at one house. The electricity company came to approve my wiring for that before final connection was made. My recollection is that I called them for my own reassurance about safety.

Clowns or no clowns, I find it difficult to understand how this intended restriction can be made workable.

Toolkit TK3 V3.00

By the time you read this, a much updated version of my EPE Toolkit TK3 PIC programming and assembly software, V3.00, should be on our Downloads site, via www.epemag.co.uk.

The most significant aspects of this version are that a Mini Simulator and facilities for PIC18F devices have been added. Note, though, that whilst much field testing for the 18Fs has been done, this extensive addition should be treated as a "beta" test version and feedback on any aspects will be much appreciated.

Both additions will be reported on in more detail in the March issue. Malcolm Wiles will also be introducing PIC18Fs to you formally in the April issue.

Reader Ian Stedman has also kindly contributed a TK3 FAQ, which is also with TK3's Folder.

Sound Card Mixer

Terry de Vaux-Balbirnie

Bring "Life" to your computerised live recordings!



HAVE you ever used your computer's sound card to make a live recording? Did you plug a microphone into the "microphone input" socket and were disappointed with the results? If so, read on!

The most common complaints from people doing this are of weak or distorted sound. One reason appears to be that there is no uniform standard set for this input. In many cases, it will have been designed for a computer microphone (say, for voice recognition purposes) rather than the general type used for music and voice recording. Even if the input is sufficiently sensitive to handle the very low signal from a good quality microphone, the on-board preamplifier is often of a low quality, resulting in distortion.

On the Level

Such problems may be overcome by using the sound card's Line input instead. This has more predictable characteristics and should be more or less the same for all makes and types of card. However, you cannot plug a microphone directly into this input and expect it to work properly. This is because it requires a signal of up to one volt to load it, rather than the few millivolts available from the microphone. A preamplifier is therefore necessary between the microphone and sound card to boost the signal.

One point worth noting is that the microphone input on a cheap sound card is sometimes a line level input anyway and the socket labelled "line input" appears to do nothing!

The Sound Card Mixer circuit described here provides the boost necessary to bring the microphone output to line level. However, while designing it, certain other issues were addressed to make it appeal to more readers. To this end, the finished device takes the form of a desktop unit which is connected to the sound card through a short length of cable. This avoids having to fumble behind the computer whenever connections need to be changed.

The new unit also provides additional inputs – for two stereo microphones (or four mono ones) plus a stereo line input. The latter allows a high-level device such as a CD player, tape deck or musical instrument to be connected. Of course not all the inputs need be used.

Six controls on the front panel allow the left and right channels of all inputs to be adjusted and mixed independently to provide a single pair of stereo outputs.

Extra Inputs

If the circuit is built in the specified case, there will be space for more sockets in addition to those described above. These could provide composite video input and output, for example, which might be used for video editing. These sockets would be connected directly to the computer, using their own cables – they would not really be part of the new circuit.

The unit is powered using an internal 9V battery pack consisting of six "AA" size alkaline cells. An On-Off switch and associated light-emitting diode (l.e.d.) "On" indicator are also fitted. The circuit draws some 40mA while operating, so the batteries may be expected to provide about 35 hours of service. Larger batteries could be used providing there is sufficient space inside the case to accommodate them (or you place them externally).

Another good method would be to use six nickel-cadmium or nickel metal hydride (rechargeable) batteries. Their 7.2V nominal output would be sufficient. It is not advisable to power the circuit from a mains-derived supply because there could be problems with mains induced hum.

Circuit Description

The full circuit diagram for the Sound Card Mixer is shown in Fig.1. IC1 to IC4 are identical low-noise dual operational amplifiers (op.amps). There are therefore eight op.amps altogether. All the "a" sections are associated with Right channels while the "b" ones are used for the Left.

Op. amps IC1a and IC1b are used for the first microphone input (MIC 1) while IC2 performs the same function for the other one (MIC 2). Op. amps IC3a and IC3b are associated with the Line Input. IC4a and IC4b are used as mixers which combine all the Right and all the Left signals obtained from IC1 to IC3.

The positive supply feed is via On/Off switch S1 and operates l.e.d. indicator D2

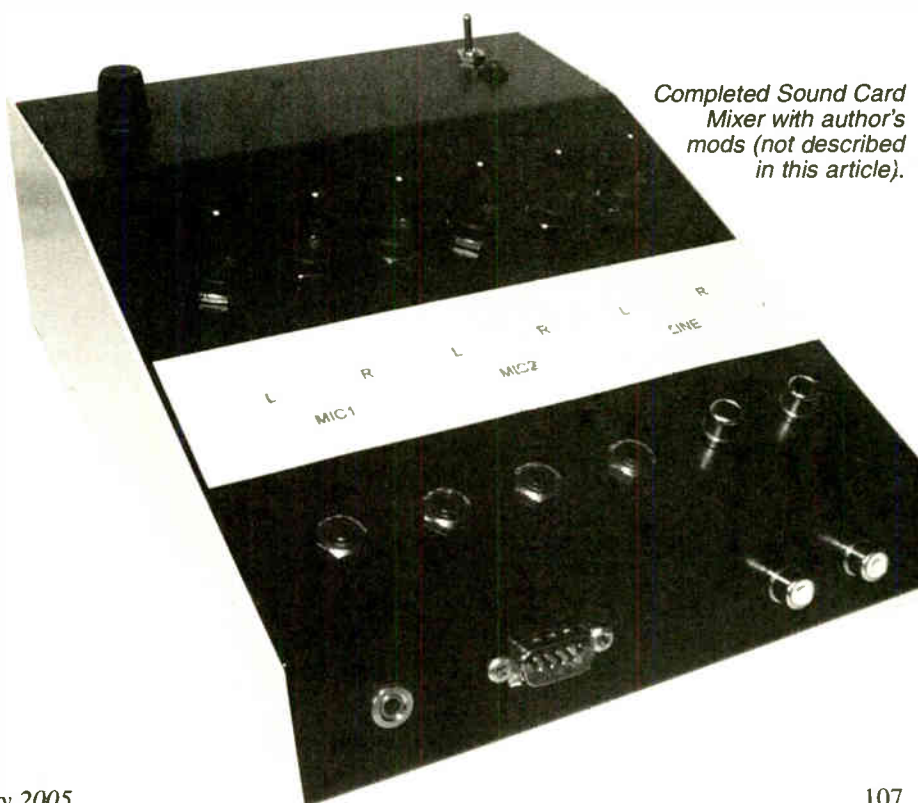

Completed Sound Card Mixer with author's mods (not described in this article).

Resistors

R1, R11, R21, R31	680Ω (4 off)
R2, R3, R6, R7, R12, R13, R16, R17, R22, R23, R32, R33, R42, R43, R52, R53	22k (16 off) 47k (4 off)
R4, R14, R24, R34	
R5, R15, R25, R35, R41, R45, R51, R55	10k (8 off)
R8, R18, R44, R54	15k (4 off)
R9	560Ω

All 0.25W 5% carbon film or better.

Potentiometers

VR1, VR11, VR21, VR31	220k enclosed carbon preset, horiz. (4 off)
VR2, VR12, VR22, VR32, VR42, VR52	10k single-turn conductive plastic, 12mm square p.c.b. mounting (2.5mm pin spacing), log. or lin. (6 off)
VR3, VR13	10k enclosed carbon preset, horiz. (2 off)

Capacitors

C1, C11, C21, C31, C41, C51	4μ7 min. radial elect. 35V (6 off)
C2, C6, C12, C16, C22, C32, C42, C52	47μ radial elect. 16V (8 off)

C3, C7, C13, C17, C23,
C33, C43, C53
C4, C5, C8, C9, C14, C15,
C18, C19, C24, C25, C34,
C35, C44, C45, C54, C55

22p ceramic disc,
5mm pitch (8 off)
10μ radial elect. 16V
(16 off)

See
SHOP
TALK
page

C20

Cx

220μ radial elect. 16V
220n ceramic disc,
5mm pitch (see text) (4 off)

Semiconductors

D1

D2

IC1 to IC4

1N4001 50V 1A rect.
diode
red l.e.d. indicator
NE5532 dual low-noise
op.amp (4 off)

Miscellaneous

S1

SK1 to SK4

SK5, SK6

s.p.d.t. toggle switch
3.5mm mono jack
socket (4 off)
non-insulated phono
sockets (see text) (2 off)

Printed circuit board, available from the *EPE PCB Service*, code 489; metal instrument case, 220mm x 170mm x 35mm (min. height) x 80mm (max. height); control knobs (6 off); rubber grommet; AA alkaline cells (6 off); PP3-type battery connector; materials for battery bracket; 8-pin d.i.l. sockets (4 off); small fixings; stereo screened cable; 3.5mm stereo jack plug; plastic p.c.b. spacers (see text); cable tie; connecting wire; solder etc.

via current-limiting resistor R9. Current also flows through diode D1 to charge capacitor C20. The capacitor provides a reserve of charge and maintains any momentary peaks of current which will be useful when the battery is nearing the end of its life.

The diode also provides reverse-polarity protection – if the supply were to be connected the wrong way round, the diode would fail to conduct and nothing would happen. This prevents damage to the other semiconductor devices. Note, however, that the l.e.d. indicator is not protected in this way.

Since the circuits based on IC1a/b and IC2a/b are identical, only a description of that centred around IC1a is required. The Right microphone input is connected to IC1a inverting input, pin 6, via capacitor C1 and input resistor R1 (the equivalent resistor in IC1b is labelled "R11" while in IC2a it is labelled "R21" and so on).

Capacitor C1 allows the a.c. signal to pass while blocking the d.c. path. The resistance of the microphone itself, therefore, does not affect the circuit following it.

Boost

The combined value of fixed resistor R4 and preset potentiometer VR1 in series (the feedback network) divided by that of R1 determines the gain (amplifying factor) of this section. In fact, this is *negative* (since it is configured as an inverting amplifier) but this does not affect the practical result.

With the values specified, the minimum gain is therefore –70 times and the maximum, –400 times approximately, depending on VR1 adjustment. This will be set at the end to match the sensitivity of the

microphone used.

Low-value capacitor C3, connected in parallel with R4/VR1, has negligible effect at audio frequencies. This is because its impedance will be high compared with that of the resistors.

However, at frequencies higher than the audio range, its impedance becomes significant and this reduces the overall value of the feedback loop. The gain therefore "rolls off" and prevents any high frequency instability which might otherwise occur.

Bias

The non-inverting input (pin 5) of IC1a is connected to the potential divider consisting of equal-value resistors R2 and R3. This biases it to one-half of the supply voltage (nominally 4.5V). It allows processing of both the positive and negative parts of the input signal by allowing them to swing above and below this level.

However, as far as a.c. is concerned, capacitor C2 maintains the non-inverting input at 0V because it has a very low impedance at audio frequencies and effectively reduces the value of the lower "arm" of the potential divider.

The output signal appears at pin 7 and the a.c. (audio) signal flows, via capacitor C4 and the track of potentiometer VR2, to 0V. Potentiometer VR2 is one of the six panel-mounted mixer controls and it allows a fraction of the output voltage to be "tapped off" by the sliding wiper contact. This is fed, via capacitor C5 and resistor R5, to the Right channel mixer section based on IC4 and which will be described presently.

The above description applies not only

to the other microphone channels but also to the line inputs. However, there are certain small differences.

Looking at IC3a (right line channel), the gain is fixed at 1.5 times by the ratio R44/R41. This is much less than the gain of the microphone channels because the signal is already at a high level. A small amount of boost is applied so that a suitable gain will be obtained when the sliding contact of mixer control VR42 is at some intermediate setting.

Mixing It

The right-hand channel signals (two microphone and one line) pass via capacitors C5, C25 and C45 and resistors R5, R25 and R45 respectively to IC4a inverting input, pin 6 (the right channel mixer input). The non-inverting input (pin 5) is biased using resistors R6 and R7 in the same way as for IC1/IC2/IC3.

The gain is the same for all channels and is set by the resistance of R8 divided by that of one of the input resistors (R5, R25 and R45) giving 1.5 times. Capacitor C7 rolls off the gain at high frequencies and promotes stability in the same way as with the previous sections.

The combined right-hand signal passes via capacitor C8 through the track of preset potentiometer VR3, whose sliding contact then "taps off" a fraction of this and the final output appears via capacitor C9. Mixing of the left-hand channels is carried out by IC4b in exactly the same way.

Preset VR3 and VR13 will be adjusted at the end to match the gain to the output requirements of the sound card, also to remove any imbalance that might exist between the right and left channels.

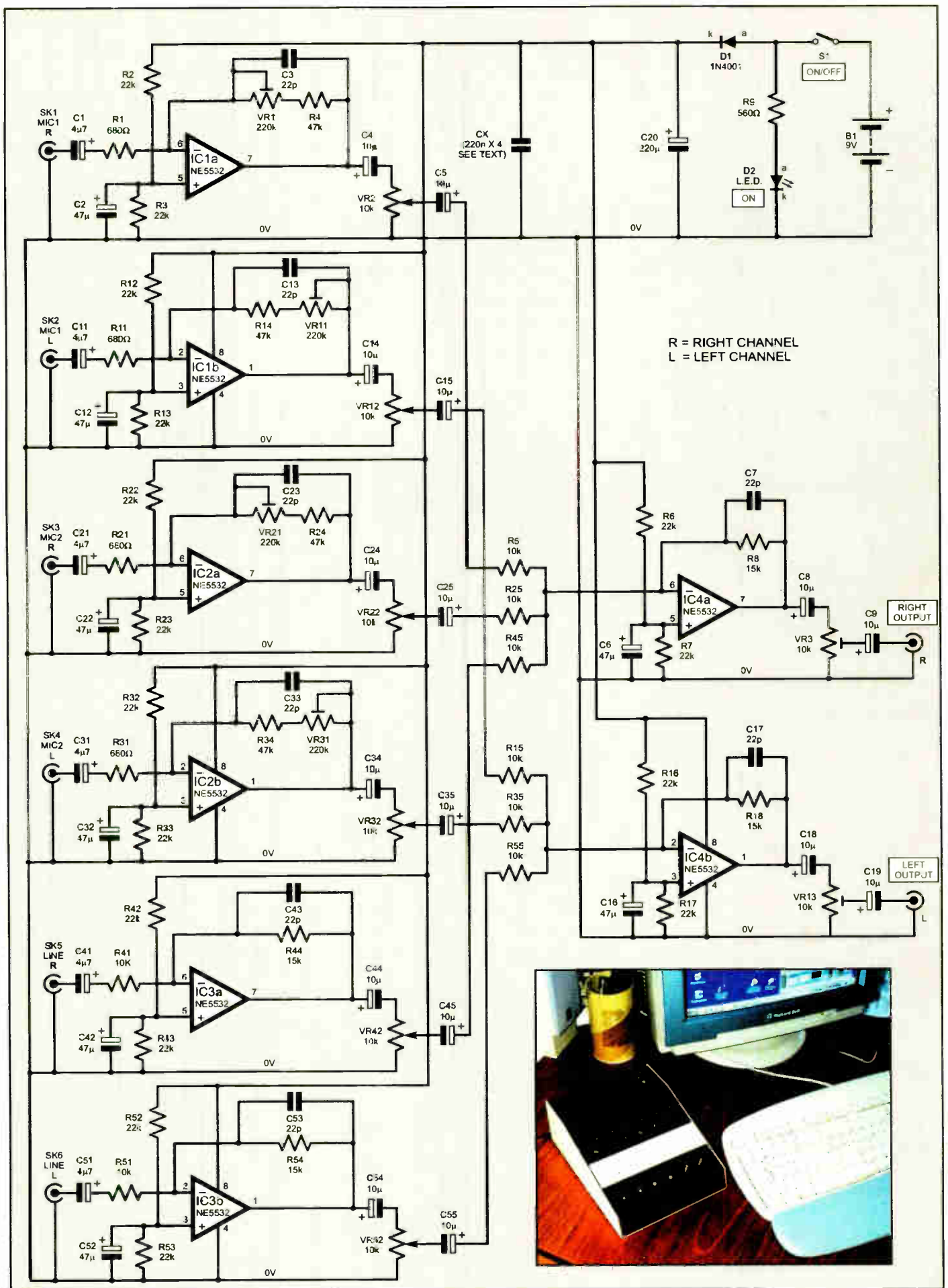

Fig.1. Complete circuit diagram for the Sound Card Mixer. Note that the author used jack sockets for the MIC inputs and un-insulated phono sockets for the Line inputs.

Construction

Construction of the Sound Card Mixer circuit is based on a single-sided printed circuit board (p.c.b.). This board is available from the *EPE PCB Service*, code 489. The component layout, interwiring and actual size copper foil master track pattern are shown in Fig.2.

Drill the five p.c.b. mounting holes in the positions indicated (they might not be needed but it is better to drill them at this stage just in case). Drill small holes in the positions indicated at the centre of each preset VR1, VR11, VR21 and VR31 position. This allows them to be adjusted through the p.c.b. when this is in position.

Solder the four 8-pin i.c. sockets and the link wire (near IC4) in place. Follow with all resistors (including the six presets) but not the mixer controls (VR2, VR12, VR22, VR32, VR42 and VR52). Add diode D1, taking care over its orientation. Next, solder the capacitors in position. Most of these are electrolytic types and must be soldered with the polarity as indicated.

Capacitor C20 should be mounted flat on the circuit board to present a low profile.

There are four decoupling capacitors (all labelled Cx) – one across the supply rails of each i.c. Only one of these capacitors is shown in the circuit diagram but all four appear on the p.c.b. layout.

Next, solder the mixer potentiometers in place. It would be better if they were of the logarithmic type since these give a better physiological response (angle of rotation against perceived change in volume) but, in fact, ordinary linear controls would be perfectly adequate. The potentiometers are mounted flat on the circuit board so that the spindles point vertically upwards.

However, those used in the prototype were really intended for vertical mounting. If the units used are of this type, the connecting pins will need to be bent through right angles. Additional support should then be given to

each potentiometer by a wire loop passing round the bush and soldered to the unconnected pad below its position.

Going Loopy

Prepare these loops using bare connecting wire (strip the insulation from ordinary single-strand wire). Using a suitable mandrel (say, the shank of a 10mm drill bit) twist the wire to make a loop at one end and solder the joint. Pass a loop over each bush, pull the wires tight and solder the ends to the free pads.

Adjust all six preset sliding contacts to approximately mid-track position. Check that the tops of all on-board components fall below the level of the potentiometer bushes and make any adjustments as necessary to make this so.

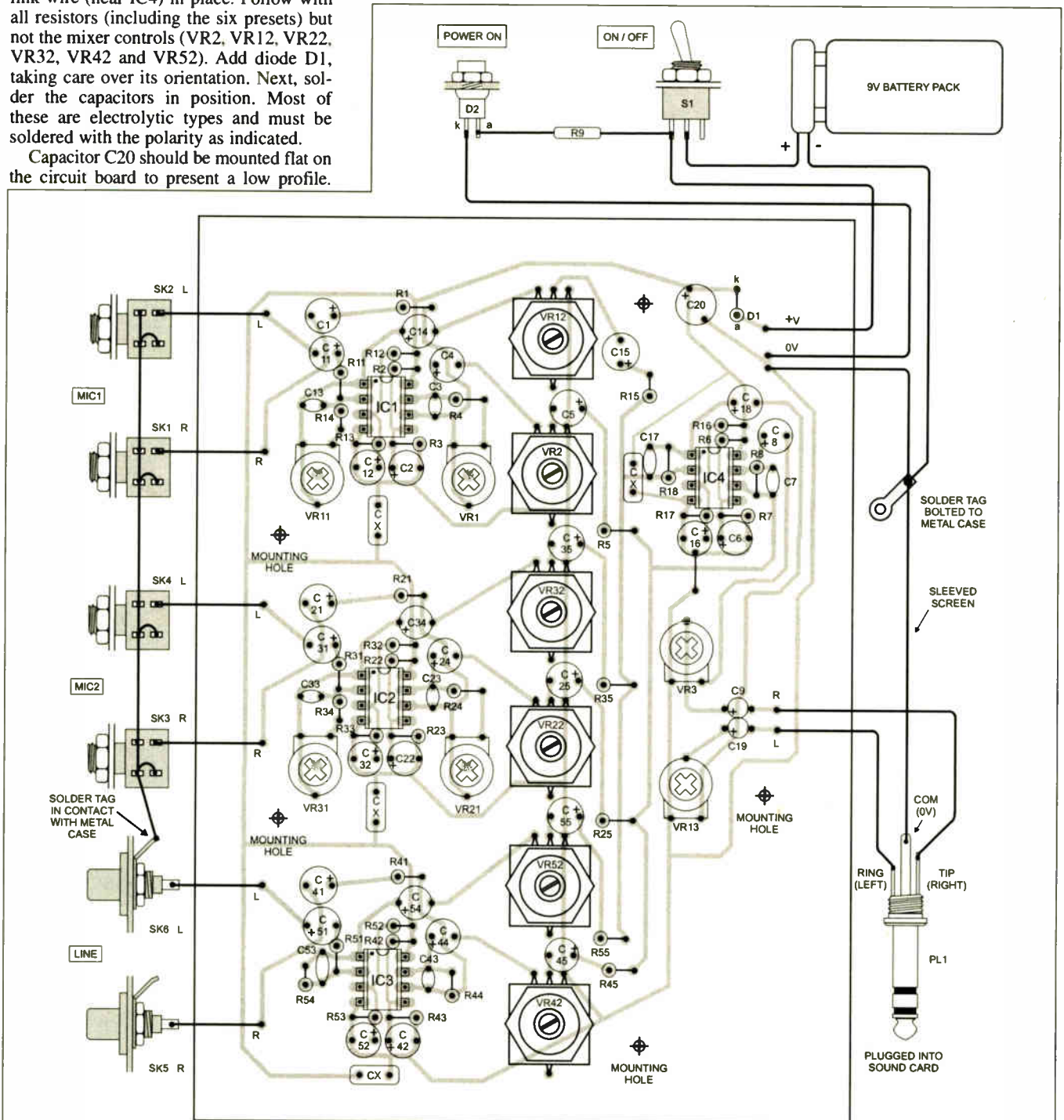

Fig.2. Sound Card Mixer printed circuit board component layout and interwiring. The full-size underside copper foil master is shown on the opposite page. The right and left outputs have been hard-wired to a stereo jack plug. Connections will, of course, have to match your own sound card set-up.

Boxing Up

An all metal box must be used for this project. This screens the circuit against possible hum pick-up which might otherwise be apparent in the final sound. The box should be large enough to accommodate all components and allow for any anticipated expansion with sockets for special purposes, etc.

Plan the layout of the front panel. This involves marking the positions of the potentiometer bushes, i.e.d. indicator, on-off switch and input sockets. Drill these holes through. In the prototype, 3.5mm mono jack sockets were used for the microphone inputs. In some cases, stereo sockets would be appropriate.

If the microphones have 6.35mm jack plugs fitted, adaptors are available to enable them to be plugged into 3.5mm sockets. Otherwise fit 6.35mm sockets if space permits. Whatever sockets are used, they should have switch contacts that open when a plug is inserted. These will be used to connect the "tip" to 0V ("earth") when a channel is left "open". This technique prevents hum that might be introduced by an unconnected input.

The Line inputs are made to a pair of phono sockets (SK5 and SK6). Mark out and drill a hole in the rear of the unit for the rubber grommet which will carry the output cable.

4.33in (110mm)

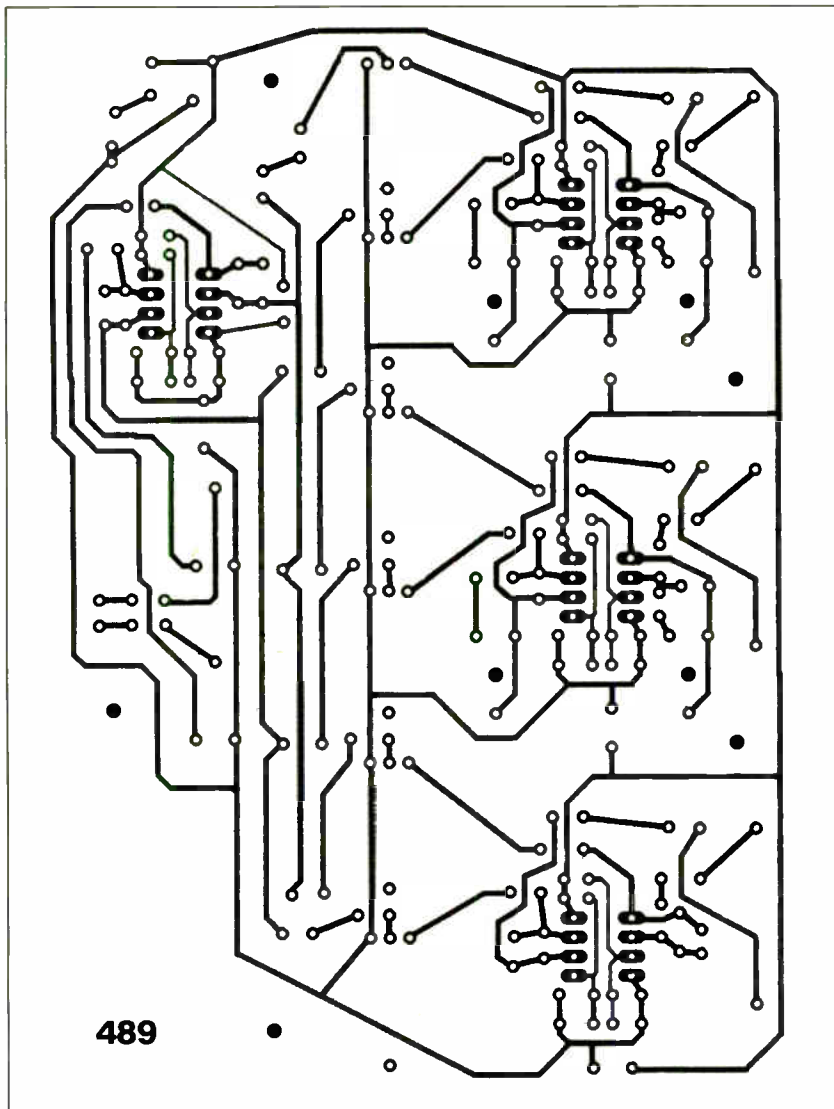

Full-size underside p.c.b. copper foil master pattern.

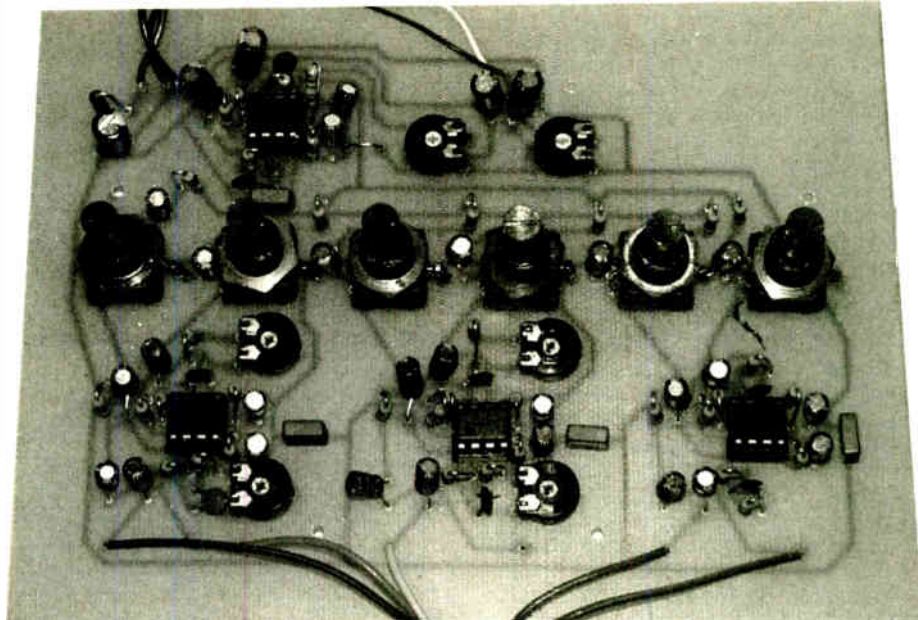

Component layout on the completed circuit board

Supply Arrangements

Decide where the battery pack is to be mounted and make a bracket to hold it. Drill the necessary attachment holes and a further one for a solder tag near the battery position. Fit these parts. Make sure

the solder tag makes good electrical connection with the case by scraping off the paint around it.

It would be better if the batteries were attached to the lid section of the case rather than being placed on the bottom. This is because the wires will not be put under any strain when the lid is removed.

Check the fit of the p.c.b. Use washers (or spare nuts) on the potentiometer bushes so that as little as possible of them will protrude on the outside. This will provide a better fit for the control knobs (but do not attach these yet). With the arrangement used in the prototype, the potentiometer fixing nuts alone were sufficient to hold the panel securely – check this point.

If necessary, mark the positions of the p.c.b. mounting holes on the box, remove the p.c.b. and drill some or all of them through. Additional support may then be given by using thin bolts through these holes. If doing this, use stand-off insulators on the bolt shanks cut to the correct length. Mount the p.c.b. temporarily making sure that no on-board components are bent out of position or put under strain when the potentiometer nuts and any other fixings are tightened.

Mount the input sockets. If the phono sockets are of the "single hole fixing" non-insulated type as specified, scrape away the paint around the holes so that the "sleeve" connections make good metallic

5.75in (146mm)

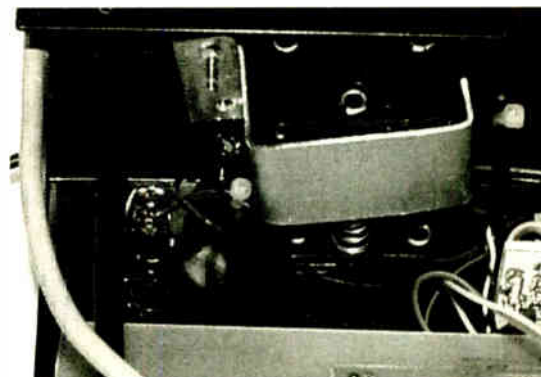

Battery holder (6 cell) clamped to the side wall of the case.

contact with the case. Also, fit a solder tag (supplied with this type of phono connector) to the one nearest the microphone jack sockets. This is used as an "earth" (0V) point for all the jack socket sleeve and switch connections. If the phono sockets used do not make an automatic connection between the "sleeve" and the metalwork, a separate solder tag making good electrical contact with the case will be needed to do this.

Well Connected

Remove the p.c.b. again. Using pieces of stranded wire, make the connections to the input pads. Make similar connections to the supply and "solder tag" position. Using some form of colour code will help to avoid wiring errors. Fit the l.e.d. indicator (D2) and On/Off switch (S1).

Referring to Fig.2, complete the internal wiring. Note how resistor R9 is hard-wired in series with the l.e.d. The connections appropriate to the jack sockets used in the prototype are shown. Check that these are correct for the sockets used.

For the output cable, use twin (stereo) screened wire having a 3.5mm stereo jack plug on the end (or as appropriate for the sound card). This wire should be no longer than necessary, to avoid hum pick-up. Fit a rubber grommet in the hole drilled in the rear panel, pass the wire through it and solder the ends to the output copper pads on the p.c.b.

The screening should be sleeved to prevent short-circuits and connected to the rear solder tag (the one near the battery position). Three wires need to be soldered here. Twist them all together and make the joint in one operation. Check that this work is sound. Apply some form of strain relief to the output wire (for example, by using a

Completed Sound Card Mixer. The knob on the top/back of the case is the Volume control for next month's Stereo Headphone Monitor.

tight cable tie on the inside of the box) so that it cannot be pulled free in use.

Mount the circuit panel and tighten the potentiometer nuts. Do not do this too tightly because you may wish to remove the p.c.b. again later. Make sure no wires are trapped or left under strain. Insert the i.c.s into their sockets and fit the batteries.

Testing

If headphone monitoring is not already possible, you might like to construct the add-on Stereo Headphone Monitor (next month) before making any accurate tests.

Connect the output to the sound card's Line input (as stated previously, this might be the microphone socket!). Turn the Mixer controls to minimum and switch on the unit. The l.e.d. should glow.

It is best to test the line inputs first. For this, you will need a device having a line-level output, such as a tape deck or the audio output from a camcorder. Make test recordings

using both Left and Right channels. You will probably find that presets VR3/VR13 provide a satisfactory output level when left at mid-track adjustment.

If you do have to adjust them, the p.c.b. will need to be removed to allow this (unless you drilled the access holes in the p.c.b. as mentioned earlier). If one channel is louder than the other, adjust VR3/VR13 slightly to restore the balance.

Now, plug a microphone into each channel in turn and speak into it while slowly advancing the corresponding mixer control. The sound should be recorded clearly. Adjust the microphone gain presets (VR1, VR11, etc) to obtain a good level and a satisfactory balance between the microphone and line channels.

If the final level is much too high or too low despite adjusting VR3/VR13, you will need to alter the gain of the mixer. If it needs to be increased, raise the value of resistors R8' and R18 equally. Conversely, if it needs to be reduced, lower the values.

It only remains to tighten the potentiometer nuts, fit the control knobs, make a label and attach self-adhesive plastic feet to the base of the box. During operation, you will know when the batteries will need to be replaced when the "power on" l.e.d. indicator becomes dim and the sound quality deteriorates. □



Layout of components mounted on the inside of the metal case cover. The sockets on the front edge are the author's additions plus the stereo socket (front right) for next month's Stereo Headset Monitor.



Easy, Safe, Fast...



**FREE
424 page
Catalogue**

JUST ONE OF OUR MANY GREAT PRE-BUILT & TESTED CONSUMER PRODUCTS!

Map Reading Made Easy!

KC-0375 £5.50

The digital map distance calculator is truly a great device. All you have to do is program the scale of your map, then roll the wheel tip along the intended route. It will then display the **ACTUAL REAL WORLD DISTANCE** in miles

(or kilometres) on the LCD. It is light and compact at around 125mm long.



Get Your **FREE UK Pounds Sterling Priced Catalogue** - all 424 pages!
Just fill out the catalogue request form at www.jaycarelectronics.co.uk/catalogue
Check our website!

- All of our 6,000+ products with search facilities.
- 128-bit secure on-line ordering - safe & secure.
- Over 3,500 product datasheets & application notes.
- And we're from Australia, so you can trust us!



MoreInfo?

www.jaycarelectronics.co.uk

Get the Video Quality You Paid For With Our Doctor Video Kit

KC-S390 £29.00

Did you know that you are not getting the best picture from that expensive movie collection you paid good money for? Copy protection is put in place on videos and DVDs for a good reason, but this robs you of the true high quality reproduction that it is capable of. Get the quality you paid for and strip out these annoying signals! It supports composite and S-video signals and can be configured for NTSC or PAL format. Kit includes case, circuit board, all electronic components, and clear English instructions. **Note:** Some SMD soldering required. **Caution:** During signal conditioning, this unit removes copy right protection. Piracy is a crime, & Jaycar Electronics takes no responsibility for its potential for unlawful use



Theremin Synthesiser Kit

KC-5295
£13.05

The Theremin is a weird musical instrument that was invented early last century but is still used today.

The Beach Boys' classic hit "Good Vibrations" featured a Theremin. Kit includes a machined, silk-screened, and pre-drilled case, circuit board, all electronic components, and clear English instructions.

This product is now available pre-built and fully tested - Cat. AM-4025 £27.25



Performance Electronics for Cars Book

85-S080 £6.35

Australia's leading electronics magazine, Silicon Chip Magazine, has developed a range of projects for performance cars. There are 16 projects in total, ranging from devices for remapping fuel curves, to nitrous controllers, and more! The book includes all instructions, components lists, colour pictures, and circuit layouts. There are also chapters on engine management, advanced systems, DIY modifications, and more. Over 150 pages! All of the projects described are available in kit form, exclusively from Jaycar. Check out our website for all the details.



Remote Control Extender Kit MkII

KC-5209 £6.70

If you have a source device such as a DVD player running to a TV in another room, or perhaps a HiFi system with speakers in the other end of your house, you probably get tired of walking to the other room just to change tracks or fast forward etc. This project effectively transfers the IR signal from your remote control and re-transmits it in the other room! Kit includes case, circuit board, all electronic components, and clear English instructions.



We Stock...

Electronic Components

Electronic Project Kits

Test & Measurement Equipment

Power Products & Accessories

Audio & Video Equipment & Accessories

Computer & Telecoms Accessories

Security & Surveillance Equipment

50MHz Frequency Meter Kit with LCD Display

KC-5369 £20.30

If you want a great value frequency meter, then this project is for you. It features Autoranging operation for ease of use, switching between its three ranges. High resolution of 0.1Hz up to 150Hz, 1Hz between 150Hz and 16MHz, and 10Hz above 16MHz. It can be powered by a 9V battery or wall adaptor (not included) and the case measures just 130 x 67 x 44mm. Kit includes case, circuit board, electronic components, and clear English instructions.



Log on to

www.jaycarelectronics.co.uk/catalogue

for your FREE catalogue!

0800 032 7241

(Monday - Friday 09.00 to 17.30 GMT + 10 hours only)

For those that want to write:

100 Silverwater Rd Silverwater NSW 2128 Sydney Australia

Jaycar
Electronics

INGENUITY UNLIMITED

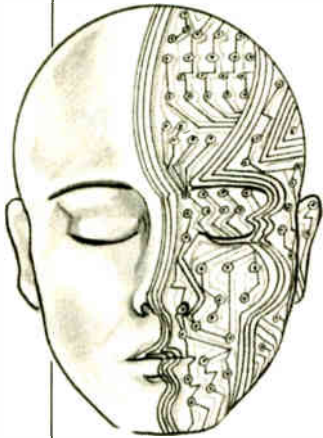

Our regular round-up of readers' own circuits. We pay between £10 and £50 for all material published, depending on length and technical merit. We're looking for novel applications and circuit designs, not simply mechanical, electrical or software ideas. Ideas *must be the reader's own work* and **must not have been published or submitted for publication elsewhere**. The circuits shown have NOT been proven by us. *Ingenuity Unlimited* is open to ALL abilities, but items for consideration in this column should be typed or word-processed, with a brief circuit description (between 100 and 500 words maximum) and full circuit diagram showing all component values. **Please draw all circuit schematics as clearly as possible.**

Send your circuit ideas to: *Ingenuity Unlimited*, Wimborne Publishing Ltd., 408 Wimborne Road East, Ferndown Dorset BH22 9ND. (We do not accept submissions for *IU* via E-mail.) Your ideas could earn you some cash and a prize!

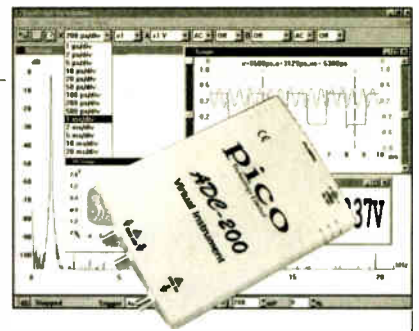

WIN A PICO PC BASED OSCILLOSCOPE WORTH £586

- 100MS/s Dual Channel Storage Oscilloscope
- 50MHz Spectrum Analyser
- Multimeter • Frequency Meter
- Signal Generator

If you have a novel circuit idea which would be of use to other readers then a Pico Technology PC based oscilloscope could be yours. Every 12 months, Pico Technology will be awarding an ADC200-100 digital storage oscilloscope for the best *IU* submission. In addition, a DrDAQ Data Logger/Scope worth £69 will be presented to the runner up.

Digital Stop Clock – On The Count

THE Digital Stop-Clock circuit diagram shown in Fig.1, opposite, was designed and built to help in the production of audio tapes for sight-impaired people. It is much easier to see and use than a small stopwatch.

The circuit is powered by a plug-in mains adaptor giving a 12V a.c. output at a minimum of 200mA. The 12V a.c. is rectified by the standard full-wave bridge arrangement (D1 to D4), and is then regulated down to 5V d.c. by IC1. Capacitors C1, C2 and C3 provide smoothing.

One side of the 12V a.c. input from the mains adaptor is fed via voltage divider resistors R1 and R2 to pin 2 of IC2, a 4518 dual BCD counter i.c. Counter A is wired to divide the 50Hz input at pin 2 of IC2 by 10.

With Clock A input and Reset pins (1 and 7) connected to 0V and the signal input fed to the Enable pin (2), the counter advances on the falling edge of each signal pulse. The output from counter A appears at Q3 (pin 6) and has a frequency of 5Hz.

Counter B is wired to divide by five and has the 5Hz output pulse from counter A connected to its Enable input at pin 10. Series connected NAND gates IC3a and IC3b are used as an AND gate. On the count of five, IC2 counter B outputs Q0 (pin 11) and Q2 (pin 13) both go high causing the AND gate output at pin 4 to also go high, resetting the counter and sending a 1Hz pulse to the collector (c) of transistor TR1, which is used to switch the clock display circuitry on and off.

Gates IC3c and IC3d are used as a “flip-flop”, controlled by Start switch S1 connected to IC3d pin 13 and Stop switch S2 connected to IC3c pin 9. Output pin 11 turns TR1 on via base resistor R5, and output pin 10 provides the Reset to the Reset switch S3.

This arrangement is used to prevent the clock from being reset whilst it is running. The Stop button has to be pushed before the Reset button will function.

The 1Hz pulse from *pnp* transistor TR1's emitter (e) is fed to the Clock input of IC7 at pin 1. This is one of four 4026 decade counter/dividers, with 7-segment

display outputs. These drive four FND500 common cathode (k) displays to show the clock's Seconds (X4/X3) and Minutes (X2/X1). Each carry out of the counter (pin 5), feeds to the Clock input (pin 1) of the next counter.

Diodes D6 to D8 and transistors TR2 and TR3 form a triple AND gate to reset the seconds display to zero each sixty seconds. The first time the segments E,F and G are turned on together in each count is for the numeral “6”.

When this happens, diodes D6 to D8 are turned off and transistor TR3 is turned on,

via resistor R10. This turns on TR2 which resets IC6 to zero and advances the minutes by one. Diode D5 is included to prevent the Minutes displays also being reset to zero.

As it stands, the Digital Stop-Clock will time up to one hour. An Hours display could easily be included by duplicating the Minutes display circuit. It is permissible to mount the Start, Stop and Reset switches some distance from the clock.

**Barry Freeman,
Morphett Vale, Australia.**

Light and Heat Sensor – Biased Solution

An ordinary l.e.d. will generate a small voltage when its *pn* junction is exposed to light or heat. This voltage may amount to a good part of 1V, and the current to a good part of 1µA. This will be appreciably higher where the l.e.d. is exposed to more intense light or heat.

In the circuit of Fig.2, a green l.e.d. (D1) and a red l.e.d. (D2) are wired “back-to-back” to the op.amp's inputs. Since these generate markedly different voltages, we thus deliberately present markedly different potentials to the inverting and non-inverting inputs – assuming of course that the two l.e.d.s are exposed to the same light and heat conditions.

Red l.e.d. D3 on the output is normally illuminated. However, withdraw some light or heat from green l.e.d. D1, and the voltage of red l.e.d. D2 predominates, thus extinguishing l.e.d. D3. This effect may be reversed, simply by reversing both D1 and D2.

To introduce a greater measure of control to the circuit, one could use the input-offset feature provided with many single op.amps. This usually wires pins 1 and 5 to the “extremities” of a 47kΩ preset potentiometer, and the “wiper” (the centre pin) to 0V. One could also add a

relay, as shown in *IU* June '04 (Pressure Pad, Fig.2).

This circuit could have many applications – among them a thermostat, a so-called “cupboard alarm”, a broken-beam alarm, or to sense when a car approaches at night. It can hardly be beaten for simplicity and cost.

Almost any op.amp with a high input impedance may be used, with the TL071CN and the OPA177GP also having been tested successfully. Widely varying supply voltages may be used, depending on the limits of the op.amp in question.

**Thomas Scarborough,
Cape Town, South Africa**

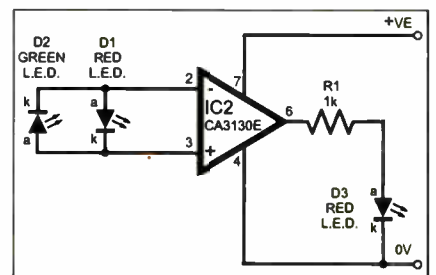
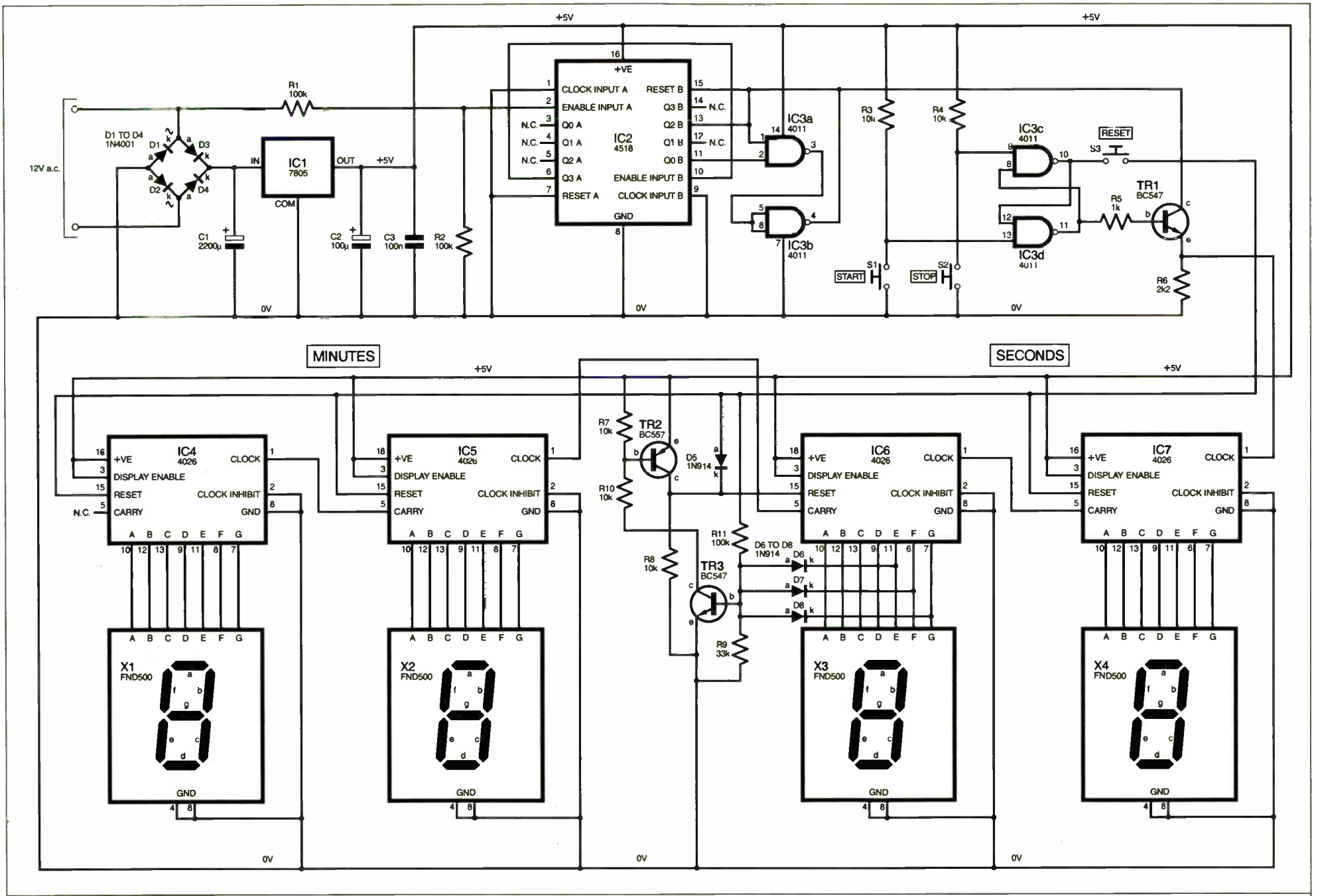
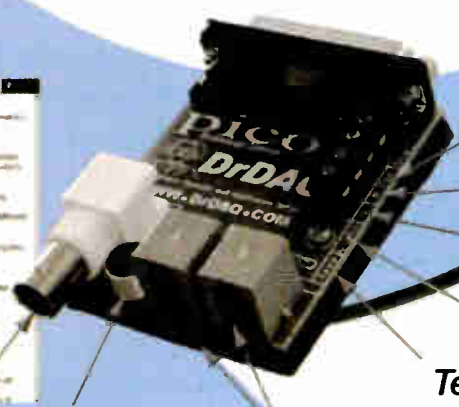

Fig.2. Light and heat sensor

Fig. 1. Complete circuit diagram for the Digital Stop Clock.



DrDAQ Data Logger



Output
Resistance
Voltage
Light level
Temperature

pH
Microphone

External sensors: Humidity
Temperature
O2 In Air
Reed Switch

- Low cost- under £60
- Built in sensors for light, temperature and sound (level and waveforms)
- Use DrDAQ to capture fast signals
- Outputs for control experiments
- Supplied with both PicoScope (oscilloscope) and PicoLog (data logging) software

For more information on DrDAQ, please visit:

www.picotech.com/drdaq113

PC Oscilloscopes

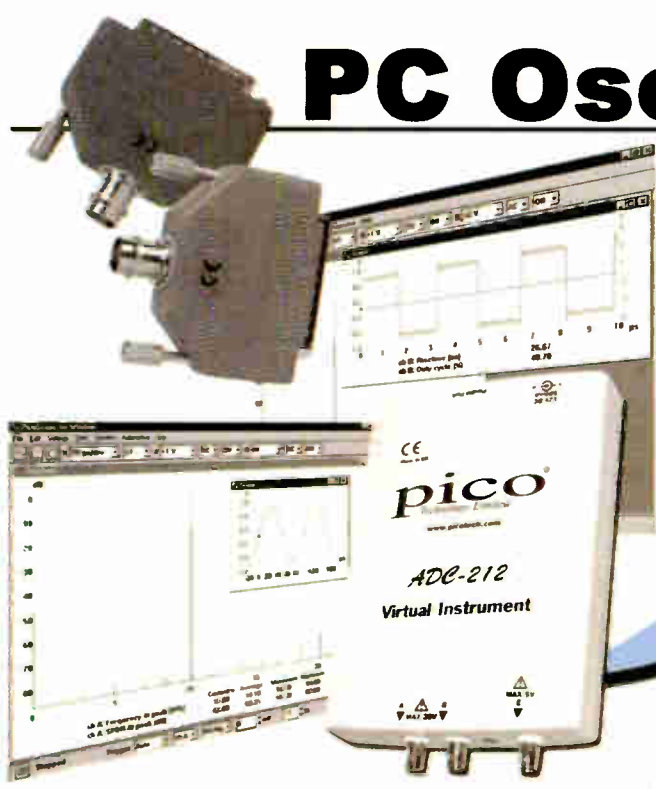

- Scope and spectrum analyser functions
- A fraction of the cost of benchtop scope
- Save multiple setups, for ease of use
- Save, print and e-mail your traces
- FREE technical support for life
- FREE software and upgrades
- Automated measurements

For more information on our scopes, please visit:

www.picotech.com/scope244

Tel: 01480 396395 Fax: 01480 396296 E-mail: sales@picotech.com

World Radio History

Pico
Technology Limited

E-Blocks and Flowcode V2.0 Reviews

by Robert Penfold

A system for learning about electronics and PIC programming

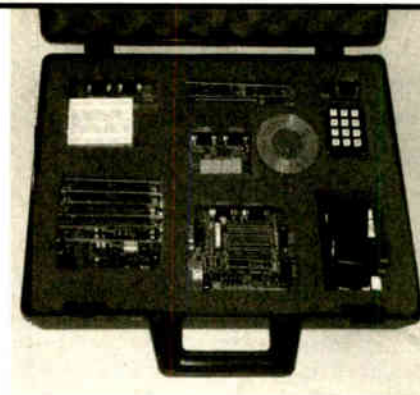

E-BLOCKS are electronic modules that are designed to enable users to learn about electronics and programming. They can also be used by experienced users as a means of quickly building and testing prototype designs based on PIC microcontrollers. The basic concept is very simple, and the system is based on a PIC programming module that also acts as the basis of the prototype designs.

Actually, there are two programmers (Fig.1), which are the "Multi" and "Lite" versions. The Multi Programmer has four sockets that accommodate a wide range of PIC processors having from eight to 40 pins. The Lite Programmer unit has a single 18-pin socket and can handle a much more restricted range of devices that includes the PIC16F88 and 18 series PICmicros. The sockets are good quality turned-pin types, but neither unit is equipped with any ZIF sockets, although 40-pin ZIF sockets can be added.

Programmers

Both programmers have a USB socket that connects to the PC. Only a USB 1.1 port is required, but the programmers will work properly with USB 2.0 ports. The Lite Programmer also has two 9-pin female D connectors, and these act as input/output ports when a device has been programmed and the new design is being tested. The Multi Programmer has no less than five of these ports, but some of them will be unused when utilising most PIC processors.

The Lite Programmer is powered from the host PC's USB port, but the Multi Programmer has a mains adapter. The latter is less convenient, but provides more power options. The Multi Programmer has the option of using a crystal or R/C clock oscillator. It is supplied with a 19-6608MHz crystal, but miniature crystals having other operating frequencies can be plugged into the

holder instead. The Lite programmer relies on the PICmicro's internal clock oscillator: a feature that is available with newer PICmicros like the PIC16F88. Both units are supplied complete with a PIC16F88 processor.

As described so far the system is of limited use. You can program a PIC microcontroller and then set it working, but without the right hardware on the input/output ports it will not do very much. Obviously it is possible to "do your own thing" and connect whatever you like to the input and output ports. The E-Blocks offer an alternative approach in the form of additional modules that provide a range of input/output functions. The additional modules, a selection of which is shown in Fig.2, vary greatly in complexity.

Starting Blocks

At the most basic level there is a board that has eight l.e.d.s, with one driven from each line of a port. This board has a 9-way male D connector that connects to a programmer board via one of the leads supplied in the kit. There is also a 9-way female D connector that can carry the port's connections through to another module. When using this facility it has to be borne in mind that loading of the output lines by this passive board will reduce the output levels. The simplest input board has eight tiny pushbutton switches that can be used to control the input lines of a port. Again, this board has a port that can carry the connections through to another module.

These boards are primarily aimed at simple experiments when learning about programming, or when first trying out the system. A more sophisticated input board is available, and this has a four by three numeric keypad that includes * and # keys. More refined

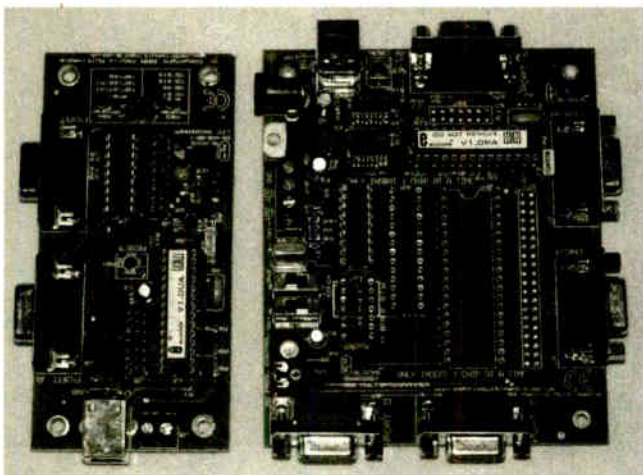

Fig.1. The Multi Programmer can be used with PICs having from eight to 40 pins. The smaller Lite Programmer is only suitable for use with 18-pin PIC processors

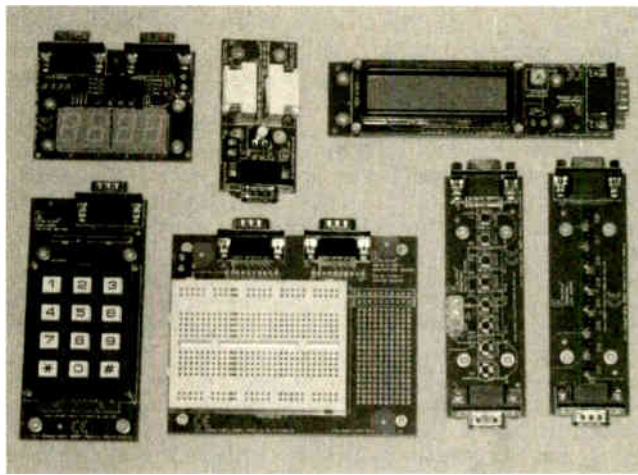

Fig.2. A selection of E-Blocks. Working clockwise from the top left-hand corner they are the four-digit l.e.d. display board, the sensor board, the l.c.d. board, the l.e.d. board, the switch board, the prototyping board, and the keypad board

output boards are available in the form of one having a four-digit 7-segment l.e.d. display and another that has a liquid crystal display. The latter provides two lines of 16 characters, and it uses a single port as it is driven using serial data. It includes a contrast control. Two ports are required to drive the multiplexed 7-segment l.e.d. display module.

Other Modules

Various other modules are available, including a prototyping board that has two ports with each one connecting to a nine-way s.i.l. socket. These sockets permit easy connection to the solderless prototyping board that has a 29 by 10 prototyping area plus four power rails. There is also a small area that has double-sided pads for prototyping of the soldered variety. In a similar vein there is a patch board. This is similar to the prototyping board, but it has a large area containing double-sided pads and no built-in solderless breadboard.

Other boards include one that provides wireless communications via an IrDA (serial infrared) link, an SPI board that provides 64K (8 by 8192) of non-volatile FRAM memory plus digital to analogue conversion, and an RS232C serial board. The serial board enables the system to communicate with another PIC system, a PC, or just about anything that has a standard serial port. There is also a sensor board that has a built-in light sensor, but it can also connect to a range of external analogue and digital sensors. Other boards include: CAN interface, Internet interface, X-10 home automation, CPLD programmer, Atmel AVR programmer, and simple screw terminal board.

All the E-Blocks have rubber feet that enable them to be used freestanding. However, it is definitely better if they are fitted on some form of base-plate, and a heavy steel plate drilled with a matrix of holes is included in the kit. Two side pieces enable the plate to be held at an angle, and this makes it much easier to use the modules. The base-plate assembly weighs a few kilograms, but it gives a firm base to work on and it should last many years. The modules are fixed to the base-plate using the supplied nuts and bolts, and then wired together using the nine-way D connector leads. The base-plate assembly, fitted with the multi-programmer plus the liquid crystal display and keypad modules is shown in Fig.3.

One or two of the modules are passive types, but most of them require power. The nine-way D connectors are only used to carry the ground connection and up to eight data lines. Power is carried via separate leads that connect to simple connector blocks that are included on the relevant modules. There is a +5 volt output on both of the programmers, and the Multi Programmer also has a +14 volt output. The latter is presumably the "raw" output from the mains adapter.

Software

The programmer boards obviously require software in order to perform their intended function, and this is provided in the form of a program called PPP. This requires the usual installation process, and it will run under Windows 98, ME, 2000, or XP. The Programmers are Plug and Play devices that require no installation under modern versions of Windows. After plugging in a programmer for the first time, Windows should report that the new hardware has been installed and is ready for use. A software driver is provided for Windows 98 users. Everything installed easily using a system running Windows XP.

In use the PPP program runs in a small window (Fig.4), and this has the usual menu bar near the top. The first step is to load the data file using the Open button or the Open option from the File menu. Then the Configure PICmicro button is operated so that the required settings for the clock oscillator, timers, etc., can be selected. The options are selected via numerous pop-down menus. A further pop-down menu is used to select the appropriate PIC chip, and radio buttons give the option of using hexadecimal, binary, or decimal source files. The configuration window is shown in Fig.5.

With the programmer set up and ready to go, it is then just a matter of operating the Send to PICmicro button. The program shows how things are progressing during the upload, and after a short while it provides a summary that (hopefully) indicates that the process was completed successfully. Simple test programs are provided with the programmers and the E-Blocks, and these make it easy to check that the various pieces of hardware are functioning correctly. I started with the "moving" lights test program for the Multi Programmer, and this worked first time.

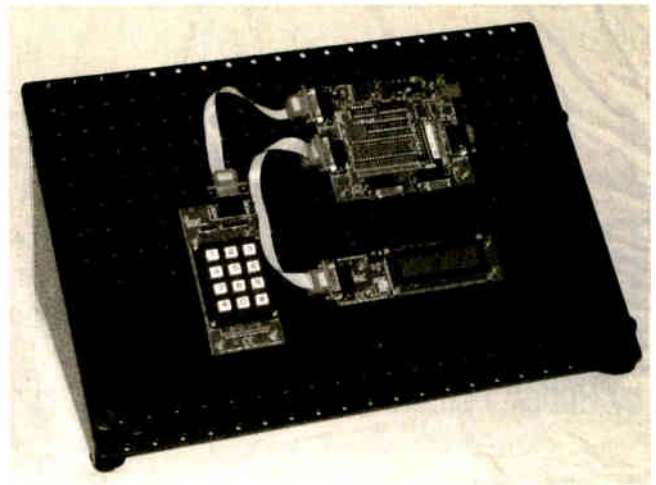

Fig.3. The A3 base-plate assembly is very heavy, tough, and can accommodate several E-Blocks



Fig.4. Running the PPP program produces this small window. Operating the Open button enables a program file to be loaded

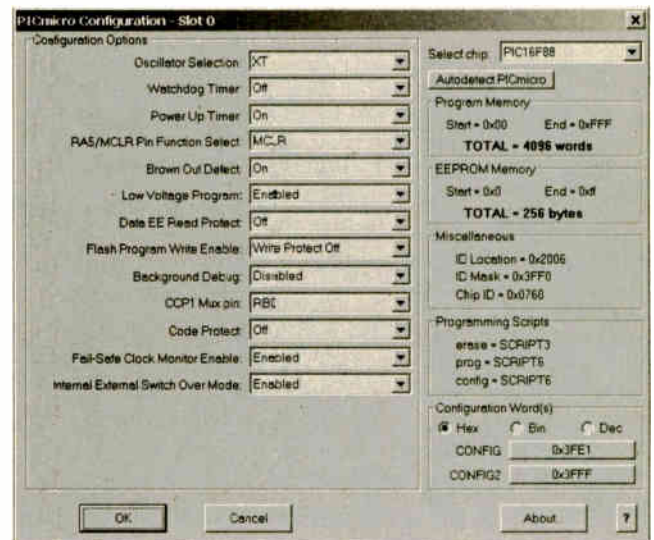

Fig.5. This window enables the PIC processor to be configured. The options vary slightly depending on the type of processor being programmed

Documentation

The documentation is provided in the form of PDF files on a mini CD-ROM that also contains the software and text files that contain last-minute information. Probably most PCs are now equipped with the Adobe Acrobat Reader program that is needed to read the PDF files, but this program is included on the disc. The PDF documents are well produced in full colour, and although quite brief they include all the information needed to use the modules. If necessary, they can be printed from the Acrobat Reader program using any installed printer. One slight problem with the documentation is that it is spread across two or three dozen files in various folders. It would be nice to have everything consolidated into a single document as well.

Also included on the disc are "lite" versions of the company's assembly language, C, and Flowcode programming languages. These are very "lite" versions that only enable the PIC16F84 to be programmed. Additionally, each "lite" language is accompanied by part of a course on programming PIC microcontrollers using that language. The cut-down versions on the disc are really just intended to provide "tasters" of the full languages and training systems. The complete languages and courses are available as optional extras, and they have additional features such as a virtual PIC microcontroller. It is important to realise that you will not become an instant PIC expert simply by buying some E-Blocks. Although the E-Blocks are easy to use, beginners will need some training in order to use them.

Conclusion

Clearly the E-Block system is quite involved, with a wide range of modules on offer. It was not possible to thoroughly test all the modules in the limited time available, but during the testing period everything functioned as expected. The modules themselves

are well made and quite tough, as is the base-plate assembly. In fact battleship grey would be a more appropriate colour for the base-plate unit! Given half a chance, the E-Block equipment should provide many years of use. The prices are very reasonable for equipment of this quality.

The kit reviewed here is (more or less) the Deluxe Starter Pack, which includes a comprehensive range of E-Blocks and is supplied in a fitted plastic carrying case. Other packs are available, and buying any of them provides an easy way of getting started with this system. The modules and accessories are available separately as well. You can therefore buy a programmer and one or two simple modules to start learning about PIC programming, and then add more units as you progress.

Experienced PIC users can adopt a similar approach, buying a programmer and one or two of the more advanced modules, with more modules being obtained as required. The system is very flexible, making it easy to mix your own hardware with any of the E-Blocks. Using the E-Blocks clearly has its advantages, but you are not tied to or limited by them.

The versatility of the E-Block system makes it suitable for a wide range of users. Together with the languages and training systems, it has obvious appeal in education. The system is suitable for both new and experienced home users. Although the price of a large kit is probably rather high for most hobbyists, a more modest and affordable system is all you need to get started. Professional users will also be attracted to the E-Block system, and it could save a significant amount of development time. The system can be recommended for just about anyone involved with or wishing to get involved with PIC microcontrollers.

Flowcode V2

Flowcode is a high level programming language for PIC microcontrollers. It is well suited to use with the E-Blocks, and it includes some support for E-Blocks such as the l.e.d. and liquid crystal display boards. It should be possible to use Flowcode independently for any PIC based project, but a few features of the program might be of limited use when it is used in this way.

The basic concept of Flowcode is by no means new, and the idea is to program using flowcharts rather than conventional programming code. This provides an easy introduction to programming for beginners, and it can enable more experienced users to produce working programs more quickly than using other methods. With this method you still have to get to grips with some conventional programming concepts, such as loops and variables, but programming using flowcharts is still an easier way of programming.

Several programming languages of this type have failed in the past. The usual problem when it is applied to general programming is that a simple concept becomes very complex in practice. More and more facilities have to be added in order to

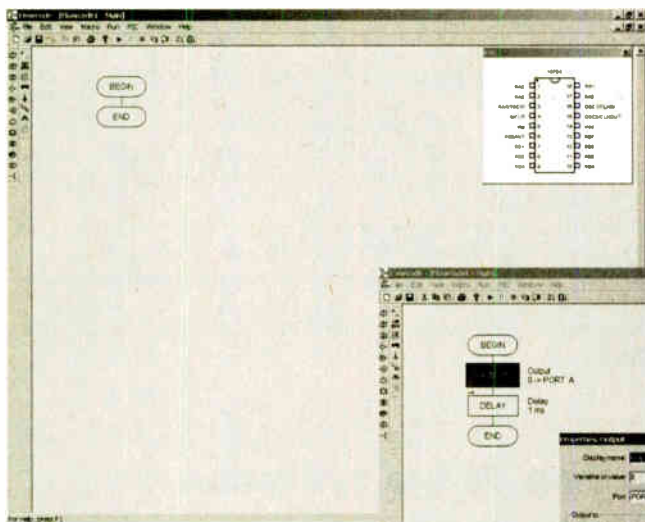

Fig.6 (above). The initial screen of the Flowcode program. Program blocks are dragged and dropped in place between the Begin and End blocks near the top left-hand corner of the screen



Fig.7 (centre). A pop-up window enables the parameters for a programming block to be set. In this case the dialogue box is for an Output instruction

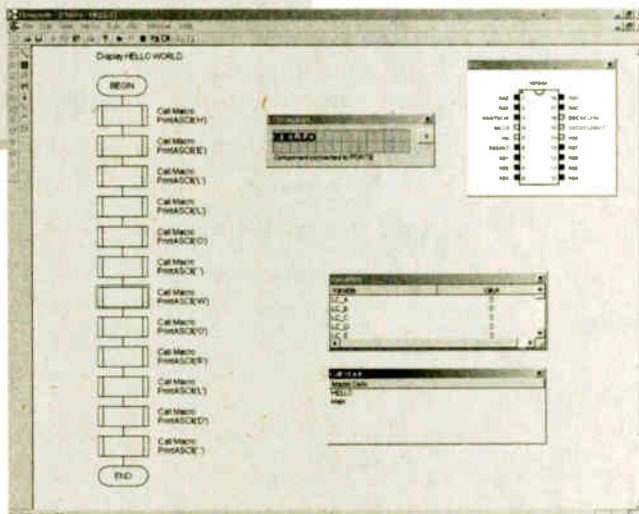

Fig.8 (right). The simulator can run the code in real-time, but it is also possible to go through the program one step at a time, as here

accommodate all the requirements of programmers producing software for different applications. This can result in a beginners' programming language becoming more difficult to use than the real thing! The flowchart method works best in situations where relatively simple programs are involved. On the face of it, the reduced instruction set of PIC microcontrollers makes them well suited to this type of programming.

Installing Flowcode is reasonably straightforward, and it will automatically install any required add-ons that are not already present. On running the program you have the choice of opening an existing program or starting a new one. The appropriate PIC processor has to be chosen if a new program is started. This takes things on to the main Flowcode programming screen (Fig.6).

There is the usual menu bar near the top of the screen, with a toolbar just beneath it. The latter provides quick access to the more frequently used menu options. The top right-hand corner of the screen has a pin-out diagram for the selected PIC device. The top left-hand corner is where the program is entered, and initially there are just Begin and End blocks. Two columns of buttons down the left edge of the screen are used to add the programming blocks and external components such as seven-segment displays and the 2 x 16 liquid crystal display. The various screen elements can be switched on and off via the View menu.

Program Until You Drop

Adding the programming blocks is just a matter of dragging them to the appropriate position in the flowchart using the mouse and dropping them in place. The blocks on offer are much as one would expect, with things like loop, delay, decision, input, and output blocks. The usual Windows Cut, Copy, Paste, and Delete functions are available, making it easy to edit charts. With most of the blocks it is necessary to set one or more parameters, such as the delay time or the initial values of variables. This is achieved by double-clicking the appropriate block to produce a dialogue box. The one shown in Fig.7 is for an output operation. It enables a value to be sent to the entire port, a single bit to be set, or masking to be used. A pop-up dialogue box is also used to set the connections to external components.

A section of a chart can be saved as a macro and then used in a program as a single block. This is important because the flowchart method tends to require large amounts of screen space for even quite simple programs. Using macros is likely to be a neater way of programming anyway, but it will often be essential to use them in order to keep programs down to a reasonable size on the screen.

The simulation facility can operate in real-time, and an appropriate clock frequency must be set for this to work properly. Virtual components such as displays will operate much like the real thing, and the simulation will also respond to input signals

from virtual switches, etc. It is also possible to run through the program one step at a time, and two pop-up windows then show current state of variables and the Call Stack. This is useful for debugging and is also helpful for those learning about programming as it is possible to see exactly what is going on. Fig.8 shows a version of the classic "Hello World" program in operation.

Problems

Finished programs can be compiled to assembler or transferred to a PIC processor via the PPP software or an alternative program selected by the user. The simulation tests all performed as expected, but some odd results were sometimes produced when programs were run on a real processor. The relevant FAQ section of the Matrix Multimedia web site helps to solve most problems, particularly one that can occur unless loops are programmed in exactly the right way.

Some 28 tutorials are installed with the program, and these cover a wide range of programming techniques. Those with a certain amount of programming experience should have no problem learning from the example programs, and being able to step through the programs is a big help here. The accompanying text for each program is quite brief, and might not be sufficient for complete beginners. A free online course is also available at Matrix Multimedia's website.

Conclusion

Flowcode provides a relatively easy way to get started in PIC programming and it is logical and straightforward in use. Things are generally done in standard Windows fashion, and this makes it possible to use the program without constantly referring to the online Help system. The simulation part of the program is very good, making it possible to learn a great deal about PIC processors before actually building real PIC projects. As is the modern trend, there is no printed manual. Flowcode fits in well with the E-Blocks system, but it is certainly not limited to operation with E-Blocks.

It is reasonably priced at £99-00 plus VAT for the Pro version, with a ten user version and a site license costing £300-00 plus VAT and £599-00 plus VAT respectively. There is also a Home/Student version that lacks IrDA and RS232C communications, keypad control, and a few other features. This is very competitively priced at £49-00 plus VAT.

Full details of the currently available E-Blocks and accessories, Flowcode, demonstration software, etc., can be obtained from the Matrix Multimedia Limited web site at www.matrixmultimedia.co.uk (telephone 0870 700 1831, fax 0870 700 1832). Flowcode is also available from EPE - see page the CDRoms pages. □

Subscribe to EPE and Save 51 p an issue over UK newstand prices on a one year UK subscription

Annual subscription rates:

- 6 Months: UK £16.50, Overseas £19.50 (standard air service), £28.50 (express airmail)
- 1 Year: UK £31.00, Overseas £37.00 (standard air service), £55 (express airmail)
- 2 Years: UK £57.00, Overseas £69.00 (standard air service), £105 (express airmail)

To: Everyday Practical Electronics,
Wimborne Publishing Ltd., 408 Wimborne Road East, Ferndown,
Dorset BH22 9ND

Tel: 01202 873872 Fax: 01202 874562
E-mail: subs@epemag.wimborne.co.uk
Order from our web site at:
www.epemag.co.uk

Name

Address

Post code Tel.

If you do not wish to cut your issue, send a letter or copy of this form.



TAKE ADVANTAGE NOW! SUBSCRIPTION ORDER FORM



To subscribe from the USA or Canada
see the last magazine page



I enclose payment of £
(cheque/PO in £ sterling only),
payable to Everyday Practical Electronics



My card number is:

Please print clearly, and check that you have the number correct

Signature

Card Security Code (The last 3 digits on or just under the signature strip)

Card Ex. Date Maestro Issue No.

Subscriptions can only start with the next available issue.
For back numbers see the *Back Issues* page.

02/05

PicoScope 3000 Series PC Oscilloscopes

The PicoScope 3000 series oscilloscopes are the latest offerings from the market leader in PC oscilloscopes combining high bandwidths with large buffer memories. Using the latest advances in electronics, the oscilloscopes connect to the USB port of any modern PC, making full use of the PCs' processing capabilities, large screens and familiar graphical user interfaces.

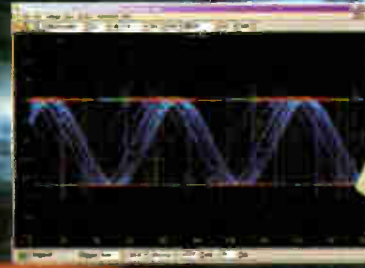

- High performance: **10GS/s** sampling rate & **200MHz** bandwidth
- **1MB** buffer memory
- High speed **USB 2.0** interface
- Advanced display & trigger modes
- Compact & portable
- Supplied with PicoScope & PicoLog software

PicoScope	3204	3205	3206
Bandwidth	50MHz	100MHz	200MHz
Sampling rate (repetitive)	2.5GS/s	5GS/s	10GS/s
Sampling rate (single shot)	50MS/s	100MS/s	200MS/s
Channels	2 + Ext trigger	2 + Ext trigger/Sig gen	2 + Ext trigger/Sig gen
Oscilloscope timebases	1ns/div to 50s/div	2ns/div to 50s/div	1ns/div to 50s/div
Timebase accuracy	30ppm	50ppm	50ppm
Spectrum ranges	0 to 25MHz	0 to 50MHz	0 to 100MHz
Buffer memory size	256KB	512KB	1MB
Resolution / accuracy		8 bits / 3%	
Range		-100mV to +20V	
PC Connection		USB2.0 (USB1.1 compatible)	

Tel: 01480 396395
www.picotech.com/243

pico
Technology Limited

For rapid development of electronic systems...

E-BLOCKS

E-blocks are small circuit boards each of which contains a block of electronics typically found in an electronic system. E-blocks can be programmed in C, Assembly and are tightly integrated with Flowcode which instantly converts flow charts into PICmicro code.



Low cost USB PIC programmers (Starting at £27, model shown £65)



...plus a wide range of add-on boards and accessories



...plus incredibly easy to use software based on flow charts...



...equals extremely rapid system development: like this mobile text messaging system built from E-blocks.

...and solutions for learning and development...

Hands on training courses



training courses in PICmicro(R) programming, CPLD programming and ECAD

Resources for learning CPLD programming



Complete courses in electronics and programming

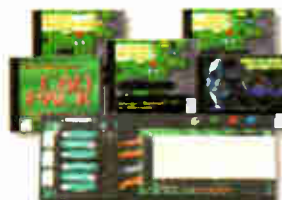

Equipment for datalogging, control and PC 'scopes



...and more at:



...see www.matrixmultimedia.co.uk

Matrix Multimedia Limited
sales@matrixmultimedia.co.uk
t. 0873 700 1831 f. 0870 700 1832

INTERFACE

Robert Penfold

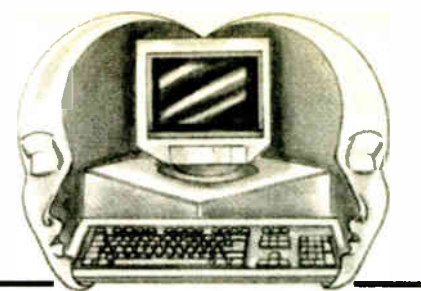

SIMPLE DIGITAL TO ANALOGUE CONVERSION FOR PCs

THE previous *Interface* article provided details of a simple and inexpensive form of digital to analogue converter. This type of circuit is fine where good precision is not important, but it is of little use where high accuracy is required. Good accuracy and resolution require the use of a proper digital to analogue converter, and various devices offering from 8-to 16-bit resolution are available. For many practical purposes there is no point in going beyond 8-bit resolution, and noise problems can make it difficult to realise the theoretical accuracy of 12- and 16-bit devices.

There are two basic types of converter chip, which are parallel and serial interfacing types. The chips that use serial interfacing are not necessarily designed with an RS232C port in mind. In fact the vast majority of them are designed to interface to the processor via a few ordinary digital lines configured to act as a synchronous serial link. This enables the chip to be interfaced via just a few input and output lines, but the data transfers tend to be relatively slow. Using a synchronous serial link also complicates the control software.

Parallel interfacing requires more lines than the serial variety, but eight output lines and a ground connection are all that is needed for an 8-bit digital to analogue converter. A big advantage of parallel interfacing is that there is normally no need for any handshaking. Driving the chip is just a matter of writing the data to it each time a change in output voltage is required. The output will not respond instantly to changes, and the delay is known as the "settling time". However, the delay is quite small and is typically about one microsecond.

AD557JN

A 12-bit digital-to-analogue converter was covered in previous *Interface* articles, so this time a parallel converter will be described. The old Ferranti converter chips were very good when a simple 8-bit parallel digital to analogue or analogue to digital converter was required. Unfortunately, devices such as the ZN426E (D/A) and ZN427E (A/D) seem to have disappeared with the company itself.

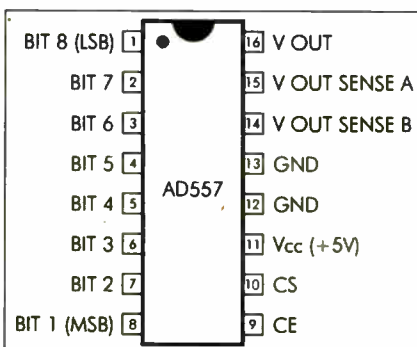

Fig.1. Pinouts for the AD557JN 8-bit D/A converter.

The nearest thing to the ZN426E currently available is probably the AD557JN. This is manufactured by Analogue Devices and in the UK it can be obtained from Rapid Electronics.

The AD557JN has a 16-pin d.i.l. (dual-in-line) encapsulation with the pin configuration shown in Fig.1. Conveniently, the eight data inputs are grouped together on one side of the device (pins 1 to 8), and in the right order.

The manufacturer's labelling for the data inputs and outputs of converter chips can be a bit confusing. Rather than the usual D0 to D7 they are often marked Bit 1 to Bit 8, as in this case. Bit 1 is the most significant bit (D7) and Bit 8 is the least significant bit (D0), which is the opposite of what one would probably expect.

On the other side of the device there are two ground pins and a positive supply input. The chip is designed to operate on an ordinary 5V logic supply, and the supply must be within the range 4.5V to 5.5V. The typical supply current is 15mA, and it will not exceed 25mA. Both ground pins are combined digital and analogue types. The data sheet for the AD557 gives a suggested earthing and decoupling arrangement for use where the lowest possible noise level is important. However, digital noise is not really a major problem with a chip that has 8-bit resolution.

Pins 9 and 10 are respectively *chip select* and *chip enable* inputs. These are only needed in applications where the chip will interface direct to the data bus of a processor. They are not needed in a PC project that has the chip driven from the latching outputs of a parallel port. Both pins are simply connected to ground to make the chip "transparent". The data placed on the data inputs is then fed straight through to the converter section.

The output section of the chip consists of an operational amplifier and three resistors in the arrangement shown in Fig.2. In normal use pins 14 to 16 are simply connected together so that all three resistors are used in the negative feedback loop. This gives an output voltage range of 0V to 2.56V. A maximum output

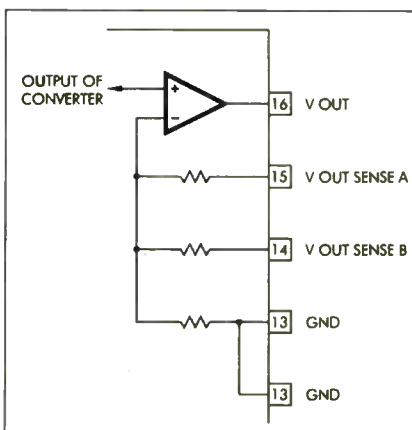

Fig.2. Internal arrangement at the output of the AD557JN.

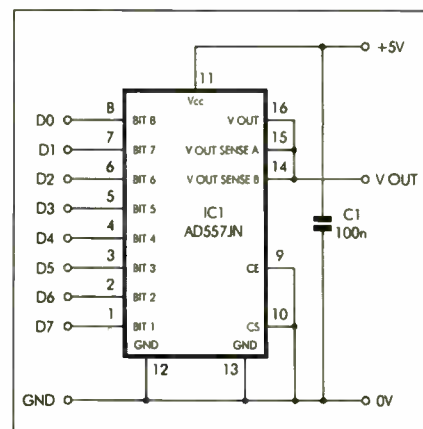

Fig.3. Simplicity of the active AD557JN d/a converter.

potential of 2.55V (10mV bit least significant bit) would have been a more logical choice, and a table in the device's data sheet seems to suggest that this is the correct figure.

Anyway, the exact maximum output voltage is usually of little practical importance. It is possible to trim the output voltage using variable resistors in series with the Sense A and Sense B pins, but in practice the standard output range of 0V to 2.56V is normally used. External amplification and processing is then used to give the required output voltage range.

No external voltage reference is required. The AD557 has a built-in precision band-gap reference source that provides a highly stable 1.2V output. Using a low reference voltage enables the device to operate from a single 5V supply. The full scale accuracy of the chip is plus and minus 2.5 LSB at 25 degrees Celsius, but can be as large as plus and minus 4.5 LSB at extreme temperatures.

Of much greater importance in most practical applications, the relative accuracy is typically plus and minus 0.5 LSB, with a maximum error of plus and minus 1 LSB. This is more than adequate for most applications. The settling time is typically 0.8 microseconds, but can be as much as 1.5 microseconds.

Basic Circuit

Few discrete components are needed in order to produce a basic digital to analogue converter based on the AD557JN. In fact the only discrete component required is a supply decoupling capacitor, as can be seen from the circuit diagram of Fig.3. The data inputs are TTL compatible and can therefore be interfaced direct to any normal PC printer port. The circuit should work equally well with any 9-bit output port that provides latching outputs at TTL levels.

The circuit requires a +5V supply, but this is not available from a PC printer port. Ways of obtaining a +5V supply from a PC have been covered in past issues of *EPE*, and this subject will not be covered again here. The

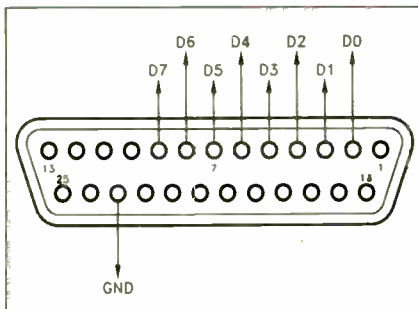

Fig. 4. 25-way D connector pinouts for use with the AD557JN circuit in Fig. 3.

connections to the PC's printer port are shown in Fig. 4. A 25-way male D connector is needed to make the connections to the printer port. One slight drawback of parallel interfacing is that the connecting cable should be no more than about two or three metres long. In this case a somewhat longer cable is acceptable provided high-speed operation is not required.

Digital PSU

In practical applications it will usually be necessary to use some amplification at the output of the converter in order to provide the required output voltage range and output current. The circuit of Fig. 5 shows the circuit diagram for a simple computer controlled power supply unit based on the AD557JN. A small monolithic voltage regulator (IC2) is used to produce a 5V supply for the converter from the main supply. The converter has the basic configuration with its nominal 0 to 2.56V output range.

The first requirement in a power supply application is to provide a more useful output voltage range. In this case operational amplifier IC3 is used in the non-inverting mode with a voltage gain of approximately five. This boosts the maximum output voltage to 12.75V with a resolution of 50mV (0.05V). In practice the voltage gain of IC3 must be adjusted to allow for any scaling errors in IC1. With a value of 255 written to the converter, VR1 is adjusted for an output potential of precisely 12.75V.

A buffer stage at the output of IC3 enables

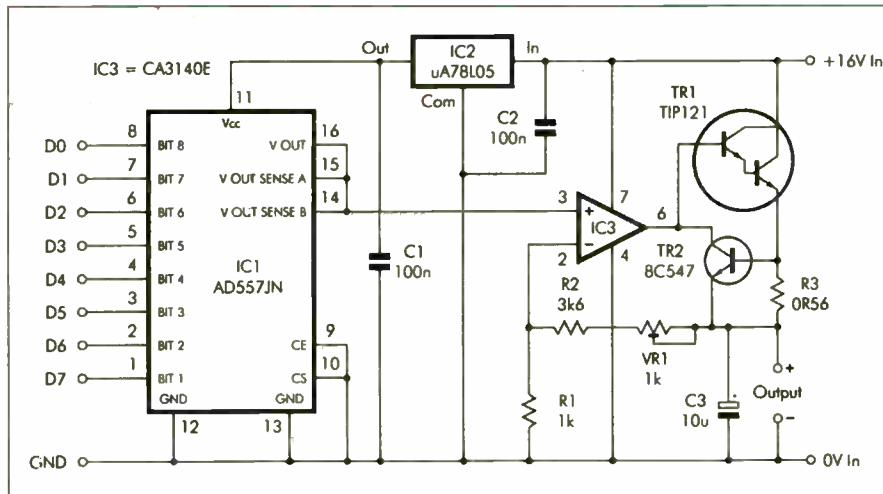

Fig. 5. Circuit diagram for the computer-controlled PSU. TR1 requires a large heatsink.

currents of up to one amp to be provided. The buffer stage is an emitter-follower type based on Darlington power transistor TR1. The high current gain of this device is needed because of the limited output current available from IC3. An ordinary power transistor is unlikely to give usable results in this circuit.

The occasional short-circuit or major overload on the output is inevitable with this type of equipment, so some form of over-current protection is essential. This circuit has a conventional current limiter which has R3 as the current sensing resistor. An output current of more than about 1.1A results in TR2 turning on and pulling the output of IC3 lower in voltage.

The output short-circuit current is typically a little over 1.2A. Other output currents can be accommodated by altering the value of R3. The correct value is obtained by dividing 0.6 by the required output current (in amps). The circuit should work well with output currents of up to about 2A or so.

Points to Note

Due to the voltage drop through the output stage it is essential for the supply voltage to the circuit to be at least 3V more than the output potential. The input supply must not

exceed about 30V with no loading on the output. A wide range of supply voltages can therefore be tolerated, and there is no requirement to use a stabilised supply. However, using a regulated supply of about 18V to 20V would probably give a slightly improvement in the stability of the output voltage.

Resistor R3 should have a power rating of at least one watt. IC3 has a PMOS input stage, and the usual anti-static handling precautions should therefore be observed when dealing with this component. The CA3140E used for IC3 is a type that will work in d.c. circuits without using a negative supply rail. Most other operational amplifiers require dual supplies and will not work properly in this circuit.

Transistor TR1 has to dissipate several watts when the unit is used at low output voltages and high currents. Consequently, it must be mounted on a substantial heatsink. Note that the collector terminal connects internally to TR1's heat-tab. Where appropriate, an insulating kit must be used when mounting this device on its heatsink. The TIP121 and TIP122 are both suitable for use in this circuit.

Some refinements to the circuit and the controlling software will be provided in the next *Interface* article.

EPE Availability

Many newsagents do not have the room for a vast range of magazines so to make sure they get you a copy of EPE please fill in the form below and hand it to your newsagent. EPE is distributed on a sale or return basis.

EVERYDAY
PRACTICAL
ELECTRONICS

THE No. 1 MAGAZINE FOR ELECTRONICS TECHNOLOGY & COMPUTER PROJECTS

NEWSAGENTS ORDER FORM

Please reserve/deliver a copy of *Everyday Practical Electronics* for me each month

Signed

Name and Address

..... Post Code

Everyday Practical Electronics is published on the second Thursday of each month and distributed S.O.R. by COMAG
Make sure of your copy of *EPE* each month – cut out or photostat this form, fill it in and hand it to your newsagent.

EPE IS PLEASED TO BE ABLE TO OFFER YOU THESE ELECTRONICS CD-ROMS

ELECTRONICS PROJECTS

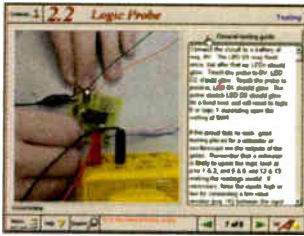

Logic Probe testing

Electronic Projects is split into two main sections: **Building Electronic Projects** contains comprehensive information about the components, tools and techniques used in developing projects from initial concept through to final circuit board production. Extensive use is made of video presentations showing soldering and construction techniques. The second section contains a set of ten projects for students to build, ranging from simple sensor circuits through to power amplifiers. A shareware version of Matrix's CADPACK schematic capture, circuit simulation and p.c.b. design software is included.

The projects on the CD-ROM are: Logic Probe; Light, Heat and Moisture Sensor; NE555 Timer; Egg Timer; Dice Machine; Bike Alarm; Stereo Mixer; Power Amplifier; Sound Activated Switch; Reaction Tester. Full parts lists, schematics and p.c.b. layouts are included on the CD-ROM.

ELECTRONICS CAD PACK

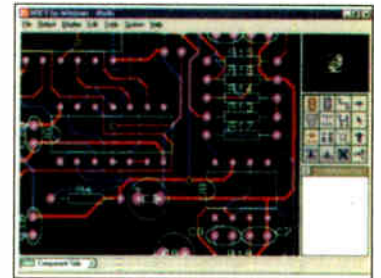

PCB Layout

Electronics CADPACK allows users to design complex circuit schematics, to view circuit animations using a unique SPICE-based simulation tool, and to design printed circuit boards. CADPACK is made up of three separate software modules. (These are restricted versions of the full Labcenter software.) **ISIS Lite** which provides full schematic drawing features including full control of drawing appearance, automatic wire routing, and over 6,000 parts. **PROSPICE Lite** (integrated into ISIS Lite) which uses unique animation to show the operation of any circuit with mouse-operated switches, pots, etc. The animation is compiled using a full mixed mode SPICE simulator. **ARES Lite** PCB layout software allows professional quality PCBs to be designed and includes advanced features such as 16-layer boards, SMT components, and an autorouter operating on user generated Net Lists.

ELECTRONIC CIRCUITS & COMPONENTS V2.0

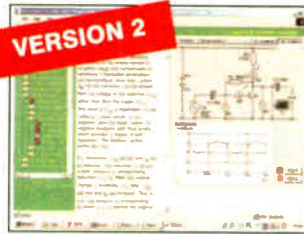

Circuit simulation screen

Provides an introduction to the principles and application of the most common types of electronic components and shows how they are used to form complete circuits. The virtual laboratories, worked examples and pre-designed circuits allow students to learn, experiment and check their understanding. Version 2 has been considerably expanded in almost every area following a review of major syllabuses (GCSE, GNVQ, A level and HNC). It also contains both European and American circuit symbols. Sections include: **Fundamentals:** units & multiples, electricity, electric circuits, alternating circuits. **Passive Components:** resistors, capacitors, inductors, transformers. **Semiconductors:** diodes, transistors, op.amps, logic gates. **Passive Circuits. Active Circuits. The Parts Gallery** will help students to recognise common electronic components and their corresponding symbols in circuit diagrams. Included in the Institutional Versions are multiple choice questions, exam style questions, fault finding virtual laboratories and investigations/worksheets.

ANALOGUE ELECTRONICS

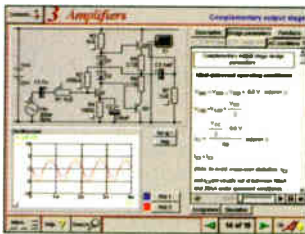

Complimentary output stage

Analogue Electronics is a complete learning resource for this most difficult branch of electronics. The CD-ROM includes a host of virtual laboratories, animations, diagrams, photographs and text as well as a SPICE electronic circuit simulator with over 50 pre-designed circuits.

Sections on the CD-ROM include: **Fundamentals** – Analogue Signals (5 sections), Transistors (4 sections), Waveshaping Circuits (6 sections). **Op.Amps** – 17 sections covering everything from Symbols and Signal Connections to Differentiators. **Amplifiers** – Single Stage Amplifiers (8 sections), Multi-stage Amplifiers (3 sections). **Filters** – Passive Filters (10 sections), Phase Shifting Networks (4 sections), Active Filters (6 sections). **Oscillators** – 6 sections from Positive Feedback to Crystal Oscillators. **Systems** – 12 sections from Audio Pre-Amplifiers to 8-Bit ADC plus a gallery showing representative p.c.b. photos.

ROBOTICS & MECHATRONICS



Case study of the Milford Instruments Spider

Robotics and Mechatronics is designed to enable hobbyists/students with little previous experience of electronics to design and build electromechanical systems. The CD-ROM deals with all aspects of robotics from the control systems used, the transducers available, motors/actuators and the circuits to drive them. Case study material (including the NASA Mars Rover, the Milford Spider and the Furby) is used to show how practical robotic systems are designed. The result is a highly stimulating resource that will make learning, and building robotics and mechatronic systems easier. The Institutional versions have additional worksheets and multiple choice questions.

- Interactive Virtual Laboratories
- Little previous knowledge required
- Mathematics is kept to a minimum and all calculations are explained
- Clear circuit simulations

DIGITAL ELECTRONICS V2.0

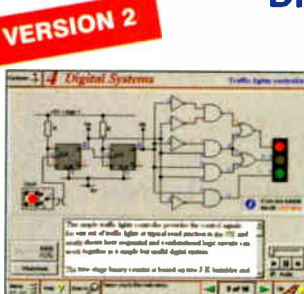

Virtual laboratory – Traffic Lights

Digital Electronics builds on the knowledge of logic gates covered in *Electronic Circuits & Components* (opposite), and takes users through the subject of digital electronics up to the operation and architecture of microprocessors. The virtual laboratories allow users to operate many circuits on screen.

Covers binary and hexadecimal numbering systems, ASCII, basic logic gates, monostable action and circuits, and bistables – including JK and D-type flip-flops. Multiple gate circuits, equivalent logic functions and specialised functions. Introduces sequential logic including clocks and clock circuitry, counters, binary coded decimal and shift registers. A/D and D/A converters, traffic light controllers, memories and microprocessors – architecture, bus systems and their arithmetic logic units. Sections on Boolean Logic and Venn diagrams, displays and chip types have been expanded in Version 2 and new sections include shift registers, digital fault finding, programmable logic controllers, and microcontrollers and microprocessors. The Institutional versions now also include several types of assessment for supervisors, including worksheets, multiple choice tests, fault finding exercises and examination questions.

ANALOGUE FILTERS

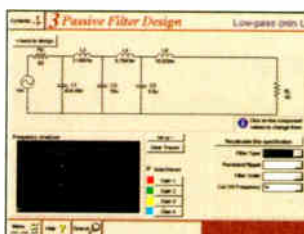

Filter synthesis

Analogue Filters is a complete course in designing active and passive filters that makes use of highly interactive virtual laboratories and simulations to explain how filters are designed. It is split into five chapters: **Revision** which provides underpinning knowledge required for those who need to design filters. **Filter Basics** which is a course in terminology and filter characterization, important classes of filter, filter order, filter impedance and impedance matching, and effects of different filter types. **Advanced Theory** which covers the use of filter tables, mathematics behind filter design, and an explanation of the design of active filters. **Passive Filter Design** which includes an expert system and filter synthesis tool for the design of low-pass, high-pass, band-pass, and band-stop Bessel, Butterworth and Chebyshev ladder filters. **Active Filter Design** which includes an expert system and filter synthesis tool for the design of low-pass, high-pass, band-pass, and band-stop Bessel, Butterworth and Chebyshev

PRICES

Prices for each of the CD-ROMs above are:

(Order form on third page)

(UK and EU customers add VAT at 17.5% to "plus VAT" prices)

Hobbyist/Student£45 inc VAT
 Institutional (Schools/HE/FE/Industry).....£99 plus VAT
 Institutional 10 user (Network Licence).....£249 plus VAT
 Site Licence.....£499 plus VAT

PICmicro TUTORIALS AND PROGRAMMING

HARDWARE

VERSION 2 PICmicro MCU DEVELOPMENT BOARD

Suitable for use with the three software packages listed below.

This flexible development board allows students to learn both how to program PICmicro microcontrollers as well as program a range of 8, 18, 28 and 40-pin devices. For experienced programmers all programming software is included in the PPP utility that comes with the development board. For those who want to learn, choose one or all of the packages below to use with the Development Board.

- Makes it easier to develop PICmicro projects
- Supports low cost Flash-programmable PICmicro devices
- Fully featured integrated displays – 13 individual I.e.d.s, quad 7-segment display and alphanumeric I.c.d. display
- Supports PICmicro microcontrollers with A/D converters
- Fully protected expansion bus for project work
- All inputs and outputs available on screw terminal connectors for easy connection

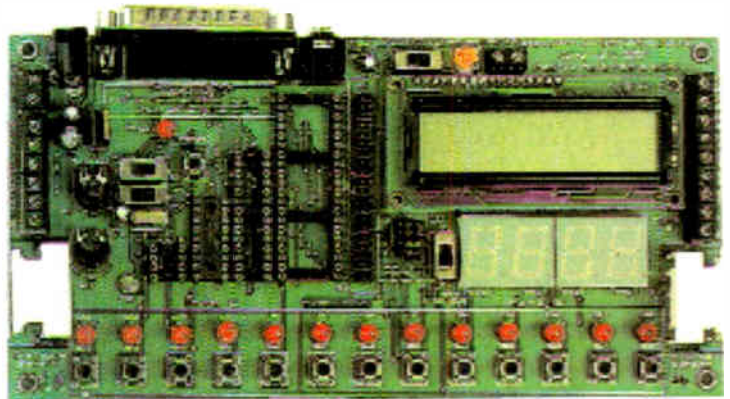

£145 including VAT and postage
12V 500mA plug-top PSU (UK plug) £7
25-way 'D' type connecting cable £5

SOFTWARE

Suitable for use with the Development Board shown above.

ASSEMBLY FOR PICmicro V2 (Formerly PICtutor)

Assembly for PICmicro microcontrollers V2.0 (previously known as PICtutor) by John Becker contains a complete course in programming the PIC16F84 PICmicro microcontroller from Arizona Microchip. It starts with fundamental concepts and extends up to complex programs including watchdog timers, interrupts and sleep modes. The CD makes use of the latest simulation techniques which provide a superb tool for learning: the Virtual PICmicro microcontroller. This is a simulation tool that allows users to write and execute MPASM assembler code for the PIC16F84 microcontroller on-screen. Using this you can actually see what happens inside the PICmicro MCU as each instruction is executed which enhances understanding.

- Comprehensive instruction through 39 tutorial sections
- Includes Viab, a Virtual PICmicro microcontroller: a fully functioning simulator
- Tests, exercises and projects covering a wide range of PICmicro MCU applications
- Includes MPLAB assembler
- Visual representation of a PICmicro showing architecture and functions
- Expert system for code entry helps first time users
- Shows data flow and fetch execute cycle and has challenges (washing machine, lift, crossroads etc.)
- Imports MPASM files.



Virtual PICmicro

'C' FOR PICmicro VERSION 2

The C for PICmicro microcontrollers CD-ROM is designed for students and professionals who need to learn how to program embedded microcontrollers in C. The CD contains a course as well as all the software tools needed to create Hex code for a wide range of PICmicro devices – including a full C compiler for a wide range of PICmicro devices.

Although the course focuses on the use of the PICmicro microcontrollers, this CD-ROM will provide a good grounding in C programming for any microcontroller.

- Complete course in C as well as C programming for PICmicro microcontrollers
- Highly interactive course
- Virtual C PICmicro improves understanding
- Includes a C compiler for a wide range of PICmicro devices
- Includes full Integrated Development Environment
- Includes MPLAB software
- Compatible with most PICmicro programmers
- Includes a compiler for all the PICmicro devices.

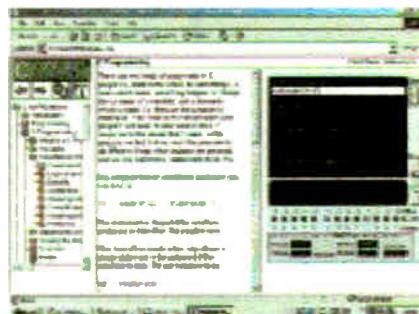

Minimum system requirements for these items: Pentium PC running Windows 98, NT, 2000, ME, XP; CD-ROM drive; 64MB RAM; 10MB hard disk space.

FLOWCODE FOR PICmicro V2

Flowcode is a very high level language programming system for PICmicro microcontrollers based on flowcharts. Flowcode allows you to design and simulate complex robotics and control systems in a matter of minutes.

Flowcode is a powerful language that uses macros to facilitate the control of complex devices like 7-segment displays, motor controllers and I.c.d. displays. The use of macros allows you to control these electronic devices without getting bogged down in understanding the programming involved.

Flowcode produces MPASM code which is compatible with virtually all PICmicro programmers. When used in conjunction with the Version 2 development board this provides a seamless solution that allows you to program chips in minutes.

- Requires no programming experience
- Allows complex PICmicro applications to be designed quickly
- Uses international standard flow chart symbols (ISO5807)
- Full on-screen simulation allows debugging and speeds up the development process
- Facilitates learning via a full suite of demonstration tutorials
- Produces ASM code for a range of 18, 28 and 40-pin devices
- Professional versions include virtual systems (burglar alarm, buggy and maze, plus RS232, IrDa etc.).



Burglar Alarm Simulation

PRICES

Prices for each of the CD-ROMs above are:

(Order form on next page)

(UK and EU customers add VAT at 17.5% to "plus VAT" prices)

Hobbyist/Student
 Flowcode V2 Hobbyist/Student
 Institutional (Schools/HE/FE/Industry)
 Flowcode Professional
 Institutional/Professional 10 user (Network Licence)
 Site Licence

£45 inc VAT
 £57 inc VAT
 £99 plus VAT
 £99 plus VAT
 £300 plus VAT
 £599 plus VAT

TEACH-IN 2000 – LEARN ELECTRONICS WITH EPE

EPE's own *Teach-In* CD-ROM, contains the full 12-part *Teach-In* series by John Becker in PDF form plus the *Teach-In* interactive software (Win 95, 98, ME and above) covering all aspects of the series. We have also added Alan Winstanley's highly acclaimed *Basic Soldering Guide* which is fully illustrated and which also includes *Desoldering*. The *Teach-In* series covers: Colour Codes and Resistors, Capacitors, Potentiometers, Sensor Resistors, Ohm's Law, Diodes and L.E.D.s, Waveforms, Frequency and Time, Logic Gates, Binary and Hex Logic, Op.amps, Comparators, Mixers, Audio and Sensor Amplifiers, Transistors, Transformers and Rectifiers, Voltage Regulation, Integration, Differentiation, 7-segment Displays, L.C.D.s, Digital-to-Analogue. Each part has an associated practical section and the series includes a simple PC interface (Win 95, 98, ME ONLY) so you can use your PC as a basic oscilloscope with the various circuits.

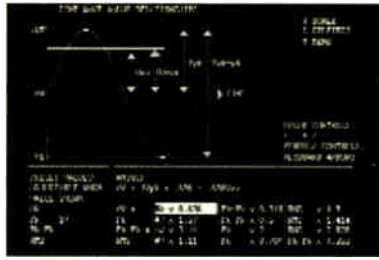

Sine wave relationship values

FREE BOOK WITH TEACH-IN 2000 CD-ROM

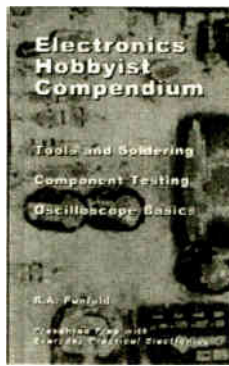

A hands-on approach to electronics with numerous breadboard circuits to try out.

£12.45 including VAT and postage. Requires Adobe Acrobat (available free from the Internet – www.adobe.com/acrobat).

FREE WITH EACH TEACH-IN CD-ROM – *Electronics Hobbyist Compendium* 80-page book by Robert Penfold. Covers Tools For The Job; Component Testing; Oscilloscope Basics.

ELECTRONICS IN CONTROL

Two colourful animated courses for students on one CD-ROM. These cover Key Stage 3 and GCSE syllabuses. **Key Stage 3:** A pictorial look at the Electronics section featuring animations and video clips. Provides an ideal introduction or revision guide, including multi-choice questions with feedback. **GCSE:** Aimed at the Electronics in many Design & Technology courses, it covers many sections of GCSE Electronics. Provides an ideal revision guide with Homework Questions on each chapter. Worked answers with an access code are provided on a special website.

Single User £29 inc. VAT. Multiple User £39 plus VAT
Student copies (available only with a multiple user copy) £6 plus VAT
 (UK and EU customers add VAT at 17.5% to "plus VAT" prices)

MODULAR CIRCUIT DESIGN

Contains a range of tried and tested analogue and digital circuit modules, together with the knowledge to use and interface them. Thus allowing anyone with a basic understanding of circuit symbols to design and build their own projects. Version 3 includes data and circuit modules for a range of popular PICs; includes PICAXE circuits, the system which enables a PIC to be programmed without a programmer, and without removing it from the circuit. Shows where to obtain free software downloads to enable BASIC programming. Essential information for anyone undertaking GCSE or "A" level electronics or technology and for hobbyists who want to get to grips with project design. Over seventy different Input, Processor and Output modules are illustrated and fully described, together with detailed information on construction, fault finding and components, including circuit symbols, pinouts, power supplies, decoupling etc.

Single User £19.95 inc. VAT. Multiple User £34 plus VAT
 (UK and EU customers add VAT at 17.5% to "plus VAT" prices)

VERSION 3

Minimum system requirements for these CD-ROMs: Pentium PC, CD-ROM drive, 32MB RAM, 10MB hard disk space. Windows 95/98/NT/2000/ME/XP, mouse, sound card, web browser.

Please send me: **CD-ROM ORDER FORM**

- Electronic Projects
- Electronic Circuits & Components V2.0
- Analogue Electronics
- Digital Electronics V2.0
- Filters
- Electronics CAD Pack
- Robotics & Mechatronics
- Assembly for PICmicro V2
- 'C' for PICmicro V2
- Flowcode V2 for PICmicro
- Digital Works 3.0

- Version required:**
- Hobbyist/Student
 - Institutional
 - Institutional/Professional 10 user
 - Site licence



- PICmicro Development Board V2 (hardware)
- Development Board UK plugtop power supply
- Development Board 25-way connecting lead

- Teach-In 2000 + FREE BOOK
- Electronic Components Photos
- Electronics In Control – Single User
- Electronics In Control – Multiple User
- Modular Circuit Design – Single User
- Modular Circuit Design – Multiple User

Note: The software on each version is the same, only the licence for use varies.

Full name:

Address:

.....Post code:Tel. No:

Signature:

I enclose cheque/PO in £ sterling payable to WIMBORNE PUBLISHING LTD for £

Please charge my Visa/Mastercard/Amex/Diners Club/Switch: £

Valid From:Card expiry date:

Card No: Switch Issue No.

Card Security Code (The last 3 digits on or just under the signature strip)

DIGITAL WORKS 3.0

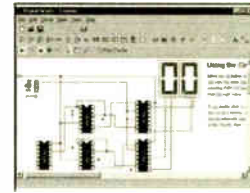

Counter project

Digital Works Version 3.0 is a graphical design tool that enables you to construct digital logic circuits and analyze their behaviour. It is so simple to use that it will take you less than 10 minutes to make your first digital design. It is so powerful that you will never outgrow its capability ● Software for simulating digital logic circuits ● Create your own macros – highly scalable ● Create your own circuits, components, and i.c.s ● Easy-to-use digital interface ● Animation brings circuits to life ● Vast library of logic macros and 74 series i.c.s with data sheets ● Powerful tool for designing and learning. **Hobbyist/Student £45 inc. VAT. Institutional £99 plus VAT. Institutional 10 user £249 plus VAT. Site Licence £599 plus VAT.**

ELECTRONIC COMPONENTS PHOTOS

A high quality selection of over 200 JPG images of electronic components. This selection of high resolution photos can be used to enhance projects and presentations or to help with training and educational material. They are royalty free for use in commercial or personal printed projects, and can also be used royalty free in books, catalogues, magazine articles as well as worldwide web pages (subject to restrictions – see licence for full details).



Also contains a **FREE 30-day** evaluation of Paint Shop Pro 6 – Paint Shop Pro image editing tips and on-line help included!

Price £19.95 inc. VAT

ORDERING

ALL PRICES INCLUDE UK POSTAGE

Student/Single User/Standard Version price includes postage to most countries in the world
EU residents outside the UK add £5 for airmail postage per order

Institutional, Multiple User and Deluxe Versions – overseas readers add £5 to the basic price of each order for airmail postage (do not add VAT unless you live in an EU (European Union) country, then add 17½% VAT or provide your official VAT registration number).

Send your order to:

**Direct Book Service
 Wimborne Publishing Ltd
 408 Wimborne Road East
 Ferndown, Dorset BH22 9ND**

To order by phone ring

01202 873872. Fax: 01202 874562

Goods are normally sent within seven days

E-mail: orders@wimborne.co.uk

Online shop:

www.epemag.wimborne.co.uk/shopdoor.htm

SURFING THE INTERNET

NET WORK

ALAN WINSTANLEY

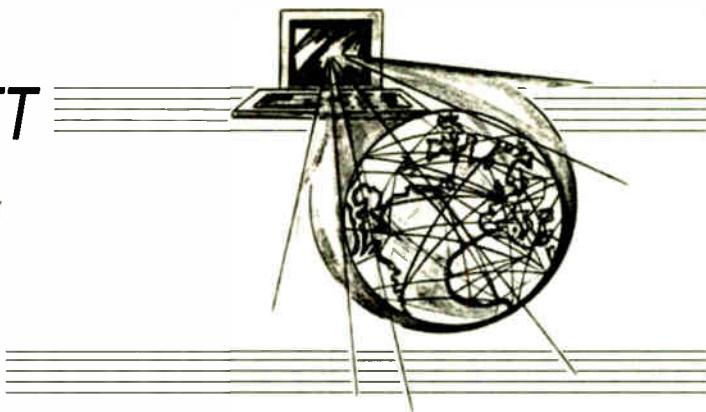

HAPPY New Year, readers! With 2005 well and truly upon us, attention often turns to starting to clear out our surplus or unwanted items, and for many of us that means mooching over to eBay (www.ebay.co.uk and countries). This month's *Net Work* revisits eBay and warns of some of the perils of buying or selling.

It has been said that eBay rates as the world's most recognised brand, even ahead of Mickey Mouse. For many people, eBay is now their first port of call when searching for just about anything. There is no question that eBay, which is probably responsible for the near collapse of traditional Classified advertising in local papers, is a uniquely useful way of putting buyers and sellers in touch with each other.

If you are anything like the author, you hate throwing anything away and you will go to the end of the Earth in order to find an unwanted item a good home. If a few pounds can be made into the bargain, so much the better. Buying on eBay can be equally rewarding, if you know what to look for. A drum of 100 high quality 8-speed DVD-R disks for £19.00 plus p&p proved to be a good bargain, and funnily enough it transpired that the seller lived just a few miles away. Hard to find PVC covers for 8cm mini CDs were also sourced on eBay, as was a rare waterproof rainjacket for a Sony camcorder (and a video lamp). Even British railway operators snap up valuable legacy electrical switchgear on eBay. Once you start, you're hooked! There is plenty for the electronics enthusiast to delve into (but *EPE Chat Zone* users report that tasty-looking second-hand oscilloscopes have a nasty habit of being dead on arrival, so be careful!).

Don't get Burnt on eBay

The principle of *caveat emptor* (let the buyer beware) applies by the shovel-full. The secret of success on eBay is to keep one's feet firmly planted on the ground and not get carried away with bidding. However, for unwary buyers, even the most legitimate-looking bargain carries the potential for fraud, so a very healthy dose of cynicism rarely goes amiss.

In England, a 28 year old woman was prosecuted for selling non-existent concert tickets on eBay. She earned £3,000 (\$5,700) for tickets for the Glastonbury Festival pop concert. Judge Richard Bray said "It [eBay] is based entirely on trust, with no checking at all. [Buyers who are] trusting people send money in good faith. I'm not surprised there is fraud. It is truly amazing." In the same way, a 17 year old youth from Wales conned buyers out of nearly £50,000 selling goods that never existed. He blew the money on an exotic lifestyle over in New York before the law caught up with him.

In another case, an English woman paid for a Sony laptop sold by an Italian eBay "user". Payment was required by Western Union before the laptop could be despatched. Anyone can waltz into their nearest Western Union office with some identification and collect the payment, then vanish into the night, and that's exactly what happened; the money was spirited away but no laptop ever arrived. If there is the slightest doubt, never pay by cash transfer for such transactions, especially not by Western Union. The chances are that a deal will work out fine, but bad experiences leave a bitter after-taste with innocent people who have been stung by a transaction facilitated through eBay's online service.

Taken for a Ride

A police acquaintance is a keen golfer who uses eBay to trade in a wide range of golf items. Over a cup of tea he told me about an item he spotted on eBay that aroused his "detective" suspicions. An electric golf cart was up for sale, complete with alloy

wheels, special paintwork and heightened suspension, which made this the Acme of all golf carts. The eBay seller's location was clearly stated as "UK" and the selling price was suspiciously low.

A photo showed the cart in all its glory. The trouble was, the houses in the background were definitely not English, neither was the licence plate on the cart. A magnifying glass confirmed that the photo was taken somewhere in Eastern Europe. Some innocent-looking emails sent by my police friend quickly revealed the scam; the seller was actually in the Czech Republic. He was offering to ship the cart across Europe for cash on delivery, provided the freight charges were paid in advance! Digging deeper, the seller's 50+ eBay rating looked suspicious as well – all of the transactions were for very trivial amounts. My police contact emailed all other bidders to warn them of the consequences of paying out. Anyone with any sense would trust their instincts and avoid this item, but the winning buyer (yes, there was one), was in mortal danger of being taken for a ride – on a golf cart that would not have arrived.

There are a number of practical aspects that potential eBayers should remember when trading in the world's largest online emporium. Firstly, it is straightforward enough to build up a positive eBay rating, e.g. by selling a large number of trivial items. Don't be fooled; check into previous transactions by clicking on the "Feedback" rating of the seller. Selling prices can also be inflated by a group of bidders collaborating between themselves to force up the bid, so you pay more.

Protect Yourself

Take nothing for granted. The golden rule is that sellers are not responsible for questions that you do not ask! For example, do not assume that (say) a second-hand inkjet printer comes with ink cartridges or a printer cable if it has not been mentioned in the advert. The cartridges will cost more than the printer! Ask the seller beforehand about all such aspects, and comb the description carefully, thinking about anything that may have deliberately been omitted.

Shipping charges are another way of boosting profits. The writer recently bought a 512MB Mini SD card (for just £39.99) and the p&p was £2.99. Since the memory card is tiny, that's another £2.50 profit on sales. Insurance is another point to consider; it is unsafe to assume that if an item is lost in the post that the seller will send another. The general assumption is that items are posted at the buyer's risk, and if you want extra protection you may need to pay extra costs. For more expensive items (e.g. a laptop), is there a land-line number available to call the seller? One highly seasoned eBay buyer pays to use 192.com to research the sellers' addresses from their phone number.

Paypal (owned by eBay) offers some limited form of protection but the general feeling appears to be that buyers may have to jump through hoops in order to establish a claim against a defaulting seller. Credit card companies may be able to help with some claims, but if you are brave enough to send cash, Western Union or bank transfers then the risks are extremely high. Revenge is sweet though: take a look at <http://tinyurl.com/685sf> to see how a fraudulent scammer in London was outscammed.

It stands to reason that eBay fraud will rise as more beginners jump on the bandwagon, with fraudsters marvelling at the simplicity of defrauding honest people out of their hard-earned cash. Here's hoping that you don't have to learn a painful lesson. In next month's *Net Work* I'll be looking at the practice of defrauding by "phishing". You can email alan@epemag.demon.co.uk.

Smart Karts

Owen Bishop

Part 5 – SK-3 Goes Pushing and Grabbing

ONE of the stimulating aspects of robotics is that it combines three technologies – electronics, mechanics, and computer programming. The emphasis is on the mechanical side this month, for we give our Smart Kart mobile robot some tools, controlled under another set of PIC program routines, which will be discussed next month. For simplicity we shall call this robot version SK-3.

New Accessories

The grabber (or gripper) is the more useful of the new tools. It picks up objects and then deposits them somewhere else, see below. However, constructing even the simplest gripper requires a certain amount of mechanical skill. We also describe a design for a pusher. This turns SK-3 into a kind of bulldozer, which pushes objects around the tabletop or floor, but does not pick them up.

The robot has to know if there is anything to push or grab, of course. It has a reflected light sensor for this purpose. As usual with mobile robots, we need some way of letting it know where it is. Line following is a sufficiently precise solution to this problem, so we have re-installed the pair of infrared sensors that were used in Part 1 (Oct '04).

A lot of the structures and electronics used in the previous versions are used again in SK-3. As just mentioned, we use the

infrared sensors. We also use the complete lower deck with its motors, battery, and power board. We use the middle deck too, with its processor board and battery.

The tools (one or the other, but not both at the same time) are mounted at the rear edge of this deck. But the upper deck is completely new, with a new Distribution board, a Light Sensor board and second copy of the Power Switching board of Part 1 (Oct '04) for driving the motor or motors that operate the new attachments.

The main theme of SK-3 is *feedback*, mainly that provided by limit switches. These tell the robot what it is doing or, rather, what it has done.

Getting Started

If you are working from SK-2 (Part 3, Dec '04), remove the bumpers and the small bumper board from the middle deck. If you originally built SK-1 (Part 1), you already have its infrared sensors. Mount these at the front edge of the middle deck, as before. They connect to the Processor board (Part 1); the power lines go to the screw terminals and the 2-way socket to pins 6 and 7 of the header plug.

SK-3 uses the same type of microcontroller, a PIC16F84, as used in the earlier versions, so you can simply re-program the one you have or program a new one. (Pre-programmed PICs are available, see *Shoptalk* page.)

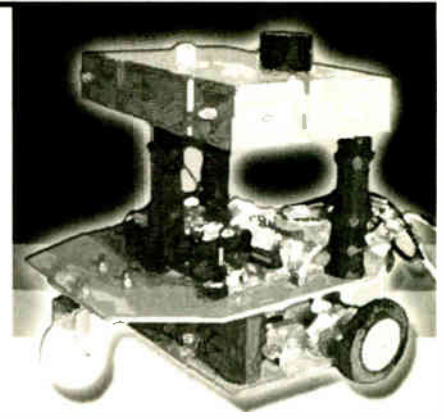

Remove the upper deck entirely and replace it with the new deck as described below. Retain the three separators, ready for supporting the new upper deck.

Upper Deck

The upper deck is a single panel with two small panels glued to its edges to support two l.e.d.s, and the two switches used for selecting the programs. It is best to defer wiring and gluing the edge panels until after the winch has been constructed and the circuit boards mounted.

The general layout of the upper deck is shown in Fig.5.1, along with the holes required. As usual, the hole diameters and exact positions depend on factors such as the dimensions of the motor, the winch and the p.c.b. supports. Six holes are needed for these supports. There is a slot for passing the lead through from the Processor board to the boards on this deck.

Winch Assembly

The motor-driven winch is used for raising and lowering the tool (pusher or grabber). Begin construction of the upper deck by building the winch. As shown in the photographs opposite, the motor (which incorporates a reduction gearbox) drives a spindle around which is wound a thin cord. This passes through the hole at the end of the cord support arm, and is tied to the tool (grabber or pusher).

Depending on the material used for the cord support arm and the eventual weight of the gripper (plus load), you may need an arm more rigid than that shown. If using foam PVC, make the arm from two strips 15mm wide and glued together in the form of an L-girder or T-girder (see later).

The various brackets and bearings used in this assembly may be made from strip aluminium drilled and bent to the required shape. Some electronics suppliers list metal angle brackets that are suitable. The prototype used small angle brackets and other Meccano parts, secured with Meccano nuts and bolts.

The motor support panel is held vertical by an angle bracket. It is drilled to accept the front bearing of the motor, which protrudes slightly from the casing. The motor used in the prototype has two M2.5

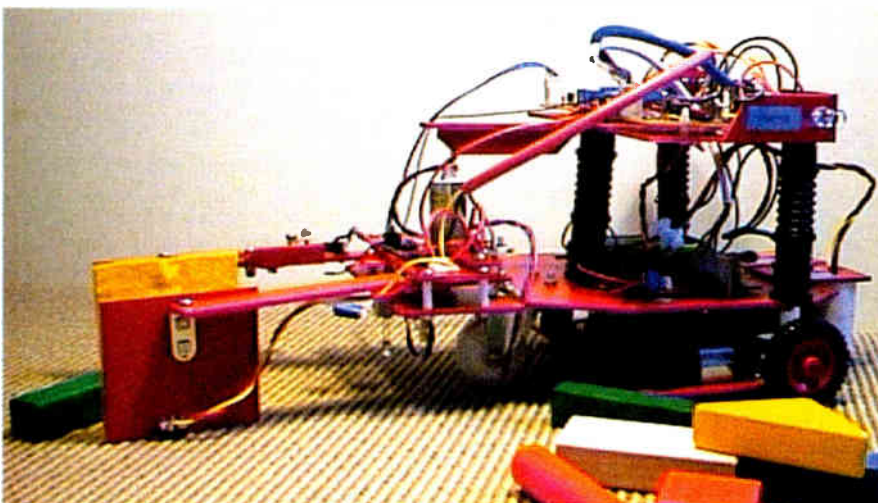

Smart Kart SK-3 with its rear-mounted grabber searches for bricks.

threaded holes on either side of the bearing and two M2.5 bolts 10mm long were used to bolt the motor to the support.

The shaft of the motor is coupled to the shaft of the winch by a short length of plastic aquarium tubing, 5mm diameter, which is a tight fit on both shafts. The winch shaft is a 4mm diameter steel rod about 50mm long.

Before assembling the motor and coupling it to the winch, check carefully that the shafts of the motor and winch are exactly in line. If the axis of the motor is found to be higher than that of the winch, cut a sliver from the bottom edge of the support before bolting it to the bracket.

When bolted to the bracket, the bottom edge of the support should rest firmly on the upper deck, to prevent it from turning. Preferably, use a shakeproof nut for securing the bracket to the deck.

The far end of the shaft is prevented from coming free of the bearings by rubber grips. Small rubber grommets or bolt-on feet could be used for this; the prototype used the Meccano equivalent. One of the grips is used to secure the end of the cord to the shaft. Thread the cord a short way from left to right (see photos) through the grip before pushing the grip on to the shaft. Tie a knot in the cord to prevent it from being pulled out of the grip.

Note the capacitor soldered across the terminals of the motor. Further work on the upper deck is described later, but first the control circuit is described, assembled and tested.

Light Sensor

The Light Sensor is designed to detect a small object placed behind the robot (the robot runs in reverse when pushing or grabbing). Its circuit diagram is shown in Fig.5.2.

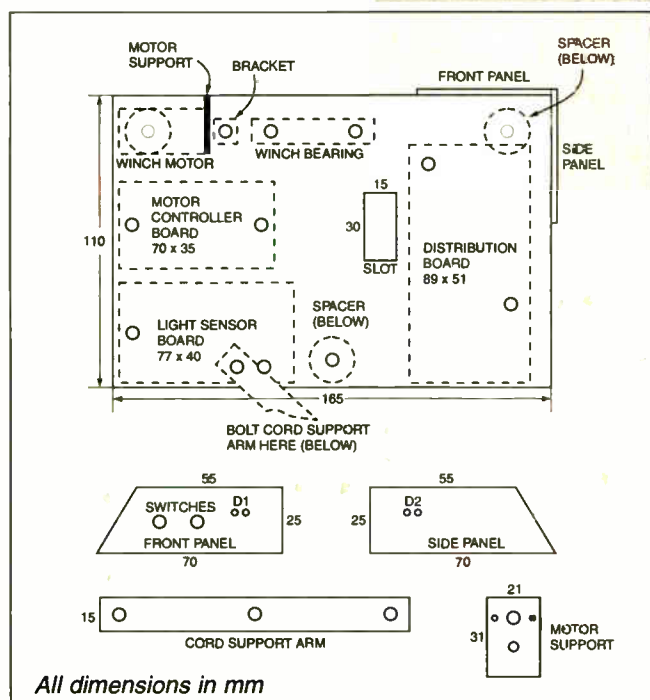
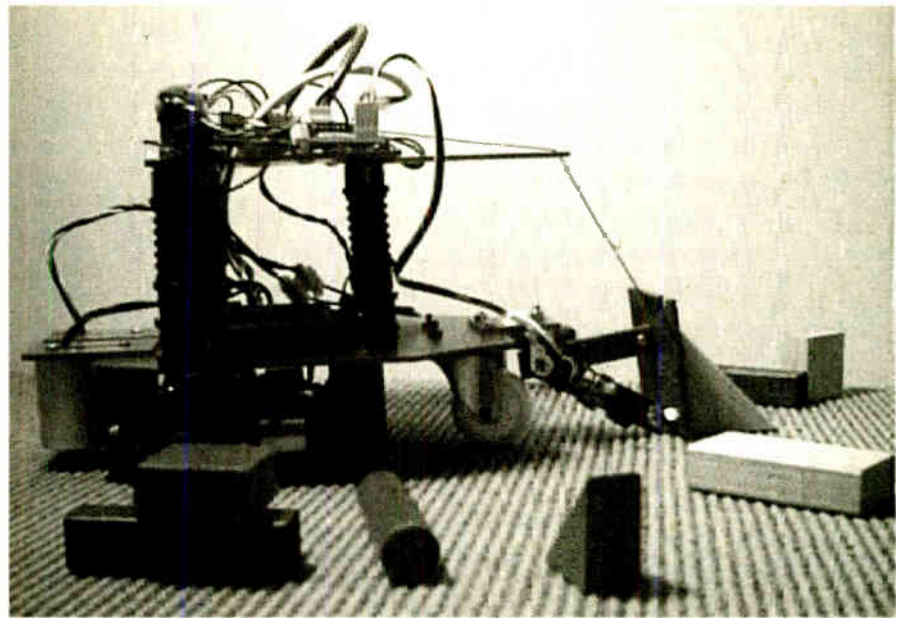
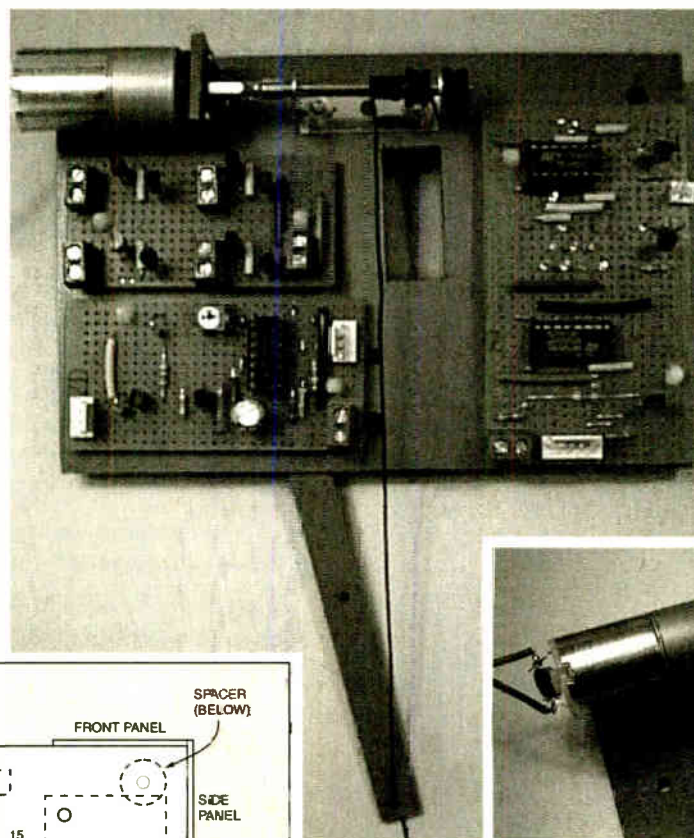

Fig.5.1. The parts and layout of the new Upper deck.



(Above) In its other version, SK-3 has a rear-mounted pusher attachment for moving objects around the room.



(Left) The upper deck before the inter-board wiring is done. Note the cord support arm.

(Below) The winch is positioned at the front of the Upper Deck and used to raise or lower the pusher or grabber at the rear of the robot.



The probe has two high-intensity l.e.d.s, one blue and one red (D1 and D2). The l.e.d.s are switched on alternately by the 1Hz astable built from two CMOS inverter (NOT) gates, IC1a and IC1b, whose outputs are buffered first by IC1c and IC1d, and then by transistors TR1 and TR2, which drive the l.e.d.s. Note that the l.e.d. ballast resistors (R3 and R4) have their values selected to suit the colour intensity of the diodes.

The astable signal is also sent via the Distribution board to the PIC (see Part 1 Fig.5, Oct '04), at pin RB4, so that it knows which l.e.d. is on. Call this the Red-On signal.

The red light is reflected by the object (or not reflected) and is detected by the light dependent resistor (LDR), R8. The voltage across the LDR is inversely proportional to the amount of light falling on it. Therefore, the voltage across resistor R5 and preset potentiometer VR1 is directly proportional to reflected light. Preset VR1 is set so that this voltage is greater than about 2.4V when the object is reflecting (counting as a logic high input to gate IC1e), and less than 2.4V when the object is not reflecting.

The output from IC1e is sent via the Distribution board to PIC pin RB5. Because of the inverting action of the gate, the signal is

low for reflecting and high for not reflecting. Call this the LDR signal.

The LDR signal alternates only if there is an object present, and only when the object is near enough (about 8cm away or less) to reflect back sufficient light. If the object is too far away, or if there is no object, the signal output logic depends on the light level in the room. In the dark it is continuously high and in a room with normal or bright illumination, it is low.

What usually happens when the probe is correctly adjusted is that the close-by object shields the LDR from the room

illumination, so the LDR signal is low but goes high when the l.e.d. comes on. The PIC monitors the two signals, Red-On and LDR, and from the inputs it receives can determine if there is an object present ready to be pushed or grabbed.

The astable also provides the signals for two 10mm l.e.d.s mounted at the front and

rear of the upper deck. The signal goes from the sensor board, through the Distribution board, to the l.e.d.s.

Sensor Assembly

The Sensor board's assembly details are shown in Fig.5.3. Assemble in the same manner as you did in Parts 1 and 3, and observing the correct orientation of any polarity-conscious components. Note that the copper tracks beneath IC1 are *not* cut at H9, I9 and K9.

You need another 4-way connecting lead, about 18cm long, to run from PL1 on this board to PL4 on the Distribution board. This has a 4-way header socket on the Sensor board end. At the other end, it has a 2-way header socket for plug PL4 of the Distribution board, and two terminal pin sockets to connect to TP2 and TP9.

Probe Assembly

Assemble the probe on a 4-way screw terminal block as shown in Fig.5.4. The block gives a compact probe that can be mounted at a convenient point on the middle deck, using tape, glue, a double-sided sticky pad or self-adhesive Velcro. This allows you to alter the angle of the probe after a few trials, or for detecting different types of object.

Keep the component wires long enough to allow l.e.d.s D1 and D2 and the LDR to be set at the best angle for reflection. Note that the LDR only responds to the red l.e.d., D1.

Slip short lengths of black or dark-coloured sleeving over l.e.d. D1 and the LDR to improve the directional property of the probe. This also prevents stray light from D1 travelling directly to the LDR.

Solder a 4-way cable to the probe, using thin flexible cable so that it does not interfere with the action of the tool on

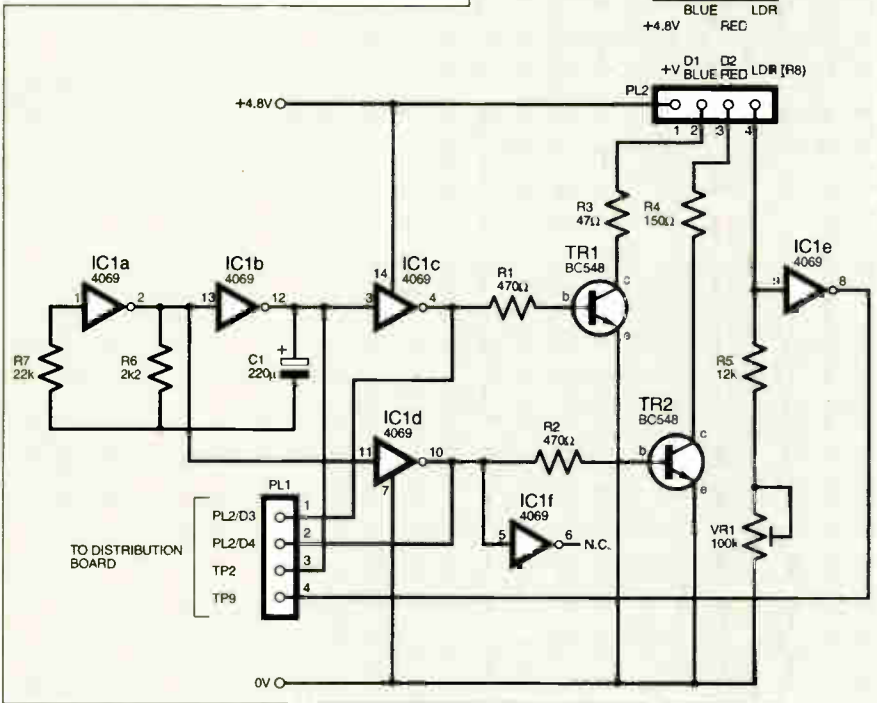

Fig.5.2. Complete circuit diagram for the Light Sensor, including probe head.

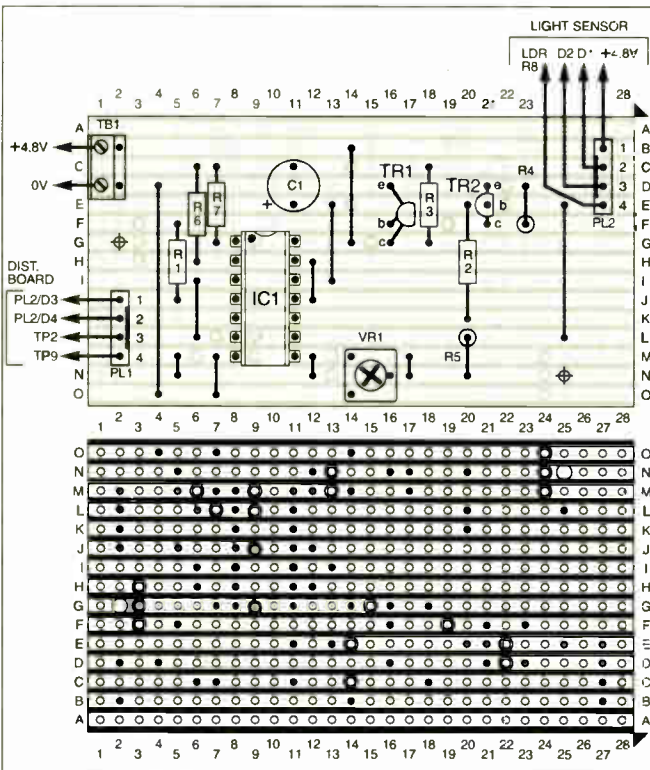
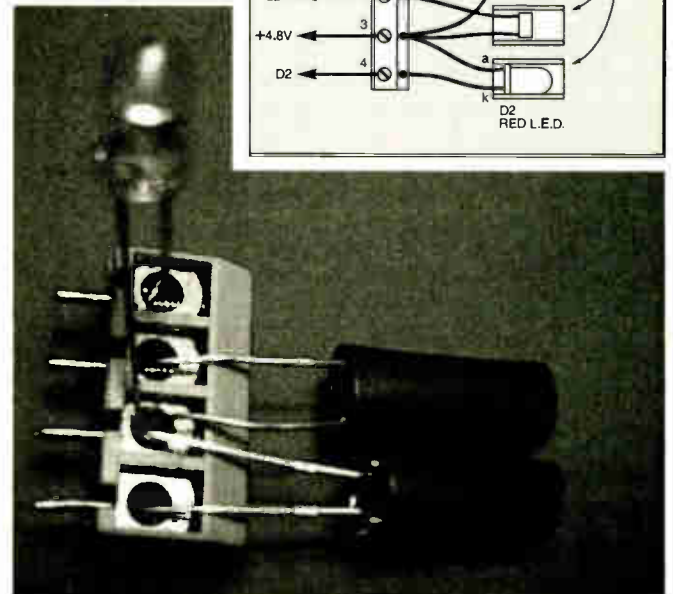
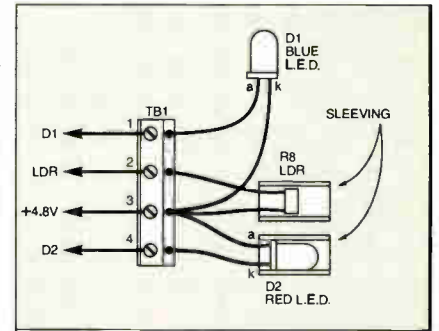

Fig.5.3. Light Sensor stripboard component layout, details of copper strip breaks and lead-off wiring to distribution board and light sensor.

Fig.5.4(right). Showing the connection between the light sensor and distribution boards.



The LDR of the probe is shielded from the red l.e.d. by pushing a piece of sleeving on them. The blue l.e.d. is directed to one side, as it is purely decorative.

which the probe is mounted. The cable should be about 30cm long, or longer if you intend to experiment with using the probe in different locations. Solder the other ends of the wires to a 4-way header socket, noting the polarity of the plug. PL2 in Fig.3.

Testing the Light Sensor

To test the Light Sensor, first connect the power supply. Test the output of IC1 at pins 4 and 12. It should alternate between 0V and +4.8V at about 1Hz. The same signals are found at PL1/1, PL1/2 and PL1/3. Assuming all is well, plug the probe into PL2. The l.e.d.s flash brilliantly, alternately red and blue.

Connect a voltmeter to IC1 output pin 8 or at PL1/4. Test the circuit in low-level room lighting, well away from windows and bright bench lamps. Place a red object close in front of the probe. Cover the end of the sleeving on the LDR, so that it is in darkness. Adjust preset VR1 until the voltage just swings high.

Remove the cover and the voltage swings sharply to just a few millivolts. It stays low if there is no object in view. If the voltage remains low at all times, it may be that the ambient light level is too high, the probe is insufficiently shaded,

COMPONENTS

Approx Cost
Guidance Only

£3

LIGHT SENSOR and PROBE

Resistors

R1, R2	470Ω (2 off)
R3	47Ω
R4	150Ω
R5	12k
R6	2k2
R7	22k
R8	ORP12 LDR, or similar

All 0.25W 5% carbon film or better

Potentiometer

VR1	100k min. preset horiz.
-----	-------------------------

Capacitor

C1	220μ radial elect. 16V
----	------------------------

Semiconductors

D1	5mm red l.e.d., high intensity (5000 mcd)
----	---

D2

5mm blue l.e.d., high intensity (5000 mcd)

IC1

4069 hex inverter

TR1, TR2

BC548 npn transistor (2 off)

Miscellaneous

Stripboard 15 strips x 28 holes; 4-way locking and polarising header plug and socket (2 off), 2-way p.c.b. screw terminal, 4-way screw terminal, 14-pin d.i.l. socket, p.c.b. supports (2 off), sleeving, 5mm dia; connecting wire; solder.

Motor Control

See component list for the same in Part 1. Only one switching circuit is required if grabber is not to be powered.

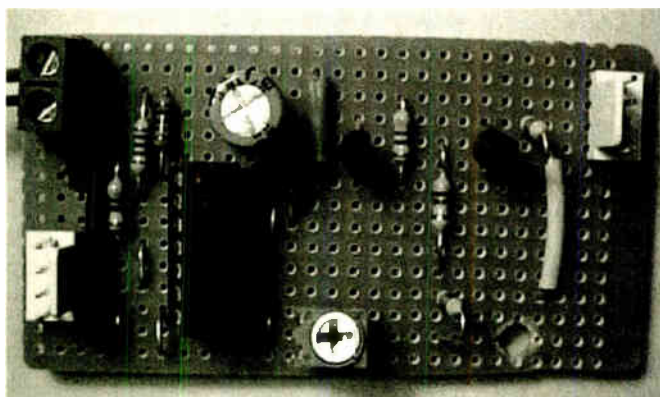

Component layout on the prototype Light Sensor board

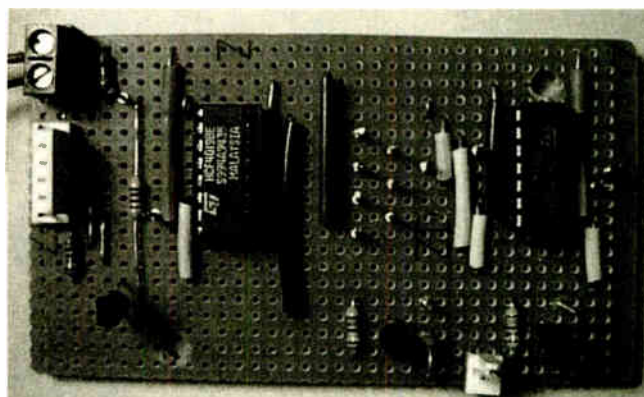

Prototype Distribution circuit board component layout

or the LDR and l.e.d. D1 are not angled to point at the same spot. Also, try readjusting preset VR1.

Distribution Board

The PIC16F84 does not have enough input/output pins to individually control all aspects. Consequently, the technique of multiplexing is used. This allows the PIC to accept data from eight sources via only four input pins. The multiplexing circuit diagram is shown in Fig.5.5.

The circuit is based on a 4019 8-line to 4-line multiplexer, IC2. This has two inputs SA (pin 9) and SB (pin 14) which, when taken high, select Group A inputs (A1 to A4) or Group B inputs (B1 to B4) respectively. Pin SA is fed directly with the signal from PIC pin RA4, pin SB is fed with the RA4 signal inverted by transistor TR3. Thus, one of the two groups is always active. Group A is selected when RA4 is high and Group B when it is low.

The selected group is output via IC2 pins Q1 to Q4. The PIC receives the data via its RB0 to RB3 pins.

IC2 input pins A1 to A3 and B1 to B3

COMPONENTS

Approx Cost
Guidance Only

£12

DISTRIBUTION BOARD

Resistors

RM1	10k s.i.l. 8-way commoned resistor module
R9, R10	10k (2 off)
R11	4k7
R12, R13	470Ω (2 off)
R14, R15	68Ω (2 off)

All 0.25W 5% or better, unless marked.

Semiconductors

D3, D4	5mm l.e.d., high intensity, any colour (2 off)
IC2	4019 8-line-to-4-line multiplexer
IC3	4081 quad 2-input AND gate

TR3

BC548 npn transistor

TR4, TR5

BC337 npn transistor (2 off)

Miscellaneous

S1, S2	sub. min. toggle switch (2 off)
S3 to S7	sub. min. microswitch (5 off)

Stripboard 20 strips x 35 holes; 2-way header plug and socket; 6-way header plug and socket; 16-pin d.i.l. socket; 14-pin d.i.l. socket; 2-way screw terminal; pin-header terminal pins and sockets (15 off), p.c.b. supports 6.35mm (2 off), connecting wire, solder.

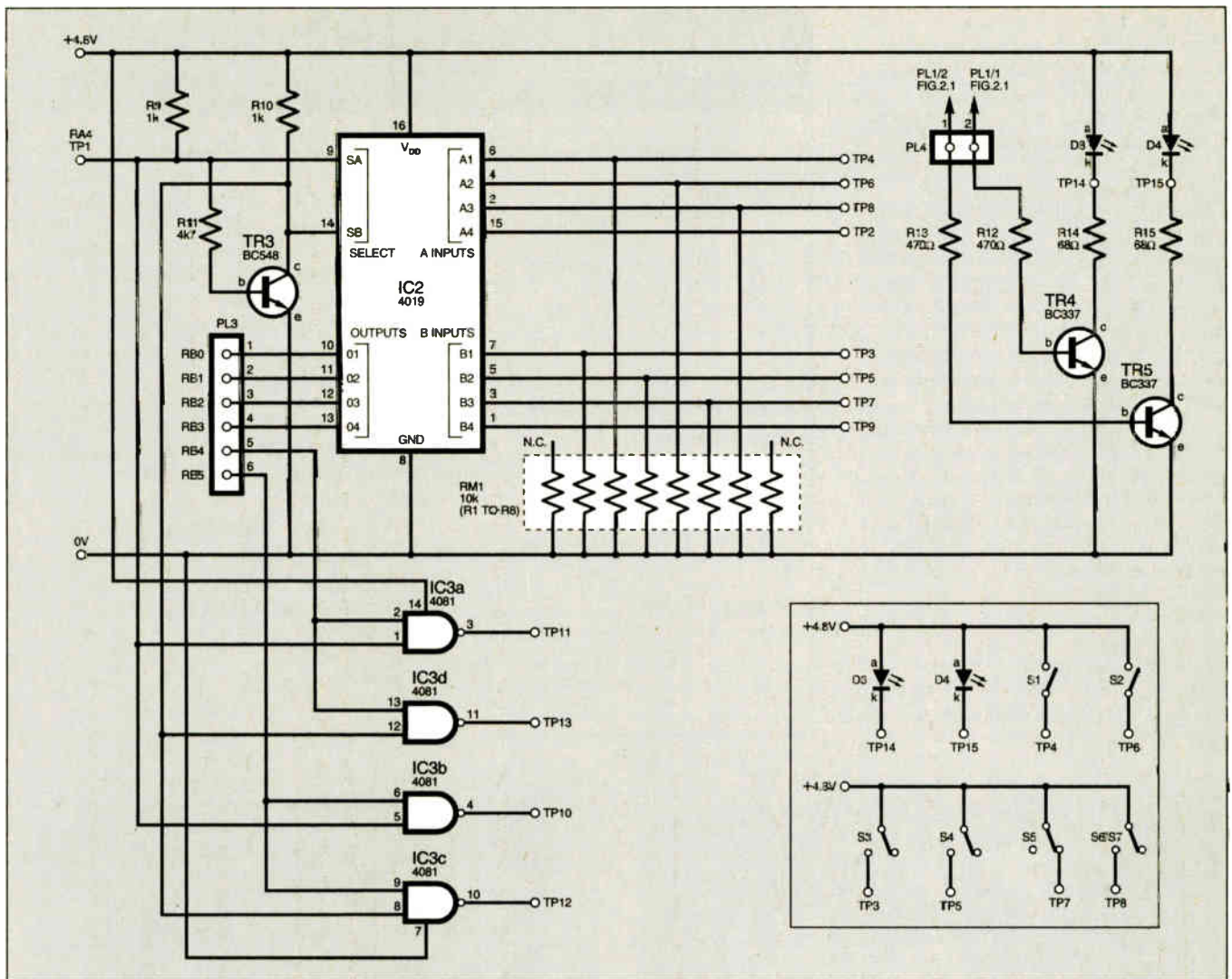

Fig.5.5. Complete circuit diagram for the PIC multiplexing distribution section of Smart Kart SK-3. The Input/Output switching arrangement is shown inset; see also Table 5.1.

are biased low by the resistors in the 8-way commoned resistor module notated as RM1. Two of the resistors are not used since inputs A4 and B4 are fed by logic level signals.

Still referring to Fig.5.5, PIC pins RB4 and RB5 (PL3/5, PL3/6) control the jaw and winch/gripper motors. These control signals are passed to a 2-line to 4-line demultiplexer based on the four AND gates of IC3.

When PIC pin RA4 is high, IC3a and IC3b pass the motor control signals to the jaws motor, via IC3 pin 10 (TP12) and IC3 pin 11 (TP13). When RA4 is low, these gates are disabled, and IC3c and IC3d are enabled instead, passing the signals to the winch motor.

The motor control circuit is the same as that shown in Part 1, Fig.3 and is not repeated here.

Transistors TR4 and TR5 are controlled by the outputs of IC1c and IC1d in Fig.5.2, and in turn control "cosmetic" i.e.d.s D3 and D4.

PIC pins RB6 and RB7 are not connected to either of the above circuits. They stay permanently connected as in Part 1 Fig.5, receiving data from that Part's infra-red sensors.

Multiplexer Data Routing

Table 5.1 sets out the connections for

PIC Port B; Port A (RA0 to RA3) is used for controlling the drive motors as in the two previous Smart Kart versions; RA4 selects input groups as described above.

Distribution Board Assembly

The component layout of the Distribution board is shown in Fig.5.6. Prepare and assemble it in the usual way. Note that the copper strips beneath IC3 are *not* cut at F30 and J30.

Resistor module RM1 is an 8-way single-in-line (s.i.l.) package. The common terminal is at C18, on the 0V line. The first two resistors are not used, so their pins (at D18 and E18) are cut off. The other pins are soldered to F18 to K18.

Header plug PL4 is oriented along the strip and requires a break to be made in the strip between T26 and T27. This is easily done using a sharp-pointed craft knife.

The board needs a 6-way cable with 6-way pin-header sockets at both ends. Make the cable about 15cm long. The cable connects PL3 on the Distribution board with six of the pins (0 to 5) on the 8-way plug PL2 of the Processor board (Fig.6 Part 1). The other two pins (6 and 7) on that plug receive the 2-way cable from the infra-red sensors (as in Part 1). Use a sharp knife to pare away one polarising strip on one of the 6-way sockets so that it fits side-by-side with the 2-way socket on the 8-way plug.

Table 5.1: Inputs and Outputs to PIC Port B

PIC Pin	Input/Output	Group A	Group B
RB0		Select S1	S3: Jaws wide open
RB1		Select S2	S4: Jaws closed and empty
RB2		S6 or S7: Pusher or jaws up/down	S5: Jaws closed on object
RB3		Red-On signal	LDR signal
RB4	O	Winch motor	Jaws motor
RB5	O		
RB6		Infra-red Sensor, right	
RB7		Infra-red Sensor, left	S3 to S7 = microswitch

Testing the Distribution Board

Connect the power supply, and connect terminal pin TP1 to 0V, setting IC2 pin 9 of IC1 low and pin 14 high. The levels invert when TP1 is connected to +4.8V.

Monitor the output voltage at PIC pin RB0 on PL3, while TP1 is connected to +4.8V (selecting Group A inputs). The inputs at TP3 and TP4 are held low by their pull-down resistors, so all you need for testing is a flying lead connected to the positive supply.

IC2 output Q1 (PL3/1) follows the logic level at the input at TP4 (the Group A input for RB0). It is unaffected by the input at TP3 (the Group B input for RB0), staying low. Reconnect TP1 to 0V and RB0 will now follow the input at TP3.

Repeat the testing for RB1, RB2 and RB3. With RB3, you need a second flying lead to connect to 0V, as TP2 and TP9 do not have pull-down resistors at the signal source. This completes the test on the multiplexer circuit.

To test the demultiplexer, use flying leads connected to PL3/5 and PL3/6 (RB4 and RB5). With TP1 connected to +4.8V (selecting Group A outputs), the outputs at TP11 and TP10 follow the inputs at PL3/5 and PL3/6 respectively. The outputs at TP12 and TP13 remain low. With TP1 connected to 0V, TP10 and TP11 remain low but TP12 and TP13 follow the inputs at PL3/6 and

PL3/5 respectively. It is essential that both PL3/5 and PL3/6 are connected to 0V or +4.8V when testing; floating inputs can give false results.

Finally, connect i.e.d.s D3 and D4 and check that they can be correctly controlled via PL4. Applying a positive voltage turns the i.e.d. on.

Motor Control

The jaws and winch motors are controlled by a copy of the Power Switching board used in Part 1, see its Fig.3 and Fig.4. Motor M1 raises and lowers the winch, motor M2 opens and closes the jaws of the grabber. If you are building only the pusher version of SK-3, you do not need the drive for motor M2 and its associated components can be omitted. Assemble and test the board as described in Part 1.

Installing the Electronics

Mount the three stripboards on their

supports, see Fig.5.1. The new motor control board is powered from the same battery on the lower deck that powers the motor board in Part 1. If necessary, remove the middle deck from the lower deck in order to get at the TB1 power supply terminal.

Having made the TB1 connection, thread the wires through the deck holes and secure them to terminal TB1 on the upper motor control board.

When soldering the wires to the tags on the motors, also solder a 100nF capacitor (C1 and C2) across the terminals.

The control leads to the board are screwed directly into the terminals provided. Their other ends require the fitting of terminal pin sockets for pushing on to the terminal pins on the Distribution board. Table 5.2 shows the connections, but there is no need to connect M2 until you install the grabber.

Next, make the cable for connecting the Light Sensor board to the Distribution board.

Table 5.2: Motor connections

Motor	Motor Board 2		Distribution board	
	Terminal	Terminal	Terminal pin	PIC pin
M1, Winch	TB2	ACONT	TP11	RB4(A)
	TB3	BCONT	TP10	RB5(A)
M2, Jaws	TB4	CCONT	TP13	RB4(B)
	TB5	DCONT	TP12	RB5(B)

Interconnection

The front and side panels are easier to wire as a unit before gluing them to the edges of the Upper Deck (see Fig.5.1). Mount the program select switches S1 and S2 so that their actuators are down when the switch is off.

Cut a wire about 15cm long for the positive supply lead and strip 3cm of insulation from one end. Thread this through the lower terminals of the switches. Bend the anode wire of the i.e.d. D3 on the front panel, to pass through the lower terminal of S1, see photo below.

Solder the wires to the terminals. Slide a short length of sleeving over the anode wire of D4, then wrap the exposed end of the wire around the anode wire of D3; solder them together. Make four leads about 10cm long. Solder one to each switch and each

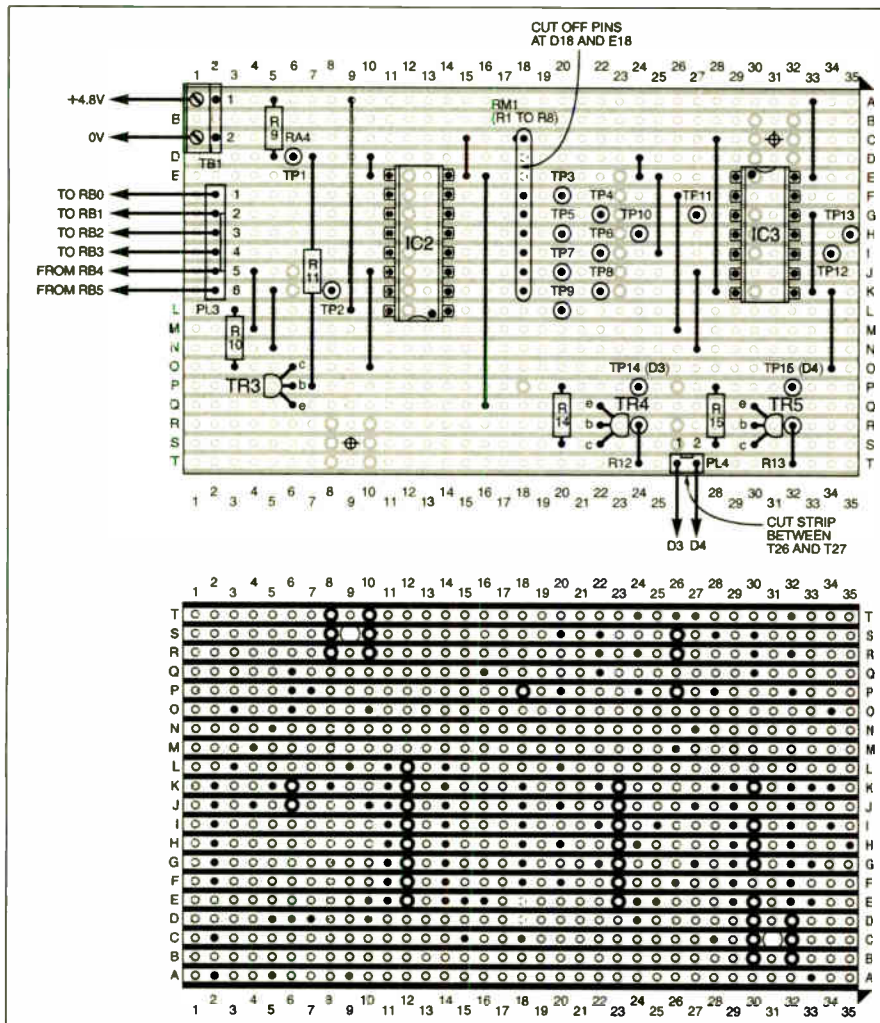
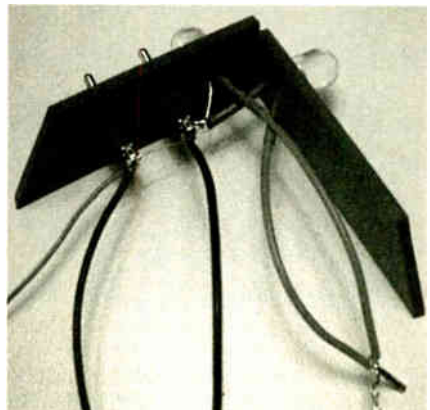

Fig.5.6. Stripboard component layout, wiring details and underside of the board showing required breaks in the copper tracks



Wiring the switches and i.e.d.s on the side panels

i.e.d. cathode (k) wire (heat-shrink sleeving makes the joint neater), and solder pin sockets to their other ends. Strip the free end of the positive supply lead; this goes to the positive supply terminal of the Distribution board.

Glue the panels to each other by their edges and glue both to the edge of the upper deck.

Complete the power line connections of the upper deck. For the positive supply, join the Distribution board at point A2 to the Light Sensor board at point B2, but *not* to the new motor board. For the 0V supply join all three boards: point D3 to motor board, to point D2 on Light Sensor, to point C2 on Distribution.

Make a 6-way cable about 24cm long and solder 6-way header sockets at both ends. The connections for RB0 to RB5 are at J7 to O7 on the Processor board, connecting to F2 to K2 on the Distribution board. Run the positive supply lead and the 0V lead from the screw terminals on the Processor board to those on the Distribution board.

Cut a wire 15cm long and solder header sockets to both ends. Use this to join the RA4 output on the Processor board to TP1 on the Distribution board.

Mount the infrared sensors (from Part 1) on the front edge of the middle deck. Their leads have a 2-way socket that fits on to pins 6 and 7 of the 8-way plug on the processor board. They also have supply lines that go into the screw terminals on the same board.

Wiring Check

The wiring check procedure is the same as outlined in Part 1. All the i.e.d.s flash as soon as the power is switched on. At the PIC socket (PIC not in it) use a flying lead to make RA4 (pin 3) high or low as required (see Table 5.1). Test the inputs from the switches and microswitches (pins 6 to 8), making pin 3 high to test Group A and low to test Group B. The inputs are normally high but go low when the switch is closed.

With RA4 high, the voltage at multiplexer IC2 pin 9 alternates as the i.e.d.s flash. It goes low when the red i.e.d. of the probe is on. With RA4 low, the LDR signal is monitored. Use flying leads to make IC2 pins 10 and 11 (PL3/1 and PL3/2) high and low, or low and high, to run one of the motors – the winch motor with RA4 low and the grabber jaws motor with RA4 high.

With RA4 high, the winch unwinds when PL3/1 is low and PL3/2 high. Conversely, with RA4 low, the jaws close when PL3/1 is high and PL3/2 low. If a motor runs the wrong way, swap the connections between it and its control board.

IC2 pin 12 (PL3/3) is high when the right infrared sensor points at white; low when it points at black (see Part 1). IC2 pin 13 (P3/4) similarly monitors the output from the left infrared sensor. These inputs are unaffected by the output at RA4.

Pusher

There is plenty of scope for inventing your own Pusher. The essential features are

that it must be mounted centrally on the back edge of the Middle Deck. That is, it is mounted so that it can be raised and lowered by the winch, and that it must not prevent the castor from swivelling in all directions. It must have the Down microswitch, S6 (see Table 5.1).

If you are intending to program the PIC yourself you could add up to three more microswitches, using registers RB0 to RB2, in Group B. One point to remember is that the pusher must not be so massive that the robot's drive wheels are lifted off the floor. This may happen with the grabber too, especially when carrying a heavy load.

There is also a loss of traction, particularly on corners and on uneven surfaces. The simplest solution is to ballast the robot by fixing a mass (try 100g to 150g) at the front of the middle deck, just behind the infrared sensors.

Just to get you going, the photos below show the prototype pusher used with SK-3. It can be made from strip and sheet aluminium; the prototype used 3mm p.v.c. boards and Meccano angle brackets. If you want a quick result, make it from stiff cardboard and glue it.

The pusher component parts are shown in Fig.5.7. The exact dimensions depend upon the height of the middle deck above the surface, and the size of the castor. In the prototype the upper surface of the middle deck is exactly 60mm above ground. There is a 2mm clearance between the surface and the lower edge of the plate when the arm is horizontal.

The base is bolted to the middle deck, using two bolts of the type that attach the

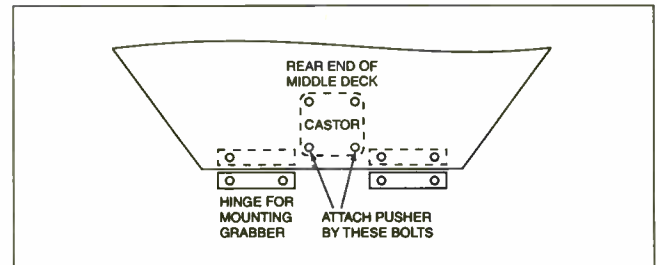
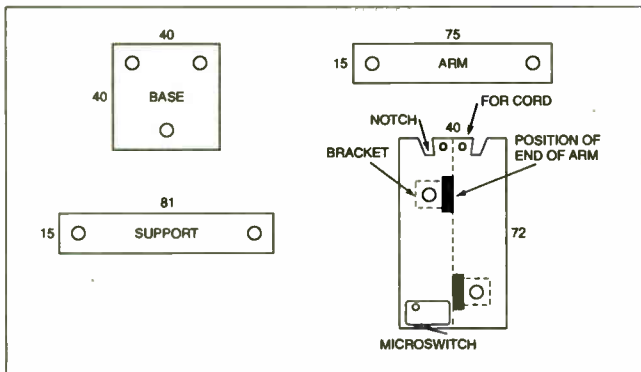
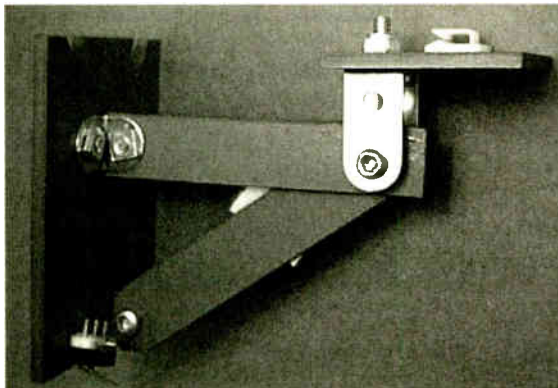
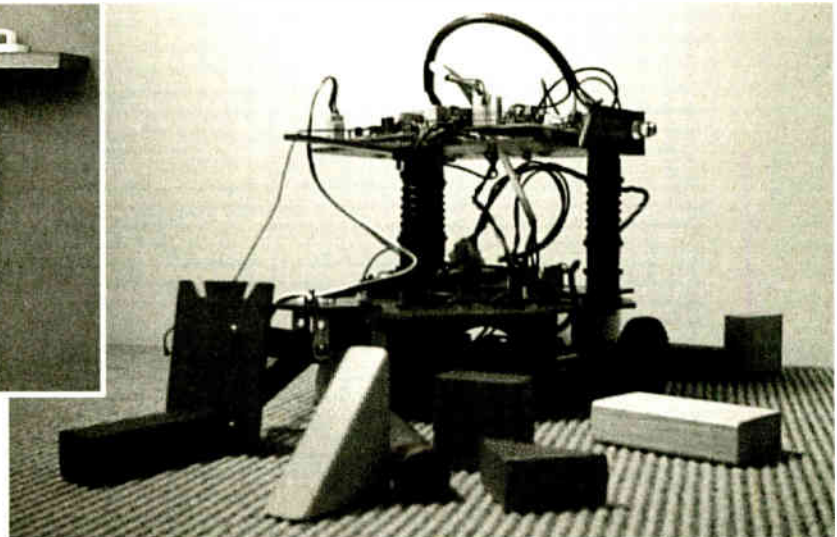

Fig.5.8. Additional holes to be drilled in the middle deck.

Fig.5.7. (left) Cutting and drilling parts for the pusher.



(Above) A rear view of the pusher showing the down microswitch S6. The white tuft behind the support bar is a patch of Velcro used for mounting the light sensor probe.



The pusher in action shunting some "building bricks"

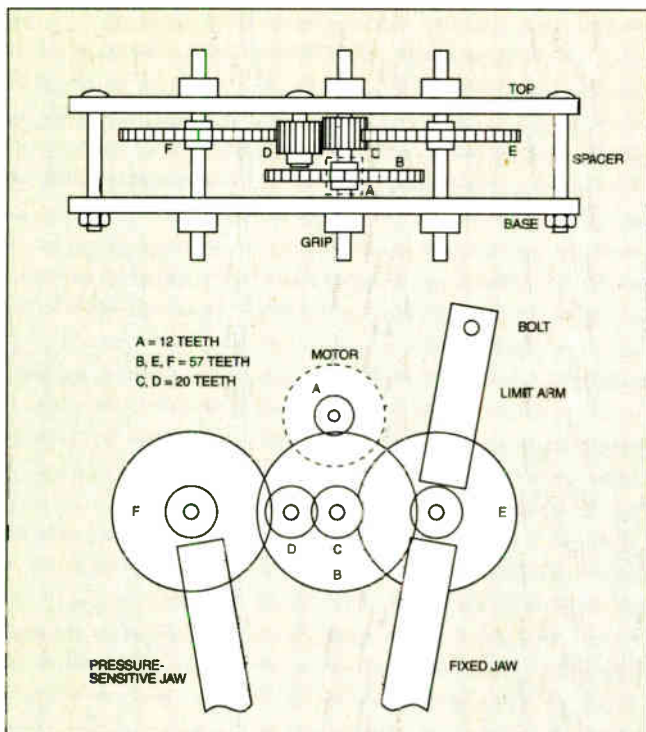

Fig. 5.9. The grabber gearbox (spacers on the shafts not shown).

castor. A double angle bracket (a square "U" in section) is bolted to the base, using a shakeproof nut. The arm and support bar pivot on a shaft threaded through this bracket. The ends of the shaft are secured by grommets or slip-on rubber grips. If necessary, washers or short spacers can be threaded on the shaft on either side of the arm and support, to keep them central.

The other ends of the arm and support are fixed to the rear surface of the plate using angle brackets (see outlines in Fig. 5.7). Run the cord from the winch, through the hole at the end of the cord support arm, and tie it to the two small holes at the top edge of the plate. Check that it is not caught by components on the circuit boards. Bolt the base to the middle deck, using the two rear bolts that fix the castor (see Fig. 5.8).

There are several places for fixing the probe, and you may prefer to experiment. The notches in the top edge of the plate allow the probe to be held in place with a rubber band. For the programs provided in the PIC, we assume that it is mounted on the support bar of the pusher so that, when the pusher is raised, the probe is horizontal and has a clear view of the object. In this position the probe is not confused by reflections from the floor or tabletop.

In our version, the pushing surface is a flat plate, but there is plenty of scope for other forms. You could glue a narrow rim to the vertical edges to prevent objects from sliding off sideways. Alternatively, add prongs made from thin metal (drinks can?) along the bottom edge of the pusher plate. Now you have the equivalent of a forklift truck, with the ability to carry as well as push.

Gripper

Referred to less formally as the Grabber, the Gripper turns the robot into a mobile arm. Compared with most

industrial mobile arms, such as those that spray newly made car bodies, this is a very simple arm. But after you have looked into the complexities of designing and building such mechanisms you will probably agree that our grabber is complicated enough!

The grabber has a pair of jaws (see photo above) that detects and closes on an object. That done, the arm lifts the object clear of the surface and the robot dashes away to drop it elsewhere. Thus the arm has one degree of freedom, the ability to rotate in a vertical direction. A pair of hinges (Fig. 5.8) join it to the rear edge of the middle deck. The lifting mechanism is the winch that was used for raising and lowering the pusher. Like the pusher, it has a microswitch (S7 in Table 5.1) to detect when the jaws are resting on the surface.

If you make the cord support arm from plastic, such as expanded p.v.c., you may find that it sags when lifting the grabber. This is worse when the grabber is lifting a weighty object. The solution is to make the arm from strip metal (or use a Meccano part).

Bolt one end of the arm to the upper deck where indicated in Fig. 5.1, and support the arm halfway along by a vertical strut fixed to the middle deck by one of the castor bolts. In our model the jaws end in flat paddles, 70mm x 80mm. These are covered with stick-on flock paper on their facing surfaces to give a non-slip grip. Thin rubber foam might be better. You could also replace the paddles with curved fingers to improve the grip on certain types of object.

The jaws are opened and closed by a motor-driven gearbox, see Fig. 5.9 and photos. The motor used is the same type as used for the winch. This has a built-in gearbox which reduces the motor speed to 70 r.p.m., but this is far too fast to operate the jaws directly.

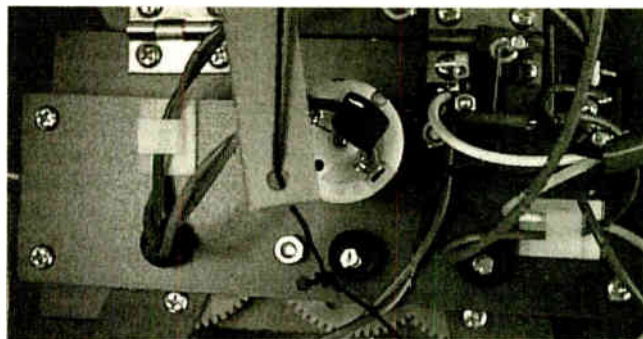

Gearbox as seen from above. Note the cord support arm.

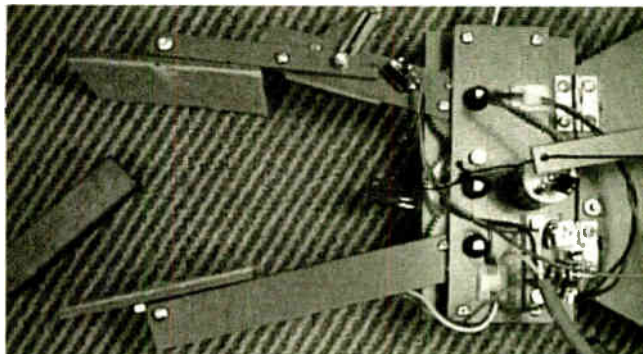

Seen from above, the grabber comprises a motor-driven gearbox and two arms. The upper arm in the photo is the pressure-sensitive arm.

However, it is possible to design a basic winch mechanism coupled to the arms of the jaw. The arms are closed by the winch and there is a spring or rubber band to open them again. We decided to go for gears. There are many plastic gearbox kits available; Meccano gears were used because the shafts are rounded triangular in shape, designed to fit the hubs of the gearwheels.

This means there is no slipping between gears B and C. The overall reduction of this gearbox is 13.5:1, reducing the motor speed to just over 5 r.p.m., or about 0.09 r.p.s., which seems just about right.

The gearbox is built on a base plate (65mm x 130mm) with a top plate (40mm x 130mm) supported on four 15mm spacers. These dimensions are for guidance only, as you may be using gears from another source. The arms of the jaws are bolted on to gears E and F.

The two jaws are referred to as the fixed jaw and the pressure-sensitive jaw (or pressure jaw for short). The fixed jaw is rigid but the pressure jaw is able to "give" slightly when pressed, when there is an object held between the jaws.

The mechanism of the pressure jaw is seen in the photo below. The arm is bolted to the gear F. It is shorter than the arm of the fixed jaw but is extended to the same

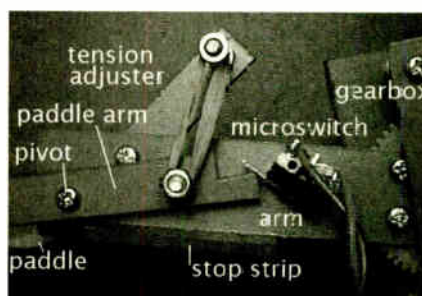

The pressure-sensitive mechanism when the jaws are not closing on an object, seen from above.

length by a narrower paddle arm that carries the paddle. The paddle arm is pivoted on the arm by a bolt secured by two nuts locked together. The paddle arm is able to rotate horizontally through a small angle.

In the photo it is shown in its normal position, held tightly against the armature of the microswitch (S5, see Table 5.1) by a rubber band. The tension is set by the angle of the tension adjusting lever. The armature is pressed tightly against the microswitch and, using the two outer contacts, the switch is off.

When the jaws have tightened on an object the paddle arm is rotated to a position which releases the armature, and the switch is turned off. A strip glued to the edge of the arm prevents the paddle arm from rotating further, providing a firm grip on the object.

More Limit Switches

The details in Fig.5.9. show a short lever, the limit arm, extending from gear E in the opposite direction to the arm of the fixed jaw. The limit arm extends from beneath the top plate and has a bolt at its end, see photo opposite.

Two microswitches (S3 and S4) are mounted on a small platform that is bolted to the edge of the top plate, so that their

armatures engage with the bolt. When the jaws are wide open, the bolt presses on the armature of one of the switches (S3); the switch is closed and a high logic level goes to the PIC at RB0 (if Group B is selected). The PIC then turns off the motor to prevent the jaws opening further and probably damaging the gearbox.

When the jaws are closed without an object between them, the other switch (S4) is closed and the PIC receives a logic high at RB1. As with the other microswitches in this robot, the switches are mounted by a single bolt, so that the angle of their actuators can be set to turn on the switch at the correct moment.

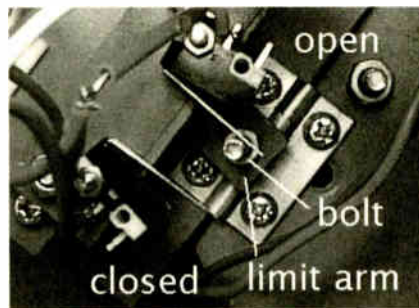

The limit switches on the gearbox seen from above.

Mount the Light Sensor probe centrally on the underside of the gearbox, so that its beam passes out between the open jaws. Connect it to PL2 on the Light Sensor board. Secure the cable with small self-adhesive cable clips.

Complete the wiring by connecting one terminal of all four microswitches to a common positive line and run this back to the screw terminal on the Light Sensor board. Solder a wire to the other terminal of each switch, and terminate their other ends with pin-header sockets. Run these four leads back to the appropriate terminal pins on the Distribution board, as indicated in Fig.5.5.

Resources

Software, including source code files, for the Smart Kart Part 5 is available on 3.5-inch disk from the Editorial office (a small handling charge applies – see the *EPE PCB Service* page). It can also be downloaded free from the *EPE Downloads* page, accessible via the home page at www.epemag.co.uk. It is held in the PICs folder, under SmartKart. Download all the files within that folder.

Next Month

In Part 6, next month, we discuss the software that controls Smart Kart SK-3.

SHOP TALK

with David Barrington

PIC Electric Mk2

We have found only a single listing for the 24LC256 256 kilobit serial EEPROM memory chip, used in the *PIC Electric Mk2* project, that was Farnell (☎ 0870 1200 100 or www.farnellone.co.uk), code 300-1696. The Hall effect current transducers were purchased from RS Components, code 286-311. They also supplied the optional MAX232 serial interface i.c., code 655-290. Likewise, they stock the rail-to-rail LMC6482 dual op.amp, code 310-919. The RS232 interface i.c. should be stocked by most of our components advertisers. If a local source proves to be elusive, the transducer, op.amp and interface i.c. can be ordered direct (credit card only) from RS on (☎ 01536 444079 or rswww.com).

For those readers unable to program their own PICs, a fully programmed PIC16F876 microcontroller can be purchased from Magenta Electronics (☎ 02083 565435 or www.magenta2000.co.uk) for the inclusive price of £10 each (overseas add £1 for p&p). The software, including source code files, is available on a 3.5-in. PC-compatible disk (Disk 8) from the *EPE Editorial Office* for the sum of £3 each (UK), to cover admin costs (for overseas charges see page 141). The software is also available for Free download via www.epemag.co.uk.

The two printed circuit boards can be obtained from the *EPE PCB Service*, codes 487 (Cont.) and 488 (Sen.) see page 141. Most of our components advertisers should be able to supply a suitable i.c.d. alphanumeric display module.

Sneaky

Some readers may have difficulty finding the RTFQ1 433MHz transmitter and RRFQ1 433MHz receiver modules used in the *Sneaky* "magic" project. These are RF Solutions modules and are currently stocked by Maplin (☎ 0870 429 6000 or www.maplin.co.uk) and sold as a pair, code N47AU. For more details of these devices you can log-on to RF Solutions at www.rfolutions.co.uk or ☎ 01273 898000. Reference document DS069-7 refers to these units.

The author's suggested 6V trembler motor for this project is the Mabuchi motor from Total Robots (☎ 0208 823 9220 or www.totalrobots.com). These are listed under Beam Robots Components and sold as a two-pack, code RM1. They also list, but has not been tried, a vibrating disk motor. We see from a recent flyer from WCN Supplies (☎ 023 8066 0700 or www.wcnsupplies.net) that they have a special offer on a 3V-6V vibrating motor (code 48-141) which may be worth investigating.

For those readers unable to program their own PICs a preprogrammed PIC16F628 microcontroller (two required) can be purchased from Magenta Electronics (☎ 01283 565435 or www.magenta2000.co.uk) for the inclusive price of £4.90 each (overseas add £1 p&p). The software is available on a 3.5 in. PC-compatible disk (Disk 8) from *EPE Editorial Office* for the sum of £3 each (UK), to cover admin costs (for overseas charges

see page 141). The software is also available for Free download via www.epemag.co.uk.

Smart Karts – 5

The same low voltage d.c. motors, with gearbox, used for the first kart in Part 1 can be used in Smart Kart SK-3, this month's mobile buggy project. They came from Magenta, see below. A good selection of motors can be found listed by Jaycar (☎ 0800 032 7241 or www.jaycar-electronics.co.uk) and Squires (☎ 01243 842424 or www.squirestools.com).

It is not essential to use such a high intensity blue i.e.d., it is only included for "effect" and almost any "high brightness" i.e.d. will suffice.

An updated ready-programmed PIC16F84 microcontroller for Smart Kart SK-3 can be purchased from Magenta Electronics (☎ 01283 565435 or www.magenta2000.co.uk) for the inclusive price of £5.90 each (overseas add £1 p&p). Please quote version SK-3 when ordering. The software is available on a 3.5-in. PC-compatible disk (Disk 8) from *EPE Editorial Office* for the sum of £3 each (UK), to cover admin costs (for overseas charges see page 141). The software is also available for Free download via www.epemag.co.uk.

Sound Card Mixer

We do not expect any buying problems to arise when shopping for components for the *Sound Card Mixer* project. All the semiconductor devices should be off-the-shelf items. The miniature 12mm square, plastic spindle, p.c.b. mounting, conductive plastic potentiometers are stocked by Rapid (☎ 01206 751166 or www.rapidelectronics.co.uk) codes 68-1292 (log.) and 68-1278 (lin.).

The printed circuit board is available from the *EPE PCB Service*, code 489 (see page 41).

PLEASE TAKE NOTE

Speed Camera Watch (Jan '05)

We have been advised by Holux that the GM-21PE GPS modules are not supplied with cables. These are available for an additional £5. They include the connector and about 150mm of bare-ended cable. The Holux phone number to call is 0870 321 5929 (not as quoted in *EPE*). Note that Holux only accept credit card orders (not American Express), do not send cheques or cash. Fig.3 shows the connections as from the module's base.

High-Efficiency L.E.D. Torch (I.U. Oct '04)

The author points out that his intention is for the anode of i.e.d. D7 in Fig.1b to go to the cathode of D2 in Fig.1a, not to +6V, and that the circuit is for white i.e.d.s.

64 L.E.D. Sequencer (I.U. Jan '05)

Transistor TR3 is an *npn* device and so should be shown with its collector connected to the collector of TR2, and its emitter connected to R6.

MW Amplitude Modulator (Nov '04)

Inductor L1 may be hard to find but the EZ45336 from JAB Components can be used instead, but C4 must be changed to 220pF.

FREE *Electronics Hobbyist Compendium* book with Teach-In 2000 CD-ROM



EPE TEACH-IN 2000 CD-ROM

The whole of the 12-part *Teach-In 2000* series by John Becker (published in *EPE* Nov '99 to Oct 2000) is now available on CD-ROM in PDF form. Plus the *Teach-In 2000* interactive software (Win 95, 98, ME and above) covering all aspects of the series and Alan Winstanley's *Basic Soldering Guide* (including illustrations and Desoldering).

Teach-In 2000 covers all the basic principles of electronics from Ohm's Law to Displays, including Op.Amps, Logic Gates etc. Each part has its own section on the interactive software where you can also change component values in the various on-screen demonstration circuits.

The series gives a hands-on approach to electronics with numerous breadboard circuits to try out, plus a simple computer interface (Win 95, 98, ME ONLY) which allows a PC to be used as a basic oscilloscope.

ONLY £12.45 including VAT and p&p

THE AMATEUR SCIENTIST CD-ROM

The complete collection of The Amateur Scientist articles from *Scientific American* magazine. Over 1,000 classic science projects from a renowned source of winning projects. All projects are rated for cost, difficulty and possible hazards.

Plus over 1,000 pages of helpful science techniques that never appeared in *Scientific American*.

Exciting science projects in: Astronomy; Earth Science; Biology; Physics; Chemistry; Weather . . . and much more! The most complete resource ever assembled for hobbyists, and professionals looking for novel solutions to research problems.

Includes extensive Science Software Library with even more science tools.

Suitable for Mac, Windows, Linux or UNIX. 32MB RAM minimum, Netscape 4.0 or higher or Internet Explorer 4.0 or higher.

Over 1,000 projects

CD-ROM

CD-ROM

£19.95

PROJECT CONSTRUCTION

IC 555 PROJECTS

E. A. Parr

Every so often a device appears that is so useful that one wonders how life went on before without it. The 555 timer is such a device. Included in this book are over 70 circuit diagrams and descriptions covering basic and general circuits, motor car and model railway circuits, alarms and noise makers as well as a section on 556, 558 and 559 timers. (Note. No construction details are given.) A reference book of invaluable use to all those who have any interest in electronics, be they professional engineers or designers, students or hobbyists.

167 pages

Temporarily out of print

POWER SUPPLY PROJECTS

R. A. Penfold

This book offers a number of power supply designs, including simple unregulated types, and variable voltage stabilised designs the latter being primarily intended for use as bench power supplies for the electronics workshop. The designs provided are all low voltage types for semiconductor circuits. The information in this book should also help the reader to design his own power supplies. Includes cassette PSU, Ni-Cad charger, voltage step-up circuit and a simple inverter.

91 pages

Temporarily out of print

HOW TO USE OSCILLOSCOPES AND OTHER TEST EQUIPMENT

R. A. Penfold

This book explains the basic function of an oscilloscope, gives a detailed explanation of all the standard controls, and provides advice on buying. A separate chapter deals with using an oscilloscope for fault finding on linear and logic circuits, plenty of example waveforms help to illustrate the control functions and the effects of various fault conditions. The function and use of various other pieces of test equipment are also covered, including signal generators, logic probes, logic pulsers and crystal calibrators.

104 pages

Order code BP267

£5.49

DIRECT BOOK SERVICE

The books listed have been selected by *Everyday Practical Electronics* editorial staff as being of special interest to everyone involved in electronics and computing. They are supplied by mail order direct to your door. Full ordering details are given on the last book page.

FOR A FURTHER SELECTION OF BOOKS SEE THE NEXT TWO ISSUES OF EPE.

All prices include UK postage

RADIO

SETTING UP AN AMATEUR RADIO STATION

I. D. Poole

The aim of this book is to give guidance on the decisions which have to be made when setting up any amateur radio or short wave listening station. Often the experience which is needed is learned by one's mistakes, however, this can be expensive. To help overcome this, guidance is given on many aspects of setting up and running an efficient station. It then proceeds to the steps that need to be taken in gaining a full transmitting licence.

Topics covered include: The equipment that is needed; Setting up the shack; Which aerials to use; Methods of construction; Preparing for the licence.

86 pages

Order code BP300

£4.45

EXPERIMENTAL ANTENNA TOPICS

H. C. Wright

Although nearly a century has passed since Marconi's first demonstration of radio communication, there is still research and experiment to be carried out in the field of antenna design and behaviour.

The aim of the experimenter will be to make a measurement or confirm a principle, and this can be done with relatively fragile, short-life apparatus. Because of this, devices described in this book make liberal use of cardboard, cooking foil, plastic bottles, cat food tins, etc.

Although primarily a practical book with text closely supported by diagrams, some formulae which can be used by straightforward substitution and some simple graphs have also been included.

72 pages

Order code BP278

£4.00

25 SIMPLE INDOOR AND WINDOW AERIALS

E. M. Noll

Many people live in flats and apartments or other types of accommodation where outdoor aerials are prohibited, or a lack of garden space etc. prevents aerials from being erected. This does not mean you have to forgo shortwave-listening, for even a 20-foot length of wire stretched out along the skirting board of a room can produce acceptable results. However, with some additional effort and experimentation one may well be able to improve performance further.

This concise book tells the story, and shows the reader how to construct and use 25 indoor and window aerials that the author has proven to be sure performers.

50 pages

Order code BP136

£2.25

TICKLING THE CRYSTAL Domestic British Crystal Sets of the 1920's

Ian L. Sanders

The first book dedicated to the topic of British crystal sets to be published in the last 25 years. For a very brief period during the early 1920's, these simple receivers played a crucial role in the expansion of domestic wireless throughout the United Kingdom. For many families, rich and poor, the crystal set provided an introduction to the new pastime of listening-in to broadcast programmes. Rapidly made obsolete from homes as suddenly as it had arrived, but not without leaving its mark on the history of wireless.

Written by a long-time authority and enthusiast, *Tickling the Crystal* is the most comprehensive work on the subject ever assembled. Containing almost two hundred excellent quality photographs and a wealth of previously unpublished material, it cannot fail to be an invaluable reference for anyone interested in the history of early wireless receivers.

256 pages hardback

Order code TC1

£34.00

ELECTRONIC PROJECT BUILDING FOR BEGINNERS

R. A. Penfold

This book is for complete beginners to electronic project building. It provides a complete introduction to the practical side of this fascinating hobby, including the following topics:

Component identification, and buying the right parts; resistor colour codes, capacitor value markings, etc; advice on buying the right tools for the job; soldering; making easy work of the hard wiring; construction methods, including stripboard, custom printed circuit boards, plain matrix boards, surface mount boards and wire-wrapping; finishing off, and adding panel labels; getting "problem" projects to work, including simple methods of fault-finding.

In fact everything you need to know in order to get started in this absorbing and creative hobby.

135 pages

Order code BP392

£5.49

TEST EQUIPMENT CONSTRUCTION

R. A. Penfold

This book describes in detail how to construct some simple and inexpensive but extremely useful, pieces of test equipment. Stripboard layouts are provided for all designs, together with wiring diagrams where appropriate, plus notes on construction and use.

The following designs are included:-

AF Generator, Capacitance Meter Test Bench Amplifier, AF Frequency Meter, Audio Multivoltmeter, Analogue Probe, High Resistance Voltmeter, CMOS Probe, Transistor Tester, TTL Probe. The designs are suitable for both newcomers and more experienced hobbyists.

104 pages

Order code BP248

£4.49

COMPUTING

COMPUTING FOR THE OLDER GENERATION

Jim Gatenby

Especially written for the over 50s, using plain English and avoiding technical jargon. Large clear type for easy reading.

Among the many practical and useful ideas for using your PC that are covered in this book are: Choosing, setting up and understanding your computer and its main components. Writing letters, leaflets, invitations, etc., and other word processing jobs. Keeping track of your finances using a spreadsheet. Recording details of holidays and other ideas using a database. Using the Internet to find useful information, and email to keep in touch with family and friends. Making "back-up" copies of your work and checking for viruses. How to use Windows XP to help people with impaired vision, hearing or mobility.

Provides the basic knowledge so you can gain enough confidence to join the local computer class.

308 pages

Order code BP601

£8.99

THE INTERNET FOR THE OLDER GENERATION

Jim Gatenby

Especially written for the over 50s. Uses only clear and easy-to-understand language. Larger type size for easy reading. Provides basic knowledge to give you confidence to join the local computer class.

This book explains how to use your PC on the Internet and covers amongst other things: Choosing and setting up your computer for the Internet. Getting connected to the Internet. Sending and receiving emails, photographs, etc., so that you can keep in touch with family and friends all over the world. Searching for and saving information on any subject. On-line shopping and home banking. Setting up your own simple web site.

228 pages

Order code BP600

£8.99

THEORY AND REFERENCE

BEBOP TO THE BOOLEAN BOOGIE Second Edition Clive (call me Max) Maxfield

This book gives the "big picture" of digital electronics. This indepth, highly readable, up-to-the-minute guide shows you how electronic devices work and how they're made. You'll discover how transistors operate, how printed circuit boards are fabricated, and what the innards of memory ICs look like. You'll also gain a working knowledge of Boolean Algebra and Karnaugh Maps, and understand what Reed-Muller logic is and how it's used. And there's much, MUCH more. The author's tongue-in-cheek humour makes it a delight to read, but this is a REAL technical book, extremely detailed and accurate.

Contents: Fundamental concepts; Analog versus digital; Conductors and insulators; Voltage, current, resistance, capacitance and inductance; Semiconductors; Primitive logic functions; Binary arithmetic; Boolean algebra; Karnaugh maps; State diagrams, tables and machines; Analog-to-digital and digital-to-analog; Integrated circuits (ICs); Memory ICs; Programmable ICs; Application-specific integrated circuits (ASICs); Circuit boards (PWBs and DWBs); Hybrids; Multiplex modules (MCMs); Alternative and future technologies.

470 pages - large format **Order code BEB1 £26.95**

BEBOP BYTES BACK (and the Bebop Computer Simulator) CD-ROM Clive (Max) Maxfield and Alvin Brown

This follow-on to *Bebop to the Boolean Boogie* is a multimedia extravaganza of information about how computers work. It picks up where "Bebop I" left off, guiding you through the fascinating world of computer design... and you'll have a few chuckles, if not belly laughs, along the way. In addition to over 200 megabytes of mega-cool multimedia, the CD-ROM contains a virtual microcomputer, simulating the motherboard and standard computer peripherals in an extremely realistic manner. In



addition to a wealth of technical information, myriad nuggets of trivia, and hundreds of carefully drawn illustrations, the CD-ROM contains a set of lab experiments for the virtual microcomputer that let you recreate the experiences of early computer pioneers. If you're the slightest bit interested in the inner workings of computers, then don't dare to miss this!

Over 800 pages in Adobe Acrobat format

CD-ROM **Order code BEB2 CD-ROM £21.95**

ELECTRONICS MADE SIMPLE

Ian Sinclair

Assuming no prior knowledge, *Electronics Made Simple* presents an outline of modern electronics with an emphasis on understanding how systems work rather than on details of circuit diagrams and calculations. It is ideal for students on a range of courses in electronics, including GCSE, C&G and GNVQ, and for students of other subjects who will be using electronic instruments and methods.

Contents: waves and pulses, passive components, active components and ICs, linear circuits, block and circuit diagrams, how radio works, disc and tape recording, elements of TV and radar, digital signals, gating and logic circuits, counting and correcting, microprocessors, calculators and computers, miscellaneous systems.

199 pages **Order code NE23 £13.99**

SCROGGIE'S FOUNDATIONS OF WIRELESS AND ELECTRONICS - ELEVENTH EDITION

S. W. Amos and Roger Amos

Scroggie's Foundations is a classic text for anyone working with electronics, who needs to know the art and craft of the subject. It covers both the theory and practical aspects of a huge range of topics from valve and tube technology, and the application of cathode ray tubes to radar, to digital tape systems and optical recording techniques.

Since *Foundations of Wireless* was first published over 60 years ago, it has helped many thousands of readers to become familiar with the principles of radio and electronics. The original author Sowerby was succeeded by Scroggie in the 1940s, whose name became

synonymous with this classic primer for practitioners and students alike. Stan Amos, one of the fathers of modern electronics and the author of many well-known books in the area, took over the revision of this book in the 1980s and it is he, with his son, who have produced this latest version.

400 pages

Temporarily out of print

GETTING THE MOST FROM YOUR MULTIMETER

R. A. Penfold

This book is primarily aimed at beginners and those of limited experience of electronics. Chapter 1 covers the basics of analogue and digital multimeters, discussing the relative merits and the limitations of the two types. In Chapter 2 various methods of component checking are described, including tests for transistors, thyristors, resistors, capacitors and diodes. Circuit testing is covered in Chapter 3, with subjects such as voltage, current and continuity checks being discussed.

In the main little or no previous knowledge or experience is assumed. Using these simple component and circuit testing techniques the reader should be able to confidently tackle servicing of most electronic projects.

96 pages

Order code BP239 £5.49

DIGITAL GATES AND FLIP-FLOPS

Ian R. Sinclair

This book, intended for enthusiasts, students and technicians, seeks to establish a firm foundation in digital electronics by treating the topics of gates and flip-flops thoroughly and from the beginning.

Topics such as Boolean algebra and Karnaugh mapping are explained, demonstrated and used extensively, and more attention is paid to the subject of synchronous counters than to the simple but less important ripple counters.

No background other than a basic knowledge of electronics is assumed, and the more theoretical topics are explained from the beginning, as also are many working practices. The book concludes with an explanation of microprocessor techniques as applied to digital logic.

200 pages

Order code PC106 £9.95

MUSIC, AUDIO AND VIDEO

QUICK GUIDE TO ANALOGUE SYNTHESIS

Ian Waugh

Even though music production has moved into the digital domain, modern synthesisers invariably use analogue synthesis techniques. The reason is simple - analogue synthesis is flexible and versatile, and it's relatively easy for us to understand. The basics are the same for all analogue synths, and you'll quickly be able to adapt the principles to any instrument, to edit existing sounds and create exciting new ones. This book describes: How analogue synthesis works; The essential modules every synthesiser has; The three steps to synthesis; How to create phat bass sounds; How to generate filter sweeps; Advanced synth modules; How to create simple and complex synth patches; Where to find soft synths on the Web.

If you want to take your synthesiser - of the hardware or software variety - past the presets, and program your own sounds and effects, this practical and well-illustrated book tells you what you need to know.

60 pages **Order code PC118 £7.45**

QUICK GUIDE TO MP3 AND DIGITAL MUSIC

Ian Waugh

MP3 files, the latest digital music format, have taken the music industry by storm. What are they? Where do you get them? How do you use them? Why have they thrown record companies into a panic? Will they make music easier to buy? And cheaper? Is this the future of music?

All these questions and more are answered in this concise and practical book which explains everything you need to know about MP3s in a simple and easy-to-understand manner. It explains:

How to play MP3s on your computer; How to use MP3s with handheld MP3 players; Where to find MP3s on the Web; How MP3s work; How to tune into Internet radio stations; How to create your own MP3s; How to record your own CDs from MP3 files; Other digital audio music formats.

60 pages **Order code PC119 £7.45**

ELECTRONIC PROJECTS FOR VIDEO ENTHUSIASTS

R. A. Penfold

This book provides a number of practical designs for video accessories that will help you get the best results from your camcorder and VCR. All the projects use inexpensive components that are readily available, and they are easy to construct. Full construction details are provided, including stripboard layouts and wiring diagrams. Where appropriate, simple setting up procedures are described in detail; no test equipment is needed.

The projects covered in this book include: Four channel audio mixer, Four channel stereo mixer, Dynamic noise limiter (DNL), Automatic audio fader, Video faders, Video wipers, Video crispener, Mains power supply unit.

109 pages **Order code BP356 £5.45**

ELECTRONIC MUSIC AND MIDI PROJECTS

R. A. Penfold

Whether you wish to save money, boldly go where no musician has gone before, rekindle the pioneering spirit, or simply have fun building some electronic music gadgets, the designs featured in this book should suit your needs. The projects are all easy to build, and some are so simple that even complete beginners at electronic project construction can tackle them with ease. Stripboard layouts are provided for every project, together with a wiring diagram. The mechanical side of construction has largely been left to individual constructors to sort out, simply because the vast majority of project builders prefer to do their own thing in this respect.

None of the designs requires the use of any test equipment in order to get them set up properly. Where any setting up is required, the procedures are very straightforward, and they are described in detail.

Projects covered: Simple MIDI tester, Message grabber, Byte grabber, THRU box, MIDI auto switcher, Auto/manual switcher, Manual switcher, MIDI patchbay, MIDI controlled switcher, MIDI lead tester, Program change pedal, Improved program change pedal, Basic mixer, Stereo mixer, Electronic swell pedal, Metronome, Analogue echo unit. **£10.95**

124 pages **Order code PC116 £5.45**

THE INVENTOR OF STEREO - THE LIFE AND WORKS OF ALAN DOWER BLUMLEIN

Robert Charles Alexander

This book is the definitive study of the life and works of one of Britain's most important inventors who, due to a cruel set of circumstances, has all but been overlooked by history.

Alan Dower Blumlein led an extraordinary life in which his inventive output rate easily surpassed that of Edison, but whose early death during the darkest days of World War Two led to a shroud of secrecy which has covered his life and achievements ever since.

His 1931 Patent for a Binaural Recording System was so revolutionary that most of his contemporaries regarded it as more than 20 years ahead of its time. Even years after his death, the full magnitude of its detail had not been fully utilized. Among his 128 patents are the principal electronic circuits critical to the development of the world's first electronic television system. During his short working life, Blumlein produced patent after patent breaking entirely new ground in electronic and audio engineering.

During the Second World War, Alan Blumlein was deeply engaged in the very secret work of radar development and contributed enormously to the system eventually to become 'H2S' - blind-bombing radar. Tragically, during an experimental H2S flight in June 1942, the Halifax bomber in which Blumlein and several colleagues were flying, crashed and all aboard were killed. He was just days short of his thirtieth birthday.

420 pages **Order code NE32 £17.99**

VIDEO PROJECTS FOR THE ELECTRONICS

CONSTRUCTOR

R. A. Penfold

Written by highly respected author R. A. Penfold, this book contains a collection of electronic projects specially designed for video enthusiasts. All the projects can be simply constructed, and most are suitable for the newcomer to project construction, as they are assembled on stripboard.

There are faders, wipers and effects units which will add sparkle and originality to your video recordings, an audio mixer and noise reducer to enhance your soundtracks and a basic computer control interface. Also, there's a useful selection on basic video production techniques to get you started.

Complete with explanations of how the circuit works, shopping lists of components, advice on construction, and guidance on setting up and using the projects, this invaluable book will save you a small fortune.

Circuits include: video enhancer, improved video enhancer, video fader, horizontal wiper, improved video wiper, negative video unit, fade to grey unit, black and white keyer, vertical wiper, audio mixer, stereo headphone amplifier, dynamic noise reducer, automatic fader, pushbutton fader, computer control interface, 12 volt mains power supply. **£10.95**

124 pages **Order code PC115 £5.45**

PC MUSIC - THE EASY GUIDE

Robin Vincent

How do I make music on my PC? Can I record music onto my PC? What's a sequencer? How can I get my PC to print a music score? What sort of a soundcard do I need? What hardware and software do I need? How do I connect a keyboard to my PC?

Just a few of the questions you've probably asked. Well, you'll find the answers to all these questions, and many more, in this book. It will show you what can be done, what it all means, and what you will need to start creating your own music on your PC. It's an easy read, it's fully illustrated and it will help you understand how a computer can be used as a creative music tool.

It covers soundcards, sequencers, hard disk digital audio recording and editing, plug-ins, printing scores with notation software, using your PC as a synthesiser, getting music onto and off the internet, using Windows, sample PC music setups, FAQs, a glossary, advice on hardware and software, and a list of industry contacts.

116 pages **Order code PC117 £11.95**

HIGH POWER AUDIO AMPLIFIER CONSTRUCTION

R. A. Penfold

Practical construction details of how to build a number of audio power amplifiers ranging from about 50 to 300/400 watts r.m.s. includes MOSFET and bipolar transistor designs.

96 pages

Temporarily out of print

FAULT FINDING, CIRCUITS AND DESIGN

AN INTRODUCTION TO PIC MICROCONTROLLERS

Robert Penfold

Designing your own PIC based projects may seem a daunting task, but it is really not too difficult providing you have some previous experience of electronics.

The PIC processors have plenty of useful features, but they are still reasonably simple and straightforward to use. This book should contain everything you need to know.

Topics covered include: the PIC register set; numbering systems; bitwise operations and rotation; the PIC instruction set; using interrupts; using the analogue to digital converter; clock circuits; using the real time clock counter (RTCC); using subroutines; driving seven segment displays.

166 pages

Order code BP394

£8.49

PRACTICAL OSCILLATOR CIRCUITS

A. Filind

Extensive coverage is given to circuits using capacitors and resistors to control frequency. Designs using CMOS, timer i.c.s and op.amps are all described in detail, with a special chapter on "waveform generator" i.c.s. Reliable "white" and "pink" noise generator circuits are also included.

Various circuits using inductors and capacitors are covered, with emphasis on stable low frequency generator. Some of these are amazingly simple, but are still very useful signal sources.

Crystal oscillators have their own chapter. Many of the circuits shown are readily available special i.c.s for simplicity and reliability, and offer several output frequencies. Finally, complete constructional details are given for an audio sinewave generator.

133 pages

Order code BP393

£5.49

PRACTICAL ELECTRONICS HANDBOOK - Fifth Edition. Ian Sinclair

Contains all of the everyday information that anyone working in electronics will need.

It provides a practical and comprehensive collection of circuits, rules of thumb and design data for professional engineers, students and enthusiasts, and therefore enough background to allow the understanding and development of a range of basic circuits.

Contents: Passive components, Active discrete components, Circuits, Linear I.C.s, Energy conversion components, Digital I.C.s, Microprocessors and microprocessor systems, Transferring digital data, Digital-analogue conversions, Computer aids in electronics, Hardware components and practical work, Micro-controllers and PLCs, Digital broadcasting, Electronic security.

444 pages

Order code NE21

£19.99

PIC IN PRACTICE

David W. Smith

A graded course based around the practical use of the PIC microcontroller through project work. Principles are introduced gradually, through hands-on experience, enabling hobbyists and students to develop their understanding at their own pace. The book can be used at a variety of levels.

Contents: Introduction to the PIC microcontroller; Programming the 16F84 microcontroller; Using inputs; Keypad scanning; Program examples; The 16C54 microcontroller; Alphanumeric displays; Analogue to digital conversion; Radio transmitters and receivers; EEPROM data memory; Interrupts; The 12C5XX 8-pin microcontroller; The 16F87X microcontroller; The 16F62X microcontroller; Projects; Instruction set, files and registers; Appendices; Index.

272 pages

Order code NE39

£17.49

COIL DESIGN AND CONSTRUCTIONAL MANUAL

B. B. Babani

A complete book for the home constructor on "how to make" RF, IF, audio and power coils, chokes and transformers. Practically every possible type is discussed and calculations necessary are given and explained in detail. Although this book is now twenty years old, with the exception of toroids and pulse transformers little has changed in coil design since it was written.

96 pages

Order code BP160

£4.49

PRACTICAL ELECTRONIC FAULT FINDING AND TROUBLESHOOTING

Robin Pain

To be a real fault finder, you must be able to get a feel for what is going on in the circuit you are examining. In this book Robin Pain explains the basic techniques needed to be a fault finder.

Simple circuit examples are used to illustrate principles and concepts fundamental to the process of fault finding. This is not a book of theory, it is a book of practical tips, hints and rules of thumb, all of which will equip the reader to tackle any job. You may be an engineer or technician in search of information and guidance, a college student, a hobbyist building a project from a magazine, or simply a keen self-taught amateur who is interested in electronic fault finding but finds books on the subject too mathematical or specialised.

The fundamental principles of analogue and digital fault finding are described (although, of course, there is no such thing as a "digital fault" - all faults are by nature analogue). This book is written entirely for a fault finder using only the basic fault-finding equipment: a digital multimeter and an oscilloscope. The treatment is non-mathematical (apart from Ohm's law) and all jargon is strictly avoided.

274 pages

Order code NE22

£25.99

OPERATIONAL AMPLIFIER USER'S HANDBOOK

R. A. Penfold

The first part of this book covers standard operational amplifier based "building blocks" (integrator, precision rectifier, function generator, amplifiers, etc), and considers the ways in which modern devices can be used to give superior performance in each one. The second part describes a number of practical circuits that exploit modern operational amplifiers, such as high slew-rate, ultra low noise, and low input offset devices. The projects include: Low noise tape preamplifier, low noise RIAA pre-amplifier, audio power amplifiers, d.c. power controllers, opto-isolator audio link, audio millivolt meter, temperature monitor, low distortion audio signal generator, simple video fader, and many more.

120 pages

Order code BP335

£5.45

A BEGINNERS GUIDE TO CMOS DIGITAL ICs

R. A. Penfold

Getting started with logic circuits can be difficult, since many of the fundamental concepts of digital design tend to seem rather abstract, and remote from obviously useful applications. This book covers the basic theory of digital electronics and the use of CMOS integrated circuits, but does not lose sight of the fact that digital electronics has numerous "real world" applications.

The topics covered in this book include: the basic concepts of logic circuits; the functions of gates, inverters and other logic "building blocks"; CMOS logic i.c. characteristics, and their advantages in practical circuit design; oscillators and monostables (timers); flip/flops, binary dividers and binary counters; decade counters and display drivers.

119 pages

Order code BP333

£5.45

AUDIO AMPS

VALVE & TRANSISTOR AUDIO AMPLIFIERS

John Linsley Hood

This is John Linsley Hood's greatest work yet, describing the milestones that have marked the development of audio amplifiers since the earliest days to the latest systems. Including classic amps with valves at their heart and exciting new designs using the latest components, this book is the complete world guide to audio amp design.

Contents: Active components; Valves or vacuum tubes; Solid-state devices; Passive components; Inductors and transformers; Capacitors, Resistors, Switches and electrical contacts; Voltage amplifier stages using valves; Valve audio amplifier layouts; Negative feedback; Valve operated power amplifiers; Solid state voltage amplifiers; Early solid-state audio amplifiers; Contemporary power amplifier designs; Preamplifiers; Power supplies (PSUs); Index.

250 pages

Order code NE24

£25.99

AUDIO AMPLIFIER PROJECTS

R. A. Penfold

A wide range of useful audio amplifier projects, each project features a circuit diagram, an explanation of the circuit operation and a stripboard layout diagram. All constructional details are provided along with a shopping list of components, and none of the designs requires the use of any test equipment in order to set up properly. All the projects are designed for straightforward assembly on simple circuit boards.

Circuits include: High impedance mic preamp, Low impedance mic preamp, Crystal mic preamp, Guitar and GP preamplifier, Scratch and rumble filter, RIAA pre-amplifier, Tape preamplifier, Audio limiter, Bass and treble tone controls, Loudness filter, Loudness control, Simple graphic equaliser, Basic audio mixer, Small (300mW) audio power amp, 6 watt audio power amp, 20/32 watt power amp and power supply, Dynamic noise limiter.

A must for audio enthusiasts with more sense than money!

116 pages

Order code PC113

£10.95 £5.45

VALVE AMPLIFIERS

Second Edition, Morgan Jones

This book allows those with a limited knowledge of the field to understand both the theory and practice of valve audio amplifier design, such that they can analyse and modify circuits, and build or restore an amplifier. Design principles and construction techniques are provided so readers can devise and build from scratch, designs that actually work.

The second edition of this popular book builds on its main strength - exploring and illustrating theory with practical applications. Numerous new sections include: output transformer problems; heater regulators; phase splitter analysis; and component technology. In addition to the numerous amplifier and preamplifier circuits, three major new designs are included: a low-noise single-ended LP stage, and a pair of high voltage amplifiers for driving electrostatic transducers directly - one for headphones, one for loudspeakers.

288 pages

Order code NE33

£32.99

BOOK ORDERING DETAILS

All prices include UK postage. For postage to Europe (air) and the rest of the world (surface) please add £2 per book. For the rest of the world airmail add £3 per book. CD-ROM prices include VAT and/or postage to anywhere in the world. Send a PO, cheque, international money order (£ sterling only) made payable to Direct Book Service or card details, Visa, Mastercard, Amex, Diners Club or Switch/Maestro to: DIRECT BOOK SERVICE, WIMBORNE PUBLISHING LIMITED, 408 WIMBORNE ROAD EAST, FERNDOWN, DORSET BH22 9ND.

Books are normally sent within seven days of receipt of order, but please allow 28 days for delivery - more for overseas orders. Please check price and availability (see latest issue of Everyday Practical Electronics) before ordering from old lists.

For a further selection of books see the next two issues of EPE.

Tel 01202 873872 Fax 01202 874562. E-mail: dba@epemag.wimborne.co.uk

Order from our online shop at: www.epemag.wimborne.co.uk/shopdoor.htm

BOOK ORDER FORM

Full name:

Address:

.....

.....

..... Post code: Telephone No:

Signature:

I enclose cheque/PO payable to DIRECT BOOK SERVICE for £

Please charge my card £ Card expiry date:

Card Number Switch/Maestro Issue No.

Card Security Code (the last three digits on or just below the signature strip)

Please send book order codes:

.....

Please continue on separate sheet of paper if necessary

ELECTRONICS MANUALS ON CD-ROM £29.95 EACH

ELECTRONICS SERVICE MANUAL

THE MODERN ELECTRONICS MANUAL

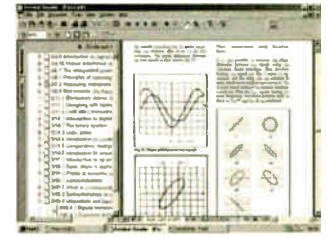
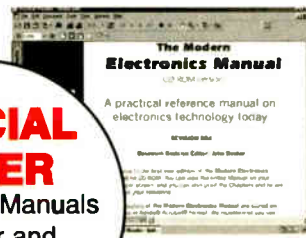

SPECIAL OFFER
Order both Manuals together and **SAVE £10**

Everything you need to know to get started in repairing electronic equipment

- Around 900 pages • Fundamental principles • Troubleshooting techniques • Servicing techniques • Choosing and using test equipment • Reference data • Manufacturers' web links
- Easy-to-use Adobe Acrobat format • Clear and simple layout
- Vital safety precautions • Professionally written • Supplements

SAFETY: Safety Regulations, Electrical Safety and First Aid.
UNDERPINNING KNOWLEDGE: Electrical and Electronic Principles, Active and Passive Components, Circuit Diagrams, Circuit Measurements, Radio, Computers, Valves and Manufacturers' Data, etc.
PRACTICAL SKILLS: Learn how to identify Electronic Components, Avoid Static Hazards, Carry Out Soldering and Wiring, Remove and Replace Components.
TEST EQUIPMENT: How to Choose and Use Test Equipment, Assemble a Toolkit, Set Up a Workshop, and Get the Most from Your Multimeter and Oscilloscope, etc.
SERVICING TECHNIQUES: The Manual includes vital guidelines on how to Service Audio Amplifiers. The Supplements include similar guidelines for Radio Receivers, TV Receivers, Cassette Recorders, Video Recorders, Personal Computers, etc.
TECHNICAL NOTES: Commencing with the IBM PC, this section and the Supplements deal with a very wide range of specific types of equipment – radios, TVs, cassette recorders, amplifiers, video recorders etc.
REFERENCE DATA: Diodes, Small-Signal Transistors, Power Transistors, Thyristors, Triacs and Field Effect Transistors. Supplements include Operational Amplifiers, Logic Circuits, Optoelectronic Devices, etc.

The essential reference work for everyone studying electronics

- Over 800 pages • In-depth theory • Projects to build
- Detailed assembly instructions • Full components checklists • Extensive data tables • Manufacturers' web links
- Easy-to-use Adobe Acrobat format • Clear and simple layout • Comprehensive subject range • Professionally written • Supplements

BASIC PRINCIPLES: Electronic Components and their Characteristics; Circuits Using Passive Components; Power Supplies; The Amateur Electronics Workshop; The Uses of Semiconductors; Digital Electronics; Operational Amplifiers; Introduction to Physics, including practical experiments; Semiconductors and Digital Instruments.

CIRCUITS TO BUILD: The Base Manual describes 12 projects including a Theremin and a Simple TENS Unit.

ESSENTIAL DATA: Extensive tables on diodes, transistors, thyristors and triacs, digital and linear i.c.s.

EXTENSIVE GLOSSARY: Should you come across a technical word, phrase or abbreviation you're not familiar with, simply look up the glossary and you'll find a comprehensive definition in plain English.

The Manual also covers **Safety** and provides web links to component and equipment **Manufacturers and Suppliers**.

Full contents list available online at: www.epemag.wimborne.co.uk

Supplements: Additional CD-ROMs each containing approximately 500 pages of additional information on specific areas of electronics are available for £19.95 each. Information on the availability and content of each Supplement CD-ROM will be sent to you.

Presentation: CD-ROM suitable for any modern PC. Requires Adobe Acrobat Reader which is included on the CD-ROM.

Wimborne Publishing Ltd., Dept Y02, 408 Wimborne Road East, Ferndown, Dorset BH22 9ND. Tel: 01202 873872. Fax: 01202 874562.

PLEASE send me



THE MODERN ELECTRONICS MANUAL CD-ROM

ELECTRONICS SERVICE MANUAL CD-ROM

I enclose payment of £29.95 (for one Manual) or £49.90 for both Manuals (saving £10 by ordering both together).

FULL NAME
(PLEASE PRINT)

ADDRESS

.....

.....

.....POSTCODE

SIGNATURE

I enclose cheque/PO in UK pounds payable to Wimborne Publishing Ltd.

Please charge my Visa/Mastercard/Amex/Diners Club/Switch/Maestro

Card No Switch/Maestro Issue No

Valid From Expiry Date

Card Security Code (The last 3 digits on or just under the signature strip)

ORDER FORM

Simply complete and return the order form with your payment to the following address:

Wimborne Publishing Ltd,
Dept. Y02,
408 Wimborne Road East, Ferndown,
Dorset BH22 9ND

Price includes postage to anywhere in the World

We will happily exchange any faulty CD-ROMs but since the content can be printed out we do not offer a refund on these items.

Your CD-ROM(s) will be posted to you by first class mail or airmail, normally within four working days of receipt of your order

PCB SERVICE

Printed circuit boards for most recent EPE constructional projects are available from the PCB Service, see list. These are fabricated in glass fibre, and are fully drilled and roller tinned. All prices include VAT and postage and packing. Add £1 per board for airmail outside of Europe. Remittances should be sent to **The PCB Service, Everyday Practical Electronics, Wimborne Publishing Ltd., 408 Wimborne Road East, Ferndown, Dorset BH22 9ND. Tel: 01202 873872; Fax 01202 874562; Email: orders@epemag.wimborne.co.uk. On-line Shop: www.epemag.wimborne.co.uk/shopdoor.htm.** Cheques should be crossed and made payable to **Everyday Practical Electronics (Payment in £ sterling only).**
NOTE: While 95% of our boards are held in stock and are dispatched within seven days of receipt of order, please allow a maximum of 28 days for delivery - overseas readers allow extra if ordered by surface mail.
Back numbers or photostats of articles are available if required - see the Back Issues page for details. We do not supply kits or components for our projects.
Please check price and availability in the latest issue.
A large number of older boards are listed on our website.
 Boards can only be supplied on a payment with order basis.

PROJECT TITLE	Order Code	Cost
★ EPE PIC Met Office	AUG '03 402	£10.46
Alarm System Fault Finder	404	£4.44
Radio Circuits-3 Regen. Radio	405	£5.07
Tuning Capacitor Board	406	£4.28
Master/Slave Intercom (Top Tenner)	407	£4.75
Two-Up (Top Tenner)	408	£4.91
Priority Referee (Top Tenner)	SEPT '03 410	£5.07
Vibration Alarm (Top Tenner)	411	£5.39
Radio Circuits-4 Varicap Tuner	412	£4.44
Coil Pack - General Coverage	413	£5.07
Coil Pack - Amateur Bands	414	£4.75
★ PIC-A-Colour - Software only	-	-
Spooky Bug (Top Tenner)	OCT '03 409	£5.07
Radio Circuits-5 Crystal Marker	415	£4.44
Super Regen. Receiver	419	£5.07
Buffer Amplifier	420	£4.44
★ Serial Interface for PICs and VB6	416	£5.23
★ PIC Breakpoint - Software only	-	-
Anyone At Home - Logic Board	NOV '03 421	£6.35
- Relay Board	422	Pair
Radio Circuits-6 Direct Conversion SW Receiver	423	£6.02
★ PIC Random L.E.D. Flasher	424	£4.60
★ PIC Virus Zapper Mk2	DEC '03 425	£5.72
Radio Circuits-7 SW Superhet Tuner/Mixer	426	£5.70
Christmas Cheeks (double-sided)	427	£4.44
★ PIC Nim Machine - Software only	-	-
Bedside Nightlight (Top Tenner)	JAN '04 417	£4.44
Sound Trigger	418	£4.60
Timing/Lamp	428	£5.71
Radio Circuits-6 Dual Conversion SW Rec. - I.F. Amp	429	£4.45
- Signal-Strength Meter	430	£4.75
- B.F.O./Prod. Detector	431	£7.61
★ Car Computer (double-sided)	-	-
★ PIC Watering Timer - Software only	-	-
★ GPS to PIC and PC Interface - Software only	-	-
Jazzy Necklace	FEB '04 432	pair £5.40
Sonic Ice Warning	433	£5.39
★ LCF Meter	434	£5.00
★ PIC Tug-of-War	435	£5.00
Bat-Band Converter	MAR '04 436	£4.76
★ MIDI Health Check - Transmitter/Receiver	437	pair £7.61
Emergency Stand-by Light	438	£5.55
★ PIC Mixer for RC Planes - Software only	-	-
★ Teach-In '04 Part 5 - Software only	-	-
Infra-Guard	APR '04 439	£5.07
★ Moon Clock	442	£5.71
★ Teach-In '04 Part 6 - Software only	-	-
★ EPE Seismograph Logger	-	-
Control Board	440	} pair £6.50
Sensor Amp. Board	441	
In-Car Lap-Top PSU	MAY '04 443	£4.60
Beat Balance Metal Detector	444	£4.60
Teach-In '04 Part 7 - Transmitter	445	£4.91
Receiver	446	£4.75
Moisture	447	£4.44
★ PIC Quickstep	JUNE '04 448	£5.71
Body Detector MkII	449	£4.91
★ Teach-In '04 Part 8 - Software only	-	-
★ MIDI Synchronome - Software only	-	-
Hard Drive Warbler	JULY '04 450	£4.60
★ Bongo Box	451	£6.02
Portable Mini Alarm - Sensor	452	£5.23
- Counter	453	£5.07
★ Teach-In '04 Part 9	-	-
PIC Combination Lock Alarm Monitor	454	£5.07
★ EPE Magnetometry Logger	455	£5.71
Keyring L.E.D. Torch	AUG '04 456	£4.12
★ Teach-In '04 Part 10 - PIC Curtain or Blind Winder	457	£5.39
Simple F.M. Radio - F.M. Tuner	458	£5.07
- Tone Control	459	£4.75
- Audio Power Amp (TDA2003)	347	£4.60
- Power Supply	460	£5.39

PROJECT TITLE	Order Code	Cost
★ EPE Scorer - Control Board	461	£6.66
- Display Board	462	£7.93
- Slave Board	463	£5.55
★ PIC to Mouse/Keyboard - Software only	-	-
EPE Wart Zapper	SEPT '04 464	£4.60
★ Radio Control Failsafe	465	£4.76
★ AlphaMouse Game	466	£4.60
★ Rainbow Lighting Controller - Software only	-	-
★ Moon and Tide Clock Calendar	OCT '04 467	£5.55
Volts Checker	468	£4.20
★ Smart Karts - Software only	-	-
Logic Probe	NOV '04 469	£4.76
Thunderstorm Monitor	470	£5.39
MW Amplitude Modulator	-	-
- V.F.O./Buffer	471	£4.76
- Modulator/PA	472	£5.07
- Power Supply	473	£4.76
Super Vibration Switch	DEC '04 474	£4.75
★ Wind Direction Indicator	475	£6.18
★ PIC Flasher Mk2	-	-
- Control Board	476	£4.75
- Transmitter	477	£4.44
- Multipurpose Board	478	£4.75
- Simple Cycler	479	£4.44
- Luxeon V Controller	480	£4.44
- Power Supply	473	£4.76
Lght Detector	JAN '05 481	£4.44
★ Camera Watch	482	£6.03
Gate Alarm - Oscillator	483	£4.92
- Delay/Timer	484	£4.92
★ Sneaky - Transmitter	FEB '05 485	£4.60
- Receiver	486	£4.91
★ PIC Electric Mk2 - Control	487	£5.87
- Sensor	488	£5.71
Sound Card Mixer	449	£7.29

EPE SOFTWARE

Software programs for EPE projects marked with a single asterisk ★ are available on 3.5 inch PC-compatible disks or free from our Internet site. The following disks are available: **PIC Tutorial V2** (Apr-June '03); **EPE Disk 3** (2000); **EPE Disk 4** (2001 - excl. PIC Toolkit TK3); **EPE Disk 5** (2002); **EPE Disk 6** (2003 - excl. Earth Resistivity and Met Office); **EPE Disk 7** (2004); **EPE Disk 8** (Jan 2005 to current cover date); **EPE Earth Resistivity Logger** (Apr-May '03); **EPE PIC Met Office** (Aug-Sept '03); **EPE Seismograph** (Apr-May '04); **EPE Magnetometry Logger** (July-Aug '04); **EPE Teach-In 2000**; **EPE Spectrum**; **EPE Interface Disk 1** (October '00 issue to current cover date). **EPE Toolkit TK3** software is available on the **EPE PIC Resources CD-ROM**, £14.45. Its p.c.b. is order code 319, £8.24.
 ★★ The software for these projects is on its own CD-ROM. The 3.5 inch disks are £3.00 each (UK), the CD-ROMs are £6.95 (UK). Add 50p each for overseas surface mail, and £1 each for airmail. All are available from the **EPE PCB Service**. All files can be downloaded free from our Internet FTP site, accessible via our home page at: www.epemag.co.uk.

EPE PRINTED CIRCUIT BOARD SERVICE

Order Code	Project	Quantity	Price
.....			
Name			
Address			
.....			
Tel. No.			
I enclose payment of £..... (cheque/PO in £ sterling only) to:			
Everyday Practical Electronics MasterCard, Amex, Diners Club, Visa or Switch/Maestro			
Card No.			
Valid From		Expiry Date	
Card Security Code Switch/Maestro Issue No			
(The last 3 digits on or just under the signature strip)			
Signature			
NOTE: You can also order p.c.b.s by phone, Fax, Email or via our Internet site on a secure server: http://www.epemag.wimborne.co.uk/shopdoor.htm			

Everyday Practical Electronics reaches twice as many UK readers as any other UK monthly hobby electronics magazine, our sales figures prove it. We have been the leading monthly magazine in this market for the last twenty years.

If you want your advertisements to be seen by the largest readership at the most economical price our classified and semi-display pages offer the best value. The prepaid rate for semi-display space is £10 (+VAT) per single column centimetre (minimum 2.5cm). The prepaid rate for classified adverts is 40p (+VAT) per word (minimum 12 words).

All cheques, postal orders, etc., to be made payable to Everyday Practical Electronics. VAT must be added. Advertisements, together with remittance, should be sent to Everyday Practical Electronics Advertisements, Mill Lodge, Mill Lane, Thorpe-le-Soken, Essex CO16 0ED. Phone/Fax (01255) 861161.

For rates and information on display and classified advertising please contact our Advertisement Manager, Peter Mew as above.

BOWOOD ELECTRONICS LTD

Suppliers of Electronic Components

Place a secure order on our website or call our sales line
All major credit cards accepted

Web: www.bowood-electronics.co.uk

Unit 1, McGregor's Way, Turnoaks Business Park,
Chesterfield, S40 2WB. Sales: 01246 200222

Send 60p stamp for catalogue

**The Versatile, Programmable
On Screen Display System**
www.STV5730A.co.uk

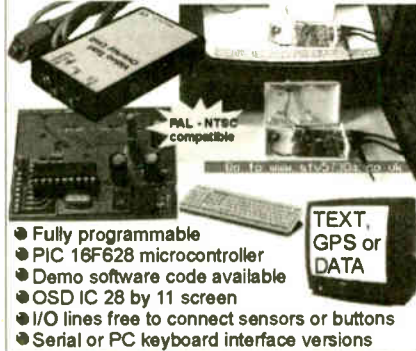

- Fully programmable
- PIC 16F628 microcontroller
- Demo software code available
- OSD IC 28 by 11 screen
- I/O lines free to connect sensors or buttons
- Serial or PC keyboard interface versions

X-10® Home Automation
We put you in control™

Why tolerate when you can automate?
An extensive range of 230V X-10 products and starter kits available. Uses proven Power Line Carrier technology, no wires required.

Products Catalogue available Online.
Worldwide delivery.

Laser Business Systems Ltd.

E-Mail: info@laser.com

<http://www.laser.com>

Tel: (020) 8441 9788

Fax: (020) 8449 0430

VVT TRANSFORMERS

Transformers and Chokes for all types of circuits including specialist valve units
Custom design or standard range
High and low voltage

Variable Voltage Technology Ltd

Unit 3, Sheat Manor Farm, Chillerton,
Newport, Isle of Wight, PO30 3HP
Tel: 0870 243 0414 Fax: 01983 721572

email: sales@vvt-cowes.freemove.co.uk

www.vvttransformers.co.uk

TOTALROBOTS

**ROBOTICS, CONTROL &
ELECTRONICS TECHNOLOGY**

High quality robot kits and components
UK distributor of the OOPic microcontroller

Secure on-line ordering
Rapid delivery
Highly competitive prices

Visit www.totalrobots.com

Tel: 0208 823 9220

Component Kits!

Mail order P&P: £2.50 (Free P&P orders over £20)
www.fastcomponents.co.uk

Tel: 0870 750 4468 Fax: 0870 137 6005
Winchester House, Winchester Rd,
Walton-on-Thames, Surrey, KT12 2RH

TRANSFORMERS

- Custom Wound
- 1 Phase to 50kVA
- 3 Phase to 100kVA
- A.C. and D.C. Chokes
- H.T. up to 5kV
- Transformer Kits
- Coils up to 1m Dia.
- Transformer Rectifiers
- Toroidals
- Motor Generators

Visit www.jemelec.com for details
or request our free leaflet

Jemelec, Unit 16, Vanguard Trading Estate, Storforth Lane,
Chesterfield, S40 2TZ

Tel: 0870 787 1769

**BTEC ELECTRONICS
TECHNICIAN TRAINING**

VCE ADVANCED ENGINEERING
ELECTRONICS AND ICT
HNC AND HND ELECTRONICS
NVQ ENGINEERING AND IT
PLEASE APPLY TO COLLEGE FOR
NEXT COURSE DATE
FULL PROSPECTUS FROM

LONDON ELECTRONICS COLLEGE
(Dept EPE) 20 PENYVERN ROAD
EARLS COURT, LONDON SW5 9SU
TEL: (020) 7373 8721

Miscellaneous

MICRO CHIP DEVICES for home and business. Worried about hidden diallers being put on your computer? Try Our new **MODEM BLOCKER!** Protect yourself and your wallet! Visit our WEB Site at: www.microchipdevices.com Projects and Products build on Microchip and 1-Wire technologies are available to build or to buy.

VALVES AND ALLIED COMPONENTS IN STOCK. Phone for free list. Valves, books and magazines wanted. Geoff Davies (Radio), tel. 01788 574774.

KITS, TOOLS, COMPONENTS. S.a.e. catalogue: Sir-Kit Electronics, 52 Severn Road, Clacton, CO15 3RB. www.geocities.com/sirkituk.

Computer Software

FREE DOWNLOADABLE SOFTWARE: Electronics, Electrical and Computing V8.2. Computer Science V8.2 and GCSE Maths V8.2. Still selling at £120 each on CDROM is now available to download and fully install to your hard drive **COMPLETELY FREE OF CHARGE.** Latest update includes the new Web Links feature. Visit www.eptsoft.com for details.

EPE BINDERS

**KEEP YOUR MAGAZINES SAFE –
RING US NOW!**

This ring binder uses a special system to allow the issues to be easily removed and re-inserted without any damage. A nylon strip slips over each issue and this passes over the four rings in the binder, thus holding the magazine in place.

The binders are finished in hard-wearing royal blue p.v.c. with the magazine logo in gold on the spine. They will keep your issues neat and tidy but allow you to remove them for use easily.

The price is £8.95 plus £3.50 post and packing. If you order more than one binder add £1 postage for each binder after the initial £3.50 postage charge (overseas readers the postage is £6.00 each to everywhere except Australia and Papua New Guinea which costs £10.50 each).

Send your payment in £'s sterling cheque or PO (Overseas readers send £ sterling bank draft, or cheque drawn on a UK bank or pay by card), to **Everyday Practical Electronics, Wimborne Publishing Ltd, 408 Wimborne Road East, Ferndown, Dorset BH22 9ND. Tel: 01202 873872. Fax: 01202 874562.**

E-mail: editoriel@epemag.wimborne.co.uk

Web site: www.epemag.co.uk

Order on-line from

www.epemag.wimborne.co.uk/shopdoor.htm

We also accept card payments. Mastercard, Visa, Amex, Diners Club or Maestro. Send your card number and card expiry date plus Maestro Issue No. with your order.

SQUIRES

MODEL & CRAFT TOOLS

A COMPREHENSIVE RANGE OF MINIATURE HAND AND POWER TOOLS AND AN EXTENSIVE RANGE OF

ELECTRONIC COMPONENTS

FEATURED IN A FULLY ILLUSTRATED

704 PAGE MAIL ORDER CATALOGUE

2005 ISSUE

**SAME DAY DESPATCH
FREE POST AND PACKAGING**

Catalogues: FREE OF CHARGE to addresses in the UK.
Overseas: CATALOGUE FREE, postage at cost charged to credit card

SHOP EXTENSION NOW OPEN

Squires, 100 London Road,
Bognor Regis, West Sussex, PO21 1DD



TEL: 01243 842424
FAX: 01243 842525



Europe's Largest Surplus Store

20,000,000 Items on line NOW !
New items added daily

Established for over 25 years, UK company Display Electronics prides itself on offering a massive range of electronic and associated electro-mechanical equipment and parts to the Hobbyist, Educational and Industrial user. Many current and obsolete hard to get parts are available from our vast stocks, which include:

- ◆ 6,000,000 Semiconductors
- ◆ 5,000 Power Supplies
- ◆ 25,000 Electric Motors
- ◆ 10,000 Connectors
- ◆ 100,000 Relays & Contactors
- ◆ 2000 Rack Cabinets & Accessories
- ◆ 4000 Items of Test Equipment
- ◆ 5000 Hard Disk Drives

**We Ship
Worldwide**

**Surplus
Wanted**

www.distel.co.uk

Display Electronics
29 / 35 Osborne Road
Thornton Heath
Surrey UK CR7 8PD

Telephone
[44] 020 8653 3333
Fax [44] 020 8653 8888

N. R. BARDWELL LTD (Est. 1948)

100	Signal Diodes 1N4148	£1.00	80	Asstd. capacitors 1nF to 1µF	£1.00
75	Rectifier Diodes 1N4001	£1.00	200	Asstd. disc ceramic capacitors	£1.00
50	Rectifier Diodes 1N4007	£1.00	50	Asstd. Sial Presets (em, stand, cermet)	£1.00
10	W01 Bridge Rectifiers	£1.00	50	Asstd. RF chokes (inductors)	£1.00
10	555 Timer I.C.s	£1.00	25	Asstd. grommets	80p
4	741 Op Amps	£1.00	6	Asstd. di switches	£1.00
50	Assorted Zener Diodes 400mW	£1.00	6	Asstd. push-button switches, multi-bank, multi-pole	£1.00
12	Assorted 7-segment Displays	£1.00	30	Asstd. di sockets up to 40 way	£1.00
35	Assorted I.e.d.s. var. shapes, colours & sizes	£1.00	10	TV coax plugs, plastic	£1.00
25	5mm I.e.d.s. red or green or yellow	£1.00	40	metres - very thin connecting wires, red	£1.00
25	3mm I.e.d.s. red or green or yellow	£1.00	20	1in. glass reed switches	£1.00
75	5mm I.e.d.s. green, 8.5mm eqg	£1.00	100	Any one value 1/4W 5% of resistors range 1R to 10M	£0.45
25	Axial I.e.d.s. 2mcd red Diode Package	£1.00	10	7B12 Voltage Regulators	£1.00
25	Asstd. High Brightness L.e.d.s., var. sizes	£1.00	300	Asstd. resistors. 1/4W/1/2W mostly on tapes	£1.00
20	BC182L Transistors	£1.00			
25	BC212L Transistors	£1.00			
30	BC237 Transistors	£1.00			
20	BC327 Transistors	£1.00			
30	BC328 Transistors	£1.00			
20	BC547 Transistors	£1.00			
20	BC548 Transistors	£1.00			
30	BC549 Transistors	£1.00			
25	BC557 Transistors	£1.00			
30	BC558 Transistors	£1.00			
25	BC559 Transistors	£1.00			
20	2N3904 Transistors	£1.00			
100	1nF 50V wkg Axial Capacitors	£1.00			
80	Asstd capacitors electrolytic	£1.00			

288 Abbeydale Road, Sheffield S7 1FL

Phone (local rate): 0845 186 2329

Fax: 0114 255 5039

e-mail: sales@bardwells.co.uk

web: www.bardwells.co.uk

Prices include VAT. Postage £1.85

44p stamp for lists or disk

POs, Cheques and Credit Cards accepted

SEE OUR WEB PAGES FOR MORE COMPONENTS AND SPECIAL OFFERS

FRUSTRATED!

Looking for ICs TRANSISTORS?

A phone call to us could get a result. We offer an extensive range and with a world-wide database at our fingertips, we are able to source even more. We specialise in devices with the following prefix (to name but a few).



2N 2SA 2SB 2SC 2SD 2P 2SJ 2SK 3N 3SK 4N 6N 17 40 AD ADC AN AM AY BA BC BD BDT BDV BDW BDX BF BFR BFS BFT BFX BFY BLY BLX BS BR BRX BRY BS BSS BSV BSW BSX BT BTA BTB BRW BU BUK BUT BUY BUW BUX BUY BUZ CA CD CX CXA DAC DG DM DS DTA DTC GL GM HA HCF HD HEF ICL ICM IRF J KA KIA L LA LB LC LD LF LM M M5M MA MAB MAX MB MC MDAJ MJE MJF MM MN MPS MP5A M5H MP5U MRF NIM NE OM OP PA PAL PIC PN RC S SAA SAB SAD SAJ SAS SDA SG SI SL SN SO STA STK STR STRD STRM STRS SV1 T TA TAA TAG TBA TC TCA TDA TDB TEA TIC TIP TIPL TEA TL TLC TMP TMS TPU U UA UAA UC UEN ULN UM UPA UPC UPD VN X XR Z ZN ZTX + many others

**PLEASE VISIT OUR WEB SITE AT
www.cricklewoodelectronics.com**
We Stock a Massive Range of Components

Mail, phone, Fax Credit Card orders and callers welcome

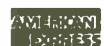

Cricklewood Electronics Ltd

40-42 Cricklewood Broadway London NW2 3ET

Tel: 020 8452 0161 Fax: 020 8208 1441

EP
Online
www.epemag.com

Get your magazine "instantly" anywhere in the world - buy from the web.

TAKE A LOOK, A FREE ISSUE IS AVAILABLE

A one year subscription (12 issues) costs just \$10.99 (US)

www.epemag.com

Watch Slides on TV.

Make videos of your slides. Digitise your slides (using a video capture card)
 "Liesgang diatv" automatic slide viewer with built in high quality colour TV camera. It has a composite video output to a phono plug (SCART & BNC adaptors are available). They are in very good condition with few signs of use. More details see www.diatv.co.uk.
 £91.91 + VAT = £108.00



Board cameras all with 512 x 582 pixels 8-5mm 1/3 inch sensor and composite video out. All need to be housed in your own enclosure and have fragile exposed surface mount parts. They all require a power supply of between 10V and 12V DC 150mA.
 47MIR size 60 x 36 x 27mm with 6 infra red LEDs (gives the same illumination as a small torch but is not visible to the human eye) £37.00 + VAT = £43.48
 30MP size 32 x 32 x 14mm spy camera with a fixed focus pin hole lens for hiding behind a very small hole £35.00 + VAT = £41.13
 40MC size 39 x 38 x 27mm camera for 'C' mount lens these give a much sharper image than with the smaller lenses £32.00 + VAT = £37.60
 Economy C mount lenses all fixed focus & fixed iris
 VSL1220F 12mm F1.6 12 x 15 degrees viewing angle £15.97 + VAT £18.76
 VSL4022F 4mm F1.22 63 x 47 degrees viewing angle £17.65 + VAT £20.74
 VSL6022F 6mm F1.22 42 x 32 degrees viewing angle £19.05 + VAT £22.38
 VSL8020F 8mm F1.22 32 x 24 degrees viewing angle £19.90 + VAT £23.38

Better quality C Mount lenses

VSL1614F 16mm F1.6 30 x 24 degrees viewing angle £26.43 + VAT £31.06
 VWL813M 8mm F1.3 with iris 56 x 42 degrees viewing angle £77.45 + VAT = £91.00
 1206 surface mount resistors E12 values 10 ohm to 1M ohm
 100 of 1 value £1.00 + VAT 1000 of 1 value £5.00 + VAT

866 battery pack originally intended to be used with an orbitel mobile telephone it contains 10 1.6Ah sub C batteries (42 x 22 dia. the size usually used in cordless screwdrivers etc.) the pack is new and unused and can be broken open quite easily
 £7.46 + VAT = £8.77

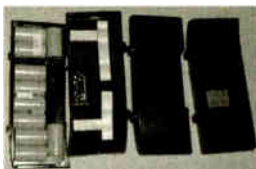

Please add £1.66 + vat = £1.95 postage & packing per order

JPG Electronics

Shaws Row, Old Road, Chesterfield, S40 2RB.

Tel 01246 211202 Fax 01246 550959

Mastercard/Visa/Switch

Callers welcome 9.30 a.m. to 5.30 p.m. Monday to Saturday

ADVERTISERS INDEX

ANTEX	92
N. R. BARDWELL	143
B.K. ELECTRONICS	Cover (iv)/104
BITZ TECH	74
BULL GROUP	Cover (ii)
CRICKLEWOOD ELECTRONICS	143
DISPLAY ELECTRONICS	143
ESR ELECTRONIC COMPONENTS	82
JAYCAR ELECTRONICS	113
JPG ELECTRONICS	144
LABCENTER	Cover (iii)
MAGENTA ELECTRONICS	80/81
MATRIX MULTIMEDIA	121
MILFORD INSTRUMENTS	93
NATIONAL COLLEGE OF TECHNOLOGY	74
PEAK ELECTRONIC DESIGN	101
PICO TECHNOLOGY	116/121
QUASAR ELECTRONICS	76/77
SHERWOOD ELECTRONICS	144
SQUIRES	143
STEWART OF READING	74
SUMA DESIGNS	92

ADVERTISEMENT MANAGER: PETER J. MEW

ADVERTISEMENT OFFICES:

EVERYDAY PRACTICAL ELECTRONICS, ADVERTISEMENTS, MILL LODGE, MILL LANE, THORPE-LE-SOKEN, ESSEX CO16 0ED. Phone/Fax: (01255) 861161

For Editorial address and phone numbers see page 83

SHERWOOD ELECTRONICS

FREE COMPONENTS

Buy 10 x £1 Special Packs and choose another one FREE

SP1	15 x 5mm Red LEDs	SP133	20 x 1N4004 diodes
SP2	12 x 5mm Green LEDs	SP134	15 x 1N4007 diodes
SP3	12 x 5mm Yellow LEDs	SP135	6 x Miniature slide switches
SP5	25 x 5mm 1 part LED clips	SP136	3 x BFY50 transistors
SP6	12 x 3mm Red LEDs	SP137	4 x W005 1.5A bridge rectifiers
SP7	12 x 3mm Green LEDs	SP138	20 x 2.2/63V radial elect. caps.
SP8	10 x 3mm Yellow LEDs	SP140	3 x W04 1.5A bridge rectifiers
SP9	25 x 3mm 1 part LED clips	SP142	2 x CMOS 4017
SP10	100 x 1N4148 diodes	SP143	5 Pairs min. crocodile clips (Red & Black)
SP11	30 x 1N4001 diodes	SP146	10 x 2N3704 transistors
SP12	30 x 1N4002 diodes	SP147	5 x Stripboard 9 strips x 25 holes
SP18	20 x BC182 transistors	SP151	4 x 8mm Red LEDs
SP20	20 x BC184 transistors	SP152	4 x 8mm Green LEDs
SP23	20 x BC549 transistors	SP153	4 x 8mm Yellow LEDs
SP24	4 x CMOS 4001	SP154	15 x BC548 transistors
SP25	4 x 555 timers	SP156	3 x Stripboard, 14 strips x 27 holes
SP26	4 x 741 Op.Amps	SP160	10 x 2N3904 transistors
SP28	4 x CMOS 4011	SP161	10 x 2N3906 transistors
SP29	3 x CMOS 4013	SP165	2 x LF351 Op.Amps
SP33	4 x CMOS 4081	SP166	20 x 1N4003 diodes
SP34	20 x 1N914 diodes	SP167	5 x BC107 transistors
SP36	25 x 10/25V radial elect. caps.	SP168	5 x BC108 transistors
SP37	12 x 100/35V radial elect. caps.	SP172	4 x Standard slide switches
SP39	10 x 470/16V radial elect. caps.	SP173	10 x 220/25V radial elect. caps
SP40	15 x BC237 transistors	SP174	20 x 22/25V radial elect. caps
SP41	20 x Mixed transistors	SP175	20 x 1/63V radial elect. caps.
SP42	200 x Mixed 0-25W C.F. resistors	SP177	10 x 1A 20mm quick blow fuses
SP47	5 x Min. PB switches	SP178	10 x 2A 20mm quick blow fuses
SP49	4 x 5 metres stranded core wire	SP181	5 x Phono plugs - asstd colours
SP102	20 x 8-pin DIL sockets	SP182	20 x 4-7/63V radial elect. caps.
SP103	15 x 14-pin DIL sockets	SP183	20 x BC547 transistors
SP104	15 x 16-pin DIL sockets	SP187	15 x BC239 transistors
SP105	4 x 74LS00	SP189	4 x 5 metres solid core wire
SP109	15 x BC557 transistors	SP192	3 x CMOS 4066
SP112	4 x CMOS 4093	SP195	3 x 10mm Yellow LEDs
SP115	3 x 10mm Red LEDs	SP197	6 x 20 pin DIL sockets
SP116	3 x 10mm Green LEDs	SP198	5 x 24 pin DIL sockets
SP118	2 x CMOS 4047	SP199	5 x 2-5mm mono jack plugs
SP124	20 x Assorted ceramic disc caps	SP200	5 x 2-5mm mono jack sockets
SP126	6 x Battery clips - 3 ea. PP3 + PP9		
SP130	100 x Mixed 0-5W C.F. resistors		
SP131	2 x TL071 Op.Amps		

RESISTOR PACKS - C.Film

RP3	5 each value - total 365 0-25W	£3.20
RP7	10 each value - total 730 0-25W	£4.45
RP10	1000 popular values 0-25W	£6.35
RP4	5 each value-total 345 0-5W	£4.10
RP8	10 each value-total 690 0-5W	£6.75
RP11	1000 popular values 0-5W	£8.60

2004 Catalogue now available £1 inc. P&P or FREE with first order. P&P £1.50 per order. NO VAT Cheques and Postal Orders to: **Sherwood Electronics, 7 Williamson St., Mansfield, Notts. NG19 6TD.**

EPE SUBSCRIPTIONS

SAVE 51p AN ISSUE OVER UK NEWSTAND PRICES ON A UK ONE YEAR SUBSCRIPTION

Subscriptions for delivery direct to any address in the UK: 6 months £16.50, 12 months £31, two years £57; Overseas: 6 months £19.50 standard air service or £28.50 express airmail, 12 months £37 standard air service or £55 express airmail, 24 months £69 standard air service or £105 express airmail. Cheques or bank drafts (in £ sterling only) payable to *Everyday Practical Electronics* and sent to EPE Subs. Dept., Wimborne Publishing Ltd., 408 Wimborne Road East, Ferndown, Dorset BH22 9ND. Tel: 01202 873872. Fax: 01202 874562. Email: subs@epemag.wimborne.co.uk. Also via the Web at <http://www.epemag.wimborne.co.uk>. Subscriptions start with the next available issue. We accept MasterCard, Amex, Diners Club, Switch or Visa. (For past issues see the Back Issues page.)

ONLINE SUBSCRIPTIONS

Online subscriptions, for downloading the magazine via the Internet, \$10.99US (approx. £7) for one year available from www.epemag.com.

USA/CANADA SUBSCRIPTIONS

To subscribe to EPE from the USA or Canada please telephone Express Mag toll free on 1877 363-1310 and have your credit card details ready. Or fax (514) 355 3332 or write to Express Mag, PO Box 2769, Plattsburgh, NY 12901-0239 or Express Mag, 8155 Larney Street, Anjou, Quebec, H1J 2L5. Email address: expmag@expressmag.com.

Web site: www.expressmag.com. USA price \$60(US) per annum, Canada price \$97(Can) per annum - 12 issues per year.

Everyday Practical Electronics, periodicals pending, ISSN 0262 3617 is published twelve times a year by Wimborne Publishing Ltd., USA agent USACAN at 1320 Route 9, Champlain, NY 12919. Subscription price in US \$60(US) per annum. Periodicals postage paid at Champlain NY and at additional mailing offices. POSTMASTER: Send USA and Canada address changes to *Everyday Practical Electronics*, c/o Express Mag., PO Box 2769, Plattsburgh, NY, USA 12901-0239.

PROTEUS

The Complete Electronics Design System

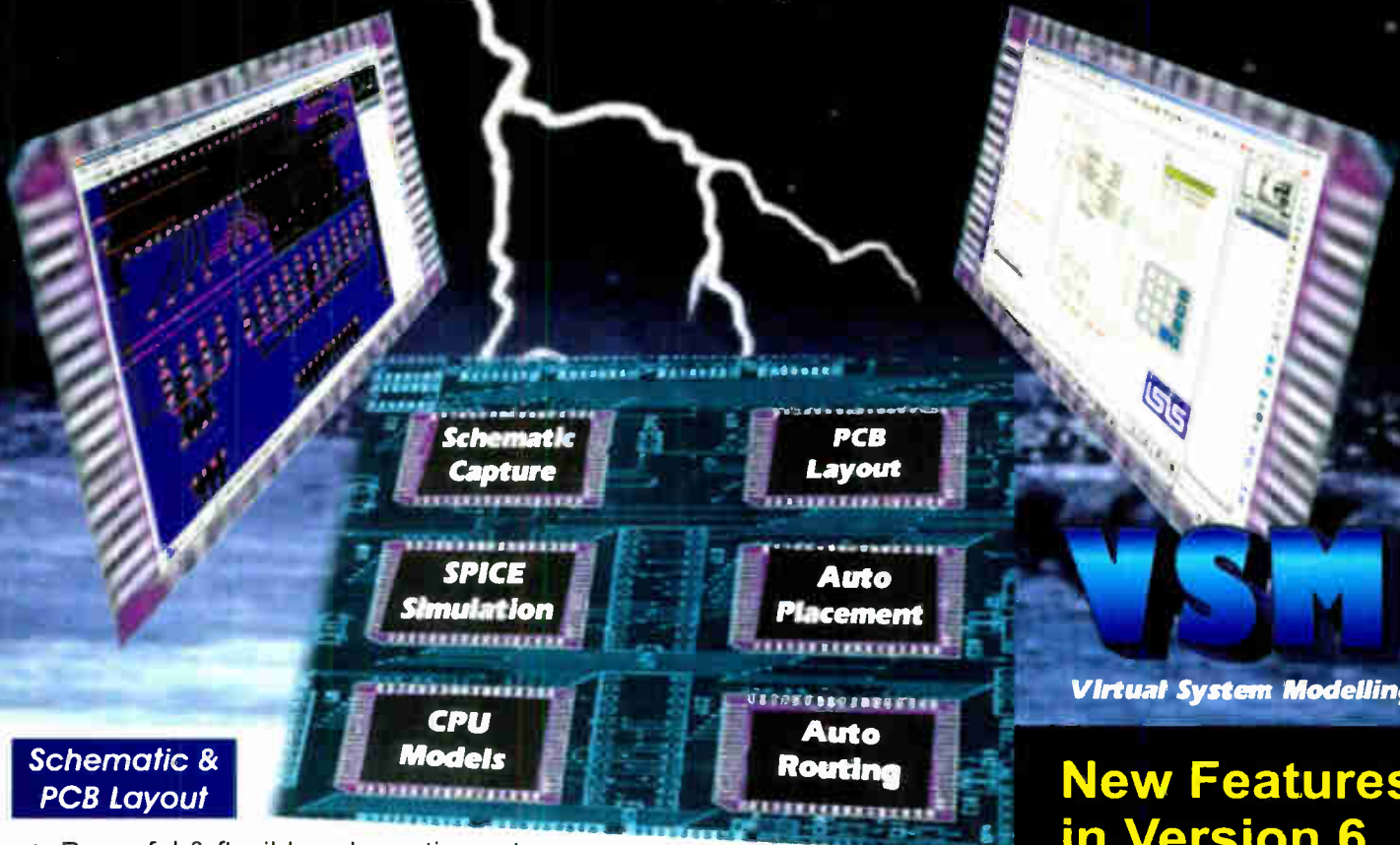

Schematic & PCB Layout

- Powerful & flexible schematic capture.
- Auto-component placement and rip-up/retry PCB routing.
- Polygonal gridless ground planes.
- Libraries of over 8000 schematic and 1000 PCB parts.
- Bill of materials, DRC reports and much more.

Mixed Mode SPICE Circuit Simulation

- Berkeley SPICE3F5 simulator with custom extensions for true mixed mode and interactive simulation.
- 6 virtual instruments and 14 graph based analysis types.
- 6000 models including TTL, CMOS and PLD digital parts.
- Fully compatible with manufacturers' SPICE models.

Proteus VSM Co-simulation and debugging for popular Micro-controllers

- Supports PIC AVR 8051 HC11 and ARM micro controllers
- Co-simulate target firmware with your hardware design.
- Includes interactive peripheral models for LED and LCD displays, switches, keypads, virtual terminal and much, much more.
- Provides source level debugging for popular compilers and assemblers from Crownhill, IAR, Keil, and others.

New Features in Version 6

- Drag and drop toolbars.
- Visual PCB packaging tool.
- Improved route editing.
- Point and click DRC report.
- Multiple design rules (per net).
- Multiple undo/redo.

Call Now for Upgrade Pricing

**Works with
PIC Basic Plus
from Crownhill
Associates**

labcenter

Electronics

53-55 Main Street, Grassington. BD23 5AA

Tel: 01756 753440

Fax: 01756 752857

Contact us for
Free Demo CD

www.labcenter.co.uk
info@labcenter.co.uk



POWER AMPLIFIER MODULES-LOUDSPEAKERS-MIXERS 19 INCH STEREO AMPLIFIERS-ACTIVE CROSS/OVERS.

- * PRICES INCLUDE V.A.T.
- * PROMPT DELIVERY

OMP MOS-FET POWER AMPLIFIERS HIGH POWER, TWO CHANNEL 19 INCH RACK

10,000's
SOLD
TO PRO
USERS



THE RENOWNED MXF SERIES OF POWER AMPLIFIERS

FOUR MODELS:- MXF200 (100W + 100W) MXF400 (200W + 200W)
MXF600 (300W + 300W) MXF900 (450W + 450W)

ALL POWER RATINGS ARE R.M.S. INTO 4 OHMS, WITH BOTH CHANNELS DRIVEN
FEATURES:- * Independent power supplies with two toroidal transformers
* Twin L.E.D. Vu Meters * Level controls * Illuminated on/off switch * Jack / XLR inputs
* Speakon Outputs * Standard 775mv inputs * Open and Short circuit proof * Latest Mos-Fets
for stress free delivery into virtually any load * High slew rate * Very low distortion * Aluminium
cases * MXF600 & MXF900 fan cooled with D.C. Loudspeaker and thermal protection.

USED THE WORLD OVER IN CLUBS, PUBS, CINEMAS, DISCOS ETC

SIZES:-
MXF200 W19" D11" H3 1/2" (2U)
MXF400 W19" D12" H5 1/4" (3U)
MXF600 W19" D13" H5 1/4" (3U)
MXF900 W19" D14" H5 1/4" (3U)

PRICES:- MXF200 £175.00 MXF400 £233.85
MXF600 £329.00 MXF900 £449.15
SPECIALIST CARRIER DEL £12.50 Each



XLS200 Active Bass System

Price £279.00+ £8.00 Carriage

We have been designing and manufacturing 5 star award winning subs since 1992

Features

- * Uses a Peerless XLS10, one of the worlds best subwoofer drive units
- * True 200W RMS 400W Peak
- * Simultaneous high and low level connections
- * Solid construction 25mm baffle and back and 18mm MDF sides with real wood veneers
- * Four fantastic finishes
- * Compact size only 390D x 295H x 295W mm
- * Over engineered for sonic excellence weighs in at 20kg



At about a cubic foot the XLS200 can be easily hidden from view, but you will certainly know it is there. With the easy to setup controls it will take only minutes to get up and running showing it's punch, agility and power. Due to its rigid sealed box enclosure and powerful 200W amplifier coupled to an extremely high quality 250mm drive unit the XLS200 sounds absolutely stunning from the off, with music that is underpinned by masses of low end extension. Movies will come to life too, as you hear the effects as well as feel them.

- ★ Free Accessories worth £40.00. 10M Speakon High Level Lead - 5M High Quality Gold Phono to Phono Lead and a set of spikes
- ★ Pay no extra for real wood veneers



Strength & Depth in the knowledge that we have supplied over 100,000 subs

For further details look on our website at :-
<http://www.bkelec.com/new>



100 WATT ACTIVE SUB BASS AMPLIFIER PANEL



AN ACTIVE SUB BASS AMPLIFIER WITH A TRUE 100W RMS OUTPUT SUPERB CONSTRUCTION WITH THE FACILITIES TO INTEGRATE SEAMLESSLY INTO MOST HI-FI OR HOME CINEMA SETUPS. USE THIS PANEL PLUS ONE OF OUR LOUDSPEAKERS TO MAKE YOUR OWN SUB WOOFER THAT WILL MATCH OR BEAT MOST COMMERCIALY AVAILABLE SUB WOOFERS.

FEATURES:- * 100W RMS INTO 8 OHMS * HIGH AND LOW LEVEL INPUTS * TOROIDAL TRANSFORMER * SHORT CIRCUIT PROTECTION * D.C. SPEAKER PROTECTION * FREQUENCY ROLL OFF, LOWER 10Hz, UPPER 60Hz TO 240Hz (FULLY ADJUSTABLE) * AC3 COMPATIBLE FILTER CAN BE BYPASSED FOR 5-1 FORMATS. * AIRTIGHT CONSTRUCTION * TENS OF THOUSANDS OF OUR PANELS ALREADY IN USE. * COMPLETE WITH LEADS

SPECIFICATIONS:- POWER 100W RMS @ 8 OHMS * FREQ RESP. 10Hz 15KHz -3dB * DAMPING FACTOR >200 * DISTORTION 0.05% * S/N A WEIGHTED >100dB * SUPPLY 230V A.C. * WEIGHT 2.7Kg * SIZE H254 X W254 X D94mm

THERE ARE 2 VERSIONS OF THE ABOVE PANEL AVAILABLE :- BSB100/8 8 OHM VERSION BSB100/4 4 OHM VERSION BOTH PANELS ARE PRICED AT £117.44 + £5.00 P&P INCL. V.A.T. CHECK WEBSITE FOR PANELS UP TO 500W

DELIVERY CHARGES:- PLEASE INCLUDE AS ABOVE, A MINIMUM CHARGE OF £8.00 TO A MAXIMUM AMOUNT OF £30.00. OFFICIAL ORDERS FROM SCHOOLS, COLLEGES, GOV'T. PLCs ETC. PRICES INCLUSIVE OF V.A.T. SALES COUNTER. CREDIT CARD ORDERS ACCEPTED



RF REMOTE CONTROLLED MAINS SWITCHES



RF Remote controlled mains switches suitable for use around the home where the operation of mains equipment up to 1KW can be controlled with the touch of one button. Ideal for equipment that has the wall socket obstructed like Hi-Fi and AV systems, or for lights. Kit comprises of one RF remote control and three sockets. The RF remote can control an additional two sockets making five in all and the sockets are programmable from 1 to 5 via a selector switch on the back of the socket. Sockets also come with an override switch to turn the power on and off without the aid of the remote control.

Features

- * Remote controller can control up to 5 switches
- * Up to 20 metre range
- * Adjustable codes
- * Manual On/Off
- * Extra socket and remote available



Kit comprises of 3 mains switches and one RF remote control

Order No. 350.112
Price £19.95

Additional Socket £6.66ea Order No.350.112A
Additional Remote £6.66ea Order No. 350.112B

OMP MOS-FET POWER AMPLIFIER MODULES

SUPPLIED READY BUILT AND TESTED

These modules now enjoy a world-wide reputation for quality, reliability and performance at a realistic price. Four models are available to suit the needs of the professional and hobby market i.e. Industry, Leisure, Instrumental and Hi-Fi etc. When comparing prices, NOTE that all models include toroidal power supply, integral heatsink, glass fibre P.C.B. and drive circuits to power a compatible Vu meter. All models are open and short circuit proof.

THOUSANDS OF MODULES PURCHASED BY PROFESSIONAL USERS

OMP/MF 100 Mos-Fet Output Power 110 watts R.M.S. into 4 ohms, frequency response 1Hz - 100kHz -3dB, Damping Factor >300, Slew Rate 45V/uS, T.H.D. typical 0.002%, Input Sensitivity 500mV, S.N.R. 110dB, Size 300 x 123 x 60mm.
Price:- £43.85 + £4.00 P&P

OMP/MF 200 Mos-Fet Output Power 200 watts R.M.S. into 4 ohms, frequency response 1Hz - 100kHz -3dB, Damping Factor >300, Slew Rate 50V/uS, T.H.D. typical 0.001%, Input Sensitivity 500mV, S.N.R. 110dB, Size 300 x 155 x 100mm.
Price:- £67.35 + £4.00 P&P

OMP/MF 300 Mos-Fet Output Power 300 watts R.M.S. into 4 ohms, frequency response 1Hz - 100kHz -3dB, Damping Factor >300, Slew Rate 60V/uS, T.H.D. typical 0.001%, Input Sensitivity 500mV, S.N.R. 110dB, Size 330 x 175 x 100mm.
Price:- £84.75 + £5.00 P&P

OMP/MF 450 Mos-Fet Output Power 450 watts R.M.S. into 4 ohms, frequency response 1Hz - 100kHz -3dB, Damping Factor >300, Slew Rate 75V/uS, T.H.D. typical 0.001%, Input Sensitivity 500mV, S.N.R. 110dB, Fan Cooled, D.C. Loudspeaker Protection, 2 Second Anti Thump Delay, Size 385 x 210 x 105mm.
Price:- £137.85 + £6.00 P&P

OMP/MF 1000 Mos-Fet Output Power 1000 watts R.M.S. into 2 ohms, frequency response 1Hz - 100kHz -3dB, Damping Factor >300, Slew Rate 75V/uS, T.H.D. typical 0.001%, Input Sensitivity 500mV, S.N.R. 110dB, Fan Cooled, D.C. Loudspeaker Protection, 2 Second Anti Thump Delay, Size 422 x 300 x 125mm.
Price:- £264.00 + £7.00 P&P

NOTE MOS-FET MODULES ARE AVAILABLE IN TWO VERSIONS. STANDARD - INPUT SENS 500mV, BANDWIDTH 100kHz OR PEC (PROFESSIONAL EQUIPMENT COMPATIBLE) - INPUT SENS 775mV, BANDWIDTH 50kHz ORDER STANDARD OR PEC

WRIST WATCH STYLE 8 CHANNEL PMR 2 WAY RADIOS



A pair of uniquely styled 2 way PMR personal radios ideal for short range communications no licence required. Each wrist watch radio is capable of transmitting up to 5 Km without obstructions and have a built in thermometer and stopwatch function, they can also tell the time!!! The set comprises two wrist watches, rechargeable batteries, and a double fast charger. These must be the smallest PMR radio's available

- * Range up to 5 Km unobstructed
- * Watch / Stopwatch and Thermometer function
- * Baby Monitor Function
- * High gain antenna
- * Supplied in pairs
- * Supplied with rechargeable batteries, 2 hands free sets and a double fast charger

Order No. 270.538
Price £46.67 Per Pair

Specifications:- Batteries supplied Li-ion, Frequency 446Mhz (PMR), Output power 0.5W ERP, Channels 8 + 38 CTCSS sub channels

B.K. ELECTRONICS REF D10
UNIT 1 COMET WAY, SOUTHEND-ON-SEA, ESSEX, SS2 6TR.
TEL: 01702-527572 FAX: 01702-420243
Web:- <http://www.bkelec.com> E-Mail sales@bkelec.com