

THE No.1 MAGAZINE FOR ELECTRONICS TECHNOLOGY & COMPUTER PROJECTS

EVERYDAY

JANUARY 2002

**PRACTICAL**

# ELECTRONICS

£2.85



**PIC  
MAGICK  
MUSICK**  
Spell-binding  
musical  
entertainment



**FOREVER  
FLASHER**  
LED flasher with  
no battery!

**TIME DELAY  
TOUCH SWITCH**  
Touchpad  
lighting timeout

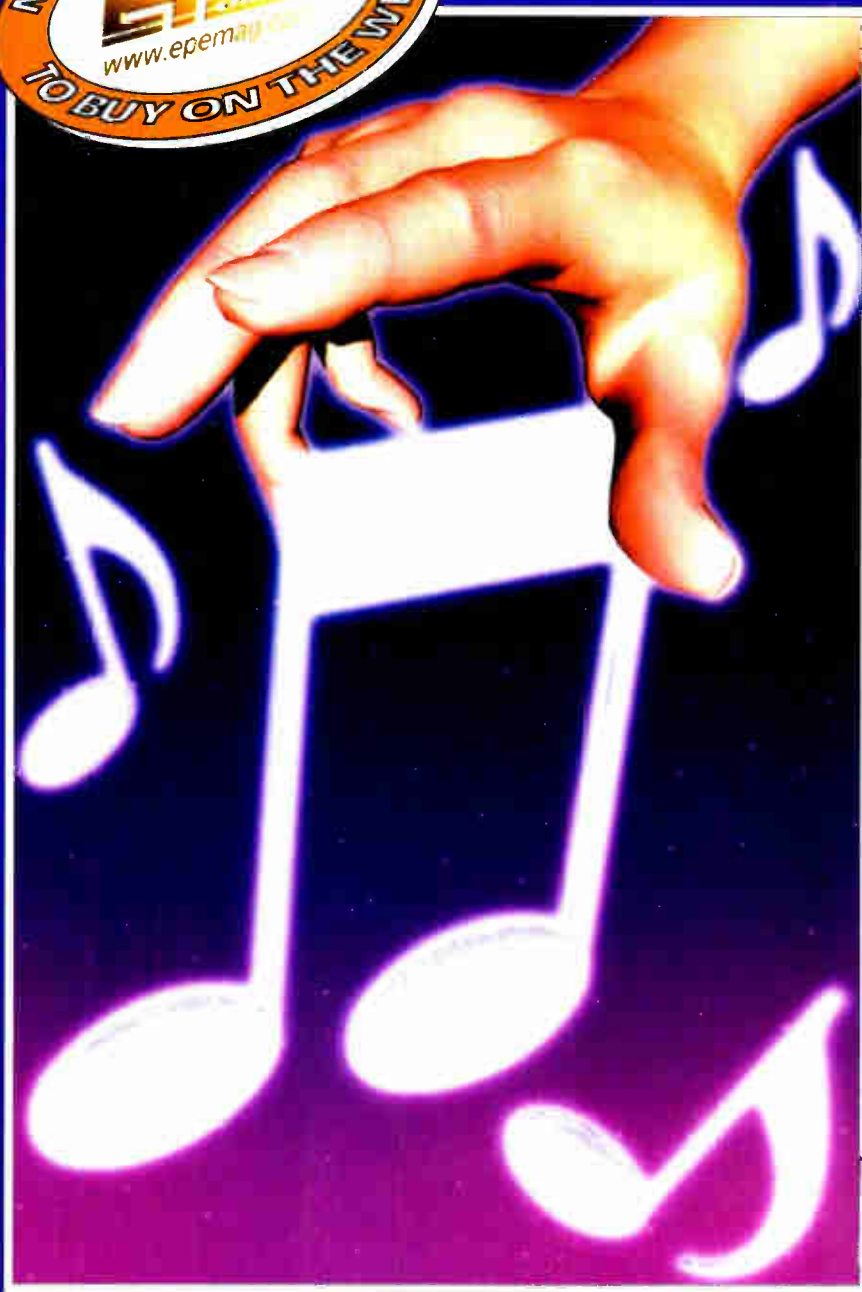

**PLUS**  
**TEACH-IN 2002 - Part 3**  
**INGENUITY UNLIMITED,**  
**TECHNIQUES, NET WORK**



<http://www.epemag.wimborne.co.uk>

**PIR OPERATED WATER VALVES.** These brand new units consist of a control box with integral PIR and a water valve fitted with 15mm compression fittings. The valve is 6V d.c. operation and latches, e.g. 6V pulse will open it, 6V negative pulse will release it. Originally made to control urinals (flush when someone comes in) they have many other uses in cat scarers, automatic watering systems etc. They have built-in adjustable time delays and settings and run quite happily for months on just a 9V battery. The valve alone could have many uses in garden features, solar systems, etc. Current retail price for the complete unit is £120, we can offer them at just £19.95 while stocks last! Ref PIRVAL2.

**PIR SECURITY SWITCHES.** These brand new swivel mounting PIR units will switch up to 2 kilowatts. Adjustable sensitivity, light level and time delay (9 seconds to 10 minutes), 15m detection range, mains operated, waterproof, £5.95. Ref PIR1PACK or a pack of 5 for £22 Ref PIR5PACK or 10 for £39.95 Ref PIR10PACK

**12V 18Ah SEALED LEAD ACID BATTERIES, new and boxed, unused, pack of 4 £44.95, Ref CYC7 or £15.95 each, Ref CYC6.**

**12V 6.5Ah SEALED LEAD ACID BATTERIES, new and boxed, pack of 5 £34.95, Ref CYC65A, or individually at £8.99, Ref CYC65B.**

**A new range of 12V to 240V INVERTERS**  
**IV400S (400 watt) £89**  
**IV800S (800 watt) £159**  
**IV1200S (1200 watt) £219**

**SODIUM LAMP SYSTEMS, £75.70.** Complete system with 250W or 400W SON-T Agro bulb, reflector with bulb holder and remote ballast and starter (uncased), all you need is wire, 250W system Ref SLS1, 400W system SLS2.

**HYDROPONICS - DO YOU GROW YOUR OWN?** Check our web site at [www.bullnet.co.uk](http://www.bullnet.co.uk)

**PC COMBINED UPS AND PSU.** The unit has a total power of 292 watts, standard motherboard connectors and 12 peripheral power leads for drives etc. Inside are three 12V 7.2Ah sealed lead acid batteries. Backup time is 8 mins at full load or 30 mins at half load. Made in the UK by Magnum, 110V or 240V a.c. input, +5V at 35A, -5V at 0.5A, +12V at 9A, -12V at 0.5A outputs, 170mm x 260mm x 220mm, new and boxed, £29.95. Ref PCUPS2.

**ALTERNATIVE ENERGY CD, PACKED WITH HUNDREDS OF ALTERNATIVE ENERGY RELATED ARTICLES, PLANS AND INFORMATION ETC. £14.50. Ref CD56.**

**AERIAL PHOTOGRAPHY KIT.** This rocket comes with a built-in camera, it flies up to 500 feet (150m), turns over, and takes an aerial photograph of the ground below. The rocket then returns, with its film, via its parachute. Takes 110 film. Supplied complete with everything, including a launch pad and three motors (no film). £29.98. Ref ASTRO.

**3HP MAINS MOTORS.** Single-phase 240V, brand new, 2-pole, 340mm x 180mm, 2,850 rpm, built-in automatic reset overload protector, keyed shaft (40mm x 16mm). Made by Leeson, £99 each. Ref LEE1.

**BUILD YOUR OWN WINDFARM FROM SCRAP.** New publication gives step-by-step guide to building wind generators and propellers. Armed with this publication and a good local scrapyard could make you self-sufficient in electricity! £12. Ref LOT81

**MAGNETIC CREDIT CARD READERS AND ENCODING MANUAL, £9.95.** Cased with fileleads, designed to read standard credit cards! Complete with control electronics p.c.b. and manual covering everything you could want to know about: what's hidden in that magnetic strip on your card! Just £9.95. Ref BAR31.

**SOLAR POWER LAB SPECIAL.** 2in. x 6in. x 6in., 6V 130mA cells, 4 l.e.d.s, wire, buzzer, switch plus relay or motor. £7.99. Ref SA27.

**SOLAR NICAD CHARGERS.** 4 x AA-size, £9.99. Ref 6P476. 2 x C-size, £9.99. Ref 6P477.

**LOCKPICKS.** We sell a full range of lockpicks and lockpicking books on our website: [www.lockpicks.co.uk](http://www.lockpicks.co.uk)

**SHUT THE BOX.** Check out [www.bullybeef.co.uk](http://www.bullybeef.co.uk) for a range of pub games and magic tricks.

**AIR RIFLES FROM LESS THAN £40, CROSSBOWS, WIDE RANGE OF BB GUNS, AMMO, TARGETS, PISTOLS, REPLICAS GUNS, UZI MACHINE GUN REPLICAS (BB), REPEATERS, LASER SIGHTS, ELECTRIC BB, GAS BB**  
**[www.alrplistol.co.uk](http://www.alrplistol.co.uk)**

**INKJET CARTRIDGES FROM JUST £3 AT**  
**[www.pinkjets.co.uk](http://www.pinkjets.co.uk)**

## ONE MILLION HITS A MONTH WWW.BULLNET.CO.UK

**Hydrogen fuel cells.** Our new Hydrogen fuel cells are 1V at up to 1A output. Hydrogen input, easily driven from a small electrolysis assembly or from a hydrogen source, our demo model uses a solar panel with the output leads in a glass of salt water to produce the hydrogen! Each cell is designed to be completely taken apart, put back together and expanded to whatever capacity you like (up to 10 watts and 12V per assembly). Cells cost £49. Ref HFC11.

**PHILIPS VP406 LASER DISC PLAYERS, SALE PRICE JUST £9.95. SCART OUTPUT, JUST PUT YOUR VIDEO DISK IN AND PRESS PLAY. STANDARD AUDIO AND VIDEO OUTPUTS. £9.95. REF VP406.**

**SMOKE ALARMS.** Mains powered, made by the famous Gent company, easy fit next to light fittings, power point. Pack of 5 £15. Ref SS23. Pack of 12 £24. Ref SS24.

**SENDER KIT.** Contains all components to build a A/V transmitter complete with case, £35. Ref VSXX2.

**CCTV CAMERAS FROM £22.** Check out our web site at [www.cctvstuff.co.uk](http://www.cctvstuff.co.uk).

**MAMOD STEAM ENGINES AND A FULL RANGE OF SPARE PARTS.**

CHECK OUT [www.mamodspares.co.uk](http://www.mamodspares.co.uk).

**14 WATT SOLAR PANEL.** Amorphous silicon panel fitted in an anodised aluminium frame. Panel measures 3ft. by 1ft. with screw terminals for easy connection. 3ft. x 1ft. solar panel £69. Ref MAG45. Unframed 4 pack (3ft. x 1ft.) £69. Ref SOLX.

**12V SOLAR POWERED WATER PUMP.** Perfect for many 12V d.c. uses, from solar fountains to hydroponics! Small and compact, yet powerful, works direct from our 10 watt solar panel in bright sun. Max hd: 17ft., max flow = 8l.p.m., 1.5A, Ref AC8. £18.99

**SOLAR MOTORS.** Tiny motors which run quite happily on voltages from 3V-12V d.c. Works on our 6V amorphous 6in. panels, and you can run them from the sun! 32mm dia., 20mm thick, £1.50 each.

**WALKIE TALKIES. 1 MILE RANGE, £37/PAIR. REF MAG30.**

**LIQUID CRYSTAL DISPLAY.** Bargain prices, 40-character 1-line 154mm x 16mm, £6.00. Ref SMC4011A.

**YOUR HOME COULD BE SELF-SUFFICIENT IN ELECTRICITY.** comprehensive plans with loads of info on designing systems, panels, control electronics, etc. £7. Ref PV1.

**SOLAR POWER LAB SPECIAL.** 2in. x 6in. x 6in., 6V 130mA cells, 4 l.e.d.s, wire, buzzer, switch plus relay or motor. £7.99. Ref SA27.

**SOLAR NICAD CHARGERS.** 4 x AA-size, £9.99. Ref 6P476. 2 x C-size, £9.99. Ref 6P477.

**MINIATURE TOGGLE SWITCHES.** These top quality Japanese panel mounting toggle switches measure 35mm x 13mm x 12mm, are 2-pole changeover and will switch 1A at 250V a.c., or 3A at 125V a.c. Complete with mounting washers and nuts. Supplied as a box of 100.

**BRAND NEW NATO ISSUE RADIATION DETECTORS, SALE PRICE JUST £39.95.** Current NATO issue standard emergency services unit used by most of the world's military personnel. New and boxed. Normal retail price £400. BULL'S bargain price just £99. The PDRM 82M is a portable, lightweight, water resistant gamma radiation survey meter to measure radiological dose rate in the range 0.1 to 300 centigrays per hour in air. The Geiger Muller (G.M.) tube detecting unit is energy and polar response corrected. The radiation level is displayed on a Liquid Crystal Display. The microcomputer corrects for the non-linearity of the G.M. tube response. The instrument is powered by three international C-size batteries giving typically 400 hours operation in normal conditions. The dose rate meter PDRM 82M, designed and selected for the United Kingdom Government, has been fully evaluated to satisfy a wide range of environmental conditions and is nuclear hard. The construction enables the instrument to be easily decontaminated. The instrument is designed for radiation surveys for post incident monitoring. Used in a mobile role, either carried by troops or in military vehicles for rapid deployment enabling radiation hot spots to be quickly located. Range 0-300 cGy/h in 0.1 cGy/h increments. Over-range to 1500 cGy/h - indicates flashing 300. Accuracy f20% of the true dose rate +1 cGy/h, 0-100 cGy/h. f30% of true dose rate, 100-300 cGy/h. Energy Response 0.3 MeV to 3 MeV - within f20% (Ra 226). 80 KeV to 300 KeV - within f40% (Ra 226). Detector Energy compensated Halogen quenched Geiger Muller Tube. Controls combined battery access and ON/OFF switch. Batteries 3 international standard C cells. Weight 560 grams. Operating temperature range 30 deg. C to +60 deg. C. Indications high contrast 4 digit l.c.d. £39. Ref PDRM.

**BASIC GUIDE TO BIO DIESEL. HOW TO MAKE DIESEL FUEL FROM USED KITCHEN OIL, £6. REF BIOF.**

## BULL ELECTRICAL

UNIT D, HENFIELD BUSINESS PARK,  
 SHOREHAM ROAD, HENFIELD, SUSSEX  
 BN5 9SL (ESTABLISHED 50 YEARS)  
 MAIL ORDER TERMS: CASH, PO  
 OR CHEQUE WITH ORDER  
 PLUS £5.00 P&P PLUS VAT  
 24 HOUR SERVICE £7.50 PUS VAT  
 OVERSEAS ORDERS AT COST PLUS £3.50  
 (ACCESS, VISA, SWITCH, AMERICAN EXPRESS)  
 'phone orders: 0871 871 1300  
 FAX 0871 871 1301  
 Sales@bull-electrical.com

**BASIC GUIDE TO LOCKPICKING.** New publication gives you an insight! £6. Ref LPK.

**30 WATTS OF SOLAR POWER** for just £69. 4 panels, each one 3ft. x 1ft. and producing 8W. 13V. Pack of four £69. Ref SOLX.

**200 WATT INVERTERS,** plugs straight into your car cigarette lighter socket and is fitted with a 13A socket so you can run your mains-operated devices from your car battery. £49.95. Ref SS66.

**THE TRUTH MACHINE.** Tells if someone is lying by micro tremors in their voice, battery operated, works in general conversation and on the phone and TV as well! £42. Ref TF3.

**INFRA-RED FILM.** 6in. square piece of flexible infra-red film that will only allow IR light through. Perfect for converting ordinary torches, lights, headlights etc. to infra-red output only using standard light bulbs. Easily cut to shape. £15. Ref IRF2.

**33 KILO LIFT MAGNET.** Neodymium, 32mm diameter with a fixing bolt on the back for easy mounting. Each magnet will lift 33 kilos, 4 magnets bolted to a plate will lift an incredible 132 kilos! £15. Ref MAG33. Pack of 4 just £39. Ref MAG33AA.

**77 KILO LIFT MAGNET.** These Samarium magnets measure 57mm x 20mm and have a threaded hole (5/16th UNF) in the centre and a magnetic strength of 2.2 gauss. We have tested these on a steel beam running through the offices and found that they will take more than 170lb (77kg) in weight before being pulled off. Supplied with keeper. £19.95 each. Ref MAG77.

**HYDROGEN FUEL CELL PLANS.** Loads of information on hydrogen storage and production. Practical plans to build a hydrogen fuel cell (good workshop facilities required), £8 set. Ref FCP1.

**STIRLING ENGINE PLANS.** Interesting information pack covering all aspects of Stirling engines, pictures of home made engines made from an aerosol can running on a candle! £12. Ref STIR2.

**ENERGY SAVER PLUGS.** Saves up to 15% electricity when used with fridges, motors up to 2A, light bulbs, soldering irons etc. £9 each. Ref LOT71. 10 pack, £69. Ref LOT72.

**12V OPERATED SMOKE BOMBS.** Type 3 is a 12V trigger and three smoke cannisters, each cannister will fill a room in a very short space of time! £14.99. Ref SB3. Type 2 is 20 smaller cannisters (suitable for mock equipment fires etc.) and one trigger module for £29. Ref SB2. Type 1 is a 12V trigger and 20 large cannisters. £49. Ref SB1.

**HI POWER ZENON VARIABLE STROBES.** Useful 12V p.c.b. fitted with hi power strobe tube and control electronics and speed control potentiometer. Perfect for interesting projects etc. 70mm x 55mm 12V d.c. operation, £6 each. Ref FLS1. Pack of 10 £49. Ref FLS2.

**HOW TO PRODUCE 35 BOTTLES OF WHISKY FROM A SACK OF POTATOES.** Comprehensive 270 page book covers all aspects of spirit production from everyday materials. Includes construction details of simple stills. £12. Ref MS3.

**NEW HIGH POWER MINI BUG.** With a range of up to 800 metres and 3 days use from a PP3 battery this is our top selling one! Less than 1in. square and a 10m voice pick-up range. £28. Ref LOT102.

**IR LAMP KIT.** Suitable for CCTV cameras, enables the camera to be used in total darkness! £6. Ref EP138.

**INFRA-RED POWER BEAM.** Handheld battery powered lamp, 4 inch reflector, gives out powerful pure infra-red light! Perfect for CCTV use, night sights etc. £29. Ref PB1

**SUPER WIDEBAND RADAR DETECTOR.** Whistler 1630. Detects both radar and laser, XK and KA bands, speed cameras, and all known speed detection systems. 360 degree coverage, front and rear waveguides, 1-1in. x 2-7in. x 4-6in., fits on visor or dash. New low price £99. Ref WH1630. Other models available at [www.radargun.co.uk](http://www.radargun.co.uk).

**LOPTX.** Made by Samsung for colour TV. £3 each. Ref SS52.

**WANT TO MAKE SOME MONEY? STUCK FOR AN IDEA?** We have collated 140 business manuals that give you information on setting up different businesses, you peruse these at your leisure using the text editor on your PC. Also included is the certificate enabling you to reproduce (and sell) the manuals as much as you like! £14. Ref EP74.

**ELECTRONIC SPEED CONTROLLER KIT.** For the above motor is £19. Ref MAG17. Save £5 if you buy them both together, one motor plus speed controller rrp is £41. Offer price £36. Ref MOT5A.

**INFRA-RED REMOTE CONTROLS.** Made for TVs but may have other uses. Pack of 100 £39. Ref IREM.

**RCB UNITS.** In-line IEC lead with fitted RC breaker. Installed in seconds. Pack of 3 £9.98. Ref LOT5A.

**STEPPER MOTORS.** Brand new stepper motors, 4mm fixing holes with 47-14mm fixing centres, 20mm shaft, 6-35mm diameter, 5V/phase, 0.7A/phase, 1-8 deg. step (200 step), body 56mm x 36mm £14.99 each. Ref STEP6. Pack of 4 for £49.95.

### On our web sites you can:

1. Order online.
2. Check your premium bonds.
3. Enter our auction or build your own.
4. Add E-commerce to your own site.
5. Discover our software site, optical site, hydroponics site, holiday home exchange site, inkjet site, radar detectors, hotels site.

<http://www.bullnet.co.uk>



ISSN 0262 3617  
 PROJECTS ... THEORY ... NEWS ...  
 COMMENTS ... POPULAR FEATURES ...

VOL. 31. No. 1 JANUARY 2002  
 Cover illustration by Jonathan Robertson

EVERYDAY  
**PRACTICAL**  
**ELECTRONICS**

INCORPORATING **ELECTRONICS TODAY INTERNATIONAL**

[www.epemag.wimborne.co.uk](http://www.epemag.wimborne.co.uk)  
**EPE Online: [www.epemag.com](http://www.epemag.com)**

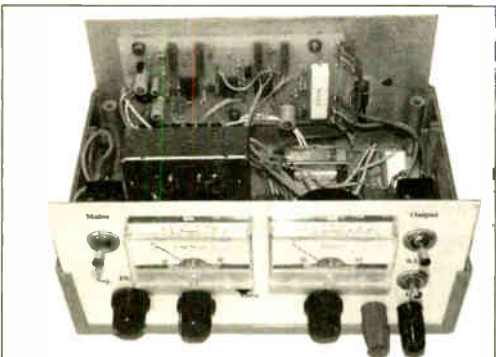
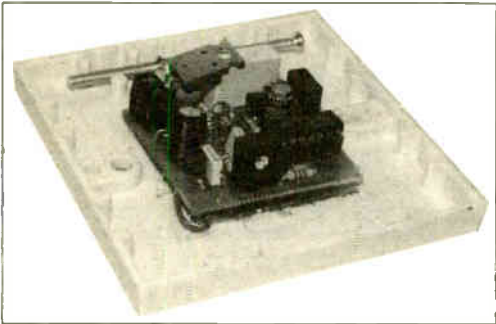
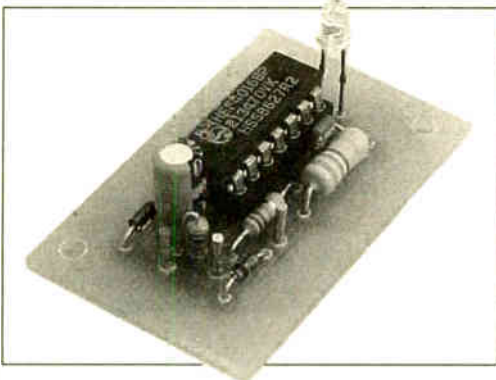

## Projects and Circuits

- PIC MAGICK MUSICK** by John Becker 12  
 A spellbinding musical experience at the slightest wave of your hand
- INGENUITY UNLIMITED** hosted by Alan Winstanley 22  
 Precision UV Timer; Transistor/Diode Go/No-Go Checker
- TIME DELAY TOUCH SWITCH** by Bart Trepak 24  
 A self-contained mains switch that will automatically turn off lights after a preset time interval
- VERSATILE BENCH POWER SUPPLY** by Andy Flind 33  
 Provides variable voltages from 0V to 20V with current limiting in two ranges of 100mA to 1A
- FOREVER FLASHER** by Thomas Scarborough 54  
 An easy-build project that will flash an l.e.d. for 20 years or more from a 9V battery

## Series and Features

- NEW TECHNOLOGY UPDATE** by Ian Poole 28  
 A bumpless drive to squeeze one billion transistors into a single i.c. package
- PRACTICALLY SPEAKING** by Robert Penfold 30  
 Component identification, symbols and circuit translation
- CIRCUIT SURGERY** by Alan Winstanley and Ian Bell 42  
 Taking a mathematical approach to solve a filter problem
- CD-ROM REVIEW** by Terry de Vaux-Balbirnie 49  
 Test driving the Electronics Circuits & Components – V2.0 disk
- TEACH-IN 2002 – 3. More on Op.amps in Sensors, plus Humidity Sensors** by Ian Bell and Dave Chesmore 56
- NET WORK – THE INTERNET PAGE** surfed by Alan Winstanley 64  
 Annual reflection on the state of the British Internet market

## Regulars and Services

- EDITORIAL** 11
- NEWS** – Barry Fox highlights technology's leading edge 19  
 Plus everyday news from the world of electronics
- BACK ISSUES** Did you miss these? Many now on CD-ROM! 40
- SHOPTALK** with David Barrington, 43  
 The *essential* guide to component buying for *EPE* projects
- READOUT** John Becker addresses general points arising from readers' letters/E-mails 45
- CD-ROMS FOR ELECTRONICS** 48, 52  
 A wide range of CD-ROMs for hobbyists, students and engineers
- TEACH-IN 2002 SPECIAL OFFER – PICO ADC-40** 65
- DIRECT BOOK SERVICE** 66  
 A wide range of technical books available by mail order
- PRINTED CIRCUIT BOARD AND SOFTWARE SERVICE** 69  
 PCBs for *EPE* projects. Plus *EPE* software
- ADVERTISERS INDEX** 72

© Wimborne Publishing Ltd 2001. Copyright in all drawings, photographs and articles published in **EVERYDAY PRACTICAL ELECTRONICS** is fully protected, and reproduction or imitations in whole or in part are expressly forbidden.

Our February 2002 issue will be published on Thursday, 10 January 2002. See page 3 for details

**Readers Services • Editorial and Advertisement Departments 11**



Visit our website  
www.distel.co.uk

# THE ORIGINAL SURPLUS WONDERLAND!

THIS MONTH'S SELECTION FROM OUR VAST EVER CHANGING STOCKS

Surplus always  
wanted for cash!

## THE AMAZING TELEBOX

Converts your colour monitor into a QUALITY COLOUR TV!



**TV SOUND & VIDEO TUNER**  
CABLE COMPATIBLE\*

The TELEBOX is an attractive fully cased mains powered unit, containing all electronics ready to plug into a host of video monitors or AV equipment which are fitted with a composite video or SCART input. The composite video output will also plug directly into most video recorders, allowing reception of TV channels not normally receivable on most television receivers\* (TELEBOX MFR) Push button controls on the front panel allow reception of 8 fully tuneable UHF or 114 Hi-Fi colour television channels. TELEBOX MB converts virtually all television frequencies VHF and UHF including the HYPERBAND as used by most cable TV operators. Ideal for desktop computer video systems & PIP (picture in picture) setups. For complete compatibility - even for monitors without sound - an integral 4 watt audio amplifier and low level Hi-Fi audio output are provided as standard. Brand new - fully guaranteed.

TELEBOX ST for composite video input type monitors £36.95  
TELEBOX STL as ST but fitted with integral speaker £39.50  
TELEBOX MB Multiband VHF/UHF/Cable/Hyperband tuner £69.95  
For overseas PAL versions state 5.5 or 6 MHz sound specification.  
\*For cable / hyperband signal reception 1 telebox MB should be connected to a cable type service. Shipping on all Teleboxes, code (B)

**NEW** State of the art PAL (UK spec) UHF TV tuner module with composite 1V pp video & NICAM hi fi stereo sound outputs. Micro electronics all on one small PCB only 73 x 160 x 52 mm enable full tuning control via a simple 3 wire link to an IBM pc type computer. Supplied complete with simple working program and documentation. Requires +12V & +5V DC to operate. **BRAND NEW - Order as MY00. Only £49.95 code (B)**  
See [www.distel.co.uk/data\\_my00.htm](http://www.distel.co.uk/data_my00.htm) for picture + full details

## FLOPPY DISK DRIVES 2 1/2" - 8"

All units (unless stated) are **BRAND NEW** or removed from often brand new equipment and are fully tested, aligned and shipped to you with a full 90 day guarantee. Call or see our web site [www.distel.co.uk](http://www.distel.co.uk) for over 2000 unlisted drives for spares or repair

- 3 1/2" Mitsubishi MF355C-L 1.4 Meg. Laptops only £25.95(B)
- 3 1/2" Mitsubishi MF355C-D 1.4 Meg. Non laptop £18.95(B)
- 5 1/4" Teac FD-55GFR 1.2 Meg. (for IBM pcs) RFE £18.95(B)
- 5 1/4" Teac FD-55F-03-U 720K 4080 (for BBC's etc) RFE £29.95(B)
- 5 1/4" BRAND NEW Mitsubishi MF501B 360K £22.95(B)
- Table top case with integral PSU for HH 5 1/4" Floppy / HD £29.95(B)
- 8" Shugart 800/801 8" SS refurbished & tested £210.00(E)
- 8" Shugart 810 8" SS HH Brand New £195.00(E)
- 8" Shugart 851 8" double sided refurbished & tested £260.00(E)
- 8" Mitsubishi M2894-63 double sided NEW £295.00(E)
- 8" Mitsubishi M2896-63-02U DS slimline NEW £295.00(E)
- Dual 8" cased drives with integral power supply 2 Mb £499.00(E)

## HARD DISK DRIVES 2 1/2" - 14"

- 2 1/2" TOSHIBA MK1002MAV 1.1Gb laptop (12.5 mm H) New £79.95
  - 2 1/2" TOSHIBA MK2101MAN 2.16 Gb laptop (19 mm H) New £89.50
  - 2 1/2" TOSHIBA MK4309MAT 4.3Gb laptop (8.2 mm H) New £105.00
  - 2 1/2" TOSHIBA MK6409MAV 6.1 Gb laptop (12.7 mm H) New £190.00
  - 2 1/2" FUJI FK-309-26 20mb MF4 MF4 RFE £14.95
  - 3 1/2" CONNER CP3024 20 mb IDE I/F (or equiv.) RFE £59.95
  - 3 1/2" CONNER CP3044 40 mb IDE I/F (or equiv.) RFE £69.00
  - 3 1/2" QUANTUM 40S Prodriv vs 42mb SCSI I/F. New RFE £49.00
  - 5 1/4" MINISCRIBE 3425 20mb MF4 MF4 (or equiv.) RFE £49.95
  - 5 1/4" SEAGATE ST-238R 30 mb RLL I/F Return £69.95
  - 5 1/4" CDC 94205-51 40mb HH MF4 I/F RFE tested £69.95
  - 5 1/4" HP 97548 850 Mb SCSI RFE tested £99.00
  - 5 1/4" HP C3010 2 Gbyte SCSI differential RFE tested £195.00
  - 8" NEC D2246 85 Mb SMD interface. New £199.00
  - 8" FUJITSU M2322K 160Mb SMD I/F RFE tested £195.00
  - 8" FUJITSU M2392K 2 Gb SMD I/F RFE tested £345.00
- Many other drives in stock - Shipping on all drives is code (C1)

## TEST EQUIPMENT & SPECIAL INTEREST ITEMS

- MITS. FA3445ETK 14" Industrial spec SVGA monitors £245
- FARNELL 0-60V DC @ 50 Amps, bench Power Supplies £995
- FARNELL AP3080 0-30V DC @ 80 Amps, bench Supply £1850
- 1kW to 400 kW - 400 Hz 3 phase power sources - ex stock £1700
- IBM 8230 Type 1, Token ring base unit driver £760
- Wayne Kerr RA200 Audio frequency response analyser £2500
- IBM SF5501 Token Ring ICS 20 port lobe modules £750
- IBM MAU Token ring distribution panel B228-23-5050N £95
- AIM 501 Low distortion Oscillator 9Hz to 330KHz, IEEE £550
- ALLGON 8360.11805-1880 MHz hybrid power combiners £250
- Trend DSA 274 Data Analyser with G703(2M) 64 i/o £POA
- Marconi 6310 Programmable 2 to 22 GHz sweep generator £6500
- Marconi 2022C 10KHz-1GHz RF signal generator £1550
- Marconi 2030 opt 03 10KHz-1.3 GHz signal generator, New £4995
- HP1650B Logic Analyser £3750
- HP3781A Pattern generator & HP3782A Error Detector £POA
- HP6621A Dual Programmable GPIB PSU 0-7 V 160 watts £1800
- HP6264 Rack mount variable 0-20V @ 20A metered PSU £675
- HP54121A DC to 22 GHz four channel test set £POA
- HP8130A opt 020 300 MHz pulse generator, GPIB etc £7900
- HP A1, A0 8 pen HPGL high speed drum plotters from HP DRAFTMASTER 18 pen high speed plotter £550
- EG+G Brookdeal 9535C Precision lock in amp £750
- View DXC-1200 computerised inspection system £1800
- Sony DXC-3000A High quality CCD colour TV camera £995
- Kithley 599 CV capacitor / voltage analyser £POA
- Racal IC840 dual 40 channel voice recorder system £3750
- Fiskers 45KVA 3 ph On Line UPS. Now batteries £9500
- Emerson AP130 2 SKVA industrial spec UPS £2100
- Mann Tally MT645 High speed line printer £2200
- Intel SB 486/33SE Multibus 486 system 8Mb Ram £945
- Siemens K4400 64Kb to 140Mb demux analyser £2950

## IC's - TRANSISTORS - DIODES

OBSOLETE - SHORT SUPPLY - BULK  
10,000,000 items EX STOCK

For MAJOR SAVINGS  
CALL OR SEE OUR WEB SITE [www.distel.co.uk](http://www.distel.co.uk)

## VIDEO MONITOR SPECIALS

One of the highest specification monitors you will ever see -  
At this price - Don't miss it!!

Mitsubishi FA3415ETKL 14" SVGA Multisync colour monitor with fine 0.28 dot pitch tube and resolution of 1024 x 768. A variety of inputs allows connection to a host of computers including IBM PCs in CGA, EGA, VGA & SVGA modes, BBC, COMMODORE (including Amiga 1200), ARCHIMEDES and APPLE. Many features. Etched keypad, text switching and LOW RADIATION MPR specification. Fully guaranteed, in EXCELLENT little

used condition.  
Tilt & Swivel Base £475  
VGA cable for IBM PC included.  
External cables for other types of computers available - CALL

Only £119 (E) Order as MITS-SVGA

Ex demo 17" 0.28 SVGA Mitsubishi Diamond Pro monitors, Full multisync etc.  
Full 90 day guarantee. Only £199.00 (E)

Just In - Microwitec 20" VGA (800 x 600 res.) colour monitors. Good SH condition - from £299 - CALL for info

PHILIPS HCS35 (same style as CM8833) attractively styled 14" colour monitor with both RGB and standard composite 15.625 KHz video inputs via SCART socket and separate phono jacks. Integral audio power amp and speaker for all audio visual uses. Will connect direct to Amiga and Atari BBC computers. Ideal for all video monitoring / security applications with direct connection to most colour cameras. High quality with many features such as front concealed flap controls, VCR correction button etc. Good used condition - fully tested - guaranteed

Dimensions: W14" x H12 3/4" x 15 1/2" D. Only £99.00 (E)

PHILIPS HCS31 Ultra compact 9" colour video monitor with standard composite 15.625 KHz video input via SCART socket. Ideal for all monitoring / security applications. High quality, ex-equipment fully tested & guaranteed (possible minor screen bums). In attractive square black plastic case measuring W10" x H10" x 13 1/2" D. 240 V AC mains powered. Only £79.00 (D)

KME 10" 15M10009 high definition colour monitors with 0.28" dot pitch. Superb clarity and modern styling. Operates from any 15.625 KHz sync RGB video source, with RGB analog and composite sync such as Atari, Commodore Amiga, Acorn Archimedes & BBC. Measures only 13 1/2" x 12" x 11" Good used condition. Only £125 (E)

20" 22" and 26" AV SPECIALS  
Superbly made UK manufacture. PIL all solid state colour monitors, complete with composite video & optional sound input. Attractive teak style case. Perfect for Schools, Shops, Disco, Clubs, etc. In EXCELLENT little used condition with full 90 day guarantee.

20"....£135 22"....£155 26"....£185 (F)  
We probably have the largest range of video monitors in Europe. All sizes and types from 4" to 42" call for info.

## DC POWER SUPPLIES

Virtually every type of power supply you can imagine. Over 10,000 Power Supplies Ex Stock  
Call or see our web site.

- HP6030A 0-200V DC @ 17 Amps bench power supply £1950
- Intel SBC 486/125C08 Enhanced Multibus (MSA) New £1150
- Nikon HFX-11 (Ephiphot) exposure control unit £1450
- PHILIPS PM5518 pro. TV signal generator £1250
- Motorola VME Bus Boards & Components List. SAE / CALL £POA
- Trio 0-18 vdc linear, metered 30 amp bench PSU. New £550
- Fujitsu M3041R 600 LPM high speed band printer £1950
- Fujitsu M3041D 600 LPM printer with network interface £1250
- Perkin Elmer 299B Infrared spectrophotometer £500
- Perkin Elmer 597 Infrared spectrophotometer £3500
- VG Electronics 1035 TELETEXT Decoding Margin Meter £3250
- LightBand 60 output high spec 2u rack mount Video VDA's £495
- Sekonic SD 150H 18 channel digital Hybrid chart recorder £1995
- B&K 2633 Microphone pre amp £300
- Taylor Hobson Talysurf amplifier / recorder £750
- ADC S5200 Carbon dioxide gas detector / monitor £1450
- BBC AM203 PPM Meter (Ernest Turner) + drive electronics £75
- ANRITSU 9654A Optical DC-2.5Gb waveform monitor £5650
- ANRITSU MS9001B1 0.6-1.7 uM optical spectrum analyser £POA
- ANRITSU ML93A optical power meter £990
- ANRITSU Fibre optic characteristic test set £POA
- R&S FTDZ Dual sound unit £650
- R&S SBUF-E1 Vision monitor £775
- WILTRON 66300 12.4 / 20GHz RF sweep generator £5750
- TEK 2445 150 MHz 4 trace oscilloscope £1250
- TEK 2465 300 MHz 300 MHz oscilloscope rack mount £1950
- TEK TDS380 400MHz digital real-time + disk drive, FFT etc £2900
- TEK TDS224A 500MHz digital real-time + colour display etc £5100
- HP3585A Opt 907 20Hz to 40 Mhz spectrum analyser £3950
- PHILIPS PW1730 10 60KV XRAY generator & accessories £POA
- CLAUDE LYONS 12A 240V single phase auto volt. regs £325
- CLAUDE LYONS 100A 240/415V 3 phase auto. volt. regs £2900



## 19" RACK CABINETS

Superb quality 6 foot 40U  
Virtually New, Ultra Smart  
Less than Half Price!

Top quality 19" rack cabinets made in UK by Optima Enclosures Ltd. Units feature designer, smoked acrylic lockable front door, full height lockable half louvered back door and louvered removable side panels. Fully adjustable internal fixing struts, ready punched for any configuration of equipment mounting, plus ready mounted integral 12 way 13 amp socket switched mains distribution strip make these racks some of the most versatile we

have ever sold. Racks may be stacked side by side and therefore require only two side panels to stand singly or in multiple bays. Overall dimensions are 77 1/2" H x 32 1/2" D x 22" W. Order as:

OPT Rack 1 Complete with removable side panels. £345.00 (G)  
OPT Rack 2 Rack 2 Less side panels. £245.00 (G)

Over 1000 racks, shelves, accessories  
19" 22" & 24" wide 3 to 46 U high.  
Available from stock !!

## 32U - High Quality - All steel RakCab

Made by Eurocraft Enclosures Ltd to the highest possible spec, rack features all steel construction with removable side, front and back doors. Front and back doors are hinged for easy access and all are lockable with five secure 5 lever barrel locks. The front door is constructed of double walled steel with a 'designer style' smoked acrylic front panel to enable status indicators to be seen through the panel, yet remain unobtrusive. Internally the rack features fully slotted reinforced vertical fixing members to take the heaviest of 19" rack equipment. The two movable vertical fixing struts (extras available) are pre punched for standard 'cage' nuts. A mains distribution panel internally mounted to the bottom rack, provides 8 IEC 3 pin Euro sockets and 1 x 13 amp 3 pin switched utility socket. Overall ventilation is provided by fully louvered back door and double skinned top section with top and side louvers. The top panel may be removed for fitting of integral fans to the sub plate etc. Other features include: lifted castors and floor levelers, pre-punched utility panel at lower rear for cable / connector access etc. Supplied in excellent, slightly used condition with keys. Colour Royal blue. External dimensions mm=1625H x 635D x 603 W (64" H x 25" D x 23 3/4" W)

Sold at LESS than a third of makers price !!  
A superb buy at only £245.00 (G)  
42U version of the above only £345 - CALL

## 12V BATTERY SCOOP - 60% off !!

A special bulk purchase from a cancelled export order brings you the most amazing savings on these ultra high spec 12v DC 14Ah rechargeable batteries. Made by Hawker Energy Ltd, type SB515 featuring pure lead plates which offer a far superior shelf & guaranteed 15 year service life. Fully BT & BS6290 approved, Supplied BRAND NEW and boxed. Dimensions 200 wide, 137 high, 77 deep. M6 bolt terminals. Fully guaranteed. Current makers price over £70 each. **Our Price £35 each (C) or 4 for £99 (E)**

## RELAYS - 200,000 FROM STOCK

Save ££££ by choosing your next relay from our Massive Stocks covering types such as Military, Octal, Cradle, Hermetically Sealed, Continental, Contactors, Time Delay, Reed, Mercury Wetted, Solid State, Printed Circuit Mounting etc. CALL or see our web site [www.distel.co.uk](http://www.distel.co.uk) for more information. Many obsolete types from stock. Save ££££

## COLOUR CCD CAMERAS

Undoubtedly a miracle of modern technology & our special buying power! A quality product featuring a fully cased COLOUR CCD camera at a give away price! Unit features full auto iris sensing for use in low light & high light applications. A 10 mm fixed focus wide angle lens gives excellent focus and resolution from close up to long range. The composite video output will connect to any composite monitor or TV (via SCART socket) and most video recorders. Unit runs from 12V DC so ideal for security & portable applications where mains power not available. Overall dimensions 66 mm wide x 117 deep x 43 high. Supplied BRAND NEW & fully guaranteed with user data, 100's of applications including Security, Home Video, Web TV, Web Cams etc.

Web ref = LK33 **ONLY £99.00 or 2 for £180.00 (B)**

## SOFTWARE SPECIALS

NT4 WorkStation, complete with service pack 3 and licence - OEM packaged. **ONLY £89.00 (B)**  
ENCARTA 95 - CDROM, Not the latest! - But at this price! £7.95  
DOS 5.0 on 3 1/2" disks with concise books c/w QBasic £14.95  
Windows for Workgroups 3.11 + Docs 6.22 on 3.5" disks £55.00  
Wordperfect 6 for DOS supplied on 3 1/2" disks with manual £24.95  
shipping charges for software is code B

# DISTEL on the web !! - Over 16,000,000 items from stock - www.distel.co.uk



**ALL MAIL TO**  
Dept PE, 29/35 Osborne Rd  
Thornton Heath  
Surrey CR7 8PD  
Open Mon - Fri 9.00 - 5.30

**LONDON SHOP**  
Open Mon - Sat 9.00 - 5.30  
215 Whitehorse Lane  
South Norwood  
On 68A Bus Route  
N Thornton Heath &  
Salturst Park SR Rail Stations.

**DISTEL**  
Visit our web site  
[www.distel.co.uk](http://www.distel.co.uk)  
email = admin@distel.co.uk

**ALL ENQUIRIES**  
**0208 653 3333**  
FAX 0208 653 8888

All prices for UK Mainland. UK customers add 17.5% VAT to TOTAL order amount. Minimum order £10. Bonus Free amount orders accepted from Government, Schools, Universities and Local Authorities - minimum amount order £50. Cheques over £100 are subject to 10 working days clearance. Carnage charges (A)=£3.00, (A1)=£4.00, (B)=£5.50, (C)=£8.50, (C1)=£12.50, (D)=£15.00, (F)=£18.00, (F)=£20.00, (G)=CALL. Allow approx 6 days for shipping - faster CALL. All goods supplied to our Standard Conditions of Sale and unless stated guaranteed for 90 days. All guarantees on a return to base basis. All rights reserved to change prices / specifications without prior notice. Orders subject to stock. Discounts for volume. Top CASH prices paid for surplus goods. All trademarks, tradenames etc acknowledged. © Display Electronics 1999 L & G L. 0799



# NEXT MONTH

## PIC SPECTRUM ANALYSER

A spectrum analyser is a sophisticated workshop tool that allows you to analyse a waveform of any shape and establish which frequencies it contains and at which relative amplitudes.

The design presented here analyses input signals up to about 50kHz and displays frequency content to around 400kHz. A signal interface board is controlled by a PIC microcontroller and outputs digitised data to a PC-compatible computer which analyses the data using a sophisticated, but automatic, mathematical analysis routine and displays it graphically on its v.d.u., the display can also be printed for later analysis. Such displays can assist in improving many types of electronic hardware design.

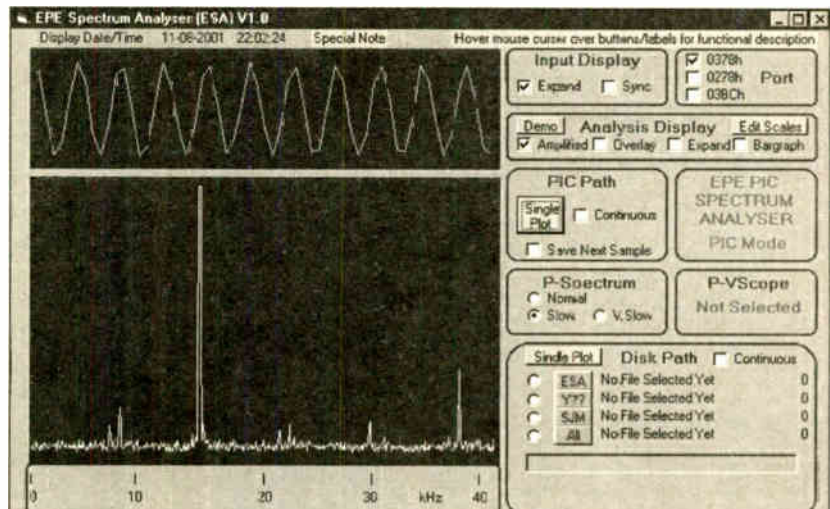

## GUITAR PRACTICE AMP

An easy-to-build, inexpensive, mains powered guitar practice amplifier which will give around 10 watts r.m.s. output, but this can be increased to over 20 watts r.m.s. if required with simple modifications. The unit has inputs for both microphone and guitar, plus loudspeaker and headphone outputs.

## HT POWER SUPPLY

This power supply unit is primarily designed for use with battery powered valve radios that require a high tension (HT) supply of about 90 volts at a current consumption of up to 10 milliamps or so.

The batteries for these receivers are now unobtainable, and they were pretty expensive when it was possible to buy them.

This simple inverter design provides three switched outputs of 67.5V, 90V and 120V d.c. for use with various "portable" valve radios.

**PLUS: TEACH-IN 2002, Part 4  
AND ALL THE REGULAR FEATURES**

# NO ONE DOES IT BETTER

EVERYDAY  
**PRACTICAL**  
**ELECTRONICS**  
INCORPORATING ELECTRONICS TODAY INTERNATIONAL

**DON'T MISS AN  
ISSUE - PLACE YOUR  
ORDER NOW!**  
Demand is bound to be high

**FEBRUARY 2002 ISSUE ON SALE THURSDAY, JANUARY 10**



# QUASAR ELECTRONICS LIMITED

Unit 14 Sunningdale, BISHOPS STORTFORD, Herts. CM23 2PA

TEL: 01279 467799 FAX: 07092 203496

ADD P&P to all orders (for 1st Class Recorded £4, Next day Insured £250) £7, Europe £5.00, Rest of World £10.00. We accept all major credit cards. Make cheques/POs payable to Quasar Electronics. Prices include 17.5% VAT. MAIL ORDER ONLY. FREE CATALOGUE with order or send 2 x 1st class stamps (refundable) for details of over 150 kits & publications.



## PROJECT KITS

Our electronic kits are supplied complete with all components, high quality PCBs (NOT cheap Tripad strip board!) and detailed assembly/operating instructions

- **2 x 25W CAR BOOSTER AMPLIFIER** Connects to the output of an existing car stereo cassette player, CD player or radio. Heatsinks provided. PCB 76x75mm 1046KT £24.95
- **3-CHANNEL WIRELESS LIGHT MODULATOR** No electrical connection with amplifier. Light modulation achieved via a sensitive electret microphone. Separate sensitivity control per channel. Power handling 400W/channel. PCB 54x112mm. Mains powered. Box provided. 6014KT £24.95
- **12 RUNNING LIGHT EFFECT** Exciting 12 LED light effect ideal for parties, discos, shop-windows & eye-catching signs. PCB design allows replacement of LEDs with 220V bulbs by inserting 3 TRIACS. Adjustable rotation speed & direction. PCB 54x112mm 1026KT £15.95; BOX (for mains operation) 2026BX £9.00
- **DISCO STROBE LIGHT** Probably the most exciting of all light effects. Very bright strobe tube. Adjustable strobe frequency. 1-60Hz. Mains powered. PCB: 60x68mm. Box provided. 6037KT £28.95
- **ANIMAL SOUNDS** Cat, dog, chicken & cow. Ideal for kids farmyard toys & schools. SG10M £5.95
- **3 1/2 DIGIT LED PANEL METER** Use for basic voltage/current displays or customise to measure temperature, light, weight, movement, sound levels, etc. with appropriate sensors (not supplied). Various input circuit designs provided. 3061KT £13.95
- **IR REMOTE TOGGLE SWITCH** Use any TV/VCR remote control unit to switch onboard 12V/1A relay on/off. 3058KT £10.95
- **SPEED CONTROLLER** for any common DC motor up to 100V/5A. Pulse width modulation gives maximum torque at all speeds. 5-15VDC. Box provided. 3067KT £12.95
- **3 x 8 CHANNEL IR RELAY BOARD** Control eight 12V/1A relays by Infra Red (IR) remote control over a 20m range in sunlight. 6 relays turn on only, the other 2 toggle on/off. 3 operation ranges determined by jumpers. Transmitter case & all components provided. Receiver PCB 76x89mm 3027KT £32.95

## PRODUCT FEATURE

### COMPUTER TEMPERATURE DATA LOGGER

PC serial port controlled 4-channel temperature meter (either deg C or F). Requires no external power. Allows continuous temperature data logging of up to four temperature sensors located 200m+ from motherboard/PC. Ideal use for old 386/486 computers. Users can tailor input data stream to suit their purpose (dump it to a spreadsheet or write your own BASIC programs using the INPUT command to grab the readings). PCB just 38mm x 38mm. Sensors connect via four 3-pin headers, 4 header cables supplied but only one DS18S20 sensor. Kit software available free from our website. ORDERING: 3145KT £23.95 (kit form); AS3145 £29.95 (assembled); Additional DS18S20 sensors £4.95 each



- **SOUND EFFECTS GENERATOR** Easy to build. Create an almost infinite variety of interesting/unusual sound effects from birds chirping to sirens. 9VDC. PCB 54x85mm 1045KT £8.95
- **ROBOT VOICE EFFECT** Make your voice sound similar to a robot or Dorek! Great fun for discos, school plays, theatre productions, radio stations & playing jokes on your friends when answering the phone! PCB 42x71mm. 1131KT £8.95
- **AUDIO TO LIGHT MODULATOR** Controls intensity of one or more lights in response to an audio input. Safe, modern auto-coupler design. Mains voltage experience required. 3012KT £8.95
- **MUSIC BOX** Activated by light. Plays 8 Christmas songs and 5 other tunes. 3104KT £7.95
- **20 SECOND VOICE RECORDER** Uses non-volatile memory - no battery backup needed. Record/replay messages over & over. Playback as required to great customers etc. Volume control & built-in mic. 6VDC. PCB 50x73mm. 3131KT £12.95
- **TRAIN SOUNDS** 4 selectable sounds - whistle blowing, level crossing bell, 'clackety-clack' & 4 in sequence. SG01M £6.95
- **PC CONTROLLED RELAY BOARD** Convert any 286 upward PC into a dedicated automatic controller to independently turn on/off up to eight lights, motors & other devices around the home, office, laboratory or factory using 8 240VAC/12A onboard relays. DOS utilities, sample test program, full-featured Windows utility & all components (except cable) provided. 12VDC. PCB 70x200mm. 3074KT £31.95
- **2 CHANNEL UHF RELAY SWITCH** Contains the same transmitter/receiver pair as 30A15 plus the components and PCB to control two 240VAC/10A relays (also supplied). Ultra bright LEDs used to indicate relay status. 3082KT £27.95
- **TRANSMITTER RECEIVER PAIR** 2-button keyfob style 300-375MHz Tx with 30m range. Receiver encoder module with matched decoder IC. Components must be built into a circuit like kit 3082 above. 30A15 £14.95
- **PIC 16C71 FOUR SERVO MOTOR DRIVER** Simultaneously control up to 4 servo motors. Software & all components (except servos/control pots) supplied. 5VDC. PCB 50x70mm. 3102KT £15.95
- **UNIPOLAR STEPPER MOTOR DRIVER** for any 5/6/8 lead motor. Fast/slow & single step rates. Direction control & on/off switch. Wave, 2-phase & half-wave step modes. 4 LED indicators. PCB 50x65mm. 3109KT £14.95
- **PC CONTROLLED STEPPER MOTOR DRIVER** Control two unipolar stepper motors (3A max. each) via PC printer port. Wave, 2-phase & half-wave step modes. Software accepts 4 digital inputs from external switches & will single step motors. PCB fits in D-shell case provided. 3113KT £17.95
- **12-BIT PC DATA ACQUISITION/CONTROL UNIT** Similar to kit 3093 above but uses a 12 bit Analogue-to-Digital Converter (ADC) with internal analogue multiplexer. Reads 8 single ended channels or 4 differential inputs or a mixture of both. Analogue inputs read 0-4V. Four TTL/CMOS compatible digital input/outputs. ADC conversion time <10µs. Software (C, QB & Win), extended D shell case & all components (except sensors & cable) provided. 3118KT £52.95
- **LIQUID LEVEL SENSOR/RAIN ALARM** Will indicate fluid levels or simply the presence of fluid. Relay output to control a pump to add/remove water when it reaches a certain level. 1080KT £5.95
- **AM RADIO KIT 1** Tuned Radio Frequency front-end, single chip AM radio IC & 2 stages of audio amplification. All components inc. speaker provided. PCB 32x102mm. 3063KT £10.95
- **DRILL SPEED CONTROLLER** Adjust the speed of your electric drill according to the job at hand. Suitable for 240V AC mains powered drills up to

## X FACTOR PUBLICATIONS

### THE EXPERTS IN RARE & UNUSUAL INFORMATION!

Full details of all X-FACTOR PUBLICATIONS can be found in our catalogue. N.B. Minimum order charge for reports and plans is £5.00 PLUS normal P&P

- **SUPER-EAR LISTENING DEVICE** Complete plans to build your own parabolic dish microphone. Listen to distant voices and sounds through open windows and even walls! Made from readily available parts. R002 £3.50
- **LOCKS** - How they work and how to pick them! This fact filled report will teach you more about locks and the art of lock picking than many books we have seen at 4 times the price. Packed with information and illustrations. R008 £3.50
- **RADIO & TV JOKER PLANS** We show you how to build three different circuits for disrupting TV picture and sound plus FM radio! May upset your neighbours & the authorities! DISCRETION REQUIRED. R017 £3.50
- **INFINITY TRANSMITTER PLANS** Complete plans for building the famous Infinity Transmitter. Once installed on the target phone, device acts like a room bug. Just call the target phone & activate the unit to hear all room sounds. Great for home/office security! R019 £3.50
- **THE ETHER BOX CALL INTERCEPTOR PLANS** Grabs telephone calls out of thin air! No need to wire-in a phone bug. Simply place this device near the phone lines to hear the conversations taking place! R025 £3.00
- **CASH CREATOR BUSINESS REPORTS** Need ideas for making some cash? Well this could be just what you need! You get 40 reports (approx 800 pages) on floppy disk that give you information on setting up different businesses. You also get valuable reproduction and duplication rights so that you can sell the manuals as you like. R030 £7.50

# SURVEILLANCE

High performance surveillance bugs. Room transmitters supplied with sensitive electret microphone & battery holder/cip. All transmitters can be received on an ordinary VHF/FM radio between 88-108MHz. Available in Kit Form (KT) or Assembled (AS).

## ROOM SURVEILLANCE

- **MTX - MINIATURE 3V TRANSMITTER** Easy to build & guaranteed to transmit 300m @ 3V. Long battery life. 3-5V operation. Only 45x18mm B 3007KT £5.95 AS3007 £11.95
- **MRTX - 3V TRANSMITTER** Our best selling bug. Super sensitive, high power - 500m range @ 9V (over 1km with 18V supply and better aerial). 45x19mm. 3018KT £7.95 AS3018 £12.95

**HPTX - HIGH POWER TRANSMITTER** High performance, 2 stage transmitter gives greater stability & higher quality reception. 1000m range. 6-12V DC operation. Size 70x15mm. 3032KT £9.95 AS3032 £18.95



- **MMTX - MICRO-MINIATURE 9V TRANSMITTER** The ultimate bug for its size, performance and price. Just 15x25mm. 500m range @ 9V. Good stability. 6-18V operation. 3051KT £8.95 AS3051 £14.95
- **VTX - VOICE ACTIVATED TRANSMITTER** Operates only when sounds detected. Low standby current. Variable trigger sensitivity. 500m range. Peaking circuit supplied for maximum RF output. On/off switch. 6V operation. Only 63x38mm. 3028KT £12.95 AS3028 £21.95

**HARDWIRED BUG/TWO STATION INTERCOM** Each station has its own amplifier, speaker and mic. Can be set up as either a hard-wired bug or two-station intercom. 10m x 2-core cable supplied. 9V operation. 3021KT £15.95 (kit form only)

- **TRVS - TAPE RECORDER VOX SWITCH** Used to automatically operate a tape recorder (not supplied) via its REMOTE socket when sounds are detected. All conversations recorded. Adjustable sensitivity & turn-off delay. 115x19mm. 3013KT £9.95 AS3013 £21.95

**700W power, PCB: 48mm x 65mm. Box provided. 6074KT £17.95**

- **3 INPUT MONO MIXER** Independent level control for each input and separate bass/treble controls. Input sensitivity: 240mV. 18V DC. PCB: 60mm x 185mm 1052KT £16.95
- **NEGATIVE/POSITIVE ION GENERATOR** Standard Cockcroft-Walton multiplier circuit. Mains voltage experience required. 3057KT £10.95
- **LED DICE** Classic intro to electronics & circuit analysis. 7 LEDs simulate dice roll, slow down & land on a number at random. 555 IC circuit. 3003KT £9.95
- **STAIRWAY TO HEAVEN** Tests hand-eye co-ordination. Press switch when green segment of LED lights to climb the stairway - miss & start again! Good intro to several basic circuits. 3005KT £9.95
- **ROULETTE LED** 'Ball' spins round the wheel, slows down & drops into a slot. 10 LEDs. Good intro to CMOS decade counters & Op-Amps. 3006KT £10.95
- **9V XENON TUBE FLASHER** Transformer circuit tests up 9V battery to flash a 25mm Xenon tube. Adjustable flash rate (0.25-2 Sec's). 3022KT £11.95
- **LED FLASHER 1** 5 ultra bright red LEDs flash in 7 selectable patterns. 3037MKT £5.95
- **LED FLASHER 2** Similar to above but flash in sequence or randomly. Ideal for model railways. 3052MKT £5.95
- **INTRODUCTION TO PIC PROGRAMMING.** Learn programming from scratch. Programming hardware, a P16F84 chip and a two-part, practical, hands-on tutorial series are provided. 3081KT £22.95
- **SERIAL PIC PROGRAMMER** for all 8/18/28/40 pin DIP serial programmed PICs. Shareware software supplied limited to programming 256 bytes (registration costs £14.95). 3096KT £13.95
- **ATMEL 89C051 PROGRAMMER** Simple-to-use yet powerful programmer for the Atmel 89C1051, 89C2051 & 89C4051 uCs. Programmer does NOT require special software other than a terminal emulator program (built into Windows). Can be used with ANY computer/operating system. 3121KT £24.95
- **3V/1.5V TO 9V BATTERY CONVERTER** Replace expensive 9V batteries with economic 1.5V batteries. IC based circuit steps up 1 or 2 'AA' batteries to give 9V/18mA. 3035KT £5.95
- **STABILISED POWER SUPPLY 3-30V/2.5A** Ideal for hobbyist & professional laboratory. Very reliable & versatile design at an extremely reasonable price. Short circuit protection. Variable DC voltages (3-30V). Rated output 2.5 Amps. Large heatsink supplied. You just supply a 24VAC/3A transformer. PCB 55x112mm. Mains operation. 1007KT £16.95.

## TELEPHONE SURVEILLANCE

- **MTTX - MINIATURE TELEPHONE TRANSMITTER** Attaches anywhere to phone line. Transmits only when phone is used! Tune-in your radio and hear both parties' 300m range. Use line as aerial & power source: 20x45mm. 3016KT £8.95 AS3016 £14.95
- **TRI - TELEPHONE RECORDING INTERFACE** Automatically record all conversations. Connects between phone line & tape recorder (not supplied). Operates recorders with 1.5-12V battery systems. Powered from line. 50x33mm. 3033KT £9.95 AS3033 £18.95
- **TPA - TELEPHONE PICK-UP AMPLIFIER/WIRELESS PHONE BUG** Place pick-up coil on the phone line or near phone earpiece and hear both sides of the conversation. 3055KT £11.95 AS3055 £20.95

**HIGH POWER TRANSMITTERS**

- **1 WATT FM TRANSMITTER** Easy to construct. Delivers a crisp, clear signal. Two-stage circuit. Kit includes microphone and requires a simple open dipole aerial. 8-30VDC. PCB 42x45mm. 1009KT £14.95
- **4 WATT FM TRANSMITTER** Comprises three RF stages and an audio preamplifier stage. Piezoelectric microphone supplied or you can use a separate preamplifier circuit. Antenna can be an open dipole or Ground Plane. Ideal project for those who wish to get started in the fascinating world of FM broadcasting and want a good basic circuit to experiment with. 12-18VDC. PCB 44x146mm 1028KT £22.95 AS1028 £34.95
- **15 WATT FM TRANSMITTER (PRE-ASSEMBLED & TESTED)** Four transistor based stages with Philips BLY 85 in final stage. 15 Watts RF power on the air. 88-108MHz. Accepts open dipole, Ground Plane, 5/8, J or YAGI antennas. 12-18VDC. PCB 70x220mm. SW5 J meter needed for alignment. 1021KT £99.95
- **SIMILAR TO ABOVE BUT 25W Output.** 1031KT £109.95

**STABILISED POWER SUPPLY 2-30V/5A** As kit 1007 above but rated at 5Amp. Requires a 24VAC/5A transformer. 1096KT £27.95

- **MOTORBIKE ALARM** Uses a reliable vibration sensor (adjustable sensitivity) to detect movement of the bike to trigger the alarm & switch the output relay to which a siren, bikes horn, indicators or other warning device can be attached. Auto-reset. 6-12VDC. PCB 57x64mm. 1011KT £11.95 Box 2011BX £7.00
- **CAR ALARM SYSTEM** Protect your car from theft. Features vibration sensor, courtesy/boot light voltage drop sensor and bonnet/boot earth switch sensor. Entry/exit delays, auto-reset and adjustable alarm duration. 6-12V DC. PCB: 47mm x 55mm 1019KT £11.95 Box 2019BX £8.00
- **PIEZO SCREAMER** 110dB of ear piercing noise. Fits in box with 2 x 35mm piezo elements built into their own resonant cavity. Use as an alarm siren or just for fun! 6-9VDC. 3015KT £10.95
- **COMBINATION LOCK** Versatile electronic lock comprising main circuit & separate keypad for remote opening of lock. Relay supplied. 3029KT £10.95
- **ULTRASONIC MOVEMENT DETECTOR** Crystal locked detector frequency for stability & reliability. PCB 75x40mm houses all components. 4-7m range. Adjustable sensitivity. Output will drive external relay/circuits. 9VDC. 3049KT £13.95
- **PIR DETECTOR MODULE** 3-lead assembled unit just 25x35mm as used in commercial burglar alarm systems. 3076KT £8.95
- **INFRARED SECURITY BEAM** When the Invisble IR beam is broken a relay is tripped that can be used to sound a bell or alarm. 25 metre range. Mains rated relays provided. 12VDC operation. 3130KT £12.95
- **SQUARE WAVE OSCILLATOR** Generates square waves at 6 preset frequencies in factors of 10 from 1Hz-100kHz. Visual output indicator. 5-18VDC. Box provided. 3111KT £8.95
- **PC DRIVEN POCKET SAMPLER/DATA LOGGER** Analogue voltage sampler records voltages up to 2V or 20V over periods from milli-seconds to months. Can also be used as a simple digital scope to examine audio & other signals up to about 5kHz. Software & D-shell case provided. 3112KT £18.95
- **20 MHz FUNCTION GENERATOR** Square, triangular and sine waveform up to 20MHz over 3 ranges using 'coarse' and 'fine' frequency adjustment controls. Adjustable output from 0-2V p-p. A TTL output is also provided for connection to a frequency meter. Uses MAX038 IC. Plastic case with printed front/rear panels & all components provided. 7-12VAC. 3101KT £69.95

## BARGAIN BUY!

Great introduction to electronics. Ideal for the budding electronics expert! Build a radio, burglar alarm, water detector, Morse code practice circuit, simple computer circuits, and much more! NO soldering, tools or previous electronics knowledge required. Circuits can be built and unassembled repeatedly. Comprehensive 68-page manual with explanations, schematics and assembly diagrams. Suitable for age 10+. Excellent for schools. Requires 2 x AA batteries. ONLY £14.95 (phone for bulk discounts).

## 30-in-ONE Electronic Projects Lab



WEB: <http://www.QuasarElectronics.com>  
email: [epesales@QuasarElectronics.com](mailto:epesales@QuasarElectronics.com)

Secure Online Ordering Facilities  
Full Kit Listing, Descriptions & Photos  
Kit Documentation & Software Downloads

www.QuasarElectronics.com

Credit Card Sales: 01279 467799



## 'PICALL' PIC Programmer

Kit will program ALL 8\*, 18\*, 28 and 40 pin serial AND parallel programmed PIC micro controllers. Connects to PC parallel port. Supplied with fully functional pre-registered PICALL DOS and WINDOWS AVR software packages, all components and high quality DSPTH PCB. Also programs certain ATMEL AVR, serial EPROM 24C and SCENIX SX devices. New PIC's can be added to the software as they are released. Software shows you where to place your PIC chip on the board for programming. Now has blank chip auto sensing feature for super-fast bulk programming. \*A 40 pin wide ZIF socket is required to program 8 & 18 pin devices (available at £15.95).



3117KT	'PICALL' PIC Programmer Kit	£59.95
AS3117	Assembled 'PICALL' PIC Programmer	£69.95
AS3117ZIF	Assembled 'PICALL' PIC Programmer c/w ZIF socket	£84.95

## ATMEL AVR Programmer

Powerful programmer for Atmel AT90Sxxxx (AVR) micro controller family. All fuse and lock bits are programmable. Connects to serial port. Can be used with ANY computer and operating system. Two LEDs to indicate programming status. Supports 20-pin DIP AT90S1200 & AT90S2313 and 40-pin DIP AT90S4414 & AT90S8515 devices. NO special software required - uses any terminal emulator program (built into Windows). The programmer is supported by BASCOM-AVR Basic Compiler software (see website for details). NB ZIF sockets not included.



3122KT	ATMEL AVR Programmer	£24.95
AS3122	Assembled 3122	£39.95

Atmel 89Cx051 and 89xxx programmers also available

## PC Data Acquisition & Control Unit

With this kit you can use a PC parallel port as a real world interface. Unit can be connected to a mixture of analogue and digital inputs from pressure, temperature, movement, sound, light intensity, weight sensors, etc. (not supplied) to sensing switch and relay states. It can then process the input data and use the information to control up to 11 physical devices such as motors, sirens, other relays, servo motors & two-stepper motors.



### FEATURES:

- 8 Digital Outputs: Open collector, 500mA, 33V max.
- 16 Digital Inputs: 20V max. Protection 1K in series, 5-1V Zener to ground.
- 11 Analogue Inputs: 0-5V, 10 bit (5mV/step.)
- 1 Analogue Output: 0-2.5V or 0-10V 8 bit (20mV/step.)

All components provided including a plastic case (140mm x 110mm x 35mm) with pre-punched and silk screened front/rear panels to give a professional and attractive finish (see photo) with screen printed front & rear panels supplied. Software utilities & programming examples supplied.

3093KT	PC Data Acquisition & Control Unit	£99.95
AS3093	Assembled 3093	£124.95

See opposite page for ordering information on these kits

## ABC Mini 'Hotchip' Board



Currently learning about microcontrollers? Need to do something more than flash a LED or sound a buzzer? The ABC Mini 'Hotchip' Board is based on Atmel's AVR 8535 RISC technology and will interest both the beginner and expert alike. Beginners will find that they can write and test a simple program, using the BASIC programming language, within an hour or two of connecting it up.

Experts will like the power and flexibility of the ATMEL microcontroller, as well as the ease with which the little Hot Chip board can be "designed-in" to a project. The ABC Mini Board 'Starter Pack' includes just about everything you need to get up and experimenting right away. On the hardware side, there's a pre-assembled micro controller PC board with both parallel and serial cables for connection to your PC. Windows software included on CD-ROM features an Assembler, BASIC compiler and in-system programmer. The pre-assembled boards only are also available separately.

ABCMINISP	ABC MINI Starter Pack	£64.95
ABCMINIB	ABC MINI Board Only	£39.95

## Advanced Schematic Capture and Simulation Software

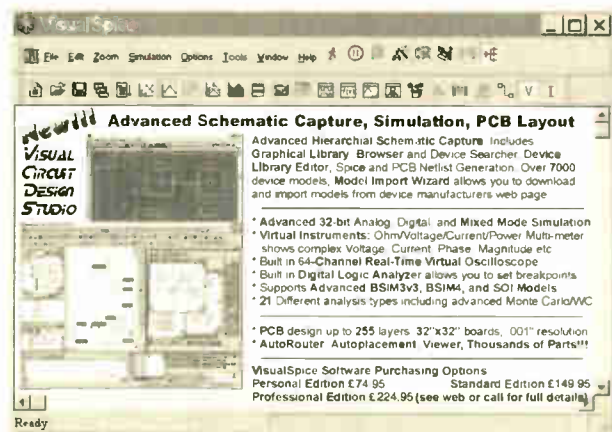

## Serial Port Isolated I/O Controller

Kit provides eight 240VAC/12A (110VAC/15A) rated relay outputs and four optically isolated inputs. Can be used in a variety of control and sensing applications including load switching, external switch input sensing, contact closure and external voltage sensing. Programmed via a computer serial port, it is compatible with ANY computer & operating system. After programming, PC can be disconnected. Serial cable can be up to 35m long, allowing 'remote' control. User can easily write batch file programs to control the kit using simple text commands. NO special software required - uses any terminal emulator program (built into Windows). All components provided including a plastic case with pre-punched and silk screened front/rear panels to give a professional and attractive finish (see photo).



3108KT	Serial Port Isolated I/O Controller Kit	£54.95
AS3108	Assembled Serial Port Isolated I/O Controller	£69.95



## DISTANCE LEARNING SHORT COURSES with BTEC CERTIFICATION

Analogue and Digital Electronics, Fibre Optics,  
Fault Diagnosis, Mechanics, Mathematics and  
Programmable Logic Controllers

- Suitable for beginners and those wishing to update their knowledge and practical skills
- Courses are very practical and delivered as self contained kits
- No travelling or college attendance
- Learning is at your own pace
- Each course can stand alone or be part of a modular study programme
- Tutor supported and BTEC certified

For information contact:  
NCT Ltd., P.O. Box 11  
Wendover, Bucks HP22 6XA  
Telephone 01296 624270; Fax 01296 625299  
Web: <http://www.nct.ltd.uk>

## FRUSTRATED!

### Looking for ICs TRANSISTORS?

A phone call to us could get a result. We offer an extensive range and with a world-wide database at our fingertips, we are able to source even more. We specialise in devices with the following prefix (to name but a few).



2N 2SA 2SB 2SC 2SD 2P 2SJ 2SK 3N 3SK 4N 6N 17 40 AD  
ADC AN AM AY BA BC BD BDT BDV BDW BDX BF  
BFR BFS BFT BFX BFY BLY BLX BS BR BRX BRY BS  
BSS BSV BSW BSX BT BTA BTB BRW BU BUK BUT BUY  
BUW BUX BUY BUZ CA CD CX CXA DAC DG DM DS  
DTA DTC GL GM HA HCF HD HEF ICL ICM IRF J KA  
KIA L LA LB LC LD LF LM M M5M MA MAB MAX MB  
MC MDAJ MJE MJF MM MN MPS MP5A MP5H MP5U  
MRF NJM NE OM OP PA PAL PIC PN RC S SAA SAB  
SAD SAJ SAS SDA SG SI SL SN SO STA STK STR STRD  
STRM STRS SV1 T TA TAA TAG TBA TC TCA TDA TDB  
TEA TIC TIP TIPL TEA TL TLC TMP TMS TPU U UA  
UAA UC UDN ULN UM UP4 UPC UPD VN X XR Z ZN  
ZTS + many others

We can also offer equivalents (at customers' risk)  
We also stock a full range of other electronic components  
Mail, phone, Fax Credit Card orders and callers welcome



Connect

## Cricklewood Electronics Ltd

40-42 Cricklewood Broadway London NW2 3ET  
Tel: 020 8452 0161 Fax: 020 8208 1441

# SQUIRES

## MODEL & CRAFT TOOLS

A COMPREHENSIVE RANGE OF MINIATURE HAND AND  
POWER TOOLS AND AN EXTENSIVE RANGE OF

### ELECTRONIC COMPONENTS

FEATURED IN A FULLY ILLUSTRATED

528 PAGE MAIL ORDER CATALOGUE

## 2002 ISSUE

Note: If you have ordered from 2001 copy you will  
receive the new catalogue automatically

**SAME DAY DESPATCH**  
**FREE POST AND PACKAGING**

Catalogues: FREE OF CHARGE to addresses in the UK.  
Overseas: CATALOGUE FREE, postage at cost charged  
to credit card

**Squires, 100 London Road,  
Bognor Regis, West Sussex, PO21 1DD**

TEL: 01243 842424

FAX: 01243 842525

SHOP NOW OPEN



## PLASTIC BOXES & ENCLOSURES

Contact us for your free catalogue

S.L.M. (Model) Engineers Ltd

Chiltern Road

Prestbury

Cheltenham

GL52 5JQ

Website: [www.slm.uk.com](http://www.slm.uk.com)

Telephone 01242 525488

Fax 01242 226288



## NEW From FED – In Circuit Debugging for PIC 16F87x series

Operates with all FED PIC Development applications (PIXIE, WIZPIC, PICDESIM, C Compiler)

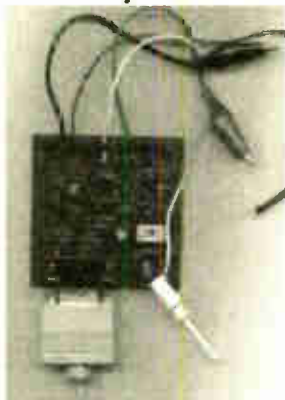

**In Circuit Debugger Board**

### What is In-Circuit Debugging (ICD) ?

In Circuit Debugging is a technique where a monitor program runs on the PIC in the application circuit. The ICD board connects to the PIC and to the PC. From any of our applications it is then possible to set breakpoints on the PIC, run code, single step, examine registers on the real device and change their values. The ICD makes debugging real time applications faster, easier and more accurate than simulation tools available for the PIC.

### Features

- Allows real hardware to be examined & programs to be debugged and to be run in real time on your application
- Powered from the application circuit (3.3V to 5V)
- The FED ICD requires only one data I/O pin on the PIC which can be chosen from any of ports B, C or D.
- Can program and re-program applications in circuit
- Up to 3 breakpoints
- Run, single step and step over, run to cursor line, set PC to any value in the program
- Trace execution in the original C or Assembler source files
- Animate operation to trace variables at breakpoints or watch the program executing
- Auto Run application if ICD not connected
- View and change values of PIC special function and general purpose registers, W and the ports.
- Uses a standard (3 wire) serial interface to a PC

### Prices

**In Circuit Debugger Board - £30.00**

You will also need a copy of PICDESIM, WIZPIC, our C Compiler, or PIXIE, all of which operate with the ICD board.

## PIXIE

### Visual Development for the FED PIC C Compiler

- An application designer for the FED PIC C Compiler FULLY including the PIC C Compiler
- Drag a software component on to your design & set up the parameters using check boxes, drop down boxes and edit boxes (see shot right).
- Connect the component to the PIC pins using the mouse
- Select your own C functions to be triggered when events occur (e.g. Byte received, timer overflow etc.)
- Simulate, Trace at up to 10x the speed of MPLAB
- Generate the base application automatically and then add your own functional code in C or assembler
- Supports 14/16 bit core PICS - 16F87x, 16C55x, 16C6x, 16F8x, 16C7xx 18Cxx
- C Compiler designed to ANSI C Standards



### Prices

**PIXIE with Introductory manual (C Manuals on CD) - £70**

**PIXIE with WIZPIC, Serial Programmer, or Development Board £50.00 CD-ROM**

## PIC & AVR Programmers

## NEW - PIC Development Board

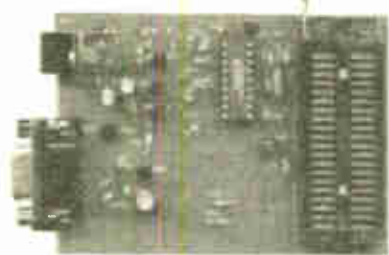

### PIC Serial Programmer (Left) including 18Cxxx

Handles serially programmed PIC devices in a 40 pin multi-width ZIF socket. 16C55X, 16C6X, 16C7X, 16C8x, 16F8X, 12C508, 12C509, 16C72XPIC 14000, 16F87X, 18Cxxx etc. Also In-Circuit programming. Operates on PC serial port

**Price : £45/kit  
£50/built & tested**

**PIC Introductory** – Programs 8 & 18 pin devices : 16C505, 16C55X, 16C61, 16C62X, 16C71, 16C71X, 16C8X, 16F8X, 12C508/9, 12C671/2 **£25/kit.**  
**AVR** – AVR1200, 2313, 4144, 8515, 8535, 4434 etc. in ZIF. 4.5V battery powered.  
**Price : £40 for the kit or £45 built & tested.**

All our Programmers operate on PC serial interface. No hard to handle parallel cable swapping ! Programmers supplied with instructions, + Windows 3.1/95/98/NT software. **Upgrade programmers from our web site !**



### Prices

**Kit with integrated programmer hardware £35.00**  
**CD-ROM including FED PIC BASIC compiler £5.00**  
**Other options available – please ring or see web site**

For ALL 40 pin PICS from 16cxxx, 16Fxxx and 18cxxx

- Includes In-Circuit Programmer – NO separate programmer required
- LCD module interface (1:1) plus contrast control
- Hex keypad interface
- 4 LED's and driver
- 32 I/O pins available on IDC headers
- Variable resistor for A/D
- Socket for 12C EEPROM
- 1A 5V regulator on board
- 2 serial interfaces
- CD-ROM supplied with FED PIC BASIC and Compiler
- Peripherals operate only on port D and E leaving others free

Manual on CD-ROM or download free from our web site

### Forest Electronic Developments

12 Buldown Walk, Sway, Lymington, Hants SO41 6DU

Email – info@fored.co.uk, or sales@fored.co.uk

Web Site – <http://www.fored.co.uk>

01590 681511 (Voice/Fax)

Prices are fully inclusive. Add £3.00 for P&P and handling to each order. Cheques/POs payable to Forest Electronic Developments, or phone with credit card details.



## 18C452

New architecture (more instructions + Hardware multiply), 40MHz clock, 16K program words, 1536 bytes RAM. Easy to upgrade from 16F877

18C452/JW £20.00  
18C452/OTP £8.00





**MAIL ORDER ONLY • CALLERS BY APPOINTMENT**

**EPE MICROCONTROLLER  
P.I. TREASURE HUNTER**

The latest MAGENTA DESIGN - highly stable & sensitive - with I.C. control of all timing functions and advanced pulse separation techniques.

- High stability drift cancelling
- Easy to build & use
- No ground effect, works in seawater



- Detects gold, silver, ferrous & non-ferrous metals

- Efficient quartz controlled microcontroller pulse generation.
- Full kit with headphones & all hardware

**KIT 847 .....£63.95**

**PORTABLE ULTRASONIC  
PEST SCARER**

A powerful 23kHz ultrasound generator in a compact hand-held case. MOSFET output drives a special sealed transducer with intense pulses via a special tuned transformer. Sweeping frequency output is designed to give maximum output without any special setting up.

**KIT 842.....£22.56**

**68000 DEVELOPMENT  
TRAINING KIT**

- NEW PCB DESIGN
- 8MHz 68000 16-BIT BUS
- MANUAL AND SOFTWARE
- 2 SERIAL PORTS
- PIT AND I/O PORT OPTIONS
- 12C PORT OPTIONS

**KIT 621**

**£99.95**

- ON BOARD 5V REGULATOR
- PSU £6.99
- SERIAL LEAD £3.99

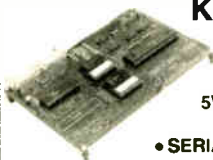

**Stepping Motors**

MD38...Mini 48 step...£8.65

MD35...Std 48 step...£9.99

MD200...200 step...£12.99

MD24...Large 200 step...£22.95



**PIC PIPE DESCALER**

- SIMPLE TO BUILD
- HIGH POWER OUTPUT
- AUDIO & VISUAL MONITORING
- SWEPT FREQUENCY

An affordable circuit which sweeps the incoming water supply with variable frequency electromagnetic signals. May reduce scale formation, dissolve existing scale and improve lathering ability by altering the way salts in the water behave. Kit includes case, P.C.B., coupling coil and all components. High coil current ensures maximum effect. L.E.D. monitor.



**KIT 868 ..... £22.95 POWER UNIT.....£3.99**

**MICRO PEST  
SCARER**

Our latest design - The ultimate scarer for the garden. Uses special microchip to give random delay and pulse time. Easy to build reliable circuit. Keeps pets/pests away from newly sown areas, play areas, etc. Uses power source from 9 to 24 volts.

- RANDOM PULSES
- HIGH POWER
- DUAL OPTION



Plug-in power supply £4.99

**KIT 867.....£19.99**

**KIT + SLAVE UNIT.....£32.50**

**WINDICATOR**

A novel wind speed indicator with LED readout. Kit comes complete with sensor cups, and weatherproof sensing head. Mains power unit £5.99 extra.

**KIT 856.....£28.00**

**★ TENS UNIT ★**

**DUAL OUTPUT TENS UNIT**

As featured in March '97 issue.

Magenta have prepared a FULL KIT for this. excellent new project. All components, PCB, hardware and electrodes are included. Designed for simple assembly and testing and providing high level dual output drive.

**KIT 866. . Full kit including four electrodes £32.90**

Set of 4 spare electrodes £6.50

**1000V & 500V INSULATION**

**TESTER**

Superb new design. Regulated output, efficient circuit. Dual-scale meter, compact case. Reads up to 200 Megohms.

Kit includes wound coil, cut-out case, meter scale, PCB & ALL components.

**KIT 848. ....£32.95**



**EPE  
TEACH-IN  
2000**

Full set of top quality NEW components for this educational series. All parts as specified by EPE. Kit includes breadboard, wire, croc clips, pins and all components for experiments, as listed in introduction to Part 1.

\*Batteries and tools not included.

**TEACH-IN 2000 -**

**KIT 879 £44.95**

**MULTIMETER £14.45**

**SPACEWRITER**

An innovative and exciting project. Wave the wand through the air and your message appears. Programmable to hold any message up to 16 digits long. Comes pre-loaded with "MERRY XMAS". Kit includes PCB, all components & tube plus instructions for message loading.

**KIT 849 .....£16.99**

**12V EPROM ERASER**

A safe low cost eraser for up to 4 EPROMS at a time in less than 20 minutes. Operates from a 12V supply (400mA). Used extensively for mobile work - updating equipment in the field etc. Also in educational situations where mains supplies are not allowed. Safety interlock prevents contact with UV.

**KIT 790 .....£29.90**

**SUPER BAT  
DETECTOR**

1 WATT O/P, BUILT IN  
SPEAKER, COMPACT CASE  
20kHz-140kHz

NEW DESIGN WITH 40kHz MIC.

A new circuit using a 'full-bridge' audio amplifier i.c., internal speaker, and headphone/tape socket. The latest sensitive transducer, and 'double balanced mixer' give a stable, high performance superheterodyne design.

**KIT 861 .....£24.99**

ALSO AVAILABLE Built & Tested... £39.99



**MOSFET MKII VARIABLE BENCH  
POWER SUPPLY 0-25V 2-5A**

Based on our Mk1 design and preserving all the features, but now with switching pre-regulator for much higher efficiency. Panel meters indicate Volts and Amps. Fully variable down to zero. Toroidal mains transformer. Kit includes punched and printed case and all parts. As featured in April 1994 EPE. An essential piece of equipment.



Kit No. 845 .....£64.95

**EPE  
PROJECT  
PICS**

Programmed PICs for all\* EPE Projects  
16C84/18F84/16C71  
All **£5.90 each**  
**PIC16F877 now in stock**  
**£10 inc. VAT & postage**  
(\*some projects are copyright)

**ULTRASONIC PEST SCARER**

Keep pets/pests away from newly sown areas, fruit, vegetable and flower beds, children's play areas, patios etc. This project produces intense pulses of ultrasound which deter visiting animals.

- KIT INCLUDES ALL COMPONENTS, PCB & CASE
- EFFICIENT 100V TRANSDUCER OUTPUT
- COMPLETELY INAUDIBLE TO HUMANS

- UP TO 4 METRES RANGE
- LOW CURRENT DRAIN



**KIT 812.....£15.00**



**NEW**

## SIMPLE PIC PROGRAMMER

**INCREDIBLE LOW PRICE! Kit 857 £12.99**

INCLUDES 1-PIC16F84 CHIP SOFTWARE DISK, LEAD CONNECTOR, PROFESSIONAL PC BOARD & INSTRUCTIONS

Power Supply £3.99

EXTRA CHIPS:  
PIC 16F84 £4.84

Based on February '96 EPE. Magenta designed PCB and kit. PCB with 'Reset' switch, Program switch, 5V regulator and test L.E.D.s, and connection points for access to all A and B port pins.

## PIC 16C84 DISPLAY DRIVER

INCLUDES 1-PIC16F84 WITH DEMO PROGRAM SOFTWARE DISK, PCB, INSTRUCTIONS AND 16-CHARACTER 2-LINE LCD DISPLAY

**Kit 860 £19.99**

Power Supply £3.99

FULL PROGRAM SOURCE CODE SUPPLIED - DEVELOP YOUR OWN APPLICATION!

Another super PIC project from Magenta. Supplied with PCB, industry standard 2-LINE x 16-character display, data, all components, and software to include in your own programs. Ideal development base for meters, terminals, calculators, counters, timers - Just waiting for your application!

## PIC 16F84 MAINS POWER 4-CHANNEL CONTROLLER & LIGHT CHASER

- WITH PROGRAMMED 16F84 AND DISK WITH SOURCE CODE IN MPASM
- ZERO VOLT SWITCHING
- MULTIPLE CHASE PATTERNS
- OPTO ISOLATED
- 5 AMP OUTPUTS
- 12 KEYPAD CONTROL
- SPEED/DIMMING POT.
- HARD-FIRED TRIACS

Now features full 4-channel chaser software on DISK and pre-programmed PIC16F84 chip. Easily re-programmed for your own applications. Software source code is fully 'commented' so that it can be followed easily.

**Kit 855 £39.95**

LOTS OF OTHER APPLICATIONS

## 8-CHANNEL DATA LOGGER

As featured in Aug./Sept. '99 EPE. Full kit with Magenta redesigned PCB - LCD fits directly on board. Use as Data Logger or as a test bed for many other 16F877 projects. Kit includes programmed chip, 8 EEPROMs, PCB, case and all components.

**NEW!**

**KIT 877 £49.95 inc. 8 x 256K EEPROMS**

## ICEBREAKER

□□□□□□□□□□

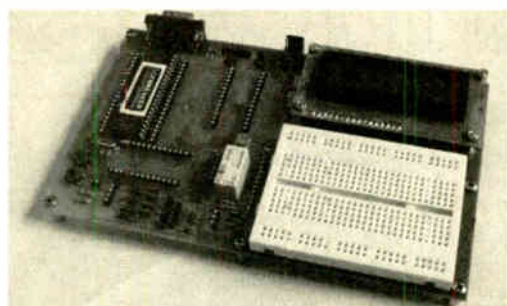

## PIC Real Time In-Circuit Emulator

- Icebreaker uses PIC16F877 in circuit debugger
- Links to Standard PC Serial Port (lead supplied)
- Windows™ (95+) Software included
- Works with MPASM and MPLAB Microchip software
- 16 x 2 L.C.D., Breadboard, Relay, I/O devices and patch leads supplied

As featured in March '00 EPE. Ideal for beginners AND advanced users. Programs can be written, assembled, downloaded into the microcontroller and run at full speed (up to 20MHz), or one step at a time.

Full emulation means that all I/O ports respond exactly and immediately, reading and driving external hardware.

Features include: Reset; Halt on external pulse; Set Breakpoint; Examine and Change registers, EEPROM and program memory; Load program, Single Step with display of Status, W register, Program counter, and user selected 'Watch Window' registers.

**KIT 900 . . . £34.99**

POWER SUPPLY £3.99 STEPPING MOTOR £5.99

## EPE PIC TOOLKIT 3

- THE LATEST TOOLKIT BOARD - 8, 18, 28 AND 40-PIN CHIPS
- MAGENTA DESIGNED P.C.B. WITH COMPONENT LAYOUT AND EXTRAS
- L.C.D., BREADBOARD AND PIC CHIP INCLUDED
- ALL TOP QUALITY COMPONENTS AND SOFTWARE SUPPLIED

**KIT 880 . . . £34.99 with 16F84 . . . £39.99 with 16F877**

## PIC TOOLKIT V2

- SUPER UPGRADE FROM V1 • 18, 28 AND 40-PIN CHIPS
- READ, WRITE, ASSEMBLE & DISASSEMBLE PICS
- SIMPLE POWER SUPPLY OPTIONS 5V-20V
- ALL SWITCHING UNDER SOFTWARE CONTROL
- MAGENTA DESIGNED PCB HAS TERMINAL PINS AND OSCILLATOR CONNECTIONS FOR ALL CHIPS
- INCLUDES SOFTWARE AND PIC CHIP

**KIT 878 . . . £22.99 with 16F84 . . . £29.99 with 16F877**

## EPE PIC Tutorial

**At last! A Real, Practical, Hands-On Series**

- Learn Programming from scratch using PIC16F84
- Start by lighting l.e.d.s and do 30 tutorials to Sound Generation, Data Display, and a Security System.
- PIC TUTOR Board with Switches, l.e.d.s, and on board programmer

## PIC TUTOR BOARD KIT

Includes: PIC16F84 Chip, TOP Quality PCB printed with Component Layout and all components\* (\*not ZIF Socket or Displays). Included with the Magenta Kit is a disk with Test and Demonstration routines.

**KIT 870 .... £27.95, Built & Tested .... £42.95**

Optional: Power Supply - £3.99, ZIF Socket - £9.99

LCD Display ..... £7.99 LED Display ..... £6.99

Reprints Mar/Apr/May 98 - £3.00 set 3

## SUPER PIC PROGRAMMER

- READS, PROGRAMS, AND VERIFIES
- WINDOWS® SOFTWARE
- PIC16C6X, 7X, AND 8X
- USES ANY PC PARALLEL PORT
- USES STANDARD MICROCHIP • HEX FILES
- OPTIONAL DISASSEMBLER SOFTWARE (EXTRA)
- PCB, LEAD, ALL COMPONENTS, TURNED-PIN SOCKETS FOR 18, 28, AND 40 PIN ICs

• SEND FOR DETAILED INFORMATION - A SUPERB PRODUCT AT AN UNBEATABLE LOW PRICE.

**Kit 862 £29.99**

Power Supply £3.99

DISASSEMBLER SOFTWARE £11.75

## PIC STEPPING MOTOR DRIVER

INCLUDES PCB, PIC16F84 WITH DEMO PROGRAM, SOFTWARE DISC, INSTRUCTIONS AND MOTOR.

**Kit 863 £18.99**

FULL SOURCE CODE SUPPLIED ALSO USE FOR DRIVING OTHER POWER DEVICES e.g. SOLENOIDS

Another NEW Magenta PIC project. Drives any 4-phase unipolar motor - up to 24V and 1A. Kit includes all components and 48 step motor. Chip is pre-programmed with demo software, then write your own, and re-program the same chip! Circuit accepts inputs from switches etc and drives motor in response. Also runs standard demo sequence from memory.



All prices include VAT. Add £3.00 p&p. Next day £6.99

Tel: 01283 565435 Fax: 01283 546932 E-mail: sales@magenta2000.co.uk





Station Road, Cullercoats, Tyne & Wear, NE30 4PQ

Prices Exclude Vat @17.5%. UK Carriage £1.50 (less than 1kg) £3.50 greater than 1kg Cheques / Postal orders payable to ESR Electronic Components. PLEASE ADD CARRIAGE & VAT TO ALL ORDERS



See Next / Last Months Ad. for ELECTRONIC COMPONENTS

**DIL Sockets**

8 Pin DIL 0.3"	£0.06
8 Pin DIL 0.3"	£0.06
14 Pin DIL 0.3"	£0.11
16 Pin DIL 0.3"	£0.11
18 Pin DIL 0.3"	£0.12
20 Pin DIL 0.3"	£0.12
24 Pin DIL 0.6"	£0.13
28 Pin DIL 0.6"	£0.13
40 Pin DIL 0.6"	£0.19

**Stamped Pin**

8 Pin DIL 0.3"	£0.06
14 Pin DIL 0.3"	£0.11
16 Pin DIL 0.3"	£0.11
18 Pin DIL 0.3"	£0.12
20 Pin DIL 0.3"	£0.12
24 Pin DIL 0.6"	£0.13
28 Pin DIL 0.6"	£0.13
40 Pin DIL 0.6"	£0.19

**Turned Pin**

8 Pin DIL 0.3"	£0.11
14 Pin DIL 0.3"	£0.20
16 Pin DIL 0.3"	£0.23
18 Pin DIL 0.3"	£0.25
20 Pin DIL 0.3"	£0.28
24 Pin DIL 0.6"	£0.35
28 Pin DIL 0.6"	£0.39

**ZIF Sockets**

Universal ZIF DIL Sockets	
24 Way 0.3-0.6"	£5.78
28 Way 0.3-0.6"	£6.60
32 Way 0.3-0.6"	£7.50
40 Way 0.3-0.6"	£8.93

**Transistor Sockets**

T018-4 Base Socket	£0.24
T05 Base Socket	£0.24

**IDC Cable Sockets**

10 Way Socket	£0.23
14 Way Socket	£0.35
16 Way Socket	£0.37
20 Way Socket	£0.37
26 Way Socket	£0.38
34 Way Socket	£0.39
40 Way Socket	£0.55
50 Way Socket	£0.80

**IDC Cable Plugs**

10 Way Plug	£0.52
14 Way Plug	£0.58
16 Way Plug	£0.62
20 Way Plug	£0.66
26 Way Plug	£0.70
34 Way Plug	£0.80
40 Way Plug	£0.92
50 Way Plug	£1.12

**PCB Box Headers**

10 Way Straight	£0.23
14 Way Straight	£0.33
16 Way Straight	£0.32
20 Way Straight	£0.41
26 Way Straight	£0.55
34 Way Straight	£0.68
40 Way Straight	£0.75
50 Way Straight	£1.03
10 Way 90°	£0.32
14 Way 90°	£0.39
16 Way 90°	£0.42
20 Way 90°	£0.63
26 Way 90°	£0.82
34 Way 90°	£0.81
40 Way 90°	£1.17
50 Way 90°	£1.14

**PCB Latch Headers**

10 Way Straight	£0.41
14 Way Straight	£0.45
16 Way Straight	£0.51
20 Way Straight	£0.55
26 Way Straight	£0.73
34 Way Straight	£0.88
40 Way Straight	£0.92
50 Way Straight	£1.27
10 Way 90°	£0.46
14 Way 90°	£0.54
16 Way 90°	£0.59
20 Way 90°	£0.81
26 Way 90°	£1.03
34 Way 90°	£1.23
40 Way 90°	£1.41

**DIL Headers**

14 Way DIL	£0.51
16 Way DIL	£0.53
24 Way DIL	£0.90
40 Way DIL	£1.37

**Transition Headers**

10 Way Transition	£0.42
14 Way Transition	£0.42
16 Way Transition	£0.48
20 Way Transition	£0.48
26 Way Transition	£0.52
34 Way Transition	£0.56
40 Way Transition	£0.63
50 Way Transition	£0.84

**D Type Connectors**

9 Way Mole Plug	£0.20
9 Way Female Socket	£0.20
15 Way Mole Plug	£0.28
15 Way Female Socket	£0.29
15 Way H.D. Plug	£0.48
15 Way H.D. Socket	£0.64
23 Way Female Socket	£0.44
25 Way Mole Plug	£0.30
25 Way Female Skt	£0.35

**9DC Ribbon Mounting**

9 Way Mole Plug	£1.08
9 Way Female Socket	£0.93
15 Way Mole Plug	£1.30
15 Way Female Socket	£1.32
15 Way Mole Plug	£1.10
15 Way Female Socket	£1.13
IDC Crimp Tool	£11.80

**Right Angled PCB**

9 Way Mole Plug	£0.33
9 Way Female Socket	£0.33
15 Way Mole Plug	£0.39
15 Way Female Socket	£0.39
15 Way H.D. Socket	£0.58
25 Way Female Socket	£0.50

**Plastic D Covers**

9 Way Cover - Grey	£0.29
9 Way Cover - Black	£0.30
15 Way Cover - Grey	£0.32
15 Way Cover - Grey	£0.38
23 Way Cover - Black	£0.38
25 Way Cover - Grey	£0.34
9 to 9 Cover / Case	£0.80
25 to 25 Cover / Case	£0.84
9 to 25 Cover / Case	£0.80

**Audio Connectors**

2.5mm Jack Plug	£0.25
2.5mm Line Socket	£0.16
2.5mm Chassis Socket	£0.20
3.5mm Mono Plug	£0.20
3.5mm Mono Line Skt	£0.30
3.5mm Mono Chassis	£0.14
3.5mm Stereo Plug	£0.35
3.5mm Stereo Line Skt	£0.35
3.5mm Stereo Chassis	£0.22
4 Mono Plug	£0.34
4 Mono Line Socket	£0.35
4 Mono Chassis Skt	£0.37
4 Stereo Plug	£0.40
4 Stereo Line Socket	£0.38
4 Stereo Chassis Skt	£0.38
Neutrik Speaker Plug	£2.81

**Phono Series**

Red Line Plug	£0.20
Black Line Plug	£0.20
Yellow Line Plug	£0.20
White Line Plug	£0.20
Red Line Socket	£0.20
Black Line Socket	£0.20
Yellow Line Socket	£0.20
White Line Socket	£0.20
Red Chassis Socket	£0.20
Black Chassis Socket	£0.20
Gold Plated Plug Red	£0.66
Gold Plated Plug Black	£0.66

**XLR Series - metal**

3 Pin Line Plug	£0.96
3 Pin Line Socket	£0.96
3 Pin Chassis Plug	£1.50
3 Pin Chassis Socket	£1.49
Neutrik Line Plug	£1.79
Neutrik Line Socket	£1.99
Neutrik Chassis Plug	£2.13
Neutrik Chassis Socket	£2.32

**RF Connectors**

BNC Plug 50Ω Solder	£0.99
BNC Plug 50Ω Crimp	£0.68
BNC Plug 75Ω Solder	£1.08
BNC Plug 75Ω Crimp	£0.68
BNC Chassis Socket	£0.81
F Plug - Twist	£0.24
F Plug - Crimp	£0.26
TNC Plug 50Ω Solder	£1.24
TNC Plug 50Ω Crimp	£0.85
TNC Plug 75Ω Solder	£1.40
TNC Plug 75Ω Crimp	£1.16
UHF Plug 5mm Cable	£0.63
UHF Plug 11mm Cable	£0.75
UHF Chassis Skt - Srd	£0.54
UHF Chassis Skt - Rnd	£0.73

**Terminals**

Colours Red, Black, Green, Blue, White or Yellow	
2mm Solder Plugs	£0.18
2mm Chassis Sockets	£0.28
4mm Plugs - Solder	£0.33
4mm Plugs - Screw	£0.38
4mm Stockable Plugs	£0.40
4mm Shrouded Plugs	£0.74
4mm Chassis Sockets	£0.24
4mm Binding Posts	£0.46
33mm Crocodile Clips	£0.10

**Power Connectors DC Low Voltage**

DC Plug 0.71ID 2.35OD	£0.47
DC Plug 1.31ID 3.40OD	£0.32
DC Plug 1.71ID 4.00OD	£0.47
DC Plug 1.71ID 4.75OD	£0.47
DC Plug 2.11ID 5.00OD	£0.25
DC Plug 2.51ID 5.00OD	£0.24
DC Plug 3.11ID 6.30OD	£0.46
DC Line Socket 2.1mm	£0.57
DC Line Socket 2.5mm	£0.68
DC Chassis Skt 2.1mm	£0.44
DC Chassis Skt 2.5mm	£0.41

**IEC Mains 6A 250Vac**

3 Pin IEC Line Socket	£1.08
3 Pin IEC Line Plug	£1.78
3 Pin Chassis Socket	£0.55
3 Pin Chassis Plug	£0.72

**8 Way Bulgin**

8 Pin Line Plug P551	£3.58
8 Pin Chassis Skt P552	£1.08

**Toggle Switches**

Sub-Miniature 3A 125V 0.250V 5mm Ø Mounting Hole	£0.53
SPST 5 x 10mm	£0.53
SPDT 5 x 10mm	£0.53
SPDT C/Off 5 x 10mm	£1.01
DPDT 9.2 x 10mm	£0.63

**Miniature 6A 125V 3A 250V 6.2mm Ø Mounting Hole**

SPST 8 x 13mm	£0.58
SPST 8 x 13mm	£0.55
SPDT c/off 8 x 13mm	£0.65
SPDT c/o Biased 2 way	£1.15
SPDT c/o Biased 1 way	£1.18
DPDT 12 x 13mm	£0.65
DPDT c/off 12 x 13mm	£0.88
DPDT c/o Biased 2W	£1.20
DPDT c/o Biased 1W	£1.28

**Standard 10A 250V Push on terminals**

12mm Ø Mounting Hole	£1.05
SPST 18 x 30mm	£1.18
SPDT 18 x 30mm	£1.18
SPDT c/off 18 x 30mm	£1.18
DPDT 21 x 30mm	£1.78
DPDT c/off 21 x 30mm	£1.78

**Slide Switches**

Miniature 300mA 125V 7 x 15mm Mounting Hole DPDT 7 x 23mm	£0.18
---	-------

**Standard 1A 125V 5.5 x 12mm Mounting Hole**

DPDT 12 x 35mm	£0.27
DPDT c/o 12 x 35mm	£0.25

**Rotary Switches**

150mA 250V Make before Break 22mm Ø 9.8mm Ø Mounting Hole	
1 Pole 12 Way	£0.84
2 Pole 6 Way	£0.84
3 Pole 4 Way	£0.84
4 Pole 3 Way	£0.84

**Push Switches**

Miniature Round 250mA 125V 28 x 10mm 7mm Ø Mounting Hole Non Latching Push to Make Black, Red, Yellow, Green, Blue or White	£0.23
Non Latching Push to Break Black PTB	£0.24

**Standard Square 1A 250V 39 x 15MM 12mm Ø Mounting Hole**

Non Latching Push to Make Black, Red, Blue or White	£0.60
Latching - push on push off Black, Red, Blue or White	£0.65

**Rocker Switches Miniature**

13 x 19mm Mounting Hole SPST 4A 250V	£0.57
SPST 6A Red Neon	£1.65
SPST 3A Red LED	£1.92
SPDT 6A 250V	£0.75
DPST 4A 250V	£0.81
DPST 4A Red Neon	£1.10
DPST 3A Amber Neon	£1.40
DPST 3A Green Neon	£1.32

**Standard 10(SP,22)(DP) x 30mm Mounting Hole**

SPST 10A 250V	£0.60
SPST 16A 250V	£0.75
SPST 15A Red Neon	£0.90
SPDT 16A 250V	£0.75
DPST 10A 250V	£0.90
DPST 15A Red Neon	£1.18
DPST Amber Neon	£1.25
DPST Green Neon	£1.25
DPDT 10A 250V	£0.90

**Relays PCB Mounting**

1A 24Vdc DPDT 5V	£1.38
3A 110V SPDT 12V	£2.00
3A 110V SPDT 12V	£0.58
3A 110V SPDT 12V	£0.60
5A 110V SPDT 6V	£0.72
5A 110V SPDT 12V	£0.72
5A 110V DPDT 6V	£0.93
5A 110V DPDT 12V	£0.93
5A 240V DPDT 6V	£1.76
5A 240V DPDT 12V	£1.55
10A 240V SPDT 6V	£1.20
10A 240V SPDT 12V	£1.44
10A 240V SPDT 24V	£1.44

**Computer Accessories Adaptors**

9M Gender Changer	£1.73
9F Gender Changer	£1.73
25M Gender Changer	£2.20
25F Gender Changer	£2.43
9 Male - 25 Female	£1.73
9 Female - 25 Male	£1.73
9M - 6 Mini Din Mole	£2.48
9F - 6 Mini Din Female	£2.23
9M Din - 6F Mini Din	£1.73
5F Din - 6M Mini Din	£1.73

**Testers / Patch Boxes**

Mini Tester 7 LEDs	£4.72
Check Tester 18 LEDs	£6.32
Enhanced Switches	£15.18
25D Patch Box M-F	£2.64
Anti-Static Wrist Strap	£4.76
R5232 Surge Protector	£5.43
5A Surge Protector	£6.20
13A Surge Protector	£10.00
4 Gang Surge Block	£10.50

**Leads & Cables**

1.5m Printer Lead	£2.55
2m BD Printer Lead	£2.98
5m BD Printer Lead	£4.98
10m BD Printer Lead	£9.88
2m IEEE1284 Printer L	£4.38
2m IEEE1284 Printer R	£8.90
10m IEEE1284 Printer L	£16.13
Serial Printer 25M-9F	£4.88
Serial Printer 25M-25FE4.38	

**Null Modem Leads**

9 Female - 9 Female	£4.38
25 Female - 25 Female	£6.48
9 Female - 25 Female	£4.38
9F25F to 9F25F	£4.88

**Modem Leads**

25Male to 9Female	£4.08
25Male to 25Female	£3.78

**PC Link Leads**

InterLink 25M to 25M	£3.88
----------------------	-------

**Patch Lead**

25Male to 25Male	£3.60
36Male to 36Male	£2.60

**Boxes & Cases**

Many more sizes available	
3.579545MHz	£0.41
3.6864MHz	£0.41
4.0MHz	£0.41
4.194304MHz	£0.41



# EVERYDAY PRACTICAL ELECTRONICS

INCORPORATING ELECTRONICS TODAY INTERNATIONAL

THE No. 1 MAGAZINE FOR ELECTRONICS TECHNOLOGY & COMPUTER PROJECTS

## VOL. 31 No. 1 JANUARY 2002

**Editorial Offices:**  
EVERYDAY PRACTICAL ELECTRONICS EDITORIAL  
WIMBORNE PUBLISHING LTD., 408 WIMBORNE ROAD EAST,  
FERNDOWN, DORSET BH22 9ND  
Phone: (01202) 873872. Fax: (01202) 874562.  
E-mail: [epe@wimborne.co.uk](mailto:epe@wimborne.co.uk)  
Web Site: <http://www.epemag.wimborne.co.uk>  
EPE Online [www.epemag.com](http://www.epemag.com)  
EPE Online Shop: [www.epemag.wimborne.co.uk/shopdoor.htm](http://www.epemag.wimborne.co.uk/shopdoor.htm)  
See notes on Readers' Enquiries below - we regret lengthy technical enquiries cannot be answered over the telephone.

**Advertisement Offices:**  
EVERYDAY PRACTICAL ELECTRONICS ADVERTISEMENTS  
MILL LODGE, MILL LANE  
THORPE-LE-SOKEN, ESSEX CO16 0ED  
Phone/Fax: (01255) 861161  
E-mail: [epads@aol.com](mailto:epads@aol.com)

## ELECTRONICS COURSES?

A letter received this month indicates that whilst UK colleges have the facilities to offer electronics courses, many do not get enough suitable applicants so the facilities stand unused and courses are not run. However, we know from enquiries made about projects, circuits, components, training material etc., that there are still a good number of people studying electronics. If you have experience of courses not running, lack of candidates, or simply of non-availability, we would be interested to hear from you.

City & Guilds list over 950 UK centres offering IT courses and last year over 1,600 certificates were issued for the introductory level courses on Digital Electronics and Microprocessors. This number has fallen from a high of approximately 1,800 in 1993 but has increased over the last two years from a low of just over 1,000 in 1996. This pattern is mirrored in our sales of p.c.b.s, back issues, books, videos, CD-ROMs etc., which have recently been at their highest level for a good few years.

What worries us is that some of the syllabuses offered have not been changed in the ten years since they were introduced and it would appear that many of the courses on offer do not meet the present needs of the electronics industry.

## INCREASE

EMTA, which is the National Training Organisation for engineering manufacture, aims to increase the number of students on modern apprenticeships from the present 26,000 to 36,000 over the next four years. We understand that approximately one fifth of these are electronics-related apprenticeships.

I wonder if potential students (and their schools) actually know what specialist electronics qualifications and training are presently available. It is an area we hope to investigate and to also let you know more about such things as on-line training, like that provided by learndirect ([www.learndirect.co.uk](http://www.learndirect.co.uk)) and other on-line resources.



**Editor:** MIKE KENWARD  
**Deputy Editor:** DAVID BARRINGTON  
**Technical Editor:** JOHN BECKER  
**Business Manager:** DAVID J. LEAVER  
**Subscriptions:** MARILYN GOLDBERG  
**Administration:** FAY KENWARD  
**Editorial/Admin:** (01202) 873872  
**Advertisement Manager:**  
PETER J. MEW, Frinton (01255) 861161  
**Advertisement Copy Controller:**  
PETER SHERIDAN, (01202) 873872  
**On-Line Editor:** ALAN WINSTANLEY  
**EPE Online (Internet version) Editors:**  
CLIVE (MAX) MAXFIELD and ALVIN BROWN

## READERS' ENQUIRIES

E-mail: [techdept@epemag.wimborne.co.uk](mailto:techdept@epemag.wimborne.co.uk)  
We are unable to offer any advice on the use, purchase, repair or modification of commercial equipment or the incorporation or modification of designs published in the magazine. We regret that we cannot provide data or answer queries on articles or projects that are more than five years old. Letters requiring a personal reply *must* be accompanied by a **stamped self-addressed envelope or a self-addressed envelope and international reply coupons**. All reasonable precautions are taken to ensure that the advice and data given to readers is reliable. We cannot, however, guarantee it and we cannot accept legal responsibility for it.

## COMPONENT SUPPLIES

We do not supply electronic components or kits for building the projects featured, these can be supplied by advertisers (see *Shoptalk*). We advise readers to check that all parts are still available before commencing any project in a back-dated issue.

## ADVERTISEMENTS

Although the proprietors and staff of EVERYDAY PRACTICAL ELECTRONICS take reasonable precautions to protect the interests of readers by ensuring as far as practicable that advertisements are *bona fide*, the magazine and its Publishers cannot give any undertakings in respect of statements or claims made by advertisers, whether these advertisements are printed as part of the magazine, or in inserts.

The Publishers regret that under no circumstances will the magazine accept liability for non-receipt of goods ordered, or for late delivery, or for faults in manufacture.

## TRANSMITTERS/BUGS/TELEPHONE EQUIPMENT

We advise readers that certain items of radio transmitting and telephone equipment which may be advertised in our pages cannot be legally used in the UK. Readers should check the law before buying any transmitting or telephone equipment as a fine, confiscation of equipment and/or imprisonment can result from illegal use or ownership. The laws vary from country to country; readers should check local laws.

## AVAILABILITY

Copies of EPE are available on subscription anywhere in the world (see below), from all UK newsagents (distributed by COMAG) and from the following electronic component retailers: Omni Electronics and Yobo Electronics (S. Africa). EPE can also be purchased from retail magazine outlets around the world. An Internet on-line version can be purchased and downloaded for just \$9.99(US - approx £7.70) per year available from [www.epemag.com](http://www.epemag.com)

## SUBSCRIPTIONS

Subscriptions for delivery direct to any address in the

UK: 6 months £15, 12 months £28.50, two years £52; Overseas: 6 months £18 standard air service or £27 express airmail, 12 months £34.50 standard air service or £52 express airmail. 24 months £64 standard air service or £99 express airmail.

Online subscriptions, for downloading the magazine via the Internet, \$9.99(US - approx £7.70) for one year available from [www.epemag.com](http://www.epemag.com).

Cheques or bank drafts (in £ sterling only) payable to Everyday Practical Electronics and sent to EPE Subs. Dept., Wimborne Publishing Ltd, 408 Wimborne Road East, Ferndown, Dorset BH22 9ND. Tel: 01202 873872. Fax: 01202 874562. E-mail: [subs@epemag.wimborne.co.uk](mailto:subs@epemag.wimborne.co.uk). Also via the Web at: <http://www.epemag.wimborne.co.uk>. Subscriptions start with the next available issue. We accept MasterCard, Amex, Diners Club, Switch or Visa. (For past issues see the Back Issues page.)

## BINDERS

Binders to hold one volume (12 issues) are available from the above address. These are finished in blue p.v.c., printed with the magazine logo in gold on the spine. Price £5.95 plus £3.50 p&p (for overseas readers the postage is £6.00 to everywhere except Australia and Papua New Guinea which cost £10.50). Normally sent within seven days but please allow 28 days for delivery - more for overseas.

Payment in £ sterling only please. Visa, Amex, Diners Club, Switch and MasterCard accepted, minimum card order £5. Send, fax or phone your card number and card expiry date with your name, address etc. Or order on our secure server via our UK web site. Overseas customers - your credit card will be charged by the card provider in your local currency at the existing exchange rate.

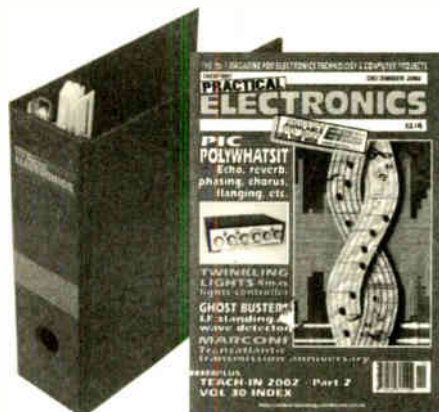

## Constructional Project

# PIC MAGICK MUSICK



**JOHN BECKER**

*Conjure music from thin air at the mere untouching gesture of a finger-tip.*

Having enchanted and puzzled his intimate audience with close-up magic, the lone magician raised his hands and made a grand sweeping gesture of departure, punctuated by the downwards glissando of an ethereal harp, conjured as though from thin air.

Later in conversation with the author, the hotel's magical entertainer showed off the splendid capabilities of his Yamaha keyboard. A superb (and probably very expensive) piece of equipment, it seemed an ideal instrument through which to further spell-bind an audience.

Then, with a less dramatic gesture, he passed his hand over a small hole in the top of the keyboard – again the descending scales of a harp were heard. On being questioned, though, all the magician would say was “there’s a magic beam”!

**I**NTRIGUED by the foregoing wizardry, the author continued to puzzle for several days about what had actually been meant by the magician’s cryptic reply. He did not have an assistant. Was the triggering done by a laser beam being intercepted? Infra-red? Ultrasonics? Quite naturally, thoughts turned to how a similar effect plus individual note playing could be achieved as a hobbyist electronics project.

This, then, was the inspiration for PIC Magick Musick, and the following discussion tells how it is achieved (without, we hope, triggering the wrath of the Magic Circle)!

### HOW TO PERFORM MAGIC?

At first, optical techniques in the form of laser or infra-red diodes and detectors seemed attractive.

It soon became apparent, however, that whilst these could be used to readily trigger a preset series of consecutive notes, it would be extremely difficult to use them if individual notes were to be triggered according to the height at which the optical beam was intercepted.

Theoretically, it is possible to measure the time lag between a light beam being

emitted and its reflected return from a passing hand. Regrettably, though, the speed of light is too Einsteinian-fast for its delayed reflection to be timed by the electronic components typically available to the average hobbyist.

The speed of light is generally taken to be 300,000 kilometres per second (186,000 miles per second). To time its transition across one metre, therefore, would require a detector and timing circuit that could respond in at least 1/300,000,000 of a second.

The response time would need to be even greater if distances varying by only a centimetre or two were to be differentiated. No, such cosmic speeds are beyond hobbyist monitoring!

Optically measuring distance can also be done by sensing the amount of light reflected when a beam of known intensity is emitted. This, though, would require the

target to have a known and constant reflectivity. Hands, by their very human nature, have widely differing reflective qualities. The target’s angle to the source would also be critical so that none of the beam’s intensity became reflected away from the detector. This rules out a waving hand as the target.

What about interferometry, measuring the phase difference between emitted and reflected light beams? Huh! Who’s going to pack that amount of equipment into a box portable enough for gigging stage work? Not even the National Physical Laboratory, that’s for sure!

Ultrasonics, then – what about that? Ah, now we’re getting somewhere reasonable. Sound travels at a mere 332 metres per second, roughly. It’s far more easy to measure short distances using ultrasonic transmitters and receivers. It has been proved in *EPE* several times, using pulsing timing techniques in the author’s *Ultrasonic Tape Measure* (Nov ’98), for instance, and phase differences in the rain sensing circuit of his *EPE Met Office* (Dec ’95/Jan ’96).

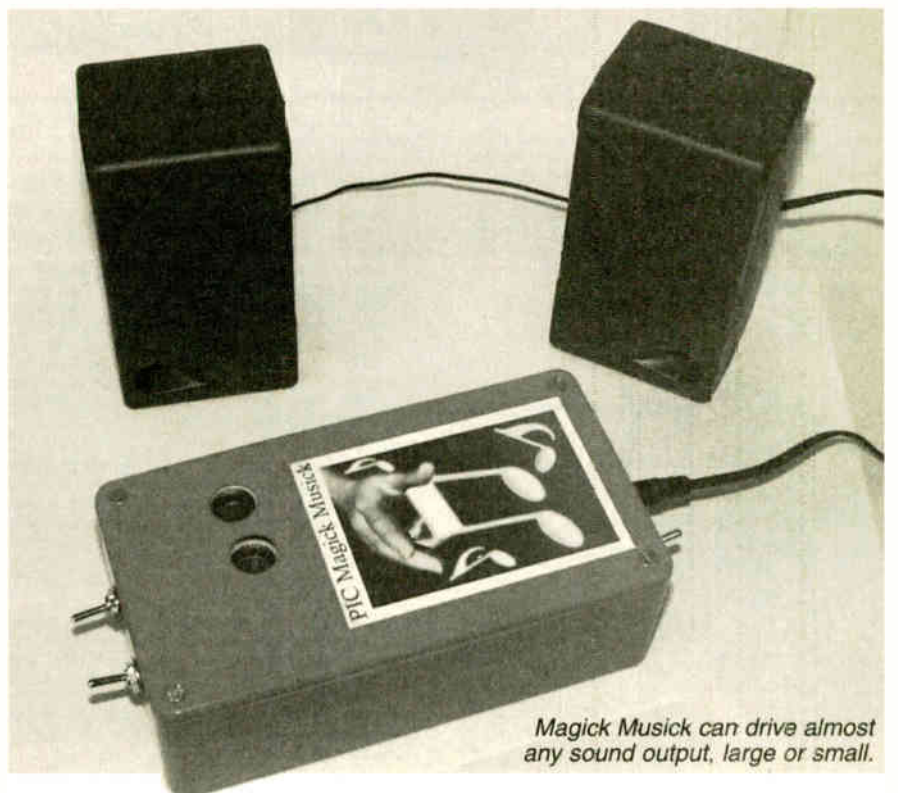

Magick Musick can drive almost any sound output, large or small.





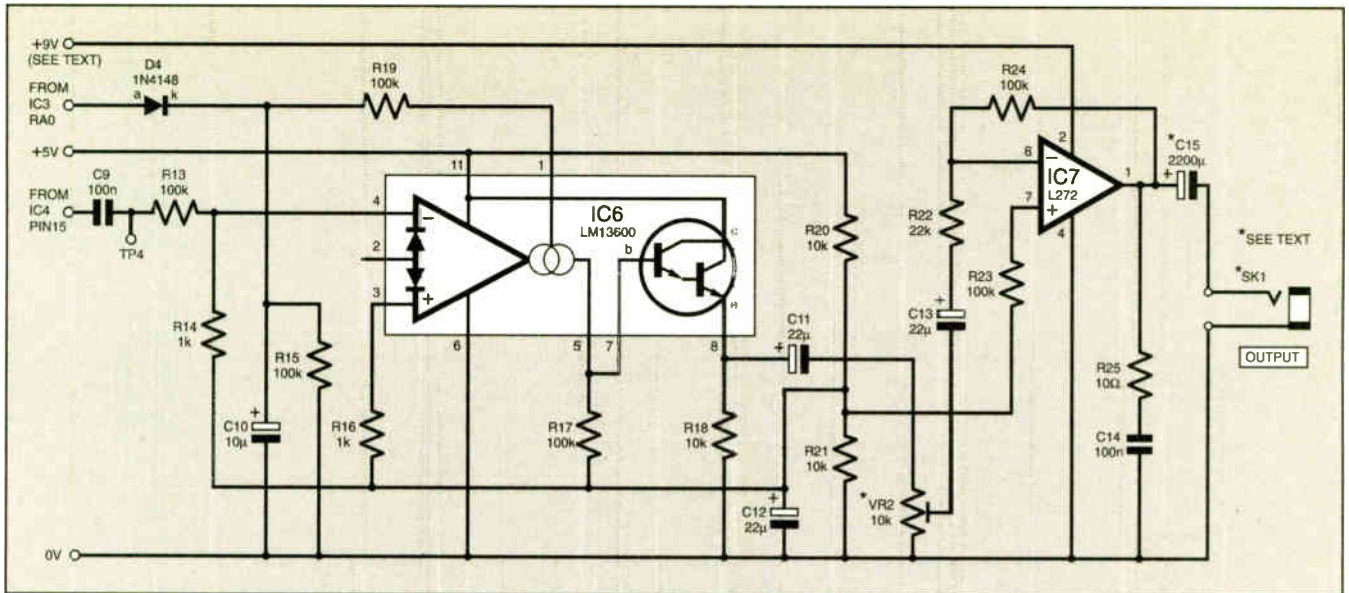

Fig.2. Envelope shaper and audio output stages.

Pins RA0 and RA1 of IC2 output brief push-pull 40kHz pulses to transmitter TX1. Echoes are detected by receiver RX1 and amplified by the serial network comprising op.amps IC1a and IC1b.

The op.amps are biased to a half-rail voltage (2.5V) by the potential divider consisting of resistors R2 and R3. Amplified pulses are output from IC1b pin 1 and are half-wave rectified by diode D1. Capacitor C4 charges to a d.c. level set by the positive-going amplitude of the rectified signals, superimposed on the 2.5V bias.

Preset potentiometer VR1 has two functions: it sets the trigger level to which transistor TR1 responds, buffered by resistor R7, and provides a discharge path for capacitor C4. The voltage at the wiper of VR1 is set to about 0.5V, just below TR1's turn-on level of about 0.6V.

In the absence of an echo pulse, TR1 stays in a turned-off condition, with its collector (c) at +5V. On receipt of pulses above its trigger level, TR1 is turned on and its collector voltage falls to a saturation level close to 0V, as governed by load resistor R8.

### MASKED COUNT

Controller IC2, having transmitted each ultrasonic pulse sequence, waits for the brief "masking time" referred to earlier, and then starts a counting sequence. On detecting a negative-going echo pulse from TR1, it stops the count and analyses its value.

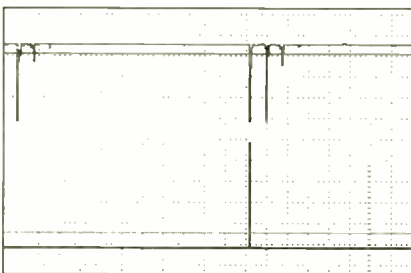

Fig.3. The lower trace shows the ultrasonic transmission pulse. The upper trace shows the "ringing" pulse received during transmission, followed by the required echo pulse, and then by a later, unrequired, minor echo.

If the count is greater than a software-set value, the pulse is considered to have arrived too late. This prevents the unit from being triggered, for example, by echoes from the ceiling above it.

If the count is in range, it is allocated to one of 15 sub-ranges, as a value between 1 and 15. This is output as a 4-bit binary code from pins RB1-RB4 to the second PIC, IC3, which receives them via its pins RA1-RA4.

### FREQUENCY GENERATION

The software for IC3 causes Port B to constantly increment through 63 steps, roll over to zero and step upwards again. The rate at which it increments is set by 15 sub-routines, each of which has a different rate of increment. The binary code received from IC2 determines which sub-routine is in current use. As soon as the code changes, so does the sub-routine. The rate at which the counter increments determines the audio tone that is ultimately heard.

The output from Port B is fed as a 6-bit value to the 8-bit digital-to-analogue converter (DAC) IC4, Texas Instruments type TLC7524, whose bits 6 and 7 are held permanently low. It is configured in the mode most suited to this application in which a binary input value causes an equivalent d.c. voltage (as opposed to current) to appear at its REF (reference) pin. In this mode the DAC has its two "normal" outputs (OUT1 and OUT2) connected to +5V and 0V, respectively (the device's data sheet, which describes the modes of operation, is downloadable free from [www.ti.com](http://www.ti.com)).

Because the input digital value is constantly counting upwards and then rolling over and so on, the output from DAC IC4 is a rising sawtooth (ramp) waveform. Its frequency is that of the musical note required, lying between 131Hz and 523Hz (musical notes C to C"). The waveform is

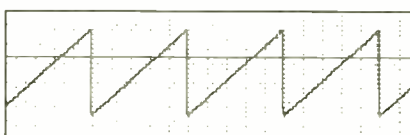

Fig.4. Sawtooth waveform created via DAC IC4.

fed via capacitor C9 and resistor R13 to pin 4 of transconductance amplifier IC6 (see Fig.2).

The reason for using a counter in 6-bit mode is to speed the frequency at which it rolls over (see the later discussion on PIC frequency generation). It also intentionally limits the range of the DAC's output voltage to about 1V peak-to-peak.

### ENVELOPE SHAPING

Transconductance amplifier IC6 is a dual device (of a similar type discussed in *Circuit Surgery* Dec '01) of which only one half is used. It is an extremely versatile device that can be used in many signal control applications. Its data sheet and applications notes are well worth studying and using (obtainable via [www.nsc.com](http://www.nsc.com)).

In this application it is used as a voltage controlled amplifier (VCA) that is under pulsed control as an envelope shaper (a term much favoured in the "golden" music project days of the 1970s and early '80s). It is controlled by the logic level output from IC3 pin RA0.

On receipt of a value that is greater than zero and different to the previous value received, IC3 briefly sets its pin RA0 high and then returns it low until the next different note value is received from IC2.

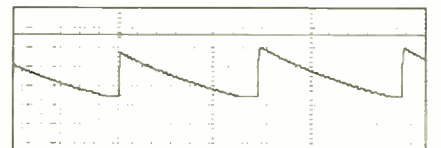

Fig.5. The envelope shaping pulses at capacitor C10.

The output from RA0 is fed via diode D4 (Fig.2) to capacitor C10. The capacitor charges rapidly, and then its voltage ebbs away via resistor R15 (and R19 - more in a moment) once the pulse from RA0 has ended.

The voltage across C10 is also a ramp, rapidly charging to a peak close to 4.3V (+5V - 0.7V voltage drop across D4), and then decaying exponentially in typical capacitor discharge fashion to close to zero volts.

VCA IC6 allows a signal to pass from its input at pin 4 to its intermediate output at



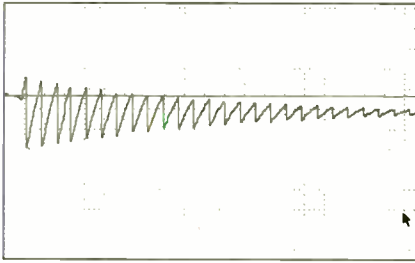

Fig.6. The attack and decay of a note as controlled by the envelope shaper.

pin 5 at an attenuation level set by the current flowing into its control pin 1, and in relation to the value of resistor R17.

The control current is derived from the voltage across capacitor C10 flowing into resistor R19. When C10 is as fully charged as it can be (at the start of the pulse from RA0) the audio signal at pin 4 appears at output pin 8 at the full level required by this application (about 1V peak-to-peak, centred around the midway bias voltage of +2.5V).

When the pulse ceases and the charge on C10 decays, so does the current flowing into IC6 pin 1. As the current falls, so IC6 progressively attenuates the signal appearing at pin 5. When the control voltage on C10 reaches about 0.5V, attenuation is total, and there is no signal output at pin 5. The note length is about three quarters of a second.

Each musical note thus commences at high amplitude and then decays away. This, together with the sawtooth shape of the waveform, creates a sound that is highly

reminiscent of a piano string being struck (perhaps a bit more like a harpsichord).

The current available at IC6 pin 5 is only very small and any significant load placed on it in parallel with resistor R17 would cause the signal amplitude to be reduced. However, IC6 also has a built-in buffer stage, formed by an emitter-coupled Darlington transistor, whose base is connected to pin 5 via pin 7.

The emitter at pin 8 is taken to 0V via resistor R18 and the resulting output voltage is about 1.2V below that at pin 7. The output is a.c. coupled via capacitor C11 to potentiometer VR2 (which may be a preset or a panel-mounted control, as preferred). This controls the maximum signal strength that can be fed to the mini-power amplifier IC7.

### AMPLIFIER STAGE

Amplifier IC7 is capable of outputting about 1W of power and is suitable for coupling into loudspeakers or headphones having impedances as low as 8Ω. The output is a.c. coupled via capacitor C15 and may also be fed into the line-input of a normal domestic amplifier system.

The op.amp has a gain of about  $\times 5$  and the maximum output level is around 3V peak-to-peak. The inclusion of resistor R25 and capacitor C14 give stability to the op.amp. It is a dual device of which only one half is used.

### SWITCHING

Returning to Fig.1, PIC Magick Musick's modes are selected via switches S1 and S2, as follows:

S1	S2	Effect
Off	Off	15-note hand-triggering
Off	On	7-note hand-triggering
On	Off	Automatic scale sequences – cycle of four
On	On	Automatic triggering of user's own theme

### POWER SUPPLY

The circuit is basically run at 5V as regulated by IC5, except for the power amp, which is powered at the full voltage of the power supply. The latter may be any d.c. source between about 7V and 15V. A 9V battery may be used (e.g. PP3). Capacitor C15's voltage rating should be increased to 25V for voltages above 12V.

Maximum current consumption will depend on the amplitude output from the power amp. In the prototype the current was about 14.5mA with no audio output, rising to about 80mA when driving an 8Ω speaker at full amplitude with IC7 powered at 9V.

### CONSTRUCTION

The printed circuit board (p.c.b.) component layout and tracking details are shown in Fig.7. This board is available from the EPE PCB Service, code 332. Assemble in any convenient order you prefer, use sockets for the d.i.l. (dual-in-line) i.c.s, and observe the correct orientation for the polarity sensitive components.

Treat all i.c.s as static sensitive and discharge static electricity from your body before handling them (touch a water pipe or the bare metal of a grounded item of

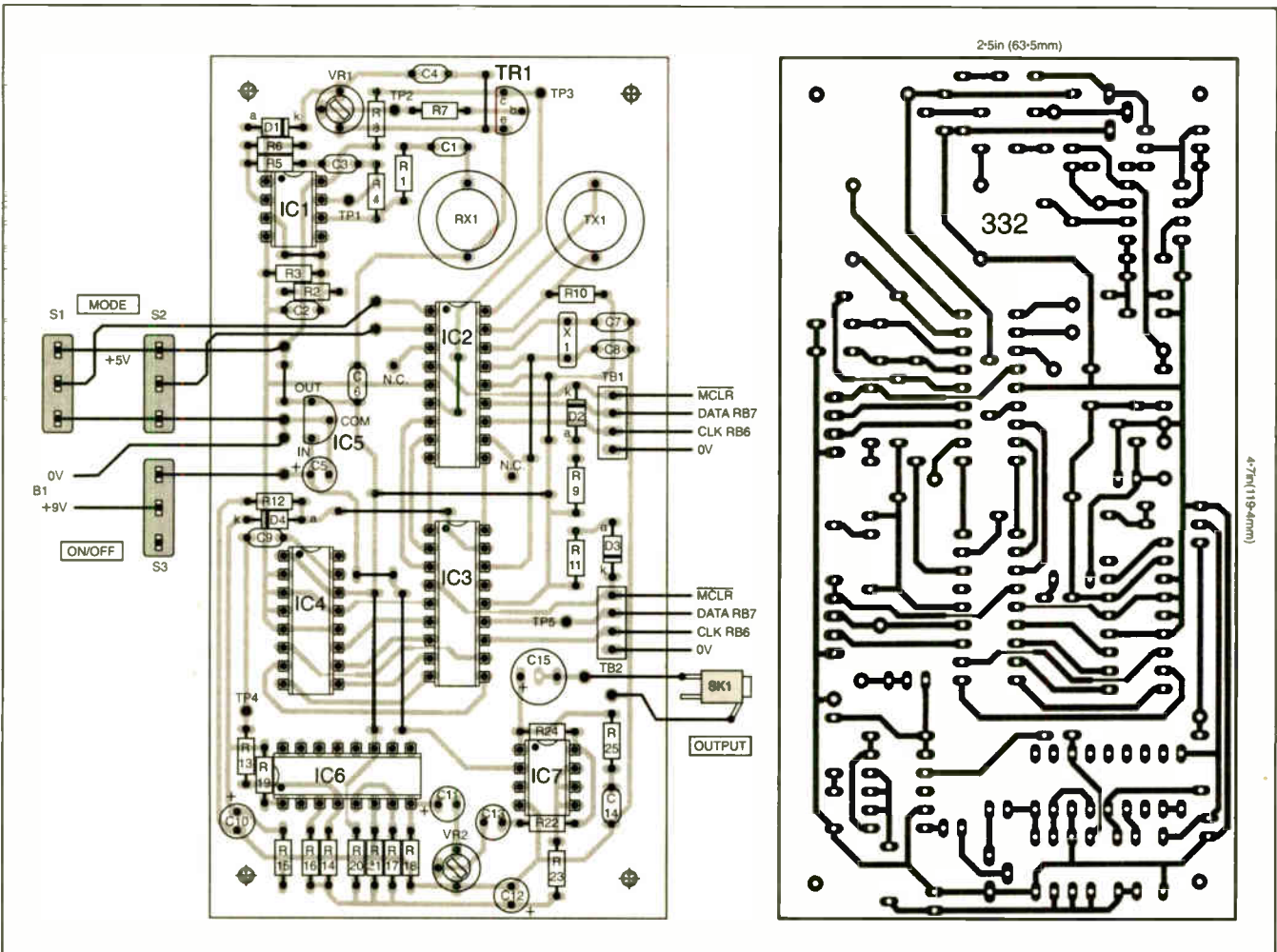

Fig.7. Component layout and full-size copper foil master track pattern.

workshop equipment). Do not insert them until the correctness of your 5V power supply has been established. Once this has been done and assembly completed, you are ready for a bit of magic of your own.

The transducers TX1 and RX1 were mounted on 24s.w.g. enamelled wire 'stalks' so that they were close to the holes drilled in the lid of the case.

## SOFTWARE

Both PICs (IC2 and IC3) are identically programmed. *It does not matter which of your two PICs is put into which IC2/IC3 socket.* The correct transmission or music generation routines are automatically selected depending on the logic level connection made to pin RA0. With IC2, the connection is to the +5V rail via resistor R10. For IC3 it is to the 0V line via resistor R12.

If programming your own PICs using *Toolkits Mk2* or *TK3*, also send file *MagicM04.MSG* to the data EEPROM via the Send Message option. (It only needs to go to PIC IC2.)

## SOFTWARE SOURCES

The software for PIC *Magick Music* is available on 3.5 inch PC-compatible disk from the *EPE* Editorial office, for which a nominal handling charge is made. It is available for free download from the *EPE* ftp site. More details are given on the *EPE PCB Service* page.

The easiest way into the ftp site, however, is via our UK web site at [www.epemag.wimborne.co.uk](http://www.epemag.wimborne.co.uk). From the entry screen click on **FTP Site (Downloads)** at the top, drill down through folders **PUB** and **PICS** and open folder *MagickMusic*.

There are three main software files, the source code (ASM written in TASM), and code for sending to the PIC in two formats: OBJ (TASM) and HEX (MPASM). PIC configuration details for TASM users are given at the top of the ASM file. They are automatically embedded in the HEX file.

There are also four example "notes" files for the data EEPROM, *MagicMxx.MSG* (where xx = 01, 02, 03 and 04).

Readers with *Toolkit Mk2* or *TK3* programmers can program the PICs while in

circuit via pin-headers TB1 (IC2) and TB2 (IC3). Components R9, R11, D2 and D3 prevent programming voltages from distressing the +5V supply line.

## TESTING

For initial testing, place the assembled p.c.b. on a flat surface facing the ceiling and switch on the power. Adjust preset VR1 so that a voltage of about 0.5V appears at its wiper (and at the base of transistor TR1). Set VR2 to maximum volume position (fully clockwise). Plug in a loudspeaker or headphones.

With the switches set to normal "hand-control" mode (both Off), slowly move your hand in from the side to about half a metre above the ultrasonic transducers. *Let there be music* – and hopefully there will be as a note is triggered by a returning echo!

Moving your hand up and down above the transducers, different notes should be played. You should find that there are minimum and maximum hand distances beyond which the notes will not be triggered (see earlier). Experimenting, you should also find that there is a "cone of sensitivity" around the transducers that causes notes to be triggered when it is entered.

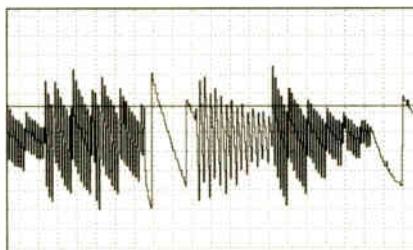
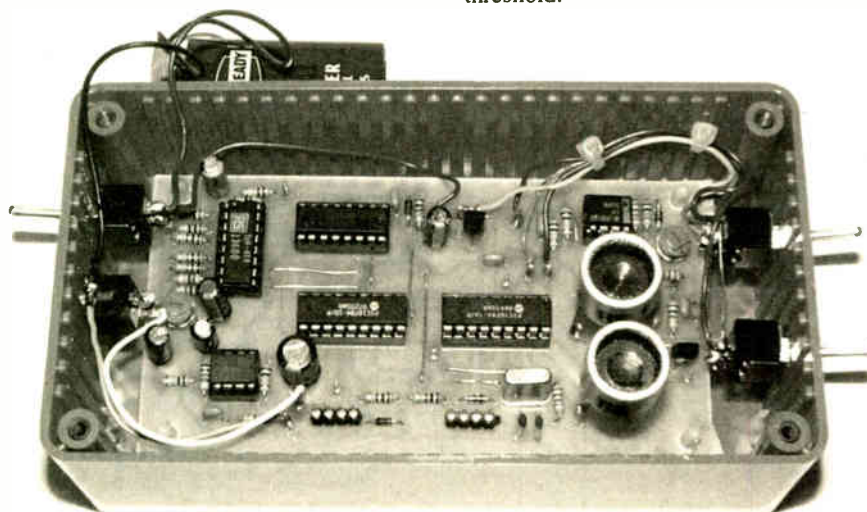

Fig.8. Finger-triggered note sequence.

If you don't achieve immediate success, slightly readjust preset VR1. If the presence of the ceiling is causing triggering (as would be indicated by lifting the board up and down above the bench), reduce VR1's wiper voltage fractionally.

If the triggering range is too small, or non-existent, increase VR1's wiper voltage a bit – but regard 0.55V as being the practical maximum, otherwise you could be setting it too close to TR1's trigger threshold.



Interior layout arrangement. The transducers are mounted on "stalks", see text.

# COMPONENTS

## Resistors

R1, R5, R7, R8, R10, R12, R18, R20, R21	10k (9 off)
R2, R3, R6, R13, R15, R17, R19, R23, R24	100k (9 off)
R4	1M
R9, R11, R14, R16	1k (4 off)
R22	22k
R25	10Ω

All 0.25W 5% carbon film or better

## Potentiometers

VR1	10k sub-min preset, round
VR2	10k sub-min preset, round, or 10k log rotary, panel mounting (see text).

## Capacitors

C1 to C4, C6, C9, C14	100n ceramic, 5mm pitch (7 off)
C5, C11 to C13	22μ radial elect, 16V (4 off)
C7, C8	10p ceramic, 5mm pitch (2 off)
C10	10μ radial elect. 16V
C15	2200μ radial elect, 16V (see text)

## Semiconductors

D1 to D4	1N4148 signal diode (4 off)
TR1	BC549 or similar gen. purpose npn transistor
IC1	LM358 dual op.amp
IC2, IC3	PIC16F84-4P microcontroller (2 off, identically pre-programmed, see text)
IC4	TLC7524 8-bit digital-to-analogue converter
IC5	78L05 +5V 100mA voltage regulator
IC6	LM13600 or LM13700 dual transconductance amplifier
IC7	L272 dual power op.amp

## Miscellaneous

RX1, TX1	40kHz ultrasonic transducer matched pair (transmitter plus receiver)
S1, S2	s.p.d.t. min. toggle switch (2 off)
S3	s.p.s.t. or s.p.d.t. min. toggle switch
SK1	3.5mm jack socket
X1	4MHz crystal

Printed circuit board, available from the *EPE PCB Service*, code 332; 8-pin d.i.l. socket; 14-pin d.i.l. socket; 16-pin d.i.l. socket; 18-pin d.i.l. socket (2 off); 1mm 4-way pin-headers, 0.1in pitch (2 off) (see text); plastic case to suit, 150mm x 80mm x 50mm; 9V battery and clip (see text); enchantable audience (many); connecting wire; solder, etc.

Approx. Cost  
Guidance Only

**£35**  
excluding case & batt.



## THEME TUNES

Users of *EPE PIC Toolkits Mk2* and *TK3* will find that writing theme tunes for downloading into PIC IC2's data EEPROM is as easy as writing program code – perhaps easier!

Using your preferred text editor, one way is to write a sequence of 64 numbers whose values lie between 0 and 15, as illustrated in file *MagicM02.MSG*. Save them as a *Toolkit* Message file (extension .MSG). Then send the file contents to PIC IC3 via *Toolkit's* Send Message option. Job done! Next time you trigger PIC *Magick Musick* when switch S1 and S2 are both in the On position, your programmed notes will be generated.

A second melody writing technique is to use alphabet letters relating to the notes required, as illustrated in file *MagicM01.MSG*. Lower case a-f are the notes for octave 1, upper case A-F for octave 2, and upper case H for top C (C<sup>''</sup>). A further example is in *MagicM03.MSG*.

But, you may ask, what numbers should I use? Ah, that's where your talents as a composer come into play! The options are shown in Table 1.

Column 1 shows the value to be written into your MSG text file. Column 2 shows the letter that could be entered instead. Column 3 shows the name that is given to the resulting note when its frequency equals that in column 4. Column 5 shows the approximate frequency that should be expected from PIC *Magick Musick*.

**Table 1. PIC music program note values, musical names, ideal (calculated) and prototype-generated frequencies (the latter may vary slightly between units).**

Value	Alpha	Note	Ideal Hz	Prototype Hz
0	--	--	none (pause)	
1	c	C	130-813	129.9
2	d	D	146-832	146.9
3	e	E	164-814	163.9
4	f	F	174-615	175.0
5	g	G	195-998	194.5
6	a	A	220-000	222.1
7	b	B	246-941	246.7
8	C	C'	261-625	263.3
9	D	D'	293-664	292.9
10	E	E'	329-627	330.1
11	F	F'	349-229	352.4
12	G	G'	391-995	397.1
13	A	A'	440-000	442.0
14	B	B'	493-883	498.4
15	H	C''	523-251	532.4

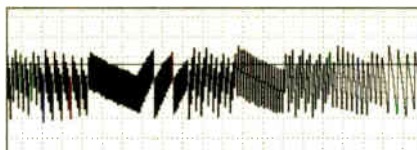

Fig.9. Part of the downwards 15-notes scale.



Fig.10. Envelope shaping waveform when 7-note scale is played.

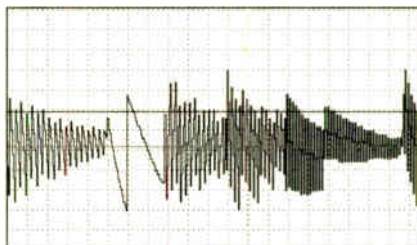

Fig.11. Ascending 7-note scale.

Another option is to use a random melody, created by loading any 64 characters of a text file. This is how the theme pre-installed (*MagicM04.MSG*) into the PICs is created. It consists of the first 64 characters of the first line in this article (*Having enchanted . . .*).

The software automatically ANDs the ASCII values of the characters with 15, so that they trigger one of the 15 notes available. Spaces, punctuation etc. may all be left in. Any resulting zero value simply creates a pause.

Once triggered, the scales and melody run their full course before another hand movement or switch setting comes into effect.

## FREQUENCY PRECISION

As the author has discussed in previous PIC controlled music generating designs, such as *PIC-olo* (Aug '97) and the *PIC Musical Sundial* (Jun '99), it is impossible to actually program a PIC to generate truly accurate musical notes. A compromise has to be accepted.

Software-generated frequencies depend on the time between a register value being taken high and low. For instance, if bit 0 of a Port register is taken high, held there for half a second, and then taken low for half a second, and the cycle constantly repeated, the resulting output at Port register pin 0 is a 1Hz square wave.

It will be obvious that with a PIC's oscillator running at a high rate, timing of the pause lengths between the cycle phases of a slow frequency square wave can be very accurately adjusted, because there are many PIC program cycles that take place during them. Frequency adjustment can be made minutely just by increasing or decreasing the count values between each phase by just one cycle.

In the case of a PIC running at an effective rate of 1MHz (i.e. its crystal clock is running at 4MHz), the precise value of a nominal 1Hz output frequency can be adjusted by a mere one millionth of a second, the duration of just one command.

Look at the other extreme, though. Again suppose the PIC's effective rate is 1MHz and we want to output a frequency via PORTB pin 0 (RB0). The fastest output frequency generating routine is:

```
HERE: INCF PORTB,F
      GOTO HERE
```

Two commands are involved, between them taking 2µs, thus to complete a full square wave cycle takes 4µs, an output frequency rate of 250kHz.

This rate cannot be increased without changing the basic clock rate. It can, however, be slowed by the addition of one command, NOP for example. There are now six commands to the square wave cycle, and an output rate of approximately 167kHz. Adding another NOP reduces the rate to 125kHz.

There are no intermediate frequencies that can be generated between either of the above frequency pairs with a 4MHz crystal controlled clock.

## LOOPED DELAYS

Although the required output frequencies for a PIC music-generating design are much slower than these examples, a similar principle prevents truly accurate music frequencies being developed.

A simplified example of frequency generation as it is done in PIC *Magick Musick* is shown in Listing 1.

Listing 1a provides a look-up table in which the PORTA value causes a jump to the correct note generating routine, one of which is shown in Listing 1b.

Here the routine is for note G, which has an approximate frequency of 195Hz. LOOPB is loaded with a delay value of 21, and then is decremented to zero. After two additional delaying commands, a jump is made to the OUTIT routine in which PORTB is incremented, and a jump made back to label TONE.





### LISTING 1a

```

ROUTE: movf VALUE,W ; VALUE holds code received via
        PORTA
        andlw 15 ; it's limited to 15
        addwf PCL,F ; added to the Program Counter, to
                    ; cause a value related jump:
        goto BVL ; 0 not used
        goto CL ; 1
        goto DL ; 2
        goto EL ; 3
        goto FL ; 4
        goto GL ; 5
        goto AL ; 6
        goto BL ; 7
                    ; etc

```

### LISTING 1b

```

TONE: goto ROUTE ; do required table jump
GL: movlw 21 ; set loop val for note 5, G 195Hz
     movwf LOOPB
GLa: decfsz LOOPB,F ; decrement loop until zero
     goto GLa
     nop ; timing adjustment
     nop ; timing adjustment
     goto OUTIT ; go and increment PORTB output
                    ; value
                    ; other note generators here
OUTIT: incfsz PORTB,F ; is PORTB value zero?
     goto TONE ; no
     (yes, so get PORTA value routine here)
     goto TONE

```

Even though it is known that the PORTA value has not been changed at this time, the seemingly unnecessary jump again to the look-up table helps to keep the frequency generation even.

When PORTB rolls over to zero, PORTA is read for its current value. If the value is the same as the previous sample, note G routine is again repeated. If a new value is found, the table automatically routes to the appropriate delay routine.

Each note's delay routine has a different LOOPB value, and varying quantities of NOP commands. These help to "tune" the frequency as close as possible to that ideally required.

In the note G example shown, the actual frequency required is 195.998Hz. The prototype produced a frequency of 194.5Hz (measured on PICGEN of July '00). Deleting one NOP to raise the frequency generated 196.9Hz. Adding one more NOP to slow it, resulted in 192.2Hz.

As illustrated earlier, the higher the required frequency, so it becomes increasingly difficult to tune software to produce it. Where the decision has been marginal, the author has generally erred for a frequency fractionally higher than the ideal.

### WAVEFORM SHAPE

It may at first sight seem that the note loops have a low value compared to the frequency expected when using a 4MHz crystal clock. Had just PORTB pin 0 been

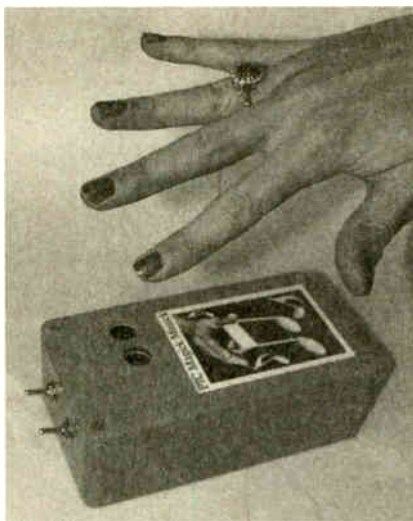

the frequency output source, generating a square wave, much higher loop counts could have been used, allowing much tighter control of the actual frequency being output.

However, the aim with PIC Magick Music was to generate a non-square waveform. Experiments were tried using sine and triangle generating algorithms, but a sawtooth was felt to produce a more interesting sound.

Its generation, though, takes 64 clock cycle steps at PORTB (used as the 6-bit counter referred to earlier), bringing the

note delay loop rates down by the same amount. Originally, 256 PORTB steps were tried, but the frequency results were too low to be acceptable.

Using 256 steps (8-bit) also produced a waveform amplitude greater than required to suitably drive the power amp via the envelope shaper. The 6-bit value basically results in a DAC output swing of about 1V peak-to-peak.

### WIZARD FUN!

Whilst music "purists" may wonder if some notes have a frequency that might not be fully welcomed in a concert hall, remember that PIC Magick Music is an inexpensive *fun* design. Had greater tuning accuracy really been desired, considerably more complex techniques would have been needed – at much greater cost.

When PIC Magick Music was demonstrated at EPE HQ, the author was delighted by the positive response it received. It is, he has to say proudly, a super little design which can generate lots of fun for anyone using or hearing it. You've just got time before the festivities to build one, and maybe even program it with an appropriate jingle.

Magick Season's Greetings from a would-be PIC Wizard!

The waveform "screen dumps" were created via the author's PIC Dual-Channel Virtual Scope of Oct '00. □

# Radio Bygones

The leading magazine  
for vintage radio  
enthusiasts

WHETHER your interest is in domestic radio and TV or in amateur radio, in military, aeronautical or marine communications, in radar and radio navigation, in instruments, in broadcasting, in audio and recording, or in professional radio systems fixed or mobile, RADIO BYGONES is the magazine for you.

ARTICLES on restoration and repair, history, circuit techniques, personalities, reminiscences and just plain nostalgia – you'll find them all. Plus features on museums and private collections and a full-colour photo-feature in every issue.

ITS MOSTLY about valves, of course, but 'solid-state' – whether of the coherer and spark-gap variety or early transistors – also has a place.

FROM THE DAYS of Maxwell, Hertz, Lodge and Marconi to what was the state-of-the-art just a few short years ago . . .

THERE IS ALSO a selection of free readers' For Sale and Wanted advertisements in every issue.

## Radio Bygones covers it all!

THE MAGAZINE is published six times a year, and is only available by postal subscription. It is not available at newsagents.

We accept Visa, Mastercard, Amex, Diners Club and Switch. Minimum card order £5.

TO TAKE OUT a subscription, or to order a sample copy, please contact:

RADIO BYGONES, Wimborne Publishing Ltd.,

408 Wimborne Road East, Ferndown, Dorset BH22 9ND.

Tel: 01202 873872. Fax 01202 874562.

Web sites: [www.radiobygones.co.uk](http://www.radiobygones.co.uk)

[www.radiobygones.com](http://www.radiobygones.com)

Now Also  
Available To  
**BUY ONLINE**  
[www.radiobygones.com](http://www.radiobygones.com)  
Log on, pay by credit card  
and download the magazine  
to your PC  
ONLY **\$9.99** (US dollars)  
**FOR 6 ISSUES**  
A free issue is  
available

## BLOWING UP THE AUDIO

Patented inflatable audio speakers are capable of producing stereo sound - whatever NXT? asks Barry Fox.

**L**OUDSPEAKERS are big heavy boxes containing air, that are awkward and expensive to move around. Soundtube in Utah and Ellula in the UK have been thinking laterally about this. Both companies are working on inflatable speakers which fold flat. Users just put air in when they get where they are going.

Conventional speakers use an electromagnetic transducer with cone diaphragm that pumps air. The transducer is mounted on the front panel of a sealed cabinet, sometimes with an air vent. Large transducers in large boxes are needed to generate loud sound. Rock groups must hire large trucks to ship speakers around the country, with tough "roadies" to hump and heave them onto the stage.

Soundtube Entertainment ([www.soundtube.com](http://www.soundtube.com)) makes speakers for entertainment and sports venues, as well as churches. The company says it takes a "unique approach to design" and is now developing inflatables that rock groups can carry flat and blow up when they arrive. The company is cagey about details but patents filed around the world (WO 01/54541) describe an "inflatable speaker assembly".

A conventional cone transducer is bolted to a flat rigid board, and the board is bonded to a large bladder. When compressed gas is released into the bladder, it expands to form a light enclosure that resembles a conventional cabinet. Fire retardant gas or powder can be used for safety, and the bladder has several chambers so that a puncture does not collapse the entire structure. At the end of the gig, the roadies use a vacuum pump to flatten the bladder.

"Getting the structure rigid is the challenge" admits a company spokesman.

### Watered Down

Twenty years ago British speaker company Wharfedale had a similar idea; light hollow cabinets would be shipped empty and then filled with water to give them strength, mass and rigidity. But the clever design never escaped from Wharfedale's research lab.

British company Ellula Sounds ([www.ellula.com](http://www.ellula.com)) is a spin-off from Loughborough University which licensed the flat panel speaker system developed by British company NXT. Ellula will soon sell small inflatable speakers, like gaily-coloured audio beachballs, for use with portable stereos and PCs. The flat panel produces sound which makes the entire inflatable resonate. Ellula's inflatable portables will cost around £30 a pair.

The Ellula inflatable neatly sums up the way NXT's plans have changed in the five years since the company was founded.

### NXT's Arrival

New Transducers Ltd was launched in late 1996 by Farad Azima of Mission and

parent Verity, with high profile plans for flat hi-fi loudspeakers. The industry was pleasantly surprised at the sound quality, although low bass had to be generated by a separate, conventional driver. Verity had bought public address technology from the MoD's Defence Research Agency, and given it hi-fi potential.

Since then NXT has filed literally thousands of patents around the world on virtually every conceivable use for flat speakers. This is a very expensive strategy, which commits the company to payment of official Government fees, patent attorney fees, translation costs, the cost of arguing the applications through Patent Offices and then paying annual renewal fees for up to 20 years.

Although NXT will not say how much this is costing, its annual report shows operating expenses and losses of around £15 million a year; share price has fallen from inflated highs of over £25 to the current depressed and depressing level of around £1.

"What the city worries about", says Andrew Williams, NXT's new marketing director, "is whether we have enough

money to see us through until the business starts making a profit".

Currently NXT has around £22 million in the kitty, most of it raised from investors who bought shares in the company and have now seen their value plummet. Farad Azima has stepped down as chairman and David Pearson, formerly with Sony UK, came in as chief executive in March 2000.

### Short on Hi-Fi

There is still only one genuine hi-fi product, the Icon, costing £2500 per pair and made by Cyrus, owned by NXT. The Icons are floor-standing cabinets with built-in conventional low frequency drivers. All the other NXT speakers are lo-fi, mid-fi, packaged with home cinema system or novelties like the Ellula inflatables.

"There are more projects in the automobile industry, and for phones and consumer audio, but we are not allowed to talk about them until they are ready", says Andrew Williams. "We expect to see car systems in 2004 or 2005 and telephones by 2003."

"We are committed to husbandry of our resources and rationalizing costs", says Andrew Williams, confirming that this means no longer patenting everything in all countries and "prioritising with different levels of protection in different countries, based on different levels of importance".

For more information contact New Transducers Ltd, 37 Ixworth Place, London SW3 3QH. Tel: 020 7343 5050.

Fax: 020 7343 5055.

Email: [marketing@nxtsound.com](mailto:marketing@nxtsound.com).

## BROTHERLY LABELLING



THE Brother P-Touch 1250 labelling machine seems just the job for the home electronics constructor who wishes to label workshop storage boxes and other containers.

The unique navigation dial and true QWERTY keyboard make the PT-1250 simple and convenient to use. Not even scissors are necessary as the machine will cut the label to your required length with one click of a button. Different text sizes, fonts and formats and two-line printing are also easy to achieve, and you can clearly see what's been typed via the 8-character display screen.

The PT-1250 costs around £50 and can be run off either a mains adaptor or batteries. It can be purchased through

branches of stationery company Staples. Other stockist information and brochure requests can be obtained through Brother, tel: 0845 6060 626, or via web site: [www.brother.co.uk](http://www.brother.co.uk).



## TABLE-TOP TV REDEFINED



LG Electronics tell us that they have demonstrated a prototype of what they call a "table-top" TV screen – size 52 inches (132cm)!

Apparently, the screen uses Texas Instruments' Digital Light Processing technology. At its heart is the Digital Micromirror Device optical sensor chip. This has an array of up to 1,310,000 hinged, microscopic mirrors which operate as optical switches to create a high resolution, full colour image (visit [www.dlp.com](http://www.dlp.com)).

The technology is widely used in a broad range of projection and display applications. It is said to achieve the clearest, sharpest, brightest and most accurate images.

A number of manufacturers are expected to announce home entertainment products based on the technology during 2002. But calling a 132cm screen "table-top" seems extraordinary. Where do you put the food plates with *that* in front of you? Puts a new light on the phrase *TV Dinners*, though!

## ESR's New Cat

ESR Electronic Components have sent us their latest catalogue, 54 pages of it, not to mention the numerous additional flyers and enclosures. ESR have established themselves as company upon whom readers can rely for an extensive range of those components that are vital to the everyday business of managing our hobby. You will no doubt be aware that ESR have a selected range of kits for *EPE* constructional projects.

Not only does the catalogue contain wide varieties of passive and active components, from capacitors to semiconductors, but it also has a good range of printed circuit board production materials, from drills to laminates, chemicals to etching tanks and guillotines. Also featured are books and camera modules.

For more information contact ESR Electronic Components, Dept *EPE*, Station Road, Cullercoats, Tyne & Wear NE30 4PQ. Tel: 0191 2514363. Fax: 0191 2522296.

Email: [sales@esr.co.uk](mailto:sales@esr.co.uk).

Web: [www.esr.co.uk](http://www.esr.co.uk).

## Mini Humanoids

FUJITSU Automation and Fujitsu Laboratories have announced that they have jointly developed a new miniature humanoid robot, named HOAP-1 (Humanoid for Open Architecture Platform). HOAP-1 has been designed for wide applications in research and development of robot technologies.

Weighing 6kg and standing 48cm tall, the light and compact HOAP-1 and accompanying simulation software can be used for developing motion control algorithms in such areas as two-legged walking, as well as in research on human-to-robot communication interfaces.

For more information: [www.fujitsu.com](http://www.fujitsu.com).

## Anti-vandal Cam

STORTECH Electronics' Pecan range of security cameras has been installed onto 550 West Midlands buses and they are successfully deterring vandalism, which is reported to cost the bus company, Travel West Midlands, around £1 million a year on its fleet of 1800 buses.

The buses typically have three to four cameras strategically placed and connected to a duplex multiplexer that rapidly scans between cameras. The driver has a small liquid crystal display in the cab which can show one or four images at any one time. All camera video activity is recorded for possible police use. Originally recording was made onto tape, but more recent installations record the data digitally.

Stortech's Pecan range of high quality CCTV cameras includes vandal-proof, covert, discreet and weatherproof cameras.

For more information contact Paul Freeman-Sear at Vector Marketing Communications. Tel: 01442 877167. Email: [paul.freeman-sear@vector.co.uk](mailto:paul.freeman-sear@vector.co.uk). Stortech Electronics of Harlow, Essex can be contacted directly through Paul Elsey, tel: 01279 419913.

## Robot Show

PRACTICALLY everyone with an interest in robots will no doubt wish to attend *The Robot Show* at Olympia in London next year.

For three days, 5 to 7 July 2002, thousands of professionals, research students, enthusiasts and consumers, are expected to visit Olympia to see the biggest display of all the latest robotic devices, developments and applications ever under one roof.

Manufacturers will have an opportunity to attract the best emerging talent in robotics and demonstrate just how far robot automation influences our lives now. They will also meet production/processing heads who will receive personal invitations to the show.

The show will bring researchers and manufacturers together and help hundreds of companies and organisations to successfully target an audience fascinated with robots. Interactivity is a feature of the show with many exhibitor-led demos and competitions, in addition to the show demos.

Visit web site [www.robotshow.co.uk](http://www.robotshow.co.uk) for information on the exhibition, demonstration arena, seminar programme, floor plans and visitors. Otherwise, phone Malcolm McGow on 0207 610 3001, mentioning *EPE*.

## FML Electronics

THE 2002 mail order catalogue for FML Electronics has arrived at HQ. "Extremely detailed" is the first phrase that comes to mind when looking at its 24 A4-size pages full of compact columns of condensed type. The first 12 pages are entirely filled with semiconductors - it seems that if it's not listed here it's probably not available anywhere!

The remaining pages cover non-semiconductor items, such as resistors, capacitors, switches, p.c.b. materials, relays and solenoids. Computer and office equipment is featured, as are surface mount devices and development packs.

FML welcomes all enquiries, including those from schools, Government and the Trade, and of course, hobbyists.

For more information contact FML Electronics, Dept *EPE*, Freepost NEA 3627, Bedale, N.Yorks DL8 2BR.

Tel: 01677 425 840.

Email: [fml.electronics@breathemail.net](mailto:fml.electronics@breathemail.net).

## Lighter Snoring

SLEEPING partners, and their pets, may be excused hoping that Graham Brooks of Stockport does not have too much success with his recent patent, GB 2359 490.

Brooks noticed that people stop snoring when there is lightning. Because lightning is not available to order, he built a modified xenon photo strobe which is placed near the snorer's head and emits 12 flashes a second for five seconds. The flasher is triggered by a sound sensor which has memorised the individual snore pattern of the snorer.

He says the system has also been "successfully used to abate snoring in dogs and other animals".

# CROWNHILL PIC BASIC

Write and compile your first program in under 5 minutes  
Distribute your applications ROYALTY FREE  
Technical Support direct from the author  
Dedicated user group mailing list  
Easy to navigate Windows IDE  
CDROM includes software and example programs  
Book Includes worked examples and projects  
Supports the popular PIC micro's including Flash devices

## PIC BASIC PRO



Crownhill PIC BASIC PRO produces tight concise code from your programs, written in the easy to learn yet powerful BASIC language. The compiler will produce code for the popular 12-bit and 14-bit micros.

For a FREE LITE version of PIC BASIC PRO visit [www.letbasic.com](http://www.letbasic.com)

The PICBASIC PLUS Compiler presents a range of interfacing solutions for the most exotic peripherals. Such as the I2C bus, Alphanumeric and Graphic types of LCD, and 2 or 3-wire SPI.

A FREE Lite version of PIC BASIC Plus! is available from [www.letbasic.com](http://www.letbasic.com)

## PIC BASIC PLUS



LITE versions of both products are available from [www.letbasic.com](http://www.letbasic.com)

For more in-depth information about our products please visit our website at [www.letbasic.com](http://www.letbasic.com)

Crownhill Associates Ltd  
32 Broad Street Ely Cambridge CB7 4AH  
Tel: 01353 666709 Fax: 01353 666710  
Order Online: [www.letbasic.com](http://www.letbasic.com)

all prices exclude delivery and VAT @ 17.5%

Free Download @ [www.letbasic.com](http://www.letbasic.com)



# INGENUITY UNLIMITED

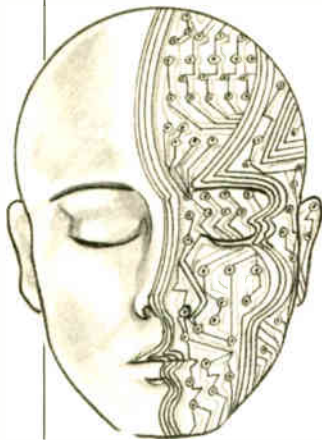

Our regular round-up of readers' own circuits. We pay between £10 and £50 for all material published, depending on length and technical merit. We're looking for novel applications and circuit designs, not simply mechanical, electrical or software ideas. Ideas *must be the reader's own work and must not have been submitted for publication elsewhere*. The circuits shown have NOT been proven by us. *Ingenuity Unlimited* is open to ALL abilities, but items for consideration in this column should be typed or word-processed, with a brief circuit description (between 100 and 500 words maximum) and full circuit diagram showing all relevant component values. **Please draw all circuit schematics as clearly as possible.** Send your circuit ideas to: Alan Winstanley, *Ingenuity Unlimited*, Wimborne Publishing Ltd., 408 Wimborne Road East, Ferndown Dorset BH22 9ND. (We do not accept submissions for *IU* via E-mail.) Your ideas could earn you some cash and a prize!



## WIN A PICO PC BASED OSCILLOSCOPE

- 50MSPS Dual Channel Storage Oscilloscope
- 25MHz Spectrum Analyser
- Multimeter • Frequency Meter
- Signal Generator

If you have a novel circuit idea which would be of use to other readers then a Pico Technology PC based oscilloscope could be yours. Every six months, Pico Technology will be awarding an ADC200-50 digital storage oscilloscope for the best *IU* submission. In addition, two single channel ADC-40s will be presented to the runners-up.

## Precision UV Timer - Get It Right

**F**OR consistent results when producing printed circuit boards, precise control of the ultra-violet exposure period is important. The circuit diagram shown in Fig.1 is intended to control a UV exposure box, but it could easily be adapted to control any mains powered device that needs to be switched off after a few minutes.

The circuit works by dividing the very accurate 50Hz (UK) mains signal by 1500 to give a high output every 30 seconds, which is then used to clock a decade counter for a pre-determined amount of time. This in turn operates a relay to cut the power to the controlled device.

Mains power is applied via switch S1 to the primary of transformer T1, which can have an output from 5V to 15V a.c. (the writer used 12V - ARW). Before the output from T1 is rectified and smoothed, the a.c. waveform is rectified via diode D7 and passed to the clock input of IC1, a 12-stage binary counter. When the circuit is initially turned on, a high pulse is produced by capacitor C2 which resets IC1 and decade counter IC3 via diodes D5 and D6; the logic can also be manually reset by pressing switch S2.

After 30 seconds, the Q3 to Q5, Q7 and Q9 outputs of IC1 as shown, go high and are fed into IC2, a triple 3-input AND gate configured as a 7-input AND gate. Both IC1 and IC2 combine to act as a divide by 1500 circuit, which produces a high output pulse every 30 seconds. This output is used to reset IC1 via diode D8 and is also used as the input for IC3.

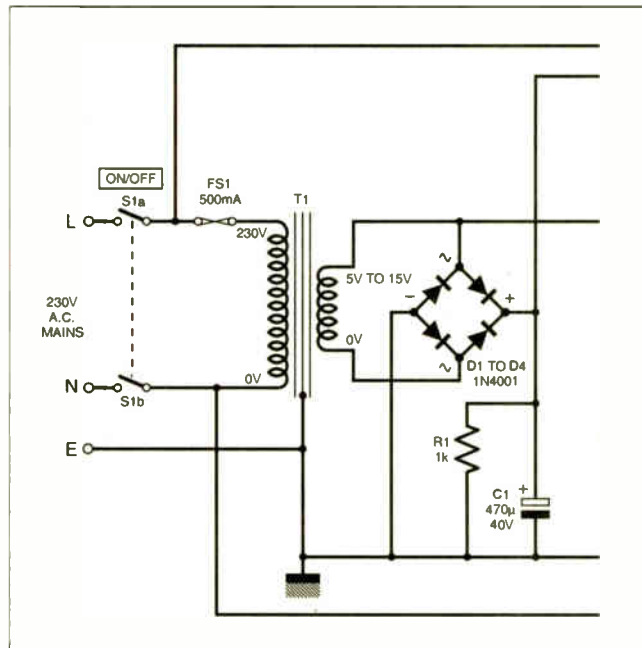
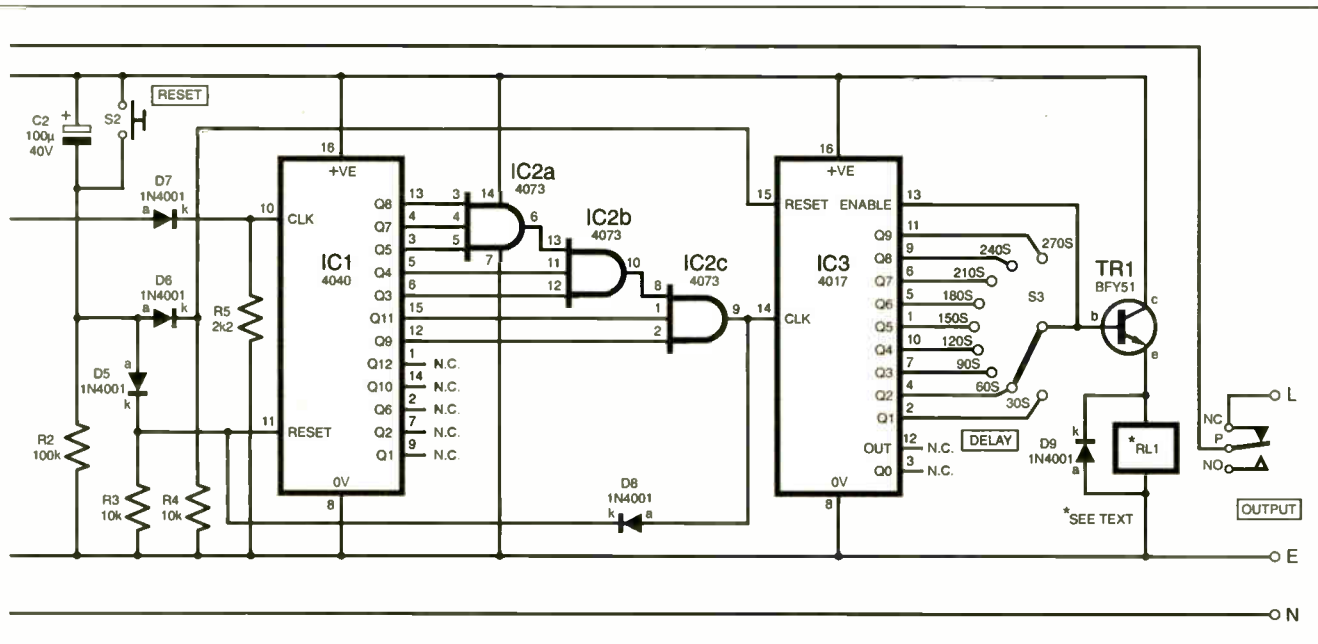

Fig. 1. Precision UV Timer circuit diagram. Switch S3 gives a delay of 30 seconds to 4½ minutes.



# Transistor/Diode Checker - Go/No Go

**WHY NOT SEND US YOUR CIRCUIT IDEA?**  
Earn some extra cash and possibly a prize!



Delay switch S3 selects the desired Q1 to Q9 outputs of IC3; Q1 produces a 30 second delay after which the load will be switched off. The other outputs increment in 30 second steps up to 4½ minutes.

Once the pre-determined period has elapsed, the Enable input (pin 13) of IC3 is held high which disables further counting. With the output of IC3 latched high, transistor TR1 (any general purpose medium npn transistor) switches on relay RL1. This must have the same coil voltage to match mains transformer T1 and have mains-rated contacts. It breaks the normally-closed contacts thus turning off the load.

If you live in a country that uses a 60Hz mains frequency then IC1 and IC2 should be re-arranged to make a divide by 1800 circuit.

Ian Hill, Crabtree, Plymouth, Devon

*Our apologies for omitting the author's name for the AM Tuning Aid published in December 2001 issue (p.879) - it was written by one of EPE's longest-standing and most popular contributors, George Hylton, best known for his "Down to Earth" column in EPE.*

The simple but useful Transistor/Diode Checker circuit shown in Fig.2 was designed to check the basic function of transistors i.e. go or no-go. As none of the component values are critical it can be built with components from the scrap box. The circuit diagram is based around a 4011 quad 2-input NAND gate but because the inputs of all the gates are tied together as an inverter, a 4001 could be used.

The main part of the circuit is an oscillator (IC1a and IC1b) of approx. 250Hz which drives the emitter probe (E). Gate IC1c inverts the pulse and drives the base terminal (B) of the transistor under test via resistor R2. The

collector (C) is driven through l.e.d. D1 (a bi-colour type was used but two single l.e.d.s would be fine).

With an npn transistor connected a low pulse from pin 4 is inverted by IC1c thus making base current flow, now with the transistor conducting, current flows through the red section of l.e.d. D1 to the collector. A pnp transistor is detected on a high pulse from the clock and short-circuited devices are shown by both l.e.d.s being on (or amber if a bi-colour l.e.d. is used).

Discrete diodes can also be checked using the collector and emitter test points.

M. James, Billingham, Cleveland

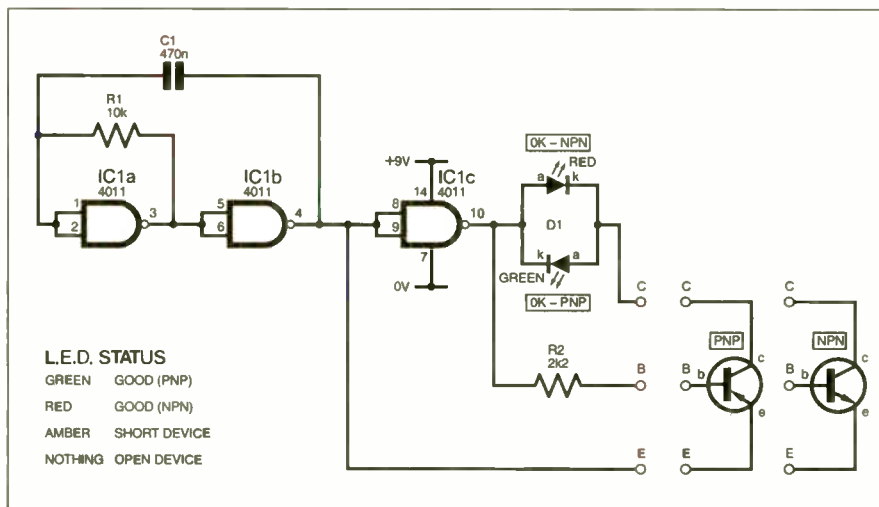

Fig.2. Circuit diagram for a simple "go/no go" Transistor/Diode Checker.

<p><b>SPECIAL OFFERS</b></p> <p><b>TEKTRONIX 2445A</b> 4-ch 150MHz delay, cursors etc. Supplied with 2 Tektronix probes. ONLY <b>£425</b></p> <p>TEKTRONIX 2232 Digital Storage Scope. Dual Trace, 100MHz, 100M/S with probes <b>£325</b> H.P. 54501A Dig. Oscilloscope, 100MHz 4-Ch <b>£425</b> H.P. 3312A Function Gen., 0-1Hz-13MHz, AM/FM Sweep/Tri/Gate/Burst etc. <b>£300</b> FARNELL Dual PSU XA35-2T, 0-35V, 0-2A, Twice QMD, l.c.d. Display <b>£180</b> CIRRUS CR1254 Sound Level Meter with Calibrator 90-200dB, LEQ <b>£150</b> EDDYSTONE 1002 Receiver, 150kHz-30MHz + Broadcast FM, unused <b>£125</b> FARNELL AMM255 Automatic Mod Meter, 1-5MHz-2GHz, unused <b>£300</b> FARNELL DSG1 Low Frequency Syn Sig. Gen., 0-001Hz-99.99kHz, low distortion, TTL/Square/Pulse Outputs etc. <b>£95</b> FLUKE 8060A Handheld True RMS, DMM, 4½ digit, As new <b>£150</b>, used <b>£95</b> BECKMAN HD110 Handheld 3½ digit DMM, 28 ranges, with battery, leads and carrying case. <b>£40</b></p> <p>H.P. 3310A Function Gen., 0.005Hz-5MHz, Sine/Sq/Tri/Ramp/Pulse <b>£95</b> FARNELL LFM4 Sine/Sq Oscillator, 10Hz-1MHz, low distortion, TTL output, Amplitude Meter <b>£125</b> H.P. 545A Logic Probe with 546A Logic Pulsar and 547A Current Tracer <b>£90</b> FLUKE 77 Multimeter, 3½-digit, handheld <b>£60</b> FLUKE 77 Series 11 <b>£70</b> HEME 1000 L.C.D. Clamp Meter, 00-1000A, in carrying case <b>£60</b></p>	<p><b>MARCONI 2019A</b></p> <p>AM/FM SYNTHESISED SIGNAL GENERATOR <b>£400</b> NOW ONLY</p> <p>MARCONI 893C AF Power Meter, Sine Measurement <b>£100</b>, Used <b>£60</b> MARCONI 893B, No Sinead <b>£30</b> MARCONI 2610 True RMS Voltmeter, Autoranging, 5Hz-25MHz <b>£195</b> GOULD J3B Sine/Sq Osc., 10Hz-100kHz, 5Hz-25MHz <b>£75-£125</b> low distortion AWO 8 Mk. 6 in Every Ready case, with leads etc. <b>£80</b> Other AVOS from <b>£50</b> GOODWILL GVT427 Dual Ch AC Millivoltmeter, 10mV-300V in 12 ranges, Freq. 10Hz-1MHz. <b>£100-£125</b> SOLARTRON 7150 DMM 6½-digit Tru RMS-IEEE <b>£95-£150</b> SOLARTRON 7150 Plus <b>£200</b> RACAL TRUE RMS VOLTMETERS 9300 5Hz-20MHz usable to 60MHz, 10V-316V <b>£95</b> 9300B Version <b>£150</b> 9301/9302 RF Version to 1-5Hz, from £200-£300</p> <p><b>HIGH QUALITY RACAL COUNTERS</b> 9904 Universal Timer Counter, 50MHz <b>£50</b> 9916 Counter, 10Hz-520MHz <b>£75</b> 9918 Counter, 10Hz-560MHz, 9-digit <b>£50</b></p>	<p><b>RADIO COMMUNICATIONS TEST SETS</b> MARCONI 2955/2995A From <b>£1500</b> SCHLUMBERGER 4040 <b>£900</b></p> <p>MARCONI 2024 Signal Gen, 9kHz-2.4GHz <b>£3000</b> MARCONI 2022Z Synth AM/FM sig gen 10kHz-1.01GHz l.c.d. display etc. <b>£525-£750</b> H.P. 8672A Synth 2-18GHz sig gen <b>£4000</b> H.P. 8657A Synth sig gen, 100kHz-1040MHz <b>£2000</b> H.P. 8656B Synth sig gen, 100kHz-990MHz <b>£1350</b> H.P. 8656A Synth sig gen, 100kHz-990MHz <b>£995</b> H.P. 8640A AM/FM sig gen, 500kHz-1024kHz <b>£400</b> H.P. 8640A AM/FM sig gen, 500kHz-512MHz <b>£250</b> PHILIPS PMS328 sig gen, 100kHz-180MHz with 200MHz, freq. counter, IEEE <b>£550</b> RACAL 9081 Synth AM/FM sig gen, 5-520MHz <b>£250</b> H.P. 3325A Synth function gen, 21MHz <b>£900</b> MARCONI 6560 Amplitude Analyser <b>£1500</b> H.P. 4275A LCR Meter, 10kHz-10MHz <b>£2750</b> H.P. 8903A Distortion Analyser <b>£1000</b> WAYNE KERR 3245 Inductance Analyser <b>£2000</b> H.P. 8112A Pulse Generator, 50MHz <b>£1250</b> DATRON AutoCal Multimeter, 5½-7½-digit, 1065/1061A/1071 from <b>£300-£600</b></p> <p>MARCONI 2440 Frequency Counter, 20GHz <b>£1000</b> H.P. 3350B Frequency Counter, 20GHz <b>£2000</b> H.P. 5342A 10Hz-18GHz Frequency Counter <b>£800</b> FARNELL AP10830 Power Supply <b>£900</b> FARNELL AP7030 Power Supply <b>£1750</b> PHILIPS PMS418TX1 Colour TV Pattern Generator <b>£2000</b> BAK Accelerometer, type 4365 <b>£300</b> H.P. 3350B Dual Directional Coupler, 2MHz-18GHz <b>£1600</b> H.P. 11692D Dual Directional Coupler, 2MHz-18GHz <b>£1250</b> TEKTRONIX P61098 Probe, 100MHz readout, unused <b>£90</b> TEKTRONIX P6106A Probe, 250MHz readout, unused <b>£95</b> FARNELL AMM2000 Auto Mod Meter, 10Hz-2.4GHz, Unused <b>£350</b> H.P. 1650B Logic Analyser, 80-channel <b>£1000</b> MARCONI 2035 Mod Meter, 500kHz-2GHz <b>£750</b> TEKTRONIX 577 Transistor Curve Tracer <b>£500</b></p>	<p><b>GOULD OS 300</b> Dual Trace, 20MHz Tested with Manual <b>£95</b> ONLY</p> <p><b>SPECTRUM ANALYSERS</b></p> <p>ADVANTEST RA131B 10kHz-3.5GHz <b>£3500</b> H.P. 8591E 1MHz-1.8GHz, 75 Orm <b>£4500</b> TEKTRONIX 492 50kHz-18GHz <b>£3500</b> EATONMAILTECH 757 0-001-22GHz <b>£1500</b> H.P. 853A (Dig. Frame) with 8559A 100kHz-21GHz <b>£2250</b> H.P. 8558B with man frame, 100kHz-1500MHz <b>£1250</b> H.P. 3580A Audio Analyser 5Hz-50kHz, as new <b>£1000</b> MARCONI 2362 100Hz-400MHz, high resoluator <b>£2000</b> B&amp;K 2033R Signal Analyser <b>£750</b> H.P. 182 with 8557 10kHz-350MHz <b>£500</b> MARCONI 2370 30Hz-110MHz <b>£250</b> from <b>£500</b> H.P. 141 SYSTEMS 8653 14Hz-110MHz <b>£2000</b> from <b>£500</b> 8554 500kHz-1250MHz <b>£1750</b> from <b>£700</b> 8555 10MHz-18GHz <b>£2500</b> from <b>£1500</b> H.P. 5372A Frequency &amp; Time Interval Analyser <b>£2250</b></p> <p><b>OSCILLOSCOPES</b></p> <p>TEKTRONIX TDS380 dual trace, 400MHz, 2GS <b>£2000</b> TEKTRONIX TDS350 dual trace, 200MHz, 1GS <b>£1500</b> TEKTRONIX TDS320 dual trace, 100MHz, 500MS <b>£1200</b> TEKTRONIX TDS310 dual trace, 100MHz, 200MS <b>£950</b> LECROY 9400A dual trace, 175MHz, 5GS <b>£1500</b> TEKTRONIX TAS 485 4-ch, 200MHz, etc. <b>£3000</b> Unused <b>£900</b> TEKTRONIX THS720A trace, l.c.d., 100MHz, 500M/S Unused <b>£900</b> HITACHI VC8523, d/trace, 20MHz, 20M/S, d/eter etc. Unused <b>£600</b> PHILIPS PM3092 2-2-ch, 200MHz, delay etc. <b>£900</b> as new <b>£950</b> PHILIPS PM3092 2-2-ch, 100MHz, delay etc. <b>£700</b> as new <b>£800</b> TEKTRONIX TAS465 dual trace, 100MHz, delay etc. <b>£750</b> TEKTRONIX 2465B 4-ch, 400MHz, delay cursors etc. <b>£1500</b> TEKTRONIX 2465 4-ch, 300MHz, delay cursors etc. <b>£900</b> TEKTRONIX 2445A/B 4-ch 150MHz, delay cursors etc. <b>£500-£300</b> FARNELL 468 dig. storage, dual trace, 100MHz, delay <b>£450</b> TEKTRONIX 468 Analogue storage, dual trace, 100MHz <b>£250</b> TEKTRONIX 465 dual trace, 300MHz, delay sweep <b>£550</b> TEKTRONIX 475 dual trace, 300MHz, delay sweep <b>£400</b> TEKTRONIX 465B dual trace, 100MHz, delay sweep <b>£325</b> PHILIPS PMS317 dual trace, 50MHz delay <b>£200-£250</b> GOULD OS1100 dual trace, 30MHz delay <b>£200</b> HAMEG HA303.4 dual trace, 30MHz component testerr <b>£325</b> HAMEG HA303 dual trace, 30MHz component tester <b>£300</b> HAMEG HA203.7 dual trace, 20MHz component tester <b>£250</b> FARNELL DTV20 dual trace, 20MHz component tester <b>£180</b></p>
<p><b>RACAL 9008</b> Automatic Modulation Meter, AM/FM 1-5MHz-2GHz <b>£95</b> ONLY</p> <p>H.P. 8494A Attenuator, DC-4GHz, 0-11dB, N/SMA <b>£250</b> H.P. 8492A Attenuator, DC-18GHz, 0-6dB, APC7 <b>£95</b> MANY OTHER ATTENUATORS, LOADS, COUPLERS ETC. AVAILABLE</p> <p><b>TIME 1051 LOW OHM RES. BOX</b> 0-01 ohm to 1Mohm in 0-01 ohm steps. <b>£100</b> UNUSED</p>	<p><b>SOLARTRON 7045 BENCH MULTIMETER</b> <b>£30</b> 4½-digit bright l.e.d. with leads It's so cheap you should have it as a spare</p> <p>MARCONI TF2015 AM/FM sig gen, 10-520MHz <b>£175</b> RACAL 9008 Auto Mod Meter, 1-5MHz-2GHz <b>£200</b> LEVEILL TG200DMP RC Oscillator, 1Hz-1MHz <b>£50</b> Sine/Sq. Meter, battery operated (batts. not supplied) FARNELL LF1 Sine/Sq. Oscillator, 10Hz-1MHz <b>£75</b> RACAL/AM 9343M LCR Databridge, Digital Auto measurement of R, C, L, Q, D <b>£200</b> HUNTRON TRACKER Model 1000 <b>£125</b> H.P. 5315A Universal Counter, 1GHz, 2-ch <b>£80</b> FLUKE 8050A DMM 4½-digit 2A True RMS <b>£75</b> FLUKE 8010A DMM 3½-digit 10A <b>£50</b></p>	<p><b>ROHDE &amp; SCHWARZ APN 62</b> Synthesised 1Hz-2800kHz Signal Generator Balanced/unbalanced output LCD display <b>£425</b></p> <p>H.P. 8012B DC PSU, 0-60V, 0-50A, 1000W <b>£1000</b> FARNELL AP6050 1kW Autoranging <b>£1000</b> FARNELL H8052 0-60V, 0-25A <b>£750</b> FARNELL H8025 0-60V, 0-50A <b>£400</b> Power Supply HPS3010 0-30V, 0-10A <b>£120</b> FARNELL L30-2 0-30V, 0-2A <b>£80</b> FARNELL L30-1 0-30V, 0-1A <b>£60</b> Many other Power Supplies available</p> <p>Isolating Transformer 250V In/Out 500VA <b>£40</b></p> <p><b>WELLER EC3100A</b> Temperature controlled Soldering Station 200°C-450°C, Unused <b>£125</b></p> <p><b>PORTABLE APPLIANCE TESTER</b> Megger Pat 2 <b>£180</b> ONLY</p>	<p><b>RACAL RECEIVER RA1772</b> 50kHz - 30 MHz LED Display Basically working <b>£250</b></p>
<p><b>STEWART OF READING</b> 110 WYKEHAM ROAD, READING, BERKS. RG6 1PL Telephone: (0118) 9268041. Fax: (0118) 9351696 www.stewart-of-reading.co.uk Callers welcome 9am-5.30pm Monday to Friday (other times by arrangement)</p> <p>Used Equipment - GUARANTEED. Manuals supplied This is a VERY SMALL SAMPLE OF STOCK, SAE or Telephone for lists. Please check availability before ordering. CARRIAGE all units £16. VAT to be added to Total of Goods and Carriage</p>			



# TIME DELAY TOUCH SWITCH

BART TREPAK

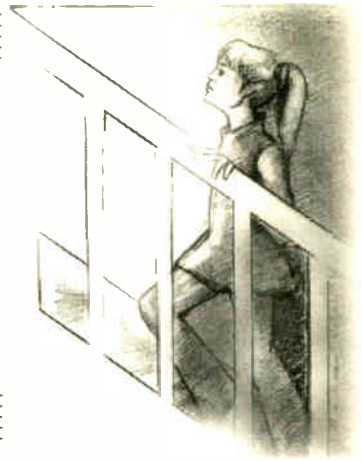

*Automatically turns off lights after a preset period*

**G**LOBAL warming in relation to our use of energy is a subject that is heavily debated. A major use of energy is the consumption of electricity in our homes and industries. Perhaps the most obvious waste of electricity in our homes (although certainly not the largest) is caused by lights being left on in areas when the occupants have left. Nowhere, perhaps, is this more common than in halls and stairways.

Fitting switches which turn off automatically after a preset time in these locations can reduce the electricity consumed quite significantly. A single 100W bulb left burning all night (say eight hours) would consume 800W/hrs. The same bulb fitted with a switch which turned off automatically after say five minutes would consume only 83W/hrs, even in the unlikely event that it were to be activated ten times during this period.

### MECHANICAL DELAYS

Commercial time delay switches for stairs and halls are generally mechanical devices which work on the basis of a leaky cylinder. When the button is pressed, air is expelled from the cylinder and a contact is made, so switching on the light. A spring now slowly pushes the cylinder back to its rest position at the limited rate at which air can re-enter the cylinder, eventually causing the contact to be broken and turning off the light.

Although simple enough, being a mechanical system it has many drawbacks. With repeated use, the components making up its valve can become worn allowing air into the cylinder faster, thus reducing the time delay. Additionally, dust and dirt can find their way into the switch, causing it to stick and preventing it from switching off.

Furthermore, the delay also depends on the depth to which the button is pressed, which determines how much air is expelled from the cylinder. As some force is required to do this fully, it can be difficult for elderly or infirm persons. Consequently, those who require the most time to make it up the stairs can end up with the least!

This circuit overcomes these problems by having no moving parts. It is activated by touch and has the added bonus of a small neon light which enables it to be easily located in the dark. The finished unit is mounted on a standard electrical blanking plate and can replace any conventional light switch.

Although intended primarily for conventional incandescent light bulbs, the circuit has also been found to work with low energy fluorescent types.

### TRIAC CONTROL

There are two major problems to solve when designing a touch switch to replace a conventional mechanical light switch and these concern the power supply and noise immunity.

The main switching element used to control the light is a triac, a semiconductor a.c. switch. This is normally in its off or non-conducting state but can be switched into conduction by means of a small trigger current fed to its gate terminal. Once triggered it will remain conducting until the current through it drops below a certain value (known as the holding current). This occurs normally on a.c. supplies when the voltage drops to zero at the end of every mains half-cycle, and the triac must be re-triggered again if the light is to remain on.

As with any switch, the voltage across a triac when it is in its off state will be the supply voltage (in this case 230V a.c.). When the triac is on, the voltage across it will be around 1V a.c., depending on the current. The triac therefore dissipates very little power so no heatsink is required.

With normal house wiring, only the Live wire and its feed to the lamp are accessible at the wall-mounted light switch. The Neutral wire from the lamp is left inaccessible in the ceiling. Thus it is not possible to simply reduce and rectify the mains to provide a d.c. voltage for the triac control circuit, which must therefore be powered "through" the lamp, i.e. from the voltage across the triac.

An adequate d.c. voltage can be derived by delaying the point at which the triac is triggered in a mains half-cycle. This allows a higher voltage to develop across it which can be rectified and used to power the rest of the circuit.

The disadvantage is that it gives rise to EMI (electromagnetic interference) which can interfere with radio reception and computer systems. As a result, bulky and expensive chokes and capacitors have to be fitted to suppress it. This is unavoidable in light dimmers where we have to delay the triggering so that the power to the lamp can be controlled. For an on/off control, though, triggering should occur as early as possible so that full power is available to the lamp and without interference being generated.

### IN CONTROL

In this circuit, a small Zener diode is connected in series with the triac. This causes sufficient voltage drop so that after rectification a 3V to 4V d.c. supply is available for the control circuits. The Zener has the load (light) current flowing through it during operation and therefore dissipates power, but for the kind of currents used in lighting this only amounts to a few hundred milliwatts, a value well within the ratings of small wire-ended Zener diodes.

The circuit provides sufficient current to enable the triac to be triggered by d.c. pulses instead of the short a.c. trigger pulses normally used. As a result, the triac does not turn off between half-cycles, and so does not cause interference to the mains supply. This point is important as it also enables the circuit to

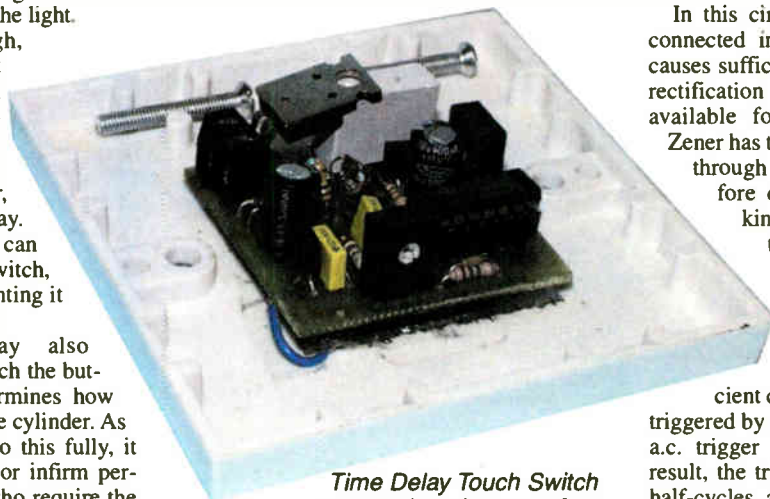

*Time Delay Touch Switch mounted on the rear of an electrical blanking plate.*

be used with low power fluorescent lamps if required.

## TOUCH CONTROL

Touch control circuits, by their very nature, tend to be prone to spurious switching in response to the many glitches and pulses which normally occur on the mains supply due to other equipment being switched on or off. This is often difficult to overcome, but it can be very much reduced by building a delay into the circuit so that short pulses, which characterise most of the interference, are ignored and the circuit only responds to longer inputs.

By fitting a delay of a few hundred milliseconds, users will not notice any delay in switching, and interference, which rarely lasts for more than a few tens of milliseconds, will be largely ignored by the circuit. This is not a complete solution to the problem, but in this case there is also the advantage that even if the circuit should switch on accidentally, it will only remain on for a few minutes anyway.

of a standard light switch blanking plate. The foil forms one plate of a capacitor. When it is approached by a hand, which becomes the other plate, the capacitor formed effectively connects the base of transistor TR1 to earth. (The human body is a fairly good conductor and exhibits a capacitance to earth of around 100pF, depending on size and area!)

Since the emitter circuit of *npn* transistor TR1 is connected via resistor R2 to the Live rail, which is at 230V a.c. with respect to earth, this is equivalent to a 230V input to the base of TR1 via the combined capacitance of the body plus that of the hand and foil.

Not surprisingly, transistor TR1 turns on when the input polarity is correct and charges capacitor C1. Resistor R1 and preset resistor VR1 set the sensitivity of the circuit, allowing it to be activated by placing one finger or the whole hand on the plate. Resistor R2 discharges the capacitor when the hand is removed.

When the input threshold of gate IC1a is exceeded, the output switches low causing

time for which the triac remains triggered and the lamp turned on.

With the components specified, the turn-on time can be made variable from around 20 seconds to 2¼ minutes. This may be increased if required by increasing either R4 or C3, or both.

## COMPONENTS

### Resistors

R1, R3	2M2 (2 off)
R2	680k
R4	330k
R5	390Ω
R6	1k
R7	150k

All 0.25W carbon film

### Potentiometers

VR1, VR2	2M2, min preset, vertical (2 off)
----------	-----------------------------------

See  
**SHOP**  
**TALK**  
page

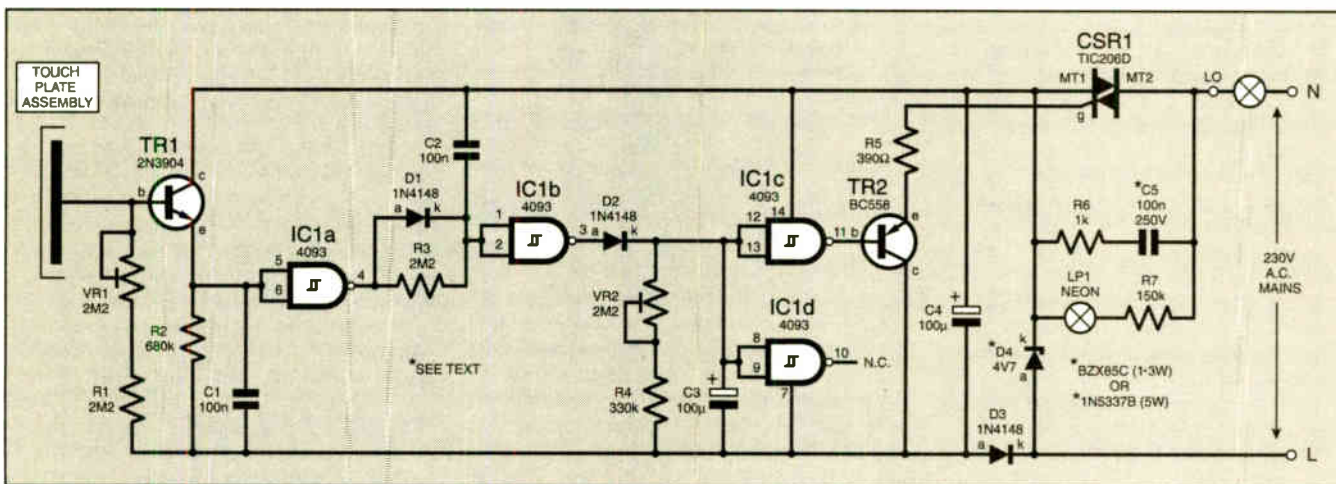

Fig.1. Complete circuit diagram for the Time Delay Touch Switch.

## CIRCUIT DESCRIPTION

The circuit diagram for the Time Delay Touch Switch is shown in Fig.1. Triac CSR1 and Zener diode D4 are connected in series with the lamp as previously discussed. The voltage appearing across the Zener is rectified and smoothed by diode D3 and capacitor C4 to provide a d.c. supply of around 4V.

As this voltage only appears when the triac is on, capacitor C5 is connected as a capacitive mains dropper to provide a small current to the Zener to maintain the d.c. supply when the triac is off. Resistor R6 is included to limit the Zener current should the circuit be powered when the capacitor is discharged (very likely) and also to limit the discharge current which could destroy the triac when it switches on (also very likely).

The rest of the circuit is quite conventional and is based on a quad CMOS Schmitt trigger NAND gate, although the gates are used as logic inverters by having both inputs connected together. This type of gate has the advantage of switching cleanly once the input threshold voltage has been exceeded.

The input sensor is formed by placing a conducting foil behind the insulating front

capacitor C2 to charge via resistor R3, which introduces the switch-on delay required to improve the noise immunity of the circuit. Should the output of IC1a go high again because TR1 turned on for only a short period due to noise, C2 would be quickly discharged via diode D1 so that the input of IC1b would not have time to go low.

Assuming a moderately long input period during which the output of IC1a remains low, however, IC1b's input will also become low, causing its output to go high, so quickly charging capacitor C3 via diode D2. This, of course, causes the output of IC1c to go low and allow gate current to flow to the triac via *pnp* transistor TR2 and resistor R5. In turn, this causes the triac to be triggered and so switch on the lamp.

Note that the circuit uses negative triggering (i.e. a current flows out of the triac gate rather than into it) because triacs are generally more sensitive in this mode and require less gate current to ensure triggering.

When the hand is removed from the touch plate, diode D2 will become reverse biased and capacitor C3 will only be able to discharge via resistor R4 and preset VR2. These two components, together with C3, therefore determine the length of

### Capacitors

C1, C2	100n ceramic, 5mm pitch (2 off)
C3, C4	100μ radial elect, 16V (2 off)
C5	100n class X2, 250V a.c. (see text)

### Semiconductors

D1 to D3	1N4148 signal diode (3 off)
D4	4V7 BZX85, or 1N5337 Zener diode (see text)
CSR1	TIC206D 400V 4A triac
TR1	2N3904 <i>nnp</i> transistor
TR2	BC558 <i>pnp</i> transistor
IC1	4093 quad Schmitt trigger NAND gate

### Miscellaneous

LP1	neon, wire-ended
-----	------------------

Printed circuit board, available from the EPE PCB Service, code 331; 2-way p.c.b.-mounting terminal block; plastic electrical blanking plate; aluminium foil; insulating materials; connecting wire; solder, etc.

Approx. Cost  
Guidance Only

£9

excluding elec. plate



Note also that the time can easily be extended by touching the plate during the on period. This will recharge C3 so that if you stop on the stairs for a chat, you need not be plunged into darkness half way through the conversation!

In any event, even if this should happen, with the triac turned off 230V a.c. will appear across it and the small neon lamp LP1 will light. This is arranged to shine through a hole in the printed circuit board, illuminating the touch area so that it should be an easy matter to find the switch in the dark. Resistor R7 limits the current through the neon, which generally strikes at about 90V.

## CONSTRUCTION

As this circuit is always live at mains voltage, its construction should only be undertaken by those who are suitably experienced or qualified.

The circuit should not be constructed on stripboard, and it must not be earthed, either intentionally or accidentally as this will cause the instant destruction of many of the components.

The recommended printed circuit board (p.c.b.) component and tracking layouts are shown in Fig.2, together with the triac and transistor pinouts in Fig.3. This board is available from the EPE PCB Service, code 331.

Care should be taken to ensure that the correct orientation of all polarity-conscious components is observed. The use of a socket is recommended for IC1, which is a CMOS device, and you should discharge static electricity from your body before handling it.

The neon should be mounted slightly above the p.c.b. to enable it to be bent to lie directly above the central hole. Insulating sleeving should be fitted over the leads to prevent them touching other components.

The triac should be a 400V a.c. sensitive-gate device and the type specified has a maximum gate current requirement of 5mA. Any substitute should have a similar specification.

Zener diode D4 will dissipate about 1W with a 100W lamp so a 1.3W type, such as the BZX85 series, should suffice. For higher lamp powers a 5W device such as the 1N5337B should be used.

The choice of capacitor for C5 is very important as this device must be rated for connection across the mains. On the face of it, a 400V rating would appear suitable but this is not usually the case as this is often a d.c. rating and many such capacitors have only a 200V a.c. specification. It is essential that a Class X2 type should be used as these are guaranteed for operation up to 275V a.c.

## TESTING

Before testing, ensure that there are no solder splashes or short circuits on the board and the soldering is of a good standard.

As the circuit operates at mains potential, do not touch any part of the p.c.b. when it is powered and ensure that the mains supply is off when fitting or adjusting it. Under no circumstances should any part of it be connected to earth.

Having said that, the circuit is safe to use once it is mounted in its wall box. There is, however, the problem of testing it safely

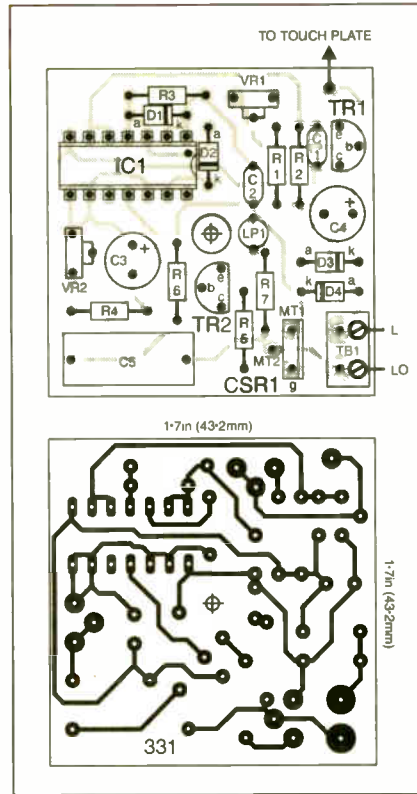

Fig.2. Printed circuit board component layout and full-size copper foil master. Note, a small "window" is cut in the centre of the p.c.b. for the neon light to shine through.

and to do this it is best to use a temporary d.c. supply and not fit the triac at this stage. For this testing an l.e.d. should be connected between the two holes adjacent to the terminal block where the triac will be mounted, with the l.e.d. cathode (k, usually denoted by a shorter lead) nearest the edge of the board.

Solder a temporary lead to the junction of components C5 and R6 and connect this to the positive terminal of a 9V d.c. power supply or battery. Secure another lead to the L terminal and connect this to the negative terminal of the power supply. The circuit can now be tested at low voltage and should work as described.

It will probably not be possible to switch the circuit on by touching the plastic front panel but it should switch when the transistor base is touched directly. If not, a 1MΩ resistor connected from the supply positive to the transistor base should cause the l.e.d. to light.

The operation of the circuit can easily be followed by monitoring the outputs of the gates with a multimeter or oscilloscope and the status of the triac will be displayed by the l.e.d. In this

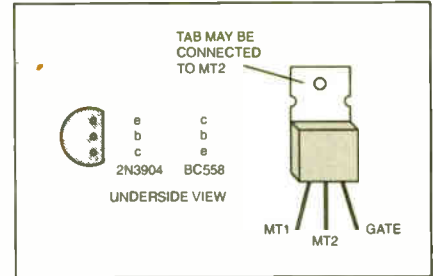

Fig.3. Pinout connection details for the transistors and triac.

way the time delay, and to a certain extent the sensitivity, can be set up by adjusting presets VR2 and VR1, respectively.

If all is well the wires should be removed and the l.e.d. replaced by the triac. This will probably need to be mounted as shown in Fig.4, to ensure that its height does not exceed 1.5cm from the board. This is important if the unit is to be mounted in a plaster-depth wall-box but is not so vital if a deeper box is available.

The triac leads will need to be bent to suit and this should be carried out carefully by holding each lead in a pair of pliers at the point where the bend is required. Do not bend the leads too close to the body of the device or bend them repeatedly as they may break.

To stop the device from moving and placing a further strain on the leads, it may be a good idea to glue the triac tab to capacitor C5 with epoxy adhesive. Many triacs (including the device specified) have the heatsink tab internally connected to the centre pin and in these cases, this must be insulated by means of insulating tape or suitable plastic sheet as shown to ensure that it cannot touch the wall box.

## TOUCH PLATE

The touch plate assembly is made by using a piece of aluminium kitchen foil about 4cm square stuck behind the centre of an electrical blanking plate, as shown in Fig.5.

Most blanking plates have a central area made of thinner plastic than the surrounding plate. This forms an ideal area for the

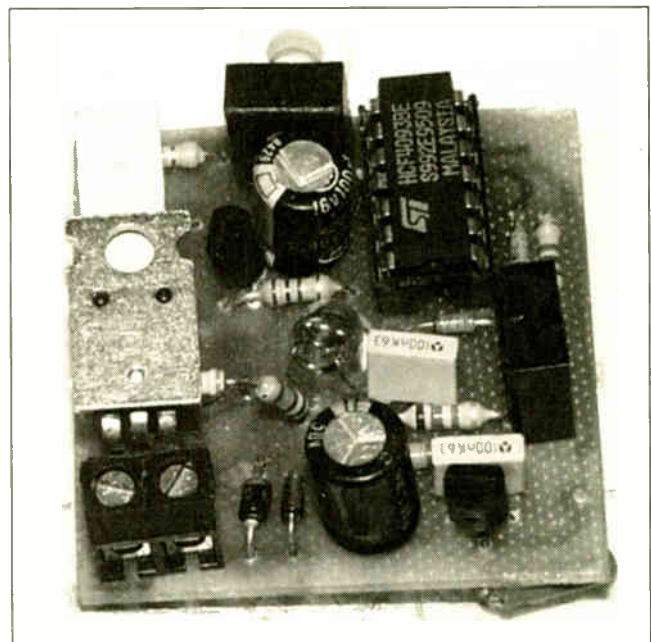

Completed circuit board. Note the neon has been bent over to lie directly over the centre hole in the p.c.b.

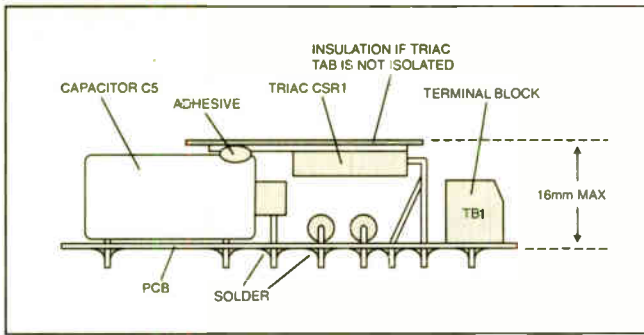

Fig.4. Suggested method of mounting the triac on the circuit board.

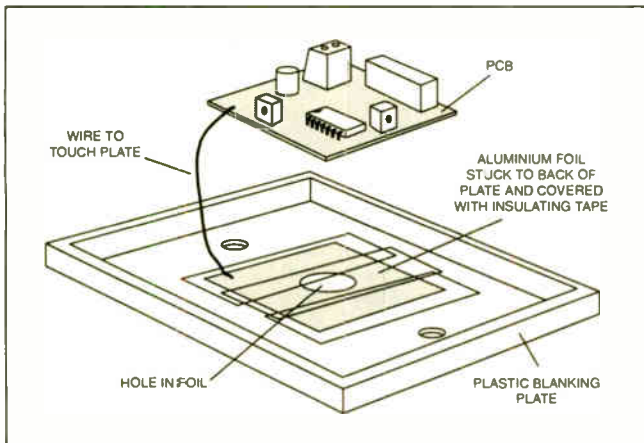

Fig.5. Suggested touch switch assembly.

neon light to shine through. (*Do not make a hole in the blanking plate.*) The aluminium foil should be removed from this area as shown in Fig.5. The surface of the foil should then be covered with strips of insulating tape.

A short piece of wire with about 1cm of insulation removed should be trapped beneath the insulation to enable the foil to be connected to the transistor on the circuit board. A small knot tied in the wire under the insulating tape may help to prevent the wire from being pulled out during final assembly.

After soldering the other end of the wire to the base of transistor TR1, the p.c.b. should be mounted on the back of the touch plate. Double-sided self-adhesive pads are ideal for this but as these grip immediately on contact, care should be taken to ensure that the board is fitted to the centre of the plate. The position of the neon should be adjusted so that it shines directly over the central hole in the foil.

## INSTALLATION

Once this has been completed, the unit can be mounted in the wall box. *The mains must be switched off before the existing switch is removed, and when making any adjustments.* The two cables inside the wall box should be connected to the terminal block on the unit. Because of the way the circuit operates, it is important that the Live wire is connected to the L terminal on the p.c.b. as shown in Fig.2.

This wire is normally coloured red but it may not be, depending on the installation. If you are not sure which of the two wires is the Live one, connect them either way around. If you have chosen the wrong one no damage will result but the circuit will not switch on and the

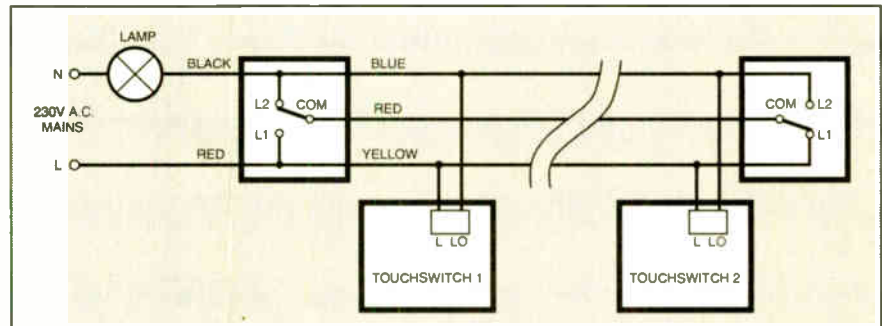

Fig.6. Two-way switching circuit. It is most important that the mains Live is connected to the correct touch switch terminal.

procedure will need to be repeated with the wires reversed.

Note that modern installations will also have an earth wire which is not connected to the switch terminals but is usually connected to a terminal on the wall box. This should be left in place and not disturbed.

Before fixing the switch, *make sure that none of the components on the board can touch any part of the box* and if there is any danger of this (especially if a shallow plaster depth box is involved) a piece of plastic sheet or a scrap piece of p.c.b. material should be fitted to the back of the box to prevent the components shorting to the (earthed) box.

Once this is done, the switch can be secured to the wall box and the mains switched on. Make sure that the light can be switched on when the plate is touched and ensure that it goes out at the end of the previously set time.

If the circuit cannot be switched on, increase the sensitivity of the circuit by turning VR1 clockwise (*switch off the mains before doing this*). If it is still impossible to switch the circuit on, turn the

preset fully anticlockwise and reverse the wires to the terminal block before repeating the procedure.

Do not increase the sensitivity beyond the point at which it switches on easily as this can make it more susceptible to random switching, or even prevent the unit from switching off at the end of the preset period. The latter can be increased by turning VR2 clockwise.

Should you wish to use the unit with a two-way switching circuit, to enable the lights to be switched on and off from two locations, this can be done quite easily with no re-wiring being involved. Fig.6 shows a typical two-way switching arrangement and the new switches may be used to replace the existing switches as shown.

The wire colours stated in Fig.6 are those normally used although they may be different depending on the installer. In any event, one of the existing wires will not be required and the touch switches should be wired in parallel as shown. It is important to ensure that the mains Live is connected to the correct terminal on each switch. □

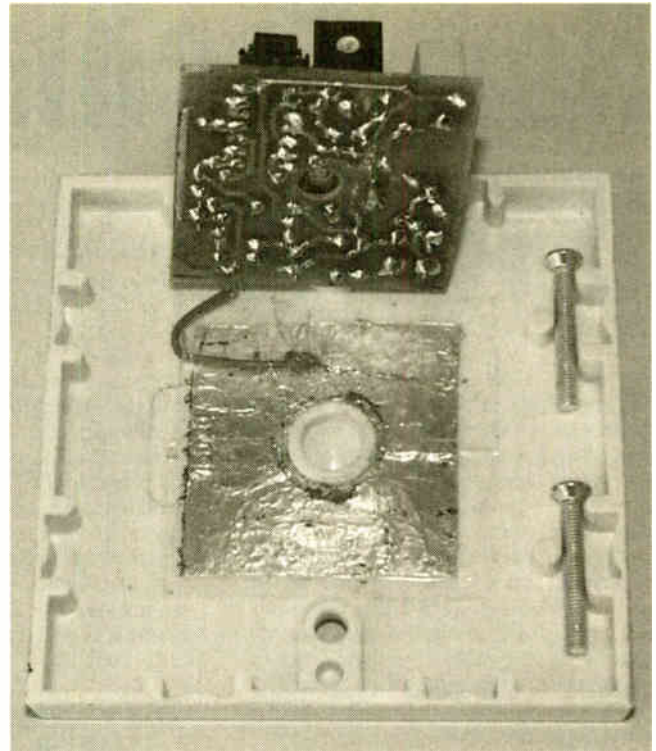

The circuit board held clear of the electrical blanking plate to reveal the foil sensor. A centre hole is cut in the foil to allow light from the neon to be seen through the plate. The foil must be covered with several layers of insulating tape.



# New Technology Update

*Smoothing out the bumps promises to extend chip densities up to a figure of one billion transistors, reports Ian Poole.*

**F**EATURE sizes in integrated circuits are continuing to fall, despite fears many years ago that the limits of current technology would soon be reached. These fears have so far been unfounded and companies like Intel have continued to make giant leaps forward in technology.

For many years *Moore's Law* has been the benchmark that has been used. In 1965 Gordon Moore predicted that the number of transistors on an integrated circuit would double every 18 months, and that the trend would continue until about 1975. However, the law has held true right up until the present day.

## New Billennium

Now Intel has broken new barriers by developing transistors featuring structures that are 20 nanometres in size. This will ultimately enable the company to build microprocessors that contain around a billion transistors and be capable of running at speeds of 20GHz. This will also extend the life of Moore's Law for another decade.

The transistors operate with supply voltages of less than a volt. This reduces the power consumption, an increasing problem as integrated circuits become larger. The minute size of the transistors also means that speed can be increased as lengths are smaller and transition times are reduced. In these transistors the gate oxide layers are only three atomic layers thick, but they still provide the necessary insulation needed.

A further advantage of the new technology is that devices can be fabricated using the same materials and physical structure used in today's chips. This feature will enable them to be introduced into production more easily. However, it is expected that a

different oxide material will be used in the transistors used for the final production.

Although the basic process has been proved, there is still a considerable amount of work to be undertaken before chips using these transistors can be manufactured. The process needs to be optimised and, of course, chips using the new transistors need to be designed. Accordingly it is anticipated the first chips using the new transistors will not appear until around the year 2007.

## New Packaging

In a further announcement made in October '01, Intel have developed a new semiconductor packaging technology that complements the new high speed transistor technology. Called a "Bumpless Build-Up Layer" the new BBUL package takes a completely different approach to integrated circuit packaging.

Inside an i.c. package there are several layers and Fig.1 shows how a conventional package is connected to the silicon die using solder bumps inside the package. When the silicon is manufactured, these solder bumps are the last structures put on.

The purpose of these is to make electrical connection between the very finely spaced bumps on the die and the external connections that are much further apart. To achieve this, current packages consist of three layers. The middle layer, known as the core, is a sheet of plastic with via holes (copper interconnections that pass vertically through the core). The top and bottom layers of the package contain a network of copper interconnections that make sure the right bump is routed to the right pin.

Manufacturing of the package starts with the core. Via holes are placed in the core by

laser-drilling holes and filling them with copper. Then the interconnection layers are built up on both sides of the core. The specifications of the via holes and interconnect layers are unique to each chip. Finally the external package connections are added, and in the case of a BGA (ball grid array) these are the solder bumps on the base of the package.

## Bumpless

In the case of the BBUL, the package is grown around the chip, enabling many of the problems to be overcome. The silicon die is embedded in the package, not attached to its surface.

Electrical connections between the die and the package are made with copper lines rather than the solder bumps. These enable the package to be made thinner and lighter than today's existing packages. They are also able to deliver a higher level of performance while reducing power consumption. The BBUL process is also able to allow multiple silicon components to be placed in a single package.

It can be seen from Fig.2 that the top interconnection layer is not required, nor are the internal bumps. Instead the silicon is embedded in the package core and only the lower interconnection layer needs to be built up. This gives rise to the term "Bumpless Build Up Layer" or BBUL.

## Advantages

There are several advantages to the new package. Firstly it is much thinner and lighter as a result of the reduction in the number of layers.

Because the interconnections are much shorter, the levels of spurious inductance are considerably reduced. Capacitors that are placed on the pin side of the package (but not shown on the diagram) are much closer to the silicon, enabling much better power delivery. In turn this allows for higher frequency operation.

The new construction also allows the chip to operate at a lower voltage because of the reduced level of electrical noise. This provides considerable power savings because the power is proportional to the square of the voltage.

The new technology also provides considerably more flexibility. It enables much higher interconnection densities to be achieved and as well as allowing signals to be routed from one part of the die to another more easily.

Finally, it allows multiple chips to be contained within the same package, and this feature alone could bring significant advantages.

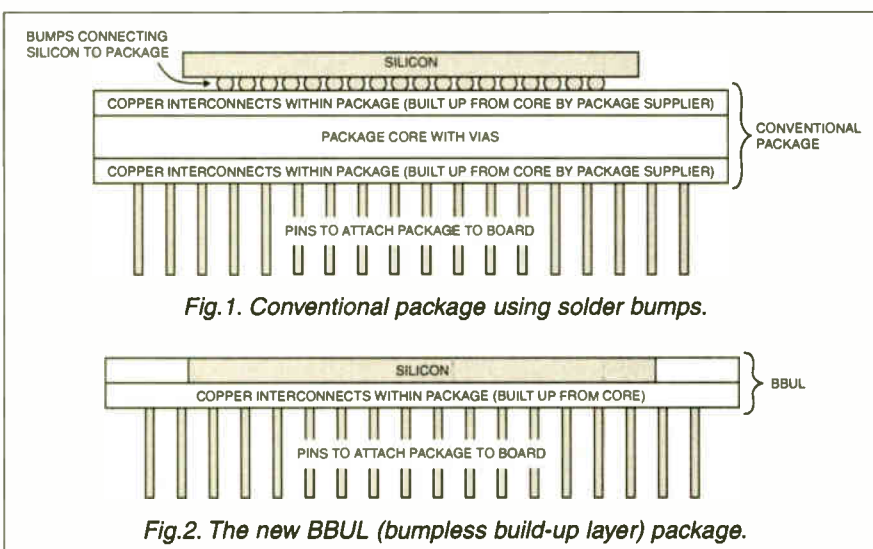

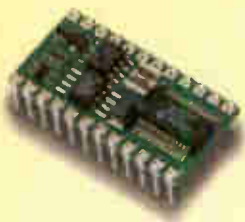

BS2-IC



BS2-SX

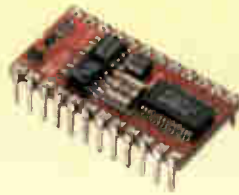

BS2E-IC



BS2P/24

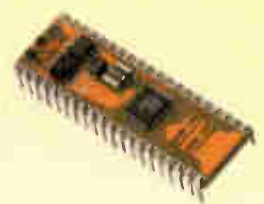

BS2P/40

**Parallax BASIC Stamps - still the easy way to get your project up and running!**



**Serial Alphanumeric and Graphic Displays,  
Mini-Terminals and Bezel kits**

# www.milinst.com



Animated Head



3-Axis Machine



Six-Legged Walkers



Robotic Arms



Bipeds

**Robotic models for both the beginner and the advanced hobbyist**



Servo Drivers



Motor Drivers



On-Screen Displays



DMX Protocol

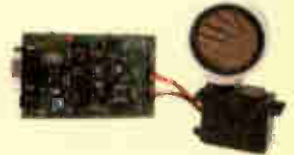

U/Sound Ranging

**Animatronics and Specialist Interface-Control Modules**

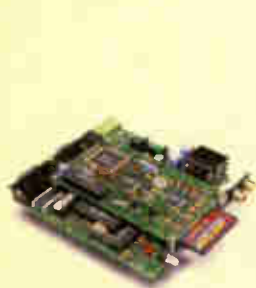

Quadravox  
MP3 & Speech Systems



SensoryInc  
Voice Recognition



Parallax  
Ubicom Tool Kits



Tech-Tools  
PIC & Rom Emulators



BASICMicro  
PIC BASIC Compilers

**Development Tools**

Milford Instruments Limited Tel 01977 683665, Fax 01977 681465, sales@milinst.com



# PRACTICALLY SPEAKING

Robert Penfold looks at the Techniques of Actually Doing It!

**B**EGINNERS at electronic project construction usually start by copying published projects that include full construction details. This "cloning" of published designs can be achieved with a minimum of technical knowledge, and it is perhaps more craft than science.

Eventually, most constructors will wish to "do their own thing", and rely less on the construction information provided in articles. There are countless circuits published in magazines, books, and on the Internet, and most constructors like to build some of these. In most issues of *EPE* there are useful circuits featured in *Ingenuity Unlimited* and *Circuit Surgery*.

The obvious problem for those of limited experience is that they have to start designing their own component layouts, etc., in order to turn one of these circuits into a working unit. Even assuming that a sensible approach is taken, and the constructor starts with something simple, designing a circuit board for the first time can be a daunting task. Always start with battery powered projects, and do not even think about working out layouts for mains powered projects until you have a few years experience.

## Symbolism

An obvious first requirement in converting a circuit into a real world component layout is the ability to read circuit diagrams. This is not particularly difficult, but it is necessary to learn the more common circuit symbols. A selection of circuit symbols and the names of the components that they represent are shown in Fig.1. With anything like this, it is necessary to bear in mind that there are stylistic differences from one source to another. The symbols you see in published circuits will not be exact matches for those shown in Fig.1, but they should closely resemble them.

The rectangular symbols are the "proper" ones for the various types of resistor. Although they are not the current British standard, the old zigzag symbols are still used a great deal in the UK. The zigzag symbols are, of course, used for the circuit diagrams in *EPE*. Both sets of symbols are shown in Fig.1.

Some years ago there was a move towards using the rectangular symbol for any component having two leads. The marking beside the symbol (R1, C1, L1, etc.) indicated what type of component the symbol represented. This system made it easy for the crude computer

based drawing systems of the time to deal with circuit diagrams. It made circuit diagrams difficult to read though, and this method has now been largely phased out. However, you may still encounter circuit diagrams of this type. In fact, you are very likely to encounter them if you search the Internet for circuits.

Circuits published on the Internet can be a bit difficult to interpret, because there seems to be no international standard for circuit symbols. In most cases the symbols are the same or quite close to the British standards and there are no problems. In American circuits for example, a capacitor has one straight line and one curved line instead of two straight lines. The symbol is still very obviously a capacitor though, and the diagrams are easy to interpret.

In other cases, and particularly with some semiconductors, there are marked differences in the symbols from one country to another. The obvious way around the problem is to look at the component number for any unrecognised symbol. The letter or letters in the component number tell you the type of component. This is also useful when you are first learning to read circuit diagrams. The

Table 1: Component Identification Letters

Letter(s)	Component	Letter(s)	Component	Letter(s)	Component
B	Battery	SW	Switch	U	Integrated circuit
BY	Battery	T	Transformer (any type including r.f.)	V	Valve (any type except CRT)
C	Capacitor (any fixed value type)	TC	Trimmer capacitor (preset variable capacitor)	VC	Variable capacitor
CH	Chassis	Th	Thermistor	VR or RV	Potentiometer or variable resistor
CRT	Cathode ray tube	TL	Earphone or headphones	WD	Warning device (buzzer, bell, etc.)
CSR	Thyristor or triac (controlled silicon rectifier)	Tr	Transistor	X	Crystal
D	Diode (any type including rectifiers, Zener diodes, photodiodes, and l.e.d.s)	TR	Transistor		
E	Earth				
FL	Filter (usually a ceramic, crystal, or mechanical type)				
FS	Fuse				
JK	Jack socket (any type)				
IC	Integrated circuit				
IFT	Intermediate frequency transformer				
L	Inductor				
LP	Lamp (neon or filament, but not an l.e.d.)				
LS	Loudspeaker				
M	Motor				
ME	Meter				
Mic	Microphone				
PCC	Photo conductive cell (a photoresistor such as a cadmium sulphide cell)				
PL	Plug (any type)				
Q	Transistor				
R	Resistor (fixed value)				
RL	Relay (coil or contacts)				
S or SW	Switch				
SK	Socket (any type, but JK is often used for jack types)				

Fig. 1. A selection of some commonly used circuit symbols.

component numbers should come to the rescue if you forget what components some of the symbols represent. Table 1 provides a list of component identification letters for some common components.

### Crossing the Line

The connections from one component to the next are represented by lines in circuit diagrams. In most cases the connections do not work on the basis of a lead on one component connecting to just one other component. Particularly with the supply lines, connections often run from component to component, perhaps connecting more than a dozen components together.

There is no difficulty in representing complex wiring on circuit diagrams, but it is inevitable that some lines have to cross other lines. To avoid confusion, a dot is used where two lines meet and join, and no dot is used where lines cross without any connection being made. In the distant past it was the convention to have one wire loop over the other at points where there were crossovers with no connections. This method is still used to a limited extent, but is no longer part of the British Standard. The dummy circuit of Fig.2 helps to explain how the diagrammatic wiring operates.

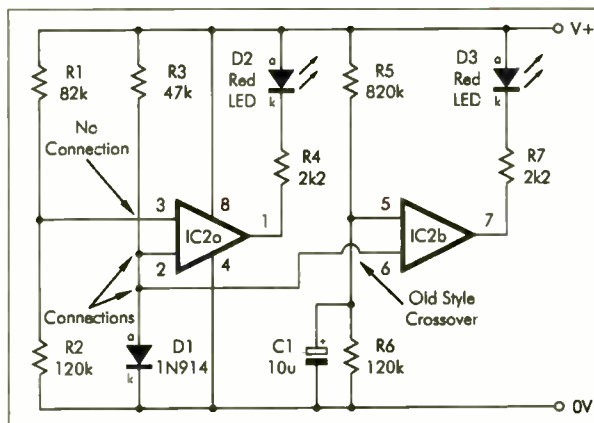

Fig.2. Dots indicate that two wires connect. No dot means that the wires cross without connecting.

### Translation

It is easy enough to see how everything connects together on the circuit diagram, but translating a circuit diagram into a working project is a little trickier. The first task is to make sure that you know how each terminal of a component on the circuit diagram equates to its real world equivalent. Provided you have some experience of project construction this should not be too difficult. With resistors and non-polarised capacitors there are only two terminals, and it does not matter which way around they are connected.

Polarised capacitors such as electrolytic types must be connected the right way around. The filled line of the circuit symbol represents the negative terminal and the "hollow" line represents the positive one. The positive terminal is usually marked with a plus sign as well, and the polarity is marked with plus and (or) minus signs on the actual components.

A number of case styles and leadout configurations are used for transistors, so it is only possible to identify the terminals of an unfamiliar device with the aid of a leadout diagram. These can be found in the larger electronic component catalogues, and masses of semiconductor data is available on the Internet. Remember that transistor leadout diagrams are base views, i.e. looking at the side from which the leads emanate.

The bar in a diode symbol is at the cathode (k or +) end of the component. Most diodes and rectifiers have a bar

marked around the body of the component next to the cathode lead. A few types are slightly narrower at this end of the body, which roughly equates to the arrowhead section of the symbol. Either way, the physical similarities between the symbols and actual components make it easy to remember how the circuit symbol relates to real world diodes and rectifiers (Fig.3).

Some integrated circuits are represented by certain shapes in circuit diagrams, such as the triangle that is used for amplifiers. Most integrated circuits are just represented by rectangles. In the current context, all that matters are the pin numbers for each device. Most integrated circuits have d.i.l. (dual-in-line) encapsulations, and the pin numbering

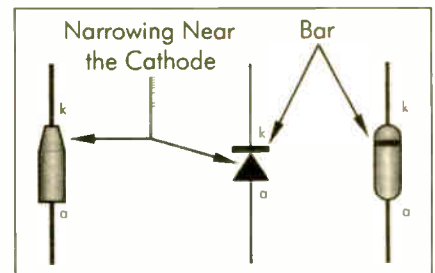

Fig.3. There is a clear correlation between diodes and their circuit symbol.

it and see" method can be used. If connecting the track one way around results in the control working "backwards", reverse the connections to the track terminals.

### Sockets, etc.

Multi-way sockets can be a bit confusing because the pin numbering is sometimes less than completely logical. Some DIN connectors certainly have some odd pin numbering arrangements. Fortunately, many multi-way connectors have the pin numbers moulded into the components themselves. They are present on DIN sockets, D-connectors, and most other computer related connectors.

With simple two-way audio connectors such as jack and phono types it is essential to get the two tags connected the right way around. Usually one of the tags can clearly be seen to connect to the metal chassis of the component, and it is this tag that connects to the earth rail of the circuit. Sockets that are enclosed in

always runs counter clockwise from pin 1 (Fig.4). Pin 1 can be indicated by a notch at the appropriate end of the encapsulation, or a dot or a bar next to pin 1. Many devices have two or even three of these markings. With the more exotic devices it is necessary to resort to component catalogues or the Internet to sort out the pin numbering. Note that, unless stated otherwise, integrated circuit diagrams show the components viewed from above. In other words, the devices are shown with the pins pointing away from you. This is the opposite of the convention for transistors.

### Potentiometers

How the potentiometer circuit symbol relates to a rotary potentiometer is shown in Fig.5. As one would probably expect, the middle tag is the wiper or moving contact. The awkward part is determining which way around the two track terminals should be connected. Circuit diagrams sometimes include "cw" and "ccw" markings, which denote the clockwise and counter-clockwise ends of the track (with the control viewed from the front). Without these markings, there is no easy way of telling the correct method of connection. Volume controls have the tag indicated in Fig.5 connected to the earth rail. With other applications that have a track connection connected to earth, this is almost certain to be the tag that connects to earth. Beyond that, it is not possible to determine the correct method of connection without some technical knowledge. However, the "suck

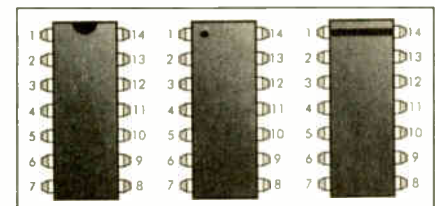

Fig.4. Dual-in-line packages all use the same basic method of pin numbering and are normally shown viewed from above.

plastic cases are more difficult to deal with, and there may be no outward clues as to which is the earth tag. However, a few simple continuity tests will show how the socket connects to the plug, and should solve the problem. If the socket has any switch contacts, continuity tests should show how these operate. Continuity tests are also useful with switches where the functions of the tags are not entirely obvious. In fact, it is a good idea to check any switch of a type that you have not used previously. This ensures that you are not misinterpreting things, and avoids the possibility of having to do a lot of rewiring.

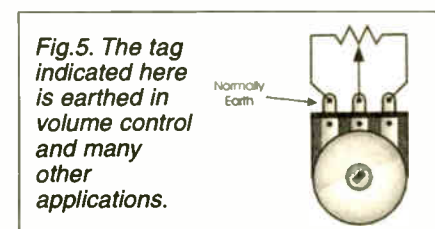

Fig.5. The tag indicated here is earthed in volume control and many other applications.



# Video Surveillance



- C-MOS B/W Camera 15mm/15mm £29.00
- C-MOS Colour Camera 15mm/15mm £65.00
- PCB B/W Camera 32mm/32mm £24.00
- PCB Colour Camera w/Audio 32mm/32mm £65.00
- 23cm (1.3GHz) Video/Audio Transmitter £35.00
- 13cm (2.4GHz) Video/Audio Transmitter £35.00
- 1-2 Watt 2.4GHz Video/Audio Transmitter £120.00
- 4" TFT Boxed Colour Monitor w/Audio £110.00
- Video to VGA Converter £65.00
- VGA to Video Converter £90.00
- 10m Outdoor IR Illuminator £55.00



All prices exclude VAT.

Many more products on our website:

[WWW.BITZTECHNOLOGY.COM](http://WWW.BITZTECHNOLOGY.COM)

Tel: 01753 522 902 Fax: 01753 571 657



## A COMPLETE RANGE OF INVERTERS

150W TO 2500W - 12V & 24V

A Complete range of regulated inverters to power 220V and 240V AC equipment via a car, lorry or boat battery. Due to their high performance (>90%) the inverters generate very little heat. The high stability of the output frequency (+/-1%) makes them equally suitable to power sensitive devices.

These inverters generate a modified sine wave, which are considerably superior to the square waves which are produced by most other inverters. Due to this superior feature they are capable of powering electrical equipment such as TV,s, videos, desktop & notepad computers, microwave ovens, electrical lamps, pumps, battery chargers, etc.

### Low Battery Alarm

The inverters give an audible warning signal when the battery voltage is lower than 10.5V (21V for the 24V version). The inverter automatically shuts off when the battery voltage drops below 10V (20V for the 24V version). Fuse protected input circuitry.

Order Code	Power	Voltage	Price
651.581	150W Continuous	12V	£36.39
651.578	150W Continuous	24V	£36.39
651.582	300W Continuous	12V	£50.64
651.585	300W Continuous	24V	£50.64
651.583	600W Continuous	12V	£101.59
651.593	600W Continuous	24V	£101.59
651.587	1000W Continuous	12V	£177.18
651.597	1000W Continuous	24V	£177.18
651.602	1500W Continuous	12V	£314.52
651.605	1500W Continuous	24V	£314.52
651.589	2500W Continuous	12V	£490.54
651.599	2500W Continuous	24V	£490.54



All prices are inclusive of V.A.T. Carriage £6.00 Per Order

Many uses include:- \* Fetes \* Fairgrounds \* Airshows \* Picnics \* Camping \* Caravans \* Boats \* Carnivals \* Field Research and \* Amateur Radio field days \* Powering Desktop & Notepad Computers.

DELIVERY CHARGES ARE £6.00 PER ORDER. OFFICIAL ORDERS FROM SCHOOLS, COLLEGES, GOVT. BODIES, PLC,S ETC. PRICES ARE INCLUSIVE OF V.A.T. SALES COUNTER. VISA AND ACCESS ACCEPTED BY POST, PHONE OR FAX, OR EMAIL US AT SALES@BKELEC.COM ALTERNATIVELY SEND CHEQUE OR POSTAL ORDERS MADE PAYABLE TO BK ELECTRONICS.



**B.K. ELECTRONICS**



UNIT 1, COMET WAY, SOUTHEND-ON-SEA, ESSEX. SS2 6TR  
TEL.: +44(0)1702-527572 FAX.:+44(0)1702-420243

For Full Specifications View our web site at:-  
[WWW.BKELEC.COM/INVERTERS.HTM](http://WWW.BKELEC.COM/INVERTERS.HTM)

# VERSATILE BENCH POWER SUPPLY

ANDY FLIND

A well-proven power supply that provides 0V to 20V with current limiting in two ranges of 100mA and 1A.

ONE of the most useful pieces of equipment an electronics experimenter can possess is a good workbench power supply. Indeed even for those who already have one, a second will often prove useful for projects requiring more than one source of supply or for the occasional design that requires long-term testing.

## POWER SUPPLY IDEALS

Ideally a workbench supply should have an output voltage that can be adjusted right down to zero as it is occasionally useful to be able to power a circuit gradually from this when fault-finding. There should also be a fast and effective current limiting facility, again adjustable from zero as this also provides valuable protection when testing circuits.

If the supply can be set to deliver a constant output current instead of a voltage it can also be used as a charger for the many types of re-chargeable battery that are available nowadays, both alkaline and small sealed lead-acid types. The latter are normally charged to a constant voltage but until this is reached a current limit is often required to prevent an excessive charge rate.

Preferably the supply should have two meters so that the voltage and current supplied to the load can be seen at a glance, and most users would probably prefer analogue meters to the digital type for this.

Power supplies meeting these specifications can be expensive, but this project can be constructed at reasonable cost, especially if some of the parts such as the case and meters are already to hand, or are purchased from inexpensive sources such as surplus stores or amateur radio rallies.

The power supply described here provides an output of up to 20V with current in two ranges of 100mA or 1A, which should be more than sufficient for most of the projects which appear in *EPE*.

## DESIGN POINTS

The design of a good power supply is more complex than might be supposed. It must provide a constant voltage or current

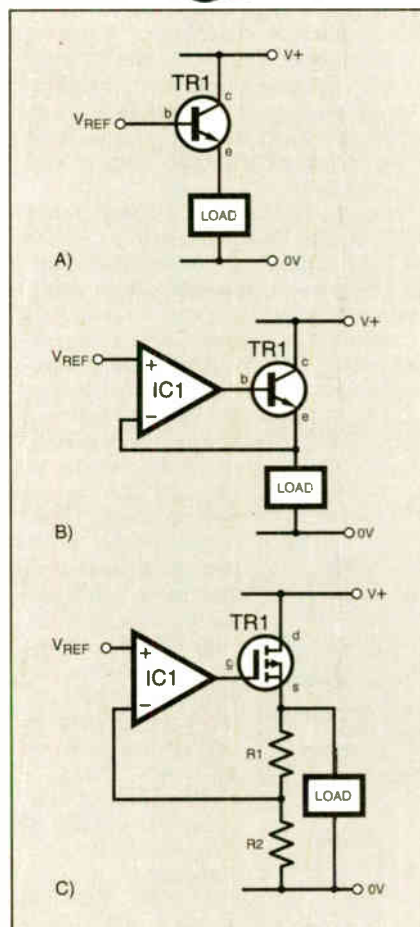

Fig.1. Various methods of voltage control: (a) transistor, (b) op.amp and transistor and (c) op.amp and power MOSFET.

whilst being able to react rapidly to any changes in the load it is supplying. This means that the circuit must have a fast response and remain stable for a wide range of output loads, voltages and currents, so the circuit is inevitably a compromise between speed and stability.

The design used for this project should be fast enough for most purposes and has good output stability.

The method of voltage control used may be a little difficult to follow so a simplified explanation is in order before a description of the full circuit. Some of the more common methods of controlling voltage are shown in Fig.1.

In Fig.1a the controlling device is a simple transistor. A reference voltage is applied to the base and this is reproduced at the emitter to supply the load, minus about half a volt for the base-emitter drop of the transistor. This can suffice for simple designs but suffers from small changes with variations in load, partly because it draws a small current from the reference source, which is usually a variable resistor connected to a fixed voltage.

Use of a power MOSFET in place of the transistor would cure this, but these have a much larger and less predictable gate-source voltage drop.

An op.amp can be used to partly overcome these problems, as shown in Fig.1b, but there are still some disadvantages. As the required output voltage rises, the input voltage to the transistor must also rise so there is effectively less control voltage available as the output approaches the supply voltage. Also, this simple circuit cannot supply an output voltage greater than the reference.



A somewhat better solution is shown in Fig.1c. A power MOSFET is controlled by an op.amp and a pair of resistors causes the op.amp to multiply the reference voltage. But the problem of low drive voltage at high output voltages remains and it is difficult to sense the output current from any of these circuits.

## BETTER CONTROL

An arrangement which overcomes these difficulties is shown in Fig.2. It uses two power supplies, a "main" one of about 25V capable of supplying up to 1A of current for the output, and an auxiliary "split" supply of +12V for the controlling circuit. The "0V" rail of this is the "ground" for the control section. It operates as follows:

A reference voltage is produced using regulator IC1 and applied to resistor R1. During normal operation op.amp IC2 uses feedback to maintain equal voltages at its inputs, so a constant current flows into R1. This current also flows through resistor R2, developing a voltage across it directly proportional to its value. If a linear variable resistor (potentiometer) is used for R2 it will provide linear control of the output.

Perhaps the easiest way to understand the action of the circuit is to consider what would happen if the voltage at the junction of R1 and R2 were to rise slightly. The output of IC2 would start to rise and thus turn on the MOSFET TR1 a little more. This would cause the 0V rail to rise with respect to the main negative supply rail so that more current would flow through R2 to bring the input to IC2 down again, restoring the balance.

The 0V rail, of course, is the positive output so the voltage developed across R2 is what is delivered to the load. Naturally, as the 0V rail rises with respect to the main supply, so do the positive and negative 12V rails, so that even when the output voltage is close to the maximum of the main supply there will still be a full 12V available for IC2 to use in controlling the gate of power MOSFET TR1.

## OUTPUT CURRENT

It is also simple to measure the output current in this arrangement using the sensing resistor R3, which develops a current-dependent voltage with respect to the

control circuit "ground". The only disadvantage of this arrangement is that the return path for the reference current from resistor R1 is via the main supply, TR1 and R3, so this current should be kept small to prevent any noticeable effect on the measured output current.

This also applies to the voltmeter which is connected directly across the output.

## MAINS SUPPLY

The full circuit diagram for the Versatile Bench Power Supply is shown in Fig.3. The incoming 230V a.c. mains passes through a 2-pole isolating switch S1 to the two transformers T1 and T2, whilst the transient suppressor VDR1 removes any brief high voltage spikes that may occur.

No supply fuses are fitted to the prototype, a 3A fuse in the mains plug being considered adequate.

Transformer T1 is a 20V 20VA (1A) type and, with bridge rectifier REC1 and reservoir capacitor C2, produces a no-load voltage of about 30V. Under full-load conditions this drops to about 24V which is still sufficient to maintain the 20V output. Capacitor C1 and resistor R1 also help to eliminate transient voltage spikes.

Transformer T2 is a smaller 100mA type with a centre-tapped 9V-0V-9V output. Arranged as shown with bridge rectifier REC2, it develops both positive and negative supplies of about 12V each. A 5V reference voltage is generated by IC1, a standard 78L05 regulator.

## DOWN TO EARTH

The earthing arrangements used in this project are slightly unusual and require some explanation. Earthing of a mains-powered project is essential both for safety and because capacitive coupling between windings in the transformer can transfer potentially damaging a.c. voltages to the output, even though from a very high impedance.

However, the output of a bench power supply is often required to have d.c. isolation from earth so that other earthed equipment, such as oscilloscopes, can be safely connected to any part of the circuit on test.

Commercially produced bench supplies often overcome this problem by using transformers with internal foil screens between

the primary and secondary windings which are earthed to eliminate the capacitive coupling. These are not readily available to the home constructor, so a different method must be used.

Switch S2 allows the mains earth to be connected directly to either the positive or negative output terminal or left "floating", where capacitively coupled a.c. voltage is grounded through capacitors C3, C4 and resistor R2. Although not ideal, this system works well in practice and reduces noise and a.c. voltage at the output to a few millivolts

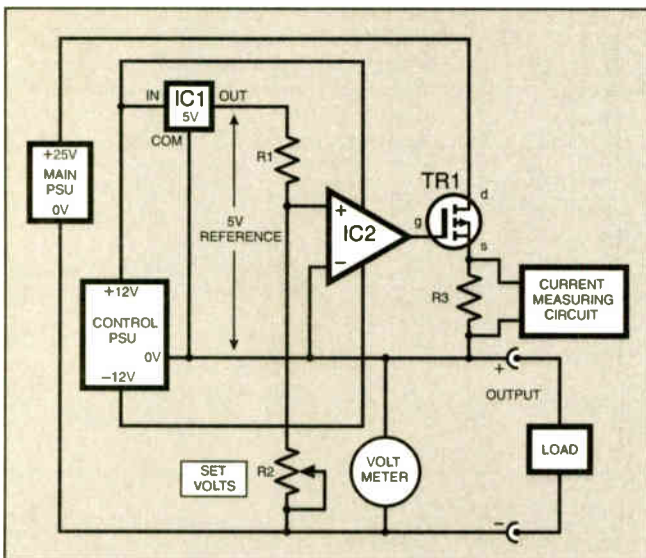

Fig.2. Simplified schematic of the voltage control method used.

# COMPONENTS

## Resistors

R1, R2	10Ω (2 off)
R3, R6,	
R8, R9	4k7 (4off)
R4	22k
R5	220k
R7, R15,	
R19	1k (3 off)
R10	1Ω (7W wirewound)
R11	180k
R12	1k8
R13	220Ω
R14	2k2
R16	27k
R17, R18	10k (2 off)
R20	820Ω
R21	68k
VDR1	250V a.c. transient supp.

All 0-6W 1% metal film, except where stated.

See  
SHOP  
TALK  
page

## Potentiometers

VR1	10k 18-turn cermet preset
VR2	100k, rotary carbon, lin.
VR3, VR4	50k 18-turn cermet preset (2 off)
VR5	1k rotary carbon, lin.
VR6	500Ω 18-turn cermet preset

## Capacitors

C1, C3, C4	470n 250V, class X2 suppression (3 off)
C2	2200μ radial elect. 63V
C5, C7,	
C9, C11,	100n ceramic,
C14 to C16	resin-dipped (7 off)
C6, C8	470μ radial elect. 16V (2 off)
C10	10μ radial elect. 50V
C12	22p ceramic, resin-dipped
C13	100μ radial elect. 63V

## Semiconductors

REC1	PW01, 6A 100V bridge rectifier
REC2	W005 1-5A 50V bridge rectifier
D1 to D5	1N4148 signal diode (5 off)
D6	BZX61C30V 30V 1-3W Zener diode
D7	red l.e.d. 3mm
TR1	BUZ11 power MOSFET
TR2	BC214L pnp transistor
IC1	78L05 +5V 100mA voltage regulator
IC2 to IC4	TL071 op.amp (3 off)

## Miscellaneous

ME1, ME2	100μA moving coil meter (2 off)
S1, S3, S4	d.p.d.t. toggle switch, 250V a.c. (3 off)
S2	1-pole 3-way rotary switch
T1	20V 20VA transformer
T2	9V-0V-9V 100mA trans.
SK1, SK2	4mm screw terminal post/socket (1 red, 1 black)

Printed circuit board, available from the EPE PCB Service, code 333; case with metal front and rear panels or metal case, 205mm x 140mm x 110mm; plastic feet (4 off); cable ties (see text); knob (2 off); 8-pin d.i.l. socket (3 off); heatsink, 100mm x 65mm; fixings; connecting wire; solder, etc.

Approx. Cost  
Guidance Only

£39

excluding meters & case

Fig.3. Complete circuit diagram for the Versatile Bench Power Supply.

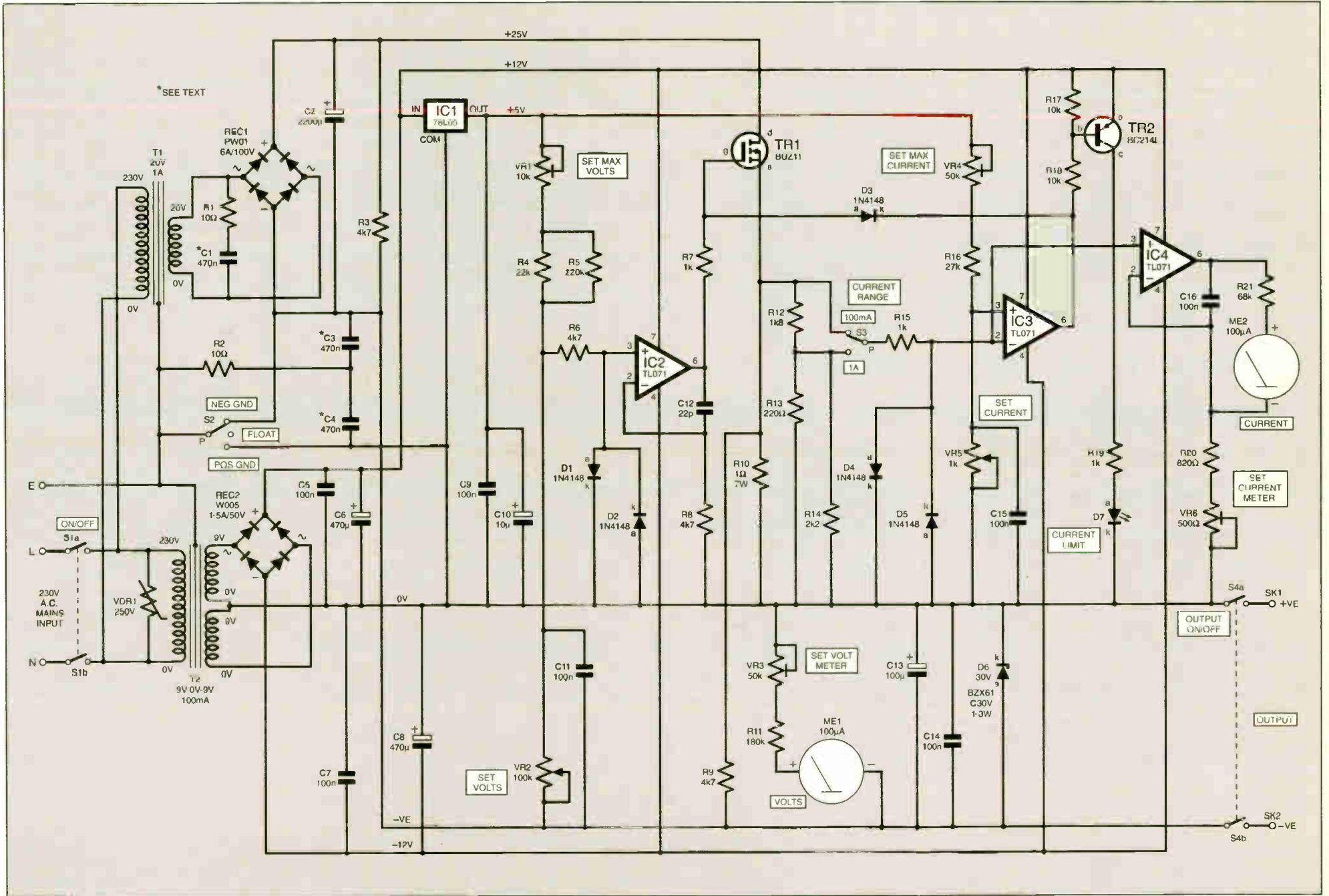



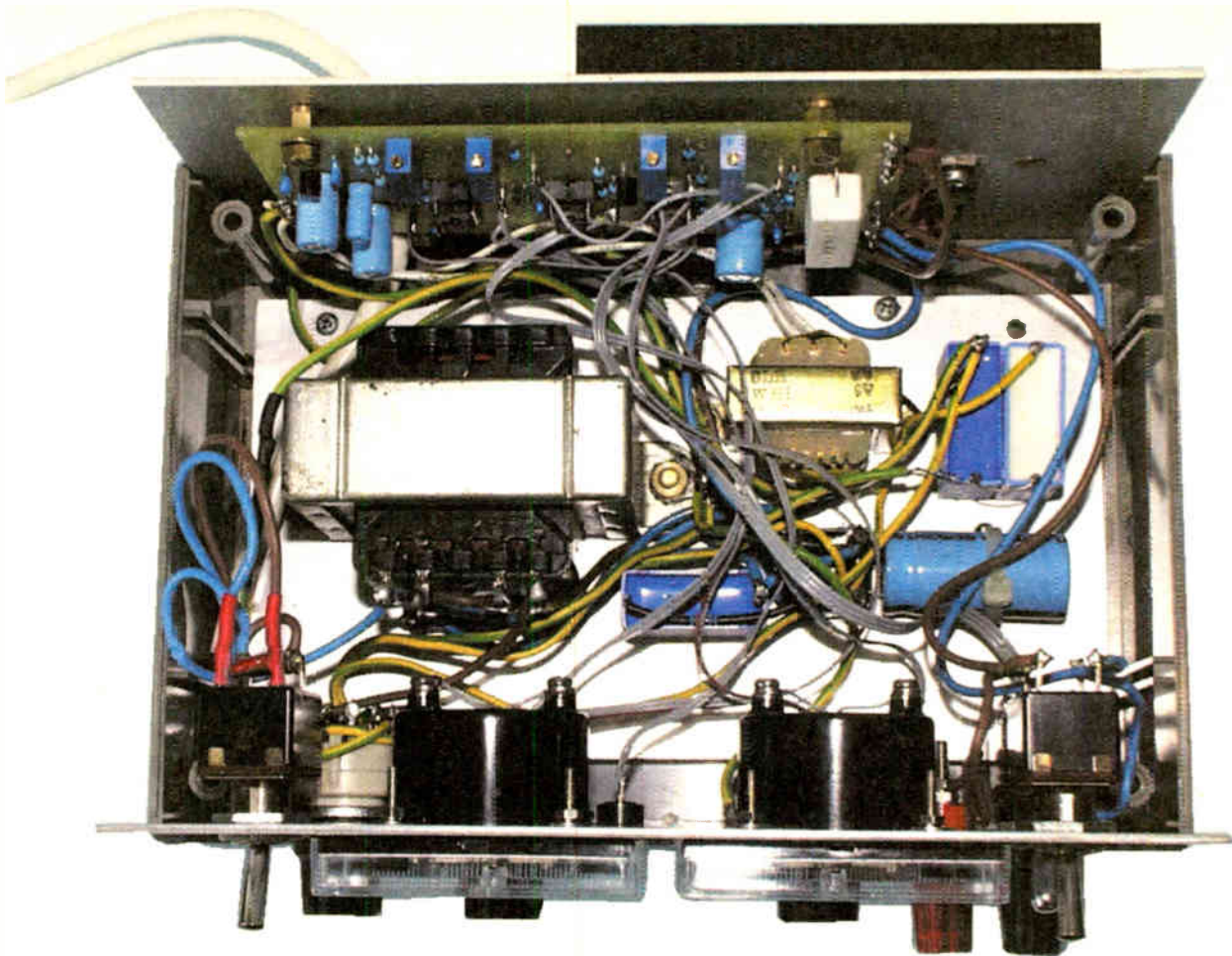

Internal view of the prototype showing the a.c. supply components.

at most. For safety, capacitors C3 and C4 must be 250V class X2 suppression types.

### VOLTAGE CONTROL

The voltage controlling part of the circuit is constructed around op.amp IC2 and operates as described earlier. The resistance to which the reference voltage is applied includes the preset VR1 so that the maximum output voltage may be set to exactly 20V.

The input to IC2 has a pair of protection diodes, D1 and D2. Capacitor C12 ensures stability but is small enough to allow a fast response to output load changes. Power MOSFET TR1 handles the full output current. Output voltage is indicated by meter ME1 with VR3 allowing preset adjustment for calibration to 20V full-scale.

Load current is sensed by the one ohm resistor R10. At full output this dissipates a watt of heat, so a 7W type is used to dissipate this safely. A potential divider across R10, consisting of R12 with R13 and R14 in parallel, allows selection of either the full potential across it or one tenth through switch S3, giving the 100mA and 1A current ranges.

The voltage from S3 is compared by op.amp IC3 with an adjustable voltage derived from the reference by divider network VR4, R16 and the current control VR5. When the S3 voltage exceeds this secondary reference voltage, the output of IC3 goes low, pulling the gate voltage of TR1 down through diode D3 to limit the current flow through this transistor.

It also turns on transistor TR2, which illuminates light emitting diode (l.e.d.) D7 to indicate that current limiting is taking place. Preset VR4 allows the current ranges

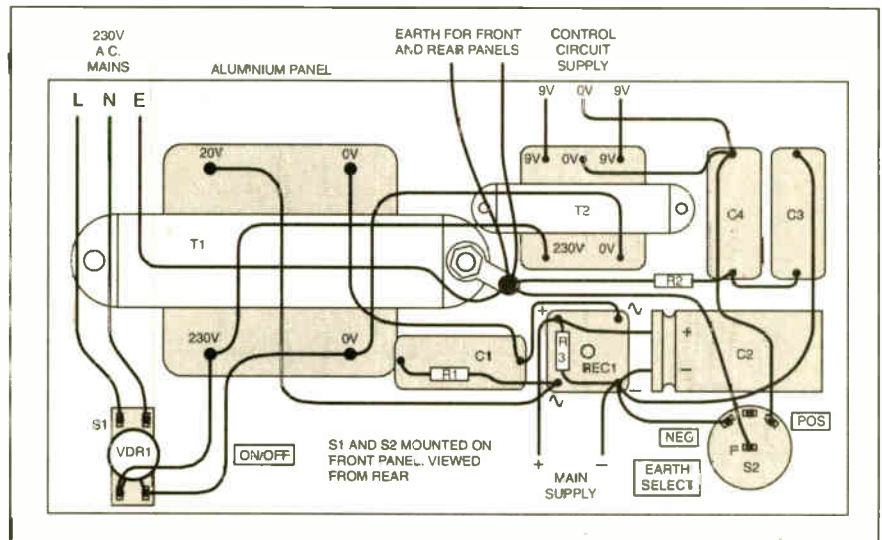

Fig.4. Layout and interwiring of power supply components mounted on an aluminium base plate. The plate also acts as the heatsink for the 6A bridge rectifier REC1. S1 and S2 are mounted on the front panel.

to be set precisely to 100mA and 1A, whilst VR5 gives control from zero to the selected maximum.

Op.amp IC4 also receives the voltage from S3, and converts it into a 1-100 $\mu$ A drive for the current indication meter ME2. Preset VR6 allows calibration of this meter for full-scale corresponding to the 100mA and 1A signal inputs. The high value of resistor R21 prevents any possibility of meter damage through overdriving.

Double-pole switch S4 allows the output to be switched off independently and also provides instant isolation from the circuit connected to it at any time.

Zener diode D6 protects TR1 from any high voltage pulses arising from the connected load. This can happen with some types of inductive load and, whilst normally tolerant of brief high currents, semiconductors are easily damaged by excessive voltage.

### CONSTRUCTION

As this unit is mains powered, its construction should only be carried out by those who are suitably experienced or supervised. All mains connections should be fully insulated using heat-shrink or other suitable materials.



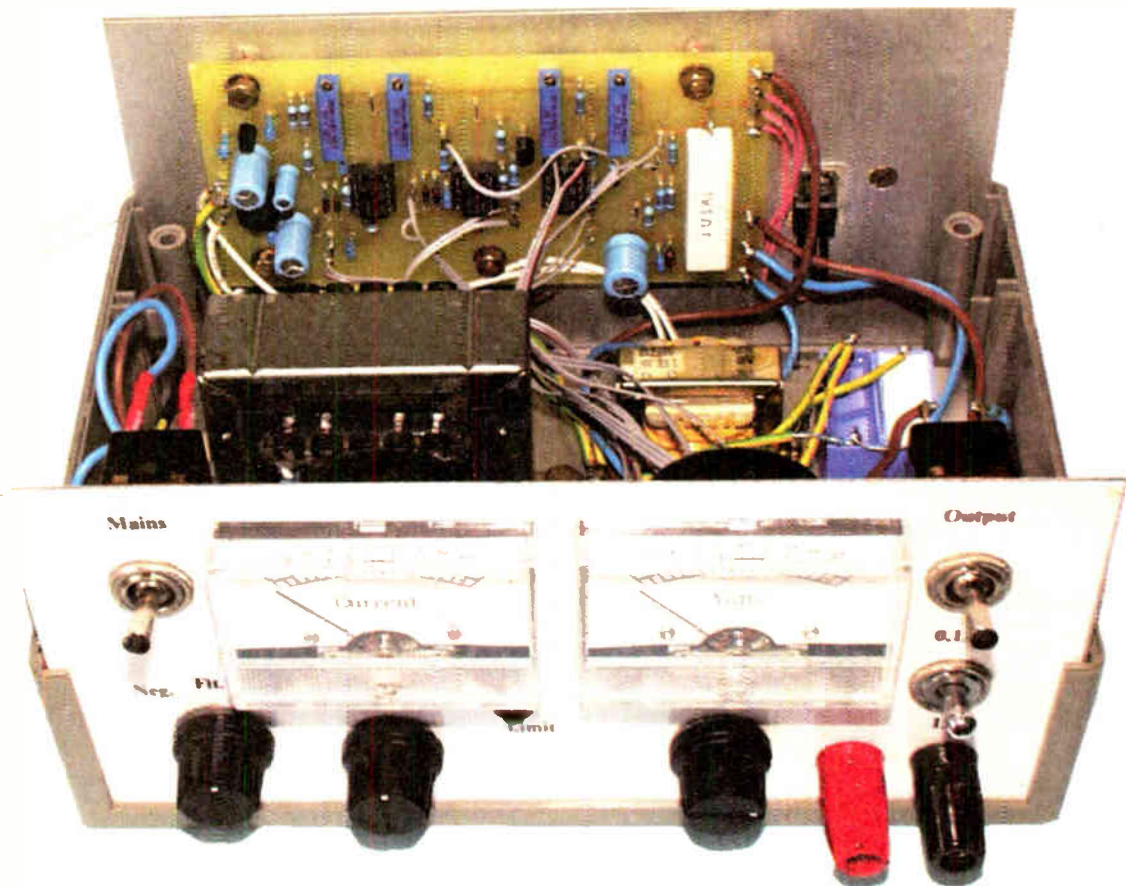

Completed power supply with the top-half of the plastic case removed to reveal the circuit board and power MOSFET TR1 bolted to the metal rear panel.

Construction should begin with the transformers, the rectifier REC1 and earthing arrangements. These can be assembled in any manner preferred by the constructor. The layout used in the prototype is shown in Fig.4.

These components are attached to a 190mm x 100mm metal plate drilled to fit the threaded mounting pillars provided in the plastic enclosure. The two transformers and rectifier REC1 are bolted in place so that the plate acts as the heatsink for the rectifier.

The large electrolytic capacitor C2 is fastened with a cable tie passed through holes to each side of it. The three 470nF capacitors, C1, C3 and C4 are glued in place. It is essential that you ensure that good adhesion occurs. Preferably also use cable ties for these components as well to prevent them from contacting mains connections should they become detached.

Note the arrangement of the earth wiring, which uses one of the main transformer mounting bolts as a "common" point for all earth connections. Any other metal parts of the case used, such as front and rear panels, must also be connected to this point.

This part of the circuit can now be fitted into the case and tested. When connected up and powered, the output of the "main" supply should be about 30V d.c. across capacitor C2 and 9V-0V-9V a.c. should be available from the 100mA transformer. These supplies will be needed for testing the remainder of the circuit.

### FRONT PANEL

The front panel should be drilled as shown in Fig.5 and assembled next. The earthing selector switch S2 should be fitted and tested with a continuity testing meter. Mains switch S1 can also be connected up. The mains input is taken to the upper two

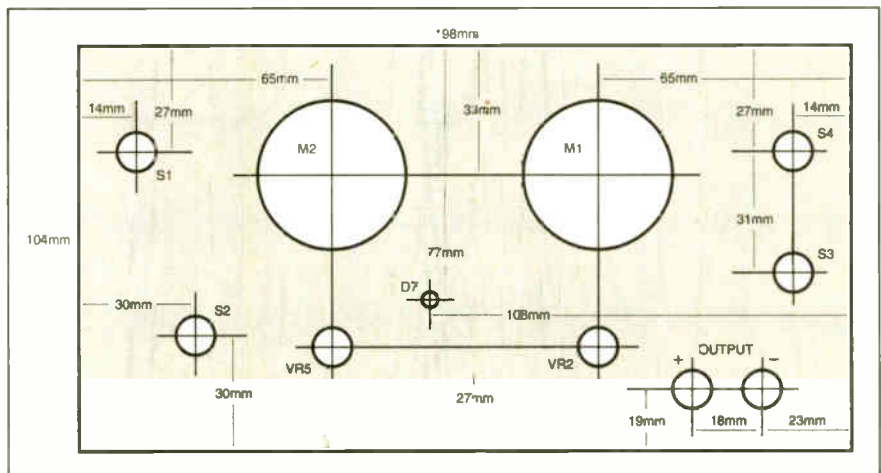
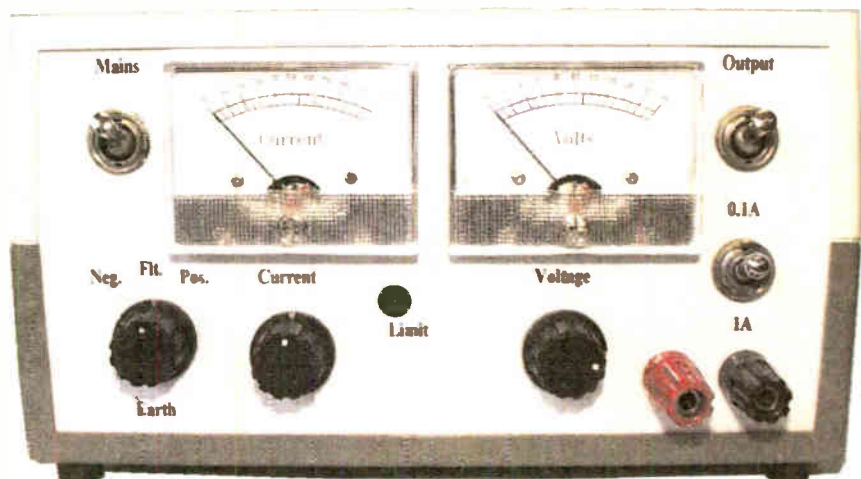

Fig.5. Front panel drilling details and dimensions. The general layout of components and front panel lettering are shown in the photograph below.





connections on this. Transient suppressor VDR1 is fitted directly to the lower two connections on the output side.

The rear metal panel of the case has four mounting bolts for the printed circuit board (p.c.b.) which can be used as a template to mark out for drilling. It also has an external heatsink to aid dissipation of heat from TR1, which is secured to the inside with an insulating mounting washer and a bolt passing right through the heatsink. Four nuts are used as spacers for the p.c.b. when it is fitted.

### P.C.B. ASSEMBLY

Most of the rest of the circuit is constructed on the p.c.b. whose details are

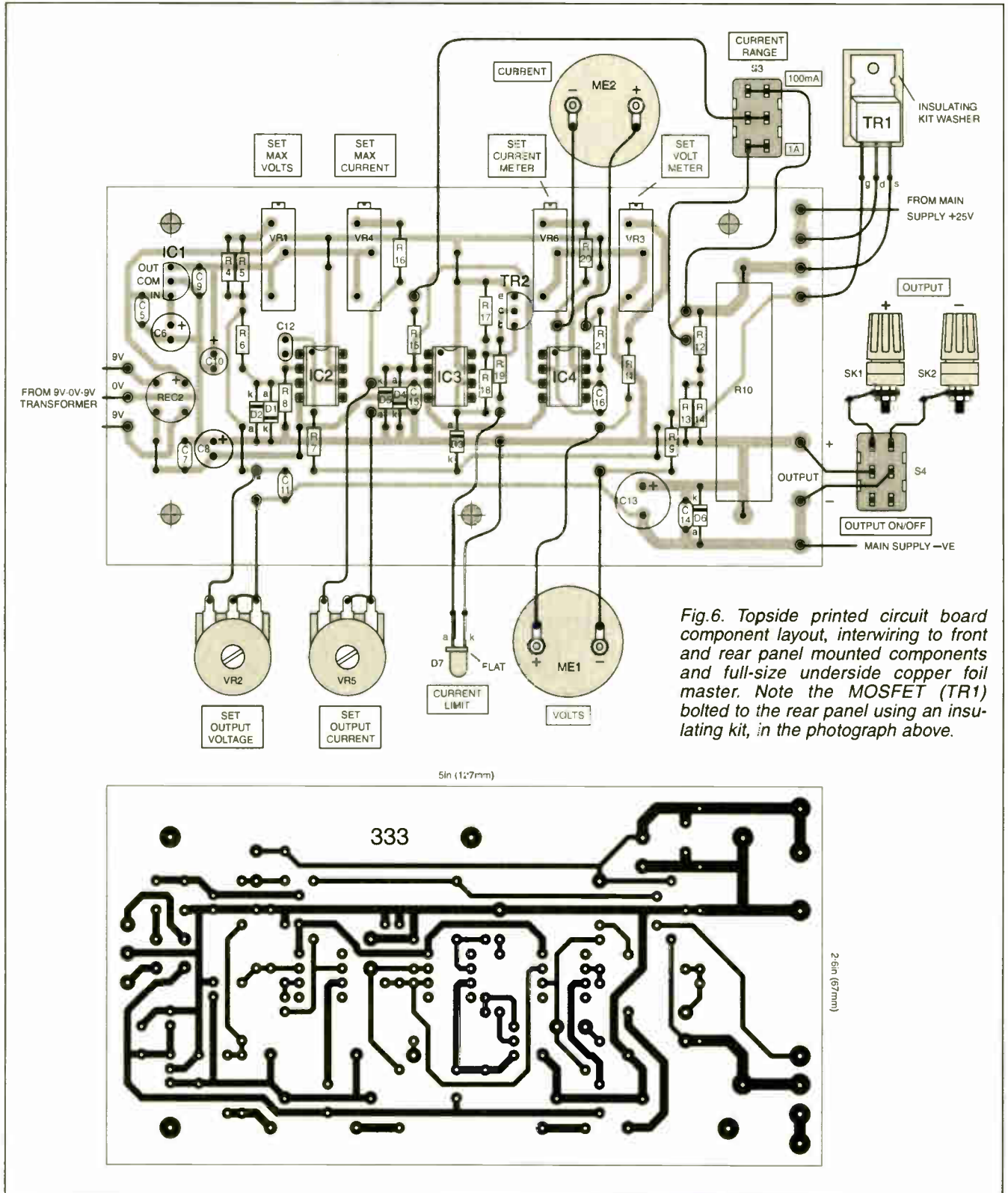
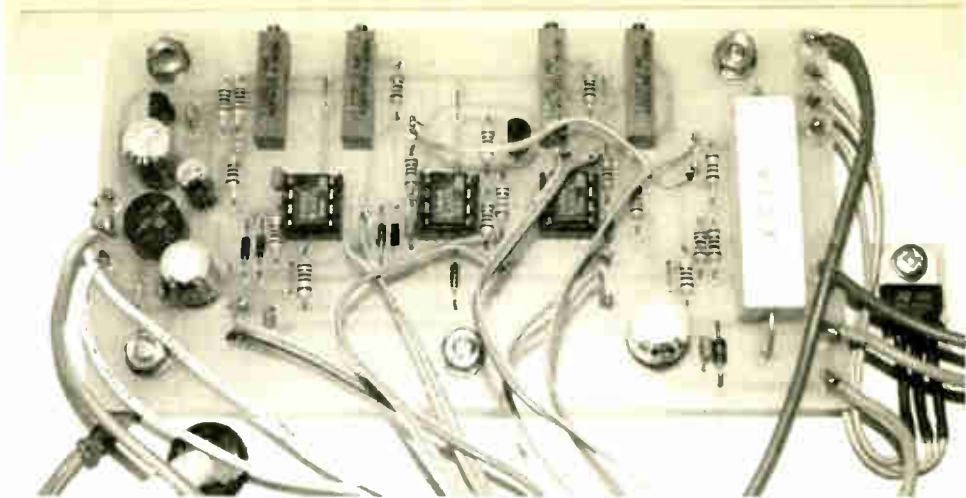

Fig.6. Topside printed circuit board component layout, interwiring to front and rear panel mounted components and full-size underside copper foil master. Note the MOSFET (TR1) bolted to the rear panel using an insulating kit, in the photograph above.

shown in Fig.6. This board is available from the *EPE PCB Service*, code 333.

After ensuring that the board will fit on the mounting bolts, the pins for external connections can be fitted, there are 23 of these, and then the links, of which there are seven. Next fit the 0.6W resistors, diodes, dual-in-line (d.i.l.) i.c. sockets, the small ceramic capacitors, presets VR1, VR3, VR4 and VR6, transistor TR2, regulator IC1, rectifier REC2, the four remaining electrolytic capacitors and 7W resistor R10, preferably in this order for ease of assembly.

Fully check your assembly for correctness of the soldering, component positioning and polarity. The board is then ready for testing.

## TESTING

The aim of using separate op.amps for the various functions is partly to make testing and trouble shooting easier, so hopefully this will be the case.

The first test is to connect the 9V-0V-9V transformer as shown in Fig.6. Using 0V (the centre-tap connection) as a reference, the circuit should be powered up and the presence of +12V and -12V checked at pins 7 and 4 respectively of the three d.i.l. sockets.

The presence of +5V from regulator IC1 can also be checked at its output pin. Next, the MOSFET TR1 and VR2, the Voltage control, should be connected, along with the two leads from the main power supply, from REC1 and C2. IC2 should now be inserted into its socket.

Whilst monitoring the output with a voltmeter, the circuit should be powered up, and it should now be possible to vary the output from zero to around 20V with Voltage control VR2. If so, VR2 can be turned right up and the voltage set to exactly 20V with preset VR1. If the voltmeter ME1 is now connected this can be adjusted for an indication of 20V (full scale) with preset VR3.

## CURRENT AFFAIRS

Next the current range switch S3 should be connected and set to 100mA, and the current control VR5 should be connected. The current control op.amp IC3 should be inserted into its socket, and a meter set to read a current of about 100mA connected in series with a 100 ohm resistor across the output. The circuit should again be powered and the voltage control turned right up.

Potentiometer VR5 should now control the current, from zero to around 100mA. Preset

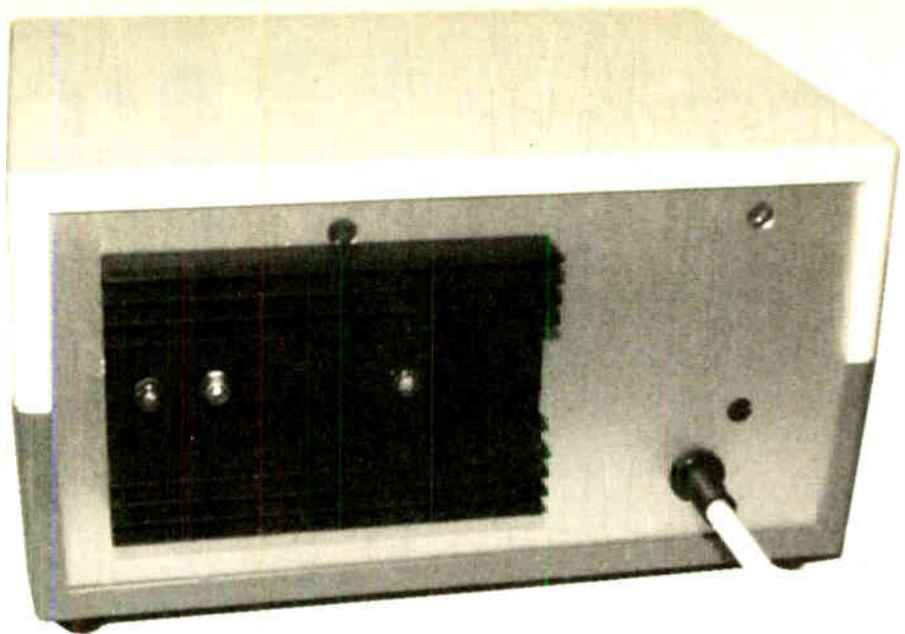

Rear of the completed power supply unit showing the finned heatsink bolted to the rear panel to aid dissipation of heat from the power MOSFET.

VR4 can be adjusted for a maximum output of exactly 100mA. The 1A range should automatically be correct following this.

The l.e.d. D7 can be connected, this should light whenever current limiting is active.

Finally, the current meter ME2 should be connected, op.amp IC4 inserted, and preset VR6 set for full scale at 100mA. As before, the 1A range should now automatically be correct following this adjustment.

## COMPLETION

Once these tests are concluded, the board can be attached to the rear panel to complete the assembly. It might be worthwhile re-checking the adjustments, the presets have been arranged for easy access with the case top half removed to make this simple.

The unit will normally be used to supply a constant voltage to circuits on test, but it may also be operated continuously in constant current mode which is very useful for charging NiCad batteries of various types.

Although the heat-sinking will be adequate for most purposes, the fact should be borne in mind that it could dissipate over 20W and therefore get rather hot. *The supply of low voltages at high currents for long periods is not recommended.* However, most loads of the kind that are likely to be found in the average workshop should present no problems.

If in doubt, just place a hand on the heatsink now and again to check temperature. The prototype has been used continually for weeks on end to power circuits used with electric clocks, and is also the favourite for programming PICs in the workshop, leaving another supply free for operating the PIC-driven circuitry.

## CURRENT LIMITATIONS

It should be noted that the current limit takes a finite time to operate so there are some applications where external limiting is needed. The output of IC3 has to come out of saturation and slew through about eight volts before limiting begins, and this will take a microsecond or two!

The limit protects the supply itself against short circuits, and in almost every practical fault situation it is fast enough to prevent damage to faulty circuits on test as these are rarely total short circuits anyway.

However, it should be remembered that the MOSFET output device can handle very high currents and has a large capacitor behind it so, for the brief time it takes for the limit to operate, many amperes can be delivered into a short! An obvious example is the testing of l.e.d.s.

The limit should never be relied upon on its own for this, a suitable series resistor should *always* be used.

EVERYDAY  
PRACTICAL  
ELECTRONICS

## NEWSAGENTS ORDER FORM

Please reserve/deliver a copy of *Everyday Practical Electronics* for me each month

*Everyday Practical Electronics* is published on the second Thursday of each month and distributed S.O.R. by COMAG. Make sure of your copy of *EPE* each month – cut out or photostat this form, fill it in and hand it to your newsagent.

Signed.....

Name and Address.....

.....

.....

Post Code.....



We can supply back issues of *EPE* by post, most issues from the past three years are available. An *EPE* index for the last five years is also available – see order form. Alternatively, indexes are published in the December issue for that year. Where we are unable to provide a back issue a photostat of any *one article* (or *one part* of a series) can be purchased for the same price. Issues from Jan. 2001 onwards are also available to download from [www.epemag.com](http://www.epemag.com).

## DID YOU MISS THESE?

### SEPT '00

**PROJECTS** • Active Ferrite Loop Aerial • Steeplechase Game • Remote Control IR Decoder • EPE Moodloop Power Supply.  
**FEATURES** • Teach-In 2000–Part 11 • New Technology Update • Circuit Surgery • Ingenuity Unlimited • Practically Speaking • Net Work – The Internet Page.

### OCT '00

**PROJECTS** • Wind-Up Torch • PIC Dual-Chan Virtual Scope • Fridge/Freezer Alarm • EPE Moodloop Field Strength Indicator.  
**FEATURES** • Teach-In 2000–Part 12 • Interface • Ingenuity Unlimited • New Technology Update • Circuit Surgery • Peak Atlas Component Analyser Review • Net Work – The Internet Page.

### NOV '00

**PROJECTS** • PIC Pulsometer • Opto-Alarm System • Sample-and-Hold • Handclap Switch.  
**FEATURES** • The Schmitt Trigger–Part 1 • Ingenuity Unlimited • PIC Toolkit Mk2 Update V2.4 • Circuit Surgery • New Technology Update • Net Work – The Internet • FREE Transistor Data Chart.

### DEC '00

**PROJECTS** • PIC-Monitored Dual PSU–Part1 • Static Field Detector • Motorists' Buzz-Box • Twinkling Star • Christmas Bubble • Festive Fader • PICtogram.  
**FEATURES** • The Schmitt Trigger–Part 2 • Ingenuity Unlimited • Interface • Circuit Surgery • New Technology Update • Quasar Kits Review • Net Work – The Internet • 2000 Annual Index.



### JAN '01

**PROJECTS** • Versatile Optical Trigger • UFO Detector and Event Recorder • Two-Way Intercom • PIC-Monitored Dual PSU–Part 2.  
**FEATURES** • Using PICs and Keypads • The Schmitt Trigger–Part 3 • New Technology Update • Circuit Surgery • Practically Speaking • Ingenuity Unlimited • CIRSIM Shareware Review • Net Work – The Internet.

### FEB '01

**PROJECTS** • Ice Alert • Using LM3914-6 Bargraph Drivers • Simple Metronome • PC Audio Power Meter.  
**FEATURES** • The Schmitt Trigger–Part 4 • Ingenuity Unlimited • Circuit Surgery • New Technology Update • Net Work – The Internet • Free 16-page supplement – How To Use Graphics L.C.D.s With PICs.

### MAR '01

**PROJECTS** • Doorbell Extender • Body Detector • DIY Tesla Lightning • Circuit Tester  
**FEATURES** • Understanding Inductors • The Schmitt Trigger–Part 5 • Circuit Surgery • Interface • New Technology Update • Net Work – The Internet Page.

### APRIL '01

**PROJECTS** • Wave Sound Effect • Intruder Alarm Control Panel–Part 1 • Sound Trigger • EPE Snug-Bug Pet Heating Control Centre.  
**FEATURES** • The Schmitt Trigger–Part 6 • Practically Speaking • Ingenuity Unlimited • Circuit Surgery • Net Work – The Internet Page • FREE supplement – An End To All Disease.

### MAY '01

**PROJECTS** • Camcorder Mixer • PIC Graphics L.C.D. Scope • D.C. Motor Controller • Intruder Alarm Control Panel–Part 2.  
**FEATURES** • The Schmitt Trigger–Part 7 • Interface • Circuit Surgery • Ingenuity Unlimited • New Technology Update • Net Work – The Internet Page.



### JUNE '01

**PROJECTS** • Hosepipe Controller • In-Circuit Ohmmeter • Dummy PIR Detector • Magfield Monitor.  
**FEATURES** • Controlling Jodrell Bank • PIC1687x Extended Memory Use • Practically Speaking • Ingenuity Unlimited • New Technology Update • Circuit Surgery • Net Work – The Internet Page.

### JULY '01

**PROJECTS** • Stereo/Surround Sound Amplifier • PIC to Printer Interface • Perpetual Projects 1–Solar-Powered Power Supply and Voltage Regulator • MSF Signal Repeater and Indicator.  
**FEATURES** • The World of PLCs • Ingenuity Unlimited • Circuit Surgery • New Technology Update • Net Work – The Internet Page.

### AUG '01

**PROJECTS** • Digitimer • Lead-Acid Battery Charger • Compact Shortwave Loop Aerial • Perpetual Projects 2 – L.E.D. Flasher – Double Door-Buzzer.  
**FEATURES** • Controlling Power Generation • Ingenuity Unlimited • Interface • Circuit Surgery • New Technology Update • Net Work – The Internet Page.

### SEPT '01

**PROJECTS** • Water Monitor • L.E.D. Super Torches • Synchronous Clock Driver • Perpetual Projects 3 – Loop Burglar Alarm – Touch-Switch Door-Light – Solar-Powered Rain Alarm.  
**FEATURES** • Controlling Flight • Ingenuity Unlimited • Practically Speaking • Circuit Surgery • New Technology Update • Net Work – The Internet Page.

### OCT '01

**PROJECTS** • PIC Toolkit Mk3 • Camcorder Power Supply • 2-Valve SW Receiver • Perpetual Projects 4 – Gate Sentinel – Bird Scarer – In-Out Register.  
**FEATURES** • Traffic Control • Ingenuity Unlimited • New Technology Update • Circuit Surgery • Interface • Net Work – The Internet Page • Free 2 CD-ROMs – Microchip 2001 Tech Library.



### NOV '01

**PROJECTS** • Capacitance Meter • Pitch Switch • Lights Needed Alert • Teach-In 2002 Power Supply.  
**FEATURES** • Teach-In 2002 – Part 1 • Practically Speaking • Circuit Surgery • New Technology Update • Ingenuity Unlimited • Net Work – The Internet Page • Free 16-page Supplement – PIC Toolkit TK3 For Windows

### DEC '01

**PROJECTS** • Ghost Buster • PIC Polywhatsit • Twinkling Lights • Mains Failure Alarm.  
**FEATURES** • Teach-In 2002 – Part 2 • Marconi – The Father of Radio • Interface • Ingenuity Unlimited • Circuit Surgery • New Technology Update • Net Work – The Internet Page • 2001 Annual Index.

**BACK ISSUES ONLY £3.30 each inc. UK p&p.**

Overseas prices £3.80 each surface mail, £5.25 each airmail.

We can also supply issues from earlier years: 1998 (except Jan. to May, July, Nov., Dec.), 1999, 2000 (except Feb., July). Where we do not have an issue a photostat of any *one article* or *one part* of a series can be provided at the same price.

### ORDER FORM – BACK ISSUES – PHOTOSTATS– INDEXES

Send back issues dates .....

Send photostats of (article title and issues date) .....

Send copies of last five years indexes (£3.30 for five inc. p&p – Overseas £3.80 surface, £5.25 airmail)

Name .....

Address .....

..... Tel: .....

I enclose cheque/P.O./bank draft to the value of £ .....

Please charge my Visa/Mastercard/Amex/Diners Club/Switch £ ..... Switch Issue No. ....

Card No. .... Card Expiry Date .....

**Note: Minimum order for cards £5.**

SEND TO: Everyday Practical Electronics, Wimborne Publishing Ltd., 408 Wimborne Road East, Ferndown, Dorset BH22 9ND.  
Tel: 01202 873872. Fax: 01202 874562.

E-mail: [orders@epemag.wimborne.co.uk](mailto:orders@epemag.wimborne.co.uk) On-line Shop: [www.epemag.wimborne.co.uk/shopdoor.htm](http://www.epemag.wimborne.co.uk/shopdoor.htm)

Payments must be in £ sterling – cheque or bank draft drawn on a UK bank. Normally supplied within seven days of receipt of order.

Send a copy of this form, or order by letter if you do not wish to cut your issue.

EM01/02



# STORE YOUR BACK ISSUES IN YOUR WALLET!



A great way to buy *EPE* Back Issues – our wallet-sized CD-ROMs contain back issues from our *EPE Online* website plus bonus articles, all the relevant PIC software and web links. All this for just £12.45 each including postage and packing.

**VOL 5  
NOW AVAILABLE**

**ONLY  
£12.45** each  
including VAT  
and p&p

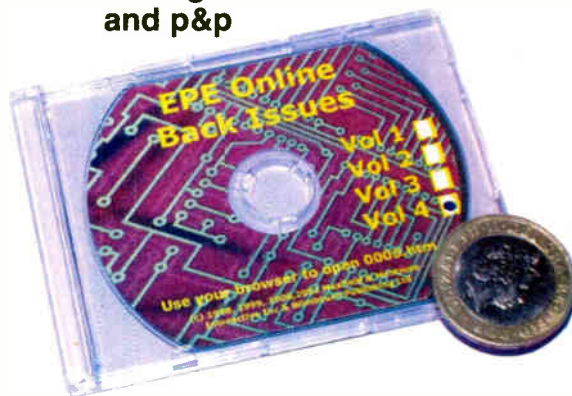

## VOL 1 CONTENTS

**BACK ISSUES** – November 1998 to June 1999 (all the projects, features, news, IUs etc. from all eight issues). Note: No advertisements or Free Gifts are included. **PIC PROJECT CODES** – All the available codes for the PIC based projects published in these issues.

## VOL 2 CONTENTS

**BACK ISSUES** – July 1999 to December 1999 (all the projects, features, news, IUs, etc. from all six issues). Note: No advertisements or Free Gifts are included. **PIC PROJECT CODES** – All the available codes for the PIC-based projects published in these issues.

## VOL 3 CONTENTS

**BACK ISSUES** – January 2000 to June 2000 (all the projects, features, news, IUs, etc. from all six issues). **PIC PROJECT CODES** – All the available codes for the PIC-based projects published in these issues.

## VOL 4 CONTENTS

**BACK ISSUES** – July 2000 to Dec. 2000 (all the projects, features, news, IUs etc. from all six issues). **PROJECT CODES** – All the available codes for the programmable projects in these issues.

## VOL 5 CONTENTS

**BACK ISSUES** – January 2001 to June 2001 (all the projects, features, news, IUs etc. from all six issues). **PROJECT CODES** – All the available codes for the programmable projects in these issues, including those for *Interface*.

## EXTRA ARTICLES – ON ALL VOLUMES

**BASIC SOLDERING GUIDE** – Alan Winstanley's internationally acclaimed fully illustrated guide.

**UNDERSTANDING PASSIVE COMPONENTS** – Introduction to the basic principles of passive components.

**HOW TO USE INTELLIGENT L.C.D.s**, By Julyan Ilett – An utterly practical guide to interfacing and programming intelligent liquid crystal display modules.

**PhyzyB COMPUTERS BONUS ARTICLE 1** – Signed and Unsigned Binary Numbers. By Clive "Max" Maxfield and Alvin Brown.

**PhyzyB COMPUTERS BONUS ARTICLE 2** – Creating an Event Counter. By Clive "Max" Maxfield and Alvin Brown.

**INTERGRAPH COMPUTER SYSTEMS 3D GRAPHICS** – A chapter from Intergraph's book that explains computer graphics technology in an interesting and understandable way with full colour graphics.

## EXTRA ARTICLE ON VOL 1 & 2

**THE LIFE & WORKS OF KONRAD ZUSE** – a brilliant pioneer in the evolution of computers. A bonus article on his life and work written by his eldest son, including many previously unpublished photographs.

**NOTE:** These mini CD-ROMs are suitable for use on any PC with a CD-ROM drive. They require Adobe Acrobat Reader (available free from the Internet – [www.adobe.com/acrobat](http://www.adobe.com/acrobat))

Order on-line from

[www.epemag.wimborne.co.uk/shopdoor.htm](http://www.epemag.wimborne.co.uk/shopdoor.htm)  
or [www.epemag.com](http://www.epemag.com) (USA \$ prices)  
or by phone, Fax, E-mail or Post

### BACK ISSUES CD-ROM ORDER FORM

Please send me ..... (quantity) BACK ISSUES CD-ROM VOL 1  
Please send me ..... (quantity) BACK ISSUES CD-ROM VOL 2  
Please send me ..... (quantity) BACK ISSUES CD-ROM VOL 3  
Please send me ..... (quantity) BACK ISSUES CD-ROM VOL 3  
Please send me ..... (quantity) BACK ISSUES CD-ROM VOL 5  
Price £12.45 each – includes postage to anywhere in the world.

Name .....

Address .....

..... Post Code .....

I enclose cheque/P.O./bank draft to the value of £ .....

Please charge my Visa/Mastercard/Amex/  
Diners Club/Switch

£ .....

Card No. ....

Expiry Date ..... Switch Issue No. ....

**SEND TO: Everyday Practical Electronics,  
Wimborne Publishing Ltd.,**

**408 Wimborne Road East, Ferndown, Dorset BH22 9ND.**

Tel: 01202 873872. Fax: 01202 874562.

E-mail: [orders@epemag.wimborne.co.uk](mailto:orders@epemag.wimborne.co.uk)

Payments must be by card or in £ Sterling – cheque or bank draft drawn on a UK bank.

Normally supplied within seven days of receipt of order.

Send a copy of this form, or order by letter if you do not wish to cut your issue.



# CIRCUIT SURGERY

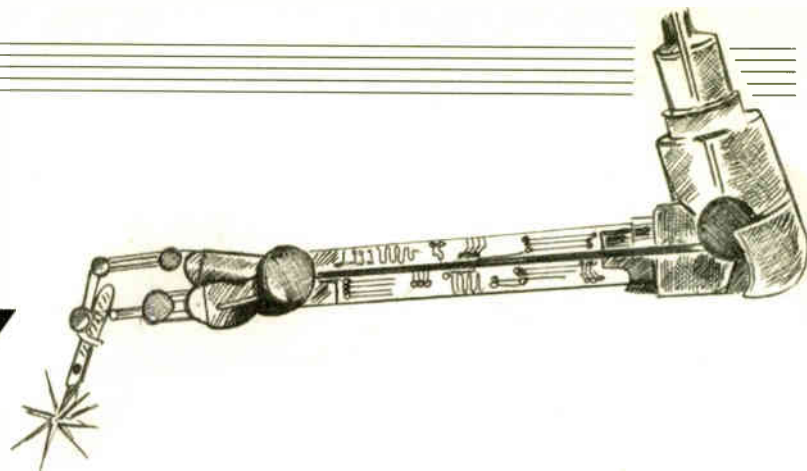

**ALAN WINSTANLEY  
and IAN BELL**

*This month our Surgeons go back to the classroom  
to find the answer to a reader's filter problem*

## Calculated Approach

A query arrived from **Graham Hunter** – who also enquired about the use of transconductance op.amps in last month's *Surgery*. Graham asks:

*In designing a notch filter, an equation I am trying to get the hang of is one that I have seen on every filter circuit that I have looked at since embarking on this problem. The first problem is that if resistor R and capacitor C need to be in "base" values, there would be an incredible number of noughts floating around to cause confusion and mistakes. Surely there is a short-hand version to avoid all those noughts!*

*My second problem is that having an idea of the frequencies that need to be filtered means a re-arrangement of the equation. Could you please go through all the stages, even though some may seem obvious to you. My sincere thanks, Graham Hunter.*

## All Being Equal

The formula Graham referred to is:

$$f = \frac{1}{2\pi RC}$$

Many readers have a set of formulae to hand which they use to calculate circuit values from time to time – such as calculating the current through a resistor when we know the voltage and resistance values (derived from Ohm's Law  $I=V/R$ ). However, these equations are more fundamental than just calculation instructions, they show the *relationship* between all the items involved and can be rearranged to suit your needs. This all hinges around the equals sign – if we do exactly the same mathematical thing to both sides of the equation then the "equals" will continue to hold true.

For example, if  $a=b+1$  then we can add 1 to both sides of the equals to get  $a+1=b+1+1$ , or more tidily  $a+1=b+2$ . This might not seem very useful, but if instead we subtract 1 from both sides then we get  $a-1=b+1-1$  or  $a-1=b$ . We can write this the other way round, as  $b=a-1$ . Thus we have *rearranged* the formula for "calculating a if we know b" into one in which we can "find b if we know a".

## Basic Rules

A key point in rearranging formulae is a set of basic "algebraic rules". These may seem obvious, but they are very important as they allow us to remove unnecessary items from equations when we are rearranging them (this is known as *cancelling*). For example we just removed the  $-1$  from the above because it equals 0, and also b plus zero is still equal to b.

A value divided by itself is one  $x/x = 1$   
 A value multiplied by 1 is equal to the value  $1 \times x = x$   
 A value minus itself is zero  $x - x = 0$   
 A value plus zero is equal to the value  $x + 0 = x$

Here is another example written in full. If  $x = y/z$  we can multiply both sides by z to get  $xz = yz/z$ , (the multiplication sign is usually left out in equations), but  $z/z$  is 1 so we have  $xz = y \times 1$ , but  $y \times 1$  is obviously equal to y, so we finish up with  $xz = y$  (or  $y = xz$ , same thing). We usually leave out these "trivial" cancelling steps when writing out a rearrangement of an equation.

We can rearrange well-known circuit equations in just the same way. For example, consider the formula for the gain (A) of a non-inverting op.amp amplifier:

$$A = V_{out}/V_{in} = R_2/R_1$$

(see *Teach-In 2002* Part 2). If you know the gain you want, and you know the value of  $R_2$ , how do you find what value to use for  $R_1$ ?

Start by subtracting 1 from both sides. Then multiply both sides by  $R_1$  and then divide both sides by  $(A-1)$  to get the formula you need. Here's how it's done:

$$A = 1 + \frac{R_2}{R_1} \Rightarrow A - 1 = \frac{R_2}{R_1} \Rightarrow R_1(A - 1) = R_2 \Rightarrow R_1 = \frac{R_2}{(A - 1)}$$

In the above the arrow symbol is used to mean "implies" or "it follows that". It shows the steps in our "mathematical reasoning". Note that when we multiplied  $A-1$  by  $R_1$  we used round brackets, also known as parentheses ( ), around the  $A-1$ ,

so we wrote  $R_1(A-1)$ . The parentheses grouped the A and the  $-1$  together as a single item that we could add, multiply, divide by etc. We could write out  $R_1(A-1)$  "in full" as  $R_1A - R_1$ .

## Side-by-Side

Using the ideas discussed above, we can also rearrange the filter equation. Start by multiplying both sides of the equation by R, which cancels out R underneath in the right hand side. You can then divide both sides by f, which cancels out f in the left hand side leaving R. Multiply by C, which cancels out C in the right-hand side and lastly, divide by R leaving the formula for calculating C. Thus we can calculate f, R or C as needed. A scientific calculator helps, especially if it is pre-programmed with the value of  $\pi$ .

$$f = \frac{1}{2\pi RC} \Rightarrow fR = \frac{1}{2\pi C} \Rightarrow R = \frac{1}{2\pi fC} \Rightarrow RC = \frac{1}{2\pi f} \Rightarrow C = \frac{1}{2\pi fR}$$

We can use a similar approach to form equations relating to quantities expressed other than in the base units (f in Hz, C in Farads, R in Ohms in this case). For example if we want to express f in kHz we can multiply the "f in Hz" value by 1000 to get the correct formula. We can then divide both sides of the equation by 1000 to get it into a useful form:

$$1,000f = \frac{1}{2\pi RC} \Rightarrow f = \frac{1}{2,000\pi RC}$$

f in kHz, R in Ohms, C in Farads

If we want R in kilohms as well, we can multiply the R by 1,000 to get

$$f = \frac{1}{2,000,000\pi RC}$$

f in kHz, R in kilohms, C in Farads

If we want C in microfarads we can divide the C value by 1,000,000.

$$f = \frac{1}{2,000,000\pi RC/1,000,000} = \frac{1}{2\pi RC}$$

f in kHz, R in kilohms, C in  $\mu F$

Which after cancellation of the "millions" neatly gets us a manageable formula without lots of zeros in it!

## Scientific Notation – no noughts

The above approach of finding new versions of formulae in different units can be useful if you make frequent use of a limited number of them under a limited range of conditions. The problem is you have to remember the correct units combination as well as the formula itself. This may be a worse source of mistakes than getting the zeros wrong! A better solution to the zeros problem is to use *scientific notation* for the large numbers, that way you do not have to write out, or type in, loads of zeros, and your formula will work correctly for any valid range of input values.

Using scientific notation is very straightforward if you use a scientific calculator – you simply use the "enter exponent" (EE) key to set the correct multiple. For example to enter 4.7 kilohms ( $4.7 \times 10^3$ ) you would type 4.7 EE 3. For 0.68µF ( $0.68 \times 10^{-4}$  Farads) you would enter something like 0.68 EE 6±, the last key being the negative/positive key (often labelled +/-). By the way, these values give a frequency of about 50Hz using the formula. Next we show you how to calculate this manually.

Please note that calculators vary on how keys are labelled and used, so you should

consult the instructions on the use of scientific notation. For more information on scientific notation, and multiples and submultiples please look at *Teach In 2002* Part 1 in the November 2001 issue, pages 777 and 781.

## In Longhand

If you do not have such a calculator, you still don't need to worry about all these zeros if you utilise scientific notation for the numbers. To multiply  $0.68 \times 10^{-6}$  by  $4.7 \times 10^3$  we first do  $4.7 \times 0.68$  to get 3.196. Then add the powers of ten  $-6 + 3$ , which is  $-3$ , so the result is  $3.196 \times 10^{-3}$ . Multiplying this by  $2\pi$  gives the result  $20.1 \times 10^{-3}$ .

We can adjust this back into "proper" scientific notation by shifting the decimal point to the left one place and changing the  $-3$  to  $-2$  (adding 1) to compensate, giving  $2.01 \times 10^{-2}$  which is more user friendly.

To calculate  $1 / (2.01 \times 10^{-2})$  we do this actually as:  $(1.0 \times 10^0) / (2.01 \times 10^{-2})$ . We do the division  $1/2.01$  and get 0.498. We subtract the power of ten we are dividing by, from the power of ten we are dividing, that's 0 minus  $-2$ , which is 2. The overall result is  $0.498 \times 10^2$ . Adjust the scientific notation by moving the decimal point one place to the right, subtracting one from the power of ten to compensate. This gives  $4.98 \times 10^1$ , which is  $4.98 \times 10$  or 49.8. (QED).

## Summing Up

To summarise, the rules are: add the powers of ten when multiplying, subtract the powers of ten when dividing; adjust the decimal point so that there is one non-zero digit before the decimal point. For each decimal place you move right, subtract one from the power of ten to compensate. Add one for each decimal place shifted left.

Lastly, if you need to add or subtract two numbers expressed in scientific notation, they must have the same power of ten value. Shift the decimal place for one of the numbers to achieve this. For example the calculation  $3.46 \times 10^{-1} + 7.9 \times 10^2$  becomes, after a 3 place shift,  $0.00346 \times 10^2 + 7.9 \times 10^2$  which you can now add together. This gives  $7.90346 \times 10^2$  or 790.346 as the result. With some practice you will soon get the hang of it. *I.M.B.*

## CIRCUIT THERAPY

*Circuit Surgery* is your column. If you have any queries or comments, please write to: Alan Winstanley, *Circuit Surgery*, Wimborne Publishing Ltd., 408 Wimborne Road East, Ferndown, Dorset, BH22 9ND. E-mail (no attachments) [alan@epemag.co.uk](mailto:alan@epemag.co.uk). Please indicate if your query is not for publication. A personal reply cannot be guaranteed but we will try to publish representative answers in this column.

## SHOP TALK

with David Barrington

### PIC Magick Musick

Most of the parts needed to construct the *PIC Magick Musick* project are RS types and can be ordered through any *bona-fide* stockists, including some of our advertisers. You can order direct (credit card only) from RS on 01536 444079 or through the web at [rswww.com](http://rswww.com). A post and packing charge will be incurred.

Both the PICs used in this project are identically programmed and it does not matter which of the two is put into which socket assigned to them. If you are unable to program your own PICs, a fully-programmed PIC16F84-4P, you will need two, can be purchased from Magenta Electronics (☎ 01283 565435 or [www.magenta2000.co.uk](http://www.magenta2000.co.uk)) for the inclusive price of £5.90 each (overseas add £1 p&p).

The printed circuit board (code 332) and the software is available from the *EPE PCB Service*, see page 69. The software is available on a 3.5in. PC-compatible disk (*EPE Disk 5*) for the sum of £3 (UK), to cover admin costs (for overseas, see page 69). It is also available *Free* from the *EPE* web site at: [ftp://ftp.epemag.wimborne.co.uk/pub/PICS/MagicMusic](http://ftp.epemag.wimborne.co.uk/pub/PICS/MagicMusic).

The 40kHz ultrasonic transducers are listed as a "matched pair" by Maplin (☎ 0870 264 6000 or [www.maplin.co.uk](http://www.maplin.co.uk)) code HY12N and they are also available from Rapid (☎ 01206 751166 or [www.rapidelectronics.co.uk](http://www.rapidelectronics.co.uk)) codes 35-0175 (Tx) and 35-0180 (Rx). The only listing we have found for the TLC7524 8-bit DAC chip is RS (see above), code 650-087. Apart from RS (code 635-167), the L272 dual power op.amp is also stocked by ESR (☎ 0191 251 4363 or [www.esr.co.uk](http://www.esr.co.uk)), code L272M.

### Versatile Bench Power Supply

Most components listed for the *Versatile Bench Power Supply* project should be readily available. The choice of panel meter is left to individual choice and "pocket". The mains rated Class X2 suppression capacitor came from Maplin (☎ 0870 264 6000 or [www.maplin.co.uk](http://www.maplin.co.uk)), code JR36P. They also supplied the 7W wirewound resistor, code L1R, transient suppressor (VDR1), code HW13P and the 100mA 9V-0V-9V mains transformer, code WB01B. The larger 20VA mains transformer came from RS (☎ 01536 444079 or [rswww.com](http://rswww.com)), code 207-166 or an alternative would be 805-091.

The PW01 6A 100V bridge rectifier seems to be no longer listed. However, a suitable substitute would appear to be listed by ESR (☎ 0191 251 4363 or [www.esr.co.uk](http://www.esr.co.uk)), code 700-601. They can also supply the BUZ11 power MOSFET.

Readers may find that it is easier to locate and use "double-pole double-throw (d.p.d.t.)" switches rather than those depicted in the prototype photographs. The printed circuit board is available from the *EPE PCB Service*, code 333 (see page 69). The case came from RS (see above), code 267-2714.

### Time Delay Touch Switch

It is vitally important that the correct type of capacitor is used for C5 in the *Time Delay Touch Switch* project, and that it must be rated for direct connection across the a.c. mains. Therefore, it is *essential* that a Class X2 type be used as these are specially rated for operation up to 275V a.c.

The X2 suppression capacitor used in the prototype was obtained from Maplin (☎ 0870 264 6000 or [www.maplin.co.uk](http://www.maplin.co.uk)), order code JE09K. A similar type is also stocked by ESR Electronic Components (☎ 0191 251 4363 or [www.esr.co.uk](http://www.esr.co.uk)), their code 867-061.

Try as we may, we have been unable to track-down an up-to-date listing for a 2.2 megohms carbon preset potentiometer, they all seem to stop short at 1 megohm. It has been suggested that a 4.7 megohms preset could be used in this circuit, or even possibly a 1 megohm type might be sufficient. A 4.7 megohms preset is listed by RS (☎ 01536 444079 or [rswww.com](http://rswww.com)), code 387-032.

The small printed circuit board is available from the *EPE PCB Service*, code 331 (see page 69). A suitable electrical blanking plate should be stocked by most DIY superstores.

### Forever Flasher

Figuratively speaking, one or two points need raising regarding the components for the *Forever Flasher* project.

As the circuit uses the CMOS 4016 bilateral switch i.c. in a relatively unorthodox manner, running it well below its minimum rated supply voltage, it is important to use one of the specific types mentioned in the article. The Philips HEF4016BP is the favoured choice and came from RS Components and can be ordered from any *bona-fide* RS stockist, or directly (credit card only) from RS (☎ 01536 444079 or [rswww.com](http://rswww.com)), code 306-033.

The author's second choice is the Texas CD4016BE (*not* the CD4016BCN), however, we have been unable to find a listing for the BE version. We understand that this uses more current, so you may need to reduce the value of resistor R3 to around 4.7 megohms.

The 33 megohm resistor (R1) used in the prototype seems to be only available in a ½W rating and was purchased from Maplin (☎ 0870 264 6000 or [www.maplin.co.uk](http://www.maplin.co.uk)). It is from their "High Voltage" range and should be ordered as: code V33M.

An extreme brightness red i.e.d. (preferably 3000mcd), with a 10 degrees viewing angle, is needed for D3. The author did not indicate which one he used, but two possible candidates appear to be listed in the Ultra-bright AlGaAs range from RS Components (see above). Both are rated at 3000mcd and are coded 564-015 (10° viewing) and 826-701 (7° viewing).

The small printed circuit board is available from the *EPE PCB Service*, code 330 (see page 69).

### Teach-In 2002 – Lab Work

Only the capacitive type humidity sensor will be difficult for readers to find locally when shopping for this month's *Teach-In 2002 – Lab Work 3* components. The one in our demonstration set-up came from Rapid Electronics (☎ 01206 751166 or [www.rapidelectronics.co.uk](http://www.rapidelectronics.co.uk)), code 61-0960, and has a rated capacitance of  $122\text{pF} \pm 15\%$  at 25°C, 43%RH, 100kHz.

All of the semiconductor devices should be readily available from our components advertisers. They are certainly listed in the latest ESR Electronic Components catalogue (☎ 0191 251 4363 or [www.esr.co.uk](http://www.esr.co.uk)).



# Measure pH, Voltage, Humidity, Sound & Light, on your PC!

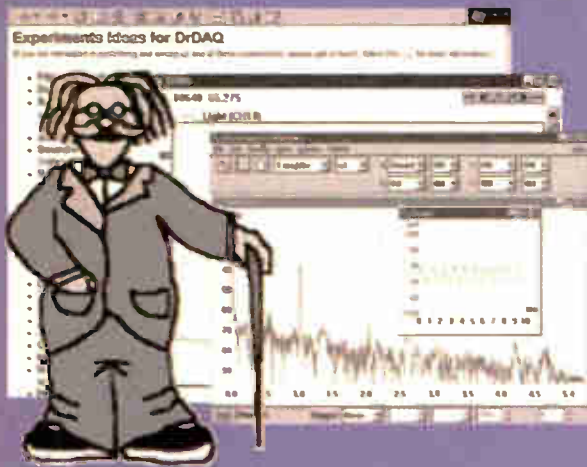

- ✓ Very low cost
- ✓ Built in sensors for light, sound (level and waveforms) and temperature
- ✓ Use DrDAQ to capture fast signals (eg sound waveforms)
- ✓ Outputs for control experiments
- ✓ Supplied with both PicoScope (oscilloscope) and PicoLog (data logging) software

**Only £59!**  
+ VAT

The DrDAQ is a low cost data logger from Pico Technology. It is supplied ready to use with all cables, software and example science experiments.

**DrDAQ represents a breakthrough in data logging.** Simply plug DrDAQ into any Windows PC, run the supplied software and you are ready to collect and display data. DrDAQ draws its power from the parallel port, so no batteries or power supplies are required.

As well as the built in sensors, DrDAQ has two sockets for external sensors. When a sensor is plugged in, the software detects it and automatically scales readings. For example, if a temperature sensor is plugged in, readings are displayed in °C. Details are provided to allow users to develop their own sensors.

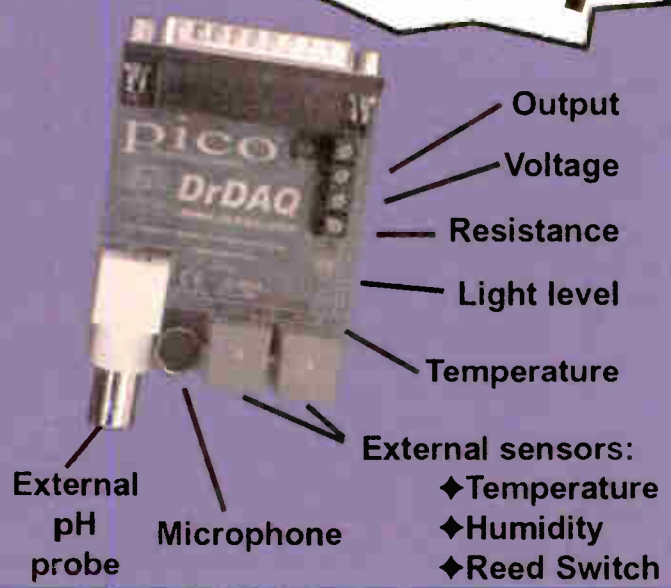

To order the DrDAQ please choose one of the following options:

- i) Visit our web site and place an order over the Internet,
- ii) Place an order over the phone by ringing the number below, or,
- iii) Fill out the order form and either fax it, or post it back to Pico Technology.

DrDAQ Order Form:			
Quantity	Package	Price inc VAT	Total
	DrDAQ + Software	£69.32	
	DrDAQ + 2 Temp Sensors	£92.85	
	DrDAQ + 2 Temp, pH Electrode, Humidity + Reed Switch Sensors	£175.08	
	Delivery	£4.11	£4.11
Grand Total		£	

Name			
Address			
Post code			
Phone			
Credit Card	<input type="checkbox"/> Visa / <input type="checkbox"/> Mastercard / <input type="checkbox"/> Switch / <input type="checkbox"/> Amex		
Card Number			
Expiry Date	/	Start Date & or Issue No.	
Cheque with order	<input type="checkbox"/>		

**PICO** A Data Logging Breakthrough  
Technology Limited



# READOUT

E-mail: [editorial@epemag.wimborne.co.uk](mailto:editorial@epemag.wimborne.co.uk)

**John Becker addresses some of the general points readers have raised. Have you anything interesting to say? Drop us a line!**

## WIN A DIGITAL MULTIMETER

A 3 1/2 digit pocket-sized l.c.d. multimeter which measures a.c. and d.c. voltage, d.c. current and resistance. It can also test diodes and bipolar transistors.

Every month we will give a Digital Multimeter to the author of the best *Readout* letter.



## ★ LETTER OF THE MONTH ★

### SO TURN THE YEARS

Dear EPE,

I can't remember quite when I abandoned electronics as a hobby – I guess it waned when I left home to go to university, and finally petered out when I became a home-owner, and swapped Veroboard for Contiboard, 14/076 for flat twin and earth and my Antex for a blowlamp.

My son seems interested now, and I thought I'd foster that, so I've been busy scheming and planning ways to make it fun, and not "electronics homework". I got to thinking about my last unfinished project, which was a bench power supply, started, if my memory serves me well, because I needed one for the testing and setup stage that I'd reached with "EMMA" (ask Messers Barrington or Kenward...).

Wondering whether to finish it, or just buy one, I thought I'd trawl the web to see what they cost, and that led me to Magenta Electronics with their kit, and their site led me to yours.

And what memories the history page brings back – I'm afraid I was never an *EE* reader, but I regularly bought *PE*, and sometimes *ETI* (in fact, I think the bench PSU is an *ETI* design). I'm sure I remember some of those front covers, and I definitely remember some of the adverts, and the suppliers. Home Radio (Components) Ltd – whatever happened to them? I wish I'd kept their catalogue. I think I've still got an old Henry's, but from the look of their website, they're a shadow of their former self. I know that Electrovalue are still going, but were catalogue-free for a while – their website is slowly (very slowly) taking shape. Maplin have gone from strength to strength it seems, and we won't talk about the fact that I remember when another little outfit was known simply as Radiospares...

A question for you, if I may – have components got a lot cheaper, in real terms?

Obviously I'm no longer on a schoolboy's budget, but even so, the prices of bits do seem to be considerably less onerous than I recall from 25-30 years ago.

Anyway – glad to see the magazine is still going after the cycles of mergers and splits. Available from "good newsgents everywhere" I guess – I shall have to look out for it. Whatever happened to *PW*? And *Wireless World*? And the (tad ambitious) *Practical TV*?

Mike Perry, via the Net

*Editor Mike replies:*

Welcome back. Yes I remember EMMA Electronic Mime Mobile Animal (I think!) and ZEE which I took to *Tomorrows World* and spent an enjoyable day for it to get about two minutes on TV.

Yes, components are much cheaper in real terms now and of course a number of them are much more complex, possibly one of the reasons there are fewer hobbyist suppliers now – not much profit in components! I still have a Home Radio catalogue – they didn't change with the times and simply faded away.

You will be pleased to hear that *PW* is still going strong and *Wireless World* has become *Electronics World* – mainly deals with software for electronics engineers now. *Practical Television* became *Television* and is still going strong.

Unfortunately with specialist titles it's now more difficult to get into most newsgents but you should find all the above titles, and *EPE*, in a large branch of WHS. *EPE* can also be bought online, via [www.epemag.com](http://www.epemag.com), or ordered from any UK newsgent.

*We hope your son will find good use for the digital multimeter you've won on his behalf!*

### LIGHTS NEEDED ALERT

Dear EPE,

I have been reading your magazine for a number of years now, and find it very interesting. I have also closely followed your *PIC Tutorial* series, getting quite involved with PIC programming, especially in my A-Level technology project where I eventually obtained an A grade. I have decided to take a gap year in industry, to get some hands on experience of professional electronics in a working environment.

I noticed that a safety precaution for fitting the *Lights Needed Alert* project (Nov '01) was to remove the car battery's positive terminal. It is standard procedure to remove the negative terminal first and reconnect it last. This is to help prevent causing a short circuit to the car body while either using the tools on the terminal or jewellery such as a metal watch strap, which could accidentally bridge the gap from the terminal to the car body.

A short circuit of an unfused car battery would cause a massive current of many hundreds of amps, welding the points of contact together, with results ranging from a dazzling flash to a nasty burn. The connection/disconnection procedure must be reversed for positive earthed cars, which are very rare these days.

By the way, I thought I'd give the Linux operating system a try after a lot of frustration with Win95, and I have not looked back! I am now using the Debian distribution which has some smart features like the ability to update all software on your system to the latest version on the Debian server by issuing only one command. I am surprised at the stability.

I am running FTP, HTTP, SMB, DNS, NET-BIOS, SMTP and POP3 internet services, as well as using it as a secure desk top PC. It has never crashed and has been running for several months and still going strong. I think the most significant thing is that all of this is totally free and available to download via the Internet.

Craig Shelley, via the Net

*We are grateful for your comments on car electrical safety, Craig, which we should have picked up on, and for your Linux observations.*

### BEEB BASIC

Dear EPE,

Readers who have used and programmed using BBC Basic may be interested to know that a new version of BBC Basic has just been released which has been written for Windows. As with previous versions of BBC Basic it includes an assembler which will allow access to PC ports for input and output.

A demo version can be downloaded from [www.rtrussell.co.uk/products/bbcwin/bbcwin.html](http://www.rtrussell.co.uk/products/bbcwin/bbcwin.html), which will allow you to write programs up to 8K in size. The full version allows you to write programs and compile them to create an executable file.

Trevor Cattermole, Colchester, via the Net

*Intriguing, Trevor! In fact most readers have moved on now and it seems best that they do. How nostalgic to think that 8K of program memory used to be regarded as big! My Toolkit TK3 requires around 1.5MB!*

### SOLDERING IRON TIPS

Dear EPE,

I intend soldering some very small and sensitive components, and I've been trying to pick out an appropriate iron. I'm considering the Weller W60P-3, a 60 watt iron which is output controlled by the tip you use. Would 60 watts be too much power for fine work?

Rob, via the Net

*This query was sent to On-Line Editor Alan, who from his knowledge of soldering replies:*

I would speculate that 60 watts is much too high for such intricate work, and the lack of precision temperature control would be a worry. Although you would have plenty of power in reserve – useful for larger joints – you don't need that with small parts. The high "mass" of these irons means they store plenty of heat in reserve. The catalogue says they are suitable for heavy electrical connections and even suitable for sheet metal! I think they will run too hot and overshoot for what you need.

I would use a 45W temperature controlled iron at most, for which you will also need the base station. Or try a cheap 15W mains-powered pencil iron with a fine tip if you don't plan to do much soldering.

I usually use 600°F to 700°F, which I can set on my soldering iron station.

Alan Winstanley

### KIWI POWER

Dear EPE,

Are your projects suitable for construction in New Zealand, where we have 230V a.c. mains power?

Simon, via the Net

*Indeed they are Simon. We in the UK also have 230V a.c. mains. In fact, though, most projects are battery powered and do not require a mains supply. But even those that do can normally be used anywhere in the world irrespective of the mains a.c. voltage simply by using a suitable mains transformer. The exceptions are the occasional (but rare) projects that use the 50Hz mains frequency for timing purposes. These are only suitable for 50Hz operation and would not work correctly on 60Hz, for example, such as is supplied in the USA.*



## TK3 AND WINZIP

Dear EPE,

Congratulations on an excellent and stimulating project in *Toolkit Mk3* (Oct/Nov '01). I have ordered a p.c.b. and look forward to many hours of enjoyment.

I have downloaded the software from your web site and breadboarded the circuit but get the message "Run time error 53 File not found" when I select the option "Check PCB" the software then crashes. There is no indication as to what file is not found. I would be very grateful if you could tell me how I might be able to get around this problem or if you are planning a fix.

Ralph Llewellyn, via the Net

*Well, as Ralph already knows, this took a bit of solving!*

*I had encountered this message when trying to run TK3 on Editor Mike's office machine known to have a printer port problem, and thought that was probably the cause. TK3 has otherwise correctly run on all the many machines it has been tried with.*

*Ralph's identical crash made me look further into the behaviour of Mike's machine. It was obviously a system failure rather than a TK3 problem, so I inserted intercepts at strategic points in my program and ran it again on Mike's PC.*

*Thus I discovered what file it was looking for, which I knew to be there! Except that it wasn't - its filename had been curtailed during the unzipping process, as had other filenames. This turned out to have been caused by Mike's PC having an old version of Winzip (curiously it's ID screen also made reference to PKunzip). Having upgraded to the current version of Winzip, TK3 ran OK.*

*After telling Ralph my findings, he E-mailed back "You hit the nail right on the head. I used PKunzip version 2.04g to unzip the files. I have now unzipped using version 8.0 and the software allows me proper access."*

*Whilst most TK3 users should be aware of this situation through notes on our ftp site and through the Chat Zone, the first CD-ROM batch did not include info on this (it was not known at that time). Readers unzipping software files for other EPE designs should also take care to use a current version of Winzip.*

*The latest version of Winzip is available for free download from [www.winzip.com](http://www.winzip.com).*

## TK3 and PIC16F870

Dear EPE,

I have been to Microchip's web-site and downloaded the programming specifications for the PIC16F870 and found that it is the same as the other PIC16F87x devices you allow for in TK3.

Could you add the PIC16F870 to the list of PICs and making its memory size 2K and data EEPROM 64 bytes?

Mark Underwood,  
via the Net

*Thanks for the comment Mark, yes I can and will if/when I do an update to TK3 sometime in the future. At that time I shall try to incorporate any practical reader suggestions that could prove useful. One thing I'm gradually doing for my own benefit is to allow keyboard selection of some button functions in the assembly-programming-editing cycle, for example.*

*In the meantime, just select the 873 or 874 option but stay within the 2K command limit of the 870.*

## TK3 INSPIRES BUGS!

Dear EPE,

I have downloaded the new *PIC Toolkit TK3*. Well done John! You seem to have included everything we need, and it's so nice to be able to switch from editing to assembly and then send the program to the PIC. Other nice points are the command listing, the number converter, being able to convert TASM/MPASM etc.

I am using my old *Mk2* board and adding that link was so easy! I was lucky as I used ribbon cable to make up the printer lead, it was only

8-way which gave me two grounds, so a bit of soldering at both ends put it to rights. I am once again into PIC programming and have renewed interest in the buggy I started many months ago.

I am also interested in the *RealRobots* buggy as per the same named magazine, not that it will ever compete with *EPE!* If there are any readers out there who would like to exchange ideas on the subject I would really like to hear from them, by E-mail to [mel.saunders@lineone.net](mailto:mel.saunders@lineone.net). My next buggy will have stepper motors for precise movement and control . . . and could even be offered to *EPE!*

Mel Saunders,  
Leicester, via the Net

*Thanks for the kind comments Mel. It's a long time since we did anything on robotics. We were offered a buggy as a possible design idea some-time ago but the designer never submitted a script. Pity, we had planned on calling it something like "The True Millennium Bug"!*

## TK3 AND MPASM DECIMAL

Dear EPE,

I recently converted a TASM file to an MPASM file because I wanted to run one of your *PIC Tutorial* programs (TUT15.ASM) on the MPASM's simulator. The program worked well but in the conversion the decimals in TASM became hexadecimals in MPASM.

What I mean is that if the TASM file has a decimal value of 16 (binary 10000), when I convert it to MPASM using *Toolkit TK3*, MPASM reads it as 16 hexadecimal (binary 10110). The two programs are different and the PIC sees it as such. Is there maybe something I am doing wrong here?

Scott Rennie, via the Net

*Yes Scott, there is (as of course we've already discussed by E-mail). You had MPASM's Radix Option set to HEX. For the embedded Radix command line inserted during TK3's TASM to MPASM conversion to be actioned, MPASM's Radix Option must be set to Default. If you examine your .ERR file created by MPASM you will see a warning message to the effect that the embedded command line has been ignored.*

*(Several E-mails between Scott and I were exchanged before we got this sorted out!)*

## HARDWARE FOR TK3

Dear EPE,

I have just downloaded the *Toolkit TK3* software. Can you recommend what hardware I can use with this program in order to program a PIC. Would your *PICtutor Deluxe Development kit* work with it or are there any other cheaper models that you sell?

Could you also please tell me what the PIC and EEPROM do? Do each run a program or is one only to hold data that is accessed by the other. If you can program a PIC through the hardware that you sell i.e. Development Kits, would they also program an EEPROM, if not what do I need to do this.

Tomas Henry, via the Net

*The TK3 software has been designed only for use with Toolkit Mk2 and Mk3 boards. It cannot be used with the PICtutor board without considerable hardware modification, an act which would invalidate that board's guarantee.*

*Your other question has answers that are too complicated to discuss here. In a nutshell, the PIC holds the program that tells the PIC what actions it is to take. Its data EEPROM holds data that can be used by the program to store and/or retrieve additional and changeable values which are preserved even after the power has been switched off. PICtutor's software cannot load data directly into the data EEPROM, although TK3 can.*

*I suggest that you complete your study of PIC programming using PICtutor and then consider migrating to TK3 and its Mk3 board when you have more experience.*

## TK3 AND WIN 2000

Dear EPE,

I downloaded your TK3 code and went to compile it but it would seem that there is a file missing *input32.bas*, although the *dll* is present.

I'm using Windows 2000 and the precompiled version crashes on my system, that's why I'm going for the recompilation. Could you put the file up on the *EPE* ftp?

Tony Wilson, via the Net

*Tony, you've raised two major points that need public airing:*

*First, input32.bas is a freeware file brought to our attention by Robert Penfold through his Interface pages. As such it is not part of my suite of source code files supplied with TK3. However, it can be downloaded from the Interface folder on our ftp site.*

*Secondly, TK3 has not been designed to run under Windows 2000, NT or XP, which have a different architecture to Win95/98/ME. I say in the text that TK3 has been designed specifically for the latter three. As I do not have machines that run W2000/NT/XP (nor intend to buy any) I regret that I do not propose to upgrade TK3 to also run with these other operating systems.*

## PIC G-SCOPE

Dear EPE,

I have built the *PIC G-Scope* (May '01) and it is running very nicely except for one problem. When inputting, for example, a 1kHz 5V p-p square wave (bypassing the input op.amp), the display seems to "hesitate" every 1 to 2 seconds (as if the A/D update was too slow for the screen update, although I don't think this is the problem). This is demonstrated by the scope trace going to zero during the hesitation.

Roger Lucas, via the Net

*Before I even had a chance to think, Roger follows up with:*

*I think I have found the reason for the "apparent" intermittent trace reset. The ADC on the '87x is 10-bit. My signal 5V p-p input occasionally exceeded the power supply, i.e. ADC ref, by a smidgen. The 10-bit seems to accept this by rolling over to a 9-bit value, but since the scope only uses 8-bit values, the processing accepts this as a zero value, which was dumped to the l.c.d. as an apparent zero signal. Why do the most perplexing problems generally turn out have the simplest solution?*

*Incidentally, I love your new TK3 software with my Magenta version of the earlier Toolkit Mk2 board, which really speeds chip programming over Picstart, although I use MPlab for assembling and program development because of the assembler directive language.*

*I was pleased to read your two last paragraphs Roger. Good news on both!*

## COMPETITION

Dear EPE,

I've been interested in electronics for many years, but the software side has always been my passion. I used to build small 6502 based processor cards, hang off old calculator i.e.d. displays and make the thing produce strange renditions of "Golden Brown" and bits of Beethoven's symphonies.

So, I suggest a challenge. Using your chat group, people form into small groups of two or three. The team then designs and builds a specific project to be set by *EPE* and within a given budget, with the software to be run on a modest PC. *EPE* to judge, and the winners given an all-expenses holiday in Bermuda, or a tour of the *EPE* offices and free lunch in the staff canteen, and perhaps also get their design published.

Joe Farr, via the Net

*Nice idea Joe! Unfortunately we have found that design competitions of this type attract a very low entry and have not proved to be worthwhile in the past. So Bermuda's off - and our canteen's yet to be built!*

## £1 BARGAIN PACKS Selected Items

**PIEZO ELECTRIC SOUNDER**, also operates efficiently as a microphone. Approximately 30mm diameter, easily mountable, 2 for £1. Order Ref: 1084.

**LIQUID CRYSTAL DISPLAY** on p.c.b. with i.c.s etc. to drive it to give 2 rows of 8 figures or letters with data. Order Ref: 1085.

**30A PANEL MOUNTING TOGGLE SWITCH**. Double-pole. Order Ref: 166.

**SUB MIN TOGGLE SWITCHES**. Pack of 3. Order Ref: 214.

**HIGH POWER 3in. SPEAKER** (11W 8ohm). Order Ref: 246.

**MEDIUM WAVE PERMEABILITY TUNER**. It's almost a complete radio with circuit. Order Ref: 247.

**HEATING ELEMENT**, mains voltage 100W, brass encased. Order Ref: 8

**MAINS MOTOR** with gearbox giving 1 rev per 24 hours. Order Ref: 89.

**ROUND POINTER KNOBS** for flatted 1/4in. spindles. Pack of 10. Order Ref: 295.

**CERAMIC WAVE-CHANGE SWITCH**. 12-pole, 3-way with 1/4in. spindle. Order Ref: 303.

**REVERSING SWITCH**. 20A double-pole or 40A single pole. Order Ref: 343.

**LUMINOUS PUSH-ON PUSH-OFF SWITCHES**. Pack of 3. Order Ref: 373.

**SLIDE SWITCHES**. Single pole changeover. Pack of 10. Order Ref: 1053.

**PAXOLIN PANEL**. Approximately 12in x 12in. Order Ref: 1033.

**CLOCKWORK MOTOR**. Suitable for up to 6 hours. Order Ref: 1038.

**TRANSISTOR DRIVER TRANSFORMER**. Maker's ref. no. LT44, impedance ratio 20k ohm to 1k ohm; centre tapped, 50p. Order Ref: 1/23R4.

**HIGH CURRENT RELAY**, 12V d.c. or 24V a.c., operates changeover contacts. Order Ref: 1026.

**3-CONTACT MICROSWITCHES**, operated with slightest touch, pack of 2. Order Ref: 861.

**HIVAC NUMICATOR TUBE**, Hivac ref XN3. Order Ref: 865 or XN11 Order Ref: 866.

**2IN. ROUND LOUDSPEAKERS**. 50Ω coil. Pack of 2. Order Ref: 908.

**5K POT**, standard size with DP switch, good length 1/4in. spindle, pack of 2. Order Ref: 11R24.

**13A PLUG**, fully legal with insulated legs, pack of 3. Order Ref: GR19.

**OPTO-SWITCH** on p.c.b., size 2in. x 1in., pack of 2. Order Ref: GR21.

**COMPONENT MOUNTING PANEL**, heavy paxolin 10in. x 2in., 32 pairs of brass pillars for soldering binding components. Order Ref: 7RC26.

**HIGH AMP THYRISTOR**, normal 2 contacts from top, heavy threaded fixing underneath, think amperage to be at least 25A, pack of 2. Order Ref: 7FC43.

**BRIDGE RECTIFIER**, ideal for 12V to 24V charger at 5A, pack of 2. Order Ref: 1070.

**TEST PRODS FOR MULTIMETER** with 4mm sockets. Good length flexible lead. Order Ref: DB6.

**LUMINOUS ROCKER SWITCH**, approximately 30mm square, pack of 2. Order Ref: D64.

**MES LAMP HOLDERS** slide on to 1/4in. tag, pack of 10. Order Ref: 1054.

**HALL EFFECT DEVICES**, mounted on small heatsink, pack of 2. Order Ref: 1022.

**12V POLARISED RELAY**, 2 changeover contacts. Order Ref: 1032.

**PROJECT CASE**, 95mm x 66mm x 23mm with removable lid held by 4 screws, pack of 2. Order Ref: 876.

**LARGE MICROSWITCHES**, 20mm x 6mm x 10mm, changeover contacts, pack of 2. Order Ref: 826.

**MAINS RELAY** with 15A changeover contacts. Order Ref: 965.

**COPPER CLAD PANELS**, size 7in. x 4in., pack of 2. Order Ref: 973.

**100M COIL OF CONNECTING WIRE**. Order Ref: 685.

**WHITE PROJECT BOX**, 78mm x 115mm x 35mm. Order Ref: 106.

**LEVER-OPERATED MICROSWITCHES**, ex-equipment, batch tested, any faulty would be replaced, pack of 10. Order Ref: 755.

**MAINS TRANSFORMER**, 12V-0V-12V, 6W. Order Ref: 811.

## THIS MONTH'S SPECIAL OFFER IS AN ANALOGUE MULTIMETER - BRAND NEW - FOR ONLY £3.50

This is a 16 range multimeter, measures d.c. and a.c. volts up to 500 and has good ranges of d.c. current and resistance. It can also test batteries 0-9V. Comes complete with its battery and test prods, complete instructions and circuit diagram. It is lovely to look at and is nicely packaged so would make an ideal gift, only £3.50. Order Ref: 3.5P26.



**VERY UP TO DATE 35MM CAMERA**. This is motorised, is focus free, has autoflash, autofilm advance, autofilm rewind and DX coating. This is brand new and nicely boxed. Price to you £10. Order Ref: 10P161.

**IT IS VERY POWERFUL**. In fact it is almost 1/4h.p. and can be driven by a 12V battery, so one on each wheel would drive a go-kart and its passenger. Made by the famous Smiths company, this motor should give a good, long, trouble-free service. Offered at £12 each or if you order a pair, then you can have the pair for £20. Order Ref: 12P41.

## SELLING WELL BUT STILL AVAILABLE

### IT IS A DIGITAL

**MULTITESTER**, complete with backrest to stand it and hands-free test prod holder. This tester measures d.c. volts up to 1,000 and a.c. volts up to 750; d.c. current up to 10A and resistance up to 2 megs. Also tests transistors and diodes and has an internal buzzer for continuity tests. Comes complete with test prods, battery and instructions. Price £6.99. Order Ref: 7P29.



**INSULATION TESTER WITH MULTIMETER**. Internally generates voltages which enable you to read insulation directly in megohms. The multimeter has four ranges, AC/DC volts, 3 ranges DC milliamps, 3 ranges resistance and 5 amp range. These instruments are ex-British Telecom but in very good condition, tested and guaranteed OK, probably cost at least £50 each, yours for only £7.50 with leads, carrying case £2 extra. Order Ref: 7.5P4.

**REPAIRABLE METERS**. We have some of the above testers but slightly faulty, not working on all ranges, should be repairable, we supply diagram, £3. Order Ref: 3P176.

**1mA PANEL METER**. Approximately 80mm x 55mm, front engraved 0-100. Price £1.50 each. Order Ref: 1/16R2.

**VERY THIN DRILLS**. 12 assorted sizes vary between 0.6mm and 1.6mm. Price £1. Order Ref: 128.

**EVEN THINNER DRILLS**. 12 that vary between 0.1mm and 0.5mm. Price £1. Order Ref: 129.

**D.C. MOTOR WITH GEARBOX**. Size 60mm long, 30mm diameter. Very powerful, operates off any voltage between 6V and 24V D.C. Speed at 6V is 200 rpm, speed controller available. Special price £3 each. Order Ref: 3P108.

**FLASHING BEACON**. Ideal for putting on a van, a tractor or any vehicle that should always be seen. Uses a Xenon tube and has an amber coloured dome. Separate fixing base is included so unit can be put away if desirable. Price £5. Order Ref: 5P267.

**MOST USEFUL POWER SUPPLY**. Rated at 9V 1A, this plugs into a 13A socket, is really nicely boxed. £2. Order Ref: 2P733.

**MOTOR SPEED CONTROLLER**. These are suitable for D.C. motors for voltages up to 12V and any power up to 1/6h.p. They reduce the speed by intermittent full voltage pulses so there should be no loss of power. In kit form these are £12. Order Ref: 12P34. Or made up and tested, £20. Order Ref: 20P39.

**BALANCE ASSEMBLY KITS**. Japanese made, when assembled ideal for chemical experiments, complete with tweezers and 6 weights 0.5 to 5 grams. Price £2. Order Ref: 2P44.

**CYCLE LAMP BARGAIN**. You can have 100 6V 0.2A MES bulbs for just £2.50 or 1,000 for £20. They are beautifully made, slightly larger than the standard 6-3V pilot bulb so they would be ideal for making displays for night lights and similar applications.

**SOLDERING IRON**, super mains powered with long-life ceramic element, heavy duty 40W for the extra special job, complete with plated wire stand and 245mm lead, £3. Order Ref: 3P221.

### TWO MORE POST OFFICE INSTRUMENTS

Both instruments contain lots of useful parts, including sub-min toggle switch sold by many at £1 each. They are both in extremely nice cases, with battery compartment and flexible carrying handles, so if you don't need the instruments themselves, the case may be just right for a project you have in mind.

The first is **Oscillator 87F**. This has an output, continuous or interrupted, of 1kHz. It is in a plastic box size 115mm wide, 145mm high and 50mm deep. Price only £1. Order Ref: 7R1.

The other is **Amplifier Ref. No. 109G**. This is in a case size 80mm wide, 130mm high and 35mm deep. Price £1. Order Ref: 7R2.

### HEAVY DUTY POT

Rated at 25W, this is 20 ohm resistance so it could be just right for speed controlling a d.c. motor or device or to control the output of a high current amplifier. Price £1. Order Ref: 1/33L1.

## RELAYS

We have thousands of relays of various sorts in stock, so if you need anything special give us a ring. A few new ones that have just arrived are special in that they are plug-in and come complete with a special base which enables you to check voltages of connections of it without having to go underneath. We have 6 different types with varying coil voltages and contact arrangements.



Coil Voltage	Contacts	Price	Order Ref:
12V DC	4-pole changeover	£2.00	FR10
24V DC	2-pole changeover	£1.50	FR12
24V DC	4-pole changeover	£2.00	FR13
240V AC	1-pole changeover	£1.50	FR14
240V AC	4-pole changeover	£2.00	FR15

Prices include base

### MINI POWER RELAYS

For p.c.b. mounting, size 28mm x 25mm x 12mm, all have 16A changeover contacts for up to 250V. Four versions available, they all look the same but have different coils:

6V Order Ref: FR17

12V Order Ref: FR18

24V Order Ref: FR19

48V Order Ref: FR20

Price £1 each less 10% if ordered in quantities of 10, same or mixed values.

### 4 CIRCUIT 12V RELAY

Quite small, clear plastic enclosed and with plug-in tags, £1. Order Ref: 205N.

**NOT MUCH BIGGER THAN AN OXO CUBE**. Another relay just arrived is extra small with a 12V coil and 6A changeover contacts. It is sealed so it can be mounted in any position or on a p.c.b. Price 75p each, 10 for £6 or 100 for £50. Order Ref: FR16.

**BIG POWER RELAY**. These are open type fixed by screws into the threaded base. Made by Omron, their ref: MM4. These have 4 sets of 25A changeover contacts. The coil is operated by 50V AC or 24V DC, price £6. Order Ref: 6P.

**SIMILAR RELAY** but smaller and with only 2 sets of 25A changeover contacts. Coil voltage 24V DC, 50V AC, £4. Order Ref: 4P.

**BIG POWER LATCHING RELAY**. Again by Omron, their ref: MM2K. This looks like a double relay, one on top of the other. The bottom one has double-pole 20A changeover contacts. The top one has no contacts but when energised it will lock the lower relay either on or off depending on how it is set. Price £6. Order Ref: 6P.

**RECHARGEABLE NICAD BATTERIES**. AA size, 25p each, which is a real bargain considering many firms charge as much as £2 each. These are in packs of 10, coupled together with an output lead so are a 12V unit but easily dividable into 2 x 6V or 10 x 1.2V. £2.50 per pack, 10 packs for £25 including carriage. Order Ref: 2.5P34.

## BUY ONE GET ONE FREE

**ULTRASONIC MOVEMENT DETECTOR**. Nicely cased, free standing, has internal alarm which can be silenced. Also has connections for external speaker or light. Price £10. Order Ref: 10P154.

**CASED POWER SUPPLIES** which, with a few small extra components and a bit of modifying, would give 12V at 10A. Originally £9.50 each, now 2 for £9.50. Order Ref: 9.5P4.

**3-OCTAVE KEYBOARDS** with piano size keys, brand new, previous price £9.50, now 2 for the price of one. Order Ref: 9.5P5.

### 1.5V-6V MOTOR WITH

**GEARBOX**. Motor is mounted on the gearbox which has interchangeable gears giving a range of speeds and motor torques. Comes with full instructions for changing gears and calculating speeds, £7. Order Ref: 7P26.

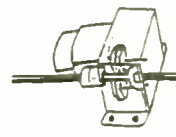

**MINI BLOWER HEATER**. 1kW, ideal for under desk or airing cupboard, etc., needs only a simple mounting frame, price £5. Order Ref: 5P23.

### TERMS

Send cash, PO, cheque or quote credit card number. If order under £25 and for heavy items add £4.50 carriage. If lightweight add postage which you think will cover.

**J & N FACTORS**  
Pilgrim Works (Dept.E.E.)  
Stairbridge Lane, Bolney  
Sussex RH17 5PA  
Telephone: 01444 881965  
E-mail: jnfactors@aol.com



# Learn About Microcontrollers

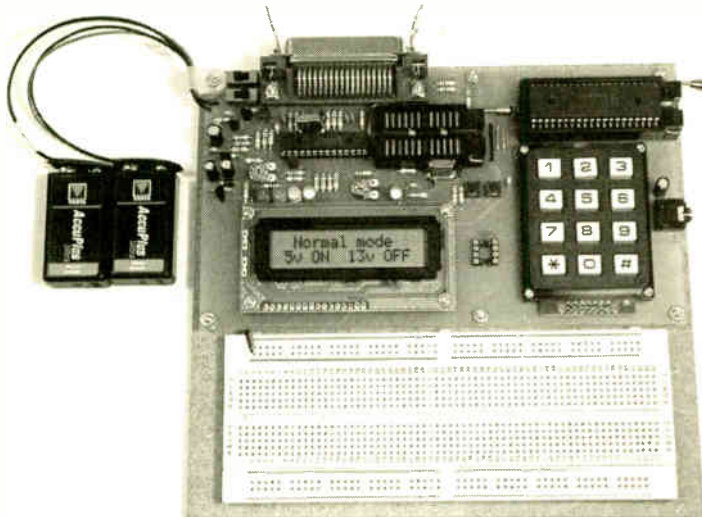

## PIC Training & Development System

The best place to start learning about microcontrollers is the PIC16F84. This is easy to understand and very popular with construction projects. Then continue on using the more sophisticated PIC16F877 family.

The heart of our system is a real book which lies open on your desk while you use your computer to type in the programme and control the hardware. Start with four very simple programmes. Run the simulator to see how they work. Test them with real hardware. Follow on with a little theory....

Our complete PIC training and development system consists of our universal mid range PIC programmer, a 306 page book covering the PIC16F84, a 212 page book introducing the PIC16F877 family, and a suite of programmes to run on a PC. The module is an advanced design using a 28 pin PIC16F872 to handle the timing, programming and voltage switching requirements. The module has two ZIF sockets and an 8 pin socket which between them allow most mid range 8, 18, 28 and 40 pin PICs to be programmed. The plugboard is wired with a 5 volt supply. The software is an integrated system comprising a text editor, assembler disassembler, simulator and programming software. The programming is performed at normal 5 volts and then verified with plus and minus 10% applied to ensure that the device is programmed with a good margin and not poised on the edge of failure. Requires two PP3 batteries which are not supplied.

- Universal mid range PIC programmer module
- + Book Experimenting with PIC Microcontrollers
- + Book Experimenting with the PIC16F877 (2nd edition)
- + Universal mid range PIC software suite
- .....+ PIC16F84 and PIC16F872 test PICs. . . . . £157.41
- UK Postage and insurance. . . . . £ 7.50
- (Europe postage & Insurance. . £13.00. Rest of world. . £22.00)

## Experimenting with PIC Microcontrollers

This book introduces the PIC16F84 and PIC16C711, and is the easy way to get started for anyone who is new to PIC programming. We begin with four simple experiments, the first of which is explained over ten and a half pages assuming no starting knowledge except the ability to operate a PC. Then having gained some practical experience we study the basic principles of PIC programming, learn about the 8 bit timer, how to drive the liquid crystal display, create a real time clock, experiment with the watchdog timer, sleep mode, beeps and music, including a rendition of Beethoven's *Für Elise*. Finally there are two projects to work through, using the PIC16F84 to create a sinewave generator and investigating the power taken by domestic appliances. In the space of 24 experiments, two projects and 56 exercises the book works through from absolute beginner to experienced engineer level.

## Ordering Information

Telephone with Visa, Mastercard or Switch, or send cheque/PO for immediate despatch. All prices include VAT if applicable. Postage must be added to all orders. UK postage £2.50 per book, £1.00 per kit, maximum £7.50. Europe postage £3.50 per book, £1.50 per kit. Rest of World £6.50 per book, £2.50 per kit.

Web site:- [www.brunningssoftware.co.uk](http://www.brunningssoftware.co.uk)

## NEW 32 bit PC Assembler

*Experimenting with PC Computers* with its kit is the easiest way ever to learn assembly language programming. If you have enough intelligence to understand the English language and you can operate a PC computer then you have all the necessary background knowledge. Flashing LEDs, digital to analogue converters, simple oscilloscope, charging curves, temperature graphs and audio digitising. Kit now supplied with our 32 bit assembler with 84 page supplement detailing the new features and including 7 experiments PC to PIC communication. Flashing LEDs, writing to LCD and two way data using 3 wires from PC's parallel port to PIC16F84.

- Book *Experimenting with PCs* ..... £21.50
- Kit 1a 'made up' with software ..... £52.00
- Kit 1u 'unmade' with software ..... £45.00

## C & C++ for the PC

*Experimenting with C & C++ Programmes* teaches us to programme by using C to drive the simple hardware circuits built using the materials supplied in the kit. The circuits build up to a storage oscilloscope using relatively simple C techniques to construct a programme that is by no means simple. When approached in this way C is only marginally more difficult than BASIC and infinitely more powerful. C programmers are always in demand. Ideal for absolute beginners and experienced programmers.

- Book *Experimenting with C & C++* ..... £24.99
- Kit CP2a 'made up' with software ..... £32.51
- Kit CP2u 'unmade' with software ..... £26.51
- Kit CP2t 'top up' with software ..... £12.99

## The Kits

The assembler and C & C++ kits contain the prototyping board, lead assemblies, components and programming software to do all the experiments. The 'made up' kits are supplied ready to start. The 'top up' kit is for readers who have already purchased kit 1a or 1u. The kits do not include the book.

## Hardware required

All systems in this advertisement assume you have a PC (386 or better) and a printer lead. The experiments require no soldering.

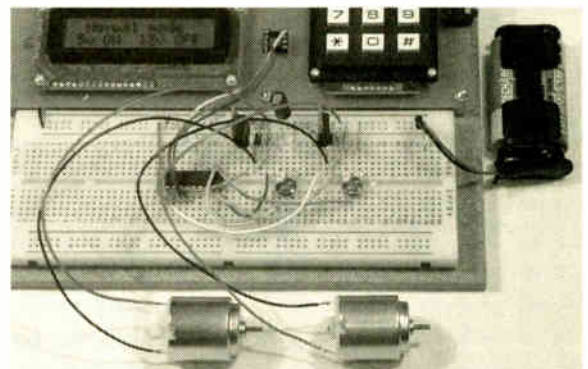

## Experimenting with the PIC16F877

The second PIC book starts with the simplest of experiments to give us a basic understanding of the PIC16F877 family. Then we look at the 16 bit timer, efficient storage and display of text messages, simple frequency counter, use a keypad for numbers, letters and security codes, and examine the 10 bit A/D converter.

The 2nd edition has two new chapters. The PIC16F627 is introduced as a low cost PIC16F84. We use the PIC16F627 as a step up switching regulator, and to control the speed of a DC motor with maximum torque still available. Then we study how to use a PIC to switch mains power using an optoisolated triac driving a high current triac.

Mail order address:

**Brunning Software** 138 The Street, Little Clacton, Clacton-on-sea, Essex, CO16 9LS. Tel 01255 862308

## Special CD-ROM Review

# ELECTRONIC CIRCUITS & COMPONENTS - V2.0



TERRY de VAUX-BALBIRNIE

*"Test driving" the latest version of this popular electronics learning resource.*

UNTIL recently, I was a moderator in Electronics for one of the larger School Examination boards. This involved visiting schools and colleges to assess students' course work. It was against this background that I looked forward to reviewing the latest *Electronic Circuits and Components – Version V2.0* CD-ROM by the well-known author, Mike Tooley.

This is one of a series of four CD-ROMS produced by Matrix Multimedia and which, together, comprise an entire course in Electronics up to university level. The other members of the series are: *Analogue Electronics*, *Digital Electronics* (also by Mike Tooley) and *Electronic Projects* (by Max Horsey). – See the *Electronics CD-ROMs* pages (pages 52 and 53) in this issue.

*Electronic Circuits and Components* may be used as a teacher-based resource with the aid of a large display. Alternatively, students may work on their own and at their own speed guided by the teacher. Subject to licence, the material may be operated on a network. Most readers will be interested in the low-cost student/home version (which has certain assessment features missing) suitable for self-study at home.

### Target Users

The course has been written for more or less anyone wishing to further his or her knowledge of electronics. However, they will require basic mathematics and science skills. They also need to be reasonably proficient in their understanding of English.

At one end of the scale, there will be individuals studying on their own at home for pleasure or employment needs. At the other, there will be students working to GCSE, A-level, GNVQ, BTEC or other pre-University stage.

### Making Changes

The original *Electronic Circuits and Components* has been in production since 1996 and Version 2.0 is a thorough revision of this and embodies changes made in response to syllabus up-dates, customer feedback and new technology available.

In particular, it is now *browser-based*. In other words, it looks and "feels" like Internet web pages. This is certain to be popular with students who will be familiar with this format. It also enables the material to be processed like any web page and delivered over the Internet for distance learning.

### Requirements and Installation

The minimum system requirements are a Pentium-based PC running Windows '95/'98/NT/2000/ME with 32MB RAM and free hard drive space (see below). You also need a Java enabled browser. Microsoft *Internet Explorer V5.0* or *Netscape Navigator V4.5* is the minimum requirement. A sound card and speakers are also needed if the user wishes to make use of the sound commentaries.

Setting-up was found to be reasonably straightforward. However, a *full installation* (to copy all files on to the hard drive) requires 360MB. Those having an older machine fitted with a 1GB (or smaller) drive, may find that they have insufficient space. When using a modern drive having a capacity of, say, 10GB or more there should be no problem unless, of course, it is "junked up" with large sound files and images.

If there is insufficient capacity, space will need to be cleared. Alternatively, a *minimum* installation could be performed requiring only 7MB. Files are then read from the CD-ROM itself. This works well. Although slower than recovering files direct from the hard drive, it is a satisfactory method.

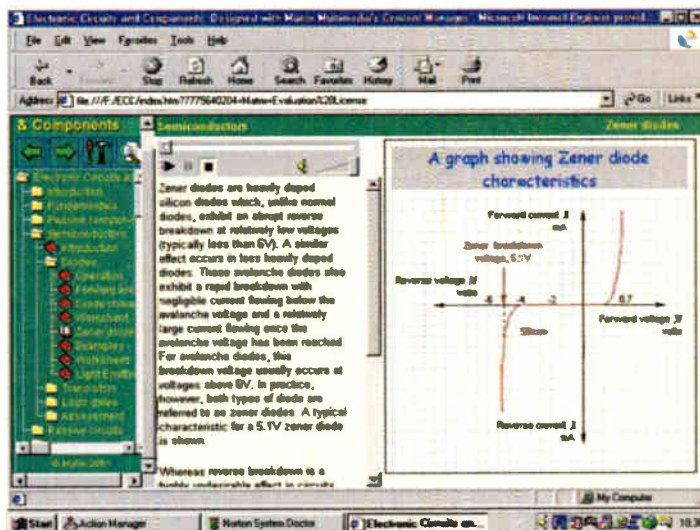

*Semiconductors/diodes and Zener diodes have been selected in this screen shot and confirmed by a title bar showing chapter and page.*

### Up and Running

With the software loaded and running, four *toolbuttons* appear near the top left-hand side of the screen (see photographs). These perform *forwards* and *backwards* (arrows) *system check* (hammer and screwdriver) and *search* (magnifying glass) functions which will be explained at the appropriate point.

Below the toolbuttons is a "tree" (similar to *Windows Explorer*) which displays the entire content. It shows eight broad areas which, when one is clicked on, expands to a set of narrower topics ("chapters"). Clicking on one of these brings pages of detailed information – one page per topic. The user can move through the pages using the *forwards* and *backwards* toolbuttons or by clicking the mouse at the appropriate point.

Selecting a page shows a window. This is typically "split" into an image, explanatory text and, perhaps, a *virtual laboratory* (see later). The text may be played over loudspeakers or headphones plugged into the sound card. This is controlled using the *start*, *stop*, *pause* and *volume* controls which appear above the text (see photographs). The commentary is in the form of a clear natural voice which will be understood by those whose first language is not English.



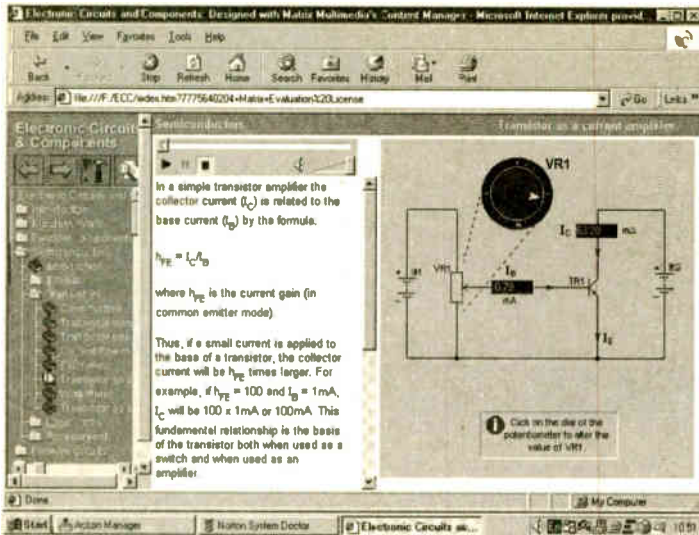

Screen shot of circuit diagram depicting a Transistor as a current amplifier. It allows the student to adjust the virtual potentiometer to control the current entering the base of a transistor and to measure the results with a virtual milliammeter.

## Content

The main topics or chapters are: Introduction, Fundamentals, Passive Components, Semiconductors, Passive Circuits, Active Circuits, Fault-Finding and the Parts Gallery.

The Introduction provides information about other resources available and includes a printable graph-paper grid. There is also a set of Teacher Notes. In this section (and with the *System Check* toolbutton), it is possible to change the style of symbols (European or US) and set UK or US spelling (analogue/analog). I note, however, that "licence" always appears as "license".

The system check will also make sure all parts of the software are in place. Contacts for the manufacturer's web site and Technical Support are given here too.

## Virtual Laboratory

In a *virtual laboratory*, students may illustrate specific principles for themselves using on-screen components. They can change certain factors and note the effect. For example, *Transistor as a current amplifier* allows the student to adjust a "potentiometer" to change the current entering the base of a transistor and measure it using a virtual "milliammeter". The collector current may then be measured using another "milliammeter" and a set of results recorded and graphed (see screen photographs).

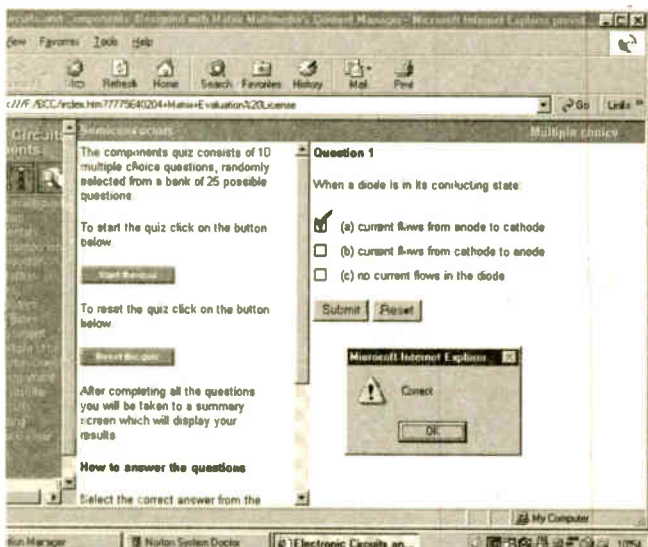

Multiple choice questions are chosen from a material store and may be reset to call up new ones. Clicking on a box brings up the "correct" window.

Opening up *Semiconductors/Diodes/Light Emitting Diodes* brings up an experiment in which a "variable resistor" may be adjusted to vary the current through an "l.e.d." which becomes brighter as the current is increased.

## Assessment

At the end of each major section there is an Assessment. This comprises multiple-choice questions, examination-type questions and an assignment (note that the student/home version has only multiple-choice questions). The multiple choice questions are chosen from a bank of material and may be reset to show new ones. Clicking on the appropriate box brings up the "correct" window (see photographs). These questions are designed for self-assessment and motivation rather than formal assessment.

Perhaps of more interest to the teacher are the examination questions and assignments which provide extension work. *Worksheets* also appear at intervals. These involve experiments which may be carried out using real equipment or linked into *Electronics Workbench/MultiSIM* files. These three elements may be used as a basis for assessment. All except the multiple choice questions may be printed off for distribution.

Sets of *examples* are given throughout the course. These are short numerical questions illustrating a specific point. The answer is written down by the student and checked against the specimen answer. I like the way the answer is explained in terms of the formula needed and the intermediate stages applied to obtain the result.

It is possible to edit the worksheets and examination questions using an HTML editor. More details are given in the *Notes for Teachers*.

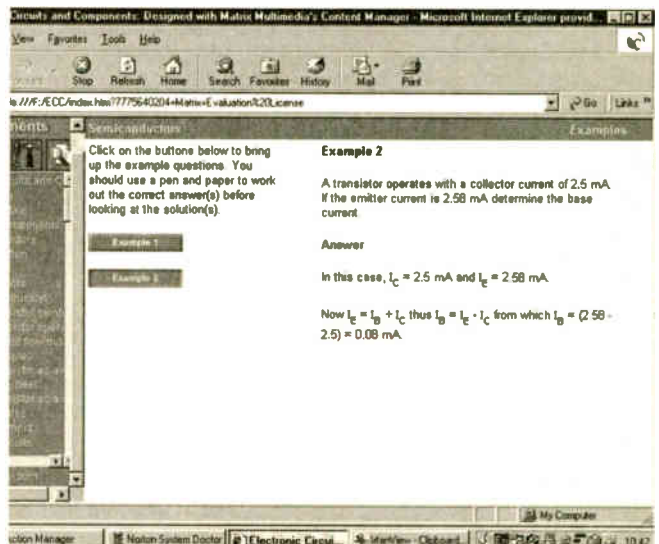

A typical "example" question and answer screen display.

## Finding Fault

The fault-finding section contains three virtual circuits (Power Supply Unit, Lamp Controller and Audio Amplifier) into which various simple faults may be introduced by pressing the appropriate button. The student then identifies the fault using virtual meters or a virtual oscilloscope.

The instrument leads are simply "dragged" to connect with the chosen components. The results are then revealed and compared with the student's findings.

## The Parts Gallery

The Parts Gallery collection provides information about many of the common components used in electronics. This is a useful resource which may be referred to at any time. As before, the "tree" is expanded to give information about a specific member of the group (enamel coated wirewound resistor, multi-pole rotary switch, etc.). For each, there is text, a sound commentary and a detailed close-up image.

The *Search* feature is another resource which is available all the time. It is activated by clicking on the *magnifying glass* toolbutton. Various options may be set. For example, a keyword or a phrase may be entered. The search may also be narrowed to a specific area if desired.

Due to different system configurations, the search engine does not always work. However, notes are given which should help the user to get it up and running.

### Summary

There is an inherent problem writing a course which aims to be "all things to all men". Teachers of those having limited ability will need to be very selective about the parts they use. Some of the material could well discourage a student at the lower end of the ability range. However, this is a job for the teacher or lecturer in the light of the qualification being sought.

Those users on their own will have to do it themselves. They will need to refer to the requirements of their own course and select appropriate work. However, there is plenty of material to satisfy all students and for those at the upper end of the range, there is plenty to challenge them.

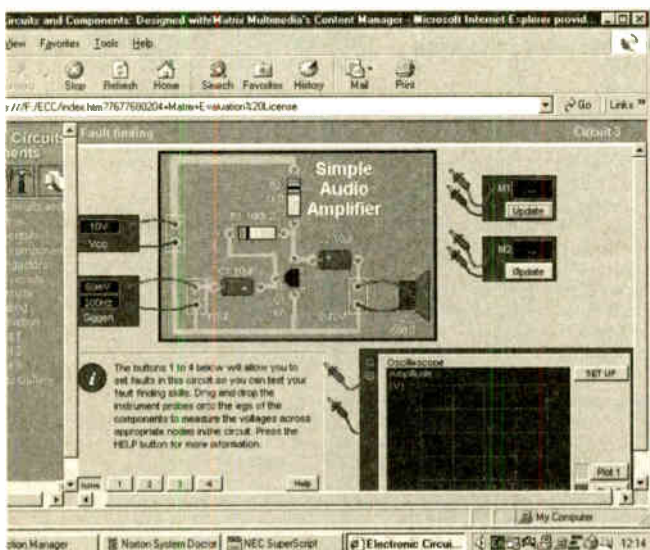

Fault-finding display for a simple audio amplifier. Fault conditions are introduced by "pressing" buttons 1 to 4 and the student's task is to investigate them using virtual test equipment, including an oscilloscope.

The course may be conducted entirely without the experience of using real equipment (providing suitable software is available). However, I think it would be a good idea to provide "hands-on" experience with actual instruments and components as often as resources allow.

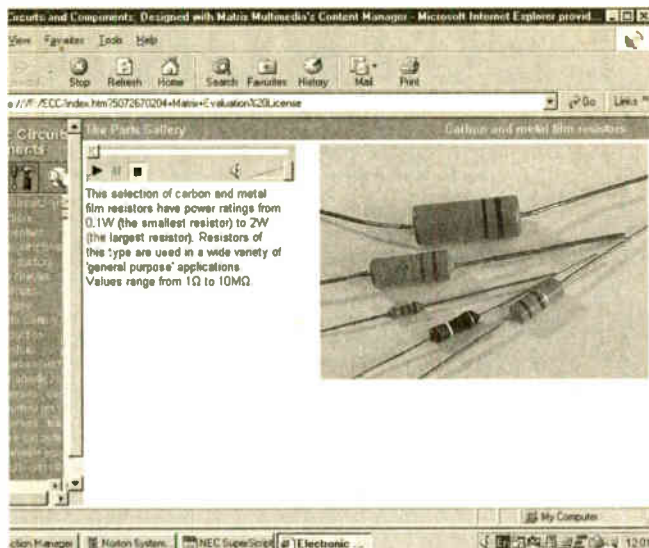

Typical screen shot from the Parts Gallery showing a group of carbon and film resistors, together with a brief description.

I liked the opportunity for students to record longer answers in written form. I also thought that answers to the numerical examples were well presented. Failure to show *how* a student reaches a numerical answer is a common reason for losing marks.

I would certainly recommend *Electronics Circuits and Components - Version V2.0*. The student/home version, although lacking some assessment material, is sufficiently inexpensive to put it within reach of most people.

### Versions

There are three versions depending on the purpose to which it is put. The prices are as follows:

Student/Home use	£45 inc. VAT
Single-user Institution (Schools, Colleges and Industry)	£99 plus VAT
Institutional Site Licence	£499 plus VAT

Note that the Student version is *not* licensed for use in institutions or businesses and must only be used by a single student working on his or her own at home.

Technical support is available at [support@matrixmultimedia.co.uk](mailto:support@matrixmultimedia.co.uk).

You can purchase the complete "set" of CD-ROMs from our *Electronics CD-ROMs* pages in this issue – see pages 52 and 53.

## MAKE IT A GIFT EVERY MONTH – AND SAVE UP TO 68p AN ISSUE



### SUBSCRIPTION ORDER FORM

Annual subscription rates (2002):

- 6 Months: UK £15, Overseas £18 (standard air service), £27 (express airmail)
- 1 Year: UK £28.50, Overseas £34.50 (standard air service) £52 (express airmail)
- 2 Years: UK £52.00, Overseas £64.00 (standard air service) £99 (express airmail)

To: Everyday Practical Electronics,  
Wimborne Publishing Ltd.,  
408 Wimborne Road East, Ferndown, Dorset BH22 9ND

Tel: 01202 873872 Fax: 01202 874562  
E-mail: [subs@epemag.wimborne.co.uk](mailto:subs@epemag.wimborne.co.uk)  
Order online: [www.epemag.wimborne.co.uk](http://www.epemag.wimborne.co.uk)



### SUBSCRIPTION ORDER FORM

I enclose payment of £..... (cheque/PO in £ sterling only), payable to Everyday Practical Electronics

My card number is: .....  
Please print clearly, and check that you have the number correct

Signature .....

Card Ex. Date ..... Switch Issue No. ....

Subscriptions can only start with the next available issue. For back numbers see the Back Issues page.

Name .....

Address .....

..... Post code .....

If you do not wish to cut your issue, send a letter or a copy of this form

01/02



# ELECTRONICS CD-ROMS

## ELECTRONICS PROJECTS



Logic Probe testing

*Electronic Projects* is split into two main sections: **Building Electronic Projects** contains comprehensive information about the components, tools and techniques used in developing projects from initial concept through to final circuit board production. Extensive use is made of video presentations showing soldering and construction techniques. The second section contains a set of ten projects for students to build, ranging from simple sensor circuits through to power amplifiers. A shareware version of Matrix's CADPACK **schematic capture, circuit simulation and p.c.b. design** software is included. The projects on the CD-ROM are: Logic Probe; Light, Heat and Moisture Sensor; NE555 Timer; Egg Timer; Dice Machine; Bike Alarm; Stereo Mixer; Power Amplifier; Sound Activated Switch; Reaction Tester. Full parts lists, schematics and p.c.b. layouts are included on the CD-ROM.

## ELECTRONICS CAD PACK

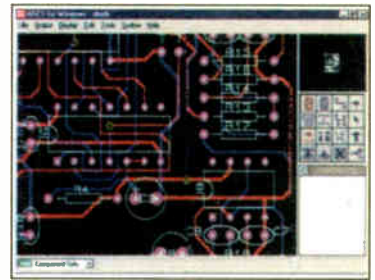

PCB Layout

Electronics CADPACK allows users to design complex circuit schematics, to view circuit animations using a unique SPICE-based simulation tool, and to design printed circuit boards. CADPACK is made up of three separate software modules. (These are restricted versions of the full Labcenter software.) **ISIS Lite** which provides full schematic drawing features including full control of drawing appearance, automatic wire routing, and over 6,000 parts. **PROSPICE Lite** (integrated into ISIS Lite) which uses unique animation to show the operation of any circuit with mouse-operated switches, pots, etc. The animation is compiled using a full mixed mode SPICE simulator. **ARES Lite** PCB layout software allows professional quality PCBs to be designed and includes advanced features such as 16-layer boards, SMT components, and an autorouter operating on user generated Net Lists.

## ANALOGUE ELECTRONICS

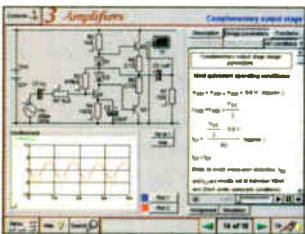

Complimentary output stage

*Analogue Electronics* is a complete learning resource for this most difficult branch of electronics. The CD-ROM includes a host of virtual laboratories, animations, diagrams, photographs and text as well as a SPICE electronic circuit simulator with over 50 pre-designed circuits. Sections on the CD-ROM include: **Fundamentals** – Analogue Signals (5 sections), Transistors (4 sections), Waveshaping Circuits (6 sections). **Op.Amps** – 17 sections covering everything from Symbols and Signal Connections to Differentiators. **Amplifiers** – Single Stage Amplifiers (8 sections), Multi-stage Amplifiers (3 sections). **Filters** – Passive Filters (10 sections), Phase Shifting Networks (4 sections), Active Filters (6 sections). **Oscillators** – 6 sections from Positive Feedback to Crystal Oscillators. **Systems** – 12 sections from Audio Pre-Amplifiers to 8-Bit ADC plus a gallery showing representative p.c.b. photos.

## DIGITAL ELECTRONICS

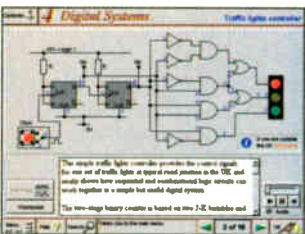

Virtual laboratory – Traffic Lights

*Digital Electronics* builds on the knowledge of logic gates covered in *Electronic Circuits & Components* (opposite), and takes users through the subject of digital electronics up to the operation and architecture of microprocessors. The virtual laboratories allow users to operate many circuits on screen. Covers binary and hexadecimal numbering systems, ASCII, basic logic gates, monostable action and circuits, and bistables – including JK and D-type flip-flops. Multiple gate circuits, equivalent logic functions and specialised logic functions. Introduces sequential logic including clocks and clock circuitry, counters, binary coded decimal and shift registers. A/D and D/A converters, traffic light controllers, memories and microprocessors – architecture, bus systems and their arithmetic logic units.

## FILTERS

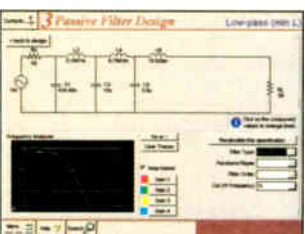

Filter synthesis

*Filters* is a complete course in designing active and passive filters that makes use of highly interactive virtual laboratories and simulations to explain how filters are designed. It is split into five chapters: **Revision** which provides underpinning knowledge required for those who need to design filters. **Filter Basics** which is a course in terminology and filter characterization, important classes of filter, filter order, filter impedance and impedance matching, and effects of different filter types. **Advanced Theory** which covers the use of filter tables, mathematics behind filter design, and an explanation of the design of active filters. **Passive Filter Design** which includes an expert system and filter synthesis tool for the design of low-pass, high-pass, band-pass, and band-stop Bessel, Butterworth and Chebyshev ladder filters. **Active Filter Design** which includes an expert system and filter synthesis tool for the design of low-pass, high-pass, band-pass, and band-stop Bessel, Butterworth and Chebyshev op.amp filters.

## DIGITAL WORKS 3.0

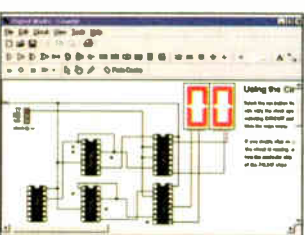

Counter project

*Digital Works Version 3.0* is a graphical design tool that enables you to construct digital logic circuits and analyze their behaviour. It is so simple to use that it will take you less than 10 minutes to make your first digital design. It is so powerful that you will never outgrow its capability.

- Software for simulating digital logic circuits
- Create your own macros – highly scalable
- Create your own circuits, components, and i.c.s
- Easy-to-use digital interface
- Animation brings circuits to life
- Vast library of logic macros and 74 series i.c.s with data sheets
- Powerful tool for designing and learning

## "C" FOR PICMICRO MICROCONTROLLERS



*C for PICmicro Microcontrollers* is designed for students and professionals who need to learn how to use C to program embedded microcontrollers. This product contains a complete course in C that makes use of a virtual C PICmicro which allows students to see code execution step-by-step. Tutorials, exercises and practical projects are included to allow students to test their C programming capabilities. Also includes a complete Integrated Development Environment, a full C compiler, Arizona Microchip's MPLAB assembler, and software that will program a PIC16F84 via the parallel printer port on your PC. (Can be used with the *PICtutor* hardware – see opposite.) Although the course focuses on the use of the PICmicro series of microcontrollers, this product will provide a relevant background in C programming for any microcontroller.

## PRICES

Prices for each of the CD-ROMs above are:

Hobbyist/Student .....£45 inc VAT  
 Institutional (Schools/HE/FE/Industry).....£99 plus VAT  
 Institutional 10 user (Network Licence) .....£199 plus VAT

(UK and EU customers add VAT at 17.5% to "plus VAT" prices)



## Interested in programming PIC microcontrollers? Learn with **PICtutor**



The Virtual PIC

This highly acclaimed CD-ROM by John Becker, together with the PICtutor experimental and development board, will teach you how to use PIC microcontrollers with special emphasis on the PIC16x84 devices. The board will also act as a development test bed and programmer for future projects as your programming skills develop. This interactive presentation uses the specially developed **Virtual PIC Simulator** to show exactly what is happening as you run, or step through, a program. In this way the CD provides the easiest and best ever introduction to the subject. Nearly 40 Tutorials cover virtually every aspect of PIC programming in an easy to follow logical sequence.

### HARDWARE

Whilst the CD-ROM can be used on its own, the physical demonstration provided by the **PICtutor Development Kit**, plus the ability to program and test your own PIC16x84s, really reinforces the lessons learned. The hardware will also be an invaluable development and programming tool for future work.

Two levels of PICtutor hardware are available – Standard and Deluxe. The **Standard** unit comes with a battery holder, a reduced number of switches and no displays. This version will allow users to complete 25 of the 39 Tutorials. The **Deluxe** Development Kit is supplied with a plug-top power supply (the **Export** Version has a battery holder), all switches for both PIC ports plus I.c.d. and 4-digit 7-segment I.e.d. displays. It allows users to program and control all functions and both ports of the PIC. All hardware is supplied **fully built and tested** and includes a PIC16F84.

### PICtutor CD-ROM

Hobbyist/Student ..... £45 inc. VAT  
 Institutional (Schools/HE/FE Industry) ... £99 plus VAT  
 Institutional 10 user (Network Licence) ... £199 plus VAT

### HARDWARE

Standard Development Kit ... £47 inc. VAT  
 Deluxe Development Kit ... £99 plus VAT  
 Deluxe Export Version ..... £96 plus VAT



Deluxe PICtutor Hardware

(UK and EU customers add VAT at 17.5% to "plus VAT" prices)

## ELECTRONIC COMPONENTS PHOTOS

A high quality selection of over 200 JPG images of electronic components.

This selection of high resolution photos can be used to enhance projects and presentations or to help with training and educational material. They are royalty free for use in commercial or personal printed projects, and can also be used royalty free in books, catalogues, magazine articles as well as worldwide web pages (subject to restrictions – see licence for full details).

Also contains a **FREE** 30-day evaluation of Paint Shop Pro 6 – Paint Shop Pro image editing tips and on-line help included!

Price **£19.95** inc. VAT



**NEW VERSION 2**

## ELECTRONIC CIRCUITS & COMPONENTS V2.0

Provides an introduction to the principles and application of the most common types of electronic components and shows how they are used to form complete circuits. The virtual laboratories, worked examples and pre-designed circuits allow students to learn, experiment and check their understanding. Version 2 has been considerably expanded in almost every area following a review of major syllabuses (GCSE, GNVQ, A level and HNC). It also contains both European and American circuit symbols. Sections include: **Fundamentals:** units & multiples, electricity, electric circuits, alternating circuits. **Passive Components:** resistors, capacitors, inductors, transformers. **Semiconductors:** diodes, transistors,

op.amps, logic gates. **Passive Circuits. Active Circuits. The Parts Gallery** will help students to recognise common electronic components and their corresponding symbols in circuit diagrams. Selections include: **Components, Components Quiz, Symbols, Symbols Quiz, Circuit Technology.** Included in the Institutional Versions are multiple choice questions, exam style questions, fault finding virtual laboratories and investigations/worksheets.

Hobbyist/Student ..... £45 inc VAT  
 Institutional (Schools/HE/FE/Industry) ..... £99 plus VAT  
 Institutional Site Licence ..... £499 plus VAT

(UK and EU customers add VAT at 17.5% to "plus VAT" prices)



Circuit simulation screen

## ELECTRONICS IN CONTROL

Two colourful animated courses for students on one CD-ROM. These cover Key Stage 3 and GCSE syllabuses. **Key Stage 3:** A pictorial look at the Electronics section featuring animations and video clips. Provides an ideal introduction or revision guide, including multi-choice questions with feedback. **GCSE:** Aimed at the Electronics in many Design & Technology courses, it covers many sections of GCSE Electronics. Provides an ideal revision guide with Homework Questions on each chapter. Worked answers with an access code are provided on a special website.

Single User £29 inc. VAT. Multiple User £39 plus VAT  
 Student copies (available only with a multiple user copy) £6 plus VAT  
 (UK and EU customers add VAT at 17.5% to "plus VAT" prices)

## MODULAR CIRCUIT DESIGN

Contains a range of tried and tested analogue and digital circuit modules, together with the knowledge to use and interface them. Thus allowing anyone with a basic understanding of circuit symbols to design and build their own projects. Version 3 includes data and circuit modules for a range of popular PICs; includes PICAXE circuits, the system which enables a PIC to be programmed without a programmer, and without removing it from the circuit. Shows where to obtain free software downloads to enable BASIC programming. Essential information for anyone undertaking GCSE or "A" level electronics or technology and for hobbyists who want to get to grips with project design. Over seventy different Input, Processor and Output modules are illustrated and fully described, together with detailed information on construction, fault finding and components, including circuit symbols, pinouts, power supplies, decoupling etc.

Single User £19.95 inc. VAT. Multiple User £34 plus VAT  
 (UK and EU customers add VAT at 17.5% to "plus VAT" prices)

Minimum system requirements for these CD-ROMs: Pentium PC, CD-ROM drive, 32MB RAM, 10MB hard disk space. Windows 95/98/NT/2000/ME, mouse, sound card, web browser.

Please send me:

## CD-ROM ORDER FORM

- Electronic Projects
- Analogue Electronics
- Digital Electronics
- Filters
- Digital Works 3.0
- Electronics CAD Pack
- C For PICmicro Microcontrollers
- PICtutor
- Electronic Circuits & Components V2.0

### Version required:

- Hobbyist/Student
- Institutional
- Institutional 10 user
- Institutional site licence

Note: The software on each version is the same (unless stated otherwise above), only the licence for use varies.



- PICtutor Development Kit – Standard
- PICtutor Development Kit – Deluxe

- Deluxe Export

Note: The CD-ROM is not included in the Development Kit prices.

- Electronic Components Photos
- Electronics In Control – Single User
- Electronics In Control – Multiple User
- Modular Circuit Design – Single User
- Modular Circuit Design – Multiple User

Note: The software on each version is the same, only the licence for use varies.

Full name: .....

Address: .....

Post code: ..... Tel. No: .....

Signature: .....

I enclose cheque/PO in £ sterling payable to WIMBORNE PUBLISHING LTD for £ .....

Please charge my Visa/Mastercard/Amex/Diners Club/Switch: £ ..... Card expiry date: .....

Card No: ..... Switch Issue No. ....

## ORDERING

ALL PRICES INCLUDE UK POSTAGE

Student/Single User/Standard Version price includes postage to most countries in the world  
 EU residents outside the UK add £5 for airmail postage per order

Institutional, Multiple User and Deluxe Versions – overseas readers add £5 to the basic price of each order for airmail postage (do not add VAT unless you live in an EU (European Union) country, then add 17½% VAT or provide your official VAT registration number).

Send your order to:

Direct Book Service  
 Wimborne Publishing Ltd  
 408 Wimborne Road East  
 Ferndown, Dorset BH22 9ND

To order by phone ring

01202 873872. Fax: 01202 874562

Goods are normally sent within seven days

E-mail: [orders@wimborne.co.uk](mailto:orders@wimborne.co.uk)

Online shop:  
[www.epemag.wimborne.co.uk/shopdoor.htm](http://www.epemag.wimborne.co.uk/shopdoor.htm)



# Constructional Project

# FOREVER FLASHER

THOMAS SCARBOROUGH



*A novel flashing l.e.d. that could run for over 20 years on a 9V lithium battery or "forever" using the "free energy" from a TV aerial or similar.*

**T**HIS article describes how a simple micropower l.e.d. flasher circuit may be pulsed off less than  $1\mu\text{A}$  power at 9V. It uses just under  $10\mu\text{W}$ , which, in theory, will enable this circuit to run for many years off a small 9V lithium battery.

Although such a battery has a nominal shelf-life of ten years, it should without trouble be able to power this circuit for twenty or thirty years or more. In some cases, even zinc carbon batteries have been known to last this long.

The proof of the miniscule power consumption lies in resistor R3 (see Fig.1), which has a value of 10M, and is wired in series with the 9V power supply. A simple calculation of  $V/R$  shows that it therefore draws less than  $1\mu\text{A}$  at 9V.

## FREE ENERGY!

Another conspicuous feature of the Forever Flasher circuit (see Fig.1) is the provision for an aerial and an earth connection. Also, diodes D1, D2, and capacitor C1 should be instantly recognisable as a standard diode pump.

Such a "pump" circuit is used when a higher d.c. output is required from a lower a.c. input. This is included in the circuit because, due to its miniscule power consumption, the flasher may in some cases be powered off a television aerial, in combination with a ground wire.

It is emphasised that this aspect of the circuit is purely experimental. However, the author found that he was able to power the flasher off various television aerials in various locations.

At first it was supposed that the aerials were picking up pure radio frequency energy. However, after extensive testing, it became clear that the real power source was not only electromagnetic waves at radio frequencies, but a wider range of electromagnetic radiations, including mains wiring and motorised equipment.

With such "free energy" in mind, the Forever Flasher has in fact been designed

to operate off a mere 2.5V at  $2\mu\text{A}$  when an aerial and a ground wire are employed as the power source, battery operation being considered optional.

## MINIMAL POWER

A CMOS 4016 quad bilateral switch i.c. (IC1) is employed at the heart of the circuit – see Fig.1. The reason for this is that CMOS devices have minimal power requirements, especially when quiescent. Their quiescent power consumption may

not even register on the  $\mu\text{A}$  scale of a multimeter.

In addition, the 4016 in particular has no input protection circuitry, which enhances its input sensitivity. It was also found to be free from a problem which commonly affects CMOS i.c.'s in low power circuits. Current consumption frequently rises quite high when input terminals are held at levels close to triggering (typically  $50\mu\text{A}$  to  $200\mu\text{A}$  at 3V), and this would render such i.c.'s useless in this application, where IC1 is used as a slow oscillator. This is not the case with the 4016 i.c.

Finally, whenever CMOS i.c.s are pushed to their limits, as is the case here, it is important to choose the i.c. from a specific manufacturer. In this case, the make of i.c. is absolutely critical. Only three specific makes were found to work at these extremes. However, other 4016s may work, but at a higher current consumption. The ones to use are the following:

The HEF4016BP (Philips); the CD4016BE (Texas Instruments), and the HCF4016BE (SGS-Thomson).

The Philips HEF4016BP proved to be the most suitable, and in this case, six individual i.c.s were tested, from two separate batches. Out of these, one failed – however, this may have been due to damage by static discharge.

The CD4016BE (not the CD4016BCN) should be the second resort. This uses very slightly more current, so that resistor R3 may be reduced to 4M7 accordingly. The HCF4016BE worked satisfactorily, although it pulsed a little erratically.

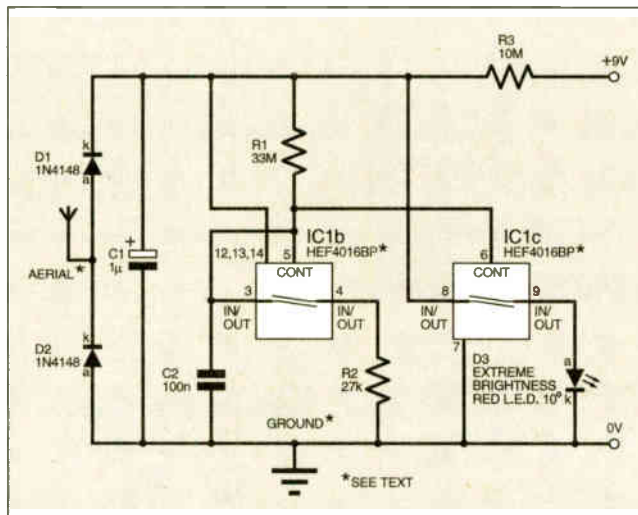

Fig.1. Complete circuit diagram for the Forever Flasher. Both sources of power supply are shown.

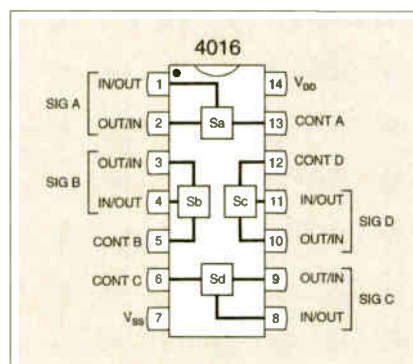

Fig.2. Pinout details for the 4016 quad bilateral switch i.c.

## CIRCUIT DESCRIPTION

The full circuit diagram for the Forever Flasher is shown in Fig.1 together with the 4016 pinout details in Fig.2. Being a quad device, the internal "bilateral" switches are labelled a to d, but we are only using switches b and c here as this fits into our printed circuit board (p.c.b.) layout. Hence, the annotations IC1b and IC1c on the circuit diagram. Note that the unused control pins (12 and 13) of switches a and d are tied to the positive supply (high); this does not affect the functioning of the circuit, but is considered good practice.

The Forever Flasher uses the 4016 (IC1) in an unorthodox manner, running it well below its minimum rated supply voltage. The main purpose of this is to draw as much power as possible from capacitor C1 to illuminate l.e.d. D3. While D3 draws all available current from C1, the voltage of the circuit plummets to about 1.7V – yet the circuit continues to function.

With most CMOS i.c.s, this would present an insurmountable problem. These may dip slightly below their minimum rated voltage (say 10%), but not much more before they fail. This does not apply, however, to the 4016. The only penalty here is that the 4016's "on" resistances gradually rise across the bilateral switches as voltage drops – to about 1kΩ (one kilohm) at 1.5V.

While it would be possible to run this circuit within its "legal" limits (at or above 3V), a theoretically perfect circuit would not make a good circuit in practice.

In this circuit, IC1 is wired as a slow oscillator. Capacitor C2 charges through resistor R1, causing pin 5 to go "high" (two-thirds of supply voltage). This closes switch IC1b, which causes C1 to be discharged through switch IC1b and resistor R2. When pin 5 goes "low" (one-third of supply voltage), switch IC1b opens again, and the charging of C1 begins over again.

At the same time as pin 5 goes "high", so also does pin 6. This causes switch IC1c to close, and so to pulse l.e.d. D3.

In order to conserve power, a very high value is chosen for R1, and a correspondingly low value for C2.

### EXTREME BRIGHTNESS

An extreme brightness red l.e.d. (above 1000mcd – preferably around 3000mcd) is used for D3, with a narrow viewing angle (say 10°). Do not use any other l.e.d. in this circuit, as it is unlikely to work. D3 is chosen especially for its very high efficiency, with its extreme brightness converting to high efficiency at low power.

An extreme brightness red l.e.d. requires between 1.7V and 1.9V, depending on the make. It does not matter if D3 is momentarily powered by more than this, as happens in this circuit when capacitor C1 first discharges. L.E.D.s can be powered by far higher than their rated voltage – on condition that this is for a small percentage of their duty cycle.

### POWER PUMP

When connected to a standard television aerial and earth, the diode pump (D1, D2 and C1) produces as much as 10V d.c. across capacitor C1 without load. Since all electromagnetic oscillations are a.c., the a.c. voltage for the pump is provided directly by the aerial.

A simple experiment may be performed with D1, D2, and C1. Allow C1 a few seconds to charge (assuming that aerial and ground wire are connected – see below). Then connect an l.e.d. across the terminals of C1, observing the correct polarity. The l.e.d. should flash brightly.

Although they are very common diodes, D1 and D2 have an extraordinarily low reverse current (25nA at 20V), which is essential in this application.

The aerial is a standard television aerial (a roof-top or attic television aerial,

connected with coaxial cable), or about 7m of coaxial cable strung up in the air. The ground wire is securely connected to metal water pipes, or to a stake driven into the ground (but not the mains earth, although this does work).

Depending on various factors, the aerial may be shortened to as little as 3m of coaxial cable. In fact, the author found that he was able to power the flasher (under the right conditions – for instance when standing close to electrical equipment) off his own body!

### CONSTRUCTION

The Forever Flasher is built on a small single-sided printed circuit board. The top-side component layout, wiring and full-size underside copper foil master are shown in Fig.3. This board is available from the *EPE PCB Service*, code 330.

Commence construction by first soldering in position the single link wire, the solder pins, and the 14-pin d.i.l. socket. This should be followed by resistors R1 to R3, then capacitors C1 and C2 and finally diodes D1 to D3. Make sure you observe the correct orientation of polarity-conscious components.

Once you have double-checked component positions, insert IC1 into the d.i.l. socket, being sure to observe anti-static precautions (ideally, do not touch the pins at all) – especially since the 4016 i.c. does not include static protection circuitry on its inputs. This is a very delicate i.c., and if any trouble-shooting is required on completion of the circuit, IC1 should be a prime suspect.

Note that it is possible that an extreme brightness red l.e.d. may have a large anode (instead of cathode) inside its plastic encapsulation, and may seemingly need to be inserted "the wrong way round".

### IN USE

If a battery is used (9V), connect it to the supply solder pins provided (positive to the "+" pin, and 0V to the ground pin, being careful to select the right pins). The Forever Flasher should begin to flash at a rate of 0.5Hz to 1Hz.

If an aerial is to be used, connect this to the aerial pin provided (see "Power Pump" crosshead earlier for more details). Next, connect a ground wire. The unit will not work without a ground wire.

All being well, l.e.d. D3 should begin to flash within five seconds, at a slowish rate of about 0.5Hz. This rate may be increased by increasing the value of capacitor C1, or decreasing the value of C2 – although this may lead to a dimmer flash. The flash may also brighten when the aerial wire is touched by moist fingers.

You might wish to work more scientifically. In this case, wire up only diodes D1, D2, and capacitor C1, with the aerial and ground wires connected. Wire a 2M2 resistor across C1. Now use a high impedance voltmeter (a digital multimeter should do) to measure the voltage across C1. This should measure more than 3V, otherwise your aerial and/or ground is inadequate. □



Completed circuit board.

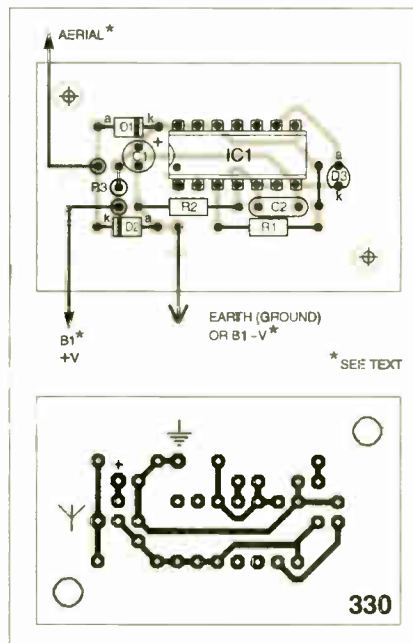

Fig.3. Component layout, wiring and full-size p.c.b. copper foil master.

## COMPONENTS

### Resistors

R1	33M metal film, 0.5W 5%
R2	27k carbon film
R3	10M carbon film

### Capacitors

C1	1µ min. radial elect. 63V
C2	100n disc ceramic

See  
**SHOP**  
**TALK**  
page

### Semiconductors

D1, D2	1N4148 signal diode (2 off)
D3	extreme brightness 3mm red l.e.d. 3000mcd 10° viewing angle
IC1	HEF4016BP CMOS quad bilateral switch (see text)

### Miscellaneous

B1	9V lithium battery (PP3), with clips (optional – see text)
----	--

Printed circuit board available from the *EPE PCB Service*, code 330; plastic case, type and size to choice; multistrand connecting wire; coaxial cable (see text); solder pins; solder, etc.

Approx. Cost  
Guidance Only

£6

excl. battery and case



# TEACH-IN 2002

## Part Three – More on op.amps in sensor circuits, plus humidity sensors

IAN BELL AND DAVE CHESMORE

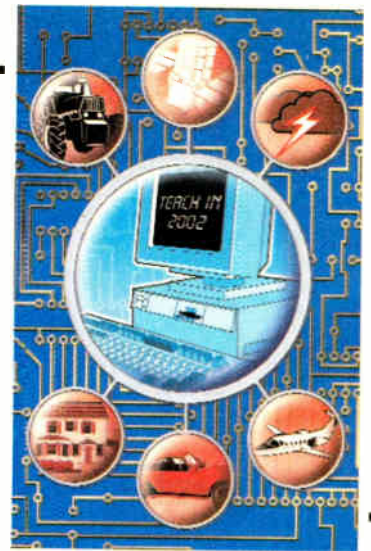

### Making Sense of the Real World: Electronics to Measure the Environment

**S**ENSORS produce variations in different parameters depending on the type of sensor: resistance, voltage, current, capacitance, inductance, frequency, etc.

In the Lab Work for Part 2 last month we made use of the current from a photodiode in a light meter application. In Part 3 we now encounter capacitive sensors for humidity monitoring. First though, we examine more aspects of op.amps in relation to their use in “conditioning” sensor outputs to interface their signals to the outside world.

#### MORE THAN VOLTAGE

We need different circuits for each type of sensor, but in many cases we end up (if necessary) converting the signal to a voltage or a frequency (or pulse time), both of which can be readily used as the input to a subsequent processing system, such as a computer or microcontroller, for instance.

As we discussed last month, the raw voltage or frequency obtained from the sensor or conversion circuit may need to be scaled or shifted.

We need an analogue-to-digital converter (ADC) (more on these later in the series) to read a voltage into a microcontroller. The ADC may be “on-chip” or an external device.

Frequency can be measured by a microcontroller directly by converting the signal to a square wave at the logic levels of the microcontroller and feeding it to a digital input pin. The software counts the number of pulses occurring in a given period and is therefore able to calculate the frequency.

If the frequency is very high, and therefore too fast for the software, we can scale it down using a frequency divider such as a ripple counter or series of D-type flip-flops. Scaling down a frequency, though, means that the measurement will take longer. For low frequencies it is easier to measure cycle time directly, rather than counting pulses. Frequency can be shifted and scaled up, but this requires sophisticated circuits such as phase-locked loops and will not be discussed here.

Resistance based sensors are commonly used as part of a potential divider, as we did with the thermistor in Lab Work 1.

Capacitance based sensors can be made one of the timing components in an oscillator or pulse generator, as we will see later when we look at humidity sensors. Current can be converted to a voltage using an op.amp circuit, as we did in Lab Work 2. We will now look at this circuit in more detail.

#### CURRENT INPUT

As we saw in last month’s Lab Work, an op.amp can be used to convert a current signal from a sensor into a voltage signal, as shown in Fig.3.1.

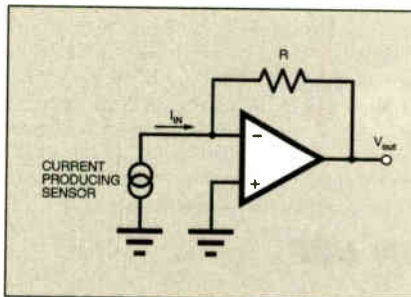

Fig.3.1. Current-to-voltage converter.

The circuit in Fig.3.1. is straightforward to understand if you recall our op.amp discussion in Part 2. The inputs are both at 0V due to the virtual earth and all the current from the sensor flows in resistor R due to the high op.amp input impedance. Thus the voltage at the output is given by

$$V_{out} = -R \times I_{in}$$

Here we have to be careful about the validity of one of our assumptions, namely the input impedance/current of the op.amp being negligible. If the current from the sensor is very small it may be comparable to the bias current required by the op.amp. For example, if the op.amp takes 200nA and the sensor current is 1µA we would get a 20% error.

For the circuit to work as intended (for our assumption to hold) we must choose an op.amp with very high input impedance and very low bias current – a FET input device is appropriate.

#### OFFSETS AND OP.AMPS

In last month’s Lab Work we had a look at measuring the offset voltage of the 741 and OP177 op.amps which we are using in this series. Offsets cause systematic errors in measurements and, to make matters worse, vary over time and with temperature.

They are a particular problem when measuring slowly changing quantities, such as room temperature and humidity. In applications in which only a.c. signals are of interest (e.g. audio signals from a microphone), offsets are less likely to be a problem as they simply cause a shift in operating point and can be blocked using capacitive coupling.

When you work with sensors you are bound to end up having to deal with offsets to get the most from practical circuits. To identify (and ideally avoid) offset problems, it helps to know about the device specifications and basic theory associated with offsets. For op.amps we have to consider both the inherent offset voltage and the offsets due to currents flowing into the op.amp. Let’s look at these in turn.

Ideally, with a differential input of zero, the op.amp’s output should also be zero, but in real op.amps there will typically be a non-zero output. The **Input Offset Voltage**  $V_{IO}$  is defined as the d.c. voltage which must be supplied between the inputs to force the quiescent (zero input signal) open-loop (no feedback resistors) output voltage to zero.

This is illustrated in Fig.3.2 as an “equivalent circuit” – a combination of an ideal op.amp and a voltage source to represent

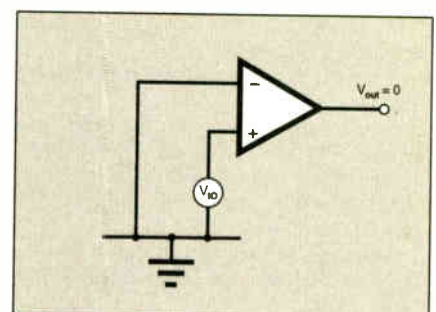

Fig.3.2. Equivalent circuit used to define offset voltage.



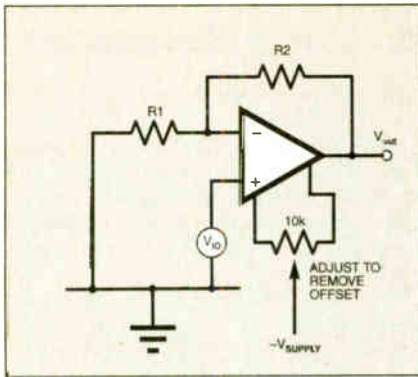

Fig.3.3. Offset Adjustment. The exact arrangement may vary for different op.amps, as will be shown in their datasheets.

the error due to the offset. We do not build this circuit, even to measure offset, it simply serves to clarify the definition.

The input offset voltage is defined with respect to the input. The error in the output voltage due to  $V_{IO}$  is equal to the circuit gain times  $V_{IO}$  (note circuit gain, not op.amp gain). So if the datasheet quoted  $V_{IO}$  as 2mV maximum and your circuit had a gain of 100 you could get a 0.2V error on the output.

Some op.amps have offset adjustment circuits (see Fig.3.3.) that allow an external trimmer potentiometer, connected to the appropriate pins, to be used to set the output voltage to zero. It is not the only offset adjustment configuration that can be used, so you need to check the datasheet for the op.amp in question.

The problem with manual offset trimming is that offsets can drift with time and are quite temperature sensitive. The temperature coefficient of input offset voltage specifies how  $V_{IO}$  changes with temperature. The datasheet for an op.amp may also have a graph showing offset variation with temperature. Low offset op.amps must be used in circuits where d.c. accuracy is required.

### BIAS CURRENTS

Bipolar op.amps require bias (base) currents for the transistors connected to their inputs, and op.amps with FET inputs have leakage currents at the inputs. The term **Input Bias Current**  $I_{IB}$  is defined as the average current into the op.amp's two inputs with the output at zero volts. This can vary greatly for different types of op.amp, from femtoamps ( $10^{-15}$ A) to tens of microamps, with bipolar op.amps having larger input bias currents than FET input op.amps.

Bias currents flow in the external components connected to the op.amp (e.g. the resistors used to set the gain) and in doing so cause voltage drops. If these voltage drops are not equal at the op.amp's two inputs they will be amplified by the op.amp and appear as d.c. errors at the output.

To find the unwanted output voltage, find the difference in resistance at the two inputs and multiply this by the bias current and the circuit gain. This effect can be minimized by adding a resistor to one of the inputs to balance the resistance through which the bias current flows (see Fig.3.4).

In Fig.3.4 the bias current to the inverting input flows through resistors R1 or R2 (in parallel), so making R3 equal to the

## PANEL 3.1. Negative Feedback

In Part 2 we used the term *feedback* and showed examples of circuits in which it is being used. It is worth considering in a little more detail:

For any op.amp configuration, subtracting a fraction  $\beta$  of the output from the input (termed *negative feedback*) gives:

$$V_{out} = A_v \times (V_{in} - \beta V_{out})$$

where:

- $A_v$  is the open loop voltage gain
- $V_{out}$  is the output voltage
- $V_{in}$  is the input voltage

To find the gain of the circuit with negative feedback applied, that is  $V_{out} / V_{in}$ , known as the closed loop gain,  $A_{CL}$ , we need to rearrange this equation. This gives:

$$A_{CL} = V_{out} / V_{in} = A_v / (1 + A_v \beta)$$

For high  $A_v$  (more specifically  $\beta A_v \gg 1$ , i.e.  $\beta A_v$  much greater than 1) the gain of the circuit may usually be approximated to  $A_{CL} = 1 / \beta$ , which is independent of the gain of the op.amp as long as the high  $A_v$  assumption holds.

For  $A_{CL}$  to be independent of  $A_v$  we need  $A_{CL}$  to be much smaller than  $A_v$ . This is usually not a problem. For example, if an op.amp has a gain of 500,000 and we require a circuit gain of 20 (ignoring the phase inversion sign) then we need  $\beta = 0.05$ , so  $\beta A_v = 25,000$  which is obviously much larger than 1 (our criteria for accepting the simplified formula  $A_{CL} = 1 / \beta$ ).

The actual gain of the op.amp if we use the full expression  $A_{CL} = A_v / (1 + A_v \beta)$  will be 19.9992 instead of 20, a difference of 0.004% - compare this with typical resistor accuracy, for example five per cent.

What is  $\beta$  for an actual circuit? The easiest configuration to look at is the

non-inverting amplifier (see Fig.2.3, centre circuit, in Part 2) as the input and feedback signals are clearly separate. In this circuit R1 and R2 form a potential divider, which provides a portion of the output voltage at the op.amp's negative input. The voltage at the inverting input ( $V_2$ ) is given by the potential divider formula:

$$V_2 = R1 \times V_{out} / (R1 + R2)$$

The voltage at the non-inverting input ( $V_1$ ) is simply  $V_{in}$ , so for this circuit the op.amp's output, which is given by:

$$V_o = A_v (V_2 - V_1)$$

$$V_o = A_v (V_{in} - R1 \times V_{out} / (R1 + R2))$$

which on comparison with our feedback formula ( $A_{CL} = \text{etc}$ ) indicates that  $\beta = R1 / (R1 + R2)$ .

This expression for  $\beta$  should not be surprising, as it is simply the proportion of the output provided by the potential divider. If our "high op.amp gain" assumption holds we can write the circuit gain as  $1/\beta$ , which is  $(R1 + R2) / R1$  or  $1 + R2 / R1$ .

This is an important result because the gain of the circuit is determined by R1 and R2, and is independent of the op.amp's gain so long as the op.amp's gain is high, making circuit design of the amplifier very straightforward.

It is important to make a distinction between op.amp and circuit input and output voltages and gains. The op.amp input voltages in last month's Fig.2.3 are  $V_1$  (non-inverting input) and  $V_2$  (inverting input), its output voltage is  $V_o$  and its gain is  $A_v$ .

The circuit has a single input voltage  $V_{in}$ , an output voltage  $V_{out}$  and a gain of  $A_{CL}$ . For this circuit it happens that  $V_{in} = V_1$  and  $V_{out} = V_o$ , but this may not always be the case. For the op.amp  $V_o = A_v (V_2 - V_1)$  and for the circuit  $V_{out} = (1 + R2 / R1) \times V_{in}$  as long as  $A_v$  is very large.

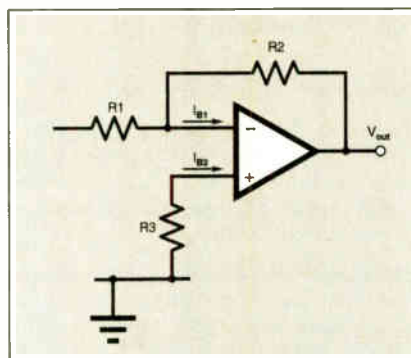

Fig.3.4. Bias Currents.

parallel combination of R1 and R2 will result in the same voltage at the two inputs due to the bias currents (assuming the bias currents are equal).

Resistor R1 in the calibration circuit (Fig.1.5) in Lab Work 1 is used for bias offset reduction and has a value close to the parallel combination of R4 and R5. The same principle can be applied to the current-to-voltage converter discussed earlier (see Fig.3.5).

In practice, the bias currents are not equal so we have **Input Offset Current**

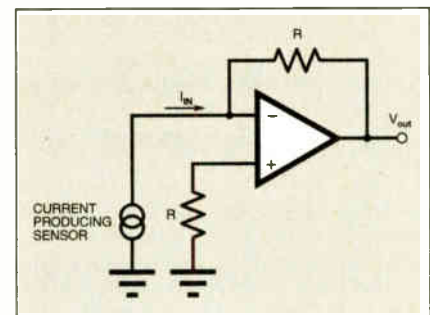

Fig.3.5. Current-to-voltage converter with offset current compensation.

$(I_{IO})$  - the difference between the currents into the two inputs with the output at zero volts, i.e.  $I_{B1} - I_{B2}$ , where  $I_{B1}$  and  $I_{B2}$  are the input currents for the two inputs.

Ideally these currents will be equal, but in practice they are not. The input currents have to flow through the external circuitry and will cause offsets even if the impedances connected to the two inputs are equal (we still want to keep the resistances equal as this is our best shot at keeping the current offsets low).



The only cure for errors due to offset currents, apart from using a better op.amp, is to reduce all the resistance values, but this option is limited by loading and power consumption considerations. Of course, bias current and offset vary with temperature so we have the **temperature coefficient of input offset current** parameter, which specifies how  $I_{IO}$  changes with temperature, and graphs on the datasheet to show these changes.

Armed with some more vital information about op.amps and their important d.c. characteristics, let's move on now to looking at another type of sensor.

## HUMIDITY SENSING

How moist is the air? We can be very sensitive to high levels of moisture, especially if the air temperature is also high. You will know this if you have visited tropical countries where high humidity can be very uncomfortable.

What is humidity? It is a measure of the moisture content of air and is most commonly expressed as the percentage of water vapour in the air relative to the saturation vapour pressure at the same temperature and pressure. In other words, it is the proportion of water vapour compared to the maximum amount the air can hold; this is the *relative humidity* (RH).

Another measure is the *absolute humidity*, which is the mass of water vapour per unit volume of air. The amount of water vapour the air can hold is dependent on air pressure and air temperature, so measuring relative humidity is not particularly easy.

One old and reliable method is to use a single strand of human hair fixed at one end and wrapped around a spindle at the other. The spindle has a pointer attached, changes in humidity cause the hair to change length and move the pointer. The sensors we will be working with are a little more sophisticated and not so fragile!

There are two main forms of humidity sensor – **resistive** and **capacitive**. We shall deal with each type separately. Most humidity sensors have a restricted operating range and will only give accurate results between 25% and 90% humidity.

Some operate between 0% and 100% but they tend to be more expensive. Also, the accuracy is not particularly good, most sensors only being accurate to  $\pm 5\%$  or  $\pm 10\%$  at low or high humidity.

Calibration is not easy and will be examined later. One other problem with all humidity sensors is that they have a very long time constant, i.e. they take a long time to change value from, say 10% RH to 90% RH. Typical time constants range from two to four minutes.

## RESISTIVE HUMIDITY SENSORS

Resistive sensors consist of a layer of material deposited on a substrate. This layer absorbs water vapour and changes its resistance. A number of resistive sensors are available and are relatively low cost. The characteristics of several readily available types are given in Table 3.1.

When designing circuits for humidity sensing, there are a number of points that should be considered:

1. Resistance is related to relative humidity in a logarithmic fashion as shown in the

## PANEL 3.2. Linear and Non Linear Responses

Mathematically, the term *linear* has a precise meaning, usually defined with respect to particular situations, perhaps the most basic being *linear functions*, so it helps to know what a *function* is to define *linear*.

A function is simply a relationship between the values of two or more variables. For example,  $y = 2x$  means that the value of  $y$  is twice that of  $x$ . So, for example, if  $x$  is 4,  $y$  will be 8. Just as  $x$  stands for "any" value when we can write  $f(x)$  to mean any function of  $x$ . In our example,  $f(x)$  is  $2x$ .

Functions, in the present context, relate to circuits and sensors. For example, if  $x$  represents the input to a circuit (e.g. in volts) and  $y$  represents the output voltage, then if the circuit function  $y = f(x)$  is  $y = 10x$ , the output voltage is ten times the input voltage, so this could be a voltage amplifier with a gain of 10.

Similarly, we can write mathematical functions which describe how a sensor responds to the parameter it is being used to measure. We saw examples of functions that relate thermistor resistance to temperature in Part 1.

A linear function of  $x$  is one of the form  $f(x) = ax + b$ , in which  $a$  and  $b$  are constants. For example, the function  $f(x) = 60x + 100$  is linear.

The *exponential function*,  $f(x) = \exp(x)$  ( $e$  to the power of  $x$ , or  $e^x$ ) is an example of a non-linear function, and quite often found in sensor responses.

The use of the term *linear* should make sense if you plot graphs of functions – for a linear function you get a straight line, this is illustrated in Fig.3.6 which shows a graph of the two functions just mentioned.

If our sensor response is linear, it is easy to extract the value we want from the sensor output. For instance, if a temperature sensor's output is in the form  $y = 0.1t + 2$ , where  $t$  is temperature and  $y$  is the current or voltage obtained, we can simply subtract 2 then multiply by 10 to get  $t$  – an example of the "shift and scale"

operation performed by the calibration circuit in Lab Work 1.

The "subtract 2, divide by 10" technique is an example of what is known as an *inverse function*. If we apply a function to a value and then apply the inverse function to the result we get the original value back.

If our sensor response is non-linear, we can apply the result to a circuit that has a response equivalent to the inverse function of the sensor response function. For an exponential sensor response this would be a *logarithmic* circuit function.

Designing an *inverse function* circuit may not always be easy and a number of other options exist. We can use a circuit function which approximates the inverse function, or we can read the sensor value directly into a microcontroller or PC and "do the maths" in software. More simply (and less accurately) we can use a small range of a non-linear function over which it can be regarded as *approximately linear*.

Referring to Fig.3.6, if you take a small part of the exponential curve it looks quite straight, even though the whole thing is obviously very curved.

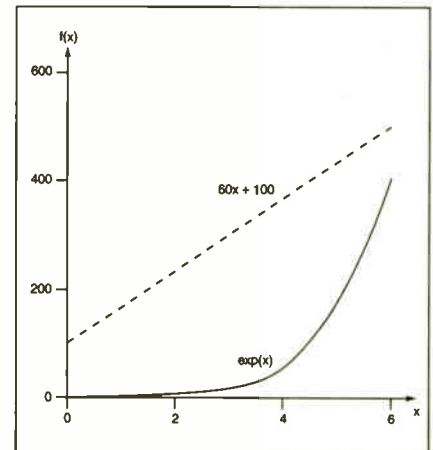

Fig.3.6. Two functions of  $x$ , one linear, the other non-linear.

graph of Fig.3.8. For example, the HS15 sensor has a resistance of 10M at 30% RH and about 90k $\Omega$  at 90% RH, measured at 5°C. We therefore need to *linearise* the resistance.

- Resistance changes as a function of temperature, hence the different curves in the graph. At 90% RH, the HS15 resistance changes from 90k $\Omega$  at 5°C to 500 $\Omega$  at 45°C. We therefore need to provide *temperature compensation*.
- Resistive sensors are damaged by d.c. voltages because the active material becomes polarized and stops working. All circuits must therefore use a.c. signals, hence the inclusion of *measuring frequency* as a parameter in Table 3.1.

If this all seems too complex, don't worry as humidity sensor modules are available which include linearisation and temperature compensation. Whilst they are more expensive, they are very easy to use, requiring only a +5V supply.

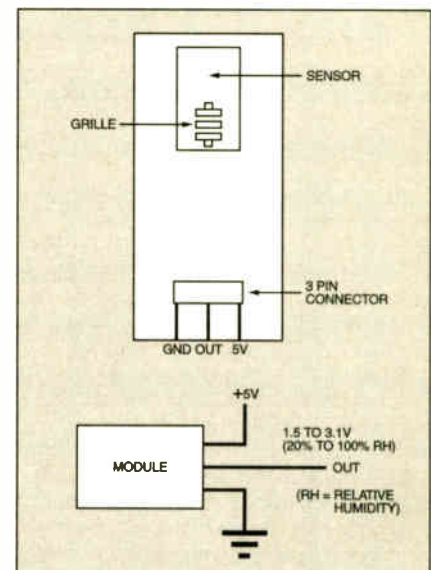

Fig.3.7. Connecting the HU10 Module.

**Table 3.1. Characteristics of some Resistive Humidity Sensors**

Parameter	HS15	C3-M3
Humidity Range	20%-100% RH	20%-90% RH
Operating Temperature	0°C-50°C	0°C - 60°C
Accuracy	±5% RH	±5% RH
Impedance at 25°C	60kΩ ±30kΩ @ 50% RH	31kΩ ±30kΩ @ 60% RH
Measuring Frequency	50Hz-1kHz	500Hz-2kHz
Temperature dependence	0.5% RH/°C	0.5% RH/°C
Drive Voltage	1V AC (rms)	1V AC (rms)
Manufacturer	Steatite Group	

**Table 3.2 Characteristics of the HU10 Resistive Humidity Module**

Supply Voltage	5V ±0.2V
Supply Current	2mA
Operating Temperature	0-50°C
Operating Humidity Range	20% - 100% RH
Measurement Humidity Range	25% - 100% RH
Output Voltage	1.5V @ 25% RH to 3.1V @ 100% RH
Accuracy	±5% RH
Sensor	HS15

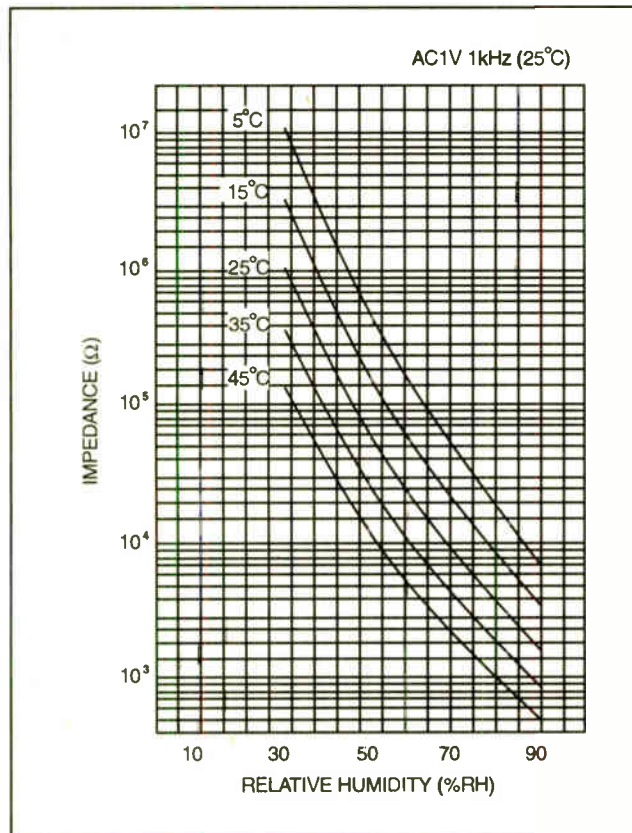
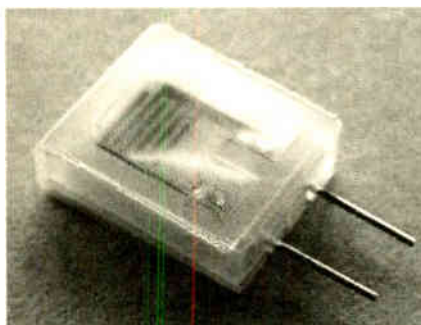

Fig.3.8. Humidity sensing performance of the HS15 sensor.



Resistive humidity sensor.

The diagram in Fig.3.7 shows how to connect an HU10 sensor module. The characteristics of this module are given in Table 3.2. The humidity range is 25% to 100% at 5% accuracy. The module has three pins - 0V,

+5V (which must not be exceeded) and the output. You will have noticed that the output voltage ranges from 1.5V at 25% to 3.1V at 100%; this may be changed only by adding a scaling and level shifting circuit.

### CAPACITIVE HUMIDITY SENSORS

Capacitive sensors are effectively capacitors that change their capacitance as a function of relative humidity. Fig.3.9 shows the cross-section of a capacitive sensor which consists of a thin layer of non-conducting dielectric material coated with gold on each side. The gold layer is so thin that it allows water molecules to pass through and change the dielectric constant of the non-conducting layer.

Other sensors use platinum instead of gold and often have special coatings that allow water vapour to pass but make the sensor immune to liquid water (waterproof).

Changes in the dielectric constant alter the capacitance. Table 3.3 gives the characteristics for some capacitive sensors.

**Table 3.3 Characteristics of some Capacitive Humidity Sensors**

Parameter	H1	SMTHS10	SMTRH05
Humidity Range	10% to 90% RH	0% to 100% RH	0% to 100% RH
Operating Temperature	-40°C to 120°C	0°C to 85°C	-40°C to 120°C
Capacitance Range	(0 to 100% RH) 70pF	approx 40pF	40pF±12%
Accuracy	±5% RH (10% to 90%)	±2% RH	±5% RH
Capacitance at 25°C	122pF 15% @ 43% RH	240pF± 20%	300pF @ 0% RH
Measuring Frequency	1kHz to 1MHz	10kHz to 1MHz	80kHz to 900kHz
Temperature dependence	negligible	0.1% RH/°C	-0.15% RH/°C
Maximum Voltage	15V	5V (a.c. only)	5V (a.c. only)
Manufacturer	Philips	Smartec	Smartec

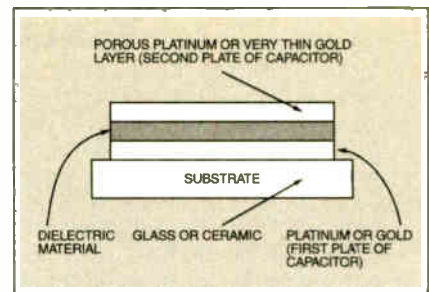

Fig.3.9. Cross-section of a typical capacitive sensor.

These sensors are also readily available. One useful thing to note is that some can operate down to 0%RH.

### USING CAPACITIVE SENSORS

In order to use a capacitive humidity sensor, we must change the capacitance value to a simpler parameter that can be measured. This can be achieved in several ways. Perhaps the most straightforward is to use the capacitor in an oscillator circuit such as that shown in Fig.3.10.

This circuit consists of a CMOS Schmitt NAND gate connected as an inverter with a resistor (R1) feedback. The capacitive sensor (C1) is connected from the combined inputs to ground.

The circuit oscillates at a rate given by the value of R1 and C1 and the supply voltage. If the capacitor's value changes due to humidity changes, the frequency of oscillation will also change. The circuit thus behaves as a humidity-to-frequency converter and its oscillation frequency can be measured by a frequency counter.

Unfortunately, depending on the sensor used, the variation in capacitance may not be a perfectly linear function of relative humidity. Consequently, we cannot directly relate frequency to relative humidity.

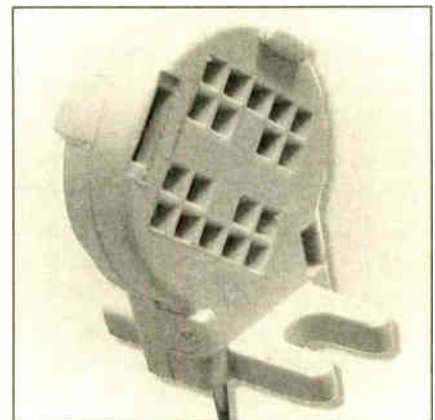

Capacitive humidity sensor.



## PANEL 3.1. A brief history of the op.amp

The name *operational amplifier* reflects the original use of these circuits – performing mathematical operations in analogue computers. The first op.amps were built using vacuum tube technology. They date from the late 1940s and were based on development work performed for the United States National Defense Research Council.

G. A. Philbrick of George A. Philbrick Researches Inc (GAP/R) and C.A. Lovell of Bell Labs are both credited with designing the first op.amps around 1948. Although analogue computers predated them, op.amps facilitated the design and construction of better computers.

Op.amps can be configured in circuits that perform mathematical operations such as addition, scaling, integration and differentiation. By wiring these operational units together, it is possible to create circuits which represent the mathematics of a complex problem, such as might be encountered in the design of an aircraft.

The early analogue computers that used vacuum tube op.amps, were used mainly for military design work. They were enormous (over 20 cubic metres) and consumed vast amounts of power (30,000 watts).

Vacuum tube op.amps became available as low cost “plug-in” devices such as the K2-W general purpose computing op.amp, which was first introduced in 1952. It was designed by GAP/R and Julie Research Labs Inc, and produced and marketed by GAP/R. Another “computer tube” from GAP/R, the K2-XA, which is a higher output power version of the K2-W, is shown top right.

The development of the transistor brought discrete component semiconductor op.amps in the 1960s from companies such as Burr-Brown and Analog Devices. These in turn were replaced by single chip devices.

The first widely used monolithic semiconductor op.amp (i.e. integrated circuit op.amp) was the  $\mu$ A709. This was designed by Bob Widlar and introduced by Fairchild Semiconductors in 1965. It was followed by the very popular  $\mu$ A741 in the late '60s. This was a lot easier to use than the 709 as it featured output short circuit protection and

internal frequency compensation. It quickly became the world's most popular op.amp.

The 741 has since been surpassed in performance by many other devices and there is now a vast range of op.amps to choose from, offering higher speed, lower noise, higher stability, lower offsets, etc. Recent developments have also pushed the power supply voltages and power consumption levels of op.amps progressively lower.

Op.amps are not only found as discrete i.c. packages, but are also found within the circuitry of other i.c.s, including the massively complex “system on a chip” integrated circuits found in modern high-tech electronic products. However, the 741 is still available and its very low cost ensures continued use in applications that do not demand high performance.

We managed to find a datasheet for the K2-XA so we can present a table of comparison for this device with the 741 and OP177 used in the Lab Works, Table 3.4.

Over the years, the primary use of op.amps has changed from analogue computing to signal processing. As you will know, most computing is now done digitally, but one can occasionally come across digitally-controlled analogue-computer-like circuits lurking inside modern i.c.s.

Signal processing is the manipulation of signals from sensors and other sources in order to get them into a form suitable for the



“user” or other parts of the system. Signal processing includes things such as amplification, level shifting, mixing and filtering and will be discussed as we progress through this series.

Table 3.4.

	K2-XA	741	OP177
Max supply voltage	$\pm 300V$ and 6.3V a.c. for heater filaments	$\pm 15V$	$\pm 22V$
Typical voltage gain	30,000 (90dB)	50,000 (94dB)	12,000,000 (142dB)
Max power dissipation	14W	85mW	500mW
Input resistance	100M $\Omega$	2M $\Omega$	200G $\Omega$
Input current	100nA	60nA	2nA
Input offset voltage drift	$\pm 8mV/day$		<2 $\mu V/month$
Output voltage range	$\pm 100V$	$\pm 12V$ ( $\pm 15V$ supply)	$\pm 13V$ ( $\pm 15V$ supply)

It is also possible to add a frequency divider to the output of the oscillator to reduce the frequency to the audio range and to drive a piezo-buzzer directly so that we can hear the changes in frequency.

An example circuit diagram is shown in Fig.3.10, in which a type 4520 dual binary counter is used. The first counter is clocked by the oscillator's output (connected to the input at pin 1). The frequency is divided by 2, 4, 8 or 16 depending on which output is chosen, in this instance pin 1Q3.

Since the oscillator operates at about 64kHz (depending on the capacitance of the sensor chosen), the output at 1Q3 will be 64,000/16 = 4kHz, a frequency that is audible. If you wish to reduce the frequency

further, connect the 1Q3 output to the clock input of the second counter (pin 9), as shown in the 4520 to give divisions of 32, 64, 128 or 256, at outputs 2Q0 to 2Q3, respectively.

The second method is to vary the width of a pulse, using an RC (resistor-capacitor) integrator, which will produce a d.c. voltage proportional to the pulse width. Fig.3.11 shows such a circuit.

The conversion is achieved by using a fixed frequency square wave which drives a monostable (see Fig.3.12). The time period of the type 4098 monostable is determined by the RC (resistor  $R_S$  and capacitive sensor  $C_S$ ) time constant, which varies as a function of humidity. The time constant is determined by the equation  $0.5R_S C_S$ .

The monostable is continually retriggered by the square wave and its output is a fixed-frequency variable width pulse train.

The monostable's output is connected to an integrator formed by the long time constant RC network ( $R_F$  and  $C_F$ ) to give a d.c. output. Narrow pulse widths result in a low voltage output, and wide pulse widths produce a higher output voltage.

The oscillator frequency is approximately 18kHz and the pulse width about 10ms for a capacitance of 200pF. The output voltage at point C will vary as a function of pulse width and hence humidity, but not by much because the capacitance only changes by a small amount. It may have to

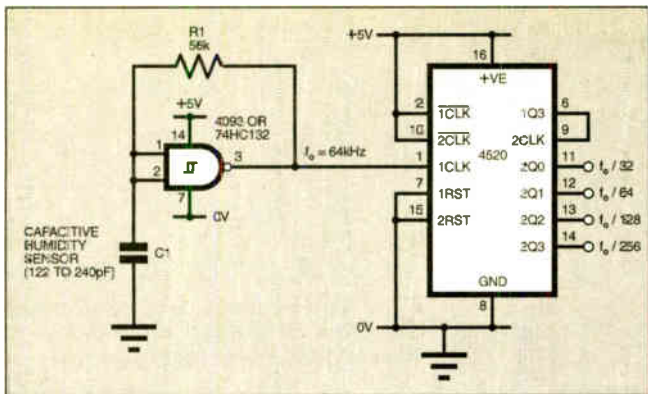

Fig.3.10. Frequency divider to reduce oscillator output to audio frequencies.

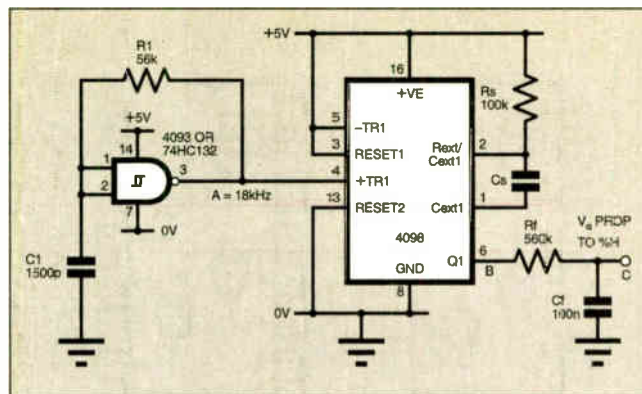

Fig.3.11. Monostable-based capacitance-to-voltage converter.

be scaled. If you want to use this circuit, you may have to change the value of  $R_s$  depending on the capacitance range of your sensor.

As you can see, the conversion of capacitance to a voltage is not easy and requires a number of steps. Unfortunately, few sensors are simple to use, as you will see as the series progresses, but our aim in this series is to help you get the best out of them. In Lab 3, we construct both the foregoing circuits

### CALIBRATING HUMIDITY SENSORS

Calibration of humidity sensors is quite difficult because we need to generate accurate and known levels of humidity. The scientific way of doing this is to place the sensor above a particular chemical solution at a known temperature in a sealed container. The air above the solution will contain a known amount of water vapour.

To give you an idea, a saturated solution of calcium chloride ( $\text{CaCl}_2$ ) at  $10^\circ\text{C}$  has a relative humidity of 38%. A saturated solution of potassium bromide ( $\text{KBr}$ ) has a

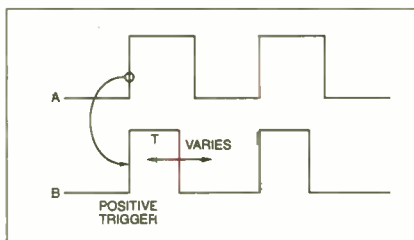

Fig.3.12. Timing diagram for Fig.3.11.

relative humidity of 84% at  $20^\circ\text{C}$ . A saturated solution is a solution that cannot dissolve any more solid chemical.

A 0% relative humidity can be obtained more simply by using the silica gel which is found in little bags in boxed electrical and photographic equipment. Silica gel absorbs moisture and will have moisture in it before you use it.

The moisture is driven out by warming it at slightly over  $100^\circ\text{C}$  in an oven for a while. Some gel changes colour from pink (or colourless) to blue when it is dry. You can place the dried silica gel into a container with the sensor and seal it. The rela-

tive humidity content should reach zero in a short while.

### HUMIDITY SENSOR APPLICATIONS

Once you have a humidity sensor, what can it be used for? The obvious application is for monitoring the weather. High humidity indicates possible rain and we all know how high humidity can get in thundery weather!

Other applications could include humidifiers and dehumidifiers, or to detect when the clothes in a tumble dryer have dried. For this application you will need to place the sensor in the air outlet and use a circuit similar to that in the Lab Work light sensing circuit Fig.2.10 in Part 2.

A relay could be used to switch off the dryer when a preset threshold has been reached. A similar application might be to open and close vents in a greenhouse to control humidity levels.

Alan now takes up the story and describes some practical experiments you can perform using an inexpensive humidity sensor.

# TEACH-IN 2002 – Lab Work 3

ALAN WINSTANLEY

## Humidity Sensors and Test Equipment Limitations

FOLLOWING on from this month's Tutorial section, in Lab Work 3 we now perform some practical experiments with humidity sensors and expose a few facts about test equipment and its limitations.

### Lab 3.1: Know the limits!

This Lab demonstrates some of the practical limitations that exist with most forms of test equipment, including the PC-based Picoscope ADC-40 used in *Teach-In 2002*.

The humidity sensor circuit in Fig.3.10 (see Tutorial section) is a simple CMOS oscillator using one Schmitt NAND gate running at roughly 64kHz. This generates

a square wave which is coupled to one half of a 4520 dual binary up-counter, so the counter's output frequency is divided by sixteen, which can be observed at pin 6.

The resultant frequency can be divided further by a factor of 2, 4, 8 or 16, by cascading and clocking the 4520's second counter, whose input is at pin 9. Using both counters this way means that the original signal can be divided by a factor of 32, 64, 128 or even 256. You would therefore expect to measure these frequencies at the counter's outputs 2Q0 to 2Q3.

The pinouts of both i.c.s are given in Fig.3.13 and you should now construct

Fig.3.10 on a solderless breadboard. You can use either a 4093 or a 74HC132 for IC1, but note that they have different pinouts. Note also that unused CMOS input pins should be grounded to 0V as usual, and that the +5V supply of the *Teach-In Power Supply* is required.

An ordinary fixed capacitor can be used in place of the capacitive humidity sensor for the time being. We used a 100pF ceramic capacitor with a 100k resistor for R1 in the RC oscillator. This means that whilst we will not necessarily expect a 64kHz signal we should still see something of that order of magnitude.



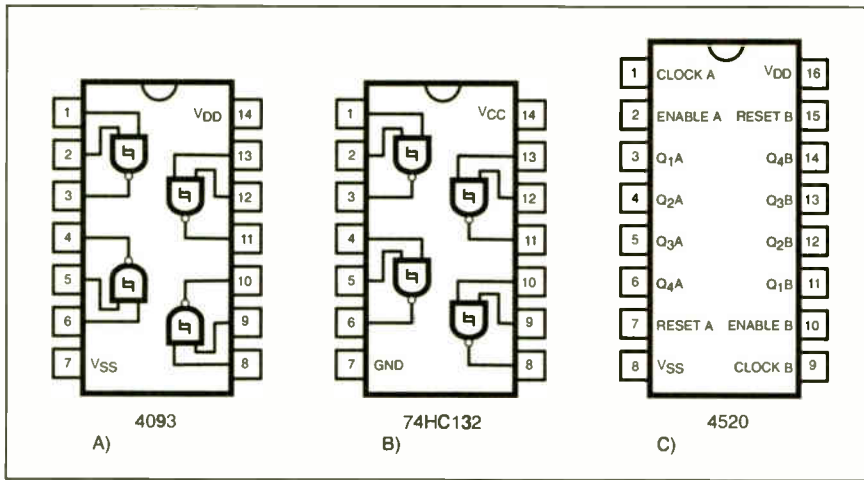

Fig.3.13. Pinouts for the 4093, 74HC132 and 4520 devices.

## PICOSCOPING

The Picoscope screenshot we obtained at the 4520 2Q2 output is shown in Fig.3.14.

By measuring the time period of the square wave (using on-screen rulers) if we wish, we can predict what the input frequency should be (use frequency in Hz = 1 / period). For example, the  $f_0/128$  output (pin 13) shows a period of 1.4ms, implying an input frequency of approximately 91kHz.

### Lab 3.2: Aliasing Effects

Now check the clock input (pin 1) of the 4520. Using the Picoscope ADC-40 to examine the clock signal results in some very strange and interesting waveforms, which illustrate a principle known as *aliasing*. Even after setting the Picoscope to its fastest setting (go File/Setup/Scope and enter say 20,000 samples per scope trace), instead of a nice square wave, you will get a noisy, small signal that bears no resemblance to the one we predicted!

Additionally, if you connect a frequency divider and look at each output in turn, you will not get accurate results until the signal has been divided by at least 8 (i.e. an output of 8kHz).

We will be covering the full explanation of this effect later but here is a brief summary:

The Picoscope's maximum sampling rate is 20,000 samples per second and according to the *Nyquist Sampling Criterion* the maximum input frequency

that can be "seen" correctly is half of the sampling frequency, 10kHz in this case. If any signals with frequencies greater than 10kHz are input, then the result will be a lower frequency than 10kHz.

In the extreme case of the input being exactly equal to the sampling frequency then the output result will appear to be d.c.! Of course we could use other Picoscope models with higher sampling rates but they would be more expensive.

### Lab 3.3: Relative Humidity to Frequency Converter

Now replace the timing capacitor with a capacitive-type humidity sensor. Our own model was a 122pF at 25°C/43% relative humidity (RH) device. Our timing resistor was 100k which produced a clock frequency

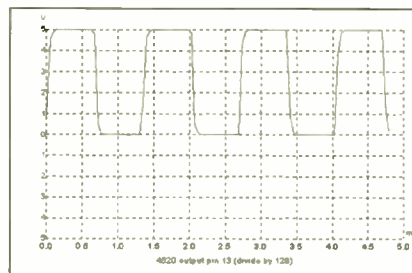

Fig.3.14. Picoscope screen display of the pin 13 output from the 4520 device in Lab 3.1.

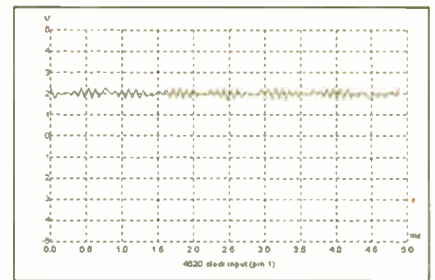
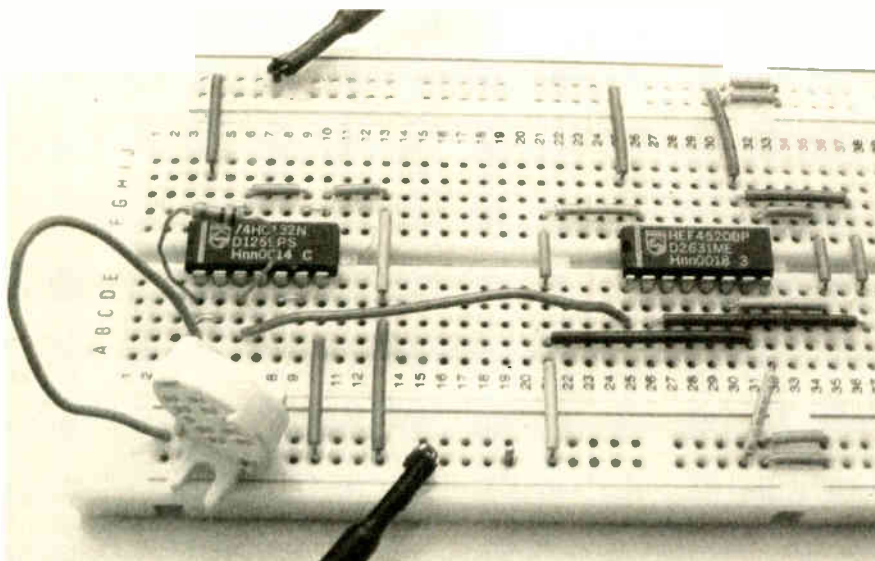

Fig.3.15. Picoscope display showing the effect of aliasing when sampling high frequencies at too slow a rate.

of about 75kHz as measured on a digital oscilloscope.

For a 240pF device, use a 56k resistor instead. A note of caution: insert the humidity sensor into the breadboard sympathetically so as to avoid bending its pins, or consider soldering a pair of leads to the sensor instead.

The output frequencies of the 4520 depend on the humidity detected by the sensor and these can be measured directly using the Picoscope as before. You can also try hooking a piezo disc to the outputs and by breathing on the humidity sensor, the



Breadboard layout for Lab 3.2.

## COMPONENTS

N.B. Some components are repeated between Lab Works

See **SHOP**  
**TALK**  
page

<b>Resistor</b>		<b>Lab 3.1</b>
R1	56k for 240p sensor, or 100k for 122p sensor	
All resistors 0.25W 5% carbon film or better		
<b>Capacitor</b>		
C1	100p ceramic	
<b>Semiconductors</b>		
IC1	4093 or 74HC132 quad Schmitt NAND gate	
IC2	4520 dual binary up counter	

(No extra parts for Lab 3.2)

<b>Lab 3.3</b>	
Capacitive humidity sensor 122p or 240p (see text)	
Piezo disc sounder element (optional)	

<b>Lab 3.4</b>	
<b>Resistors</b>	
R1	56k
R <sub>s</sub>	100k
R <sub>t</sub>	560k
<b>Capacitors</b>	
C1	1500p ceramic
C <sub>s</sub>	122p or 240p humidity sensor
C <sub>t</sub>	100n polyester
<b>Semiconductors</b>	
IC1	4093 or 74HC132 quad Schmitt NAND gate
IC2	4098 dual monostable

Approx. Cost  
Guidance Only

**£14**

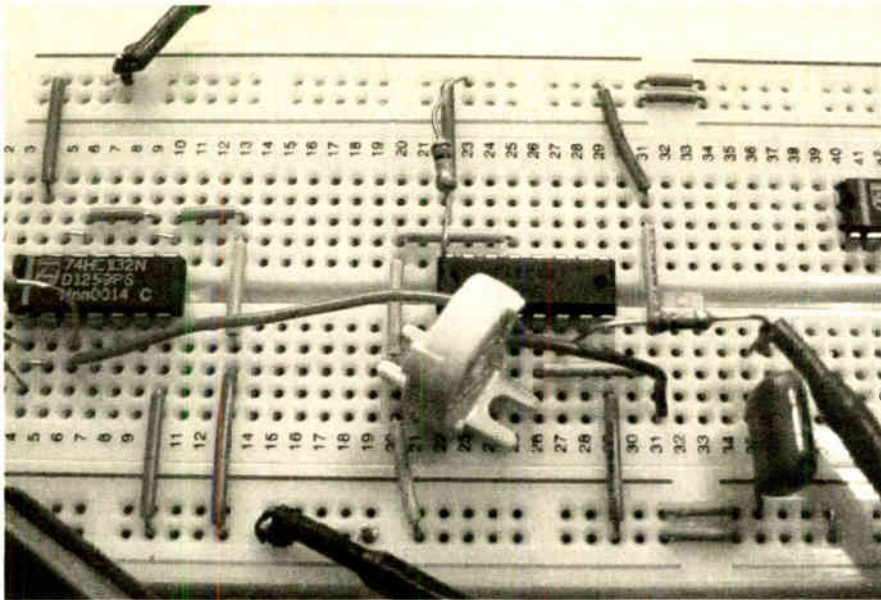

Breadboard layout for Lab 3.4.

audio tone from the disc will rise slightly. The resulting square wave can be connected to further processing systems to enable some detection and monitoring of humidity levels to be made.

#### Lab 3.4: RH to Voltage Converter

Lab 3.4 is an optional experiment. The circuit in Fig.3.11 (see Tutorial section) shows a technique for producing a voltage which is dependent on relative humidity. A fixed frequency oscillator is formed of discrete components using a NAND Schmitt gate, and a capacitive humidity sensor is used as the timing capacitor in a 4098 dual monostable multivibrator. Thus the oscilla-

tor triggers one of the monostable timers, the period of which is controlled by a humidity sensor.

The period of waveform at point B is determined roughly by  $0.5 R_S C_S$ , therefore time is proportional to the percentage of relative humidity. A low-pass filter,  $R_f$  and  $C_f$ , produces a d.c. voltage which is proportional both to the time period and the %RH as well. Note that the change in voltage will be small as the change in capacitance is in itself small.

In practice, it is only really possible to demonstrate the changing square wave with a high quality oscilloscope due to the higher frequencies involved. Nevertheless,

some meaningful waveforms can be measured with the Picoscope. The circuit was constructed on solderless breadboard and we measured a voltage of about 745mV on the filter output (point C). By breathing on the humidity sensor the voltage rose to 790mV.

Next month: We offer some novel ideas related to the use of strain gauges and we take a look at some possible ways in which vibration can be detected.

### CORRECTIONS

We regret that in Part 2 incorrect drawings were published for Figs.2.5 and 2.7. The correct ones are printed below.

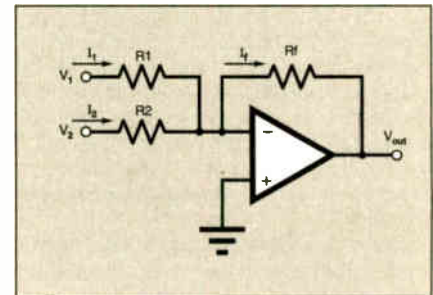

Fig.2.5. Two input adder circuit.

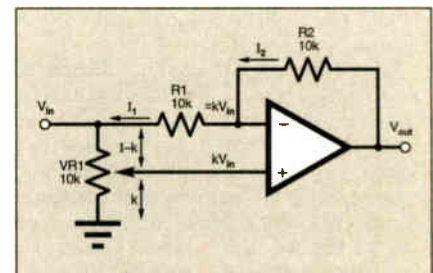

Fig.2.7. Circuit with variable gain from -1 to +1.

# EPE TEACH-IN 2000

## Now on CD-ROM

The whole of the 12-part *Teach-In 2000* series by John Becker (published in *EPE* Nov '99 to Oct 2000) is now available on CD-ROM. Plus the *Teach-In 2000* software covering all aspects of the series and Alan Winstanley's *Basic Soldering Guide* (including illustrations and *Desoldering*).

*Teach-in 2000* covers all the basic principles of electronics from Ohm's Law to Displays, including Op.Amps, Logic Gates etc. Each part has its own section on the interactive PC software where you can also change component values in the various on-screen demonstration circuits.

The series gives a hands-on approach to electronics with numerous breadboarded circuits to try out, plus a simple computer interface which allows a PC to be used as a basic oscilloscope.

**ONLY £12.45** including VAT and p&p

We accept Visa, Mastercard, Amex, Diners Club and Switch cards.

NOTE: This mini CD-ROM is suitable for use on any PC with a CD-ROM drive. It requires Adobe Acrobat Reader (available free from the Internet - [www.adobe.com/acrobat](http://www.adobe.com/acrobat))

### TEACH-IN 2000 CD-ROM ORDER FORM

Please send me ..... (quantity) TEACH-IN 2000 CD-ROM  
Price £12.45 (approx \$20) each - includes postage to anywhere in the world.

Name .....

Address .....

Post Code ..... Tel. ....

I enclose cheque/P.O./bank draft to the value of £ .....

Please charge my card £ .....

Card No. ....

Expiry Date ..... Switch Issue No. ....

Note: Minimum order for cards £5.

SEND TO: Everyday Practical Electronics, Wimborne Publishing Ltd.,  
408 Wimborne Road East, Ferndown, Dorset BH22 9ND.

Tel: 01202 873872. Fax: 01202 874562.

E-mail: [orders@epemag.wimborne.co.uk](mailto:orders@epemag.wimborne.co.uk)

Online store: [www.epemag.wimborne.co.uk/shopdoor.htm](http://www.epemag.wimborne.co.uk/shopdoor.htm)

Payments must be by card or in £ Sterling - cheque or bank draft drawn on a UK bank.  
Normally supplied within seven days of receipt of order.



# SURFING THE INTERNET

## NET WORK

ALAN WINSTANLEY

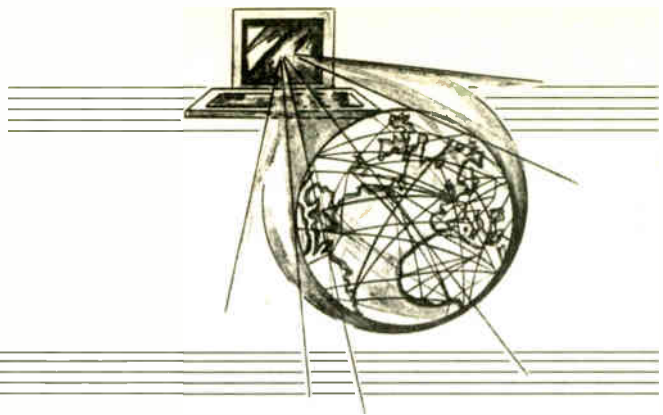

### On the Broadband Wagon

IT'S TIME once again for my yearly spell of navel-gazing as we reflect on the state of the British Internet market, looking at what is really happening, as opposed to what might actually have been.

In this respect, as a barometer of the state of the nation I have decided to nominate the wooden telegraph pole stuck in the pavement just outside my home. It carries my three telephone lines, and it seems to embody neatly the challenge of trying to get a fast and dependable Internet service delivered to British homes at a reasonable rate.

Every three or four years the lines have to be repaired because the wind and rain eventually damages the terminations through wear and tear. The pole also carries bare electricity wires: in Summer 2001 along came the local electricity board who decided to move the cables onto taller poles – so a second, larger wooden pole was planted next to the old one, and the live mains wires were moved higher up out of harm's way.

This left my three phone lines draped like hammock strings from the older pole nearby. Just to remind me how dangerously low the phone lines actually are, a courier's truck then sheared through the whole lot when making a delivery to neighbouring premises. Thankfully a laptop and an infrared mobile phone kept me going for several days until the phone wires were "temporarily" repaired. Four months later though, there is no sign of them being migrated onto the new poles, and even less sign of the old poles being taken away. I await the dreaded day when a BT workman suddenly appears, shins up the telegraph pole and cuts my wires for the day without any warning.

### It's a Cop-out

Which brings me to the pavement (sidewalk) down below: all the villages in the region are connected by a foot-wide strip of tarmac levelled into the pavement, interspersed by metal access covers stamped with "CATV". Underneath lies the makings of a very good cable network. In fact the cable was laid over three years ago, the only problem being that NTL has never switched it on, and furthermore they have no plans to "enable" it in the foreseeable future. Whenever I ask, no-one at NTL has ever been able to say anything remotely encouraging about a switch-on date.

Today NTL is far more interested in earning more money out of its existing customers than it is in attracting new ones. I often gaze at that neat tarmac strip and dream about what could have been, wondering why I should struggle with archaic dial-up access when a cable modem could have brought many benefits to the locality.

Meantime, British Telecom continues to keep a tight grip on that critical bit of the network, namely the stretch of copper wire that connects most homes to the telephone system. This length of wire – known as the "local loop" – has probably been bought many times over by BT's customers, but earlier hopes of forcing BT to relinquish its vice-like hold in a process known as LLU, or local loop unbundling, have gradually faded away. The idea was then to allow other "telcos" to install their own equipment alongside BT's racks in the telephone exchanges, which would open up the market to better competition, but many telecoms companies withdrew from the process due to a combination of escalating costs, their widely reported frustrations of dealing with BT, and perhaps a degree of attrition setting in.

We are now into the 21st Century and all that BT has to offer is a number of miserly "Surftime" monthly tariffs littered with small print and get-out clauses. Even its "Anytime" package, which lets you "surf the net whenever you want" will throw you off the Internet after no more than two hours of continued use – just the thing when downloading large software upgrades. And should you ever leave your connection unattended, BT may withdraw the tariff

from you altogether. I await satellite Internet access, if only so that I can snub NTL sales reps. when they finally call at my door.

### Open Season

Mention "Openworld" and seasoned Internet users immediately think of BT's ADSL broadband service and all the problems it has created. ISPs including AOL and Freeserve want to get on the (broad) bandwagon but BT gave itself a headstart on ADSL (asymmetric digital subscriber line) through its Openworld division (known by many of its hard-bitten customers as Openwoe or Openwound). BT then re-sells the ADSL service to other ISPs.

Newsgroups are full of complaints from unhappy Openworld ADSL customers relating to installation problems, poor service, technical headaches and slow speeds. Surprisingly, BT Internet has ditched its name in favour of the Openworld brand and so you will soon start to see adverts for ordinary dial-up Internet access services from BT Openworld instead.

One ADSL user found out when trying to upgrade his 500k ADSL link to a faster and even more expensive 2MB, that his cable quality was not adequate enough to handle the higher speed reliably, so now he is effectively stuck with the handbrake half on. The possibility of having ADSL all depends on the distance from the 'phone exchange to the customer's premises, and the technology also relies heavily on the quality of the connection.

Users' expectations are very high but the fact is that DSL is a highly-strung technology and it seems to be pot luck whether it can be made to work for you. Even if a phone line passes basic DSL compatibility tests, there is no guarantee that it can handle higher speeds later on. My old wooden telegraph pole(s) with dodgy phone lines that crackle in the rain, appear to have no hope of seeing anything faster than good old 56k V.90 rattling by, and a cable modem will be just a dream for years.

### Shopping Caught

Last month I mentioned a few shopping carts worth checking out, including RS Components (<http://rswwww.com>) which is an advanced and powerful catalogue system. Not to be left out, competitor Farnell Components has its own system available at [www.farnell.com](http://www.farnell.com). It must be said that none of us at *EPE* have ever thought very much to the Farnell CD-ROM catalogue, so how would their online version fare? To find out, I placed my first order, and what a disappointment I found the experience to be.

It took several attempts at creating a user profile before the penny dropped that actually, it had created it all along, the system just hadn't told me: it refreshes details without confirmation. And it was some time before I realised that the order codes used online are different from catalogue order codes – there is no hyphen (and no mention of this anywhere). As a new user I found the basic navigation to be poor and unintuitive: for example, why is the "Add 5 (blank) lines to your order" the third option along when you have to start there first?

However, undeterred, I pressed on and eventually placed an order for £75 worth of parts. Perhaps I must have missed something else during the long-winded, unintuitive process, because having submitted the order I have to report that my order never arrived. It is hard to know what went wrong, but a Farnell sales agent could offer no reason for the order not appearing on the system so my order was re-entered the old fashioned way. I found the Farnell system to be unrewarding and slow to use. At this rate who needs broadband anyway?

Time for the writer to head over to the *Teach-In 2002* labs, so wherever you are around the world, I would like to thank all those who follow *Net Work*, for their feedback and encouragement, and I wish you all a safe and prosperous New Year. See you in 2002!

You can contact the writer at [alan@epemag.co.uk](mailto:alan@epemag.co.uk).

# PICO ADC-40 SPECIAL TEACH-IN 2002 OFFER LOW COST SINGLE CHANNEL PC-BASED OSCILLOSCOPE

**EPE  
SPECIAL  
OFFER**

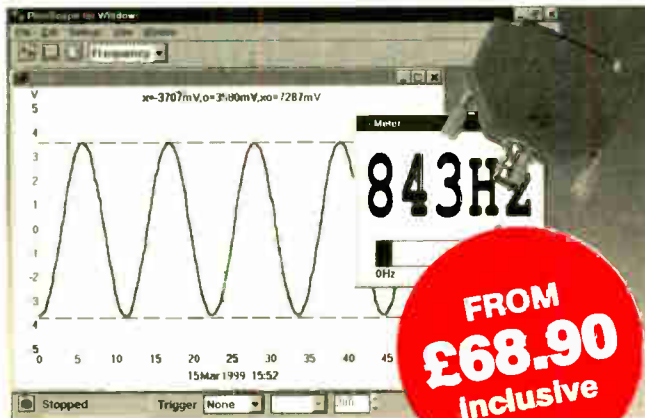

- ★ Save over £12 on the normal price
- ★ Oscilloscope and data logging software
- ★ Uses PC monitor for large display
- ★ No power supply required
- ★ Compact design (55mm x 55mm x 15mm)
- ★ No complex set-up procedures
- ★ Shows: frequency, DC voltage, AC voltage, peak-to-peak, risetime etc.
- ★ Windows 3.x, 95/98/ME, NT/2000 compatible
- ★ Two-year guarantee

This easy to use low cost PC-based oscilloscope has been chosen for use with our *Teach-In 2002* series. We have been able to arrange a special offer on the Pico ADC-40 for readers. Just fill in the coupon below and send it in with your remittance or credit card details. You can order the ADC-40 on its own or together with a x1/x10 oscilloscope probe and two metre parallel port extension lead to connect to your PC.

Post the coupon below to: PICO/EPE SPECIAL OFFER, Wimborne Publishing Ltd., 408 Wimborne Road East, Ferndown, Dorset BH22 9ND.

You can also order by phone, fax or via the web. Tel 01202 873872. Fax 01202 874562.

[www.epemag.wimborne.co.uk/shopdoor.htm](http://www.epemag.wimborne.co.uk/shopdoor.htm)

**OFFER ENDS JANUARY 28, 2002**

## SPECIFICATION

Resolution	8 bits
Channels	1 x BNC
Voltage ranges	±5V
Overload protection	±30V
Input impedance	1MΩ
Sampling rate	20kS/s
Accuracy	±1%
Scope timebases	500μs/div to 50s/div
Spectrum ranges	0 to 10kHz
Dynamic range	50dB
Analogue bandwidth	10kHz

*Orders normally sent within 7 days but please allow up to 28 days for delivery – more for overseas orders*

## PICO/EPE SPECIAL OFFER ORDER FORM

Please supply ..... (quantity) ADC-40 + software  
..... (quantity) ADC-40 + software + probe + lead

Name .....

Address .....

.....

.....

Post Code ..... Tel: .....

I enclose a cheque to the value of £..... Make cheques payable to *Everyday Practical Electronics*

Please charge my card – Visa, Mastercard, Amex, Diners Club or Switch

Card No. ....

Expiry Date ..... Switch Issue No .....

### UK PRICES

ADC-40 + software **£68.90**

ADC-40 + software + x1/x10 probe + parallel port extension cable **£87.90**

*Both prices include VAT and postage*

### OVERSEAS PRICES

**To European Union Countries (other than UK):**

ADC-40 + software **£71.90**

ADC-40 + software + probe + lead **£90.90**

*Both prices include VAT and postage*

**To all countries outside of the European Union**

ADC-40 + software **£64.60**

ADC-40 + software + probe + lead **£83.40**

*Note these countries do not have to pay VAT Both prices include postage*

**OFFER ENDS JANUARY 28, 2002**

If you do not wish to cut your issue send a copy of the coupon or order by letter





## EPE TEACH-IN 2000 CD-ROM

The whole of the 12-part *Teach-In 2000* series by John Becker (published in *EPE* Nov '99 to Oct 2000) is now available on CD-ROM. Plus the *Teach-In 2000* interactive software covering all aspects of the series and Alan Winstanley's *Basic Soldering Guide* (including illustrations and Desoldering).

*Teach-In 2000* covers all the basic principles of electronics from Ohm's Law to Displays, including Op.Amps, Logic Gates etc. Each part has its own section on the interactive software where you can also change component values in the various on-screen demonstration circuits.

The series gives a hands-on approach to electronics with numerous breadboard circuits to try out, plus a simple computer interface which allows a PC to be used as a basic oscilloscope.

ONLY £12.45 including VAT and p&p

Order code Teach-in CD-ROM

## Robotics

### INTRODUCING ROBOTICS WITH LEGO MINDSTORMS

Robert Penfold

Shows the reader how to build a variety of increasingly sophisticated computer controlled robots using the brilliant Lego Mindstorms Robotic Invention System (RIS). Initially covers fundamental building techniques and mechanics needed to construct strong and efficient robots using the various "click-together" components supplied in the basic RIS kit. Then explains in simple terms how the "brain" of the robot may be programmed on screen using a PC and "zapped" to the robot over an infra-red link. Also, shows how a more sophisticated Windows programming language such as Visual BASIC may be used to control the robots.

Details building and programming instructions provided, including numerous step-by-step photographs.

288 pages - large format Order code BP901 £14.99

### MORE ADVANCED ROBOTICS WITH LEGO MINDSTORMS - Robert Penfold

Covers the Vision Command System

Shows the reader how to extend the capabilities of the brilliant Lego Mindstorms Robotic Invention System (RIS) by using Lego's own accessories and some simple home constructed units. You will be able to build robots that can provide you with 'waiter service' when you clap your hands, perform tricks, 'see' and avoid objects by using 'bats radar', or accurately follow a line marked on the floor. Learn to use additional types of sensors including rotation, light, temperature, sound and ultrasonic and also explore the possibilities provided by using an additional (third) motor. For the less experienced, RCX code programs accompany most of the featured robots. However, the more adventurous reader is also shown how to write programs using Microsoft's VisualBASIC running with the ActiveX control (Spirit.OCX) that is provided with the RIS kit.

Detailed building instructions are provided for the featured robots, including numerous step-by-step photographs. The designs include rover vehicles, a virtual pet, a robot arm, an 'intelligent' sweet dispenser and a colour conscious robot that will try to grab objects of a specific colour.

298 pages Order code BP902 £14.99

### ANDROIDS, ROBOTS AND ANIMATRONS

John Lovine

Build your own working robot or android using both off-the-shelf and workshop constructed materials and devices. Computer control gives these robots and androids two types of artificial intelligence (an expert system and a neural network). A lifelike android hand can be built and programmed to function doing repetitive tasks. A fully animated robot or android can also be built and programmed to perform a wide variety of functions.

The contents include an Overview of State-of-the-Art Robots; Robotic Locomotion; Motors and Power Controllers; All Types of Sensors; Tilt; Bump; Road and Wall Detection; Light; Speech and Sound Recognition; Robotic Intelligence (Expert Type) Using a Single-Board Computer Programmed in BASIC; Robotic Intelligence (Neural Type) Using Simple Neural Networks (Insect Intelligence); Making a Lifelike Android Hand; A Computer-Controlled Robotic Insect Programmed in BASIC; Telepresence Robots With Actual Arcade and Virtual Reality Applications; A Computer-Controlled Robotic Arm; Animated Robots and Androids; Real-World Robotic Applications.

224 pages Temporarily out of print

# DIRECT BOOK SERVICE

NOTE: ALL PRICES INCLUDE UK POSTAGE

The books listed have been selected by *Everyday Practical Electronics* editorial staff as being of special interest to everyone involved in electronics and computing. They are supplied by mail order to your door. Full ordering details are given on the last book page.

For a further selection of books see the next two issues of *EPE*.

## Radio

### BASIC RADIO PRINCIPLES AND TECHNOLOGY

Ian Poole

Radio technology is becoming increasingly important in today's high technology society. There are the traditional uses of radio which include broadcasting and point to point radio as well as the new technologies of satellites and cellular phones. All of these developments mean there is a growing need for radio engineers at all levels.

Assuming a basic knowledge of electronics, this book provides an easy to understand grounding in the topic.

Chapters in the book: Radio Today, Yesterday, and Tomorrow; Radio Waves and Propagation; Capacitors, Inductors, and Filters; Modulation; Receivers; Transmitters; Antenna Systems; Broadcasting; Satellites; Personal Communications; Appendix - Basic Calculations.

263 pages Order code NE30 £15.99

### PROJECTS FOR RADIO AMATEURS AND S.W.L.S.

R. A. Penfold

This book describes a number of electronic circuits, most of which are quite simple, which can be used to enhance the performance of most short wave radio systems.

The circuits covered include: An aerial tuning unit; A simple active aerial; An add-on b.f.o. for portable sets; A wavetrap to combat signals on spurious responses; An audio notch filter; A parametric equaliser; C.W. and S.S.B. audio filters; Simple noise limiters; A speech processor; A volume expander.

Other useful circuits include a crystal oscillator, and RTTY/C.W. tone decoder, and a RTTY serial to parallel converter. A full range of interesting and useful circuits for short wave enthusiasts.

92 pages Order code BP304 £4.45

### AN INTRODUCTION TO AMATEUR RADIO

I. D. Poole

Amateur radio is a unique and fascinating hobby which has attracted thousands of people since it began at the turn of the century. This book gives the newcomer a comprehensive and easy to understand guide through the subject so that the reader can gain the most from the hobby. It then remains an essential reference volume to be used time and again. Topics covered include the basic aspects of the hobby, such as operating procedures, jargon and setting up a station. Technical topics covered include propagation, receivers, transmitters and aerials etc.

150 pages Order code BP257 £5.49

### VALVE RADIO AND AUDIO REPAIR HANDBOOK

Chas Miller

This book is not only an essential read for every professional working with antique radio and gramophone equipment, but also dealers, collectors and valve technology enthusiasts the world over. The emphasis is firmly on the practicalities of repairing and restoring, so technical content is kept to a minimum, and always explained in a way that can be followed by readers with no background in electronics. Those who have a good grounding in electronics, but wish to learn more about the practical aspects, will benefit from the emphasis given to hands-on repair work, covering mechanical as well as electrical aspects of servicing. Repair techniques are also illustrated throughout.

A large reference section provides a range of information compiled from many contemporary sources, and includes specialist dealers for valves, components and complete receivers.

288 pages Order code NE34 £20.50

## Computers and Computing

### MULTIMEDIA ON THE PC

Ian R. Sinclair

In this book, you'll find out what a CD ROM is, how it works, and why it is such a perfect add-on for a PC, allowing you to buy programmes, text, graphics and sound on a CD. It also describes the installation of a CD ROM drive and a sound card, pointing out the common problems that arise, and then shows how to use them to create a complete multimedia presentation that contains text, photos, a soundtrack with your own voice recorded as a commentary, even animation and edited video footage.

184 pages Order code PC112 £12.95

### HOW TO BUILD YOUR OWN PC

Morris Rosenthal

More and more people are building the own PCs. They get more value for their money, they create exactly the machine they want, and the work is highly satisfying and actually fun. That is, if they have a unique beginner's guide like this one, which visually demonstrates how to construct a state-of-the-art computer from start to finish.

Through 150 crisp photographs and clear but minimal text, readers will confidently absorb the concepts of computer building. The extra-big format makes it easy to see what's going on in the pictures. For non-specialists, there's even a graphical glossary that clearly illustrates technical terms. The author goes "under the hood" and shows step-by-step how to create a socket 7 (Pentium and non-intel chipsets) and a Slot 1 (Pentium II) computer, covering: What first-time builders need to know; How to select and purchase parts; How to assemble the PC; How to install Windows 98. The few existing books on this subject, although badly outdated, are in steady demand. This one delivers the expertise and new technology that fledgling computer builders are eagerly looking for.

224 pages - large format Order code MGH2 £21.99

### PIC YOUR PERSONAL INTRODUCTORY COURSE

SECOND EDITION John Morton

Discover the potential of the PIC microcontroller through graded projects - this book could revolutionise your electronics construction work!

A uniquely concise and practical guide to getting up and running with the PIC Microcontroller. The PIC is one of the most popular of the microcontrollers that are transforming electronic project work and product design.

Assuming no prior knowledge of microcontrollers and introducing the PIC's capabilities through simple projects, this book is ideal for use in schools and colleges. It is the ideal introduction for students, teachers, technicians and electronics enthusiasts. The step-by-step explanations make it ideal for self-study too: this is not a reference book - you start work with the PIC straight away.

The revised second edition covers the popular reprogrammable EEPROM PICs: P16C84/16F84 as well as the P54 and P71 families.

270 pages Order code NE36 £13.99

### UNDERSTANDING PC SPECIFICATIONS

R. A. Penfold (Revised Edition)

If you require a microcomputer for business applications, or a high quality home computer, an IBM PC or compatible is often the obvious choice. They are competitively priced, and are backed up by an enormous range of applications programs, hardware add-ons, etc. The main difficulty for the uninitiated is deciding on the specification that will best suit his or her needs. PCs range from simple systems of limited capabilities up to complex systems that can happily run applications that would have been considered beyond the abilities of a microcomputer not so long ago. It would be very easy to choose a PC system that is inadequate to run your applications efficiently, or one which goes beyond your needs and consequently represents poor value for money.

This book explains PC specifications in detail, and the subjects covered include the following: Differences between types of PC (XT, AT, 80386, etc); Maths coprocessors; Input devices (keyboards, mice, and digitisers); Memory, including both expanded (EMS) and extended RAM; RAM disks and disk caches; Floppy disk drive formats and compatibility; Hard disk drives (including interleaved factors and access times); Display adaptors, including all standard PC types (CGA, Hercules, Super VGA, etc); Contains everything you need to know if you can't tell your EMS from your EGA!

128 pages Order code BP282 £5.45



# Theory and Reference

## Bebop To The Boolean Boogie

By Clive (call me Max) Maxfield  
**Specialty imported by EPE - Excellent value**

An Unconventional Guide to Electronics Fundamentals, Components and Processes

This book gives the "big picture" of digital electronics. This in-depth, highly readable, up-to-the-minute guide shows you how electronic devices work and how they're made. You'll discover how transistors operate, how printed circuit boards are fabricated, and what the innards of memory ICs look like. You'll also gain a working knowledge of Boolean Algebra and Karnaugh Maps, and understand what Reed-Muller logic is and how it's used. And there's much, MUCH more (including a recipe for a truly great seafood gumbo!). Hundreds of carefully drawn illustrations clearly show the important points of each topic. The author's tongue-in-cheek British humor makes it a delight to read, but this is a REAL technical book, extremely detailed and accurate. A great reference for your own self, and also an ideal gift for a friend or family member who wants to understand what it is you do all day...

470 pgs - large format **Order code BEB1** £26.95

**DIGITAL ELECTRONICS - A PRACTICAL APPROACH**  
 With FREE Software: Number One Systems - EASY-PC

**FREE SOFTWARE**

**Professional XM and Pulsar (Limited Functionality)**

Richard Monk  
 Covers binary arithmetic, Boolean algebra and logic gates, combination logic, sequential logic including the design and construction of asynchronous and synchronous circuits and register circuits. Together with a considerable practical content plus the additional attraction of its close association with computer aided design including the FREE software.

199 pages **Order code NE23** £13.99

There is a 'blow-by-blow' guide to the use of EASY-PC Professional XM (a schematic drawing and printed circuit board design computer package). The guide also conducts the reader through logic circuit simulation using Pulsar software. Chapters on p.c.b. physics and p.c.b. production techniques make the book unique, and with its host of project ideas make it an ideal companion for the integrative assignment and common skills components required by BTEC and the key skills demanded by GNVQ. The principal aim of the book is to provide a straightforward approach to the understanding of digital electronics.

Those who prefer the 'Teach-In' approach or would rather experiment with some simple circuits should find the book's final chapters on printed circuit board production and project ideas especially useful.

250 pages (large format) **Order code NE28** £17.99

## ELECTRONICS MADE SIMPLE

Ian Sinclair

Assuming no prior knowledge, *Electronics Made Simple* presents an outline of modern electronics with an emphasis on understanding how systems work rather than on details of circuit diagrams and calculations. It is ideal for students on a range of courses in electronics, including GCSE, C&G and GNVQ, and for students of other subjects who will be using electronic instruments and methods.

Contents: waves and pulses, passive components, active components and ICs, linear circuits, block and circuit diagrams, how radio works, disc and tape recording, elements of TV and radar, digital signals, gating and logic circuits, counting and correcting, micro-processors, calculators and computers, miscellaneous systems.

199 pages **Order code NE23** £13.99

## SCROGGIE'S FOUNDATIONS OF WIRELESS AND ELECTRONICS - ELEVENTH EDITION

S. W. Amos and Roger Amos

Scroggie's Foundations is a classic text for anyone working with electronics, who needs to know the art and craft of the subject. It covers both the theory and practical aspects of a huge range of topics from valve and tube technology, and the application of cathode ray tubes to radar, to digital tape systems and optical recording techniques.

Since *Foundations of Wireless* was first published over 60 years ago, it has helped many thousands of readers to become familiar with the principles of radio and electronics. The original author Sowerby was succeeded by Scroggie in the 1940s, whose name became synonymous with this classic primer for practitioners and students alike. Stan Amos, one of the fathers of modern electronics and the author of many well-known books in the area, took over the revision of this book in the 1980s and it is he, with his son, who have produced this latest version.

400 pages **Order code NE27** £21.99

## GETTING THE MOST FROM YOUR MULTIMETER

R. A. Penfold

This book is primarily aimed at beginners and those of limited experience of electronics. Chapter 1 covers the basics of analogue and digital multimeters, discussing the relative merits and the limitations of the two types. In Chapter 2 various methods of component checking are described, including tests for transistors, thyristors, resistors, capacitors and diodes. Circuit testing is covered in Chapter 3, with subjects such as voltage, current and continuity checks being discussed.

In the main little or no previous knowledge or experience is assumed. Using these simple component and circuit testing techniques the reader should be able to confidently tackle servicing of most electronic projects.

96 pages **Order code BP239** £3.45

## DIGITAL GATES AND FLIP-FLOPS

Ian R. Sinclair

This book, intended for enthusiasts, students and technicians, seeks to establish a firm foundation in digital electronics by treating the topics of gates and flip-flops thoroughly and from the beginning.

Topics such as Boolean algebra and Karnaugh mapping are explained, demonstrated and used extensively, and more attention is paid to the subject of synchronous counters than to the simple but less important ripple counters.

No background other than a basic knowledge of electronics is assumed, and the more theoretical topics are explained from the beginning, as also are many working practices. The book concludes with an explanation of microprocessor techniques as applied to digital logic.

200 pages **Order code PC106** £9.95

# Music, Audio and Video

## QUICK GUIDE TO ANALOGUE SYNTHESIS

**NEW**

Ian Waugh

Even though music production has moved into the digital domain, modern synthesizers invariably use analogue synthesis techniques. The reason is simple - analogue synthesis is flexible and versatile, and it's relatively easy for us to understand. The basics are the same for all analogue synths, and you'll quickly be able to adapt the principles to any instrument, to edit existing sounds and create exciting new ones. This book describes: How analogue synthesis works; The essential modules every synthesiser has; The three steps to synthesis; How to create phat bass sounds; How to generate filter sweeps; Advanced synth modules; How to create simple and complex synth patches; Where to find soft synths on the Web.

If you want to take your synthesiser - of the hardware or software variety - past the presets, and program your own sounds and effects, this practical and well-illustrated book tells you what you need to know.

60 pages **Order code PC118** £7.45

## QUICK GUIDE TO MP3 AND DIGITAL MUSIC

**NEW**

Ian Waugh

MP3 files, the latest digital music format, have taken the music industry by storm. What are they? Where do you get them? How do you use them? Why have they thrown record companies into a panic? Will they make music easier to buy? And cheaper? Is this the future of music?

All these questions and more are answered in this concise and practical book which explains everything you need to know about MP3s in a simple and easy-to-understand manner. It explains:

How to play MP3s on your computer; How to use MP3s with handheld MP3 players; Where to find MP3s on the Web; How MP3s work; How to tune into Internet radio stations; How to create your own MP3s; How to record your own CDs from MP3 files; Other digital audio music formats.

Whether you want to stay bang up to date with the latest music or create your own MP3s and join the on-line digital music revolution, this book will show you how.

60 pages **Order code PC119** £7.45

## AN INTRODUCTION TO LOUSPEAKERS AND ENCLOSURE DESIGN

V. Capel

This book explores the various features, good points and snags of speaker designs. It examines the whys and wherefores so that the reader can understand the principles involved and so make an informed choice of design, or even design loudspeaker enclosures for him - or herself. Crossover units are also explained, the various types, how they work, the distortions they produce and how to avoid them. Finally there is a step-by-step description of the construction of the *Kapellmeister* loudspeaker enclosure.

148 pages **Temporarily out of print**

## ELECTRONIC MUSIC AND MIDI PROJECTS

R. A. Penfold

Whether you wish to save money, boldly go where no musician has gone before, rekindle the pioneering spirit, or simply have fun building some electronic music gadgets, the designs featured in this book should suit your needs. The projects are all easy to build, and some are so simple that even complete beginners at electronic project construction can tackle them with ease. Stripboard layouts are provided for every project, together with a wiring diagram. The mechanical side of construction has largely been left to individual constructors to sort out, simply because the vast majority of project builders prefer to do their own thing in this respect.

None of the designs requires the use of any test equipment in order to get them set up properly. Where any setting up is required, the procedures are very straightforward, and they are described in detail.

Projects covered: Simple MIDI tester, Message grabber, Byte grabber, THRU box, MIDI auto switcher, Auto/manual switcher, Manual switcher, MIDI patchbay, MIDI controlled switcher, MIDI lead tester, Program change pedal, Improved program change pedal, Basic mixer, Stereo mixer, Electronic swell pedal, Metronome, Analogue echo unit.

124 pages **Order code PC116** £10.95

## THE INVENTOR OF STEREO - THE LIFE AND WORKS OF ALAN DOWER BLUMLEIN

Robert Charles Alexander

This book is the definitive study of the life and works of one of Britain's most important inventors who, due to a cruel set of circumstances, has all but been overlooked by history.

Alan Dower Blumlein led an extraordinary life in which his inventive output rate easily surpassed that of Edison, but whose early death during the darkest days of World War Two led to a shroud of secrecy which has covered his life and achievements ever since.

His 1931 Patent for a Binaural Recording System was so revolutionary that most of his contemporaries regarded it as more than 20 years ahead of its time. Even years after his death, the full magnitude of its detail had not been fully utilized. Among his 128 patents are the principal electronic circuits critical to the development of the world's first electronic television system. During his short working life, Blumlein produced patent after patent breaking entirely new ground in electronic and audio engineering.

During the Second World War, Alan Blumlein was deeply engaged in the very secret work of radar development and contributed enormously to the system eventually to become 'H2S' - blind-bombing radar. Tragically, during an experimental H2S flight in June 1942, the Halifax bomber in which Blumlein and several colleagues were flying, crashed and all aboard were killed. He was just days short of his thirtieth birthday.

420 pages **Order code NE32** £15.99

## VIDEO PROJECTS FOR THE ELECTRONICS CONSTRUCTOR

R. A. Penfold

Written by highly respected author R. A. Penfold, this book contains a collection of electronic projects specially designed for video enthusiasts. All the projects can be simply constructed, and most are suitable for the newcomer to project construction, as they are assembled on stripboard.

There are faders, wipers and effects units which will add sparkle and originality to your video recordings, an audio mixer and noise reducer to enhance your soundtracks and a basic computer control interface. Also, there's a useful selection on basic video production techniques to get you started.

Complete with explanations of how the circuit works, shopping lists of components, advice on construction, and guidance on setting up and using the projects, this invaluable book will save you a small fortune.

Circuits include: video enhancer, improved video enhancer, video fader, horizontal wiper, improved video wiper, negative video unit, fade to grey unit, black and white keyer, vertical wiper, audio mixer, stereo headphone amplifier, dynamic noise reducer, automatic fader pushbutton fader, computer control interface, 12 volt mains power supply.

124 pages **Order code PC115** £10.95

## PC MUSIC - THE EASY GUIDE

Robin Vincent

How do I make music on my PC? Can I record music onto my PC? What's a sequencer? How can I get my PC to print a music score? What sort of a soundcard do I need? What hardware and software do I need? How do I connect a keyboard to my PC?

Just a few of the questions you've probably asked. Well, you'll find the answers to all these questions, and many more, in this book. It will show you what can be done, what it all means, and what you will need to start creating your own music on your PC. It's an easy read, it's fully illustrated and it will help you understand how a computer can be used as a creative music tool.

It covers soundcards, sequencers, hard disk digital audio recording and editing, plug-ins, printing scores with notation software, using your PC as a synthesiser, getting music onto and off the Internet, using Windows, sample PC music setups, FAQs, a glossary, advice on hardware and software, and a list of industry contacts.

116 pages **Order code PC117** £11.95

## HIGH POWER AUDIO AMPLIFIER CONSTRUCTION

R. A. Penfold

Practical construction details of how to build a number of audio power amplifiers ranging from about 50 to 300/400 watts r.m.s. includes MOSFET and bipolar transistor designs.

96 pages **Order code BP277** £4.49



# Circuits, Data and Design

## PRACTICAL ELECTRONIC FILTERS

Owen Bishop

This book deals with the subject in a non-mathematical way. It reviews the main types of filter, explaining in simple terms how each type works and how it is used.

The book also presents a dozen filter-based projects with applications in and around the home or in the constructor's workshop. These include a number of audio projects such as a rhythm sequencer and a multi-voiced electronic organ.

Concluding the book is a practical step-by-step guide to designing simple filters for a wide range of purposes, with circuit diagrams and worked examples.

88 pages Order code BP299 £5.49

## ELECTRONIC HOBBYISTS DATA BOOK

R. A. Penfold

This book should tell you everything you are ever likely to want to know about hobby electronics, but did not know where to ask or refer. Comprehensive contents pages makes it easy to quickly locate the data you require.

The subjects covered include: Common circuits, and related data (including helpful graphs and tables of values); Colour codes for resistors, capacitors and inductors; Pinout details for a wide range of CMOS and TTL devices, plus basic data on the various logic families; Pinout details and basic data for a wide range of operational amplifiers; Data and leadout information for a wide range of transistors, FETs, power FETs, triacs, thyristors, diodes, etc.; General data including MIDI message coding, radio data, ASCII/Baudot coding, decibel ratios, etc.

242 pages Temporarily out of print

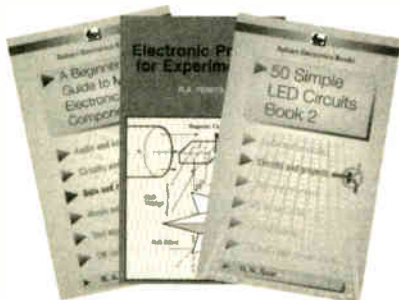

## 50 SIMPLE LED CIRCUITS

R. N. Soar

Contains 50 interesting and useful circuits and applications, covering many different branches of electronics, using one of the most inexpensive and freely available components - the light-emitting diode (LED). Also includes circuits for the 707 common anode display.

64 pages Order code BP42 £2.99

## CIRCUIT SOURCE BOOK 1

R. A. Penfold

Written to help you create and experiment with your own electronic designs by combining and using the various standard "building block" circuits provided. Where applicable, advice on how to alter the circuit parameters is given.

The circuits covered in this book are mainly concerned with analogue signal processing and include: Audio amplifiers (op.amp and bipolar transistors); audio power amplifiers; d.c. amplifiers; highpass, lowpass, bandpass and notch filters; tone controls; voltage controlled amplifiers and filters; triggers and voltage comparators; gates and electronic switching; bargraphs; mixers; phase shifters, current mirrors, hold circuits, etc.

Over 150 circuits are provided, which it is hoped will be useful to all those involved in circuit design and application, be they professionals, students or hobbyists.

182 pages Temporarily out of print

## A BEGINNER'S GUIDE TO TTL DIGITAL ICs

R. A. Penfold

This book first covers the basics of simple logic circuits in general, and then progresses to specific TTL logic integrated circuits. The devices covered include gates, oscillators, timers, flip/flops, dividers, and decoder circuits. Some practical circuits are used to illustrate the use of TTL devices in the "real world".

142 pages Order code BP332 £5.45

## HOW TO USE OP.AMPS

E. A. Parr

This book has been written as a designer's guide covering many operational amplifiers, serving both as a source book of circuits and a reference book for design calculations. The approach has been made as non-mathematical as possible.

160 pages Order code BP88 £4.49

## CIRCUIT SOURCE BOOK 2

R. A. Penfold

This book will help you to create and experiment with your own electronic designs by combining and using the various standard "building blocks" circuits provided. Where

applicable, advice on how to alter the circuit parameters is provided.

The circuits covered are mainly concerned with signal generation, power supplies, and digital electronics.

The topics covered in this book include: 555 oscillators; sinewave oscillators; function generators; CMOS oscillators; voltage controlled oscillators; radio frequency oscillators; 555 monostables; CMOS monostables; TTL monostables; precision long timers; power supply and

regulator circuits; negative supply generators and voltage boosters; digital dividers; decoders, etc.; counters and display drivers; D/A and A/D converters; opto-isolators, flip/flops, noise generators, tone decoders, etc.

Over 170 circuits are provided, which it is hoped will be useful to all those involved in circuit design and application, be they professionals, students or hobbyists.

192 pages Order code BP322 £5.45

# Project Building & Testing

## ELECTRONIC PROJECTS FOR EXPERIMENTERS

R. A. Penfold

Many electronic hobbyists who have been pursuing their hobby for a number of years seem to suffer from the dreaded "seen it all before" syndrome. This book is fairly and squarely aimed at sufferers of this complaint, plus any other electronics enthusiasts who yearn to try something a bit different. No doubt many of the projects featured here have practical applications, but they are all worth a try for their interest value alone.

The subjects covered include: Magnetic field detector, Basic Hall effect compass, Hall effect audio isolator, Voice scrambler/descrambler, Bat detector, Bat style echo location, Noise cancelling, LED stroboscope, Infra-red "torch", Electronic breeze detector, Class D power amplifier, Strain gauge amplifier, Super hearing aid.

138 pages Order code BP371 £5.45

## PRACTICAL FIBRE-OPTIC PROJECTS

R. A. Penfold

While fibre-optic cables may have potential advantages over ordinary electric cables, for the electronics enthusiast it is probably their novelty value that makes them worthy of exploration. Fibre-optic cables provide an innovative interesting alternative to electric cables, but in most cases they also represent a practical approach to the problem. This book provides a number of tried and tested circuits for projects that utilize fibre-optic cables.

The projects include: Simple audio links, F.M. audio link, P.W.M. audio links, Simple d.c. links, P.W.M. d.c. link, P.W.M. motor speed control, RS232C data links, MIDI link, Loop alarms, R.P.M. meter.

All the components used in these designs are readily available, none of them require the constructor to take out a second mortgage.

132 pages Order code BP374 £5.45

## ELECTRONIC PROJECT BUILDING FOR BEGINNERS

R. A. Penfold

This book is for complete beginners to electronic project building. It provides a complete introduction to the practical side of this fascinating hobby, including the following topics:

Component identification, and buying the right parts; resistor colour codes, capacitor value markings, etc;

advice on buying the right tools for the job; soldering; making easy work of the hard wiring; construction methods, including stripboard, custom printed circuit boards, plain matrix boards, surface mount boards and wire-wrapping; finishing off, and adding panel labels; getting "problem" projects to work, including simple methods of fault-finding.

In fact everything you need to know in order to get started in this absorbing and creative hobby.

135 pages Order code BP392 £5.49

## BEGINNER'S GUIDE TO MODERN ELECTRONIC COMPONENTS

R. A. Penfold

The purpose of this book is to provide practical information to help the reader sort out the bewildering array of components currently on offer. An advanced knowledge of the theory of electronics is not needed, and this book is not intended to be a course in electronic theory. The main aim is to explain the differences between components of the same basic type (e.g. carbon, carbon film, metal film, and wire-wound resistors) so that the right component for a given application can be selected. A wide range of components are included, with the emphasis firmly on those components that are used a great deal in projects for the home constructor.

166 pages Temporarily out of print

## HOW TO USE OSCILLOSCOPES AND OTHER TEST EQUIPMENT

R. A. Penfold

This book explains the basic function of an oscilloscope, gives a detailed explanation of all the standard controls, and provides advice on buying. A separate chapter deals with using an oscilloscope for fault finding on linear and logic circuits, plenty of example waveforms help to illustrate the control functions and the effects of various fault conditions. The function and use of various other pieces of test equipment are also covered, including signal generators, logic probes, logic pulsers, and crystal calibrators.

104 pages Order code BP267 £4.00

## BOOK ORDERING DETAILS

All prices include UK postage. For postage to Europe (air) and the rest of the world (surface) please add £1 per book. For the rest of the world airmail add £2 per book. Send a PO, cheque, international money order (£ sterling only) made payable to **Direct Book Service** or card details, Visa, Mastercard, Amex, Diners Club or Switch - minimum card order is £5 - to:

**DIRECT BOOK SERVICE, WIMBORNE PUBLISHING LTD.,  
408 WIMBORNE ROAD EAST, FERNDOWN, DORSET BH22 9ND.**

Books are normally sent within seven days of receipt of order, but please allow 28 days for delivery - more for overseas orders. Please check price and availability (see latest issue of Everyday Practical Electronics) before ordering from old lists.

For a further selection of books see the next two issues of *EPE*.

Tel 01202 873872 Fax 01202 874562. E-mail: [dbs@epemag.wimborne.co.uk](mailto:dbs@epemag.wimborne.co.uk)

Order from our online shop at: [www.epemag.wimborne.co.uk/shopdoor.htm](http://www.epemag.wimborne.co.uk/shopdoor.htm)

## BOOK ORDER FORM

Full name: .....

Address: .....

.....

..... Post code: ..... Telephone No: .....

Signature: .....

I enclose cheque/PO payable to DIRECT BOOK SERVICE for £ .....

Please charge my card £ ..... Card expiry date.....

Card Number ..... Switch Issue No.....

Please send book order codes: .....

.....

Please continue on separate sheet of paper if necessary  
If you do not wish to cut your magazine, send a letter or copy of this form

# PCB SERVICE

Printed circuit boards for most recent *EPE* constructional projects are available from the PCB Service, see list. These are fabricated in glass fibre, and are fully drilled and roller tinned. All prices include VAT and postage and packing. Add £1 per board for airmail outside of Europe. Remittances should be sent to **The PCB Service, Everyday Practical Electronics, Wimborne Publishing Ltd., 408 Wimborne Road East, Ferndown, Dorset BH22 9ND. Tel: 01202 873872; Fax 01202 874562; E-mail: orders@epemag.wimborne.co.uk. On-line Shop: www.epemag.wimborne.co.uk/shopdoor.htm.** Cheques should be crossed and made payable to *Everyday Practical Electronics* (Payment in £ sterling only).  
**NOTE: While 95% of our boards are held in stock and are dispatched within seven days of receipt of order, please allow a maximum of 28 days for delivery – overseas readers allow extra if ordered by surface mail.**  
**Back numbers or photostats of articles are available if required – see the Back Issues page for details.**

**Please check price and availability in the latest issue.**  
**Boards can only be supplied on a payment with order basis.**



PROJECT TITLE	Order Code	Cost
★EPE Mood PICker	JULY '99	233 £6.78
12V Battery Tester	234	£6.72
Intruder Deterrent	235	£7.10
L.E.D. Stroboscope (Multi-project PCB)	932	£3.00
Ultrasonic Puncture Finder	AUG '99	236 £5.00
★8-Channel Analogue Data Logger	237	£8.88
Buffer Amplifier (Oscillators P1 2)	238	£6.96
Magnetic Field Detective	239	£6.77
Sound Activated Switch	240	£6.53
Freezer Alarm (Multi-project PCB)	932	£3.00
Child Guard	SEPT '99	241 £7.51
Variable Dual Power Supply	242	£7.64
Micro Power Supply	OCT '99	243 £3.50
★Interior Lamp Delay	244	£7.88
Mains Cable Locator (Multi-project PCB)	932	£3.00
Vibralarm	NOV '99	230 £6.93
Demister One-Shot	245	£6.78
★Ginormous Stopwatch – Part 1	246	£7.82
★Ginormous Stopwatch – Part 2	DEC '99	247 £7.85
Giant Display	248	£3.96
Serial Port Converter	249	£4.44
Loft Guard	250	£4.83
Scratch Blanker	JAN '00	932 £3.00
Flashing Snowman (Multi-project PCB)	251	£5.63
★Video Cleaner	252	£4.20
Find It	253	£4.52
★Teach-In 2000 – Part 4	MAR '00	254, 255 } £5.49
High Performance Regenerative Receiver	256	Set
★EPE Icebreaker – PCB257, programmed PIC16F877 and floppy disc	Set only	£22.99
Parking Warning System	258	£5.08
★Micro-PICscope	APR '00	259 £4.99
Garage Link – Transmitter Receiver	261 } Set	£5.87
262		
Versatile Mic/Audio Preamp	MAY '00	260 £3.33
PIR Light Checker	263	£3.17
★Multi-Channel Transmission System – Transmitter Receiver Interface	264 } Set	£6.34
265		
266		
★Canute Tide Predictor	JUNE '00	267 £3.05
★PIC-Gen Frequency Generator/Counter	JULY '00	268 £5.07
Q-Meter	269	£4.36
★EPE Moodloop	AUG '00	271 £5.47
Quiz Game Indicator	272	£4.52
Handy-Amp	273	£4.52
Active Ferrite Loop Aerial	SEPT '00	274 £4.67
★Remote Control IR Decoder	Software only	–
★PIC Dual-Channel Virtual Scope	OCT '00	275 £5.15
Handicap Switch	NOV '00	270 £3.96
★PIC Pulsometer	Software only	–
Twinkling Star	DEC '00	276 £4.28
Festive Fader	277	£5.71
Motorists' Buzz-Box	278	£5.39
★PICtogram	279	£4.91
★PIC-Monitored Dual PSU-1 PSU	280	£4.75
Monitor Unit	281	£5.23
Static Field Detector (Multi-project PCB)	932	£3.00
Two-Way Intercom	JAN '01	282 £4.76
UFO Detector and Event Recorder	283 } Set	£6.19
Magnetic Anomaly Detector	284	
Event Recorder	285	
Audio Alarm	–	–
★Using PICs and Keypads	Software only	–
Ice Alarm	FEB '01	287 £4.60
★Graphics L.C.D. Display with PICs (Supp)	288	£5.23
Using the LM3914-6 L.E.D. Bargraph Drivers	289 } Set	£7.14
Multi-purpose Main p.c.b.	290	
Relay Control	291	
L.E.D. Display	–	–
★PC Audio Power Meter	Software only	–
Doorbell Extender: Transmitter	MAR '01	292 £4.20
Receiver	293	£4.60
Trans/Remote	294	£4.28
Rec./Relay	295	£4.92
EPE Snug-bug Heat Control for Pets	APR '01	296 £6.50
Intruder Alarm Control Panel	297	£6.97
Main Board	298	£4.76
External Bell Unit		

PROJECT TITLE	Order Code	Cost
Camcorder Mixer	MAY '01	299 £6.34
★PIC Graphics L.C.D. Scope	300	£5.07
Hosepipe Controller	JUNE '01	301 £5.14
Magfield Monitor (Sensor Board)	302	£4.91
Dummy PIR Detector	303	£4.36
★PIC16F87x Extended Memory Software only	–	–
Stereo/Surround Sound Amplifier	JULY '01	304 £4.75
Perpetual Projects Uniboard-1	305	£3.00
Solar-Powered Power Supply & Voltage Reg.		
MSF Signal Repeater and Indicator		
Repeater Board	306	£4.75
Meter Board	307	£4.44
★PIC to Printer Interface	308	£5.39
Lead/Acid Battery Charger	AUG '01	309 £4.99
Shortwave Loop Aerial	310	£5.07
★Digitimer – Main Board	311	£6.50
– R.F. Board	312	£4.36
Perpetual Projects Uniboard-2		
L.E.D. Flasher – Double Door-Buzzer	305	£3.00
Perpetual Projects Uniboard-3	SEPT '01	305 £3.00
Loop Burglar Alarm, Touch-Switch Door-Light and Solar-Powered Rain Alarm		
L.E.D. Super Torches – Red Main	313 } Set	£6.10
– Display Red	314	
– White L.E.D.	315	£4.28
★Sync Clock Driver	316	£5.94
★Water Monitor	317	£4.91
Camcorder Power Supply	OCT '01	318 £5.94
PIC Toolkit Mk3	319	£8.24
Perpetual Projects Uniboard-4	305	£3.00
Gate Sentinel, Solar-powered Bird Scarer and Solar-Powered Register		
Teach-In 2002 Power Supply	NOV '01	320 £4.28
Lights Needed Alert	321	£5.39
Pitch Switch	322	£5.87
Capacitance Meter – Main Board (double-sided)	323 } Set	£12.00
– Display Board (double-sided)	324	
★ ★PIC Toolkit TK3 – Software only	–	–
4-Channel Twinkling Lights	DEC '01	325 £6.82
Ghost Buster – Mic	326 } Set	£5.78
– Main	327	
★PIC Polywhatsit – Digital	328 } Set	£7.61
– Analogue	329	
Forever Flasher	JAN '02	330 £4.44
Time Delay Touch Switch	331	£4.60
★PIC Magick Musick	332	£5.87
Versatile Bench Power Supply	333	£5.71

## EPE SOFTWARE

Software programs for *EPE* projects marked with a single asterisk \* are available on 3.5 inch PC-compatible disks or free from our Internet site. The following disks are available: **PIC Tutorial** (Mar-May '98); **PIC Toolkit Mk2 V2.4d** (May-Jun '99); **EPE Disk 1** (Apr '95-Dec '98); **EPE Disk 2** (1999); **EPE Disk 3** (2000); **EPE Disk 4** (2001); **EPE Disk 5** (Jan 2002 issue to current cover date); **EPE Teach-In 2000**; **EPE Interface Disk 1** (October '00 issue to current cover date). ★ **PIC Toolkit TK3** software (Nov '01) is on CD-ROM. The 3.5 inch disks are £3.00 each (UK), the CD-ROM is £6.95 (UK). Add 50p each for overseas surface mail, and £1 each for airmail. All are available from the *EPE PCB Service*. All files can be downloaded free from our Internet FTP site: <ftp://ftp.epemag.wimborne.co.uk>.

## EPE PRINTED CIRCUIT BOARD SERVICE

Order Code	Project	Quantity	Price
Name .....			
Address .....			
Tel. No. ....			
I enclose payment of £..... (cheque/PO in £ sterling only) to:			
		<b>Everyday Practical Electronics</b> 	
		<b>MasterCard, Amex, Diners Club, Visa or Switch</b>  	
Minimum order for cards £5		Switch Issue No. ....	
Card No. ....			
Signature.....		Card Exp. Date.....	
NOTE: You can also order p.c.b.s by phone, Fax, E-mail or via our Internet site on a secure server:			
<a href="http://www.epemag.wimborne.co.uk/shopdoor.htm">http://www.epemag.wimborne.co.uk/shopdoor.htm</a>			



Everyday Practical Electronics reaches twice as many UK readers as any other UK monthly hobby electronics magazine, our sales figures prove it. We have been the leading monthly magazine in this market for the last seventeen years.

If you want your advertisements to be seen by the largest readership at the most economical price our classified and semi-display pages offer the best value. The prepaid rate for semi-display space is £8 (+VAT) per single column centimetre (minimum 2.5cm). The prepaid rate for classified adverts is 30p (+VAT) per word (minimum 12 words).

All cheques, postal orders, etc., to be made payable to Everyday Practical Electronics. VAT must be added. Advertisements, together with remittance, should be sent to Everyday Practical Electronics Advertisements, Mill Lodge, Mill Lane, Thorpe-le-Soken, Essex CO16 0ED. Phone/Fax (01255) 861161.

For rates and information on display and classified advertising please contact our Advertisement Manager, Peter Mew as above.

Valve Output Transformers: Single ended 50mA, £4.50; push/pull 50W, £38; 100W, £53. Mains Transformers: Sec 220V 30mA 6V 1A, £3; 250V 60mA 6V 2A, £5; 250V 80mA 6V 2A, £6. High Voltage Caps: 50µF 350V, 68µF 500V, 150µF 385V, 330µF 400V, 470µF 385V, all £3 ea., 32+32µF 450V £5, 4µF 800V oil filled paper block, £10. Postage extra.  
 Record Decks and Spares: BSR, Garrard, Goldring, motors, arms, wheels, headshells, spindles, etc. Send or phone your want list for quote.

**RADIO COMPONENT SPECIALISTS**

**337 WHITEHORSE ROAD, CROYDON  
 SURREY, CR0 2HS. Tel: (020) 8684 1665**  
 Lots of transformers, high volt caps, valves, output transformers, speakers, in stock.  
 Phone or send your wants list for quote.

**Test Equipment**



**Service Manuals.**

Contact  
[www.cooke-int.com](http://www.cooke-int.com)  
 Tel: +44 01243 55 55 90

**TIS - Midlinbank Farm  
 Ryeland, Strathaven ML10 6RD**

*Manuals on anything electronic*

Circuits - VCR £8, CTV £6  
 Service Manuals from £10  
 Repair Manuals from £5  
 P&P any order £2.50

Write, or ring 01357 440280 for full details  
 of our lending service and FREE quote for  
 any data

**BTEC ELECTRONICS  
 TECHNICIAN TRAINING**

VCE ADVANCED ENGINEERING  
 ELECTRONICS AND ICT  
 HNC AND HND ELECTRONICS  
 NVQ ENGINEERING AND IT  
*Next course commences*  
**1st FEBRUARY 2002**  
 FULL PROSPECTUS FROM

**LONDON ELECTRONICS COLLEGE  
 (Dept EPE) 20 PENYWERN ROAD  
 EARLS COURT, LONDON SW5 9SU  
 TEL: (020) 7373 8721**

**THE BRITISH AMATEUR  
 ELECTRONICS CLUB**

exists to help electronics enthusiasts by  
 personal contact and through a quarterly  
 Newsletter.

For membership details, write to the  
 Secretary:

Mr. M. P. Moses,  
 5 Park View, Cwmaman,  
 Aberdare CF44 6PP

Space donated by  
 Everyday Practical Electronics

**X-10® Home Automation**  
 We put you in control™

**Why tolerate when you can automate?**

An extensive range of 230V X-10 products  
 and starter kits available. Uses proven Power  
 Line Carrier technology, no wires required.

Products Catalogue available Online.

Worldwide delivery.

**Laser Business Systems Ltd.**



E-Mail: [info@laser.com](mailto:info@laser.com)

<http://www.laser.com>

Tel: (020) 8441 9788

Fax: (020) 8449 0430



**Z88** NOW AVAILABLE WITH  
 128K AND 512K - OZ4

**ALSO SPECTRUM  
 AND QL PARTS**

**W. N. RICHARDSON & CO.**

PHONE/FAX 01494 871319

E-mail: [wnr@compuserve.com](mailto:wnr@compuserve.com)

RAVENSEMEAD, CHALFONT ST PETER, BUCKS, SL9 0NB

**2002 CATALOGUE**

PLEASE SEND SAE FOR A FREE COPY TO:

**FML ELECTRONICS**

FREEPOST NEA 3627 BEDALE

NORTH YORKSHIRE, DL8 2BR

TEL: 01677 425840

SUPPLIERS OF ELECTRONIC COMPONENTS, EPE KITS AND  
 PARTS FOR TEACH-IN 2002

**Miscellaneous**

**FREE PROTOTYPE PRINTED CIRCUIT  
 BOARDS!** Free prototype p.c.b. with quantity  
 orders. Call Patrick on 028 9073 8897 for details.  
 Agar Circuits, Unit 5, East Belfast Enterprise Park,  
 308 Albertbridge Road, Belfast BT5 4GX.

**EDUCATIONAL ELECTRONIC KITS,**  
 GCSE, Physics, Hobbyist. 2 x 1st class stamps  
 for catalogue. Electroteach, PO Box 2594,  
 Cannock, WS12 4YH.

[www.electroteach.com](http://www.electroteach.com).

**PRINTED CIRCUIT BOARDS - QUICK  
 SERVICE.** Prototype and production artwork  
 raised from magazines or draft designs at low  
 cost. PCBs designed from schematics.  
 Production assembly, wiring and software pro-  
 gramming. For details contact Patrick at Agar  
 Circuits, Unit 5, East Belfast Enterprise Park,  
 308 Albertbridge Road, Belfast, BT5 4GX.  
 Phone 028 9073 8897, Fax 028 9073 1802,  
 E-mail [agar@argonet.co.uk](mailto:agar@argonet.co.uk).

**G.C.S.E. ELECTRONICS KITS,** at pocket  
 money prices. S.A.E. for FREE catalogue. SIR-  
 KIT Electronics, 52 Severn Road, Clacton,  
 CO15 3RB, [http://www.geocities.com/  
 sirkituk/index.htm](http://www.geocities.com/sirkituk/index.htm).

**VALVES AND ALLIED COMPONENTS  
 IN STOCK** - please ring for free list. Valve  
 equipment repaired. Geoff Davies (Radio).  
 Phone 01788 574774.

**EPE NET ADDRESSES**

**EPE FTP site:** <ftp://ftp.epemag.wimborne.co.uk>

Access the FTP site by typing the above into your web browser, or by setting  
 up an FTP session using appropriate FTP software, then go into quoted  
 sub-directories:

PIC-project source code files: [/pub/PICS](#)

PIC projects each have their own folder; navigate to the correct folder and open  
 it, then fetch all the files contained within. *Do not try to download the folder  
 itself!*

EPE text files: [/pub/docs](#)

*Basic Soldering Guide:* [solder.txt](#)

*Ingenuity Unlimited* submission guidance: [ing\\_unlt.txt](#)

New readers and subscribers info: [epe\\_info.txt](#)

Newsgroups or Usenet users advice: [usenet.txt](#)

Ni-Cad discussion: [nicadfaq.zip](#) and [nicad2.zip](#)

Writing for EPE advice: [write4us.txt](#)

You can also enter the FTP site via the link at the top of the  
 main page of our home site at:

<http://www.epemag.wimborne.co.uk>

Shop now on-line:

[www.epemag.wimborne.co.uk/shopdoor.htm](http://www.epemag.wimborne.co.uk/shopdoor.htm)

Ensure you set your FTP soft-  
 ware to ASCII transfer when  
 fetching text files, or they may be  
 unreadable.

Note that any file which ends in  
 .zip needs unzipping before use.  
 Unzip utilities can be downloaded  
 from:  
<http://www.winzip.com> or  
<http://www.pkware.com>

## TRAIN TODAY FOR A BETTER FUTURE

Now you can get the skills and qualifications you need for career success with an ICS Home Study Course. Learn in the comfort of your own home at the pace and times that suit you. ICS is the world's largest, most experienced home study school. Over the past 100 years ICS has helped nearly 10 million people to improve their job prospects. Find out how we can help YOU. Post or phone today for FREE INFORMATION on the course of your choice

Electrical Contracting & Installation  
Electrical Engineering  
C&G/CS Basic Electronic Engineering  
C&G/CS Basic Mechanical Engineering  
TV and Video Servicing  
Radio and Hi-Fi Servicing  
Refrigeration Heating & Air Conditioning  
Motorcycle Maintenance

**FREEPHONE 0500 581 557**

Or write to: International Correspondence Schools, FREEPOST 882, 8 Elliot Place, Croydon SkyPark, Glasgow, G3 8BR. Tel: 0500 581 557 or Tel/Fax: Dublin 285 2533

Please send me my Free Information on your Electronics Courses.

Mr/Ms/Ms/Miss (BLOCK CAPITALS PLEASE) \_\_\_\_\_ Date of Birth / /

Address \_\_\_\_\_

Postcode \_\_\_\_\_

Occupation \_\_\_\_\_ Tel. No. \_\_\_\_\_

From time to time, we permit other carefully screened organisations to write to you about products and services. If you would prefer not to hear from such organisations please tick box  Dept. ZEEVC11

## Bowood Electronics Ltd

### Suppliers of Electronic Components

Batteries, Buzzers, Capacitors, Connectors, Diodes, Cases, Ferrites, Fuses, Heatshrink, ICs, Inverters, L.E.D.s, P.C.B., Potentiometers, Power Supplies, Presets, Rectifiers, Relays, Resistors, Soldering Equipment, Stripboard, Switches, Test Meters, Thermistors, Thyristors, Tools, Transistors, Triacs...

**Catalogue available NOW**

**Send 41p stamp or visit our website**

Website: <http://www.bowood-electronics.co.uk>  
sales@bowood-electronics.co.uk



Mail Order Only

7 Bakewell Road, Baslow, Derbyshire, DE45 1RE, UK  
Telephone/Fax: 01246 583777

## SHERWOOD ELECTRONICS

**FREE COMPONENTS**

Buy 10 x £1 Special Packs and choose another one FREE

SP1	15 x 5mm Red LEDs	SP135	6 x Miniature slide switches
SP2	12 x 5mm Green LEDs	SP136	3 x BFY50 transistors
SP3	12 x 5mm Yellow LEDs	SP137	4 x W005 1.5A bridge rectifiers
SP6	15 x 3mm Red LEDs	SP138	20 x 2.2/63V radial elect. caps.
SP7	12 x 3mm Green LEDs	SP140	3 x W04 1.5A bridge rectifiers
SP8	10 x 3mm Yellow LEDs	SP142	2 x CMOS 4017
SP10	100 x 1N4148 diodes	SP143	5 Pairs min. crocodile clips (Red & Black)
SP11	30 x 1N4001 diodes	SP145	6 x ZTX300 transistors
SP12	30 x 1N4002 diodes	SP146	10 x 2N3704 transistors
SP20	20 x BC184 transistors	SP147	5 x Stripboard 9 strips x 25 holes
SP21	20 x BC212 transistors	SP151	4 x 8mm Red LEDs
SP23	20 x BC549 transistors	SP152	4 x 8mm Green LEDs
SP24	4 x CMOS 4001	SP153	4 x 8mm Yellow LEDs
SP25	4 x 555 timers	SP154	15 x BC548 transistors
SP26	4 x 741 Op.Amps	SP156	3 x Stripboard, 14 strips x 27 holes
SP28	4 x CMOS 4011	SP160	10 x 2N3904 transistors
SP29	3 x CMOS 4013	SP161	10 x 2N3906 transistors
SP34	20 x 1N914 diodes	SP165	2 x LF351 Op.Amps
SP36	25 x 10/25V radial elect. caps.	SP166	20 x 1N4003 diodes
SP37	12 x 100/35V radial elect. caps.	SP167	6 x BC107 transistors
SP39	10 x 470/16V radial elect. caps.	SP168	6 x BC108 transistors
SP40	15 x BC237 transistors	SP172	4 x Standard slide switches
SP41	20 x Mixed transistors	SP175	20 x 1/63V radial elect. caps.
SP42	200 x Mixed 0.25W C.F. resistors	SP177	10 x 1A 20mm quick blow fuses
SP47	5 x Min. PB switches	SP182	20 x 4-7/63V radial elect. caps.
SP49	4 x 5 metres stranded core wire	SP183	20 x BC547 transistors
SP102	20 x 8-pin DIL sockets	SP187	15 x BC239 transistors
SP103	15 x 14-pin DIL sockets	SP189	4 x 5 metres solid core wire
SP104	15 x 16-pin DIL sockets	SP192	3 x CMOS 4066
SP109	15 x BC557 transistors	SP193	20 x BC213 transistors
SP112	4 x CMOS 4093	SP195	3 x 10mm Yellow LEDs
SP115	3 x 10mm Red LEDs	SP197	6 x 20 pin DIL sockets
SP116	3 x 10mm Green LEDs	SP198	5 x 24 pin DIL sockets
SP124	20 x Assorted ceramic disc caps	SP199	5 x 2.5mm mono jack plugs
SP126	8 x Battery clips - 4 ea. PP3 + PP9	SP200	5 x 2.5mm mono jack sockets
SP130	100 x Mixed 0.5W C.F. resistors		
SP131	2 x TL071 Op.Amps		
SP133	20 x 1N4004 diodes		
SP134	15 x 1N4007 diodes		

2002 Catalogue now available £1 inc. P&P or FREE with first order. P&P £1.25 per order. NO VAT

Orders to:  
**Sherwood Electronics,**  
7 Williamson St., Mansfield,  
Notts. NG19 6TD.

### RESISTOR PACKS - C.Film

RP3	5 each value - total 365 0.25W	£3.00
RP7	10 each value - total 730 0.25W	£4.25
RP10	1000 popular values 0.25W	£6.15
RP4	5 each value-total 365 0.5W	£4.00
RP8	10 each value-total 730 0.5W	£6.65
RP11	1000 popular values 0.5W	£8.40

## VARIABLE VOLTAGE TRANSFORMERS

INPUT 220V/240V AC 50/60Hz OUTPUT 0V-280V PANEL MOUNTING

	Price	P&P
0.5KVA 2.5 amp max	£33.00	£6.00 (£45.84 inc VAT)
1KVA 5 amp max	£45.25	£7.00 (£61.39 inc VAT)
<b>SHROUDED</b>		
0.5KVA 2.5 amp max	£34.00	£6.00 (£47.00 inc VAT)
1KVA 5 amp max	£46.25	£7.00 (£62.57 inc VAT)
2KVA 10 amp max	£65.00	£8.50 (£86.36 inc VAT)
3KVA 15 amp max	£86.50	£8.50 (£111.63 inc VAT)
5KVA 25 amp max	£150.00	(- Carriage & VAT)

Buy direct from the Importers Keenest prices in the country.

### 500VA ISOLATION TRANSFORMER

Input lead 240V AC. Output via 3-pin 13A socket. 240V AC continuously rated, mounted in fireproof case with handle. Internally fused. Price £35.00 carriage paid + VAT (£41.13)

### TOROIDAL L.T. TRANSFORMER

Primary 0-240V AC. Secondary 0-30V + 0-30V 600VA. Fixing bolt supplied. Price £25.00 carriage paid + VAT (£29.38)

### COMPREHENSIVE RANGE OF TRANSFORMERS - LT - ISOLATION & AUTO

110V-240V Auto transfer either cased with American socket and mains lead or open frame type. Available for immediate delivery.

### ULTRA VIOLET BLACK LIGHT BLUE FLUORESCENT TUBES

4ft 40 watt	£14.00 (callers only)	(£16.45 inc VAT)
2ft 20 watt	£9.00 (callers only)	(£10.58 inc VAT)
12in 8 watt	£4.80 + 75p p&p	(£6.52 inc VAT)
9in 6 watt	£3.96 + 50p p&p	(£5.24 inc VAT)
6in 4 watt	£3.96 + 50p p&p	(£5.24 inc VAT)

### 230V AC BALLAST KIT

For either 9in, 9in or 12in tubes £8.05 + £1.40 p&p (£9.75 inc VAT)  
The above Tubes are 3500/4000 angst. (350-400nm) ideal for detecting security markings, effects lighting & Chemical applications  
Other Wavelengths of UV TUBE available for Germicidal & Photo Sensitive applications. Please telephone your enquiries.

### 400 WATT BLACK LIGHT BLUE UV LAMP

GES Mercury Vapour lamp suitable for use with a 400W P.F. Ballast  
Only £39.95 incl. p&p & VAT



## SERVICE TRADING CO

57 BRIDGMAN ROAD, CHISWICK, LONDON W4 5BB

Open Monday/Friday Tel: 020 8995 1560 FAX: 020 8995 0549



Ample Parking Space

## Watch Slides on TV.

Make videos of your slides. Digitise your slides (using a video capture card)

"Liesgang diatv" automatic slide viewer with built in high quality colour TV camera. It has a composite video output to a phono plug (SCART & BNC adaptors are available). They are in very good condition with few signs of use. More details see [www.diatv.co.uk](http://www.diatv.co.uk).  
£91.91 + VAT = £108.00



Board cameras all with 512 x 582 pixels 8.5mm 1/3 inch sensor and composite video out. All need to be housed in your own enclosure and have fragile exposed surface mount parts. They all require a power supply of between 10V and 12V DC 150mA.  
47MIR size 60 x 36 x 27mm with 6 infra red LEDs (gives the same illumination as a small torch but is not visible to the human eye) £37.00 + VAT = £43.48  
3CMP size 32 x 32 x 14mm spy camera with a fixed focus pin hole lens for hiding behind a very small hole £35.00 + VAT = £41.13  
40MC size 39 x 38 x 27mm camera for 'C' mount lens these give a much sharper image than with the smaller lenses £32.00 + VAT = £37.60  
Economy C mount lenses all fixed focus & fixed iris  
VSL1220F 12mm F1.6 12 x 15 degrees viewing angle £15.97 + VAT £18.76  
VSL4022F 4mm F1.22 63 x 47 degrees viewing angle £17.65 + VAT £20.74  
VSL6022F 6mm F1.22 42 x 32 degrees viewing angle £19.05 + VAT £22.38  
VSL8020F 8mm F1.22 32 x 24 degrees viewing angle £19.90 + VAT £23.38

## Better quality C Mount lenses

VSL1614F 16mm F1.6 30 x 24 degrees viewing angle £26.43 + VAT £31.06  
VWL813M 8mm F1.3 with iris 58 x 42 degrees viewing angle £77.45 + VAT = £91.00  
1206 surface mount resistors E12 values 10 ohm to 1M ohm  
100 of 1 value £1.00 + VAT 1000 of 1 value £5.00 + VAT

## 666 battery pack originally intended to be used with an orbital mobile telephone it contains 10 1.6Ah sub C batteries (42 x 22 dia. the size usually used in cordless screwdrivers etc.) the pack is new and unused and can be broken open quite easily

£7.46 + VAT = £8.77



Please add £1.66 + vat = £1.95 postage & packing per order

## JPG Electronics

Shaws Row, Old Road, Chesterfield, S40 2RB.

Tel 01246 211202 Fax 01246 550959

Mastercard/Visa/Switch

Callers welcome 9.30 a.m. to 5.30 p.m. Monday to Saturday



## N. R. BARDWELL LTD (Est. 1948)

100	Signal Diodes 1N4148	£1.00
75	Rectifier Diodes 1N4001	£1.00
50	Rectifier Diodes 1N4007	£1.00
10	W01 Bridge Rectifiers	£1.00
10	555 Timer I.C.s	£1.00
4	741 Op Amps	£1.00
5	Assorted Zener Diodes 400mW	£1.00
12	Assorted 7-segment Displays	£1.00
25	5mm I.e.d.s. red, green or yellow	£1.00
25	3mm I.e.d.s. red, green or yellow	£1.00
75	5mm I.e.d.s. green, 6.5mm legs	£1.00
50	Axial I.e.d.s. 2mod red Diode Package	£1.00
25	Assd. High Brightness I.e.d.s. var cols	£1.00
20	BC182L Transistors	£1.00
25	BC212L Transistors	£1.00
30	BC237 Transistors	£1.00
20	BC327 Transistors	£1.00
30	BC328 Transistors	£1.00
30	BC547 Transistors	£1.00
20	BC547B Transistor	£1.00
30	BC548 Transistors	£1.00
30	BC549 Transistors	£1.00
25	BC557 Transistors	£1.00
30	BC558 Transistors	£1.00
30	BC559 Transistors	£1.00
20	2N3904 Transistors	£1.00
100	1nf 50V wkg Axial Capacitors	£1.00
100	4N7 50V wkg Axial Capacitors	£1.00
80	Assd capacitors electrolytic-	£1.00
80	Assd. capacitors 1nF to 1µF	£1.00

200	Assd. disc ceramic capacitors	£1.00
50	Assd. SMD Presets (sm, stand, cermet)	£1.00
50	Assd. RF chokes (inductors)	£1.00
50	Assd. grommets	£1.00
80	Assd. solder tags, p/conn, terminals	£1.00
10	Assd. crystals - plug in	£1.00
8	Assd. di/ switches	£1.00
20	Miniature slide switches sp/co	£1.00
100	Assd. beads (ceramic, teflon, fish spine)	£1.00
80	Assd. small stand offs, Vthroughs etc	£1.00
30	Assd. di/ sockets up to 40 way	£1.00
10	TV coax plugs, plastic	£1.00
40	metres very thin connecting wire, red	£1.00
20	1in. glass reed switches	£1.00
100	Any one value ¼W 5% of resistors range	
	1R to 10M	£0.45
10	7812 Voltage Regulators	£1.00
300	Assd. resistors, ¼W/½W, mostly on	
	tapes	£1.00

288 Abbeydale Road, Sheffield S7 1FL  
 Phone: 0114 255 2886 ★ Fax: 0114 255 5039  
 e-mail: sales@bardwells.co.uk ★ Web: www.bardwells.co.uk  
 Prices include VAT. Postage £1.65  
 44p stamp for lists or disk  
**POs, Cheques and Credit Cards accepted**



## DIGITAL TEST METER

Built-in transistor test socket and diode test position.  
 DC volts 200mV to 1000V.  
 AC volts 200V to 750V.  
 DC current 200mA to 10A.  
 Resistance 200 ohms to 2000K ohms.

£5.99 incl. VAT

SEE OUR WEB PAGES FOR MORE COMPONENTS AND SPECIAL OFFERS  
[www.bardwells.co.uk](http://www.bardwells.co.uk)

## COVERT VIDEO CAMERAS

Black and White Pin Hole Board Cameras with Audio. Cameras in P.I.R., Radios, Clocks, Briefcases etc. Transmitting Cameras with Receiver (Wireless). Cameras as above with colour. Audio Surveillance Kits and Ready Built Units, Bug Detector etc.

## A.L. ELECTRONICS

Please phone 0181 203 6008 for free catalogue.  
 Fax 0181 201 5359

E-mail: [surveillance@btclick.com](mailto:surveillance@btclick.com)    [www.uspy.com](http://www.uspy.com)

New DTI approved Video Transmitters and Receivers (Wireless)  
*Major credit cards now taken*

## ADVERTISERS INDEX

A.L. ELECTRONICS	72
N. R. BARDWELL	72
BITZ TECHNOLOGY	32
B.K. ELECTRONICS	Cover (iii)/32
BOWOOD ELECTRONICS	71
BULL ELECTRICAL	Cover (ii)
CRICKLEWOOD ELECTRONICS	6
CROWNHILL ASSOCIATES	21
DISPLAY ELECTRONICS	2
EPTSOFT	Cover (iv)
ESR ELECTRONIC COMPONENTS	10
FOREST ELECTRONIC DEVELOPMENTS	7
ICS	71
J&N FACTORS	47
JPG ELECTRONICS	71
MAGENTA ELECTRONICS	8/9
MILFORD INSTRUMENTS	29
NATIONAL COLLEGE OF TECHNOLOGY	6
PICO TECHNOLOGY	44
QUASAR ELECTRONICS	4/5
SERVICE TRADING CO	71
SHERWOOD ELECTRONICS	71
SKY ELECTRONICS	72
SLM (MODEL) ENGINEERS	6
SQUIRES	6
STEWART OF READING	23

**ADVERTISEMENT MANAGER:** PETER J. MEW

**ADVERTISEMENT OFFICES:**

EVERYDAY PRACTICAL ELECTRONICS, ADVERTISEMENTS,  
 MILL LODGE, MILL LANE, THORPE-LE-SOKEN,  
 ESSEX CO16 0ED.

Phone/Fax: (01255) 861161

*For Editorial address and phone numbers see page 11*

# ELECTRONICS 2002

FREE 304-page colour catalogue

Great value for Speakers, Microphones, Headphones, Aerials, Transmitters, TV Amps, Plugs, Sockets, Leads, CD Storage Cases, CCTV Security, Connectors, Adaptors, Switch Boxes, Gadgets, Discs Lighting & Effects, Mixers, Amplifiers, Turntables, Musicians' Leads, Car Audio, Test Equipment, Hobby Kits, Computer Leads & Accessories, Power Supplies, Inverters, Transformers, Battery Chargers, Tools, Soldering, Switches, Fuses, Indicators, Cable & Wire, Crossovers, Speaker Hardware, PA Amps, and a great deal more... all for the price of a stamp.

Sky Electronics

40-42 Cricklewood Broadway,  
 London, NW2 3ET

Tel: 020 8450 0995  
 Fax: 020 8208 1441

Email: [sales@cricklewoodelectronics.com](mailto:sales@cricklewoodelectronics.com)  
[www.skyelectronics.co.uk](http://www.skyelectronics.co.uk)

The Catalogue is FREE to shop callers or send stamps to the value of £1.85 to cover postage.

ELECTRONICS 2002

Published on approximately the second Thursday of each month by Wimborne Publishing Ltd., 408 Wimborne Road East, Ferndown, Dorset BH22 9ND. Printed in England by Apple Web Offset Ltd., Warrington, WA1 4RW. Distributed by COMAG Magazine Marketing, Tavistock Rd., West Drayton, UB7 7QE. Subscriptions INLAND: £15 (6 months); £28.50 (12 months); £52 (2 years). OVERSEAS: Standard air service, £18 (6 months); £34.50 (12 months); £64 (2 years). Express airmail, £27 (6 months); £52 (12 months); £99 (2 years). Payments payable to "Everyday Practical Electronics", Subs Dept, Wimborne Publishing Ltd. E-mail: [subs@epemag.wimborne.co.uk](mailto:subs@epemag.wimborne.co.uk). EVERYDAY PRACTICAL ELECTRONICS is sold subject to the following conditions, namely that it shall not, without the written consent of the Publishers first having been given, be lent, resold, hired out or otherwise disposed of by way of Trade at more than the recommended selling price shown on the cover, and that it shall not be lent, resold, hired out or otherwise disposed of in a mutilated condition or in any unauthorised cover by way of Trade or affixed to or as part of any publication or advertising, literary or pictorial matter whatsoever.





# POWER AMPLIFIER MODULES-LOUDSPEAKERS-MIXERS 19 INCH STEREO AMPLIFIERS-ACTIVE CROSS/OVERS.

\* PRICES INCLUDE V.A.T.  
\* PROMPT DELIVERY

## OMP MOS-FET POWER AMPLIFIERS HIGH POWER, TWO CHANNEL 19 INCH RACK

10,000's  
SOLD  
TO PRO  
USERS



### THE RENOWNED MXF SERIES OF POWER AMPLIFIERS

FOUR MODELS:- MXF200 (100W + 100W) MXF400 (200W + 200W)  
MXF600 (300W + 300W) MXF900 (450W + 450W)

ALL POWER RATINGS ARE R.M.S. INTO 4 OHMS, WITH BOTH CHANNELS DRIVEN  
FEATURES:- \* Independent power supplies with two toroidal transformers  
\* Twin L.E.D. Vu Meters \* Level controls \* Illuminated on/off switch \* Jack / XLR inputs \*  
\* Speakon Outputs \* Standard 775mv inputs \* Open and Short circuit proof \* Latest Mos-Fets  
for stress free delivery into virtually any load \* High slew rate \* Very low distortion \* Aluminium  
cases \* MXF600 & MXF900 fan cooled with D.C. Loudspeaker and thermal protection.

USED THE WORLD OVER IN CLUBS, PUBS, CINEMAS, DISCOS ETC

SIZES:-  
MXF200 W19" D11" H3 1/2" (2U)  
MXF400 W19" D12" H5 1/4" (3U)  
MXF600 W19" D13" H5 1/4" (3U)  
MXF900 W19" D14" H5 1/4" (3U)

PRICES:- MXF200 £175.00 MXF400 £233.85  
MXF600 £329.00 MXF900 £449.15  
SPECIALIST CARRIER DEL £12.50 Each



## CATALOGUE 2001 2002

Robots

Test & Tools

Electronic Kits

The Sky's  
The Limit  
Catalogue

Communication

B.K. Electronics

Unit 1, Comet Way, Southend-on-Sea, Essex, SS2 6TR

TEL: 01702-527572 FAX: 01702-420243

E-MAIL: sales@bkelec.com

Web Site: www.bkelec.com

FREE Our Sky's The Limit Catalogue is free with any item ordered from this advert and to personal callers or £4.00 to cover P&P if ordered separately. This is a fully refundable with your first order.

### 100 WATT ACTIVE SUB BASS AMPLIFIER PANEL



AN ACTIVE SUB BASS AMPLIFIER WITH A TRUE 100W RMS OUTPUT SUPERB CONSTRUCTION WITH THE FACILITIES TO INTEGRATE SEEMLESSLY INTO MOST HI-FI OR HOME CINEMA SETUPS. USE THIS PANEL PLUS ONE OF OUR LOUDSPEAKERS TO MAKE YOUR OWN SUB WOOFER THAT WILL MATCH OR BEAT MOST COMMERCIALLY AVAILABLE SUB WOOFERS.

FEATURES:- \* 100W RMS INTO 8 OHMS \* HIGH AND LOW LEVEL INPUTS \* TOROIDAL TRANSFORMER \* SHORT CIRCUIT PROTECTION \* D.C. SPEAKER PROTECTION \* FREQUENCY ROLL OFF, LOWER 10Hz, UPPER 60Hz TO 240Hz (FULLY ADJUSTABLE) \* AC3 COMPATIBLE FILTER CAN BE BYPASSED FOR 5-1 FORMATS. \* AIRTIGHT CONSTRUCTION \* TENS OF THOUSANDS OF OUR PANELS ALREADY IN USE. \* COMPLETE WITH LEADS

SPECIFICATIONS:- \* POWER 100W RMS @ 8 OHMS \* FREQ RESP. 10Hz 15KHz -3dB \* DAMPING FACTOR >200 \* DISTORTION 0.05% \* S/N A WEIGHTED >100dB \* SUPPLY 230V A.C. \* WEIGHT 2.7Kg \* SIZE H254 X W254 X D94mm

THERE ARE 2 VERSIONS OF THE ABOVE PANEL AVAILABLE :- **BSB100/8 8 OHM VERSION** **BSB100/4 4 OHM VERSION** BOTH PANELS ARE PRICED AT £117.44 + £5.00 P&P INCL. V.A.T. CHECK WEBSITE FOR PANELS UP TO 500W

## FLIGHTCASED LOUDSPEAKERS

A new range of quality loudspeakers, designed to take advantage of latest loudspeaker technology and enclosure designs. All models utilise high quality studio cast aluminium loudspeakers with factory fitted grilles, wide dispersion constant directivity horns, extruded aluminium corner protection and steel ball corners, complimented with heavy duty black covering. The enclosures are fitted as standard with top hats for optional loudspeaker stands. The FC15-300 incorporates a large 16 X 6 inch horn. All cabinets are fitted with the latest Speakon connectors for your convenience and safety. Five models to choose from.



PLEASE NOTE:- POWER RATINGS QUOTED ARE IN WATTS R.M.S. FOR EACH INDIVIDUAL CABINET ALL ENCLOSURES ARE 8 OHMS

15=15 inch speaker  
12=12 inch speaker

ibl FC15-300 WATTS Freq Range 35Hz-20kHz, Sens 101dB. Size H695 W502 D415mm  
Price:- £299.00 per pair  
ibl FC12-300 WATTS Freq Range 45Hz-20kHz, Sens 96dB. Size H600 W405 D300mm  
Price:- £249.00 per pair  
ibl FC12-200 WATTS Freq Range 40Hz-20kHz, Sens 97dB. Size H600 W405 D300mm  
Price:- £199.00 per pair  
ibl FC12-100 WATTS Freq Range 45Hz-20kHz, Sens 100dB, Size H546 W380 D300mm  
Price:- £179.00 per pair  
ibl WM12-200 WATTS Freq Range 40Hz-20kHz, Sens 97dB. Size H418 W600 D385mm  
Price:- £125.00 Each

SPECIALIST CARRIER DEL:- £12.50 per pair, wedge monitor £7.00 each  
Optional Metal Stands PRICE: £49.00 per pair Delivery:- £6.00

## OMP X03-S STEREO 3 WAY ACTIVE CROSSOVER

SWITCHABLE 2-WAY



BASS MID TOP CONFIGURED 3 WAY  
BASS/MID TOP 2 WAY BASS/MID COMBINED  
BASS MID/TOP 2 WAY MID/TOP COMBINED

### FEATURES:-

Advanced 3-Way Stereo Active Cross-Over (Switchable two way), housed in a 19" x 1U case. Each channel has three level controls: Bass, Mid & Top. The removable front fascia allows access to the programmable DIL switches to adjust the cross-over frequency: There are two versions available:- X03-S Bass-Mid 125/250/500Hz, Mid-Top 1.8/3/5KHz, all at 24 dB per octave. X03 Bass Mid 250/500/800Hz, Mid-Top 1.8/3/5KHz, all at 24 dB per Octave. Please make sure you ask for the correct model when ordering. The 2/3 way selector switches are also accessed by removing the front fascia. Each stereo channel can be configured separately. Bass Invert Switches are incorporated on each channel. Nominal 775mV input/output. Fully compatible with the OMP Rack Amplifier and Modules.

BOTH MODELS PRICED AT :- £117.44 + £5.00 P&P

## OMP MOS-FET POWER AMPLIFIER MODULES

SUPPLIED BUILT AND TESTED

These modules now enjoy a world-wide reputation for quality, reliability and performance at a realistic price. Four models are available to suit the needs of the professional and hobby market i.e. Industry, Leisure, Instrumental and Hi-Fi etc. When comparing prices, NOTE that all models include toroidal power supply, integral heatsink, glass fibre P.C.B. and drive circuits to power a compatible Vu meter. All models are open and short circuit proof.

### THOUSANDS OF MODULES PURCHASED BY PROFESSIONAL USERS

OMP/MF 100 Mos-Fet Output Power 110 watts R.M.S. into 4 ohms, frequency response 1Hz - 100kHz -3dB, Damping Factor >300, Slew Rate 45V/uS, T.H.D. typical 0.002%, Input Sensitivity 500mV, S.N.R. 110dB. Size 300 x 123 x 60mm.  
Price:- £42.85 + £4.00 P&P

OMP/MF 200 Mos-Fet Output Power 200 watts R.M.S. into 4 ohms, frequency response 1Hz - 100kHz -3dB, Damping Factor >300, Slew Rate 50V/uS, T.H.D. typical 0.001%, Input Sensitivity 500mV, S.N.R. 110dB. Size 300 x 155 x 100mm.  
Price:- £66.35 + £4.00 P&P

OMP/MF 300 Mos-Fet Output Power 300 watts R.M.S. into 4 ohms, frequency response 1Hz - 100kHz -3dB, Damping Factor >300, Slew Rate 60V/uS, T.H.D. typical 0.001%, Input Sensitivity 500mV, S.N.R. 110dB. Size 330 x 175 x 100mm.  
Price:- £83.75 + £5.00 P&P

OMP/MF 450 Mos-Fet Output Power 450 watts R.M.S. into 4 ohms, frequency response 1Hz - 100kHz -3dB, Damping Factor >300, Slew Rate 75V/uS, T.H.D. typical 0.001%, Input Sensitivity 500mV, S.N.R. 110dB. Fan Cooled, D.C. Loudspeaker Protection, 2 Second Anti Thump Delay. Size 385 x 210 x 105mm.  
Price:- £135.85 + £6.00 P&P

OMP/MF 1000 Mos-Fet Output Power 1000 watts R.M.S. into 2 ohms, frequency response 1Hz - 100kHz -3dB, Damping Factor >300, Slew Rate 75V/uS, T.H.D. typical 0.001%, Input Sensitivity 500mV, S.N.R. 110dB. Fan Cooled, D.C. Loudspeaker Protection, 2 Second Anti Thump Delay. Size 422 x 300 x 125mm.  
Price:- £261.00 + £12.00 P&P

NOTE: MOS-FET MODULES ARE AVAILABLE IN TWO VERSIONS. STANDARD - INPUT SENS 500mV/BANDWIDTH 100kHz OR PEC (PROFESSIONAL EQUIPMENT COMPATIBLE) - INPUT SENS 775mV, BANDWIDTH 50kHz. ORDER STANDARD OR PEC

# B.K. ELECTRONICS

REF D5

UNIT 1 COMET WAY SOUTHEND-ON-SEA ESSEX. SS2 6TR.  
TEL.: 01702-527572 FAX.: 01702-420243

Web:- <http://www.bkelec.com> E-Mail [sales@bkelec.com](mailto:sales@bkelec.com)



DELIVERY CHARGES:- PLEASE INCLUDE AS ABOVE TO A MAXIMUM AMOUNT £30.00. OFFICIAL ORDERS FROM SCHOOL, COLLEGES, GOVT. PLCs ETC. PRICES INCLUSIVE OF V.A.T. SALES COUNTER, CREDIT CARD ORDERS ACCEPTED BY POST PHONE OR FAX.



# 'Electronics and Computing Principles V7'

A Complete PC Based Electronics and Computing Course.

**ELECTRONICS - ELECTRICAL - MATHEMATICS - COMPUTER SCIENCE - INFORMATION TECHNOLOGY - PIC MICRO CONTROLLERS - PHYSICAL SCIENCE**

**Electronics and Computing Principles V7.1**

DC AC Electrical Semi-Conductors Op-Amps Maths Digital Computing Testing Micro PIC@ Toolbox Lab Index SAQ Window

**ACTIVE FILTERS: RC High Pass Active Filter.**

$f_c = \frac{1}{2 \times \pi \times R1 \times C1}$

$Z_{in} = \sqrt{R1^2 + Xc^2}$

$A_v = \frac{R2}{Z_{in}}$

$V_{out} = V_{in} \times A_v$

(-) indicates output phase inversion.

$C2 = 100nF$   
 $R1 = 1k$   
 $R2 = 10k$   
 $f_c$  'cut-off' @ -3dB point = 1.59kHz  
 $Xc$  of 100nF @ 1.59kHz = 1k  
 $Z_{in}$  @ -3dB point = 1.41k  
 $A_v = (-7.07)$   
 $V_{out}$  @ -3dB = -7.07mV

Parameters:  $V_{in}$  1mV, Resistor 'R1' 1k, Resistor 'R2' 10k, Capacitor 'C1' 100nF.

Graph:  $V_{out}$  vs Freq.  $V_{in} \times A_v = -3dB$ . Pass Band.  $f_c$  'cut-off'.

More than a thousand fully interactive Electronics and Computing topics.

FREE V7.1 upgrade to add Computer Science and Information Technology.

Mathematics Principles from simple numbers to statistics.

PIC Micro controllers, Toolbox, Components and Equipment Picture Dictionary, Electrical topics all in one package.

OPTIONAL EPT Electronics Lab hardware add-on unit for real practical electronics experiments.

Used in hundreds of schools, colleges and universities in the UK and overseas.

Covers GCSE, A'Level, BTEC Nationals and University courses.

Extremely easy to use for interactive learning with a unique approach to multiple choice Self-Assessment-Questions.

A huge source of dynamic electronics and computing information all in one place.

Select printing, clipboard, explanatory text, calculations and graphs from toolbar buttons.

OnLine £29.95 + VAT p.a.  
 Personal user CD-ROM £99.95 +VAT  
 Education CD-ROM £299.95 +VAT  
 (Includes unlimited multi-user site licence.)

**FREE TRIAL DOWNLOAD**  
 complete package  
 with a description by  
 Robert Penfold  
[www.eptsoft.com](http://www.eptsoft.com)

Windows from '95 to XP

eptsoft limited. Pump House, Lockram Lane, Witham, Essex. UK. CM8 2BJ.  
 Tel: +44 (0)1376 514008. Fax: +44 (0)870 0509660. Email: [info@eptsoft.com](mailto:info@eptsoft.com).  
 Switch, Delta, Visa and MasterCard accepted.  
 No additional postage or airmail charges.