

To be Completed in about 32 weekly parts.

NEWNES PRACTICAL ELECTRICAL ENGINEERING

IN THIS PART

THE DEVELOPMENT
OF ELECTRICAL
MACHINERY
MEASURING ONE
TEN-MILLIONTH OF
AN AMPERE
SMALL ELECTRIC
GENERATING SETS
ASBESTOS
AND WOOD
WALL AND FLOOR
FIXINGS FOR ELECT-
RICAL APPARATUS
TESTING SMALL D.C.
AND A.C. MOTORS

1 1/4

PART
25

A PRACTICAL WORK WRITTEN BY EXPERTS

Of extraordinary value to every handyman

NEWNES' Home Mechanic BOOKS

Clearly written and fully illustrated
each book contains 96 pages

TOY MAKING FOR AMATEURS

Tells you how to make toys of every description and lays bare the principles by means of abundant illustrations and simple text. Every mechanical movement known in toy manufacture is included.

TWENTY-FIVE TESTED WIRELESS CIRCUITS

A book for the modern wireless enthusiast. All the sets described have been designed to meet modern needs. They range from simple crystal receivers to a seven-valve super-heterodyne, and all the sets have been made and tested before inclusion.

SIMPLE ELECTRICAL APPARATUS

An excellent little book for those who wish to make simple and useful electrical appliances, such as galvanometers, electric motors, dynamos, and Leyden jars. All these may be made by anyone with the aid of a few tools and some inexpensive materials. Clear instructions are given in every case.

MODEL BOAT BUILDING

There are few more fascinating hobbies than Boat Building. In this book there are designs for a battleship, a speed boat, a paddle-steamer and yachts, from which excellent models may be built with the help of the simple directions and diagrams that are given. No elaborate tools are needed, and each model can be made at small cost.

Other Titles

THE HANDYMAN'S ENQUIRE WITHIN

THE HOME WOODWORKER

25 SIMPLE WORKING MODELS

MODEL AEROPLANES AND AIRSHIPS

One Shilling each

On sale at all Newsagents and Bookstalls, or by post 1/2 each from George Newnes, Ltd., 8-11, Southampton Street, Strand, London, W.C.2

Geo. Newnes, Ltd.

THE DEVELOPMENT OF ELECTRICAL MACHINERY

By Professor MILES WALKER, D.Sc., M.I.E.E., F.R.S.

IN a recent article (p. 741, vol. II) on the relations between the quantities in the electric and magnetic circuits, these two circuits were treated as separate entities interlinked with one another. In practice they often occupy part of the space in common. All the laws still hold, but care must be taken to specify the particular path we have in view, so as to ascertain the quantity of flux enclosed by that path. When there is movement of

left. Sliding the bar to the right will increase the lines and generates an E.M.F. from A to B.

The "Flat Hand Rule."

The most convenient rule for remembering the direction of the E.M.F. in cases of this kind is the following: Hold the right hand perfectly flat with the thumb at right angles to it. Imagine that the magnetic lines are received vertically

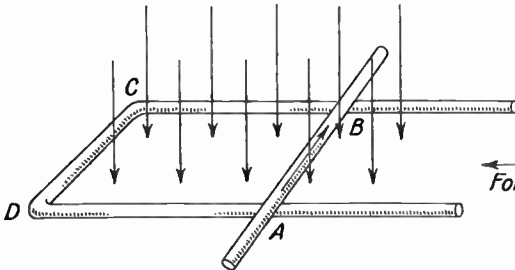

Fig. 1A.—THE ELECTRODYNAMIC MACHINE IN ITS SIMPLEST FORM.

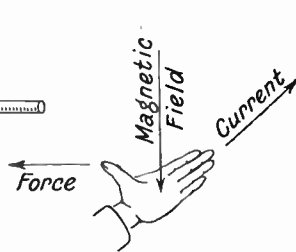

Fig. 1B.—THE "FLAT HAND RULE" FOR FORCE AND CURRENT.

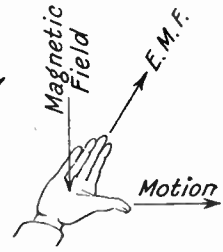

Fig. 1C.—THE "FLAT HAND RULE" FOR E.M.F. AND MOTION.

one circuit with respect to the other, some important phenomena occur.

GENERATION OF ELECTROMOTIVE FORCE.

Take the case illustrated in Fig. 1 in which is shown an electric circuit ABCD enclosing a number of vertical magnetic lines along which a N-pole would travel downwards. If the number of lines through the rectangle changes there will be an E.M.F. generated in the circuit proportional to the rate of change. We can change the number either by increasing the field strength through the rectangle or by sliding the bar AB to the right or

(like falling rain) in the palm of the hand, then if a conductor is moved in the direction of the thumb (Motion) the E.M.F. is in the direction indicated by the four fingers. This flat hand rule will be found more convenient to apply for fields and conductors in any position than the well-known "Fleming Rule" which sometimes calls for acrobatics* in its application.

The value of the E.M.F. in volts is equal to $Bvl \times 10^{-8}$ where v is the velocity in cms. per second at right angles to the lines, and l is the effective length

*An Irish student of mine once said: "If you want to find the direction of an E.M.F. you must draw a figure on the blackboard and make faces at it with your hands."

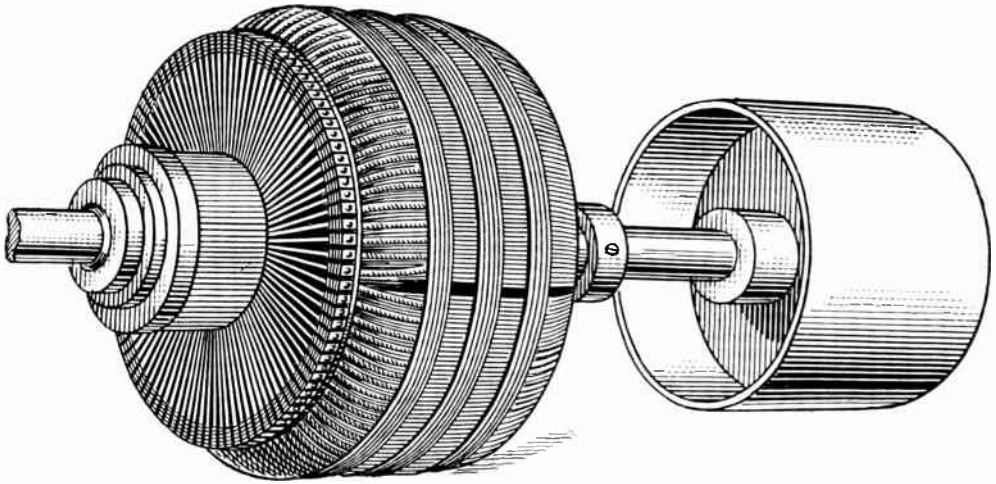

Fig. 2.—FULLER-GRAMME RING ARMATURE.

Showing tappings to the commutator taken from the continuous winding about a ring of laminated iron. The coils were wound in a closed ring and permanently connected in series, independently of any connection to a commutator.

in cms. of the conductor at right angles to the motion.

Creation of Mechanical Force.

In 1819, Oersted, of Copenhagen, showed that a conductor carrying a current exerts a force upon a magnetic pole, and it follows from the principle of equal actions and reactions that a magnetic pole exerts a force upon a conductor carrying a current. Ampère made exhaustive experiments on the forces on conductors carrying a current and laid down precise laws. In Fig. 1 we have the phenomenon illustrated in its simplest case. If the vertical magnetic field shown is uniform and the flux density is B , then the conductor carrying a current of I amperes in the direction A to B will be subjected to a force of $0.1 B I l$ dynes where l is the effective length of the conductor at right angles to the lines. The direction of the force in Fig. 1B will be towards the left as indicated by the "left-hand rule." Notice that the thumb in the left hand gives the direction of the *force*. The direction of motion will depend upon other conditions. If the conductor is fixed, the force will still be there; or the conductor may be forcibly moved towards the right, but the force we are speaking of will be towards the left.

The Electrodynamic Machine in its Simplest Form.

Thus in Fig. 1 we can study the action of a generator or of a motor. Let the current go from A to B , then the magnetic force is towards the left. By means of a greater external force move the conductor to the right. In doing so you generate an E.M.F. in the same direction as the current and the bar delivers electric power and requires mechanical power to move it. Now let the conductor move towards the left. An opposite or "back" E.M.F. is now set up in the conductor and current will not pass from A to B unless we have some external E.M.F. big enough to overpower the generated E.M.F. and and force the current against the back E.M.F. Thus we supply electric energy and get in return mechanical energy for we can make the conductor do work as it moves to the left. These simple principles enter into all generators and motors whether D.C. or A.C.

In the generator the generated E.M.F. is with the current and in the motor it is against the current.

Electrical Power.

Power is always the product of two factors:—

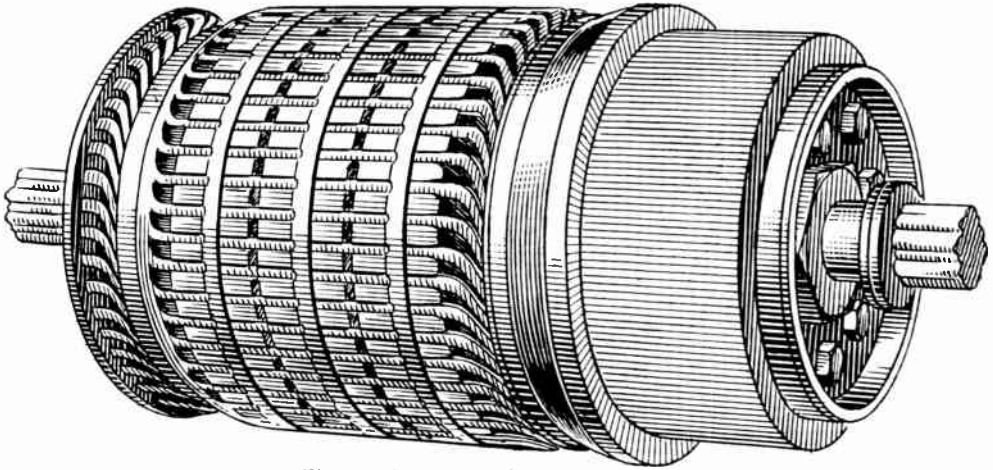

Fig. 3.—COMPLETED DRUM ARMATURE.

The "return" conductors are placed under a pole of a polarity opposite to that of the pole under which the "go" conductors are placed. Thus the E.M.F. per turn is doubled.

(1) A force tending to bring about a motion of some kind ;

(2) A motion at a certain rate under the action of the force.

A common example occurs in hydraulic transmission. A pipe carries water under a hydraulic pressure of 1,000 lbs. per sq. inch. When water is being drawn off (say to work a lift) at the rate of 33 feet per minute along a pipe whose area is one sq. in., the power delivered is $1,000 \times 33$ foot lbs. per minute, that is one horse power.

Similarly with electric power, we have two factors:—

(1) Electromotive force tending to move electricity ;

(2) A motion of electricity at a certain rate—a certain current in amperes. When a current of 10 amperes flows under a pressure of 74.6

volts, the resulting power is 746 watts, equivalent to one horse power.

An Interesting Point.

Now when we generate electric power by moving a conductor in a magnetic

field, it is interesting to note that the factors, mechanical force and motion in one case and electrical motion (that is current) and electromotive force in the other, are reversed in a way that we would not have expected. It is the motion of electricity in the magnetic field that creates the mechanical force on the conductor and it is the motion of the conductor that creates the electromotive force.

As long as we have a continually flowing current through the field we get a static force on the

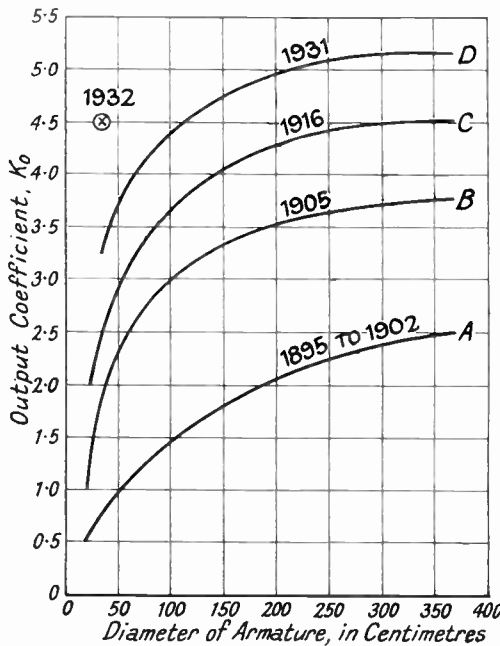

Fig. 4.—OUTPUT COEFFICIENTS FOR D.C. GENERATOR.

Showing how improvements in design have given increased output for a given size.

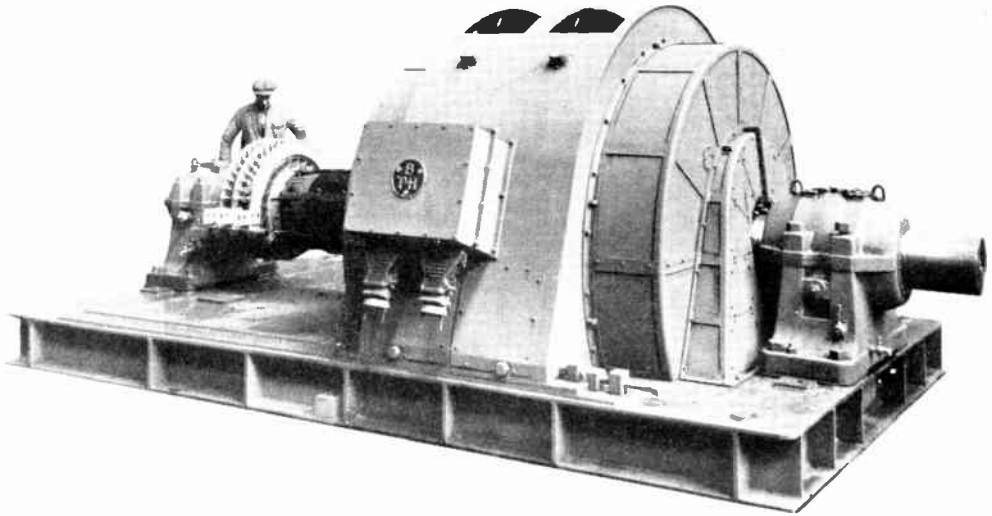

Fig. 5.—4,500 to 11,250 H.P. THREE-PHASE INDUCTION MOTOR BUILT BY THE BRITISH THOMSON-HOUSTON CO., LTD.

conductor, but if the latter does not move there is no power. On the other hand as long as the conductor moves through the field we get an electromotive force, but if the current does not flow there is no power. Both factors must be there in both cases. It is the motion factor in the one case that gives the force factor in the other.

Early Dynamos.

Faraday's first successful experiments on magneto-electric induction were made on a simple transformer in which the inter-linked circuits were separated and the electromotive force was produced by the rate of change of flux in an iron core. He went on almost immediately to the movement of a conductor in the magnetic field and his first continuous current generator was what we would call a homopolar in which the conductor moved continuously under the same pole. Homopolars have the advantage of avoiding the use of a commutator, but they are cumbersome and heavy machines for their output and have been almost entirely superseded by heteropolar machines, except where very great currents at a low voltage are required. In the heteropolar machine the conductors move under N-poles and S-poles successively and therefore generate an alternat-

ing voltage so that a commutator must be used to reverse the connections to the outside circuit if a continuous current is required.

Commutation.

The first commutators consisting of two parts of a split tube gave a rectified current of varying intensity and sparked badly. It was not until after the invention of the Gramme ring that there was a really satisfactory dynamo. The Pacinotti or Gramme ring was really a revolutionary invention. Before it came, inventors of dynamos wound their coils on projections or poles and brought both ends to commutators. All sorts of arrangements of brushes were devised to connect the coils in series so as to get a uniform direct current.

The Gramme Ring.

In the Gramme ring the coils were wound in a closed ring, as in Fig. 2, and permanently connected in series independently of any connection to a commutator. Branch wires were brought off from junctions of the coils to the bars of the commutator so that a continuous current could be led in at one bar and out at another at a diametrically opposite point passing through the two halves of

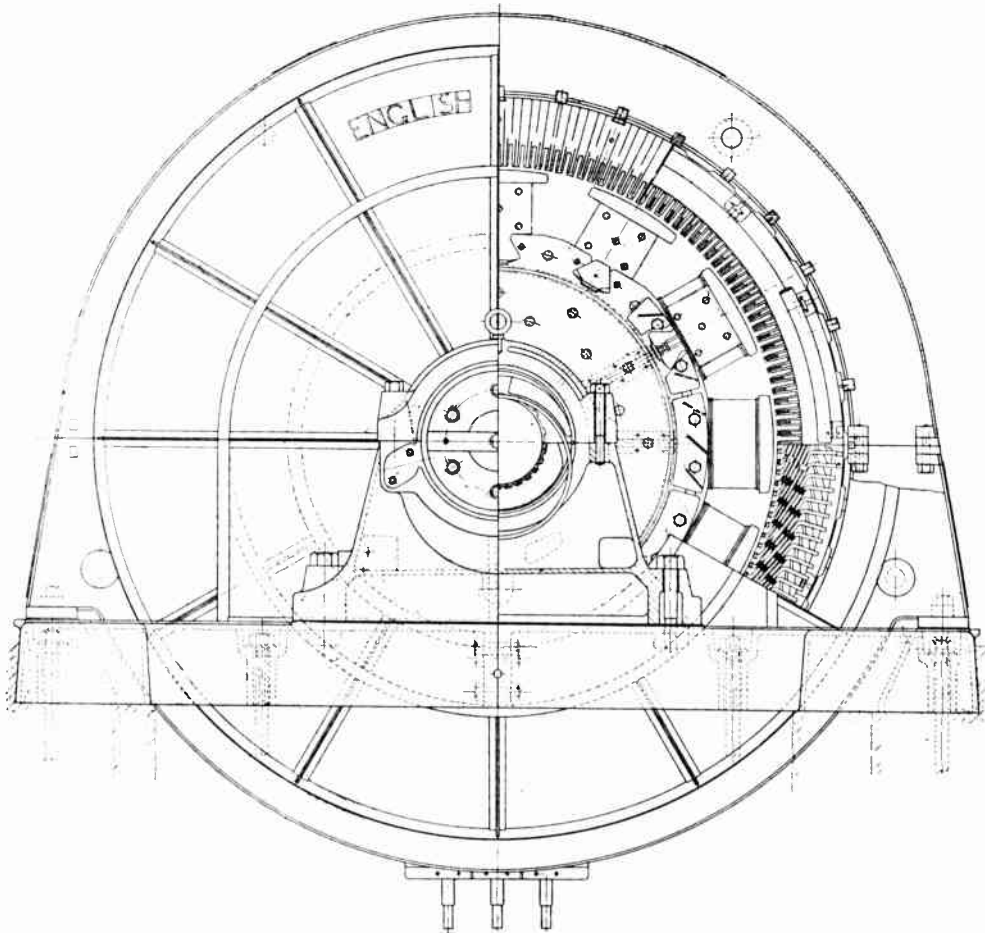

Fig. 6.—SECTIONAL ARRANGEMENT OF ALTERNATOR. (*English Electric Co., Ltd.*)
 Twelve poles, 500 r.p.m., 8,820 K.V.A., 6,000 volts, 50-cycle three-phase.

the winding. When this armature is revolved between the poles of a magnet the E.M.F.'s in all the coils in series opposite one pole are added together and the current in each coil can be reversed separately as it passes a brush so that the commutation is easy though the number of turns in series is sufficient to generate a high electromotive force. The secret of success of the Gramme winding is the large number of turns in series and the few turns between commutator bars.

The Drum Armature.

While the ring armature is quite economical when the axial length is not great

as compared with the diameter, it becomes wasteful in copper for armatures of greater axial length because the return conductors inside the ring are inactive. In the drum armature (Fig. 3) the "return" conductors are placed under a pole of a polarity opposite to that of the pole under which the "go" conductors are placed. Thus the E.M.F. per turn is doubled.

Growth of the Dynamo.

In the early eighties much had been done to commercialise the dynamo by Gramme, Siemens and others, but its quantitative design was not properly

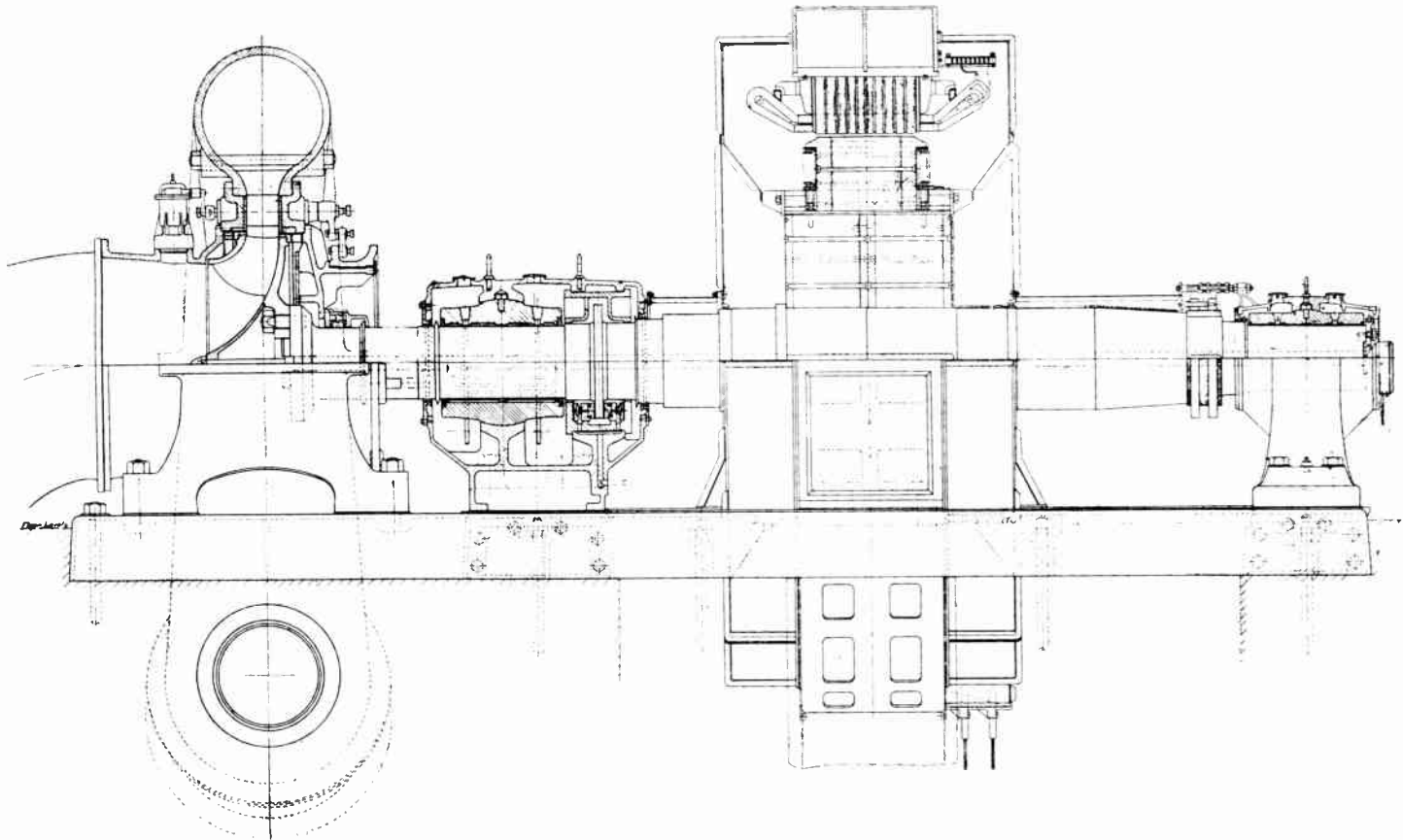

Fig. 7.—SECTIONAL ARRANGEMENT OF WATER TURBINE AND ALTERNATOR. (*English Electric Co., Ltd.*)

TURBINE.

Maximum static head, 497 feet. Average nett head, 472 feet. Normal full load, 10,600 B.H.P. Maximum overload, 12,650 B.H.P. Speed, 500 r.p.m.

ALTERNATOR.

Twelve poles, 500 r.p.m., 8,820 K.V.A., 6,600 volts, 50 cycles, three-phase.

understood. In 1886 John and Edward Hopkinson published a paper in which they taught engineers how to deal scientifically with the quantities involved in a dynamo. They showed how to calculate the total magnetic flux in a given magnetic circuit and how to predict the performance of the machines from its dimensions. After that date large and economical machines began to be built. Kapp showed

greater than the opposing ampere turns on the armature. Any smaller value than this only makes the commutation worse.

The decrease in the weight per kilowatt in modern continuous-current machines has been greatly aided by improved systems of ventilation and by the introduction of commutating poles. The latter have not only enabled the total field copper to be reduced, but have increased the

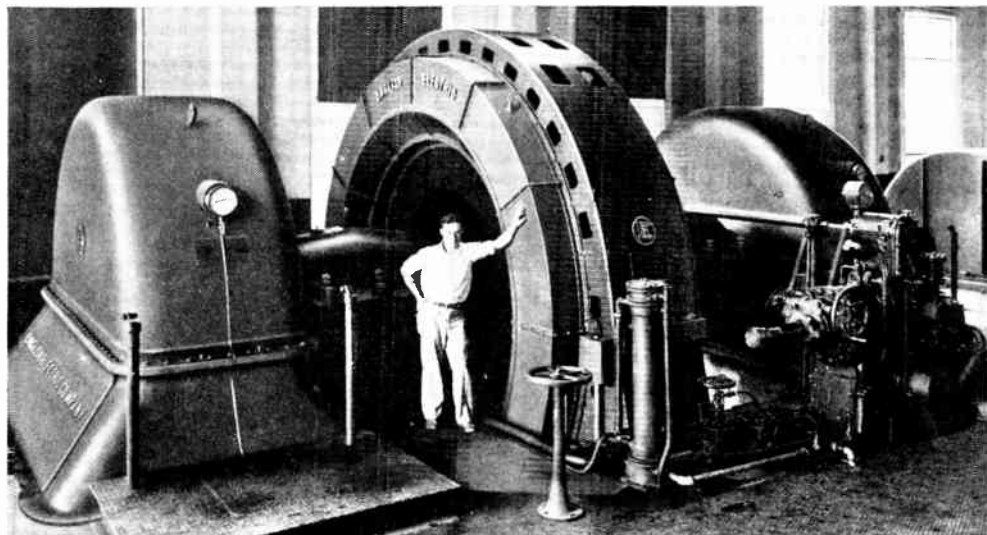

Fig. 8.—15,000 K.V.A., THREE-PHASE, 6,600-VOLT, 60-CYCLE GENERATOR. (English Electric Co., Ltd.)

This is driven by a water impulse turbine at a speed of 300 r.p.m.

the advantage of the multipolar frame for large machines and the big two-polars that had been previously built were superseded by 6-pole, 8-pole, and for large traction generators multipolar frames.

Carbon Brushes, Interpoles and Compensating Windings.

The problem of commutation was more carefully studied, carbon brushes were introduced and commutating poles and compensating windings were invented by Menges, Ryan, Thomson and others; but it was not until many years after their invention that they came into use. Commutating poles were at first thought to be an unnecessary complication and only some designers appreciated the fact that the ampere-turns in these poles must be

permissible ampere-wires per centimetre of periphery while maintaining good commutation.

The Output Coefficient.

It is interesting to see the change in the value of the output coefficient of dynamos during the last 30 years. Let us for this purpose define the output coefficient K_o as the output in kilovolt-amperes divided by the product $D_m^2 L_m R_{pm}$ where D_m is the diameter of the armature in metres, L_m the gross axial length of iron in meters, and R_{pm} the revolutions per minute, so that

$$K_o = \text{KVA} / D_m^2 L_m R_{pm}$$

We may observe that this output coefficient is not a complete index of economical design, because, in the first place, it only

relates to the armature, taking no account of the metal of the field system; and, in the second place, even when given the dimensions of the armature, we cannot determine the cost, unless we know the ratio between the copper and iron weights. For it is well known that we can sometimes increase the output of a given frame by increasing copper and reducing the iron; but the resulting machine costs more than an iron machine built upon a larger frame. Nevertheless, with machines of the same

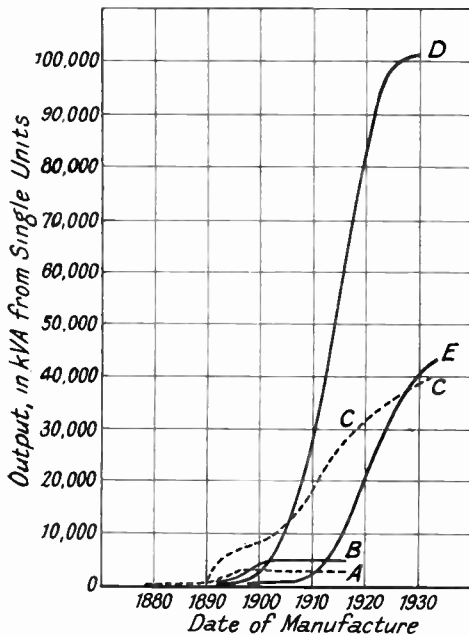

Fig. 9.—OUTPUTS FROM SINGLE UNITS AT VARIOUS DATES.

type, employing the best ratio of iron to copper, the output coefficient does give us a fair guide to the progress that is being made in the use of material. One must remember, however, that K_o is strictly not a constant for a given machine, but varies with the speed, being greater at higher speeds. We shall assume when it is used here that the peripheral speeds are sufficient to give the right ventilation. The early Gramme armatures had very low output coefficients, so that writers on the dynamo before 1900 gave values as low as 1 for the output coefficient of machines less than 50 cm. in diameter; but this

value was regarded as low for bi-polar drum armatures. As the size of machine was increased up to 2 metres in diameter, the value of output K_o improved up to 2.5. Hobart, in his "Continuous-current Dynamo Design" (1906), gives curves showing values of output coefficients at various dates. Two of these curves are reproduced in Fig. 4. See page 1163. The lowest, A, is after Fischer-Hinnen and relates to machines dating between 1895 and 1902, and curve B gives good values of output coefficients in 1905. Curve C, shows somewhat how the matter stood in 1916 when commutating poles and a good system of ventilation were employed.

In the fifteen years that have elapsed up to 1931 still further improvements in design and ventilation have enabled the output coefficient to be still further increased so that the curve D may be taken to represent good modern practice. But this is not all. In cases where it is desirable to get machines of the greatest possible output into the smallest possible space, special devices can be employed to give truly marvellous figures.

An Interesting Experimental Machine and What it Indicates.

In a D.C. machine constructed at the Manchester College of Technology to see what can be done in this direction, an output coefficient as high as 4.5 was obtained on an armature only 32.5 cm. in diameter. The cross in Fig. 4 gives one point in a new curve. The experiments point to coefficients of about 6 for large diameters.

ALTERNATING-CURRENT MACHINERY.

The demand for electricity for lighting was at first met by the supply of direct current, but when electric power had to be transmitted over distances greater than the precincts of a small town, the advantages of higher voltages and smaller currents became obvious. The alternating current transformer offered such a simple and reliable method of stepping down the voltage from that suitable for transmission to that suitable for incandescent lamps as to bring A.C. transmission into general use in the late eighties.

At first transformers of small capacity (1 or 2 kw.) were used, placed in or near to the house; but as the use of alternating current extended, transformer substations were installed in which banks of large transformers dealt with hundreds of kilowatts.

Alternating current transmission on a large scale did not come into being until after the invention of polyphase machinery.

Polyphase Machinery.

In the middle eighties there were no satisfactory alternating-current motors, so

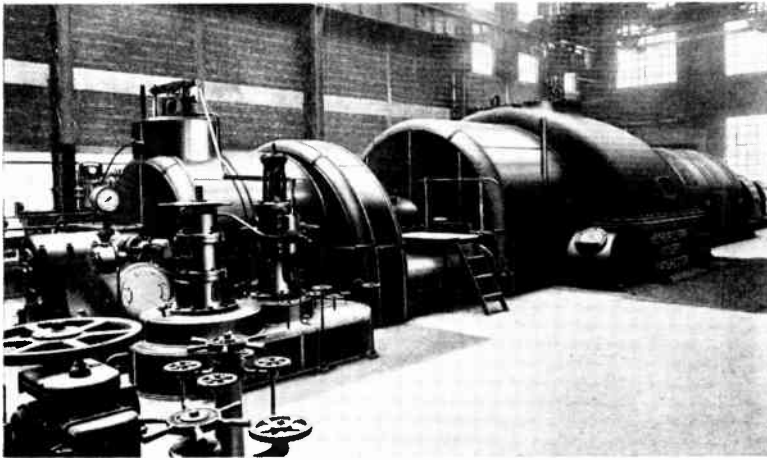

Fig. 10.—50,000 K.W., 11,000-VOLT, 50-CYCLE, THREE-PHASE TURBO GENERATOR RUNNING AT 1,500 R.P.M. (Metropolitan Vickers Elec. Co., Ltd.)

that for power purposes direct current distribution was regarded as best. In 1888 Ferraris showed that when two alternating currents differing in phase as do the cranks of a locomotive are passed through two coils whose axes are at right angles, they produce a rotating magnetic field which will cause a suitable conducting mass to revolve. This gave the possibility of a revolving member or rotor without any electrical connections to the external circuit, so that the alternating-current motor had this great point of advantage over the direct-current motor.

The Three-Phase Induction Motor.

Ferraris extended his idea to three currents differing in phase by 120° passing

through coils whose axes are 120° to one another, and thus invented the three-phase induction motor. His ideas were developed along practical lines by C. E. L. Brown, Dobrowolsky, Nikola Tesla and others, until to-day we have induction motors of great power and wonderful efficiency. It is not necessary here to explain fully the action of these motors as this has already been done in an excellent article by Mr. A. T. Dover (see p. 809 vol. III).

Difficulties Overcome.

When first the induction motor was introduced it was regarded as a machine

having constant speed characteristics similar to those of a shunt direct-current motor. It was at that time only possible to change the speed over a wide range by the insertion of wasteful resistances. Moreover, it had the drawback that its power factor at light loads was poor and at all times it drew a lagging magnetising current

from the line. These drawbacks have to a great extent been eliminated by the methods described in the article above referred to. The induction motor to-day, when fitted with suitable appliances, can be run as a highly efficient variable speed motor, having a power factor near unity or, if desired, a leading power factor can be obtained.

Eleven Thousand Horse-Power.

Fig. 5 shows a very large three-phase induction motor built by the British Thomson Houston Co., Ltd., for driving a rolling mill. This motor with a continuous rating of 4,500 h.p. can deliver peaks up to 11,250 h.p. at a speed of 375 r.p.m. The frames of the stator and rotor and the

base plate are built up entirely of rolled steel plate cut to the shapes desired and welded together. These "fabricated" frames are largely replacing the cast-iron frames commonly employed a few years ago. They are not only cheaper to construct, especially when only a few of one size are needed, but they are lighter and more reliable. They give the maximum space for the circulation of air for a given size of frame. The bearing

for a given weight of material. The design of three-phase generators of large output driven by high-speed water turbines has been brought to a high state of perfection. One of the difficulties to be met arises from the fact that the large output calls for a revolving field magnet of fairly large diameter involving very great centrifugal forces. The runaway speed of a water turbine (assuming that something has gone wrong with the governor) is

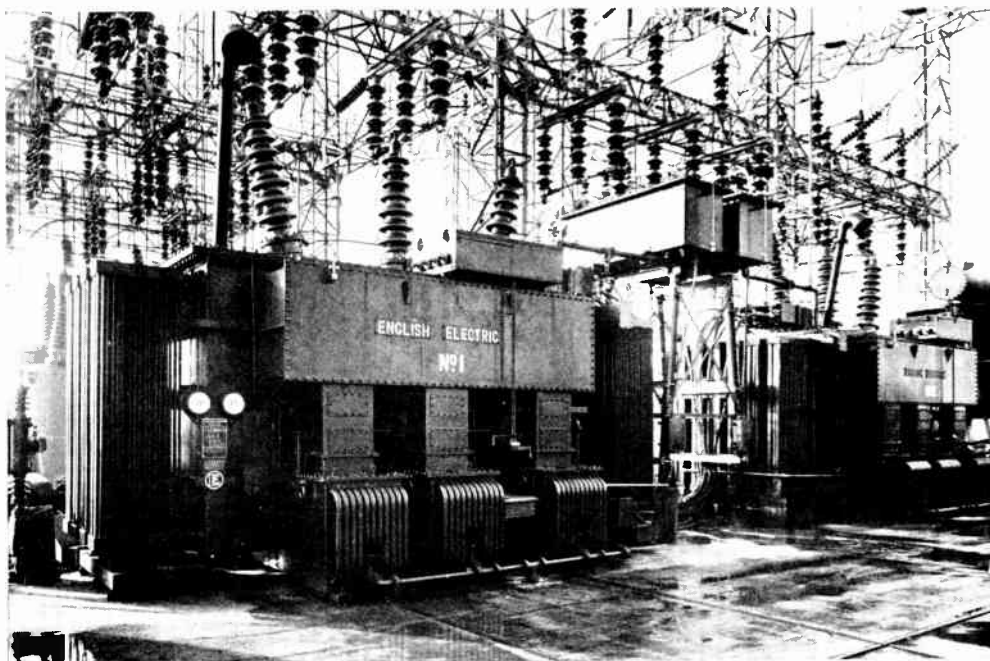

Fig. 11. — Two 15,000 K.V.A., 132-K.V., THREE-PHASE TRANSFORMERS WITH ON-LOAD TAP-CHANGING GEAR, BUILT BY THE ENGLISH ELECTRIC CO., LTD., AND INSTALLED IN THE YOKER SUBSTATION, CENTRAL SCOTLAND ELECTRICITY SCHEME.

pedestals are the only parts visible in the picture made of cast iron.

Three-phase Transmission.

The introduction of the polyphase motor gave great impetus to three-phase transmission and it was soon recognised that this was the most convenient method of taking power from one place to another. It made possible the utilisation of great water powers that otherwise would have gone to waste. It can be shown that the polyphase generator is more efficient than a single-phase one and has a greater output

80 per cent. higher than the normal speed. The revolving member of the generator must be designed so that in case of accident to the governor it will withstand 80 per cent. above normal running speed. To meet these conditions the field magnet is commonly constructed from a ring of specially treated steel and the poles are held by dovetail designed for maximum strength.

Water-driven Generators.

The method of securing the poles against the great centrifugal forces is well illus-

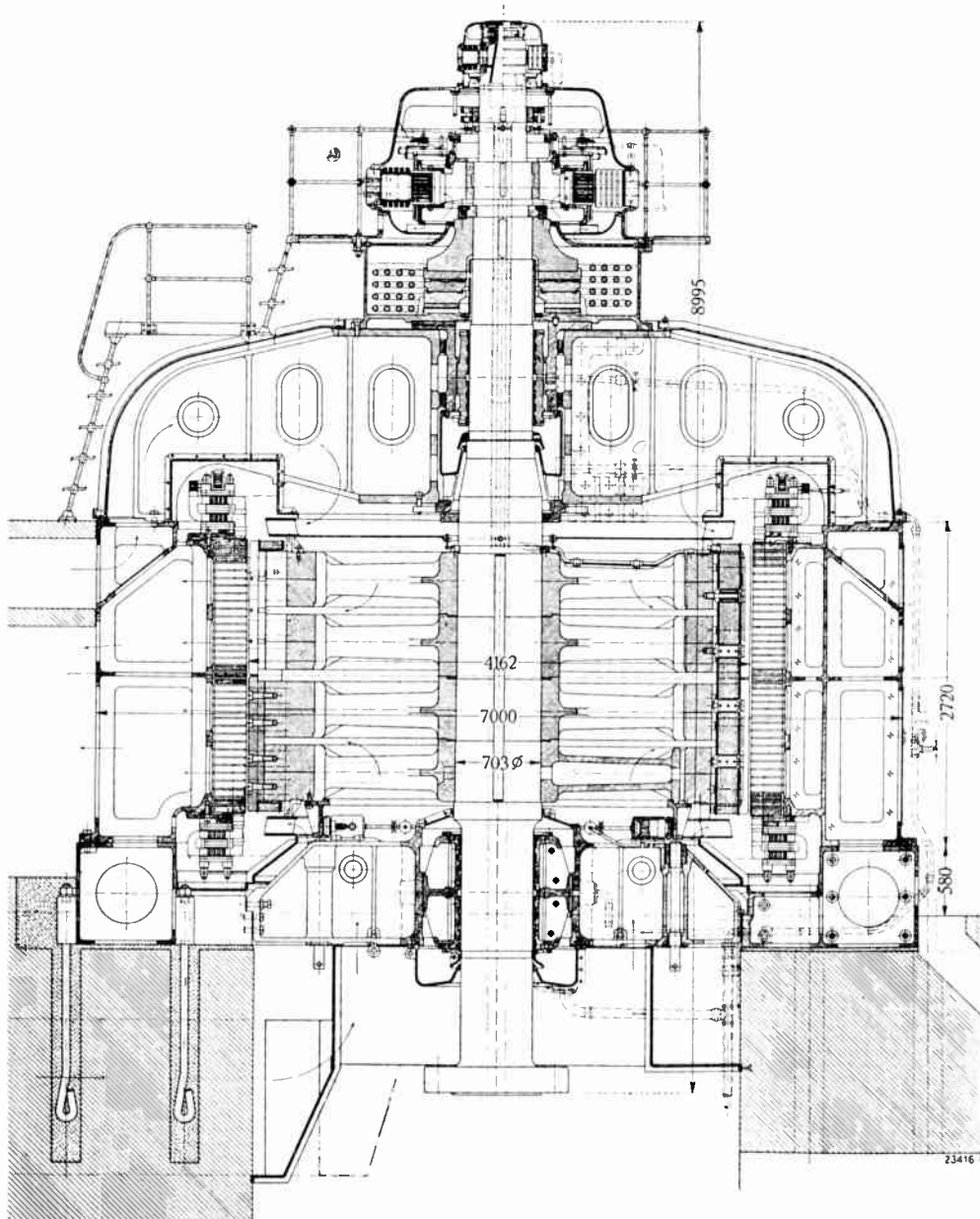

Fig. 12.—A WATER-DRIVEN GENERATOR.

Three-phase vertical shaft alternator, 30,000 K.V.A., 10,000 volts. Power factor 0.8, 42/50 cycles, 252/300 r.p.m.
 (Reproduced by courtesy of the "Brown Boveri Review.")

trated in Fig. 6 which gives a sectional view of an 8,820 K.V.A., 6,600-volt, 50-cycle 3-phase generator designed to run at a normal speed of 500 r.p.m. built by the

English Electric Co., Ltd. A section through the axis is given in Fig. 7. The poles are built up of laminated steel flanked by steel castings which give

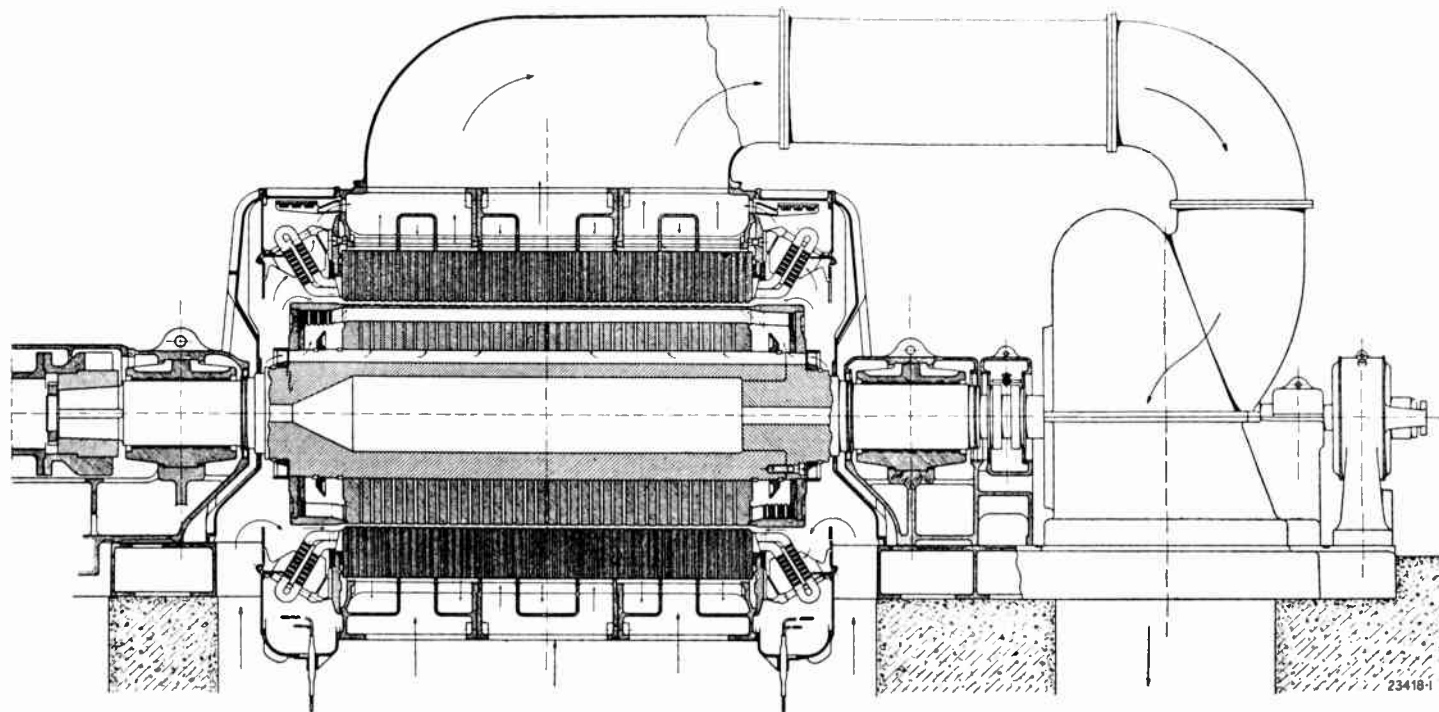

Fig. 13.—100,000 K.V.A. HELL GATE GENERATOR.

This is a three-phase turbo-alternator, 60 cycles, 1,200 r.p.m. This figure shows the internal construction of a 100,000 K.V.A., 3-phase turbo-generator built by Brown Boveri & Co. It is a six-pole generator running at 1,200 r.p.m. The rotor has a central hub of forged steel with the centre bored out to get rid of all internal flaws. In this hub are pressed rolled steel plates with ventilating ducts between them. The slots for the winding are then cut in these plates. The ends of the windings are held by rings of non-magnetic steel. The system of ventilation is clearly shown in the figure by the arrow which indicates the direction of the air supplied by the special fan on the right of the figure. The air after being discharged from the fan passes through a cooler supplied by cold water circulating in pipes. Thus clean air circulates over and over again and the internal surfaces can be kept clean for years. (Reproduced by courtesy of the "Brown Boveri Review.")

support to the ends of the coils. The central hub is built up in two sections of laminated steel plate. The sections are separately pressed on to the shaft and form an exceedingly strong centre into which the dovetails on the poles are fitted. The latter are tightened up by means of wedges shown in the drawing. This machine will withstand a runaway speed of 900 r.p.m. with perfect safety. The armature is provided with open slots. The coils are fully insulated before they are placed in position. The end windings are of the lattice type and are strengthened by means of insulated rings fixed to the frame and secured to the outer side of the coils.

Fig. 8 shows a 15,000 K.V.A., 6,600-volt, 60-cycle, three-phase generator, built by the same Company. The normal speed is 300 r.p.m. under an effective head of 1,010 ft. and the rotor is designed for an over-speed of 555 r.p.m.

Steam Turbine-driven Generators.

In this country we do not have water power sufficient to supply our needs so we have to rely mainly upon steam plant for generating our electricity. For this purpose the steam turbine has almost entirely superseded the steam engine, largely on account of the ease with which it can make use of the low-pressure, low-temperature steam at the far end of the expansion. Another reason for the economy of the steam turbine is the fact that it can make use of very high-pressure steam at a

temperature too high for any oil lubricated sliding surfaces such as are found in a steam engine. The possibility of working between these extremes of temperature gives such a high efficiency that it is possible to generate a kilowatt hour with a consumption of not more than 9 lbs. of steam. This is about one half of the steam used in the best steam engines 25 years ago. The use of cheap-powered fuel and

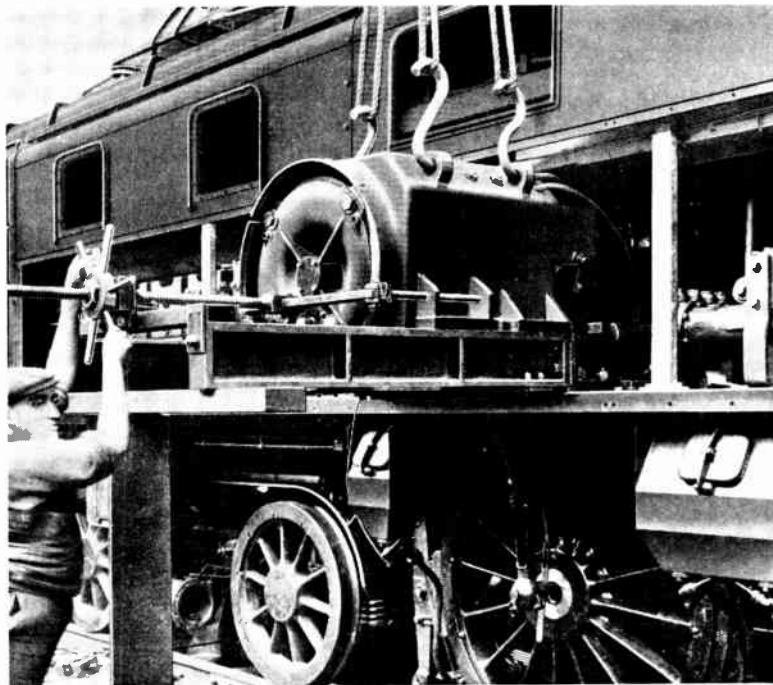

Fig. 14.—INSTALLING A TRACTION MOTOR IN AN ELECTRIC PASSENGER LOCOMOTIVE FOR THE INDIA RAILWAYS. (*Metropolitan Vickers Elec. Co., Ltd.*)

high efficiency boilers has so far reduced the cost of steam raising that the combined running costs of generation in our super power stations are well below 0.2 of a penny per kilowatt hour. This would not be possible if the design of the electric generator had not kept pace with the design of the high-speed steam turbine.

Outputs from Single Units at Various Dates.

Twenty-five years ago it was thought that to help the electrical designer it was necessary to employ low turbine speeds for large outputs. Speeds of 1,000 to 1,500 r.p.m.

were thought to be the maximum for generators of 5,000 kw. As 50 cycles became a standard in this country, a two-pole generator running at 3,000 r.p.m. was the desideratum from the turbine builders' point of view, but in the year 1900 it was thought quite a good performance to build a generator running at 3,000 r.p.m. as large as 500 kw.

One Thousand Kilowatts in 1905.

Some bold spirits suggested the possibility of 1,000 kw. at that speed, but there was much shaking of heads. About

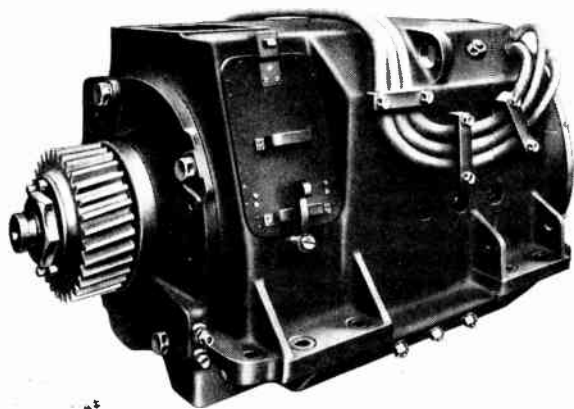

Fig. 15.—ONE OF THE 400-H.P. MOTORS BELONGING TO THE LOCOMOTIVE SHOWN IN FIG. 14. (Metropolitan Vickers Elec. Co., Ltd.)

the year 1905, 1,000 kw. at 3,000 r.p.m. became quite usual, and then the outputs still went on rising.

Five Thousand.

After that 5,000 kw. was regarded as a goal which might possibly be reached by some very special type of construction.

Ten Thousand.

When 5,000 kw. at 3,000 r.p.m. became usual, it was only a step to make it 7,500 kw. and another to make it 10,000 kw.

At this point the electrical designer had caught up the steam turbine designer, for the difficulty of dealing with the exhaust steam seemed for the moment to preclude the steam turbine greater than 10,000 kw. which runs at 3,000 r.p.m.

Forty Thousand Kilowatts in 1932.

But that difficulty has now been overcome, and units of 40,000 kw. at 3,000 r.p.m. are the order of the day. Things have changed, for when the turbine designer looks back doubtfully at the electrical man, the latter says assuringly, "Go on, I'll follow you."

It is interesting to plot curves showing the sizes of single units built on various dates. In Fig. 9 are plotted five such curves.

A relates to continuous-current engine-driven generators.

B relates to alternating-current engine-driven generators.

C relates to water turbine-driven alternating-current generators.

D relates to steam turbo-generators (any speed).

E relates to steam turbo-generators, 3,000 r.p.m.

Modern Turbo Generators.

Fig. 10 shows a 50,000 kw., 11,000-volt, 50-cycle, 3-phase turbo generator made by the Metropolitan-Vickers Electrical Co., Ltd., for the Burton Power Station, Manchester. This machine feeds into the 132,000-volt grid by means of step-up transformers.

Substations on the Grid.

The interconnecting of all the great power stations in the United Kingdom, by means of the 132,000-volt grid, has called for the erection of numerous outdoor high-voltage substations in which the switching in and out of transformers can be carried out independently of the weather conditions.

Fig. 11 shows one of these outdoor substations, situated at Yoker, of the Central Scotland Electricity scheme. In the foreground are two 15,000 K.V.A., 132,000-volt, 3-phase transformers, built by the English Electric Co., Ltd. These transformers are provided with suitably designed contactors under oil for changing the tappings to the windings while the transformer is still on load. This gives great convenience in regulating the voltage supplied to various branches of the Grid.

The on-load tap changing devices are contained in the rectangular compartment, seen in front of the transformer above the three smaller pipe-cooled receptacles which contain auto-transformers for equalising the voltage between taps at the moment of switching. Each of the large transformers is provided with a number of large cooling wings in which the transformer oil circulates and is cooled by air blown from down below. The picture shows the seven petticoated condenser bushes which bring the high tension current to the transformers and are designed to stand up to 1,32 kv. in any weather. The breakdown voltage of one of these bushes under the worst weather conditions is 320 kv.

Electric Traction.

If the recommendations contained in the Report of the Weir Commission on the Electrification of our Railways is carried out, the Grid will be called upon to supply an all-day load of hundreds of thousands of kilowatts for driving the trains on our railways.

The steady all-day load would considerably reduce the cost of generation of electric power and lower the price to all users.

Fig. 14 shows the method of installing a large traction motor in a passenger locomotive. The locomotive shown is the 22 G.I.P. built by the Metropolitan-Vickers Electrical Co., Ltd., which are giving such good service in India. Fig. 15 shows one of the 400 h.p. motors belonging to this locomotive.

The Four Methods of Converting A.C. to D.C.

The main power throughout this country is supplied as three-phase current from the Grid so that where direct current is required it will in general have to be obtained by conversion from alternating current. For this purpose we may use either motor generators, motor-convertors, synchronous convertors or mercury arc rectifiers.

The synchronous convertor has a very high efficiency and is preferred by some

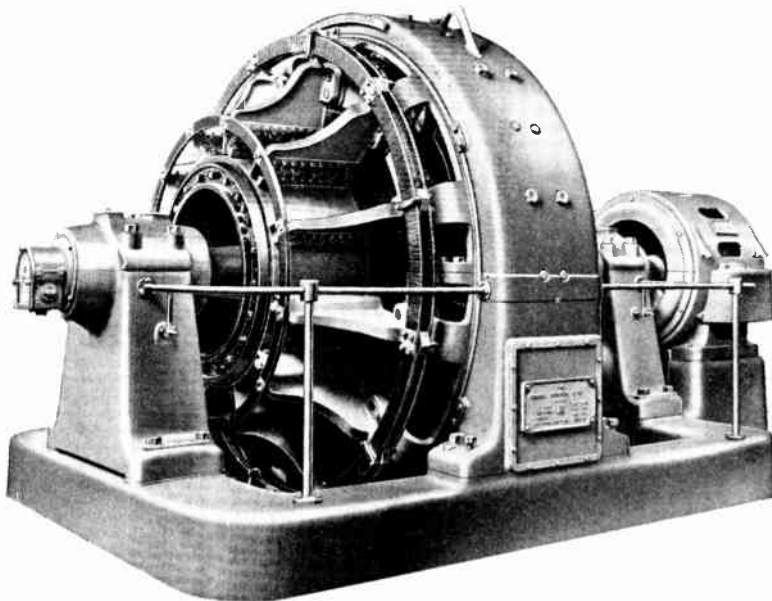

Fig. 16.—2,000 K.W. SYNCHRONOUS SIX-PHASE CONVERTER, 500 VOLTS D.C., 4,000 AMPERES, 500 R.P.M. (General Electric Co., Ltd.)

users on account of the steadiness of the D.C. voltage. Overall efficiencies as high as 96 per cent. can be obtained. These are very widely used in this country for supplying direct current for traction at voltages up to 1,500 or higher.

The mercury vapour rectifiers are coming widely into use on account of their high efficiency where a D.C. voltage is required. Single rectifiers have been built to carry as much as 6,000 amperes. It is difficult to imagine a current of 6,000 amperes carried across a partial vacuum by means of electrons. To carry only one ampere requires about 6 million, million, million electrons per second.

MEASURING ONE TEN-MILLIONTH OF AN AMPERE



AN INTERESTING EXPERIMENT.

This illustration shows how the minute E.M.F. generated by holding the hand near the thermopile can be easily indicated on this sensitive microid galvanometer. To the engineer this instrument is of special interest by reason of its robustness combined with extreme sensitivity.

AN electrical instrument which can easily be carried from place to place, and which will give a perceptible scale reading when one ten-millionth of an ampere is passed through it, will interest many readers, especially those who like experimental work. The above picture shows one of these instruments connected up to a thermopile. If the hand is placed a little distance from the thermopile hood this causes a large deflection on the needle of the instrument. The heat from a lighted match held 20 ft. away would be easily detected on this instrument. Readers will hardly need to be told that the thermopile consists of a number of thermocouples which generate a minute electromotive force when the

junctions of the couples are subjected to heat. The "Microid" galvanometer, manufactured by Griffin & Tatlock, is a moving-coil instrument—the coil being suspended in the air gap of a very powerful permanent magnet. It is made in several grades of sensitivity. The most sensitive type gives a deflection of *one scale division per ten-millionth of an ampere*. The standard type, however, requires one millionth of an ampere to give the same deflection. With a suitable rectifier connected in circuit this instrument can be used for comparing the very minute currents which are obtained in a wireless aerial when different stations are being received. Full details as to the method of doing this are given in a later article "Installing Wireless Sets."

SMALL ELECTRIC GENERATING SETS

HOW TO INSTALL AND OPERATE THEM

By T. J. BARFIELD

THE following notes apply generally to all sets of the petrol or petrol-paraffin engine type. With different makes and systems—automatic, semi-automatic and non-automatic—there are variations in operating procedure, but most makers issue detailed instructions.

ERECTION.

Small sets have the engine complete with radiator, tanks, etc., and generator mounted on one bedplate, and these merely require bolting down to a prepared concrete foundation. The surface of the foundation should be truly level, or it is quite possible for the bedplate to be distorted, with consequent misalignment of bearings and bearing trouble. It is best to raise the bedplate from the foundation by $\frac{1}{4}$ inch to $\frac{1}{2}$ inch by means of wedges, flow concrete into the gap and remove the wedges just before the concrete sets. The

bedplate will then settle level without distortion.

With separate engine and dynamo, belt coupled, erect each on a level concrete foundation with a distance between pulley centres of not less than four times the



Fig. 1.—MAKING THE CONCRETE BED FOR AN ELECTRIC LIGHTING PLANT.
(Stuart Turner, Ltd.)

Note how the formers of the holes for the foundation bolts are located on the wooden mould. The mould was made to the dimensions on the blue print hanging on the wall.

B

diameter of the larger pulley. Align the pulleys carefully, as described in a previous article dealing with the installation of motors, and take particular care that the belt joint is smooth, to avoid vibration and noise.

garage or workroom by running the pipe from the top of the water jacket along the wall of the room up to the tank, running the return pipe back at a lower level. The amount of heat radiated in this way by even a small set is quite surprising; a cock in the return pipe will allow the temperature to be regulated to secure the best operation of the engine.

Connecting Up.

Unless the switchboard is mounted immediately above the generator it is best to run the connections of V.I.R. cable in conduit. Both these and the connections from the battery should be kept as short as possible to avoid resistance losses, and for the same reason care should be taken to make a thorough job of all sweated connections. The switchboard is best mounted on the wall between the dynamo and battery rooms, to keep down the length of connections. After connecting according to diagram, make a "Megger" insulation test from both negative and positive wiring to earth (disconnecting any permanent earth on the negative for the purpose of test) and between poles (with generator, battery



Fig. 2.—ANOTHER STAGE IN MAKING THE CONCRETE BED. (Stuart Turner, Ltd.)

Withdrawing the formers which make the holes for holding-down bolts. Note that these formers are tapered slightly for easy withdrawal. They are drawn out before the concrete has set hard.

Water and fuel and exhaust connections, in the case of engines not self-contained, should be made to particulars supplied by the makers. With an independent cooling water tank, it is possible to arrange for the warming of an adjacent

connecting according to diagram, make a "Megger" insulation test from both negative and positive wiring to earth (disconnecting any permanent earth on the negative for the purpose of test) and between poles (with generator, battery

and voltmeters disconnected). All these tests should show readings of several megohms.

Trial Run—Engine.

The engine should be started up and the dynamo run disconnected, or supplying lights only, before preparing to put the battery into service. A run of a few hours on light load is very valuable in the case of a new engine, to get the bearings and the piston thoroughly "run in."

Fill fuel and water tanks, the crank case and all lubricating points with the recommended oil, not forgetting dynamo bearings if of the sleeve type. The automatic cut-in and cut-out on the switchboard may have a mercury cup which should be filled.

If the engine will not start when the maker's instructions are followed, check the following points:—

Fuel.—Is tank filled and tap on? Is supply pipe blocked? Is the jet choked? (A common trouble with new machines.) Are you trying to start on paraffin? If the weather is cold, some hot water poured into the cooling hopper or tank may help.

Ignition.—Switched on? Plug gap correct? (About the thickness of a visiting

card.) Unscrew the plug, rest the body on a metal part of the engine, with the H.T. lead connected and the terminal clear of the engine, and give the engine a smart turn or two. A fat blue spark should be observed if the ignition is in order. If damp weather, wipe any con-

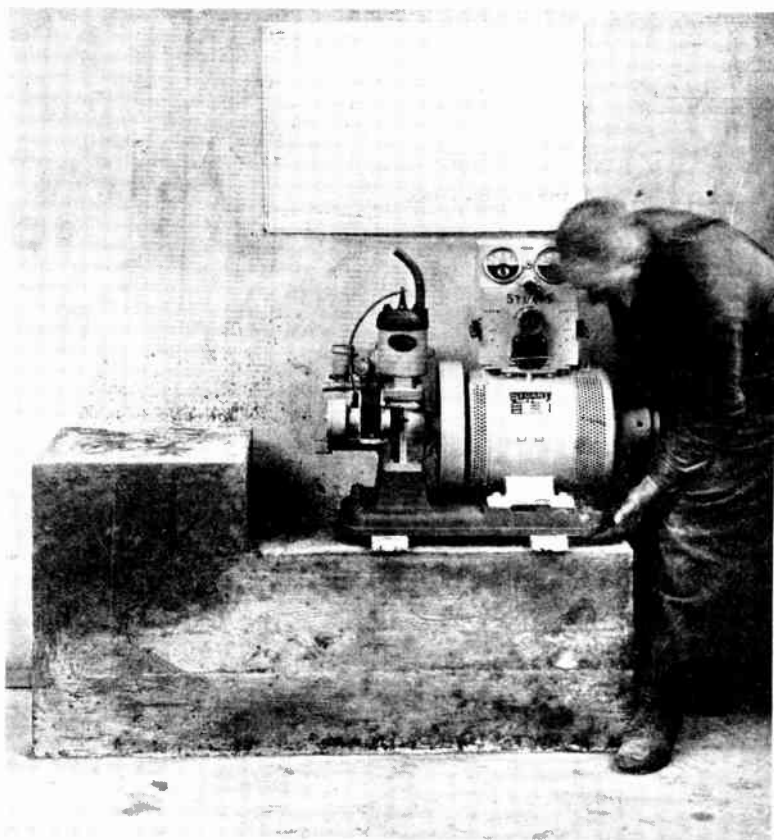

Fig. 3.—PLACING THE PLANT IN POSITION ON THE CONCRETE BED. (Stuart Turner, Ltd.)

Always put across the bed two strips of wood and drop the plant on them. This avoids the possibility of damage to the hands. The holding-down bolts are previously threaded through their holes in the plant base and suspended by their nuts and washers. See that the nuts run freely on the bolts and that threads are not damaged.

densed moisture off the plug insulator.

THE DYNAMO.

When the engine is running steadily, bring it to normal speed and read the dynamo voltage. Failure of the dynamo

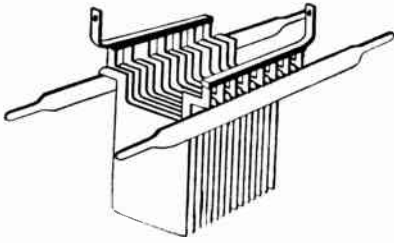

Fig. 4.—METHOD OF LIFTING BATTERY PLATES ON TWO STRIPS OF WOOD. (D.P. Battery Co., Ltd.)

to build up to correct voltage may be caused by:—

- (1) Wrong direction of rotation—unlikely except in the case of belt-driven dynamos, and then only if the dynamo has been ordered incorrectly. If the direction of rotation cannot be reversed easily, change over the field connections so that the field lead which was connected to the positive pole of the dynamo is connected to the negative. This alteration may usually be carried out by changing links in the terminal box, according to a diagram probably pasted on the inside of the lid or cover.
- (2) Brushes lifted or brush rocker in wrong position. See that the brushes are free in their holders by pulling on the pig-tails, and that they are making good contact with the commutator. The correct position of the brush rocker is obtained by registering a mark on the rocker with one on the frame.
- (3) Speed low. If this is the case it is probably due to low engine

speed caused by an incorrectly adjusted governor or bad running. If the engine speed is correct, then, in the case of belt-driven machines, either the belt is slipping, the ratio of pulley diameters incorrect, or the dynamo has been ordered for the wrong speed.

- (4) Connections not made according to diagram. If everything else fails, carefully check all connections one at a time, marking them off on the diagram as they are verified.
- (5) Shunt field regulator making bad contact, or resistance wire broken. To check this, first shut down and then temporarily bridge the regulator terminals or connect the two leads to one terminal. Then run up slowly, and if the voltage rises at normal speed to the maximum, the regulator is at fault.

When the engine and dynamo are running correctly, if possible make a load test of some hours duration, by supplying the lights direct, to make quite sure that all will be in order when the battery is installed.

THE BATTERY.

Before installing a new battery, be quite

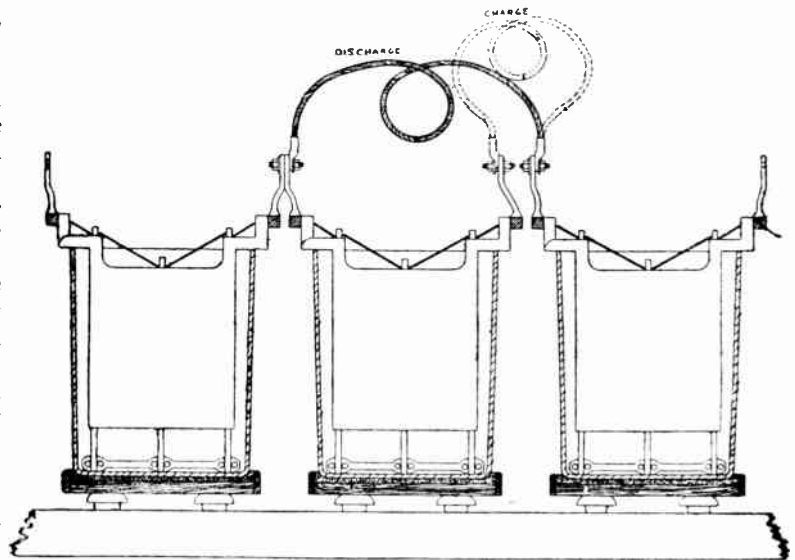

Fig. 5.—CONNECTIONS FOR CHARGING A LOW CELL. (D.P. Battery Co., Ltd.)

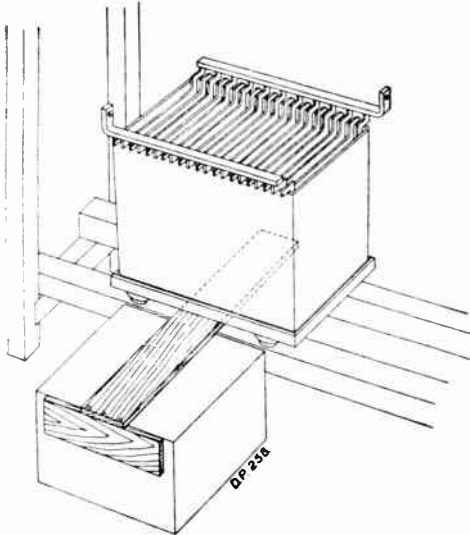

Fig. 6.—METHOD OF REMOVING A HEAVY CELL. (D.P. Battery Co., Ltd.)

sure that the engine and dynamo are in order, and that the polarity of the dynamo is correct. If a moving coil voltmeter is fitted to the switchboard, or is available, this can be used. This type of voltmeter will only read when correctly connected, and the positive terminal is marked + or coloured red. Failing this, run up the set, take an insulated wire from the two poles, or the cables to be connected to the two ends of the battery, and dip the bare ends in a glass of water to which a little sulphuric acid has been added. Bubbles will rise from the negative wire.

Battery Room.

The battery should be housed in a room apart from the engine and dynamo. Good ventilation is essential, and ample room and light desirable. Avoid erecting cells in the corners if they are arranged round the sides of the room.

Erection.

Wood stands are usually supplied with the battery. See that they are erected level, then lift the cells into position, accurately lining them by means of string stretched taut, when the end connections should come opposite each other. If glass insulators are supplied, these should be filled with resin oil.

Most small house lighting batteries are supplied in sealed-in glass cells. If of the open type, the plates must be assembled according to the makers' instructions. Fig. 4 shows the method of lifting the plates.

In connecting up, well cover the connecting lugs and the nuts and bolts with vaseline. (This not only prevents corrosion, but acts as a tell-tale by melting if a bad contact gets hot.) Tighten nuts securely, taking care that in so doing the cells are not tilted.

Filling the Cells.

After erection, if the cells are not delivered filled, first make sure that enough acid of the correct specific gravity is available, then fill by syphoning through a rubber hose or from an earthenware jug. A metal pail must not be used.

If it is necessary to dilute the acid always add acid slowly to water, never *vice versa*.

The Important First Charge.

Immediately after filling, begin the first charge, which plays a very important part in the subsequent performance of the

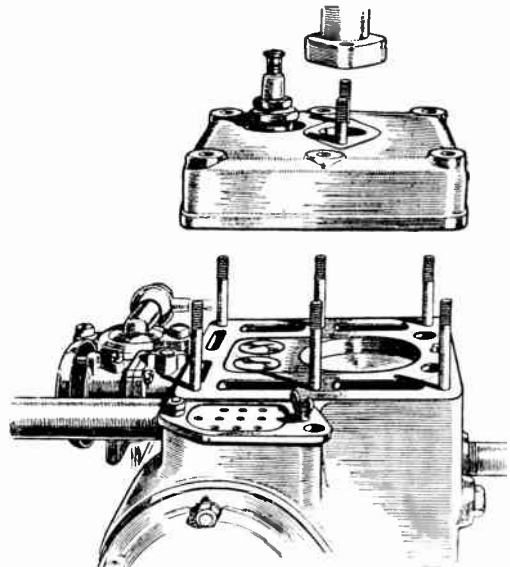

Fig. 7.—TYPICAL FOUR-STROKE ENGINE WITH HEAD REMOVED FOR DECARBONISING. (Boulton and Paul, Ltd.)

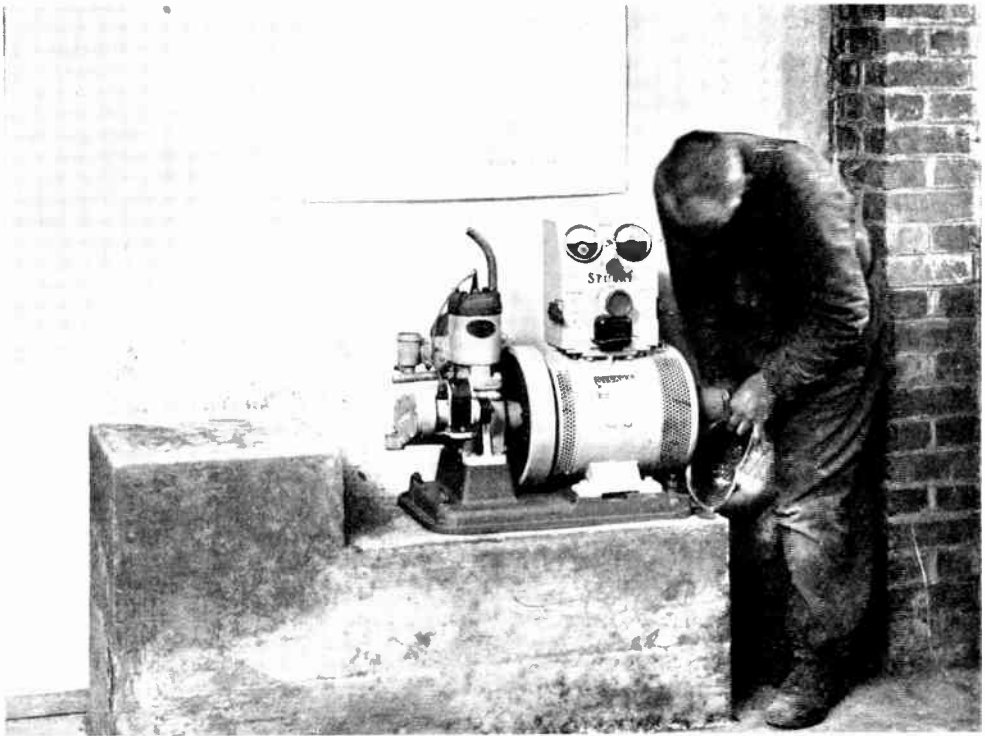

Fig. 8.—GROUTING IN THE ELECTRIC LIGHTING PLANT. (Stuart Turner, Ltd.)

The top of the bed is faced with liquid cement, the strips of wood removed and the plant lowered into position. The bolt holes in the bed are filled with liquid cement. If the bolt holes do not show, a small channel leading into them should have been scraped in the top of the bed.

battery. Many cells are now supplied dry charged, or filled with acid and charged. Nevertheless, even with such cells a first charge should be made before the battery is called upon to give a discharge. The maker's instructions for first charge must be followed exactly. This is so important that no information will be given here to assist any engineer in carrying out this operation without the battery maker's recommendations, which vary slightly with different batteries.

Battery "Don'ts."

The care and operation of the battery should also be carried out according to the maker's regulations, the following being the most important "don'ts" according to the D.P. Battery Co., Ltd. :—

(1) Don't overcharge the battery—give the cells 10 minutes' gassing at

each charge, and once a week about 30 minutes extra.

- (2) Don't undercharge it—every cell in the battery should gas freely from both positives and negatives at the end of charge.
- (3) Don't gas the cells more frequently than once in 24 hours or less frequently than once a week. If the battery is being freely used they may be gassed 10 minutes every day, but if lightly used 40 minutes once a week may be sufficient.
- (4) Don't work blindly by watt-hour or ampere-hour meters—the indications furnished by the cells themselves are the only reliable guides.
- (5) Don't take it for granted that every individual cell is gassing—look at each cell periodically and make sure.
- (6) Don't neglect low cells, they must be

dealt with immediately—the longer they are left the worse they get.

- (7) Don't trust to memory—write the weekly readings of each cell in the battery log book.
- (8) Don't let the tops of the plates become exposed—add distilled or pure water as often as necessary.
- (9) Don't put in acid unless there is some good reason for doing so.
- (10) Don't remain in doubt—consult the manufacturer if anything unusual occurs, and shift the responsibility on to him.

Treatment of Sulphated Plates.

Plates which have become sulphated by under-charging—a condition indicated by a gradual fall in the density of the electrolyte—may be restored (unless the sulphation is severe) by a prolonged charge at half or one-third of normal rate. Continue until gas is coming freely from positives and negatives. If the temperature of the cells above 60° F., reduce or temporarily stop the charge.

Charging a Low Cell.

If one cell does not gas when all the others are up, find and remove the cause, probably a short circuit between plates. The cell must then be charged separately, and Fig. 5 shows the usual method of doing this in the case of cells bolted together. It will be seen that by connecting as shown by the full line connection on discharge, the centre (low) cell is cut out of circuit, and does not discharge, and when connected as shown by the dotted line on charge it receives full charge. It may be necessary to spare the cell more than one discharge, unless the following charge is a long one.

Cleaning Cells.

In normal use a quantity of sediment will be slowly deposited at the bottom of the cell. When this deposit is deep enough to reach near the bottom of the plates it should be removed. The simplest method of doing this, in the case of small cells, is to lift the plates, carefully pour off the clear acid into a clean tub or earthenware vessel, and then wash out the con-

tainer, afterwards refilling the cells with the original acid.

Replacing Broken Container.

If the cell is small, simply unbolt from adjacent cells, bridge across the gap with a piece of copper cable or strip firmly bolted to the lugs. If too heavy to lift, remove the plates first, then the container. If there is insufficient head-room to permit this to be done, get a box a little lower than the height of the stand, prepare a piece of wood, as shown in Fig. 6, with smooth top greased with soap, and insert under the container by levering up the latter half an inch, afterwards sliding the container out. Remove any insulators from under the container as soon as it is on the wood slide, or they may be dislodged and fall into a cell below. In replacing, when the new cell (or old plates in new container) is over its final position, place the insulators in position, lever up the cell off the slide and withdraw the latter.

Taking a Battery Out of Service.

It sometimes happens that a plant is to be shut down for a few months. The battery must not be left idle for this length of time, but may be taken out of service as follows:—

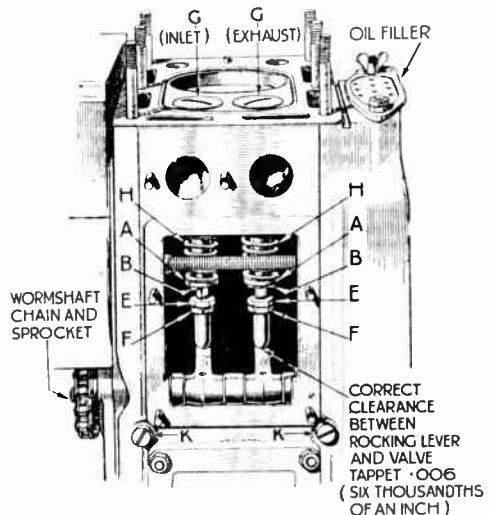

Fig. 9.—ADJUSTMENT OF TAPPERS.
F is the locknut, E the adjusting nut.
(Boulton and Paul, Ltd.)

Discharge at the normal 10-hour rate to 1.8 volts per cell. Draw off acid into carboys, fill cells with pure water and allow to remain in cells for 36 hours. Then syphon out the water and allow the plates to drain and dry. When putting the cells into service again, fill with the same acid, or acid of the same specific gravity, and charge.

OPERATION.

Most makers issue fully detailed operating instructions, which vary considerably, especially for automatic and semi-automatic sets. It is therefore impossible to

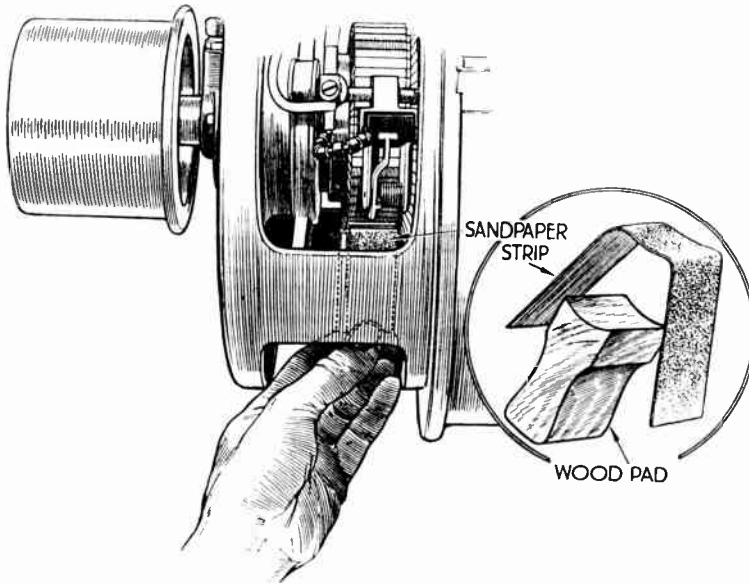

Fig. 10.—POLISHING DYNAMO COMMUTATOR. (Boulton and Paul, Ltd.)

give detailed rules, but the following general conditions are important:—

Engine.—Use a good grade of fuel and fill the tank through a strainer. Use one of the lubricating oils recommended by the makers and drain the sump occasionally (see "Care of Engine"). Keep the oil level correct, plugs clean and gaps correct, and decarbonise if the engine begins to knock or lose power. In very cold weather, if the engine room is not frost-proof, drain off the water from the cylinder jacket and pipes.

Battery.—Do not under or over-

charge or discharge too fast or to below normal voltage. Keep cells topped up. In summer, if very little current is required (especially when the household is on holiday), leave a few lights on one night every fortnight and give a full charge the next day. Regular use and proper charging will prolong the life of a battery by years.

Dynamo.—Take care of the brushes and commutator (see "Care of Dynamo").

General.—Keep everything clean.

CARE OF ENGINE.

The following points apply generally to all engines. For fuller instructions, consult the maker's handbook.

Spare the Battery at Starting.

Many sets are arranged to start by motoring from the battery, but to spare the battery as much as possible, either start by hand (especially with a new, stiff engine) or give the engine a few turns by hand to free the bearings (especially in cold weather) before starting from the battery. If the

battery is low, or has just been installed, start by hand. If the engine fails to start in a few seconds from the battery, do not keep it motoring, but find the cause of failure to start.

Bad Running.

If the engine runs unsatisfactorily, the following may be the symptoms and causes:—

- (1) Slow running. Governor set incorrectly.
- (2) Loss of power. Engine needs decarbonising; poor fuel; partially

- choked jet; ignition timing faulty; exhaust pipe and silencer choked.
- (3) Misfiring or "popping back." Partial fuel stoppage or choked jet; dirty plugs; weak mixture caused by misadjustment of carburetter; sticking valves.
 - (4) Stoppage. Lack of fuel; ignition failure such as loose lead, oiled plug or magneto trouble; fault in the control system of an automatic set.

of the oil by dilution with petrol or paraffin; a worn engine also will need new oil oftener than a new one.

When the oil seems thin or very dirty, drain the sump after the engine has stopped and is still warm, and swirl out the crankcase with paraffin, or better still, a little clean, thin oil. If paraffin is used, every trace must be removed before adding new oil. The best procedure

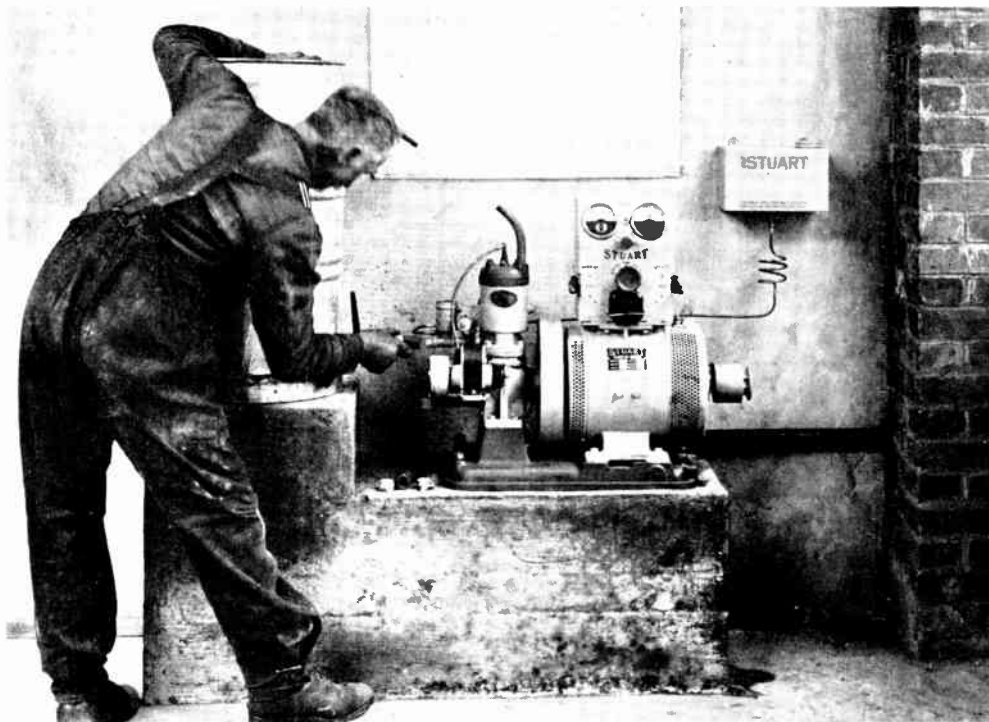

Fig. 11.—ERECTING THE TANKS AND EXHAUST PIPE. (Stuart Turner, Ltd.)

See that the pipes from the water tank lead fair and straight. The top water pipe must slope upwards from engine to tank throughout its length. Put the petrol tank the correct height above the carburetter according to the makers' instructions. A coil in the petrol pipe provides flexibility. The coil must be vertical as shown. Be sure that the pipe falls all the way to the carburetter and that there are no rises in its length. They cause air locks. Install the exhaust pipe so that it slopes downwards from the plant.

- (5) Knocking. Engine badly needing de-carbonising; worn bearings; lack of oil.

Draining Off Old Oil.

It is very necessary periodically to renew the lubricating oil. Makers' instructions vary, some saying after 100 hours' running; others every month. A hard and fast rule is impossible, for light load running or the use of inferior fuel will lead to quick deterioration

after draining is to add enough oil for the oil pump to work, give the engine a few turns by hand, again drain and then fill up with the usual oil. The cost of oil is much less than the cost of premature wear caused by running on thin, sludged oil.

Note.—With some systems of lubrication, especially on two-stroke engines, only very occasional cleaning of the crankcase is required.

Attention to Valves.

Keep the clearance between the tappets and valve stems to the recommended amount, usually about the thickness of a magneto gauge, measured when the

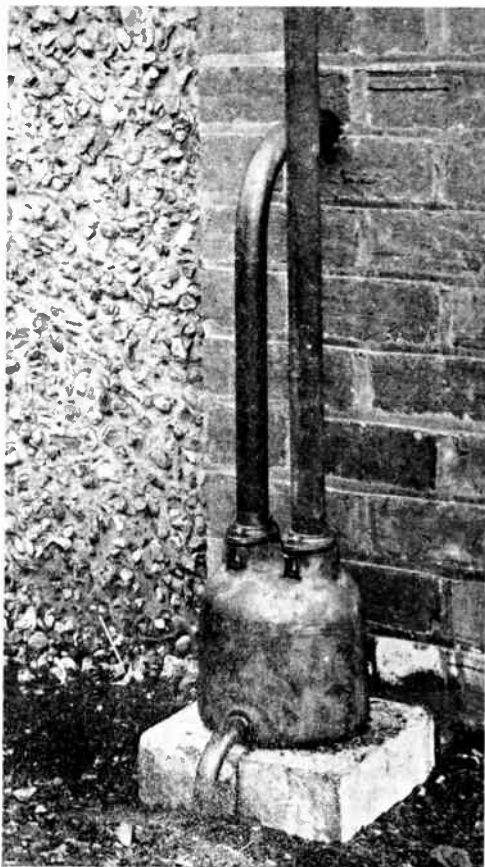

Fig. 12.—THE EXHAUST SILENCER.
(Stuart Turner, Ltd.)

The exhaust pipe should slope down to the silencer so that moisture may drain away. The pipe must not be cemented into the wall. It must be removable for cleaning. Means of draining the silencer must be provided. A small drain pipe is shown. The exit from the silencer is taken straight up 6 to 8 feet. Keep exhaust pipes as short and straight as possible. The fewer bends there are, the better. Elbows must not be used.

engine is warm. When the head is removed the valves should be ground-in. The procedure is generally the same as for a car or motor-cycle engine, and will

be familiar to most engineers. The following points should be noted :—

In grinding, rotate several times through a quarter turn at a time, lifting the valve before grinding through the next quarter turn. Apply light pressure directly downwards on the valve head, not at an angle.

Use coarse paste only when the valves are badly pitted. Usually medium, finishing with fine, grinding paste is enough.

Do not grind more than is necessary to form a continuous bright line on the valve face and seating, or the valves will be "pocketed" below the normal level of the seating and power will be lost.

Very carefully clean all traces of grinding compound from valves and engine before re-assembly.

Do not replace the exhaust valve in the inlet position or *vice versa*.

Decarbonising.

Most engines have detachable cylinder heads. To detach, first drain off water, disconnect water pipe (and exhaust pipe, if necessary) and ignition lead; then loosen the nuts on the holding-down bolts and smartly swing the engine over compression. This should loosen the cylinder head. If not effective, use the following method:—Loosen the cylinder nuts half a turn only and start up the engine in the ordinary way; the explosion in the cylinder will loosen the head. Avoid prising apart the head from the cylinder with a chisel or screwdriver or the gasket will be damaged.

When the head is removed, cover the cylinder with a clean rag, take the head to a bench and clean out all carbon with a blunt tool, such as an old wide screwdriver with slightly rounded edges. A cranked scraper, which can be made easily from a piece of soft iron strap, is useful for cleaning out the exhaust ports and around the valves.

When decarbonising, grind in the valves as already described.

Clean the Plug.

The plug should be removed when decarbonising and thoroughly cleaned with a wire brush. The electrodes may have to be scraped clean of carbon with a

knife. After cleaning, set the gap between the points to the thickness of a visiting card by bending in or out the outer electrode—never the centre one.

Replacing Cylinder Head.

After decarbonising and grinding in valves, wipe the head perfectly free from loose carbon, clean the facing down on which the head bolts, and the gasket. Thinly smear both sides of the gasket with gold size or jointing compound, drop over the cylinder bolts, and then drop the head into position. Make very sure that no dirt gets between the faces. Screw up the holding-down nuts finger tight, then with a spanner give each a few turns one after the other. Tighten diagonally opposite nuts in turn, not all on one side first; and when fair pressure has to be exerted with the spanner, give each nut one turn only at a time. In this way distortion of the cylinder head is avoided.

If the gasket is damaged and a new one is not to hand, a substitute may be made out of a stout, undamaged sheet of brown paper, carefully cut by using the old one as a pattern. This should be replaced by a proper gasket when next decarbonising.

After replacing the head, reconnect exhaust and water pipes, etc., and fill the

cooling system with water. If the engine can be left a few hours for the jointing compound to set, so much the better. As soon as the engine gets warmed on the next run, go over all nuts again, and finally tighten after the run. If water leaks between the head and the cylinder, or exhaust gas blows out, the joint is bad.

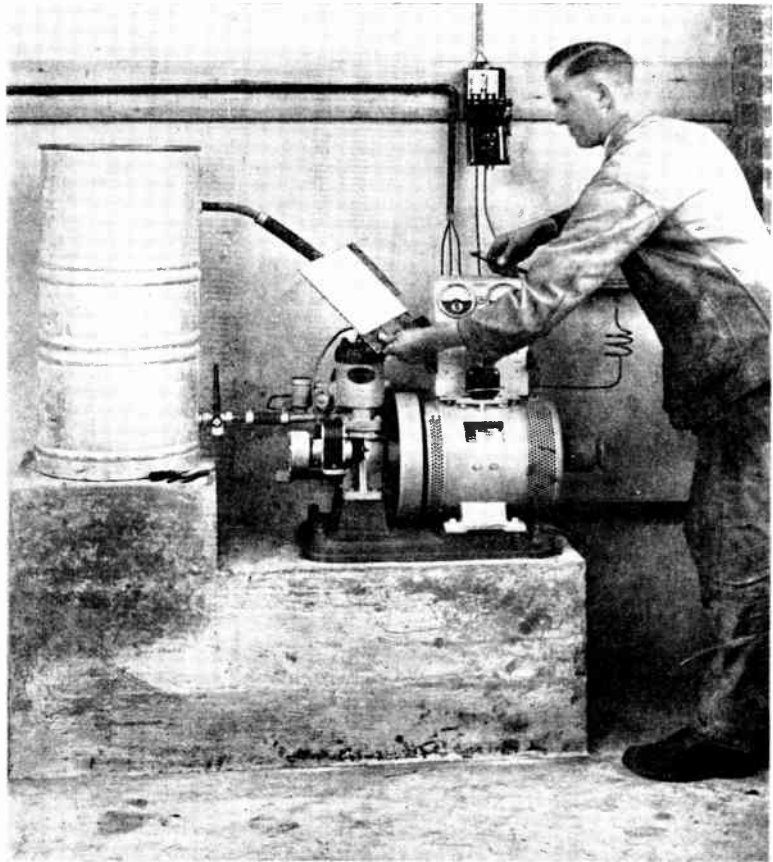

Fig. 13.—CONNECTING UP THE ELECTRIC LIGHTING PLANT. (Stuart Turner, Ltd.)

Working to the makers' wiring diagram. The three leads from the battery are shown encased in conduit. The electrician is making the final connection of the main cable to the house. This cable passes through an ironclad D.P. main switch and fuse (shown open).

probably because of dirt or a damaged gasket.

Magneto.

Do not interfere with the magneto unnecessarily. If a bad spark or mis-firing suggests trouble, check the gap

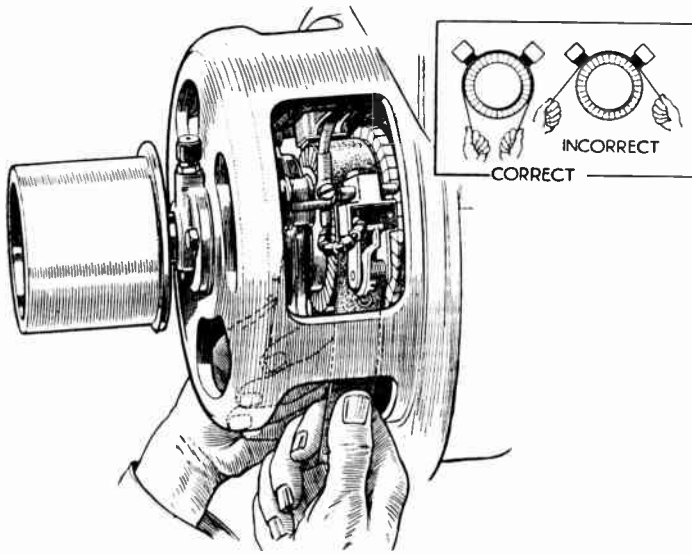

Fig. 14.—BEDDING-IN DYNAMO BRUSHES. (Boulton and Paul, Ltd.)

between the contact breaker points when open with the gauge on a magneto spanner and see that they butt squarely together, if necessary cleaning up with a very smooth file.

In damp weather the rocker arm may stick due to swelling of the fibre bearing bush, which should be eased with a piece of glass paper wrapped around a thin pencil. The least possible use should be made of the sandpaper.

Adjusting Tappets.

Remove cover over valve stems and try with a gauge between end of valve stems and tappet heads (see makers' instructions regarding clearance). If clearance is too little to allow the gauge to be inserted, or so much that the gauge can be lifted up and down, loosen the locknut and adjust the gap by turning the adjusting nut, then lock, and again feel with the gauge in case locking has shifted the adjustment. It is usually recommended that this adjustment be made with the engine warm, as unequal expansion with heat may upset an adjustment made when cold. This adjustment of the tappets is usually necessary after grinding-in the valves (see Fig. 9).

The Silencer Needs Attention.

Loss of power may be caused by back pressure in the exhaust system. Once a year dismantle the silencer and clean out all soot, and clean the piping if it seems necessary. Plugging one end of the pipe, inserting a handful of sharp gravel, plugging the other end and shaking violently, will remove most of the soot if no suitable brush is available.

MAINTENANCE OF DYNAMO.

Cleaning.—Unless the engine room is dusty, little cleaning is needed

beyond an external wipe down every few days. Occasionally open the end covers or remove guards (when the set is shut down, of course) and blow out dust in the windings with a pair of bellows or a reversed vacuum cleaner. The commutator and the connections from the commutator segments to the armature need special attention, as here carbon and copper dust from brushes and commutator may lodge. This point should be remembered after bedding down brushes or truing commutator.

Bearings.—Most small dynamos are now fitted with ball and roller bearings. These need attention not oftener than annually, unless the housings leak grease. They should be filled with grease when necessary through the grease plug, if fitted, or by removing the end cover. Do not cram too much grease into the races, or "churning" will be set up, which causes friction and heating. Use the grease recommended by the machine makers, or in the absence of any recommendation use Price's Belmoline "C" or similar.

Bedding the Brushes.

Occasionally check the brush pressure

(which with most machines should be in the region of $1\frac{1}{2}$ to $2\frac{1}{2}$ lbs. per square inch) with a spring balance, altering the spring adjustment if necessary. The brushes should slide freely in the holders and bear evenly on the commutator. If they do not, bed them down by slipping a strip of sandpaper, face upwards, between the brushes and the commutator and working backwards and forwards (Fig. 14). This operation is necessary when fitting new brushes, which are needed when the old ones are worn down to about $\frac{1}{8}$ inch long. Always use the grade of brush recommended by the makers. Clean away all carbon dust before putting the machine into use again.

To bed down the brushes it may be necessary to move the rocker to bring the brushes into a convenient position. If this is done, reset afterwards to the marked position.

Care of Commutator.

A commutator should naturally polish itself in use and need little attention

unless the brushes are neglected and sparking develops. If it becomes rough, shape a wood block to the surface of the commutator and, using this as a holder, apply carborundum cloth or sandpaper while the machine is running (not on load, and with the brushes lifted or removed), see Fig. 10. Do not exert much pressure, and use fine carborundum cloth. Remove all dust before putting the machine into use again.

Ridges in the commutator will only develop if the brushes are not staggered and their tracks consequently coincide. Bad ridging can only be removed by withdrawing the armature and skinning up the commutator in a lathe, afterwards polishing.

After grinding or polishing the commutator, see that the mica is below the surface by about $\frac{1}{32}$ inch, if necessary undercutting with narrow cutter made to fit the grooves. Also, after repolishing the commutator, remove sharp edges on the segments by drawing a sharp V-shaped tool between them.

QUESTIONS AND ANSWERS

What tests should be made after connecting up the dynamo ?

A "megger" insulation test should be made from both negative and positive wiring to earth (disconnecting any permanent earth on the negative for the purpose of test). Also test between the positive and negative sides of the installation (with generator, battery and voltmeters disconnected).

If everything is in order, what indication will be given by the "megger" ?

Readings of several megohms should be obtained.

What would you do if the engine will not start when the maker's instructions are followed ?

(1) See that the fuel tank is filled and the tap on.

(2) See if the supply pipe or jet is choked.

(3) See if the ignition is switched on.

(4) See if the plug gap is correct.

(5) Test the ignition by unscrewing the plug, resting the body on a metal part of the engine with the H. T. lead connected and the terminal clear of the engine, and giving the engine a smart turn or two. A blue spark should be observed.

If the dynamo fails to build up to correct voltage, what faults would you look for ?

(1) Wrong direction of rotation.

(2) Brushes lifted or brush rocker in wrong position.

(3) Speed low.

(4) Connections not made according to diagram.

(5) Shunt field regulator making bad contact, or resistance wire broken.

ASBESTOS AND WOOD

ELECTRICAL PROPERTIES AND USES

THE ancients called asbestos by a name describing its fireproof quality. The Greek word "asbestos" means "inextinguishable" or indestructible. It has been regarded for centuries as an indestructible substance. It was formerly used for lamp wicks. Asbestos occurs as a rock, chiefly in Canada where it is called *chrysotile*. The rock is found to be composed of closely packed soft, white fibres which are easily split off. In spite of this peculiar appearance, asbestos is actually a mineral compound of magnesium and silicon.

The Heat-Resisting Properties of Asbestos.

The fibres of asbestos are extremely weak mechanically, and attract moisture. The electric strength is poor, and the only reason for the use of asbestos is to employ its heat resistance. Asbestos is unaffected by temperatures up to 1000 C. It melts at 1200-1300 C.

It is a difficult matter to spin asbestos fibre, but tape can be produced without the addition of any adhesive. It is coarse compared with cotton tape, and usually contains adulteration in the form of cotton fibres to give better mechanical

strength. Impregnated asbestos tapes are heat resisting.

Asbestos Paper and Boards.

Paper is made of asbestos fibres in the same way as cellulose paper. The paper is thick, soft and felted, and resembles coarse blotting-paper. It is used for lining fuse boxes and for separating insulated coils in large generators, where "hot-spots" occur. Boards may be built up from paper sheets stuck together, but a more common type of board is that produced by a mixture of asbestos and Portland cement. This mixture is particularly good, for asbestos is a mineral fibre, and a chemical action takes place between the asbestos and the cement, making a well-bonded, although hygroscopic, material. Such boards do not burn and will not support combustion, nor will they suffer under high temperatures. A particular advantage is their resistance to damage by electric arc, making them suitable for arc barriers in switches and on commutators. Asbestos-cement boards are easily sawn, drilled and otherwise machined. A wide outlet is the build-

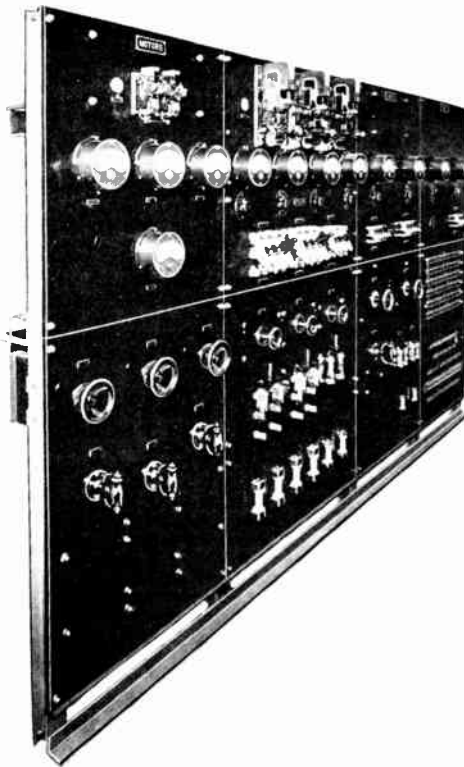

Fig. 1.—AN IMPORTANT USE OF ASBESTOS-CEMENT COMPOUND.

This illustration shows an ebony "Sindanyo" switchboard at the Manchester station of the British Broadcasting Corporation. (*The Relay Automatic Telephone Co., Ltd.*)

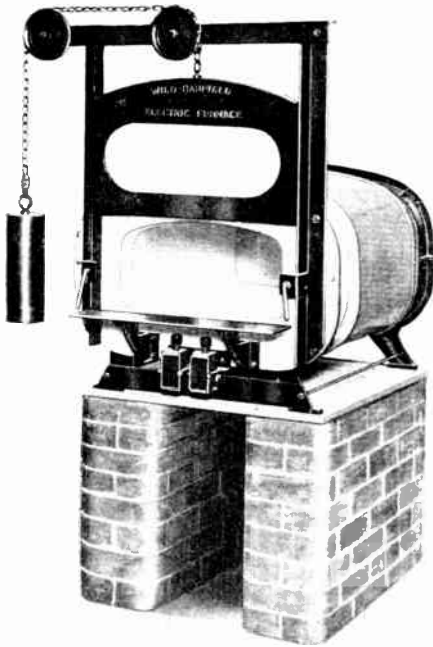

Fig. 2.—AN ELECTRO-MAGNETIC HARDENING FURNACE.

Used as made of "Sindanyo" arc-resisting board for front plate, base plate and door. (Wild-Barfield Electric Furnaces, Ltd.)

ing trade in which large quantities are used.

Untreated boards are not electrically good. An asbestos-cement-bitumen combination, however, has better electrical insulating properties, although not so good as arc shields. Under various trade names it is coming into use for suitable panels as a substitute for slate.

Wire Coverings.

Conductors for use in hot situations can be insulated with asbestos paper or tape. It has even been found possible to insulate wires on the s.c.c. and d.c.c. principle. Another

form, used, for example, in electric cooker wiring, comprises a braiding of asbestos fibres, soaked with a gummy dressing and compressed to size.

Boards for High Temperatures.

Boards and tubes composed of bakelite and asbestos have been developed for use at high temperatures. The material is acid and insect-proof, unspittable, unaffected by water and oil, and stable up to 200 C. Further, it can be machined, is mechanically strong, and proof against acids, oils, petrol and steam. The electrical strength, as with all asbestos products, is moderate. It is used, for example, for packing-pieces in turbo alternators, and for brake blocks.

WOODS.

The electrical value of wood depends almost entirely on its condition as regards sap and moisture—that is, the degree of its seasoning. Well-dried and well-seasoned wood has satisfactory electric strength and its hard, fibrous character gives it valuable mechanical advantages. It requires considerable care, however, to effect a proper seasoning of wood: it is necessary to dry the timber slowly in a kiln for several years, a costly process.

"Soft" and "Hard" Woods.

The trade recognises "soft" and "hard" woods. The former are not used in electrical work, but several of the hard woods are employed. Among these are ash, box, ebony, hickory, hornbeam, lignum vitæ, maple, oak and teak.

All woods are hygroscopic to varying degrees. Hence for use under conditions in which the wood is liable to electrical stress, impregnation of some sort is essential. Plain varnishing after drying is suitable for small switch mountings for low voltages,

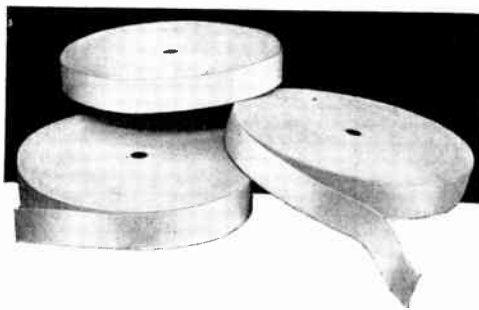

Fig. 3.—ASBESTOS ELECTRICAL PAPER TAPE. (Turners Asbestos Cement, Ltd.)

This tape is largely used for insulating magnet wires of tramway motors, railway motors, mill motors and welding transformers, or where excessive temperatures may be necessary.

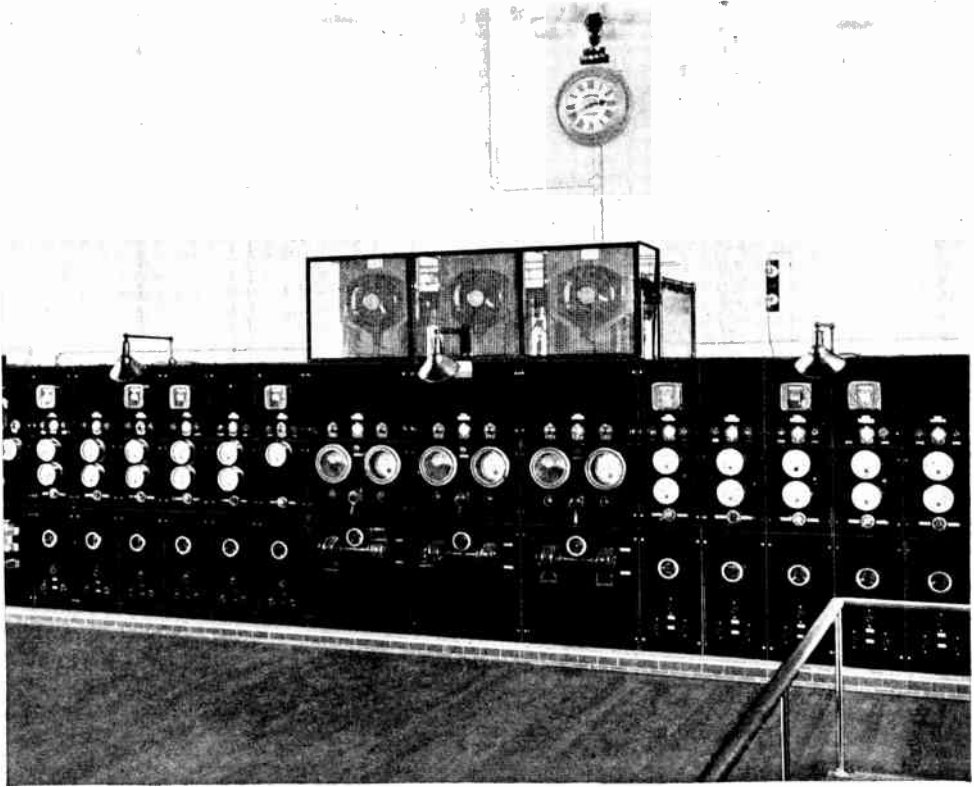

Fig. 4.—EBONY "SINDANYO" SWITCHBOARD FOR THE B.B.C. LONDON REGIONAL STATION AT BROOKMAN'S PARK. (*English Electric Co., Ltd.*)

"Sindanyo" is made from an asbestos base and has special electrical properties—being capable of withstanding high temperatures, also rapidly changing temperatures, and will not readily carbonise under an electric arc. It is non-hygroscopic and possesses a high dielectric strength.

but for higher voltages vacuum impregnation is advisable. Even so, the depth of penetration is but small. Treatments include boiling in paraffin wax or linseed oil, or impregnation with oil, varnish or synthetic resin.

The uses of impregnated hard woods include high-voltage switch rods, packing blocks, etc.

Bakelised Wood.

The use of bakelite has spread even to the impregnation of wood. The

valuable hardening (polymerisation) of this synthetic resin with heat treatment enables comparatively soft woods to be used as a foundation, as they allow of a far better penetration. Sheet material is built up in plywood fashion with a number of thin laminæ, each well bake-lised, the whole stack being subjected to heat and pressure to produce a solid, homogeneous board with excellent electrical and mechanical strength, impervious to water. Hard wood pieces so impregnated have been used for the pins of pin-type insulators.

WALL AND FLOOR FIXINGS FOR ELECTRICAL APPARATUS

ILLUSTRATING PRACTICAL METHODS OF FIXING SWITCHGEAR, CONDUIT AND OTHER ELECTRICAL APPARATUS TO WALLS AND FLOORS

WHEN a new building is being erected wooden plugs are sometimes built into the walls ready for the electrical fixings. The labour of inserting wood plugs when such provision has not already been made during erection can be obviated to a large extent by the use of Rawplugs.

For Heavy Fixings.

The first series of pictures show the process of fixing an ironclad switch to a brick wall, using large size Rawplugs. Notice that $\frac{3}{8}$ -inch coach screws are used with a No. 28 Rawplug for heavy jobs.

Lighter Work.

Ordinary wood screws with smaller Rawplugs can be used for lighter fittings such as the protected wall lamp shown in Fig. 6, and the conduit fixing saddles shown in Figs. 7 and 10.



Fig. 1.—FIXING HEAVY SWITCHGEAR TO BRICK WALL. THE FIRST OPERATION.

This shows how the hole should be drilled. After each blow with the hammer the tool should be given a slight turn to prevent wedging.

C

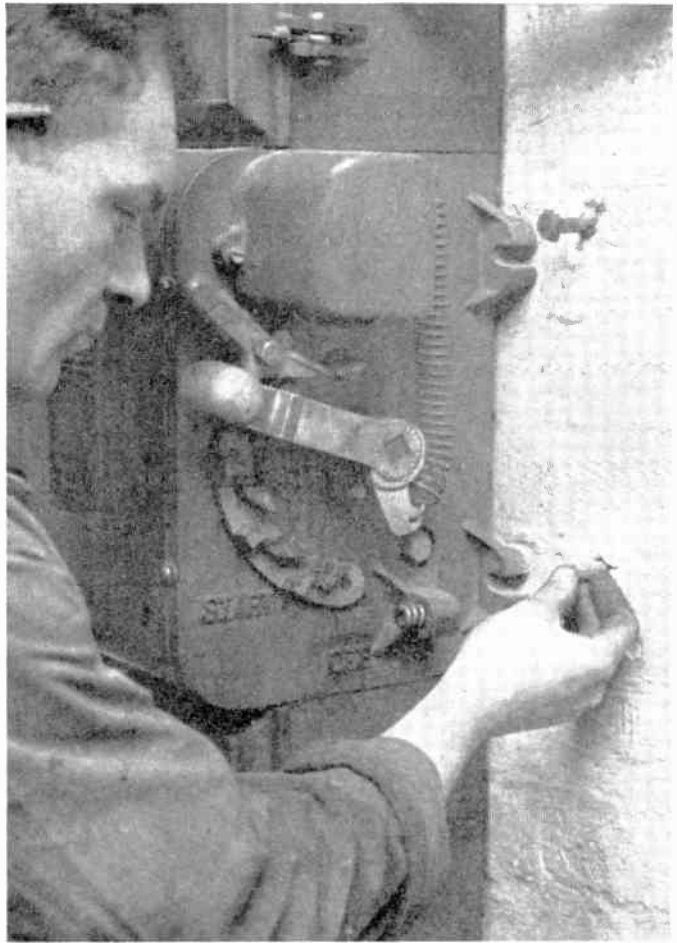

Fig. 2.—FIXING HEAVY SWITCHGEAR TO BRICK WALLS. THE SECOND OPERATION.

Inserting the Rawlplug in the hole. This is pushed in so that it is flush with the wall.



Fig. 3.—FIXING HEAVY SWITCHGEAR TO BRICK WALLS. THE FINAL OPERATION.

Screwing in the $\frac{3}{8}$ -in. coach screw which holds the switchgear in position.



Fig. 4.—A MECHANICAL HAMMER BEING USED TO DRILL A HOLE IN A BRICK WALL.

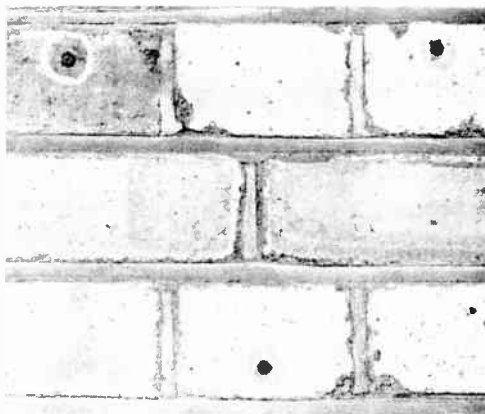

Fig. 5.—PLUGS INSERTED INTO A WALL READY FOR FIXING THE PROTECTED WALL LAMP SHOWN IN FIG. 6.

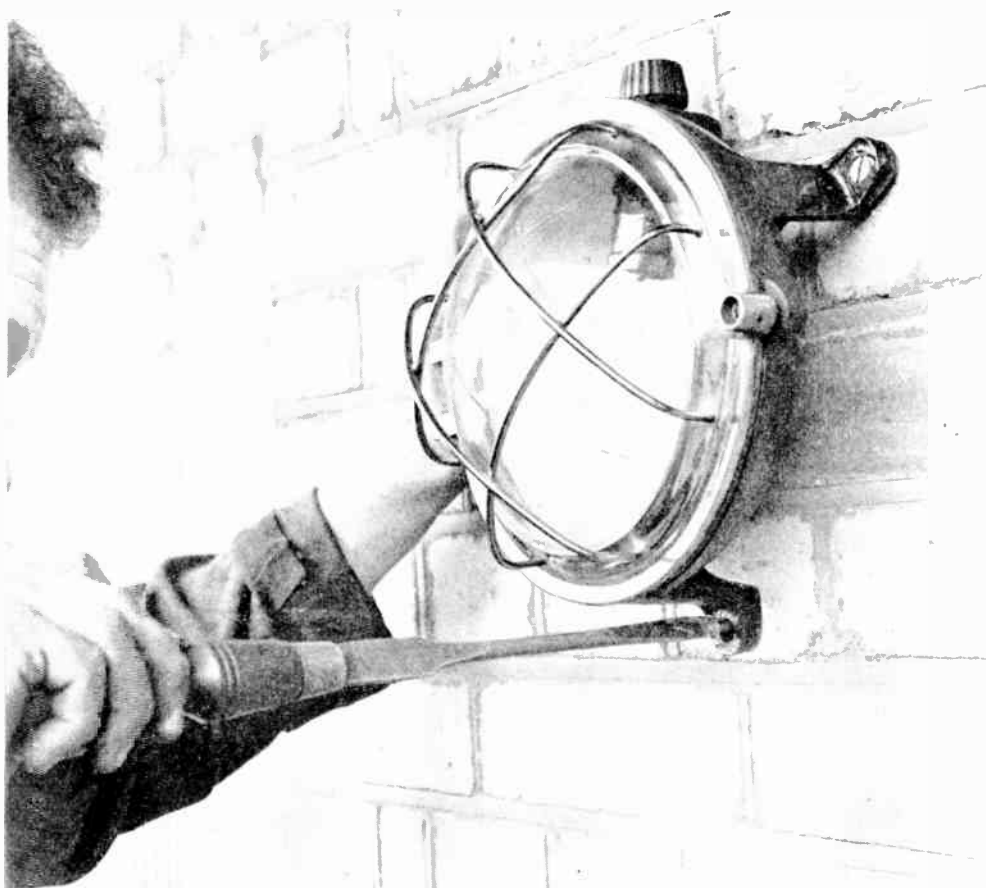

Fig. 6.—SCREWING A PROTECTED WALL LAMP TO A WALL.



Fig. 7.—HOW TO FIX CONDUIT OR TUBING TO A WALL. FIRST OPERATION.

Showing the points where holes for the conduit fixing saddles are to be drilled being marked with a pencil on the wall.



Fig. 8.—HOW TO FIX CONDUIT OR TUBING TO A WALL. SECOND OPERATION.

This shows the holes being made with the special tool.

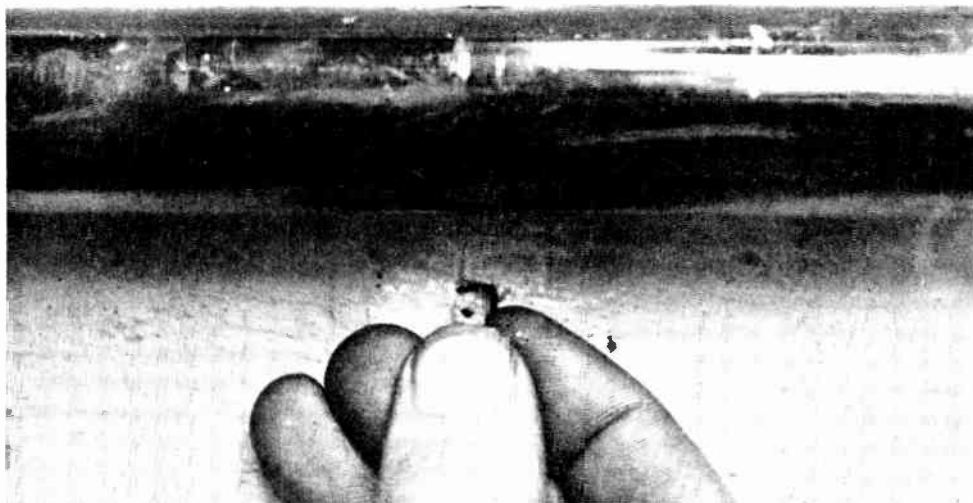

Fig. 9.—How to Fix Conduit or Tubing to a Wall. THIRD OPERATION.
Inserting the Rawplugs in the holes. No. 8 by 1 inch Rawplugs are quite large enough for a job of this kind.



Fig. 10.—How to Fix Conduit or Tubing to a Wall. FINAL OPERATION.
Screwing the fixing saddles in position.



Fig. 11.—How to Fix Heavy Machinery to a Concrete Floor (1).

This shows the first operation, which consists of drilling a hole in the concrete, in which to insert the Rawlplug bolt anchor.

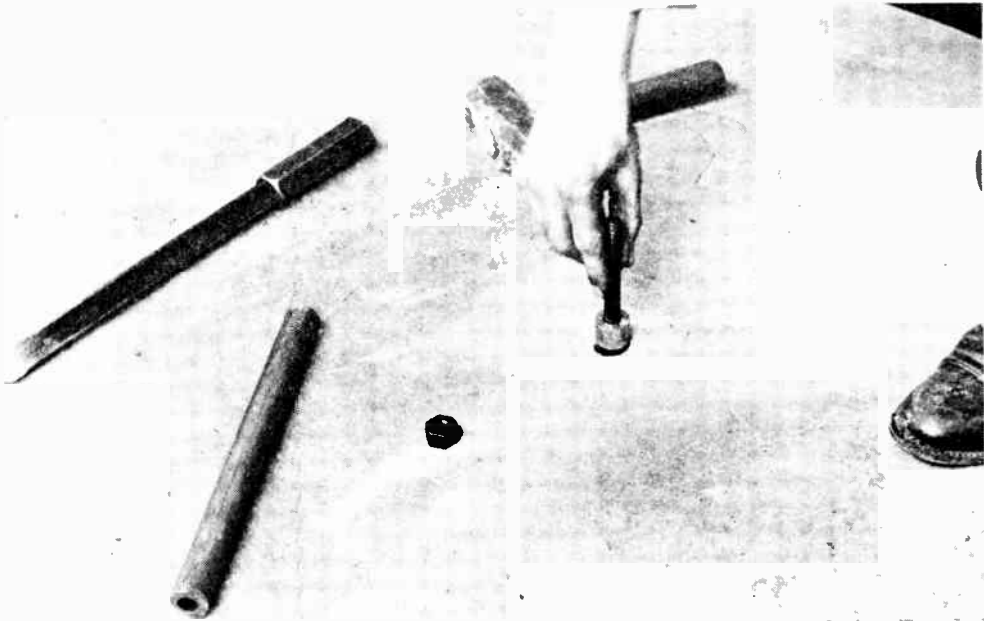

Fig. 12.—How to Fix Heavy Machinery to a Concrete Floor (2).

This shows the second operation, the bolt being placed in the hole with the steel washer and Rawlplug bolt anchor in position.



Fig. 13.—How to Fix Heavy Machinery to a Concrete Floor (3).
The caulking tool is placed over the bolt and the caulking then carried out with a heavy hammer.

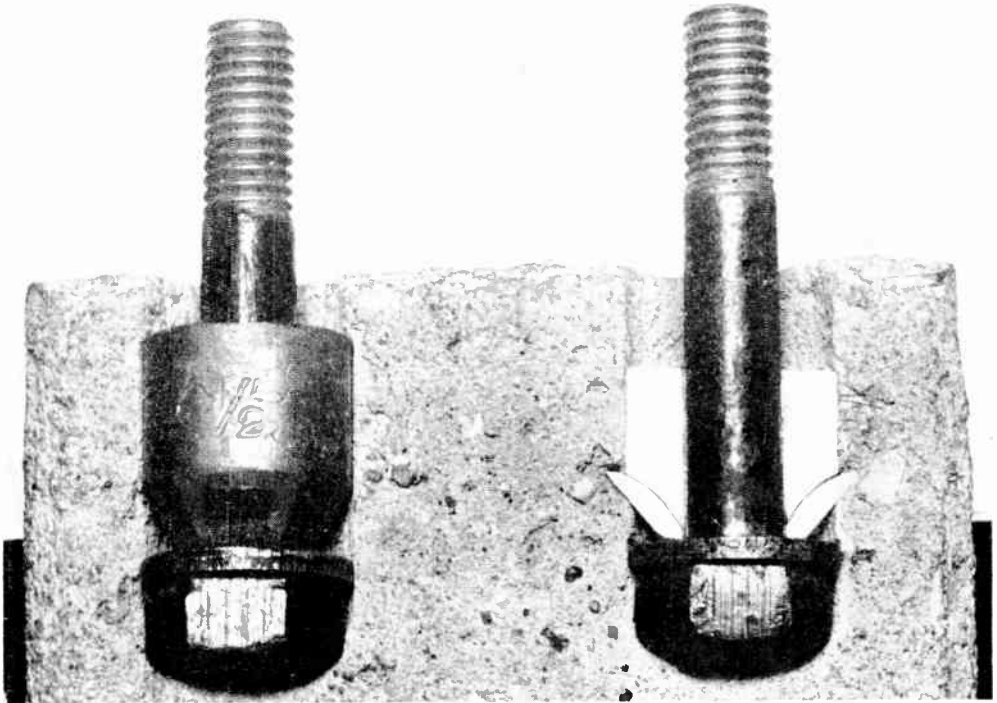

Fig. 14.—THE BOLT ANCHOR BEFORE AND AFTER CAULKING.
Notice how the upper lead portion of the bolt anchor forces the chilled iron sections outwards so that they engage firmly with the concrete.

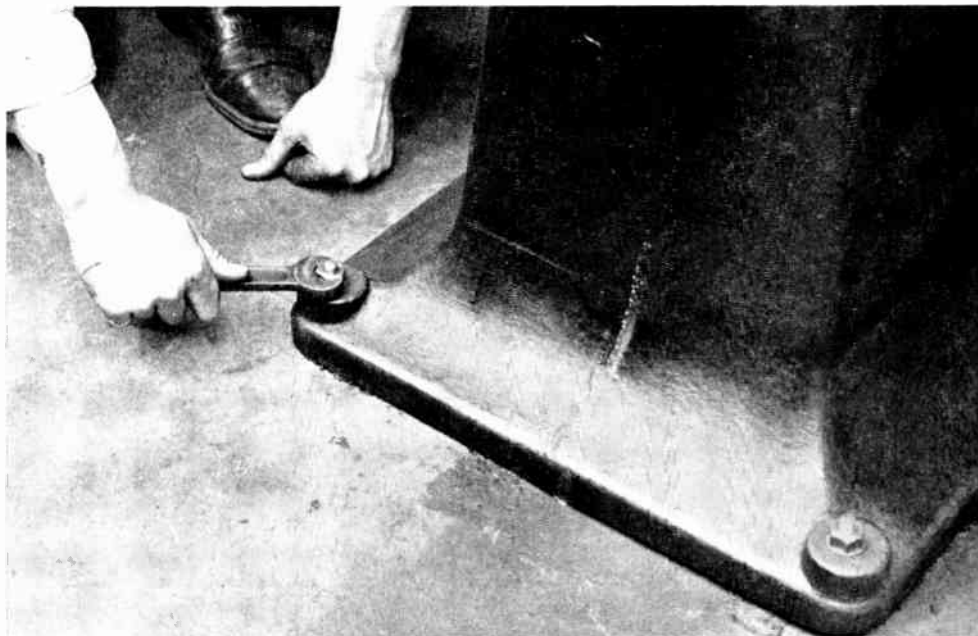

Fig. 15.—THE FINAL OPERATION IN FIXING HEAVY MACHINERY TO A CONCRETE FLOOR.
Showing the nut being screwed down on the anchored bolt.

A Useful Time Saver.

Where a large number of Rawlplugs have to be used much time can be saved by using the mechanical hammer illustrated in Fig. 4. The hammer is held as shown and the turning of the handle delivers hammer blows on the head of the drill and also rotates the drill carrier through 20° between the blows. The wing nut which can be seen at the lower end of the front casing enables the force of the blows to be varied according to the size of the drill and the material which is being drilled.

AN INGENIOUS FOUNDATION BOLT.

When heavy machinery has to be fixed on a concrete floor which has not been previously prepared, the Rawlplug bolt anchor can be used to give a satisfactory job with a minimum of inconvenience. This anchor is fitted on to an ordinary bolt

and inserted in the manner illustrated in Figs. 11 to 14. The bolt holes are first marked out on the concrete, which is then drilled as shown in Fig. 11. A steel washer and Rawlplug bolt anchor is then placed on the bolt, which is then lowered into the hole as shown in Fig. 12.

Caulking.

The caulking tool, which is in the form of a steel tube, is now placed over the bolt and the caulking carried out with a heavy hammer. Fig. 13 shows the caulking tool being placed in position and Fig. 14 shows the bolt anchor before and after caulking. Notice how the upper lead portion of the anchor forces the chilled iron sections outwards so that they engage firmly with the concrete, making a sound fixing. The top of the holes can then be filled in with concrete if desired, although this is not necessary.

TESTING SMALL D.C. AND A.C. MOTORS

By A. T. DOVER, M.I.E.E.

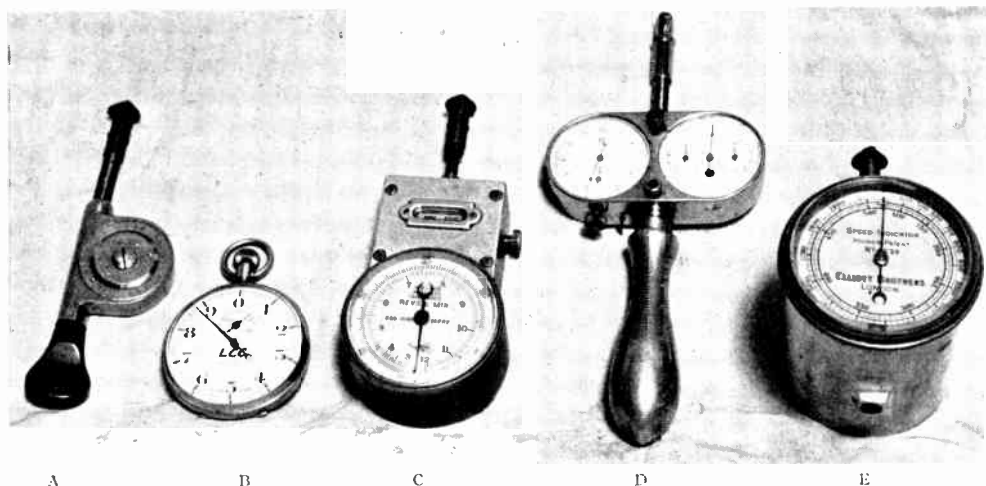

Fig. 1.—INSTRUMENTS FOR MEASURING MOTOR SPEEDS.

A, revolution counter; B, stopwatch (the large hand makes one revolution in 10 seconds); C, tachometer with change-speed gear box giving three ranges; D, synchronised revolution counter and stopwatch; E, tachometer with two ranges.

Note that all the spindles have conical rubber tips for engaging with the shaft centre. These tips should always be used with the above instruments as only light pressure of the tip in the shaft centre is then necessary.

Tests Required to Determine Performance of Motor.

THE performance of a motor—i.e., the relationship between the output, speed, input, efficiency—may be determined either directly, by loading the motor with a brake and measuring the torque, speed and input; or indirectly, by determining the losses by means of no-load tests and calculating the output corresponding to a given input. The direct, or brake, method should always be employed whenever possible, as the accuracy obtainable with the indirect method is not always of a high order owing to the actual losses on load being different from the calculated losses.

Apparatus and Equipment Required for Brake Test.

In addition to a suitable source of supply and suitable electrical measuring

instruments, a brake and testing stand is required, together with means for measuring the torque and speed.

Types of Testing Brakes.

The function of a testing brake is to apply a retarding torque (which can be measured accurately) to the armature shaft of the motor. This torque may be obtained by either mechanical or hydraulic friction or by electrical methods, viz., by rotating in a magnetic field a system of conductors forming closed electric circuits. Mechanical friction brakes are usually employed with small motors because they are easily and cheaply applied, and do not require external sources of energy, such as water (for the hydraulic brake) or electricity (for the electric brake).

Mechanical Friction Brakes.

With these brakes the retarding torque

is produced by the friction of a cord, rope, band or brake blocks on the periphery of a pulley or drum fitted to the armature shaft. The frictional force is measured by spring balances or weights and the torque is calculated from the product of the frictional force and the radius of its application.

excessive pressure between the brake band and the pulley will be necessary, which will cause overheating of the brake drum and band. On the other hand, if a large diameter brake drum is used with a small fractional-h.p. motor, the frictional force necessary to load the motor will be so small that difficulties will be encountered in its measurement.

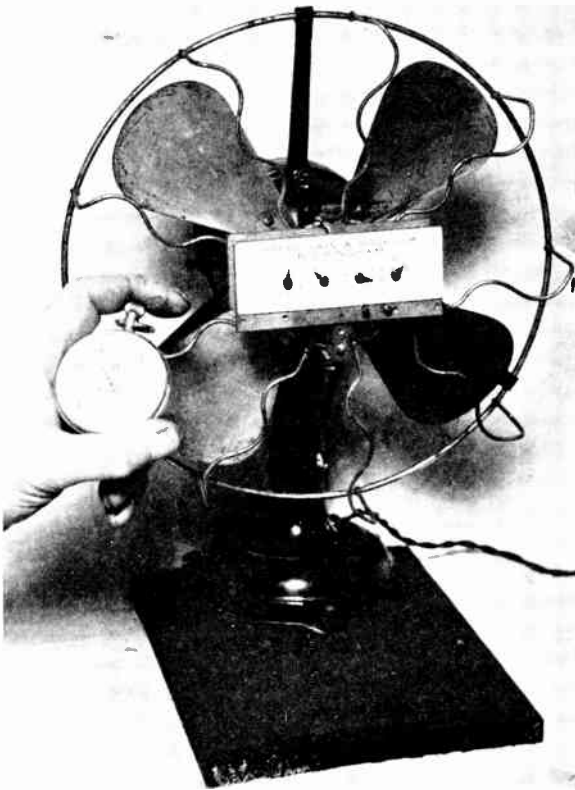

Fig. 2.—DETERMINING THE SPEED OF A FAN MOTOR BY MEANS OF A COUNTER DIAL AND STOPWATCH.

The counter dial is the type used on house service meters and is driven by a light spring connected to the armature shaft.

For fractional-h.p. motors a cord or small rope will give sufficient friction, but for larger motors a band or brake blocks must be used. A water-cooled pulley or brake drum is necessary for motors above 3 h.p. if tests are required over a range of loads.

The Brake Drum.

The diameter of the pulley or brake drum is important. If it is too small,

Practical Details.

A brake drum 2 in. in diameter gives good results with small fractional-h.p. motors: a $3\frac{1}{2}$ -in. drum is suitable for $\frac{1}{2}$ -h.p. motors and a 6- or 7-in. drum is suitable for 1-h.p. motors. For 2-3-h.p. motors, running at speeds between 1,200 and 1,500 r.p.m., the brake drum should be about 8-9 inches in diameter. For 5-h.p. motors a 10-12-in. water-cooled drum is necessary.

The smaller drums should have shallow flanges to prevent the cord, rope or band sliding axially off the drum. The larger water-cooled drums are not flanged, as the brake blocks for these drums are fitted with check plates to limit the axial movement of the blocks on the drum.

Brake Cord and Rope, Practical Details.

For small fractional-h.p. motors ($\frac{1}{10}$ -h.p.) a cord about $\frac{1}{16}$ -in. diameter wrapped once round the 2-in. brake drum is very satisfactory; and for a $\frac{1}{4}$ -h.p. or $\frac{1}{2}$ -h.p. motor a $\frac{3}{8}$ -in. diameter rope wrapped once round a 3-in. or $3\frac{1}{2}$ -in. brake drum is very satisfactory.

Brake Bands, Practical Details.

For larger outputs a band extending over half the circumference of the brake drum gives satisfactory results. A piece of 2-in. by $\frac{1}{8}$ -in. canvas belting is suitable for motors of 1-2 h.p., and a piece of 3-in. by $\frac{3}{8}$ -in. canvas belting on a 9-in. drum is suitable for a 3 h.p. motor. In place of the canvas belting, a band of Ferodo or other specially prepared friction brake material may be used, but in this case the thickness of the band should not

exceed $\frac{3}{16}$ in. and the diameter of the brake drum should not be less than 8 inches, as these materials are not so flexible as the canvas belting.

A Durable Brake Band.

Excellent results have been obtained over extended tests on 1-2-h.p. motors using a Ferodo band 2 inches wide and $\frac{3}{16}$ in. thick on a 9-in. dry brake drum. This Ferodo band was found to be much more durable than similar bands of canvas belting owing to its ability to withstand heat, whereas with brake bands of canvas belting the heat produced by the friction of the band on the brake drum chars the surface of the band soon becomes glazed and brittle.

An ideal brake band for 1-3-h.p. motors would consist of a canvas band 2-3 in. wide and about $\frac{3}{16}$ in. thick with a Ferodo lining (next to the brake drum) about $\frac{1}{16}$ in. thick.

An Important Point.

An important point when using canvas and Ferodo brake bands is that the surface of the brake drum must be dry and free from grease and oil.

Brake Blocks, Practical Details.

Wooden brake blocks are used on the

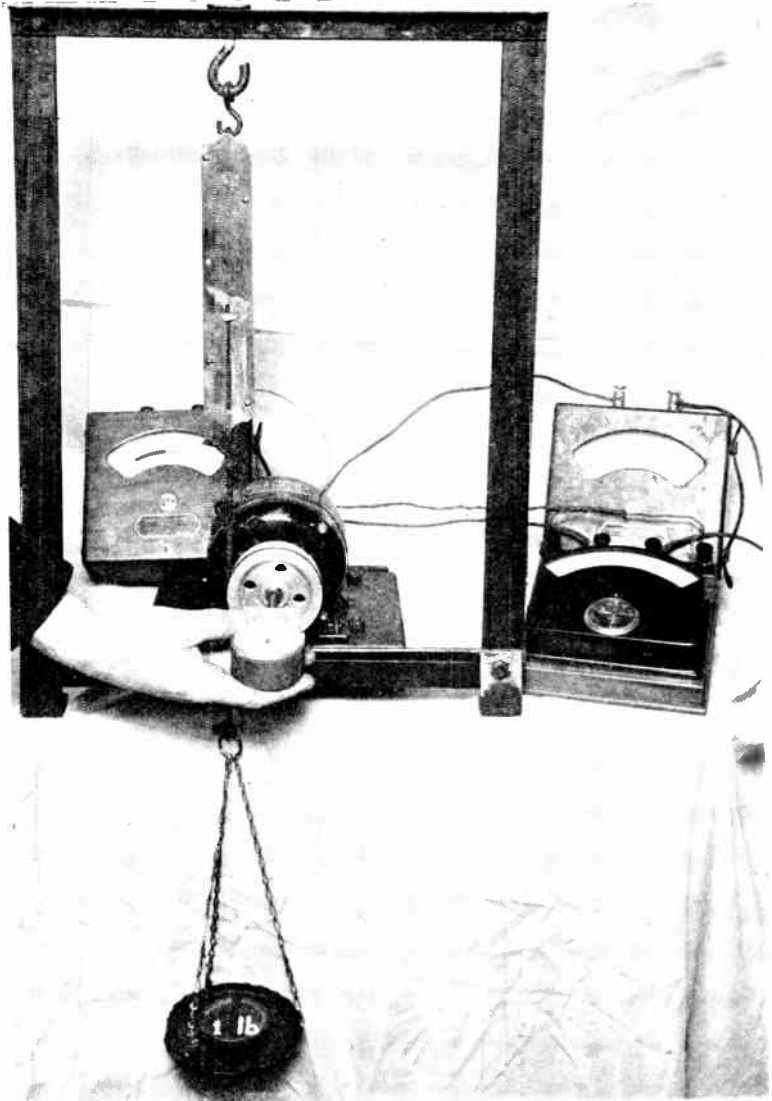

Fig. 3.—ROPE BRAKE AND TESTING STAND FOR TESTING FRACTIONAL H.P. MOTORS.

The rope (about $\frac{1}{8}$ inch in diameter) is wrapped once round the grooved pulley, one end being attached to the spring balance and the other end to the scale pan. The motor on test is a $\frac{1}{2}$ -h.p. single-phase motor, and the measuring instruments include a voltmeter (left), an ammeter and a wattmeter. The speed is measured by a tachometer.

brake drum for motors of 5 h.p. and above.

For a 5-h.p. motor and a 12-in. brake drum, about eight blocks each about 3 inches square and about $\frac{3}{4}$ to 1 in. thick are satisfactory. The surfaces of the

blocks are shaped to fit the drum, and each surface has two shallow diagonal grooves for holding grease. The blocks may be fitted to a band of thin sheet steel

frictional force between the brake band and the brake drum depends upon the pressure between the band and the drum. In brakes where the band covers only

one half of the circumference of the drum the pressure is varied by applying a tension to the tight side of the band. When the band is applied to the underside of the brake drum the required tension is obtained by means of a handwheel and screw, as shown in Fig. 4. But when the band is applied to the upper portion of a bracket drum, the tension is varied by changing the weight attached to the tight side of the band.

With brakes in which a cord or rope is wrapped once round the brake drum, the frictional force is varied by altering the weight or force applied to the tight side of the rope, as explained in the following section.

How the Speed is Measured.

The speed of rotation of the armature in revolutions per minute must be measured accurately, as any error in the measurement of the speed affects directly the calculated output, since the latter is proportional to the product of speed and torque.

Various speed-measuring instruments are shown in Fig. 1.

Revolution Counter.

On the left in Fig. 1 is a Starrett revolution counter. The rubber-tipped spindle (which is lightly pressed into the shaft centre of the motor) is worm geared to the central bevelled disc, which makes one revolution for each 100 revo-



Fig. 4.—BAND BRAKE AND TESTING STAND FOR SMALL MOTOR.

The ends of the brake band are attached to spring balances which measure the tensions in the tight and slack sides.

The motor on test is a 2-h.p. three-phase induction motor, and the measuring instruments include a voltmeter, an ammeter and a double (polyphase) wattmeter.

to encircle the brake drum, and the ends of this band may be fitted with lugs, with a bolt and nut for adjusting the tightness of the blocks on the drum.

How the Torque is Varied and Adjusted.

With all mechanical friction brakes the

lutions of the spindle. The portion of the frame surrounding the disc is divided into 100 parts and an index mark on the disc enables the number of revolutions to be read. The revolution counter must be used in conjunction with a stop watch, and the best procedure is to time a given number of revolutions. To reduce the magnitude of any errors, the period of the timing should not be less than a minute.

Stop Watch.

The stop watch shown adjacent to the revolution counter in Fig. 1 is a special type developed by Venner Time Switches for testing purposes. The large hand makes one complete revolution in 10 seconds, and as the dial is divided into 100 divisions, very accurate timing is possible.

Such methods of speed measurement, however, are useless when the speed is fluctuating, and in these cases a tachometer or speed indicator must be used.

Tachometers.

These instruments have a flyball mechanism geared to the driving spindle (which is inserted in the shaft centre of the motor), the movement of the balls causing the pointer to move over the dial and give the speed directly. Such instruments must be calibrated by reference to a standard instrument, and the calibration should be checked from time to time, as

wear of the internal parts is liable to cause errors in the indications.

Two forms of tachometer are shown in Fig. 1. The one in the centre of the illustration has a change-speed gearbox giving three speed ranges; the one on the extreme right has two spindles giving two speed ranges.

Synchronised Revolution Counter and Stop Watch.

This instrument is shown in Fig. 1 between the two tachometers. The left-hand dial is a stop watch, and the right-hand dial is a revolution counter, with extra dials for recording hundreds and thousands of revolutions of the central driving spindle. This spindle is normally disconnected (by means of a spring and clutch) from the worm of the revolution counter, but when it is pressed into the shaft centre the worm is engaged and at the same instant the stop watch is started. The withdrawal of the spindle from the shaft centre causes the simultaneous stopping of the watch and revolution counter. Thus very accurate readings of speed are possible, even over brief intervals of time, such as 10-15 seconds, as the human factor (which is associated with the use of a separate revolution counter and stop watch) is eliminated. Such an instrument is very useful for general testing and for checking the calibrations of tachometers.

TABLE I.—LOG OF TEST READINGS ON A BRAKE TEST OF A 2½-H.P. D.C. SHUNT-WOUND MOTOR WITH THE TESTING BRAKE ILLUSTRATED IN FIG. 4.

Volts.	Line Amperes.	Speed by Tachometer (r.p.m.).	Brake Tensions.	
			Tight side (T ₁) (lb.).	Slack side (T ₂) (lb.).
105	3.5	1,200	0	0
105	5	1,200	4½	1½
104	8.5	1,180	13	4½
103	11.5	1,160	18	5½
102	13.5	1,140	22½	6½
100	15.5	1,130	25½	7½
100	17.5	1,128	28½	8½
100	20	1,120	32½	8¾
99	22.5	1,118	36½	9½
99	24	1,110	30	10
98	27	1,100	41½	10½
98	29	1,095	44	10½

Note.—The method of correcting the readings to correspond to a constant supply voltage will be dealt with in an article on "Calculations relating to D.C. and A.C. motors."

TABLE II.—LOG OF ACTUAL READINGS ON BRAKE TEST OF 200-VOLT UNIVERSAL SERIES-WOUND MOTOR FROM VACUUM CLEANER. A.C. TEST AT 200 VOLTS, 50 CYCLES.

Volts.	Brake.		Speed.			Watts.	Amperes.
	Weight applied to brake cord (lb.)	Tension in slack side of brake cord (lb.).	Revolutions by counter.	Time by stop watch (sec.).	Calculated revolutions per minute.		
200	1.75	0	1,533	19.4	4,750	237	1.33
200	1.05	0	1,568	19	4,950	230	1.28
200	1.55	0	1,620	18.7	5,200	224	1.24
200	1.45	0	1,812	19.6	5,550	218	1.2
200	1.35	0	1,864	19.8	5,660	212.5	1.17
200	1.25	0	1,932	19.2	6,050	205	1.13
200	1.15	0	2,150	19.4	6,650	200	1.09
200	1.05	0	2,375	20.6	6,900	194	1.03
200	0.95	0	2,230	18.5	7,240	188	0.99
200	0.85	0	2,408	19	7,780	180	0.94
200	0.75	0	2,080	21.5	8,300	173.5	0.9
200	0.65	0	2,930	19.5	9,000	165	0.85
200	0.55	0	4,720	29.8	9,440	155	0.81
200	0.45	0	3,120	19.2	10,050	146	0.75

Precautions Necessary When Measuring Speeds of Very Small Motors.

In measuring speeds with any of the instruments shown in Fig. 1 the rubber-tipped driving spindle must be pressed into the shaft centre to obtain sufficient grip between the former and latter to prevent slipping. Thus an end thrust is applied to the motor armature.

With a sleeve-bearing machine of very small output the additional friction caused

by this end thrust, together with the power required to drive the revolution counter or tachometer, may add an appreciable load to that already applied by the brake. Thus both the speed and the input corresponding to a given *brake* load will be in error. Tests have shown, however, that with the careful use of a tachometer and a light pressure, a close approximation to the actual speed may be obtained.

TABLE III.—LOG OF ACTUAL READINGS ON BRAKE TEST OF 200-VOLT UNIVERSAL SERIES-WOUND MOTOR FROM VACUUM CLEANER. D.C. TEST AT 200 VOLTS.

Volts.	Brake.		Speed.			Amperes.
	Weight applied to brake cord (lb.).	Tension in slack side of brake cord (lb.).	Revolutions by counter.	Time by stop watch (sec.).	Calculated revolutions per minute.	
200	1.75	0	1,880	19.1	5,900	1.12
200	1.05	0	1,990	19.4	6,150	1.09
200	1.55	0	2,060	19.6	6,310	1.06
200	1.45	0	2,085	19.4	6,450	1.03
200	1.35	0	2,210	19.1	6,920	1.0
200	1.25	0	2,320	19.6	7,100	0.99
200	1.15	0	2,355	19.6	7,200	0.92
200	1.05	0	2,625	19.9	7,920	0.88
200	0.95	0	2,666	19.7	8,120	0.85
200	0.85	0	2,810	19.7	8,550	0.8
200	0.75	0	2,955	19.7	9,000	0.77
200	0.65	0	3,100	19.1	9,740	0.73
200	0.55	0	3,250	19.5	10,000	0.69
200	0.45	0	5,322	30	10,644	0.65

Special Methods of Measuring Speed.

Other methods of measuring the speed in such cases are:—(1) by means of a high grade dial counter (such as are fitted to house service electric supply meters) and a stop watch; (2) an optical method, e.g., by means of a stroboscopic disc and a vibrating viewing slit having a known and constant period of vibration.

Fig. 2 shows the application of the first method to a desk fan motor. The spindle of the "tenths" dial is coupled to the armature shaft by a light spring which does not apply any end thrust.

The optical (stroboscopic) method is the only method of measuring speed without applying a load to the motor, but it requires a skilled observer and its application is more suited to the laboratory and experimental test room rather than the workshop.

Example of Rope Brake for Fractional-H.P. Motors.

Fig. 3 illustrates a simple brake and testing stand which has given very satisfactory service in the testing of fractional-h.p. motors. The testing frame is built up of flat bars and angle iron, and a block of wood is secured to the base of the frame to act as a base plate for the motor, which is fixed to the block by screws or bolts.

The rope (about $\frac{3}{16}$ in. diameter) is wrapped once round the brake drum; the upper end is attached to the spring balance suspended from the top cross-bar of the frame and the lower end is attached to a scale pan in which are placed various

weights to give the required pressure between rope and drum. The end of the rope to which the scale pan is attached must be the *tight* side, and the direction of rotation for the arrangement shown in Fig. 3 must, therefore, be *clockwise* when

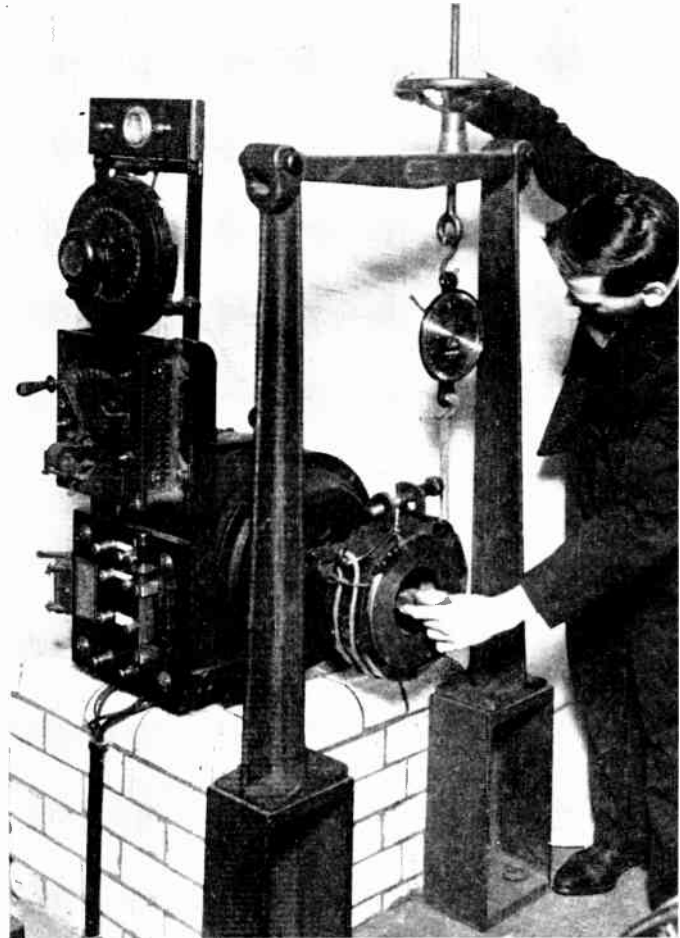

Fig. 5.—WATER-COOLED BRAKE WITH WOODEN BRAKE BLOCKS. The blocks are fitted to a sheet steel band and the pressure is adjusted by the screw bolt. The frictional drag on the brake blocks is measured by the spring balance.

Water is poured into the brake drum at the front as required.

viewed from the brake end, i.e., the friction between the brake drum and the rope tends to lift the scale pan.

The force balancing the retarding force due to friction is equal to the difference between the tensions in the tight and slack sides of the rope. The tension in the

tight side is equal to the weight in the scale pan; that in the slack side is equal to the reading on the spring balance.

Typical test readings are given in Tables II and III.

Example of Band Brake for Small Motor.

Fig. 4 illustrates a simple arrangement of a band brake for a small motor. The

fitted to a band of sheet steel. The ends of this band are fitted with lugs, and also a bolt and nut for adjusting the pressure between the blocks and the drum. The balancing force is measured by a spring balance which is attached to a rope passing round the band and terminating at a hook on one of the lugs. The direction of rotation for the arrangement shown in Fig. 5

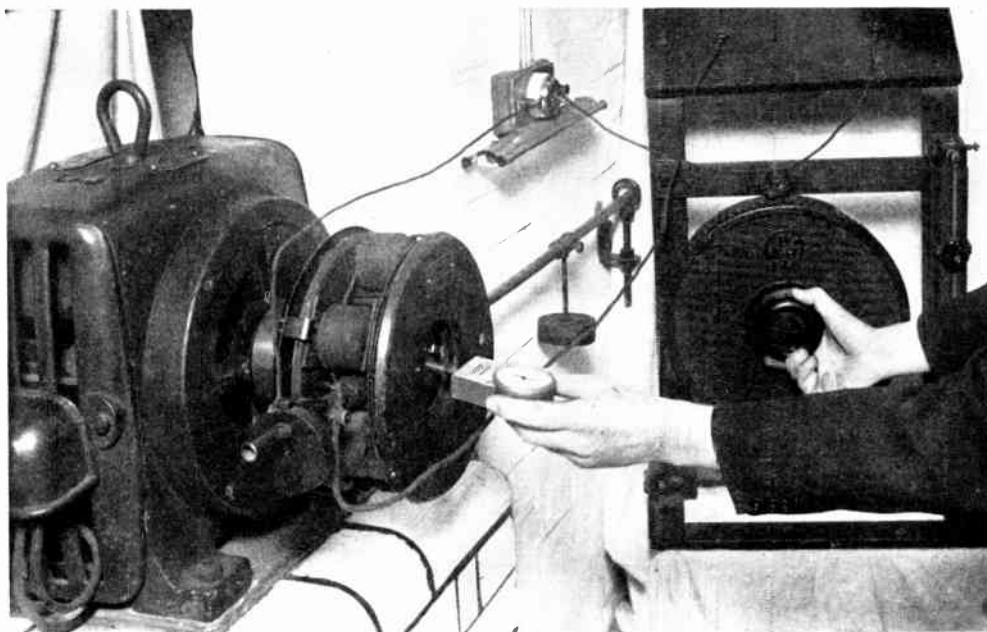

Fig. 6.—AN ALL-ELECTRIC TESTING BRAKE.

This type of brake has many advantages over mechanical friction brakes. It consists of two copper discs which rotate in the magnetic field of a multipolar electromagnet. The torque is adjusted by varying the excitation (as shown) and is measured by means of a weight and graduated yard-arm.

brake drum is 7 in. in diameter and the band is a piece of canvas belting 2 in. wide and $\frac{3}{16}$ in. thick. Small iron plates are riveted to the ends of the band for the purpose of connecting the band to the spring balances which measure the tensions on the tight and slack sides. The spring balance connected to the tight side must be suspended by a screw bolt in order that the pressure between the band and the brake drum may be adjusted.

A typical set of readings is given in Table I.

Example of Water-Cooled Brake.

Fig. 5 illustrates a water-cooled brake drum with wooden brake blocks which are

must be clockwise when facing the brake.

The brake drum has a solid back web and a deep front internal flange, so as to provide a receptacle for water.

When running a test, cold water is poured into the drum from time to time.

For a prolonged test on a 5 h.p. or larger motor, the brake drum requires a continuous supply of cold water, and means for extracting the hot water. The latter is effected by a scoop, which should be placed approximately opposite to the cold water inlet pipe.

Example of Electric Brake for Small Motor.

Fig. 6 illustrates an electric brake

The Weekly for Every- one with a Hobby

"HOBBIES" deals with every practical hobby and handcraft. Every issue contains numerous illustrations which explain how to make such varied articles as Model Aeroplanes and Gliders, Electric Motors, Model Trains, Wireless Sets, pieces of Furniture, Musical Instruments. There are pages for the stamp collector, amateur photographer and collector. Articles on how to do things, how to solder and french polish, do your own printing, how to work in wood, metal, etc.

THE free advice bureau unravels readers' problems in all practical hobbies. The pages are packed with practical and informative matter prepared by expert contributors and artists. Competitions with hundreds of prizes regularly appear.

ALL the features in "Hobbies" are new, and the matter is prepared so that the various articles can be made with a minimum of expense and without an elaborate tool-kit.

Hobbies

and Practical Wireless

Every Wednesday

Twopence

On sale at all Newsagents and Bookstalls, or post free, 3d. (6 months 6/6) from George Newnes, Ltd., 8-11, Southampton Street, Strand, London, W.C.2.

Geo. Newnes, Ltd.

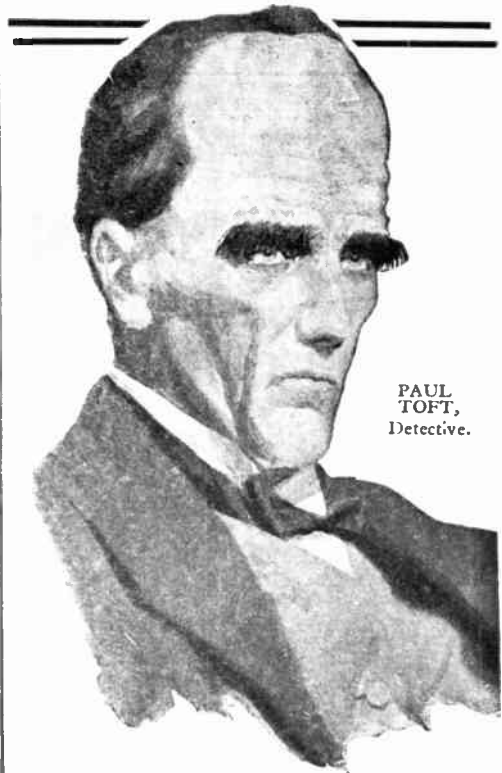

PAUL
TOFT,
Detective.

THE CASE OF THE BURNT-OUT CAR

A thrilling detective story introducing Paul Toft, a detective attached to Stripe Police Station, whose methods of crime detection are highly unorthodox. Ignoring the usual assistance given by clues, circumstantial evidence and so on, he brings an uncanny sense of intuition to bear on a case, generally with success, and often to the embarrassment of his superior officers.

*The Best Detective
Series for Years.*

The April

PEARSON'S MAG. NOW ON SALE 1/-

This article on Testing Small D.C. and A.C. Motors is continued in Part 26. Ready April 8th. Order your copy to-day.

Free Gifts for Gardeners



Be sure to get the following numbers of "Home Gardening," four of which give **FREE** flower seeds with every copy.

THIS WEEK.

FREE packet of **ANNUAL CHRYSANTHEMUM** seeds. With issue on sale April 1st.

FREE packet of **CALIFORNIAN POPPIES** seeds. With issue on sale April 8th.

SPRING GARDENING NUMBER. Specially enlarged. With a beautiful coloured picture cover. On sale April 15.

FREE packet of **ORANGE and LEMON MARI-GOLDS** seeds. With issue on sale April 22nd.

FREE packet of **CARNATION POPPIES** seeds. With issue on sale April 29th.

Be sure to get *your* copy each week

HOME GARDENING

The Gardening Paper which understands Amateurs' difficulties.

2^D