

To be Completed in about 32 weekly parts.

# NEWNES PRACTICAL ELECTRICAL ENGINEERING



**DEALING WITH**

ALL PRACTICAL APPLICATIONS OF ELECTRICITY IN EVERYDAY LIFE.

**INTENDED FOR**

ELECTRIC LIGHTING  
and  
POWER ENGINEERS.  
ELECTRICIANS AND  
WIREMEN.

WIRELESS DEALERS.

STUDENTS,  
APPRENTICES AND  
IMPROVERS IN ALL  
BRANCHES OF  
THE ELECTRICAL AND  
WIRELESS INDUSTRIES.

1 1/2

PART  
17

A PRACTICAL WORK WRITTEN BY EXPERTS

STUDY  
AT  
HOME

YOU CAN HAVE A COLLEGE  
TRAINING IN ALMOST ANY  
CAREER FOR A FEW  
SHILLINGS MONTHLY

IN  
YOUR  
SPARE  
TIME

FOUNDED 1900.

32 YEARS OF SUCCESS.



**THIS IS THE BENNETT COLLEGE - - ALL OF IT**

The Bennett College is not a Rented Room in a well-known street—it is a College. Over 31 years ago the Founder took as his motto what has now become a household slogan:

# LET ME BE YOUR FATHER

In many trades and professions there are more vacancies than trained men to fill them. We do not profess to act as an employment agency, but our gigantic organisation certainly does tell us where the demand exists, thus enabling us to give **FATHERLY ADVICE ON ALL CAREERS AND THE POSSIBILITY OF EMPLOYMENT, FREE.**



*J.B. Bennett*

WE TEACH ALL  
BRANCHES OF  
THE FOLLOW-  
ING VOCATIONS  
AND SPECIALISE  
IN ALL EXAM-  
INATIONS CON-  
NECTED THERE-  
WITH.

**THE MOST SUCCESSFUL AND MOST PROGRESSIVE  
CORRESPONDENCE COLLEGE IN THE WORLD**

Aviation Engineering.  
Boiler Engineering.  
Boiler Making.  
B.Sc. (Engineering).  
Civil Engineering :  
A.M.I.C.E.  
Quantities—Specifications.  
Commercial Art

Concrete and Steel.  
Draughtsmanship :  
Electrical or  
Mechanical.  
Electrical Engineering :  
A.M.I.E.E.  
City and Guilds.  
Engineering Mathematics.  
Foundry Work.  
Heat Engines.

Heating, Ventilating and  
Lighting.  
Internal Combustion Engines.  
Machine Designs :  
Theory of Machines.  
Marine Engineering :  
Motor.  
Steam.  
Mechanical Engineering :  
A.M.Inst.B.E.  
A.M.I.Mech.E.  
City and Guilds.  
Pattern Making.

Mechanics.  
Metallurgy of Steel.  
Mine Electrician :  
A.M.E.E.  
Mining (all examinations).  
Motor Engineering :  
A.M.I.A.E.  
Municipal and County  
Engineers :  
M. and C.E.  
Naval Architecture  
Pumps and Pumping  
Machinery.  
Ship Building.  
Structural Engineering.  
Telegraphy and  
Telephony.

IF YOU DO NOT SEE YOUR OWN REQUIREMENTS ABOVE, WRITE TO US ON ANY SUBJECT.

IT COSTS NOTHING TO ENQUIRE.

Also ask for Our New Book  
(FREE OF CHARGE)

**THE HUMAN MACHINE**

SECRETS OF  
SUCCESS

WE TEACH BY POST IN ALL PARTS OF THE WORLD

Note Address Carefully :

The **BENNETT COLLEGE, Ltd.**, Dept. 119, Sheffield



Dept. 119

# THE DISTRIBUTION OF ELECTRICITY

By REGINALD O. KAPP, B.Sc., M.I.E.E.

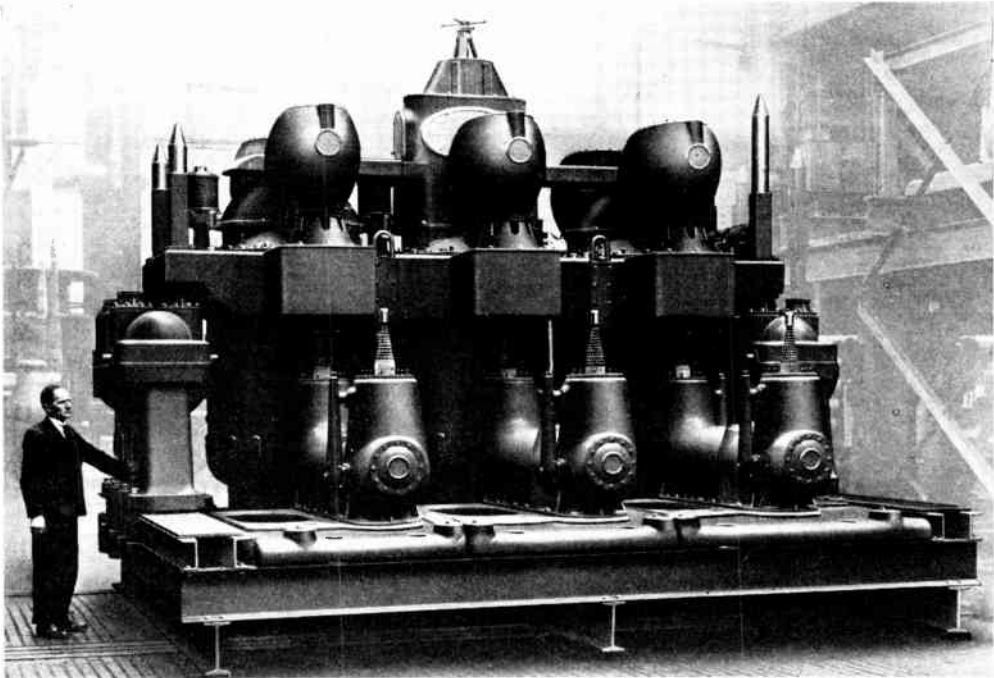

Fig. 1.—A 66,000-VOLT METAL-CLAD SWITCHING UNIT.

This unit is part of equipment supplied to the Battersea Power Station of the London Power Company. (*Metropolitan Vickers.*)

**T**HE electric supply industry in Great Britain has not escaped the Briton's habit of under-rating his nation's achievements. It is very common for someone to point to some foreign country as an example of what ought to be done here, and to imply at the same time that England lags behind the rest of the world in electricity supply.

There is a grain of truth in this view, but if anyone were to take the opposite line and say that England leads in electrical matters there would be a grain of truth in that, too. The error lies in exaggerating this grain and making of it a complete cornfield. It is true that the sales of

electricity per head of population are low in this country; it is true that there is a regrettable lack of uniformity in electricity supply. In some places only continuous current is available; in others only alternating current.

## Variations of Voltages and Frequencies.

There is a great variety of voltages and frequencies, although the latter, at least, are becoming standardised to 50 cycles under the National Scheme. The cost of electricity varies between less than one halfpenny and more than a shilling per unit in different localities and under different circumstances, but these defects

▲



are not peculiar to England. Other countries have a variety of voltages and frequencies, if not always quite such a large variety as Great Britain. Examples can be found elsewhere of charges for electricity equal to the highest occurring here, as well as the lowest, and probably the methods of charging for electricity are, if anything, more rational in Great Britain than in most other parts of Europe.

### **Where Electricity is Not Available.**

Amongst the many indictments brought against electricity supply in Great Britain the most unjust is the charge that there are large and important parts of the country in which electricity is not available. The truth is that all but a very small percentage of the inhabitants of this Island are within reach of an electric supply main. Every important industrial area is completely covered by a network of transmission and distribution mains. All the large and most of the small towns have an electric supply. It is only in sparsely populated rural areas that electricity is not always available, and even in many purely rural districts intensive development is going on at the present time.

### **What Grid Lines are For.**

Such development is not due, or at least not directly due, to the British "Grid." It is perhaps natural that many people should think that these grid lines which they see scattered about the country must be for the purpose of bringing electricity to places which are not yet served, but the instances where the lines owned by the Central Electricity Board fulfil this purpose are rare. The real function of the grid lines is to interconnect generating stations or distributing centres which already have a supply of electricity. By doing this the British grid enables the generating stations to pool their resources and to work to a common programme. It saves the stations a certain amount of spare plant by ensuring them outside help in case of emergency, and it saves a considerable proportion of the national coal bill by enabling the most efficient generating stations to supply the bulk of the national require-

ments and relieve the less efficient ones of the necessity for generating, except at times of peak load or emergency.

### **Making Electricity Cheaper.**

The National Grid, therefore, must not be looked upon as a means of making electricity readily available, except incidentally. The primary purpose of the British grid is to cheapen the generation of electricity. The British grid lines are almost always interconnectors between generating stations and should be regarded as adjuncts to the generating plant, and not adjuncts to the distribution systems.

### **How Electric Supply Undertakings are Formed.**

The distribution of electricity is in the hands of electricity supply undertakings and will still be in the hands of the same undertakings when the whole of the grid scheme is working. An electric supply undertaking may be a company or it may be a local authority such as the corporation of a town, a borough council, an urban district council, or a rural district council. Sometimes a number of various authorities may combine to form an electric supply undertaking. In Great Britain there were last year 276 undertakings owned by companies, and 393 owned by various public bodies, all of which had powers given them by Parliament to supply electricity in certain defined areas. Such an area is very frequently that enclosed within the boundary of a town or district council, but very frequently the area extends beyond such boundaries to the neighbouring villages and rural districts. The greater part of Great Britain has already been parcelled out between the 669 undertakings and so there are only a few gaps left in which there is no authority to give an electric supply. Most of the gaps are in outlying sparsely populated districts, and even these are being filled rapidly by enterprising people willing to develop the electrical possibilities there.

### **Cost of Transmission Systems.**

When an undertaking obtains from Parliament the necessary authority to

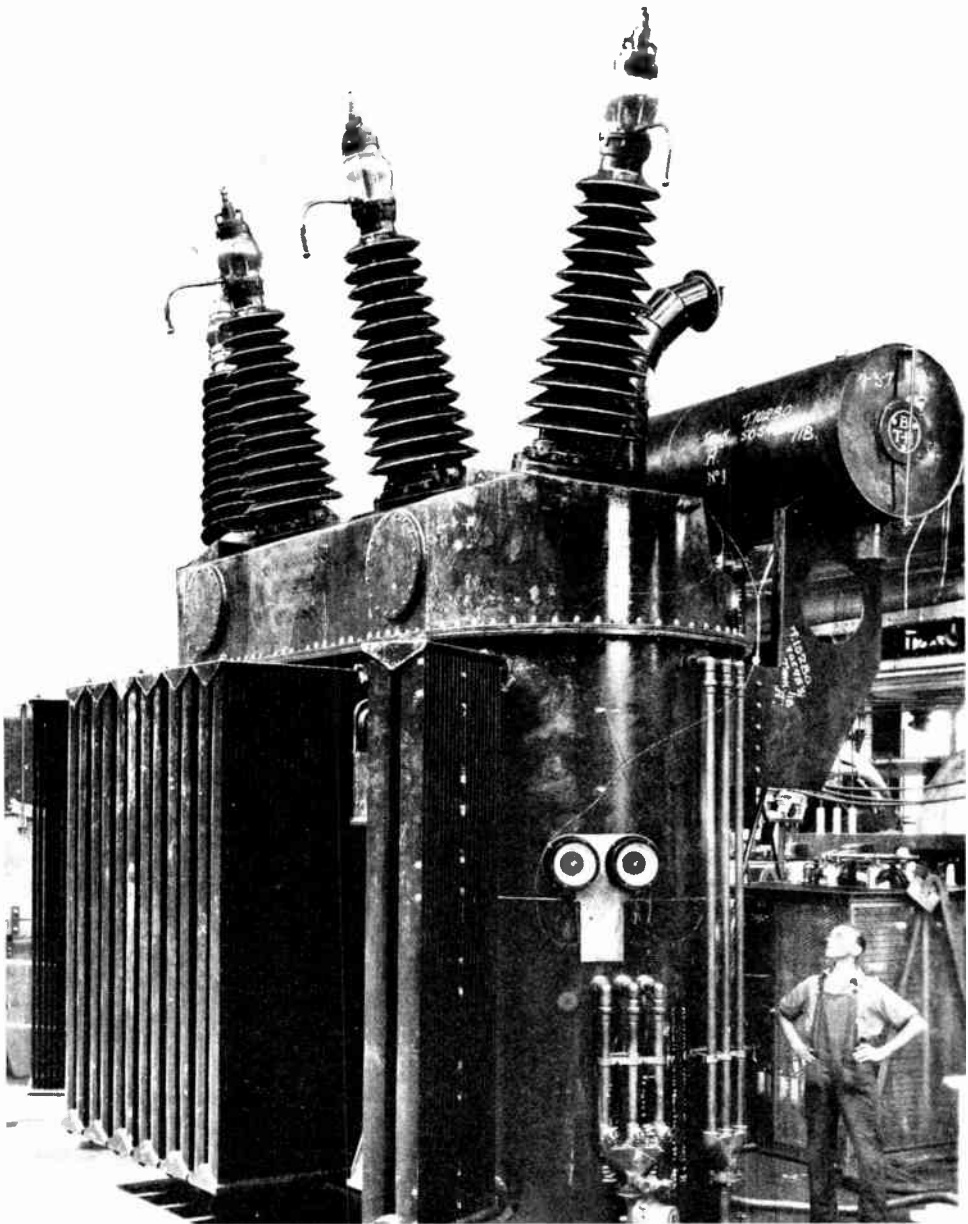

*Fig. 2.*—TRANSFORMER SUPPLIED FOR THE GRAMPAN ELECTRICITY SUPPLY Co. (B.T.-H. Co.)  
The rating is 20,000 K.V.A., three-phase, 11,000, 132,000 volts (partly water-cooled).

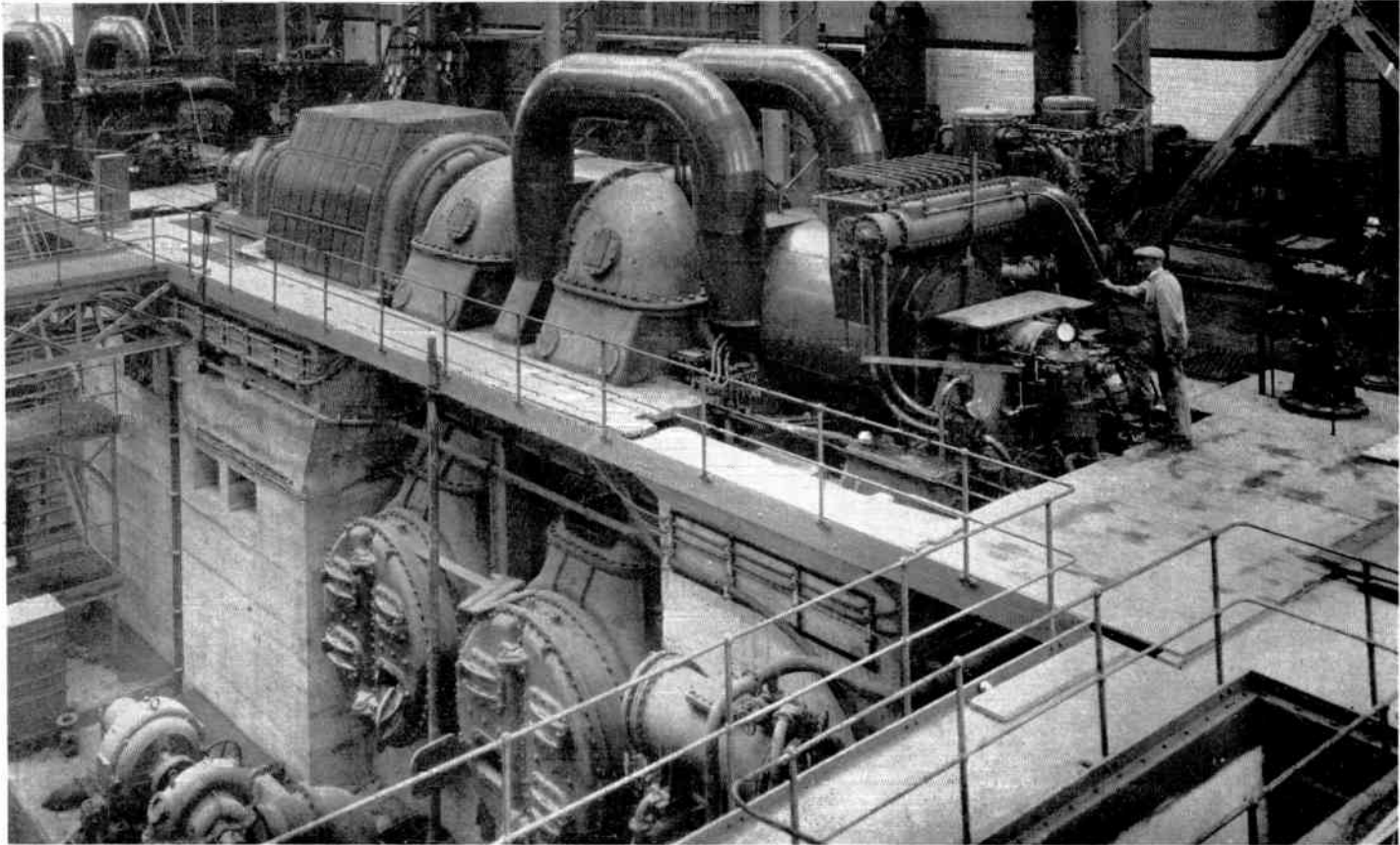

Fig. 3.—Two 18,750 kw., 3,000 r.p.m., 6,600 volts, 50 cycles, Two-cylinder Turbo Alternators at Longford Power Station of Coventry Corporation. (B.T.-H. Co.)

give a supply in a certain district, that supply is, of course, not immediately forthcoming. The undertaking must first design and execute the necessary system of distributing mains. If there are not many people in the district who are likely to buy electricity, the undertaking will hesitate before incurring the heavy expenditure of the main. The cheapest possible transmission system is bound to cost at least a few hundred pounds per mile. Where there are only one or two houses or farms to the mile the proportion of the cost of the mains for each customer is obviously too heavy. As the undertaking is not run on philanthropic lines it would have to charge each customer a fair proportion of the cost of such lines and the customer would certainly prefer to carry on with oil lamps, or similar primitive illumination, rather than pay the very heavy charge for electricity which would be necessary to cover the cost of bringing it to his home. That explains why there are bound to be many places in the country which are within the area of an authorised undertaking, but which cannot obtain electricity from that undertaking, and many others where electricity is expensive.

#### **Present-day Developments.**

But even in country districts, where villages are very close together, intensive construction of electric distribution systems is going on at the present time. Last year, for instance, 1,024 miles of distributing lines were constructed in such rural districts by 277 of the undertakings in the country.

In many parts of the country all the undertakings in a certain district combine to form a joint electricity authority with the purpose of co-operating to obtain a better electrical development of the district.

By far the greatest number of persons in Great Britain live in towns or urban districts, and these have almost invariably an extensive and ever-growing distribution network provided by the local undertaking. Such a network consists of distributors carried in the public streets and tapped into the houses receiving a supply. These distributors are supplied with electricity at certain points through cables

called "feeders." The feeders in turn are supplied from generating stations or sub-stations, and the latter may contain transformers or rotating machinery.

#### **Feeders and Distributors.**

The feeders and distributors are low tension mains carrying current at the voltage at which it is supplied to houses. At this voltage electricity can only be transmitted over short distances. The distance is of the order of a mile or less in a densely populated town, and would not be more than a few miles in a district of sparse demand. In quite a small town a low tension system of feeders and distributors is all that is required, but if the area of supply covers more than one or two square miles, it is necessary to have higher voltage transmission mains to take the current to suitable distributing points. At these distributing points transformers reduce the voltage to that required by the householder. Large individual consumers, such as factories, would also be supplied by the higher voltage system. The most usual transmission voltages in this country are 6,600 volts, 11,000 volts and 33,000 volts. A large undertaking will have a network of mains at one of these voltages with a centre at the generating station.

We, therefore, may now picture a generating station owned by a large undertaking, and from this generating station high voltage mains going out to various parts of the district supplied. At certain points these high tension mains feed transforming stations, from which energy is distributed at lower voltages.

#### **How Electricity is Bought.**

By no means all of the 669 authorised undertakings in Great Britain own a generating station. Nearly all the large towns own at least one generating station and some own two or three, but a great number of the smaller undertakings purchase electricity from some neighbouring larger undertaking. They find it cheaper to do so than to incur the cost of a generating station, with all it entails, for their comparatively small requirements. Thus, for instance, Hampstead Borough Council purchases its electricity from Marylebone,



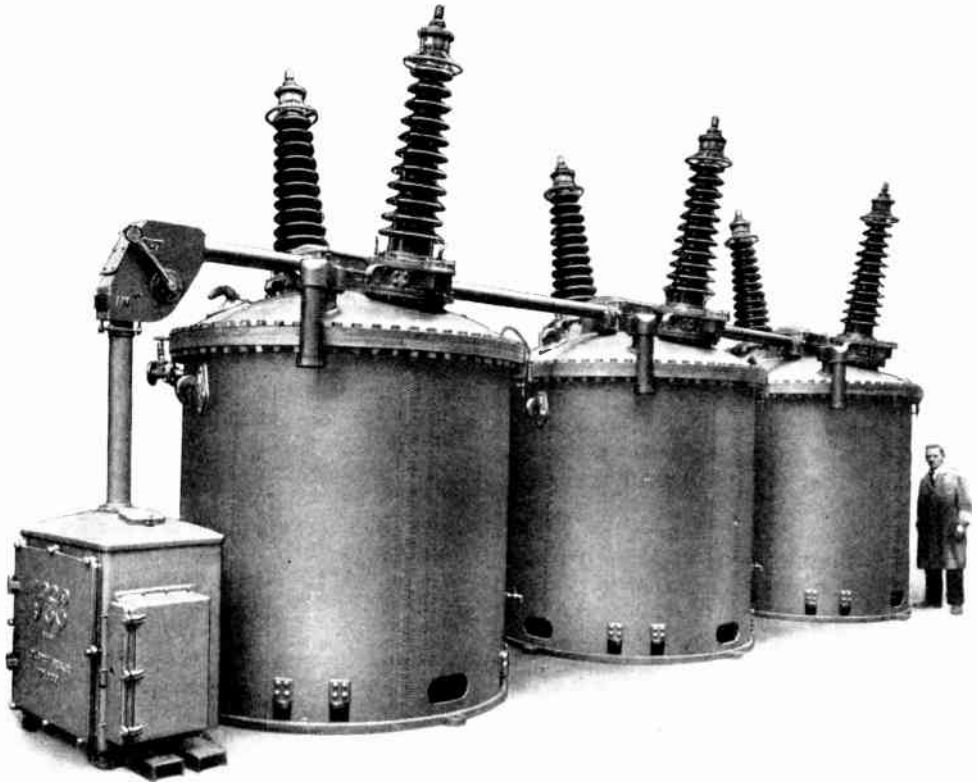

Fig. 4.—ONE OF EIGHTY 1,500,000 KVA, 132,000 VOLTS, OUTDOOR THREE-PHASE OIL CIRCUIT-BREAKERS SUPPLIED BY THE G.E.C. FOR THE NATIONAL GRID.

and Sutton Coldfield from Birmingham Corporation. Both Marylebone and Birmingham are primarily distributors of electricity to householders and factories within their own area. The sales of bulk supply to their neighbour is somewhat of a side issue. There are, however, a number of power companies in Great Britain, the sole purpose of which is to sell bulk supplies of electricity to undertakings which do not generate their own requirements. Such power companies may now be compared with wholesale merchants, whilst their customers, the distributing undertakings, are analogous to retail shopkeepers. Such power companies have acquired the necessary authority from Parliament to give bulk supplies of electricity to distributing authorities within the area defined by Parliament.

#### When High Voltages are Used.

These power companies do not do any of the retail work of electricity supply: they do not distribute it to individual customers. They own one or more generating stations suitably situated within their area, and from these generating stations they construct a network of high tension transmission lines, from which they are able to give the necessary supply to their customers. Such power companies generally cover large areas. The Lancashire and Yorkshire Power Companies, for instance, cover the greater part of their respective counties. They have to transmit the electricity they supply over long distances and, therefore, almost invariably employ high voltages such as 33,000 volts, and frequently even 66,000 volts.



### Joint Transmission Mains.

Such a power company does not supply every town within its area by any means: though Manchester and Liverpool are in Lancashire they neither of them purchase a bulk supply from the Lancashire Power Company, but when a large town adjoins the area of a power company, the two may frequently construct a joint transmission main to interconnect their generating stations for the purpose of mutual help. We thus have a number of interconnectors in different parts of the country as well as the high tension transmission mains and the elaborate network of medium and low tension transmission mains that exist between the generating stations and the individual consumers.

### The Effect of Grid Lines.

In addition to this network, there will soon be throughout the country the inter-

connecting network of the British grid. The primary lines belonging to this system will work at the highest voltage so far adopted for Great Britain, namely, 132 kv. Nearly all the most important centres of distributing undertakings and power companies will be interconnected at this voltage. Where the power to be passed over a grid line is small or the distance of transmission not too great, the national interconnectors will be worked at some lower voltage, generally, 33 kv., but they will still be more in the nature of interconnectors between generating and distributing centres than transmission lines. The British grid lines will have the effect of welding all the generating stations in the country into one unit. They enable all the generating plant to supply a common pool and all the distributing authorities in the country to draw their requirements from this common pool. In this sense they are national bus-bars.

## QUESTIONS AND ANSWERS

**What is the main purpose of the grid system?**

To cheapen the generation of electricity.

**How will this be effected?**

Broadly speaking, by making it possible for the most efficient generating stations to operate at nearly full load during 24 hours of the day, whilst the less efficient stations can in some cases be closed down and in other cases they will only be brought into operation during periods of peak load. A further gain is in the reduction of the amount of stand-by plant necessary.

**How does the grid system operate?**

Generating stations all over the country supply current to the grid, and electricity supply undertakings for the various areas will draw the current as required from the grid lines. After the necessary step-down transformation this current is distributed to consumers' premises.

**What is the voltage at which the grid operates?**

Most of the system is operated at 132,000 volts. In a few cases the lower voltage of 33,000 is employed.

**By what stages would a 460-volt D.C. installation be supplied from the grid?**

A typical system would be as follows:—

Grid.

Oil circuit breakers.

Step-down transformer, 132,000-6,600 volts.

Oil circuit breakers.

6,600-volt busbars.

Step-down transformer, 6,600-460 volts.

Rotary converter, 460 volts A.C., 460 volts D.C.

D.C. circuit breakers.

D.C. busbars, 460 volts.

Distribution pillar.

Feeder cables.

Network box.

Service cable.

Consumers' main fuses.

An alternative system would be to step down 132,000-33,000 volts; then 33,000-6,600 volts; then 6,600-460.

Another method adopted is to step down as follows: 132,000-11,000; then from 11,000-460.

The particular system adopted depends on local conditions, especially as regards the stations which may have to be interconnected at the intermediate voltages.

# PHOTO-ELECTRIC AND SELENIUM LIGHT CELLS

By A. E. WATKINS.

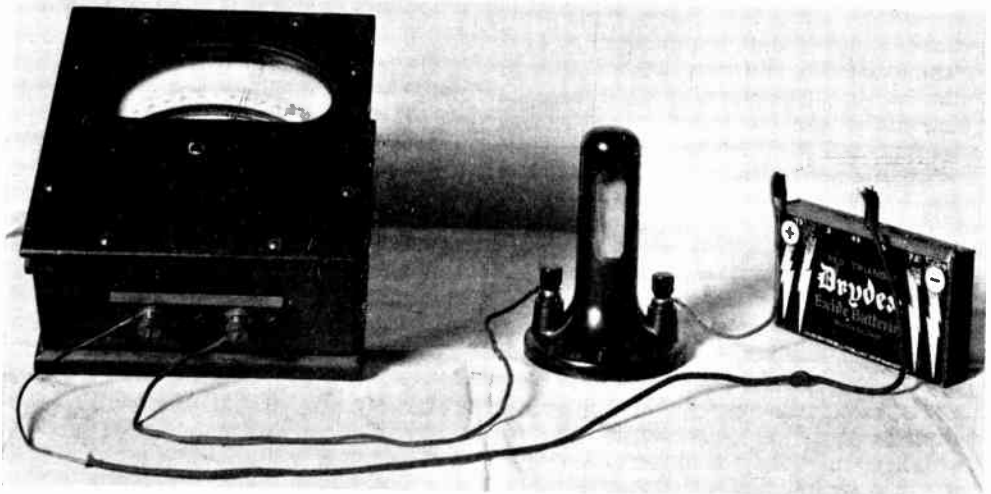

Fig. 1.—HOW THE RADIOVISOR CELL IS CONNECTED UP FOR MEASURING LIGHT.

## Light Cells.

THERE are two types of light cells, the selenium cell or the photo-electric cell. The first is a rare chemical element, and is found in various forms, the grey crystalline being the most essential. Selenium is a bad conductor of electricity but its resistance diminishes on exposure to light.

The second type of light cell is the photo-electric cell, and is the most widely used as it is much more sensitive and quicker in action, and it is these properties which make this class of cell suitable for use in talking pictures, and without this cell the sound on films would not be possible.

## Applications of Photo-Electric Cells.

The applications of photo-electric cells are numerous, for by their use the action of light can be made to control all kinds of instruments such as relays, counting

apparatus, starting and stopping motors, and measuring the intensity of light—and this is very important for such things as spectrophotometry and photometry which require a high standard of constancy, making the use of vacuum cells essential.

## Controlling Switching for Signs.

Another important application to electrical engineering is that of controlling switching for signs. As daylight fails, the signs or lights would be switched on or, if necessary, switched off in the event of daylight. For instance, the ordinary time switch will only switch on the light at a predetermined time of setting, unless some special form of solar dial is used; but by the addition of a light sensitive cell it can be made to switch the lights on at the failing of daylight and to switch off automatically at a predetermined time at evening by clock. This, therefore, makes an absolutely automatic time switch, the

cell operating the switch earlier as the days shorten, while the clock is mechanically controlled for switching off. For this purpose, the selenium cell can be used, as the time lag is not important, but in instances where rapid counting is required, or in the case of sound reproduction, it is necessary to use the vacuum photo-electric cell.

### Photo-Electric Cells for Wireless.

The future of the radio valve may depend upon photo-electric cells, for it is quite probable that it will be possible to use valves which require no filaments, for the light falling on the cathode of the photo-electric cell forms a substitute for the current in the filaments. Filamentless valves in which the light is used as a means of creating an electron discharge have been used, and while considerable illumination is at present necessary to create a workable value of anode current, the practical results obtained are interesting and they undoubtedly indicate the trend of development. It may be that in the near future, instead of using batteries or mains to heat the filaments of valves, we shall only need a constant source of light and it is possible that exposure to ordinary light will be sufficient.

### Using a Valve Amplifier.

As the current of the photo-electric cell is usually not sufficient to operate electromagnetic relays, it is usual to use a valve amplifier, the fundamental circuit of which is shown in Fig. 2. This is a very

powerful method of detecting light and enables an electromagnetic relay operated with about 5 milliamps. to be worked by a single valve. An amplifier designed to operate from the supply mains and embodying such a similar circuit is shown in Fig. 4.

Assuming that the photo cell is kept dark, there will be an open circuit between the electrode. Hence, a current of several milliamps. will flow in the anode circuit of the valve, energising the coil of the relay and holding the armature on. When the cell is illuminated, electron emission from the cathode charges the grid negatively and reduces the anode current to zero, releasing the armature contact M.T. and closing the contact T.M.

### Why Three Contacts are Provided.

It should be clear that the provision of three contacts enables light on the photo cells to switch external mechanism on or off. As the spring contacts of the relays will usually only carry small current, it is necessary when large currents are to be switched on and off to use an extra contactor. That is to say, the small relay will energise the operating coil of a large type of relay which can incorporate mercury switch contacts, therefore, dealing with large currents.

### Control of Light Sensitivity.

The control of the light sensitivity at which the set operates can be effected by adjusting the aperture over the light cell or by altering the value of the resistance R.

Increasing this resistance makes the cell less sensitive to light.

### Measuring the Value of Light Intensity.

If instead of connecting a relay in the plate circuit of the amplifying valve we use a measuring instrument it is possible to measure the

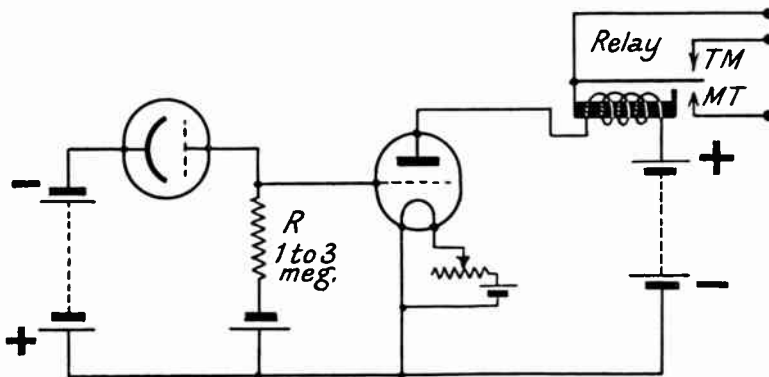

Fig. 2.—Circuit for Using a Valve Amplifier with a Photo-Electric Cell.

value of the light intensity and an instrument of this description would be extremely useful to the electrical engineer for comparing the values of various lamps, as an increase in the intensity of light causes a decrease in the anode current. It must be remembered, however, that the limits of measurement are controlled by the saturation point of the cells, but this can be made very large by means of varying the distance of the source of light. This is the basic principle on which talking films are operated, as it is owing to the varying intensity of the light that the fluctuations in the amplifier are used to operate the loud speakers. The use of photo-electric cells for talking picture work will be found in the article beginning on page 521.

#### Types of Photo-Electric Cells.

These are very varied and wide, and it is almost impossible to classify them as there are so many different shapes of cathodes and the different metals and compounds used in their construction for the different purposes for which they are used.

#### The Cathode.

The cathode may consist of any of the alkaline metals or a combination of them. It may consist of a thin film of these metals either on another alkaline metal or a metal plate, and may have present an intermediate layer of some material such as oxygen. The geometrical construction of the cells may be of any shape to suit the purpose for which it is to be used.

#### Vacuum and Gas-filled Cells.

There is, however, one big division which should be recognised. A difference should be made between vacuum and gas-filled cells. In the former type of cell, the vacuum has a high degree so that a pure electron discharge may pass from the anode to the cathode. In the latter type a certain amount of inner gas is present and the primary electron emission from the cathode surface is amplified by supplying an electric field to produce ionisation by collision. It is essential that the purposes for which the cells are to be used is com-

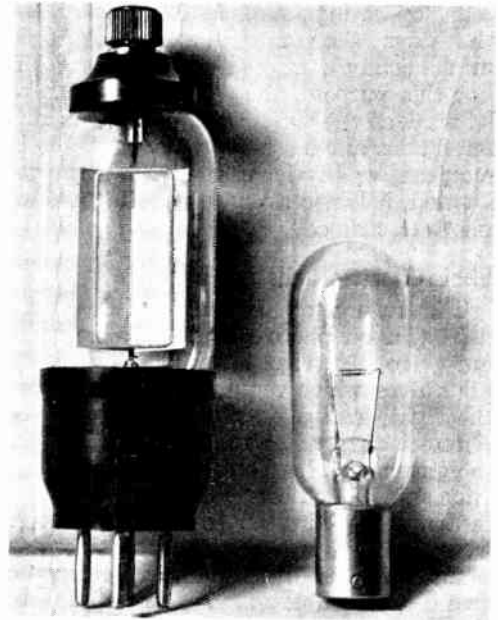

Fig. 3.—LATEST TYPE OF VACUUM CELL AND EXCITER LAMPS. (G.E.C.)

municated to the manufacturers and they will then assist in selecting the correct cell for the purpose. Secondly, owing to the development of photo-electric cells only being of recent years, it naturally follows that great developments are taking place and therefore many new types of cells may have been developed even since this article was written.

Typical illustrations of the latest type of cell manufactured by the G.E.Co. are illustrated in Fig. 3. They consist simply of cathode and anode, there being only two elements.

#### Battery Connections.

The negative of the H.T. battery is connected to the cathode. The anode is connected to the grid of the amplifying valve, while the positive of the H.T. battery is connected to the filament of the amplifying valve. It will be seen that we actually have the reverse action to that of a radio valve. That is the reason why in the circuit shown there are two high-tension batteries—one for the amplifying valve and one for the photo-electric cell. When the photo-electric cell is acted upon



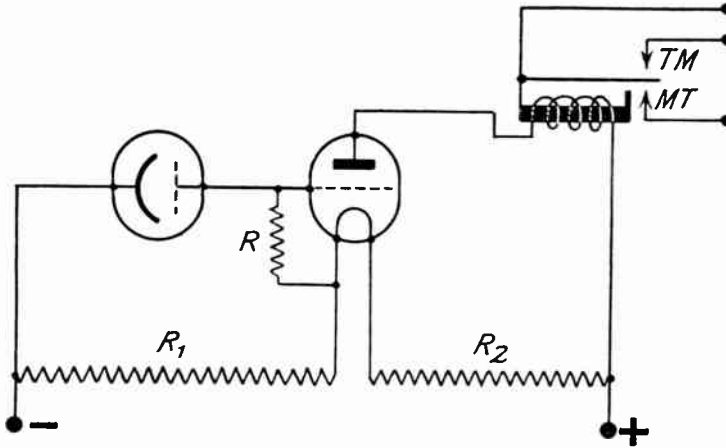

Fig. 4.—CIRCUIT FOR AN AMPLIFIER DESIGNED TO OPERATE FROM THE SUPPLY MAINS.

by light, a negative current is flowing to the grid of the amplifying valve and will cause a current change in the anode circuit of the amplifying valve. The output of the photo-electric cell can be amplified to many million times with remarkable fidelity. With this in mind, together with simplicity of the apparatus required, it will be realised that the application of the photo-electric cells to automatic industrial control is still only in its infancy and is capable of remarkable applications.

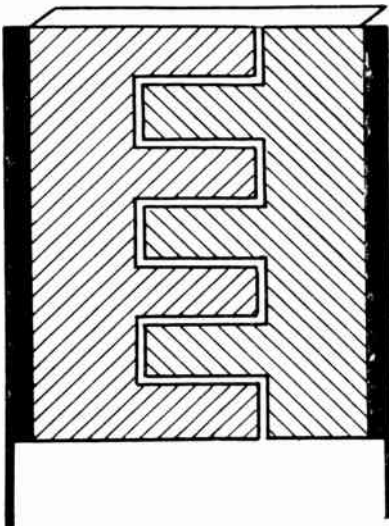

Fig. 5.—THE TWO INTERDIGITATED COMBS WHICH FORM THE ELECTRODE.

### LIGHT SENSITIVE CELLS.

A type of light sensitive cell developed by Radiovisor, Ltd., is worthy of notice, as this development has placed selenium cells in the forefront of light-detecting devices, particularly for those devices for recording and operating relays, etc., for, unlike the photo-electric cell, it is relatively inexpensive and is also much more simple to use.

Earlier types of selenium cells were constructed by covering a narrow gap with selenium. Thus a bridge was constructed by Liesegang by making a fine scratch on a piece of silvered glass and filling the scratch with selenium. Faelfort Bridwell introduced the practice of winding two wires on a block of insulated material and spreading molten selenium over the surface. Others have spread the selenium over the edges of a number of alternate plates of mica and metal and covered the edges with selenium, but in all these types the selenium cells were not very sensitive or quick in action.

### How the Radiovisor Bridge is Constructed.

The construction of the Radiovisor bridge is as follows:—

The base consists of a thin glass surface on which a gold grid is in the form of two interdigitated combs which form the electrode, as shown in Fig. 5.

The gold layer being thin and the combs only approximated at their edges, the

capacity is very small. Molten selenium is spread thinly over the surface and is then subjected to a carefully controlled thermal process by which it is converted into crystalline light sensitive variety. The selenium layer is of the order of  $2.5 \text{ by } 10^3$  cms. in thickness and the effect of the thin layer on a transparent base is to make the utmost quantity of material accessible to light and to leave as little as possible to act as an inert shunt to the active portion. This forms the actual sensitive surface which may be varied considerably in size for special purposes. The standard size being  $25 \text{ m/m}$  by  $50 \text{ m/m}$ .

#### Holding the Sensitive Surface in Position.

This sensitive surface is held by two german-silver clips making contact with the gold electrodes and is enclosed in a glass container which is exhausted and filled with an inert gas and mounted in an ordinary screw socket. It is then subjected to a process of ageing lasting some weeks, when its performance is observed, after which, if satisfactory, it is passed for use. This ageing is done on direct current, the centre contact of the taps being positive. When used on direct current this polarity should never be changed, but the bridge should always be so connected because the crystals in the film are orientated and uniterminal.

#### How the Cells are Set Up.

The Radiovisor bridge thus prepared is permanent, reliable and capable of standing up to high voltages. It can be made to any resistance from about  $\frac{1}{2}$  to 250 megohms and will pass in darkness a

current of from 1 to 250 micro-amps. A standard bridge of about 4 megohms will give a change between current in darkness and in light of the order of 100 to 150 micro-amps. This cell in its finished state can be seen in Fig. 1. The electrical circuit for the use of these cells is simple and where they are required to operate a relay a valve amplifier is used in a similar manner to that used for the light photo-electric valves, that is to say, the change of current is amplified by an ordinary radio valve amplifier. These cells are set up in the usual manner so that a light falls upon the surface of the cells. If this is interrupted there is a current change which takes place in the valve amplifier, therefore operating the relay.

#### Selenium Cells for Sound Reproduction.

It is claimed that these selenium cells can be used for sound reproduction, such as the reproduction of music and speech of a talking film, but it is necessary that a suitable filter circuit should be used, including the low frequency components. A suitable circuit is shown in Fig. 6 with the value of the various components necessary. When the cell is used to reproduce speech it is important that every care should be taken to see that the value of these components are adhered to. With the further development of these cells it is quite possible that home talking pictures will be a possibility, that is to say, of the type using sound on the film, for with the standard photo-electric cell the equipment is very expensive. In any case, there is a lot of experimental work for those who are interested in this direction.

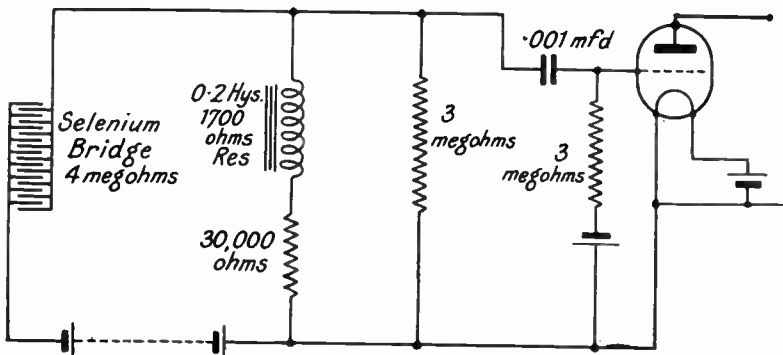

Fig. 6.—CIRCUIT SHOWING THE INCLUSION OF A SUITABLE SOUND FILTER FOR USE WHEN A SELENIUM CELL IS USED FOR SOUND REPRODUCTION.

# THE ILLUMINATION OF A DOMESTIC INSTALLATION

By E. H. FREEMAN, M.I.E.E.

**I**N designing a lighting scheme for a private house the illuminating engineer is usually forced to subordinate his own ideas to those of the architect or the house-owner. As a rule, the client decides the principle of the lighting scheme and the engineer has only to arrange the details to suit those principles. The position is further complicated by the fact that the decorative arrangements are practically never decided when the lighting scheme is being settled and the engineer has to work out his technical design without knowing whether walls will be dark or light; whether brackets will be of candle lamp type or something quite different, and so on.

## Maximum Number of Points Allowed.

Fortunately these difficulties do not prove as serious in practice as they appear at first sight. The maximum number of points allowable on a circuit is 10 under I.E.E. rules, and as domestic loads rarely average over 40 to 50 watts per point there is an ample margin on each circuit for larger lamps to meet any special requirement in one room or another.



Fig. 1.—TYPICAL PENDANT SUITABLE FOR A DRAWING-ROOM.

Also, in houses up to eight or ten bedrooms, the length of main cables is not great and very little extra cost is incurred if these are put in rather larger than is really necessary. The result is that for a very small extra cost the whole installation can be designed to meet any special requirements likely to occur and it is always wise to make such provision as this.

The attached plans (Figs. 2A and 2B) show an imaginary house and the simplest method of illustrating the problems of a domestic installation will be to carry through the complete design of a suitable lighting scheme.

The scheme can be begun at the hall, continued through the reception rooms to the domestic offices and then on to the various bedrooms and other rooms on the first floor.

## THE GROUND FLOOR.

### Entrance.

A light will be required outside and may be either a pendant in the porch or a bracket outside. This depends on the details of the design, headroom available in the porch, and, most of all, on the owner's

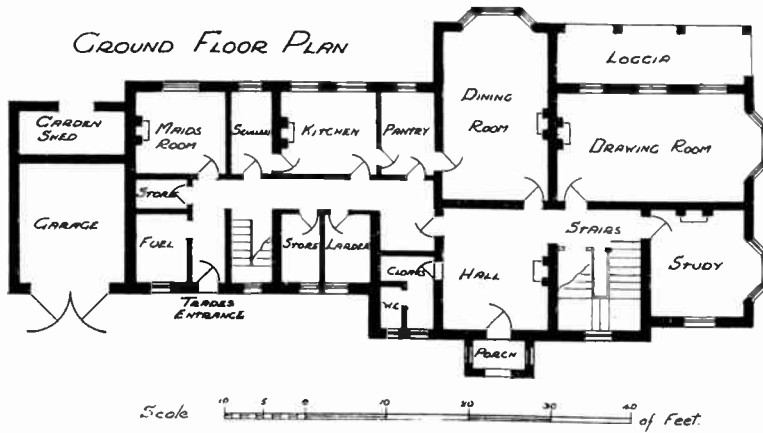

Fig. 2A.—GROUND FLOOR PLAN OF AN IMAGINARY HOUSE.

The complete design of a suitable lighting scheme for this house is described in the article.

wishes. Whatever fitting is adopted a lamp of 40 to 60 watts will be sufficient.

With regard to the question of switch arrangements, particulars of switches and types of light switches now available, together with appropriate wiring diagrams, will be found on pages 329-340.

**Hall.**

A central light will probably be best, though the owner might wish to have brackets by the fireplace. The hall is about 14 feet square or, say, 200 square feet in total area. Probably 3 to 4 candle-feet will be sufficient so that the total nett lumens required would be 600 to 800, or, allowing for losses, lamps giving about 1,000 to 1,200 lumens would be required. Assuming the supply is 230 volts, it will be found from the makers' lamp tables that a 100-watt pearl gas-filled lamp will give 1,130 lumens, and this will therefore suit the requirements.

If two brackets are preferred—say each two-light—there will be four lamps, and these could be 40-watt with an output of 316 lumens each, making a total of 1,264 lumens.

Note, in passing, the relative efficiency of the two schemes. The brackets require 150 watts

for 1,264 lumens, whilst the single pendant requires only 100 watts for 1,130 lumens—i.e., the brackets require 60 per cent. more current for only 11 per cent. extra lumens.

**Staircase Hall.**

This is a small area and a pendant near the foot of the stairs will be ample with a 40-watt

or 60-watt lamp, according to the type of fitting used.

**Study.**

For a study, the best scheme of lighting is undoubtedly a central pendant with one or two plugs for standard lamps—say, one near the window for a writing table and another near the fire for a reading lamp (see Fig. 4).

The room is about 150 square feet in area and the central lamp should give 5 to 6 candle-feet—say, 800 to 900 lumens nett or about 1,200 actual from the lamp, i.e., a 100-watt lamp will suit, as in the hall.

The lamps for the plugs should be taken as 40 to 60 watts.

**Drawing-room.**

The lighting of the drawing-room will

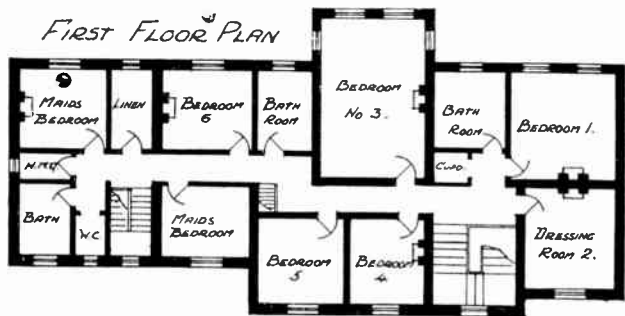

Fig. 2B.—FIRST FLOOR PLAN.





*Fig. 3.*—SUITABLE LIGHTING ARRANGEMENT FOR A DRAWING-ROOM  
Showing a centre pendant and wall brackets.

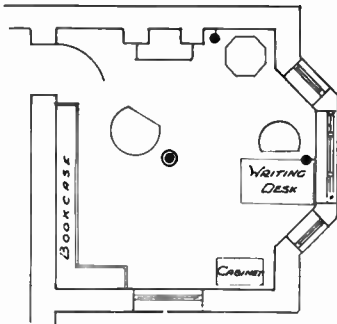

Fig. 4.—SUITABLE SCHEME OF LIGHTING FOR A STUDY.

certainly need to be designed in accordance with the owner's personal taste. Pendant lighting will be most efficient and also cheapest to install. The room is 24 feet by 12 feet or, say, 288 square feet, and the illumination should be 5 to 6 candle-feet requiring a total of, say, 1,600 lumens nett or 2,500 to 3,000 gross. A single 200-watt lamp (2,600 lumens) would provide this. The lighting would certainly be uneven in an ordinary room of 9 to 10 feet in height, but as there will be plugs for local lighting this will not be important (see Fig. 5).

Two pendants, each with a 100-watt lamp, would give much more uniform lighting, but may not suit the ceiling decorations, if any.

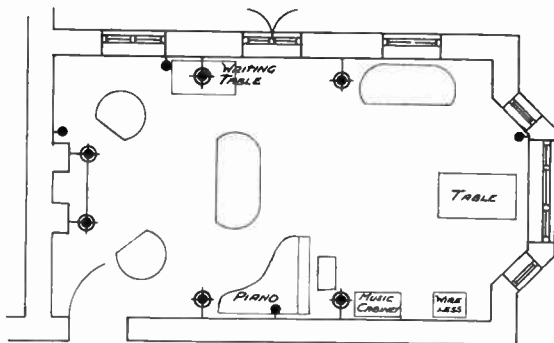

Fig. 6.—AN ALTERNATIVE SCHEME FOR DRAWING-ROOM.  
Using six wall brackets.

### Brackets for the Drawing-room.

If brackets are selected, there might be four or eight of these, and they may be one, two or three lights each. With four brackets, the lamps for each must give about 600 to 700 lumens and a 60-watt lamp (570 lumens) or two 40-watt (each 316 lumens) would be suitable. If 60-watt lamps are used, however, care must be taken in selecting the fittings to avoid glare. The brackets would normally be fixed at 7 feet or thereabouts from the floor and would thus be nearly opposite the eyes. If not carefully screened they would be most unpleasantly glaring and for this reason it would be much better

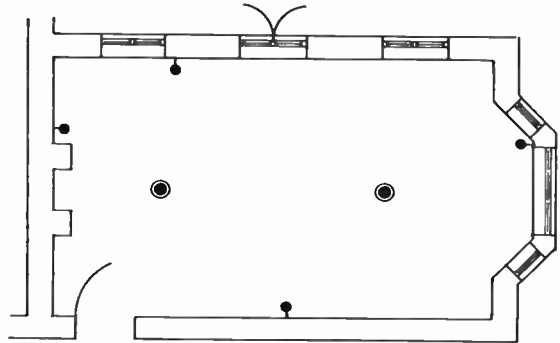

Fig. 5.—SCHEME FOR DRAWING-ROOM.  
Showing position of two pendants and plugs for local lighting. (Furniture arranged as in Fig. 6.)

to use eight (or perhaps six) brackets with smaller lamps. Six brackets each with two 30-watt lamps would certainly be the most satisfactory scheme (see Fig. 6).

It is quite probable that smaller lamps than those calculated would be large enough, as plugs should be provided at positions to suit the probable arrangements of the furniture. There may be a writing or work table near the window; a piano will go near one of the inner walls and away from risk of dampness, and a standard lamp near the fire would be desirable. Three or four plugs could thus be located, and if these are in use as required, the pendant or bracket lamps could be reduced. The wiring should be

installed to carry the larger lamps, however, whether the plugs are available or not.

### Dining-room.

The dining-room of such a house as this is another room where the opinions of the owner must decide the lighting scheme. The room would probably not be much used, except for meals, and with a room such as this, with the fireplace at one end and a large projecting bay at the other, it is possible that meals might be served at the inner end in winter and at the window end in summer. Such a possibility would call for two pendants—one opposite the fire and the other near the bay. On the other hand, many householders much object to pendant lighting in a dining-room and prefer brackets. In either case, with an area of 20 feet by 14 feet, or 280 square feet, a total nett light output of about 1,200 to 1,400 lumens would be required or, say, 2,000 to 2,500 gross—allowing for the fact that a dining-room may be panelled or furnished with a darker paper than a sitting-room (see Fig. 10).

### Brackets for the Dining-room.

If brackets are used, the individual lamps must be small in size, as guests at table will be facing directly towards

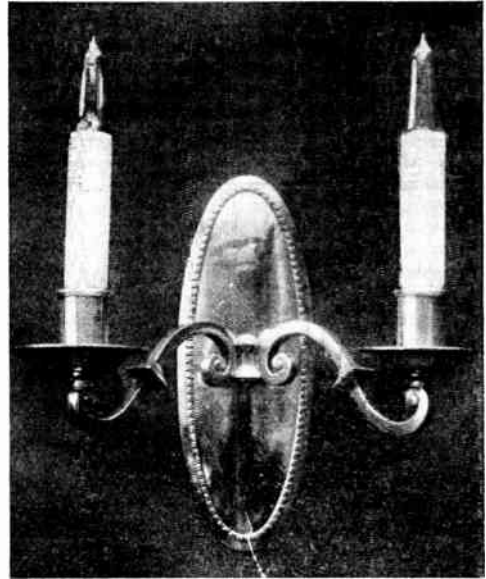

Fig. 7.—TYPE OF WALL BRACKET SUITABLE FOR USE IN EITHER DRAWING-ROOM OR DINING-ROOM.

them. If the lamps are limited to 20-watt, giving 152 lumens each (230 volts being the assumed voltage), about 14 to 16 such lamps would be required. Six two- or three-candle brackets would thus be suitable—one each side of the fire and one farther along the same wall; two on the opposite wall and one on the inner end wall where a carving table might well be located (see Fig. 11).

If pendants are used, two six-light 20-watt candle fittings would suit, as the lights being directly over the table the total illumination could be slightly reduced. Dim lighting in the corners of the room will not be important, but an extra light would be advisable over the carving table—say, a plug with standard lamp.

Another plug by the window and one by the fire, in case the room is required for general purposes, might also be desirable.

### Loggia.

The loggia does not require any special lighting as a rule in this country, as the occasions when it is possible to sit outside after dark are not frequent. One pendant



Fig. 8.—ANOTHER TYPE OF PENDANT SUITABLE FOR A DRAWING-ROOM (SEE ALSO FIG. 1).



Fig. 9.—TYPICAL ARRANGEMENT OF LIGHTING IN A DINING-ROOM.



in the centre or a bracket on the wall or a plug for a standard lamp would be ample, each suitable for about a 60-watt lamp.

**Pantry.**

A single light of 40 watts should be sufficient for this. The room is more a passage than a working area and the light would best be central, unless a sink or table for cleaning silver is provided near the window, in which case the light should be placed to suit this.

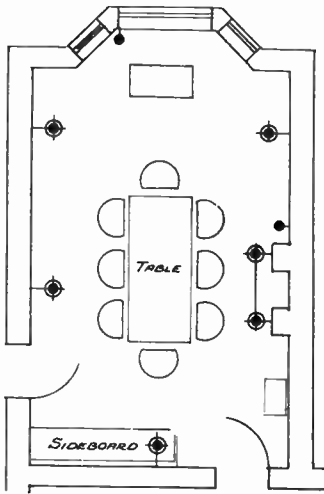

Fig. 11.—ANOTHER SCHEME FOR DINING-ROOM. Using six wall brackets.

**Kitchen.**

The working area of the kitchen will almost certainly be a central table, and a single central pendant with a 60-watt lamp will provide all that is required, except for the range. For this a local pendant, adjustable bracket or plug and hand lamps will be desirable, as the cook will be directly "in her own light" if only the centre pendant is available.

**Scullery.**

A pendant over the sink is best in this room, i.e., at the position where the work is done. A 25-watt lamp will probably be sufficient, but 40 watts would be preferable.

**Stores and Larder.**

A pendant with 25-watt lamp in each case will be ample.

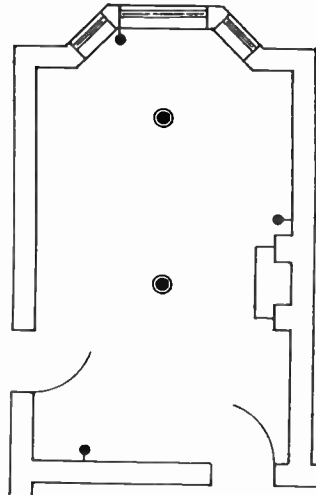

Fig. 10.—SCHEME FOR DINING-ROOM.

Showing position of two pendants and plugs for local lighting. (Furniture arranged as in Fig. 11.)

**Maid's Sitting-room.**

A single central pendant will suit this room, and a 60-watt lamp will give ample light over the table for working—or for reading if sitting in front of the fire.

**Cloaks.**

A pendant in each section of this will be best—over the basins, if any in the lavatory, but otherwise central. Lamps of 25 watts would be sufficient, but it would be as well to allow for 40 watts.

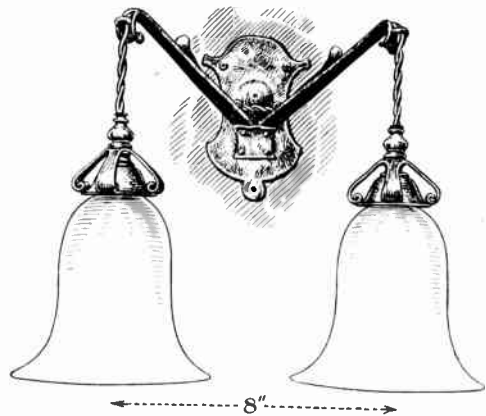

Fig. 12.—A WALL BRACKET SUITABLE FOR EITHER DRAWING-ROOM OR DINING-ROOM.

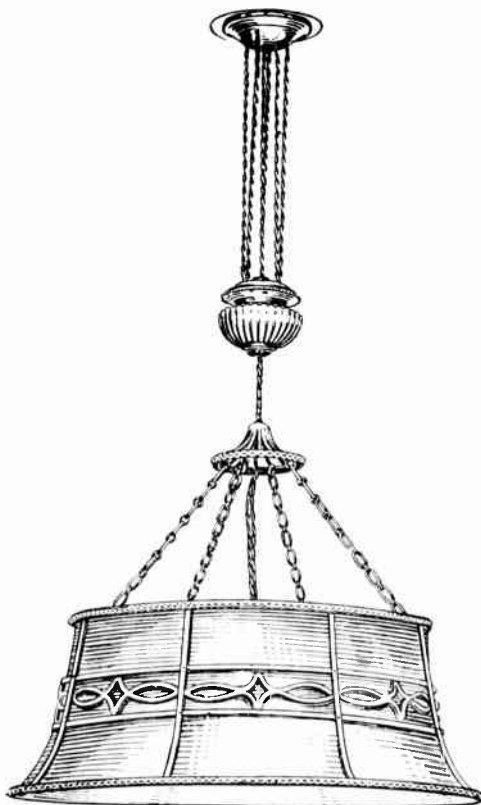

Fig. 13.—A SUITABLE PENDANT FOR USE IN A DINING-ROOM LIGHTING SCHEME.

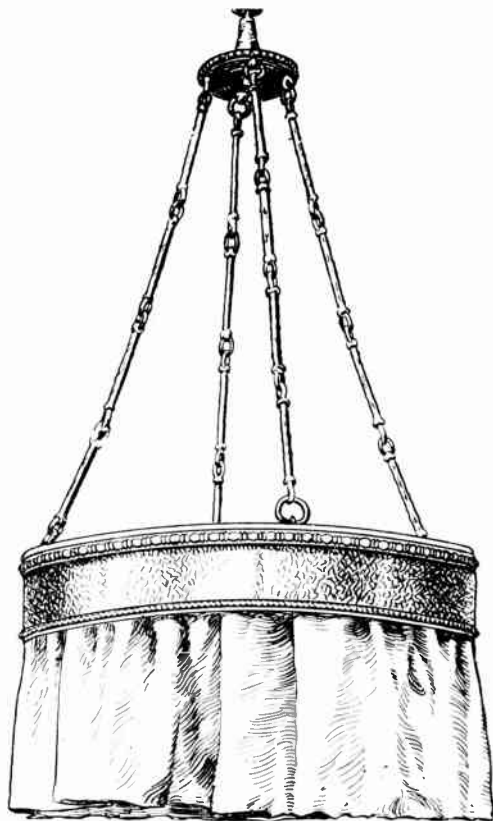

Fig. 14.—ANOTHER PENDANT FOR DINING-ROOM. This is fixed to the ceiling by a hook.

### Corridors.

Lights will be required in the corridors at a spacing of about 25 feet, with extra lights if there are awkward corners. For the plan shown a light will be required in the covered way and one other near the trades' door. One light near the foot of the service stairs will be necessary and one in the centre of the lobby outside the servery.

### Garage.

A pendant and a plug for hand lamp will provide all the lighting required for the garage. It is not

necessary to light the whole area, and a 60-watt lamp in the pendant and a 40-watt lamp in the hand lamp will be quite sufficient. Both points should be located if possible according to the way the owner drives in his car. Some drivers always back in, and pendant and plug should then be near the front so that the lights will be over the bonnet of the car. Alternatively, if the owner drives straight in, the lights should be towards the back of the garage. A central light is nearly

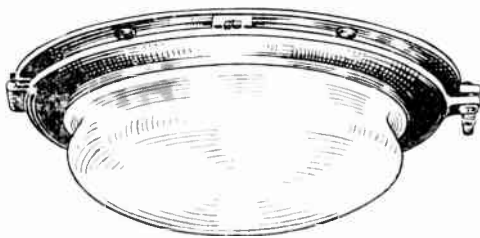

Fig. 15.—A FITTING SUITABLE FOR CEILING IN THE CENTRE OF A BEDROOM.

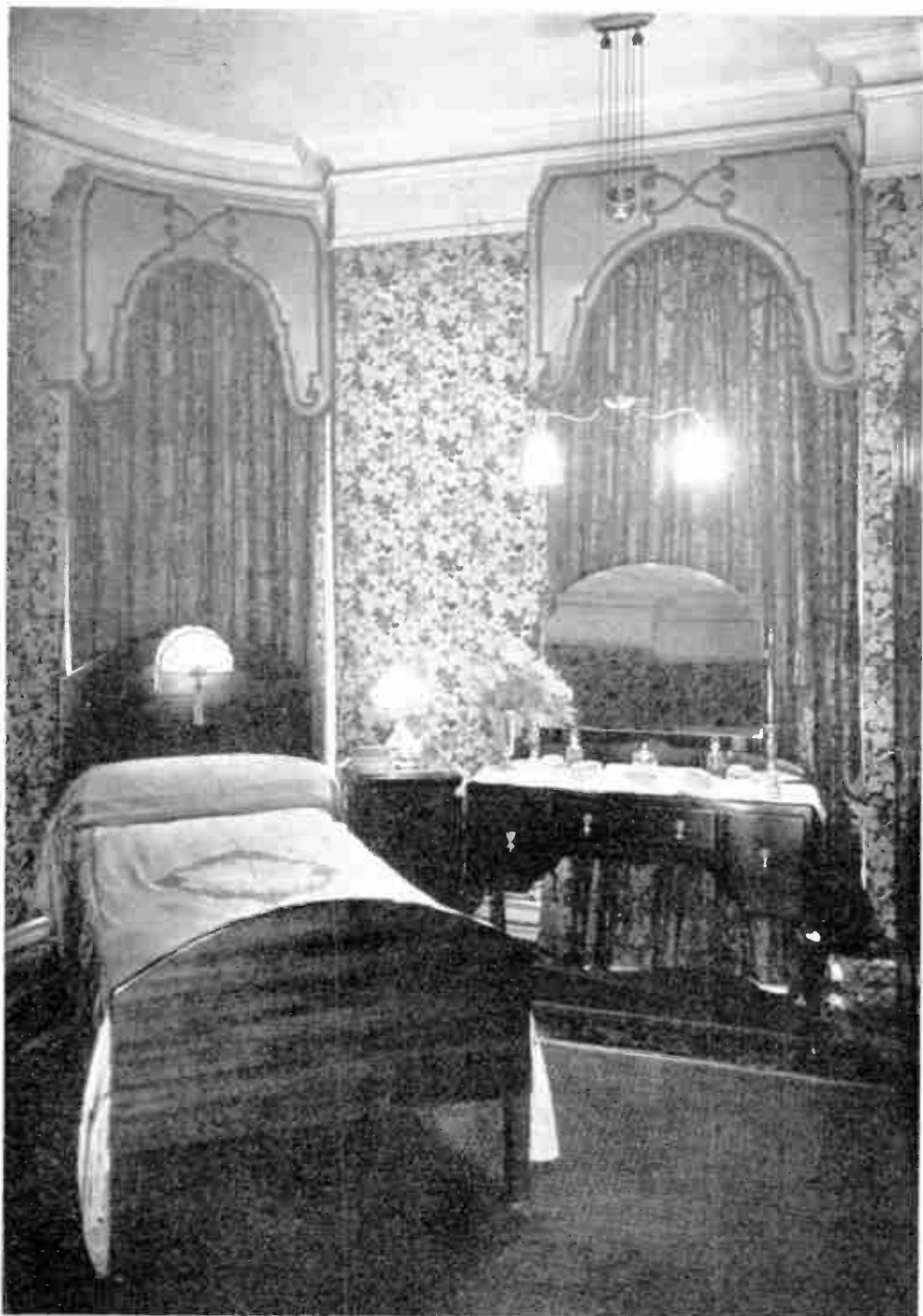

Fig. 16.—SUITABLE LIGHTING ARRANGEMENT FOR THE CORNER OF A BEDROOM.

## SCHEDULE OF LIGHTING POINTS.

Room.	No. of Points.	Type of Fitting.	No. and Type of Switches.	Position of Switch.	Watts per Fitting.	Total Watts.
<i>Ground Floor.</i>						
Porch .. ..	1	Pendant	1	Inside door .. ..	60	60
Hall .. ..	1	Pendant	3, D.C.	Front door, stairs and service door ..	100	100
Foot of stairs ..	1	Pendant	2, D.C.	Stairs and first floor	60	60
Study .. ..	1	Pendant	1	Door .. ..	100	100
Drawing-room ..	2	Plugs	1	Door .. ..	40	80
	6	Brackets	3	Door .. ..	60	360
Loggia .. ..	4	Plugs	2	Door .. ..	40	160
	1	Pendant	1	Door .. ..	40	40
Dining-room ..	1	Pendant	2, D.C.	2 doors .. ..	120	120
	1	Pendant	1	Hall door .. ..	120	120
Pantry .. ..	1	Plug	1	Service door ..	40	40
	2	Plugs	1	Hall door .. ..	40	80
Kitchen .. ..	1	Pendant	1	Kitchen door ..	40	40
	1	Plug	1	Door .. ..	60	60
Scully .. ..	1	Pendant	1	Near plug .. ..	40	40
	1	Plug	1	Door .. ..	40	40
Maids .. ..	1	Pendant	1	Door .. ..	60	60
Garage .. ..	1	Pendant	1	Door .. ..	60	60
	1	Plug	1	Near plug .. ..	40	40
Lobby .. ..	1	Pendant	1	Door .. ..	25	25
Trades door ..	1	Pendant	1	Inner end .. ..	25	25
Foot of stairs ..	1	Pendant	2, D.C.	Ground and first floors	25	25
Store .. ..	1	Pendant	1	Door .. ..	25	25
Larder .. ..	1	Pendant	1	Door .. ..	25	25
Cloaks .. ..	2	Pendants	2	Doors .. ..	40	80
	1	Pendant	2, D.C.	Service stairs and hall door .. ..	40	40
<i>First Floor.</i>						
Landing .. ..	1	Pendant	2, D.C.	Ground and first floors	60	60
Dressing-room No. 4	1	2-light pendant	1	Door .. ..	50	50
	1	Plug by bed	1	By bed .. ..	40	40
Bedroom No. 3 ..	1	Centre pendant	1	Door .. ..	40	40
	1	Plug for dressing table	1	Door .. ..	50	50
Bathroom .. ..	1	Plug by bed	1	Bed .. ..	40	40
	1	Plug by fire	1	Door .. ..	40	40
Lobby .. ..	1	Pendant	1	Door .. ..	40	40
	1	Pendant	1	Near .. ..	25	25
Bedroom No. 2 ..	1	Centre pendant	1	Door .. ..	40	40
	1	Plug for dressing table	1	Door .. ..	50	50
Bathroom .. ..	1	Plug by bed	1	Bed .. ..	40	40
	1	Plug by fire	1	Door .. ..	40	40
Bedroom No. 1 ..	1	Pendant	1	Door .. ..	40	40
	1	2-light pendant	1	Door .. ..	50	50
Linen .. ..	1	Plug by bed	1	By bed .. ..	40	40
	1	Pendant	1	Door .. ..	25	25
Maid's room ..	1	Pendant	1	Door .. ..	40	40
Linen .. ..	1	Pendant	1	Door .. ..	25	25
Maid's bathroom ..	1	Pendant	1	Door .. ..	25	25
Stairs .. ..	1	Pendant	2, D.C.	Ground and first floors	25	25
Bedroom No. 7 ..	1	2-light pendant	1	Door .. ..	50	50
	1	Plug by bed	1	By bed .. ..	40	40



**SCHEDULE OF LIGHTING POINTS.**

Room.	No. of Points.	Type of Fitting.	No. and Type of Switches.	Position of Switch.	Watts per Fitting.	Total Watts.
Bedroom No. 6 ..	1	2-light pendant	1	Door .. .. .	50	50
	1	Plug by bed	1	By bed .. .. .	40	40
Bedroom No. 5 ..	1	2-light pendant	1	Door .. .. .	50	50
	1	Plug by bed	1	Bed .. .. .	40	40
Passage .. .. .	1	Pendant	2, D.C.	Two stairs .. .	25	25
Attic.						
Store .. .. .	1	Pendant	1	Door .. .. .	25	25
	1	Plug	1	Near plug .. .	25	25
Stairs up .. .	1	Pendant	1	Foot of stairs ..	25	25

useless with the almost universal saloon car.

**THE FIRST FLOOR.**

The lighting of the first floor consists mainly of bedroom lighting, and if the principles of this are fully considered for one room, the others can be settled on the same basis.

The minimum lighting is a single pendant—one or two lights, as may be preferred—and if this minimum is adopted the light should be near the window at which the dressing table will probably be placed. In smaller rooms, the table will be placed against the wall and the light should then be about 18 inches out from the wall. In larger rooms, a passage may be left between the wall and the table, and, if this is preferred by the owner, the light would be about 3 feet from the wall.

**Principal Bedroom Lights.**

This bare minimum lighting will be insufficient in the principal rooms, and

in such a bedside light must certainly be added. Pendants over beds are undesirable, as the light is directly above the eyes of anyone lying in bed, and brackets are not much better. Fixed fittings such as these also mean that the bed position is definitely fixed as well, and this is not always possible. A plug and suitable standard lamp give much more opportunity for convenient lighting, the standard lamp being arranged to stand on a table or to hang from the wall or from the back of the bed.

The desirability of being able to move furniture suggests also that the pendant by the window is not quite the best method of lighting and a further improvement would be obtained by substituting a plug to which two dressing table standards can be connected. If this is done a central pendant or brackets suitably located should be added, as portable lamps alone are not satisfactory for adequate lighting when the room is being cleaned or to give illumination in wardrobes, etc.

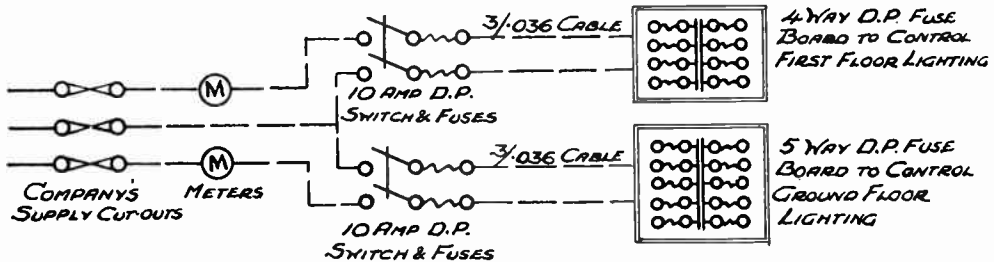

Fig. 17.—How the Load Should be Distributed.

As the maximum number of points per circuit must not exceed 10, the most suitable number of ways required would be : Ground floor, five ways , first floor, four ways.

Any such pendants or brackets must be effectively screened from the bed, as any glaring light would be very trying. An extra plug by the fire can be added, if desired, or if the room is used partly as a sitting-room.

### Small Lamps may be Used.

Exact calculations for bedroom lighting are not necessary, as brilliant lighting is not only unnecessary, but would be definitely unsuitable. Good lighting is required only for a few local areas—by the dressing table and by the bedstead—and this can be obtained from comparatively small lamps.

### Other Bedrooms.

The three schemes of lighting previously described would probably all be used in different bedrooms according to their importance. In the maids' rooms the single dressing-table pendant would be suitable. In the rooms 1, 4, 5, 6 and 7 a dressing-table pendant and a bedside plug would be sufficient. These might, on the other hand, depending on the views of the owner (and probably on the question of cost), be provided with a centre light, bedside plug and dressing-table plug, and this same arrangement would certainly be desirable in bedrooms 1 and 3, with an extra fireside plug if the owner wishes it.

The lamp sizes to be used will depend on the decorations and fittings selected, but the following should be sufficient:—

Maids' rooms 40-watt.

Smaller bed-rooms. Two 25 or 40-watt lamps (50/80 watts total) for the pendant and 40-watt for the bedside lamps.

Bedrooms 1 and 3. 60 watts for the centre pendant with two 25-watt lamps (or 50 watts total) for the dressing-table standards and 40 watts for the bedside and fireside plugs.

### Other Rooms.

Apart from the bedrooms the lighting details will be obvious. A single pendant with 25 or 40-watt lamp will be wanted in each bathroom or W.C., and

preferably one in the linen cupboard. A pendant (40-watt) would be required over the servants' staircase and another at the bend in the corridor. Finally, one good fitting with a 60-watt lamp over the main staircase will light that and the section of corridor near.

### A Light in the Roof.

If there are rooms in the roof space a light in each with a 25-watt lamp will be sufficient if these are used as stores—or if they are bedrooms they should be treated as described according to their importance. A plug with a hand lamp in the roof space will be found very useful, either when cleaning the water tanks or for examining contents of boxes if the space is used as a box room.

### LIGHTING SCHEDULES.

Having thus schemed out the details of the lighting points, largely, as will be seen, to suit the views of the owner, a detailed schedule of the lamps to be used should be prepared as a preliminary to calculating the cables, fuse-boards and other details of the wiring. Such schedules can be made out in many ways, but it is convenient to include the details of the switches, and if a column showing the total wattage of the lamps is included as well as (or in place of) one showing only the watts for each lamp, the totalling up of the loads on the fuse-boards can be carried out easily.

The supply company's service requirements must be considered before any distribution scheme can be worked out. If the supply is 2-wire, any convenient arrangement of fuse-boards can be adopted; but if 3-wire or 3-phase, the number of boards must be schemed out to provide a suitably balanced load.

### Three-wire Supply.

For a 3-wire supply, two fuse-boards might be used in the example under consideration, and positions must be found for these which will be (a) inconspicuous and (b) convenient for access. Suitable positions would be the lobby outside the pantry and outside bedroom No. 6, and the circuits might be arranged so that the former board supplies all the ground floor

and the latter all the first floor. An alternative arrangement would have the board near the pantry to supply all the west end, both ground and first floors, and another board near the service stairs for the whole of the east end of the house.

### Three-phase Supply.

If the supply were 3-phase and the company required a balanced load, the three boards then necessary could be fixed:—

Phase A near pantry to supply west end, ground floor.

Phase B near bedroom 6 to supply west end, first floor.

Phase C, service stairs, east end, ground and first floors.

Rooms such as the pantry, cloaks, bath-room or bedroom No 6, could be connected to one or other board as may be necessary to obtain a balanced load.

### How the Load Should be Distributed.

Taking as an example a 3-wire supply at 220/440 volts, and connecting the ground floor to one side and the first floor to the other side of the supply, the loads on the two boards will be:—

Ground floor—37 lighting points, totalling 1,925 watts.

First floor—30 lighting points, totalling 1,195 watts.

As the maximum number of points per circuit must not exceed ten, and should not exceed eight for good work, so that some margin for alterations will be available on any circuit, the number of ways required would be:—

For ground floor—5 ways.

First floor—4 ways.

### Current on the Main Cables.

The current on the main cables to these boards will be 8.7 amps. and 5.4 amps. respectively. The permissible voltage drop (3 per cent. plus 1 volt) is 7.6 and an allowance of 3 volts is desirable for the circuit wiring and fittings. The drop allowable in the mains would therefore be 4.6 volts. With the company's service fixed near the fuel store, the length of cables would be about 50 feet run for either board (this should be measured exactly where close calculations are necessary, as, for example, where the runs are long or where a low voltage is being used) and for such a length the voltage drop will be, as given in I.E.E. rules, only 1 volt for every 31 feet with 3/.036 cables (which will carry the current) or only about  $1\frac{1}{2}$  volts for the run as measured.

The distribution scheme will thus consist of two 10-amp. main switches; two runs of sub-mains each 3/.036 section and two fuse-boards of 5 and 4 ways respectively.

---

## MAGNETIC CLUTCHES AND CHUCKS ON A.C.

THE problem of operating magnetic clutches and chucks from an A.C. supply is one which must be faced when the supply mains are eventually changed over from D.C. A magnetic chuck will not work on A.C., because apart from the fact that it would heat up badly it would not hold the work securely. A clutch could be designed to work on an A.C. supply, but an existing type run from D.C. would not do so on account of the solid construction of the iron circuit.

The conversion of A.C. into D.C. for this purpose is effectively accomplished by installing a Westinghouse metal rectifier, or a rotary converter. The metal rectifier is preferable, because it requires no attention and is silent in operation. The output from the metal rectifier is of a pulsating nature, but is quite suitable for this purpose without smoothing, because the inductive nature of the magnet windings provides all the smoothing necessary.

# A HANDY ELECTRICAL DISTRIBUTION BOARD

By DAVID CHARLES

**T**HE purpose of a distribution board, as its name indicates, is to distribute a source of electrical current to more than one direction. That is to say, where it is required to make use of several pieces of electrical apparatus and there happens to be only one plug available, an attachment of this kind makes it practical to do so without making alterations in the house wiring.

Where it is likely that the necessity for the use of several plugs in place of one will be regular and continuous it is not at all a difficult matter to disconnect a switch plug as fitted, for instance, for a radiator supply and to screw in its place one of these small distribution boards with two, three or even more switch plugs of *smaller size*.

## Uses of the Distribution Board.

On the other hand, for general use it is preferable to keep the board loose and to plug it in as required. By this means the distribution board can often be placed or hung on a wall in a more convenient position for switching on and off than where the main source of supply happens to be situated. By the use of a little board of this kind, it becomes easy, for instance, to keep the radiator for warming the room going at the same time as one is using an electric flat iron, toaster and so on, or even on occasions when circumstances demand it, two or more radiators, all from one power main. Bear in mind the maximum "wattage" that the existing wiring allows for and see that this is not exceeded.

## Making the Distribution Board.

To make a distribution board of this kind all that is required is the necessary number of plugs and a switch block of suitable size. In the case of the board shown in Fig. 1 the switch block is one

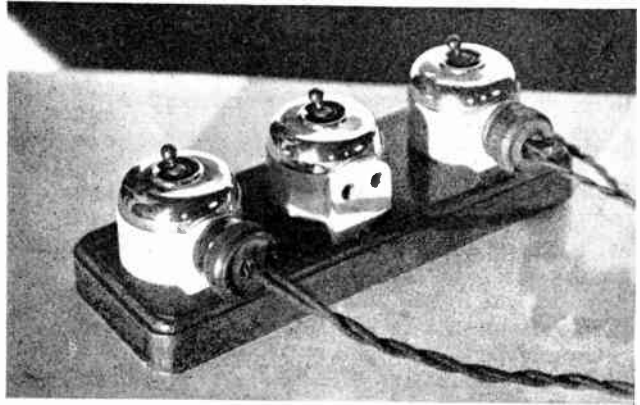

Fig. 1.—THE COMPLETED DISTRIBUTION BOARD.

This neat and compact piece of apparatus can be made in half an hour, and enables a single supply to be used for several purposes at once.

measuring 9 by 3 inches, and this holds three 5-amp. switch-plugs quite conveniently.

## The Wiring.

A length of flex with a spare plug at the end for inserting in the wall socket is required, this being wired "in parallel" with all three switches, as is clearly explained in Fig. 2, showing a back view of the same distribution board. It is advisable to err, if anything, on the side of using wire on the rather heavy side. This not only obviates any risk of overheating, but it must be remembered that even if such overheating (due to using more current than the wire is made to carry) is not sufficient to cause actual danger, it certainly reacts upon the efficiency of any



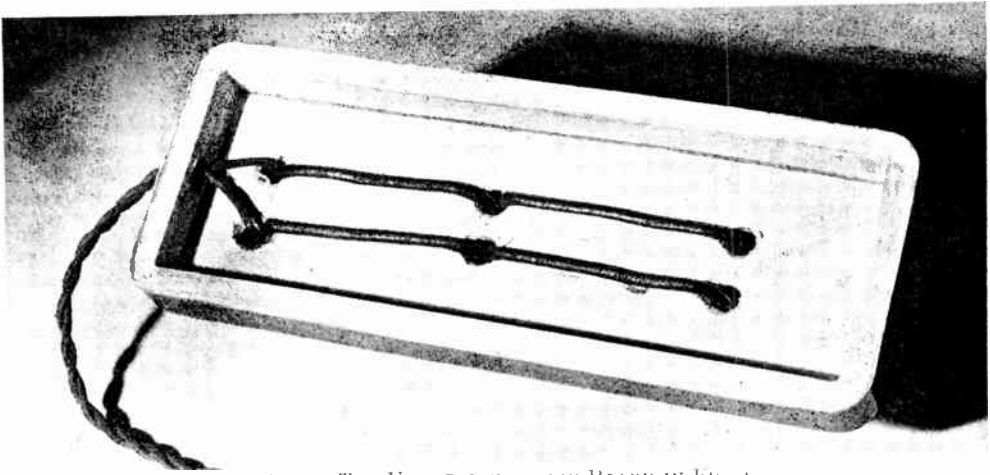

Fig. 2.—THE UNDERSIDE OF THE BOARD IN FIG. 1. Showing the simplicity of the wiring.

electrical apparatus that may be in use by reason of the resistance which it sets up.

**Flex Should be Detachable.**

A user of such a distribution board which is not in regular use may find it a

rather inconvenient piece of apparatus to store upon a shelf when it is provided with rather a long length of flex. The latter, especially if of a substantial kind, is apt to be found straggling about none too tidily. In such cases as these it is a great advantage to have the flex entirely

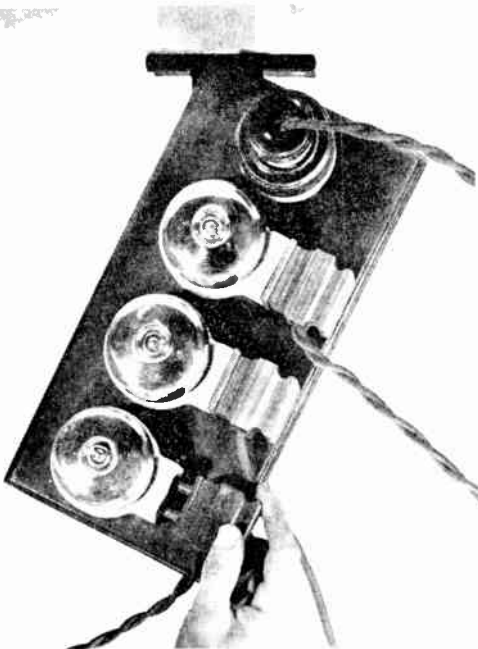

Fig. 3.—THE "INPUT" FLEX, AS WELL AS THOSE TO THE APPARATUS, CAN BE MADE DETACHABLE.

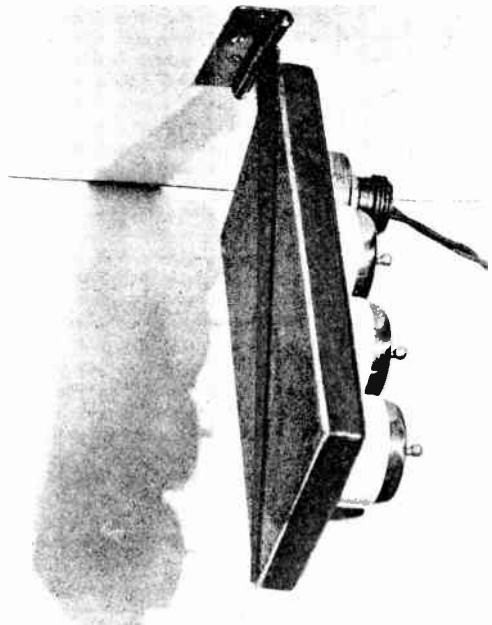

Fig. 4.—HOW THE BOARD IS FIXED TO THE CEILING BY MEANS OF A HINGE.

detachable. This can be achieved by means of an extra socket, wired also in parallel, on the distribution board, and to have a plug attached to *each* end of the length of flex. This idea is shown carried out in Fig. 3, which shows a 10-amp. distribution board intended for use in a workshop where movable apparatus of a rather heavy current consumption type is employed.

#### Fixing in a Workshop.

Another feature of this particular switchboard is that it is supported from the ceiling, where it is just within reach. In this way loose flexes do not hang about on benches. The means of support is, as shown in Fig. 4, an ordinary Tee-hinge

of large size. The back of the distribution board is first covered in with a piece of plywood, and the screws to fix the hinge are put right through this into the thickness of the switch block. The advantage of fixing in this way is that it is as easy to fix as any other form of bracket, and it happens that when an accidental pull occurs on any particular flex it does not result (as might happen if the switchboard were firmly fixed) in the detachment of the plug from the switch. Moreover, it happens that the ceiling in this particular workshop is none too high, and if any bulky article is moved about and gets knocked against the switchboard, the latter merely swings and nothing is damaged.

## ADJUSTING A NOISY FAN

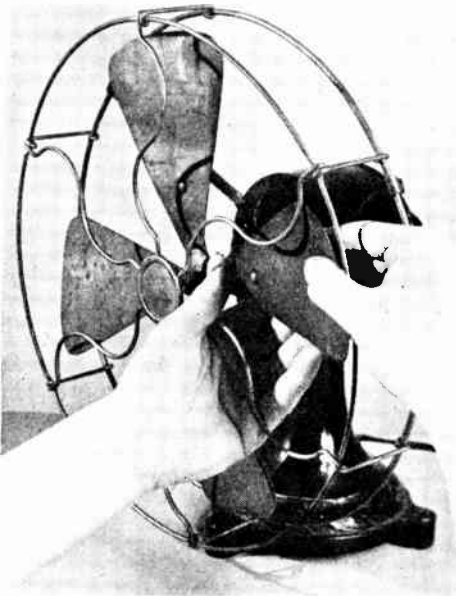

Fig. 1.—HOW TO ADJUST A BENT BLADE.

**N**OTHING is more irritating than a fan that works noisily, and the practical electrician may often be called in to put the matter right.

Most probably all that has happened is that the fan has had a knock which has caused the safety guard to bend and so catch a blade of the fan.

Another fault that might have developed is that one of the blades has become bent.

The first thing to do is to disconnect the fan from the source of supply and revolve it slowly by hand. If it is found that all the blades just slightly touch the frame, then the latter should be bent out. If only one of the blades catches, it is the blade that needs bending free of the frame.

If the noise is not cured by either of these adjustments, it may be that one of the coils on the armature or field has worked loose.

# COTTON, PAPER AND FIBRE IN ELECTRICAL ENGINEERING

By M. G. SAY, PH.D., M.Sc.

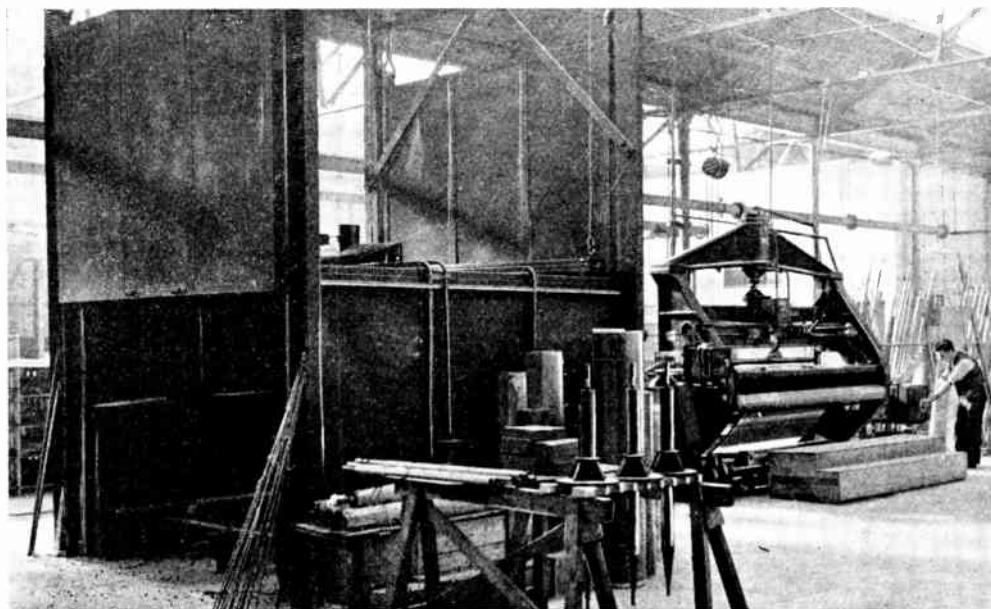

Fig. 1.—WINDING CONDENSER BUSHINGS FROM BAKELIZED PAPER.

Bakelized paper is used for rolling into condenser-type terminal bushings, used for leading very high-voltage conductors into transformer tanks or buildings. At the right is a winding machine; at the left a baking oven. (*Ieco Rubber and Waterproofing Co.*)

**T**HE cotton used for electrical purposes comes from plants cultivated in America, Egypt and India. In making up and weaving the cotton, the manufacturers usually size the threads to facilitate the operation of the looms. Some of the sizing chemicals are deleterious for insulating uses, and the woven cotton may be scoured to remove them.

## Uses of Cotton.

Cotton is used as thread, tape, or cloth. As thread it is employed for covering single wires in one, two or more layers. The former are more common and are known as S.C.C. (single cotton-covered) and D.C.C. (double cotton-covered). Successive layers are wound in opposite directions. A useful

arrangement is to cover an *enamelled* wire with single cotton covering; the enamel gives excellent electric strength and the S.C.C. protects the enamel skin from mechanical damage.

Cotton is highly hygroscopic; it absorbs water so readily that plain cotton insulation cannot be tolerated in finished apparatus. It is essential that cotton covering be "filled" with some impregnating compound, varnish or wax.

## Cotton Tapes—Size and Purpose.

Cotton tapes are made in various sizes, the most common lying in the range  $\frac{1}{4}$ — $1\frac{1}{2}$  inches. The three varieties are ordinary straight weave, bias and webbing. The bias tape is particularly useful for "half-lap" insulation, i.e., a winding of

tape in helical form so that there is a continuous half-width overlap of successive turns. The principal function of tape is to bind other superior insulation (if any) and the conductors of, say, a coil, in position. The tape for this purpose should be thin and strong.

Untreated cloth in widths up to about 1 yard is used for backing mica products. Various thicknesses between 3 and 20 mils are used.

### Linen and Silk.

Besides cotton, linen tapes have certain

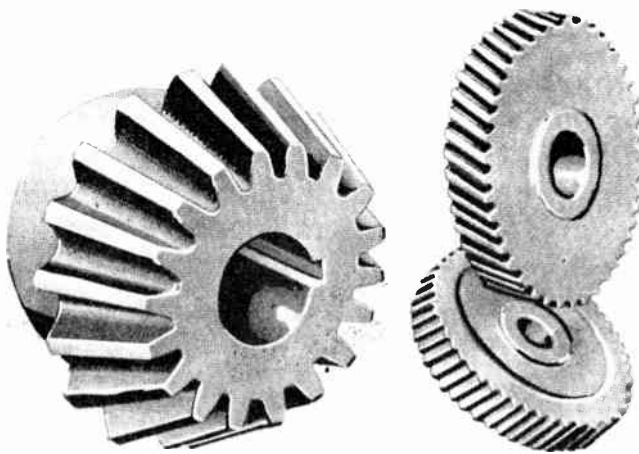

Fig. 2.—BAKELIZED CLOTH GEARS.

Bakelized cloth is particularly suitable as a substitute for metal gears and the distinctive features are: Silent operation; no end support required for the teeth; unaffected by water, oil or vermin; will not distort when used at temperatures up to 100° C.

(Bakelite, Ltd.)

applications, and silk is used as a wire covering where it is particularly desired to save space. Silk is useful for very fine wires.

### TREATED FABRICS.

Low-voltage coils may be taped with treated material—e.g., varnished tapes—instead of being wound with untreated tapes and subsequently impregnated. The common term for varnished cotton fabrics is “Empire cloth.” Although the untreated cloth itself is of but little insulating value and is only used to carry the films of varnish, the selection of a suitable fabric is of importance. It must be free from defects in weaving and be either

“undressed” or uniformly “dressed” to take a smooth, regular finish. The fabric is treated in lengths of about 50 ft., which are passed through a vat of varnish and then through a baking oven. Drying may take 10 hours per coat at 100° C.

### The Disadvantage of Bias Tape.

Varnished tapes are cut from sheets. As with untreated tapes they may be straight cut or bias. The former is stronger in tension because the threads take the strain directly. With bias-cut tapes, however, the threads cannot take the direct tension, which is therefore thrown on the varnish film. This is important, as varnish is mechanically weak, and may crack, with consequent electrical failure.

Empire cloth is useful for large wrappings and for slot linings for low-voltage machines. Varnished silk can be used where space is limited and good electric strength is needed.

### Why Treated Cloth is Weaker.

Treated cloth and tape are weaker mechanically than the untreated material. This is because the latter, when stretched, contracts laterally and more threads are drawn together to take the strain, and the bunch of threads thus formed gives a strong strand. When varnished the cloth cannot stretch. Thus the material tears and splits if unevenly pulled or overloaded in tension.

### Bakelized Cloth.

A comparatively recent development is the production of materials composed of cloth impregnated with a synthetic resin of the bakelite “A” type. Layers of treated cloth are then assembled in a stack and placed in a steam-heated press. The heat treatment completes the change of the resin from the “A” to the “C” state, and leaves the material in the form



of sheets of any desired thickness, hard, solid and mechanically strong. The electrical strength is moderate to good, but the material is quite suitable for low-voltage uses. The thin grades (up to  $\frac{1}{8}$  inch thick) are admirable for punching, in which form they can be used for assembling small telephone parts, contacts, etc. The thick grades are manufactured especially for silent gears.

### A Substitute for Metal Gears.

Bakelized cloth is particularly suitable for this use, and as a substitute for metal gears or for gears made of untreated paper or raw hide. The distinctive features are (1) silent operation; (2) no end support required for the teeth; (3) unaffected by water, oil or vermin; (4) will not distort when used at temperatures up to 100° C.

In addition to being used for gears and pinions, cloth treated with synthetic resin can be moulded into various shapes to meet special requirements, such as fish-plate insulators on railways using electric signalling, rectangular and round tubes, washers, bushings, discs, cleats, channels, handles, knobs, pulleys, liners for tanks. It should be noted that with bakelite, a heat and pressure process is always required to convert the resin to its final state.

## PAPERS.

To the uninitiated the number of varieties of paper now manufactured is quite astonishing. The electrical industry is a comparatively minor consumer of paper, and consequently a choice has often to be made from the range manufactured for other purposes. Many papers are very suitable, although not specially made for electrical use.

### Paper—How It Varies.

Papers of all classes are cellulose materials, but their characteristics depend

largely on the kind of cellulose used in their production—particularly the length and nature of the fibres. Cheap paper is manufactured from wood pulp. The shortness of the fibres makes the paper brittle and easily torn, as can be demonstrated by a newspaper read before the fire; the outside pages soon become dry, brittle and weak. A paper that depends too much on dampness to hold it together is not suitable for electrical needs. Of course, moisture is an essential in all papers to some extent. The long-fibred manila papers, however, can keep their mechanical

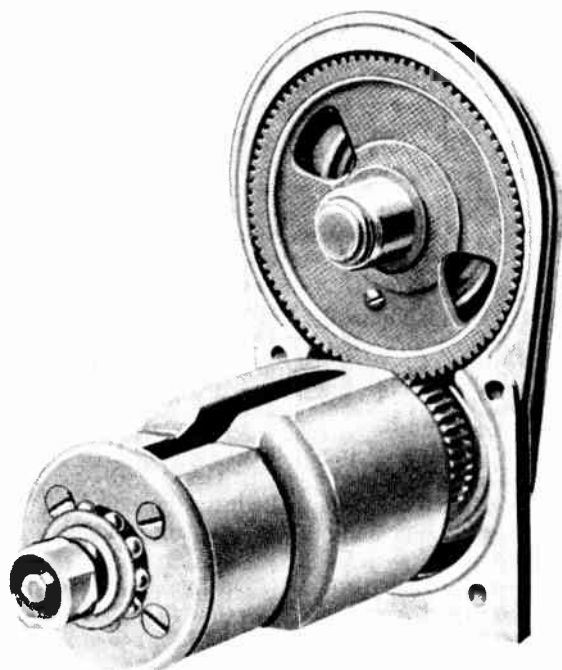

Fig. 3.—BAKELIZED CLOTH GEAR IN OMNIBUS MAGNETO.  
(Bakelite, Ltd.)

strength even when comparatively dry,

### How Paper is Made.

The process of manufacture of paper is most ingenious and interesting. Very briefly, it consists in running a thin, flat, wide stream of wet pulp on to a moving tray. The water drains off, leaving a thick film of damp fibrous pulp. In this state the film is extremely tender. It is passed through drying rolls, steam heated, and calendering or smoothing rolls, finally

emerging as a sheet of paper. It is wound up on a drum at the end of the paper machine.

The pulp used contains wood fibre, rags, plant fibres, straw, etc., also hemp, flax, jute and esparto grass. The various types of paper have distinctive trade names, some of which (with their description) are given below :—

NAME.	DESCRIPTION.
Cable ..	Cotton, hemp and jute, acid-free.
Core plate ..	Thin wood-pulp paper for insulating core discs for armatures, etc.
Foiled ..	High-grade flax and linen paper, coated with tinfoil for making condensers.
Grease-proof	Non-absorbent wood-pulp and cotton, used for carrying gums.
Kraft ..	Strong wood-pulp.
Leather or fish	Cotton rags treated with zinc chloride; used for slot lining.
Manila ..	If pure, contains only manila; strength is its chief characteristic.
Tissue ..	Condenser and electrical tissue made from rags.

#### Paper for Telephone Cables.

Paper is very rarely used in its untreated state. Probably the most important use of untreated paper is for telephone cables. In these a number of pairs of wires are made up with dry paper strip insulation and enclosed in a lead sheath. Great care has to be taken to prevent the introduction of moisture, especially when repairing or jointing.

Paper is porous and hygroscopic, and deteriorates with time (e.g., old newspapers and documents). It should not be exposed to heat above 120° C., as it carbonises or chars.

#### TREATED PAPERS.

Cable papers are impregnated with heavy mineral oil, sometimes with an admixture of resin oil. Most other treated papers, other than that used for backing mica, etc., is employed in the manufacture of a number of useful fibrous sheet materials.

#### Pressboard and Its Uses.

This is a thick cardboard of high-grade paper, formerly known as "fullerboard" or (on the Continent) "presspahn." Its insulation value is comparatively low,

but it is useful for linings of tanks, slots, etc. Being somewhat hygroscopic, it is often varnished to reduce the moisture absorption.

#### Vulcanized Fibre.

A common name is "leatheroid" or "hard fibre." It is manufactured from thick sheets of cardboard stacked and compressed after a long chemical process which unites the layers together in a solid mass. It has good machining qualities, and consequently slot wedges, rollers, tubes, insulating feet, insulating nozzles, etc., can be produced from it. With a skilful use of ordinary tools a reasonably good screw thread can be obtained. Fibre is hygroscopic, but its hardness and density prevent it from being properly impregnated.

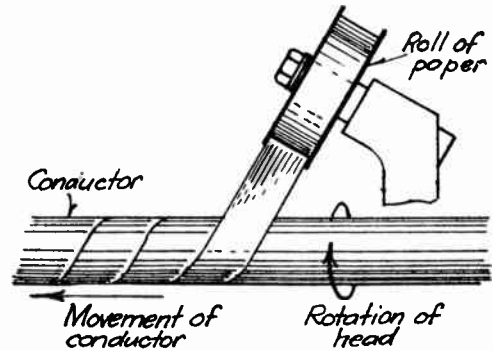

Fig. 5.—METHOD OF WRAPPING CONDUCTORS WITH PAPER.

#### Synthetic-Resin-Paper Boards.

Grease-proof papers impregnated with synthetic resins, such as bakelite "A," are assembled in stacks and subjected to hot pressing in the same way as already described in connection with cloth. Grades are manufactured for high electrical and mechanical strength, for use under oil, and for punching. Tubes and other shaped sections are also made in these grades. The oil-immersible tubes are nowadays used very extensively for the mounting of coils of core-type transformers, and for leading the connections up to the top of the tank.

Bakelized paper is used for rolling into condenser-type terminal bushings, used for leading very-high-voltage conductors into transformer tanks or buildings.

# TYPES OF A.C. INDUSTRIAL MOTORS AND THEIR APPLICATIONS

By A. T. DOVER, M.I.E.E., Assoc.Amer.I.E.E.

## A.C. Motors in Industry.

WITH the extension and ultimate completion of the Central Electricity Board's "National Grid" scheme of three-phase, 50-cycle, alternating-current transmission and distribution, A.C. motors will be used in increasing numbers for industrial purposes. Their use in industry may ultimately become universal, except in special cases—such as variable-speed reversing motors of large output, exceptionally severe starting conditions, etc.—where the service conditions can only be met satisfactorily by D.C. motors.

A.C. motors, however, have limitations which are not possessed by D.C. motors, and their characteristics differ considerably from those of D.C. motors. Whereas the three types of D.C. motors (viz., shunt, series, compound) can meet the whole range of industrial requirements, over a dozen types of A.C. motors are necessary to meet the same requirements.

### Necessity for Numerous Types.

The necessity for these numerous types of A.C. motors is due to a number of causes, such as: (1) the high cost of A.C. commutator motors having characteristics

similar to the corresponding D.C. motors; (2) the poor starting performance and low efficiency of certain types of motors; (3) the imposition of tariffs penalising low power factor; (4) the smaller installations

having a single-phase supply instead of a three-phase supply (the single-phase supply being given from a general three-phase, four-wire, distribution system). Moreover, three fundamental principles of operation are applicable to A.C. motors, whereas only one principle is applicable to D.C. motors.

### CLASSIFICATION OF MOTORS.

The classification may be made broadly according to: (1) the *mechanical features*, such as the type of enclosure; (2) the *electrical features*, such as (a) the number of phases in the supply system on which the motor is to operate; (b) the principle of operation, or method of transferring energy to the member in which the useful torque is developed; (c) the speed characteristics; (d) the starting characteristics; (e) the power-factor characteristics.

### NUMBER OF PHASES.

The National Grid scheme of electrical distribution is on the three-phase system, and accordingly all large factories will

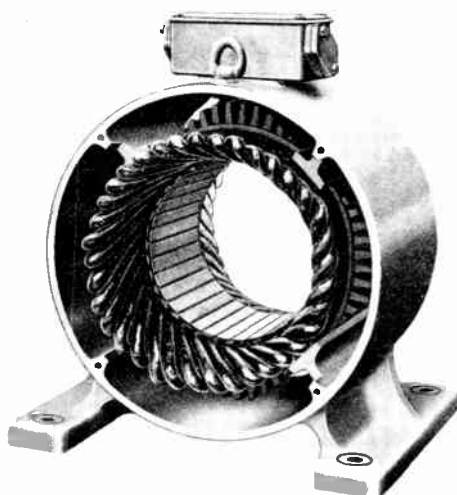

Fig. 1.—COMPLETE STATOR OF MODERN THREE-PHASE INDUCTION MOTOR. (B.T.H. Co.)

Observe the small radial depth of iron in the stator core and the large air space between the core and the frame for the circulation of the ventilating air by the fan on the rotor (see Fig. 2A).

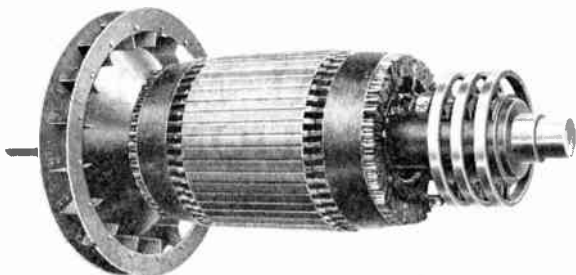

Fig. 2A.—SLIP-RING ROTOR FOR STATOR ILLUSTRATED IN FIG. 1. (B.T.-H. Co.)

The rotor conductors consist of insulated bars which are connected to form a three-phase star winding, the ends being brought out to the slip-rings for inserting starting resistances in the rotor circuits.

have a three-phase supply, and factories of medium size may also have a three-phase supply, but small factories will probably only have a single-phase supply. Private residences, business premises, hotels and places of entertainment will in general have a single-phase supply. The types of motors which will need consideration, therefore, are those which are suitable for the three-phase and single-phase systems.

### GENERAL PRINCIPLES OF OPERATION.

Although the fundamental principle governing the action of D.C. motors is also applicable to A.C. motors, other principles are available, due to the alternating voltage and current of the supply system.

#### Conductive and Inductive Methods of Transferring Energy.

In D.C. motors the armature or rotating member in which the mechanical power is developed must receive its electrical energy *conductively* from the supply system, i.e., a direct electrical connection must exist between the armature and the supply system. But with an A.C. supply, energy may also be transferred *inductively*, as well as *conductively*, from one circuit to another. The essential condition for the inductive transference of energy is

the linkage of the two circuits by an alternating magnetic field. No electrical connection is necessary between the circuits.

The *conductive method* of energy transference is used in *single-phase series* (commutator) motors; *three-phase series* (commutator) motors; *three-phase shunt* (commutator) motors.

The *inductive method* of energy transference is used in all *induction* motors (single-phase and three-phase) and in *single-phase repulsion* (commutator) motors. It is also used in all types of stationary transformers.

A combination of both methods is used in certain types of three-phase *variable-speed* motors and three-phase *compensated induction* motors.

#### Energy Transference by Interaction of Magnetic Fields.

A further principle of operation is available, viz., the interaction between two concentric magnetic fields. When two such magnetic fields rotate at the same speed in the same direction, their magnetic axes tend to coincide and to remain fixed relatively to each other. This principle is applied to A.C. motors by arranging that one field is produced by the alternating supply currents and the other is produced by a field-magnet system excited with direct current. In

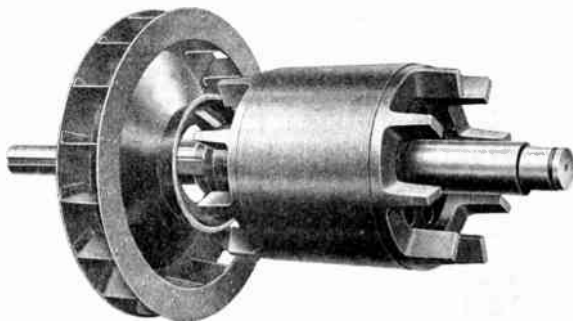

Fig. 2B.—SQUIRREL-CAGE ROTOR FOR STATOR ILLUSTRATED IN FIG. 1. (B.T.-H. Co.)

The conductors and end rings are of aluminium and are cast in one piece by a special process. The projecting lugs on the end rings act as radiating fins for dissipating the heat produced in the rotor conductors and end rings.



small and fractional h.p. motors the field-magnet system, if of suitable form, may be excited by induced magnetism from the alternating field. Motors operating on this principle are called *synchronous motors*.

**Summary.**

The general principles of operation and the types of motors in which they are used are summarised in Table I.

TABLE I.—PRINCIPLES OF OPERATION OF A.C. MOTORS.

Principle of Operation.	Types of Motors in which Principle is used.
Conductive transference of energy. Excitation obtained from A.C. supply. (Principle similar to that employed in D.C. motors.)	Single-phase series-wound; three-phase series-wound; three-phase shunt-wound. [NOTE.—All these motors have commutators.]
Inductive transference of energy. Excitation obtained from A.C. supply.	Induction (single-phase and three phase); single-phase repulsion; single-phase repulsion-induction. [NOTE.—Induction motors have no commutators; repulsion motors have commutators.]
Conductive and inductive transference of energy. Excitation obtained from A.C. supply.	Three-phase variable speed, shunt characteristic. [NOTE.—These motors have commutators.]
Inductive transference of energy. Excitation obtained from A.C. supply, but compensated at low frequency by commutator-type frequency changer.	Compensated induction three-phase. [NOTE.—These motors have commutators.]
Interaction of magnetic fields. Excitation supplied by direct currents.	Synchronous. [NOTE.—These motors have no commutators.]

**USE AND APPLICATIONS OF THE VARIOUS TYPES OF MOTORS.**

**Three-phase Induction Motors.**

The three-phase induction motor is the most extensively used type of motor in industrial plants, as it is the cheapest, simplest and most robust of all A.C. motors, and possesses good starting characteristics. It is, however, a practically constant-speed machine and takes lagging currents from the supply system.

The chief parts of a typical motor are illustrated in Figs. 1, 2A and 2B, and further details are given later.

The applications of induction motors are in general similar to those of D.C. shunt-wound motors (i.e., to all drives requiring approximately constant speed). Any starting requirements, light or heavy, can be met by the two types of rotors,



Fig. 3A.—COMPLETE STATOR OF COMPENSATED INDUCTION MOTOR. (English Electric Co.)

The stator winding is an ordinary three-phase winding, but the phases are not interconnected (as in the stator winding of an induction motor), i.e., all the six ends are brought out to terminals in the terminal box.

viz., the squirrel-cage rotor for light- and medium-duty starting, and the slipping rotor for heavy-duty starting.

**Three-phase Commutator Motors.**

The three-phase induction-commutator motor is used when efficient speed regulation, with shunt characteristics, is desired over a wide range of speeds. A modification of this motor is used when practically constant-speed operation at leading power factors is desired. Such operation may be necessary to compensate the lagging currents of other induction motors and so obtain a more favourable tariff from the supply authority. These commutator-type motors are considerably more expensive (30 to 40 per cent.) than induction motors, and their uses are accordingly restricted to the above services.

The chief parts of a typical motor are illustrated in Figs. 3A and 3B, further details are given later.

Three-phase shunt-wound and series-wound commutator motors have a very limited use: in fact, they may be considered as superseded by the variable-

speed induction-commutator motor. They are not manufactured in this country, and will not be considered further.

### Three-phase Synchronous and Synchronous-induction Motors.

The *three-phase synchronous motor with direct-current excitation* is used fairly extensively in large sizes on account of its high efficiency, absolute constancy of speed, and controllable power factor. It is more costly (10 to 15 per cent.) initially than a corresponding induction motor, but the high efficiency and the ability to

*without D.C. excitation*, in sizes up to 15 h.p., is a recent development. It is self-starting (due to a squirrel-cage winding on the rotor) and runs at an absolutely constant speed, but its power factor is low (approximately 25 per cent. lower than that of a squirrel-cage induction motor of similar output and speed). Its cost is slightly higher than that of squirrel-cage induction motors of corresponding size.

This type of motor has a number of applications in textile factories, gas works and automatic conveyors, where synchronization of a number of processes is necessary.

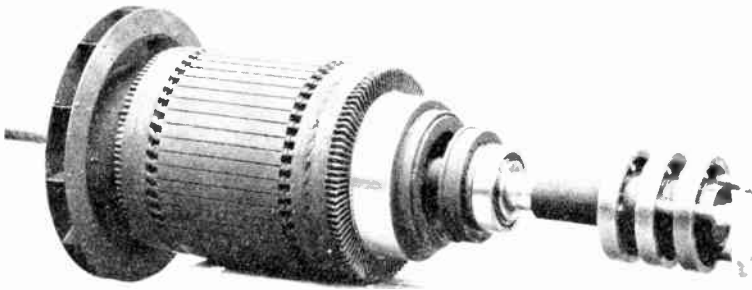

Fig. 3B.—ROTOR OF COMPENSATED INDUCTION MOTOR. (English Electric Co.)

The rotor slots contain two sets of conductors; one set forming a three-phase winding which is connected to the slip-rings, and the other set forming a lap winding which is connected to the commutator.

operate at unity and leading power factors result in the running costs being lower than those for the corresponding induction motor. Unless the field magnets are provided with additional windings the starting performance is very poor, but with these windings starting torques comparable with those of a squirrel-cage induction motor may be obtained.

The *synchronous-induction motor* is a slip-ring induction motor adapted for D.C. excitation. It combines the good starting qualities of a slip-ring induction motor with the constancy of speed and controllable power factor of a synchronous motor. It is slightly more costly than a synchronous motor and is used in cases where difficulties due to the starting requirements would prevent the installation of a synchronous motor.

The *small three-phase synchronous motor*

The chief parts of a typical motor are illustrated in Fig. 4.

### Single-phase Motors.

Single-phase motors have a very extensive use in small sizes for domestic appliances, such as vacuum cleaners, sewing machines, refrigerators, ironing machines, washing machines, etc. They have also a very extensive use in the smaller factories, laundries, dairies, bakeries, etc., which have only a single-phase supply. Five types are used for these services, viz., series-wound (commutator type), repulsion (commutator type), induction (split-phase starting), induction (repulsion starting), induction-repulsion. The necessity for all these types is due primarily to the very poor starting performance and low power factor of the single-phase induction motor.

**Single-phase Series-wound Motors.**

The series-wound commutator motor, in small fractional h.p. sizes (up to about  $\frac{1}{10}$  h.p.), is used extensively for vacuum cleaners, sewing machines, and similar loads for which approximately constant torque is required. In these small sizes the motor is constructed similarly to a D.C. series-wound motor (the field magnet frame being laminated throughout), and is capable of running on either A.C. or D.C. circuits, thus leading to considerable simplification in the manufacture and marketing of these appliances. This con-

better commutation. The chief parts of a typical repulsion motor are illustrated in Fig. 5A.

**Single-phase Induction and Repulsion-induction Motors.**

The single-phase induction motor is a practically constant speed machine like the three-phase induction motor, but it is not self-starting. For light-duty starting a *split-phase motor*, with an auxiliary (starting) winding on the stator, may be used; but for heavy-duty starting either a *repulsion-start motor* or a *repulsion-induc-*

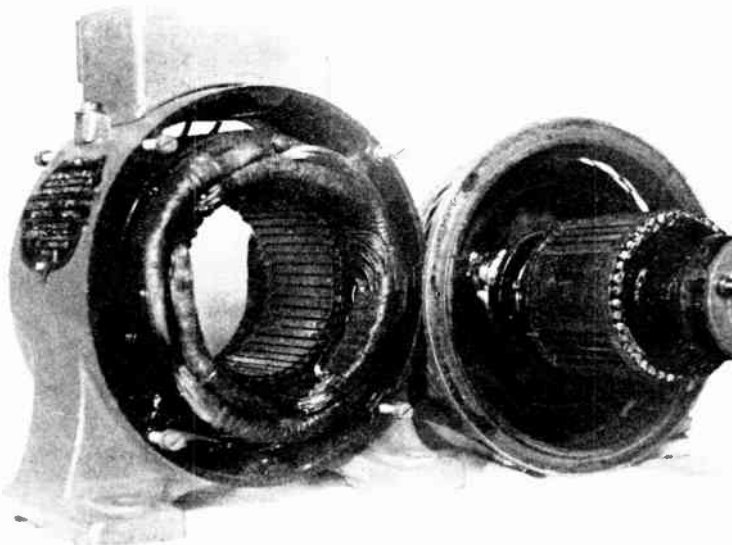

Fig. 4.—STATOR AND ROTOR OF SMALL THREE-PHASE SYNCHRONOUS MOTOR. (Lancashire Dynamo & Crypto, Ltd.)

The stator is similar to that of a three-phase induction motor. The rotor has polar projections together with an ordinary squirrel-cage winding. The ends of the conductors are visible in the illustration, and also the conductors occupying the spaces between the polar projections.

struction cannot be used for larger sizes because of difficulties with commutation.

**Single-phase Repulsion Motors.**

The repulsion motor has a restricted use to those applications requiring exceptionally large starting torque and a speed characteristic resembling that of the D.C. series-wound motor. In small and medium sizes this motor is used in preference to a single-phase series-wound motor because it is cheaper than the latter and has

*tion motor* must be used. The difference between these latter motors is that the repulsion-start motor has a single, commutator-type, rotor winding, which is short-circuited by a centrifugal device when the speed reaches a predetermined value, whereas the repulsion-induction motor has two rotor windings in separate slots (viz., a commutator winding and a squirrel-cage winding) and does not therefore require a centrifugal short-circuiting device. Of these motors the split-phase

type is the cheapest and the repulsion-induction type is the most expensive. Both the repulsion-start motor and the repulsion-induction motor possess the constant-speed characteristic of an induction motor together with the good starting qualities of a repulsion motor.

The chief parts of a repulsion-induction motor are illustrated in Fig. 6, and further details are given later.

**Single-phase Synchronous Motors.**

The single-phase fractional h.p. synchronous motor without direct-current excitation is being used in increasing numbers

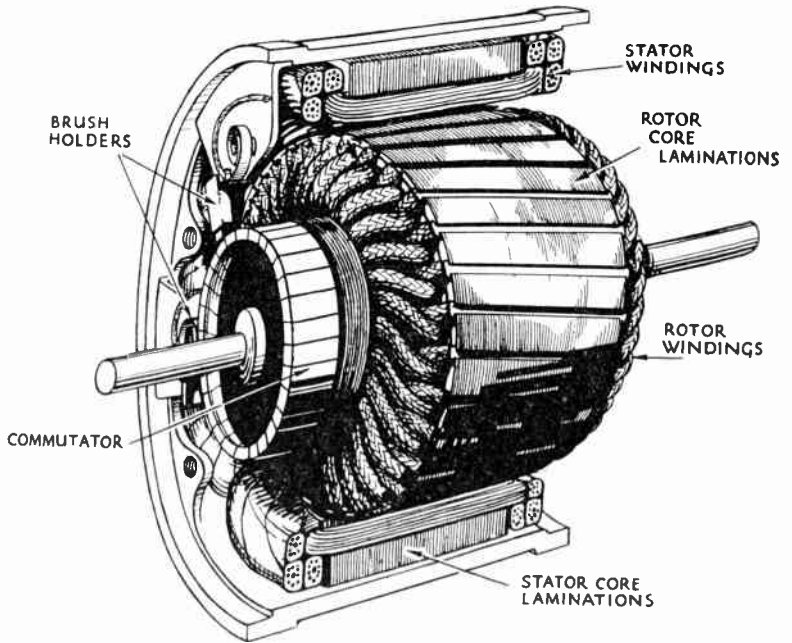

Fig. 5A.—GENERAL ARRANGEMENT OF STATOR, ROTOR AND BRUSH GEAR OF A REPULSION MOTOR (SMALL SIZE).

The stator core is similar to that of an induction motor, but the stator winding is of the single-phase type with the coil sides of each coil group distributed in three or four slots.

The armature has partially closed slots and the brushes are permanently short-circuited, as shown in the view of Fig. 5B.

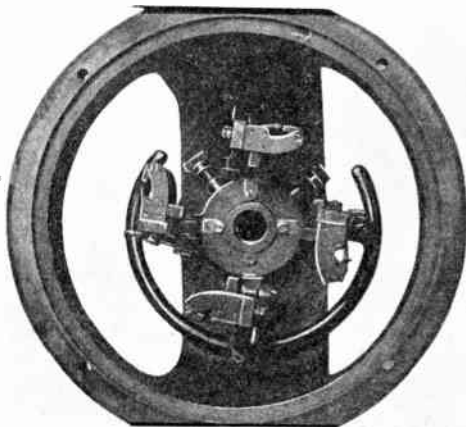

Fig. 5B.—COMMUTATOR END-BRACKET OF FOUR-POLE REPULSION MOTOR.

Notice the absence of brush-gear insulators, interconnections and terminals. The brush spindles are fixed directly to the brush rocker without the interposition of insulation.

for electric clocks, master frequency meters and numerous other types of A.C. instruments, timing mechanisms, mechanical rectifiers, sound recording and reproduction, wireless picture transmission, automatic telegraphy, small automatic conveyors, etc. It is self-starting and runs at constant speed (assuming the frequency of the supply system to be controlled by a master frequency meter).

**Summary.**

The types of three-phase and single motors and their general applications are summarised in Tables III and IIIA on pages 817 and 818.

**MECHANICAL FEATURES.**

**Types of Enclosure for Industrial Motors.**

As the three-phase induction motor is the most extensively used machine for



industrial plants, types of enclosure for this machine have been developed to meet all practical requirements. The types of enclosure for small and medium-size motors (up to about 250 h.p.) include the following: Screen protected, drip proof, pipe ventilated, forced draught, totally enclosed, totally enclosed fan cooled, flame proof. Large motors are usually of the open-protected type, or of the open type with separate bedplate and pedestal bearings.

Commutator motors (small sizes) have types of enclosure similar to those for D.C. motors (i.e., screen-protected, drip proof, pipe ventilated, totally enclosed). Medium size and large motors are of either the screen-protected, open-protected or open types.

Synchronous motors with separate excitation are usually built in large sizes, and are of the open-protected or open types.

**Screen Protected, Drip Proof, Pipe Ventilating and Totally Enclosed Induction Motors.**

These types of enclosure closely resemble the corresponding types for D.C. motors, and the illustrations in the article on "Types of D.C. Motors and their Applications" (pp. 149-166) may be considered as representative for both A.C. and D.C. motors.

**Special Totally Enclosed Type for Coalmines.**

A special form of small totally enclosed squirrel-cage motor, with a rolled steel frame, without feet, and boiler-plate end-brackets, has been developed (by Metropolitan Vickers) for driving belt conveyors

in coal workings. The requirements are that the motor must be capable of being rolled into the position where the conveyor is situated, and that the frame and end-brackets must be unbreakable.

**Forced Draught Motors.**

This type of enclosure is similar to the pipe-ventilated type, but the ventilating air is blown or forced into the motor by an external fan or blower, instead of being drawn into the motor by an internal fan. Forced draught is necessary in certain special cases where the motor runs at an abnormally slow speed or where the length of the pipe line is such that an internal

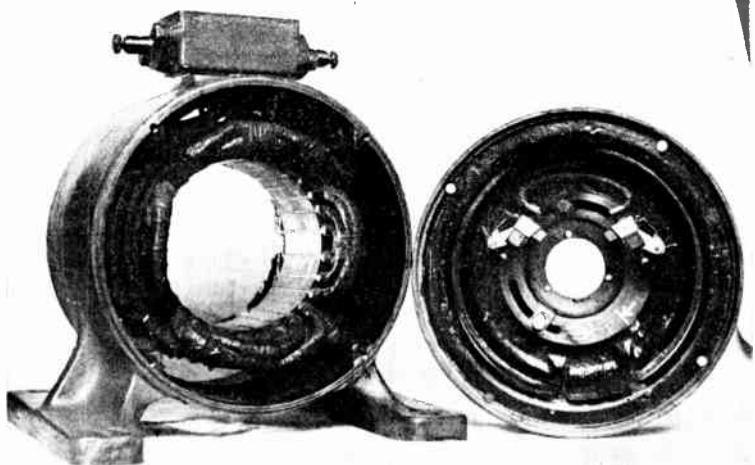

Fig. 6.—STATOR AND COMMUTATOR END-BRACKET OF SMALL REPULSION-INDUCTION MOTOR. (B.T.-H. Co.)

The stator has a four-pole single-phase winding and the outward appearance of the rotor is similar to that of a D.C. armature.

In this motor there are only two brush spindles, which are shown mounted on a rocker. The white lines on the latter indicate the positions of the rocker for clockwise and anti-clockwise rotation of the rotor.

fan is ineffective. The external fan may be either driven by a small separate motor or mounted adjacent to the motor and driven by a belt or chain.

The forced-draught closed circuit system of ventilation is used with large ship-propulsion motors. This system is described on p. 157.

**Totally Enclosed, Fan Cooled.**

This type of enclosure has been developed to overcome the disadvantages of the

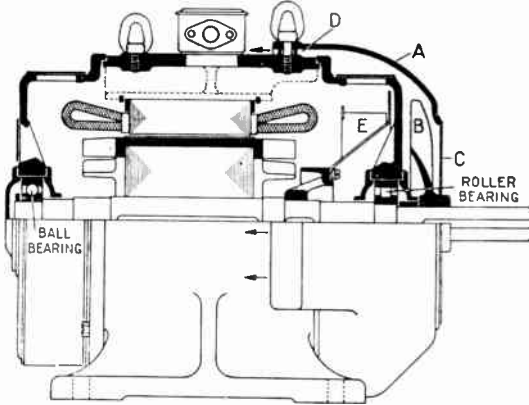

Fig. 7A.—TOTALLY ENCLOSED FAN-COOLED MOTOR. (B.T.-H. Co.)

This motor has a stator frame similar to that in Fig. 1, and a cast aluminium rotor winding similar to that in Fig. 2B.

ordinary totally enclosed machine, which becomes extremely costly for sizes above about 10 h.p. owing to the large size of frame required to obtain adequate cooling. In the new type of enclosure cool air is blown over the surface of the frame by a fan mounted on the shaft between the pulley-end bearing bracket and the pulley. The arrangement is shown in Fig. 7A, in which this fan is shown at B. A hood, A, fixed to the frame, deflects the cooling air, which is drawn in at C, over the surface of the frame, as indicated by the arrows. An internal fan, E, is also fitted for circulating the air enclosed in the motor through and around the windings and stator core.

In some cases a double frame is employed as shown in Fig. 7B.

This type of enclosure produces such good results in an induction motor (enabling the continuous rating in some cases to be 50 per cent. higher than that of an ordinary totally enclosed motor of the same frame

size) because the greatest heating occurs in the stator, the laminations of which are in direct contact with the frame over which the cooling air is blown.

**Flame-proof Enclosure.**

This type of enclosure is provided for totally enclosed induction motors which have to work in coal mines, gas works, oil plants, chemical factories and pulverised coal plants where an explosive mixture is liable to occur in the surrounding air. The frames and bearing brackets are specially strong and the joints have large surfaces. Moreover, a special labyrinth gland is used at the shaft extension. This gland and the large surfaces at the joints effectively prevent the flame, resulting from an internal explosion of methane (fire damp) and air, being communicated to a surrounding explosive mixture.

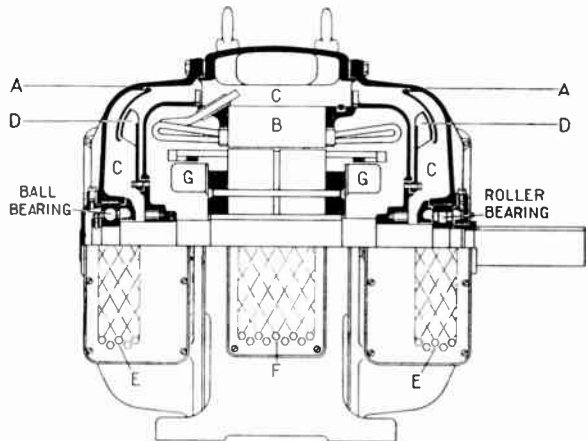

Fig. 7B.—TOTALLY ENCLOSED FAN-COOLED MOTOR WITH DOUBLE FRAME. (B.T.-H. Co.)

A, outer frame and end brackets; B, stator core; C, annular space between inner and outer frames; D, outer fans; E, air inlets; F, air outlet; G, inner fans.

**Summary.**

The types of enclosure and their applications are summarised in Table II.

TABLE II.—TYPES OF ENCLOSURE FOR A.C. MOTORS AND THEIR APPLICATIONS.

Type of Enclosure.	Suitable for	Type of Enclosure.	Suitable for
Protected and screen-protected.	Engineering workshops (individual and group drives); woodworking plants; printing works; textile factories (weaving and printing); rubber plants; lifts; pumping plants; air compressors; refrigerators.	Forced draught ..	Specially slow-speed motors and cases where a long pipe line would be necessary for a pipe-ventilated motor.
Canopy protected or drip proof	Laundries and wash-houses; base ment pump rooms in power stations; outdoor plants (gantry cranes, sawmills, etc.) not exposed to driving rain.	Forced draught, closed air circuit.	Large ship-propulsion motors.
Pipe ventilated ..	Textile factories (spinning mills and card rooms); flour mills; cement works; paper mills; chemical works; paint and varnish factories.	Totally enclosed, ordinary type.	Boiler-house plant (mechanical stokers and coal-handling machinery); foundries; capstans; winches; underground coal conveyors.
		Totally enclosed, fan cooled.	All cases requiring total enclosure, except those in preceding and following paragraphs.
		Totally enclosed, flame proof.	Coal mines (coal cutters and other machinery in "gaseous" mines); pulverised fuel plants; gas works; oil plants; "gaseous" chemical factories.

TABLE III.—TYPES OF A.C. MOTORS AND THEIR GENERAL APPLICATIONS.

Type of Motor.	Chief Characteristics.	General Applications.
Three-phase induction ..	Slight drop in speed (between 3 and 5 per cent.) from no load to full load. No load speed (revs. per sec.) = supply frequency ÷ half number of poles. Power factor lagging (about 0.9 at full load, 0.6 at quarter load).	Non-reversing and reversing drives with frequent and infrequent starting. Any starting duty and any output. Machine tools, woodworking machines, cranes, hoists, winders, fans, pumps, lifts, textile mills, etc.
Three-phase induction-commutator (variable speed).	Variable speed, shunt characteristic. Usual speed range 3 : 1. Speed controlled by brush shifting. Power factor unity at top speed, but lagging at lower speeds. Max. operating voltage 650 volts.	Non-reversing drives, with frequent and infrequent starting, requiring moderate outputs up to about 250 h.p. Textile mills, printing presses, large lathes, paper-making machines, lifts, fans, pumps.
Three-phase compensated induction (commutator type).	Speed characteristic similar to that of induction motor. Power factor unity at full load and leading at fractional loads. Max. operating voltage 650 volts.	Non-reversing drives, with frequent and infrequent starting, requiring moderate outputs up to about 250 h.p.
Three-phase small synchronous, without D.C. excitation.	Speed constant at constant frequency. Self-starting (light duty). Low power factor.	Textile mills, gas works, automatic conveyors where synchronisation of a number of processes is necessary.
Three-phase synchronous, with D.C. excitation.	Speed constant. Can be made self-starting. Power factor is controllable, and can be adjusted to leading values for power factor correction purposes. Highest efficiency of all types of A.C. motors.	Non-reversing drives with infrequent light-duty starting. Large outputs. Air compressors, ammonia compressors, motor-generator sets.
Three-phase synchronous-induction.	Speed constant. Starting characteristics similar to those of slip-ring induction motor. Controllable power factor.	Non-reversing drives with infrequent heavy duty starting. Any output.

TABLE IIIA.—TYPES OF SINGLE-PHASE MOTORS AND THEIR GENERAL APPLICATIONS.

Type of Motor.	Chief Characteristics.	General Applications.
Single-phase induction (split-phase start and repulsion start).	Speed characteristic similar to that of three-phase induction motor. Requires auxiliary windings for starting.	Non-reversing fractional h.p. drives requiring slunt speed characteristic.
Single-phase series . .	Made in small fractional h.p. sizes only. Series speed characteristic. Good starting torque.	Vacuum cleaners, sewing machines.
Single-phase repulsion . .	Series speed characteristic. Good starting torque. Additional stator winding required for reversible operation.	Reversing and non-reversing drives with heavy frequent and infrequent starting. Lifts, cranes, etc.
Single-phase repulsion-induction.	Slunt speed characteristic similar to that of induction motor. Good starting torque. Additional stator winding required for reversible operation.	Reversing and non-reversing drives with heavy frequent and infrequent starting. Machine tools, lifts, pumps, fans, mixing machines, etc.
Single-phase small synchronous, without D.C. excitation.	Speed constant. Requires auxiliary windings for starting.	Non-reversing constant speed drives with light duty starting. Clocks, timing mechanisms, automatic telegraphs, mechanical rectifiers, picture and sound recording and reproduction, etc.

### CHARACTERISTICS AND APPLICATIONS OF THREE-PHASE INDUCTION MOTORS.

#### Chief Electrical Parts and Constructional Features.

The chief electrical parts are (1) a stationary member, called the *stator*, and (2) a rotating member, called the *rotor*.

The stator consists of a laminated core with partially closed slots spaced uniformly along its inner periphery. A three-phase winding, designed for the full supply voltage, is wound in these slots, and when excited by three-phase currents produces a rotary magnetic field of the required number of poles. The winding is either star or delta connected according to the starting requirements and other conditions.

The rotor also consists of a laminated core with partially closed slots spaced uniformly along its outer periphery. Two types of winding are used, viz., a normal three-phase winding with the ends connected to slip rings, and a permanently short-circuited winding, consisting of bars and short-circuiting end rings (called a

*squirrel-cage*). Their uses are explained in the following sections.

The stator and rotor are arranged concentrically as represented in the perspective sectional sketches of Fig. 8, which show clearly the arrangement of the rotor windings. The slip-ring rotor winding is always star connected and has the same number of poles as the stator winding. The usual diagrammatic representations of slip-ring and squirrel-cage motors are shown in Fig. 9.

#### The Air Gap.

An item of very great importance in an induction motor is the air gap between the stator and rotor. This gap must be made as small as practicable if the motor is to operate with a high power factor. For example, in a 10-h.p. motor the air gap is about 0.03 inch, and in a large motor with a 6-ft. diameter rotor it is about 0.08 inch (i.e., less than a tenth of an inch!). Hence in small motors accurate machining and centring of the rotor are extremely important. Such machines, therefore, are fitted with ball or roller bearings, and the stator and rotor cores at the air gap are ground to true cylindrical surfaces.



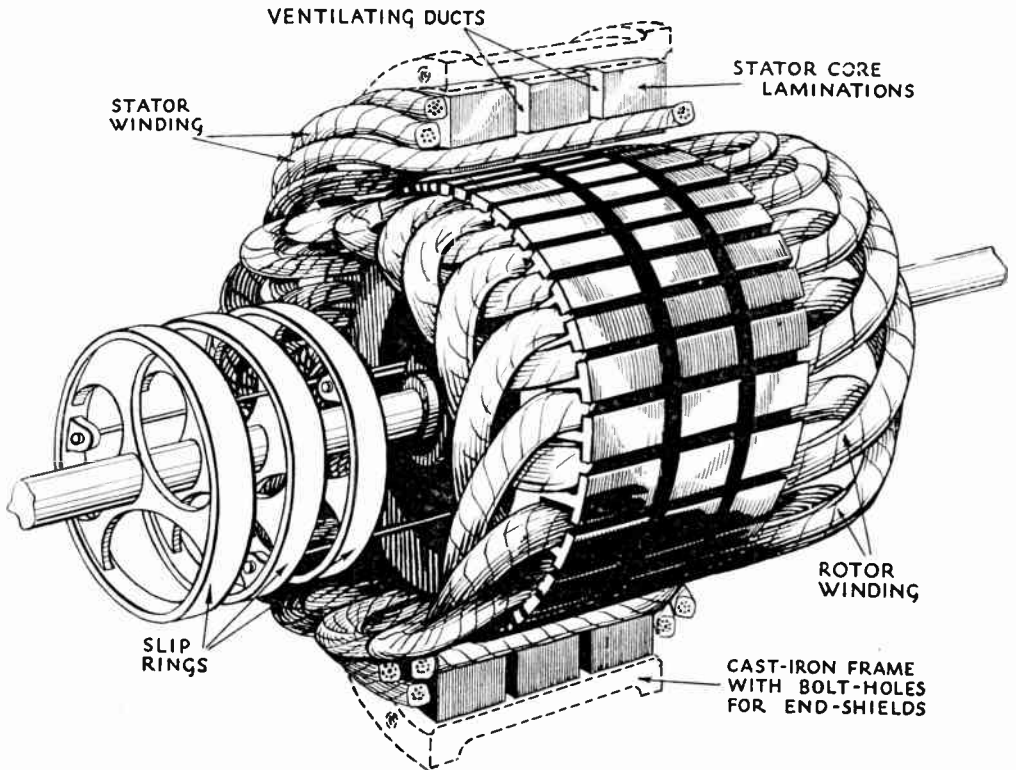

Fig. 8A.—GENERAL ARRANGEMENT OF STATOR AND ROTOR OF A SLIP-RING MOTOR.

Notice the manner in which the end connections of the rotor winding are arranged so as to be self-supporting. This is called a "mush" arrangement.

Notice also the partially closed slots and the radial ventilating ducts.

### How the Torque is Produced.

An essential condition for the production of torque in an induction motor is the establishment of a *rotary* magnetic field. In three-phase motors this field is produced by the three-phase currents circulating in the stator windings. The rotary field may be likened to a rotating field frame of a D.C. motor, the speed of rotation in revolutions per second being equal to: Supply frequency ÷ half the number of poles in the stator winding. The rotor conductors (which form a short-circuited winding) are cut by this field, and alternating e.m.f.'s and currents are induced in them, the frequency of these being equal to: Speed (revs. per second) at which rotor conductors are cut × half number of poles. If the rotor winding were non-inductive, the currents in the

conductors under a given pole of the rotary field would be in phase with the flux, and the direction of these currents would always bear a constant relationship to the direction of the flux (i.e., when the flux changes sign the currents would also change direction). Hence a continuous and steady torque would be produced. These conditions are represented graphically in the pictorial diagram of Fig. 10.

In practice the rotor winding is inductive, and the currents lag with respect to the flux, i.e., the rotor conductors which are carrying maximum current at a particular instant are displaced with respect to the centre of the pole face of the rotary field. In consequence the torque is smaller than that produced by a non-inductive rotor winding. The in-

ductive effect is greatest at starting, because the frequency in the rotor is then equal to the supply frequency, and in order to obtain a large torque at starting resistance must be added to the rotor circuit to reduce the lag of the current. This is one of the reasons why a slip-ring motor can start against heavy loads and why an ordinary squirrel-cage motor is unsuitable for this duty. At normal speed the frequency in the rotor is very small and the inductive effect is correspondingly small.

decreases when the armature current and torque increase; the decrease in counter-e.m.f. requiring a corresponding decrease in speed to maintain electrical equilibrium. As the percentage drop in speed from, say, no load to full load in a shunt-wound motor depends upon the resistance of the armature winding, so also does the percentage drop in speed of an induction motor depend upon the resistance of the rotor circuit; i.e., for given conditions a high-resistance rotor circuit will cause a greater percentage drop in speed from no load to full load than a low-resistance rotor circuit.

Again, just as in the D.C. shunt-wound motor a relatively high armature resistance results in high armature losses and low efficiency, so also in the induction motor a high rotor resistance results in high rotor losses and low efficiency.

The analogy between the induction motor and the D.C. shunt-wound motor, however, ceases to hold at overloads, as due to inductance and magnetic leakage the torque in the induction motor does not increase in proportion to the current input and reaches a maximum

value at about twice to two and a half times full-load torque.

**Typical Speed-Torque Curves.**

A typical speed-torque curve for a motor with the usual low-resistance rotor winding is shown by curve A, Fig. 11. The change in speed from no load to full load is about 3 per cent. of the no load (synchronous) speed. B, C, D show the corresponding curves when the resistance

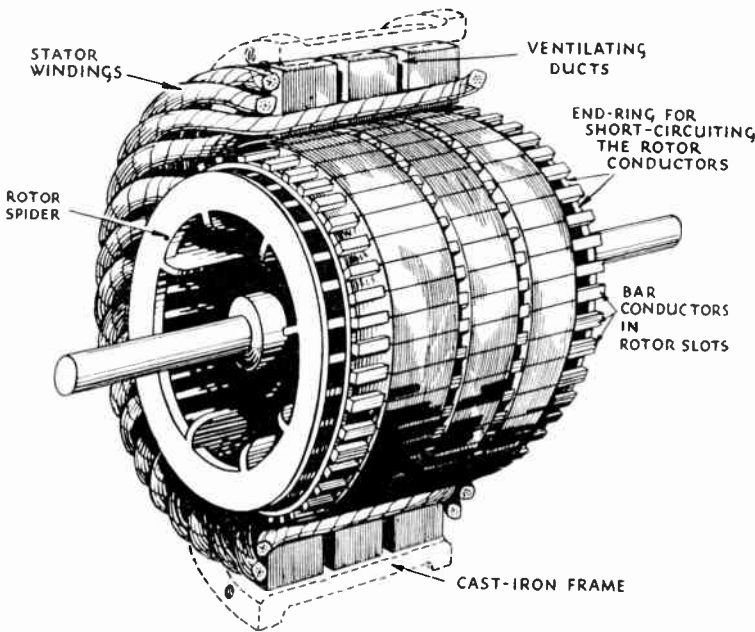

Fig. 8B.—GENERAL ARRANGEMENT OF STATOR AND ROTOR OF A SQUIRREL-CAGE MOTOR.

Notice the "mush" arrangement of the stator end connections.

In this motor the rotor bars and end rings are of copper. The joints between bars and end rings are usually made by electric welding.

**Speed Characteristics.**

The principle of operation of an induction motor requires that the speed should drop slightly as the torque increases. This drop in speed provides the additional e.m.f. in the rotor conductors to pass the additional current through the rotor circuit. The conditions are somewhat similar to those occurring in the D.C. shunt-wound motor, in which the counter-e.m.f. (or back-e.m.f.) in the armature

of the rotor circuit is increased (by means of external resistance inserted *via* the slip-rings) to 2, 5 and 10 times the normal value. These curves show that for a given torque any speed between zero and normal may be obtained by inserting appropriate resistance in the rotor circuit. This, then, is a simple but inefficient method of regulating temporarily the speed of an induction motor. The efficiency is low because of the large losses in the rotor circuit. Moreover, as the resistance of the rotor circuit is increased the slope of the speed-torque curve increases and ultimately resembles that of a series motor. Thus an induction motor controlled by resistance in the rotor circuit loses its shunt or constant-speed characteristic.

**Power Factor and Efficiency.**

The power factor and efficiency of small motors with squirrel-cage rotors are always slightly higher than the corresponding quantities for these motors with slip-ring rotors. Typical average curves which are representative of modern motors are given in Fig. 12.

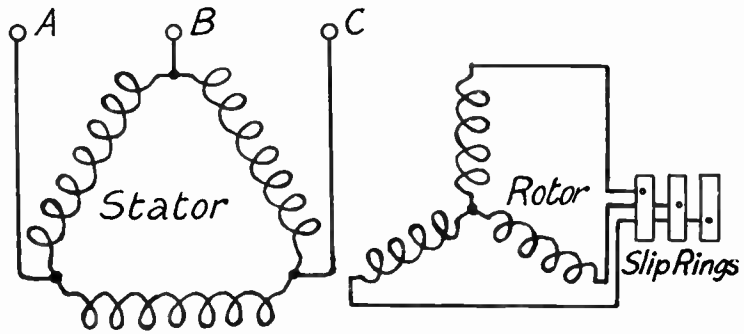

Fig. 9A.—USUAL METHOD OF REPRESENTING A THREE-PHASE SLIP-RING INDUCTION MOTOR IN WIRING DIAGRAMS.

**Applications.**

Ordinary squirrel-cage motors can only be used when the starting conditions are light, as with the usual methods of starting—e.g., by star-delta connections (only suitable for motors up to 35 h.p.), and auto-transformer—the starting torque is about 35 per cent. of full-load torque for star-delta starting (the starting current being about  $1\frac{3}{4}$  times full-load current), and between 35 and 70 per cent. of full-load torque for auto-transformer starting (the corresponding starting currents taken from the supply system being between  $1\frac{3}{4}$  and 3 times full-load current). When the starting conditions are suitable, the squirrel-cage motor should *always* be used, because of its cheapness, simplicity, robustness and higher efficiency and power factor compared with the slip-ring motor.

A slip-ring motor is capable of starting against any load within the maximum torque of the motor. Full-load starting torque can be obtained with a starting current about  $1\frac{1}{4}$  times full-load current, and higher torques with correspondingly higher currents.

*Squirrel-cage motors* are suitable for driving fans, blowers, centrifugal pumps and machines, looms in weaving rooms of textile mills, machine tools, woodworking machines, and all machines which can be started light.

*Slip-ring motors* are suitable for driving air compressors, ram pumps, crushing mills, pulverising mills, haulages, cranes, winches, hoists, winders, lifts, and machines

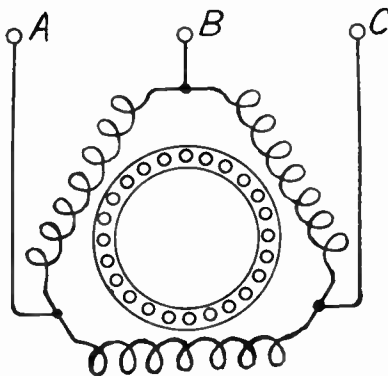

Fig. 9B.—USUAL METHOD OF REPRESENTING A THREE-PHASE SQUIRREL-CAGE MOTOR IN WIRING DIAGRAMS.

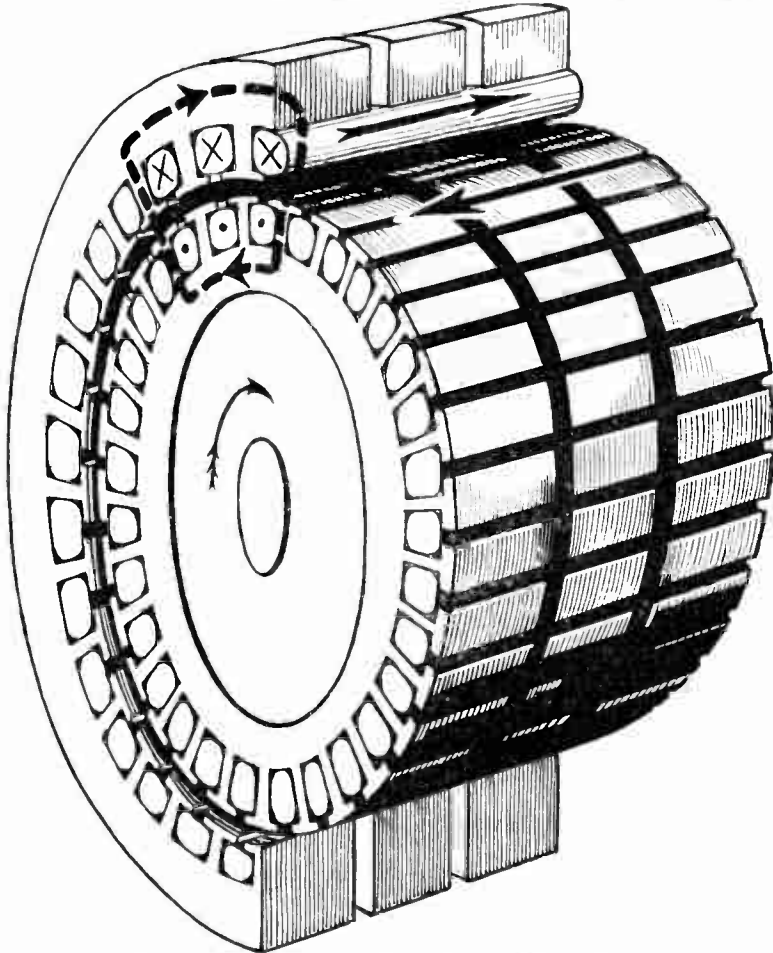

Fig. 10.—PICTORIAL REPRESENTATION OF STATOR AND ROTOR CORES OF A THREE-PHASE INDUCTION MOTOR.

Showing the directions of currents, flux and torque at a particular instant.

with heavy flywheels which have to be started slowly.

### CHARACTERISTICS AND APPLICATIONS OF SPECIAL TYPES OF THREE-PHASE INDUCTION MOTORS.

#### DOUBLE SQUIRREL-CAGE HIGH-TORQUE MOTORS.

The chief disadvantage of the ordinary squirrel-cage motor is that the starting torque is very small in comparison with the current taken from the supply system. Any attempt to improve the starting performance by increasing the resistance of the ordinary squirrel-cage winding adversely affects the efficiency and general

performance of the motor. If, however, the resistance of the rotor winding were increased temporarily at starting, improved starting performance would be obtained without detriment to the efficiency. This is the principle utilised in the double squirrel-cage motor.

#### How the Double Squirrel-cage Windings are Arranged.

One of the two squirrel-cage windings occupies slots at the periphery, as in an ordinary motor, and the other occupies slots in the body of the rotor core. The outer winding has a high resistance, and the inner winding has a low resistance.

At starting the current is confined to the outer winding because the reactance of the inner winding is high, due to the embedded conductors and the relatively high frequency in the rotor. But at normal speed the reactances of both windings become very small, and therefore the rotor current divides between these windings in the inverse ratio of their resistances, i.e., the inner winding now carries practically all the current. Thus the efficiency is not impaired by the high-starting torque characteristics.

#### Speed and Starting Characteristics.

A typical speed-torque curve is shown in Fig. 13, and for comparison the speed-



torque curve for an ordinary squirrel-cage motor is also shown.

The double squirrel-cage motor, when started by the star-delta method, gives a starting torque of 60 to 75 per cent. of full-load torque, with a starting current of  $1\frac{1}{2}$  to  $1\frac{3}{4}$  times full-load current. Thus the starting torque is about twice that obtained with an ordinary motor, and the current taken is slightly smaller than that taken by an ordinary motor started by the star-delta method. Thus the ratio of starting torque/starting current for the double squirrel-cage motor is over twice that for an ordinary squirrel-cage motor.

**Power Factor and Efficiency.**

The full load efficiency and power factor are practically the same as those for an ordinary motor.

**Applications of Double Squirrel-cage Motors.**

These motors should be used when high torque is required at starting combined with moderate starting current.

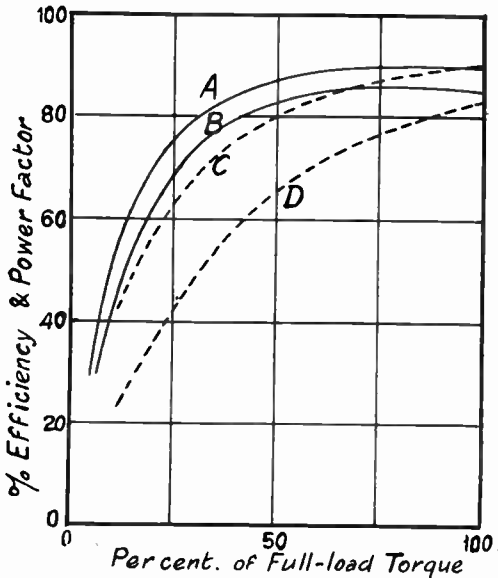

Fig. 12.—AVERAGE EFFICIENCIES AND POWER FACTORS OF STANDARD THREE-PHASE SQUIRREL-CAGE MOTORS.

A, efficiency (10-20 h.p. motors); B, efficiency (2-5 h.p. motors); C, power factor (10-20 h.p. motors); D, power factor (2 h.p. motors).

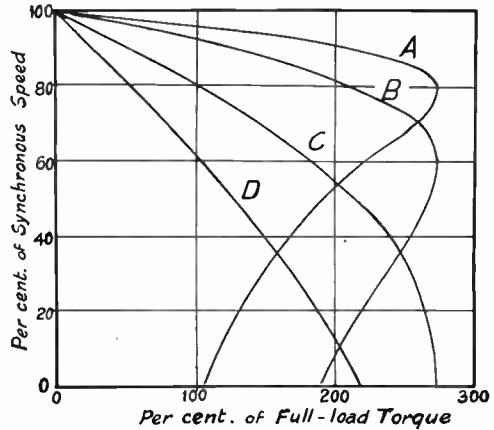

Fig. 11.—TYPICAL SPEED-TORQUE CURVES FOR A SLIP-RING INDUCTION MOTOR.

A, slip-rings short circuited; B, C, D, external resistances connected to slip-rings, of 2, 5 and 10 times, respectively, the resistance of the rotor winding.

They may also be used with advantage for driving punching and shearing machines (which have rapidly fluctuating loads), because the speed-torque curve of these motors droops rapidly at overloads, and therefore the load fluctuations are supplied by the stored energy of the rotating parts, instead of by increased output from the motor. But they should not be used when a low-starting torque is required (e.g., for air compressors fitted with unloading valves, where the initial torque to start the machine is from 15 to 30 per cent. of the full-load torque), as such starting duty is suitable for ordinary squirrel-cage motors. Again, they are not so suitable for starting fans and centrifugal pumps as ordinary induction motors, because the torque-speed characteristic of these loads rises steeply as the speed increases, and resembles that of an ordinary squirrel-cage motor rather than that of a double squirrel-cage motor.

**CHANGEABLE POLE (MULTI-SPEED) INDUCTION MOTORS.**

When two, three or four efficient speeds having definite ratios are required they may be obtained by means of one or two pole-changing windings, i.e., windings in

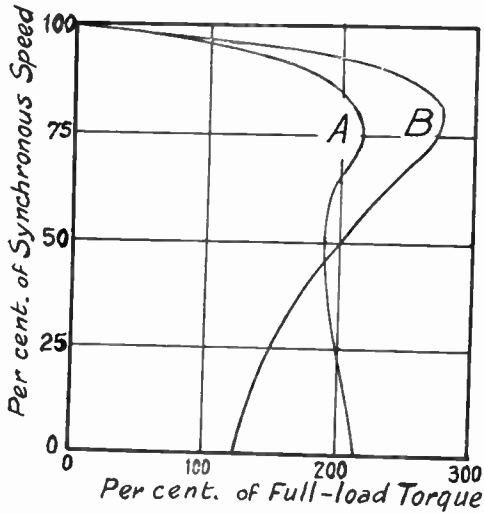

Fig. 13.—SPEED-TORQUE CURVES OF THREE-PHASE INDUCTION MOTORS HAVING A DOUBLE SQUIRREL-CAGE ROTOR (A) AND AN ORDINARY SQUIRREL-CAGE ROTOR (B).

which the connections can easily be changed by a throw-over switch to give two sets of poles, which are usually in the ratio of 1 : 2. The scheme is shown diagrammatically in Fig. 14.

Two-speed motors may have either squirrel-cage or slip-ring rotors (the latter having separate windings and slip-rings for each set of poles), but three and four-speed motors must have squirrel-cage rotors.

With a two-speed slip-ring motor intermediate speeds may be obtained by inserting resistance in the appropriate rotor circuit, and speed-torque curves similar to those of Fig. 11 may be obtained for each set of poles. With a squirrel-cage rotor only one speed-torque curve can be obtained for each set of poles.

**Speed and Starting Characteristics.**

The speed-torque characteristic for each set of poles is similar to that for an ordinary induction motor, but the starting torque, for a given power input to the motor, is greater for the low-speed connection (larger number of poles) than for the high-speed connection (smaller number of poles).

**Power Factor and Efficiency.**

The power factor of a changeable-pole motor is always lower than that of a corresponding single-speed motor, because

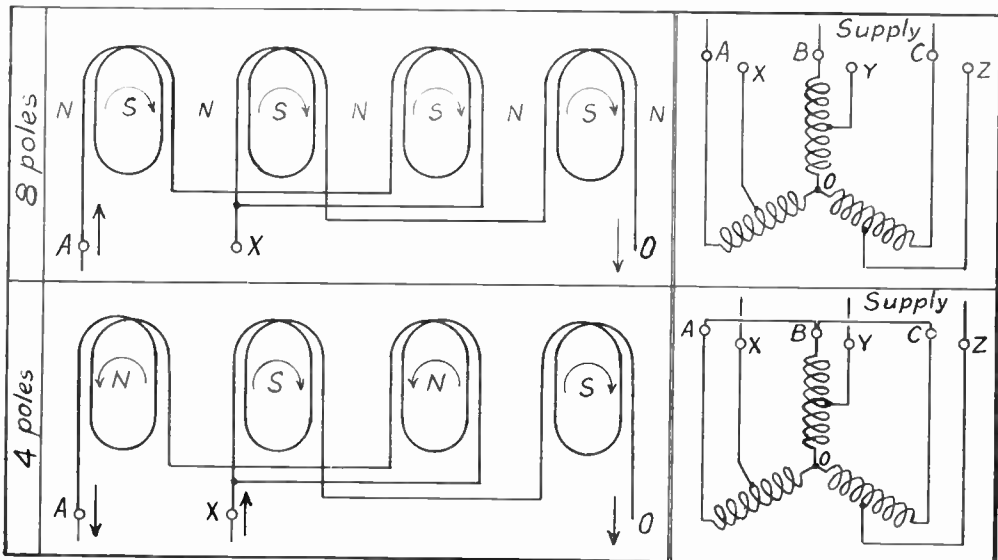

Fig. 14.—How Two Sets of Poles may be Obtained from a Single Winding. This is done by reversing the direction of current in alternate coils of each phase. NOTE.—In the development diagrams the coils of only one phase are shown.

# RALPH STRANGER'S WIRELESS BOOKS

*The Wireless Library for the  
Man in the Street:*

- MATTER AND ENERGY
- ELECTRONIC CURRENTS
- ELECTRIFIED MATTER
- MAGNETISM AND ELECTRO-  
MAGNETISM
- THE MATHEMATICS OF WIRELESS
- BATTERIES AND ACCUMULATORS
- SEEING BY WIRELESS (TELEVISION)
- MODERN VALVES
- WIRELESS COMMUNICATION AND  
BROADCASTING
- WIRELESS WAVES
- HOW TO UNDERSTAND WIRELESS  
DIAGRAMS
- SELECTION OF WIRELESS SIGNALS
- DETECTION OF WIRELESS SIGNALS
- AMPLIFICATION OF WIRELESS SIGNALS
- REPRODUCTION OF WIRELESS SIGNALS
- WIRELESS RECEIVING CIRCUITS
- WIRELESS MEASURING INSTRUMENTS
- THE BY-PRODUCTS OF WIRELESS

**SOME PRESS OPINIONS:—**

"The new shilling library aims at giving the wireless enthusiast a sound theoretical and practical grip of his subject. The author employs clear and simple language, and starts practically from zero."—*The Broadcaster*.

"These books deal with a highly technical subject in the simplest language which enables those who have no scientific training to grasp the wonders of wireless, and assist the listener to get the best possible results from a receiving set."—*Railway Review*.

**ONE SHILLING EACH**

By Post 1 2 each.

## WIRELESS: THE MODERN MAGIC CARPET

Fourth and Revised Edition

If you know nothing about wireless and do not even possess a receiving set, this book will show you how to provide yourself with an interesting and absorbing hobby. If you are a listener, but rather weak on the technical side, it will save you much unnecessary worry and expense. If you wish to experiment, this volume will provide you with valuable experimental data. If you are an expert and have to lecture, it will give you some useful lecture material.

**SOME PRESS OPINIONS:—**

"Mr. Stranger . . . gives a simple, yet authentic introduction to all the 'mysteries,' and explains them away in an exceedingly interesting and readable way. . . . A book which should go on every listener's bookshelf."—*The Star*.

"A good book simply written."—*The Daily Mirror*.

" . . . It will be surprising if such an ably written book as this does not find a wide sale."—*Daily News*.

" . . . Mr. Stranger has succeeded in doing one thing that will endear him to all students interested in electricity. He has succeeded in making static electricity fascinating. . . . The book should prove of great value to all those who have a set or contemplate the construction of one."—*World-Radio*.

" . . . The subject, in both theoretical and practical aspects, is dealt with in a lucid manner guaranteed to inculcate knowledge without pains."—*Amateur Wireless*.

**3/6 nett.**

By Post 3/9.

On sale at all Newsagents, Bookstalls and Bookshops, or by post from **GEORGE NEWNES, Ltd., 8-11, Southampton Street, Strand, London, W.C. 2**

Geo. Newnes, Ltd.

**This article on Types of A.C. Industrial Motors and their Applications will be continued in Part 18. Ready February 12th.**

Of extraordinary value to every handyman

# NEWNES' Home Mechanic BOOKS

Clearly written and fully illustrated  
each book contains 96 pages

## TOY MAKING FOR AMATEURS

Tells you how to make toys of every description and lays bare the principles by means of abundant illustrations and simple text. Every mechanical movement known in toy manufacture is included.

## TWENTY-FIVE TESTED WIRELESS CIRCUITS

A book for the modern wireless enthusiast. All the sets described have been designed to meet modern needs. They range from simple crystal receivers to a seven-valve super-heterodyne, and all the sets have been made and tested before inclusion.

## SIMPLE ELECTRICAL APPARATUS

An excellent little book for those who wish to make simple and useful electrical appliances, such as galvanometers, electric motors, dynamos, and Leyden jars. All these may be made by anyone with the aid of a few tools and some inexpensive materials. Clear instructions are given in every case.

## MODEL BOAT BUILDING

There are few more fascinating hobbies than Boat Building. In this book there are designs for a battleship, a speed boat, a paddle-steamer and yachts, from which excellent models may be built with the help of the simple directions and diagrams that are given. No elaborate tools are needed, and each model can be made at small cost.

### Other Titles

THE HANDYMAN'S ENQUIRE WITHIN  
THE HOME WOODWORKER  
25 SIMPLE WORKING MODELS  
MODEL AEROPLANES AND AIRSHIPS

## One Shilling each

On sale at all Newsagents and Bookstalls, or by post 1/2 each from George Newnes, Ltd., 8-11, Southampton Street, Strand, London, W.C.2

Geo. Newnes, Ltd.

Printed in Great Britain for the Proprietors, GEORGE NEWNES, LTD., 8-11, Southampton Street, Strand, W.C.2, by WILLIAMS, LEE & Co., LTD., Clifton House, Worship Street, E.C.2. Sole Agents: Australasia: GORDON & GOTCH (Australasia), LTD South Africa: CENTRAL NEWS AGENCY, LTD.