

A MONTHLY MAGAZINE OF ELECTRICAL PROGRESS

The **PRACTICAL**
ELECTRICAL
ENGINEER

VOL. I.—No. 4

DECEMBER, 1932

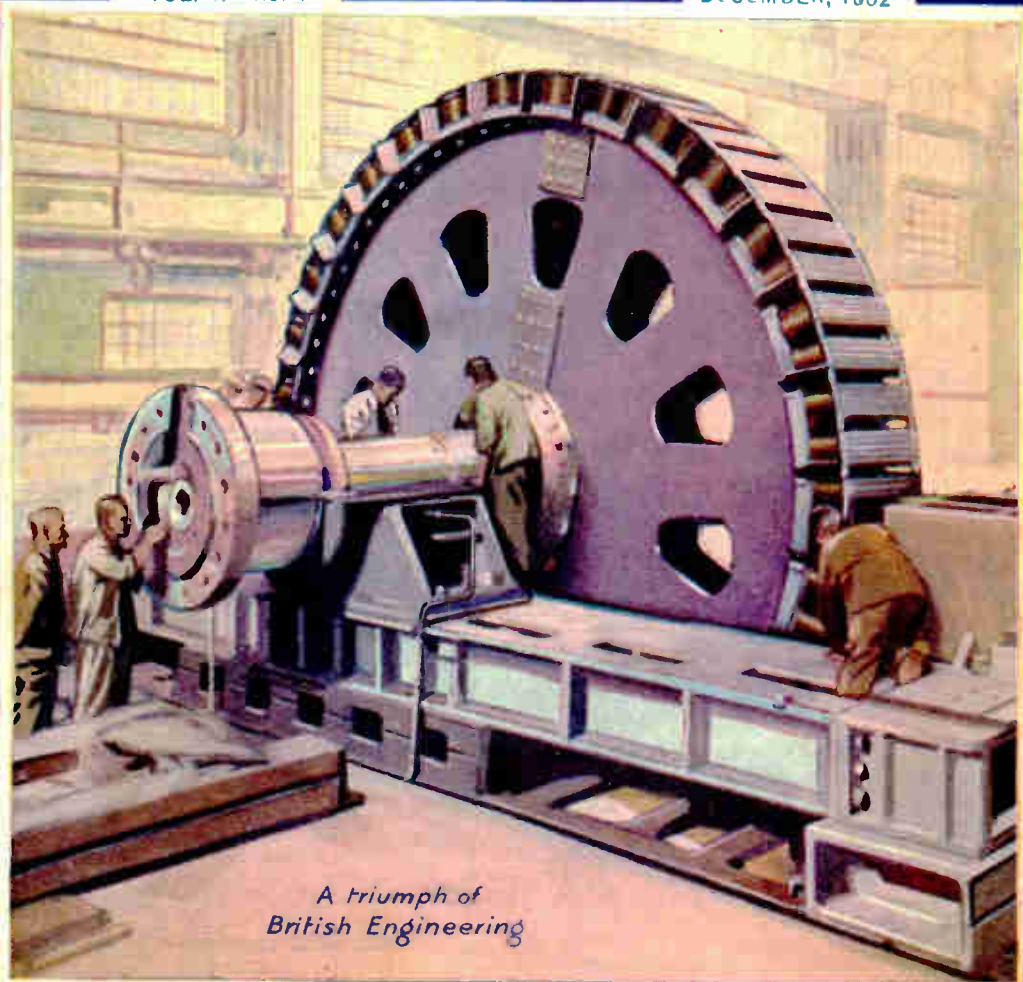

*A triumph of
British Engineering*

GEORGE NEWNES LTD.

1¹/₂

DECEMBER

PRACTICAL ELECTRICAL ENGINEER

NO. 4

STUDY
AT
HOME

YOU CAN HAVE A COLLEGE
TRAINING IN ALMOST ANY
CAREER FOR A FEW
SHILLINGS MONTHLY

IN
YOUR
SPARE
TIME

LET ME BE YOUR FATHER

Unless you are in touch with all branches of industry, you cannot see the possibilities of employment, but with our gigantic organisation we are in touch with every sphere of activity and we know that in many trades and professions there are more vacancies than there are trained men to fill them.



WE DO NOT PROFESS TO ACT AS AN EMPLOYMENT AGENCY, BUT WE CERTAINLY ARE IN A POSITION TO GIVE FATHERLY ADVICE ON ALL CAREERS AND THE POSSIBILITY OF EMPLOYMENT THEREIN.

WE teach by post all branches of the following vocations and specialise in all examinations connected therewith. Our advice is always Free.

J. Bennett

THE MOST SUCCESSFUL AND MOST PROGRESSIVE CORRESPONDENCE COLLEGE IN THE WORLD

Aviation Engineering.
Boiler Engineering.
Boiler Making.
B.Sc. (Engineering).
Civil Engineering :
A.M.I.C.E.
Quantities—Specifications.

Commercial Art.
Concrete and Steel.
Draughtsmanship :
Electrical or
Mechanical.
Electrical Engineering :
A.M.I.E.E.
City and Guilds.
Engineering Mathematics.
Foundry Work.

Heat Engines.
Heating, Ventilating and
Lighting.
Internal Combustion Engines
Machine Designs :
Theory of Machines.
Mechanical Engineering
A.M.Inst.B.E.
A.M.I.Mech.E.
City and Guilds.
Pattern Making.
Mechanics.
Metallurgy of Steel.

Mine Electrician :
A.M.E.E.
Mining (all examinations).
Motor Engineering :
A.M.I.A.E.
Municipal and County
Engineers :
M. and C.E.
Naval Architecture.
Pumps and Pumping
Machinery.
Radio Reception.
Ship Building.
Structural Engineering.
Telegraphy and
Telephony.
Transport

IF YOU DO NOT SEE YOUR OWN REQUIREMENTS ABOVE, WRITE TO US ON ANY SUBJECT.

WE TEACH BY
POST IN ALL PARTS
OF THE WORLD

DO NOT DELAY

THERE MAY BE CHANCES FOR YOU
TO-DAY FOR WHICH YOU MAY BE
TOO LATE TO-MORROW. EVERY
DAY COUNTS IN A MAN'S CAREER

IT COSTS
NOTHING TO
ENQUIRE

Also ask for Our New Book
(FREE OF CHARGE)

THE HUMAN MACHINE

SECRETS OF
SUCCESS

Note Address Carefully:

The BENNETT COLLEGE, Ltd., Dept. 190, Sheffield



What do you look for in a DRY BATTERY?



The most important features of a dry battery are its output and life, its 'shelf' life (or life while not actually on discharge), its immunity from exacting external conditions. Values given for voltage and internal resistance are always approximate and, while the resistance values obtained from Edison cells are low, it should be noted that a low internal resistance does not necessarily indicate the quality of the cell, an inferior and rapidly deteriorating cell frequently showing a high short circuit current reading.

All Edison cells are manufactured from carefully selected materials and are tested for voltage and resistance immediately prior to dispatch from the works. Long experience of dry battery manufacture and continued research ensures the highest possible standard of performance.

in a STATIONARY BATTERY?

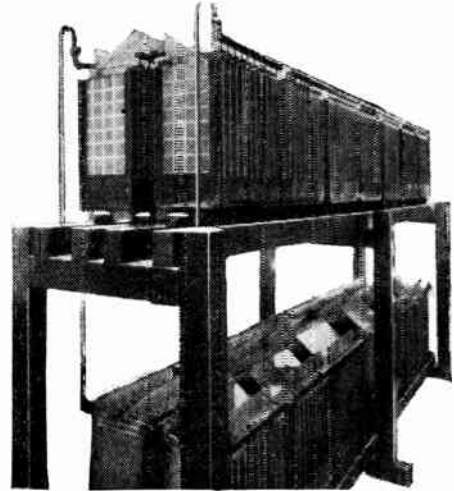

The majority of stationary battery installations for house lighting receive very little attention from their owners. It is essential therefore, that batteries for that purpose should be robust and well able to withstand a certain amount of neglect. It is for this reason that pasted plates are not used in Edison stationary type batteries. Such plates are more prone to buckle and 'shed' than the more substantial Plante-type positives and 'box' negatives. The Plante positives used in Edison batteries are of special construction, being cast with strengthening ribs which give great rigidity; the 'box' negatives are carefully filled to allow for expansion in use, while the formation process is carried out under constant and expert supervision. Time has proved the excellence of these manufacturing methods and Edison batteries are giving satisfactory service in installations all over the country.

EDISWAN

THE EDISON SWAN ELECTRIC CO. LTD.



PONDERS END MIDDLESEX

B 11-2



—that's the "TONG-TEST"

PLEASE CUT OUT THE COUPON

THE ONLY instrument in the world that can be used to measure alternating or direct current, without breaking circuit or making electrical connections, of any current from millamps. to hundreds of amps., —that's the Crompton "TONG-TEST." Read the article in the September issue of the "Practical Electrical Engineer"—learn the many uses of this remarkable instrument—then write for full details. The "TONG-TEST" is the biggest bargain in portable ammeters it is possible to buy.



Please send me Specification A.613 and Publication 1.629

NAME.....
 ADDRESS.....

Post in unsealed envelope (add stamp) to Crompton Parkinson Ltd. (L.O. 3), Bush House, London, W.C. 2.

Insulation troubles you can forget by using Spicers' Sistoflex

SISTOFLEX

(REGD.)

BRITISH MADE

INSULATING SLEEVING

0.5 m.m. to 30 m.m.

USUAL COLOURS

SUPPLIED ONLY BY

SPICERS LIMITED

INSULATION DEPARTMENT

19, New Bridge St., London, E.C.4

Telegrams :
 "Nykoping Ltd,
 London"

Telephones :
 City 6251
 Extension 49

THE BEST OF OPPORTUNITIES

More than 430,000 men have studied I.C.S. Electrical Courses since 1894. A very considerable percentage of them now hold important and well-paid positions. The reason for this is that these Courses are absolutely the best in the world, having been specially prepared and constantly revised for correspondence tuition by many experts of very high standing at a cost, exclusive of printing, of more than £80,000.

If you wish to make rapid progress in the wonderful and fascinating field of electricity, you owe it to yourself to obtain all particulars of I.C.S. Training and what it can do for you. Among our Courses are the following—

- | | |
|---------------------------------|--------------------------------|
| Complete Electrical Engineering | Engine and Dynamo Running |
| Electrical Designers | Lift Operation and Maintenance |
| Hydro-Electric | Water-Power Electrical |
| Electric Lighting | Mining Electrical |
| Electric Traction | Practical Telephony |
| Steam Electric | Wireless Engineering |
| Gas Electric | Professional Exams. |

Write to-day for our 80-page FREE BOOKLET, "ELECTRICAL ENGINEERING" stating the subject in which you are most interested
 International Correspondence Schools, Ltd.
 238 International Bldgs., Kingsway, London, W.C 2



FUSE

6
D.



HOLDER 6d., COMPLETE 1/-

Read these extracts from the "Wireless World" Laboratory Test Report:—
MICROFUSES.

WE have recently received for test some samples of the latest flat-type Microfuses. The fuse elements are mounted on a flat ebonite base fitted with eyelets which engage with spring contacts on the special base provided, and are readily replaceable. No fewer than 18 types of fuses are available with current-carrying ratings from 3 to 750 mA. They are made in three types for voltages up to 260, 750, and 1,500.

Tests on eighteen fuses ranging from 3 to 500 milliamperes, showed that the fusing current was between 75 and 105 per cent. above the current-carrying capacity. The rated currents were carried for several hours without the slightest sign of overheating. The fuses are now mounted on a cellulose acetate strip which is non-inflammable.

MICROFUSES LTD., 36, CLERKENWELL RD., LONDON, E.C.1
Telephone: Clerkenwell 4049.

MICROFUSES

PROTECT YOUR RADIO AND LABORATORY APPARATUS

Important Features.

FUSIBLE ELEMENT.—A thin gold film which cannot depreciate with time.

VERY ROBUST DESIGN.—The electrical characteristics of the fuse cannot be altered by careless handling.

SPEED OF OPERATION.—Varies from 1/10 sec. at 3-fold overload to 1/1000 second at 8-fold overload.

This amazing speed, unapproached by any other make of fuse, ensures complete protection for any form of wire, however fine.

THE FUSE carries its rated current indefinitely and operates at twice that current.

STOCK RATINGS from 3 mA. to 750 mA. carrying capacity. Any intermediate rating can be supplied at short notice without extra charge.

VOLTAGES.—Voltages up to 1,500 volts D.C.

RADIO.—Type F2 is suitable for all wireless purposes, including mains fuses.

THE MICROFU IS AN ALL-BRITISH PRECISION INSTRUMENT.

Folder "P.E." gives full technical details of the Microfu and prices for special ratings.

Send to **FOYLES FOR BOOKS**

New and secondhand books on Electricity and all other subjects. Over two million volumes in stock. Catalogues free on mentioning your interests. Instalment terms arranged.

119-125, CHARING CROSS ROAD, LONDON, W.C. 2.
Telephone Gerrard 5660 (7 lines).

Engineers' Guide

containing the widest selection of engineering courses in the world

Study at home with The T.I.G.B. for a well-paid post. Become an A.M.I.C.E., A.M.I.Mech.E., A.M.I.E.E., etc. Training until Successful is Guaranteed. WRITE NOW for Free Guide, stating branch, post or qualification that interests you, to: THE TECHNOLOGICAL INSTITUTE OF GREAT BRITAIN, 221, Temple Bar House, London, E.C.4. (Founded 1917, 18,000 Successes.)



To Success

Telephone:
RIVERSIDE, 5151.
(3 LINES)

Contractors to the
ADMIRALTY, WAR OFFICE, POST OFFICE, INDIA OFFICE, E.T.S. E.T.

Telegrams:
SAXATILE. PHONE. LONDON

HIGH GRADE
BELL ACCESSORIES

Specialists in

ELECTRIC BELLS
RELAYS
INDICATORS
FIRE ALARMS
BURGLAR ALARMS
BATTERIES

Works, Warehouse
and Wharf
LOWER MALL,
HAMMERSMITH.

ESTABLISHED 1855

JULIUS SAX & COMPANY

LIMITED

MANUFACTURING ELECTRICAL ENGINEERS.

HIGH GRADE
LIGHT ACCESSORIES

Specialists in

WALL PLUGS
PLUG ADAPTORS
LAMP HOLDERS
CANDLE FITTINGS
HOLOPHONE GLASS
AND FITTINGS

Regd. Offices & Showrooms,
"WEST LODGE"
27, Lower Mall, Hammersmith,
LONDON, W. 6.

Goods Entrance
ASPEN PLACE
FROM WATERLOO STREET,
KING ST HAMMERSMITH.

Filter Equipment as
supplied to the large
Grid Scheme Trans-
forming Stations.

THE STREAM-LINE FILTER CO LTD

MAKERS OF
THE MOST
EFFICIENT OIL-
PURIFYING
EQUIPMENT
EVER
KNOWN

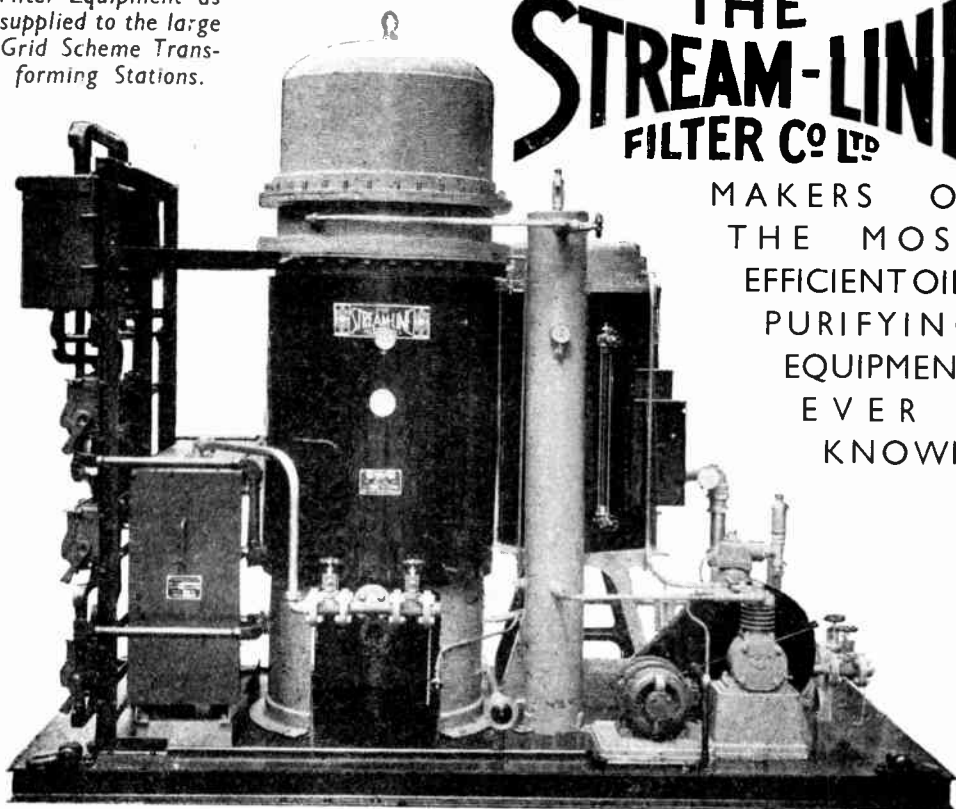

FROM THE LARGEST TO THE SMALLEST
SWITCHING AND TRANSFORMING STATIONS

—THERE IS A STREAM-LINE
FILTER EQUIPMENT SUITABLE
FOR MEETING THE REQUIREMENTS

*Stream-Line
Filters, which
are simple static
plants, easier and more
economical to operate than
centrifuges and blotter presses,
have been supplied to:—*

PRICES
FROM
£49

THE CENTRAL
ELECTRICITY BOARD
(39 sets already completed)

UHL RIVER HYDRO-ELECTRIC SCHEME
THE GENERAL ELECTRIC COMPANY,
MESSRS. REYROLLES,
THE ENGLISH ELECTRIC COMPANY,
MESSRS. C. A. PARSONS,
and hundreds of others.

THE STREAM-LINE FILTER Co. Ltd.
45, HORSEFERRY ROAD,
LONDON, S.W. 1

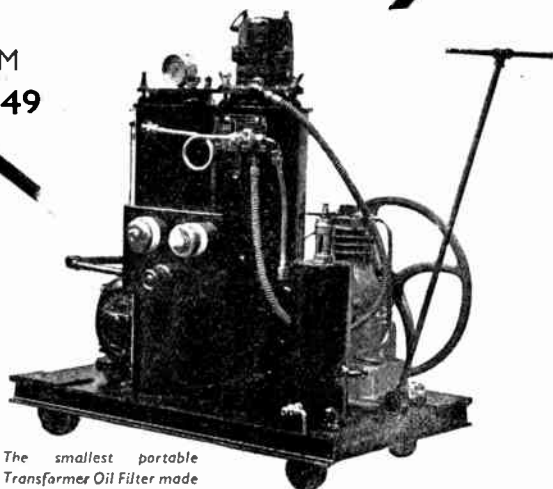

*The smallest portable
Transformer Oil Filter made*

The PRACTICAL ELECTRICAL ENGINEER

A MONTHLY SURVEY OF MODERN PRACTICE IN ELECTRICAL ENGINEERING

VOL. I

DECEMBER, 1932

No. 4

Published by GEORGE NEWNES, Ltd.,
8-11, Southampton Street, Strand, London W.C. 2.

Telephone—Temple Bar 7760

Telegrams—"Newnes, Rand, London"

Price - 1/- Monthly

Yearly Subscription, 14/- Post Free

6 months' Subscription, 7/- Post Free

Registered for Transmission by Canadian Magazine Post
Canadian Rate: Yearly Subscription, 13/6 Post Free
6 months' Subscription 6/9 " " "

Prospects in the Industry

The President of the Institution of Electrical Engineers, Dr. E. W. Marchant, recently gave some interesting views concerning the future prospects for Electrical Engineers. In the course of his address, Dr. Marchant expressed the opinion that tremendous developments would be seen in the industry within the next few years. He considers that the greatest scope lies in the extension of electricity supply to rural areas, and that a rich reward awaits the engineer who can show a way of cheapening the existing cost of overhead connections from the grid to distribution lines. We understand that at present the cost of tapping the grid is in the neighbourhood of £20,000.

Readers who had not the opportunity of listening to Dr. Marchant's address will no doubt be interested to read this very condensed summary of his views.

In the present issue readers will notice that special attention has been paid to the latest developments in electrical practice. A fine achievement of the British Thomson-Houston Com-

Britain Still Leads

pany, which is dealt with in the article on "Fabricated Construction," is an encouraging indication of the present-day tendency for Britain to re-establish her old supremacy in the engineering world.

Still a Burn- ing Question

Dr. C. C. Garrard's article, "The Tendency of Modern Switchgear Design," is well worth careful perusal by every reader whatever his position in the industry may be. The adequate control of the enormous quantities of electrical energy which the grid will ultimately be capable of delivering, is a problem of vital concern to everyone who depends directly or indirectly on the electrical industry for their livelihood.

The articles on Photo-electric Cells, Electric Clocks, Shop Window Lighting, Battery Charging and the Design of an A.C. Mains Transformer, will, it is hoped, be appreciated by those readers who, while interested in the larger questions, are, after all, primarily concerned with the application of electricity to the affairs of everyday life.

N

THE TENDENCY OF MODERN SWITCHGEAR DESIGN

By CHARLES C. GARRARD, Ph.D., M.I.E.E.

In this interesting article Dr. Garrard, one of the foremost designers of switchgear in the country, explains in a most interesting manner how the new problems which have arisen as a result of the grid development are being tackled and solved by switchgear engineers

UP to comparatively recently the centre of gravity, so to speak, of electrical engineering was the power station, and the generation of the current was the main preoccupation of the electrical engineer. But nowadays things are different. We have, in fact, pretty well come to a limit with what we can do as regards generation, at least if steam is to continue to be our prime mover. By means of larger units, higher steam pressures, and the like, we increase the efficiency of our power stations to a clearly defined asymptotic limit.* From this point of view we cannot do much more to reduce the price of electricity, that is to say, of course, failing the invention of some entirely new method of producing electricity on the large scale.

The Grid and the Turbo-alternator.

However, we all know there is a big field for the cheapening of the cost of electric power based upon generation with the steam turbine, which as far as can be seen at present, will be our main source of power

* It closely approaches ideal conditions, though absolute perfection can never be achieved.

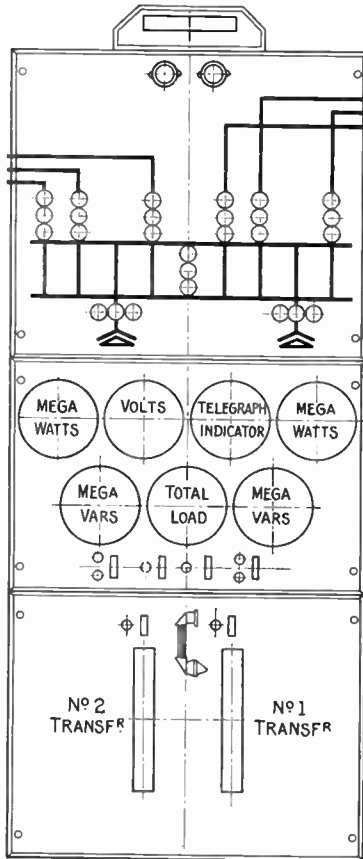

CONTROL INDICATOR AND TELEPHONE BOARD FOR THE CONTROL OF LARGE INTERCONNECTED SYSTEMS.

of the work of the modern switchgear engineer is away from the mere design of individual switches and pieces of apparatus, and towards the development of systems of control upon which, there can be no doubt, depends the whole possibility of progress in electric supply.

in this country for many years to come. This knowledge is the basis upon which the grid has been established in Great Britain by the Central Electricity Board. A steam turbine (if its size be the same) has an equal efficiency whether it feed the grid or supply an isolated system.

Increased Load Factor Lowers Electricity Costs.

The interconnection afforded by the former enables the load factor to be increased, and as the capital charges form the bulk of the costs of electricity, the total cost is reduced in a ratio approaching that of the load factors of the two conditions of working.

Control and Its Paramount Importance in the Grid Scheme.

Now all this improvement depends on the control of the electric supply, and it may be said, therefore, that the main tendency

Centralised Control.

It is obvious that if the benefits indicated in the previous paragraphs are to be obtained with present-day large interconnected systems, it is impossible to allow the individual power houses to follow their own inclinations as to how their plant is to be run. They must each be subordinated to the running conditions of the whole of the system. This is not to say that the interests of the constituent generating stations will suffer. On the contrary, they will be benefited, as, as has been pointed out, their respective load factors will be increased. It will be realised, however, that the proper functioning of the whole combination depends upon the work of the central control engineer.

The Central Control Rooms.

In each of the areas of the Central Electricity Board—for example, Central England, South East England, etc., there is provided a central control room. This is connected by central indicators and telephones with the various substations and generating stations within the area, and these constitute the means by which the necessary central control is exercised. These control rooms illustrate very well the present state of the art, and at the same time the ultimate condition to which this branch of engineering work is tending.

Tendency in Control Room Practice.

While in them it is possible to tell at a glance the whole electrical state of affairs in every part of the area, yet the controls are not directly exercised from them. This is done by telephonic communication with the station engineers.

The whole tendency is to direct centralised control whereby the operations of the plant in the stations are directly initiated in the central control room, the intervening chain of working being entirely automatic in nature.

An Opportunity for Inventive Capacity.

Herein is a large field for the energies and inventive capacity of the switchgear engineer. As it is, progress is very rapid. It is only a few years since supervisory control (the generic name of this class of work) was

thought of. Statistics are already available which prove its reliability, and it may be said that in general, in all branches of electric control, the more the human element is eliminated the better are the results.

CONTROL ROOM INDICATOR PANEL.

The diagram shows one panel of a central indicator and telephone board of the type just described.

Substation Connections.

At the top of the panel will be seen lines corresponding to the 132 kV. connections in the substation. It should be explained that the latter consist of duplicate bus bars shown (single line) by the two horizontal lines. It will be seen there are six feeders going out from the substation, three vertical and then to the left, and three vertical and then to the right.

The Oil Circuit Breakers.

In each of the vertical connections (at the top of the panel) are three small circles; these are indicating lamps which show the state of the oil circuit breaker which is situated at that point.

The three small circles arranged vertically between the two horizontal bus bars in the middle are to indicate the bus bar coupler oil circuit breaker.

The Transformers and Corresponding Circuit Breakers.

It will be seen there are two transformers, the oil circuit breakers of which are each indicated by three lamps (shown as three small circles side by side horizontally) in each transformer circuit. It will be observed that the vertical lines from each transformer and each feeder cross the two horizontal bus bar lines, the whole having the appearance of a series of rectangles.

Transformer and Feeder Connections at Substation.

In explanation of this it must be pointed out that either transformer, or any feeder, can be connected at will to either bus bar by means of hand-operated isolating selector

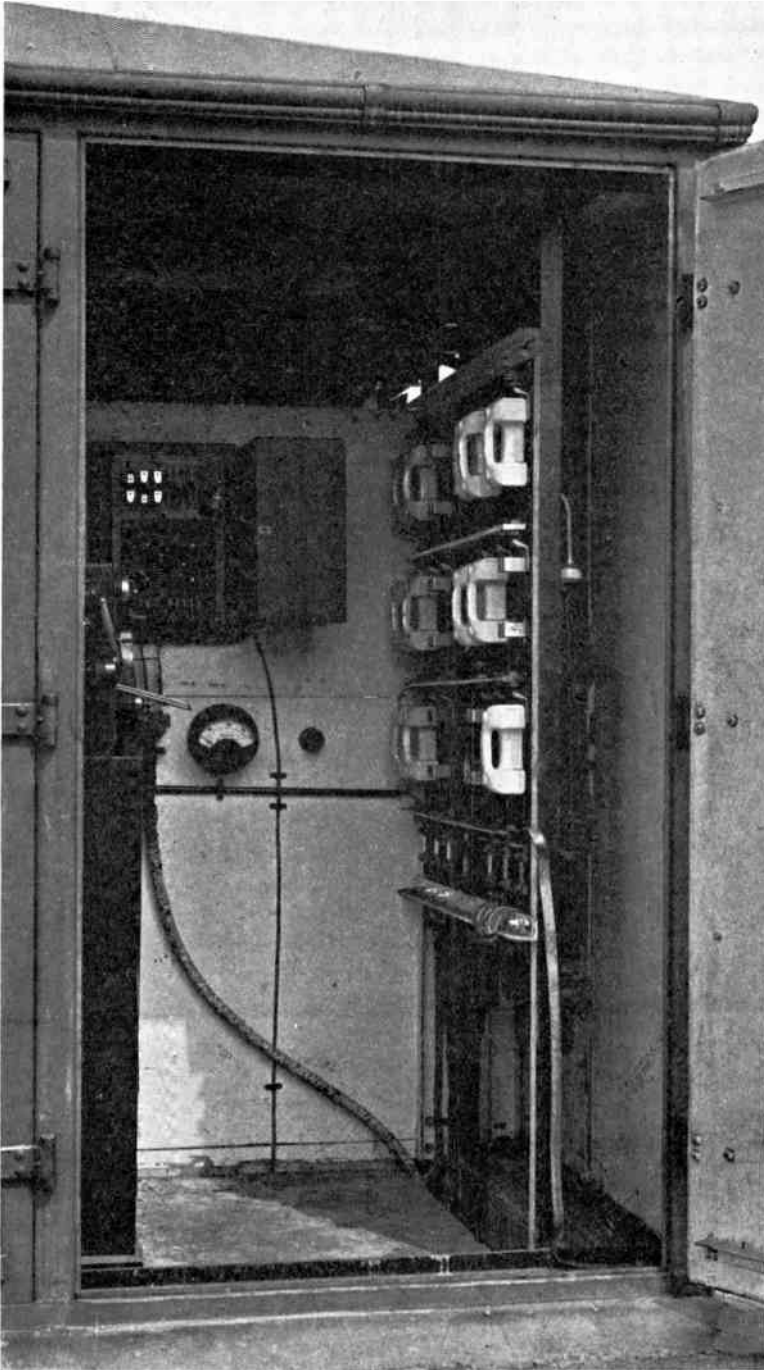

A TRANSFORMER KIOSK WITH SUPERVISORY CONTROL. (G.E.C.)

switches in the substations. The positions of these isolator and selector switches are, however, not automatically indicated on the control board. A separate master key diagram shows these.

The Instruments and What They Show.

There are seven instruments, the nature of the indications of which is shown on the diagram. (VARs means reactive volt - amperes.) Further, at the bottom of the panel, the two position indicators (long vertical rectangles) will be noted. These automatically indicate the position of the tap-changing switches on the substation transformers. The total indications on the panel are therefore

- 29 indicating lamps
- 7 instruments
- 2 tapping switch indicators.

Connections from Control Room to Substation.

These, together with the telephones, are

operated over a single Post Office telephone pair connecting the control panel with the substation. This connection does not always follow the same route; all that the Post Office does is to connect through from the control room to the substation similarly to an ordinary telephone connection. The current in the pilot pair is an alternating current of a high frequency (speech frequency).

What the Pilot Currents Do.

The use of such pilot currents enables the control to be exercised over long distances as repeater stations can be connected in the pilot if necessary.

How the Control Panel is Used.

Such a control panel enables the control engineer to see at a glance the exact electrical state of affairs in each substation. If he desires to make a change he telephones his instructions.

The Next Stage of Development.

The logical development is that he should initiate the change directly as in the control room of a power house. There can be no doubt this will be the next stage of evolution.

It will be easily realised that direct control of this character over a very large interconnected system of generating plant and transformer substations is not an easy task. Its complete solution, at a cost which will render its use an economic possibility, is only a matter of time.

AUTOMATIC STATIONS.

Apart from the increased reliability there are two other considerations which are among those to which the marked tendency to automatic working is due; that is to say, the saving in labour charges and the improved service given by the electric supply.

How Automatic Working Affects the Consumer.

An important feature in connection with the last point is that of constancy of supply voltage. The consumer, after all, pays for a constant voltage to be maintained at his terminals. If his

declared voltage be 230 and the actual supply be, say, 190 or 200 volts, the service he receives goes down very much more than the reduction in his meter readings. This matter becomes of increasing importance when dealing with scattered areas and rural supply. It has been suggested that the limit of permissible variation from declared voltage allowed by the electricity commissioners should be increased in such cases. But this would certainly detract from the popularity of the use of electricity, and here again automatic working combined with supervisory control methods come to the rescue.

Transformer Kiosks with Remote Control.

Kiosks containing small transformers with remotely controlled tap-changing gear are now available. A number of these can be supervisorily controlled in tandem over two telephone lines, i.e., four conductors, and the whole cost is so low that a standard of supply is obtained in such scattered areas that can be said to be revolutionary in character. Part of a kiosk so equipped is shown in the photograph, and it will be seen that the supervisory equipment is a very small affair.

RELIABILITY OF SUPPLY.

It has been said by some pessimists that the reliability of electric supply in this country, depending as it will to a greater extent upon overhead transmission lines, will be less in the future than in the past. As regards this, all that need be said is that experience already available has not confirmed these fears, nor, as well-informed engineers know, is it likely to be the case. There can be no doubt that this is due, to no small extent, to the developments which have been made and are being made in discriminating protective gear, which is designed to localise the effects of system disturbances.

Where Britain Leads.

This country has always led the way in the production of protective gear. As regards the one scheme where the Continent was more advanced than we were,

that is the distance relay, for use with overhead lines, the position has been entirely reversed, as British reactance and impedance relays are nowadays unsurpassed. There is, however, a vast field for development still open in protective gear engineering. The tendency is to discard special pilot wires; in fact, for long transmission lines their use is prohibitive on account of cost.

Carrier Current Systems.

Hired Post Office telephone lines are being used in some cases, but there can be little doubt that the future lies with carrier current systems. The Central Electricity Board has already installed one such system (Reyrolle-G.E.C.) on the Little Barford-Bedford line. The engineers responsible for this development are prepared for the largest and widest applications. Naturally the initial development charges are very high for this class of work, but these having been liquidated, the installation costs should thereafter be comparatively low, and a very large extension of such applications is to be expected. At any rate, there is a considerable field for the switchgear engineer in this branch of work.

SWITCHGEAR APPARATUS.

It is only possible in a short article to give a few indications of the tendencies operating in the vast range of switchgear apparatus. The most marked is that towards metal-clad construction. In order to diminish eddy current and hysteresis losses in the metal enclosures, these are now largely made of silicon-aluminium alloys. Such aluminium alloys are fire-proof, and for equal or greater mechanical strength are much lighter than cast iron, with resulting saving in building costs.

Round or Rectangular Tanks ?

For oil circuit breakers, round tanks are being strongly pushed in some quarters. With round tanks in the case of 3-phase breakers (with the 3 phases in one tank) it is not possible to use steel plate phase separation. Such phase separation is an advantage in preventing phase-to-phase faults. It is probable, therefore, that the rectangular tank will continue to be used for 3-phase breakers, the round one

being confined to those cases where each phase is in its own tank.

Gas Blast Breakers.

It is, of course, possible that the oil circuit breaker will become entirely superseded by some other form of circuit rupturing device. Considerable work is being done with gas blast circuit breakers and breakers utilising steam as the arc quenching medium.

Pneumatic Actuating Gear.

Pneumatic operation of large air-break contactors for mine hoists and for traction control gear is, of course, old; but the adoption of air pressure pistons to close the large oil circuit breakers in the Kraftwerk West in Berlin and the Blackman Meadows Station of the Sheffield Corporation in this country, is likely to be extensively followed in the future. One of the chief reasons for the adoption of pneumatic operation is to secure quicker closing of large breakers. An electric solenoid has a time constant which is the longer the larger the size. If a closing motor be used, the closing has to be done by means of a spring, which is a great difficulty with a heavy mechanism. The air cylinder gets over both these difficulties.

High Speed Circuit Opening—The Switchgear Engineer's Problem.

If it be necessary in some cases to speed up the closing of electric circuit breakers, it is yet more essential to quicken their opening. This does not refer to the velocity of movement of their parts; this is fixed within certain limits by the physics of arc quenching in oil. Rather it refers to the celerity with which the occurrence of a fault in the system is followed by the opening of the arcing contacts in the circuit breaker nearest to the fault. *This is probably the greatest problem facing the switchgear engineer at the present day.* Unfortunately it is not simply a question of mechanism design. The time interval which, in the interests of system stability, it is desired to shorten, is mostly due to the protective gear. Considerable progress has been made in the solution of the problem, but much remains to be done.

SHOP WINDOW LIGHTING

By E. H. FREEMAN, M.I.E.E.

In this article Mr. E. H. Freeman gives an authoritative summary of the most modern practice in shop window lighting



TYPICAL WINDOW LIGHTING WITH CONCEALED REFLECTORS.

THE effective lighting of the display windows of the modern shop is recognised by all shop fitters to-day to be one of their most valuable methods of advertising. Tests have been made to ascertain the value of good lighting and one such test showed that an increase in the illumination of a shop window from 17-foot candles up to 80-foot candles, resulted in an increase in the number of persons stopping to examine the goods displayed from 32 per hour to 212 per hour.

Lighting with Modern Lamps.

The advent of the modern gas-filled lamp with very high intensities and of larger sizes than the early lamps, coupled with the growing demand for improved illumination, completely altered all the methods of lighting, and the modern window reflectors fixed usually at the top of the windows is the result.

Window lighting is now almost universally carried out on this principle, though in exceptional cases some modification is necessary.

Intensity of Illumination Required.

The quantity of light that should be

provided for any particular shop must depend on a variety of factors—its location; the lighting schemes for adjacent shops; the class of goods to be displayed and so on. The primary object of the shop window is to call the attention of the passer-by to the shop and it should therefore have some distinctive features. This may be achieved by providing better lighting than in neighbouring windows and this result may be obtained in one district with a much smaller current consumption than in another. The illumination necessary in Regent Street would be quite unnecessary, and even out of place, in a small suburban shopping district.

The goods to be displayed also affect the matter. Goods dull in colour and texture, such as tweed cloths, require much more brilliant lighting for effective display than blacks and whites.

In most cases the lighting must be provided to suit displays varying from day to day, and it is therefore necessary to wire for and install reflectors that will carry the maximum size of lamp necessary for the most uninteresting class of goods and to leave the shopkeeper, if he wishes, to vary the amount of light to suit different displays.

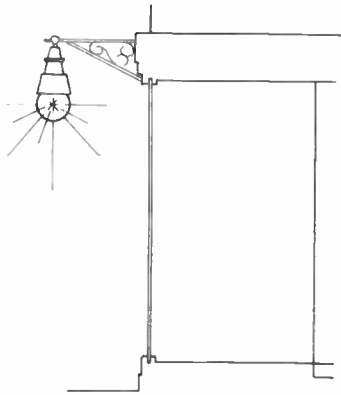

WINDOW LIGHTING FROM EXTERNAL LAMPS—
NOW OUT OF DATE.

Most of these reflectors are made with fluted mirrored glass interiors to give a high efficiency of reflector.

Narrow Windows.

For the ordinary narrow window up to 5 or 6 ft. in depth, a single row of reflectors will usually be ample, arranged close to the glass front. The lamp sizes provided should give from 50 to 100 foot candles near the bottom of the window. The reflector used should be selected to throw the light where it will be most useful. This must depend on the goods displayed, as these may be mainly shown at the bottom or at the back or in the central area in different cases.

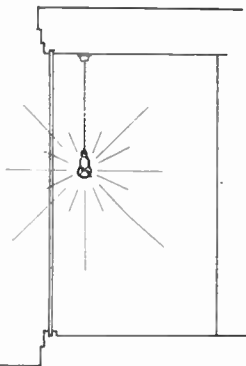

WINDOW LIGHTING BY INTERNAL EXPOSED LAMPS.
Unsuitable with modern lamps.

Lamps Required per Foot Run of Frontage.

For modern conditions the following lamp sizes may be taken as providing very good lighting for average windows.

Important shopping centres : 150 to 200 watts per foot run of frontage ; Ordinary main

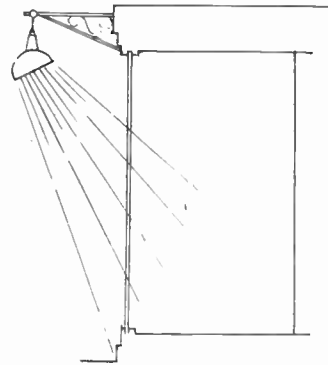

ANOTHER EXAMPLE OF WINDOW LIGHTING FROM EXTERNAL LAMPS.

road shops : 100 watts per foot run ; Side streets : 100 watts per 2 ft. run or more if it is desired to attract attention from a main road nearby.

The lamps must, of course, be fitted in suitable reflectors in each case.

Deep Windows.

If the windows are over 8 or 10 ft. in depth it may be necessary to provide a double row of reflectors or to tilt alternate reflectors so that some direct the light down for the front area and others direct it backwards for the back area. The result might be obtained by fixing the reflectors at an angle or by using special types that reflect sideways.

The total quantity of light must be increased according to the depth of the window, but it would probably not be necessary to double the quantity even for windows up to 15 ft. deep.

Concealing Window Reflectors—Pelmet.

The effective concealment of the window reflectors is often a matter of great difficulty. The usual system is to place the reflectors on the ceiling as high as possible and as close to the glass

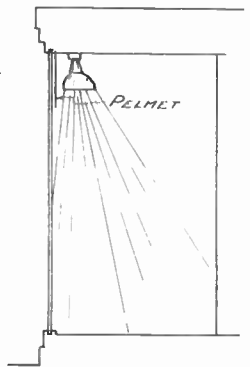

WINDOW LIGHTING WITH CONCEALED REFLECTORS.
Standard practice for modern schemes.

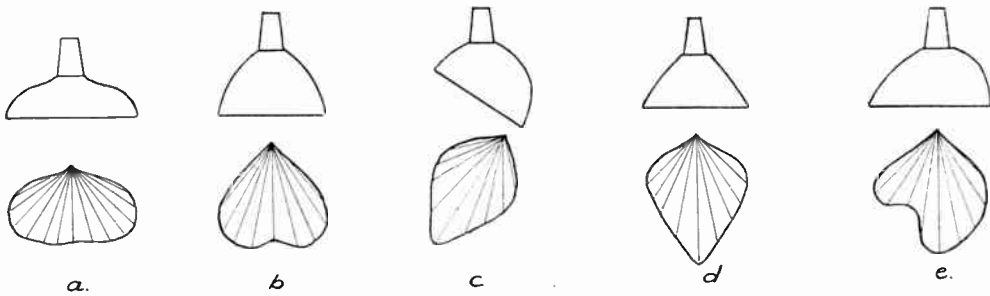

TYPES OF WINDOW REFLECTORS WITH THEIR POLAR CURVES.

as possible and to provide a pelmet or screen in front of them of such depth as is necessary to hide the reflectors. Such pelmets may be decorative or may be used to provide a background for advertising matter. If the window is high the pelmets must be deep and this is often objectionable, as they may be a great obstruction to daylight.

False Ceiling.

It is sometimes possible to fix the reflectors above a false ceiling. If such an arrangement is possible it should certainly be adopted, and it will also allow the depth of pelmet, if any, to be reduced.

Reflectors Behind Beams.

Another method of concealment that is sometimes available is to place the reflectors behind a beam or blind box. Such beams frequently exist, and if the ceiling behind is not carried down to the bottom of the beam, the beam itself may be used as a screen.

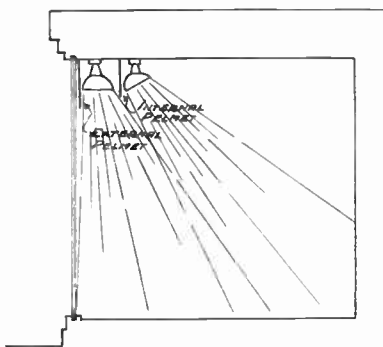

ARRANGEMENT OF DOUBLE ROW OF REFLECTORS FOR VERY DEEP WINDOW.

Double Rows of Reflectors.

If a double row of reflectors is necessary, the problem is naturally more difficult, but may be overcome by using an internal pelmet or screen between the two rows of reflectors. This must be arranged so that it does not cut off the light from the front row of reflectors whilst affording a screen for the back row.

Corner Windows.

Another difficult problem arises with the lighting of corner windows—particularly those now becoming common with large display areas on each side of an arcade leading up to an inner shop entrance. An adaptation of the “cell” lighting mentioned later will probably be necessary if the reflectors are to be screened in such a case, short metal or opaque screens being dropped between each two reflectors.

Island Cases.

The problem is still more difficult with island windows. If these are comparatively narrow—that is, say, only 6 or 8 ft. wide—an inner pelmet will probably be sufficient, but if the window is very much wider, this pelmet would probably cut off the light to such an extent as to leave the centre of the window insufficiently lit, and in such a case some central lighting on the cell principle or from an illum-

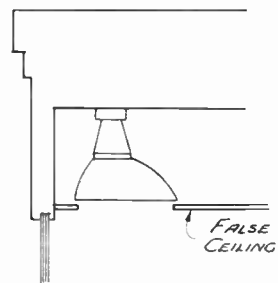

REFLECTORS CONCEALED IN FALSE CEILING TO WINDOW.

nated daylight would be necessary. Two of the illustrations show the methods suggested for corner and island windows.

Special Shields for Reflectors.

In extra deep windows further precautions may be taken to ensure effective lighting over the entire display area. The entire ceiling has been divided up into "cells" somewhat like an enlarged honeycomb, with a lamp and reflector in each. The sides of the "cells" in such a scheme must be deep enough to ensure that the lamps cannot be seen by the customers in the street and the lamp sizes can be much reduced, as lighting is provided over the whole display area and not from one side only. About 40 watts per square foot should be ample, but the sizes of the

"cells" and lamps can be adjusted to suit ceiling decorations and planning and the intensity of illumination required.

One of the illustrations shows the interior of such a window with rippled glass screens between the reflectors. A lamp and reflector is fixed in each cell.

Bottom Lighting.

Another method of improving the lighting in deep windows is to provide the equivalent of stage footlights. Such lighting must be installed with great care as obviously the lamps are in a position where they must be very carefully screened if they are not to be visible to the public.

The lamps must be concealed, and strong objection is often made to the appearance of the main floor of the window falling

LIGHT AND COLOUR EFFECTS.

Natural Colour of Object,	Red.	COLOUR OF LIGHT FALLING ON OBJECT.				Violet.
		Orange.	Yellow.	Green.	Blue.	
		RESULTANT COLOUR APPEARANCE.				
Black ..	Reddish-Black	Orange-Black	Yellow-Black	Greenish-Black	Blue-Black	Violet-Black
White ..	Red.	Orange.	Yellow.	Green.	Blue.	Violet.
Red ..	Red.	Scarlet.	Orange.	Brown.	Purple.	Reddish-Purple.
Orange ..	Orange-Red.	Orange.	Yellow-Orange.	Greenish-Yellow.	Violet-Brown.	Red.
Yellow ..	Orange.	Yellow-Orange.	Yellow.	Yellowish-Green.	Green.	Reddish-Brown.
Light Green	Reddish-Grey.	Yellow-Green.	Greenish-Yellow.	Green.	Blue-Green.	Light-Purple.
Deep Green	Reddish-Grey.	Rusty-Green.	Yellowish-Green.	Green.	Greenish-Blue.	Greenish-Purple.
Light Blue ..	Violet.	Slate-Grey.	Yellowish-Grey.	Greenish-Blue.	Blue.	Violet-Blue.
Deep Blue ..	Purple.	Bluish-Grey.	Slate.	Blue-Green.	Blue.	Blue-Violet.
Violet ..	Purple.	Red-Purple.	Violet-Grey.	Blue.	Violet-Blue.	Violet.

The above Table indicates the appearances of Coloured objects when subjected to different coloured Lights. (Reproduced by courtesy of the Lighting Research Bureau).

away behind to a lower level. The reflectors must be placed behind a glazed screen to prevent goods falling on the lamps with consequent risk of fire, and this also involves difficulty and expense in construction, as the screens must be dust-tight and yet easily moved for lamp renewals.

Such a scheme of lighting is not suitable for corner or island windows, as the lamps would be directly in sight from the opposite side.

Spot Lights.

It is frequently desirable to call special attention to some particular article and a special spot light with a bright beam of light directed on to this will be of great value. To allow the use of these, plugs should be provided at intervals at both top

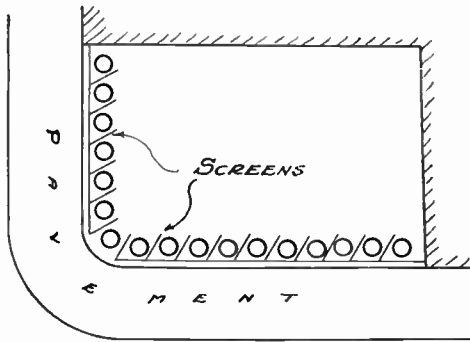

LIGHTING FOR CORNER WINDOWS WITH SCREENS BETWEEN REFLECTORS.

and bottom of the windows and in wiring should be rated as carrying 300 to 500 watts per plug, according to the conditions. These plugs should be at the top and bottom corners of each window with additional intermediate plugs, if the windows are over 10 ft. in width (frontage to street).

Colour Screens.

In certain cases it may be necessary or desirable to provide for the use of colour screens on the main system of window lighting reflectors. This involves no difficulty as such screens are standardised to clip on to the reflectors, but it does involve

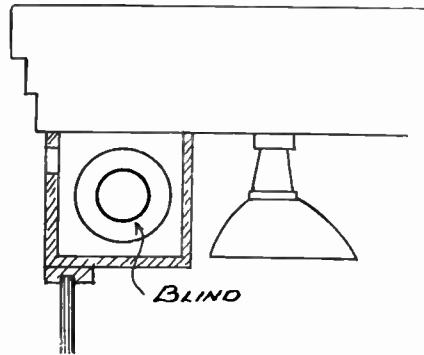

REFLECTORS CONCEALED BEHIND BLIND BOX.

the use of much larger lamps. The screens used may reduce the illumination by from 50 per cent. to 80 per cent., and to obtain the same lighting effect this means that lamps of two to four times the size must be used. The wiring must be arranged accordingly.

It is only occasionally that colour lighting is really effective.

Effect of Colour Lighting.

That this must be so is obvious from the table on page 154, published by the Lighting Research Bureau, which shows the appearances of various colours when lit by coloured beams.

Needless to say, to display yellow fabrics and flood them with blue light so that they appeared grey (for example) would not be advantageous to the shopkeeper.

Jewellery and Similar Windows.

The ordinary display of goods in a jewellery and silversmith's shop, and in

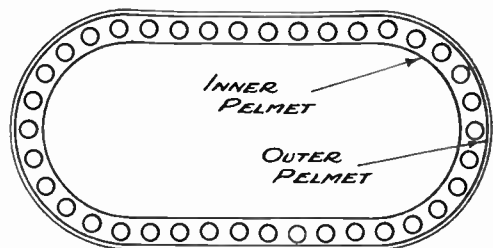

LIGHTING FOR ISLAND WINDOWS WITH INTERNAL PELMET.

some others of a similar character, consists of small articles that will reflect the light, and such windows call for a method of lighting quite different from that required for relatively dull materials in large

The lamps may be of tubular form concealed behind a metal trough reflector, like the Linolite, or of standard types in small cup-shaped reflectors. Such lamps and reflectors can be clipped on to the

shelves or to the frames of the windows.

Whatever method of fixing is adopted it is necessary to screen the actual lamp effectively so that there is no possibility of direct glare, and this usually involves the use of a comparatively large number of low candle-power lamps and small reflectors.

The Use of Standard Lamps.

If the type of goods displayed permits, effective results can sometimes be obtained by including small standard lamps as part of the display, the position of these standards and the type of shade used being arranged to throw the light on to other goods. The shades must be opaque, or nearly so, in order that they shall not provide a patch

of brilliant lighting that would be detrimental to the display of other goods.

Power Plugs.

If the tariff for current used shows a considerable difference between lighting and power rates, it may be desirable to



THE ENTRANCE ARCADE TO THE ARDATH GIFT SHOP IN REGENT STREET.
(Designed by Mr. J. Emberton.)

windows. There are usually many shelves carrying the small articles that would cut off the light from the lower goods if only top lighting were used.

To meet these conditions, plugs should be provided freely and numbers of some form of screened lamp wired from these.

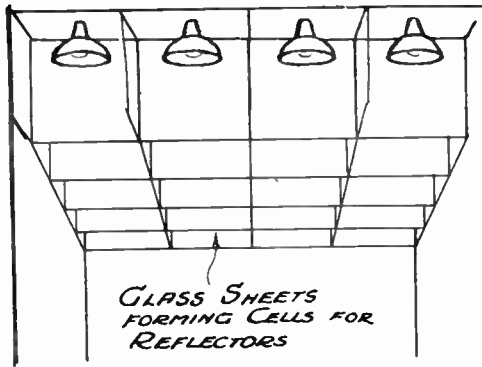

GLASS SHEETS FORMING CELLS FOR REFLECTORS

DIAGRAM SHOWING CELLULAR ARRANGEMENT OF CEILING FOR DEEP WINDOWS WITH REFLECTOR IN EACH CELL.

provide one or two power plugs in each window. Attractive displays can frequently be arranged by providing some moving machinery, and a power plug to which the necessary motor can be attached is then very useful. Such displays will rarely require more than 1 h.p., and wiring should be run accordingly.

Transome Lighting.

The larger modern shop has almost abandoned daylight for ground floor areas. The only source of daylight is usually from the front window, and the value of the window is so great as an advertising medium that it must be used in this way. A dark background for the goods is usually essential, and daylight is thus cut off entirely, unless the front is sufficiently high for transome windows to be provided above the display windows.



TYPICAL SPOT LIGHT FOR LIGHTING EFFECTS.

In such cases it is desirable to provide lighting for the transome so that this area shall not show from the street as a dull feature in the general appearance of the lighted shop.

Strong lighting is not required as it is not desirable to provide transome illumination of an intensity that will compete with the windows. Small reflectors averaging 30 watts per foot or thereabouts (depending on the position in which they can be placed; the kind of glass used for the transome and so on) will probably give the desired effect. The reflectors should, if possible, be placed so that they are not noticeable from the shop.

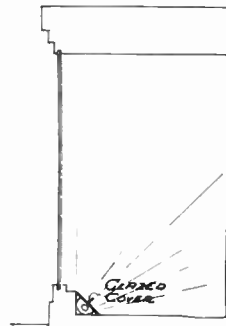

BOTTOM LIGHTING AT FRONT OF WINDOW.

Facia Lighting.

Facia lighting is often a very important part of the shop lighting as seen from the street, but it must depend entirely on the architecture of the shop front. In many cases none is required,

the facia being of metal or stone and any names being also of metal and so not requiring illumination.

Opaque Letters and Background.

If such a facia is to be lit, a method must be adopted that (A) gives no direct lighting except on the facia ;

(B) Provides even illumination over the whole area.

The last condition usually makes it impossible to use any form of bottom lighting. The projecting trough does screen the lamps and provides for even lighting, but it will also obstruct the view of the facia lettering from the customer on the pavement below. Reflectors placed above the

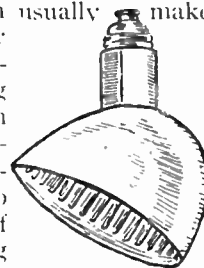

SMALL METAL REFLECTOR FOR JEWELLERY OR SIMILAR WINDOWS.



FACIA AND LETTERING WITH NEON TUBE LIGHTING.

letters are also difficult as they are so easily seen by the person looking up, and it is almost impossible to screen the lamps and avoid all glare effects and at the same time ensure effective lighting of the letters.

If the fascia can be arranged with a definite slope forwards, either straight or curved, the problem is much simplified and schemes can be brought into use which will give very attractive results.

Glazed Facias.

The use of a glazed fascia is unusual, i.e., of one which can be completely illuminated from behind. If such a fascia is used the lighting is generally a simple matter, the only problem being to ensure even lighting. This involves a glass of considerable density, and an independent opal glass backing may be necessary to avoid patchy lighting.

Neon Tube Lettering.

Another very common

and very effective fascia is obtained by the use of Neon tubes. These may be bent to form the actual letters required and placed directly on the fascia board, but this method provides no effective display in daytime. The more usual plan is to provide suitable lettering in metal fixed to the fascia, and to outline these letters with Neon tubes. The tubes can be of different colours, if desired, and are scarcely visible in daytime, so that the full daytime benefit of an attractive fascia is obtained, unspoiled by reflectors or

lamps, combined with brilliant lighting at night. In the illustration of such a fascia the corner "coat of arms" in this case is also outlined in Neon tubes of different colours.

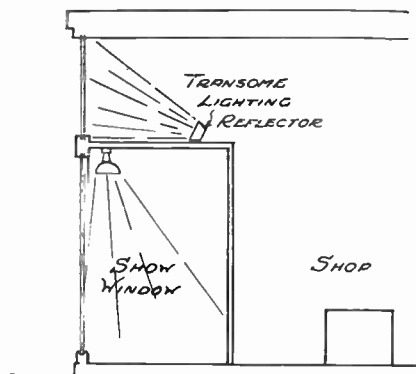

ARRANGEMENT OF REFLECTORS FOR TRANSOME LIGHTING.

Ventilation Schemes.

Problems due to the heating effects are most important and a later article deals thoroughly with ventilation schemes

ELECTRIC POWER GENERATION AND DISTRIBUTION IN SWEDEN

By A. T. DOVER, M.I.E.E.

In this article Mr. Dover, who spent several weeks in Sweden this summer, gives some first-hand information concerning Sweden's national electric power plants



Fig. 1.—VIEW OF THE MAIN, OR UPPER, FALLS AT TROLLHÄTTAN.

One of the roller regulating dams is just visible through the spray and the opening in the masonry arch. The water flow was practically at its minimum value when this photograph was taken on July 12th, 1932.

SOME FACTS CONCERNING SWEDEN.

SWEDEN—the country of forests, rivers, lakes and waterfalls—has an area of 173,035 square miles (i.e., about $1\frac{1}{2}$ times the combined area of Great Britain and the whole of Ireland), but its population is less than that of Greater London. Its largest city, Stockholm, has a population of only 600,000.

Yet Sweden is one of the most progressive countries in Europe, particularly as regards electrical developments.

The main Grid transmission voltage (130,000 volts) is practically the same as used in this country (132,000 volts).

Electrical Energy Not Extensively Used for Heating and Cooking.

Although electrical energy is produced on a large scale, it is used principally for industrial, agricultural, lighting and traction purposes. Electric cooking and room heating are not used to the extent to which one might expect, as although water power is abundant, the costs of development, transmission and distribution are such that, at present, the energy cannot be supplied to domestic consumers at a price sufficiently low to compete with silver birch when burnt in the special types of

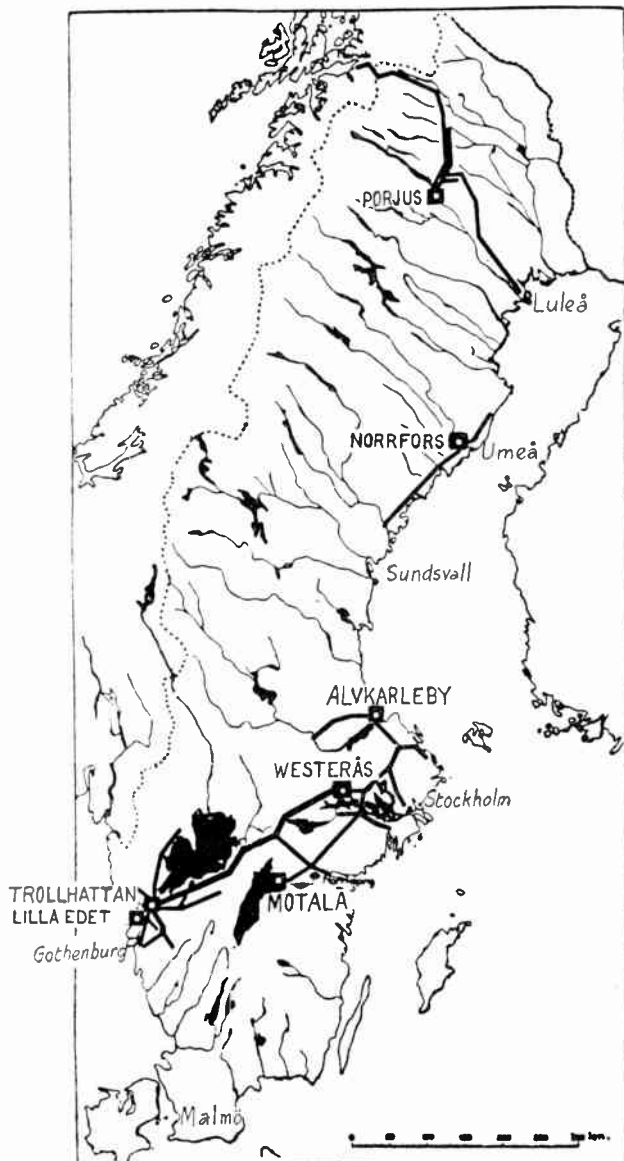

Fig. 2.—MAP OF SWEDEN SHOWING THE NATIONAL POWER STATIONS (CAPITAL LETTERS) AND THE PRINCIPAL RIVERS AND LAKES.

The heavy lines indicate the routes of the main transmission lines.

enclosed heating and cooking stoves which are in common use in all country houses and town flats not provided with central heating. These enclosed stoves are very economical in fuel, and develop-

ments are in progress for still further increasing their economy.

Again, the winter temperatures are lower than those of this country, and the residential quarters of large towns consist entirely of large blocks of flats, the majority of which are centrally heated. Hence for electric room heating to be possible under these conditions the electrical energy would have to be supplied at a very low price per unit. All the modern flats, however, are provided with electric lifts.

THE NATIONAL GRID SYSTEM OF SWEDEN.

The Swedish Government (Royal Board of Waterfalls) has had in operation for a number of years a system of inter-connected power stations and transmission lines supplying power to industries, railways and towns in Central Sweden. Four water-power stations (viz. Trollhättan, Lilla Edet, Alvkarleby, Motala) and a reserve steam station (Westerås) are connected to the grid. The Waterfalls Board own in addition two other water power stations in North Sweden: one of these (Porjus) is used principally for supplying power to the 280-mile mineral railway and the iron mines in Lapland; the other (Norrfors) supplies power to a large industrial district connected with the timber trade. These stations, however, are not interconnected, and operate entirely independently of the "grid" stations in Central Sweden. The location of the stations and the routes of the trunk transmission lines are shown in the map, Fig. 2.

Plant Capacity of the Grid Power Stations.

The four interconnected water-power stations of the grid have an aggregate plant capacity of approximately 300,000 h.p., or 225,000 kW. (320,000 kVA. at

0.7 power factor). Of the northern stations, Porjus has a plant capacity of 80,000 h.p. and Norrfors 25,000 h.p.

These stations represent about one-third of the whole of the water-power plants which are in operation throughout the entire country.

In this article we shall confine our attention to three of the stations of the grid system which possess features of special interest, viz. : (1) the largest power station (Trollhättan), which is the "heart" of the grid system and is equipped with horizontal turbines working at a moderate head of water ; (2) the most modern station (Lilla Edet), which is equipped with vertical turbines working at a very low head of water ; (3) the standby steam station (Westerås).

THE POWER PLANT AT TROLLHATTAN

Trollhättan is Sweden's largest water-power station. Its turbine plant has an aggregate output of approximately 200,000 h.p. The station is situated just below the renowned Trollhättan waterfalls

(Fig. 1), on the Gotha river, which is a 45-mile navigable waterway (for vessels up to 1,350 tons) connecting Lake Venern and Gothenburg. The falls are nearly a mile in length and the gross head available at the power station is 103 ft. The flow of water at the head of the falls varies between 90,000 and 240,000 cubic ft. per second, depending on the outflow from, and the level of, Lake Venern. A scheme is in progress to control the level of the lake and so obtain a more uniform flow throughout the year. The power available at the falls with the maximum flow is about 280,000 h.p., of which nearly 200,000 h.p. can be utilised in the power plant.

1,000,000,000 kWh. per Annum.

The one-hour peak load is about 130,000 kW., and the energy generated per annum is of the order of 1,000,000,000 kWh.

How the Water is Regulated.

The water required for the power station is taken from the river a short distance above the falls at the "intake" shown on the large-scale map of Fig. 3. It then flows along the "power" canal or "head race" to the penstock house (which is located just above the power house). The flow in the power canal is regulated normally by a regulating dam of the roller type, immediately above the falls, but

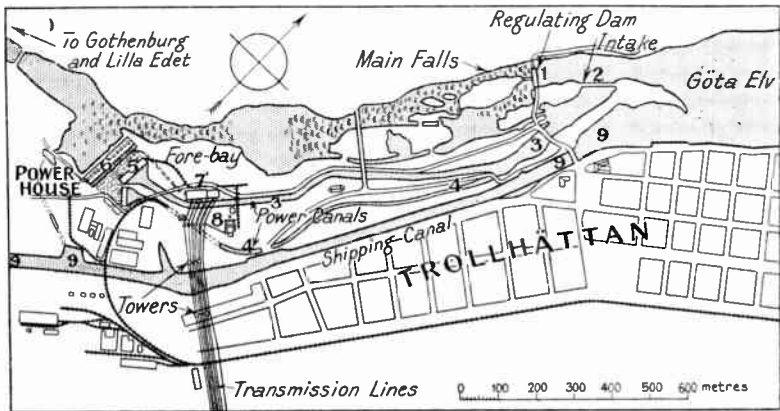

Fig. 3.—MAP OF TROLLHÄTTAN, SHOWING THE POSITIONS OF POWER STATION, INTAKE, ETC.

Reference.—1, regulating dam ; 2, intake ; 3, 4, power canals ; 5, forebay ; 6, power house ; 7, switch house ; 8, outdoor transformers ; 9, shipping canal.

sluice gates are also provided across the power canal.

The Power Canals.

The first 1,150 ft. of the power canal has a cross section of 2,700 sq. ft. at normal water level. The remaining portion (about 3,200 ft. long) consists of two separate canals (see Fig. 3), each terminating in its own forebay. The two forebays have a common overflow.

How Ice is Dealt With.

Ice floes entering the power canal at the intake are diverted into the larger section and travel down to the larger forebay, where they are turned into the overflow and thence into the river. The



Fig. 4.—GENERAL VIEW OF TROLLHÄTTAN POWER PLANT.

On the extreme right foreground is the tail race. The large building is the power house; above, is the penstock house; and to the left (on the high ground) is the switch and control house. The large towers carrying the whole of the transmission lines across the shipping canal are just visible in the background. The industrial part of Trollhättan is shown in the background of the power house and penstock house.

formation of ice in the penstocks is prevented by electrically heating the water as explained below.

The Penstocks.

Each of the 13 main turbines receives its water from the forebay through a separate pipe or penstock, 14 ft. in diameter, which terminates at the cylindrical casing of the appropriate turbine.

The flow of water in each penstock is controlled by a sluice gate in the penstock house. Before entering the penstocks the water is screened to prevent debris from entering the turbines. The general arrangement is shown in Fig. 5.

Electrically Heating the Water to Prevent Freezing.

Each screen is constructed of metal bars, which are arranged electrically in three balanced sections, insulated from one another. Connections are brought out to terminals, to which a low-voltage three-phase supply may be connected

when desired. Thus any tendency for ice to form on the screens may be prevented by connecting the three-phase supply to the screen and dissipating just sufficient energy in the water to keep its temperature above the freezing point.

Power House.

The power house is an imposing building of granite nearly 500 ft. long. It contains 13 main A.C. generating units and three auxiliary D.C. units, all with horizontal shafts and Francis (reaction type) turbines.

The main turbines have double wheels or runners in cylindrical casings, and operate at a speed of 187.5 r.p.m. The auxiliary turbines have single runners in

cylindrical casings, and operate at a speed of 410 r.p.m.

The power house commenced service in 1910 with four main A.C. generating units, each consisting of a 12,500 h.p. turbine and an 11,000-kVA., 11,000-volt, 25-cycle three-phase alternator. This plant supplied power to large electro-chemical works in the immediate neighbourhood.

175,000 kVA.

Extensions were carried out during the period 1915-1920, and on completion the plant consisted of eight 12,500 h.p. turbines each coupled to an 11,000-kVA.,

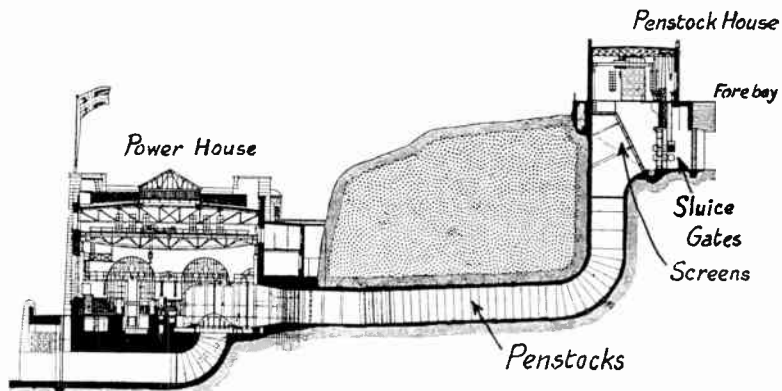

Fig. 5.—CROSS-SECTION OF POWER HOUSE AND PENSTOCK HOUSE AT TROLLHÄTTAN.

The penstock house is about 100 ft. above the power house and the penstocks are 14 ft. iron pipes laid in tunnels cut in the rock.

11,000-volt, 25-cycle three-phase alternator; three 12,500 h.p. turbines each coupled to an 11,000-kVA., 11,000-volt, 50-cycle three-phase alternator; two 13,200 h.p. turbines each coupled to a double alternator, viz., a 25-cycle, 13,500-kVA., 11,000-volt three-phase alternator; and a 50-cycle, 13,500 kVA., 11,000-volt three-phase alternator; three 500 h.p. turbines each coupled to a 350-kW., 220/300-volt D.C. generator; a 4,750 ampere-hour storage battery. The D.C. generators and battery supply the lighting and auxiliary services.

Reconstructed Units—Obtaining 16,000 h.p. from a 12,500-h.p. Turbine.

A scheme is now in progress for the gradual reconstruction and modernisation

of the turbines with the object of obtaining a larger output and higher operating efficiencies.

By increasing slightly the diameter of the runners and the dimensions of the casing, and using the existing foundations, the output from the 12,500-h.p. turbine has been increased to 16,000 h.p.

Efficiencies.

At the same time the efficiency at a load of 12,500 h.p. has been increased from 82.3 per cent. to 90.6 per cent. The most efficient load is now 15,000 h.p., at which the efficiency is 91.6 per cent., and the maximum load is 17,800 h.p., at which the efficiency is 83 per cent. These figures refer to the mechanical efficiency of the turbine itself.

How the Expense of Reconstruction Will be Recovered.

The result of the reconstruction is that an additional output of 1,000 h.p. is obtained with the same quantity of water passing through the turbine. The revenue obtained from this additional output will be sufficient to pay for the cost of reconstruction in a very short time, after which this revenue will form an additional credit balance to the undertaking.

The existing alternators are able to give the increased output without exceeding the standard temperature limit, but on account of the increasing demands for 50-cycle energy, some of the reconstructed units will be provided with double generators, viz., the existing 25-cycle generator and a new 50-cycle generator rated at 16,500 kVA.

Switch House.

The switchgear and the control room are located in a separate building on the high ground a short distance from the power house. The connections between the generators and the switchgear are made by underground cables run in tunnels drilled in the rock.

Remote Control.

The control room is well laid out and is in accordance with modern ideas. Miniature control switches are mounted on desk-type panels, by means of which all

the control operations for the plant in the power house and penstock house can be carried out. In addition to the indicating instruments for the generators recording instruments are installed to show continuously the levels of the water in (1) Lake Vänern; (2) the intake; (3) the forebay; (4) the tail race. As Lake Vänern is 9 miles distant, and the intake is nearly 1 mile distant, from the control room, these instruments are operated electrically through pilot wires.

Transformers.

On account of the varied nature of the transmission system supplied by Trollhättan, three different groups of transformers and switchgear have had to be provided. Thus in the switch house there are three step-up transformer banks, totalling 44,000 kVA, 10,000/50,000 volts, 25 cycles; one step-up transformer bank totalling 22,000 kVA., for 10,000/50,000 volts, 50 cycles.

The switchgear for these transformers is of the indoor type and is installed in the switch house.

Adjoining the switch house there is an outdoor transformer station with three 3-phase transformers totalling 48,000 kVA. for 10,000/130,000 volts, 50 cycles. The 130,000-volt switchgear is installed out of doors adjacent to the transformers.

Transmission Lines—130,000 Volts for Trunk Transmission.

The transmission and distribution system now covers a territory with a maximum radius of nearly 100 miles. In addition, a trunk transmission line, about 200 miles long, connects Trollhättan directly with the Westerås standby steam station, and thence indirectly with the water-power stations at Älvkarleby and Motala, so that Trollhättan can supply energy to the latter stations during times of low waterflow.

The trunk transmission line operates at 130,000 volts and is run on steel towers and hollow concrete poles, depending upon local conditions.

A 130,000-volt line (50 miles long) also supplies Alingsås, which is an important distribution centre and is one of the substations for the Gothenburg—Stock-

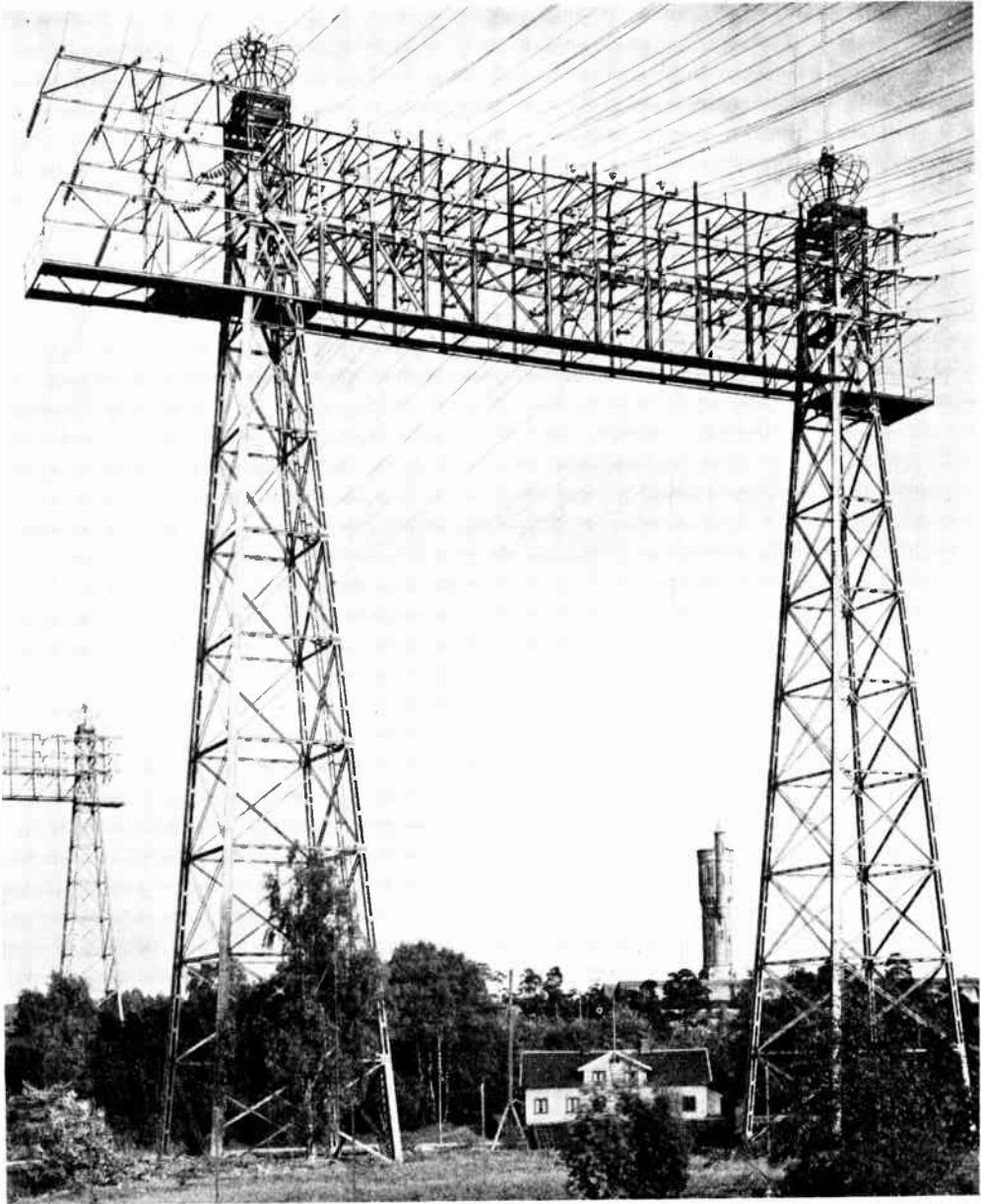

Fig. 6.— SHIPPING CANAL CROSSING AT TROLLHÄTTAN.

The whole of the transmission lines (130 kV., 50 kV., 10 kV) are carried across the shipping canal on these towers.

holm railway. This line, and also the trunk transmission line, operate at 50 cycles.

Fig. 6 shows the steel towers carrying the whole of the transmission lines across the shipping canal at Trollhättan.

Telephone Service Over 130,000-volt Transmission Lines.

The 130,000-volt trunk transmission line and the 50,000-volt lines interconnect-

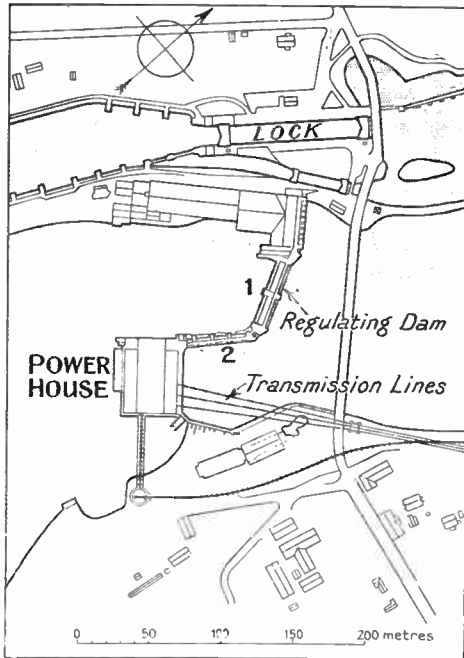

Fig. 7.—PLAN OF THE POWER PLANT AT LILLA EDET.

Reference.—1, regulating dam (roller type); 2, sluice gates.

ing the power stations are used for private telephone service between the power stations at the same time as they are transmitting electrical energy. The carrier-current or "wired-wireless" system is used.

Substations.

The principal transformer substations (ten in number) for the primary transmission system are supplied at 50,000 volts, about 250 miles of lines being involved. From these substations secondary transformer stations are supplied through a

secondary transmission system at voltages of 30,000, 20,000 and 10,000 volts. This secondary transmission system includes nearly 1,500 miles of lines and over 300 transformer substations.

Low Tension Distribution.

The consumers are normally supplied from these substations by a 4-wire distribution system at 220 volts between lines and neutral. Large consumers, however, are supplied direct from the secondary transmission system.

Wood poles are used exclusively for the secondary transmission lines and the local distributing lines.

THE POWER PLANT AT LILLA EDET. General.

The Lilla Edet power station is situated on the Gotha river, 12½ miles below Trollhättan, at a point where there are short low head falls (21 ft. head). Thus the water which is discharged from Trollhättan is again utilised for power purposes. The station supplies energy principally to the city of Gothenburg (about 35 miles distant) and to industrial works in the immediate vicinity. It is operated as a base-load station (i.e., the machines run as far as possible fully loaded), peak loads being supplied by Trollhättan. All the energy produced at Lilla Edet is at 25 cycles.

The one-hour peak load is about 25,000 kW., and the energy generated per annum is about 150,000,000 kWh.

Features of Technical Interest.

Although the station is small compared with Trollhättan its relative smallness does not deprive it of technical interest. On the contrary, the Lilla Edet station possesses many features of special interest to the electrical engineer, because it is the most modern of Sweden's water-power plants and represents the most advanced ideas in hydro-electric practice. Moreover, owing to the low head available and the large quantity of water required, the design of the head and tail races, the layout of the station, and the type of plant installed form a complete contrast to those at Trollhättan. The chief features of contrast between the stations are summarised in Table I.

Layout of the Station.

A transverse cross-section of the station is shown in Fig. 9, and a sectional plan in Fig. 10. The design and layout are such that extensions can easily be made when required.

Turbines.

Three turbines, each of 10,000 h.p., are installed. Two of these are of the Lawaczeck propeller type with fixed blades, and the third is of the Kaplan propeller type with movable blades.

Impellers—Blades Adjustable to Meet Variations in Load.

Sketches of the impellers or runners of the Lawaczeck and Kaplan turbines, together with that of a Francis turbine for comparison, are shown in Fig. 11.

The inclination of the blades of the Kaplan turbine are adjusted automatically by the governor gear to meet variations in the load, and in this manner a very "flat" efficiency curve is obtained over a wide range of load.

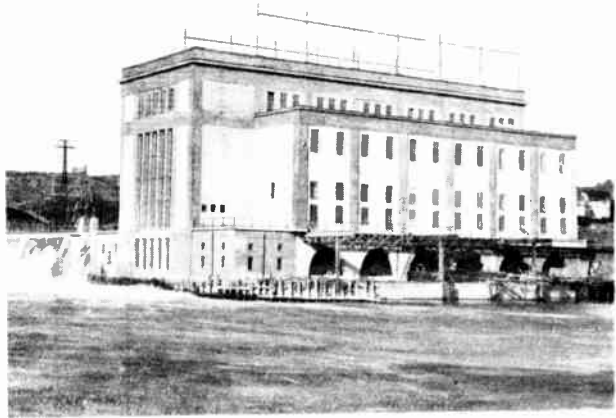

Fig. 8.—GENERAL VIEW OF POWER PLANT AT LILLA EDET. This view was taken before the transmission lines were erected on the roof of the building.

but the efficiency rapidly decreases at lighter loads, becoming slightly less than 70 per cent. at half load. On the other hand, the efficiency of the Kaplan turbine is not only high (about 90 per cent.) at full load, but is maintained at approximately this value down to half load, due to the movable blades. The maximum efficiency occurs at about three-quarter load, and is 92 per cent.

The comparison of the efficiencies of the two types of turbine is shown better in Table II, which gives the mechanical efficiency of each turbine at various loads.

In normal operation the Lawaczeck turbines are kept fully loaded and all variations of load are taken by the Kaplan turbine. The station could also be run efficiently at light loads (below 10,000 h.p.) by means of the Kaplan turbine.

How the Impeller Blades are Adjusted.

Each of the blades of the Kaplan impeller is fixed to a short shaft which is mounted in bearings in the boss of the impeller. To each of these shafts levers are fitted which are connected by links to a horizontal spider fitted to a control shaft inside the hollow main shaft. Thus vertical movements of the control shaft

TABLE I.

Comparison of the layout of and the plant in Lilla Edet and Trollhattan Power Stations.

LILLA EDET.	TROLLHATTAN.
Low operating head (21 ft.).	Medium operating head (103 ft.).
Vertical shaft turbines and generators.	Horizontal shaft turbines and generators.
Turbines of the propeller type with single wheels.	Turbines of the reaction type with double wheels.
Island site in river.	Land site on river bank.
Single building housing power plant, control room, switchgear, transformers, etc.	Separate buildings for power plant, penstock house, switchgear, transformers, etc.
Intake adjoins power station.	Intake nearly a mile from power station, requiring a "power canal."
Single voltage and frequency.	Two voltages and two frequencies.
Base-load station.	General-load station.

Efficiencies—90 per cent. Efficiency at Half Load.

The Lawaczeck turbines have a high efficiency (nearly 90 per cent.) at full load,

TABLE II.—MECHANICAL EFFICIENCIES OF LAWACZECK AND KAPLAN TURBINES AT VARIOUS LOADS.

Load, as percentage of full load	30	40	50	60	70	80	90	100
Efficiency, Lawaczeck turbine (per cent.)	53.3	60.3	66.6	73.2	79.2	84.8	90.5	89
Efficiency, Kaplan turbine (per cent.)	84	87.2	89.7	90.7	91.7	92	91.7	89

Maximum efficiency of Lawaczeck turbine is 93 per cent. at 95 per cent. of full load.

cause corresponding movements of the spider and linkwork, by means of which appropriate angular movements are given to the blades.

The control shaft is operated by a servo motor which is supplied with oil under

r.p.m. The design follows conventional practice for a vertical shaft machine, but provision has been made in both stator and rotor for operation at 50 cycles should this be required at a future date. The alterations involved (which could be

carried out at the power station) would be (1) re-arranging, re-connecting and re-insulating the end connections without disturbing the conductors in the slots; (2) replacing the present 48 poles and field coils with 96 new poles and field coils. The present stator winding is of the double-layer type with the end connections arranged as shown in Fig. 12. If this winding is to be reconnected for 50

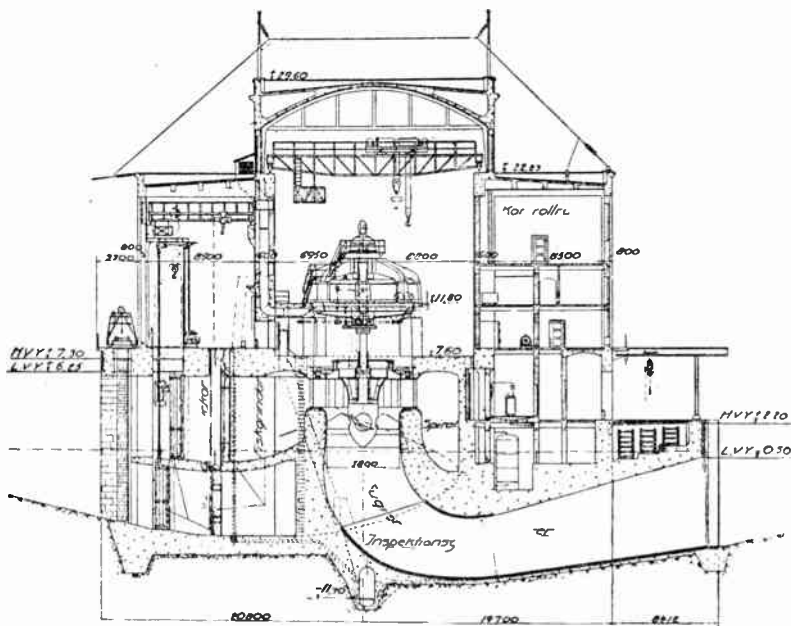

Fig. 9.—TRANSVERSE CROSS-SECTION OF POWER STATION AT LILLA EDET. The cross-section is taken through the centre line of the Kaplan turbine unit. The intake is on the left-hand side and the tail race is on the right-hand side. The screens and sluice gates are located in the compartments at the left-hand side of the turbine. The rooms on the right-hand side of the turbine contain the switchgear and transformers.

pressure from valves controlled by the governor.

Generators Can be Converted from 25 to 50 Cycles.

The three generators are identical as far as the alternators are concerned. Each generator is rated at 10,000 kVA., 0.7 power factor, 10,000/11,000 volts, 25 cycles, 62.5

cycles the end connections would be re-arranged as indicated in Fig. 13.

Gear-driven Direct-coupled Exciters.

The exciters for the generators driven by the Lawaczeck turbines are mounted above the alternators and are driven from the alternator shaft through planetary gearing of 6 : 1 ratio, so that the exciters

run at a speed of 400 r.p.m. In this manner an economical design is obtained.

For the Kaplan machine a separate exciter set consisting of a small vertical Kaplan turbine and a 200-kW., 220-volt, 375 r.p.m. D.C. generator is installed.

The Hydraulic Brake.

As the rotating parts of each turbine and generator weigh approximately 230 tons and the external diameter of the pole wheel is over 22 ft., a hydraulic brake is fitted which can, when required, bring the machine to rest from full speed in one minute.

The brake will hold the machine stationary in the event of leakage of water into the turbine when the gates are closed. It is also used for lifting slightly the rotor when the main supporting bearing is inspected.

The brake blocks engage a supplementary ring fitted to the yoke ring of the alternator field magnets.

are bedded upon a total of 496 spiral springs fitted in the bearing housing. The segments are entirely immersed in an oil well formed in the bearing housing.

Two guide bearings are provided, one just below the supporting bearing and the other just below the field magnets of the alternator. These bearings are of the babbitted sleeve type.

All the bearings are lubricated by forced circulation of oil from a motor-driven pump

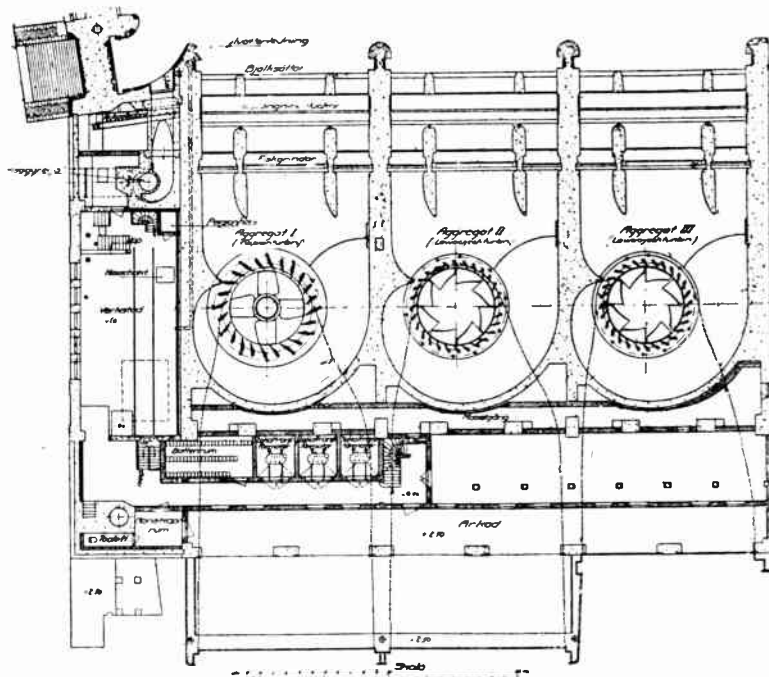

Fig. 10.—SECTIONAL PLAN OF POWER STATION AT LILLA EDET. The section is taken through the turbines and shows the runners and stationary guides or wicket gates. The Kaplan turbine is on the left.

How the Supporting Bearing Carries a Load of 600 Tons.

The whole of the weight of the rotating parts together with the end thrust due to unbalanced water pressure (which total to nearly 600 tons) is supported on a single bearing which is carried in the upper cross-arms of the alternator frame. This bearing is of the spring-supported segmental type and the general arrangement is shown in the perspective sketch of Fig. 14. The supporting hub, which is fixed to the shaft, rests upon 16 segmental babbitted bearing surfaces, which, in their turn,

in the basement of the power house. The oil is pumped through separate pipes to all the bearings and also to the gearing driving the exciters; it then drains to a common sump, where it is cooled and filtered before being used again.

Transformers and Switchgear.

The station building contains three transformer banks totalling 33,000 kVA. for 10,000/50,000 volts, 25 cycles, together with appropriate switchgear (indoor type).

THE STANDBY STEAM STATION.

Owing to the national importance of

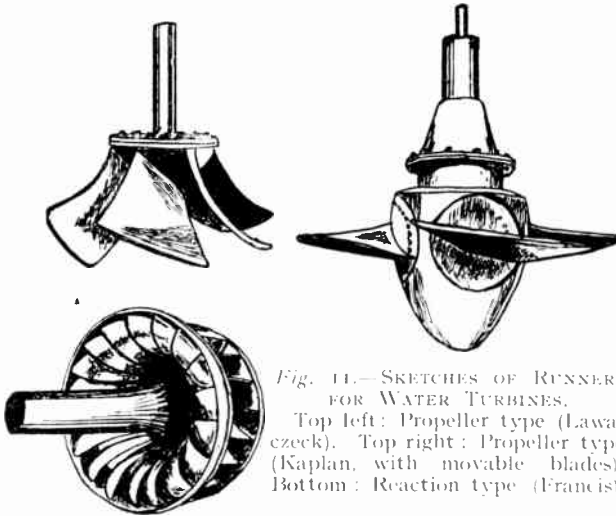

Fig. 11.—SKETCHES OF RUNNERS FOR WATER TURBINES. Top left: Propeller type (Lawa-czeek). Top right: Propeller type (Kaplan, with movable blades). Bottom: Reaction type (Francis).

maintaining continuity of service under all contingencies, a standby, or reserve, steam station has been built at Westeras. This station occupies a central position with respect to the whole grid system and is situated on the shores of Lake Mälaren, which is in direct connection (via the Södertalje Canal) with the Baltic. Coal vessels and barges up to 6,000 tons from the Baltic ports may be unloaded at the wharf adjoining the station. The station adjoins the large works of A.S.E.A. (The Swedish General Electric Co.). This firm supplied not only the

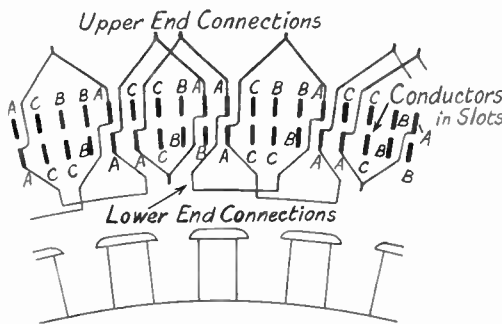

Fig. 13.—SHOWING HOW THE END CONNECTIONS OF THE WINDING OF FIG. 12 WOULD BE RE-ARRANGED WHEN THE FREQUENCY IS CHANGED TO 50 CYCLES.

The number of poles in the rotor is doubled, so that the winding now has $1\frac{1}{2}$ slots per pole per phase. Each phase group consists of one-turn and two-turn coils arranged alternately. The conductors belonging to the three phases are lettered A, B, C.

whole of the plant at the steam station but also the entire electrical plant at all the other water-power stations.

How a Load of 70,000 kW. can be Supplied in 10 Minutes from a Cold Start.

The standby station is remarkable for the short time in which it can come into full operation in an emergency. Thus, in the event of the breakdown or failure of one of the water-power stations, the steam station can take over its load (up to a total of 70,000 kW.) in the space of 10 minutes. This remarkable performance, however, does not necessitate having banked boilers permanently under steam.

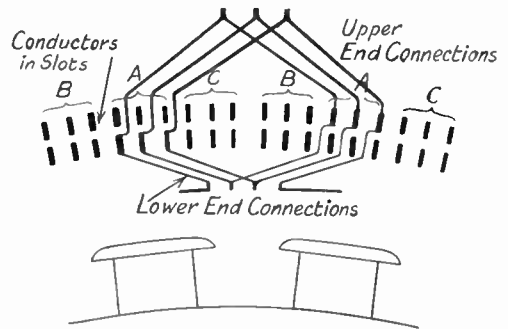

Fig. 12.—ARRANGEMENT OF END CONNECTIONS OF THREE-PHASE, 25-CYCLE ALTERNATOR AT LILLA EDET.

This is a standard arrangement for a double layer winding with two conductors per slot and three slots per pole per phase. Each phase-group consists of three coils, and the phase groups are lettered A, B, C.

The quickness with which the station can supply load is due to (1) the use of steam turbines of the Ljunström type; (2) the installation of tubular boilers of a special vertical type with rapid steaming properties and arrangements for burning either oil (when quick steaming is necessary) or coal; (3) the installation of a 3,000-kW. electric boiler which is permanently under steam (the steam being produced by electrical energy obtained from the water-power stations); (4) the operation of the turbo-alternators

normally as synchronous condensers, so that these machines are always running at full speed.

All the turbo-alternators are 50-cycle, 3,000 r.p.m. machines, and the steam turbines are supplied with steam at 300 lb. per sq. in. and 350° C.

THE POWER PLANT AT ALVKARLEBY AND MOTALA.

In both these stations horizontal double-runner Francis turbines are installed, there being five 15,000 h.p. units at Alvkarleby and two 6,000 h.p. units at Motala. All the A.C. generators are single-unit, 50-cycle, three-phase machines wound for 11,000 volts.

The water flow at Alvkarleby is extremely variable due to the river from which the station is supplied draining a rocky and mountainous country of about 10,260 sq. miles. In consequence, the full output of the station can only be obtained during the spring and early summer. The available head varies between 53 and 65 ft. according to the water flow.

On the other hand, the water flow at Motala is fairly regular, as the river Motala is supplied from Lake Vättern.

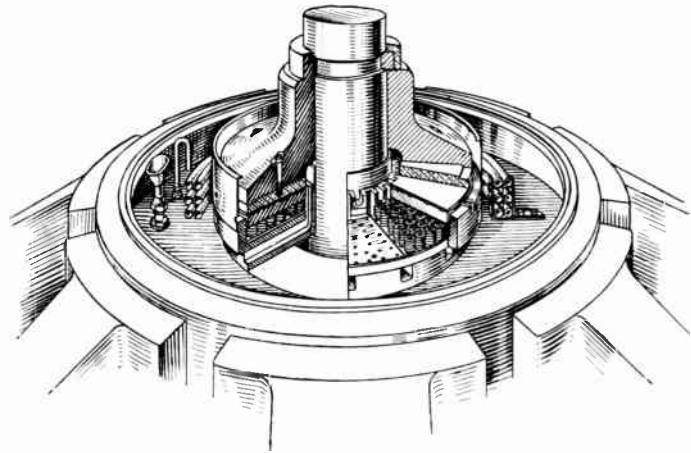

Fig. 14.—ARRANGEMENT OF THE MAIN SUPPORTING BEARING OF THE LILLA EDET GENERATOR UNITS. (A.S.E.A.)

The bearing supports a load of nearly 600 tons. The lower bearing surface consists of 16 segmental babbitted bearing surfaces which are bedded upon a total of 496 springs. The bearing is entirely immersed in oil, which is circulated by a pump and cooled by an external cooler.

But the quantity of water available is relatively small on account of the drainage area being only about 2,550 sq. miles. The available head is about 50 ft.

Acknowledgments.

Acknowledgments are due to the Royal Board of Waterfalls, A.S.E.A. (London, Gothenburg, Westeras), and Dr. Alfred Ekström (Stockholm) for many courtesies and facilities in connection with the visits to the power stations. Special thanks are due to Mr. John E. Molin for many courtesies at Trollhättan, and for supplying the photographs and plans illustrating this article.

THE INSTITUTION OF ELECTRICAL ENGINEERS

DATES OF MEETINGS, SESSION 1932-1933.

Ordinary Meetings

(Thursdays).

1932—Dec. 1, 15.

1933—Jan. 5, 19; Feb. 2, 23; Mar. 6, 23; April 6, 27.

Also April 10 (Monday) Joint Meeting with The Institute of Transport.

Annual Dinner

Thursday, 10th February, 1933.

Wireless Section Meetings

(Wednesdays).

1932—Dec. 7.

1933—Jan. 4; Feb. 1; Mar. 1; April 5; May 3.

Meter and Instrument Section Meetings

(Fridays).

1932—Dec. 2.

1933—Jan. 6; Feb. 3; Mar. 3, 17; April 7, 28.

Section Dinner: 3rd December, 1932.

Informal Meetings

(Mondays).

1932—Dec. 5, 19.

1933—Jan. 9, 23; Feb. 6, 27; Mar. 13, 27.

Particulars of the papers to be read at informal meetings were published in the November issue.

HOW PHOTO-ELECTRIC CELLS ARE USED IN INDUSTRY

By A. L. WHITELEY, B.Sc.

The photo-electric cell has been known to electrical engineers for many years. It is only recently, however, that it has been employed to any large extent in industry. Mr. Whiteley, in this article, gives a survey of some present-day applications

THOUGH the photo-electric cell as a laboratory article has been known at least as long as the thermionic valve, it is only within the last two years that it has entered the industrial field. The steady demand by the Talking Film Industry has enabled the device to be produced on a manufacturing basis, with the result that it is no longer a laboratory article, but a device which can be put into continuous use, with a long useful life.

Brief Outline of Operation.

It is not proposed in this article to enter into a detailed description of the mode of operation of the photo-electric cell itself, since many articles describing its action have appeared recently in contemporary technical journals. It is sufficient to state that when light falls on the sensitised cathode (the semi-cylindrical plate which can be seen in the photograph) electrons are emitted, which under the influence of the potential between cathode and anode—the centre wire—are attracted to the latter. The flow of these electrons constitutes the photo-electric current, which is proportional to the light intensity on the cell cathode. As this current is very small, being in the order of one millionth of an ampere, amplification is

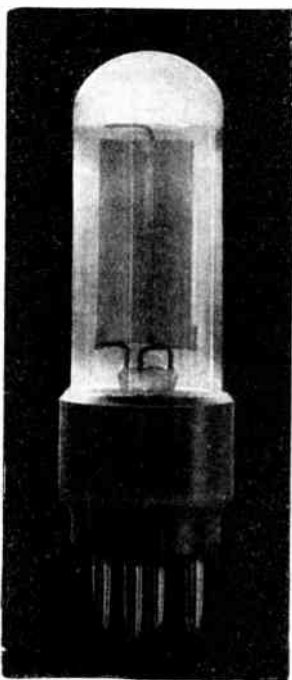

A MAZDA PE7B PHOTO-ELECTRIC CELL.

Briefly, the operation of the cell is that when light falls on the sensitised cathode (the semi-cylindrical plate) electrons are emitted which under the influence of a potential between cathode and anode (the centre wire) are attracted to the latter. The flow of these electrons constitutes the photo-electric current.

required, and is invariably carried out by a thermionic valve, in order to operate electro-magnetic relays.

Two Main Classes for Industrial Application.

The applications of photo-electric apparatus are very diverse and embrace many industries, but for the present purpose can be divided into two main classes, first, those applications where a relatively large change of light is available and is required to open or close an electric circuit, and, secondly, the various applications where the photo-electric cell is used to detect rapid or minute changes in light and accordingly is used in conjunction with special apparatus.

Opening or Closing an Electric Circuit.

Applications of the former type are, of course, in the majority and to meet these applications photo-electric relays with somewhat similar operating features have been placed on the market by various manufacturers. In this article it

is proposed to deal with applications of these relays only, since the special applications each require separate treatment.

A Relay for Industrial Control Purposes.

The photograph shows a photo-electric

relay developed by the British Thomson-Houston Co., Ltd., for industrial control purposes, and is arranged to work off A.C. supply mains. The essential components of this relay are the photo-electric cell and an amplifying circuit. The latter combines a thermionic valve, a transformer

All components with the exception of the cell are housed in a steel case, for wall mounting. The use of an external cell makes the device more flexible since the cell can be placed in any convenient position to receive the controlling beam of light, whereas the main relay case must be mounted vertically.

The Light Source or Exciting Lamp.

A description of the photo-electric apparatus is not complete without mention being made of the light source, or exciting lamp which projects a beam of light into the photo-electric cell. It will subsequently be seen that applications of the relay exist where no special light source has to be provided, but in the majority of cases it forms a necessary part of the photo-electric gear. A low voltage, thick filament type of lamp as commonly used in motor-car headlamps is the most suitable, especially if the apparatus is mounted on a machine subject to vibration. Such a lamp when under-run in voltage has a good life. The photo-electric relay can be arranged to operate at distances up to 25-30 ft. with a relatively simple projector lamp.

Having thus described the essential features of the photo-electric relay apparatus, an outline of the main types of application will be given.

1.—CONTROL OF OPERATIONS ON DELICATE FABRICS.

A very obvious advantage of control by light exists when a material being handled in an industrial process is too delicate or insufficiently rigid to actuate the usual form of limit switches or control levers. Thus, photo-electric relays have found various applications in the paper-making, printing, and allied industries. A very simple use to which the relays have been put is to detect the breakage of a "web" (i.e., the paper sheet) during the manufacturing process. A photo-electric



A B.T.H. PHOTO-ELECTRIC RELAY FOR INDUSTRIAL CONTROL PURPOSES.

for supplying suitable potentials to cell, valve, etc., together with various resistances and condensers. The thermionic amplifier energises a sensitive electro-magnetic relay, which in turn controls a small contactor, or magnetic switch. The latter is capable of making and breaking a current of several amperes, and provision is made so that a circuit can either be made or broken when light intensity on the photo-electric cell increases.

relay and light source are placed on opposite sides of the web, which normally obscures light from the cell. If breakage of the web occurs, light reaches the cell, and the relay operates to give a warning and stops the plant; thus, any mechanical contact on the delicate-moving "web" is avoided.

Using a Relay in Paper Bag Manufacture.

In the manufacture of paper bags it is usual to feed a continuous web of paper to the bag-making machine. To ensure a satisfactory product it is essential that the "side lay" i.e., the lateral displacement of the web, should be maintained within certain limits. Two photo-electric cells are now being used with a single relay to observe the position of the edge of the paper web during its transmission to the bag-making machine. A warning is given by the relay if the side lay varies so that the edge of the paper crosses the field of vision of either cell. A similar system is in use on a machine which cuts and folds tissue-paper napkins.

OPERATION OF THE PHOTO-ELECTRIC RELAY AS SPECIAL FORM OF LIMIT SWITCH.

Electrical limit-switches operated by some form of lever mechanism are frequently found on electrically driven apparatus; e.g., overrun of an electric lift is prevented by the provision of a limit switch at the limits of travel of the lift, so that if by accident the lift approaches dangerously near the top or bottom of the shaft, it runs against a limit switch and the latter operates to shut down the lift motor. In many cases, however, the moving object which is required to open or close a circuit, may be too light and may be incapable of providing sufficient force to operate the conventional form of limit switch.

Control of Specific Gravity of Liquid Produced by an Acid Plant.

An example illustrating the foregoing

occurs in the control of the specific gravity of the liquid produced by an acid plant. A hydrometer floating in the acid carries a small screen; when the acid is of the correct density the screen part cuts off a narrow beam of light from one photo-electric cell and just allows another beam to reach a second cell.

What Happens if Acid Density is too Great.

If the acid density is too great, the hydrometer rises and cuts off light from the first cell, which thereby operates the relay connected thereto; the contactor of the photo-electric relay closes and energises an electrically operated valve which allows water to flow in, to lower the acid density.

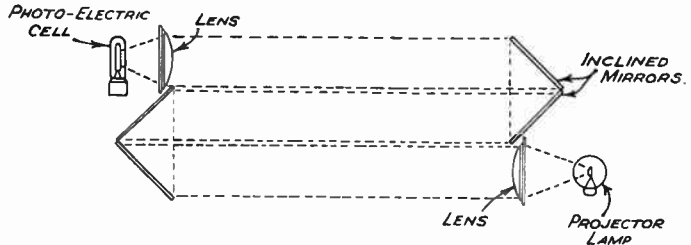

THIS SHOWS THE ARRANGEMENT OF MIRRORS WHEN A PHOTO-ELECTRIC CELL IS USED TO FORM A "BARRIER" IN FRONT OF A PRESS.

In the production of pressed steel work it is desirable that during the down stroke of the die of the press, the operators should be clear of the machine. This diagram shows how a system of mirrors is arranged to permit a single photo-electric relay to take care of an area wider than a single light beam.

What Happens if Acid Density Falls.

Conversely, if the acid density falls, light is received on the second cell, and the corresponding relay serves to open a valve permitting the inflow of concentrated acid. Thus the acid is automatically maintained within definite limits of specific gravity.

Photo-electric Relays for Measuring Instruments.

It is often convenient to perform an operation according to the movements of the needle of an instrument, but in many cases the torque of the instrument is too low to operate a switch, and further the addition of the latter is likely to impair the accuracy of the instrument. Thus, photo-electric relays are being used

on automatic weighing machines; a photo-electric cell together with a suitable light source is placed against the dial of the weighing machine, so that when the weight of material fed to the machine reaches the desired amount the pointer cuts off light from the cell, thereby causing the feed of material to the hopper to be stopped. This method of automatic weighing is particularly suitable for weighing out quantities of tea, sugar, coal, etc.

How a Relay Can Replace a Mechanical Stop in the Production of Rolled Steel Bar.

Only one further example of a photo-electric relay acting as a limit switch need be given to illustrate the wide diversity

operates the photo-electric relay, and causes the shear to descend. Thus apart from the shear itself, all mechanical parts subject to wear are eliminated.

THE PHOTO-ELECTRIC RELAY AS A PROTECTIVE DEVICE.

The burglar alarm type of protective device is now well known. It is only necessary to point out here that the "invisible ray" is derived from an ordinary electric bulb with an infra red filter. The latter only allows the infra red or heat rays to pass, which though not visible to human eye, are quite satisfactory for operating the modern type of caesium film photo-electric cell.

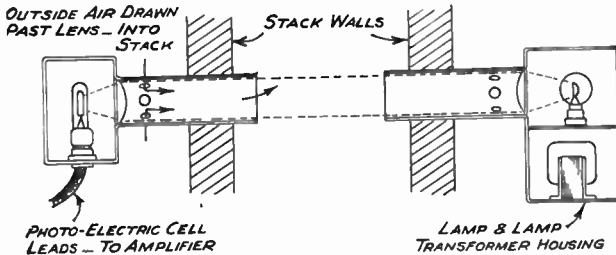

HOW A PHOTO-ELECTRIC CELL IS USED AS A SMOKE DENSITY INDICATOR.

This consists of a source of light projecting a beam across a chimney stack into a photo-electric cell, which is connected to a relay and so arranged that when the light intensity of the cell falls below a predetermined value, an alarm is given. Alternatively the cell can be connected to an amplifier with a meter in the anode circuit.

of applications under this heading. In the production of rolled steel bar it is customary to cut it into lengths as it comes from the last stand of the mill. The red-hot bar is normally run out until it comes against a mechanical stop; a shear then descends, cutting the bar to the required length; the bar is then propelled forward again and the operation repeated. The photo-electric relay has been used here with advantage, replacing the mechanical stop, which was subject to severe wear due to repeated impacts from the red-hot bar.

The photo-cell is placed near the position formerly occupied by the stop, and the red hot leading end of the bar passes before the field of vision of the cell, and in so doing

Reducing Risk of Accidents to Operators of Plant.

The photo-electric relay can act as a protective device in a more important respect, viz., in the prevention, or at least, in reducing the risk of accidents to operators of certain types of plant. In the production of pressed steel work, it is desirable that during the down stroke of the die of the press, the operators should be clear of the machine, and not in a position where they might be tempted to make hurried final adjustments to the work.

The accompanying illustration shows how a system of mirrors is arranged near the machine, forming a "barrier" of light. If a beam is intercepted during the down stroke of the press, power is cut off from the latter, and a brake applied to stop the die.

The arrangement of mirrors shown permits a single photo-electric relay to take care of an area wider than a single-light beam, which usually is of only 2 in. diameter. The arrangement shown is being used to protect an area of approximately 7 in. \times 5 ft., which is generally quite sufficient, since the operator is only in danger during the final part of the stroke of the die.

REMOTE OPERATION BY PHOTO-ELECTRIC RELAYS.

The photo-electric relay may often be used with advantage when a remote or inaccessible object is required to actuate an electrical device or machine. A few characteristic examples will indicate the general form taken by this type of application.

Relays for Counting Passing Objects.

One of the simplest uses to which the relay may be put, viz., the counting of passing objects, can be classified under this heading. A magnetic type counter is suitable for use in conjunction with the relay, a count being made every time an object intercepts the light beam on the photo-electric cell. Traffic counting, or counting of customers entering a store, etc., are obvious applications. The relay is particularly suitable, however, for the counting of light or rapidly moving articles on a conveyor belt. A standard form of relay and counter will count up to 350 per minute. For higher speeds, a relay can be constructed to operate the counter for every second or higher multiple of light interruption, so that it is possible to count the flickers of an electric lamp on a 25-cycle A.C. supply.

Automatic Floodlighting of Electric Signs by a Passing Train.

A different example of a form of remote control by photo-electric methods is the operation of flood lighting of electric signs facing a railway, according to the passage of trains. A passing train intercepts a light beam spanning the railway track, and thereby causes the adjacent signs to be illuminated. The system has the double advantage of increased advertising value, due to the sudden illumination of the displayed matter when in view of the passengers, and it also results in a saving of power. With a sign consuming 15 kw. or more, it can be shown that the cost of the photo-electric control may be recovered in a year or thereabouts.

Automatic Opening of Restaurant Service Doors.

The automatic opening of restaurant service doors has been accomplished by

photo-electric control; a beam of light is focused in a photo-electric cell at a suitable distance from the door, so that the person approaching the door cuts off light from the cell; the relay connected to the cell then energises the door-opening mechanism, which may be a system of levers operated by a solenoid, or preferably an electric-hydraulic device.

PHOTO-ELECTRIC INSPECTION.

The photo-electric cell provides a means of rapid inspection of mass produced articles. For the detection of small flaws in a quantity produced article, elaborate apparatus with special thermionic amplifiers may be necessary. Cases exist, however, where a standard form of relay, as previously described, may be used to eliminate visual inspection. For example, a photo-electric relay is being used to reject rubber caps for storage batteries, if not provided with vent holes.

SMOKE DENSITY INDICATORS.

The restrictions enforced by local authorities, aiming at smoke abatement, have opened up a further industrial field for the photo-electric cell, which can be used to actuate an alarm or to give smoke density readings on a meter.

Simplest Form of Smoke Indicator.

The simplest form of smoke indicator consists of a source of light projecting a beam across the chimney stack into a photo-electric cell. The latter may be connected to a relay, which is arranged to close its contacts when the light intensity of the cell falls below a predetermined value, and thereby gives an alarm indicating that the smoke density in the stack is above the permissible limit.

How a Meter Can be Calibrated in Terms of Smoke Density.

Alternatively, the cell may be connected to a thermionic amplifier, in the anode circuit of which is placed a meter. As the smoke density rises, cutting off light from the photo-electric cell, the current in the latter falls. The amplified current through the meter is, therefore, reduced also, and hence the meter can be calibrated in terms of smoke density.

DOMESTIC ELECTRIC CLOCKS

By D. WINTON THORPE, A.M.I.E.E.

In this article Mr. Thorpe, who writes from close personal knowledge of the contracting side of the industry, gives some useful advice regarding the selling and installation of electric clocks

ALTHOUGH most engineers already understand the operation of the clock perfectly, it may be as well if I make a passing reference to the fact that under the new Central Electricity Scheme the frequency of the "grid" is standardised at 50 cycles per second.

The Grid Has Made the Electric Clock a Commercial Proposition.

Now this does not mean that the frequency is approximately 50 cycles; it means that it is exactly 50 cycles, no more and no less. In fact, the "grid" system is what is known as "frequency controlled." That is to say, there is not the slightest variation in the number of alternations which occur on any system which is connected with this "frequency controlled" grid. If, therefore, we have a motor which will run absolutely synchronously with this frequency we can be certain that the speed of the motor will not vary in any degree whatsoever. Thus, it is only a matter of mathematics so to gear this motor that it turns the hands of a clock at a constant and unalterable speed which represents the correct chronological speed.

Radio Receivers and Electric Clocks—A Note for the Electrical Dealer.

Although I may be accused of digressing I should like to interpolate here a suggestion which may not be out of place. It is this. When, several years ago, the wireless boom started, the retailing industry was very slow, with the result that a large part of the wireless trade—if

not the majority—got into the hands of music-shops and garages, instead of passing through the hands of the electrical retailers. This trade is now coming back

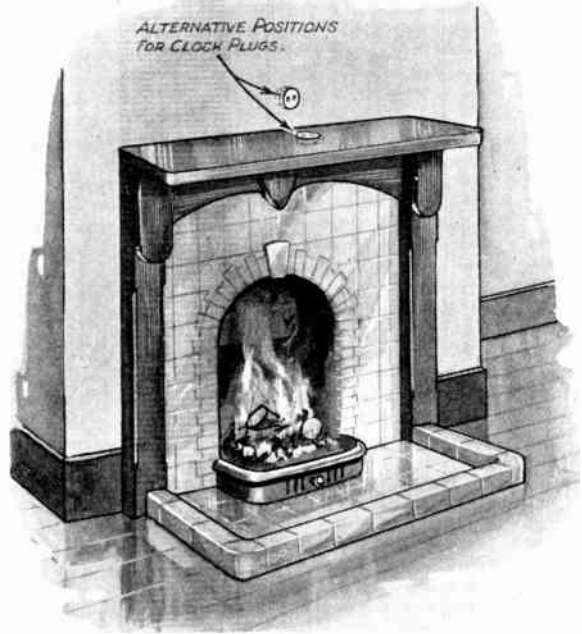

THIS SHOWS TWO ALTERNATIVE POSITIONS FOR THE CLOCK PLUG.

into its proper channels, but a lot of ground has been lost. In the same way I think that there is a very serious risk that electrical retailers may neglect the boundless possibilities of stocking and selling synchronous electric clocks now that what we may, I think without exaggeration, call the electric clock boom is upon us. If electrical retailers do neglect this opportunity to assert themselves as the normal and proper channel for distributing these appliances, then, as in

P

the wireless boom, they will find that other trades have got in before them, and it will be a comparatively difficult matter to get back the trade in synchronous electric clocks into their own hands.

Some Sales Points.

It is, I think, one thing for an electrical engineer to understand a particular subject, or a particular commodity; but it is quite a different matter for him to have at his tongue's tip the arguments in favour of this commodity when he is trying to advocate its use to laymen. It always seems to me that in the matter of synchronous electric clocks the trade, generally speaking, is too diffident in laying emphasis on the fact that a synchronous electric clock cannot keep bad time. It can stop. It is very unlikely

No Ticking

It is an advantage that the clock itself is comparatively cheap. It is an undoubted advantage that there is no irritating ticking connected with the operation of the clock. These and several other advantages are undoubtedly helping to popularise the use of the clock.

Cannot Keep Bad Time.

But the fundamental and by far the most important asset possessed by the synchronous electric clock is the fact that **it cannot keep bad time.** Regulating becomes a thing of the past and there is no longer any excuse for missing one's train. If evidence is needed of the amazing convenience of a clock of this sort, it is only necessary to point to the fact that synchronous electric clocks are in operation on the mains of supply companies which

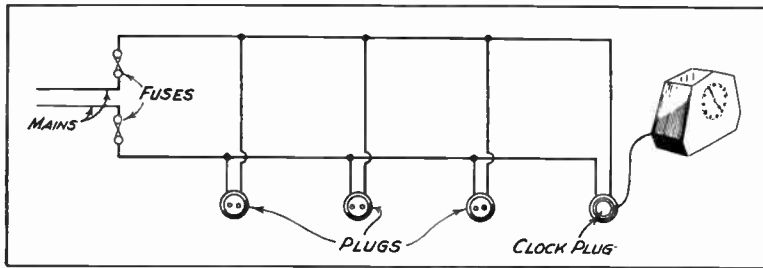

TYPICAL BAD ARRANGEMENT OF LOOPED PLUG OUTLETS ON CIRCUIT SERVING A CLOCK.

If either plug outlet causes a fuse to blow, the clock will stop.

are not yet "frequency controlled." That is to say, that in spite of a very slight discrepancy in the declared frequency of supply, these clocks are still an improvement on their old-fashioned clock work, spring-operated ancestors.

to do so, but we must admit that if the supply from the main ceases for any reason, such as a temporary breakdown on the part of the supply undertaking, then the synchronous electric clock will undoubtedly stop. But such occurrences are so rare that they may be reasonably ignored.

No Winding.

Short of an actual breakdown, that is to say an actual interruption of the supply of current to the clock, it is physically impossible for that clock to do anything but keep the correct time. It is of course an advantage that one does not have to wind a synchronous electric clock.

Installing.

So much then for the sale of electric clocks. With the sale, however, there is bound up the question of installation. I do not, of course, mean that there is any great labour or ingenuity necessary to plug in to any given outlet the flexible cord connected to the clock, but if reliance is placed on this method of connecting clocks, I am afraid that their popularity will suffer very considerably. In fact, it is in this feature of their use that the chance of the electrical contractor and retailer chiefly lies.

Keep Flexible Connection Short.

The average house to-day is rather overwhelmed with flexible cord. Flexible

cords connect lamp standards to lighting plugs, flexible cords connect radiators to heating plugs, flexible cords connect vacuum cleaners to power plugs and so on. Therefore, we can start with the maxim that the less flexible cord there is connected with the use of electric clocks the better.

The "T" Adaptor.

Further than this, if we assume that the owner and user of an electric clock plugs his clock flex into the nearest electricity outlet, we immediately find that that outlet was designed for and is probably normally used for, say, a standard lamp. This means that he is depriving himself of the use of a standard lamp, unless he uses that pernicious accessory the T adaptor. If he does take his clock supply in this manner there will undoubtedly be occasions when, accidentally or deliberately, he removes the plug or the adaptor from its connection. The moment he removes the plug or adaptor the clock will stop. And it will be necessary for him to restart it and put it right.

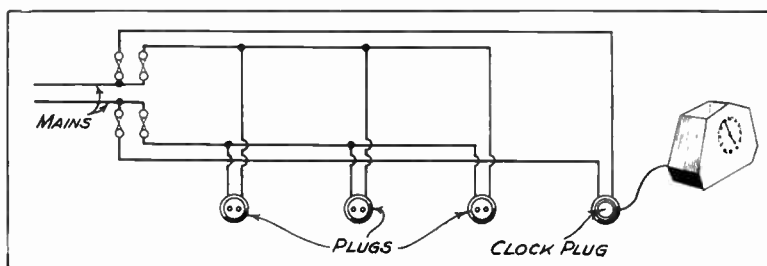

GOOD CIRCUITING ARRANGEMENT IN WHICH CLOCK IS TAKEN BACK TO SEPARATE FUSES ON BOARD.

The clock is here quite independent of faults occurring on plug outlet circuit.

A Self Checking Feature of the Electric Clock.

Again, in parenthesis, it is necessary to observe that the better type of synchronous electric clock is so arranged that if the current is cut off for any reason, the clock stops naturally, but will not resume when the current is reconnected. In order to start the clock it is necessary to operate a small trigger. The purpose of this is obvious; if there were to occur any temporary failure in the supply of electricity, whether due to the supply station or temporary disconnection of a plug in the house, it would be extremely misleading if, perhaps, two minutes after the interruption had occurred the clock resumed working. For, since it would be

obviously working and more or less the correct time, its very infallibility would lead the occupants of the house to assume that it was showing the correct Greenwich time, whereas, in fact, it would be two minutes slow. To obviate this disability, therefore, it is normally arranged that the clock shall not restart itself when the current is reconnected. Thus, the very fact of having to operate the trigger to start the clock is a reminder that the clock must also be put right.

The third, and probably the most important, reason why a synchronous electric clock should not be connected to an ordinary plug outlet is because this plug outlet is on a circuit having its own controlling fuse, which may blow owing to the failure of any other piece of apparatus on that circuit. Let us, for instance, assume that a synchronous electric clock

is connected by its flex and plug with an outlet which is on a circuit which also serves a standard lamp. If, for any reason, such as the lamp burning out or somebody tripping over the flex of the standard lamp, the circuit fuse were to blow, this would immediately stop the clock, though the clock itself had no hand in causing the fuse to blow and, given a separate circuit to itself, would not have stopped.

The Best Method of Installing.

It is, therefore, the best practice always to arrange that clock circuits are wired straight back to their own fuses on the board. Sometimes it is a little difficult to persuade customers to incur the slight extra expense of so wiring these circuits

back. But the facts of the case confidently presented will usually inspire sufficient return of confidence to allow the work to be carried out in this manner.

Now, if we can arrange a separate circuit for clocks, then there is no reason to be hidebound in the matter of choosing the position for the plug outlets to serve these clocks. For instance, it is a conventional idea that all plug outlets should be on the skirting board. This clearly is the most inconvenient position for a plug outlet for a clock, particularly when we bear in mind the fact that we are trying to avoid as far as possible long lengths of flexible cord.

The Ideal Position.

The ideal position for a clock plug outlet, to my mind, is the mantelpiece. If we have a wooden mantelpiece, or one which it is possible to cut into, quite the

rather unsightly, should be arranged so that it comes behind the clock and is masked by it. Again, if the chimney-breast is liable to become really hot, this must be taken into consideration before running wires, whether in steel tubing or in lead-covered cable in a chase in this breast. However, these are all points which must be decided by the electrician carrying out the work.

There are Immense Possibilities for Electric Clocks in Large Buildings.

Although when dealing with the question of electric clocks one's mind is apt to turn automatically to their use in private houses, it is a fact that probably the most valuable use for them is to be found in schools, hospitals and institutions generally. The importance of exact time and correct time being available throughout

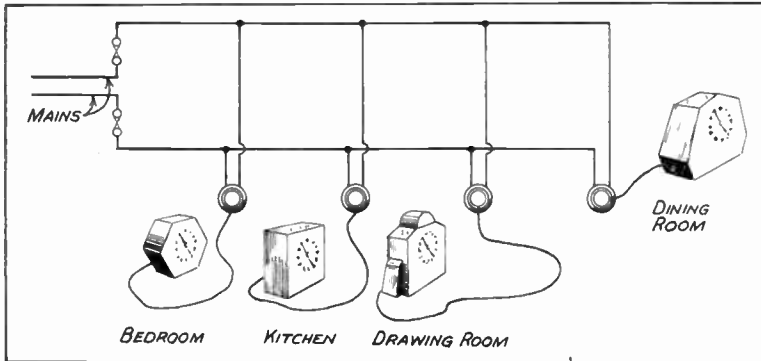

CIRCUIT ARRANGEMENT FOR USING MORE THAN ONE CLOCK IN A HOUSE.
Note that it is not necessary to use more than one fuse for the circuit.

most inconspicuous position for a plug is let into the horizontal surface of the mantelpiece. Preferably the position should be more or less central, so that what flex there is should be underneath the clock and will not straggle along the top of the mantelpiece.

Sometimes it is impossible or undesirable for the plug outlet to be placed actually on or in the horizontal surface of a mantelpiece. In this case it is usually a simple matter to arrange that the plug outlet is placed on the vertical surface of the wall behind the mantelpiece. In such cases, however, it is as well to bear in mind, in the first place, that such a plug socket which, at the best of times, is

a large institution is very great indeed. And the presence of a large number of clocks in corridors, classrooms, wards, etc., all giving exactly the same time and not competing with one another in novel methods of time-keeping, is an asset for which it is well worth paying quite a lot of money. Fortunately, it is not necessary to pay even as much money for this as would be the case with reliable clockwork clocks.

The actual list price of synchronous electric clocks varies, of course, considerably. But from a figure of about thirty shillings up to ten pounds or so there exists a very wide variety and range of clocks.

Looking Ahead.

Whether the watchmaker or the electrician reaps the benefit from this remains to be seen. But the electrician who makes no effort to secure this very lucrative and entirely satisfactory business will have nobody to blame but himself.

CONTROLLING THE LIGHTS ON A STAIRWAY

By H. W. JOHNSON

THE first and second - floor staircase lights of a warehouse are controlled by two-way and intermediate switches fixed on the ground, first and second floors.

The ground-floor staircase light may be turned on or off by a separate switch when the first and second-floor lights are switched off, but this light is always lit when the first and second-floor lights are switched on.

The following diagrams show clearly how this is effected, and will it is hoped be found of interest. The enlarged views of the switches show respectively the two positions of the two-way switches, and the two positions of the intermediate switch.

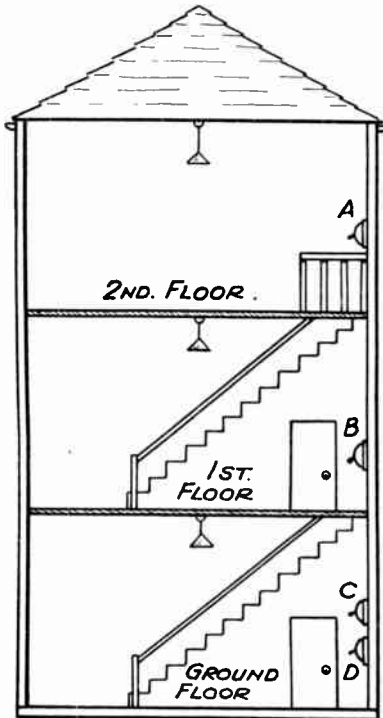

(Above) This shows the positions of the switches.

Multiple Switching Arrangements.

The contractor and wireman would be well advised to bear in mind the possibilities offered for multiple switching arrangements in houses and larger buildings. If such possibilities are tactfully pointed out to the customer in many cases he will be very glad to avail himself of the additional convenience which can be secured by utilising the range of switches which are now available from the leading makers.

POSITION 1.

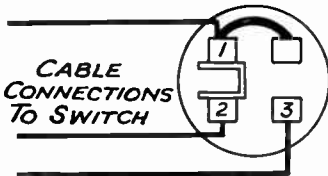

POSITION 2

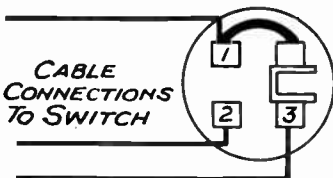

CABLE CONNECTIONS

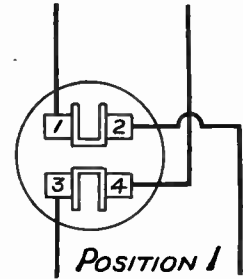

CABLE CONNECTIONS

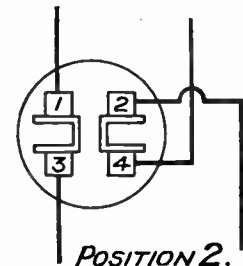

(Left) This illustrates the two positions of the two-way switches A and C. The common contact 1 is connected to contact 2 in one position of the switch, and to contact 3 in the other position of the switch.

(Right) The two positions of the intermediate switch B. The switch has two pairs of contacts, 1 and 2 and 3 and 4. In one position contact 1 is connected to contact 2; and contact 3 to contact 4. In the other position of the switch contact 1 is connected to contact 3, and contact 2 to contact 4.

This shows how the first and second-floor lights may be switched on or off by any of the switches A, B and C. The ground-floor light must be lit irrespective of the position of the switch blade in the separate two-way switch D. Compare this with the first diagram which shows the positions of the switches in a warehouse.

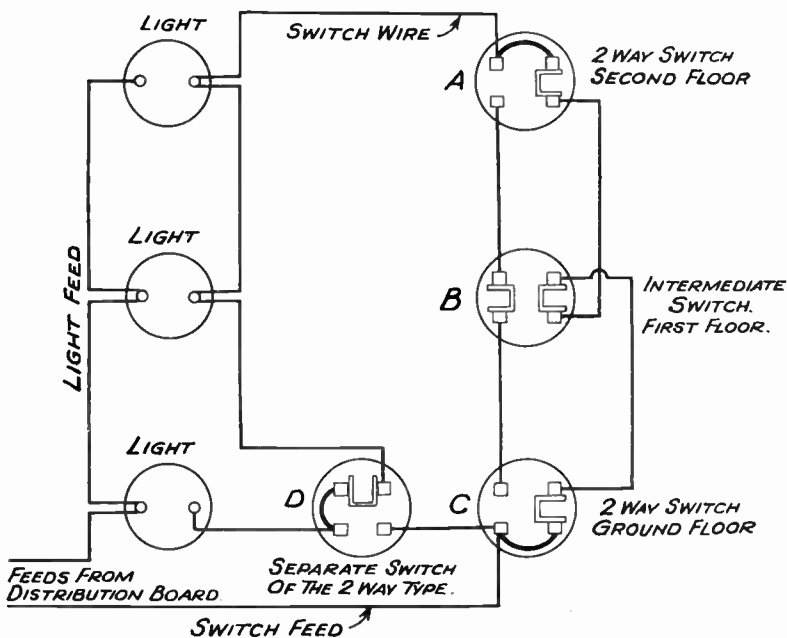
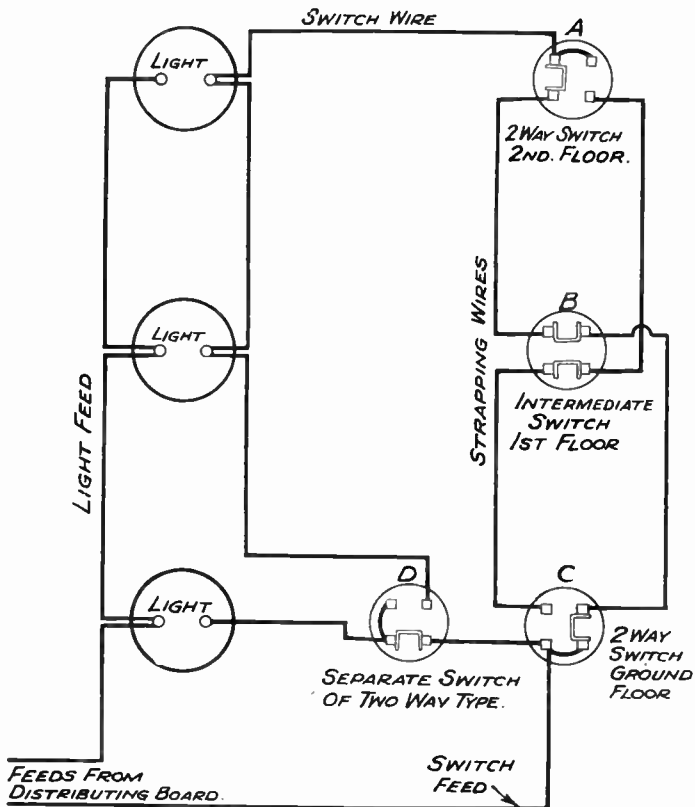

Here the first and second-floor lights have been switched off by switching over the two-way switch A to its other position. The ground-floor light may now be switched on or off by the separate two-way switch D in its present position the ground-floor light is switched off, and it may be switched on by switching over the switch D to its other position.

A USEFUL BATTERY CHARGER

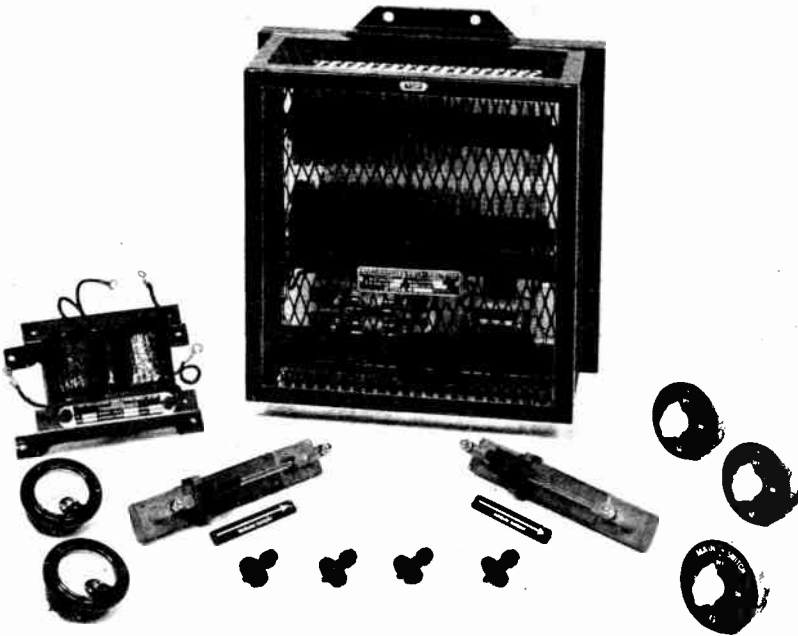

THE COMPONENTS REQUIRED FOR A BATTERY CHARGER TO GIVE 5 AMPS. AT 12 VOLTS.

THE diagram shows a battery charger giving an output of 12 volts at 5 amperes. This incorporates a Westinghouse metal rectifier, style R.F. 4.4.8, with a 125-watt transformer giving an output of 25 volts A.C.

Design for Transformer.

The transformer required is easily constructed and has two windings. The size of the stampings are as shown in the illustration. The core section is 1½ in. by 1½ in. The primary winding for supplies of 50/60 cycles is given in the accompanying table.

The Secondary Winding.

The secondary coil consists of 125 turns of 15 S.W.G. double silk-covered copper wire. This is wound on top of the primary or mains winding, from which it is insulated with two layers of ¼-in. thick presspahn.

The Circuit.

The rectifier is suitable for charging up to six cells in series, that is 12 volts.

The rheostats must be designed to carry 3 amperes each, or more if the two charging circuits are unequally loaded. If R_1 is 200 ohms, this will enable single cells to be charged at ½ ampere, and by

PRIMARY WINDING FOR DIFFERENT VOLTAGES.

Volts.	S.W.G.	Turns.
100	20	495
110	20	511
120	21	557
200	23	939
210	23	975
220	23	1023
230	23	1070
240	24	1115
250	24	1160

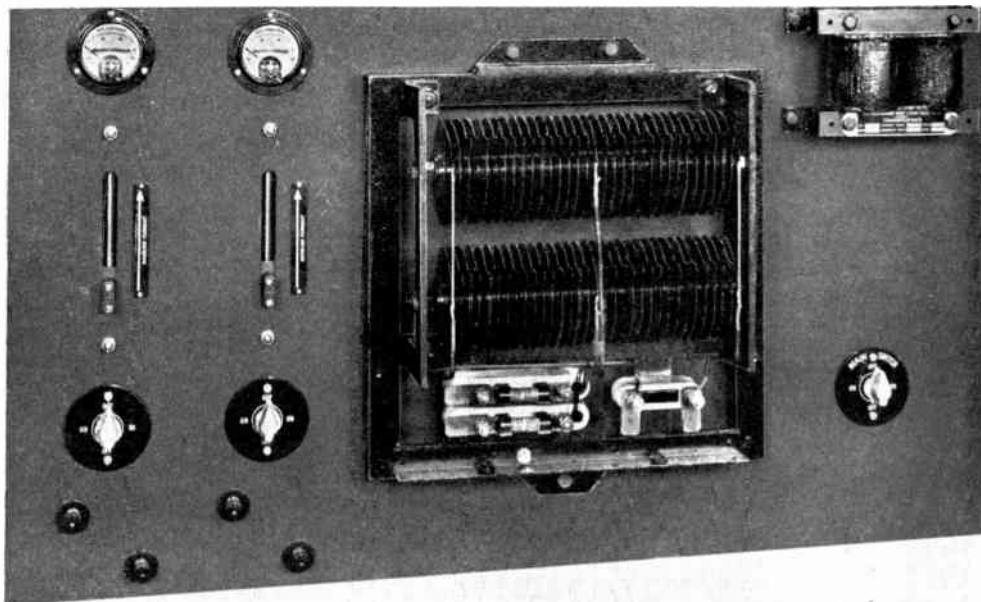

HOW THE COMPONENTS ARE MOUNTED IN POSITION.

making R_2 10 ohms single cells may be charged at 1 ampere in this point of the circuit. The total charging current must not exceed 5 amperes.

The variable resistance may be constructed from 18 S. W. G. resistance wire, about 2 lb. of which are required to produce 30 ohms.

The two switches shown on the left

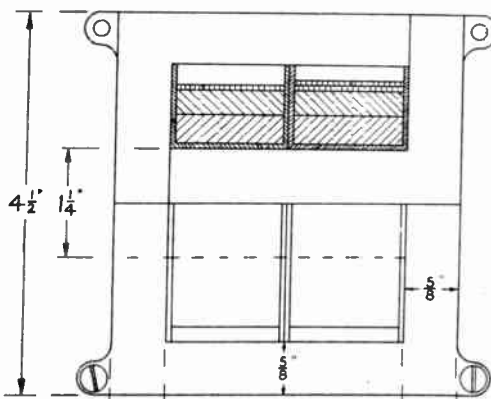

DETAILS OF THE STAMPINGS. The width of the stampings is 2 1/4 in.

are inserted in the two battery charging circuits. These are necessary to prevent the cells discharging through the rectifier when the mains supply is switched off.

The complete kit of components shown can be obtained from the Westinghouse Brake and Saxby Signal Co., Ltd., 82, York Road, N. 1.

CIRCUIT OF A BATTERY CHARGER GIVING AN OUTPUT OF 12 VOLTS AT 5 AMPERES.

Note that a switch should be included in each separate battery charging circuit.

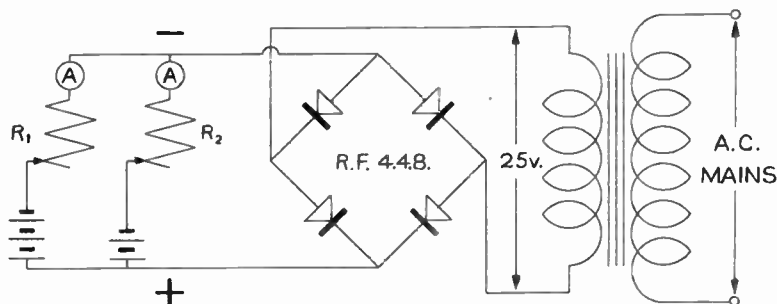

THE DESIGN AND CONSTRUCTION OF MAINS TRANSFORMERS

By FRANK PRESTON, F.R.A.

In this article Mr. Frank Preston describes how to construct a mains transformer suitable for use when building practically any all-mains receiver having up to four valves

BY making use of component parts now supplied by many manufacturers transformers of any type can be constructed at a cost of no more than half that of ready-made ones. And, what is more, the home-made instrument can be just as good as the commercial job provided that a sound design is adopted and that reasonable care is exercised. The amount of care necessary is no more than that required when dealing with any electrical appliance which is subject to more or less high voltages and is certainly no greater than the average wireless enthusiast takes when making a receiver or any of its accessories. The principles of design are not hard to understand if a few simple rules are borne in mind.

Design—The Core.

First we must choose a core. This will be made up of a number of stampings of a size which will be determined by the amount of power, or the number of watts, with which the transformer has to deal. Without going into theoretical considerations, it can be stated that for powers up to, say, 50 watts (the maximum required for any ordinary receiver having up to five valves) a core with a cross section of 1 sq. in. is ample. When only about 25 watts are

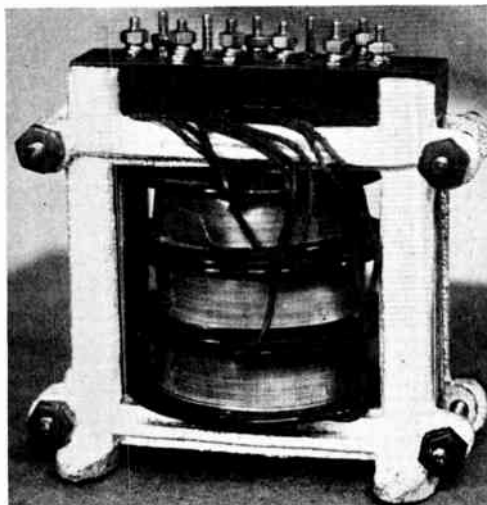

THE TRANSFORMER DESCRIBED IN THIS ARTICLE.

to be handled this area can safely be reduced to $\frac{3}{4}$ sq. in.

Windings — Turns per Volt.

Next we must decide on the number of turns to allow per volt. This figure depends upon the core cross section and the frequency of the mains supply. With a cross section of 1 sq. in. and a frequency of 50 cycles per second, eight turns per volt is most suitable;

this figure applies to both primary and secondary windings. If either the frequency or core cross section is doubled the number of turns per volt (usually stated as t.p.v.) may be halved, and conversely if either of those factors is halved the t.p.v. must be doubled.

Gauge of Wire.

Having decided on the core cross section, and hence the t.p.v., we must find what gauge of wire will be required for each winding. The current to be taken from the secondary is known, so the smallest gauge of wire capable of carrying that current without undue heating is chosen by making reference to Wire Tables. If more than one secondary winding is required this process must be repeated for each one. The primary current is not known, but can easily be found by ascertaining the power it has to handle. The

power in watts is the sum of those of all the secondary windings plus about 10 per cent. to compensate for any losses occurring in the core and windings. When the number of watts has been found, the current (in amps.) is obtained by dividing the mains voltage into it. Thus :—

$$\text{Primary current} = \frac{\text{Primary watts}}{\text{Mains voltage}}$$

From this we can decide on a suitable gauge of wire for the primary.

Winding Space—Size of Spools.

When the number of turns and gauge of wire for each winding are known, it is not

vary from slightly over 5 sq. in. to just under 1 sq. in.

A TYPICAL EXAMPLE.

It is now proposed to deal with the construction of a transformer which is suitable for use when building practically any all mains receiver having up to four valves. The H.T. secondary will give 250 volts at 30 milliamps., which is suitable for use with a style H.T.7 metal rectifier connected on the half-wave principle. Two L.T. secondaries are provided, one to supply 4 volts, 3 amps. for the cathodes of three indirectly heated A.C. valves and

the other to give 6 volts, 1 amp. for the filament of a directly heated super power output valve. The primary is tapped for 210- or 240-volt, 50-cycle A.C. supply mains; actually it works equally well on any volt-

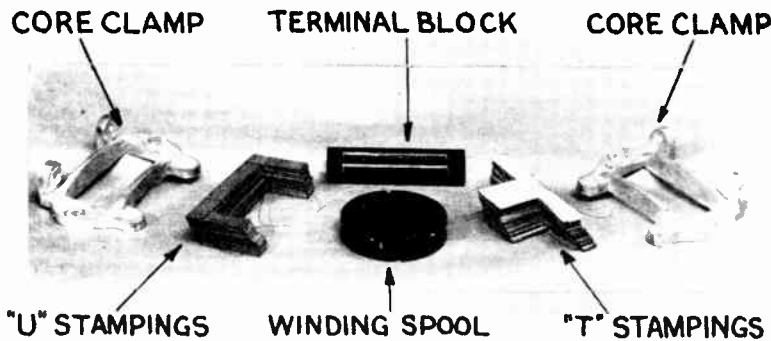

THIS SHOWS THE COMPONENTS REQUIRED FOR A SMALL TRANSFORMER.

difficult to calculate the amount of space required for the whole of the windings (by consulting our Wire Tables again to find the number of turns that can be wound per sq. in.). The numbers given in the tables assume perfect regularity and evenness of winding so it is well to subtract about 10 per cent. to allow for the inevitable unevenness. To the calculated winding space must be added the space taken by the winding spools and the necessary insulation.

It is the winding space which determines the actual size of the core stampings, because although we have already decided upon the cross sectional area there are a variety of core sizes for each area, all having a different winding space. For instance, Stalloy stampings Nos. 4, 30, 30A and 30B each have a tongue $\frac{1}{16}$ in. wide and can therefore be built up to give cores of similar cross section, but areas of winding space in the four cases

age from 200 to 240 by choosing the tapping nearest to the supply voltage.

The total output is about 25 watts, so a core of $\frac{3}{4}$ sq. in. cross section would be sufficient. As, however, the winding spools chosen have a core tunnel measuring $\frac{1}{16}$ in. square this size of core is employed. The total area is approximately .9 sq. in., but as each stamping has a layer of insulation on one side, the actual area of iron will be slightly less. In consequence, 10 turns per volt will be suitable.

The Spools.

The spools employed are "Lumenite" (Reg.) ones and three Size 4 spools just fit on the "tongue" of No. 4 Stalloy stampings. These special spools have a great advantage over those of more usual type in that they are made of bakelite and can thus be made with very thin end cheeks so that they occupy a minimum of space. They also have a circular winding

track, even though the core tunnel is square, and this enables the wire to be maintained at a more even tension whilst it is being run on.

Winding the Spools.

Before winding it is well to make some kind of holder for the spools. The simplest way is to take a slightly tapered length of square wood which will tightly fit the tunnel; the wood can then either be gripped in a lathe or held in the hand.

Commencing with the primary—this consists of 2,400 turns of 36 s.w.g. enamelled wire wound in one spool—start by soldering a 12-in. length of rubber-covered flex, pass about 7 in. of this through one of the side holes and let the remainder form the first turn of the winding. Continue winding until about 1,200 turns have been put on and cover with a layer of empire tape; then proceed with the winding, taking care that no later turns slip past the insulation. When the 2,000th turn is reached solder another length of flex to form a tapping and cover the joint with a small piece of empire tape or waxed paper. Take the flex once round the spool before bringing out the tapping. Finish the winding by putting on the last 300 turns and then solder a third length of flex to the end. Cover the windings with two or three layers of empire tape after marking the leads by sticking on pieces of stamp edging. The H.T. secondary is wound on another spool in exactly the same way, putting on 2,500 turns of the same wire—no tapping is required. It will be noticed that 36 s.w.g. wire will carry a good deal more current than the H.T. secondary requires to do, but there is

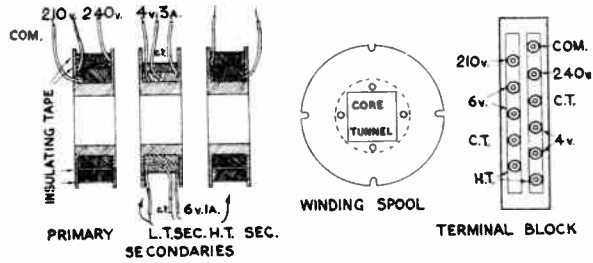

SECTIONS THROUGH THE SPOOLS.
Showing arrangement of windings and, on the right, details of terminal block.

sufficient winding space for the thicker wire, which is easier to handle.

Both L.T. windings are put on the same spool, a few layers of empire cloth separating them. The 4-volt winding consists of 40 turns of 20's gauge d.c.c. wire and the 6-volt one of 60 turns of 24's gauge d.c.c. Both windings have a centre tapping. In bringing out the leads from the L.T. spool the side holes cannot be used because the spool has to fit flush up to the other two.

Assembling the Core.

When all the windings are complete the core stampings can be inserted. These latter are of "T" and "U" shape and are inserted from alternate ends. Notice the relative positions of the spools shown in the drawing; they are arranged so that the L.T. one is between the other two. Since the L.T. windings will be connected to earth (in the set) they act as a screen between the other windings and so prevent the passage of mains hum into the H.T. circuit. First put in a "T" and then a "U" from one end, do the same from the other and repeat the process until the spool tunnels are quite full. The stampings should be

made to fit as tightly as possible to prevent vibration, so it might be necessary gently to tap the last few into position. In assembling the core notice that the insulated (white) sides of all the stampings must face in the same direction so that each one is insulated from its neighbour.

The next thing is to grip the core in the clamps, but before

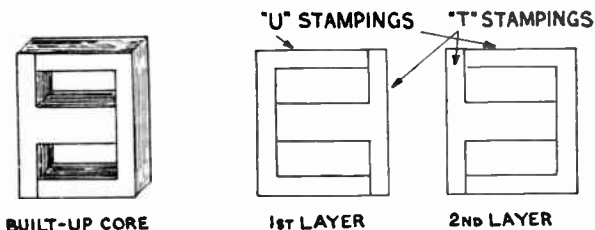

DETAILS OF THE CORE.

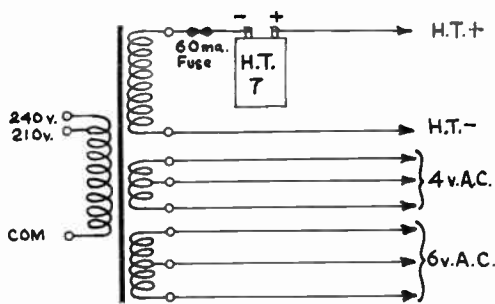

HOW THE TRANSFORMER IS CONNECTED TO RECTIFIER.

finally tightening up, the terminal block must be prepared and fitted. The latter is a "Lumenite" one specially made for use with the spools. Its width is equal to the thickness of the core so it is gripped by the clamps and held in position without the use of screws. The positions of the terminal holes are shown in a drawing and they should be made $\frac{7}{16}$ in. diameter to take 6 B.A. terminals. The terminals should be fitted with a small soldering tag under the nut to receive the leads. When the terminals have been put in place the leads from the windings can be cut off to suitable lengths

and carefully soldered to the appropriate terminals (also indicated on the drawing).

It then only remains to put the terminal block in position and firmly to tighten up the clamp screws.

Transformer Output.

A circuit diagram is given to show how the transformer should be connected to the metal rectifier. A 60 m.a. safety fuse is wired in one transformer lead to protect both the transformer and rectifier in case of a short circuit.

With the connections shown, a maximum D.C. supply of 220 volts at 28 milliamps. is available. Of course, the usual smoothing choke and condensers will be required and the resistance of the former will reduce the voltage to just about 200, which is the maximum required for most indirectly heated A.C. valves.

Wire Tables.

For the benefit of those who are not in possession of a set of wire tables the abbreviated one given below will prove useful. Only those gauges of wire generally required for transformers of the type described are dealt with.

Standard Wire Gauge.	Safe Current in Amps.	Enamelled.		Double Cotton Covered.	
		Winding turns per sq. in.	Yards per lb.	Winding turns per sq. in.	Yards per lb.
18	7	392	47	300	45
20	4	685	80	470	73
30	.5	5,400	700	2,000	550
32	.4	6,900	920	2,500	700
36	.18	13,000	1,800	4,000	1,325
38	.1	20,000	3,491	5,000	3,000
40	.07	32,500	4,900	6,000	4,500

FABRICATED CONSTRUCTION FOR LARGE ELECTRICAL MACHINES

By A. T. DOVER, M.I.E.E.

In this article Mr. Dover shows how fabricated construction has been used for the construction of a large alternator motor. No patterns or castings are needed and the resultant machine is considerably easier to transport than would have been the case if older methods involving the use of heavy castings had been employed

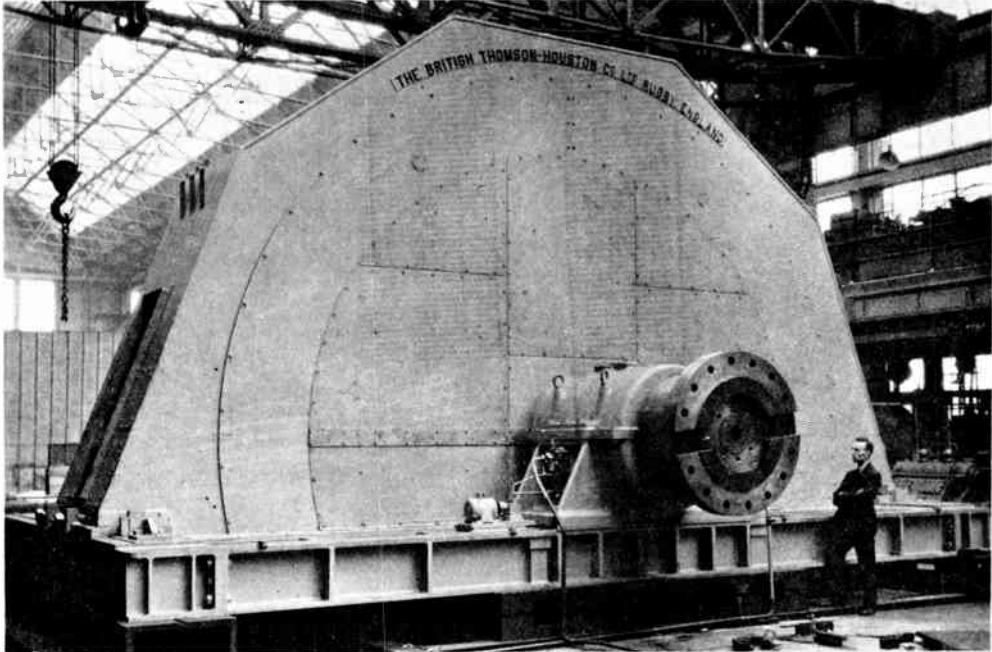

MADE IN RECORD TIME.

On August 19th the British Thomson-Houston Co., Ltd., received an order from the Tata Iron and Steel Co., India, for a large synchronous motor with automatic control gear for the main drive of a steel rolling mill. On October 8th—seven weeks after the order was received—this huge machine was completed and had passed its final tests. Fabricated construction contributed largely to this amazing triumph of British electrical engineering.

FFIFTY DAYS after the receipt of the order for a large 7,500 h.p. slow-speed special synchronous motor the machine had passed its final tests! The dates concerned are:—receipt of order, August 19th, 1932; completion of tests, October 8th, 1932.

An astounding feat; but only possible with modern methods of construction and works organisation.

The firm responsible for such a record-breaking achievement is the British Thomson-Houston Co., Rugby, and the machine concerned is the first large slow-speed synchronous motor to be built in

this country for rolling mill direct drive. In fact, the motor may be the largest of its kind in the world. Its destination is the Jamshedpur Works of the Tata Iron and Steel Co., India.

The Motor.

The motor is rated at 7,500 h.p., 6,300 volts, 50 cycles, 93.8 r.p.m., and will take peak loads of 18,750 h.p. It is of the totally enclosed type with closed-circuit air-cooling, and has 64 poles.

The outside diameter of the stator frame is 26 ft., and the overall length of the complete machine over the coupling

is 22 ft. 10 in. The weight of the complete motor, including baseplate and pedestal bearings, is 160 tons; of which the complete stator accounts for 53 tons; the complete rotor, 47 tons; and the shaft, 21 tons. The weight of the stator laminations is about 19 tons, and there is nearly 27 miles of copper strip in the stator winding and field coils.

Fabricated Method of Construction.

The extraordinary quickness of delivery of this motor was due to the fabricated method of construction. In this method the whole frame, rotor spider and bedplate are constructed by welding together pieces of steel plate which have been cut to the required shape and size in a special oxy-acetylene flame-cutting machine. Thus the delay due to the making of large patterns and castings is completely eliminated. In fact, constructional work in cutting out the steel plates for the stator frame of the motor was actually commenced within 24 hours of the order being received!

Equipment Necessary.

Special equipment is, of course, necessary for cutting out to shape the steel plates, and for welding the several pieces together to form a rigid structure.

Automatic Flame-cutting Machines.

Special automatic flame-cutting machines are used for cutting out the steel plates from flat sheets of boiler plate. Thicknesses up to about 1½ in. can be cut quite easily and rapidly.

For cutting out large work the cutting torch is fitted to a motor-driven carriage, which is propelled slowly over a full-sized

template clamped to the boiler plate. The flame cuts through the boiler plate automatically, and the path of the cut agrees with the shape of the guiding edge of the template.

For small and repetition work a machine working on the copying principle is used. The operator merely guides the point of a stylus over a "copy," or outline drawing, of the *shape* required. The flame then cuts out from the boiler plate a piece of material of exactly the same shape as the outline of the "copy" and



THE STATOR FRAME BEING TURNED OVER FOR COMPLETION OF WELDING.

of the required size, which may be, and usually is, larger than the "copy." Thus, pole end-plates, and the smaller parts of machines can be rapidly cut out with the greatest ease, and to the correct sizes, from flat sheets of steel boiler plate.

The size of flame is adjustable to suit the thickness of the plate to be cut, and when once adjusted the flame remains constant. Thus a constant rate of cutting can be obtained by moving the stylus uniformly round the outline of the copy.

How the Flame-cut Steel Plates are Welded Together.

After the required number of plates

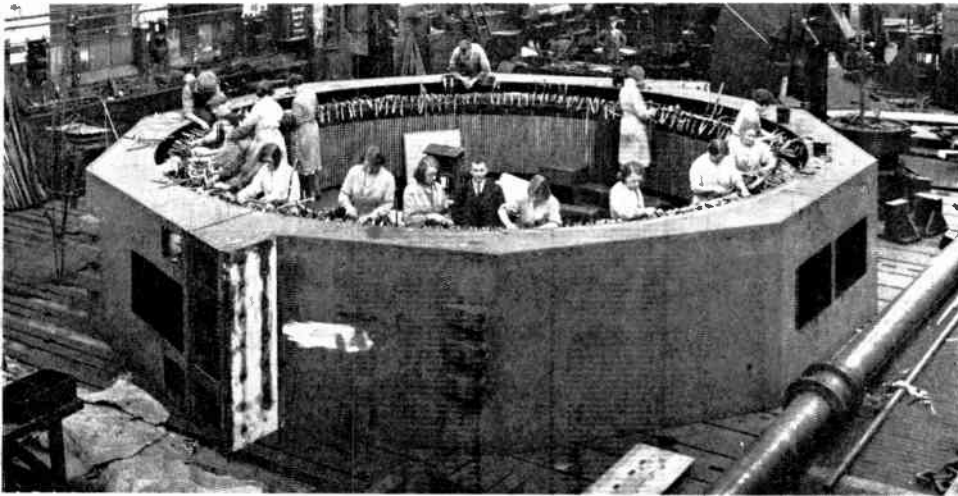

WINDING THE STATOR.

The stator frame is of box section fabricated from heavy steel plates and cross bars.

have been cut out they are placed in the correct relative positions and the seams are joined by electric arc welding so as to form a rigid structure. The welding is done by hand, and skilled operators are necessary.

Two forms of electric arc welding are in use for steel plates, viz.: (1) the direct-current metallic arc; (2) the alternating current atomic hydrogen arc.

The D.C. Metallic Arc Process.

In the direct-current metallic-arc process the arc is struck between the work and a metal wire, which forms the functions of both electrode and filling material. The arc is kept very short ($\frac{1}{16}$ in. to $\frac{1}{8}$ in.) to ensure good penetration and to facilitate the transfer of metal from the wire electrode to the work.

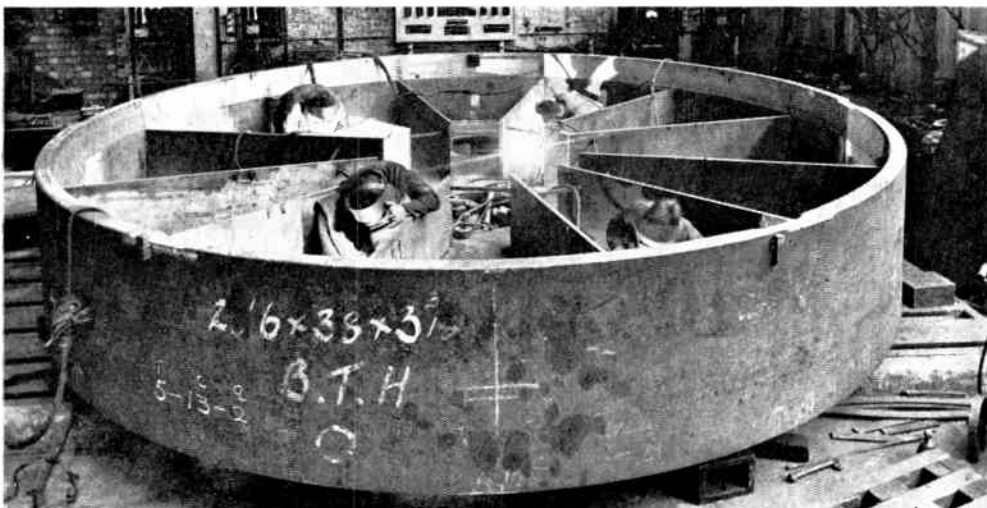

SHOWING THE FABRICATED CONSTRUCTION OF THE ROTOR SPIDER.

The A.C. Atomic Hydrogen Arc Process.

In this process a single-phase A.C. arc is maintained between adjustable tungsten electrodes, and hydrogen gas is fed to the arc around the electrodes. The hydrogen molecules are broken up into atoms by the intense heat, and, in recombining outside the arc, heat is liberated far in excess of that obtainable by any gas flame.

This heat is used to fuse the metals to be joined together. Owing to the great heat high welding speeds are possible. When additional metal is required to fill the joint a filler rod is fused into the work.

The chief advantages of this process over the older direct-current metallic-arc process, are: (1) higher welding speeds; (2) the job being welded does not form part of the electric circuit; (3) hydrogen, being a reducing agent, prevents the formation of oxides at the weld, so that flux-coated electrodes are unnecessary.

Advantages of Fabricated Construction.

The chief advantages of this method of construction are: (1) elimination of large patterns, moulding operations, castings, and the delays associated therewith; (2) the fabricated steel frame can be built very much lighter than a cast-iron frame of equal strength, owing to the high tensile strength of steel boiler plate compared with cast iron (average values

of the ultimate tensile strength are: boiler plate, 24 tons per sq. in.; cast iron, 14 tons per sq. in.); (3) the lighter construction facilitates transport; (4) very quick deliveries of special machines can be effected.

Applications of Fabricated Construction.

Fabricated construction is better suited

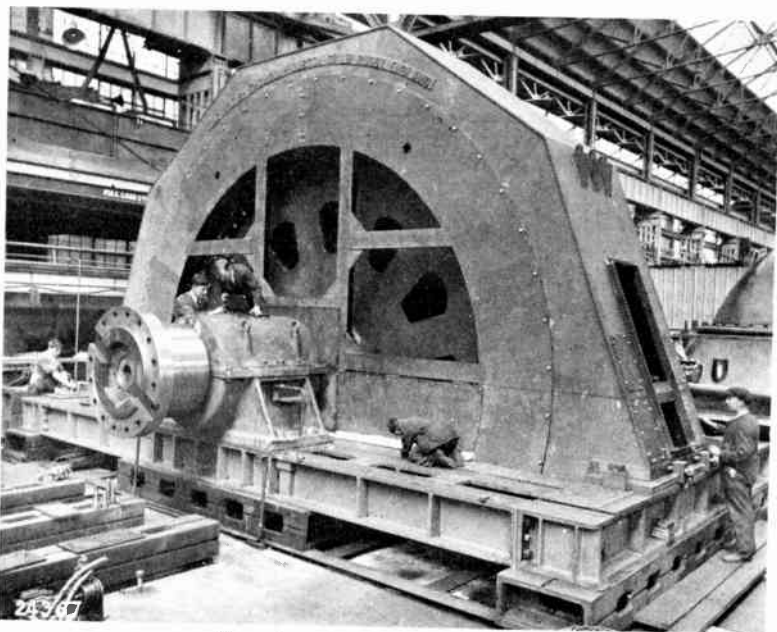

THE COMPLETION OF ASSEMBLY.

Note that even the baseplate is fabricated from heavy steel girders.

to large and special machines than to moderate-size standard machines which have to be manufactured in quantities. In fact, the more special the design of the machine, the greater will be the advantage of fabricated construction.

Fabricated construction is now used extensively by all the largest electrical manufacturers for large water-wheel alternators, large special induction and synchronous motors, turbo-alternators, large and small bedplates. Transformer tanks have been made of welded boiler plate for a number of years.



This 250 PAGE BOOK

ON SUCCESSFUL ENGINEERING CAREERS

Free
ON
REQUEST

*We teach successfully
by correspondence in
all parts of the World.*

Our Handbook "ENGINEERING OPPORTUNITIES" contains a vast amount of useful information and indicates many ways in which a successful career may be planned and followed. It is not merely a pamphlet, but a 250-page book of reference that will alter your entire outlook and earning power.

Among other things, our Handbook outlines courses in *all* branches of Engineering. Those appealing specially to Electrical Engineers include:—

I.E.E.	B.Sc.	G.P.O.	CITY AND GUILDS
ELECTRICAL ENG.			MAINS ENG.
ALTERNATING CURRENT			TELEGRAPHY
ELECTRICAL INSTALLATIONS			TELEPHONY
POWER HOUSE			WIRELESS
TRACTION			TALKING PICTURE ENG.
TELEVISION			ELECTRICITY SUPPLY
ELECTRICAL DESIGN			ELECTRICAL METERS

In the last seven I.E.E. Examinations B.I.E.T. students have returned the remarkable average Pass record of

95.72% SUCCESSES

We undertake to return full fees to any unsuccessful candidate. This is a unique and welcome departure in the Examination coaching field

"ENGINEERING OPPORTUNITIES" should really be in your hands, irrespective of your position or age, education or experience.

Send for your copy to-day—**FREE** and POST FREE. A specialist's advice on your particular career is also awaiting your request—without obligation.

BRITISH INSTITUTE OF ENGINEERING TECHNOLOGY

383, SHAKESPEARE HOUSE, 29-31, OXFORD ST., LONDON, W.1



Lewcos
REGD.

Radio Components

Fundamentally sound in every sense, Lewcos precision-made components owe their superiority to their creators' long experience as first-class wire-manufacturers. All reputable dealers stock and confidently recommend Lewcos components of every type.



*Descriptive Literature
of the components you
need will be supplied
on demand to Radio
Publicity Dept P.*

THE LONDON ELECTRIC WIRE COMPANY AND SMITHS, LIMITED, CHURCH ROAD, LEYTON, LONDON, E.10

Printed in Great Britain for the Proprietors, GEORGE NEWNES, LTD., 8-11, Southampton Street, Strand, W.C. 2, by WILLIAMS, LEA & Co., LTD., Clifton House, Worship Street, E.C. 2. Sole Agents: Australasia: GORDON & GOTCH (Australasia), LTD. South Africa: CENTRAL NEWS AGENCY, LTD.