

# Contents

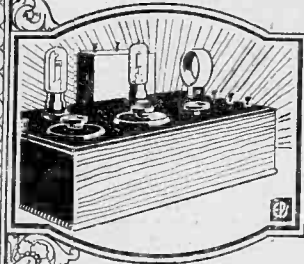

A Nine-Valve Supersonic Heterodyne Receiver ...	411
By JOHN SCOTT-TAGGART, F.Inst.P., A.M.I.E.E.	
In Passing	418
KDKA—The East Pittsburg Broadcasting Station...	420
By CAPTAIN L. F. PLUGGE, B.Sc. F.R.Ae.S.	
F.R.Met.S.	
The Four-Valve De Luxe Cabinet Receiver ...	423
By PERCY W. HARRIS, M.I.R.E.	
How to Use a Power Valve ...	429
By STANLEY G. RATTEE, M.I.R.E.	
A Novel Three-Valve Receiver	434
By C. P. ALLINSON.	
Regular Programmes from Continental Broad-	
casting Stations ...	445
By CAPTAIN L. F. PLUGGE, B.Sc., F.R.Ae.S.	
F.R.Met.S.	
An Experimenter's Supersonic Receiver ...	453
By G. P. KENDALL, B.Sc.	
An Interesting Valve Crystal Receiver ...	460
By HAROLD H. WARWICK.	
A Change-over Switch for Comparing Loud	
Speakers ...	466
By JOHN UNDERDOWN.	
Tested by Ourselves ...	469
An Enclosed Crystal Receiver ...	473
By A. JOHNSON-RANDALL ...	
Trouble Corner ...	489



*Editor:*  
**JOHN SCOTT-TAGGART,**  
 F.Inst.P., A.M.I.E.E.

*Assistant Editor*  
**PERCY W. HARRIS, M.I.R.E.**

*Staff Editors:*  
**E. H. CHAPMAN,**  
 M.A., D.Sc.  
**A. D. COWPER, M.Sc.**  
**G. P. KENDALL, B.Sc.**  
**R. W. HALLOWS, M.A.**  
**STANLEY G. RATTEE, M.I.R.E.**

*Scientific Adviser:*  
**Prof. G. W. O. HOWE,**  
 F.Sc., M.I.E.E.

*Advisory Editors:*  
**Prof. R. WHIDDINGTON,**  
 M.A., D.Sc.  
**Prof. C. L. FORTESCUE,**  
 M.A., M.I.E.E.

*Advertisement Managers:*  
**BARCLAYS**  
**ADVERTISING LTD.,**  
 Bush House, Strand, W.C.2  
 Tel.—City 9911.

**Radio Press, Ltd.,**  
 Publishers of "Wireless Weekly" and "The  
 Wireless Constructor,"  
**Bush House, Strand, W.C.2.**  
 Telephone.—City 9911.

All correspondence relating to contributions is to be  
 addressed to the Editor of "Modern Wireless."

Nothing contained herein is to be regarded as permission  
 or encouragement to infringe any patent rights.

# Duodyne

The NEW PORTABLE IV LOUDSPEAKER MODEL

—really portable

Complete with four D.E. Valves.  
 Batteries, Headphones, etc.

Guaranteed loud speaker range on self-  
 contained frame aerial, 30 miles on 1½  
 K.W. (An earth connection with double  
 this distance.)

Full particulars upon application.

**THE MOST EFFICIENT PORTABLE OBTAINABLE**

The circuit arrange-  
 ment employs the  
 Famous Curtis Con-  
 stant-Tuned H.F.  
 (Aperiodic) Amplifier.  
 This explains the  
 wonderful performance  
 of the Duodyne  
 Portable IV.

Now on Demonstration.  
**PRICE £21**  
 Guaranteed delivery at  
 specified dates.

SALES ORGANISATION:

**PETER CURTIS LTD.**

In association with  
**THE PARAGON RUBBER MFG.,**  
 CO., LTD., HULL.

**75, CAMDEN RD., N.W.1.**

Tel.grams: "Faracurtex." Phone: North 3112  
**BIRMINGHAM: 76, Newhall St., Central 7236**  
**MANCHESTER: 312, Deansgate. Central 5095**

*The Secret is  
 in the Coil!*



COMPLETE INFORMATION  
 SENT UPON REQUEST

# Resistance-Capacity Coupling and its merits

RESPONSE OF POLAR R.C.C. UNIT  
AT VARIOUS AUDIO FREQUENCIES

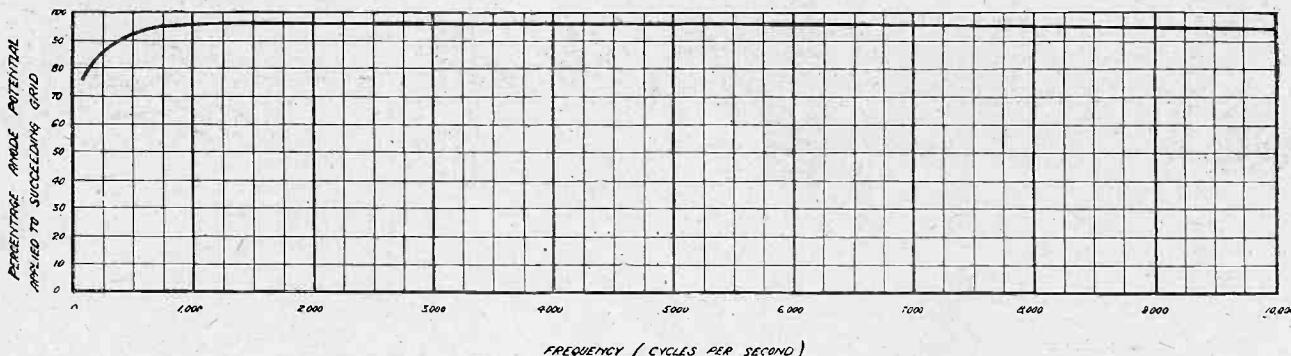

IN some previous notes on the subject of distortionless amplification by R.C.C. units, stress was laid on the pre-eminence of a resistance in the anode circuit as a means of obtaining e.m.f.s for application to the grid of the next valve.

The R.C.C. unit consists electrically of three elements, namely:—

- (a) An anode resistance,
- (b) A coupling condenser, and
- (c) A grid leak.

Let us now consider the functions of each element and the reasons prompting the choice of electrical values.

(a) THE ANODE RESISTANCE.

- (i.) It must be wire-wound in order to avoid extraneous noises.
- (ii.) It must be capable of working on high voltages.
- (iii.) The temperature rise must be safe.
- (iv.) The resistance value must be such that the amplification per stage is as great as freedom from distortion will permit.

If the resistance is gradually increased, we find that at first the amplification increases rapidly, but there comes a point where hardly any improvement results.

Moreover, if the resistance is increased greatly, some distortion is introduced by capacity currents to the valve electrodes, and also that due to accidental grid current is increased.

- (v.) A moderately high resistance is more reliable than a very high one.

(b) THE COUPLING CONDENSER.

The functions of this are two-fold, namely, to communicate the voltage ripples on the anode of one valve to the grid of the next, and to insulate the grid conductively from the H.T.

supply so that the grid may be biased at some suitable datum potential.

For the latter purpose it is necessary to use a unit of the highest quality, having mica dielectric.

The insulation must be very good to prevent the grid bias being upset by leak from the H.T. supply.

Mica condensers are costly for large sizes, therefore it is unsound to use a higher capacity than is necessary. The coupling condenser has to feed two impedances in parallel, namely, the capacity of the grid and the resistance of the grid leak.

The former varies with frequency in the same way as does the coupling condenser, hence there is no frequency preference introduced from this cause.

The impedance of the grid leak is, however, constant, and the capacity of the coupling condenser must therefore be such that even at low frequencies its impedance does not begin to be comparable with that of the grid leak.

This point has been the subject of very extensive test, and the curve reproduced above shows how constant is the coupling at all audible frequencies.

As an instance of the adequacy of the coupling condenser fitted in the R.C.C. unit, it may be mentioned that even, if it is changed to one having 100 times the capacity, no material difference can be detected in the quality of reproduction.

(c) THE GRID LEAK.

This must be high enough to avoid poor amplification, especially at low frequencies. It must be low enough to be reliable and to prevent accidental leakages elsewhere in the circuit, upsetting the grid bias, and so causing distortion.

The care taken in the design of R.C.C. units makes it possible to obtain fine reproduction at low cost.

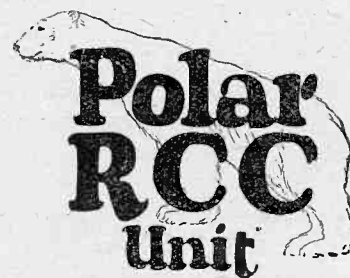

The Polar R.C.C. Unit consists of wire-wound anode resistance, grid leak and specially built Dubilier condenser. It is perfectly self-contained, with four clearly marked terminals correctly positioned for easy wiring.

Illustration is five-sixths actual size.



15/-

*Norman Hea*

Chief Engineer,  
Radio Communication Co., Ltd., London, W.C.2.



**Radio Communication Co., Ltd.,** 34-35, NORFOLK STREET, STRAND, LONDON, W.C.2

# A NINE-VALVE SUPERSONIC HETERODYNE RECEIVER

By JOHN SCOTT-TAGGART *M.C.F. Inst. P., AM.IEE.*  
 EDITOR OF MODERN WIRELESS.

TO construct and work a successful superheterodyne set is probably the ambition of every keen wireless worker. Unfortunately, the data for such sets has hitherto not been available, but different members of the Radio Press staff have been working on the problem and the shortage of information is now being remedied. Needless to say, work has had to be conducted from the very beginning. Not only has there been an absence of information in this country, but such American data as exists is of little use chiefly because special superheterodyne components are only just coming on to the British market and because British valves and other components are different from those used in the U.S.A.

### Considerations in Design

Experimental work has consequently been carried out with British apparatus, and American circuits as well as our own ideas have been tried out, and readers may be interested to hear the reasons for the particular circuit I have arrived at in the 9-valve set described below.

First, as regards the number of valves. A 5-valve set which I described in *Wireless Weekly* formed a good instructional set for demonstrating all the features of the superheterodyne principle. It was obvious, however, that 5 valves were insufficient for real distance and power. In arriving at the 9-valve circuit I had regard especially to the following points:

1. A stage of H.F. to increase the strength of the oscillations supplied by the frame aerial.
2. The provision of reaction on this H.F. stage.
3. The provision of a separate oscillator valve, the tuning of its circuits so arranged as not to vary the tuning of the receiving circuit (a troublesome fault with some circuits).
4. The elimination of as much radiation of continuous waves as possible to cut down any possible interference with neighbours.
5. The cutting out of the unpleasant and often troublesome

"double click" when the oscillator tuning is adjusted.

6. The use of leaky grid condenser rectification throughout.

7. The provision of reaction on the long wave or "intermediate frequency" amplifier.

8. The tuning of this long wave amplifier and the provision of means of "matching" or tuning the stages and also of varying the wavelength on which the long wave amplifier is to work.

9. The elimination of hand capacity effects without the difficulty of constructing special metal screening boxes, etc.

There is nothing superfluous, and nothing which could be profitably added. Any merit of the circuit does not lie in its novelty, but in its value for the particular purpose which we have in mind, and the conclusions arrived at are far more obvious after working on the proposed design for a considerable time than when one is presented with the problem of developing a circuit which will, for example, give all the B.B.C. stations on the loud-speaker and will separate out stations within 10 metres wavelength of each other.

### The Short Wave Side

I have arrived at much the same conclusions as Mr. R. W. Tingey, of the Radio Press Service Department, and whose admirable set (described recently in *Wireless Weekly*) I had the opportunity of testing. A demonstration of this set brought home to me very forcibly the great importance of introducing reaction on the long wave side of the superheterodyne, and I have consequently provided for this by arranging "inherent" reaction controlled by a potentiometer and by the individual filament rheostats. A stage of H.F. amplification appears at the beginning of the circuit because it was found of very great value for long distance work. The superheterodyne principle supplements, but does not really replace ordinary H.F. amplification. It also enables us to introduce extremely useful reaction into the frame (controlled by a potentiometer) without getting this reaction seriously mixed up with the effect of the oscillator, which would be inevitable if reaction were applied to the detector valve into whose grid circuit were fed the local oscillations from the heterodyne oscillator. The first valve does the one job and does it well. The second valve acts as the first rectifier or converting apparatus for changing the short wave currents into the long wave currents. (A full description of the operation of superheterodyne receivers appeared in *Wireless Weekly*, Vol. 5, Nos. 1 to 9 inclusive). Although anode current rectifica-

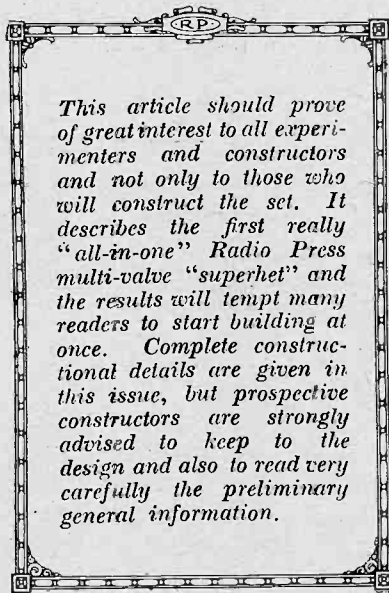

10. The provision of L.F. amplifying valves for loud-speaker work.

To fulfill all these conditions, nearly all of which I regarded as vital, I arrived at the general circuit shown in Fig. 1.

### Practical Experiment

Before going into further detail as to the reasons for this design, it might not perhaps be out of place to say that whereas the general circuit presents no new or very special features, yet each component has been placed in its position in the circuit as the result of practical experiment.

tion is sometimes used in superheterodyne circuits, the ordinary grid leak method was chosen as minimising the variable controls and also because it proved perfectly effective.

In the grid circuit, but outside the tuned grid oscillatory circuit, is a coil of wire coupled to a local oscillator circuit. This oscillator employs a separate valve with a tuned coil in the grid circuit and an aperiodic coil coupled to it in the anode circuit. The idea of using an H.F. transformer I have copied from Mr. Tingey's set, but I have added a couple more grooves containing 35 turns of wire, two external terminals forming the ends of this coupler coil.

**Radiation**

With these oscillator and initial H.F. arrangements I have found no "plonking" sounds as the oscillator cuts across the wavelength to which the receiver is tuned, and the amount of possible C.W. radiation is cut down to a very small extent. Let me, however, say that the ordinary "oscillating" amateur is a pleasant diversion compared to the superheterodyne "expert" who is really on the experimental war-path. The radiation from a frame

can be very considerable, and if no initial stage of H.F. amplification is used, neighbours will probably soon realise that a "superhet" has started working in the neighbourhood. If an indoor aerial is tacked on to the receiver the trouble will be enormously accentuated, although the receiver's results, fortunately, are usually no better, taking everything into consideration.

**A Frame Aerial Preferable**

Keep to your frame, preferably use an initial stage of H.F., employ a wavemeter, and do not needlessly swing your oscillator condenser. These are rules for your own as well as your neighbour's good. Unfortunately, perhaps, the operator of a nuisance superheterodyne set is often quite unconscious of the fact. Unlike an ordinary set, the "superhet" hardly responds to the effect of the oscillator on the carrier wave itself of the station being received, however much the dial of the oscillator condenser is twiddled. A small chirp, however, will usually be heard when the condenser dial is set to a point about half-way between the two points on the dial at which broadcasting comes in. If the operator remembers that this chirp is being

heard at about a hundred times the strength by his neighbours he will avoid giving unnecessary trouble. In my own house there is a separate set used for entertainment purposes working on an aerial of its own. Its extreme proximity provides an effective check on radiation! A good design and proper handling should, however, result in little or no interference, and the set here described has the advantage that the neighbour's point of view has been studied. I might mention that practically no "superhet," whatever its design, will interfere with a neighbour's reception when the "superhet" is itself receiving the same signals. I will not say, however, that a "superhet" may not interfere with a neighbouring "superhet" or that a "superhet" will not occasionally interfere with the reception by a neighbour of a different station. This, however, is going rather outside the scope of the present article; I can only say that this set can be constructed with a still and easy conscience and not with that shifty, guilty feeling common to constructors of Flewelling and like receivers.

From Fig. 1 it will be seen that the oscillator circuit enables hand capacity effects to be reduced to a

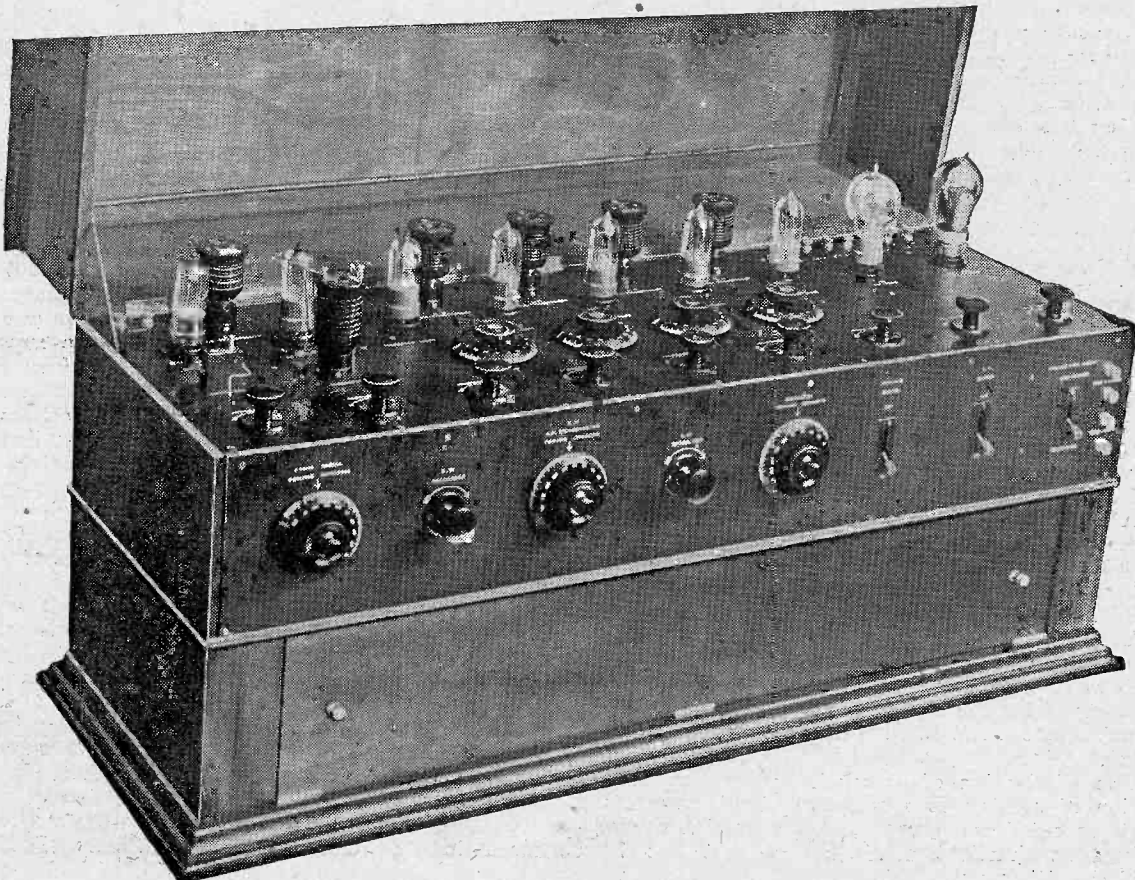

A general view of the completed receiver with the lid open.

minimum. If a single oscillation ("Hartley") circuit were used, both sides of the variable condenser would be at H.F. potential to earth, whereas now one side, the moving plates, is at earth potential, and is therefore harmless as regards hand capacity effects. Throughout the design the moving vanes of all the variable condensers are connected to the "earth" side of the set, i.e., the filament battery; this is principally because if the moving vanes were at H.F. potential to earth, the capacity of the hand when placed near the knob (into which is usually screwed the metal spindle carrying the moving vanes) would alter the tuning, the reaction effect, etc.

**The Long-Wave Amplifier**

Coming now to the long-wave amplifier, it is only necessary to state that reaction is obtained by relying on the inherent reaction effect obtained when several stages of H.F. transformer coupling are employed. The resulting tendency to oscillate is controlled by the long-wave potentiometer.

Experience indicated that three stages of long-wave amplification were required for really good results. This is one more than Mr. Tingey used in the *Wireless Weekly* set; for ease of handling I prefer the extra valve in the long-wave side rather than in the short-wave receiver.

**The Test Department**

I would like to emphasise very strongly the need for obtaining the full reaction effect if the *best* results are to be obtained. Some sets ignore this long-wave reaction effect which to me seems vital for "distance," and which also improves selectivity. The long-wave potentiometer should give a wide range of signal strength, and the long-wave side should be capable of being made to oscillate. I shall go further into these matters in a further operating and fault-finding article, but at this stage I want to warn optimists without experience that by altering the design they may obtain a far less efficient set. The effective control of reaction on the short- and long-wave side of the apparatus is so important that anything which may lessen the tendency to oscillate may result in insufficient reaction being obtainable. When using nine valves you are deliberately courting trouble if you play about with the design merely because, for example, you have an old cabinet. Some readers will persist in altering quite needlessly the design and then optimistically expect the Radio Press Service Department to put the set right for them. Such sets, needless to say, are returned untested because it is often hopeless to put such a set right, and because the Radio Press Service Department is not run at a financial loss to act as general consulting engineers, but as a support to the designs published in our papers and other R.P. publications, and as a guarantee that all such designs are thoroughly sound. We want every reader to feel the utmost confidence that a Radio Press set, whoever the designer may be, is a thoroughly successful set, and this great and growing confidence has resulted in such general success that the expensiveness of the Service Department has proved worthwhile. Only the extent of the activities of Radio Press, Ltd., enables such a department to be conducted. If a reader knows that if he makes some slight error or one or more of his components is faulty his set will be put right by the Service Department, he will obviously prefer a Radio Press set to any other which may or may not give good results. The Service Department has to give the reader satisfaction in each case, and does so. This, more than ever, makes it extremely necessary for us to test every design exhaustively before publication. We cannot, however, accept responsibility for sets which have been modified.

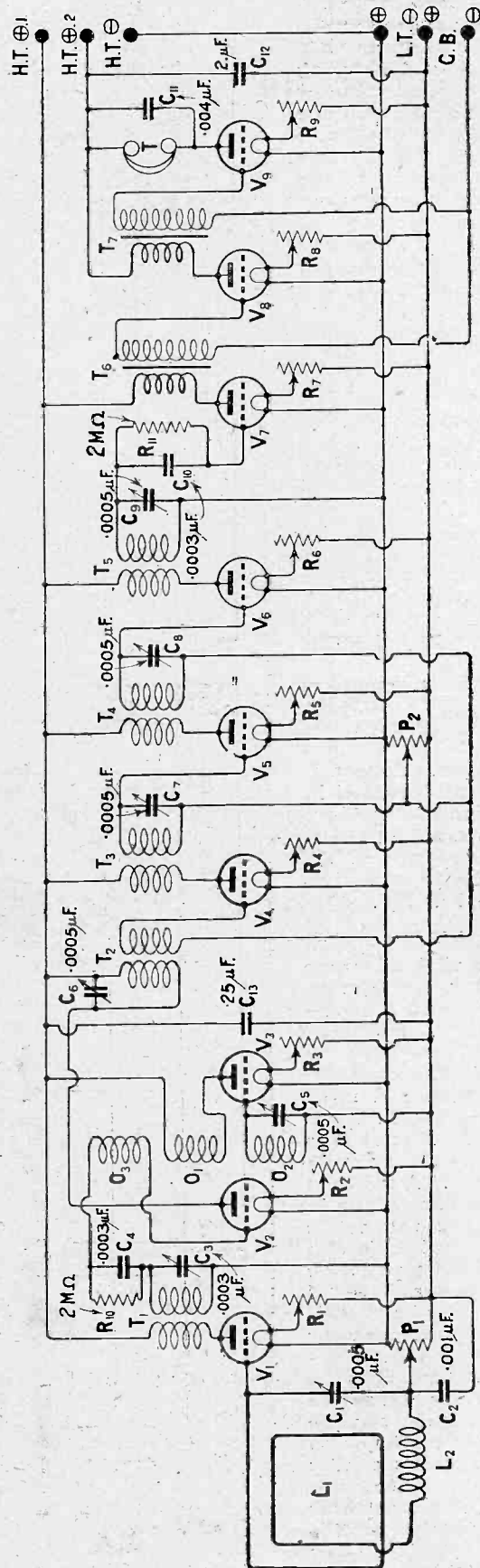

Fig. 1.—The simplified circuit. The loading coil  $L_1$  is only needed in exceptional cases where frame aerials possessing very few turns are used.

If I have been tempted to wander from the article to digress into matters which concern me more in my capacity as controller of the Radio Press, it is only because I realise that in the case of this set there will be those who will modify the design and get into deep water; it will not be for want of full warning.

A list of components is given in the description which follows, and any variation of this may lead to inadequate reaction or range. This is not to say that these components are the best in their class; it simply means that the set has been designed with these particular components, and that if others were used, equally good results might be obtained, but a variation in design might be necessary. This brings me, moreover, to the question of valves. Those normally used were eight Ediswan AR valves, and the ninth (the last L.F. amplifier) a B.T.H. type B4 (or its equivalent B6 or B7).

**Valves**

The vital valves are the first, fourth, fifth and sixth, as these are the H.F. amplifiers. The others are less important, especially the eighth and ninth which act as L.F. amplifiers. I prefer two valves, such as the B4 for these. A switch is provided for putting in these last two valves and a switch is also provided for phones or loud speaker, both of which may be alternatively used with or without the L.F. amplifier. Changes in the valves may lead to the long or short wave amplifier oscillating to such an extent that the potentiometer will not bring the amplifier back to the reaction point, or on the other

Fig. 2.—The drilling diagram. A full-size Blue Print, No. 110a, may be obtained from the Sales Dept., price 3/6, post free.

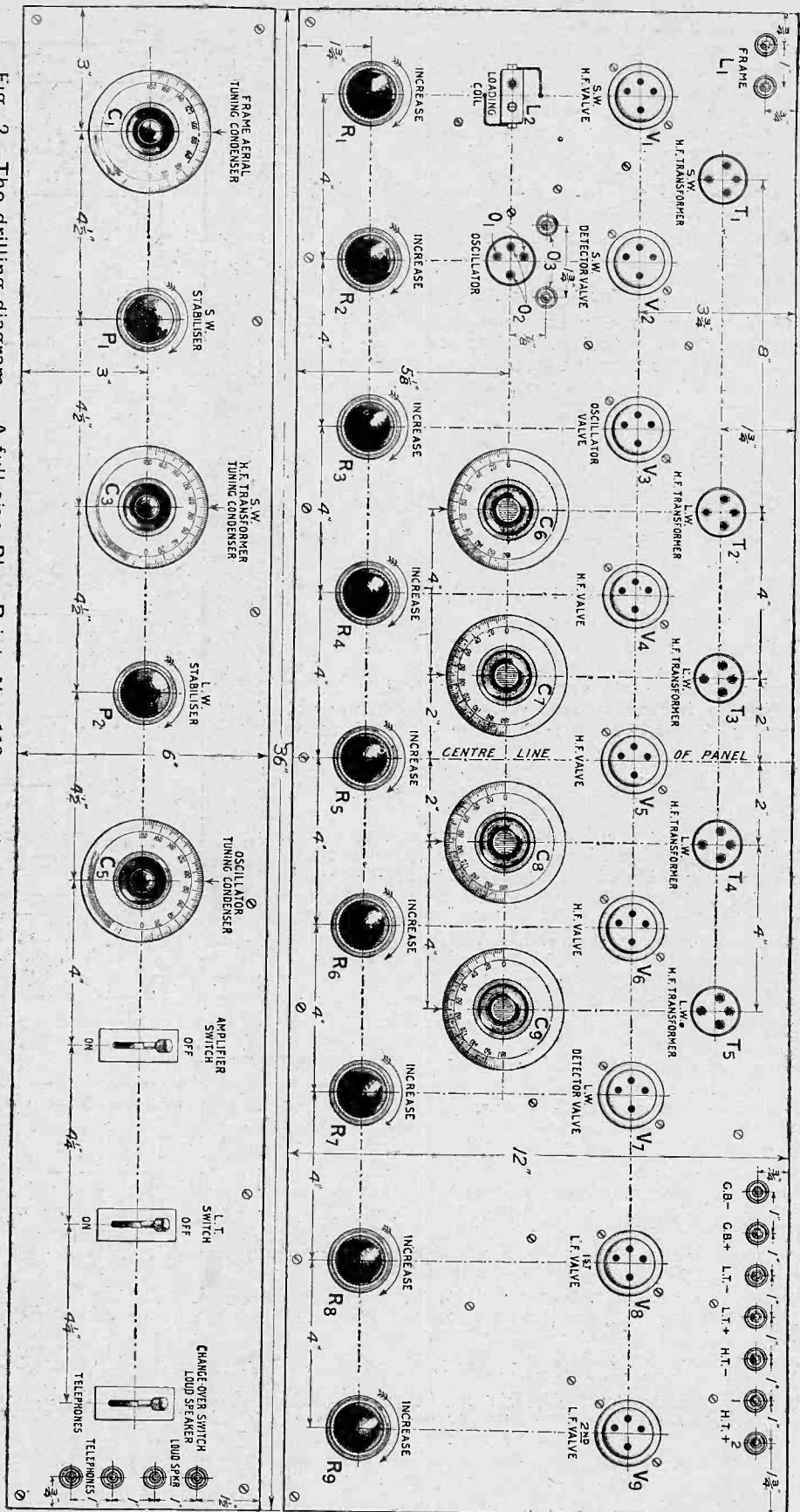

hand, there may not be sufficient reaction to give the full signal output. Using the valves specified (8 A.R. and 1 B4) the set takes about 5 amperes from the accumulator and 24 milliamperes from the H.T. battery (preferably an H.T. accumulator). The individual experimenter may be able to modify the design to compensate for changes of components or valves, retaining the type of circuit and the general constructional design. For example, if the potentiometer will not control the tendency of the amplifier to oscillate, the filament rheostat of each H.F. amplifying valve may be connected in the positive lead to the accumulator. At present, the rheostats are in the negative lead, which results in a small normal negative bias which helps the oscillating tendency.

**Position of Valves**

The valve problem is emphatically a difficult one because unfortunately most makers are slack in the absolute standardisation of their valves. The result is that a change of position of valves is often beneficial in a superheterodyne set. A popular American "superhet"—the six-valve Radio Corporation second harmonic reflex set—which I have tested out, is very susceptible to valve changes and this is likely to cause considerable annoyance, but it seems inevitable if the best results are to be obtained. Dull-emitter valves generally seem to be more erratic in their characteristics, and out of ten of a well-known make, one valve produced an extraordinary buzzing noise which would baffle many experimenters who have an implicit belief in their valves. I think it is only fair to say that all the Ediswan A.R. valves were very uniform and gave every satisfaction.

**Points to Watch**

I do not wish to discourage prospective builders of superheterodyne sets, but on the other hand, the task must not be undertaken too light-heartedly or by beginners. The "superhet" involves almost all the well-known processes in radio reception, and although I propose to go into details in a future issue as to fault-finding in such sets, yet the tracing and correction of faults is work for a man with technical knowledge. The actual construction of the set is simple and presents no more difficulty than an ordinary set—except that there is more of it! The operation of the set is also simple when it is working properly. The only difficulty, in my opinion, is the trouble which

A plan view of the receiver showing the arrangement of components on the main panel. This photograph will be of great assistance if used in conjunction with the drilling diagram.

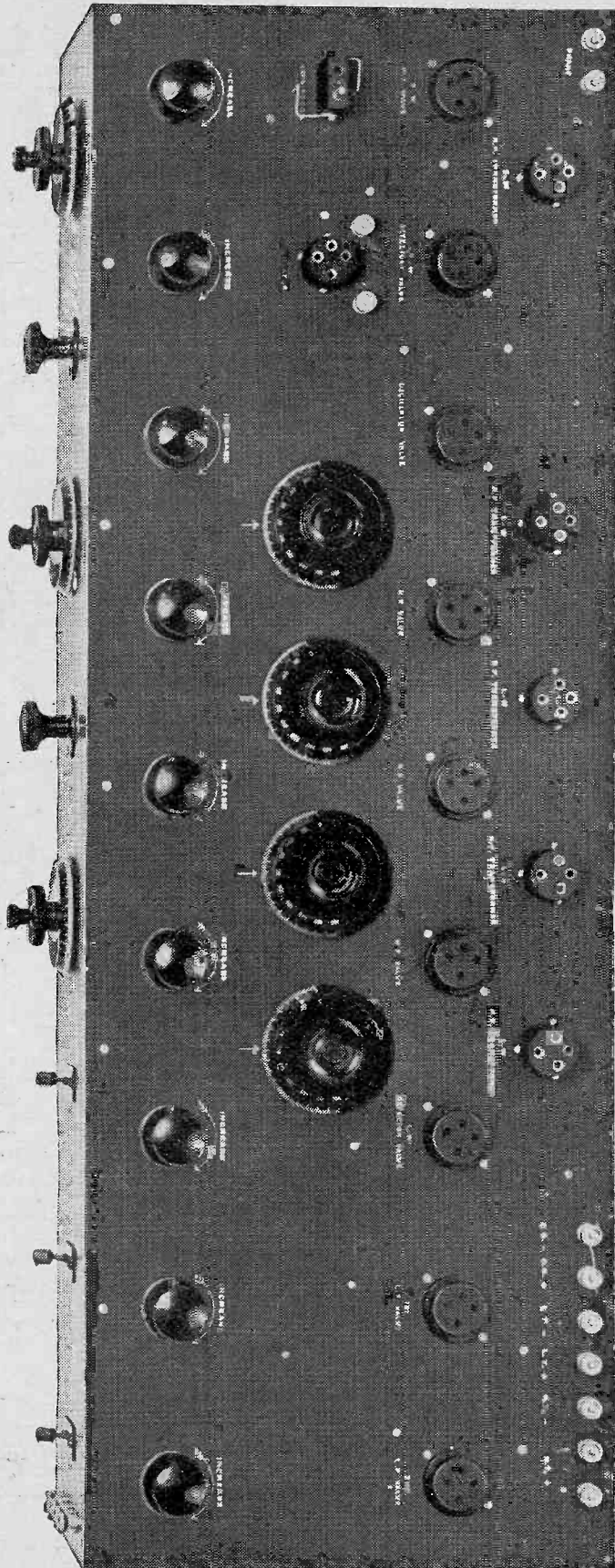

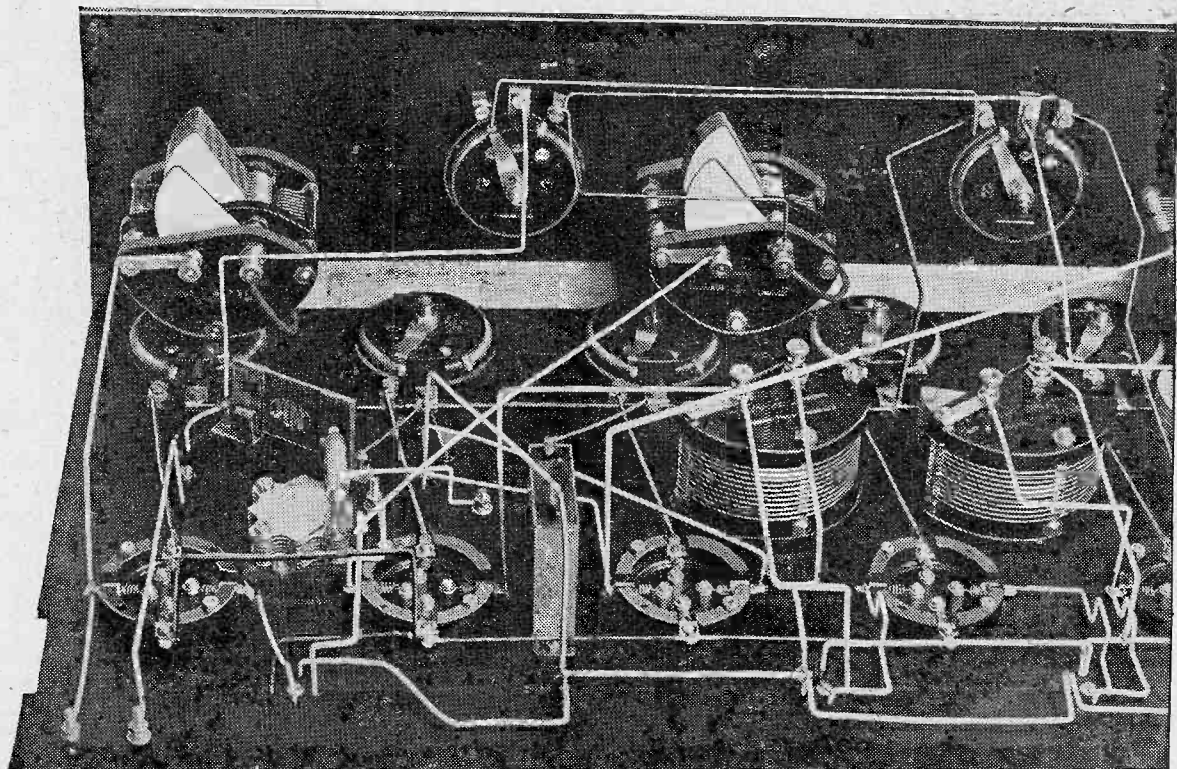

A sectional wiring view which includes the connections of the short wave side of the receiver.

may be caused by using wrong valves, or different components. The H.F. transformers, for example, are of matched McMichael type (2,000 to 7,000 metres), but while their choice is recommended for this particular set, no reflection is intended on other equally good makes. The first short-wave H.F. transformer, by the way, is connected a different way round to the maker's diagram, but there are reasons for this (wavelength range and oscillating tendency). The oscillator unit is of my own design and Messrs. Peto-Scott made it for me. Variable long wave tuning is provided so that:

1. Experiments on different wavelengths may be carried out.
2. The ease of tuning due to a variation in selectivity may be adjustable.
3. The long wave amplifier is liable to pick up *direct* long-wave signals to which it may be accidentally tuned. By making its tuning variable, the long wave amplifier may be tuned so as to avoid the interference caused by such direct unwanted reception.

High frequency transformers are used and are shunted by  $0.005\mu\text{F}$  variable condensers for tuning purposes, as shown in the circuit diagram.

**Results Obtainable**

Assuming that the set has been properly constructed and suitable reaction effects are obtained on the two H.F. amplifiers, all the B.B.C. stations should be obtained on the loud-speaker without difficulty. Most of them come in at full loud-speaker strength. These results have often been repeated, but a preliminary report appears in

tabular form in this article, and the stations mentioned give an indication of the wavelength adjustments of the set. Of course many other stations can be received, and a fuller report of results will be published next month.

At nine miles from 2LO, loud-speaker signals are obtainable from Cardiff and Manchester without interference from London—a fair

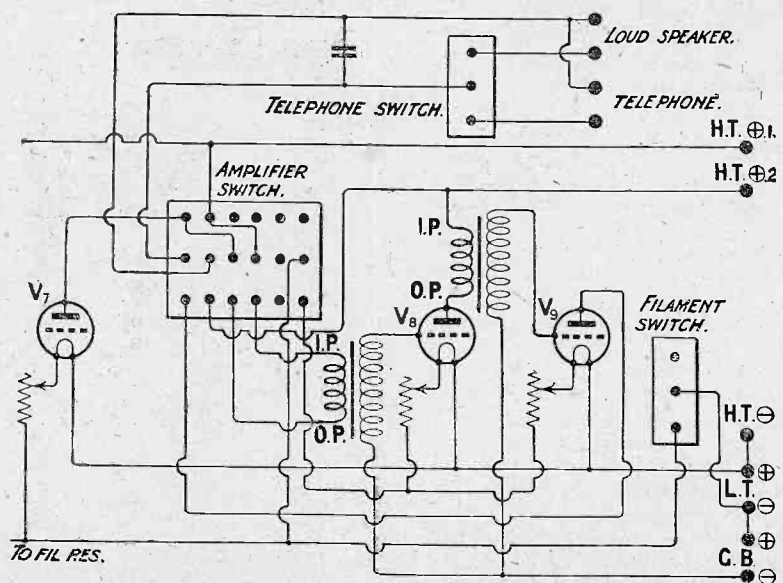
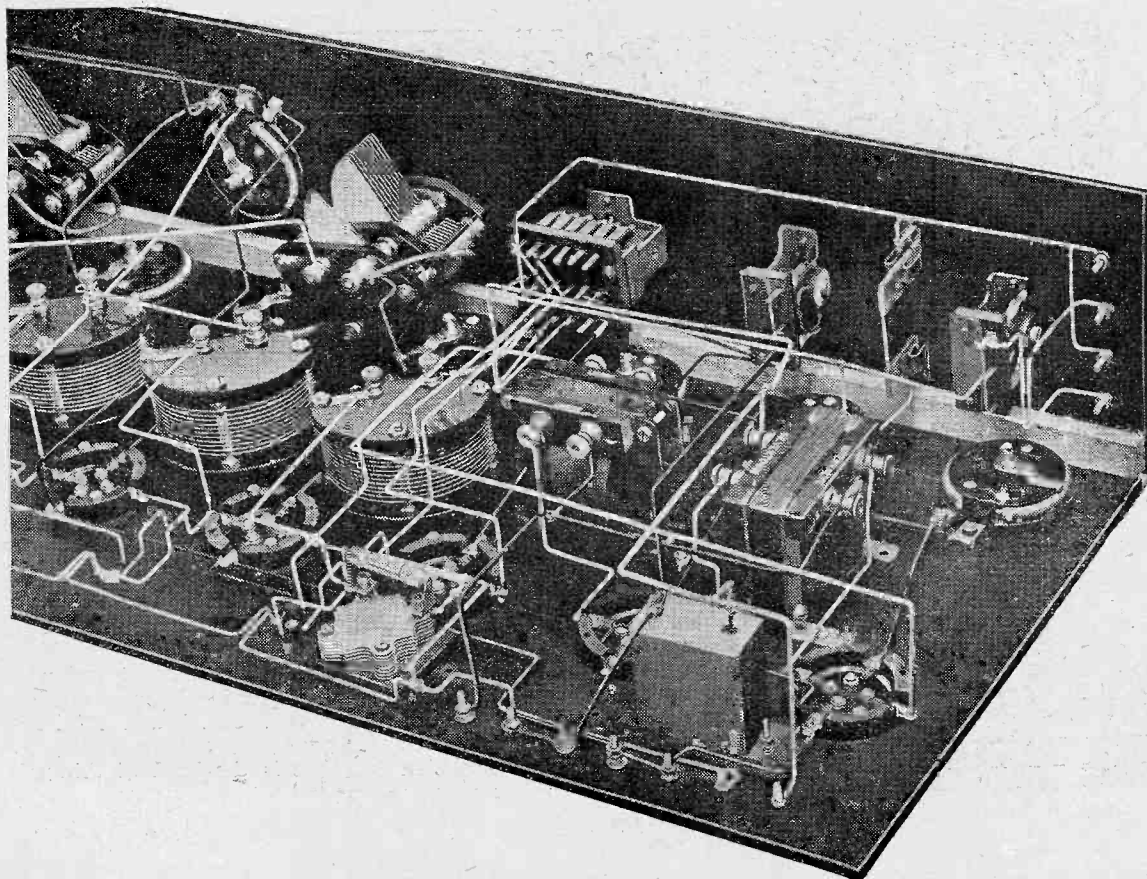

Fig. 3.—A circuit showing the switch connections. The condenser across the loud-speaker and telephones is optional.





This sectional view shows the positions of the L.F. transformers and the wiring of the amplifier switch.

test for both sensitivity and selectivity. The furthest relay station, Dundee, came in very loudly on the speaker during a test when the other stations were closed down—another fair test of the range possibilities of the set. Large numbers of foreign stations came in with ease; these results, of course, all being obtained with a small 2 ft. 9 in. frame aerial, which was described in *Wireless Weekly*, Vol. 5, No. 9, and a short description of which will be given next month. The general tendency of Radio Press test reports is to err on the side of moderation in view of the fact that local reception conditions and operating skill vary so much, and there is a large margin of safety in the case of the present set.

**The Constructional Design**

As regards the structural design, I followed the American style of a minimum of front controls and components. There are only five controls, three only of which are essential when first tuning-in. These are the frame tuning condenser, the first H.F. transformer tuning condenser, and the oscillator condenser. All these have verniers—useful refinements when signals

are weak. In fact, there is also an on-off filament switch, a loud-speaker or phones switch, and an L.F. amplifier switch. Short-wave and long-wave potentiometers are for signal strength control. At first I controlled the output by the second detector valve rheostat, but

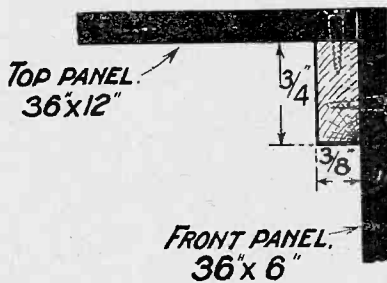

Fig. 4.—The method of joining the two panels.

I found the long-wave potentiometer better. The secondary controls, e.g., filament rheostats, long-wave tuning condensers, etc., are mounted on a horizontal panel completely covered by the lid of the cabinet, much in the same style as my "Omni" receiver. These controls, once set, need practically no alteration.

In the matter of the structural

design, I desire to give credit to the valuable assistance given by Mr. W. H. Fuller, of the Radio Press Service Department.

**Constructing the Instrument**

While the receiver presents, when completed, a strikingly handsome and imposing appearance, its construction may be undertaken with confidence by anyone who has previously built a valve set, no matter how small. The wiring is rendered remarkably simple by the judicious spacing of the components. The chief requirement is the expenditure of care throughout the constructional work.

**List of Components**

- A complete list of the components required for building the receiver is given below, manufacturers' names being included.
- One cabinet. (Carrington Mfg. Co., Ltd.)
- One component panel, 36 in. x 12 in. x 1/4 in. (Peto-Scott Co. Ltd.)
- One control panel, 36 in. x 6 in. x 1/4 in. (Peto-Scott Co., Ltd.)
- Two .0005 μF. square law condensers (ebonite ends with verniers). (Ormond Engineering Co.)

(Continued on page 482.)



**A Noble Idea**

**T**HIS idea of broadcasting the doings of members of Parliament seems to me one of the best that has yet been mooted for adding to the gaiety of nations with the help of the wireless set.



Prof. Goop was leaping up and down.

By this I do not mean that debates, taken as debates, are usually particularly hilarious events. If ever you have sat in the Strangers' Gallery—I always have a place in the Distinguished Strangers' Gallery but you can hardly hope for that—if ever, as I say, you have sat in the Strangers' Gallery you have no doubt experienced considerable difficulty in keeping yourself awake. This was certainly the case with Professor Goop, who frequently attends Parliament because he thinks that it is the duty of every patriotic citizen to do so from time to time. Finding that he had dropped off eleven times running into a sleep which, though refreshing, failed to add to his knowledge of the affairs of the Empire, the Professor set his great mind to work and very soon perfected a little device which he christened the Ecclesiocentron, a neat and crisp little name derived from two Greek words, the first of which means an assembly and the second a goad. It is a compact little thing which fits (or rather used to fit) into his coat pocket. It contains the mechanism of an alarm clock, minus the bell and plus a hatpin. The idea is that having settled into your place you set the Ecclesiocentron to jab in five minutes' time. If you are awake you forestall its action and

set it five minutes further ahead; if, however, you are asleep, the hatpin soon puts an end to that. On his next visit to the House the Professor wound up and set the Ecclesiocentron and sank happily into his seat. Five minutes later, just as an extremely important member of the Cabinet rose to his feet, there was a wild scream from the gallery, and all eyes were fixed upon Professor Goop, who was leaping up and down and waving his arms like anything. He was promptly thrown out, and was some little time under suspicion as a Bolshevist agent. It appears that he had arranged the jabbing part of the mechanism all right, but had quite forgotten to make provision for the withdrawal of the hatpin once inserted.

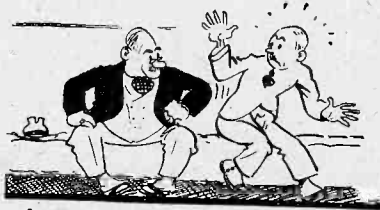

A perfect stranger nudged me in the ribs.

**The Real Truth**

If you have never actually attended Parliament you have probably a misguided idea that those who visit its halls are entertained by a wonderful feast of oratory. Speeches and things look splendid in the papers, but they are very different when you come to hear them. The last time that I went, determined to play my little part by listening to the deliberations of those who are responsible for our country's guidance, this is the kind of thing I heard:

MINISTER (reading from a sheet of paper and speaking all in one breath): "No. 13 the answer is in the negative No. 14 the honourable member is referred to the answer which I gave six months ago to the honourable member for

Slopley No. 15 I am causing inquiries to be made No. 16 there is no record that the man Buggins was ever employed in my department and if he was there is no doubt that his dismissal was thoroughly justified No. 17 . . .".

THE HON. MEMBER FOR FOOTLE: "Is the minister aware that Mr. Buggins was his personal secretary?"

MINISTER: "I must have notice of that question" (Opposition cries of "Oh! Oh!" and Ministerial cheers.)

That is the kind of thing that really happens. I once went to hear the member for Little Puddleton (oh, yes, we have one, and he is a Financial Secretary, so there) ask his enormously important question about the sewage farm, but I regret to say that when my next door neighbour, a perfect stranger, had the impudence to nudge me in the ribs and request in a hoarse whisper that I should refrain from snoring, our member had put his question, and with what result I know not (though probably the answer was in the interrogative), and retired gracefully.

**The Enthusiasts**

There are, as I was saying, people who imagine that when the broadcasting of Parliament becomes an established fact they will only have to tune in to the prescribed wavelength to hear fluent speechifying that will turn them green with envy if the orator is on the side which they favour, or all colours of the rainbow with fury if he is not. These people believe that having



"I...er...ah...hrmph... hrmph...ZIP!"

found the parliamentary wave and having sunk in the clinging embrace of a favourite arm-chair their ears will be soothed by a mellifluous flow of words formulating great ideas, so simply expressed that the listener is absolutely carried away by what he hears. Let me disabuse the minds of these people at once. What you will probably hear on tuning in to the Parliamentary Broadcasting Station (whose call sign I understand is to be SOS) is something like this. I imagine, by the way, that the

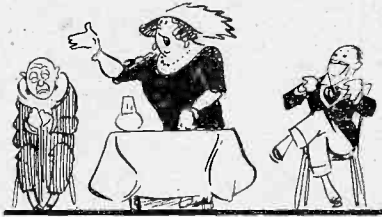

.....his lady wife.

Speaker or one of his minions will carry out the duties of announcer.

"Hullo the British Isles. SOS calling. The Hon. Member for Muckton-in-the-Clay has just caught the Speaker's eye and will now address the House." At this moment there will be loud howls from a dozen or so of your wireless neighbours and semi-friends who have also had the bright idea of picking up Parliament. When they have quietened down, some American ship or other about fifty metres off its wavelength and using heaven alone knows how many kilowatts will chip in with a rasping Morse message about nothing in particular. Northolt will follow with its well-known imitation of mush, and then you will be able to hear the hon. member.

**A Model Speech**

This is the kind of thing you will hear. "Mr. Speaker—I—er—ah—hrmph—hrmph. That is to say (squeeee-oooo) what I mean is—er—ah—hrmph—hrmph—(zing-zing-zip zing-zip zip-zip-zing-zip) on account of the (ow-eee-ow) as I was saying—er—ah—er—hrmph—hrmph—that is to say (oo-ow-oo) it seems to me (zing-zing-zip zing-zip-zip-zing-zip) in the present—er—ah—hrmph—hrmph—condition of the (squeeeeeeeal) it is—er—ah—er—hrmph—hrmph— or perhaps I might say—er—ah—hrmph (shshshsh tweedletweed-letweedle shshshsh cracklefizz) it is obvious therefore that, or rather I should say it is clear to any thinking man that—er—ah—hrmph—hrmph— (eeeeeeee-oo-eeeeeee) we may therefore—er—ah—hrmph—hrmph. ....

**The Stuff to give 'em**

Yes, this is the kind of thing, dear reader, that, if I mistake not, your set will bring in. This stuff broadcast to the world will show the foreigner that the British Parliament is not a thing to be lightly reckoned with. Of course there may be brighter spots as, for example, when one of the more obstreperous members insists upon screaming "You dirty dog—you are a nice one, you are," or little endearments of that sort. Still I think that our Parliament will remain the model for the whole world so far as procedure and decorum are concerned. The benighted foreigner listening to a stormy debate will wait in vain for the sound of the fisticuffs and pistol shots which enliven his own assembly when things are getting a little heated. He will learn that despite all our faults we British can still show the world how to carry on the debates which help to make our Empire what it is. He will listen entranced, and he will not be able to understand a word, which is extremely lucky both for him and for us.

**A Despicable Suggestion**

Some people have had the nerve to suggest that the broadcasting of debates will be a bad thing, because if it comes about members in search of self-advertisement will leap to their feet on the slightest provocation and will speak to the gallery—by which is meant their constituents—purely and simply to show what fine fellows they are. I am proud to say that the member for Little Puddleton will certainly not fall into this error or this category. Nobody here has ever heard him speak, and I am quite sure that he will not do so by means of wireless. At all his meetings here he arrives with a vast muffler swathed round his neck and a sweet smile. When the chairman calls upon him he gets on to his feet, makes a noise like a crow suffering from croup and looks pathetically round. The chairman then lays a hand on his arm and induces him to resume his seat. This done the chairman rises and explains that the member (or candidate as the case may be) much as he would like to address us is prevented from doing so by a terrible attack of laryngitis. His lady wife then steps into the breach, and after talking for some length about nothing at all is cheered to the echo for her sporting performance. The meeting then ends with a unanimous vote of

confidence in the member (or candidate). Is such a man as this going to butcher himself to make a wireless holiday? I rather think not.

**For the Country's Good**

No, rather I believe that the fellow who might have bored the House to extinction with an endless oration of appalling dullness will think twice before jumping on to his hind legs so long as he is confronted with a microphone. The introduction of broadcasting will speed up parliamentary procedure, reducing the number of speeches and of silly questions.

THE LISTENER-IN.

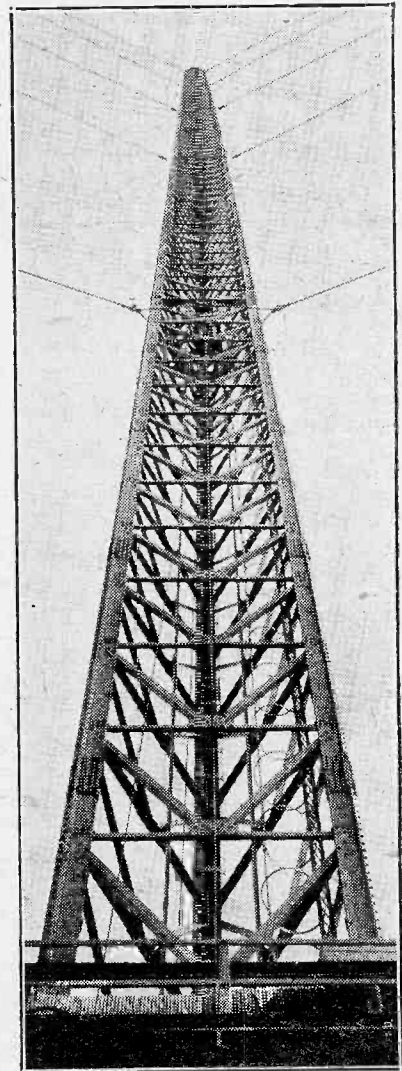

One of the 820 foot masts of the new high power wireless station at Hillmorton, near Rugby. This station, when completed, will be one of the most powerful in the world.

# K D K A

## The East Pittsburg Broadcasting Station

By Capt. L. F. PLUGGE, B.Sc., F.R.Ae.S., F.R.Met.S.

*In this absorbing article our Foreign Broadcasting Correspondent describes in an interesting manner the famous American short wave station which is so frequently heard in this country.*

**T**HE relaying of KDKA by the British Broadcasting Company, both last year and this, has made this station familiar, I am sure, to most of my readers. I think it could be rightly said that KDKA as a sequence of letters comes as naturally as ABCD to the tongue of any British listener, be he a multi-valve owner or a crystal and catwhisker user.

Few stations, I feel sure, could boast of being relayed so often and by so many other stations as KDKA. The famous East Pittsburg station has been heard in all parts of the world—in Australia, South America, South Africa, Europe—and its programmes have been re-transmitted through most local broadcasting stations; and thus by means of wireless its call-sign and programmes have reached the ears of wireless enthusiasts of all degrees, in whatever part of the world they may have been.

### A Remarkable Test

The latest test, and probably the most remarkable one carried out by this station was made on January 26 of this year. Signals were to be picked up from KDKA

and relayed by all the Australian stations. Everything was in readiness and transmission was agreed to start at 5 a.m. in Pittsburg. Two minutes after the transmission began, Australia was picking it up, although it was 8 p.m. in that part of the world. The programme was relayed by such cities as Perth, Melbourne, and Sydney, in South Australia, and also by towns in Tasmania. No greater distance can possibly be covered by any station, unless it can be proved that the signal has gone round the world

type of aerial and insulated counterpoise which is used for the regular 309 metres transmission; the other, consisting of a number of vertical copper tubes, forms the aerial system used in connection with the short-wave transmission.

### The Aerial System

Wooden poles are a feature of the KDKA station, and are much favoured by Mr. Frank Conrad, assistant chief engineer of the Westinghouse Electric Company, in whose opinion the introduction

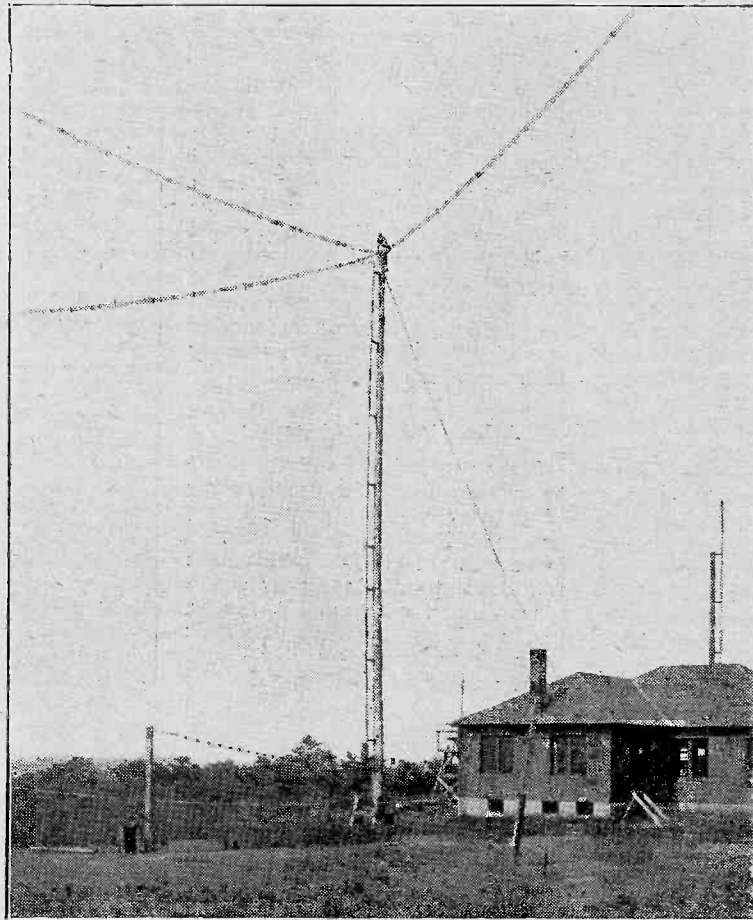

A view of the main aerial and experimental station at KDKA.

several times before being picked up. KDKA therefore has the distinction of being the first really world-wide station, and to short waves goes the credit of having accomplished this.

The experimental station used for these remarkable transmissions is established at Barclay Avenue, East Pittsburg. Upon arriving at the top of the hill on which the station stands, the visitor is confronted with a brick building one storey in height, surrounded by quite a number of tall wooden poles and various spreading aerials.

Two aerial systems are in use at KDKA—one in general following the conventional

of steel towers would introduce shielding and additional losses which would more than counter-balance any gain in height. The aerial "down lead" or connecting conductor between aerial and counterpoise is a rigid copper tube, and is not carried into the transmitter building as is customary with the usual type of transmitting sets. This rigid "down lead" and also the wooden supporting poles form the important and special feature of this station's aerial system, and are claimed to help in a great measure in maintaining a constant wavelength. The coupling scheme used between the transmitter and aerial systems, by obviating the necessity of carrying the main aerial circuit right into the transmitter, tends, it is claimed, towards further reduction of losses, with the natural corresponding increase of radiation efficiency.

#### The Short Wave Aerial

The aerial used in conjunction with the short-wave set consists of a vertical copper tube supported by porcelain insulators running from a few feet above the ground to a few feet above the top of the wood supporting pole. A small horizontal counterpoise element is affixed at the lower end of the copper tube. This small counterpoise is used to adjust the wavelength to some particular value, as it has been found that this method is much simpler than adjusting the length of the vertical conductor.

The rigid copper tube system of conductor tends towards steadiness of wavelength, which is extremely important on the shorter wavelengths where such high frequencies are used. The coupling between the aerial and the transmitter is similar to that used with the long-wave transmitting gear.

In addition to this single or main short-wave aerial, other similar aeri-als are placed at certain pre-determined distances from it. These secondary aeri-als are not connected to the main one, but are energised by induction. Their purpose is to give a certain directional effect to the radiating signals.

#### Special Features

A number of these secondary aeri-als are erected at various distances from one another in order to take advantage of this effect, and project a maximum signal strength in any desired direction. These directional aeri-als can be rendered inoperative by breaking the continuity of the upper and lower sections of the copper tube.

The transmitting station build-

ing is so constructed as to reduce as much as possible any losses which might be incurred by using metal. The building is of brick, with composition roofing, and all metal circuits and pipes are kept as near the ground as possible. The building consists of office space, shop, control room, experimental room, and large apparatus room. Under the apparatus room is the power-room, which is situated in the basement.

#### The Station Equipment

As can be seen in the accompanying illustrations, on entering the apparatus room there are two large rectifier panels along the back wall facing inwards. Each of these rectifiers contains a 150-kilowatt

adding valves and raising the plate voltage. It consists of rather a simple-looking arrangement of parts, but each of these parts has been designed with the greatest of care, and is the outcome of the years of experimental work which has been carried out at KDKA ever since its opening in 1919.

The valves that are used in the short-wave transmitter have copper anodes which are water-cooled. They are capable of handling more than 10 kilowatts without any detrimental effect.

As the transmitter stands at present, four such valves in parallel are used, and they are operated well below their rating. Cooling water circulates in spirally-wound coils of rubber hose; this to avoid

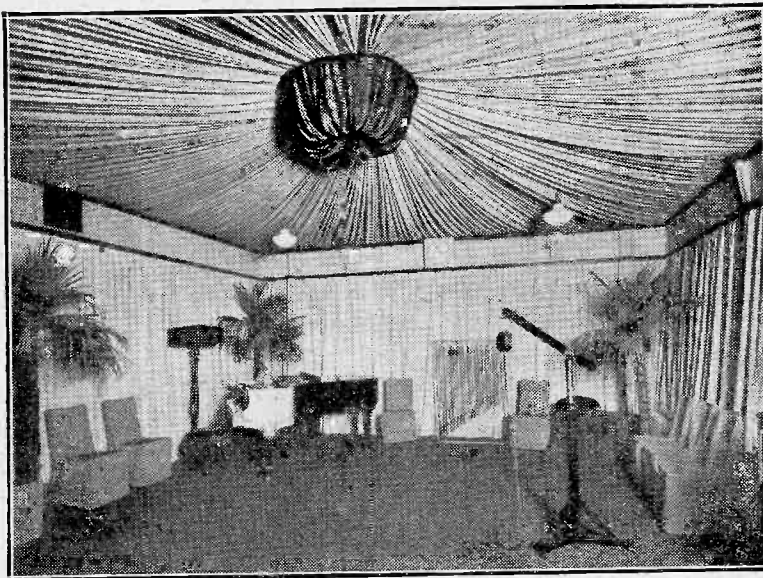

The studio at KDKA. Note that the walls and ceiling are draped to prevent echo.

transformer, and arrangements are being made whereby additional 300-kilowatt transformers may be switched in. At the right-hand end of the room the short-wave transmitting equipment can be seen. It consists of the oscillators and modulators. At the opposite end of the room stands the equipment used for the higher wave, also oscillators and modulators. In the centre there is a 20-kilowatt short-wave transmitter designed for operation on approximately 45 metres, which is at present being used for telegraph signals. The short-wave transmitter—the one which has reached such distant parts all over the world—is at present operating on 68 metres with 15 kilowatts in the aerial. This power, I am told, will be in the near future increased by

any possibility of earthing the plate circuits.

To the rear of the frame containing the transmitting equipment two large brass pots with glass covers can be seen. Lifting the cover, a smaller-sized pot can be seen inside the outer one, immersed in oil. These two jars form the condenser used for tuning the short wave transmitter to the wave desired. Above the condensers an inductance made of copper ribbon is wound upon glass supports. These are in turn mounted on a wooden frame. The grid and plate coupling condensers are placed on a shelf immediately behind the valves.

#### Further Details

The grid leak takes up quite an amount of space. This is unavoidable.

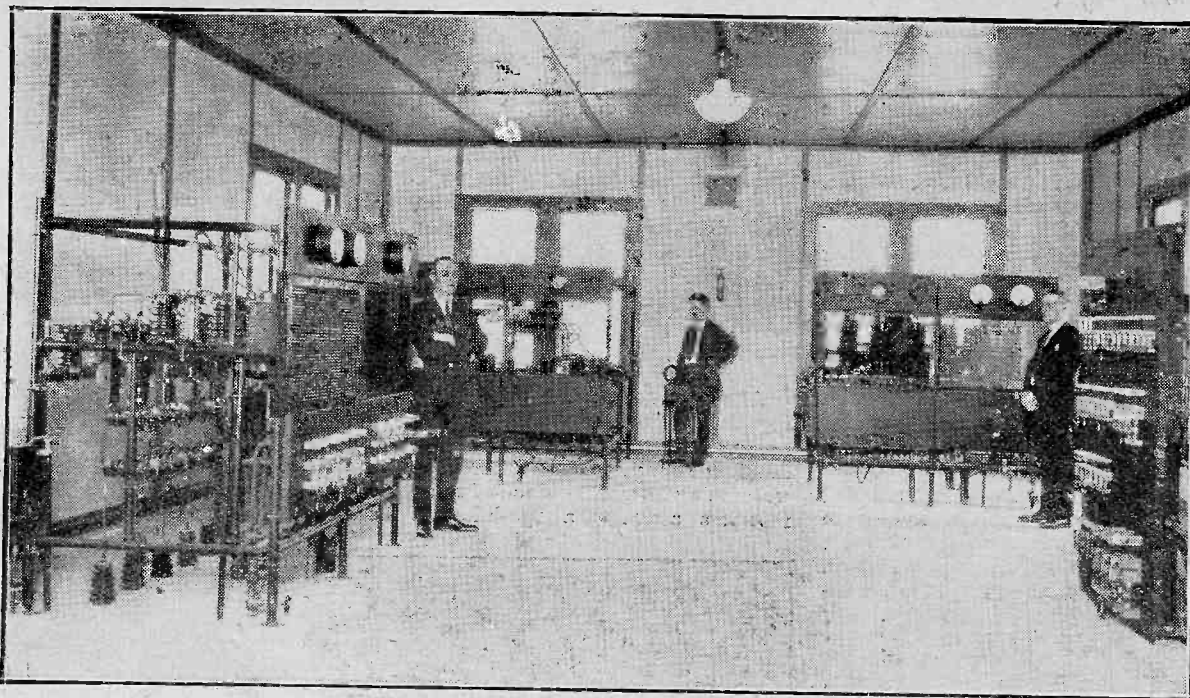

The inside of the transmitting room showing the modulator and oscillator panels.

able, as a large section is required in view of the large amount of grid current handled by these valves.

The tuning circuit of this transmitter is coupled to the aerial either through capacity or by means of an inductive coupling. Experimental work is continuously going on at KDKA, and the visitor may find either method of coupling in use at the time. He may, by the way, find many other changes from the outline I have given in these columns. Owing to the high power used and the shortness of the transmitting wave, or, more exactly, the high frequency used, the oscillator must be designed with the utmost care, and with a view to reducing losses to a minimum, or it will not be possible to make the system oscillate at all. Most of the parts and material used are the outcome of purely experimental work, even up to the proper glass to be used for the valves. I was informed that some of the early samples of glass melted when the valves were used. Difficulties were great in this direction and in others, as it must be remembered that, although these short-wave transmissions are termed "experimental," they have nevertheless been performing a continuous and reliable broadcasting service and have had to be constructed as such.

#### Measuring Instruments

Next to the oscillator cage is the modulator frame. Modulation is carried out by means of six valves.

This number, however, can be doubled if necessary, and switching arrangements are provided so that any valve can be switched out and another switched in. The grid bias controls, and meters for reading grid current and grid voltage, are placed alongside the modulator frame. On the front of the panel are also placed the necessary meters for reading plate voltages, filament current, etc.

#### Motor Generators

The modulator and oscillator panels at the other end of the room are similar in construction to that of the short-wave transmitting equipment which has just been described, except that they are tuned to a different wavelength. There are one or two departures, however, one being that the condensers have an air dielectric. This transmitter, which works on 309 metres, can be operated with efficiency on powers up to 50 kilowatts. It is a notable feature of this station that there is sufficient energy provided to permit extremely high powers being used. Descending to the basement, two immense motor generators can be seen. Each of the water-cooled valves previously mentioned requires from 50 to 55 amperes of lighting current. As some of the sets are equipped with as much as 16 valves which may be in service at the same time, it is easy to see that current running into hundreds of amperes is necessary. The two large

motor generator sets mentioned which furnish this current are capable of yielding 800 amps.

A large number of transformer shroudings will be observed in the various parts of the basement. Some of them contain step-up transformers, others house large choke coils. Each one of the rectifiers mentioned in the early part of this article needs three transformers. Each rectifier frame contains either 6 or 12 valves. Either one or two valves in parallel are used for rectifying each stage, this depending on the amount of power required.

In front of the transformers large panels stand on which the control apparatus is mounted.

#### Conclusion

There was a day when wireless engineers were convinced that only long waves would span long distances. The work of the pioneers of these latter years has reversed this theory; the short wave has come to stay. The day of international communication by exchange of broadcast is here. Occasionally broadcasting stations have been heard over great distances, but the difference between such occasional freak reception and the consistent, regular, dependable and reliable transmissions conducted by the Westinghouse Electric Broadcasting Station KDKA from East Pittsburg on its short wave make this station stand alone.

# The FOUR VALVE DE LUXE CABINET RECEIVER

By Percy W. Harris  
ASSISTANT EDITOR.

ON several occasions I have been asked to construct a wireless set in the form of a piece of furniture, but it is only recently that I have been able to evolve a design which really satisfies me from the point of view of efficiency and accessibility. It is, of course, a fairly simple matter to take a conventional set and surround it by an elaborate cabinet, and indeed, many such sets are commercial products. The design of the set to be described differs, however, from sets that can be purchased ready made, for in the "wireless" portion it combines the advantages of the single panel mounting with many of what has come to be known as the 'American method,' in which the front panel is used for controls and a baseboard at the rear for holding a number of the components.

### A Special Loud-Speaker

A second feature of this instrument is the specially designed loud-speaker equipment, which is built into the right-hand side of the cabinet. It consists of a metal bowl, the shape of which somewhat resembles the more pointed half of an egg, in front of this being mounted a flared tube to which is fastened a gramophone attachment, such as is sold for converting your existing gramophone into a loud-speaker. The sound waves pro-

ceed from this attachment through the flared tube and are thereupon reflected into the room from the bottom and sides of the bowl. This loud-speaker is built into the cabinet as supplied, and the Cabinet-de-Luxe, with loud-speaker, can be obtained from the makers, The Unica Cabinet Co., 73, Camden Street, N.W.1. The price of the cabinet and loud-speaker horn (but minus the loud-speaker attachment, which can be of any of the existing makes) is £12 10s. 0d.

The cupboard beneath the instrument serves to carry the accumulator, high tension battery, spare coils, and other impedimenta which generally litter the wireless table.

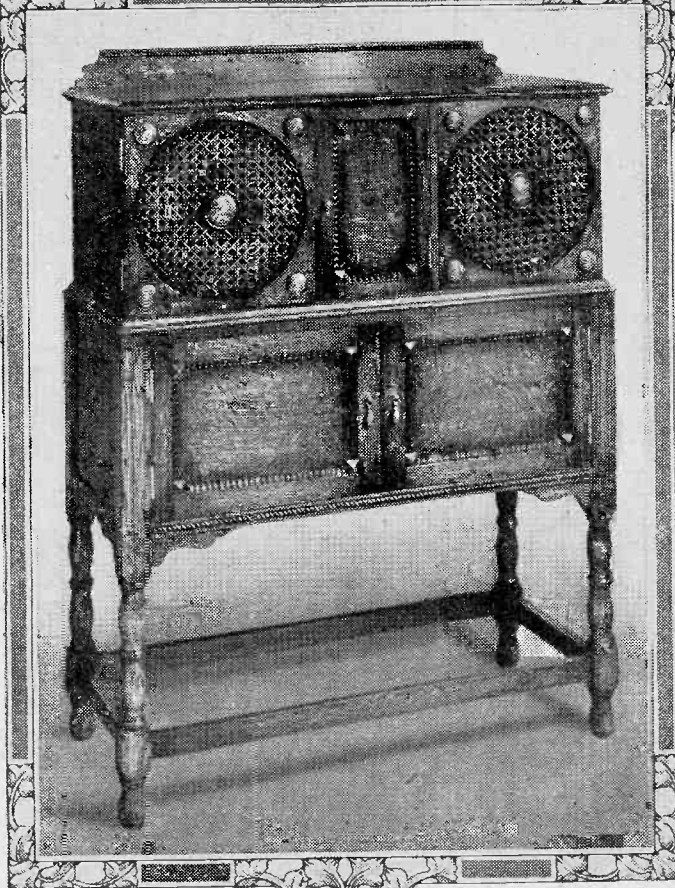

The ebonite panel is fastened into a wooden frame, pivoted to fall forward horizontally when released by a key. A folding strut prevents the panel from dropping below the horizontal. On this panel are mounted all the components necessary to make a four valve set, while valves, and coils (of which there are three) are all concealed behind the panel when this is placed in a vertical position, although the adjustment of the coupling between the reaction and the tuned anode coil is controlled by a knob on the front of the instrument.

### A Well-tried Circuit

The circuit used is very well known and simple, and consists of one high frequency valve coupled by the tuned anode method to a detector valve, a reaction-coil in the anode circuit of this last being coupled to the tuned anode coil. Control of self-oscillation and fine adjustment is made by a combination of the potentiometer and, of course, the variable reaction between the coil in the anode circuit of the detector valve and the tuned anode coil itself. There are two stages of note magnification, the first being transformer-coupled and the second resistance coupled. In order that the best effect may be obtained and a wide variety of valves used, there are separate

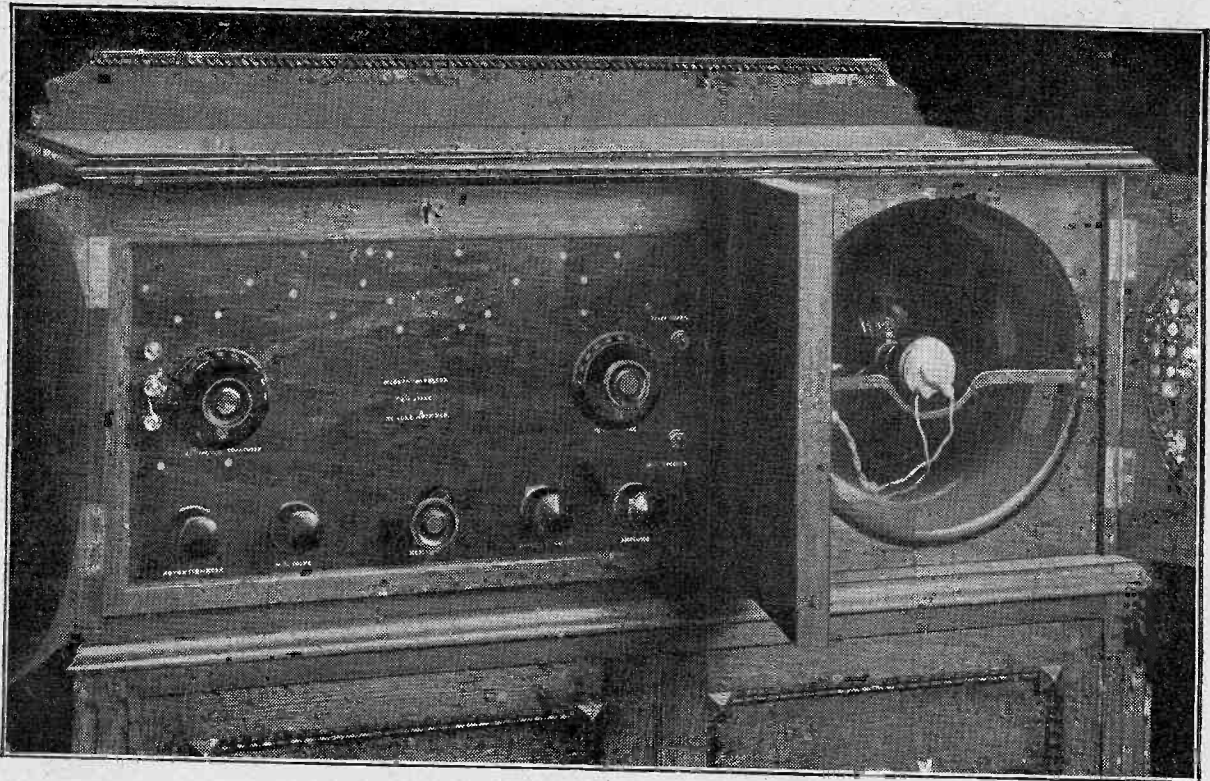

The panel carries all controls, while the loud-speaker is situated on the right.

High tension tappings for each valve and separate grid bias connections are made to each note magnifying valve. Dual resistances are provided to enable either bright or dull emitter valves to be used.

ment resistances would have been fitted in these last two cases, but as the receiver is designed for entertainment purposes only, it was considered unnecessary to complicate the controls.

simple matter to adjust both to the maximum efficiency. The man who is limited to dry cells can, of course, use four .06 amp. valves, as there is ample room in the cabinet for the largest type of dry cell supplied for this type of valve.

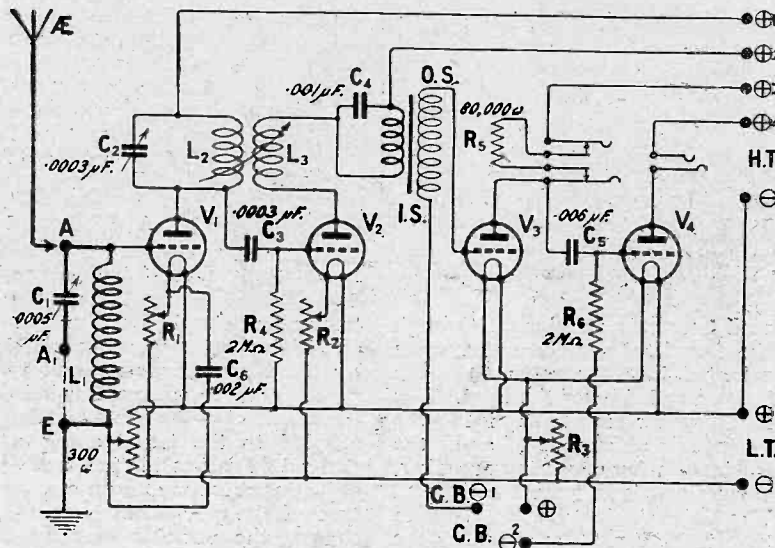

The circuit contains one transformer, and one resistance coupled, note magnifier. Three or four valves can be used at will.

Although there are four valves, only three filament resistances have been fitted, one being made to serve for the last two valves. If this set had been designed purely for the experimenter, separate fila-

Any two valves which require the same filament voltage can be used in these last two sockets, and as separate high tension leads and separate grid bias connections are made to these two valves it is a

**Simplicity a Feature**  
As the set is designed as a loud-speaker receiver for simplest operation and construction, no provision has been made for switching to give one or two valves only. As, however, there are times when listening with telephones is desirable, jacks are provided to allow the user to plug in the telephones on either three or four valves as desired. For loud-speaker operation a flexible lead connected to a plug is inserted into the jack of the fourth valve circuit. This arrangement is also useful when it is desired to connect the set to an external loud-speaker for comparison purposes, as it is only necessary to fix a plug to the leads of the outside loud-speaker to connect it in a moment to the receiver.

**Components**

Below I have listed the actual components used in the set described. If good results are to be obtained, it is essential that all components shall be of first-class quality, but with the wide variety of choice available to our readers,



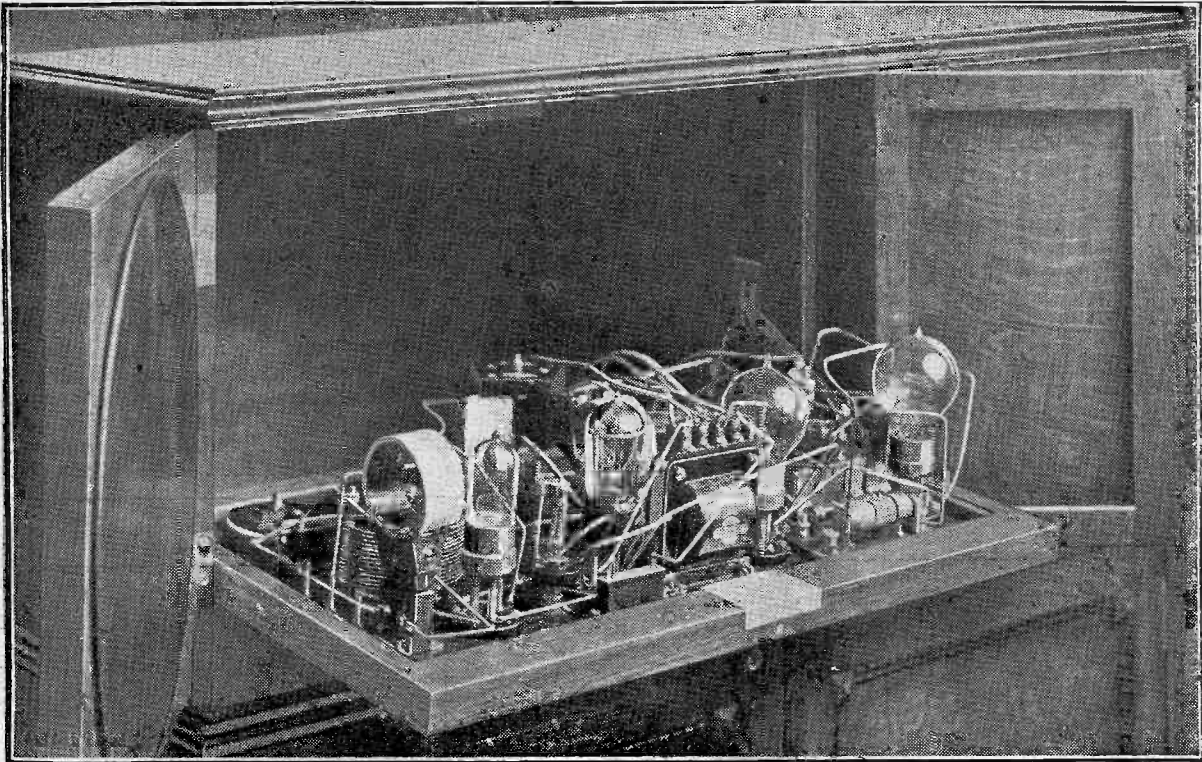

The panel drops forward when required, revealing all valves and coils in place.

it is possible to vary several of the components listed, without any detrimental effect.

One panel measuring 18 in. by 10 in. (I have used Radion Mahoganite).

Three terminals.

One square law condenser— $.0005\mu\text{F}$  (Bowyer-Lowe Co., Ltd.).

One square law condenser— $.0003\mu\text{F}$  (Bowyer-Lowe Co., Ltd.).

One fixed coil socket (Magnum).

One back of panel mounting two-coil holder (Peto-Scott, Ltd.).

Four valve sockets for back-of-panel mounting (Magnum).

One potentiometer 300 ohms. (Burndept, Ltd.).

Three dual filament resistances (Burndept, Ltd.).

One double circuit jack (Elwell).

One single circuit open jack (Elwell).

Two plugs for jacks (Elwell). (One for telephones and one for loud-speaker).

One combined grid leak and grid condenser mounting (Dorwood Precision). (A note regarding this component will be given later).

One fixed condenser  $.001\mu\text{F}$  (Dubilier vertical type).

One fixed condenser  $.002\mu\text{F}$  (Dubilier vertical type).

One grid leak 2 megohms (Dubilier).

One combined condenser and grid leak mounting with condenser  $.006\mu\text{F}$  and grid leak 2 megohms (McMichael, Ltd.). This condenser, by the way, can be any value up to  $.25\mu\text{F}$  and can well be the largest of the clip-in type available.

#### An Interesting Component

A component which I have used for the first time in this set and which has several merits is the Dorwood Precision condenser and grid leak mounting. This consists of a small pillar secured to the panel with a single screw, carrying a fixed condenser of circular shape attached to a disc of ebonite on the top of which is fixed a grid leak. One advantage of the device is that there are three soldering lugs which make it possible to connect the grid leak across the grid condenser, or from the grid of the valve to the filament. The value of the condenser used was  $.0003\mu\text{F}$ , and the grid leak 2 megohms. Other values of grid condenser can be obtained.

Owing to the fact that the batteries are inside the cabinet and need to be connected with flexible leads to the receiver, it has not been found necessary to use many terminals. The actual terminals used are three in number, and are provided on the left-hand side of the panel where they serve to give series or parallel aerial condenser connections as desired. For parallel working the aerial is connected to the uppermost terminal, the two lower ones being joined by a wire. The earth connection is taken to the lowest of the three terminals. For series connection the aerial is removed from the top terminal and

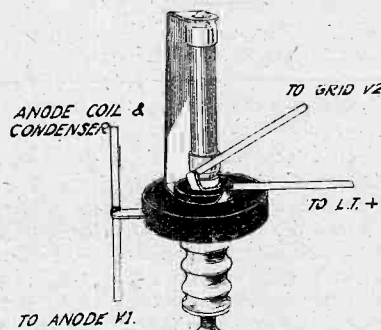

How to wire up the Dorwood condenser fitting.

One intervalve transformer (Igranic, 1 to 5).

One 80,000 ohm resistance (Dubilier).

One gramophone loud-speaker attachment (S. G. Brown, Ltd.).

One Set Radio Press Panel Transfers.

And finally, of course, the cabinet and loud-speaker equipment (as illustrated).

placed on the second, while the link joining the two lower terminals is removed. The earth connection remains on the lowest terminal as before.

**Panel Arrangements**

Looking at the front of the panel we see on the left the three terminals just mentioned, while the aerial tuning condenser and the anode tuning condenser are placed respectively on the left and right of the panel. Along the bottom are certain knobs clearly labelled, the first from the left being the potentiometer knob and three filament resistance knobs for the H.F., detector and two note magnifying valves respectively. The

as there are only three filament resistances it is not a difficult matter to turn the set on and off by these, in this way there being less strain imposed on the valve filaments.

**Constructional Work**

The constructional work will be readily apparent from the drawings provided with this article. Wiring up is greatly simplified by the fact that all components are mounted on the back of a single panel. The actual layout given should be closely followed, and it is advisable when preparing for drilling the panel to arrange the coil-holder with coils in place, and the valve sockets with valves in them so as

nothing to prevent their doing this, and if the set is made in the ordinary style it is suggested that the flexible leads to the batteries be dispensed with, stiff wire connections being made to a row of terminals on the right-hand side of the panel. The panel can then be screwed into any suitable box and the connections made externally as is usually the case. In passing, it may be mentioned that to remove the panel with its framework from the cabinet it is only necessary to lower the panel, undo the two screws which secure the strut to the framing of the panel, and also to undo the two screws which hold the right-hand fillet to the side walls of the cabinet. The whole panel

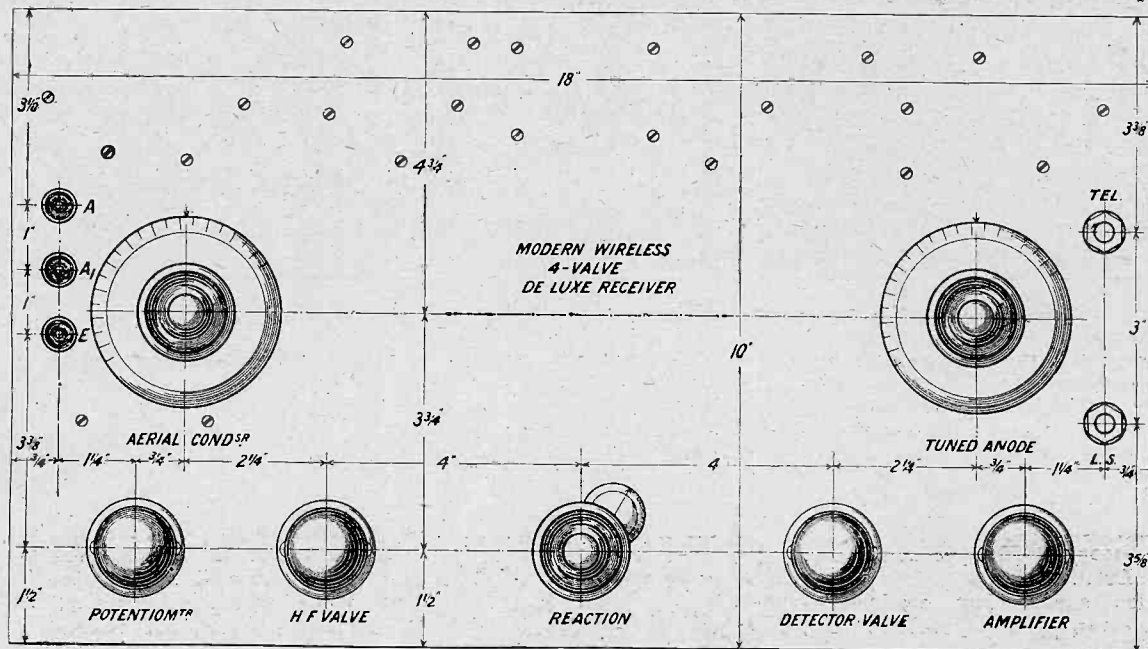

A scale drawing of the panel, showing dimensions and lettering. Blue Print No. 112a may be obtained, price 1/6, post free.

central knob on the panel controls the reaction coupling between the coil in the anode circuit of the detector valve, and the anode coil itself. It will be noticed that this carries an indicating disc with an arrow marked upon it. If this disc is set so as to show vertical when the coils are closest it will show a horizontal position when they are widest apart, and thus one can judge visually the degree of reaction coupling. On the right-hand side of the panel we see the two jacks for plugging in to the third and fourth valve circuits respectively. It will be noticed that there is no direct "on and off" switch in this receiver. This is due to the fact that frequent switching "on and off" of valves imposes a certain strain on the filaments, and

to see that coils and valves clear one another. In the actual set described, it was found possible to use the largest valves and the largest coils without fouling. All battery connections and grid bias connections are made by flexible rubber-covered wires. These wires can be threaded down holes in the back of the cabinet, so as to reach the necessary battery terminals. It will be noticed that by undoing the key the panel can be made to fall forward and the valves and coils can be readily changed in a moment.

**Alternative Arrangements**

There may be many readers who would like to make up this set but who do not desire to purchase such a cabinet. There is, of course,

with the fillet can then be lifted out, being replaced when all wiring is done.

**Operation of the Receiver**

For preliminary tests with this instrument it is suggested that the four H.T. leads should be joined together ready to connect to, say, 50 volts on an H.T. battery, a negative lead, of course, being taken from the positive L.T. wire to the negative socket of the H.T. battery. The filament resistances should be first placed at the "off" position, and a suitable battery for the valves in use connected up. Do not connect the H.T. battery yet. Now turn on one valve filament after another to see that they all light properly and are suitably controlled by the filament

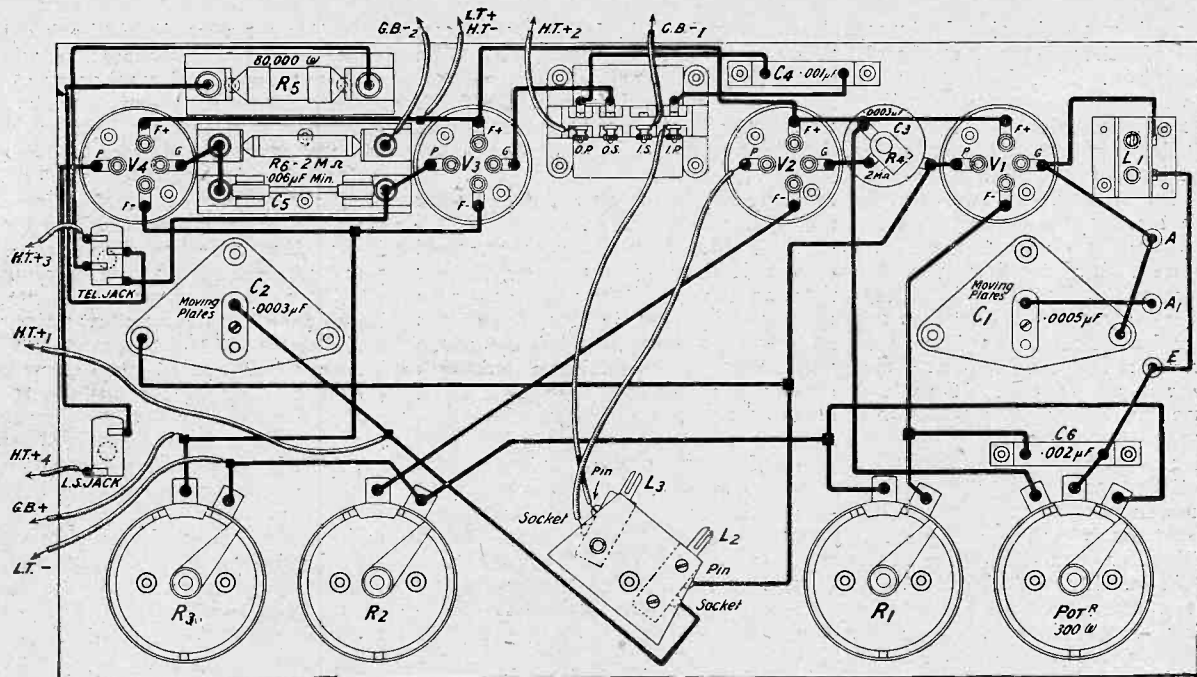

The back of panel wiring, showing connections of flexible leads. A full-sized Blue Print No. 112b may be obtained from the Sales Dept., price 1/6, post free.

resistances. At the moment it does not matter which end of the circle the arm of the potentiometer knob is situated. If all valves light up, connect the H.T. battery, plug in the telephones into the third valve position, place a No. 25 or 35 coil in the aerial socket and a No. 50 or 75 in the anode

socket with, say, a 35. or even a 25 in the reaction socket. Open up the reaction and anode coils as wide as possible (*i.e.*, at right angles), connect the aerial and earth with the parallel position, and see whether you hear signals when you manipulate the two tuning dials. The three grid bias connections

can also be temporarily joined together for this experiment. If signals can be heard and tuned, set the filament resistances for the best results, find which is the best H.T. tapping for loudest signals, and make fine adjustment for your tuning. Now, by turning the reaction knob, see whether there

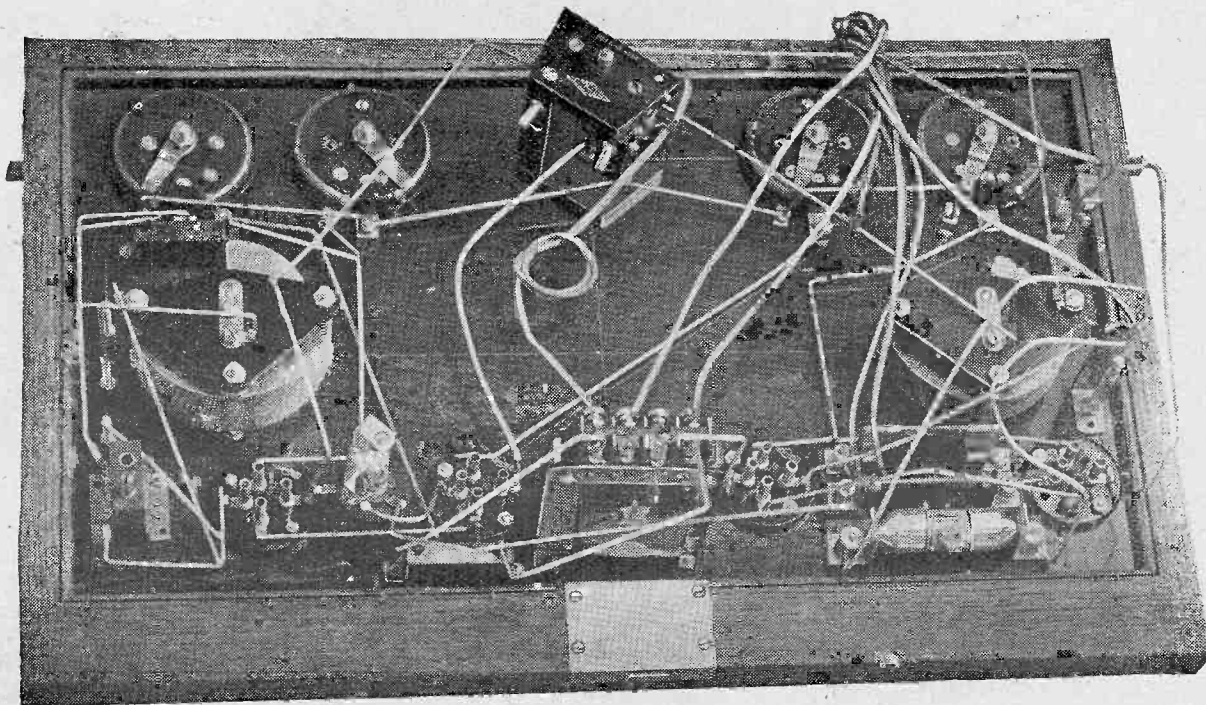

How the panel appears when lowered. Note the position of the lock. The panel is held in the wooden frame by the thin beading supplied.

is an increase in signal strength, and whether the set comes near oscillation. If it does not, reverse the leads to the reaction coil. If the set oscillates very readily try turning the potentiometer knob in one direction or the other, according to its setting. In one direction the tendency to oscillation will be decreased and in the other increased. By turning the knob towards the direction of increase in signal strength the same effect will be obtained as if you had brought the reaction coil closer to the anode coil. If with the reaction coil at right angles to the anode coil the set still oscillates, then turn the potentiometer knob until it ceases to oscillate. A few experiments with the potentiometer knob and reaction control will show you the best working position. By plugging in to the last valve circuit there should be a very large increase in signal strength, and on the local station you should not be able to hear the telephones on the head, except when you have de-tuned. You can now try the effect of adding grid bias by connecting the positive grid bias terminal to the positive terminal of the grid bias battery, and plugging in the wires connected to the other grid bias leads to suitable values of the negative voltage.

If you do not already know the coils to use for the various wavelength stations, I suggest you obtain the Radio Press Coil Table, which shows clearly the coils to use of the various makes in the aerial, tuned anode and reaction sockets respectively. Any of the coil-makers will send you on request a list of the coils required to cover the various wave lengths together with their prices.

#### Valves to Use

Any of the well known makes of valves will work well in this set, but for the first socket I would recommend one of the makes specially designed for high-frequency amplification. For the second or detector socket any good general purpose valve can be used, whilst in the third and fourth sockets either the ordinary note magnifying valves of good make, or a pair of the .25 ampere small power valves can be used. By these I mean B. 4, D.E. 5, or D.F.A. 1, or similar valves of the Ediswan line. Best of all for the third socket is a valve of the D.E. 5B, or D.F.A. 4, type for these are specially designed to work in resistance coupled circuits.

When you have had the set

working in this fashion you can try the effect of varying the high tension on the different valves. If you are using a single H.T. battery I would suggest you shunt the various tappings by Mansbridge condensers of the value of  $1\mu\text{F}$ . I have not incorporated these condensers in this set, for I look upon them really as a part of the high tension battery, rather than the set. They can easily be accommodated in the cupboards below, and if four of them are screwed on to a baseboard, you can join one lug of each of them to a common bus bar, which can go to the common negative terminal of the high tension battery. We will say, for example, that you try a voltage of, say, 60 on the high-frequency valve, 40 on the detector, 100 on the third valve, and, say, 120 on the fourth. The remaining four lugs of the Mansbridge condensers should be connected to each of these voltage tappings.

#### Results Obtainable

Within 15 or 20 miles, at a con-

servative estimate, it will be found that a broadcasting station will give adequate loud-speaker results for an ordinary room on three valves only, and frequently will bring in some of the more distant stations at loud-speaker strength after dark. On four valves at night several broadcasting stations should come in at full volume, and I can assure you that with all four valves going excellent loud-speaker results can be obtained on the smallest indoor aerial from at least one station. Receiving conditions vary a great deal according to the aerial used and the particular locality, but it is safe to say that save in the hands of a raw beginner and provided an ordinary outdoor aerial of average efficiency is used, there is no difficulty whatever in hearing all of the main B.B.C. stations with the headphones on three valves, and a large number of those from the Continent. The results are, in fact, fully up to what one would expect with a four-valve tuned anode circuit using one stage of high-frequency amplification.

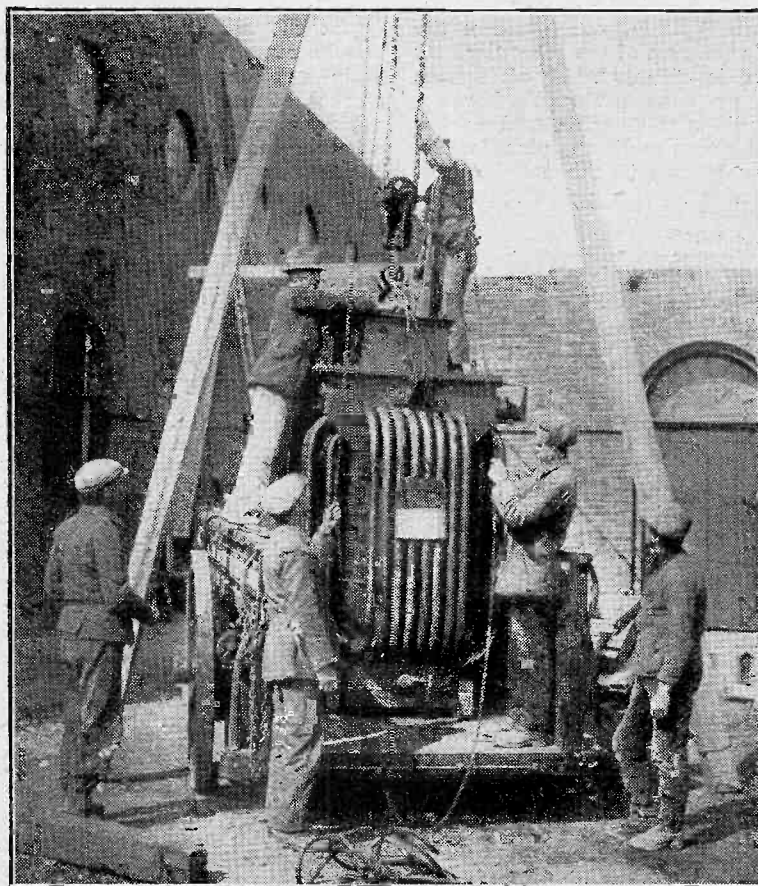

The Government high-power station at Rugby in the process of erection. Workmen are here seen unloading a 4-ton transformer.

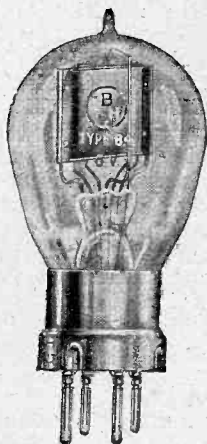

A popular type of small power valve, the B.T.H. B4.

# How to Use a Power Valve

By STANLEY G. RATTEE, M.I.R.E.,  
Staff Editor.

*This interesting article explains in a simple manner how you may incorporate a power valve in your existing receiver in order to improve the purity of signals.*

**T**HOUGH some little time ago it was practically beyond the average experimenter to use power valves for purposes of low-frequency amplification for reasons of cost, there are to-day a number of small power valves which may be used at little above the running costs of an ordinary general purposes valve.

Whereas in the past the price of a power valve was somewhat prohibitive, the present cost of a valve for the same work is much more reasonable. Further, whereas the old power valves were somewhat greedy in their filament consumption, taking in some cases over one ampere, with an anode potential of two to three hundred volts, the present-day valves for power amplification purposes require an anode potential of nothing higher than 120 volts, and consume certainly not more than half an ampere; in the majority of cases a quarter of an ampere is nearer the figure.

### Suitable Valves

Such valves as those referred to are, among others, the B.T.H. B4, which requires a 6-volt accumulator, consumes .25 ampere, and works with an anode potential of 100-120 volts; another valve of this type which works under precisely the same conditions is the Marconi - Osram D.E.5. Other valves which may be chosen to do the same work are the Mullard D.F.A.0, which requires a 4-volt accumulator, consumes .35 ampere, and works with an anode potential of 80-100 volts, and the D.F.A.1, which works from a 6-volt accumulator, the filament current being .2 with 80-100 volts on the plate.

Still another type which may be chosen is the D.F.A.2, which is used with a 4-volt accumulator, the filament current being .25 ampere with an anode potential of 80-100 volts.

For low-frequency amplification work, that is distortionless amplification for loud-speaker work, the power valve is without doubt the best.

### Construction

As to construction, the main difference between a power valve and a valve of the ordinary type is that in general the former is larger in every detail.

Since a valve of this type has to deal only with low-frequency currents, the question of inter-electrode capacity need not be very seriously considered, with the result that both the plate and grid can be large; and if we examine the

### Where a Single Tapping is Employed

In all probability many readers of MODERN WIRELESS are in possession of receivers, either purchased or home-constructed, incorporating low-frequency amplification, which by virtue of their construction do not permit the successful use of a power valve even though it may be desired to do so.

In the case of the ordinary receiver, which is so made that there are just two H.T. terminals, that is one H.T. positive and one H.T. negative, if a power valve is inserted in the last valve socket with the ordinary value of H.T. voltage, signals will be perhaps weaker, certainly not very much louder, than when using an ordinary valve. If, on the other hand, the H.T. voltage is increased to the figure advocated by the makers of the power valve chosen, then results

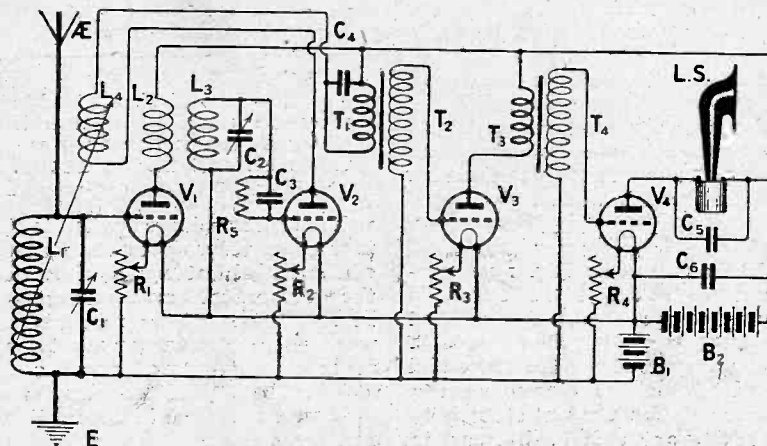

Fig. 1.—A common form of four-valve circuit with only one H.T. tapping.

majority of power valves we shall find that the plates are quite large compared with those of the ordinary type of valve, whilst their shape is usually oval. It will be further observed that the grid is more open than usual. Another point of difference in the construction of a power valve is that the filament is much longer than is the case with valves of the ordinary type.

will become distorted and poor for the following reasons.

### Increased H.T. Voltage Essential

Suppose, for instance, the circuit of the receiver is that given in Fig. 1, which is a very common form of four-valve circuit, comprising a transformer-coupled high-frequency valve, a detector, followed by two transformer-coupled

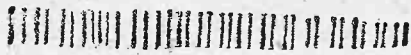

# Brandes

*The name to know in Radio*

All Brandes products carry our official money-back guarantee, enabling you to return them within 10 days if dissatisfied. This really constitutes a free trial. Brit. Manuf. (B.B.C. Stamp)

BRANDES, LIMITED,  
296, Regent Street, W. 1.  
Works : Slough, Bucks.



## *Grandpa's Choice*

Grandpa now neglects his evening paper—a surprising fact, because with him it was almost a fetish. Someone brought home Brandes and the clarity with which he gets the broadcast programme, the melodious tones ensured by their *Matched Tone* feature, claim his fervid interest. There he sits, with a finger in the bowl of a half-filled and forgotten pipe, oblivious to our entreaties.

As soon as we are able to penetrate his intense interest, perhaps he will adjust the *Table-Talker* and the full, rich tones will fill the room. *Matched Tone* serves us all. Ask your Dealer for Brandes.

*Table-Talker*  
42/-

*Matched Tone*  
*Headphones*  
20/-

so doing they will reduce the plate current and so prolong the life of the H.T. battery.

Characteristic curves of the valve chosen will usually be found within the wrapper of the valve, and in those cases where they are not supplied manufacturers should be asked for them. By a careful examination of these the best value of grid bias for different anode voltages will be found by reading along the bottom line of grid-volts values as was done with the imaginary curves given in Fig. 4.

**Practical Application**

Though these remarks relative to the adding of terminals are applied to the four-valve circuit illustrated, they apply to any circuit incorporating one or more transformer-coupled low-frequency stages, whether the detector be preceded by high-frequency stages

this done, increase the value of the extra H.T. battery until its value plus the voltage of the usual battery gives a total voltage of, say, 120, leaving the adjustment of the usual H.T. battery at its normal value of about 60 volts, and increase the value of grid-bias by moving the negative plug to the 3-volts tapping, then to  $4\frac{1}{2}$  volts, and so on until the very best result is obtained. If the voltage is too high then signals will become weak and impure.



The Marconi-Osram D.E.5 Valve.

In the case of some receivers it

in Fig. 5. In these circumstances the arrangement of connecting the grid battery is the same as previously explained, whereas the manner of making the H.T. connections is as follows:

The H.T. negative of the battery is connected to the H.T. negative of the set, whilst the H.T. +1 terminal, which usually supplies the anode potentials to all the valves, exclusive of the last, is connected to the socket in the H.T. battery, which gives a value of about 60 volts. The H.T. +2 terminal which applies potential to the anode of the last valve should be connected so as to give a potential of 100-120 volts.

When using power valves, careful experimenting in the values of H.T. and grid voltages is the key to success for pure and distortionless amplification, though it must, of

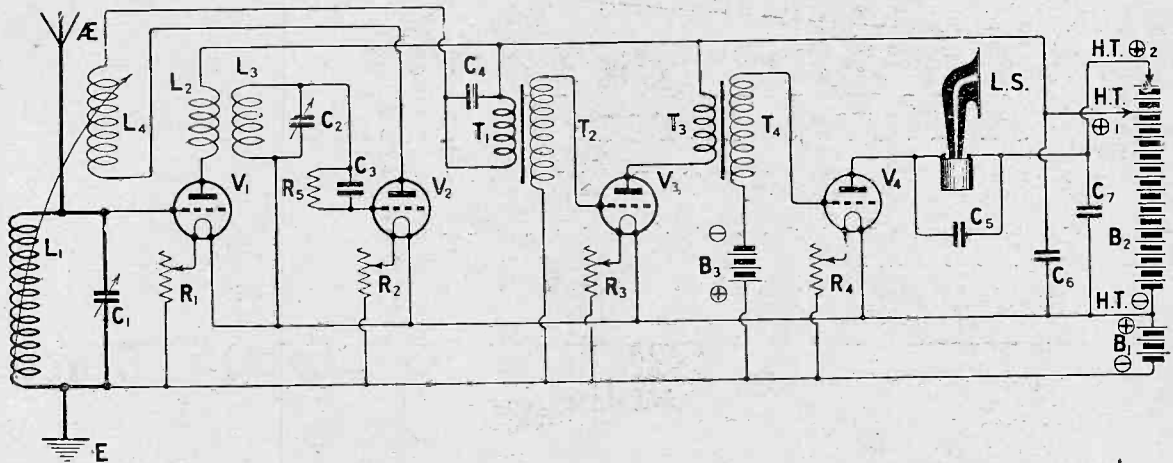

Fig. 5.—A four-valve circuit incorporating two H.T. positive terminals.

or not, or whether the detector used is a crystal, the exceptions in so far as the connections described are concerned being certain reflex circuits wherein the last valve forms part of the feed-back arrangement, when special facilities must be provided. The best method whereby to learn how to use a power valve in the circumstances under discussion is probably a practical application, and assuming that the extra H.T. battery has been added as suggested and the grid battery terminals fitted, we will insert a power valve in the last valve socket, connect the positive grid battery terminal to the positive socket of a 9-volt grid battery, procurable from most wireless shops, and the negative terminal to the next socket. With the set tuned to a station which can be received with good volume, light the valves and tune the set to give the loudest results consistent with purity. With

will be found that the arrangement of H.T. terminals is such that it is not necessary to add an extra battery in series with the loudspeaker, in that two H.T. positive terminals are provided as indicated

course, be remembered that the input applied to the grid or grids of the low-frequency valve or valves as the case may be must of necessity be distortionless to start with.

**Conclusion**

Though the circuits illustrated show the more common form of low-frequency amplification, that is to say by means of iron core transformer coupling, the suggestions given also hold good for resistance coupling in so far as the last stage is concerned; and though this article does not pretend to give a theoretical explanation of how a power valve should be used, it will nevertheless be of considerable assistance to those readers who wish to add a power stage to either an existing receiver lacking the requirements for its use or else to a receiver already possessing separate high-tension positive and grid battery terminals for its inclusion.

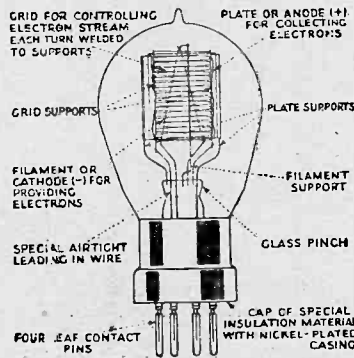

Constructional details of a well-known type of power valve.

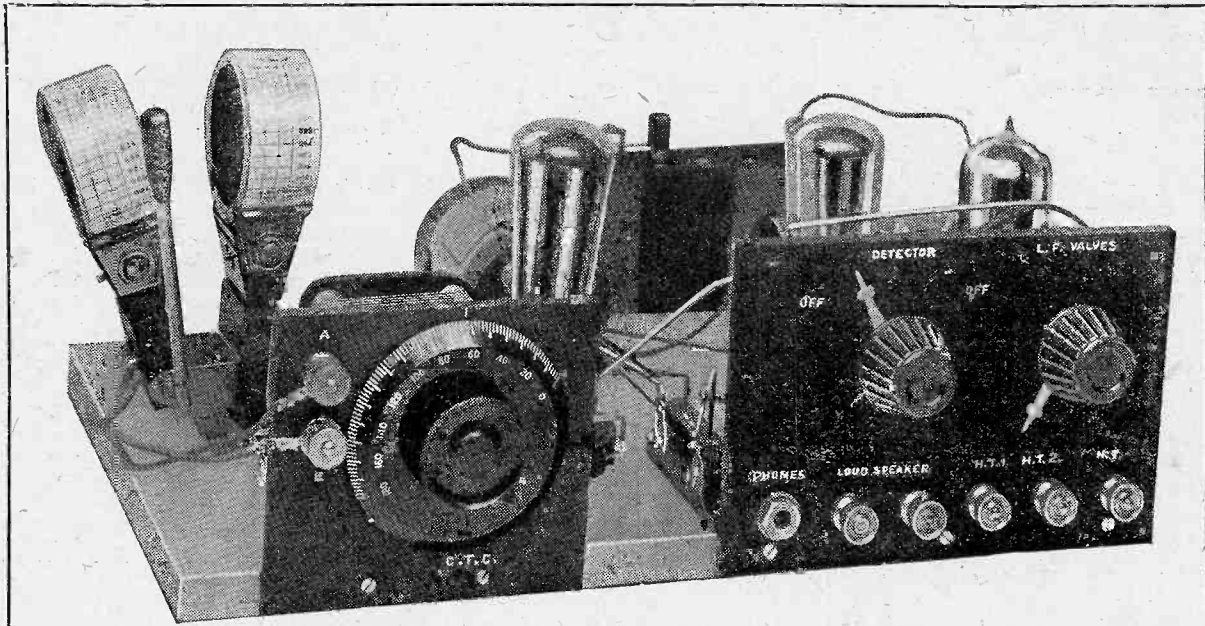

## A Novel Three-Valve Receiver

By C. P. ALLINSON.

*Mounted only on a baseboard, this receiver took but a few minutes over three hours to construct and wire up. The uncommon circuit employed gives simple control and good selectivity, and will certainly interest the more advanced experimenter.*

FOR some time the writer has had under consideration the question as to whether it was not possible in some way to simplify the control of reaction. Take, for instance, a receiver using a three coil holder with either tuned or semi-aperiodic aerial, tuned secondary and magnetic reaction. The circuit is that shown in Fig. 1. The first point that is noticed when operating this receiver is that when the coupling of the aerial coil  $L_1$  is altered with respect to the secondary  $L_2$ , it is necessary to re-adjust the coupling of the reaction coil  $L_3$  in order to keep the set in the same reactive state. By this is meant, that if with the set just off the oscillating point the aerial coupling is tightened, the reaction coupling must also be tightened in order to keep the set just on this point and *vice versa*. Further, as the value of the secondary condenser  $C_2$  is increased, the reaction demand usually becomes greater, and so the reception of distant transmissions becomes somewhat a matter of

skill, for every alteration of one of the variables calls for a re-adjustment of the others.

### Further Reaction Effects

Returning to the first point referred to above, it occurred to the writer that if the aerial and

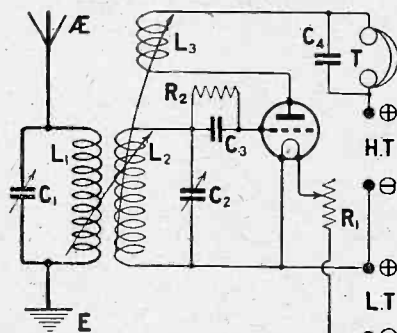

Fig. 1. A conventional loose-coupled receiver which may be tricky to operate.

reaction coils could be combined so that loosening the aerial coupling also reduced the reaction, a circuit would result in which these two

adjustments would to a certain extent compensate each other or balance each other out.

Another point that was noticed was that if when receiving a distant station with the aerial coil not in tune, this latter was brought into resonance, reaction coupling had to be tightened, while if it was detuned still further less reaction was required to keep the set just off the oscillation point. Therefore with a circuit in which the same coil functioned both as aerial and reaction coupling a certain size might be found which though in tune at the lower readings of the secondary tuning condenser would gradually become detuned as the secondary condenser was increased, and so the increased reaction demand occasioned by increasing the value of the secondary condenser would also be balanced out.

### The Circuit

The circuit finally evolved was that shown in Fig. 2, which shows the inclusion of two stages of low-frequency amplification.  $L_1$  is



# LISSENIUM

## Separating Chelmsford and Radio-Paris

Receiving Radio-Paris without interference from the high power station at Chelmsford has previously been very difficult at any position within about 75 miles of Chelmsford. The high power used by the British Station has necessitated the use of a loose-coupled circuit, or other selective device, with the attendant difficulties of operation.

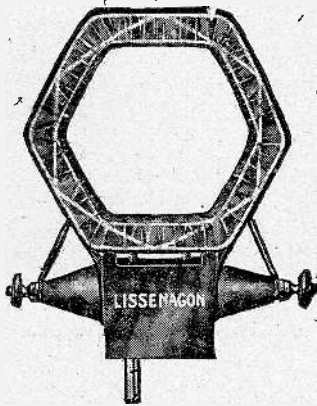

### LISSENIUM "X" COILS

No. 250 . . . 9/9  
 No. 50 . . . 6/-  
 No. 60 . . . 6/4  
 No. 75 . . . 6/4

## LISSENIUM LIMITED

20-24, WOODGER ROAD, GOLD-  
 HAWK ROAD, SHEPHERD'S  
 BUSH, LONDON, W.12.

Telephones: Riverside 3380, 3381,  
 3382, 1072.  
 Telegrams: "Lissenium, London."

**B**Y means of the new LISSENIUM "X" COIL No. 250, the necessary selectivity can be obtained without any addition to the existing tuning arrangements of the receiver. A very selective circuit is obtained by using a LISSENIUM "X" COIL No. 250 in the anode circuit of the H.F. valve. Any tuned anode circuit can be altered in a few moments by removing the wire connecting the plate of the H.F. valve to the anode coil, inserting the "X" Coil and connecting the plate of the H.F. valve to one of the tapping points on the "X" Coil. The connection from one side of the anode coil to the grid condenser of the next valve remains unaltered, whilst the other side of the coil is still connected to H.T. Positive. It should be noted that the latter connection should be to the socket of the LISSENIUM "X" COIL, and the connection from the plate of the H.F. valve should be tried on each of the two terminals to prove which gives best results. The tuning condenser remains across the whole of the coil and tuning is carried out as usual.

The LISSENIUM "X" COIL can also be used as an aperiodic aerial coil, and in cases where interference is exceptionally heavy a LISSENIUM "X" COIL can be used in both aerial and anode circuits. For use as an aperiodic aerial coil it is only necessary to plug the coil into the aerial coil holder and connect the aerial to one of the terminals on the side of the coil mount. Note that the socket of the coil should be connected to earth.

In addition to the No. 250 LISSENIUM "X" COIL, we are also making LISSENIUM "X" COILS Nos. 50, 60 and 75. Used as described above, they give a great degree of selectivity, stability and smoothness of reaction control on the broadcast band of wavelengths. The LISSENIUM "X" COIL No. 60 covers the 300 to 600 metre band of wavelengths, but the No. 50 "X" Coil is recommended for the lower band of wavelengths, and the No. 75 for the higher wavelengths.

### ASK FOR LISSENIUM COILS — THE COILS WHICH INTENSIFY TUNING

Send for Text Book of Lissen Parts—free to readers of "Modern Wireless"

In replying to advertisers, use Order Form enclosed.

A BRITISH BATTLE CRUISER

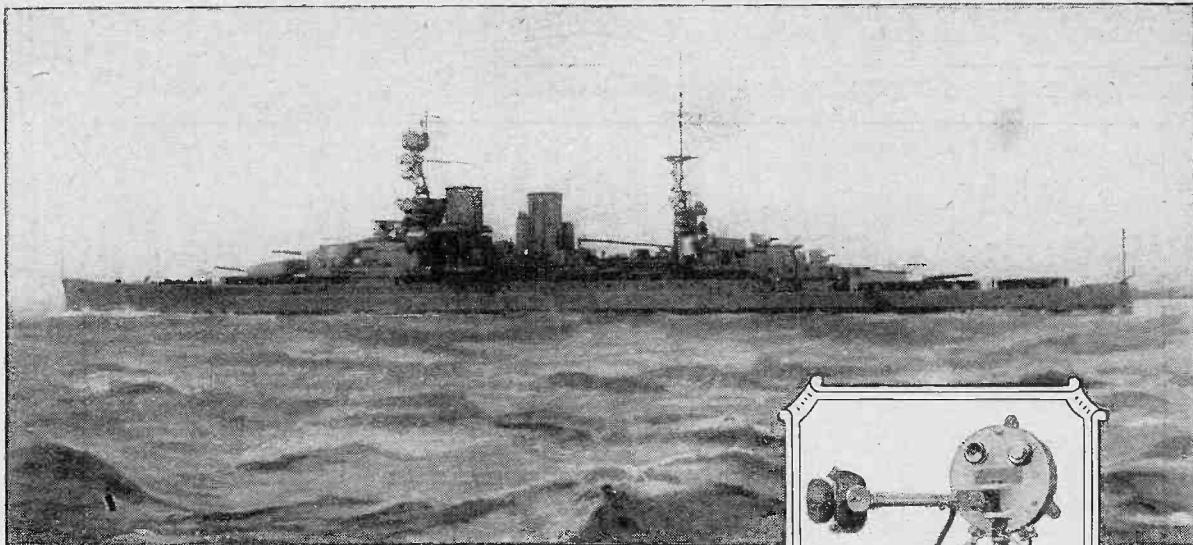

H.M.S. REPULSE

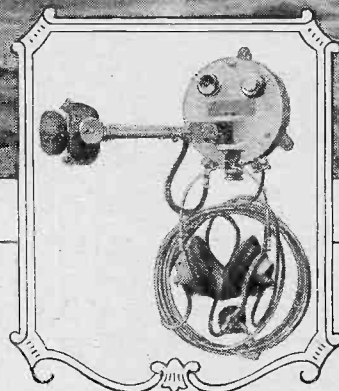

# On Land and Sea

Loud Speaking Telephone Apparatus manufactured by **THE HOUSE OF GRAHAM** is used throughout the British Navy and adopted by many foreign Governments, as also by leading Shipping Companies in all quarters of the Globe.

With over thirty years' pre-eminence in every field of Loud Speaker application, the utility, technical efficiency, and reliability of **GRAHAM** instruments are conclusively demonstrated.

Just as the most exacting requirements of Naval and Maritime experts have been adequately met by production to meticulously accurate standards, so the present-day needs of Radio reception have been fully satisfied in the evolution of the **AMPLION** Loud Speaker.

## A Product of The House of 'Graham

Many patented and therefore exclusive features contribute to the superlative qualities of the **AMPLION**, recognised as the World's Standard Wireless Loud Speaker, and acknowledged as synonymous with "Better Radio Reproduction."

Obtainable from **AMPLION STOCKISTS**  
and Wireless Dealers everywhere.

Patentees and Manufacturers:

**ALFRED GRAHAM & CO. (E. A. GRAHAM),**  
St. Andrew's Works, Crofton Park, London, S.E.4.

Demonstrations gladly given during broadcasting hours at:-

West End Showrooms - - - - - 25-26, Savile Row, W.1  
Suburban Showrooms - - - - - 79-82, High Street, Clapham, S.W.4

A  
Typical Graham  
Loud Speaking  
Naval Telephone  
as fitted on board  
ships of the  
Royal Navy.



The  
**AMPLION**  
shown is the  
**STANDARD**  
"Dragon"  
Model AR 19  
at  
£5 : 5 : 0.

# AMPLION

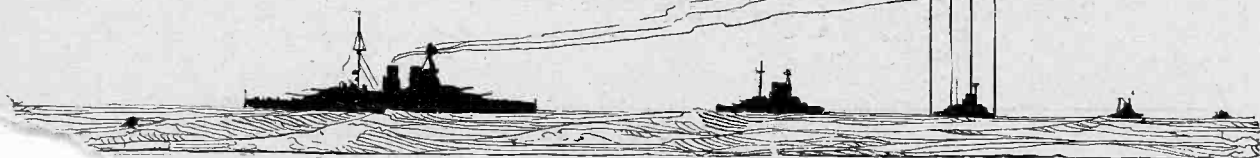

the aerial-cum-reaction coil and is untuned,  $L_2$  the secondary coil is tuned by a  $.0005\mu\text{F}$  variable condenser. This is of the square law type and might with advantage incorporate a vernier, as tuning was found to be exceedingly sharp. The usual values for grid condenser and grid leak were found satisfactory, and these are connected in the conventional manner. The anode of the detector valve, however, is connected to the aerial side of  $L_1$ , the earth side of this coil being connected to O.P. of the intervalve transformer. After this the circuit is that of a conventional two stage amplifier and needs no further comment.

**A Novel Feature**

An examination of the photographs shows that the usual ebonite panel has been done away with, two small pieces only being used on which to mount the tuning condenser, aerial earth terminals, filament resistances, 'phone jack, and H.T. and loud speaker terminals. These pieces of ebonite will probably be found lying about in the scrap box, and even if there are no suitable pieces handy the outlay involved is negligible. A small refinement that was found of great value was the use of a 'phone jack, for by this means a transmission may be tuned in on the headphones, and on withdrawing the

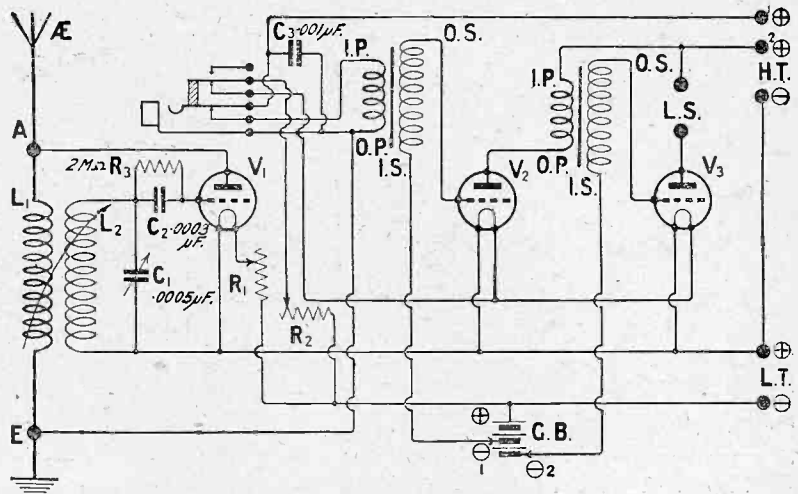

Fig. 2.—This theoretical circuit shows how a jack is used to control the two L.F. valves.

plug the two stages of L.F. amplification are automatically switched into circuit, the loudspeaker already being connected.

**Components**

The following components will be required, the actual makers' names being given for the information of those who desire exactly to make a copy of the receiver as constructed by the writer, but it is understood of course that as long as first-class components by makers of known repute are used, the use of the actual ones given is

not indispensable to the functioning of the receiver.

You will need:—

- 1 2-coil holder, type "R" (Burne-Jones).
- 1  $.0005\mu\text{F}$  square law variable condenser (Jackson Bros.)
- 1  $.0003\mu\text{F}$  fixed condenser and
- 1 2-megohm grid leak (Dubilier).
- 1  $.001\mu\text{F}$  fixed condenser (Peter Curtis).
- 3 Base mounting valve holders. Anti-phonics have been used, but if valves are employed that are known not to be microphonic

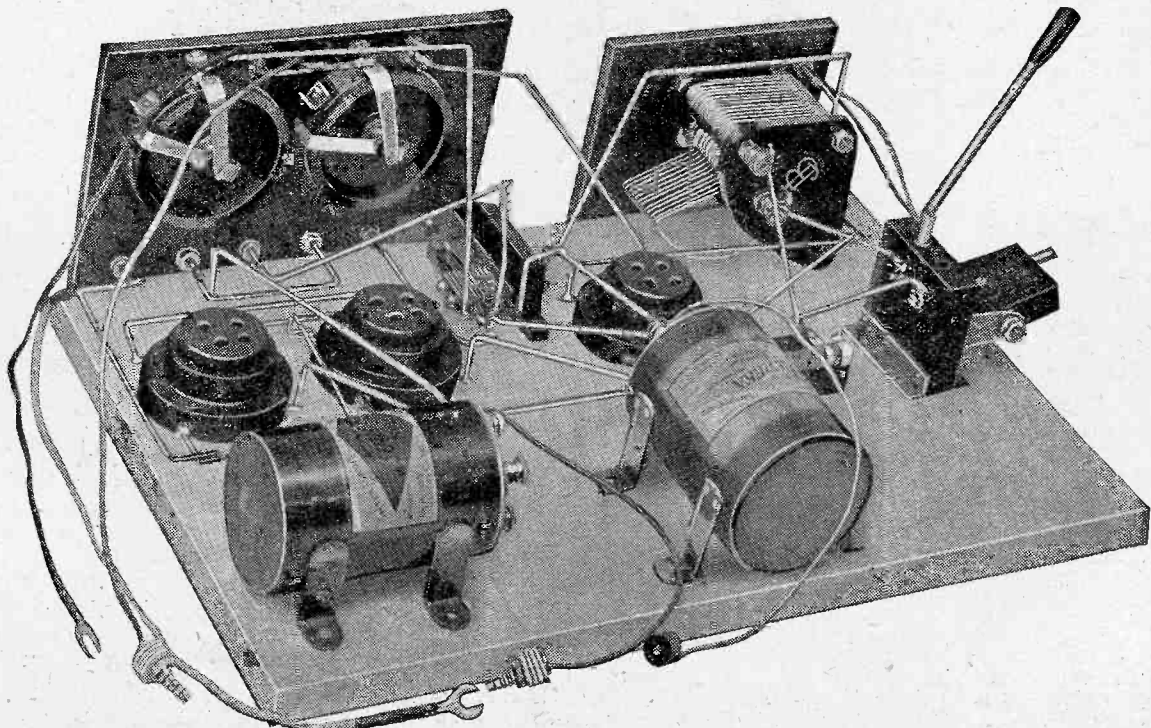

The above photograph shows the economy in ebonite effected in the construction of the receiver. Used in conjunction with Fig. 4, wiring up should be an easy matter.

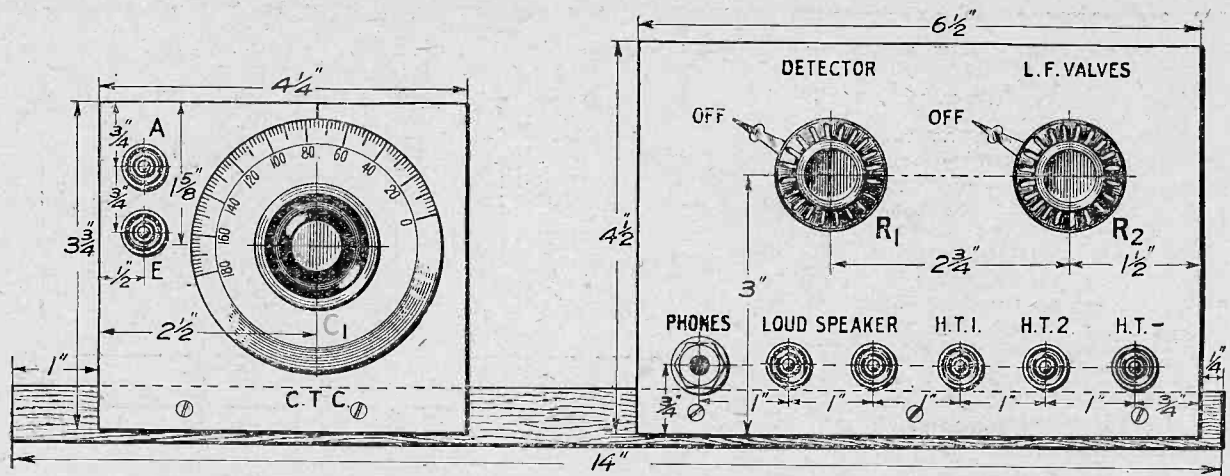

Fig. 3.—This drawing shows the dimensions of the small panels used and the positions at which they are fixed to the baseboard.

- other makes can be used (Burn-dept, Ltd.).
- 2 Filament resistances. These should be suited to the valves it is intended to use; for bright emitters 6 ohms is a usual value, for dull emitters 30. Those used were actually 35 ohms (Rothermel).
- 1 Double contact filament control jack (G.R.C.).
- 1 Telephone plug (G.R.C.).
- 1 Eureka Concert Grand L.F. transformer and
- 1 2nd stage Eureka L.F. transformer (Portable Utilities).
- 1 Grid battery, tapped 1 1/2 volts (Ever-Ready).
- 1 Piece of ebonite approximately 4 1/2 in. by 3 3/4 in. by 1/4 in.
- 1 Piece of ebonite approximately 6 1/2 in. by 4 1/2 in. by 1/4 in.

- 1 Wooden base board 14 in. by 8 1/2 in. by 3/4 in.
- 7 Nickel plated terminals.
- 1 Set of Radio Press panel transfers.
- 3 Clix or wander plugs, 4 spade tags, some rubber flex and square tinned copper wire, 16 gauge hard drawn for connecting up, and a few 1/2 in. No. 3 wood screws.

**Making the Set**

The construction of this receiver is not only a simple straightforward matter, but also a quick one, owing to the disposition of parts and the fact that it is laid out on a baseboard without any ebonite panel. Another advantage of the form of construction used is, that if the constructor wishes to strip the

receiver down and use the parts in another set, it can be done very easily and quickly, and further he is not left with a large piece of ebonite full of holes.

**Mounting Components**

The first thing to do is to mount the tuning condenser and aerial and earth terminals on the smaller piece of ebonite which must be free from surface leakage. If the constructor is at all doubtful let him remove the surface first with No. 0 glasspaper, rubbing both sides down carefully. In the latter case the transfers should be affixed before the original black finish of the panel is restored by wiping it over with a slightly oily rag. Next the filament resistances, terminals and jack are mounted on the other piece of ebonite, and both are fixed to the baseboard at the positions shown in Figs. 3 and 4. These drawings are exactly to scale and the dimensions will enable the lay-out to be followed exactly in mounting the other components on the baseboard. Little or no difficulty should be experienced in soldering the various connections. Permanent leads have been connected for the L.T. battery; these have spade tags on their ends. The two flexible leads to the moving coil-holder also have spade tags soldered on so that the connections to the aerial-reaction coil may be reversed if necessary.

**Hand Capacity**

The run of the lead from the earth terminal to the jack should be carefully copied as this helps materially in eliminating hand capacity effects when tuning in. In case the connections to the jack should give rise to any

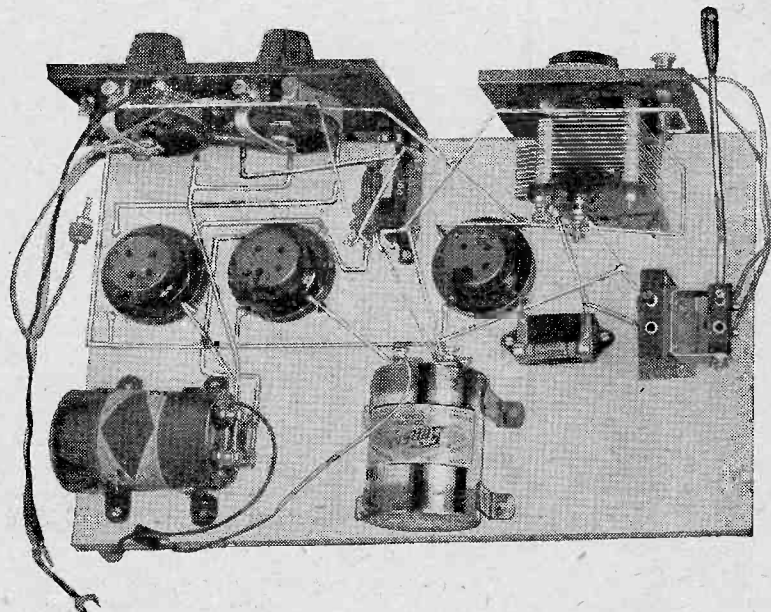

A useful photograph which illustrates the simple arrangement of the components on the baseboard.

# STERLING SQUARE LAW CONDENSERS

These Condensers banish all tuning troubles. The wave-length curve is a straight line, i.e., the wave-length is directly proportional to the number of degrees through which the knob is turned. This gives much greater ease of tuning, a fact readily appreciated by any radioist.

The end plates are of reinforced insulating material, and the vanes are of brass. Made in three capacities, either with or without Vernier attachment. A small knob controls the latter independently of the other vanes.

Sterling Square Law Condensers are unrivalled for use in receiving sets and are specially recommended for use in the construction of wave-meters and other radio measuring instruments. Compare them at your dealer's and note their accuracy and finish.

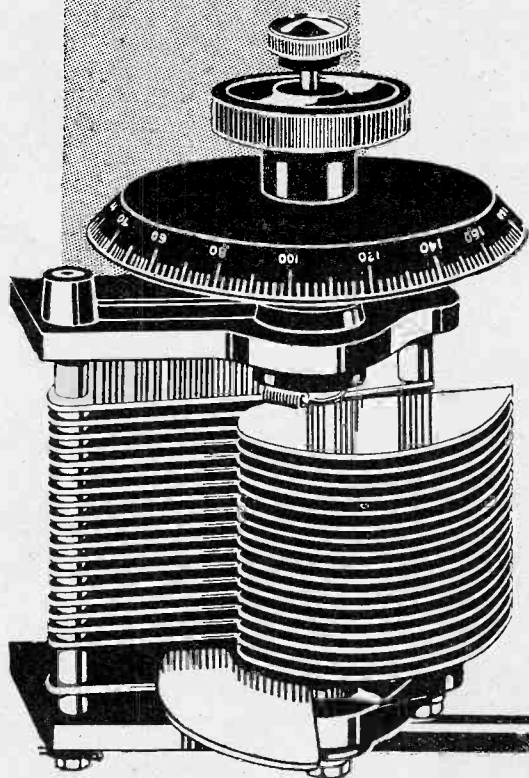

## Panel Types

With Vernier Adjustment (as illustrated)			Without Vernier Adjustment		
No.	Capacity	Price	No.	Capacity	Price
R.2724	.00025 mfd.	£1 3 0	R.2729	.00025 mfd.	£1 0 0
R.2725	.0005 mfd.	£1 5 6	R.2730	.0005 mfd.	£1 2 6
R.2726	.001 mfd.	£1 10 6	R.2731	.001 mfd.	£1 7 6

## For Tuning H.F. Amplifying Circuits

No.	Capacity	Price
R.2740	.00025 mfd. (each unit)	For two stages - £1 7 6
R.2743	.00025 mfd. (each unit)	For three stages - £1 15 0

## Enclosed Type in Metal Case

Specially recommended for experimenters or laboratory use. Rigidly mounted on a heavy cast aluminium plate, in which special provision has been made for the insulation of the fixed vanes. The moving vanes are electrically connected to the metal casing, which thus forms an adequate screen.

A fine index, secured to the spindle, works over an accurately engraved ivory dial, and thus enables exact readings to be taken. Two ebonite shrouded terminals are provided. N.P.L. Certificate will be supplied at extra cost if desired.

With Vernier Adjustment.			Without Vernier Adjustment.		
No.	Capacity	Price	No.	Capacity	Price
R.2733	.00025 mfd.	£2 2 6	R.2737	.00025 mfd.	£1 19 6
R.2734	.0005 mfd.	£2 5 0	R.2738	.0005 mfd.	£2 2 0
R.2735	.001 mfd.	£2 10 0	R.2739	.001 mfd.	£2 7 0

*Your Radio Dealer can supply*

Agents of **STERLING TELEPHONE & ELECTRIC CO., LTD.** Manufacturers of Telephones and Radio Apparatus, etc.  
210-212, TOTTENHAM COURT ROAD, LONDON, W.1. WORKS: DAGENHAM, ESSEX.

*Do this for increased  
Volume and Clarity*



JUST take out your last L.F. stage valve and insert a Mullard D.F.A. MASTER VALVE. You will be delighted with the immediate increase in volume and clarity from your loud speaker. The special construction of these Master Valves gives powerful and pure amplification and yet requires *LESS* current than your present valves.

If you use a 4-volt accumulator,  
ASK FOR A MULLARD D.F.A.0 (.35 amp.), Price 26/-

If you use a 6-volt accumulator,  
ASK FOR A MULLARD D.F.A.1 (.2 amp.), Price 30/-

If you use dry cells (6 volts),  
ASK FOR MULLARD D.F.A.3 (.06 amp.), Price 32/-

*Leaflet V.R. 23 gives full technical information.*

# Mullard

## THE • MASTER • VALVE

*Advt.—The Mullard Radio Valve Co., Ltd. (M.W.), Nightingale Works, Balham, S.W. 12.*

*In replying to advertisers, use Order Form enclosed.*

difficulties, Fig. 5 shows an enlarged view of this component with the points to which the leads go clearly marked. The numbers on the contacts correspond with those shown in the wiring diagram. A full size blue print of this wiring diagram (No. 113) may be obtained from our Sales Department for 1s. 6d. post free and will be found of great help in following the scheme of connections employed.

**Testing Out**

Having checked over the wiring the set may now be connected up. Place the filament resistances in the off position, insert a No. 35 or 50 coil into the aerial socket, a 50 or 75 into the secondary and connect the L.T. battery. Place the valves in the three holders and turn them up to the correct brightness by means of the filament resistances. Now place the 'phone plug in

the jack and the last two valves should go out. If all is well connect the H.T. leads and the loudspeaker leads to their respective terminals, the valves having been turned off first. A suitable value of H.T. for the detector valve is 20-40 volts and for the two L.F. valves 80-120 will be correct according to the type of valves used. The three Clix should be plugged into their sockets in the grid battery, using a common bias potential to begin with of about 3 volts. With the 'phones plugged in and  $L_1$  well away from  $L_2$ , turn up the detector valve to the correct working temperature. Now tighten the coupling between the two coils whereupon the set should go into oscillation. If this does not occur the leads to the moving coil-holder should be reversed. It is important that this test be carried out with the aerial and

earth leads disconnected for it will be found that with these connected to the set it can sometimes be made to oscillate even with the moving coil connected the wrong way round.

**A Warning**

The aerial and earth leads should now be connected and a very important warning must be noted here. If the reader has any system in which one side of the L.T. battery is earthed, this earth lead must be broken, otherwise the H.T. circuit will be completed through the earth, and will not apply any P.D. to the plate of the first valve. Not only will a heavy current be taken from the H.T. battery but the sudden "make" may cause a large surge in the windings of the first L.F. transformer. The L.T. battery should therefore be carefully insulated.

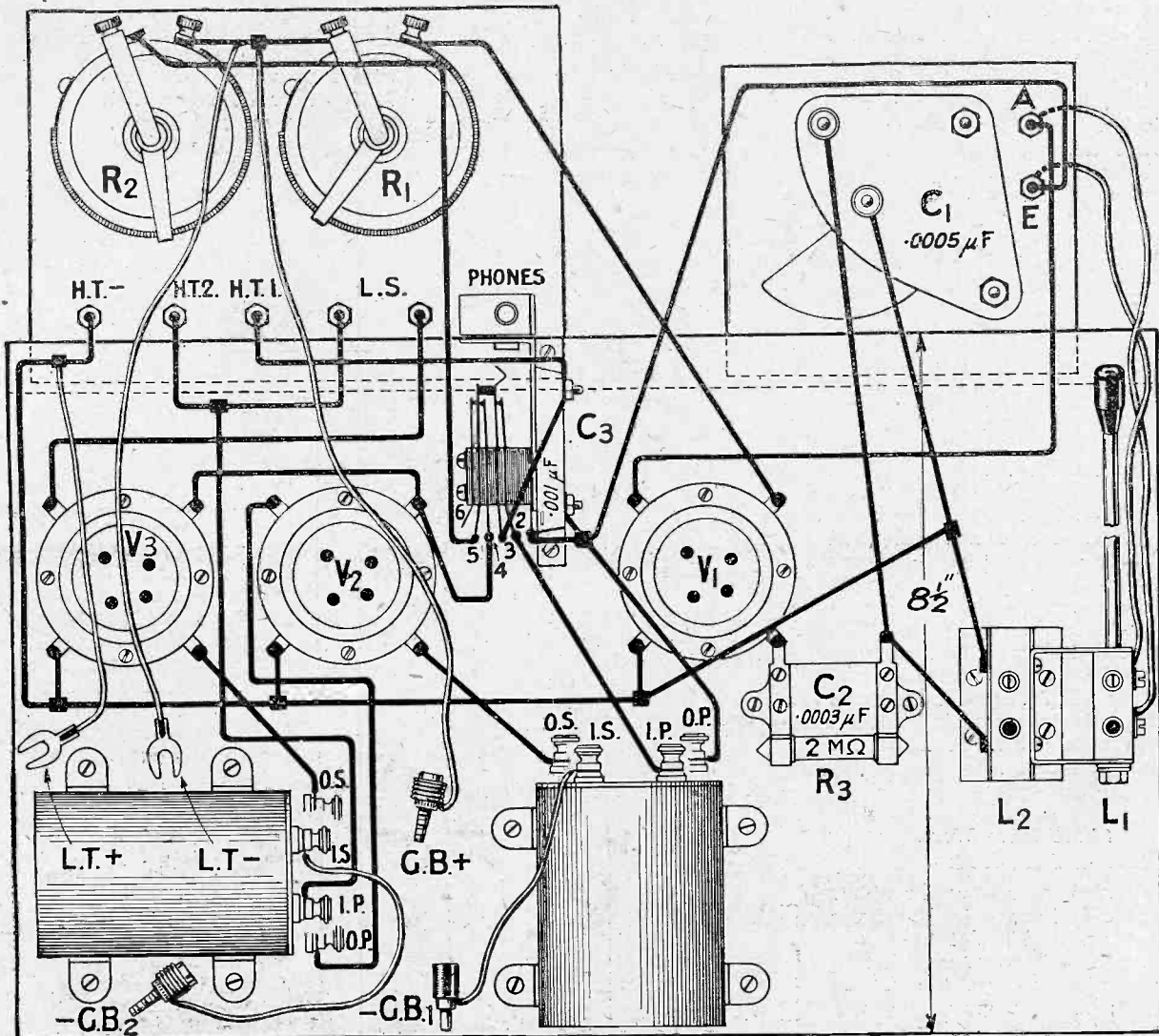

Fig. 4.—The chief feature of this wiring diagram is its simplicity. The numbers on the jack contacts correspond with those shown in Fig. 5. (Blue Print No. 113).

**Operating Notes**

With the aerial coil at about 30 degrees from the secondary, the local station may be tuned in. Searching for other transmissions will be found a curious business at first for the receiver is quite different to handle from any other. In some cases it may be found that it is necessary to tighten the aerial-reaction coupling in receiving other stations, and it may be found in most cases that there is one position of the tuning condenser at which the set oscillates least, either side of this less reaction being required. With fairly tight coupling between the two coils it will be found that variations in coupling will affect the tuning much more than when the coupling is loose, and in general it will be found that best results are obtained with very loose coupling, depending on the makes of coils employed. Tuning will be found to be fine as the receiver is rather selective.

The sizes and relationship in size of the two coils is not very critical, but different coils should be tried out to see which give the maximum selectivity and ease of reaction control. On the writer's aerial a No. 25 or Gambrell "A" in the aerial gave excellent results being markedly more selective than a larger size coil. Different valves should also be tried out as detector, as with some it may be found that there is a certain amount of "backlash" which makes it difficult to get the best results. If difficulty is experienced in making the set oscillate it may be necessary to increase the H.T. voltage applied to the anode of the detector-valve, and if this still fails to produce the desired result a small fixed condenser may be placed in series with the aerial, as the failure to get the set to oscillate may be due to excessive damping. The value of this condenser may be .0003  $\mu$ F or even .0001  $\mu$ F as is used for C.A.T. (constant aerial tuning). Further reaction control may be obtained by means of the filament resistance.

**Short Wave Work**

The receiver can be used very successfully for short wave reception. In this case it may be necessary to use an aerial detuning coil or a small series condenser before it is possible to get the set to oscillate; the coil may consist of about 30 turns of 18 S.W.G. d.c.c. copper wire wound on a former 3 in. in diameter and a simple

means of making the series condenser is to take a length of twisted flex, one wire of which is connected to the aerial and the other to the aerial terminal of the set. This gives very little diminution of signal strength, and the use either of the detuning coil or condenser throws the aerial out of tune

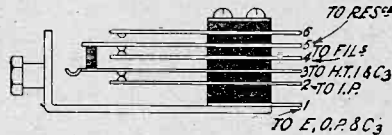

Fig. 5. This sketch will prove helpful in connecting up the jack.

and the receiver will oscillate freely over the whole wave band covered by the tuning condenser. In the writer's case loudest signals were obtained by raising the plate voltage of the detector to the value necessary to get the set to oscillate and not using the detuning coil or series condenser.

**L.F. Oscillation**

Should there be any tendency for a high pitched whistling noise to develop when both stages of L.F. are switched in the two cores of the transformers should be connected together and to earth.

When used on the broadcast

wavelengths care should be taken not to let this set oscillate as it is a rather powerful radiator and nearby listeners may be seriously interfered with.

The writer would be very pleased to receive reports from readers who make up this set, so as to obtain some idea of its performance and range under differing conditions.

**Test Report**

The receiver was tested out thoroughly on an aerial about 6 miles N.W. of 2LO, the aerial being a short one badly screened and situated in a locality not noted for good reception conditions. Results varied of course on different nights but those given will give an idea of what this receiver is capable. There was little difference in signal strength using either a 50 or 75 coil in the secondary; what there was, was in favour of the larger coil. Further to the results obtained on the broadcast wavelengths the following American amateurs were received on the loudspeaker during a half hour's test made on the short waves:— 1BD, 3HJ, 2BO, 1CM, 1AM, and 2BRC. KDKA was received at medium strength in the loud speaker, and WGY was also found on the 40-metre wave but was very faint and swinging badly, sometimes fading out completely.

Name of Station.	Condenser in degrees.		Results.
	With 50 coil.	With 75 coil.	
Unidentified	65		Fair loudspeaker.
"		32	Good loudspeaker.
"	70		Full loudspeaking.
French station	80		Good loudspeaker.
Cardiff	94	40	Strong in 'phones.
2LO London	100	44	Loudspeaker slightly overloaded.
Manchester	108	50	Fair loudspeaking, strong interference from 2LO.
Bournemouth		55	Good in 'phones, but badly interfered with by 2LO.
Unidentified	121		Fair loudspeaker strength; a little interference from 2LO.
Newcastle	125	61	Full loudspeaking, 2LO just audible in background.
German station		64	Medium loudspeaker strength.
Glasgow	133	68	Fading badly; sometimes fair loudspeaker.
Belfast	140	75	Medium loudspeaker.
FPTT	147	80	Weak loudspeaker, strong in 'phones.
Birmingham		89	Medium loudspeaker.
Aberdeen		95	Fair in 'phones.



# A GILT EDGED SECURITY

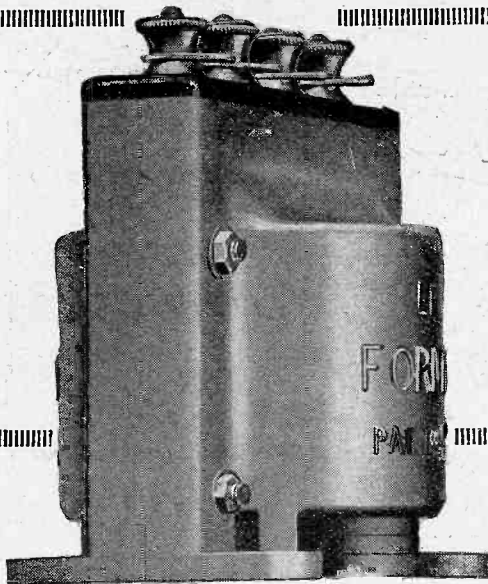

## -a Pioneer Product

We have considerable satisfaction in reviewing the period during which Radio has become a popular science. As the pioneer manufacturers—the first makers of L.F. Transformers to back our product with an unconditional guarantee—we feel immensely proud to take count of the many, many thousands of Famous Formo L.F. Transformers which are in daily use.

We have characterised the purchase of some types of L.F. Transformers as being a great adventure. It can be speculative or otherwise . . .

Successful transformer manufacture—and truly successful is the Famous Formo—is made up of tireless research and fearless originality combined with an untiring capacity to make improvements upon what hitherto was considered faultless.

And this reveals the combined effort exemplified in the Famous Formo. The Famous Formo L.F. Transformer is the greatest example extant of combined excellence; technically, electrically and mechanically.

Those experimenters who have learnt wisdom at the cost of bitter disappointment build the Famous Formo L.F. Transformer into each progressive set.

They know only too intimately that the search for good speech and music reproduction ends abruptly—it begins and ends with the Famous Formo L.F. Transformer.

**Price 10/6**

The standard turn ratio is 5-1, which is advised for the first stage. Lower ratios for succeeding stages are obtainable; 3-1 for the second is strongly approved. Effectively shrouded against electrical interaction.

## The FORMO COMPANY

(ARTHUR PREEN & CO., LTD.)

Contractors to the Admiralty, War Office, India Office, Air Ministry, and Post Office.

Chief Office and Works:  
CROWN WORKS, CRICKLEWOOD LANE, N.W.2.

### Resident Representatives:

Scotland: Mr. Miller, 22, York Place, Edinburgh.  
Manchester: Mr. J. B. Lever, 23, Hartley Street, Levenshulme.  
Birmingham: Mr. H. E. Crocker, 134, Reservoir Road, Edingtoan.

Barclays 1013

# MINUTE ADJUSTMENTS

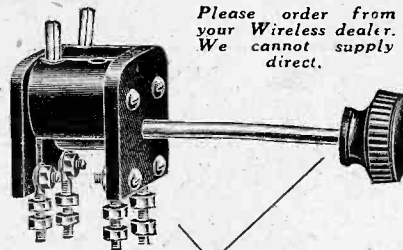

Please order from your Wireless dealer. We cannot supply direct.

No. R.C. 50/4  
2-way each 5/-

No. R.C. 50/5  
3-way each 7/6

# DUCCO

## VERNIER COIL HOLDER

Permits of remarkably fine adjustment. Vernier Control is continuous with an entire absence of backlash. The rubber ring affixed to control spindle engages firmly with the circular coil holder and provides for flexibility of transmission and minute adjustment. Polished ebonite with plated fittings. Connections are enclosed within the holder and led down to the securing screws, thus obviating loose and broken wires.

# Brown Brothers

— Allied Companies —  
THOMSON AND BROWN BROTHERS LTD  
BROWN BROTHERS (IRELAND) LTD

WHOLESALE ONLY. Head Offices and Warehouses:  
GREAT EASTERN STREET, LONDON, E.C.2.  
118, George St., EDINBURGH, and Branches.

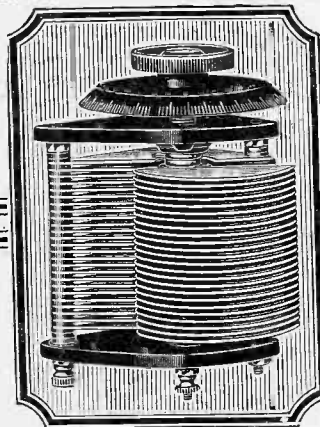

## More about Losses !

In choosing a variable condenser, be sure that its dielectric losses are extremely low. Losses can prevent oscillation on the lower degrees of the scale, can absorb energy, and reduce the effective range of your receiver, and generally cause complete inefficiency of your receiver.

Therefore, examine a variable condenser and observe just how much material can introduce losses. Take end plates for example—notice the thickness! The ebonite comprising the end plates should not be thicker than is consistent with the tensile strength, rigidity, and freedom from any tendency to warp.

Remember, therefore, that the variable condenser you purchase and build into your sets should have guaranteed ebonite end plates no thicker than is built into J.B. Instruments! These truly give extremely low losses and the utmost tuning efficiency.

From all dealers throughout the world, or in cases of difficulty, send direct to the manufacturers. Post:—One, 6d.; Two, 9d.; Three, 1s.



Look for the Trade Mark. Indicative of perfect tuning.

SQUARE LAW			
.001	9/6	.00025	6/9
.00075	9/-	.0002	5/6
.0005	8/-	.0001	5/3
.0003	6/9	Vernier	4/6
STANDARD			
.001	8/6	.00025	5/9
.00075	8/-	.0002	5/-
.0005	7/9	.0001	4/9
.0003	5/9	Vernier	4/-

# JACKSON BROS.

8, POLAND ST- OXFORD ST  
LONDON - W.1.  
(First Floor)

Telephone: GERRARD 7414

Barclays 999.

In replying to advertisers, use Order Form enclosed.

# “CLARKE'S ATLAS” LOW LOSS COILS

PATENT NO. 215053.

## USED BY EXPERTS.

These five receivers are shown by the courtesy of the Publishers of *Modern Wireless* and *Wireless Weekly*. Chosen almost at random, they represent a few only of the many in which the foremost Radio designers of the day have used “ATLAS” Coils. The nearest to no-loss is “ATLAS” Low-Loss. Lowest loss means highest efficiency, and Clarke's “ATLAS” Low-Loss Coils are a revelation even to the man with wide experience of modern coil design.

The patent twin-wire winding means a double-surface path for H.F. Currents, and the whole design of an “ATLAS” Coil ensures DISTANCE, SELECTIVITY, and VOLUME. Clarke's “ATLAS” Low-Loss Coils are master-keys to distant stations.

To hear more stations with greater ease; to get louder signals with less interference, plug in Clarke's “ATLAS” Low-Loss Coils and conserve every particle of energy received on the aerial.

**H. CLARKE & Co. (Mcr.) Ltd.**  
Radio Engineers, ATLAS WORKS,  
OLD TRAFFORD, MANCHESTER.

'Phones: Trafford Park, 683 & 793.  
'Grams: "Pvtloid, Manchester."

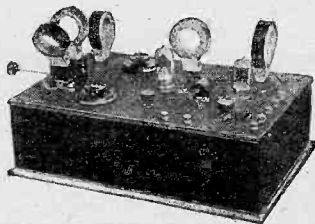

Two-valve and Crystal Receiver using the ST152 Circuit. From WIRELESS WEEKLY, Nov. 5, 1924.

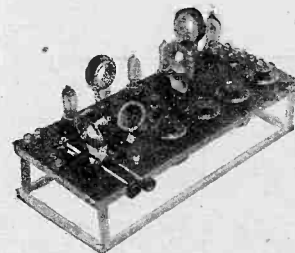

Multi-stage high-frequency amplification. From MODERN WIRELESS, Sept., 1924.

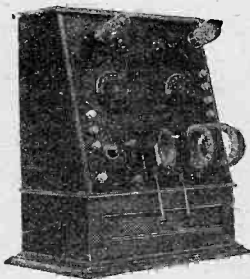

Two-valve Double-reaction Receiver. From MODERN WIRELESS, Sept., 1924.

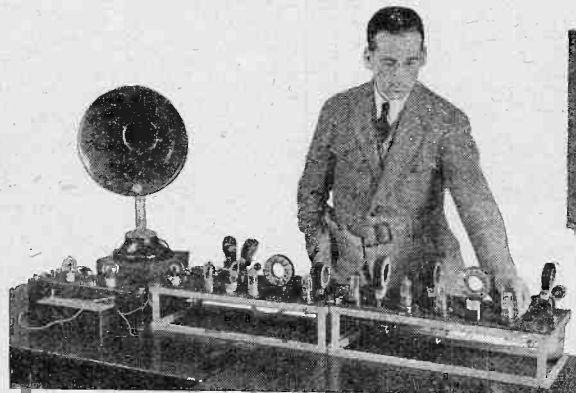

A Ten-valve set using seven stages of T.A.T. high-frequency amplification. From MODERN WIRELESS, Nov., 1924.

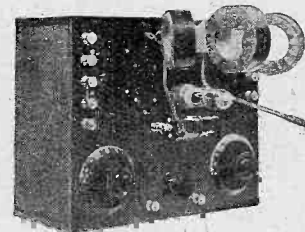

A Tri-Coil Reflex for Dry Cells. From MODERN WIRELESS, Sept., 1924.



# Regular Programmes from Continental Broadcast Stations

Edited by CAPTAIN L. F. PLUGGE,  
B.Sc., F.R.Ae.S., F.R.Met.S.

All Hours of Transmissions reduced to British Summer Time.

Ref. No.	B. S. T.	Name of Station.	Call Sign and Wave-length.	Situation	Nature of Transmission.	Closing Time or Approx. Duration.	Approx. Power used.
<b>WEEK DAYS.</b>							
	a. m.						
1	6.59	Hamburg	— 395 m.	Germany	Time Signal in C.E.T. and Exc	5 mins.	1.5 Kw.
2	7.40	Eiffel Tower	FL 2600 m.	Paris	Weather Forecast	5 mins.	5 Kw.
5	7.55	Persbureau Vaz Dias	PCFF 2125 m	Amsterdam	Stocks, Shares and News	10 mins.	2 Kw.
4	8.05	Lausanne	HB2 850 m.	Switzerland	Weather Report	5 mins.	300 Watts.
211	9.00	Radio-Wien	— 530 m.	Austria	Market prices	10 mins.	1 Kw.
9	9.55	Persbureau Vaz Dias	PCFF 2125 m	Amsterdam	Stocks, Shares and News	10 mins.	2 Kw.
8	10.23	Eiffel Tower	FL 2650 m...	Paris	Time Signal in G.M.T. (Spark)	3 mins.	60 Kw.
11	10.30	Lyons	YN 505 m.	Lyons	Gramophone Records	30 mins.	300 Watts.
10	11.00	Eiffel Tower	FL 2650 m...	Paris	Time Signal in Greenwich Sidereal Time (Spark)	5 mins.	60 Kw.
156	11.00	Radio Wien	— 530 m.	Austria	Concert	12.50 p.m.	1.5 Kw.
180	11.15	Breslau	— 418 m.	Silesia	Weather Report—Exchange	10 mins.	1.5 Kw.
12	11.30	Kbel	— 555 m.	Prague	Exchange quotations	10 mins.	1 Kw.
13	11.44	Eiffel Tower	FL 2650 m.	Paris	Time Signal in G.M.T. (Spark)	3 mins.	60 Kw.
14	11.55	Eiffel Tower	FL 2600 m...	Paris	Fish Market Quotations—Cot- ton Exchange.	10 mins.	5 Kw.
15	11.55	Frankfurt	— 470 m.	Frankfurt	Time Signals in C.E.T. (spoken) followed by News	5 mins.	1 Kw.
	noon						
182	12.00	Leipzig	292 & 454 m.	Germany	Concert	12.50 p.m.	700 Watts.
184	12.00	Zurich	— 515 m.	Switzerland	Weather Report	5 mins.	500 Watts.
24	12.00	Persbureau Vaz Dias.	PCFF 2125 m.	Amsterdam	Stocks and Shares	8 mins.	2 Kw.
	p. m.						
17	12.10	Persbureau Vaz Dias.	PCFF 2125 m.	Amsterdam	Stocks and Shares	20 mins.	2 Kw.
18	12.14	Eiffel Tower	FL 2600 m.	Paris	Time Signal in Greenwich Time (spoken), followed by Weather Forecast.	5 mins.	5 Kw.
20	12.15	Voxhaus	— 505 m.	Berlin	Exchange Opening Prices	5 mins.	700 Watts.
30	12.30	Stockholm	SASA 430 m.	Sweden	Weather Forecast, followed by Exchange and Time Signal from Nauen.	1 p.m.	750 Watts.
32	12.30	Radio-Paris	SFR 1780 m.	Clichy	Concert followed by News	2 p.m.	8 Kw.
31	12.45	Persbureau Vaz Dias.	PCFF 2125 m.	Amsterdam	Stocks and Shares	10 mins.	2 Kw.
23	12.57	Nauen	POZ 3000 m.	Berlin	Time Signal in G.M.T. (Spark) This signal is relayed by Zu- rich and all German Stations except Frankfurt, Munich and Stuttgart.	8 mins.	50 Kw.
157	1.00	Zurich	— 515 m.	Switzerland	Weather Forecast, Shares, News	5 mins.	500 Watts.
33	1.00	Haeren	BAV 1100 m.	Brussels	Weather Forecast in French and English.	8 mins.	150 Watts
26	1.15	Geneva	HB1 1100 m.	Switzerland	Lecture	1.45 p.m.	300 Watts.
25	1.30	Kbel	— 555 m.	Prague	Exchange Quotations	10 mins.	1 Kw.
27	1.30	Lausanne	HB2 850 m.	Switzerland	Weather Reports, Time Signa- in C.E.T. and News	15 mins.	300 Watts.
34	2.00	Munich	— 485 m.	Bavaria	News and Weather Report	10 mins.	1 Kw.
35	2.00	Komarow	— 1800 m.	Czecho- Slovakia.	Stock Exchange and Late New	10 mins.	1 Kw.
37	2.15	Voxhaus	— 505 m.	Berlin	Stock Exchange News	5 mins.	700 Watts
39	2.45	Eiffel Tower	FL 2600 m.	Paris	Exchange Opening Prices (Sat. excepted)	8 mins.	5 Kw.

Ref. No.	B. S. T.	Name of Station.	Call Sign and Wave-length.	Situation.	Nature of Transmission.	Closing Time or Approx. Duration.	Approx. Power used.
<b>WEEK DAYS (Contd.)</b>							
181	p.m.	Breslau	— 418 m.	Silesia	News & Exchange Quotations	10 mins.	1.5 Kw.
40	3.30	Munster	— 410 m.	Westphalia	Stocks, Shares and News	10 mins.	1.5 Kw.
47	3.35	Eiffel Tower	FL 2600 m.	Paris	Exchange Quotations (Sat. excepted).	5 mins.	5 Kw.
38	3.40	Persbureau Vaz Dias.	PCFF 2125 m.	Amsterdam	Stocks, Shares and News	10 mins.	2 Kw.
48	3.55	Persbureau Vaz Dias.	PCFF 2125 m.	Amsterdam	Stock Exchange and News	10 mins.	2 Kw.
158	4.00	Zurich	— 515 m.	Switzerland	Hotel Baur au Lac Concert, Relayed.	6 p.m.	500 Watts.
202	4.00	Munster	— 410 m.	Westphalia	Concert	5 p.m.	1.5 Kw.
159	4.00	Radio-Wien	— 530 m.	Vienna	News followed by Concert	6 p.m.	1.5 Kw.
42	4.30	Frankfurt	— 470 m.	Germany	Light Orchestra	6 p.m.	1 Kw.
43	4.30	Konigsberg	— 463 m.	East Prussia	Light Orchestra (Wed. & Sat., Children's Hour).	6 p.m.	1 Kw.
44	4.30	Voxhaus	— 505 m.	Berlin	Concert, followed by News	6 p.m.	700 Watts.
46	4.30	Leipzig	292 & 454 m.	Germany	Concert	6 p.m.	700 Watts.
51	4.30	Radio-Paris	SFR 1780 m.	Clichy	Concert preceded and followed by News.	5.45 p.m.	8 Kw.
52	4.30	Eiffel Tower	FL 2600 m.	Paris	Exchange Closing Prices (except Saturday).	8 mins.	5 Kw.
160	5.00	Breslau	— 418 m.	Silesia	Light Orchestra	6 p.m.	1.5 Kw.
226	5.00	Stuttgart	— 443 m.	Wurtemberg	Concert	6.30 p.m.	1 Kw.
54	5.00	Radio-Belg.	SBR 265 m.	Brussels	Concert followed by News.	6 p.m.	2.5 Kw
186	6.00	Frankfurt	— 470 m.	Germany	Lectures	7.30 p.m.	1 Kw.
187	6.00	Hamburg	— 395 m.	Germany	Music or Lecture	7.00 p.m.	1.5 Kw.
162	6.00	Eiffel Tower	FL 2600 m.	Paris	Concert followed by News Bulletin	6.55 p.m.	5 Kw.
177	8.00	Radio-Barcelona	EAJI 325 m.	Barcelona	Concert	7.00 p.m.	650 Watts.
161	6.30	Munich	— 485 m.	Bavaria	Light Orchestra or Lecture	7.30 p.m.	1 Kw.
230	7.00	Komarow	— 1800 m.	Czecho-Slovakia	Lecture or Concert	8 p.m.	1 Kw.
222	7.00	Ryvang	— 1025 m.	Denmark	Concert, except Thurs. and Sat.	8.0 p.m.	—
57	7.15	Kbel	— 555 m.	Prague	Lecture	20 min.	1 Kw.
63	7.30	Stuttgart	— 443 m.	Wurtemberg	Lecture followed by Evening Programme	11 p.m.	1 Kw.
164	7.30	Radiofonica Italiana.	— 425 m.	Rome	Concert followed by News (Interval between 8.20 and 8.30).	9.30 p.m.	4 Kw.
58	8.00	Eiffel Tower	FL 2600 m.	Paris	General Weather Forecast	8 mins.	5 Kw.
188	8.00	Frankfurt	— 470 m.	Germany	Lecture	8.30 p.m.	1 Kw.
61	8.00	Konigsberg	— 463 m.	East Prussia	Concert and News	10 p.m.	1.5 Kw.
62	8.00	Hamburg	— 395 m.	Germany	Concert and Late News and Dance Music	11 p.m.	1.5 Kw.
229	8.00	Graz	— 404 m.	Austria	Concert	9.30	500 Watts.
226	8.00	Stuttgart	— 443 m.	Wurtemberg	Concert	9.0 p.m.	1 Kw.
234	8.00	Prague	— 570 m.	Czecho-Slovakia.	Concert	10 a.m.	1 Kw.
227	8.00	Kbel	— 555 m.	Prague	Evening Concert	10 p.m.	1 Kw.
74	8.15	Radio-Belg.	SBR 265 m.	Brussels	Concert preceded and followed by News.	10.10 p.m.	2.5 Kw.
66	8.15	Lausanne	HB2 850 m.	Switzerland	Concert (Monday excepted)	10.30 p.m.	300 Watts.
64	8.15	Zurich	— 515 m.	Switzerland	Concert followed by Late News	10 p.m.	500 Watts.
65	8.15	Leipzig	292 & 454 m.	Germany	Concert and News (3 days a week till 11.30 p.m.)	10 p.m.	700 Watts.
76	8.15	Radio-Paris	SFR 1780 m.	Clichy	Detailed News Bulletin	9 p.m.	8 Kw.
67	8.30	Frankfurt	— 470 m.	Germany	Concert and News	11 p.m.	1 Kw.
59	8.30	Munster	— 410 m.	Westphalia	Concert followed by News	10.45 p.m.	1.5 Kw.
72	8.30	Voxhaus	— 505 m.	Berlin	Concert followed by News and Weather Report	10.30 p.m.	1.5 Kw.
73	8.30	Munich	— 485 m.	Bavaria	Concert and News	11 p.m.	1 Kw.
69	8.30	Breslau	— 418 m.	Silesia	Concert	10 p.m.	1.5 Kw.
228	8.30	Hilversum	— 1060 m.	Holland	Concert	10.30	1.5 Kw.
60	8.30	Radio-Wien	— 530 m.	Vienna	Evening Programme	10 p.m.	1.5 Kw.
77	8.45	Radio-Paris	SFR 1780 m.	Clichy	Time Signal followed by Concert	9.50 p.m.	8 Kw.
78	9.00	Radio-Iberica.	RI 392 m.	Madrid	Concert and Advertisements.	Midnight	3 Kw.
75	9.30	Ecole. Sup.	FPTT 450 m.	Paris	Concert, sometimes preceded by Lecture, relayed every evening by Lyons on 505 m. using 500 Watts.	9 p.m.	500 Watts.

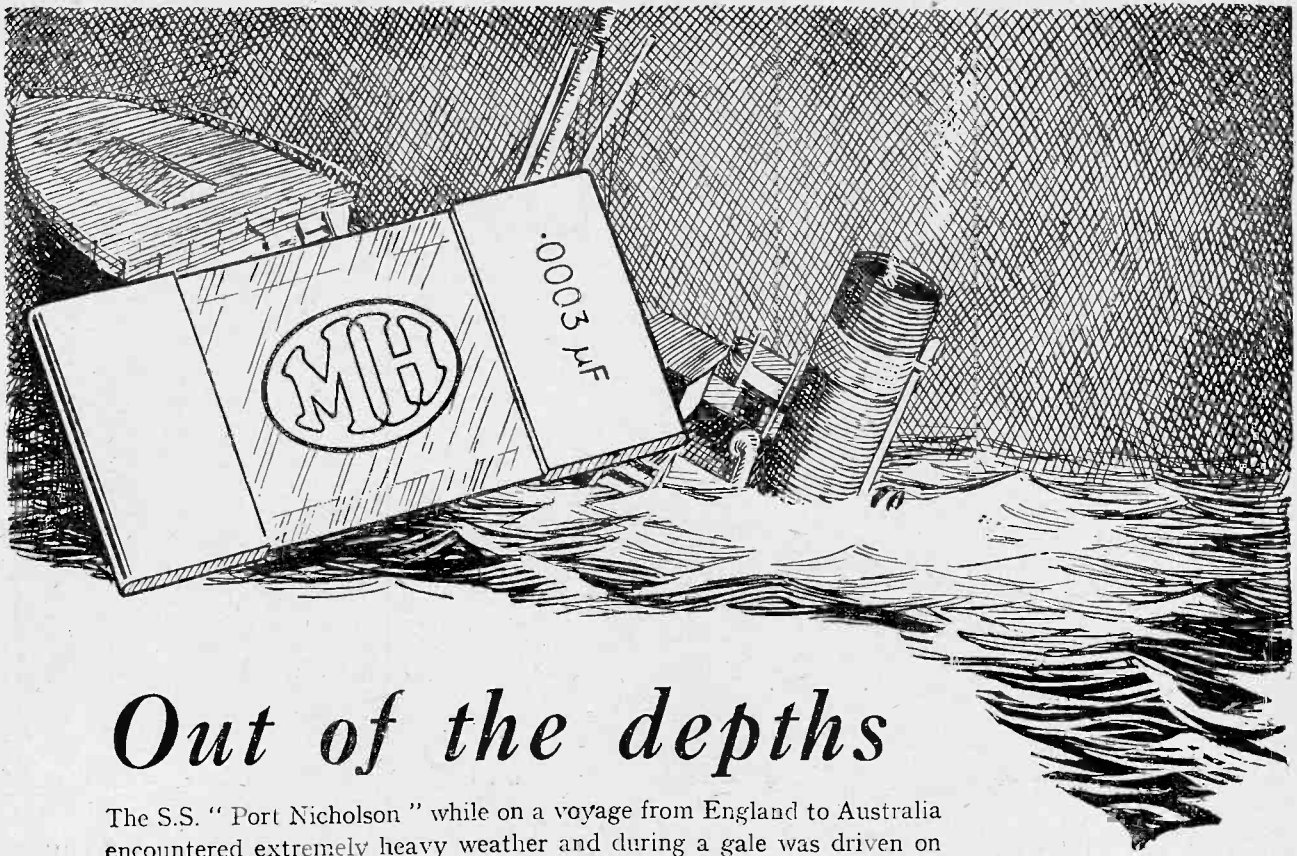

## Out of the depths

The S.S. "Port Nicholson" while on a voyage from England to Australia encountered extremely heavy weather and during a gale was driven on to a reef. The ship sank, but a portion of the cargo was eventually recovered. This included a valuable consignment of wireless apparatus from Messrs. L. McMichael, Ltd., to their agents in Melbourne for the Australian market. When the salvaged portion reached London, the underwriters sold it by auction and, as a matter of interest, we obtained samples of our consignment, and upon examination and practical tests of the **MH** Fixed Condensers which had been under water for some considerable time they gave the same perfect results as those obtained under factory tests before shipment.

This remarkable occurrence gives even further proof of the efficiency and durability of **MH** Fixed Condensers under conditions more stringent than any ever likely to be imposed upon them by their inclusion in your receiver.

Only the best materials are used in **MH** Condensers, high-grade ruby mica and heavy gauge tinfoil, ensuring long life and perfect satisfaction. The **MH** Condenser is one of the guaranteed products of the firm of Messrs. L. McMichael, Ltd.

**PRICES.**

Any value.  
 0.0001  $\mu$ F to 0.001  $\mu$ F,  
 1/9 each.  
 0.002  $\mu$ F to 0.01  $\mu$ F  
 2/3 each.  
 (Two clips are supplied  
 with each condenser)



**PRICES.**

Mounted on ebonite  
 base with terminals,  
 any value.  
 0.0001  $\mu$ F to 0.001  $\mu$ F,  
 2/9 each.  
 0.002  $\mu$ F to 0.01  $\mu$ F,  
 3/3 each.

Obtainable from all dealers.

Advertisement of L. McMICHAEL, LTD., Hastings House, Norfolk Street, Strand, London, W.C2

Barclays 1055

In replying to advertisers, use Order Form enclosed.

TWENTY-FIVE YEARS  MANUFACTURING EXPERIENCE

"ORMOND" "ORMOND" "ORMOND" "ORMOND" "ORMOND" "ORMOND" "ORMOND"

ENGINEERING COMPANY

Ormond Low Loss Condensers  
SQUARE LAW

See the Inspection Label on every Condenser.

A new departure in British Condenser design, giving the following advantages:

1. Practically negligible losses.
2. One-hole fixing—one 3/8 in. diam. hole is needed to fix this condenser to panel.
3. Rigid construction—cannot warp; end plates of stout aluminium, perfectly flat.
4. Fixed vanes supported by 1/4 in. ebonite strips.
5. Smooth action, spindle tension is maintained by a specially designed friction washer.
6. Moving vanes and end plates are at earth potential.
7. One-piece knob and dial—supplied loose. Secured by 4 B.A. Set Screw.

This Condenser is fitted with optional soldering Tags, or Terminals, and can be supplied with or without Vernier as desired.

There is no variation in price, the prices being the same as our ordinary Square Law Condensers.

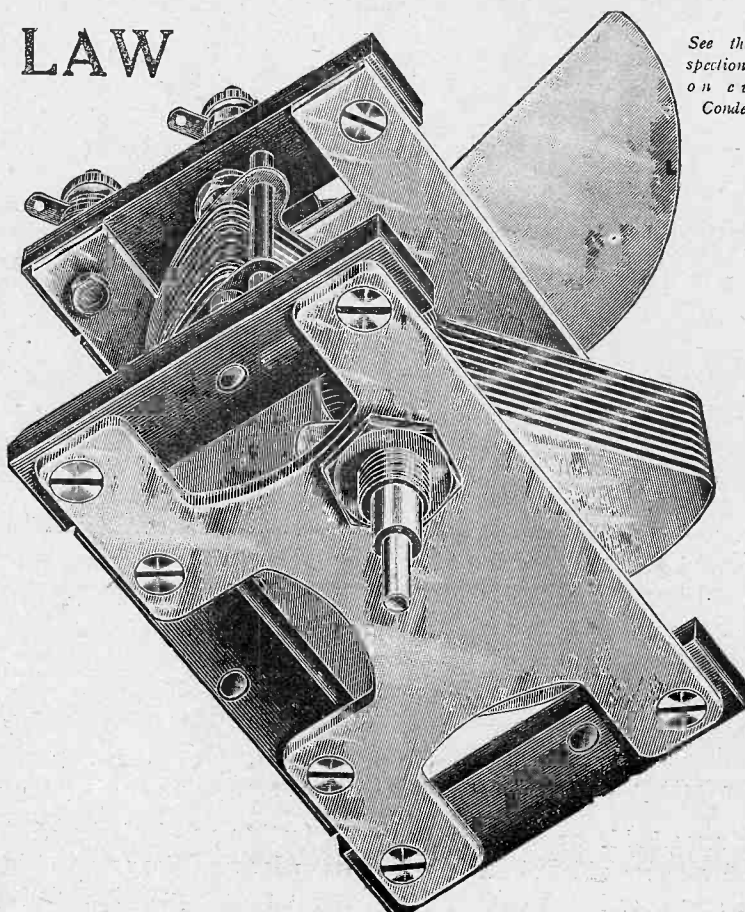

Supplied in the following sizes:—

Size.	Price with Vernier.	Price without Vernier.
.00025	8/-	6/6
.0003	9/-	7/6
.0005	9/6	8/-
.001	10/6	9/-

We specialise in turning Brass and Steel Screws and Machined Parts and Accessories of all descriptions.

All Cheques and Postal Orders should be crossed and made payable to "The Ormond Engineering Co."

Write for our new (1925) Catalogue.

TRADE TERMS ON REQUEST.

199-205, PENTONVILLE RD, KING'S CROSS, LONDON, N.1.

Factory:- Whiskin Street, Clerkenwell, E.C.1

THE BEST MEANS —  
ORMOND

Telegrams:- "ORMONDENGI, KINCROSS."

Telephone:- CLERKENWELL 9344 (3lines).

"ORMOND" "ORMOND" "ORMOND" "ORMOND" "ORMOND" "ORMOND" "ORMOND"

Ref. No.	B. S. T.	Name of Station.	Call Sign and Wave-length.	Situation.	Nature of Transmission.	Closing Time or Approx. Duration.	Approx. Power used.
<b>WEEK DAYS (Contd.)</b>							
79	p.m. 11.00	Eiffel Tower	FL 2650 m.	Paris	Time Signal in Greenwich Sidereal Time (Spark).	5 mins.	60 Kw.
80	11.10	Eiffel Tower	FL 2600 m.	Paris	General Weather Forecast	5 mins.	5 Kw.
81	11.44	Eiffel Tower	FL 2650 m.	Paris	Time Signal in G.M.T. (Spark)	3 mins.	60 Kw.
189	12.00	Radio-Barcelona	EAJI 325 m.	Barcelona	Concert	1 a.m.	650 Watts.
82	12.57	Nauen	POZ 3000 m.	Berlin	Time Signal in G.M.T. (Spark)	8 mins.	50 Kw.

**SUNDAYS.**

83	a.m. 8.30	Frankfurt	— 470 m.	Germany	Morning Prayer	1 hour	1 Kw.
85	9.00	Leipzig	— 454 m.	Germany	Morning Prayer	1 hour	700 Watts.
165	9.00	Konigsberg	— 463 m.	E. Prussia	Morning Prayer	9.45 a.m.	1.5 Kw.
212	9.00	Voxhaus	— 505 m.	Berlin	Morning Prayer	10 a.m.	700 Watts.
213	9.40	Bloemendaal	— 345 m.	Holland	Divine Service..	1 hour	—
86	10.00	Komarow	— 1800 m.	Czecho-Slovakia	Sacred Concert	1 hour	1 Kw.
87	10.23	Eiffel Tower	FL 2650 m.	Paris	Time Signal in G.M.T. (Spark)	3 mins.	60 Kw.
93	10.30	Lyons	YN 550 m.	Lyons	Gramophone Records..	11 a.m.	300 Watts.
89	11.00	Eiffel Tower	FL 2650 m.	Paris	Time Signal in Greenwich Sidereal Time (Spark).	5 mins.	60 Kw.
235	11.00	Prague	— 570 m.	Czecho-Slovakia	Sacred Music	12.0	1 Kw.
90	11.00	Kbel	— 1160 m.	Prague	Classical Music	1 hour	1 Kw.
92	11.00	Radio-Wien	— 530 m.	Vienna	Concert	12.50 p.m.	1.5 Kw.
191	11.15	Hamburg	— 395 m.	Germany	Sacred Concert	12.15 p.m.	1.5 Kw.
94	11.30	Stuttgart	— 443 m.	Wurtemberg	Classical Concert	1 hour	1 Kw.
192	11.30	Munich	— 485 m.	Bavaria	Sacred Concert	12.30 p.m.	1 Kw.
96	11.30	Konigswusterhausen	LP 2900 m.	Berlin	Concert	12.50 p.m.	6 Kw.
95	11.44	Eiffel Tower	FL 2650 m.	Paris	Time Signal in G.M.T. (Spark)	3 mins.	60 Kw.
97	11.55 noon	Eiffel Tower	FL 2600 m.	Paris	Fish Market Quotations, followed by Weather Report.	12 mins.	5 Kw.
214	12.00	Munster	— 410 m.	Westphalia	Morning Prayer	1.30 p.m.	1.5 Kw.
98	12.00 p.m.	Stockholm	— 440 m.	Sweden	Divine Service..	1.15 p.m.	500 Watts.
102	12.45	Radio-Paris	SFR 1780 m.	Clichy	Concert followed by News	2.00 p.m.	8 Kw.
101	12.57	Nauen	POZ 3000 m.	Berlin	Time Signal in G.M.T. (Spark)	3 mins.	—
233	2.50	Hilversum	— 1060 m.	Holland	Concert	4.50	1.5 Kw.
216	3.00	Lyngby	— 2400 m.	Denmark	News	10 min.	500 Watts.
108	4.00	Munich	— 485 m.	Bavaria	Concert	5.00 p.m.	1.5 Kw.
215	4.00	Munster	— 410 m.	Westphalia	Concert	5.30 p.m.	1.5 Kw.
104	4.00	Breslau	— 418 m.	Silesia	Children's Stories	4.30 p.m.	1.5 Kw.
105	4.00	Stuttgart	— 443 m.	Wurtemberg	Light Orchestra	6.00 p.m.	1 Kw.
107	4.00	Frankfurt	— 470 m.	Germany	Children's Corner	5.00 p.m.	1 Kw.
167	4.00	Zurich	— 515 m.	Switzerland	Local Hotel Concert	6.00 p.m.	500 Watts
106	4.00	Radio-Wien	— 530 m.	Vienna	Afternoon Concert, preceded by News.	6.00 p.m.	1.5 Kw.
168	4.30	Konigsberg	— 463 m.	E. Prussia	Lecture	5.00 p.m.	1.5 Kw.
169	4.30	Voxhaus	— 505 m.	Berlin	Light Orchestra	6 p.m.	1 Kw.
170	4.30	Leipzig	— 454 m.	Germany	Light Orchestra	6.00 p.m.	700 Watts.
217	4.40	Bloemendaal	— 345 m.	Holland	Divine Service..	5.40 p.m.	—
110	4.45	Radio-Paris	SFR 1780 m.	Clichy	Concert, followed by News	1 hour	8 Kw.
171	5.00	Frankfurt	— 470 m.	Germany	Light Orchestra	6.00 p.m.	1 Kw.
168	5.00	Konigsberg	— 463 m.	E. Prussia	Light Orchestra	6.00 p.m.	1.5 Kw.
111	5.00	Radio-Belg.	SBR 265 m.	Brussels	Concert	1 hour	2.5 Kw.
173	6.00	Frankfurt	— 470 m.	Germany	Lecture, followed by Evening Programme.	10.00 p.m.	1 Kw.
112	6.00	Eiffel Tower	FL 2600 m.	Paris	Concert, followed by News	1 hour	5 Kw.
219	6.00	Malmö	SASC 270 m.	Sweden	Concert	8 p.m.	500 Watts.
176	6.45	Copenhagen	— 750 m.	Denmark	Concert, followed by News	7.45 p.m.	2 Kw.
237	7.00	Komarow	— 1800 m.	Czecho-Slovakia	Lecture or Concert	8 p.m.	1 Kw.
126	7.40	Ned. Seintoesl Fabriek	NSF 1060 m.	Hilversum	Concert	10.10 p.m.	3 Kw.
114	8.00	Radio-Wien	— 530 m.	Vienna	Concert	10.00 p.m.	1 Kw.
118	8.00	Konigsberg	— 463 m.	E. Prussia	Concert	10.00 p.m.	1.5 Kw.
119	8.00	Hamburg	— 395 m.	Germany	Concert, followed by News	10.00 p.m.	1.5 Kw.

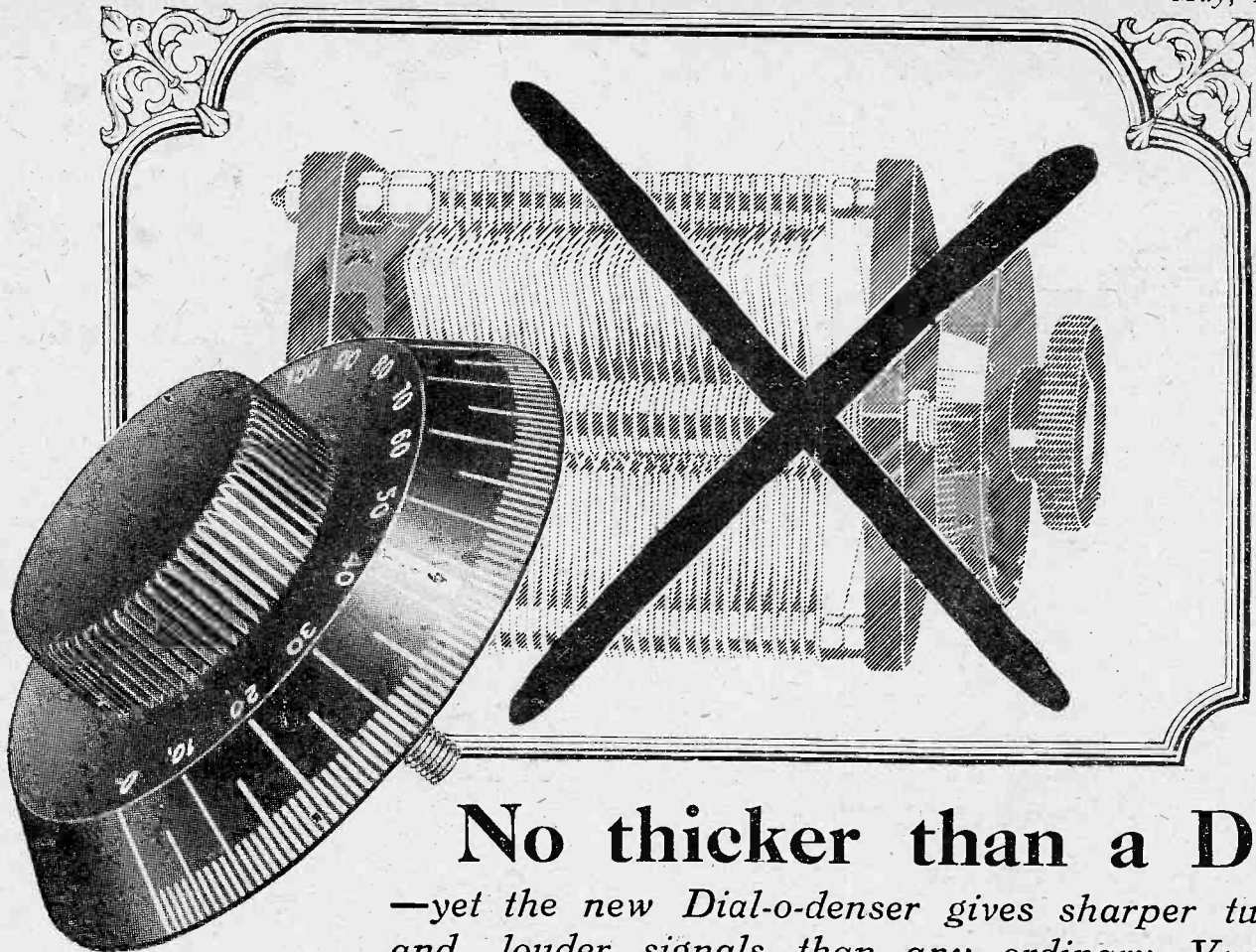

## No thicker than a Dial

—yet the new Dial-o-denser gives sharper tuning and louder signals than any ordinary Variable Condenser and requires no space behind the panel.

### Exclusive Dial-o-denser advantages.

1. A minimum capacity of 3 micro microfarads—the lowest of any variable condenser on the market.
2. All vanes—moving and fixed—totally enclosed and protected against dirt and dust.
3. A genuine low-loss Condenser through the elimination of oxidation losses.
4. Standard 2½ inch Dial no thicker than an ordinary Condenser Dial.
5. Permanent contact to moving vanes made by pigtail armoured connection.

Prices—

•003 10/- •005 10/- •001 12/6

**PORTABLE UTILITIES CO., Ltd.**

(Makers of the Eureka Transformer),  
FISHER ST., LONDON, W.C.1

EVERYONE who has examined this revolutionary Variable Condenser declares that its possibilities are enormous. No thicker than ordinary Dial with simple one-hole fixing, it can be used anywhere in the Set in place of the ordinary type of Variable Condenser. And because it is a true low-loss Condenser it will give better results—louder signals and more accurate tuning.

The Dial-o-denser is a multi-vane condenser with the minimum capacity of 3 micro-microfarads. Even if you are not a technical man you will appreciate that this is far lower than the ordinary variable condenser.

It is extremely low minimum capacity that makes the Dial-o-denser so efficient—and will very soon make it so popular. Consider for a moment—here is a variable

condenser with all the advantages of the finest standard condenser and no disadvantages.

A condenser that is fully guaranteed—that is accurate and cannot alter—that cannot be damaged in use—that is fully protected against dust and dampness—a condenser that costs no more, and in some cases even less, than a standard variable condenser with thick aluminium plates.

# Dial-o-denser

" THE CONDENSER WITHIN THE DIAL "



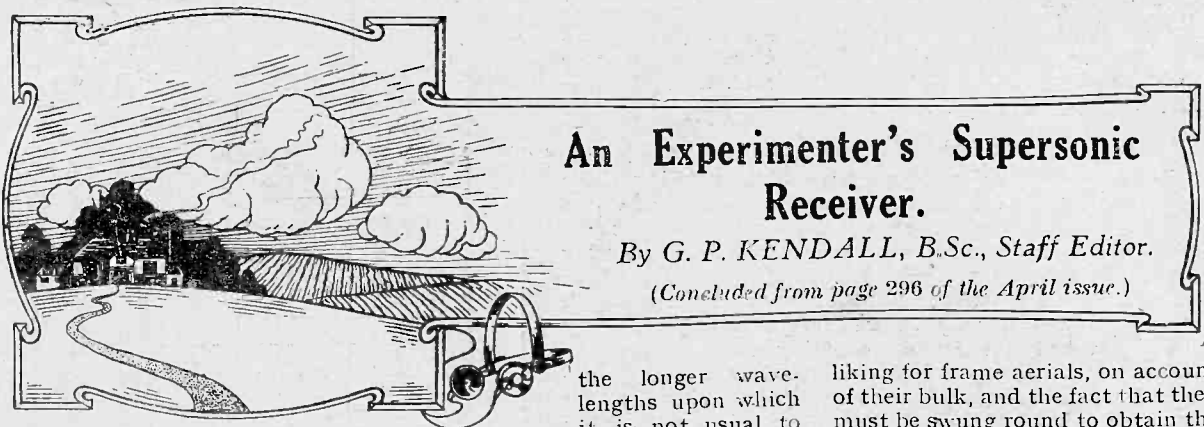

## An Experimenter's Supersonic Receiver.

By G. P. KENDALL, B.Sc., Staff Editor.

(Concluded from page 296 of the April issue.)

IT may be remembered that I concluded the first section of these notes by stating that it is desirable to wind for oneself the centre tapped coil for the oscillator, since it is difficult to locate this tapping upon an existing winding.

The best procedure is therefore to take a section of 3 in. diameter ebonite tube, 1½ in. long, and upon this wind 65 turns of No. 32 double silk covered wire. In the course of winding, twist a loop at the centre turn and in the two turns on either side of this, making five tapping points in all. The whole coil may be mounted upon a standard coil plug, which can be obtained from certain dealers complete with the small piece of ebonite or fibre attached, to which the coil tube can be bound by means of adhesive tapes, somewhat after the fashion employed and protected by Messrs. Burndept Wireless, Limited, as illustrated in one of the photographs which accompany this article (Fig. 1). It will be seen that the coil which I used is actually mounted upon a spare Burndept plug, since I happened to have this plug as a result of my misguided endeavours to locate the exact centre point upon a standard S5 coil.

### Receiving on long Wavelengths

The only other component requiring mention is the jack of the type which closes the filament circuit upon insertion of the plug, which is mounted near the right-hand bottom corner of the panel. This jack is wired in series in the anode circuit of the first detector valve, in order that a pair of telephones may be inserted here, and the filament controls switch on the filaments of both the valves of the unit. The object of inserting a pair of telephones here is simply to enable one to use this unit as a complete two-valve receiver in conjunction with the tuner, so that one can receive

the longer wavelengths upon which it is not usual to employ the whole super-heterodyne arrangement. All that is necessary is to stop the valve V<sub>2</sub> from generating local oscillations, and to insert a suitable plug-in transformer in place of the short-wave transformer T<sub>1</sub>. The set then functions in a perfectly normal manner, tuning being done upon the two condensers in the tuner, or upon one only, according to whether single or double circuit tuning is employed, and upon the transformer tuning condenser in the Tropadyne unit.

### Type of Aerial to use

The oscillator condenser C<sub>5</sub> can simply be set to a small value and ignored. Reaction can then be obtained upon the aerial circuit in the ordinary way, by removing the shorting plug from the reaction socket of the tuner and inserting

liking for frame aerials, on account of their bulk, and the fact that they must be swung round to obtain the loudest signals from any given station. No doubt the selectivity which they give is extremely pleasing, but where the selectivity of the receiving set itself is already very high it is certainly very much a matter of taste whether they should be employed or not.

My own personal preference is for an extremely small aerial of the indoor variety, consisting, in the case of this receiver, of about 6 ft. of flex, one of whose ends is attached to the picture rail and the other to the aerial terminal of the receiver. An ordinary outdoor aerial is not desirable, except perhaps for the first tests after finishing the set, since it brings in so much general noise that reception is extremely unpleasant. The ordinary earth connection is used, and the aerial tuning condenser is left in parallel, quite a large

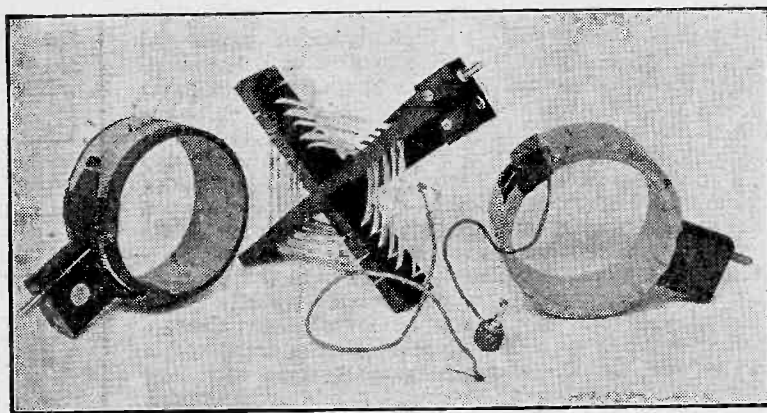

Fig 1.—The coil on the left is a home-made oscillator coil, and that on the right a centre-tapped S4 coil.

it in place of the reaction coil upon the oscillator coil holder.

We turn now to the question of the actual working of the complete installation, and the first point requiring attention is the matter of the aerial to be used and the aerial tuning arrangements. Personally, I have no very great

tuning coil being required, such as the Burndept S<sub>4</sub>, or the Gambrell B, other suitable sizes being any standard No. 50, or the Lissen No. 60. With this arrangement it will probably be found that the first high-frequency valve will oscillate quite readily when its anode circuit is tuned to the

incoming wavelength and the potentiometer is moved towards the negative end. Quite a nice control of reaction can be obtained in this way, the best method being to find the oscillation point and then shift the potentiometer some little way from it.

**The Long Wave Amplifier**

Before embarking on the question of the working of the complete set, the long wave amplifier must receive a little attention, and it should be explained that the method of intervalve coupling adopted has a very important bearing upon the quality of the results which will be obtained, varying between good signal strength and very poor quality of telephony, if an extremely sharply tuned intervalve coupling is employed, to poorer signal strength but good quality when an extremely aperiodic coupling is inserted. Evidently, one must strike some happy medium, varying in one direction or another according to one's personal likings, and also bearing in mind that it is quite possible to make the mistake of using some coupling which is very efficient upon the long wavelength employed, but which also permits of considerable amplification of low-frequency noises which may be coming through, thus making the whole set extremely noisy and unpleasant to operate.

**Intermediate Frequency Transformers**

Space does not permit me to go into this matter very fully, and I may say that such work as I have done leads me to think that it is better to sacrifice a considerable amount of signal strength to obtain quality and stability on the long-wave side, and this can be achieved with reasonable success by the use of transformers wound with a not very fine gauge of resistance wire, in order to introduce the necessary damping into the circuits. It must be borne in mind that the object of introducing damping into these windings is to flatten out the resonance peak of the transformers so that the side frequencies of a telephony carrier-wave are fairly well covered in order that reasonably good quality of reproduction may be obtained.

When I commenced the construction of this receiver none of the British manufacturers had placed upon the market a transformer specially intended for super-heterodyne work, and I tried various improvised transformers, obtaining quite good results with some very much resembling the ordinary plug-in type for the 2,000 to 7,000 metres waveband, specially wound with resistance wire. One of the advantages of the experimental receiver which we are considering is that it gives one the power to try various types of intervalve coupling, provided that any unit which it is desired to test is mounted upon some form of plug-in base, so that it may be plugged into a socket upon the long-wave amplifier. This feature is one possessing considerable advantages from the point of view of the experimenter who desires to try alternative methods, and will no doubt be valuable in view of the fact that it is to be expected that a considerable number of British wireless manufacturers will now devote their attention to super-heterodyne transformers, in view of the increasing popularity of the circuit. There will no doubt be considerable differences in the efficiency of the transformers produced, and it will probably prove desirable to try them for oneself under working conditions. Some of the transformers which appear upon the market will no doubt be of the self-tuned type, in which the resonance peak is adjusted by the manufacturers to some arbitrary value, and with these, of course, the triple condenser will not be needed. It can be cut out of circuit by means of the three single-pole switches provided upon the amplifier. It will no doubt be found interesting to try one or more of these transformers in conjunction with a stage of resistance-capacity coupling; for example,

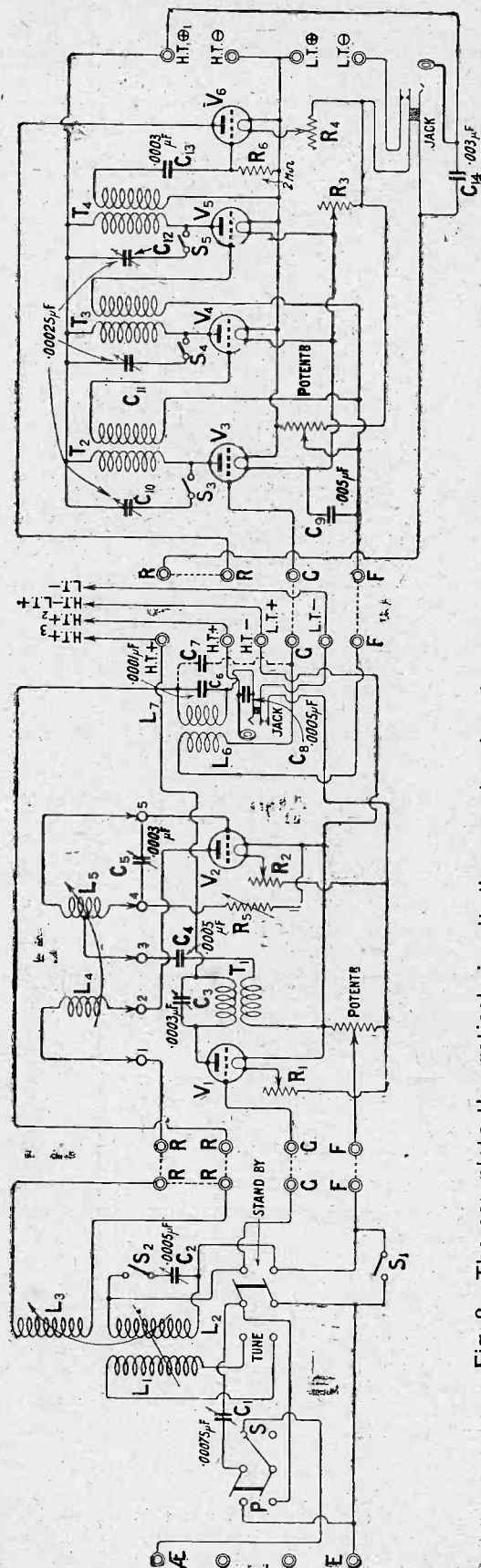
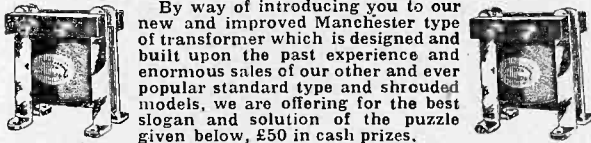

Fig. 2.—The complete theoretical circuit diagram showing the method of connecting the three units.

Can you do this one?



1st PRIZE £25; 2nd PRIZE £10;  
3rd do. £5; 10 prizes of £1;  
and 144 Prizes of a Filament Resistance.

**RULES FOR COMPETITORS.**

Send your solution and slogan in an envelope marked "Pouquin Puzzle" in the top left-hand corner to the address given below, by July 15th, 1925, together with a receipted invoice for any one of our fully tested and guaranteed transformers which has been purchased since April 1st, 1925. We reserve the right to use any slogan submitted, and our decision must be accepted as final.

The List Prices of our Transformers are:

STANDARD MODEL 14/6 BUCKS 12/-  
SHROUDED MODEL 18/- MANCHESTER 15 6

The name of your local dealer will be sent on application, or write direct to us. Should you desire your receipted invoice returned, kindly enclose with your entry a 3d. stamped addressed envelope.

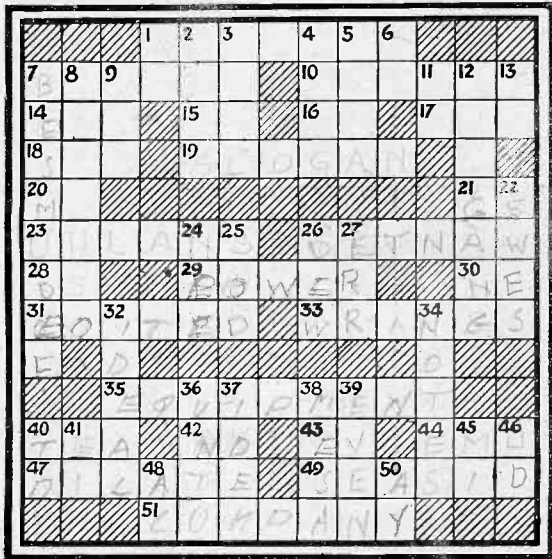

Slogan \_\_\_\_\_  
Name \_\_\_\_\_

- Address \_\_\_\_\_
- CLUES ACROSS.**
- 1 Abolish.
  - 7 Quit!
  - 10 Conductors.
  - 14 Genuine (beheaded).
  - 16 Chemical symbol for gold (reversed).
  - 19 Metal (beheaded).
  - 17 One end of a shoe.
  - 18 What America is.
  - 19 The best one together with the correct solution wins the prize.
  - 20 Saine as 11 down.
  - 21 Pressure (curtailed).
  - 23 German Cavalry.
  - 26 Wanted (reversed).
  - 28 Exist.
  - 29 Strength.
  - 30 Cold Wind.
  - 31 Reversed.
  - 33 Twists.
  - 35 The soldier's bugbear.
  - 40 A beverage.
  - 42 Two-thirds of finish.
  - 43 Two-thirds of the first woman.
  - 44 Australian bird.
  - 47 Distend.
  - 49 By the sea (curtailed).
  - 51 Assemblage of people.
- CLUES DOWN.**
- 1 Two-thirds hot.
  - 2 Burden.
  - 3 Ratify.
  - 4 Half of one who quits his own country to settle in another.
  - 5 Girl's name.
  - 6 A paved road (abbr.).
  - 7 Smeared.
  - 8 A protected aerial.
  - 9 Two-thirds of an English river.
  - 11 There.
  - 12 The business of cutting down timber.
  - 13 Point of the compass.
  - 22 Fausle sheep.
  - 24 Re-arrange and you will find an enclosure for 22 down.
  - 25 Turf.
  - 26 Falls lightly.
  - 27 Sin.
  - 32 Perfect.
  - 34 Memory aids.
  - 36 To.
  - 37 The same (Latin).
  - 38 Elevated tableland.
  - 39 Not will.
  - 40 Delirium tremens (reversed).
  - 41 "That is" (reversed).
  - 45 Half a very small object.
  - 46 Urban district.
  - 48 Half an acre.
  - 50 Yes.

The **POWER EQUIPMENT COMPANY LIMITED**  
KINGSBURY WORKS, THE HYDE, HENDON, N.W.9

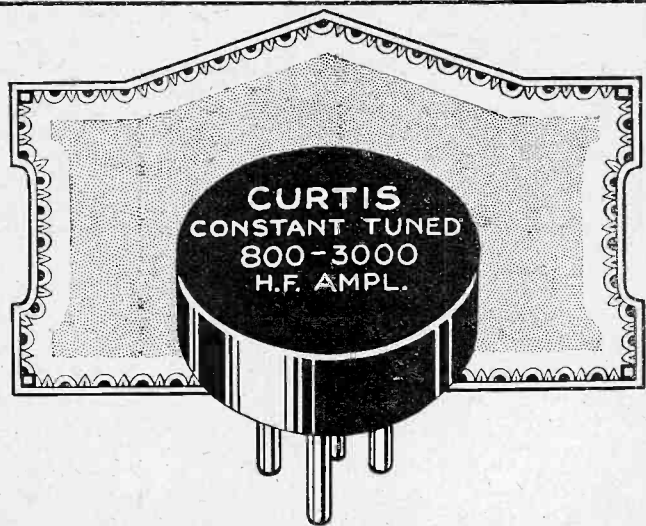

Dispensing with Control in H.F. Stages

**CURTIS CONSTANT-TUNED (Aperiodic) H.F. AMPLIFIER**

Automatic Tuning—No Condenser required.  
As used in DUODYNE and CURTIS Circuits.

The use of one or more H.F. Stages (whether Tuned Anode or Transformer Coupled) introduces further tuning controls which complicate the operation of the receiver.

Self-oscillation is almost uncontrollable with sharply-tuned circuits resulting from the use of tuned transformers with steep resonance peaks.

The employment of the Curtis Constant-Tuned (Aperiodic) H.F. Amplifier introduces the desired effective control. THESE RESPOND TO AND GIVE EQUAL AMPLIFICATION OVER A DEFINITE BAND OF FREQUENCIES. In operation, it increases selectivity by giving a very smooth control over self-oscillation and, obviously, by permitting the safe use of more reaction.

An aperiodic stage, of course, requires no tuning control. This is the great utility of the Curtis Constant-Tuned (Aperiodic) H.F. Amplifier. As many as four H.F. stages are effective if coupled in this way. The first input and the last output circuits need only be tuned. While the Curtis Constant-Tuned (Aperiodic) H.F. Amplifier gives all the amplification required—the working of an H.F. Receiver is so simplified that a child could tune it.

"Using a Curtis Amplifier and the Duodyne Circuit, I receive all British stations with an indoor aerial on a set made by myself." J. S., Tufnell Park.

**For Super Heterodynes**

Increasing the Range Selectivity and Stability.

The present rising popularity of the Super Heterodyne Receiver has revealed a surprising absence of suitable intermediate frequency transformers. Three or four stages, employing tuned transformers with a steep resonance peak, encourages the inherent tendency of the intermediate long wave stages to burst into self-oscillation.

Experiment has also discovered that, in all super heterodyne work, the efficiency of the long wave amplifier contributes largely to the stability and success of the complete receiver.

Where provision is made for three intermediate stages, the highest efficiency is secured when only the filter circuit is tuned—the remaining stages being aperiodic. In the case of four intermediate stages, alternate stages of tuned and aperiodic are advised.

THE CURTIS CONSTANT-TUNED H.F. (APERIODIC) AMPLIFIER PROVIDES A VERY EFFICIENT APERIODIC COUPLING. It is designed with the four-pin plug-in mounting, and is interchangeable with the ordinary plug-in transformer. The efficiency of this Curtis production is proved by its remarkable performance in the famous Duodyne Receivers. Its use in the long wave intermediate amplifier will stabilise this very important unit and will give you control over the tendency to self-oscillate with a consequent improvement in tonal quality.

Finally, in such cases where an H.F. Valve is employed in front of the first detector, the Curtis Constant-Tuned H.F. (Aperiodic) Amplifier is particularly efficient. It gives just the required amount of amplification without adding another tuning control. Full information and diagrams can be obtained upon request.

- Type A, 300 to 800 Metres. Price 15/-
  - Type B, 800 to 3,000 Metres. Price 17/6
  - Type C, 2,000 to 7,000 Metres. Price 18/6
- Type C is especially designed for Super Heterodynes.

The Curtis Constant-Tuned (Aperiodic) H.F. Amplifiers are obtainable from all dealers. If you have any difficulty please send direct giving name and address of dealer who could not supply.

Sales Organisation: **PETER CURTIS, LTD.**  
in association with THE PARAGON RUBBER MANUFACTURING CO., LTD., HULL  
**75 CAMDEN ROAD, N.W.1.**  
Telegrams: "PARACURTEX." Phone: NORTH 3112.  
BIRMINGHAM: 78, Newhall Street. Central 7238  
MANCHESTER: 312, Deansgate. Central 5095



Wuncell exclusive advantages featured:  
No. 3

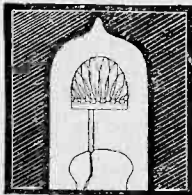

**A**n inherent disadvantage of all Dull Emitters—previous to the introduction of the Wuncell—has always been the annoyance of microphonic noises. A touch on the receiver, a tap on the table, or even footsteps across the room, have often caused the valves to transmit loud ringing noises to the phones or loud speaker. This cannot happen with the Wuncell. Its rigid filament—arched and supported at its centre by an additional electrode—in combination with the world-famed Cossor Grid precludes the possibility of any undesirable noises being created. This is but one of the many exclusive Wuncell advantages fully described in the large illustrated Folder to be obtained free of charge from any dealer—or from us on receipt of a postcard.

**Prices:**

W.1 For Detector or L.F. Amplifier

W.2 (With red top) for long distance reception  
18/- each

\*W.R.1 Corresponding to W.1

\*W.R.2 Corresponding to W.2  
20/- each

\*Fitted with internal resistance so that Valve can be used with 2-, 4-, or 6-volt Accumulator without alteration to Set.



# Cossor discards the Dry Battery

**T**HEORY and practice—even in wireless—cannot always be said to progress hand in hand. Apparatus or circuits which according to all the laws of physics or electricity should perform perfectly frequently fail to function as they should. Such a case in point is the use of Dry Batteries with Dull Emitters.

\* \* \* \* \*

When the first Dull Emitters were placed on the market a new era was prophesied in which dry batteries would take the place of accumulators. That, at present, there is no likelihood of this being realised must be apparent to all clear-thinking wireless enthusiasts.

\* \* \* \* \*

Time and again it has been proved that unless the dry battery is very large—and consequently expensive—it cannot possibly cope with the requirements of several Dull Emitters in use at one time. You should remember that the working of a Valve—whether rectifying or amplifying—is a very delicate operation. The filament current must be absolutely constant, otherwise electron emission will vary and upset the whole balance of the Receiver.

\* \* \* \* \*

Dry batteries are not built to give a constant output—they were originally developed for ringing bells and other intermittent work. They have to generate their own electricity, and in so doing are apt to polarise. Their output fluctuates: at first it is high and then it falls off. All the time you need to keep constantly adjusting the rheostats to be getting the best results.

\* \* \* \* \*

But compare them with the small accumulator. No matter whether you use an accumulator for five minutes or five hours its output is perfectly constant. It does not generate its own electricity—it merely stores it against demand. For economy, too, the little portable accumulator stands supreme. A small initial cost and a few coppers every few weeks is all you need to spend if your Set is equipped with Wuncells.

\* \* \* \* \*

On every side there is marked evidence that the most popular type of Dull Emitter is the new Wuncell—the Dull Emitter that does not rely on an excessively fine filament and a dry battery of uncertain reliability; the Dull Emitter that possesses a filament every whit as robust as that used in a bright emitter—a filament, moreover, that operates at the dullest of dull red heat; the nearest approach, in fact, to the cold valve that has yet been evolved.

# Cossor Wuncell Valves

THE ONLY DULL-EMITTER VALVES SOLD IN SEALED BOXES

Advertisement of A. C. Cossor Ltd., Highbury Grove, N.5

Gilbert Ad. 2585

the T.A.T. method might well be used for arranging the tuned and untuned stages.

#### Adjusting the Wavelength

For the first experiments, the ordinary type of long-wave plug-in transformers for the range of 2,000 to 7,000 metres can be employed with quite considerable success, and a great deal of experimental work can be carried out. These transformers are very much less sharply tuned than the shorter wave equivalent, and the triple condenser shown in the design of the long-wave amplifier enables one to shift their maximum response point about over quite a wide wavelength band. Thus, with the combination of Gambrell H coils which I have mentioned, with a  $0.001 \mu\text{F}$  condenser in parallel with the primary, if the triple condenser is set to about 20 degrees upon the scale, the circuits involved will be roughly in resonance with one another, the final adjustment being performed as follows:

#### Final Adjustments

With the four valves of the long wave amplifier turned on and with high-tension connected, the other two valves of the set being turned out, listen in the phones, and revolve the triple condenser around its scale backwards and forwards, gradually turning the potentiometer of the long wave amplifier towards the negative end. As the potentiometer is advanced, a point will presently be found at which the long wave amplifier breaks into oscillation over quite a narrow band upon the dial of the triple condenser. This indicates that the three tuned stages have come more or less into resonance with the tuned circuit of the filter, and the triple condenser can then be set to roughly the centre point of this oscillation band, and the potentiometer turned back towards the positive until oscillation just comfortably ceases. The long wave amplifier is then correctly adjusted, and it can be left once and for all, while we turn our attention to the other part of the set. Any final adjustments can be made here, once signals have been picked up, by a manipulation of the potentiometer and a fine adjustment of the triple condenser, although as a matter of fact there is nothing really critical about either of these adjustments. A suitable anode voltage must, of course, be chosen for the valves, about 60 volts being suitable in my own case, using general purpose valves.

#### A Milliammeter Desirable

We come now to the more critical adjustments of the oscillator and first high-frequency valve, and here I would like to explain that it appears to me most desirable in any experiments with this supersonic heterodyne receiver that a milliammeter, even if only of the cheapest sort, should be kept permanently in the high-tension feed to the oscillator valve, namely, between high-tension positive and the terminal marked H.T. + 2 upon the various diagrams. The reading of this milliammeter enables one to tell in a moment whether the oscillator is functioning correctly at all times.

Assuming that it can be used, the first operation is to turn on the filament of the oscillator valve, after connecting up the various batteries, and gradually advance

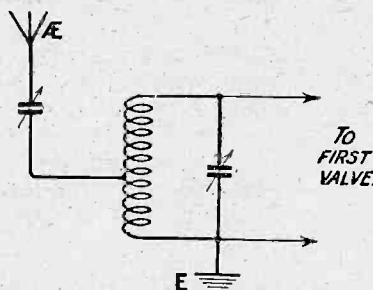

Fig. 3.—A method of tuning when an outside aerial is used for short waves.

the reaction coil  $L_4$  towards the fixed coil  $L_5$  until a sudden flick of the milliammeter needle to a new reading indicates that the valve has started to oscillate. Now endeavour to find a suitable reaction setting which maintains this condition of oscillation over the whole scale of the oscillator condenser  $C_5$ , finally clamping up this adjustment on the coil holder when found.

#### Tuning-in

Now turn on the first high-frequency valve to its normal brilliancy, and insert the telephone plug into the jack upon the intermediate frequency amplifier. In passing, it should be explained that a dummy telephone plug is used to insert in the jack in the middle unit, in order to turn on the filament of the valves. The two parts of this plug should be shorted together by means of a short piece of wire. With all the valves alight, listen in the phones, revolve the condenser  $C_5$ , and note whether a loud howl is heard at any particular point upon its

scale. If this is heard, it means that the oscillator itself is howling and the reaction between the coils  $L_5$  and  $L_4$  should be slackened somewhat.

When a size and setting of reaction coil has been found which enables the valve to oscillate freely round the entire range of the condenser without howling at any point, commence the search for signals. Set the aerial tuning condenser to about 20 or 30 degrees and the transformer tuning condenser  $C_3$  to, perhaps, 50 degrees. Now revolve the oscillator condenser  $C_5$  until the nearest station is picked up, and tune it to the loudest degree possible by means of this one condenser. Next adjust the treble condenser and the potentiometer of the long wave amplifier for the best results, and then transfer your attention to the aerial circuit. Tune again here for maximum signals and repeat the operation on the condenser  $C_3$ .

All this should have been done, it should be explained, with the potentiometer in the central unit turned about half-way from negative to positive. Now cautiously revolve this potentiometer towards the negative end, and it will probably be found with most very small aerials that at a point fairly close to the negative end the first valve will break into oscillation and signals will probably vanish entirely. You should then turn the potentiometer back once more towards the positive end until oscillation just ceases, and the set is correctly tuned.

In this condition it will probably be found that the great majority of the B.B.C. stations can be tuned in upon the oscillator condenser alone, signals being picked up by this means and then tuned in louder by varying the condensers  $C_3$  and  $C_1$ , namely, the H.F. transformer primary tuning condenser and the aerial tuning condenser.

#### Finding the centre point tapping

Having once got the set more or less working, we can proceed to adjust more accurately the centre point tapping upon the coil  $L_5$ , which may be done roughly by means of a piece of light flex, one end of which is bared and temporarily twisted round each tapping point in turn, the other terminating in a Clix plug to be inserted in socket No. 3. If the correct centre point is not found, it will usually be found that the oscillator valve ceases to oscillate when the circuit  $L_5 C_5$  comes into tune with the preceding circuit.

and this can be taken as an indication until the correct centre-point is found; where such stopping of oscillation should not take place, a slight adjustment of the variable gridleak  $R_5$  is, perhaps, necessary to ensure a proper balance. As a matter of fact, a complete balance is decidedly difficult to obtain, and perfectly good results can be obtained even though the valve does stop oscillating over just a few degrees of the condenser scale. Little difficulty will be experienced from this, but it is better to get rid of it entirely.

**Searching**

This method of tuning is perfectly successful so long as signals are not unduly weak, in which case a slightly different procedure is called for. Those skilled in the handling of sets with several controls will be able to perform simultaneous searching by means of the aerial tuning condenser and the oscillator condenser, which will suffice to pick up quite weak signals, which can then be strengthened by the adjustment of the condenser  $C_3$ .

**A Simple Method**

An easier method is to make the long wave amplifier oscillate by turning its potentiometer towards the negative end, whereupon carrier waves when tuned in will be heard in the ordinary way as a whistle of adjustable pitch with a silent point in the centre. When the long wave side is maintained in the oscillating condition it is quite possible to pick up even the weakest of signals by mere rotation of the oscillator condenser  $C_5$ . The carrier wave can then be picked up in the ordinary manner, strengthened by adjustments of the aerial and transformer tuning condensers  $C_1$  and  $C_3$ , after which the long wave side is taken off the oscillation point and final slight adjustments made upon the oscillator condenser  $C_5$  and the appropriate vernier condenser.

**Practice Required**

The hints which I have given should suffice to enable the constructor to get the set working, and one or two evenings' practice will no doubt teach him more than many pages of description upon my part. I would most strongly impress upon the reader that he must not expect to finish this set and then sit down and go the round of the B.B.C. stations within his first half hour. On the contrary, however, he is quite likely to hear nothing except his local station within the first

half hour, and it is only with increasing practice in the ways of the set that he will begin to obtain the wonderful results of which such a circuit is capable.

**Results**

The actual results which can be obtained from such a set are so largely dependent upon the skill of the user, local conditions, type of valve employed, and so on, that it is very difficult to give a fair idea of what may be expected, but I think it may be regarded as a safe minimum that with the very smallest of aerials it should be quite easy to receive all the B.B.C. and Continental stations, and a number of the relays, with the pleasing selectivity which is such a characteristic of the super-heterodyne receiver, and which forms, to me, its main attraction. My own testing work is now done entirely without an aerial, signals being picked up upon a plug-in coil in the tuner, and upon a short earth lead which is not more than 7 ft. long, and with this arrangement I have no difficulty in receiving all the B.B.C. stations and have, upon occasions, heard the Plymouth relay at good strength.

**Short Wave Reception**

I have obtained quite good results upon the shorter waves of 100 metres and below with this apparatus. Upon these short wavelengths I find it rather difficult to make the oscillator valve function correctly if one attempts to make it oscillate upon the actual wavelengths being received, much more convenient operation being obtained by using one of the harmonics which this valve generates when oscillating upon the longer wavelengths. In practice, therefore, I used a coil consisting of 30 turns of No. 30 d.c.c. wire upon a 3 in. diameter ebonite tube, this section of tube being 1 in. in length. The centre tapping is located upon this in the ordinary way, and one of the harmonics generated when this circuit oscillates is used to produce the desired beat with the short-wave signals. Using this coil, very good signals were obtained from KDKA on the 63 metre transmission (this being the wavelength in use at the time of my tests), using a Gambrell "a/2" coil and no aerial of any sort, the usual earth connection being taken from the earth connection of the tuner. When the long-wave amplifier is made to oscillate, an extraordinary number of amateur transmissions can be picked up, American stations being heard at excellent strength any evening after 9.30.

**Cutting out the first H.F. Valve**

For such short-wave reception the first high-frequency valve is cut out of circuit, and the detector-oscillator valve connected directly to the tuning circuit. This is accomplished by removing the lead which joins the G terminal of the tuner to the G terminal of the Tropadyne unit, and taking instead a longer lead from the G terminal of the tuner, to the end of which is attached an ordinary valve pin, and inserting it in the grid socket of the high-frequency transformer of the Tropadyne unit, this transformer, of course, being removed from its socket. The first high-frequency valve is then turned out, and all tunnig done upon the aerial circuit and the oscillator condenser.

I have found it possible, also, to use a full-sized outside aerial for these wavelengths by employing the circuit arrangement shown in Fig. 3 for the tuned circuit. Here it will be seen that there is a secondary winding across which the first valve is connected, the aerial being taken through a variable condenser to a tapping upon this winding, whose lower end is earthed. For the short waves mentioned, this winding may consist of seven turns of No. 22 d.c.c. wire upon a ring one inch wide cut from a three-inch diameter ebonite tube, the aerial tapping being located at the third turn. The coil can be readily constructed to plug into the tuner in question, and if a flexible lead is taken from the tapping and furnished with an ordinary coil pin, this can be plugged into the aerial socket of the coil holder; whereupon, if the aerial tuning condenser is switched into the series position, the circuit illustrated will be automatically obtained by turning the other "Utility" switch to the left-hand setting and bringing the secondary condenser into operation by turning the small on-and-off switch which controls it to the "on" position.

NOTE.—The flexible lead must terminate in either a coil pin or plug socket, in order that it may be inserted in the element of the aerial coil socket which is wired internally *via* the series-parallel switch to the A.T.C. and so to the aerial terminal.

**Queries.**

The Query Department is now re-opened to accept readers' queries. Readers are advised that a charge of 2s. 6d. is made per question, and a stamped envelope should be enclosed.

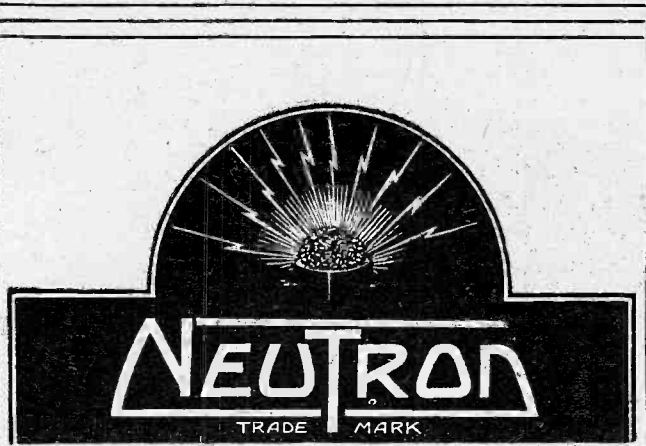

**“For Distance Neutron  
Outshines All.”**

Orrell, Bootle.

No doubt you will be pleased to hear the following details re your crystal.

Friday evening I tuned in Bournemouth after Liverpool station closed down at 10.30, and heard them quite loud enough to tell the music and follow same, after which I succeeded in tuning in the Dance Music from Glasgow until 11.30, when the announcer gave the tunes played and closed down. I may state that it is by no means the first time I have tuned in Glasgow, and on two occasions Belfast. Manchester I can obtain any time, daylight or dark, and is everything one may wish for on three Pairs of Headphones.

Set Edison Bell Vario with square law condenser across Neutron Crystal and Micro Deet.

I consider this all the more remarkable as the crystal is well handled, having been set in various detectors with Woods metal, sometimes with too much heat—in fact, so hot that I could not hold cup in hand.

I have tried most Crystals and Detectors, but for Distance Neutron outshines all, and not one spot but nearly all over.

F. G. U.

Stocked by the Best Radio Dealers.  
Packed in tin with silver catswhisker.  
Insist on Neutron in the Black and Yellow Tin. If unable to obtain, send 1/6 with dealer's name and this wonderful crystal will be mailed by return. **1/6**

Sole Distributors  
for Gt. Britain & Ireland:  
**V. ZEITLIN & SONS,**  
144, Theobald's Road,  
London, W.C.1.  
Phone: Museum 6841.

Sole Producers:  
**NEUTRON LTD.,**  
Sicilian House,  
Southampton Row,  
London, W.C.1.  
Phone: Museum 2677.



**Insist upon Grade A**

The key position in your receiver is the ebonite you use. You may easily sacrifice efficiency by mounting your components upon poor quality ebonite. It is of little avail to use low loss components mounted on high loss ebonite—build on a sure foundation—Paragon Grade A Ebonite.

In addition to high dielectric strength, its non-hygroscopic properties and high resistance to high frequency current, Paragon Grade A Radio Quality Ebonite gives distinction to the simplest of receivers.

**STANDARD SIZES.**

8 x 6 x 3/16	2/6
8 x 6 x 1/2	3/3
10 1/2 x 8 1/2 x 1/2	5/3
12 x 10 x 1/2	7/3
12 x 12 x 1/2	8/6
14 x 12 x 1/2	10/-
16 x 12 x 1/2	11/6
18 x 12 x 1/2	13/-
24 x 10 x 1/2	14/6
24 x 12 x 1/2	17/6
8 x 5 1/2 x 1/2	2/9
10 1/2 x 7 x 1/2	4/7
12 x 6 x 1/2	4/6
22 x 11 x 1/2	15/3
16 x 9 x 1/2	9/-
12 x 11 x 1/2	8/3
18 x 6 x 1/2	6/9
12 x 8 x 1/2	6/9
10 x 8 x 1/2	6/9
7 x 5 x 1/2	2/3
10 x 9 x 1/2	5/8
9 x 5 1/2 x 1/2	3/5
10 x 5 x 1/2	3/3
12 1/2 x 9 1/2 x 1/2	7/6

Panels cut to size, squared and edges ground, 1d. per square inch.

Paragon Polished Mahogany Ebonite Panels cut to size, squared, edges ground, 1d. per square inch.

You are advised when using certain types of polished ebonite to remove the surface skin. By using Paragon Grade A Ebonite, you obviate this irksome necessity. For, by means of a secret process, Paragon Grade A Ebonite is prepared without the metallic surface conducive to surface leakage.

Therefore purchase Paragon Grade A Ebonite. The dead black surface, by which it can easily be recognised, is distinctive and exclusive to Paragon Grade A Ebonite. Regardless of exposure to sun or any kind of artificial light, this ebony-like matt surface remains unimpaired. Just imagine the distinction Paragon Grade A Ebonite will impart to your new set!

Remember Paragon Grade A Ebonite is easy to work by means of tools ordinarily in the possession of home constructors.

For the especial convenience of readers of Radio Press Publications we can deliver any panel to the specified dimensions *from stock*.

You do not purchase Paragon Grade A Ebonite by weight. To avoid substitution and other devices we protect the experimenter's interests by selling Paragon Grade A Ebonite in sealed envelopes only. Every dealer of repute throughout the world sells Paragon Grade A Ebonite. No ebonite is guaranteed Paragon Grade A Radio Quality Ebonite unless sold in a sealed envelope stamped Paragon Grade A.



Sales Organisation: **PETER CURTIS, LTD.**  
In conjunction with THE PARAGON RUBBER MFG. CO., LTD., HULL.  
**75 CAMDEN ROAD - N.W.1.**  
Telegrams—"PARACURTEN" Phone NORTH 3112.  
BIRMINGHAM: 76, Newhall Street. MANCHESTER: 321, Deansgate.  
Central 7236. Central 5995.



The completed instrument has a neat and compact appearance.

# An Interesting Valve - Crystal Receiver

By

HAROLD H. WARWICK

**R**ECENTLY much has been heard of reflex circuits, and they have attained a popularity equalled by only very few other arrangements, the reason being that where a single valve is made to do the work of two, cost of upkeep for valves and battery charging may be materially reduced. Besides this there is always a gratifying feeling in obtaining results equal to those of one's friends with a receiver of, perhaps, only half the size.

At the same time the addition of apparatus always entails greater skill in construction and care in choice of components, and this is even more so when new parts are assembled round one valve. Consequently there are quite a large number of people who have not been successful in obtaining completely satisfactory results with dual receivers. The arrangement to be discussed is calculated to remove a number of the usual difficulties encountered. This is done by adopting a simpler method of increasing the strength and the range of a set than the usual high frequency amplification carried out by the valve.

### A Novel Principle

Mr. John Scott-Taggart, who has developed the reflex system to a greater extent than any other individual, was the originator of this interesting method whereby

reaction is used in a modified circuit of what is, in fact, a crystal detector followed by one note magnifier.

Let us then first examine the circuit diagram, Fig. 1, of the receiver, in order to find out in

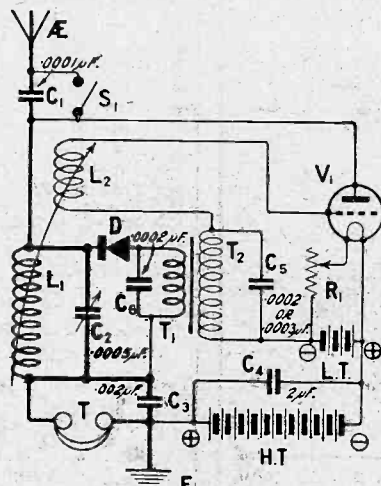

Fig. 1.—The circuit diagram.

what manner it carries out these functions.

### The Circuit

Disregarding for the moment the coil  $L_2$ , it will be seen that we have a somewhat unusual variation of the crystal and one note magnifier in common use. High frequency oscillations are received in the aerial circuit and the coil  $L_1$  is

tuned to any required wavelength by the variable condenser  $C_2$ . Rectification is carried out by the crystal detector  $D$ , and the resulting low frequency currents are passed on by the intervalve transformer  $T_1, T_2$  into the grid circuit of the valve  $V_1$ . The anode circuit of this valve contains, besides the aerial tuning coil, the headphones, which must be shunted by a fixed condenser  $C_3$  to by-pass the high frequency oscillations in the aerial circuit.

### Reaction Control

Reaction is applied by coupling the coil  $L_2$  to the aerial coil  $L_1$ . A condenser  $C_5$  across the transformer secondary  $T_2$  will in most cases be found necessary, but its value should be kept as low as possible, whilst allowing sufficient reaction effect to be obtained, and should certainly not be higher than  $.0003\mu F$ . This will vary to some extent according to the type of valve and transformer used and may be determined by experiment. In the present set, using an Igranit transformer 5-1, a value of  $.0002$  was found satisfactory.

A fixed condenser of  $.0002\mu F$  connected across the primary winding of the transformer  $T_1, T_2$  was found in the case of the instrument described to facilitate its operation. Without this condenser overlap was predominant, and could only be eliminated by its use, when operating the set became a fairly easy matter.

### H.T. Shunting Condenser

The condenser  $C_4$ , shown in Fig. 1, whilst not being an absolute necessity, may effect an improve-



This little instrument makes use of an interesting circuit similar to that which was first described by Mr. John Scott-Taggart, F. Inst. P., A.M.I.E.E., in the March issue of the "Wireless Constructor."

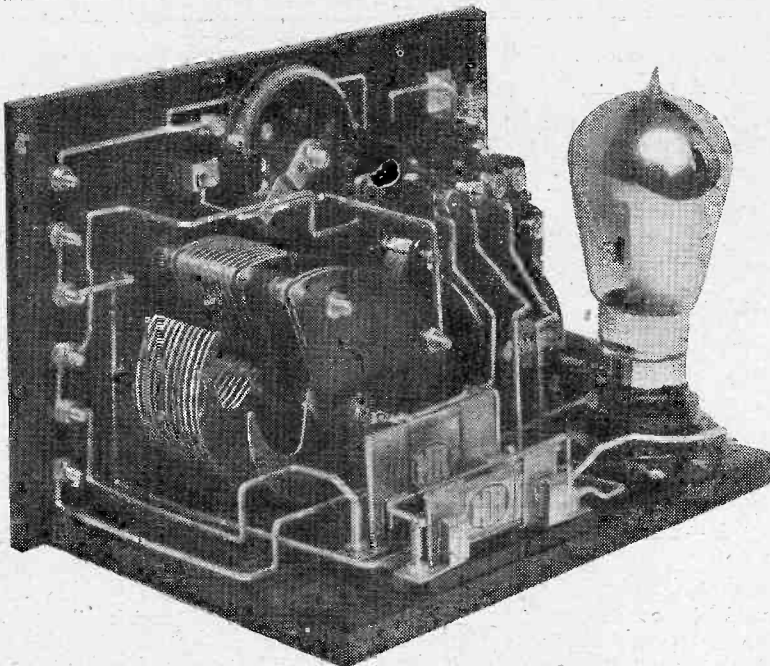

The use of clip-in condensers greatly facilitates experiments.

ment in the working of the set. It is not included in the receiver, as it should be considered part of the H.T. equipment. A suitable value is  $2\mu\text{F}$ , but so long as it is large this value is not critical.

The use of the C.A.T. condenser was found to be an advantage, and a switch has been incorporated in the set in order that changing from C.A.T. to the direct aerial connection and vice versa may be effected with a minimum of trouble.

For the possessor of a set comprising a crystal rectifier and one low frequency amplifying valve, a few wiring alterations and the addition of one coil will considerably increase its sensitivity.

Before examining the layout of components, a list of those necessary is given, and these may be identified in the photographs.

One Polar vernier 2-coil holder (R.C.C.).

One ebonite panel, 9 in. by  $5\frac{1}{2}$  in. by  $\frac{1}{4}$  in. (American Hard Rubber Co.).

One Antiphonic valve-holder (Burndept).

One dual filament rheostat (Burndept).

One fixed condenser (clip-in)  $.0001\mu\text{F}$  (McMichael).

One fixed condenser (clip-in)  $.0002\mu\text{F}$  or  $.0003\mu\text{F}$  (McMichael).

One fixed condenser (clip-in)  $.002\mu\text{F}$  (McMichael).

One fixed condenser  $.0002\mu\text{F}$  (Dubilier).

One variable condenser, Square Law with vernier,  $.0005\mu\text{F}$  (Wates).

One fixed crystal detector (Radio Instruments).

One L.F. transformer, 5-1 ratio (Igranic).

One 2-way switch (Lissen).

Eight nickel terminals.  
Box with base-board for panel, 9 in. by  $5\frac{1}{2}$  in. deep (Carrington Manufacturing Co., Ltd.).

One Packet Radio Press Panel transfers.

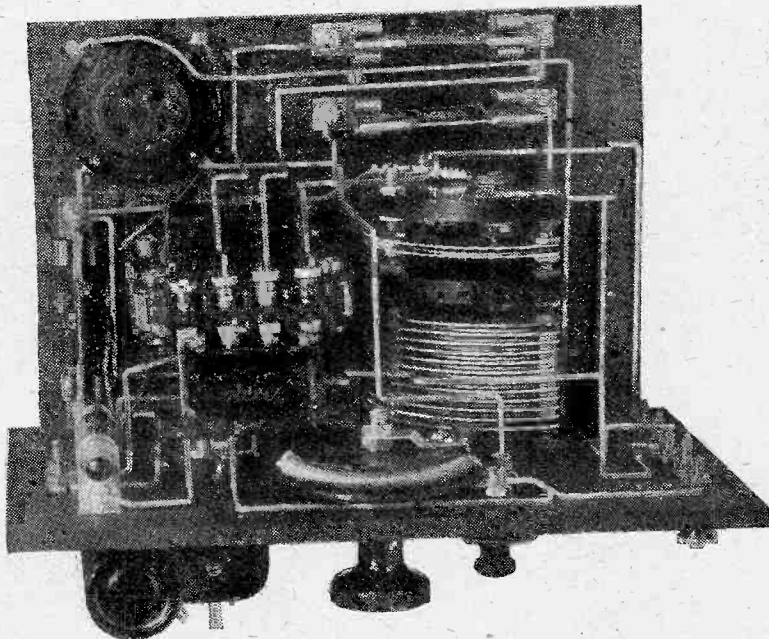

A plan view of the receiver which will materially assist in the construction.

**Marking Out the Panel**

No difficulty should be experienced in marking out with the aid of the diagram giving the dimensions. All marking should be made on the back of the panel and a lead pencil should not be used, as leaks may result if any lines are left, and these would prove seriously detrimental to efficient working. A scribe is the correct implement to employ. There are very few positions on the panel to determine, for, excepting terminals, there is only one hole each for the switch

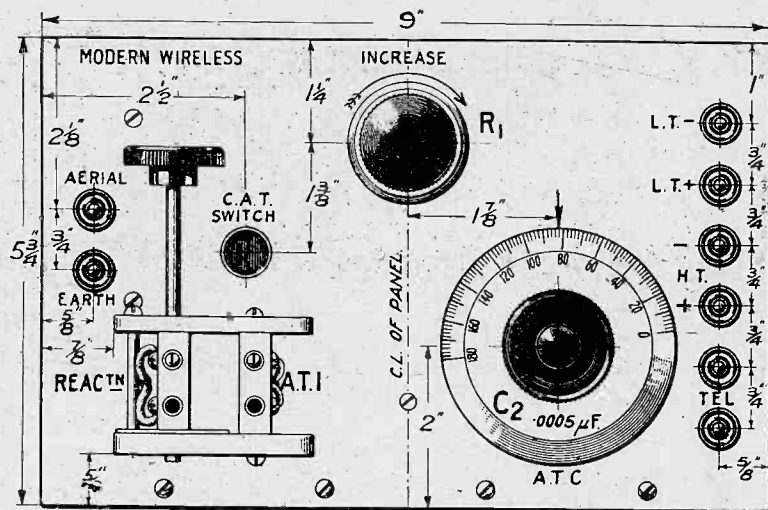

Fig. 2.—Constructors should ask for Blue Print No. 111a, price 1s. 6d., post free.

and variable condenser, two for the coil-holder, two for the crystal detector, whilst a template is supplied with the Burndept dual rheostat.

Other holes are required for the attachment of the panel to the base-board by means of four half-round nickelled wood-screws, placed at equal distances along the bottom of the panel. A further hole is required if an angle bracket be used, after the manner adopted in this instrument, further to increase its strength.

It will be found more convenient when assembling first to mount all the components required on the panel, and then to fit in the others upon the base-board in positions approximating to those shown in the photographs, and to hold them down by wood-screws. This will save a considerable amount of measurement and will facilitate matters if other components than those specified are used.

**Layout of Components**

The front of the panel presents an attractive appearance, and each control is placed in the most easily accessible position for its use. The coil-holder and variable condenser are placed towards the bottom of the panel, and the switch for C.A.T. is placed close to the coil-holder. The filament rheostat is in the centre of the panel, while terminals for batteries and headphones appear on the right of the panel, and aerial and earth on the left.

**Adjusting the Detector**

Upon the back of the panel, in addition to the above, is held the R.I. detector, in the top left-hand corner as seen from the front.

It is arranged so that quick adjustment may be made if required by raising the lid of the box, when the knob is immediately to hand. This position for the detector was adopted because it is less likely to be adjusted or meddled with unnecessarily, and care should be taken, if an R.I. detector be used not to jamb the two crystals together, but to carry out adjustments by first pulling out the adjusting arm, then turning and allowing to fall back gently. Clip-in condensers will be seen in various positions upon the base, mounted upon ebonite strips. The condenser

on the right of the transformer is the C.A.T. condenser, while the two together upon the left are the telephone condenser, which is the one nearest to the variable condenser, and the condenser shunted across the transformer secondary, which it may be necessary to vary as explained elsewhere. That above the transformer is the one connected to its primary terminals.

**Wiring**

As will be seen from the photographs, the connections present a very neat and attractive appearance when wire of the square tinned-copper variety is used. Throughout the instrument described, No. 16 gauge hard drawn wire was used, and soldered into place where tags were provided upon the parts; connections to the terminals, however, were made by making complete loops in the ends of the wire, placing over the shanks, putting a washer on each and screwing nuts down really hard.

Flexible leads were used for the coil-holder and made to pass in pairs through two holes in the panel and were soldered at points upon the stiff wire.

Do not forget, when soldering, to clean all joints thoroughly, use as little flux as possible and wipe up any excess, and employ a really hot iron with just the right amount of solder.

**Operating the Set**

When the set has been completed, aerial, earth, accumulator, and

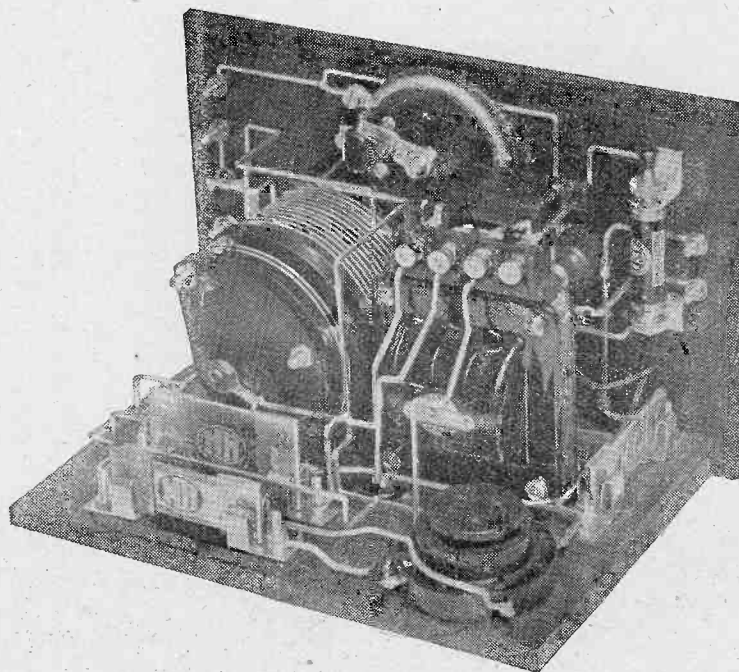

Although all the space is utilised, there is ample clearance between the components.

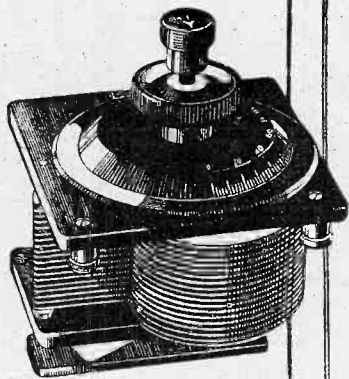

**The Dubilier Vanicon  
Square Law Condenser.**

Supplied in three capacities  
with Vernier as illustrated.

0.00025 mfd.	..	17/6
0.0005	..	22/6
0.001	..	27/6

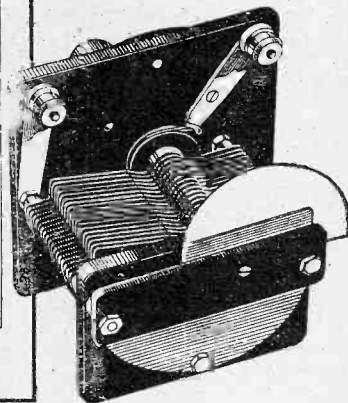

***A Real Square Law at Last!***

**T**HE Dubilier Square Law Condenser is no doubt as welcome an arrival to you as it is to everyone else who is interested in Wireless.

It has been produced at the request of many insistent amateurs after a period of experiment and research extending over nearly two years. Besides having all the properties which have made the Vanicon famous, such as low electric losses, positive contact to moving plates, mechanical rigidity, etc., it has been designed with such care and manufactured with such precision as to give

**A True Square Law Effect.**

That is to say, the variation in wavelength produced is actually in direct proportion to the angle through which the dial is turned. It is this quality which makes the Square Law Vanicon a necessity not only to the serious experimenter, but also to every constructor.

The most efficient and accurate Square Law Condenser on the market, yet it costs no more than the Standard Vanicon with Vernier.

When you require a Square Law Condenser, see that you

*Specify Dubilier.*

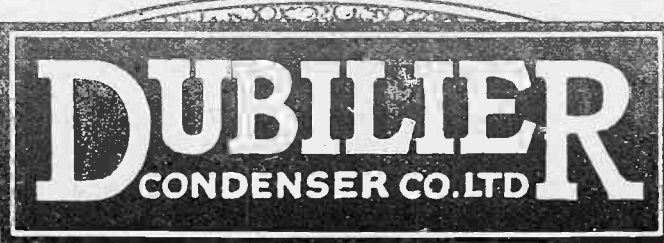
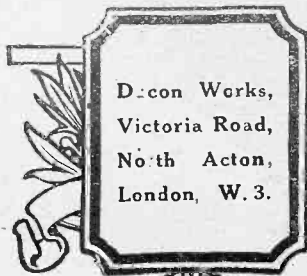

*In replying to advertisers, use Order Form enclosed.*

# Radiola Receivers

**Radiola I**  
(Valve-crystal)



**B**OTH these sets employ a special, easily tuned reflex circuit, which is equivalent, in effect, to an extra valve. Both are fitted with B.T.H. type B.5 (0.06 amps) valves, which consume so little current that standard dry cells can be quite successfully used for filament lighting.

**Radiola I (Valve-Crystal) Receiver**

This is the ideal set for head telephone reception over distances up to 100 miles, two crystals, with change-over switch are provided

	PRICE	£	s.	d.
with enclosed H.T. Battery and B5 Valve	-	9	0	0
B.T.H. Headphones (4,000 ohms)	-	1	0	0

**Radiola II (2-Valve) Receiver**

The power of three valves is secured by the use of a dual amplification circuit. Under average conditions this set will receive all B.B.C. stations.

	PRICE	£	s.	d.
with enclosed H.T. and L.T. Dry Batteries and two B.5 Valves	-	18	0	0
B.T.H. Headphones (4,000 ohms)	-	1	0	0

Obtainable from all Electricians & Radio Dealers

We also make Crystal Sets, Loud Speakers, Amplifiers and "Tungar" Battery Chargers

**The British Thomson-Houston Co. Ltd**

Works  
Coventry

Offices: Crown House,  
Aldwych, London,  
W.C.2.

**Radiola II**  
(Two-valve)



2224

headphones should be connected to their respective terminals, and coils should be placed in the holder. The filament rheostat should now be placed in an on-position to see if the valve lights. If this is all right, next connect momentarily a 3 or 4½ volt section of the H.T. battery. If the valve brilliancy is seen to alter, the reason must be ascertained before proceeding, lest the valve should come to a premature end. This being satisfactory, the H.T. voltage may be increased to an extent depending upon the type of valve, when a loud click should be heard in the headphones.

Supposing broadcast is required, a No. 50 or 75 coil in the movable socket of the coil-holder and a No. 50 in the fixed will generally serve to cover a wavelength of between about 250-500 metres when using C.A.T., that is, when the switch is pushed in.

**Tuning**

For a preliminary adjustment separate the two coils as far as possible and remove the fixed condenser shunted across the transformer secondary. The set should now function as a crystal detector and one low frequency amplifier, and since the crystal is permanently adjusted signals should be received on an outdoor aerial up to 10 to 15 miles from a B.B.C. main station by simply turning the aerial tuning condenser. When signals have been obtained try the effect of bringing the two coils together. The condenser will probably require a further adjustment as the coils are brought together. Very likely no increase in signal strength will result, but upon placing a fixed condenser of about .0003µF across the transformer secondary little difficulty will be encountered in obtaining reaction effects. If trouble is still experienced, reversing the leads to one of the coils will almost certainly correct matters. This having been accomplished, other adjustments may be made, such as regulating the filament voltage and H.T. voltage. The effect of removing the earth lead from E and placing it on H.T. can also be tried.

The next step is to try different values of the condenser C<sub>5</sub>. The smallest value possible with consistent and uniform operation should be used, as if made too large it may by-pass low frequency impulses handled by the transformer.

Different ranges of wavelengths may be covered by the use of plug-in coils, and waves down to 150 metres have been received with ease. A No. 150 in the aerial

circuit and 200 in the grid circuit will usually be satisfactory for receiving Chelmsford with parallel aerial tuning.

**Test Report**

All tests were carried out on a good outdoor aerial 90 ft. long and 40 ft. high about six miles from the London broadcasting station, in a locality where reception as a whole is only moderate. Out of

on the headphones, and 5XX was not far short of London in strength. Radio-Paris, Brussels, Hamburg, Breslau, Madrid, were all received, and also some of the B.B.C. relay stations, which were not identified.

**KDKA**

At 11.20 one evening two home-made basket coils wound with No. 18 gauge D.C.C. wire were plugged into the coil-holder; the

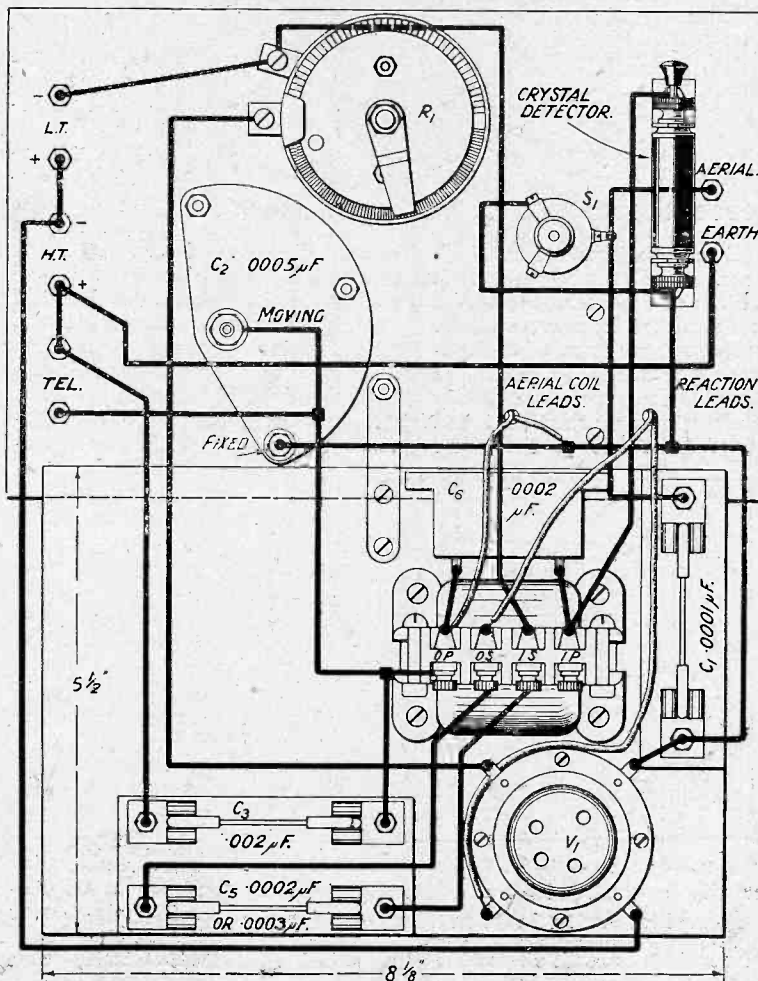

Fig. 3.—The wiring diagram which may be obtained from the Sales Dept., price 1s. 6d., post free. Blue Print No. 111b.

some seven or eight different types of valves tried, a low impedance valve, the B.T.H. B<sub>4</sub>, was found to give the best results with about 100 volts on the plate. With it reaction was more easily obtained and more easily controlled. C.A.T. was only used below 200 metres.

2LO was received at sufficient strength on an Amplion loud-speaker to be all that could be desired for an ordinary sized room, while it could be heard in all parts of the house. All the B.B.C. main stations were heard

grid coil consisted of 16 turns and the aerial coil of 8 turns, and in a few moments KDKA was received at quite good strength despite the particularly strong atmospherics that were prevalent. For this the outdoor aerial was used with constant aerial tuning, and the B<sub>4</sub> was the only valve with which oscillation could be obtained, valves with higher impedance being only effective down to a wavelength of about 150 metres. KDKA on this occasion was working upon a wavelength between 40 and 70 metres.

A Change-over Switch

MODERN WIRELESS

May, 1925



"THE HALL MARK OF RADIO PERFECTION"

If you haven't seen the new A.J.S. models you haven't seen the latest developments in Radio Construction

Ask the nearest dealer to show you the Instruments illustrated, as well as the "Unit System" 4-valve Cabinet and A.J.S. Component parts.

A. J. STEVENS & Co. (1914) Ltd.

Wireless Branch, Wolverhampton.

Phone: Wolverhampton 1550.

W. Call Sign: 5R.L. Grams: "Reception, Wolverhampton."

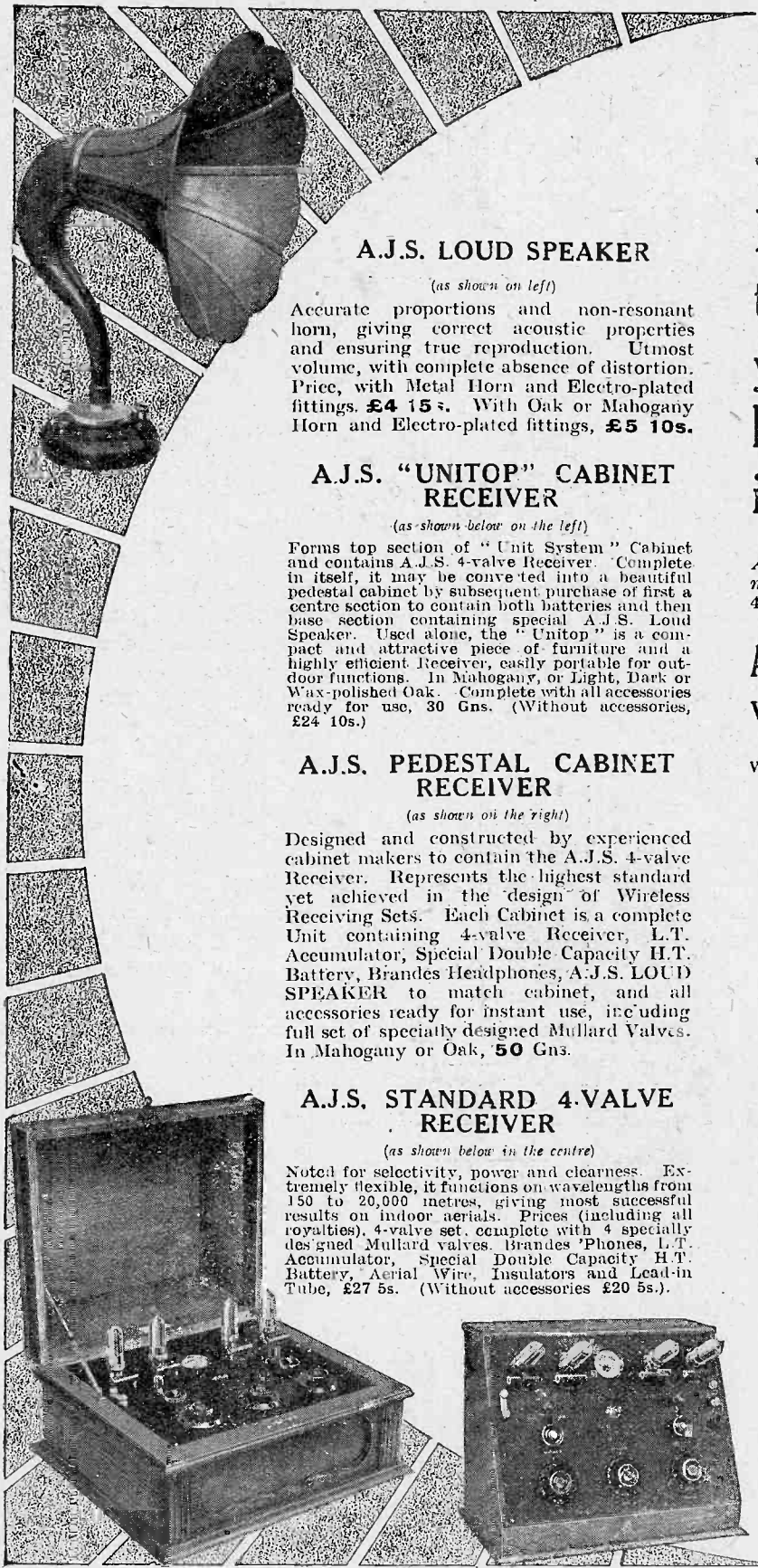

A.J.S. LOUD SPEAKER

(as shown on left)

Accurate proportions and non-resonant horn, giving correct acoustic properties and ensuring true reproduction. Utmost volume, with complete absence of distortion. Price, with Metal Horn and Electro-plated fittings, £4 15s. With Oak or Mahogany Horn and Electro-plated fittings, £5 10s.

A.J.S. "UNITOP" CABINET RECEIVER

(as shown below on the left)

Forms top section of "Unit System" Cabinet and contains A.J.S. 4-valve Receiver. Complete in itself, it may be conveyed into a beautiful pedestal cabinet by subsequent purchase of first a centre section to contain both batteries and then base section containing special A.J.S. Loud Speaker. Used alone, the "Unitop" is a compact and attractive piece of furniture and a highly efficient receiver, easily portable for outdoor functions. In Mahogany, or Light, Dark or Wax-polished Oak. Complete with all accessories ready for use, 30 Gns. (Without accessories, £24 10s.)

A.J.S. PEDESTAL CABINET RECEIVER

(as shown on the right)

Designed and constructed by experienced cabinet makers to contain the A.J.S. 4-valve Receiver. Represents the highest standard yet achieved in the design of Wireless Receiving Sets. Each Cabinet is a complete Unit containing 4-valve Receiver, L.T. Accumulator, Special Double Capacity H.T. Battery, Brandes Headphones, A.J.S. LOUD SPEAKER to match cabinet, and all accessories ready for instant use, including full set of specially designed Mullard Valves. In Mahogany or Oak, 50 Gns.

A.J.S. STANDARD 4-VALVE RECEIVER

(as shown below in the centre)

Noted for selectivity, power and clearness. Extremely flexible, it functions on wavelengths from 150 to 20,000 metres, giving most successful results on indoor aeriads. Prices (including all royalties), 4-valve set, complete with 4 specially designed Mullard valves, Brandes Phones, L.T. Accumulator, Special Double Capacity H.T. Battery, Aerial Wire, Insulators and Lead-in Tube, £27 5s. (Without accessories £20 5s.)



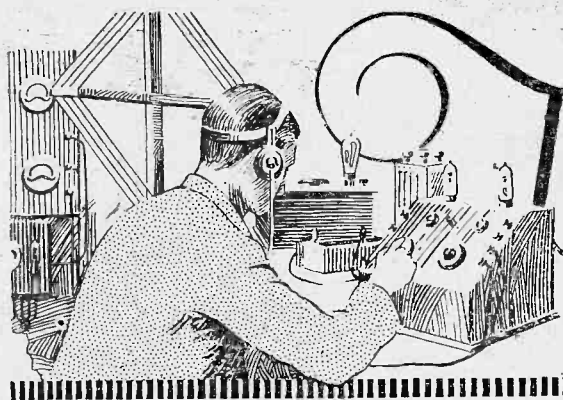

# Tested by Ourselves

## Panel Plugs and Sockets

Messrs. Belling and Lee, Ltd., have sent for our inspection samples of a neat form of plug-connector for aerial, earth, phones and battery connections, etc., on the panel. These have a socket with back-nut and engraved indicator-ring, in black or red, for fixing in the panel, with soldering lug at the end. An uncommon type of plug, consisting of spring tongues pressing outwards, ensures good electrical contact with the socket. On to the end of the plug screws the coloured insulating handle, having a conical pin-chuck in its interior which will hold, the makers claim, a wire from No. 14 to No. 40 S.W.G., or an aerial wire. This is actuated by being forced into the conical end of the plug body.

On trial, a firm grip was obtained with the chuck on a large square bus-bar, ordinary flex, or single wire, and the plug proved in each case to have a secure fit and good contact in its socket. The fitting is very neat in appearance, and should provide a decided improvement over the old screw terminal for repeated and rapid changes of connections, etc. The price is moderate, considering the relative complexity of the device and the high finish.

## An Easily Fixed Switch-Arm

Messrs. Athol Engineering Co. have sent for our inspection a sample of a new type of "one-hole-fixing" switch-arm, which can actually be mounted on the panel with the minimum amount of trouble. A hole about  $\frac{1}{16}$  in. diameter is required for the centre bush. This is fitted with a large lock-nut at the back of the panel, large enough to pass over the usual small lock-nuts on the end of the spindle. It only has to be removed when actually mounting the switch, and the smaller nuts are not touched. The switch-arm is laminated, and is securely fixed

in a notch in the boss of the controlling knob, so will give no trouble by working loose. The device is well finished, and operates smoothly. We can strongly recommend it to amateur constructors. The finish is in nickel-plate.

## Naylor "Fulstop" Variable Condenser

Messrs. J. H. Naylor have submitted a sample of their geared variable condenser fitted with isolated controlling mechanism and earthed shielding plate, drawing attention to this method of eliminating practically all harmful

between the knob and scale and the condenser proper. By earthing this and the gears, it is evident that hand-capacities are rendered wholly innocuous. The instrument is of the one-hole-fixing variety, and showed a capacity fairly close to the nominal, low minimum capacity, low losses on ultra-short waves, and excellent insulation resistance. It is well made, and operates with smoothness and minimum back-lash in the gears. The knob and scale are securely fixed on the spindle, an indicating disc being provided fitting into a recess in the knob.

## A Tubular Earth

A Hedges patent tubular earthing device has been submitted for practical test by Messrs. General Electric Co., Ltd. This is in the form of an iron pipe about 1 in. diameter and 32 in. long, with a pointed end for driving down vertically into the earth, preferably in a damp spot in the garden. A top casting is provided with holes, which are covered with a slip of paper during transit, and the pipe is filled apparently with granular carbon material, a plug of steel wool and a washer keeping this in position. A length of copper flex passes down into the interior of the pipe, and provides the necessary earth-lead connection. This lies safely in a slot in the top casting when driving the pipe. The usual instruction is given as to watering the ground around the pipe.

On test in direct comparison with an excellent direct water-pipe earth, and with a three-wire counterpoise spaced under the single-wire 80 by 20 ft. suburban aerial at a few feet from the ground, with a low-loss thick-wire and air-core variometer, the measured signal-strength at about 13 miles from 2LO was 20 microamperes (rectified by excellent galena crystal) with the water-pipe earth, and 18 microamperes with the

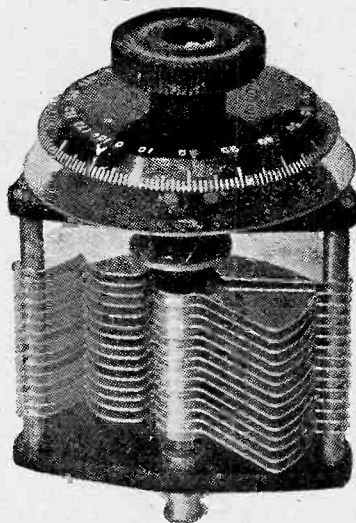

The "Fulstop" Variable Condenser

hand-capacity effects for fine tuning purposes. This type of condenser has been reviewed previously in these columns. The instrument submitted, of nominal  $0.005 \mu\text{F}$  capacity, and with plates of the "square-law" shape, resembles closely the former example tested. The two-to-one gearing is isolated from the spindle of the moving plates by an ebonite bush; and a disc of aluminium, which at the same time provides a zero indicator, is interposed

*Secure your Aerials!*

**Flexible Steel Wire Rope**  
For use where strength and strain is required. Extremely flexible and easily handled on pulleys.

No.	Diameter.	Strain 100 ft.	Breaking Price
0	1/16"	5 Cwt	4/6
1	3/32"	"	6/-
3I	5/32"	25 "	10/-
52	3/16"	35 "	12/-

Strainers double ended, for use with above 0d. each, 8/6 doz. Orders of 10 and over Carr. paid, otherwise please add 9d. extra.

**SMITH & ELLIS, Ltd. (Dept. 85),**  
11, Little Britain, Aldersgate Street, E.C.1.

**REPAIRS**

TO HEADPHONES  
TO LOUD SPEAKERS  
TO COILS

*Rewound to any Resistance and made equal to new. Price quoted on receipt of instruments. Prompt Delivery.*

**THE VARLEY MAGNET CO.**  
(Dept. M), WOOLWICH, S.E.18  
Established 26 years.  
Phone: Woolwich 888.

**ELECTRADIX RADIOS**

"C" Valves, Air Force, low loss, 6/6 (post at buyer's risk), Wavemeters, 50/-, £4, £5 and £6. Morse Recorders, £6 10s.; Wheatstone, £8. Alternators, £3 10s. Valve Transmitters, £3. Spark Sets, 15/6. R.A.F. Steel Masts, 2/6 per 5-ft. run. Receivers - 2-valve, 2B, £2; 3-valve, Mk. 4, £3; 5-valve, £5 10s.; 7-valve, Marconi, £8. All prices less valves. Bridges, £3 and £5 10s. Res. Boxes, multi-range standards, 1 to 2,000 ohms, 17/6 to 50/-; Loud Speakers, 19/-; Ebonite Horns, 8/-; A.C. Chargers, £4 10s.; Charging Dynamos, £3. Marconi Round Valves, 3/6. Milliammeters, 27/6. Microammeters, 65/-; Amp. and Voltmeters, all ranges. Ohmmeters, £10. Testing Sets, £4 to £14. Condensers, L.T. to 10,000 V., 1/6 to £2. Call or write for new and enlarged catalogue. Post free, 4d.

**LESLIE DIXON & CO., LTD.,**  
9, Colonial Avenue, Minorities, E.1.  
Buses pass the door. Telephone—Avenue 4166  
M.M.V.

**LET YOUR HOUSE LIGHTING  
RUN YOUR RADIO SET**

**RAMPLING'S ACE**  
(The Voltage Equalisator)

Will do this. No Accumulators Required. Send No. of Valves on your Set and £2 2s. to **RAMPLING'S, Park Chambers, Ipswich,** and abolish Disappointed Evenings.

*Cabinets You Want!*  
For Radio Perfection

**PICKETTS**—are used for Finest Sets.  
ESTIMATES PER RETURN.  
Send for Cabinet List, Free.  
**PICKETTS CABINET (M.W.) WORKS,**  
BEXLEY HEATH, S.E.

PATENTS, DESIGNS AND TRADE MARKS

**J. S. Withers & Spooner,**  
Chartered Patent Agents

Staple House, 51 & 52 Chancery Lane, London, W.C. Tel. "Improvably," Holb. London, Tel. 480 Holborn

Hedges tubular earth driven right down into damp clay and with direct short earth-lead well isolated and insulated. The counterpoise gave only 15 microamperes, the diminution in effective height here masking any lowered H.F. resistance. The water-pipe and tubular earth together gave the same optimum figure of 20 microamperes, indicating a minimum resistance.

In valve reception no difference could be noted at all between the two "earths" with quite sensitive reaction, the German stations coming in as well as usual on one or two valves, and the receiver being very lively. Late at night, after the B.B.C. stations had signed off, there was no difficulty in hearing Petit Parisien on the plain crystal, faint but intelligible, with the Hedges earth.

In situations where space is valuable, or a disturbance of the soil is to be avoided, this form of earth can be recommended.

**Spedding "Super Solderflux"**

A sample of a soldering flux for which great dirt penetrating powers and ease of application are claimed has been submitted by Arthur Spedding. This is a red preparation, in the form of a thick paste, which is to be applied to the parts to be soldered apparently without any preliminary cleaning, even on a greasy or painted surface; on the application of the hot iron the directions state that a firm soldered joint results. On practical trial, first on clean metallic surfaces, the flux was found to operate in the usual way if the iron was made very hot; on "dirty" surfaces which would long resist ordinary attempts to produce a tinned surface and sound joint, this flux on trial gave a sufficiently clean surface for tinning when an extremely hot iron was used, but not with any great ease, as suggested in the pamphlet accompanying the tin.

Whilst under the conditions indicated this flux certainly operates successfully, we do not think that any great advantage will ensue from the encouragement thus given to amateur constructors to slur the preliminary cleaning of a joint for sound electrical connections; or that they will, in general, find the directions so very easy to follow to a successful issue. Used in the ordinary way, with cleaned surfaces, the flux operates effectively and without any special difficulties. There was no indication of acidity on test.

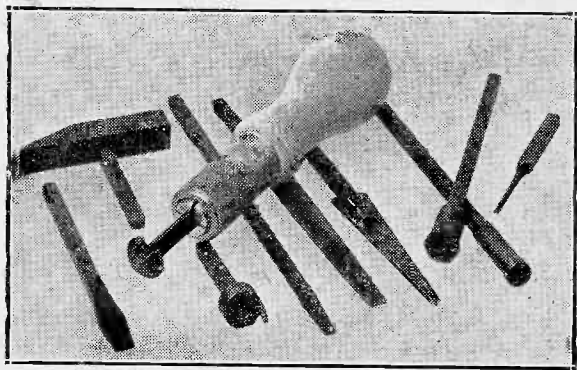

The C.A.V. Tool Set which has been specially designed for wireless constructors.

**Tool Set**

Messrs. C.A.V. Small Tools, Ltd., have sent for our comment a set of small tools, in a carton, for use in practical radio construction, and marketed at a reasonable inclusive price. These consist of a universal holder, with a screw chuck and convenient handle; together with two screw-drivers, wire-bender device, small hammer-head, two box spanners, Nos. 4 and 6 B.A., counter-sink, reamer, bradawl and file. It is evident that this assortment will facilitate a number of the operations needed in connection with radio construction, though a pair of small cutting pliers, a hack-saw blade, and a couple of small drills might well have been included. On close examination, the tools appeared to be of good quality (unlike many boxed or carded sets), and of suitable design. The holder was substantial and well finished.

**Microhm Neurodyne Condenser**

Messrs. Microhm Engineering Co. have sent for our trial and comment samples of their small-capacity fine adjustment or neurodyne condenser. This is a very neat little fitting, strongly suggesting one type of variable grid leak in outward appearance, and similarly of the one-hole-fixing variety. A substantial terminal is fitted at the further end, the nearer connection being made to the fixing bush. A small knurled knob controls the spindle, which screws in and out, thus adjusting the relative positions of the small plates enclosed in the 1/2 in. diameter ebonite tube which forms the body of the instrument.



It measures about 2½ in. overall and beneath the panel, when installed, and of course a minimum amount of space is occupied in the set. The maximum capacity available, with spindle screwed home, proved to be just under 11 μF; the minimum, average of three samples, after deducting casual capacities of leads, etc., came out at about 1.8 μF. It is thus suitable for use in certain types of neutralised high-frequency couplings, where a small adjustable capacity of this order is needed. For fine adjustment in ordinary tuning, it would be necessary to guard against hand-capacity effects with the short metallic spindle of this instrument.

**"Crawford" Jack**

Messrs. "Romac" Motor Accessories, Ltd., have submitted for our inspection and trial samples of the "Crawford" Jack, for 'phone connections and earthing switch. This is a small fitting in the form of a disc carrying two terminals on the periphery, and intended to be fastened at any convenient point in a house by means of two small screws through the base. In the face of the disc there are two plug-holes; and a small two-pronged plug, carrying terminals for the attachment of the 'phone leads, can be inserted at will in the fixed disc. When forced home, the conical end of one of the prongs pushes apart a spring contact-device that normally short-circuits the terminals on the fixed base, and introduces the 'phones into circuit in series with any other instruments connected up to the jack. On removal of the jack the circuit is automatically made again. Evidently as many as are desired of these jacks can be wired in series throughout a house; and the telephones (or loud-speaker) can be plugged in anywhere at will.

On test the jack operated satisfactorily, and the insulation passed a severe test. It was found quite convenient in use, especially for temporary introduction of a pair of 'phones in a loud-speaker circuit, as the effect of the extra resistance was to make the signals bearable in the 'phones for a brief time, for more accurate adjustments.

**Erratum**

With reference to the G.E.C. advertisement in our April issue advertising Gecophone Wireless Components, it is regretted that the two illustrations of the grip terminals were transposed in position.

**"Modern Wireless" in South Africa**

The following extract from the Johannesburg *Sunday Times* illustrates the great interest taken in this magazine in South Africa:—

*Modern Wireless*, Part I., Vol. IV., 18.

This part sees the beginning of a new volume, and the Editor, Mr. John Scott-Taggart, must be congratulated on the comprehensiveness of its contents. Every page contains something for the wireless amateur, and this something is generally illustrated in the most intelligible fashion imaginable. An attraction likely to prove of great value is the very comprehensive wiring instructions and pictures which are included in a well-printed issue.

**Radio for Pitmanite Language Students**

Students of foreign languages, and particularly those who wish to practise Pitman adaptations by means of Radio, are frequently embarrassed in finding circuits suitable for their needs. Many of the sets advertised are ill-adapted for the reception of Continental telephony, and the difficulties are enhanced by reason of the fact that the dealers generally are entirely ignorant of foreign tongues and advance claims for their sets that cannot be maintained. A well-known London Pitman's Shorthand teacher, who has been experimenting, has now discovered a circuit that meets his requirements. This circuit is the Scott-Taggart four-valve T.A.T. set, which was planned in detail in the December issue of MODERN WIRELESS, from which it has been constructed, with the addition of Square Law condensers and verniers. By means of this set, the London Pitmanite was able to tune-in on the loud-speaker twelve French and German-speaking stations in about five minutes, and in seven cases addresses were being given in the languages at a pace suitable to enable listeners-in to record them in the foreign adaptations of Pitman's Shorthand.—*Pitman's Journal*.

**THE HARRIS WAVEMETER.**

In Mr. Harris' wavemeter described in the February issue of MODERN WIRELESS, the pin and socket of the two plug mountings are shown connected. When using the double coil method it will be found better to join the two pins, the lead from condenser being taken to the socket and not to the pin as shown. In other words, the connections to one of the sockets can with advantage be reversed.

**Quality RADIO**

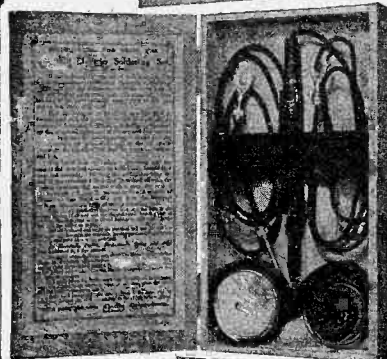

Quality Soldering SET

**SOLDERING**

simplified by this new invention, which works from any wireless accumulator with a carbon soldering bit. No gas, fire or lamp is needed. Everything necessary, including Flux and Solder, in stout wooden box, for 5/6. Postage 3d.

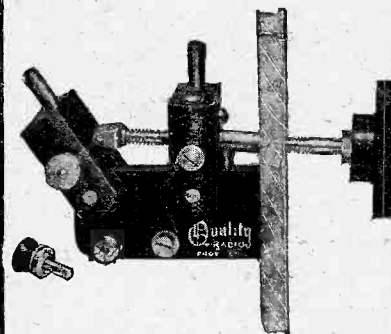

**Quality BACK OF RADIO PANEL VERNIER COIL HOLDER**

with detachable coloured terminals for reversing reaction. Price 10/6. Post 3d.

If your dealer has not got them we send post free if you mention his name and address.

**GOSWELL ENGINEERING CO., LTD.,**

12a, Pestonville Road, London, N.1.

Liberal Trade Terms. 'Phone: North 3057.

**Summer Conditions and Long-Distance Reception**

AS the summer advances the days lengthen and the period of darkness during which wireless enthusiasts have been conveniently able to attempt, with reasonable success, long-distance reception, becomes shorter, and thus much attention is being directed to the construction of sets which will cover long distances while daylight is still in evidence. This means, of course, either utilising more valves for high-frequency amplification, or getting more from those already in use.

The general tendency at present is rather towards the former, but, whichever method is favoured, a real ability to handle the set used efficiently is absolutely essential.

Those who are interested in receiving other than British broadcasting stations will do well to read the article which appears in the May *Wireless Constructor*, entitled, "Secrets of Long-Distance Working."

A type of receiver which many will favour during the summer months is that which lends itself

to portability. In the same issue of the *Wireless Constructor* will be found a complete and clearly detailed constructional article dealing with a set of this type. Apart from aerial and earth, this set, batteries etc. included, is completely contained in a small-sized attaché case, and will present a great appeal to motorists and picnic parties who wish to listen to broadcast programmes without the inconvenience of having to carry heavy or cumbersome equipment. To say that the set was designed and described by Mr. Percy W. Harris is sufficient guarantee of its efficiency.

**Selectivity**

For those who desire selectivity of a high order in a single-valve set, a constructional article of much interest appears in *Wireless Weekly* dated April 8th. This set was designed and constructed by Stanley G. Rattee, M.I.R.E., whose single-valve set for KDKA, which was described in the March issue of MODERN WIRELESS, met with such success in the hands of constructors. The article in question is entitled, "Some Experiments with Aerial Coupling Methods," and very successfully attains its object, which is selectivity in a single-valve receiver.

Two articles for those who desire pure reproduction of broadcast

recently appeared in *Wireless Weekly*, one in the issue dated April 1st entitled "A Filter Circuit for Loud Speakers," and the other in the April 8th issue under the heading, "Some Notes on Low-Frequency Amplification." Both of these articles were written by A. Johnson-Randall, and the man who desires real music from his loud speaker will do well to act upon the information given in them.

In the April 8th *Wireless Weekly* is a very useful and instructive article by C. P. Allinson, entitled, "How to Charge Accumulators." The man who possesses a multi-valve set and uses an accumulator of large capacity will welcome this article if he is fortunate enough to have a direct current supply to his house, for not only will the continual expense of charging batteries be done away with, but the very tedious journey to the charging station with a heavy accumulator will be no longer necessary.

Correspondence received regarding "The Foreign Radio Times" shows that in practically all circles this is highly appreciated and made use of. Those people who possess receivers capable of bringing in Continental broadcast cannot afford to be without this supplement, which is included in each edition of *Wireless Weekly*.

**BUILDING A NEW RECEIVER**

H.T.C. Products are designed by electrical engineers; and it is an unrivalled electrical performance that has brought their products into the forefront of present British receiver design.

Build successfully—therefore build with H.T.C. Products, which are proved the most efficient for radio telephony.

Give your set range by fitting H.T.C. Low Capacity Valve Holders. The ordinary type of valve holder with embedded sockets, sockets with large nuts and washers dangerously close together, and so-called low capacity valve holders paralyse your receiver, putting distant stations beyond its reach. For mounting the four-pin valve and the popular plug-in H.F. Transformer you can only expect the best results if you use the H.T.C. Low Capacity Valve Holders.

These are protected by Letters Patent No. 222,545. The public and trade are hereby warned against any or all infringements of this patent, whether resulting from the manufacture, sale or use of any apparatus which embodies this invention.

It must be borne in mind by the Trade and Public that the sale or use in this country of any infringement renders the seller or user liable for action with the unlicensed manufacturer and importer. It is this Company's intention to uphold its patent rights and the novelties protected thereby.

- Type A (above panel) ... 1/9
- Type B (Board mounting. Available 1st May) ... 1/9
- Type C (below panel) ... 1/6

**H.T.C. ELECTRICAL Co. Ltd.**

Telephone: Battersea 374.  
2-2a, BOUNDARIES ROAD, BALHAM, LONDON, S.W.12.

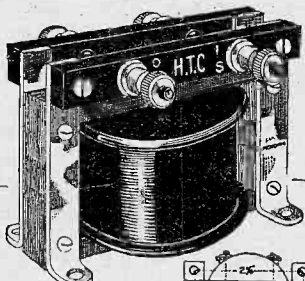

LENGTH • 2 3/4"  
HEIGHT • 2 1/4"

Seventy-four per cent. of the total weight of the H.T.C. L.F. Transformer is effective copper and iron. This makes for very high efficiency. Price 15/-

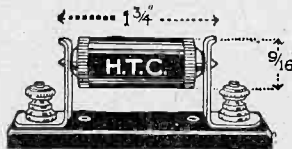

**REALLY PERMANENT.**

The H.T.C. Fixed Detector (Prov. Pat. 30258/24) is really permanent. You can put it under your panel and forget it. It will function better than any galena with its constant need for adjustment and will give louder signals than the majority of the semi-permanent types. It employs a proved crystal combination which held the Admiralty record (over 5,000 miles) for long-distance reception.

Remember the H.T.C. Fixed Detector is really permanent. It reaches you, broadcast tested.  
H.T.C. Fixed Detector ... 3/6  
Complete with Ebonite Base, Clips & Terminals ... 4/6  
Detector Clips only ... 3/9

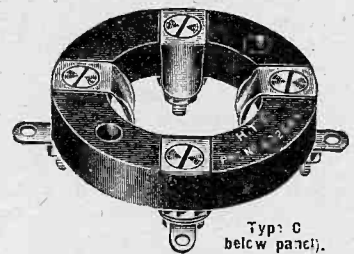

Type C (below panel).



Type A (above panel).

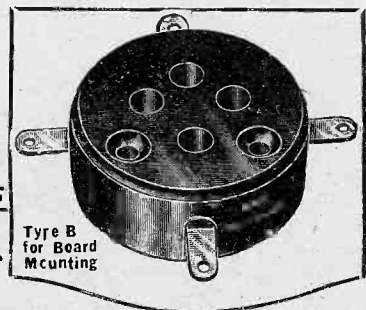

Type B for Board Mounting

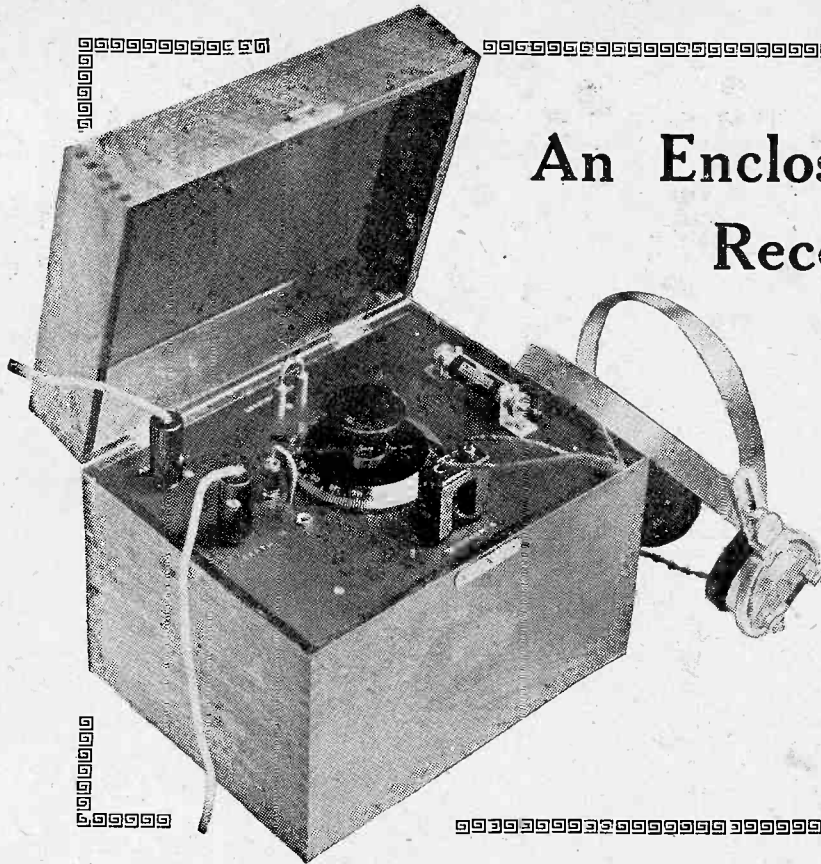

# An Enclosed Crystal Receiver

By

A. JOHNSON-RANDALL

*A simple and effective little set, particularly suitable for those who object to crystal detectors which require constant adjustment.*

IF you ask yourself the question, "What do I object to most in a crystal receiver?" I think the reply will invariably be: "The necessity for constantly having to adjust the detector because some slight vibration has disturbed the sensitive setting." There are a number of excellent detectors on the market which are so well designed that the adjustment remains constant for long periods; but a considerable number of broadcast listeners persist in the use of cheap and badly made instruments of doubtful origin, and in consequence spend a considerable portion of the evening in trying to find and keep a sensitive adjustment, and often in so doing miss some of the most attractive items on the programme. In order to cater for that section of the broadcast public who desire to construct a simple set which will not require constant adjustment, I have designed the receiver which I am about to describe. I have made no startling departures from existing practice, but the reader may rest assured that if he follows the instructions carefully he will be the proud possessor of an efficient crystal set which for range and volume will be fully equal to any other that he has heard and tried in the same conditions. For the comparison to be fair, of course, the test would need to be conducted on

the same aerial and at the same time. The special points which require to be emphasised are, firstly, no terminals are employed; secondly, a new type of permanent detector is used; and lastly, the tuning inductance consists of an efficient and easily constructed coil which, although taking only a few minutes to make, will be found as good as the best and a great deal better than many of those used by constructors.

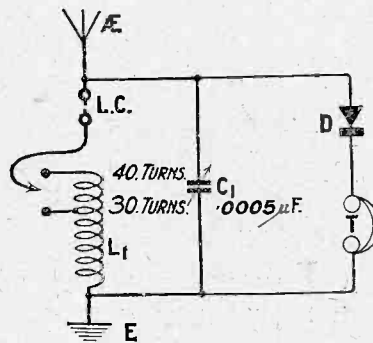

The theoretical circuit diagram.

This aerial coil is tuned by means of a  $0.0005 \mu F$  square law variable condenser, and once the correct position of the dial has been found, the receiver may be left "set."

The aerial is connected to the set by means of a plug, and the earth lead by means of a socket;

and to disconnect the receiver and at the same time earth the aerial, it is only necessary to withdraw the plug and socket from the set and to insert one within the other as shown in the photograph.

The telephones may also be removed in the same manner by withdrawing the telephone plug, and the lid of the box may then be closed, thus protecting the receiver from dust and possible damage.

### Components Required

- 1 Mahogany box with lid, 8 in. x 6 in. x 6 in. (Camco).
  - 1 Ebonite panel, 8 in. x 6 in. x  $\frac{1}{4}$  in. (Paragon).
  - 1 Ebonite coil former (Burne-Jones).
  - 1  $0.0005 \mu F$  variable condenser, square law pattern (Jackson Bros.).
  - 2 Sockets and a plug for tappings 1 and 2.
  - 1 Telephone plug (Burndept).
  - 1 Aerial plug and socket (General Electric Co.).
  - 1 Earth socket and plug (General Electric Co.).
  - 1 Loading coil plug and socket for mounting beneath the panel.
  - 1 Crystal detector (Radio Instruments).
  - 1 Set of Radio Press panel transfers.
- A quantity of tinned-copper wire and four 6 B.A. screws with nuts.  
Approximately 2 oz. of No. 22 S.W.G. d.c.c. copper wire.

# HULLO EVERYBODY!

NOTE  
K. RAYMOND'S  
2 ADDRESSES.

NOTE ALL THESE GOODS post free U.K. except where stated. Foreign orders must include extra for packing and post.

- SUNDRIES**
- Aerial, 7/22, 100 ft. 2/6
  - 50 ft. ditto 1/8
  - Basket Holder and Plug 2 for 2/-
  - Ditto, best quality 2 for 2/3
  - Ditto, spike holder 2 for 2/-
  - 2-way coil stands 2/9
  - 3-way coil stands 4/6
  - 2-way nickel 3/6
  - 3-way nickel 3/6
  - 2-way gear 5/6
  - 2-way Shipton cam 6/-
  - 3-way Shipton cam 7/6
  - 2-way Polar cam 6/-
  - 3-way Polar cam vernier 9/-
  - 2-way cam vernier 3/6
  - Coil plugs, plain 2 for 1/3
  - Shaped wedge 2 for 1/6
  - Do. Edison Bell 2 for 2/-
  - Do. Nickel sides 2 for 2/-
  - Do. fitted fibre 2 for 1/8
  - Variometer 2/6
  - Ebonits do. 4/11
  - Igranic do. 10/-
  - Edison Bell do. 10/-
  - Fixed Condensers—
  - Edison Bell, .001 1/3
  - .001 up to .0005 1/3
  - .002 up to .006 2/-
  - Grid leak and clips 1/6
  - .0003 and grid leak 2/6
  - Dubilier .001 to .0005 each 2/6
  - .001 to .006 each 3/-
  - 2 or 3 meg Grid Leak 2/6
  - Anode res. on stand 5/6
  - (50, 70, 80, 100,000 ohms.)
  - Raymond Ebonite Base—
  - .0001 up to .0005 1/1
  - .001 up to .006 1/3
  - Grid leak and clips 1/3
  - .01 and .02 each 1/9
  - Mansbridge T.C.C. 2 mfd. 4/6
  - 1 mfd. 3/10
  - .25 3/8
  - Flush panel sockets, with nuts, doz. 1/3
  - Spade terminals, doz. 1/-
  - Pin terminals, doz. 1/-
  - Spade tags, doz. 6d.
  - Studs, Nuts, and washers, doz. 9d.
  - Shorting plug 8d.
  - Bus Bar, 1/2 sq. 12 ft. 1/-
  - Solid Rod Valve Holders 1/3
  - Murray Valve Holders 1/3
  - Bretwood do. 1/9
  - H.T.C. under panel 1/6
  - H.T.C. over panel 1/9
  - Barrie anti-cap 1/3
  - Burndept Detector 4/-
  - Dual Rheostat 7/6
  - Ormond Rheostat 2/-
  - Ormond L.F. 14/6
  - Rheostat C. & S. 1/3
  - Lo. Raymond 1/6
  - R.I. Detector 6/-
  - Empire Tape 1/4 in. 12 yds. 1/-
  - Twin Flex, 12 yds. 1/9
  - Red & Black, 12 yds. 2/-
  - 72in. Phone Cords 1/11
  - Loud Speaker Cords 1/11
  - Easi Fix 3/-
  - Set of Drills (7) 1/9
  - Screwdrivers 8d.
  - Set of 5 Spanners 8d.
  - Soldering Iron 1/-
  - Tin Soldo 1/6
  - Hovimo Crystal

- LISSEN Minor** 3/6
- Lissenstat 7/3
  - Universal 10/6
  - Switch 2-way 2/9
  - Series Parallel 3/9
  - Anode Res. 2/6
  - Var. Grid Leak 2/6
  - Choke 10/6
  - Lissen L.F. T.1 30/-
  - Lissen L.F. T.2 25/-
  - Lissen L.F. T.3 18/6
  - Coils, LISSEN 260, 6/4
  - 25, 4/10 35, 40, 4/10
  - 50, 5/- 60, 5/4
  - 75, 5/4 100, 6/9
  - 150, 7/- 200, 8/5

- LOUD SPEAKERS**
- C.A.V. Tom-Tit 30/-
  - C.A.V. Junior 55/-
  - Sterling Baby 55/-
  - Sterling Dinkie 27/6
  - Amplion Junior 27/6
  - Amplion Dragonfly 25/-
  - Amplion Do. III 50/-
  - Amplion De Luxe 65/-
  - Amplion AR19 105/5
  - Dulcevox 42/-
  - True Music Minor 21/-

- ENERGO H.F.**
- No. 1 150/450 3/6
  - No. 2 250/700 3/11
  - No. 3 450/1,200 4/3
  - No. 4 900/2,000 4/6
  - No. 5 1,600/3,000 4/9

- QUALITY (GOSWELL) RADIO COILS MOUNTED.**
- 25 1/6
  - 35 1/9
  - 50 2/0
  - 75 2/3
  - 100 2/9
  - 150 3/0
  - 175 3/6
  - 200 3/9

- Valve Legs, Set 4 1/6**
- Valve Holder 1/9
  - 2-way Cam Vernier 9/-
  - 3-way Cam Vernier 12/8
  - 3-way Ordinary 7/6
  - 2-way Panel 3/-
  - 3-way Panel 5/-
  - Basket Holders 1/4

- "LOTUS" 2-way Cam Vernier 7/-**
- 3-way do. 10/6

- POLAR .001, .0003, .0005, .00025 10/6**
- Micrometer 5/6
  - 2-way cam vernier 6/-
  - 3-way cam vernier 9/-

- N & K HEADPHONES. Genuine.**
- Guard against inferior imitations which are "cleverly" got up to deceive. Make sure of the genuine article, and see letters N & K stamped on back of 'phones.
  - 4,000 ohms 12/11
  - Post 6d. pair.

- DR. NESPER HEADPHONES**
- Adjustable diaphragm detachable receivers, double leather-covered head - springs, long flexible cords, nickel-plated parts. Very comfortable fitting to the head. Per Pair, 12/11 Post 3d. pair.

- TRANSFORMERS L.F.**
- Eureka Concert Grand 30/-
  - Eureka Second Stage 22/6
  - Igranic Shrouded New Model 21/-
  - Formo Shrouded 18/-
  - Formo Open Type 12/6
  - Portland 12/6
  - General Radio 83 15/-
  - Super Success (black) 21/-
  - Royal 20/-

- "UTILITY" SWITCHES**
- 2 Pole c/o Knob 4/-
  - 2 Pole c/o Lever 5/-
  - 4 Pole c/o Knob 8/-
  - 4 Pole c/o Lever 7/6

- HEADPHONES**
- British B.T.H. 20/-
  - Brandes Matched 20/-
  - General Radio 20/-
  - Brown's F Type 29/-
  - Sterling's 22/6
  - All 4,000 ohms.

- TELEFUNKEN**
- Adjustable 'Phones, 4,000 ohms, only genuine when bearing No. EH 333 on each earpiece. These 'phones are lighter than a feather, and simply wonderful for reception. 17/11 pair.

- ERICSSON E.V. CONTINENTAL 12/11**
- Your favourite 'phones. Entirely NEW MODEL. Most beautifully finished, exquisite tone. (4000 ohms)

- VALVES**
- All makes stocked. B.T.H. Ediswan, Mullard, Cossor, Marconi. Bright Emitter, Dull Emitter, and Power Valves.

- TRADE DISCOUNT 20%**
- on any goods on this page and variable condensers. Not less than 20/- order trade by post.

- "R.I." NEW MODEL IN SEALED BOX**
- R.I. PERMANENT DETECTOR, 6/-
  - SHIPTON STRIP. 7 ohm Rheostat 3/-
  - 30 or 60 ohm 3/-
  - Potentiometer, 600 ohms 4/6

- 7. Grid Leak and .0003 2/2
- Edison Bell do. 2/6
- Dubilier do. 5/-
- Terminals complete. 9. Pillar 1/3
- 10. Do. 1/-
- 11. W.O. 1/3
- 12. 'Phone 1/1
- (Nickel 9d. doz. extra.)
- 14. Voltmeter each 5/6
- 15. Grid Leak and Clips 1/4
- 16. Rheostat & Dial 2/3
- 20. Murray Valve Holder 1/3
- 21. C. & S. Rheostat 1/4
- 23. D.P.D.T. Nickel (panel) 1/3
- 24. S.P.D.T. Nickel (panel) 1/-
- 27. Headphones. See lists.
- 28. Sterling Square Law & Vernier: .001, 30/8; .0005, 25/6; .00025 23/6
- 29. Shaped Coil Plug, 2 for 1/9
- 30. On or Off Switch 1/3
- 31. Igranic Rheostat 4/6
- 33. Energo H.F. all W.L. See lists elsewhere.
- 34. Water Microstat (For D.E. or R valves.) 2/9
- 35. Ebonite Tumbler Switch 1/3
- 36. Real Ebonite Dials 1/3
- 41. Loud Speakers. See List.
- 43. 2-way Basket Stand 5/6
- 44. Bretwood Valve Holder 1/9
- 45. One-hole fixing Brass 10d.
- Ditto Nickel 1/2
- 46. Solid Rod Valve Holder 1/3
- 48. L.F. Transformer 5-1 9/11
- 49. Formo Shrouded 18/-
- 51. Enclosed Detector (large) 1/6
- Also Micrometer movement 2/3
- 54. Variometer and Dial 3/11
- 55. Rheostat, one-hole fixing 1/8, 1/4
- 57. Manchester "Powquip" 15/6
- 58. Standard "Powquip" 14/6
- 59. Shrouded "Powquip" 18/-
- 60. Ormond 14/6
- 61. Igranic L.F. 21/-
- 62. 3-way Stand, 4/3 4/11
- 63. Lissen L.F. T.3 16/6
- 64. Lissen Pull and Push 2/9
- 65. Lissen, 5 point 4/-
- 66. Lissen Minor 3/6
- 67. Lissen Grid Leak 2/6
- 68. Screw Spades, doz. 1/-
- 69. Legless Valve Holder 1/3
- Goswell Do. 1/6
- 70. 3-way Coil Stand 5/8
- 71. Valve Holder 1/3
- 72. T.C.C. Mansbridge 15/-
- 73. Energo L.F. 30/-
- 74. Eureka Grand 30/-
- 75. 3-way Cam Vernier 7/6
- 76. Utility Switch. See List.
- 77. Success Super 21/-
- 78. T.C.B. 6 or 30 ohms 4/-
- Potentiometer, 300 ohms 5/-
- Ferranti L.F. 17/6
- WONDER AERIAL. Phosphor bronze, 49 strands. Not cheap imitation. 110 ft., 3/8

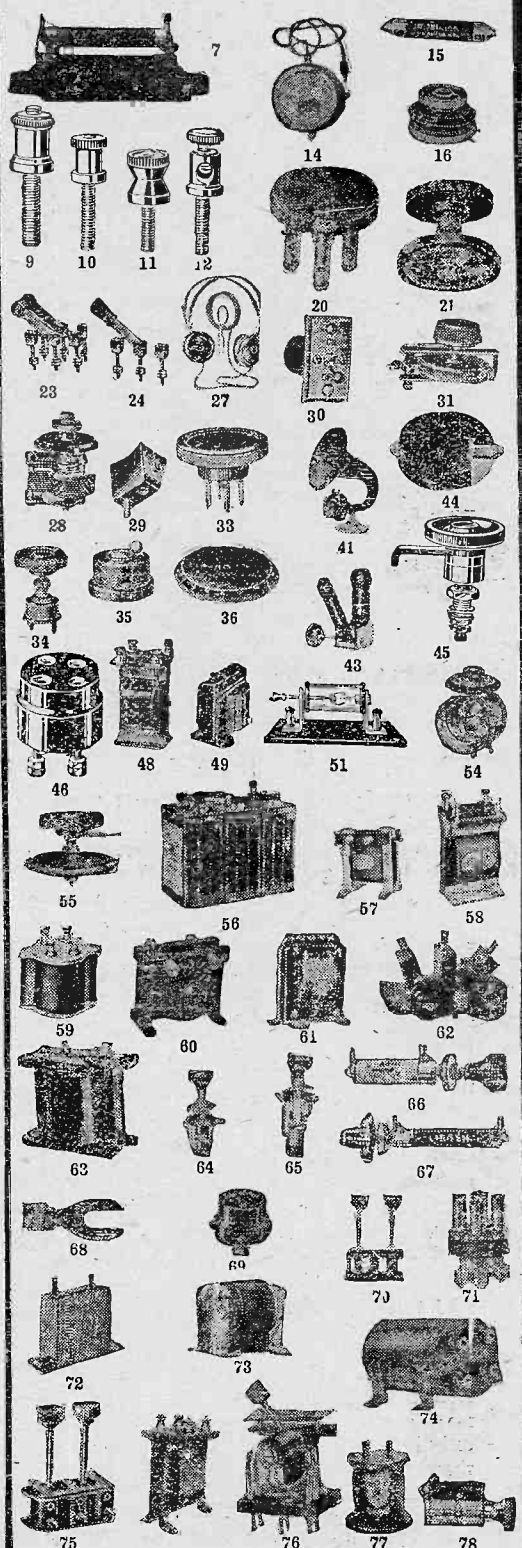

**7, GRAPE STREET, SHAFTESBURY AVENUE, W.C.2.**  
(New Oxford Street End.) (Close to Prince's Theatre.)  
Also at 27, LISLE STREET, W.C. 2.

All postal communication to 7, Grape Street, W.C.2.

Hours of Business at 7, Grape Street: 9.30 to 7. (Closed Sundays.)

# RAYMOND'S FOR WIRELESS!

## THESE GOODS ARE SENT BY POST. LOW LOSS AIR DIELECTRIC CONDENSERS

### THE Condenser for low wave-lengths. Also for general purposes.

The importance of reducing losses in the transmission of energy through a wireless receiver is obvious. An almost minute loss of energy when amplified means a very large loss of volume when finally the "results" of a receiver are heard by means of headphones or a loud speaker.

It is highly necessary to the experimenter who desires to work on low wave-lengths to embody low-loss condensers.

These instruments are specially adapted for this use, and in comparison with any other instrument of whatever make and price, will give marked superiority of reception.

### SPECIFICATION.

High-grade ebonite, End Plates, Aluminium Vanes, 22 S.W.G., planished true. All metal parts turned out of solid brass to most accurate limits, and nickelled throughout. Terminals fitted for connections. Complete with knob and dial. Solid brass spacer washers (nickelled), ensuring non-oxidisation when in contact with aluminium vanes. British components and manufacture throughout.

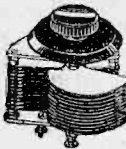
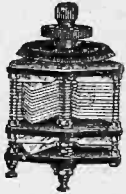

## SQUARE LAW SQUARE LAW & VERNIER

•0005	6/9	•0005	8/9
•0003	6/-	•0003	8/6

Ebonite ends. POST 6d. SET.      Ebonite ends. POST 6d. SET.

## RAYMOND VARIABLE CONDENSERS (SQUARE LAW LOW-LOSS)

One-hole fixing. Aluminium ends. WITH VERNIER	EBONITE Bushes. Highly recommended. WITHOUT VERNIER
•001 - - - 8/6	•001 - - - 7/7
•0005 - - - 7/6	•0005 - - - 5/9
•0003 - - - 7/-	•0003 - - - 5/3

Post 6d. Set.      Prices include Knob and Dial.

## TWIN CONDENSERS

Equal parts of •0005, •0003, and •00025. With Knob and Dial.

Ebonite Ends.

•0005 ebonite ends	18/11
•0003 "	12/6
•00025 "	12/6

Post 6d. Set.

## DE LUXE ORDINARY

Complete with Knob and Dial.

•001 alum. ends	6/11
•0005 "	5/6
•0003 "	4/11
•0002 "	4/6

POST 3d. SET.

London's Largest Stockist of  
**JACKSON BROS.**  
"J.B." Condensers, Square Law with Vernier.

•0005	12/6
•0003	11/6

SQUARE LAW

•001	9/6
•0005	8/-
•0003 and •00025	6/9
•0002	5/6

STANDARD

•001	8/6
•0005	7/-
•0003	5/9
•0002	5/-

With Knob & Dial. Post 4d.

**Criterion Coils**  
Very Special Offer  
25, 35, 50, 75, 100 set of 5 ..... 10/-  
50, 5/6 ..... 200 ..... 6/-  
50, 5/6 ..... 300 ..... 7/-  
Razor-sharp tuning. Mounted on plug.

**IMPORTANT!**  
By arrangement with Messrs. Bower Electric offer **GENUINE 5-PIN**

**THORPE K4 17/6**  
Unidyne Valves, 1/3  
5-pin Valve Holder, 1/3

**VARIABLE GRID LEAKS**  
Lissen ..... 2/6  
Watmel ..... 2/6  
Allen ..... 1/6  
Bretwood ..... 3/6

**ANODE RESISTANCE**  
Lissen ..... 2/6  
Watmel ..... 3/6  
Allen ..... 1/6  
Bretwood ..... 3/-  
Super-Selective Resistance Bretwood 3/-  
E.M.C. .... 4/6  
Watmel ..... 3/6

**PORTLAND L.F. 5-1**  
Highly recommended. 12/6.

**IGRANIC COILS**  
Coils: 25, 5/-; 35, 5/-; 50, 5/2; 75, 5/3; 100, 7/-; 150, 7/10; 200, 8/8; 250, 9/-; 300, 9/5; 400, 10/3; 500, 10/6; Rheostat, 4/6; 30 ohms, 7/-.

**Parts for "P.W." Continental Set:**  
•0005 Square Law 5/9  
•0003 Square Law 5/6  
2 Special Valve Holders for ..... 2/3  
•001 Holder ..... 1/3  
Condenser and Grid Leak ..... 2/6  
002 Fixed Condenser ..... 1/3  
10 Terminals ..... 1/3  
Transfers, Bus Bar Screws, Nuts, &c. 1/-  
Two-way Coil Stand ..... 4/11  
2 Microstays ..... 5/6  
Postage extra.

**GENUINE "BRUNET"**  
L.F. Transformers.  
-1. Primary 5,000 Secondary 15,000.  
-1. Primary 5,000 Secondary 25,000. 13/6 each.

**"BRUNET" PHONES**  
New model, Black cords, 4,000 ohms, 16/6.

All orders accepted and despatched on strict understanding that the place of payment is 7, Grape Street, W.C.2. Please cross Postal Orders and register each.

West End Stockist of Edison Bell, Igranic, (of excellent quality), Polar, Jackson Bros. (J.B.), Harconi, Cossor, Mulard, Ediswan Valves, Sterling, B.T.H., McMichael's, Lissen, Jubilee, T.C.B., Ship

## THESE ARE SPECIAL CALLERS' PRICES. All post orders from other column.

Loud speakers.....15/9  
4,000 ohm phones, 6/6  
3-way coil stands, 3/6  
Special rheostats, 1/-  
Crystals, best.....6d.  
Enclosed detectors, 8d.  
Extra large do.....1/-  
(One-hole fixing) 1/3  
2-w. AC accumulator, 7/6

**SWITCH ARM**  
12 studs, 12 nuts, 12 washers. Theolt. Brass 10yd.; Nickel 1/3.

**SWITCH ARMS**  
Brass 6d.; Nickel 9d.  
One-hole fixing.

**SPECIALS IN COIL STANDS**  
2-way, extra quality  
1-w. 1/11  
2-way cam vernier, 3/3  
2-way geared ..... 5/3

**DUPLEX WAX LEAKS.** Set of 5 coils, 25, 35, 50, 75, 100 ..... 1/8

Ebonite basket holders. 6d., 7d., 8d., 9d., 10d., 1/1  
Valve windows ..... 4d.  
Screws & nuts, 2 a 1d.  
Phone connectors, 1d.  
Pliers, good make, 10d.  
1/-  
Climax earth tubes, 5/-  
Twin silk flex, 6 yards, 6d.  
Gold whisker.....3d.  
Silver ..... 2d.  
4 (one gold) ..... 1d.

**MANSBRIDGE**  
2 mid., 3/9; 1 mid., 3/3; 25, 2/9

**RHEOSTATS**  
Ormond ..... 1/8  
C. & S. .... 1/6  
Raymond ..... 1/3, 1/6  
With dial, 1/8, 1/11

**SHAW'S GENUINE HERTZITE 8d.**

**Panel Switches**  
D.P.D.T. .... 10/1/-  
S.P.D.T. .... 10/1/-  
China base: 1/-  
D.P.D.T. .... 1/3  
S.P.D.T. .... 8d.

**VERNIERS**  
Michromi.....2/6  
Calvern.....2/6  
Ormond.....2/-

**PERMANENT Detector, "Y.O." 3/9.**  
Why pay more?

**DR. NESPER**  
(genuine) 4,000 ohm phones. Callers, 11/9

**Reactone Coils**  
Set of 5.....3/9  
1 for 5XX.....1/9

5/- **PHONES.**  
Customers buying 20/- worth full-price goods can have a first-class pair of phones for 5/-. Must be taken at time of purchase.

**Fixed Condensers**  
Raymond (ebonite base) •001, •0001, 2, 3, 4, 5, 10d.  
•002, 3, 4, 5, 6, 1/-  
Terminal fittings.

**TRANSFORMER**  
Special line. 8/11  
I.F. 5-1

**ELECTRICIANS'**  
insulated pliers. Good quality. Pair 10d. Limited number.

1,000 ohm bobbins 10d.  
Tumbler switches 10d.  
Shorting plug.....3d.  
Egginsulators 4 for 3d.

Variometer 250/650 1/3  
Murry valve holder 1/3  
Anticlip ditto.....10d.  
Solid rod standard 1/-  
Good quality do. 8d.  
H.P.G., Bretwood, etc.  
Hank 1/15th sq. Bus Bar ..... 6d.  
Lead-in (10 yds.) 1/-  
Ebonite dial.....8d.  
Unbreakable knobs 3d.  
Adhesive tape, roll 2d.  
Valve templates, 1d.  
Tape aerial, 100ft. 1/10

**ACCUMULATORS**  
(well-known makes)  
2v. 40a.....7/6, 8/6  
4v. 40a. 13/11, 15/11  
4v. 60a.....17/6, 18/3  
6v. 80/115th sq. 23/6  
6v. 60a. 25/11, 27/6  
6v. 80a.....33/-  
6v. 100a.....38/6  
Hart's & Rotax stocked.

Set of 5 spanners 3d.  
Screwdrivers.....2d.  
Soldering irons.....6d.  
Drills (7) ..... 1/2  
Solder (2 sticks) 2d.

**Ebonite Coil Plugs**  
Fitted Fibre ..... 7d.  
Plain ..... 4d.  
Shaped ..... 6d. & 7d.  
Edison Bell ..... 11d.

**WONDER AERIAL**  
Phosphor bronze, 49 strands. Not cheap imitation. 110 ft., 3/-

**SQUARE LAW**  
Variable Condensers.  
•0005 ..... 5/-  
Including knob & dial. Ebonite ends 1/- extra.

**SQUARE LAW**  
Variable Condensers.  
•0003 ..... 4/6  
Including knob & dial. Ebonite ends 1/- extra.

**PHONE BLOCKS**  
Ebonite base. Take 4 pairs' phones, 2/9

**1-5 BATTERIES**  
Siepens', Hellosens', B.T.H., O.K. etc., etc. Lowest prices.

**H.T. BATTERIES**  
(Various makers).  
60-v., 5/6, 8/6, 6/11  
100-v., 12/6, 14/11

**EVER-READY**  
65v. ....13/6  
105v. ....22/6

**B.B.C.**  
60v. ....8/6  
85v. ....5/6  
16-5 .....2/9  
9v. (grid bias) .....2/3

**CHELMSFORD**  
D.C.C. coils. Wonderful value. 10d., 1/-, 1/3

**BREAST DRILLS**  
Double pinions. Cut bevel 2 1/11 with 5/- worth full-price goods.

**TRANSFORMERS**  
B.B.C. (H.F.).....2/6  
5XX (H.F.).....2/11

**YOUR FARE PAID**  
on certain goods up to 2/- in the 2s. post. (N.A.R.M. and fixed excluded).

Terminals, 1d;  
Nickel, 2d; doz. 10d.  
Valve sockets, 4 for 3d.  
Stop or valve pins, 1d.  
Washers.....12 a 1d.  
Nuts.....6 a 1d.  
Spade tags.....6 a 1d.  
Spade terminals, 2 for 1d.  
Pin terminals, 2 for 1d.  
Above red and black, 2 for 3d.  
Copper foil, foot. 2d.  
Bell wire, 10 yds., 5d.  
Empire tape, 6d.  
Red and black flex, 12 yards, 1/6  
Aerial, 7/22-00ft. 1/10  
Battery clips, 3 a 1d.  
Sleeving, 12 yards 6d.  
Wander plugs, nr. 2d.  
Contact studs complete.....2 a 1d.  
Phone cords, 6 ft., 1/3

**MICROMETER**  
Crystal detector, enclosed.....1/6

**CRYSTAL SETS.**  
with 'phones, 4,000 ohms, aerial, & lead-in. 15/6 and 18/6.

**ERICSSON E.V.**  
Continentals 4,000 ohm 'phones, worth much more. Callers' price, 11/8 pair.

7/22 Aerial, 50ft., 1/1  
Ins. Hooks, 2 for 1d.  
Loud speaker cords, 1/4, 1/6  
Ins. Staples.....5 a 1d.  
Flush panel sockets (nickel and nuts), 1d.  
Rheostats, special, 9d.  
Vernier condensers, 1/9

**VARIOMETER**  
250/700 terms inside winding, worth 10/- 50 at 4/11.

**EBONITE**  
Stock sizes 3/16th, 5/8, 6-7 x 5 each, 1/2  
8 x 6-9 x 6 each 1/10  
10 x 8-12 x 6.....3/-  
12 x 9 .....4/3  
12 x 12 .....5/8  
12 x 15 .....6/6  
1/4th in. also stocked.

**D.C.C. WIRE**  
1 lb. reels.  
18 or 20 g.....9d.  
22 g.....10d.  
24 g.....11d.  
26 g.....11/2  
28 g.....1/2  
16 g., per lb.....2/4

**COIL FORMERS**  
Double ..... 1/3

"Popular Wireless" Limited number FREE weekly.

**CRITERION Coils.**  
25, 35, 50, 75, 100. Set of 5.....8/11.  
Sold separately.  
Very special offer.  
150. 4/6; 200. 5/11  
250. 5/6; 300. 5/11  
Razor-sharp tuning. Mounted on plug.

Knobs and Dials, 1d.  
Knobs and Dials, 10d.  
Empire Tape, 12 yds, 6d.  
Valve Holders, special.  
'Phone Plug and Jack.  
Cheap lines daily, as an advertisement.

**7, GRAPE STREET, SHAFTESBURY AVENUE, W.C.2.**  
(New Oxford St. End) near Princes Theatre.  
ALL POST ORDERS TO ABOVE.

**27, LISLE STREET, LEICESTER SQUARE, W.C.2**  
Phone: Gerrard 4637.

**HOURS OF BUSINESS DAILY 9-7.45.**  
Sunday 10-1.  
27, LISLE STREET  
:: ONLY ::

In replying to advertisers, use Order Form enclosed.

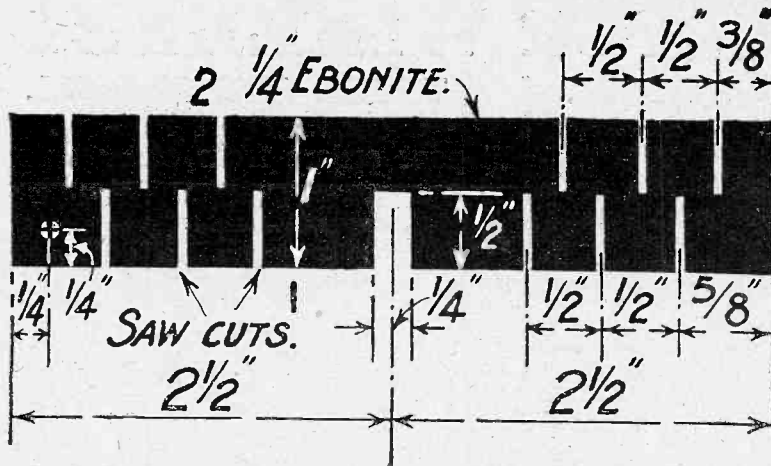

Fig. 1. The dimensions of the ebonite former. In the latest types the slots overlap, but either pattern will be found equally satisfactory.

**Construction**

The construction of the set is a very simple matter. First take the ebonite panel, which, it is well to mention, should be guaranteed free from surface leakage, and mark it out by means of a 12-inch steel rule and scribe to the dimensions given on the drilling diagram, Fig. 2. For mounting the Burndeft telephone plug a 5/16-inch drill is required, and as a template is supplied by the makers it is an easy matter to set out the holes correctly.

The distance between centres for the loading coil plug and socket is 3/8 inch, and a 1/4-inch drill should suffice here. Makers of repute also usually supply a template with this component.

The variable condenser requires a 3/8-inch hole, and a clearing hole may be drilled for the earth plug, which may be secured with a nut

and washer. The aerial socket, on the other hand, is a driving fit, and a hole should be drilled slightly smaller than the outside diameter of the socket, which may then be tightly forced into position. Those who wish to construct their own cabinet should bear in mind that the dimensions of the box are 8 inches by 6 inches internal, and that the depth, including the lid, is also 6 inches. There should be a clearance of 1 1/2 inches between the lid itself and the fittings on the panel.

**The Tuning Coil**

The type of tuning inductance used is known as the Kendall "X" coil, and is due to Mr. G. P. Kendall, B.Sc., who described it very fully in *Wireless Weekly*, Vol. V., No. 17. Readers who require more information regarding this coil than can be given here are advised to refer to the above

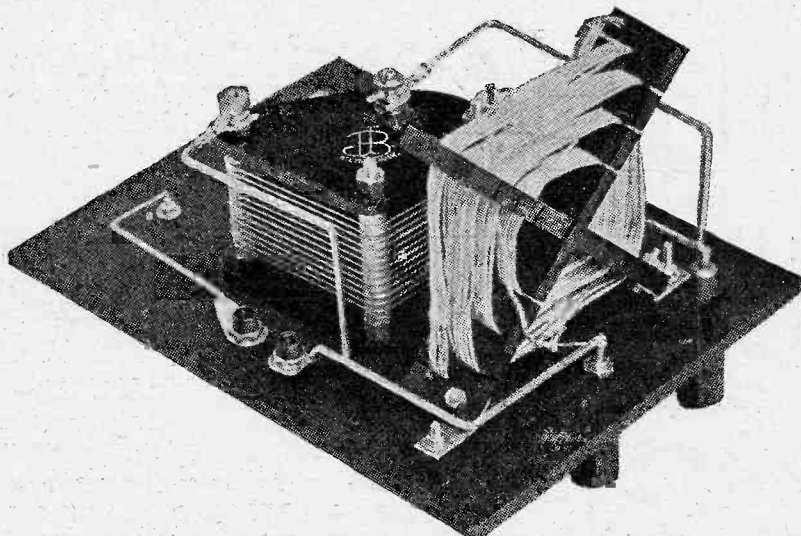

The coil is secured to the panel by means of two small strips of brass and four No. 6 B.A. screws and nuts.

article. The basis of the coil is the well-known cross-shaped former, which it will be remembered was first described by Mr. Percy W. Harris, M.I.R.E., and consists of two strips of ebonite 5 inches long and 1 inch wide, as shown in Fig. 1. These formers can be obtained already cut to size from advertisers in this journal, but readers who prefer to make them will have no difficulty in so doing if they follow carefully the dimensions given. The actual coil in the set is wound with 40 turns of No. 22 S.W.G. d.c.c. wire, and a tapping is taken after winding on 30 turns. This enables a wavelength range of from 300-500 metres to be obtained in conjunction with the

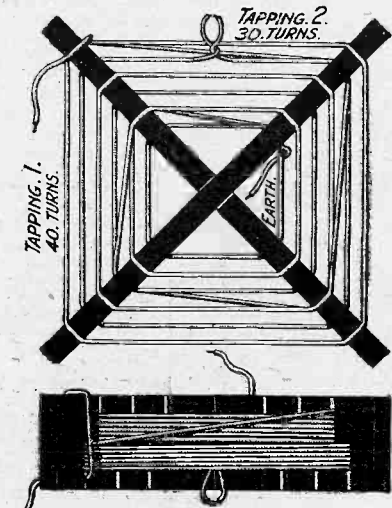

A drawing of the coil showing the method of winding.

0005 μF variable condenser; but those who are situated within an area covered by a main station will not in all probability require this tapping. On my own aerial 2LO is received on about 40 degrees of the square law condenser with all the turns in circuit and the loading coil plug short-circuited.

To construct the coil, take about 2 oz. of 22 S.W.G. wire and commence winding a layer of wire in the slots marked 1 in the diagram, then cross over and wind a layer in those marked 2, and so on. After winding on 30 turns take a tapping by twisting the wire and scraping off the cotton covering. Then continue winding until the whole 40 turns are completed. The turns may not pull out absolutely straight but this will not be detrimental to the efficiency of the coil. The inductance may be mounted by means of two small strips of brass and four 6 B.A. screws and nuts, two for fixing to the panel and two for

# VOLUME

WITHOUT

# DISTORTION

is obtained with

## GAMBRELL INTERVALVE L.F. TRANSFORMERS

STAGE I  
27/6

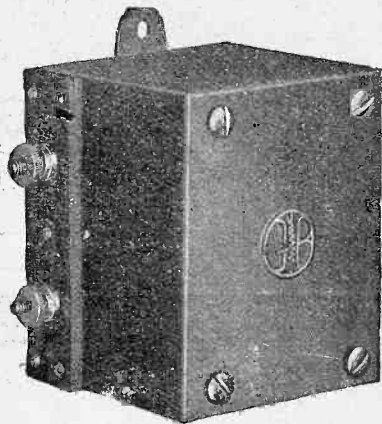

STAGE II  
27/6

As used in circuits described by Mr. Percy W. Harr's and Mr. John Underdown.

**POINTS.**

Constant amplification at all frequencies. Perfect insulation. Excellent magnetic coupling between Primary and Secondary.

Pressed steel case. Ebonite Terminal boards. Stalloy laminated core. Moisture proof sealing.

If your retailer has not these Transformers in stock, he can quickly obtain same to your order. Insist that he does. There are none "Just as Good."

The Gambrell Stabilising Condenser for Neutrodyne Circuits is the original one shown in Circuits in Radio Press Publications. Price 5/6 each.

## GAMBRELL BROS., LTD.

76, Victoria Street, London, S.W.1

Works: Merton Road, Southfields, S.W.18

Phones: VICTORIA 9938 — PUTNEY 3641-2

# Rothermel American Radio

Radio practice in America is considerably in advance of design in this country. The present growing popularity of Super Receivers has found the British Manufacturer guessing. If you want to build the Super Set of your dreams use American apparatus of proved efficiency. The products illustrated here are most popular in America—and remember if it's American Radio—ask Rothermel!



This Kit is now supplied with new improved Oscillator Coupler.

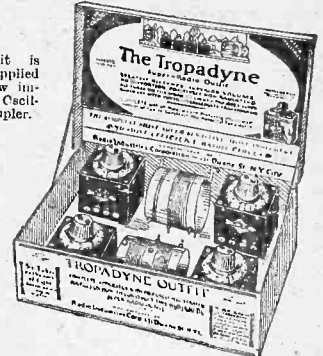

### For the TROPADYNE.

**THE TROPAFORMER.**

The Tropafomer is a long wave transformer for use in the Tropadyne and Super Heterodyne circuits. Tunable range of 2,000 - 10,000 metres. List Price, 28/6 each. Oscillator Couplers . . . 18/6 each.

**TROPADYNE KIT.**

Contains four tropafomers, improved type oscillator, coupler and tuner, together with circuit diagram, drilling template and complete instructions for building the Tropadyne receiver. List Price, 28/6 each.

**BREMER TULLY APPARATUS.**

Bremer Tully Low Loss Bank Wound Tuners and Oscillator Couplers are famous on the world over. Made in two types— Type B, 200 to 365 metres. List Price, 26/6 each.

Type SW, 60 to 150 metres. List Price, 28/6 each. The B.T. Oscillator Coupler. List Price, 22/6 each.

**COCKADAY COILS.**

Built in accordance with Cockaday's specifications. Tapped at 1, 3, 7, 13, 21 and 43 turns. List Price, 29/6 each.

**APEX GEARED VERNIER DIALS.**

The Apex Geared Vernier Dial provides the vernier control so essential to easy and selective tuning for long-distance stations. It can readily be adapted to any Condenser shaft. Each. List price 10/6

Royal brass and black . . . List price 10/6 Set in silver and black . . . List price 13/6

**HAYNES GRIFFIN TRANSFORMERS.**

Haynes Griffin Intermediate Wave Transformers are specially suitable for use in Super-Heterodyne Receivers. They are sold only in matched sets of four, consisting of one input and three inter-stage transformers. Coil peak about 2,000 metres. Set of four, List Price 35/6.

**THE HEATH LOW LOSS CONDENSER**

Strictly low loss —

- No. 11A. .00025 plain . . . each 21/6
- No. 23A. .0005 plain . . . each 24/6
- No. 43A. .001 plain . . . each 28/6
- No. 12A. .00025 Vernier . . . each 28/6
- No. 24A. .0005 Vernier . . . each 28/6
- No. 44A. .001 Vernier . . . each 34/6

Prices include dial. Without dial, 3/- each less.

We stock the following well-known publications of interest to the Amateur and Experimenter alike. CONRAD BOOKS. Bound in hard two-colour covers.

**ONE-AND-NINEPENNY SERIES.**

100 hook-ups, including Tropadyne, Neutrodyne, Ultradyne, Super Heterodyne circuits. The Neutrodyne and all about it. The Super Heterodyne and all about it.

CONRAD PATTERNS. Complete wiring diagrams, drilling templates and book of instructions are furnished with these patterns.

**THREE SHILLING SERIES.**

- How to make a Reinartz Receiver.
- Cockaday Receiver.
- Neutrodyne Receiver.
- Tropadyne Receiver.
- Haynes G.
- 5-Valve Cockaday Receiver.
- Ultradyne Receiver.

Twenty diagrams and hook-ups. Contains all the well-known circuits.

**FIVE SHILLING SERIES.**

How to make a Standard Super Heterodyne Receiver. Sent Post Paid. Super Success by A. J. Haynes. 1/8 Bremer Tully Book of Better Tuning. 6d.

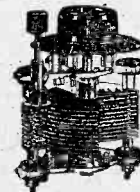
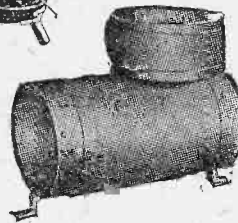
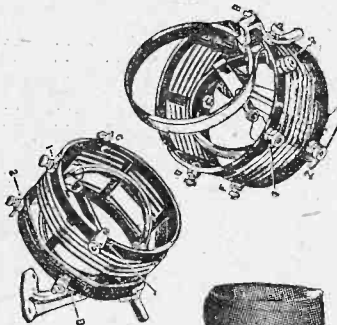

You are invited to send for our complete price list, dealing with Genuine Cardwell Condensers, Hammarlund, Continental, Bremer Tully and General Instruments Condensers, Amer Products, Ultra Vernier and Na-dial Dials, Precision Autodyne Couplers, Amperites, Royalty Wire, Wound Grid Leaks and High Resistances, etc. etc.

## R. A. ROTHERMEL, LTD.

Manufacturers and Wholesale Suppliers of Electrical Goods, 24-26, MADDOX STREET, LONDON, W.1. Telephone: MAYFAIR 578 and 579.

# Build the Modern Wireless Supersonic Heterodyne Set described in this issue

BUY all your parts for this splendid Receiver from Peto-Scott's, and then you'll know that your Set will work correctly from the commencement. The panels will be cut exactly to size, carefully drilled and neatly engraved. Remember, every component manufactured and supplied by us is fully guaranteed. Every reader of MODERN

WIRELESS should send 3d. for a copy of our 48-page Catalogue containing illustrations and descriptions of every component you are likely to want in building a Set. You save pounds by purchasing guaranteed components from Peto-Scott's—one of the oldest firms in the Wireless industry.

COMPLETE SPECIFICATION—

9-VALVE SUPERSONIC HETERODYNE RECEIVER.

£ s. d.		£ s. d.	
2	Peto-Scott square law condensers with vernier, .0005 mfd. ....	1	0
1	Ditto ditto .0003 mfd. ....	9	3
4	Peto-Scott square law condensers, .0005 mfd. ....	1	12
2	Ormond grid condensers, .0003 mfd. ....	4	0
1	McMichael clip-in fixed Condenser, .001 mfd. ....	2	3
1	Ditto ditto .004 mfd. ....	2	3
1	T.C.C. Mansbridge condenser, .25 mfd. ....	3	0
1	Ditto ditto 2.0 mfd. ....	4	8
2	Dubilier grid leaks, 2 megohms ...	5	0
2	Burndept potentiometers ...	15	0
9	Burndept dual filament resistances ...	3	7
9	Burndept anti-phonous valve holders ...	2	5
6	Peto-Scott anti-capacity valve holders (for H.F. transformers) ...	4	0
2	R.L. transformers ...	2	10
1	Utility 6-pole 2-way switch ...	8	0
2	Utility 1-pole change over lever-pattern switches ...	9	0
15	B.A. terminals ...	2	6
6	Coils Glazite, assorted colours ...	9	0
4	Sheets Radio Press transfers (if required) ...	2	0
1	Peto-Scott coil socket ...	1	2
1	Peto-Scott shorting plug ...	1	0
	Necessary fixing screws, nuts, etc. ...	2	0
1	Peto-Scott H.F. transformer No. 1 (300-600 m.) ...	7	0
4	Peto-Scott H.F. transformers, 2,500-7,000 metres ...	14	0
1	Peto-Scott oscillator transformer ...	12	6
1	Component panel of Red Triangle ebonite, 36 x 12 x 1/2 ...	7	0
	Drilling ...	10	0
	Engraving ...	10	6
1	Control panel of Red Triangle ebonite, 36 x 6 x 1/2 ...	13	6
	Drilling ...	5	0
	Engraving ...	5	6
1	Polished mahogany cabinet as described by the author ...	5	5

N.B.—Where the complete kit of components, together with the two drilled and engraved panels, are purchased, Marconi Royalties at the rate of 12/6 per valve holder (9-valves) are payable and should be added to the prices quoted above.

## PETO-SCOTT CO., LTD.,

Registered Offices, Mail Order and Showrooms: 77, CITY ROAD, LONDON, E.C.1.  
 Branches: LONDON—62, High Holborn, W.C.1. WALTHAMSTOW—230, Wood St. PLYMOUTH—4, Bank of England Place. LIVERPOOL—4, Manchester Street. CARDIFF—94, Queen Street.



Set-builders!  
 You need this  
 Pilot Chart.

THIS 32-page Booklet contains illustrations and specifications of more than 30 different Receiving Sets that can be built at home by anyone, no matter how inexperienced. Send for it to-day and read how little you need pay for a first-class Receiver, such as the famous S.T.100 or the Transatlantic V. No one need be without a good Valve Receiver on account of expense when Pilot Sets for home constructors cost so little.

Typical PILOT Receivers illustrated in the PILOT Chart.

- All Concert de Luxe.
- S.T.100.
- All Britain.
- Family 4-Valve.
- Transatlantic V.
- 7-Valve T.A.T.
- Anglo American Six.
- Etc., etc., etc.

Send three penny stamps direct to our Head Office, 77, City Rd., London, E.C.1, and your copy will be sent by return.

3d.

P.S. 2738.

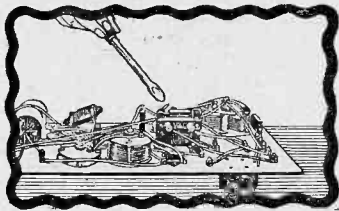

Your Soldering-iron can't burn or melt

# GLAZITE

The new coloured connecting wire

BY using Glazite you have none of the old insulating sleeving to manipulate or burn.

"Glazite" Connecting Wire is already insulated and is flameproof. "Glazite" consists of tinned copper wire first covered with cotton and then with a film of heavy insulating material.

It will not deteriorate in any way, is flexible and possesses high dielectric strength.

PRICE 1/6 PER COIL (Length 10 ft.)

made in four different colours; Red, Blue, Yellow and Black. Obtainable from all radio dealers. Send P.C. for "Glazite" leaflet and the name of nearest dealer with stock.

## The LONDON ELECTRIC WIRE CO. AND SMITHS LTD.

Playhouse Yard, Golden Lane, London, E.C.1.  
 Telegrams: Electric, London. Telephone: Clerkenwell 1388, 1389, 1390, 1391

This PAD makes all the difference in the world

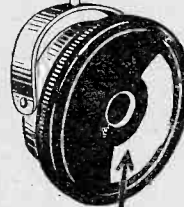

1/3d per pair

Sold by Wireless Dealers, or post free from the makers, on receipt of 1s. 3d.

A. DE ST. DALMAS & CO., LIMITED, LEICESTER.

The "Kumfi" de Luxe Ear Pad is a veritable boon to listeners. Instead of the hard surface of the headphone earpieces pressing continuously on your ears, you have a soft, luxurious pad that relieves pressure and prevents all discomfort.

The "Kumfi" de Luxe Ear Pad is the only scientifically prepared pad. It is hygienic and absorbent, and shuts out exterior noises. Try a pair and add greatly to your comfort; they are easy to fix and easy to remove.

## 'KUMFI' De Luxe EAR PAD

Patent applied for.





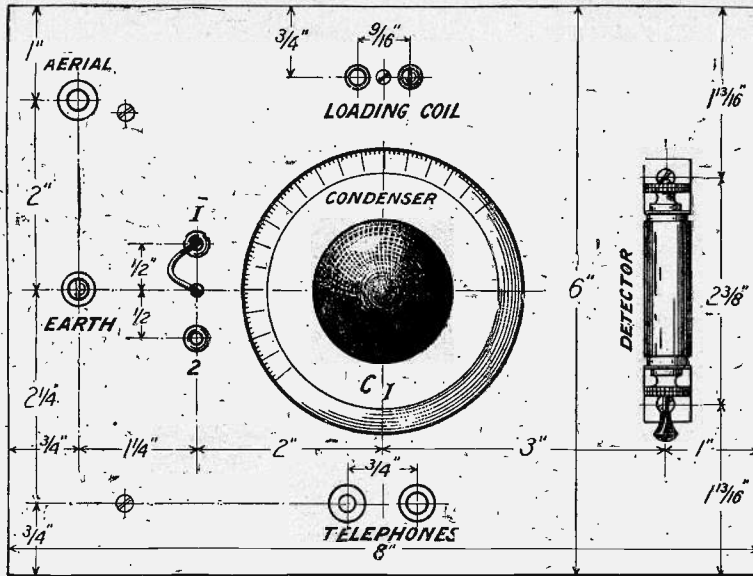

Fig. 2. The panel layout is very simple and no difficulties will arise if the above dimensions are adhered to.

securing the brass strips to the former.

**Operating the Set**

To operate the receiver, place the aerial plug in the socket marked aerial and push the earth socket on to the earth pin. Then plug in the telephones. If your local station is one of the main stations transmitting on a wavelength of between 351 and 495 metres, plug into No. 1 socket and rotate the condenser dial. The loading coil should, of course, be short-circuited. Turn the dial until the position for loudest signals is found, and the receiver is then adjusted correctly. It should not be necessary to adjust the crystal detector, but a slight improvement in sensitivity will some-

times be effected by withdrawing the small adjusting knob and twisting it slightly, afterwards gently releasing it so as not to damage the faces of the crystals.

Once set, the receiver will always be ready for work and will require no attention, and when not in use the aerial plug should be inserted in the earth socket, the telephone plug should be withdrawn and the lid of the box closed.

**Results**

The signals obtained at a distance of 15 miles from 2LO on an un-screened aerial 35 feet in height (average) and 100 feet long, in conjunction with a low-resistance earth, are extremely good. 5XX

is received at about the same strength, or slightly louder, than 2LO by inserting a No. 150 or its equivalent in home-made coils in the loading coil socket and returning. Readers who are situated within normal crystal range of any of the B.B.C. stations will find that this little set will give them all the results they require, and this with the minimum of trouble.

**Erecting the Aerial**

In order to assist those readers who have had no previous experience I have decided to add a few hints on the erection of a suitable aerial. You will require a 100-foot coil of 7/22 hard-drawn copper wire, six porcelain insulators, and a leading-in tube of ebonite. Buy from your local timber merchant or builder, a good stout straight pole about 30 feet long. If you can erect a higher one do so, but the length given will give good results. Fasten a pulley to the top end of the

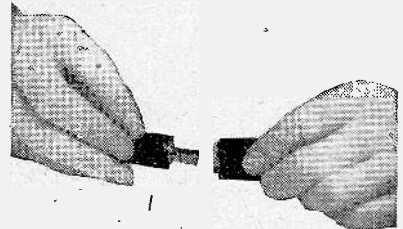

By inserting the aerial plug into the earth socket the aerial is effectively earthed.

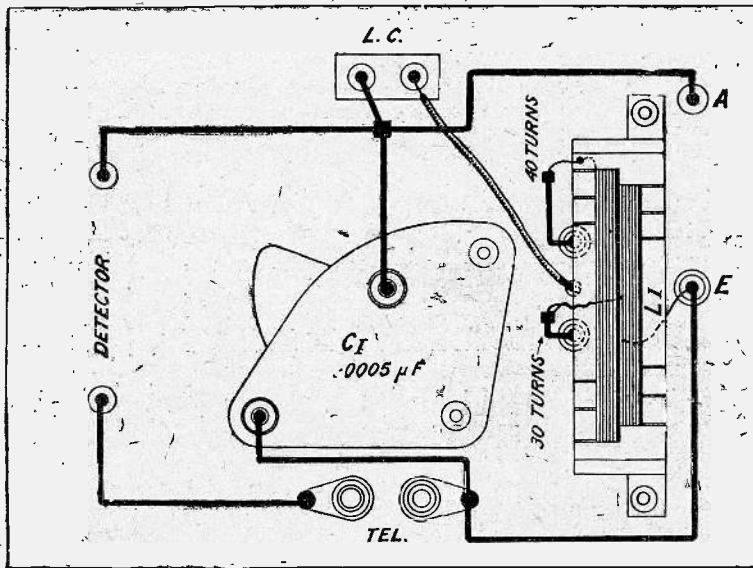

The wiring is simplicity itself and the complete receiver can be constructed in a single evening.

pole and reeve through it a strong rope or flexible wire for the purpose of hoisting the aerial. Erect the mast, using stays if necessary to make it secure. To insulate the aerial effectively I recommend that you use at least two insulators at each end. Connect two to one end of the aerial wire and attach it to the halyards on the mast. Secure the other end to a convenient support on the house so that the aerial is at least 6 feet from the wall. Take the lead-in from this end down to the leading-in tube, taking the pull of the wire off the tube itself by a short insulated stay secured in any convenient manner to a rigid support. The portion of the lead-in inside the house may be ordinary insulated flex. For distances up to about five miles from a main station an indoor aerial consisting of two or three wires stretched across the room will give satisfactory results. The earth may consist of a stout length of copper wire attached by means of a clip to the main water pipe or to a piece of zinc sheet 3 feet square buried at a depth of 3 or 4 feet in damp soil.

**The "General Purpose Three"**

SIR,—As requested at the close of the description of the "General Purpose Three" (described by Mr. A. Johnson-Randall in the April issue of MODERN WIRELESS), I append hereafter the results I have obtained.

Before I describe them, I might say that I have constructed nearly all the 2 and 3-valve sets, D. and L.F. and H.F. D. and L.F., including practically all the fancy circuits described in this paper and the other two, which I have taken in since the start.

Up to the present time I have failed to obtain what I call satisfactory results, except from the D. and one or two L.F., which, by the way, brings in rather too much "mush," etc., for my liking.

On Saturday afternoon I put together on my experimental panel your wiring system of the well-known H.F. circuit, using an Ormond S.L. .0005 with vernier in the aerial, an Ormond ordinary .0003 with vernier in the anode, Igranic unshrouded transformer, Polar cam vernier coil-holder, Dubilier fixed condensers, and home-made low loss coils.

As I live not a mile away from the local station and on the

**Two Letters of Interest**

top of the adjacent hill I have always found it impossible to cut it out, even on Chelmsford's wavelength, using a wave trap, but on Saturday evening I did it, and obtained that station on the loud speaker, and at the present moment while I am typing this I am hearing Birmingham through Chelmsford on the loud speaker. Now that is something that your wiring has done for me.

Yesterday I had some Continental stations in the morning, afternoon and evening, and several in the evening on the loud speaker. While Newcastle was not transmitting in the evening I heard London, Manchester and Bournemouth nicely on the 'phones.

I am using B.T.H. B4 valves and find that reaction is not required on the low wavelengths, but on Chelmsford I have to use either 100 or 150 with 150 in the aerial and 200 in the anode.

HY. C. T. IRELAND.  
Newcastle-upon-Tyne

**The S.T. 100**

SIR,—Having recently constructed the famous "S.T. 100" circuit (as described by Mr. John Scott-Taggart in Radio Press Envelope No. 1), I am pleased to say I have found it unique in design and extremely powerful for its size.

There is one great disadvantage: that is the crystal.

It appears to me that the elimination of the crystal and replacement by a valve would greatly improve the circuit. This would make it constant in operation and ideal for moderate loud-speaker range.

I suggest that a Lissenstat Minor resistance should be used to control the proposed valve detector, for I find that there is ample space to permit this.

Perhaps you will consider the matter and arrange for an interesting article to be published in an issue of MODERN WIRELESS, of which I am a reader.

Hoping to hear from you on the matter.

Yours truly,  
Acton, W.3. L. W. PATRICK.

[If you want a valve detector why not build the 3-valve dual, which is much more powerful than the S.T.100? In any case, the new R.I., the Harlie and the Eureka detectors are great advances in crystal detector design.—ED.]



300 ft. (two 150 ft. lengths laid double), 5/-, carriage paid.



500 ft. (two 250 ft. lengths laid double), 8/-, carriage paid.

**ELECTRON WIRE**  
FOR PERFECT EXTENSIONS OF LOUD SPEAKER AND TELEPHONES.

Owing to the enormous popularity of ELECTRON WIRE, we are able to place upon the market a special wire for loud speaker and 'phone extensions. This Wire is more pliable and absolutely ideal for its purpose; actually increases the volume. TWO different length extensions are attractively boxed—300 ft. and 500 ft. The Wire is laid double in runs of 150 ft. and 250 ft. We will guarantee that with ELECTRON WIRE EXTENSIONS there will be increased volume in the signal strength, however far you choose to extend your 'phones or loud-speakers. This wire can be supplied to any required length for extensions to any part of the house or garden, no further insulation required.

**A FAIR AND HONEST OFFER.**

Here is an unconditional offer made only because we know and thousands of Amateurs and Experts know that Electron Wire is the best Aerial in the World.  
**THE OFFER.** If you have not yet used ELECTRON WIRE, go to your nearest Wireless Dealer; then, **AT OUR RISK**, purchase a coil. If after an exhaustive test ELECTRON WIRE does not prove to be just the finest Aerial in every way you ever used, take advantage of this offer and return it to us with the Special Box, and your money will be immediately refunded.

100 Ft.  
**1/8**  
Postage 6d.

**WARNING.**  
Buy "Electron Wire" in our distinctive box only, plainly printed in blue on every side.  
**ELECTRON WIRE**  
THE PERFECT AERIAL  
Refuse all others offered at a cheaper price.

**ON SALE EVERYWHERE**

There is a shop on your way home.

In case of difficulty write—



**THE NEW LONDON ELECTRON WORKS, LTD.**

Dept. No. 99, (Members of the B.B.C.)

**EAST HAM, LONDON, E.6.**

Telephone: 1408 East Ham (3 lines).

Telegrams: "Stannum, London."



Ensure perfect reception

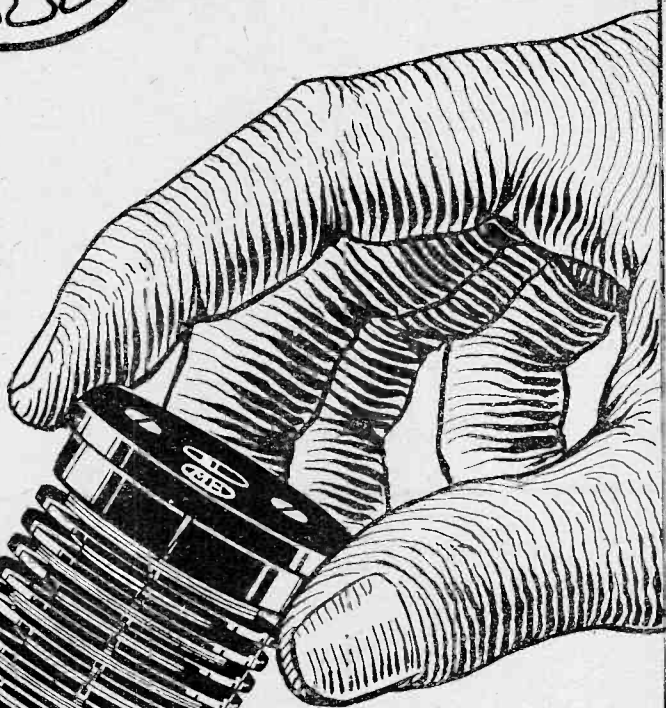

by using —



**H.F. TRANSFORMERS**

Increase your range and add to the selectivity of your set by adding a stage of H.F. Amplification.

By using **MH** H.F. Transformers perfect reception is ensured. All wavelengths from 80-7,000 metres in six units.

**10/- each.**

Neutrodyne Units No. A.6 for Broadcast Wavelength and No. 3 for 5XX.

**MH** H.F. Transformers and Fixed Condensers are used in the 9 Valve Supersonic Receiver described in this issue.

*Some interesting information is available on H.F. amplification. On receipt of a post card there will be sent you an instructive folder which is well worth reading.*

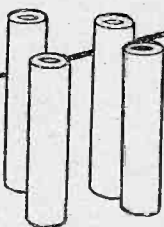
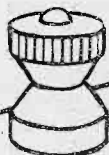

HFT

HEAD OFFICE:  
HASTINGS HOUSE,  
NORFOLK STREET, STRAND,  
LONDON, W.C.2.

**L.M<sup>c</sup>MICHAEL LTD**

Manufacturers of Wireless and Scientific Apparatus.

SHOW ROOMS:  
179, STRAND, LONDON, W.C.2.  
Works:  
SLOUGH, BUCKS.

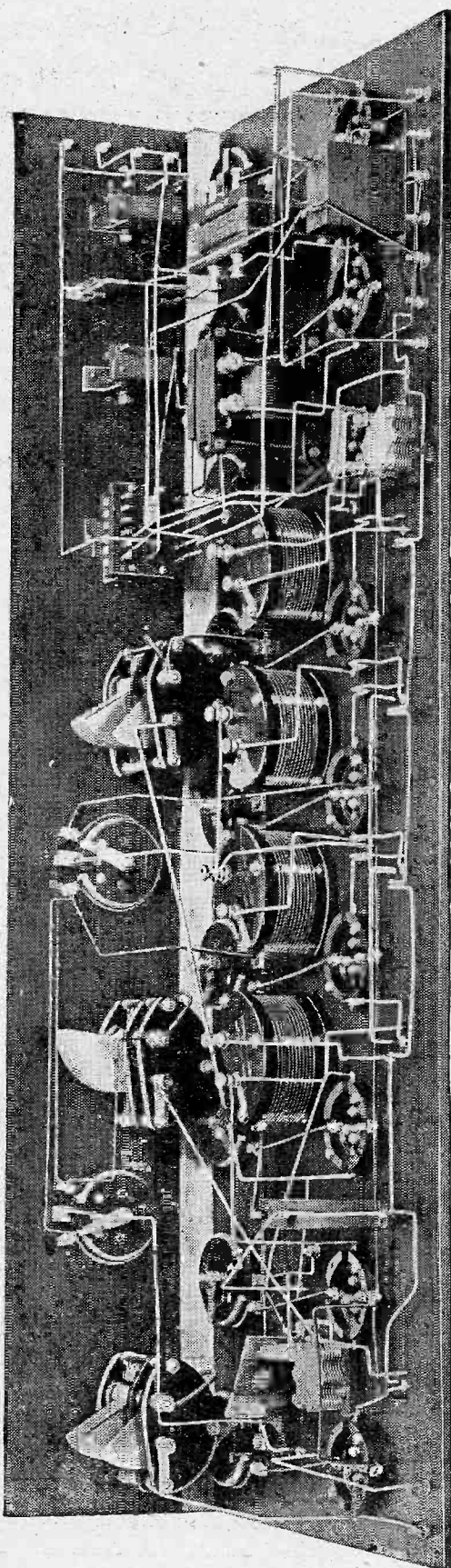

A general view of the wiring of the complete receiver.

(Continued from page 417)

- One .0003  $\mu$ F. square law condenser (ebonite ends with vernier). (Ormond Engineering Co.)
- Four .0005  $\mu$ F. square law condensers (ebonite ends). (Ormond Engineering Co.)
- Two .0003  $\mu$ F. grid condensers. (Ormond Engineering Co.)
- One .001  $\mu$ F. clip-in condenser with clips (L. McMichael, Ltd.)
- One .004  $\mu$ F. clip-in condenser with clips. (L. McMichael, Ltd.)
- One .25  $\mu$ F. T.C.C. condenser.
- One 2  $\mu$ F. T.C.C. condenser.
- Two grid leaks, 2 meg. (Dubilier.)
- Two potentiometers. (Burndept Wireless, Ltd.)
- Nine filament resistances (dual type). (Burndept Wireless, Ltd.)
- Nine anti-phonic valve holders. (Burndept Wireless, Ltd.)
- Six valve holders. (Goswell Engineering Co.)
- One L.F. transformer. (Lissen, Ltd., T2.)
- One L.F. transformer. (Silvertown Co.)
- One 6 pole double way switch. (Wilkins and Wright.)
- Two 1 pole double way switches. (Wilkins and Wright.)
- Fifteen 4 B.A. terminals.
- About six coils of "Glazite" for wiring purposes. (London Electric Wire Co.)
- Four sheets of Radio Press transfers.
- One coil socket.
- One shorting plug.
- A quantity of screws.
- For use on the Broadcast range:
- One H.F. transformer, 300-600 metres. (L. McMichael, Ltd.)
- One oscillator transformer. (Peto-Scott Co., Ltd.)
- Four H.F. transformers, 2,500-7,000 metres. (L. McMichael, Ltd.)

**The Ebonite Panels**

The correct sizes for the ebonite panels are given in the list of components. Be sure that good quality ebonite is obtained, for leakage is fatal to efficient working, and, needless to say, it is unwise to take risks when building a receiver of this type.

**Drilling the Panels**

If this is proceeded with in a systematic manner, much time will be saved. The drilling diagram in Fig. 2 gives all the necessary dimensions, and must be followed carefully. It is advisable to have at hand all the components to be used, when the correct sizes for the holes to be drilled in the panels may easily be ascertained. This done, it will be necessary to change the drill only after completing all holes of one size. Holes for the screws which are to hold the two panels together are seen in the diagram, the method of effecting the latter being detailed later.

Numerous screw heads may be seen on the panels, whose positions are not dimensioned. The reason is that certain components, even of the same make, sometimes differ slightly in regard to the positions of the fixing holes, so that it is advisable to use the components themselves as templates when drilling the panels.

It is necessary to cut three slots in the smaller panel for the purpose of controlling the three lever switches externally. With suitable tools the slots are easily made, but a drill and a coarse file suffice if nothing more elaborate is to hand.

**Marking out**

Radio Press panel transfers have been used liberally on the panels of the receiver, and they not only greatly enhance the appearance, but are practically necessary if confusion is to be avoided. All markings should be

(Continued on page 485.)

# NEW EDISWAN VALVES

## WORTHY ADDITIONS

## TO A FAMOUS SERIES

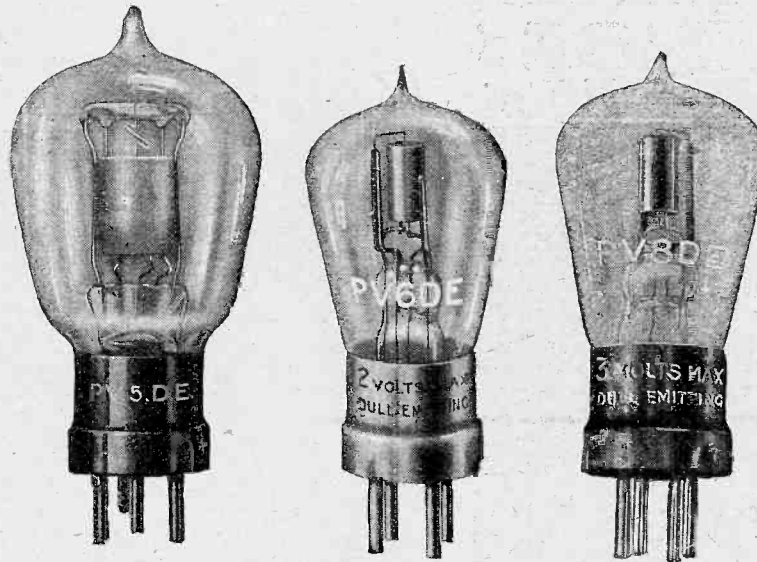

### Volume without distortion

To secure volume free from distortion you must use the right valves in the L.F. stage. This new series of Ediswan Power Valves is the outcome of much experimental work which has resulted in the valves being perfect before being offered to the public.



**TYPE ARDE**  
HF and LF

P.V.5.D.E.		P.V.6.D.E.		P.V.8.D.E.	
Fil. volts ...	5.0	Fil. volts ...	2.0	Fil. volts ...	3.0
" amps ...	0.25	" amps ...	0.4	" amps ...	0.12
Plate volts ...	50-150	Plate volts ...	60-120	Plate volts ...	60-120
Impedance ...	8,500	Impedance ...	12,500	Impedance ...	12,000
Price 30/-		Price 22/6		Price 30/-	

Valves for H.F. and L.F. Ediswan Dull Emitter Valves, types ARDE and AR '06, are now especially made for H.F. and L.F. work. They are distinguished by Red (H.F.) and Green (L.F.) lines.

Prices: ARDE, 18/-; AR '06, 21/-

**The EDISON SWAN ELECTRIC CO., Ltd.,**

123-5, Queen Victoria Street, E.C.4.



**TYPE AR06**  
HF and LF

*If your dealer does not yet stock EDISWAN POWER VALVES or VALVES for HF and LF—write to us for full particulars and name of nearest agent*

*In replying to advertisers, use Order Form enclosed.*



# Cosmos Components for Efficient Radio Sets

## THE FOUNDATIONS

of your Radio Receiving Set are sound, efficient and reliable when the tuning circuit embodies the Components shown above.

"COSMOS" STRIP INDUCTANCE COILS are constructed on a new principle which results in Low Resistance, Low H.F. Resistance, Robust Constructions and Low Self-Capacity. With regard to the last feature, a report on an independent test conducted by "The Wireless Trader" (issue March 4th) reads as follows:—

*"Our tests proved satisfactory, for the coil (tested on 377 metres) was found to have quite exceptionally low self-capacity. It was tested at the same time as a well-known and favourite type of plug-in coil, and the decrease in self-capacity was phenomenal, the other coil having approximately thirteen times the amount of self-capacity found in the 'Cosmos.'"*

THE POLAR PRECISION VARIABLE CONDENSER is a remarkably Compact, Robust, Dustproof Component with low minimum capacity, low losses, high insulation and a smooth movement. The last-named feature is so effective that a Vernier plate is really unnecessary, but to provide for those amateurs who require exceptionally fine tuning, a separate Vernier attachment can be obtained. The Polar Precision Condenser is conveniently mounted by means of one hole in the panel.

YOU CAN OBTAIN THESE COMPONENTS FROM YOUR LOCAL WIRELESS DEALER, ALSO "COSMOS" RHEOSTATS, POTENTIOMETERS, FIXED CONDENSERS, GRID LEAKS, VARIOMETERS, REACTANCE COILS AND ALL DETAIL ACCESSORIES.

**METRO-VICK SUPPLIES, LTD.,**  
4, Central Buildings, Westminster,  
London, S.W.1.

"COSMOS" STRIP PLUG-IN INDUCTANCE COILS are made in the following sizes:—

Coil No.	Inductance Microhenries.	Price s. d.
20	12.5	4/9
25	25	4/9
35	50	4/6
40	100	4/9
50	150	4/9
75	300	5/0
100	700	6/0
150	1000	6/6
175	1400	7/0
200	2500	7/6
300	5000	8/9
400	9000	9/0

POLAR PRECISION VARIABLE CONDENSERS are made in the following capacities, all having the same outside dimensions.

Max. Capacity.	Price.
.001 mfd.	12/6 unmounted
.0005 mfd.	12/6 "
.0003 mfd.	12/6 "

Mounted 5/6 extra.  
SEPARATE VERNIER ATTACHMENT  
8/6

"HEARING  
IS  
BELIEVING."

Wireless Retailers are giving specific demonstrations of "Cosmos" Universal Valve Sets. You who are interested in Radio will be delighted with the purity of reproduction obtained by this set, and will realise at once why it is called the "Musicians' Set." Hearing is believing.

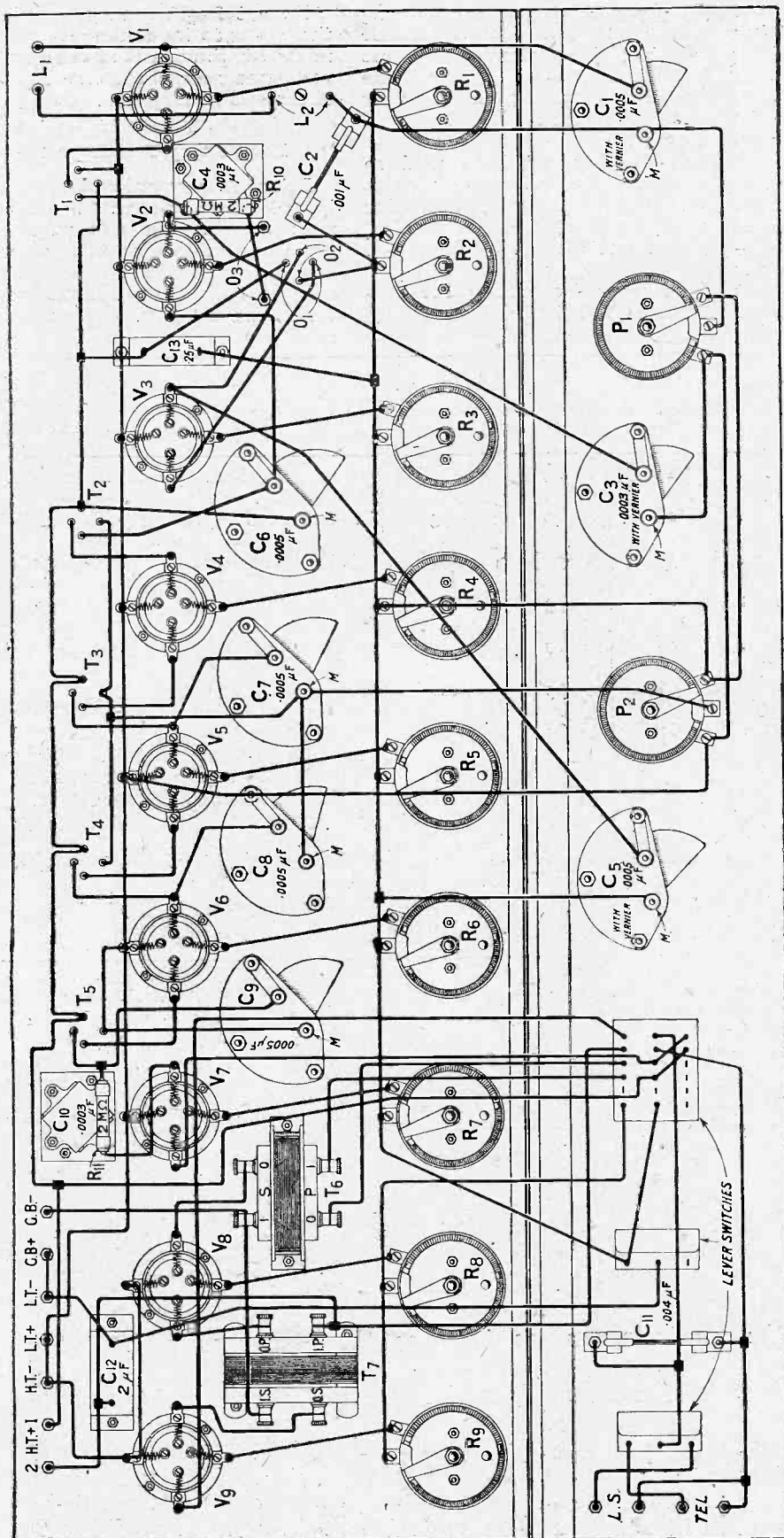

Fig. 5. This wiring diagram should be followed very carefully. Blue Print No. 110b (full size) may be obtained, price 3/6 post free.

(Continued from page 482).

made before mounting the components, suitable positions being observed in the photographs.

**Mounting the Components**

No skill is required to mount all the components correctly upon the panels. The drilling and wiring diagrams should be referred to frequently, while the photographs will also be found helpful at this stage. The correct method of mounting each component becomes obvious upon scanning the diagrams, screws and nuts being used in practically every instance. Exceptions are the variable condensers, for which one-hole fixing is provided, and the H.F. transformer sockets and coil socket, each of which is held by a single screw.

The two low-frequency transformers differ in construction, so that there should be no difficulty in distinguishing between them. In the wiring diagram the Silvertown transformer is seen on the left, and the Lissen to the right.

All condenser values are clearly marked, and where vernier plates are included this is also indicated.

**Joining the Panels**

With the components assembled on the two panels, the latter may now be fixed together at right angles. As will be seen from the photographs, the smaller panel is fitted to the larger in such a manner that the former adds its thickness to the width of the large panel. Fig. 4 shows the method adopted, and should serve to render further description unnecessary. Suitable positions for the securing wood-screws are seen in the drilling diagram.

**Wiring the Receiver**

Considerable care has been taken in the preparation of the wiring diagram to make all the connections perfectly clear.

The wire mentioned in the list of components has been used throughout for connecting up the various components, different colours of sleeving being employed for the separate circuits. If this plan is followed by the constructor it will be an easier matter to check the wiring accurately when the Receiver is completed.

In the present case red sleeving has been used for the anode circuits; blue sleeving for the positive filaments; black for the negative filaments; while yellow has been used in the grid circuits.

Solder has not been used so profusely in this receiver as is usual, the relatively thin wire being readily twisted round a terminal shank and secured by lock-nuts. Actually solder may be used throughout for making the connections, if desired.

Do not forget upon completing the wiring to insert the grid leaks in their clips upon the special grid condensers; nor should the clip-in condensers be forgotten.

**Preliminary Test Report**

Information regarding the working of the receiver will be given next month. On this page is given a preliminary test report of the set, which indicates the settings of the controls on various wavelengths.

Call sign and wavelength.	Name.	Frame condenser in degrees.	H.F. condenser in degrees.	Oscillator condenser in degrees.	Results.
6ST 306 metres	Stoke-on-Trent ..	19	29	48½	Moderately loud 'phone signals (in daylight).
6LV 315 metres	Liverpool ..	28	40	53	Moderate loud speaking (in daylight).
5NG 328 metres	Nottingham ..	37½	51½	61½	Moderate loud speaking (in daylight).
2DE 331 metres	Dundee ..	38½	53	63½	Full loud speaking.
5WA 353 metres	Cardiff ..	49	67	77	Medium loud speaking.
2LO 365 metres	London ..	56	75	86	Very good loud speaking.
2ZY 375 metres	Manchester ..	61	80	94	Excellent loud speaking. Good loud speaking without 1st H.F.
6BM 385 metres	Bournemouth ..	67	87	101	Full loud speaking. Loud speaking without 1st H.F.
5SC 420 metres	Glasgow ..	80	104	125	Very good loud speaking (in daylight).
5IT 475 metres	Birmingham ..	98½	129	152	Good loud speaking.
2BD 495 metres	Aberdeen ..	103	138	159	Good loud speaking.

*Valves used in Test:—*

First eight valves Ediswan A.R., ninth valve B.T.H. B4. H.T. 1—60 volts. H.T. 2—80 volts.

*Settings of long wave condensers:—*

No. 1 .. 160.      No. 2 .. 160.      No. 3 .. 160      No. 4 .. 160

*Our Cover Design shows the Editor operating the finished instrument. The next issue will contain full details for manipulating the controls, so as to give the best results, a detailed record of stations heard, and some notes on tracing possible faults.*



# SIEMENS HIGH-TENSION RADIO BATTERIES

## NEW TYPE—LARGE CAPACITY

THE H.T. BATTERIES EE LUXE.



Type R.B. 3, 72 volts, with lid removed.

They embody the results of very many years' experience in the manufacture of dry cells and batteries, and we confidently recommend these new batteries for all types of wireless receiving apparatus, including multi-valve sets with one or two power valves. (It is necessary, however, that suitable neg. grid bias is applied to any amplifying valve where a high anode voltage is used.) Ample supplies are now available.

Descriptive Price Sheet 645 on application.

**SIEMENS BROTHERS & CO., LTD., WOOLWICH, S.E.18.**

## HOW TO MAKE

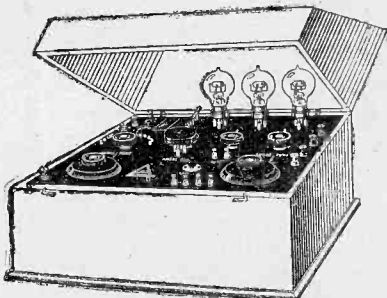

THE SET OF YOUR CHOICE.

Detailed instructions and plan-diagrams free with each set of Components. Build a Radiax Set and save money.

	Complete Components	Panels drilled and fully engraved	Cabinets High-grade Mahogany Polished
No. 31 1 Valve and Crystal	£3 0 0	11s. 6d.	£1 1 0
No. 24 2 Valve Set	£2 13 6	11s. 6d.	£1 2 6
No. 26 3 Valve Set	£4 5 6	14s. 6d.	£1 7 6
No. 30 4 Valve Set	£5 10 0	18s. 6d.	£1 10 0

If Components and Panel are ordered at same time, 12/6 per valve Marconi Royalty must be paid.

**Don't take chances—Radiax Universal Receivers** are powerful regenerative sets on design, but build a set which will deal efficiently with all wave-lengths and embody detail modern refinements which few other sets, however expensive, can boast. They are wonderful for distant reception.

Radiax Receivers are supplied on Deferred Payment System. Complete Catalogue of Radiax Sets, Components and Accessories, Post Free 3d.



**RADIAX, LTD.,**

40, Radio House, Percy Street, Tottenham Court Road, London, W.1.

3 minutes from Tottenham Court Road and Goadge Street Tube Stations. Phone: Museum 490.

Barclays 1031



**PLUG-IN COILS—**  
*Give Selectivity*

The type of inductance used has a considerable effect upon the selectivity of a receiver. Instead of tuning sharply with a steep resonance peak, high H.F. resistance in a coil flattens tuning so that two signals on proximate wavelengths are not separable. If you would gain selectivity you must employ coils which tune sharply. Such coils must have a very low H.F. resistance—these are the proved Diamond Sunflower.

The particular design of the Diamond Sunflower is distinctive and novel—maximum air spacing, no shellac, and turns of high and low potential widely separated—produces a coil of minimum H.F. resistance and of extremely low loss. You gain utmost selectivity if you fit Diamond Sunflower Coils, because they tune with a steep resonance peak.

Note Swivel Mounting.

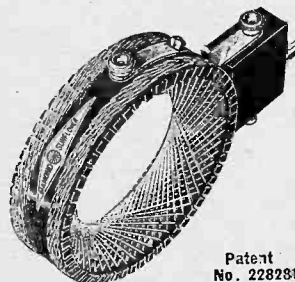

Patent No. 228281

Get Diamond Sunflower Coils from your dealer.

No. of Coil.	Approx. Wave-length in metres .001 Condr. in Shunt.	Price per Coil.
25	100—290	4/3
*30	142—377	4/8
35	185—465	4/9
*40	215—561	4/11
50	245—658	5/-
*65	310—820	5/3
75	395—1,090	5/6
*85	500—1,350	5/9
100	619—1,495	6/-
*125	671—1,720	6/6
150	720—2,000	7/-
*175	850—2,400	7/3
200	980—2,780	7/6
*225	1,010—3,160	7/9
250	1,240—3,520	8/-
	Etc.	

**DIAMOND WIRELESS LTD., 184a, Oxford Street, London, W.1.**  
Telephone: Museum 1380. Entrance Gt. Titchfield Street.

Barclays 907

In replying to advertisers, use Order Form enclosed.

THE PANEL DE LUXE

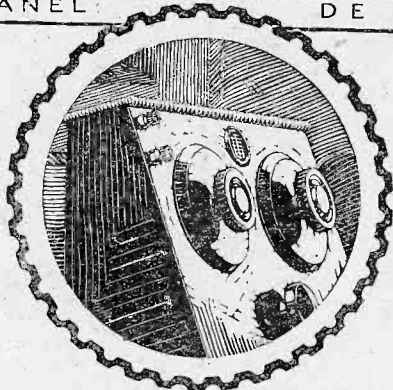

**BECAUSE** Radion has been universally selected by the leading wireless experts of this country and America, it must possess sterling qualities other than that of appearance.

The man who is aiming for 100% efficiency will do well to follow the lead given by experts who have the cream of the world's ebonite at their disposal—and choose Radion.

**R** Radion is available in 21 different sizes in black and mahogany. Radion can also be supplied in any special size. Black 1d. per square inch, mahogany 1½d. per square inch.

# RADION

American Hard Rubber Company (Britain) Ltd.

Head Office: 15a Fore Street, London, E.C. 2      Depots: 120 Wellington Street, Glasgow, 116 Snow Hill, Birmingham.      Irish Agents: 8 Corporation Street, Belfast.

G.A. 2611

## For the TROPADYNE.

Builders of this very efficient type of Super-Heterodyne Receiver must recognise that they cannot hope for successful work without the Colvern General Purpose Vernier fitted in parallel with the Oscillator Condenser. Tuning at this point of the receiver is exceptionally sharp. So exceedingly sharp that one can pass over a station.

A peculiar pop indicates the reception of a carrier wave: the actual telephony lies in the centre. The comparatively large .0005 tuning condenser special will pass over the station. Unless a Colvern Low Maximum is fitted in parallel with the Oscillator Condenser your Tropadyne will not function anywhere approaching efficiency.

The Colvern General Purpose Vernier must not be confused with large capacity condensers into which is built a two- or three-plate vernier. This arrangement defeats the object of fitting a vernier. The theoretical capacity of an integral vernier is considerably increased by the mutual capacity between the main vanes and the vernier. It is patent that the vernier is thus deprived of its intrinsic value—that of permitting a comparatively larger physical movement for a minute variation in capacity. Builders of the Tropadyne must take a leaf from the book of those who have done considerable experiments with this receiver. Tuning is so exceptionally sharp that it is more easily handled and operates most efficiently by using the Colvern General Purpose Independent Vernier.

It gives you fine tuning!

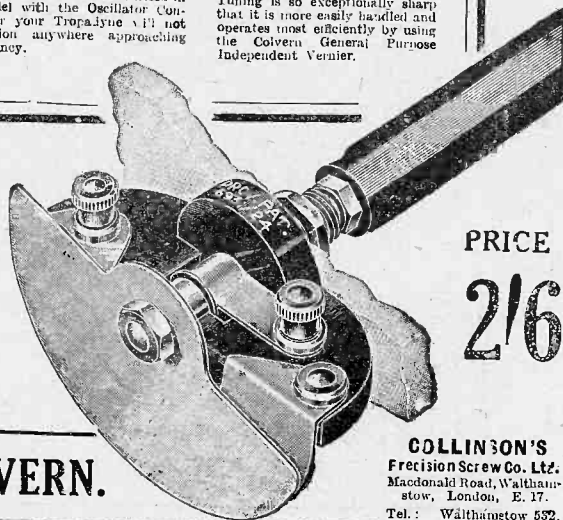

PRICE

2/6

The COLVERN.

COLLISON'S Precision Screw Co. Ltd. Macdonald Road, Walthamstow, London, E. 17. Tel.: Walthamstow 532.

Barclays 1001

# Learn FREE how to make this better Super-Heterodyne

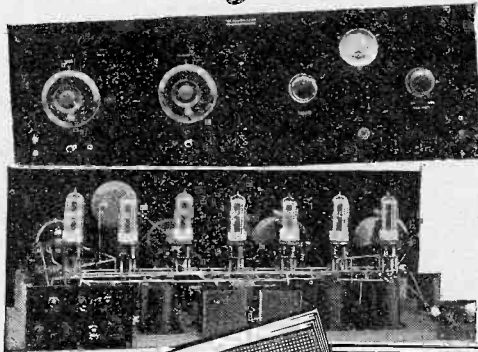

IT is within the power of every keen amateur to make a successful Super-Heterodyne Set now that Bowyer-Lowe Intermediate Transformer Units are available. These Units are built for use with British Valves, and have less internal capacity and more stability than foreign units, so that high efficiency and quiet functioning are obtained with increased selectivity and power. Complete instructions for building a remarkably simple and effective Seven Valve Receiver are given with every set.

Bowyer-Lowe Super-Heterodyne Transformer Units are all matched in complete series, each guaranteed to function at a uniform peak frequency. Each set is tested at 500 volts between windings to eliminate all chance of short circuiting. The transformers are contained in cases of Grade "A" Ebonite, and sold in complete sets of four (Dubilier Fixed Condenser .0005 included) at £4 the set. A special Oscillator Coupler Unit, uniform with the transformers in size and shape to cover the broadcast band with a .0005 Variable Condenser, is also made, and costs £1

**COMPLETE SERIES:** comprised of 1 Input Filter and 3 Interstage Transformers with Dubilier .0005 Fixed Condenser for tuning primary of Filter. Each set individually matched and sold in boxes with Instruction Booklet for making 7-Valve Receiver shown. Price £4. The set as above, but with Oscillator Coupler Unit, £5. Ample supplies. Order direct or from your local agent.



How to Build a Better Super-Heterodyne

This book given FREE with every complete set.

Progressive wiring photographs, circuit diagram, list of parts and complete instructions for making this 7-Valve Super-Heterodyne Receiver are given FREE with every set of Bowyer-Lowe Super-Heterodyne Transformer Units. Start work on it to-day. The booklet may be had separately. Price 3d.

## Bowyer-Lowe INTERMEDIATE WAVELENGTH H.F. TRANSFORMERS

BOWYER-LOWE CO LTD LETCHWORTH



# Trouble Corner

By ADSUM.

*In which a description is given of some obscure faults, and their remedies, together with a few useful hints on testing Potentiometers.*

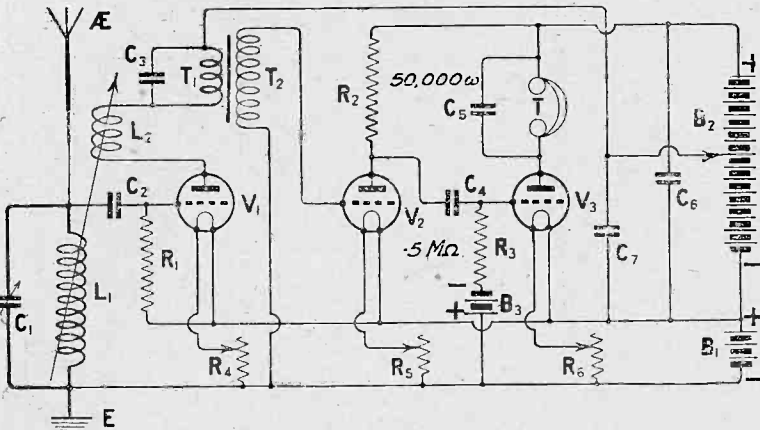

Fig. 1.—A resistance-capacity coupled note magnifier which gave trouble.

I HAD a curious case the other day of trouble in a three valve set, the circuit of which is shown in Fig. 1. As will be seen, it consists of a rectifier and two note magnifiers. The first of these is coupled to the rectifier by means of a transformer, whilst the coupling between the second and third valve is by means of the resistance capacity method. This set, which had only just been finished by an amateur constructor, refused to work properly from the very first. It was terribly noisy, and when telephony was tuned in there was bad distortion, whilst signal strength was exceedingly poor. Very pronounced symptoms of fading were also present, signals being at one moment all but inaudible, whilst a little later they would work up for a brief instant to a fairly respectable strength, only to die away again.

### The Trouble

The components were the first to be examined to see if any of them were of the cheap and nasty variety. It was found that all were of first-rate make, and as they were brand new, one might have thought that they would have been above suspicion. When the third valve was cut out altogether, and the telephones placed in the plate circuit of the second, results were quite up to the standard for a two valve set of this class. On wiring up the third valve again, and placing a milliammeter in its plate circuit, it became evident that the last valve was rectifying. The needle of the instrument showed a periodic fall and return

to normal. The source of the trouble then was obviously to be looked for in the coupling between the second and third valves. A fresh anode resistance was first of all tried with no improvement in results; nor did the substitution of a grid condenser known to be in good condition have any effect. There remained the grid leak, which was marked .5 megohm, which is one of the most satisfactory values to use in low-frequency amplifiers coupled in this way. On exchanging the leak for another we found that signals rose at once to normal strength, that noises ceased and that the fading effect disappeared. The leak was returned to the makers with a letter explaining what had happened. A fresh one was received in substitution within a couple of days, and in their covering letter the

makers stated that the faulty leak when tested was found to have a resistance far higher than that stated.

### The Value of Good Components

This is the first case I have come across of a component by a first-rate maker proving faulty from the very first. Such occurrences are doubtless very rare indeed, but the fact that this did happen shows that when trouble occurs it does not pay to take any component for granted even if it is perfectly new and of reliable make. Though the leak proved faulty the advantage of buying the products of firms of standing was amply demonstrated, for it was exchanged at once without a question. I have always found that good firms are most willing to rectify any defect in their products if it is due to any fault of theirs. One can thus be sure of getting satisfaction when one buys good components, which is far from being the case if cheap, nameless brands are purchased.

### Valve Trouble

Another patient brought round for treatment was a set whose original circuit is shown in Fig. 2. Here the first valve was a high-

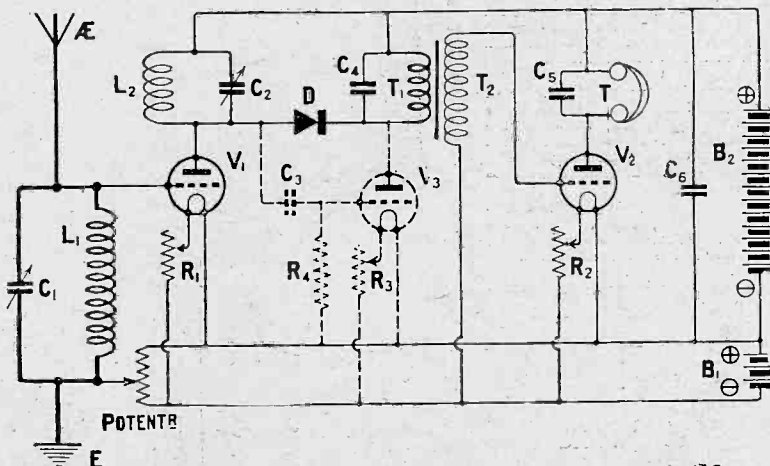

Fig. 2.—This circuit would not work when a valve-rectifier was substituted for the crystal.

frequency amplifier with tuned anode coupling; the second was a note magnifier, rectification being performed by a crystal detector. The constructor had removed the detector, substituting for it a valve rectifier, which inspection showed to be correctly wired up. His complaint was that with the valve rectifier signal strength was far smaller than it was with the crystal. Here again all the components used were of unimpeachable quality. The three valves used were all dull emitters of the 1.8 volt .3 ampere class. All of them had seen a certain amount of service, but they appeared at first sight to be in good condition. When I tried out the set I found that its owner's statement was amply justified. The three valves in fact gave less signal strength than one would have expected from a single valver. As this test, made with my batteries, produced just the same results as when the set was working at its owner's house it was clear that the batteries were not to blame. This led me to suspect that the valve placed in the rectifier holder was probably faulty. When another was substituted for it the set gave excellent results. The valve was subsequently tested,

when it was discovered that the emission from the filament had fallen off at the normal working temperature to a mere fraction of what it ought to have been. This is a thing that does happen

What happens in the case of a coated filament is that the active layer is destroyed. In a valve whose filament contains thoria, emission at a low temperature can take place only if this substance

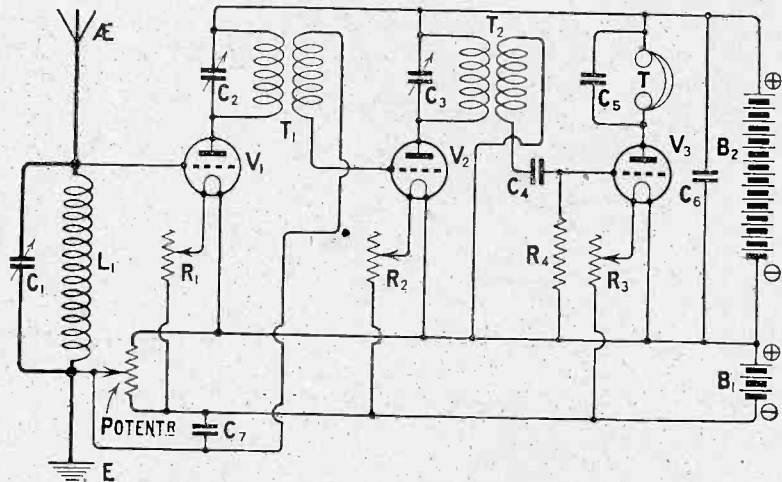

Fig. 3.—A circuit in which a defective potentiometer caused violent oscillation.

occasionally with dull emitters of most kinds when old age is approaching, or it may be brought about by running the valve with its filament at too high a temperature.

is present in sufficient quantities upon the surface of the filament. Either age or excessive heat may drive off the thoria, leaving a surface of tungsten alone. When

# "K" CONDENSERS

Recommended by Experts.

The 'K' Square Law Variable Model

is incorporated in the Crystal and Note Magnifier described in this issue. Proof that experts appreciate its efficiency. Super-rigid plates, accurate air spacing and the general sturdy construction make the usual condenser troubles impossible. The Square Law Principle—which gives greater selectivity—is not new, but the "K" system is true and remains so. Having logged your station once, you can always get it again on that adjustment. Supplied with or without Vernier

Send at once for our latest Illustrated Catalogue which describes this and many other Wates Specialities, including the "K" Tubular Fixed Condenser which fixes to the panel in clips. Being easily interchangeable—an invaluable asset to the experimenter.

Wates Products are sold by all discriminating Radio Dealers, who will willingly demonstrate. We can supply carriage paid, but your Dealer's name must be enclosed with order.

Capacity m.f.	PRICES	
	Without Vernier	With Vernier
0.001	10/0	12/6
0.0005	8/3	11/6
0.0003	7/9	10/6
0.0002	7/3	—
0.0001	6/6	—

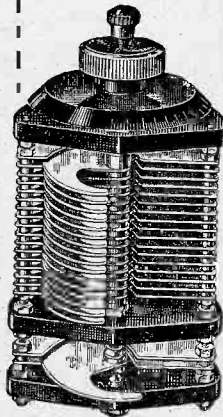

## WATES Bros., Ltd.

Head Office:

12-14, Great Queen St., Kingsway, W.C.2

Phone: Gerrard 575-576.

Grams: Zycateseng, Westcent.

WORKS: LONDON, BIRMINGHAM AND WESTCLIFF.

The combined Cabinet and Loud Speaker for the "Modern Wireless" de luxe Receiver described by Mr. Percy W. Harris in this issue was made by us

Full particulars of this and other handsome Wireless Cabinets to harmonise with the furniture of any room will be sent post free.

### Unica Cabinet Co.,

Makers of Superior Wireless Cabinets.

73, Camden Street,  
London, N. W. 1

a valve of either class has lost its emission it will not work at the original filament voltage, though it may give quite good service as a bright emitter. Lost emission can sometimes be restored by cutting out the high tension battery and leaving the valve for some time with its filament glowing at a dull red heat. As a rule, however, this remedy is not very efficient, and the best course is to have the valve fitted with a new filament.

**Violent Oscillation**

A third set which turned up for examination was a three valver whose circuit appears in Fig. 3. Here we have two stages of high-frequency amplification, both with tuned transformer coupling, and a rectifier. The owner of the set, who is also its constructor, reported that it had suddenly become impossible to "hold down." Until a few days before the set could be controlled quite well by means of the potentiometer, but now it would do nothing but oscillate in the wildest manner, and adjustments of the potentiometer appeared to have no effect whatever. I traced out the circuits, finding that the wiring was as it

should be and that nothing had come adrift. The transformers, condensers and other components were tested with equally negative results. Next, other valves were substituted for those upon the set without there being any signs of improvement. As soon as anything like sharp tuning was attempted the set burst into violent oscillation. Even when the slider of the potentiometer was

there was a break in its windings quite close to the end which had been connected to the positive low tension lead. The potentiometer I should say was one of the very small ex-Army type which are wound with wire of much finer gauge than is generally used for these instruments. Luckily the break was in an accessible place, so that I was able to effect a repair without much difficulty. The set then resumed its normal good behaviour.

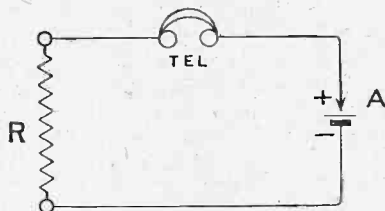

Fig. 4.—Testing a potentiometer for continuity.

moved right up to the positive end, which should have introduced an amount of damping sufficient to steady things down, the set was completely out of hand. This led me to suspect the potentiometer itself. As it was easily detachable I removed it and tested it out. It was discovered at once that

**Points to Watch**

I have come across a good deal of trouble both in my own sets and in those of friends directly traceable to faults in potentiometers. I understand, too, that the Radio Press Test Department not infrequently traces faults in the working of sets to defective potentiometers. One of the commonest faults is that the slider does not make proper contact with the windings throughout its travel. This is due as a rule to one of two causes. Sometimes the former supporting the windings is slightly out of the true, having a slight depression at one point. In this case the slider makes either

# Insulation

is of the greatest importance in L.F. Transformers. Look at the G.R.C.83. See the spacing of the terminals. Note the thickness of the polished erinoid top and base—and what you can't see is the insulation of the bobbin—of the wire—between the windings (every layer is insulated)—the coil from case—the connections to leads—and the leads to terminals. Every detail of the greatest importance in a Transformer which must stand up to a guaranteed service.

**ONLY** *General Radio* **PROVIDES THIS GUARANTEE:—**

*This Audio Frequency Transformer has been most carefully tested before leaving our works, and is guaranteed for one year to function efficiently if correctly used.*



Price 15/-



**"THE BIG THREE"**  
FAMOUS EFFICIENCY



*General Radio*

**"GENERAL RADIO" OR A BROADCAST RECEIVER OR COMPONENT MEANS THAT IT IS GUARANTEED TO GIVE PERFECT SATISFACTION.**



GENERAL RADIO COMPANY LIMITED  
RADIO HOUSE, 335, REGENT ST., LONDON. W.1

In replying to advertisers, use Order Form enclosed.

very poor contact or no contact at all when it reaches a bad spot. Or the defect may be the result of insufficient pressure between the contact arm or arms and the windings. In rotary potentiometer

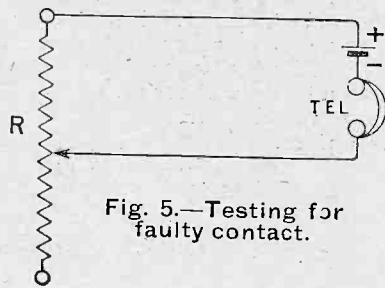

Fig. 5.—Testing for faulty contact.

meters I have come across two other defects—faulty insulation and bad contact between the spindle of the moving arm and its bush. Ex-Army or other second-hand potentiometers should always be tested for continuity of windings before being mounted in any set. Fig. 4 shows a simple way of doing this with the help of a single cell and a pair of telephones. There should be a strong click whenever the lead A is touched upon the unconnected pole of the battery.

The quality of the contact provided by the slider throughout its run can be tested in the manner shown in Fig. 5. Here again a pair of telephones and a single dry cell are the only aids needed. The potentiometer and the telephones are connected in series, a lead from the cell being taken to one of the fixed terminals of the potentiometer, whilst the disengaged telephone lead is connected to the slider. The slider is now moved slowly from end to end of its travel. If the contact is all that it should be a continuous slight rasping noise will be heard as movements are made. On the other hand, should the contact be faulty at any point there will be an interruption of the rasping noise followed by a loud click as contact is made once more.

Never make use of a potentiometer shown by such tests to be faulty. It will only be a source of trouble. If it is a new instrument made by a well-known firm the makers will be able to put it right; but if the potentiometer is second-hand it is best as a rule to scrap it rather than attempt to rectify matters in the workshop unless the fault is due to some simple little thing easily dealt with.

Another Step Ahead

LAST summer Radio Press Limited, took the bold step of transferring its offices from the quiet, old-world premises previously occupied in Devereux Court, Strand, to spacious and up-to-date apartments in Bush House, the finest office building in this country. The change to Bush House seemed, as indeed it was, a bold step, and many people questioned the wisdom of taking premises which at the time seemed unnecessarily large. Those who have watched the growth of this great wireless publishing house will learn with interest that the offices occupied by Radio Press at Bush House proved inadequate for their needs, and that within the last few weeks—just as soon as the necessary structural alterations could be carried out—large additional accommodation on the second floor was taken to house the steadily increasing editorial staff, leaving the old premises for the sales branch which, owing to the great success of Radio Press publications, required a very large portion of these offices.

**DO IT NOW!**  
 MAKE YOUR SET SELECTIVE by using  
**"Tangent" Tuning Coils**  
 The Coil with the extraordinary Low Self Capacity.

COIL NO.	25	35	50	75	100	150	200	250
Self Capacity in Micro Farads.	8	9	25	31	22	16	22	22
PRICE	4/3	4/3	4/3	4/6	5/-	6/-	7/-	7/6

**Complete Sets**  
 4 Concert Coils (w/l 250 to 1,180)—16/- the set.  
 11 Concert Coils (w/l 250 to 9,500)—67/- the set.

**GENT & CO. LTD. Est. 1872.**  
**"Faraday Works," LEICESTER.**

London: 25, Victoria Street, S.W.1.  
 Newcastle-on-Tyne: "Tangent House," Blackett Street.

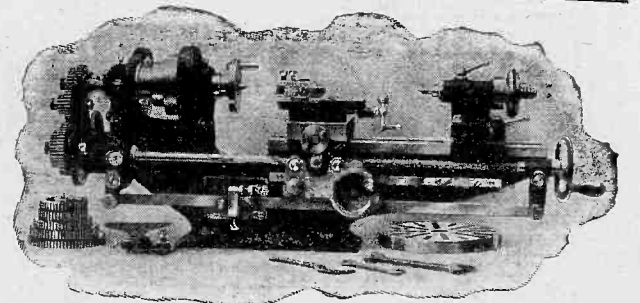

The Ideal small Manufacturing Lathe  
**The DRUMMOND 3 1/2 in.**

Has a truly wonderful capacity for varied work; screwcutting, boring, milling, sawing, etc., in metal, wood or ebonite. Note turret attachment illustrated for repetition work. All forms of drive; complete attachments available, including saw table, etc. Guaranteed.

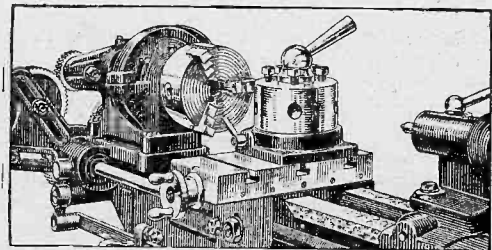

Send for full particulars and list to makers:—

**DRUMMOND BROS., LTD.,**

Reid Hill, Guildford.

## Some change their value many times in a few hours

Constant resistance is the primary and most essential feature of a variable grid leak. Truly, some types change their value many times in a few hours. The adjustment of the grid leak value in some circuits is fairly critical, and the composition of the material providing the resistance should not be subject to change by any varying conditions of the atmosphere or by the application of voltage if results are to be reproduced. In buying any variable grid leak you build endless trouble into your sets. But by purchasing a WatMel Variable Grid Leak you incorporate Detector Valve Control of the highest efficiency. Its resistance value is constant.

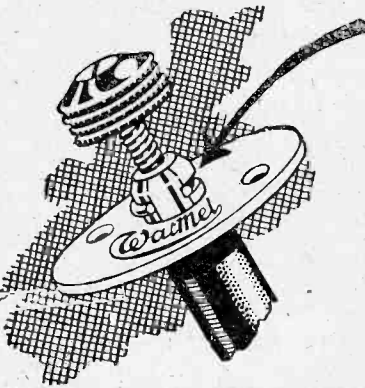

# WatMel

All goods of our manufacture bear this mark. It is your only guarantee.

If you are troubled with poor results pay particular attention to the working of the Detector Valve. Reduce the H.T. voltage consistent with good volume and incorporate a WATMEL Variable Grid Leak. Send P.C. for Descriptive Folder.

When at your dealers' SEE THE TRADE MARK

ON EVERY GRID LEAK. BEWARE OF IMITATIONS!

Recessed into the collar a D shape spring presses firmly upon the controlling plunger. This device—truly a refinement which improves reception—ensures after constant use that the essential contact is always maintained electrically good.

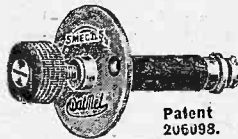

Patent 206098.  
5 to .5 Megohms .. 2/6  
50,000 to 100,000 Ohms 3/6

**WARNING!** It is the aim of this Company to protect traders', customers' and also its own interests by securing Patent protection for the novelties in its specialities. It is these novelties, invented by experts and exhaustively tested, which are the Hall Mark of all Watmel Products.

The Watmel Wireless Co. wish to notify the trade and public that their Variable Grid Leak Patent Application No. 206098 was contested in the Comptroller's Court, and on appeal, in both instances the Patent Grant was upheld and costs awarded.

**The WATMEL WIRELESS CO. LTD.**

352a, Goswell Road, LONDON, E.C.1.

Telephone

CLEKKENWELL 7990.

Barclays 1005

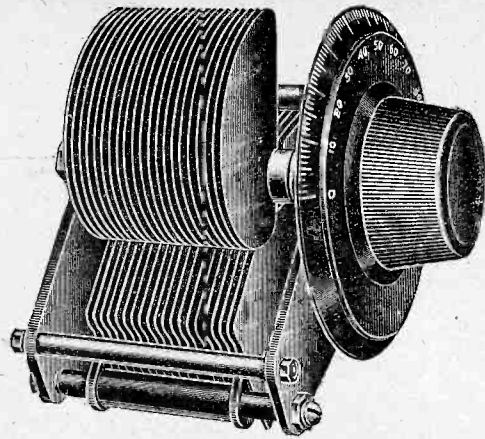

## You can now build entirely with Igranitic components

With the introduction of the Igranitic Square Law Variable Condenser it is now possible for you to build almost any circuit entirely with Igranitic Radio Devices. Now indeed you can build a better set.

The Igranitic Square Law Variable Condenser has fixed and moving plates of stout sheet brass designed to provide for proportionate changes of wavelength in relation to uniform variations on the condenser scale.

Perfectly insulated, dielectric losses are for all practical purposes negligible—whilst hand-capacity is eliminated by the provision of efficient aluminium end plates giving ample shielding.

Ball-bearings support the condenser shaft and an exceptionally smooth turning movement is afforded.

The minimum capacity of the Igranitic Square Law Variable Condenser is less than one-twentieth of the maximum capacity, and the tuning range, when used in conjunction with a given coil, is, therefore, extremely wide.

A handsome four-inch combined Knob and Dial is provided.

PRICES:

.003 mfd. 21/- each. .005 mfd. 24/- each. .001 mfd. 27/6 each.

All reputable dealers carry stocks.



149, Queen Victoria Street, London.  
Works: BEDFORD.

Branches —  
BIRMINGHAM: 73-74, Exchange Bldgs.  
CARDIFF: Western Mail Chambers.  
GLASGOW: 50, Wellington Street.  
LEEDS: Standard Buildings, City Sq.  
MANCHESTER: 30, Cross Street.  
NEWCASTLE: 90, Pilgrim Street.

### IGRANIC RADIO DEVICES INCLUDE

- |                             |                           |
|-----------------------------|---------------------------|
| Honeycomb Duolateral Coils. | Vario Couplers.           |
| Variable Condensers.        | Bi-plug Coil Holders.     |
| Fixed Condensers.           | Tri-plug Coil Holders.    |
| Filament Rheostats.         | Battery Potentiometers.   |
| Interval Transformers.      | Vernier Friction Pencils. |
| Variometers.                | etc., etc.                |

All carry the IGRANIC guarantee  
Write for List Z 493.

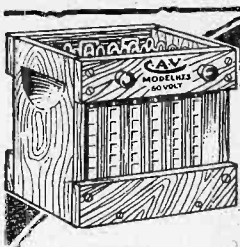

## Experience Tells!

The superiority of secondary H.T. cells over the low capacity dry types is now more widely recognised. The

crackling noises due to chemical action in the dry batteries are eliminated, and they give a consistent discharge over a long period.

**60 Volt H.T. ACCUMULATOR £3.**

Write for catalogue of C.A.V. Wireless Accumulators, Loud Speakers and Transformers.

**CAVandervell & Co. Ltd.**  
WARPLE WAY ACTON LONDON W3

In replying to advertisers, use Order Form enclosed.



**A.B.C. WAVETRAP.**  
Complete and ready for use.  
£2 17s. 6d.  
Complete set of components for  
constructing above  
£2.

**MAGNUM TAPPED REACTANCE UNIT.**

For replacing H.F. Trans-  
formers and converting to T A T  
Type A—Having Resistance in  
series with last stud, 15/-  
Type B—As above, but in-  
cluding Grid Leak and  
Condenser, 21/-.



**MAGNUM TAPPED COILS.**  
No 1 equivalent to Nos. 25,  
35, 50, 75 Plug in Coils, 12/6  
No 2 equivalent to Nos. 100,  
150, 200, 250 Plug in Coils, 15/-

**MAGNUM SAFETY WANDER PLUGS.**

An entirely new design. Protects  
your valves. 5/- per pair.  
Send for List.



**MAGNUM H.F. TRANSFORMERS**  
With Protected Windings.  
The most efficient H.F. Trans-  
former obtainable. (See report in  
"Wireless Weekly.") 7/- each.  
Postage 3d. Guaranteed correctly  
matched 14/- per pair. (Postage  
3d.)

No. 0	150-300
†No. 0A	250-325
No. 1	300-600
No. 2	550-1200
No. 3	1100-3000
*No. 4	2500-7000

\*Specially recommended for super hetero-  
dynamic circuits.  
†Special winding for Anglo-American  
Six referred to as Neurodyne Units. Per  
set of 3, 21/- (post free).

Use **MAGNITE** Crystal for better  
reception.  
1/- post free.

**EBONITE COIL FORMER**  
(CROSS TYPE)

As used by Mr. G. P. Kendall, 3/- post free.  
**COIL FORMER** for A B C Wave Trap cut  
from ebonite tube to author's design, 5/6  
(postage 3d.)

Carriage and Packing **FREE** on Retail  
Orders value £2 and over.  
Send stamp for illustrated list and set of  
leaflets dealing with Radio Press Circuits.

Anode Coils wound and tapped, as  
used in the Simplicity 3 and T.A.T  
8/-, post free.

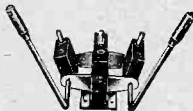

**MAGNUM 3 COIL HOLDER.**

As used on Radio  
Press sets, 12/6

**MAGNUM 2-COIL HOLDER.**

As used on Radio Press  
sets, 9/6.



**MAGNUM ANTI-CAPACITY VALVE HOLDER.**

As used on Radio Press  
Sets, 2/6

**MAGNUM NEUTRODYNE CONDENSER.**

As used in Anglo-American and  
many Neurodyne Circuits, 4/6



**MAGNUM**

Bring your Receiving Station up-to-date by  
constructing the "Rolls-Royce of Radio," a  
Supersonic Heterodyne  
We have pleasure in introducing new Magnum  
Components possessing all the inherent qualities  
associated with the House of Magnum, to wit:  
Design, Efficiency, and Craftsmanship.

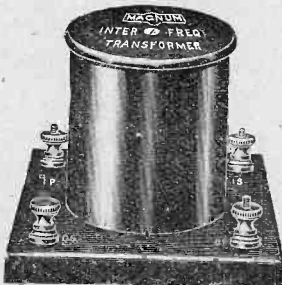

**MAGNUM INTERFREQUENCY TRANSFORMERS.**

These are supplied as single units or in sets  
guaranteed correctly matched as required. Each  
unit comprises a self-contained Transformer with  
a fixed Condenser across the Primary, and are  
without doubt the most efficient type of coupling  
extant. Price 18/-

Make your Supersonic Heterodyne to operate  
on all wavelengths. This can be achieved by  
using **MAGNUM INTERCHANGEABLE OSCIL-  
LATOR UNITS.**

No. 0	150/300 metres.
No. 1	300/600 "
No. 2	550/1200 "
No. 3	1200/3000 "

Price £1 each or £3 15s. per set of four.

**CONSTRUCT THE 9-VALVE SUPER HETEROCY-  
DYNE AS DESCRIBED BY MR. JOHN SCOTT-  
TAGGART IN THIS ISSUE.**

1 Polished Mahogany Cabinet, as described	£ 5 10 0
1 Ebonite Panel, 36 x 12 x 1/4 in., drilled	1 10 0
1 Ebonite Panel, 36 x 6 x 1/4 in., drilled	0 15 0
2 Var. Condensers, Square Law .0005 and Vernier, complete	0 19 0
1 Var. Condenser, Square Law .0003 and Vernier, complete	0 9 0
4 Var. Condensers, Square Law .0005 (less Vernier), complete	1 12 0
2 Fixed Grid Condensers .0003	0 5 0
1 Clip in Condenser .001	0 1 9
1 Clip in Condenser .004	0 2 3
1 T.C.C. Condenser .25 mfd.	0 3 0
1 T.C.C. Condenser 2 mfd.	0 4 8
2 Dubilier Grid Leaks, 2 meg.	0 5 0
2 Burndept Potentiometers	0 15 0
9 Burndept Dual Rheostats	3 7 6
9 Antiphonic Valve Holders	2 5 0
6 Panel Valve Holders	0 7 6
1 Lissen L.F. Transformer	0 16 6
1 Silvertown L.F. Transformer	1 1 0
1 Utility Switch 6-Pole 2-Way Lever	0 10 0
2 Utility Switch 1-Pole 1-Way Lever	0 9 0
15 Terminals, 4 B.A., complete	0 2 6
6 Coils Glazite (various colours)	0 9 0
4 Sets Radio Press Transfers	0 2 0
1 Coil Socket and Shorting Plug	0 2 0
1 H.F. Transformer, 300/600 metres	0 7 0
4 H.F. Transformers, 2500/7000 metres	1 8 0
1 Oscillator Transformer (Plug-in type)	0 18 6
Quantity of screws, etc.	0 2 10
	<b>£25 0 0</b>

(Any of above supplied separately a desired.)

**BURNE-JONES & CO., LTD.**

Magnum House,  
288, 296, BOROUGH HIGH ST., LONDON, S.E.1.  
Telephone Hop 6257. Telegrams BURJOMAG  
Sedist London. Cables BURJOMAG, LONDON.  
Mail order Dept.; 288, Borough High Street,  
London, S.E.1.

Trade Enquiries Invited.

**GENUINE G.P.O. TELEPHONE LEADS**  
as illustrated.  
**6d. EACH POST FREE**

Suitable for **HEADPHONES, LOUD SPEAKERS, H.T. connections,** and various uses where reliable and flexible leads are required.



Braided, average length 6 ft.

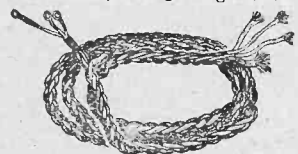

Plaited, average length 10 ft.

3 wires each distinguished by its colour. Plaited are slightly used, Braided unused.

All one Price, 6d. EACH Post free.

**HANDY WIRELESS SCREWDRIVERS**



**4d. EACH**  
Post free.



**N-E-W**  
H.T. Wireless Battery  
Volt 60

**5/- EACH** Postage 1/- extra.  
List price 8/6

**SPECIAL OFFER OF NEW GUARANTEED 60 VOLT H.T. WIRELESS BATTERIES.**

Perfect fresh stock, latest improvements. Tapped every 3 volts. Order now for we have only a limited number at this price and our offer cannot be repeated when stock is exhausted. Trade enquiries invited.

**W. HURLOCK, Jn. Ltd. (Dept M.W.)**  
55, EFFRA ROAD, BRIXTON, S.W.2  
Phones; Brixton 4040 (3 lines).

**YOUR SELLING CAMPAIGN!!!**

Modern Wireless  
Wireless Weekly  
The Wireless Constructor

The Media in Wireless  
Journalism which consti-  
tute a complete and efficient  
Advertising Campaign for  
Selling Sets, Components  
or Accessories.

For rates write Advertisement Managers:

**Barclays Advertising, Ltd.,**  
Advertising Consultants & Contractors,  
Bush House, Strand, London, W.C.2.  
Telephone: City 9911 (3 lines).



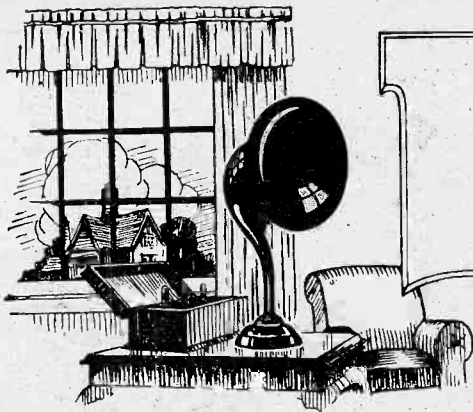

# Radio Press News

A Popular New Book

**A**LTHOUGH the latest addition to the Radio Press series of books, "Wireless Faults and How to Find Them" (Radio Press Series, No. 24, 1s. 6d., or 1s. 8d. post free), by R. W. Hallows, M.A., Staff Editor of MODERN WIRELESS, *Wireless Weekly* and *The Wireless Constructor*, has only been published a few weeks, it is already apparent that this valuable little book is working a speedy change in the outlook of many constructors who have previously felt a certain timidity in starting the building of a new set.

## Confidence

The wise constructor, of course, has always chosen a Radio Press design when contemplating a new receiver, and in that way he assured himself a perfect feeling of confidence in the soundness of the design itself; but, however great the efforts of Radio Press to provide absolute accuracy and dependability, there always remains the uncomfortable feeling that he may be so unfortunate as to incorporate in the instrument a defective component of some sort, that he may make a mistake in wiring, that his soldered joints may not be good, and so on.

The Radio Press Test Department was inaugurated to overcome this last difficulty of the constructor, and, of course, it does provide him with an assurance that as a last resource he can invoke its aid and have his problem solved for him, but many people feel that they would rather clear their difficulties for themselves, and in any case to submit a set to the Test Department means that its owner must part with it for a few days. To very many, therefore, "Wireless Faults and How to Find Them" comes as a very great boon, since a perusal of this most useful and original little book will give them a feeling of confidence in their own powers of fault-finding, which will enable them to begin a new set with the assurance of the

expert that when finished the set will work, or if a fault is present, that they will be able to clear it quickly and without worry.

The whole arrangement of the book is such that it can be used and understood with perfect ease by even the absolute beginner, who will particularly appreciate the very full and complete way in which it has been illustrated. Every point that could be made clear by means of a diagram is illustrated, so that there is never the slightest doubt as to how any particular test is to be applied. The book opens with a chapter giving the necessary details for the construction of an extremely simple but cheap and effective little appliance which is used in conjunction with a pair of telephones for the major portion of the testing of components and complete sets. Later sections of the book deal in great detail with the testing of all the principal components which may give trouble, and then the

author passes on to consider the various accessories which may be used with a finished receiver. These sections of the book are to be regarded as preliminary to the chapters on actual set testing, these occurring in the latter part.

## Complete Sets

Complete chapters are devoted to the testing of particular types of sets, all the more common arrangements being covered, and at the end of each of these chapters will be found a summarised series of tests for that particular type of instrument. Taken as a whole, the book may be regarded as a complete guide to the more simple types of fault-finding tests, these tests being so arranged that in working through them one gradually narrows down the possible location of the fault until it is clearly indicated in one particular component or part of a circuit, where it may, as a rule, be quite easily identified.

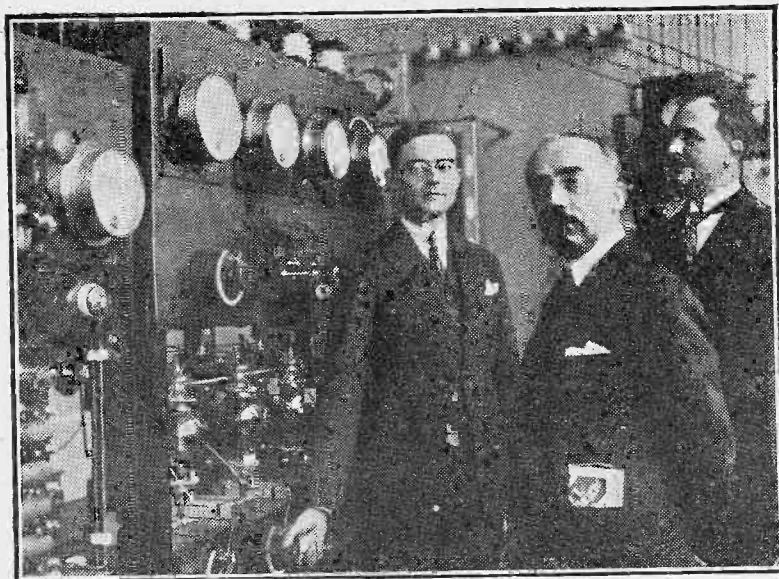

M. Belin, the President of the Amateur Radio Congress, Paris, entertaining two English delegates in the transmitting room of his private station at Malmaison.

# Why I read "Wireless Weekly"

1. BECAUSE, chiefly, I feel safe. I know that behind this paper is the RADIO PRESS, the largest Wireless Publishing concern in the World, and this is their weekly.
2. BECAUSE the Editor is John Scott-Taggart, F.Inst.P., A.M.I.E.E., and the Assistant Editor is Percy W. Harris, M.I.R.E., and because this is the only weekly paper which contains articles by such other well-known writers as Cowper, Hallows, Kendall, Rattee, Redpath, etc., etc.
3. BECAUSE it is beautifully printed on the finest quality paper, and all the photographs come out clearly and not as smudges, as is so often the case.
4. BECAUSE of the notes on valves which appear frequently and are written by the Editor. Nothing like these appears anywhere else. WIRELESS WEEKLY appeals to me because I am a valve user, and the paper caters very largely for the valve man.
5. BECAUSE I thoroughly enjoy "Jottings by the Way," a very witty weekly feature (now illustrated), by the way.
6. BECAUSE new circuits and designs appear regularly and many of them never appear elsewhere. I know that if I miss my WIRELESS WEEKLY I shall miss something new.
7. BECAUSE I am pleased to reply "WIRELESS WEEKLY" when my friends ask me what I read. I know that they know that WIRELESS WEEKLY is a paper in a class by itself. Its price is the highest of the weeklies, and though not a snob, I don't mind my friends knowing that I want the best—and get it.
8. BECAUSE it's a "live" paper. It does things. It's the most virile of the Wireless periodicals. It criticises fearlessly on wireless topics of the day. Its test reports on wireless apparatus are equally fearless. If something new comes along, whether it is oscillating crystals, a new circuit, a new move by the Post Office, every keen wireless man wants to know "what WIRELESS WEEKLY has to say about it"—and they are never disappointed..



Cut Here

To Newsagent.

Please deliver  
reserve me a copy of  
"WIRELESS WEEKLY" every  
week.

Name .....

Address .....

.....

.....

.....

## MY PAPER!

Published every Wednesday by  
Radio Press, Ltd., Bush House,  
Strand, London, W.C.2.

6d. WEEKLY.

# Silvertown Wireless Accessories

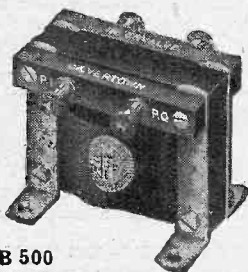

B 500

## INTERVAL VALVE TRANSFORMER

Guaranteed for 12 months.

This transformer has been adopted by leading Manufacturers of Wireless Receiving Sets and discriminating amateurs in all parts of the world.

High amplification without distortion and complete freedom from internal noises. Correct design, high-class finish.

Excellent results have been obtained on tests carried out by the National Physical Laboratory. Copy of the curve can be had on application.

Price 21/- each.

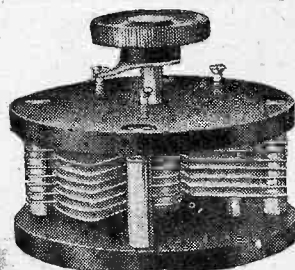

## VARIABLE CONDENSERS

(For panel mounting)

Strongly constructed. Moving vanes are shaped to give low minimum capacity. Fitted with a stop to allow of a movement of 180° only.

From 5/6 each

## TELEPHONE HEADPIECES

The "Stalloy" diaphragms are matched so as to secure a balance of tone and quality. Resistance from 120 to 12,000 ohms.

Price (4,000 ohms) 20/- each

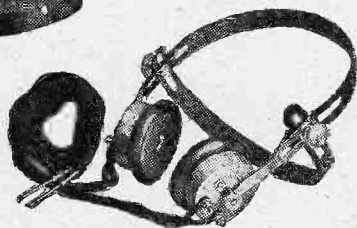

MAKERS:

**THE SILVERTOWN COMPANY,**  
106, CANNON STREET, LONDON, E.C.4.

Works: SILVERTOWN, LONDON, E.16.

BELFAST: 75, Ann Street.  
BIRMINGHAM: 15, Martin Street.  
BRISTOL: 4, Victoria St.  
CARDIFF: Pior Head Chambers, Bute Docks.  
DUBLIN: 70, Middle Abbey Street.  
GLASGOW: 15, Royal Exchange Square.  
LEEDS: 1, New York Rd.  
LIVERPOOL: 54, Castle St.  
LONDON: 100 and 102, Cannon Street.  
MANCHESTER: 16, John Dalton Street.  
NEWCASTLE ON TYNE: 59, Westgate Road.  
PORTSMOUTH: 49, High Street.  
SHEFFIELD: 88-90, Queen Street.



# Contentment

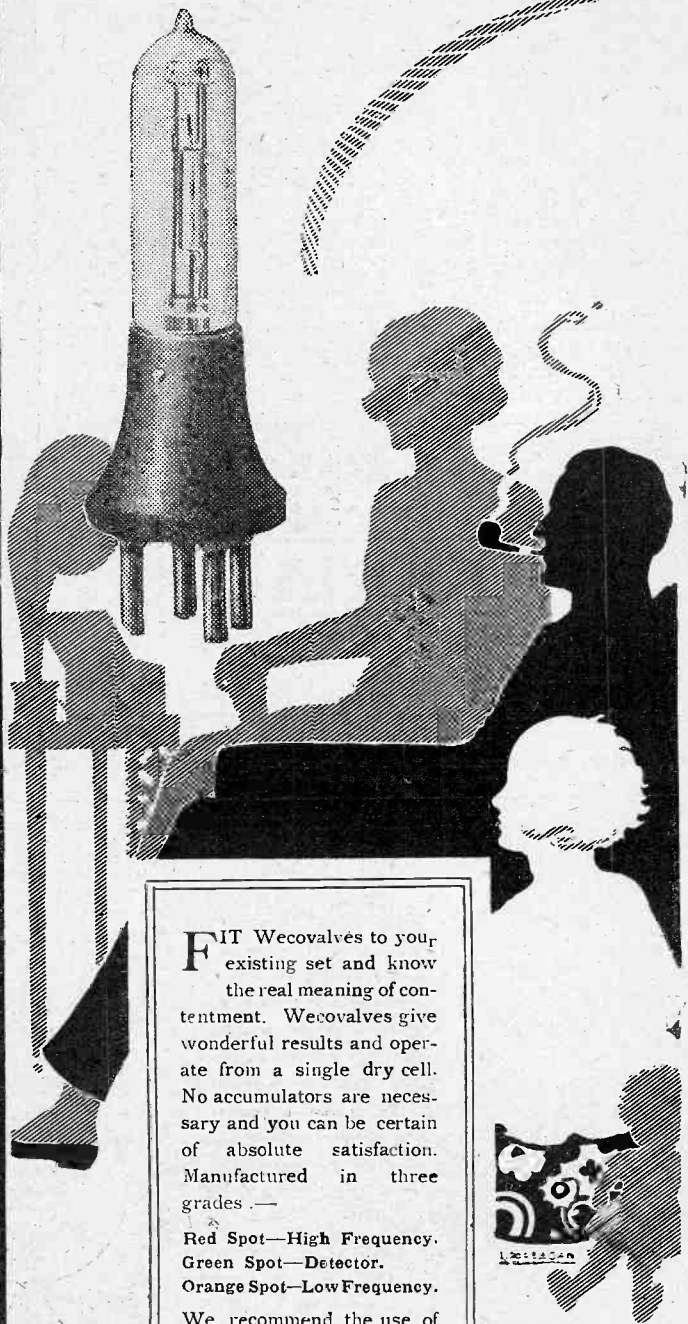

**F**IT Wecovalves to your existing set and know the real meaning of contentment. Wecovalves give wonderful results and operate from a single dry cell. No accumulators are necessary and you can be certain of absolute satisfaction. Manufactured in three grades.—

Red Spot—High Frequency.  
Green Spot—Detector.  
Orange Spot—Low Frequency.

We recommend the use of Radio A Cells.

The World's Premier  
dry battery valve  
**WECOVALVE**

Adopted by Western Electric Company, Limited, Comnaught House, Aldwych, London, W.C.2



**The Woodhall**  
Valve unit combines  
Rheostat, Valve Holder,  
Bracket and Window, in  
one compact fitting. And you  
need to drill *two holes only*.

This newest addition to the Woodhall Range of Components fills a definite need of many 'home constructors.' It gives the popular 'back of panel' fitting for the valve, occupies a minimum of space, and is highly efficient in use.

Consist of Woodhall Valve Holder, on rigid brackets, with nickel-plated valve window and Woodhall Vernier Rheostat (see below)

PRICE (complete):  
With 6 ohms Rheostat 6/6  
With 10 ohms Rheostat 7/-  
With 30 ohms Rheostat 7/6



The **WOODHALL** Vernier Rheostat (Pat. No. 213,030). Combined plunger and rotary movement. Push-pull movement for coarse setting; rotary for vernier. Wonderfully smooth movement; best ebonite former; one-hole fixing. 6 ohms, 2/6; 10 or 12 ohms, 3/-; 30 ohms, 3/6.

# WOODHALL

**Guaranteed Components**

WOODHALL WIRELESS MANUFACTURING CO., LTD.  
London Showrooms: 21, Gerrick Street, London. (Tube Station: Leicester Square.)  
Sold by all the best Radio Dealers.

Sole Distributors: — PRESSLAND ELECTRIC SUPPLIES, LTD.,  
HAMPTON-ON-THAMES. Phone: Molesey 22.



**REAL TESTIMONY TO THE WORLD'S BEST RADIO CRYSTAL.**

Knutsford.  
"I don't claim to have reached Timbuctoo nor Chili, but I get the local Broadcasting Station, which is 15 miles distant, even though slightly deaf, at comfortable strength. I hear every note, and that is all that counts. I have tried umpteen kinds of crystals with varying degrees of efficiency, but the Gil-Ray is the NIBS."—E.M.

**INSIST ON GIL-RAY** The Guaranteed Crystal.  
**OUR GUARANTEE:** We will gladly replace any crystal free of charge that does not give entire satisfaction.

In case of difficulty please send 1/6 and name of dealer to  
**GIL-RAY TRADING CORPORATION,**  
Sicilian House, Sicilian Avenue, London, W.C.1  
Telephone: Museum 3206.  
**TRADE ENQUIRIES SOLICITED.**

PRICE  
**1/6**  
EACH  
with silver  
on 's whisker

# Knivetown Cords

FOR 100% EFFICIENCY

**BRITISH CORDS ARE THE BEST—AND KNIVETOWN WIRELESS CORDS are the Best British Cords.**

They will improve reception and do away with crackling. THE KNIVETOWN WIRELESS CORD is a flexible, hard-wearing cord of high conductivity, manufactured from the best materials only. Made for loud-speakers, headphones and batteries.

Loudspeaker Cords	6 ft.	3/3	12 ft.	5/6
Headphone Cords	7 ft.	3/9		
Battery Cords		3/9		

Every length guaranteed.

Send direct if unable to obtain locally.

**KNIVETOWN ELECTRIC WIRE CO., LTD.,**  
88, Rosebery Avenue, London, E.C.1.

Phone: Clerkenwell 5614.

Grams: Knivetown, London.

# "ELLA" BATTERY CHARGERS

*They work from a lampholder*

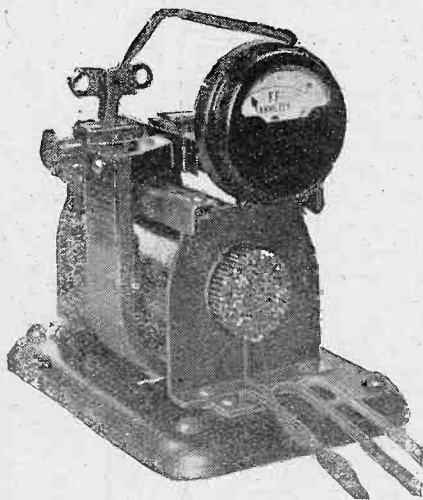

A.C. Model

Output 6 amps. 9 volts. Complete with Pole Indicating Ammeter and all connecting leads and adapter. To standard voltages and frequencies up to 220 volts. £6 6 0

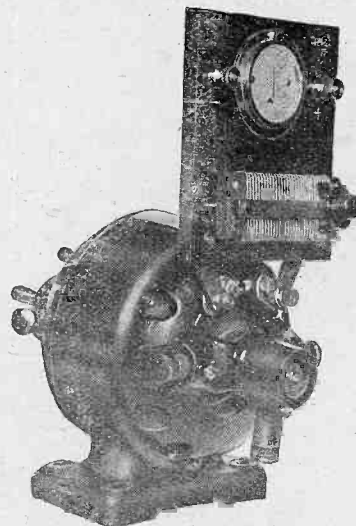

D.C. Model.

Output 5 amps. 9 volts. Machine only £5 12s. 6d. With Switchboard and Pole Indicating Ammeter and Regulating Resistance as illustrated - £6 15 0

Other voltages and frequencies £1 extra.

BATTERIES charged at home have much longer life and give better service than when charged outside.

"ELLA" Battery chargers save their cost many times over. Write to Dept. "A" for descriptive leaflet. Trade supplied.

**LIONEL ROBINSON & CO.** 3a, Staple Inn, London, W.C.2.

Phone: Holborn 6323 (Two Lines).

# Every Condenser on your set a vernier for 2/-

WITHOUT the cost of buying Vernier attachments and the trouble of pulling your set to pieces, the "Easitune" Anti-capacity Vernier Tuning Handle will fine-tune every condenser you have. By a spring, in one touch the handle is made to grip surely any condenser knob and one touch releases the handle when tuning is done. The handle is perfectly insulated, and the tuner's hand is 5 1/2" away from condenser knob. Hand-capacity is therefore avoided & the finest tuning assured. Price 2/-.

A. H. HUNT, LTD., H.A.H. WORKS, TUNSTALL RD., CROYDON.

Write to Dept. 5.

## FIG. 910 EASITUNE Anti-Capacity Vernier Tuning Handle



# ONE "EASITUNE" HANDLE FITS ALL CONDENSERS

H.P.



## TAPPED COILS

The making of a tapped coil is a difficult task for the most enthusiastic amateur, and it is well to purchase complete units, such as the Efesca series of tapped coils. In these the ideal has been attained in every respect—the winding is particularly accurate, each tapping is soldered up to its corresponding stud, and the whole unit is arranged for the Standard Efesca One-Hole Mounting to the panel. The unit incorporates a switch as an integral part and the tappings are so arranged that there are no dead ends.

Ask your Wireless Dealer to show you Efesca components, or write to us for Catalogue 522/12 describing Efesca Products.

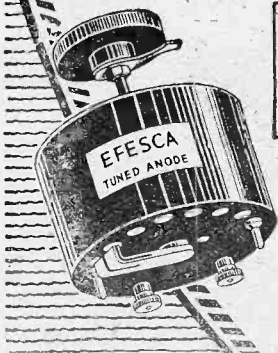

**EFESCA TUNED ANODE**  
An alternative method to H.F. Transformer Coupling. Must be used in conjunction with a variable condenser of 0.003 to 0.005 mfd. Wavelength range, 150 to 2,600 metres. Complete with self-contained split switch, knob, pointer and scale, one-hole fixing. 2/- each.

Sold by all Wireless Dealers and Electricians.

Wholesale only—

**FALK, STADELMANN & Co., Ltd.**  
Efesca Electrical Works,  
83-87, FARRINGTON RD., LONDON, E.C.1.  
And at Manchester, Glasgow and Birmingham.



## Building with Laboratory Apparatus

The stated capacity of every individual Thera Condenser is tested and guaranteed by Faraday House.

Fixed condensers are of a certain capacity by description alone. Guaranteed they may be; but never accurate. It is accuracy that makes for success in radio—accuracy, laboratory accuracy. And such accuracy as your radio set deserves—if you would get one over on the other fellow—build not with a guaranteed condenser, but with a tested capacity condenser. It takes the guess out of radio; gives you the efficiency which brings results.

The first tested capacity fixed condenser available to the British amateur is the Thera. Every individual Thera is tested for accurate capacity by Faraday House—and guaranteed. Mass production can only produce nominal

capacities—it cannot produce accurate capacities. Accuracy means results, and the Thera Tested Capacity Fixed Condenser gives you supreme accuracy. You build as though you had a laboratory at your command. And all this at no extra cost!

You buy a Thera Fixed Condenser, which is not affected by temperature or by the humidity of the atmosphere. Useful soldering tags are integral in the design and enable you to make a neat wiring job.

Ask your dealer for a Thera Tested Capacity Fixed Condenser. Look for the guarantee on every carton.

**PRICES:**

.0001 to .0015 mfd., 1/3 each.

.002 to .006 mfd., 2/- each.

FROM ALL DEALERS.



REGD NO 457042

Sole Distributing Agents—

**THE SEL-EZI WIRELESS CO.,**  
6, GREEK ST., LONDON, & 20, OLD HAYMARKET, LIVERPOOL.

Advertisements 1005

# VALVES repaired Quick!

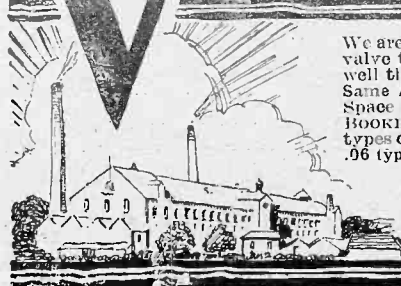

We are actual makers of valves, therefore we can repair and exhaust the valve to give the necessary high vacuum. In fact we do this job so well that we guarantee—

Same Amplification. Same Radiation. Not to consume more current. Space won't permit of full price list here, but we'll gladly send you Booklet post free on request. Here are prices for the most popular types of valves. Bright Emitters 6/6. Dull Emitters: 2 volt type 9/- .06 type 10/6. Postage 3d. extra.

If your dealer is not alert enough to collect valves, for RADION repair, send straight off to us with remittance and obtain real prompt service.

**RADIONS Ltd., BOLLINGTON, Near Macclesfield**



FREE BOOK entitled: "How long should my accumulator charge last?" gives this information and curves of RADION Valves—high in performance low in cost. Send Now.

In replying to advertisers, use Order Form enclosed.

# YOUR OPPORTUNITY!

Thousands of men have lost their one great opportunity in life through leaving over until to-morrow that which should have been done immediately. You have to move in the world, you cannot stand still, so why not move in the right direction? Why not move now?



MY ADVICE IS FREE.

We have helped thousands of others to a successful career, we may or may not be able to help you, but in any case it costs nothing to enquire: our advice is Free, and there is a possibility that it may be worth thousands of pounds to you, it may change your whole career, it may help you up in the world socially and financially, it certainly cannot harm you: therefore, you have all to gain and nothing to lose by seeking our advice.

We have booklets setting out the possibility in connection with each of the subjects shown in the lists, sent for the one in which you are interested, or ask for our Private Advice.

**WE TEACH BY POST** Have You **ANY Ambition?**

The Bennett College specializes in all Exams. in the following subjects and guarantees tuition until successful. No extra fees. Most Moderate Charges. Payable Monthly. All Text Books Free. Expert Tutors for every Department.

- J.H. Bennett*
- COMMERCIAL,**
- Accountancy
  - Advert Writing
  - Salesmanship
  - Auditing
  - Banking
  - Book-keeping
  - Commercial Arithmetic
  - Commercial Law
  - Company Law
  - Costing
  - Economics
  - English and French
  - Excutorship Law
  - Foreign Exchange
  - Modern Business Methods
  - Secretaryship
  - Workshop Organisation

- TECHNICAL.**
- Architectural Drawing
  - Building Construction
  - Clerk of Works' Duties
  - Boiler Engineering
  - Boiler Making
  - Chemistry
  - Civil Engineering
  - Concrete and Steel
  - Draughtsmanship
  - Electricity
  - Engineering
  - Foundry Work
  - Internal Combustion Engines
  - Marine Engineering

- TECHNICAL—Cont.**
- Mathematics
  - Matriculation
  - Metallurgy
  - Mining
  - Mine Surveying
  - Motor Engineering
  - Naval Architecture
  - Pattern Making
  - Sanitation
  - Shipbuilding
  - Structural Engineering
  - Surveying and Levelling
  - Telephony & Telephony
  - Wireless Telegraphy
  - Works Managers' Course

**WRITE FOR FREE BOOKLET**

to The Bennett College, Dept. 134, Sheffield, naming the subject you are interested in. Parents should seek our advice for their sons. Please state your age. Courses specially combined to meet all requirements. Why stay in the rut?



**ENGINEERING DICTIONARY, PART ONE FREE.**

To extend the name of the Bennett College we are publishing an Illustrated Encyclopedic Dictionary of Engineering, Civil, Motor Elect., Mech., etc. You may have Part I FREE. Send for Part I to-day: you are under no obligation.

## "That finishing touch"

By using "RADIO PRESS WIRELESS PANEL TRANSFERS" you can give to your set that finished appearance which makes all the difference. Not only are these transfers the cheapest and best, they are officially used by the Radio Press for their sets.



They are obtainable from all bookstalls, newsagents or wireless dealers. 6d. per packet, or 8d. post free direct from—

**Radio Press Ltd., Bush House, Strand, W.C.**

### A HANDSOME Solid Oak Standard Cabinet WITH LOCKS

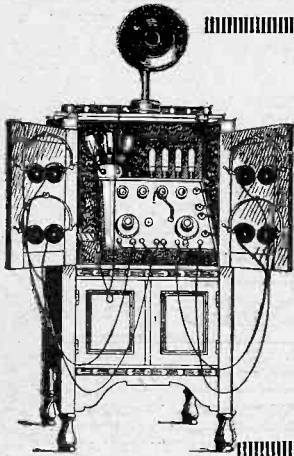

in which to lock up or build large panel receivers, such as:

4-valve Family. All Concert de Luxe. Transatlantic IV. and V. Wireless Magazine 4-valve Receiver. Anglo-American 6, 3-valve Dual, etc.

Write for full particulars.

Willingly sent on approval against remittance.

Guaranteed first-class workmanship.

Immediate delivery.

TRADE SUPPLIED

Price: 22 in. inside width	... £4 15 0
24	... £5 0 0
36 (modél de luxe)	... £8 0 0

Carriage Paid. Packing Free.

**M. VERSTRAETEN**  
(Dept. 2)  
50a, Lord St., Liverpool

### A NEW "CHASEWAY" TRIUMPH HOME BATTERY CHARGER for Alternating Current



Connected by lamp socket or wall plug. Costs only 1/5th unit to recharge 6-volt 30 actual. Will recharge 2, 4, 6, 8, 10 or 12-volt batteries. Silent running, absolutely mechanical. No acids or liquids, no expensive bulbs to be replaced. No vibrating armatures or buzzers. Self-contained and complete. Adjustable to recharge at from zero up to 5 amps. Cheaper and infinitely better than all the foreign chargers on the market.

Before buying any A.C. Charger ask the Guaranteed "efficiency"—then you'll buy CHASEWAY.

Home Chargers also for Direct Current.

Full details on application, giving voltage and periodicity of local electric supply. Send stamp for Catalogue of "CHASEWAY" Components.

**CHASE ELECTRICAL Mfg. Co., Ltd.**  
184, Fleet Street, London, E.C.4.

Size approx. 7" x 6" x 4".

### DON'T BUY COILS—WIND THEM WITH A KAYNITE MACHINE

INDUCTANCES, H.F. TRANSFORMERS, H.F. CHOKES, CLOSE COUPLED WAVE TRAPPING COILS, etc., can be produced at the speed of 120 turns to the minute. Any wire from 40 s.w.g. to 22 s.w.g. may be used, but 26 or 28 is recommended. Coils can be from 2 in. to 6 in diameter, either 1/4 in., 1/2 in. or 3/4 in. thick. Coils are easily coupled to make them any desired thickness.

### THE KAYNITE SINE WAVE WINDING SCORES

A copy of the complete treatise supplied with each Machine can be had separately for stamps value 7d. Investigate the utility before purchasing the machine.

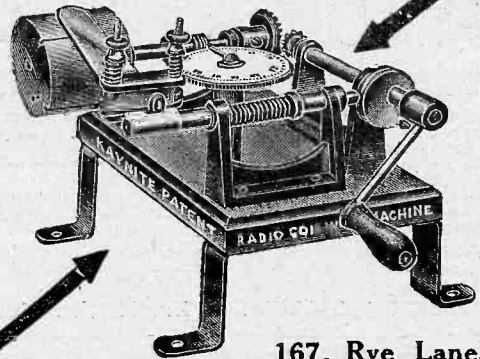

### PRICE LIST OF KAYNITE MACHINES

No. 1 Machine. Without counting device .. .. .	21/-
No. 2 Machine, Standard Machine, with counter .. .. .	25/-
Tension Attachment, fitted to either Machine, or sold separately, at	2/6

### A. W. KNIGHT LTD.

167, Rye Lane, Peckham, LONDON, S.E.15

HUNT'S  
"VERNIER"  
DETECTOR,  
Fig. 922,

**4/-**

Complete with  
fixing bolts and  
spare Crystal  
Cup.

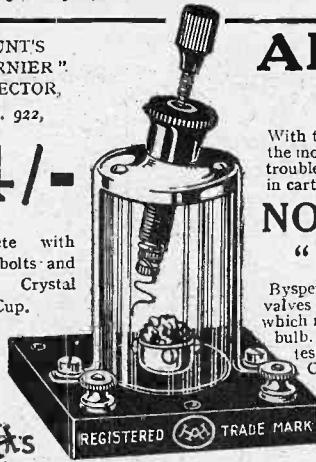

# ADJUSTS to a TEN THOUSANDTH

*Hunt's Detector with Micrometer Setting.*

With the ball-and-socket action and the Micrometer adjustment, Hunt's "VERNIER" Detector gives the most delicate setting of any type known, and then locks the whisker in position. All common crystal troubles disappear. Spare crystal cup for double crystal or Perikon work with each detector. Packed in carton with full instructions.

## NO MORE BURNT-OUT VALVES

"Saveit" Fuses Protect Your Filaments

Byspending 2/- on a Hunt's Patent Safety Fuse Winder Plug, you save several valves at a cost of 15/- or 20/- each. Accidents are bound to happen, and one which might have meant a burnt-out valve costs only 6d. to replace a flash-light bulb. The fuse operates in the H.T. circuit, and may also be used as a battery tester, being designed with a special split Plug to fit standard battery sockets. Can be used with either bright or dull emitter valves. Instructions in carton.

A. H. HUNT, LTD., Dept. 5,  
HAH Works, Tunstall Road, Croydon.

"SAVEIT"  
PATENT  
SAFETY  
FUSE  
WINDER  
PLUG,

**2/-**

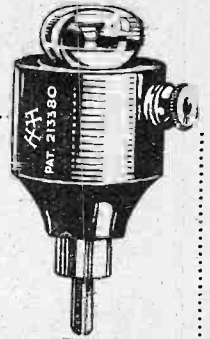

Fig. 828.



REGISTERED TRADE MARK



## "GOLTONE" REGD. CONSTRUCTIONAL WIRELESS RECEIVING SETS (British Made).

These Sets are despatched with ready-drilled Ebonite Panels, Wound Transformers, Assembled Condensers and with the aid of the simplified illustrated instructions supplied, anyone, with or without Technical knowledge, can construct these sets with ease and simplicity.

The circuits employed have been severely tested under varying conditions and are thoroughly recommended.

## "GOLTONE" MICROMETER REGULATING COIL HOLDERS

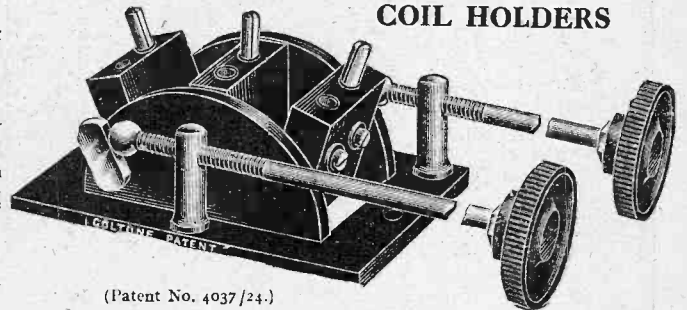

(Patent No. 4037/24.)

High grade finish. Excellent design. Enables the finest possible tuning, considerably increasing the Efficiency, Selectivity and Reliability of the Receiving Set. Maximum insulation. **TWO-COIL TYPE**, No. R15/40 Price 7/6. **THREE-COIL TYPE**, as illustrated, No. R15/41. Price 10/6. See Catalogue No. R/112 for details of other types.



- |   |                 |   |                |
|---|-----------------|---|----------------|
| <b>ONE-VALVE SET.</b><br>Marconi Royalties<br>12/6 extra. | <b>£2 9 0</b>   | <b>THREE-VALVE SET.</b><br>In Cabinet, as illus-<br>trated. Marconi Royalties 37/6 extra. | <b>£6 17 0</b> |
| <b>TWO-VALVE SET.</b><br>In Cabinet.                      | <b>£5 5 6</b>   | <b>FOUR-VALVE SET.</b><br>In Cabinet.   | <b>£9 2 0</b>  |
| Marconi Royalties 25/- extra.                             |                 | Marconi Royalties 50/- extra.   |                |
| <b>FIVE-VALVE SET.</b><br>In Cabinet.                     | <b>£12 19 0</b> |   |                |
| Marconi Royalties 62/6 extra.                             |                 |   |                |

The above prices include suitable Plug-in Coils for the reception of B.B.C. Stations, other Coils can be promptly supplied.  
For full particulars send for Catalogue No. R/112 free on request.

## "GOLTONE" CRYSTAL DETECTORS.

Excellent finish and appearance. Fitted with Glass Dust Shield. Mounted on Ebonite Base. Price 1/9 each. Parts only, without Ebonite Base, for Panel Mounting, Price 1/6 each. Vertical and horizontal types supplied. "Mercury" Type **Dustproof Detector**. (Patent Applied.) No searching for Sensitive Spots. Utmost volume assured instantly. Complete with Crystal and Bottle of Mercury, 3/6 each.

These lines are stocked by the Leading Radio Stores.  
Write direct if unobtainable.

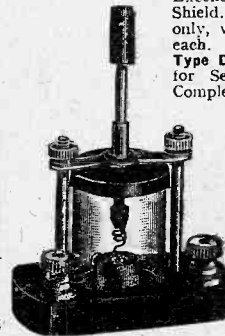

Address all communications to Head Office and Works:  
**PENDLETON, MANCHESTER.**

STOCKS ALSO HELD AT GLASGOW DEPOT:  
95, PITT STREET.

## RADIO WIRES



Silk, Cotton and Enamelled Wires, Aerial Wires, Telephone Receiver and Loud-Speaker Cords, "Easifix" Assemblies, etc. Send your inquiries. Keen prices.

## "GOLTONE" SUPER CRYSTAL.



Super sensitive in any position. Ensures good volume over long distances. Price, complete in Glass Tube with Cat's Whisker and Crystal Tweezers: Price 1/-

Large fully illustrated Radio Catalogue No. R/112 Post Free on request Enclose Business Card for Trade Terms.

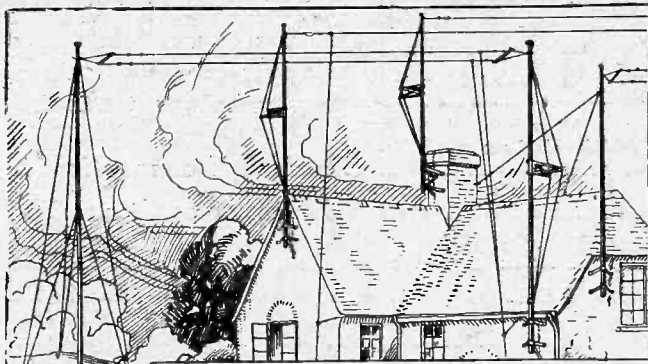

"TURRET"  
MASTS

"TURRET" Columbian Pine Masts Designed by Naval experts.  
27ft. Turret Two £2 4 6 25ft. Telescopic £4 10 6 Phone:  
36ft. Complete 3 19 0 55ft. " " 6 15 6  
42ft. Telescopic 4 4 0 68ft. super " 6 19 6  
SIMPSON & BLYTHE, 8-9, Sherwood St., Piccadilly, W.



## BASEBOARD SINGLE COIL HOLDER

NOTE THE TOP AND SIDE  
FIXING HOLES.

Ideal for American Type Sets.

We will send goods post free if you mention  
dealer's name.

**Athol ENGINEERING CO**  
CORNET STREET, H<sup>2</sup>BROUGHTON, MANCHESTER

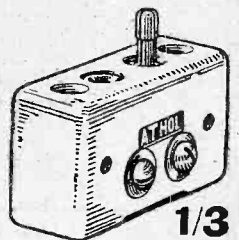

**1/3**  
EACH

Ask for Illustrated  
List of ATHOL  
Components.

# "UTILITY" VARIABLE SQUARE LAW CONDENSERS

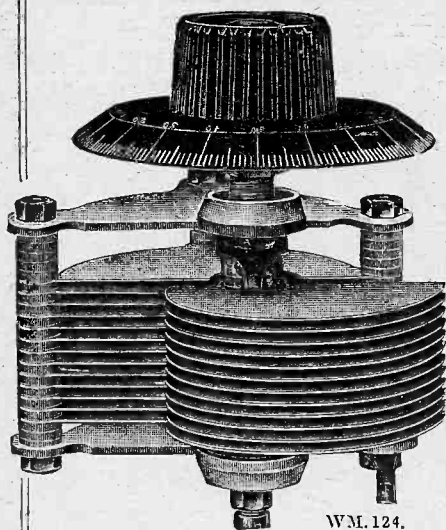

at  
same price  
as our  
**ORDINARY**

**PRICES.**

Ref. No.	Cap.	Price.
WM.123	.001	12/6
WM.144	.00075	11/9
WM.124	.0005	10/6
WM.125	.0003	8/9
WM.145	.0002	7/9
WM.146	.0001	7/6

Vernier 2/6 extra.  
Fitted with  
Radion Dials.

## NO-CAPACITY

The "UTILITY" NO-CAPACITY SWITCH, as used in the constructional articles appearing in this journal. Specially designed by electrical engineers to reduce the electrostatic capacity, this switch has proved to be exceptionally reliable in action and has self-cleaning contacts.

Size	Knob Type	Price
1 Pole Change over	WM.130/1	3/6
2 "	WM.130/2	4/-
3 "	WM.130/3	5/-
4 "	WM.130/4	6/-
5 "	WM.130/5	7/-
6 "	WM.130/6	8/-

Size	Lever Type	Price
1 Pole Change over	WM.147/1	4/6
2 "	WM.147/2	5/-
3 "	WM.147/3	6/-
4 "	WM.147/4	7/6
5 "	WM.147/5	8/0
6 "	WM.147/6	9/0

Black bronzed, lever pattern, nickel-plated, 6d. each extra.

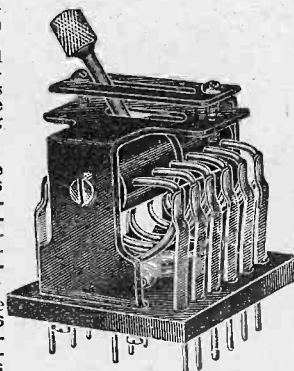

WM. 147/6.

# SWITCHES

Manufactured by  
**WILKINS & WRIGHT LIMITED,** ESTD. 1887.  
UTILITY Works, Kenyon Street, Birmingham

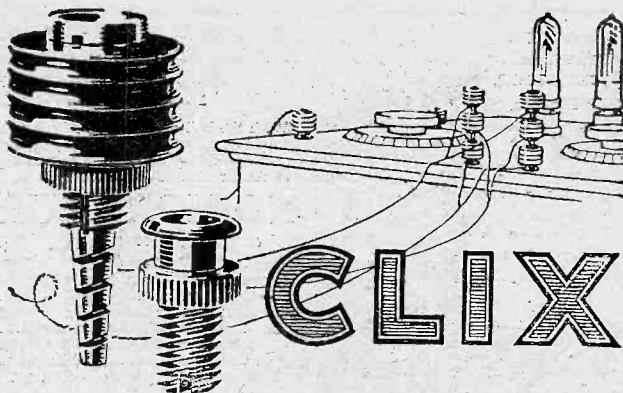

CLIX metal parts continue to be machine-turned from the best hard brass rod. But a special nickel-bathing process is now employed to increase CLIX high standard of efficiency, workmanship and finish.

In high-frequency circuits the milliamperes function on the skin of all conductors. The connections in radio circuits are commonly responsible for 90% of the high-frequency resistance in wiring between components.

Vital importance attaches, therefore, to the high-frequency resistance of every connection. The new skin of special nickel-silver alloy of high electrical conductivity ensures in CLIX a perfect fitting connection with a high-frequency resistance of practically zero. This fact, in conjunction with the large area of contact surface provided with the minimum of capacitive metal in both plug and socket portions, gives CLIX its supremacy over every other form of plug, switch or terminal.

Retail Prices of the New CLIX.	
CLIX with Locknut	3d.
CLIX Adapter with Locknut	2d.
CLIX Insulators (6 colours)	1d. each
CLIX Bushes (6 colours)	1d. pair

Obtainable from all Wireless Dealers or direct from the Patentees & Manufacturers

**Solder all connections!**  
**Where you can't, use CLIX!**

## AUTOVEYORS, LTD.

Radio Engineers and Contractors,  
84 VICTORIA STREET, LONDON, S.W.1



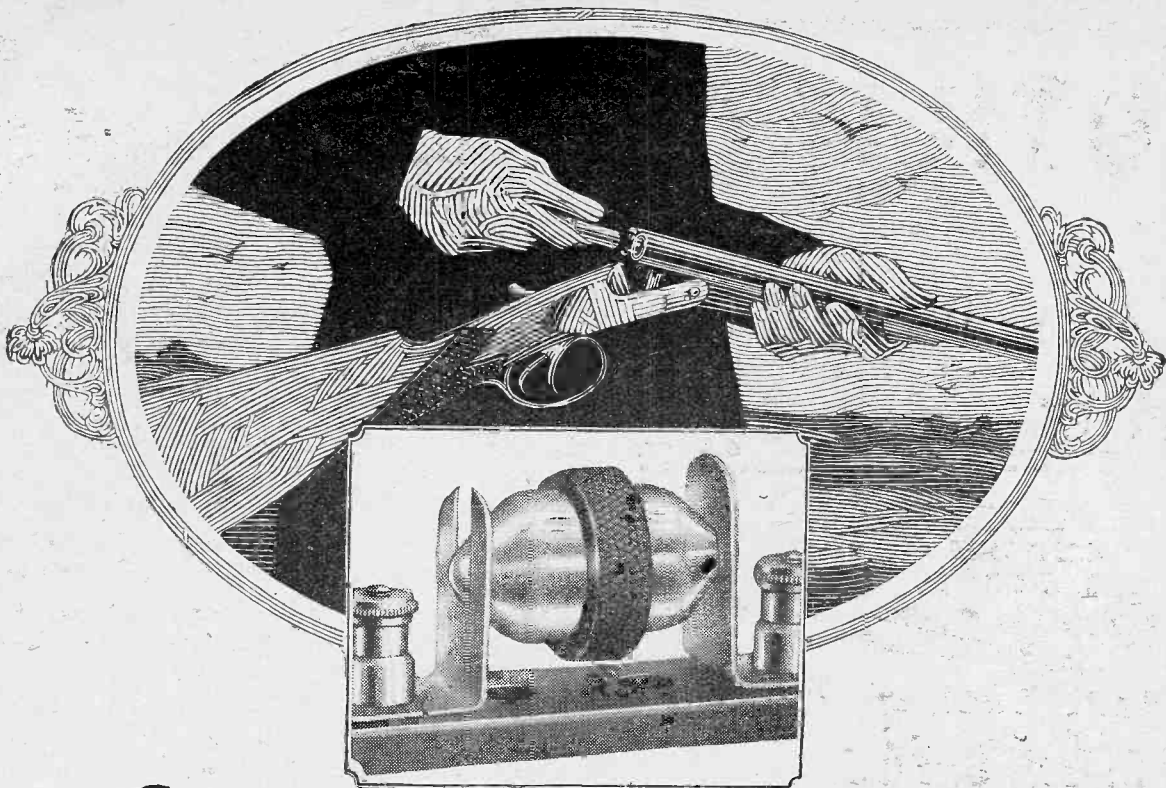

## As easy as loading a gun

**ADVANTAGES YOU GET WITH NO OTHER DETECTOR.**

The Crystal is firmly held in a spring cup and the moving points fall to make contact with it as the cartridge is rotated.

\* \* \*

When the Gravity Detector is in use the Crystal is fully enclosed and protected from dirt.

\* \* \*

The Gravity Detector can be reloaded with a new crystal in a moment. Nothing to unscrew or solder.

Complete with Crystal

6/6

EVERYONE who buys a Crystal Detector wants to know two points: Will it work without attention? Can the crystal be changed in a moment? How few Detectors on the market can satisfy even one of these requirements—certainly we know of none besides the Eureka Gravity that can satisfy both.

Its principle is just this: The crystal is held in a cup within the centre of the cartridge. Around the periphery of the case is placed a row of catwhisker points, each one of which is weighted at the head. When the Gravity is rotated these points are caused to drop one by one to make contact with the Crystal. Thus it is only necessary to give the Detector a twist until the loudest signals are heard. There is no catwhisker to adjust—merely rotate the cartridge. And when you want to use a new Crystal merely remove the Gravity from its clips—separate the two halves and drop in the new piece of Crystal. It's as easy as loading a gun! All first-class Wireless Shops sell the Gravity.

Manufactured only by—

**PORTABLE UTILITIES CO., LTD.,**  
Manufacturers of the Eureka Transformer,  
FISHER STREET, LONDON, W.C.1.

**ADVANTAGES YOU GET WITH NO OTHER DETECTOR.**

The slightest turn of the Detector automatically brings into use a new spot on the crystal and a new contact point.

\* \* \*

Stout plated spring clips are supplied, and the base can be removed for fitting the Detector direct to the panel.

\* \* \*

Nothing to wear out—the Gravity Detector will last a lifetime.

Complete with Crystal

6/6

# CRYSTAL DETECTOR GRAVITY

Gilbert Ad. 2696

In replying to advertisers, use Order Form enclosed.

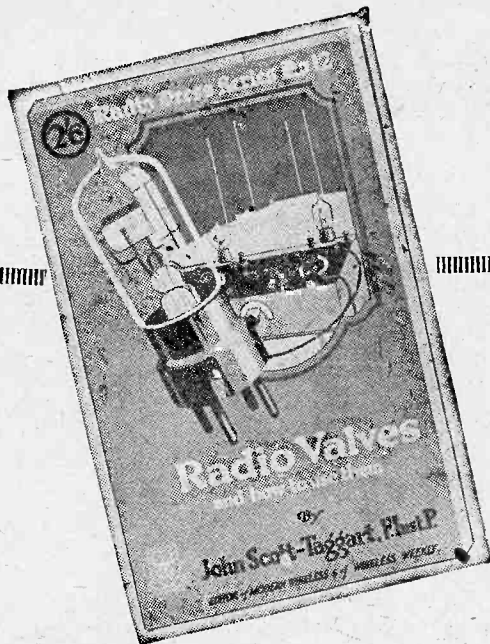

## Are you getting the most out of your set?

The efficient working of a valve set depends essentially on the control of the valves. Burning out of valves, distortion, and many other set complaints could be eliminated if the owner had an elementary knowledge of the subject of valves.

### Radio Valves and How to Use Them.

By JOHN SCOTT-TAGGART, F.Inst.P., A.M.I.E.E.

Contains all the information an enthusiast should know on this important subject. Although dealing with a difficult subject, the author succeeds in making the reading both interesting and instructive to the beginner.

Realising that formulæ and advanced technique are enigmatical to the average person, the author has substituted, instead of these, simple comparisons, intelligible to the veriest novice.

2/6. Post Free, 2/8  
Ask for Series No. M. 12.

OBTAINABLE FROM ALL BOOKSTALLS, NEWS-AGENTS AND WIRELESS DEALERS, OR DIRECT FROM THE PUBLISHERS, DEPT. M.

Radio Press, Ltd.  
BUSH HOUSE, STRAND, LONDON, W.C.2.

Barclays Ad.

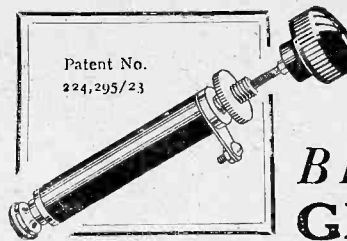

Patent No. 224,295/23

## The BRETWOOD GRID LEAK

The Grid Leak with the N.P.L. Report.

Send for copy.

The only accurate variable Grid Leak of watch-like precision and scientific design.

Successfully used and recommended everywhere.

If you are not satisfied within seven days, money will be refunded.

Price 3/-, Postage 3d.



### The "Bretwood" Anode Resistance

(Patent No. 224,295/23) gives accurate readings consistently from 10,000 ohms to over 100,000 ohms. This BRETWOOD Component is particularly suited for the ST100 circuit (*Modern Wireless*), the super-sensitive circuit (*Popular Wireless*), and for resistance coupling, etc.

It is constructed on the same principles that have made BRETWOOD Components famous, and, of course, it carries the BRETWOOD Guarantee.

Price 3/- Postage 3d.

Designed on the same principle as the "BRETWOOD" GRID LEAK mentioned above.



### The "Bretwood" Anti-Capacity Switch.

Constructors will welcome news of a further Bretwood Product, an Anti-Capacity Switch, the principal features of which include:—Absolute freedom from capacity effects—Perfect contact—Workmanlike finish and neatness of appearance—Simple single hole fixing and Easy to make wiring connections. Special spring loaded balls in the base make the Bretwood Switch wonderfully smooth in action and ensure clean and perfect electrical contact at all times. It is confidently offered to wireless constructors as the Anti-Capacity Switch *par excellence*, and of course it carries the famous Bretwood Guarantee.

Price 5/-  
Postage 3d.

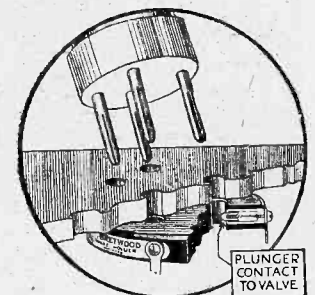

### The "Bretwood" Patent Valve Holder.

Fix this efficient component and get maximum results. Positively no leakage or capacity effects. Perfect contact. Can be mounted on front or back of panel.

Price 1/9 Postage 3d.

All Bretwood specialities are obtainable from most Wireless Dealers.

# BRETWOOD, Limited

12-18, London Mews, Maple Street, London, W.

Barclays 1004.

**"The old order  
changeth —"**

**B**UT a very few years ago the enthusiast desirous of constructing his own receiver trod a path fraught with peril. Of guidance and advice there was none, and the few text-books that existed dwelt in terms unintelligible to the novice.

To-day the Radio Press Envelope system has completely banished all hesitation in building your own set, in fact, the novice now argues, why buy a ready-made one when you can build one just as good?

And why? Radio Press Envelopes contain all the necessary advice and instruction, even to the minutest detail. The possibility of going wrong has been minimised to such an extent as to make it almost non-existent.

The building of radio sets is the most entrancing of all hobbies, and it would be unfortunate when you have completed the set to have that supreme moment marred by inferior results. Build according to Radio Press Envelope specifications and avoid all disappointment.

Besides full instructions, Radio Press Envelopes contain Blue Prints of Wiring and Panel Drilling, working diagrams, and a set of photographs showing all the details of the Receiver.

Among the Envelopes Nos. 1 to 9 there is sure to be one exactly suited to your particular needs. Choose now!!!

- |   |   |       |
|---|---|-------|
| 1 | How to Build an S.T.100 Receiver ...              | s. d. |
|   | By John Scott-Taggart, F.Inst.P.,                 | 1. 6  |
|   | A.M.I.E.E.  |       |
| 2 | How to Build a 4-Valve Receiver ...               | 2. 6  |
|   | By Percy W. Harris, Member I.R.E.                 |       |
| 3 | How to Build the "Simplicity" 3-Valve Set ...     | 2. 6  |
|   | By G. P. Kendall, B.Sc.                           |       |
| 4 | How to Build the All-Concert-de-Luxe Receiver ... | 2. 6  |
|   | By Percy W. Harris, Member I.R.E.                 |       |
| 5 | How to Build the Omni Receiver ...                | 2. 6  |
|   | By John Scott-Taggart, F.Inst.P.,                 |       |
|   | A.M.I.E.E.  |       |
| 6 | How to Build the A.B.C. Wave Trap ...             | 1. 6  |
|   | By G. P. Kendall, B.Sc.                           |       |
| 7 | How to Build a 2-Valve Amplifier de Luxe ...      | 1. 6  |
|   | By Herbert K. Simpson.                            |       |
| 8 | How to Make a 1-Valve Reflex Receiver ...         | 1. 6  |
|   | By Herbert K. Simpson                             |       |
| 9 | How to Build an Efficient Single-Valve Set ...    | 1. 6  |
|   | By Herbert K. Simpson.                            |       |

All the above can be obtained from Wireless Dealers, Booksellers or direct (plus 3d. postage) from Dept. M.

**Radio Press, Ltd.**  
BUSH HOUSE, STRAND, LONDON, W.C.2.

*circles 214.*

# PULSATION

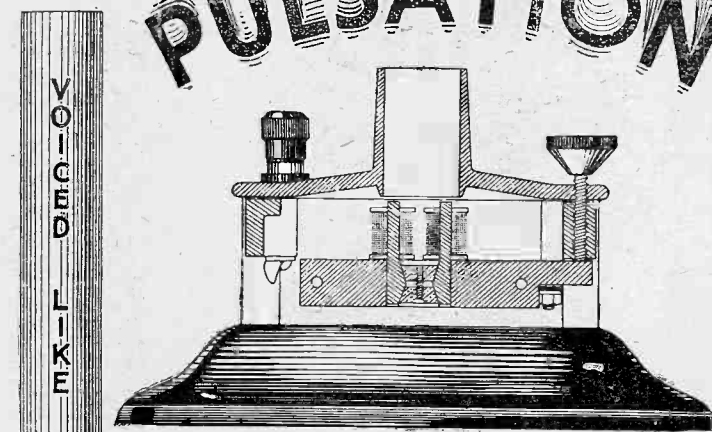

**Features of design that emphasise  
THE WONDERFUL DIFFERENCE  
of  
RADIO SUN LOUDSPEAKERS**

Look at the section illustrated above. The construction of the poles and magnet system is as rigid as if it were in one solid piece. As a result of this rigidity the whole of the energy from the magnetic system is transmitted to the diaphragm. *The vibrations of the diaphragm are therefore correct and true to the incoming signal.*

The sound chamber with its mouth VOICED LIKE AN ORGAN PIPE transfers the vibrations to the air *without adding or taking away any harmonics.*

**This means : PERFECT INTONATION,  
PERFECT RANGE,  
and STRONG CARRYING POWER.**

Remove the trumpet and listen to the purity of tone.

Replace the trumpet and note that the purity of tone is reproduced in the mouth of the horn and not the box.

**FOR FAITHFUL REPRODUCTION GET  
A RADIO SUN.**

In sunlit mahogany finish.

## £5

Write for leaflet describing the Wonderful Difference, and ask your dealer to arrange with us for a demonstration.

**HEARING IS BELIEVING.**



**AUTO SUNDRIES LTD., 10, Lower Grosvenor Place, London, S.W.1.**

*In replying to advertisers, use Order Form enclosed.*

# Free!

## Full details showing how to build a Super-Heterodyne.

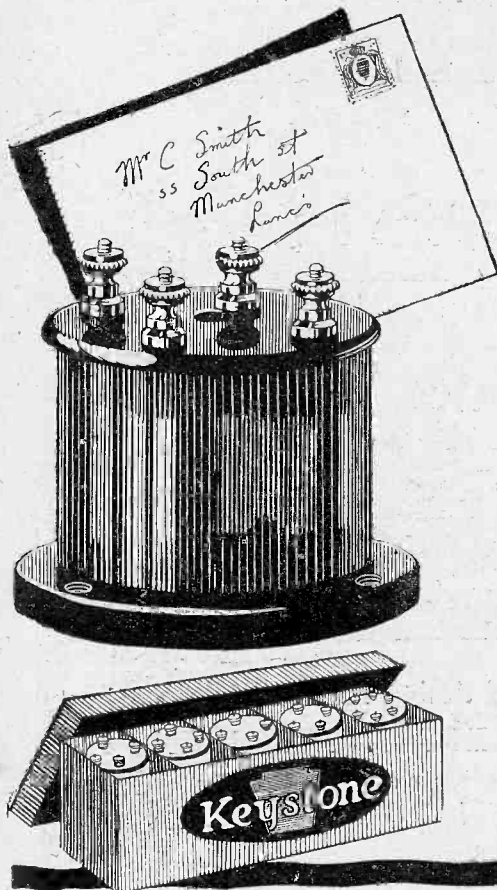

Send two penny stamps to cover postage, and you will receive complete constructional details of the latest Super-Heterodyne. This wonderful set will easily tune out your local station and receive distant stations using a wavelength five metres below or above it.

Cardiff and Manchester have been received at Loud Speaker strength when 2LO has been transmitting just over one mile away. All B.B.C. stations can be received at Loud Speaker strength (including most relay stations) on a small frame aerial, while practically every Continental station is within easy range under any conditions. No outside aerial required with this set.

**PETO-SCOTT Co. Ltd.**  
Sole Agents for Keystone Radio Components.

Registered Offices and Mail Order:  
**77, CITY ROAD, LONDON, E.C.1.**

Branches—  
LONDON—62, High Holborn, W.C.1. WALTHAMSTOW—220, Wood Street. PLYMOUTH—4, Bank of England Place. LIVERPOOL—4, Manchester Street. CARDIFF—84, Queen Street.

### Keystone Super-Het. Kit

3 Intermediate Transformers carefully matched and fully tested. Each one contained in handsome oxidised metal case. These transformers have been designed to function with standard British valves.

1 Tuned Filter complete with fixed condenser for tuning the primary winding. (As all these Units are carefully matched a variable condenser is unnecessary.)

1 Oscillator Coupler designed to cover all wavelengths between 300 and 600 metres, in conjunction with a .0005 mfd. variable condenser.

If Oscillator Coupler is not required, deduct £1 from total purchase price.

**£5**

P.S. 2605.



### COMPONENTS for PERMANENT RELIABILITY

**Finston Fixed & Variable Square Law Condensers & Variometers.**  
The Finston Fixed Condenser is the only "one hole" fixing condenser on the market and is guaranteed within 5 per cent. of stated capacity; no wax is used, therefore climatic conditions have no ill effects upon them. Buy one. Test one. It will prove our statements and thoroughly satisfy you. Capacities: .0001 to .002, 2/- each. .003 to .006, 2/6 each.

If your dealer cannot supply Finston Components, send your order to us together with his name and address, please!

**LIGHTING SUPPLIES CO., 2, Finsbury Ave., London, E.C.2.**

Barclays 1021

2/-

Post Free.



If unable to obtain from your dealer send us his name and address.

is actually working a large Loud Speaker 7 miles from 2LO with sufficient volume for speech to be clearly heard 15 ft. from instrument.

PARTICULARLY USEFUL IN REFLEX CIRCUITS.

**LAWLER ELECTRICS**

67, LUCIEN RD., LONDON, S.W.17.

### MADRID, BRUSSELS, PARIS

Received on a "FELIX."

Read the following extract from testimonial:  
56, Gloucester Rd., Peckham, S.E.

I was astonished by the remarkable clarity and volume of music received from 2LO. After this station closed down I heard some music. At about midnight, the programme ended with the announcement that Radio-Iberica, Madrid, was closing down. A truly wonderful performance. (Sd.) J. A. H.

All these results without amplification.



### No. 1 W.

Standard Pocket Lamp Size — 4½ volt with patent spiral wire terminals and plug sockets to take Wander Plugs.

Note:—1 doz. = 54 volts.

Used units replaced easily.

Connect as illustrated

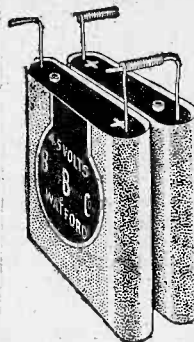

To connect in Series insert straight Terminal in Spiral of next battery. Bend spiral and thus ensure permanent electrical connection without soldering.

Guaranteed BRITISH MADE at our Watford Works. Patent No. 202760.

PRICE CARRIAGE PAID 7/- PER DOZ., WITH PLUG



Prices include Wander Plug. Carriage paid.

Each.  
No. 2W, 16½ volts, 3 volt tappings. Price 3/-  
No. 4W, 36 " " " " " " 6/6  
No. 5W, 60 " " " " " " 12/-  
No. 6W, 9 volts, Grid, 1½ volts tapping " 2/3

## BRITISH BATTERY Co., Ltd.

CLARENDON ROAD, WATFORD, HERTS. (Telephone: Watford 617.)

Barclays 1029

## A.B.C. WAVETRAP



There are times when you wish to listen to other stations. The programme at your local station may not be to your liking, or perhaps you want to roam about.

Anyway, as soon as you begin to search you will find yourself up against interference and jamming, making unmolested reception from one station almost impossible. What is really required is some method of discrimination between wavelengths, selecting the desired one and blotting out adjacent ones.

The A.B.C. Wave Trap, an instrument which is the result of much research work by G. P. Kendall, B.Sc., into the question of elimination of undesired signals, will do this. When tested 3 miles from 2 LO. the A.B.C. Wave Trap completely eliminated that station and allowed Bournemouth to be received. Although theoretically a loss in signal strength must be admitted, it is so small that it is seldom apparent to the human ear.

The instrument contains no less than 3 distinct types of Wave Traps arrangements, any one of which can be brought into operation at will.

Radio Press Envelope No. 6 contains full instructions in the building of the A.B.C. Wave Trap. The contents include a general treatise on the experiments, instruction sheets, blue prints, photographs and working drawings.

*It is neither a difficult nor expensive matter to build this Wave Trap which is normally constructed to operate on the 300-600 metre band.*

We have every confidence in telling our readers that the A.B.C. WAVE TRAP will enable them to cut out their Local Station without appreciable sacrifice of signal strength, provided always that their aerial and earth systems are of average efficiency.

Ask for Radio Press Envelope No. 6, it may be obtained from your regular wireless dealer, newsagent, or direct from Dept. M., Radio Press, Ltd., Bush House, Strand, London, W.C. 2.

Price  
**1/6**

(Post Free 1/9).

Build yourself this Wave Trap  
and cut out your local station

**Radio Press, Ltd.,**  
BUSH HOUSE, STRAND; LONDON, W.C.2

Barclays Ad.

# Brown

LOUD SPEAKERS AND HEADPHONES



## Ask the man who wore a blue-and-white armlet!

If you want to know the measure of esteem in which Brown Headphones were held during the Great War, ask any member of the Royal Engineers. He will readily tell you of their extreme reliability even under the rigours of campaigning. When messages simply had to go through—when men's lives depended upon communication with the front line being maintained—Brown A-type Headphones were entrusted with the work of interpreting the signals.

To-day, thousands of wireless enthusiasts—experts and amateurs alike—think only of the Brown A-type when fine headphones are mentioned. Obviously their exclusive reed mechanism (patented throughout the world) places them in a class apart.

And now that a greatly increased demand permits a reduction in manufacturing costs they are even better value at their new prices. For long-distance reception every Radio enthusiast needs at least one pair of Brown A-type Headphones.

### REDUCED PRICES:

#### A-type Headphones.

120 ohms	} 50/-
2000 ohms	
4000 ohms	
8000 ohms	} 60/-

**S. G. BROWN, LIMITED,**  
Victoria Road, N. Acton, W.3.

Showrooms:  
19, Mortimer Street, W.1.  
15, Moorfields, Liverpool.  
67, High Street, Southampton.

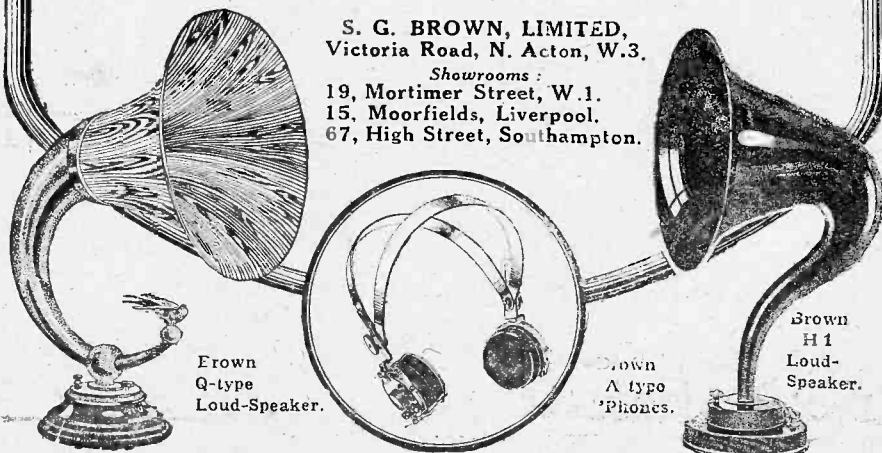

Brown  
Q-type  
Loud-Speaker.

Brown  
A type  
Phones.

Brown  
H1  
Loud-Speaker.

Gilbert Ad. 259

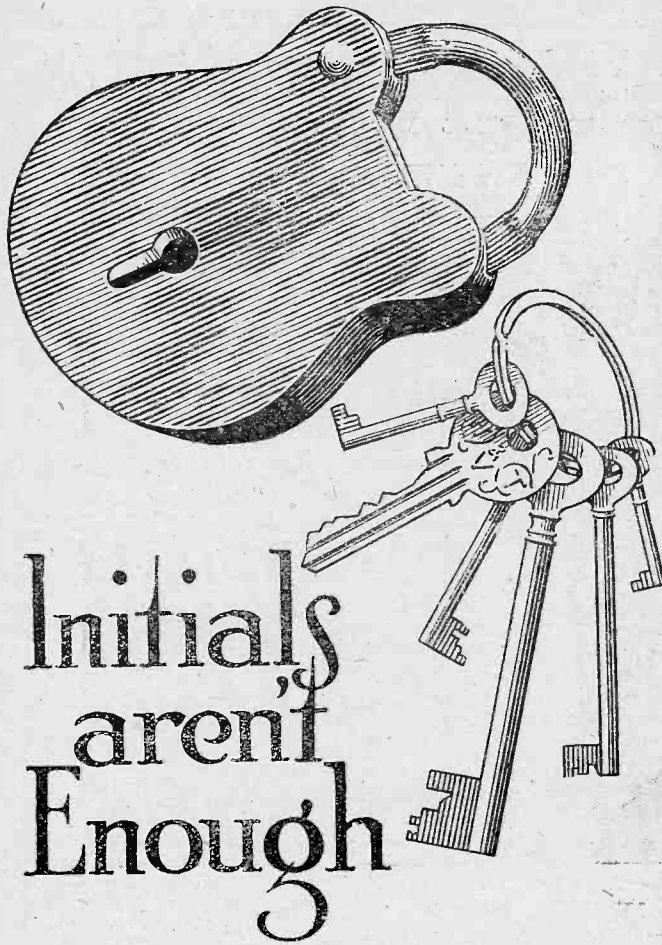

Initials  
aren't  
Enough

A wit once remarked that he could resist anything but temptation. Happily the world is not too full of such, though many have felt disposed to break the tenth commandment. If imitation is the sincerest form of flattery, covetousness is the highest form of compliment; but it is a compliment we would gladly do without. All of which is to point the moral—Don't be satisfied with putting your initials on good tools; buy a lock and key for them. With Wade Lathes such safeguards are essential.

Below is illustrated the Wade No. 2 Lathe. It is back-g geared, self-acting and screw-cutting. It has 13 change wheels, which cut all threads, right or left-hand, from 6 to 60 T.P.I., including metric pitches. It takes work up to 4 ins. in diameter and 12 ins. in length. With a Wade Lathe on your bench there is no limit to your activities as a craftsman.

If you would like one of our fully descriptive catalogues post free, drop us a card to-day. Write to Dept. E.

**WADE**  
Lathes

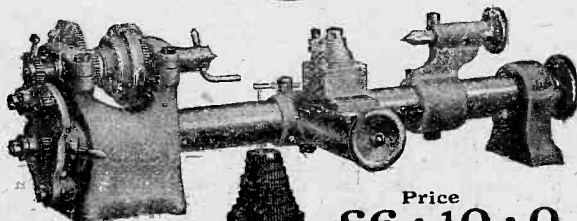

Price  
**£6 : 10 : 0**

C.A.V. Small Tools, Ltd., 181, Queen Victoria Street, London, E.C.4. E.P.S:25.

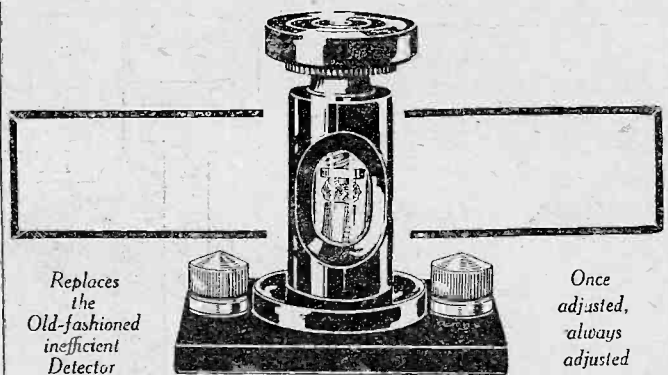

Replaces  
the  
Old-fashioned  
inefficient  
Detector

Once  
adjusted,  
always  
adjusted

## REVOLUTIONARY PROGRESS IN CRYSTAL DETECTION

A Crystal Detector which requires no Catswhisker and is as near permanence as Science can make it.

IMITATORS HAVE NOT QUITE SUCCEEDED IN DISCOVERING OUR SECRET AND RARE MINERAL.

The nearest approach to permanency in crystal detection, is that achieved by the "HOVIMO" CRYSTAL VALVE, which, in its original very simple form, is now quite well known to wireless users and investigators.

Careful experiments have proved that the success of the HOVIMO CRYSTAL VALVE does not lie exclusively with the combination of Crystals—but that it is the amount of pressure between the two crystals which actually "does the trick."

The new "HOVIMO" Crystal Valve has been designed so that this important adjustment is made first by a micrometer screw, which acts on a spring placed over the Crystal so that infinitely small alteration of pressure is possible, thus allowing each Crystal Valve to be adjusted to the particular set with which it is going to be used. Furthermore, this arrangement makes it practically impossible to crush the Crystals by over-pressure.

THE NEW

# "HOVIMO" CRYSTAL VALVE

WHY PAY MORE?

ONLY

**3/6**

EACH

Will save its cost in a very short time as there is no renewal of crystals required. Despite this advantage it is just as cheap in the outset as the ordinary crystal detector and a thousand times more efficient and sensitive. So simple that a child can use it. So certain that wireless becomes the pleasure it should.

If any difficulty in obtaining write direct to:—

**M. MOLBACK,**  
27, HIGH HOLBORN, LONDON, W.C.1,  
Telephone: Chancery 8391.

## An Expert at your elbow

It is one thing to listen to the advice of an expert in a lecture theatre but another to have that lecturer give you advice whenever you want it.

Ever and anon every radio enthusiast is "bunkered" by some difficulty which needs explanation. What one needs is an Encyclopædia to refer to whenever the occasion arises.

## 500 WIRELESS QUESTIONS ANSWERED,

by  
G. P. Kendall, B.Sc.,  
and E. Redpath,

is a Wireless Encyclopædia in itself. No matter what the query is you find an answer in its pages.

2/6 POST FREE 2/8

Ask for Radio Press Series No. 13.

Obtainable from all Bookstalls, Newsagents, and Wireless Dealers or direct from the Publishers Dept. M.

**Radio Press, Ltd.,**  
Bush House, Strand, London,  
W.C.2.

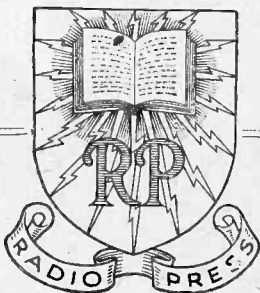

Barclays Ad.

## Designed specially for Dull Emitters



Reverse it  
—shake it—  
and still the  
acid will not  
fall out

WHEN dull emitters first came on the market a new era was announced. The accumulator was to be relegated to the Dark Ages and all valves would be run from Dry Batteries. This happy state of affairs, however, has not been realised. The Dry Battery has not proved itself to be the ideal method of lighting the filaments of Dull Emitters.

On the contrary—wireless enthusiasts now know that the Dry Battery fluctuates in output so much that good reception is impossible. Apart from this, of course, Dry Batteries are a perpetual expense.

The new portable Oldham Accumulator is so small that it can be placed in the pocket, and yet its output—for its size—is so high that it will run a 2-Valve Set using Vecos, Wuncells or 1-volt Oras for 25 hours on a charge. For '06 Valves, two of them in series will run an S.T.100, for instance, six weeks on one charge. Whereas a Dry Battery, when exhausted, must be discarded, an Oldham Portable costs only a few coppers to be recharged. Go to your dealer today—if he is out of stock give us his name, and we will see that he gets a stock at once.

The Oldham "Non-Spill," constructed of best seamless celluloid with large terminals and a screw vent. Absolutely non-spillable. Plates manufactured under the exclusive Oldham Special Activation Process. 2 volts 10 amp. hours continuous.

12/6

**OLDHAM & SON, LTD.,**  
**DENTON, MANCHESTER.**

LONDON: Gt. Chapel St., Oxford St., W.1.  
NEWCASTLE: 1, St. Mary's Place.  
GLASGOW: 120, Wellington Street.



Gilbert Ad. 2607

In replying to advertisers, use Order Form enclosed.

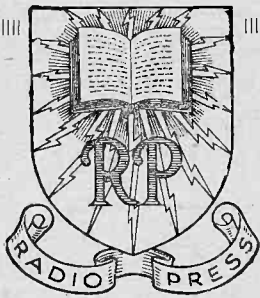

# Experience Wins

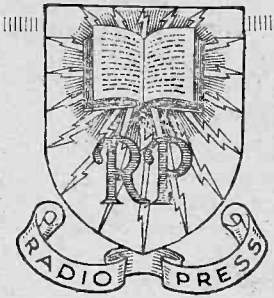

**T**HE days when a man had to scour London to obtain the necessary knowledge to start him on the right road in Wireless have passed. And no small thanks is due to the Radio Press for their passing. From the time wireless became a popular pastime, they have provided the radio public with dependable literature. To attain this end they have gathered together the finest technical and practical staff of any wireless publishing firm in the world.

Their extensive knowledge and cold, hard, experience is imparted in all

the publications of the Radio Press, but in a manner interesting and instructive to the layman, and not too reminiscent of the laboratory.

As the months sped on, so the list grew, until it has attained dimensions larger than that of any other radio publishing firm. It caters for the widest circle of wireless enthusiasts, and we cannot lay too much emphasis on the point that every contributor is an expert in Radio, drilled in the school of experience. Surely, such knowledge is worth pounds to you, whether you are a novice, or an experimenter.

## Products of a famous House.

### The Radio Press Series.

No.		Price.
1	Wireless for All ..	9d.
	By John Scott-Taggart, F.Inst.P., A.M.I.E.E.	
2	Simplified Wireless	1/-
	By John Scott-Taggart, F.Inst.P., A.M.I.E.E.	
3	How to Make Your Own Broadcast Receiver ..	1/6
	By John Scott-Taggart, F.Inst.P., A.M.I.E.E.	
4	How to Erect Your Wireless Aerial ..	1/-
	By B. Mittell, A.M.I.E.E.	
5	The Construction of Wireless Receiving Apparatus ..	1/6
	By P. D. Tyers.	
6	The Construction of Crystal Receivers ..	1/6
	By Alan L. M. Douglas.	
7	How to Make a "Unit" Wireless Receiver ..	2/6
	By E. Redpath.	
8	Pictorial Wireless Circuits ..	1/6
	By Oswald J. Rankin.	
9	Wireless Valves Simply Explained ..	2/6
	By John Scott-Taggart, F.Inst.P., A.M.I.E.E.	
10	Practical Wireless Valve Circuits ..	2/6
	By John Scott-Taggart, F.Inst.P., A.M.I.E.E.	
12	Radio Valves and How to Use Them ..	2/6
	By John Scott-Taggart, F.Inst.P., A.M.I.E.E.	
13	500 Wireless Questions Answered ..	2/6
	By G. P. Kendall, B.Sc., & E. Redpath.	
14	12 Tested Wireless Sets ..	2/6
	By Percy W. Harris, Member I.R.E.	

### The Radio Press Series.

No.		Price.
15	More Practical Valve Circuits ..	3/6
	By John Scott-Taggart, F.Inst.P., A.M.I.E.E.	
16	Home-Built Wireless Components ..	2/6
17	Wireless Sets for Home Constructors ..	2/6
	By E. Redpath.	
18	Tuning Coils and How to Wind Them ..	1/6
	By G. P. Kendall, B.Sc.	
21	Six Simple Sets ..	1/6
	By Stanley G. Raltee.	
22	Switches in Wireless Circuits ..	1/6
	By Oswald J. Rankin.	
24	Wireless Faults and How to Find Them ..	1/6
	By R. W. Hallows, M.A.	

### SIMPLEX WIRING CHARTS.

No.		Price.
1	For 2-Valve Set ..	1/-
2	For 3-Valve Set ..	1/-
3	For 4-Valve Set ..	1/-

### RADIO PRESS PANEL CARDS.

No.		Price.
1	How to Make the W.I. Receiver ..	1/-
	By Herbert K. Simpson.	

"Modern Wireless" Coil Table for Aerial, Anode, and Reaction Coils ..		6d.
---	--	-----

All the above can be obtained from wireless dealers, booksellers—or direct (plus 2d. postage on books and 3d. on envelopes) from Dept. M.

### RADIO PRESS ENVELOPES.

The Radio Press Envelopes are the most complete guide to wireless construction ever devised. Every possible detail is explained and you cannot go wrong.

1	How to Build an S.T.100 Receiver ..	1/6
	By John Scott-Taggart, F.Inst.P., A.M.I.E.E.	
2	How to Build a 4-Valve Receiver ..	2/6
	By Percy W. Harris, Member I.R.E.	
3	How to Build the "Simplicity" 3-Valve Set ..	2/6
	By G. P. Kendall, B.Sc.	
4	How to Build the All-Concert-de-Luxe Receiver ..	2/6
	By Percy W. Harris, Member I.R.E.	
5	How to Build the Omni Receiver ..	2/6
	By John Scott-Taggart, F.Inst.P., A.M.I.E.E.	
6	How to Build the A.B.C. Wave Trap ..	1/6
	By G. P. Kendall, B.Sc.	
7	How to Build a 2-Valve Amplifier de Luxe ..	1/6
	By Herbert K. Simpson.	
8	How to Make a 1-Valve Reflex Receiver ..	1/6
	By Herbert K. Simpson.	
9	How to Build an Efficient Single-Valve Set ..	1/6
	By Herbert K. Simpson.	

"That finishing touch."

Radio Press Wireless Panel Transfers ..	6d.
per large packet of 80 labels.	

## Radio Press, Ltd.

BUSH HOUSE, STRAND, LONDON, W.C.2.



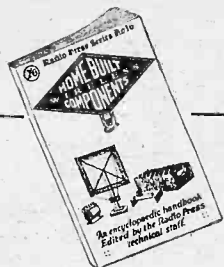

## Construct your own components !

It is surprising the number of simple components the enthusiast who can use a few simple tools can make. A Frame Aerial, for instance, can be constructed at home during your spare time and besides dispensing with the unsightly outside aerial will give you wonderful results on a multi-valve set.

The details in the construction of a Frame Aerial and the instructions in building many other radio components is contained in,

# HOME BUILT WIRELESS COMPONENTS

Every wireless constructor ought to possess this book. It is prolific in ideas, simply expressed.

The chapters on coil winding should appeal to all radio beginners and the chapter on Transformer manufacture will gain the appreciation of the more advanced constructor.

Most of the described components can be made for a quarter of the cost of the ready-made article, in some cases even less, which is a consideration to many set builders.

Ask for Radio Press Series No. 16.

Obtainable from all Book-stalls, Newsagents and Wireless Dealers, price 2/6, or 2/8 post free direct from the Publishers (Dept. M.),

RADIO PRESS LTD.,  
Bush House, Strand, W.C.

Barclay's Ad.



## You buy brains when you choose the Eureka

**P**EDRO LOPEZ—the famous painter—was once asked his fee for painting the portrait of a nobleman. “Five hundred crowns, Sire,” he answered. “What! Such a fabulous sum for a few days’ work!” exclaimed the astonished grandee. “No, Sire, but a just reward for a lifetime’s study,” gently replied the artist.

**I**T’S the “knowing how” that counts in Transformer building, too. A Eureka is very much more than a few thousand turns of wire wound around an iron core. Back of every Eureka is the skill and experience gained from ceaseless and costly experiment. Even to-day—eighteen months after the first Eureka Transformer was issued—the search for improvement continually goes on. A better method of winding—an electrical test even more searching and critical than before—the discovery of new methods of insulation—all these new ideas now incorporated in the 1925 Eureka demonstrate effectively a tireless quest for efficiency.

Yet in spite of its seemingly high cost the Eureka Concert Grand is one of the most economical Transformers you can buy. For instance, a Eureka Concert Grand used in conjunction with one of the now popular Power Valves will give more volume than two stages of amplification using cheap Transformers. Again, owing to its unique construction, the Eureka is a long-life Transformer. It can never break down through dampness—the arch-fiend of signal strength—for its stout steel case is a sure protection against the atmosphere.

Be wise, therefore, when you build your next Set and choose the superb Eureka.

# EUREKA

BRITAIN'S FINEST TRANSFORMER

Concert Grand 30/-

Manufactured only by  
Portable Utilities Co. Ltd.  
Fisher St., London, W.C.1

Eureka No. 2 22/6

For second stage

Gilbert Ad. 26:0

511

In replying to advertisers, use Order Form enclosed.

# An ANNOUNCEMENT



IN every field of life, in every branch of industry, there is almost always one individual or one firm standing out above the rest. In the wireless publishing business we have no exception—the words “RADIO PRESS” spring to the lips of novice and expert alike, as the obvious source to go to for wireless literature, whether books or periodicals.

The three great British papers, “Modern Wireless,” “Wireless Weekly” and “The Wireless Constructor,” have the words “Radio Press Ltd.” indelibly stamped on every copy because these words mean more than an indication that these periodicals are owned and issued by that great publishing house—they stand for reliability, confidence, accuracy, enterprise, sound technique, fearless criticism where necessary, brilliant editorship, keenness, a whole-hearted love for the work which turns out week by week and month by month the papers which reach almost every corner of the earth.

Is it any wonder, then, the Radio Press announce a more than doubling of their rent? In other words, that they have taken another huge floor area in Bush House, that loftiest and finest example of business architecture standing at the foot of Kingsway, and between that thoroughfare and the Strand.

The great new editorial and managerial offices will leave about 5,000 square feet entirely to the vastly developing sales and publishing departments.

This new step is a proof that “A Radio Press paper is a Radio Press success.” If a periodical is issued by the Radio Press, it is a brilliant success in its own field. That is why everyone interested looks to the Radio Press for the best in wireless literature.

Radio Press, Ltd.,

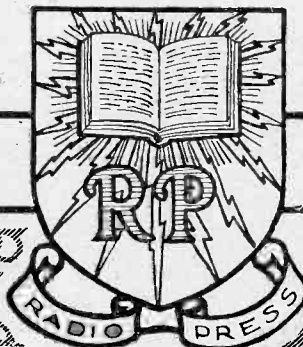

Bush House, Strand, W.C.2

Barclays Ad.



## 20 Years ago

FOR more than twenty years T.C.C. condensers have been the standard fixed condensers for all electrical requirements. First in telegraphy—afterwards in wireless telegraphy—now in Broadcast reception, their dependability and accuracy have always earned unstinted praise.

Among all your wireless friends you will never have known one who has ever been disappointed with a T.C.C. condenser. And, after all, this feeling of supreme confidence is a great thing. It means that you can accept a T.C.C. Condenser, place it in the circuit, and know that its capacity is exactly as marked and that it cannot possibly short circuit. The most frequent and rigorous tests that can be devised safeguard both of these points for you.

But not all green condensers are T.C.C., and not all condensers produced to imitate the T.C.C. are of the genuine Mansbridge pattern. In fact, very few of them are. But you are always safe if you see the letters T.C.C. stamped on the side of the case.

Made in all values  
from .0001 mfd. to  
2 mfd.

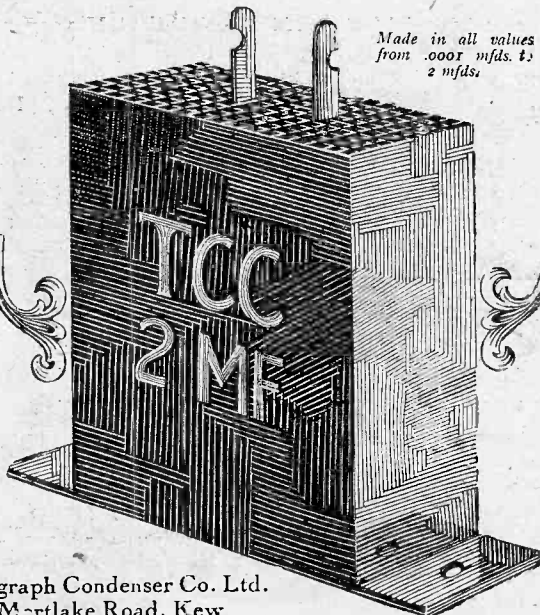

Telegraph Condenser Co. Ltd.  
Mertlake Road, Kew

G.A. 2740

# Stop that — HOWLING

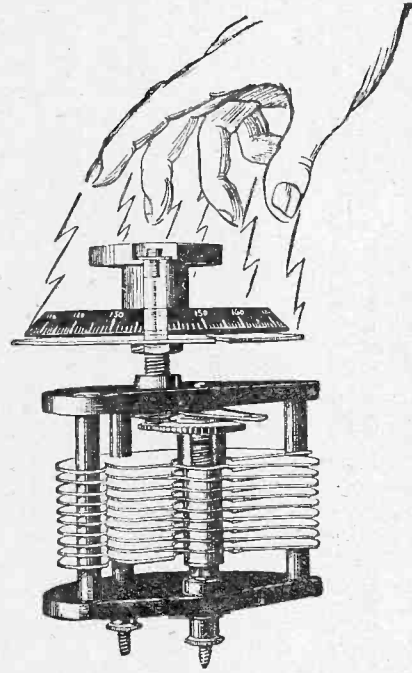

WHE-E-E-Z-E HOW-W-L-L  
SP-T-Z-Z F-Z-Z-Z-

STOP IT? HOW? EASY.

Fit a "Fulstop." A Fulstop Variable Condenser; and if that doesn't stop hand capacity effects, we're prepared to eat our hats, our condensers and anything else you may prescribe. AND we'll return your money into the bargain.

ONE "FULSTOP" USER SAYS:

*I have had the finest distant reception this last few weeks, using your condensers, that I have had during my two-and-a-half years of listening-in.*

**Guaranteed to Abolish Hand Capacity.**

PROTECTED THROUGHOUT THE WORLD.

.001	.....13/6	.0003	.....10/3
.0005	.....11/3	.0002	.....9/6

Stocked by most Wireless Dealers, but if you have any difficulty in obtaining, write to:—

J. H. NAYLOR, LTD., WIGAN



VARIABLE CONDENSER

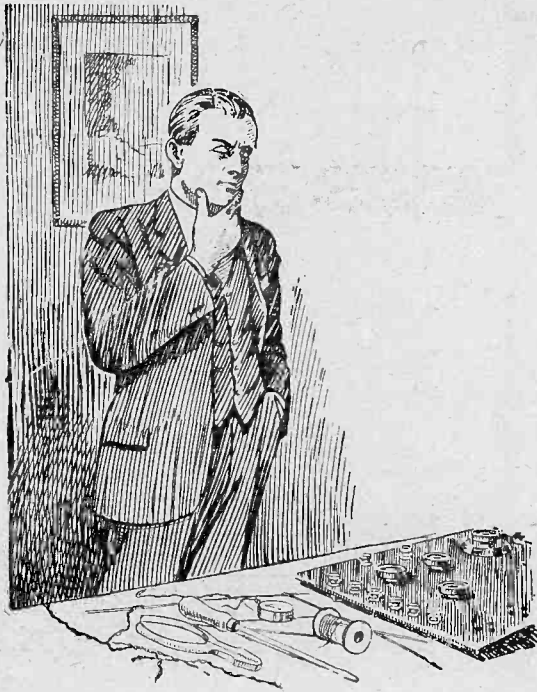

# Stumped!

**F**AULTS are rarely visible in a wireless receiver, and many thousands owning sets have hitherto been baffled in their attempts to locate some little trouble.

The latest addition to the already large list of authoritative books published by the Radio Press is "Wireless Faults and How to Find Them," by R. W. Hallows, M.A. Like all other Radio Press publications, it fulfils a definite need of the radio public. It shows the amateur how he can locate the most elusive seat of trouble in his set.

By an ingenious method of trouble tracing devised by the author it is difficult to see how the most stubborn of faults can escape for long the simple but searching tests. The first chapter in the book is devoted to the construction of a simple and extremely inexpensive appliance, which is used in conjunction with a pair of telephones and forms practically the only apparatus required.

Further chapters then proceed to deal thoroughly with the testing of variable and fixed condensers, transformers, coils, detectors and other components. The testing of receiving sets ranging from crystal to multi-valve is described in a lucid way, relieving the amateur of all perplexity and anxiety.

An extremely useful feature of the book is the tables appended to every chapter on set testing, with the headings "Symptoms" "Possible Causes," etc., and the reader by glancing at these can ascertain quickly how to apply a series of tests to locate his particular trouble.

Altogether it is a book that should be in the possession of every wireless enthusiast, whether advanced or beginner. Readers are assured of simple and ready methods of detecting even the most aggravating faults, enabling them at all times to secure the best results from their sets.

*Obtainable from all Newsagents, Booksellers, Wireless Dealers or direct from (Dept. M).*

**Ask for Radio Press Series No. 24.**

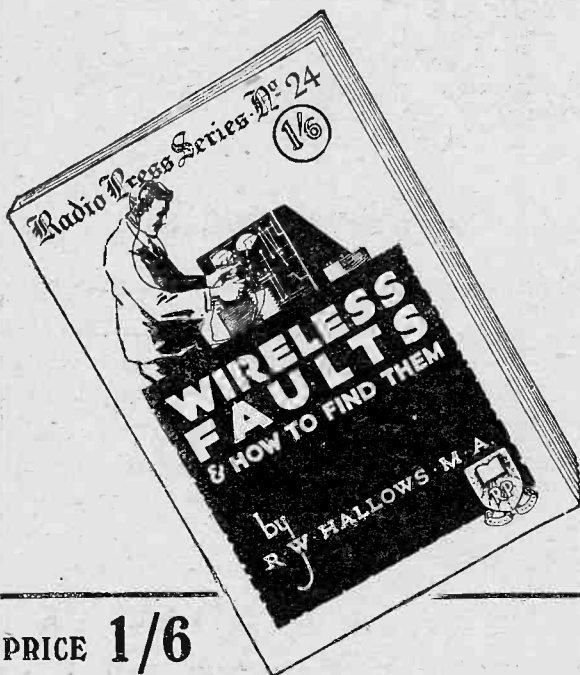

**PRICE 1/6**

or post free 1/8.

**Radio Press, Ltd.**  
BUSH HOUSE, STRAND, LONDON, W.C.2.

# Re-creation

Reproduction in all the beauty of its original rendering of everything that enters the microphone—nothing added, nothing lost. Just re-creation. That's how the "Sparta" performs its duties.

It is the voice that will awaken your receiver to vigorous, tuneful life—reproducing with vivid realism the subtle shadings and overtones of a melody—the *personality* of the artistes themselves.

The "Sparta" is the speaker of combined excellence. The supremely good combination of good components, conceived by master designers, built by master craftsmen. All good dealers stock it. Ask for a demonstration—the best proof you can have of its extraordinarily good reproduction.

All "Sparta" Products are guaranteed for 12 months. Send a card for List 315 B—it tells you all about them.

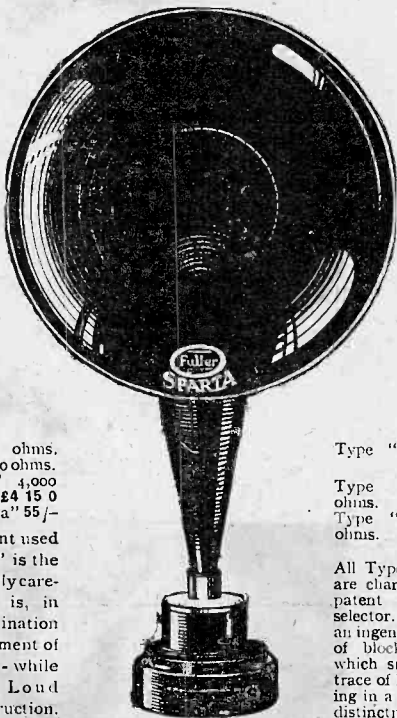

Type "A." 120 ohms.  
Type "H.A." 2,000 ohms.  
Type "H.H.A." 4,000 ohms. £4 15 0  
The Little "Sparta" 55/-

Every component used in the "Sparta" is the outcome of equally careful thought—it is, in fact, the co ordination into one instrument of all the worth-while features in Loud Speaker construction.

Type "B." 120 ohms. £5 15 0

Type "H.B." 2,000 ohms. £6 0 0  
Type "H.H.B." 4,000 ohms. £6 0 0

All Type "B" Speakers are characterised by the patent 6-position tone selector. This consists of an ingenious arrangement of blocking condensers, which smooths away all trace of harshness, resulting in a remarkably pure distinctness of tone.

# SPARTA LOUD SPEAKER

Fuller's United Electric Works, Limited,  
Woodland Works, Chadwell Heath, Essex.

## Build the Vokes McLaughlin ONE-CONTROL Superheterodyne

Every station within range comes in by turning one dial.

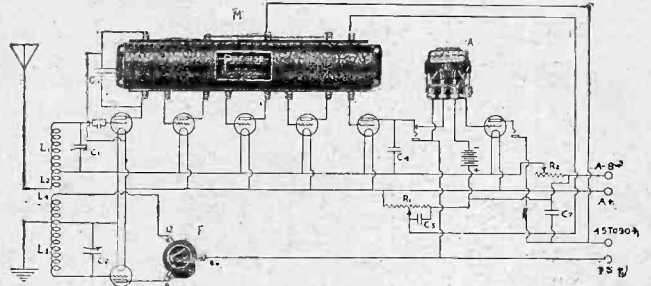

Fully illustrated Constructional Book, including full size drawings, 5/- post free; Write or call for particulars of complete sets of parts as specified by the author, or individual parts to suit your requirements.



## THE PRECISE SUPER MULTIFORMER

One Instrument which does the work of four.

Replaces all long-wave transformers in any type or modification of the superheterodyne circuit. This instrument has met with the unanimous approval of noted radio experts and is already demanded by the public which is rapidly learning of its superiority over the conventional type of superheterodyne transformers. It cuts in half the time and eliminates all trouble in building the superheterodyne, and assures the builder of successful results due to the short connections which are required from the instrument to the respective valve sockets—thus preventing the experimenter from unconsciously causing undesirable coupling between circuits.

Price £4 17s. 6d.

### —KEELOCK—

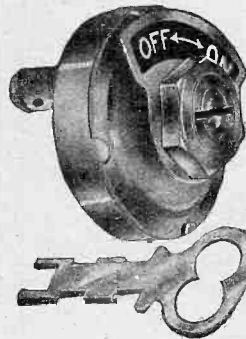

The Keelock Switch operates with a key—locks and unlocks your battery circuit. When desired, can be used as an ordinary type battery switch, as key can be left in switch. Simply turn to "on" or "off" position. It protects your set from people (particularly children) not familiar with wireless who can cause irreparable damage to your valves and batteries.

Price 5/-, post free.

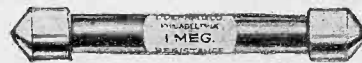

## Durham Fixed and Variable Metallic Grid Leaks and Resistances

Manufactured by a process developed by a professor of electrical and a professor of chemical engineering of one of the largest universities of the Eastern United States after months of scientific research. The Durham Metallic Grid Leak is made from a rare metal deposited on the inner or outer surface of a glass rod or tube, ensuring PERFECT RESISTANCE, CONDUCTIVITY, PERMANENCE OF RESISTANCE, and absolutely noiseless operation.

### PRICES:

50,000 ohm resistances	.. 3/6
100,000 "	.. 3/6
2 megohm Grid Leaks	.. 3/-
3 "	.. 3/-

### VARIABLE GRID LEAKS.

1,000 to 100,000	.. 3/-
1 to 5 megohms	.. 3/-
2 to 10 "	.. 3/-

N.B.—All our products are fully tested and guaranteed by our Principal, C. G. Vokes, A.M.I.Mech.E., etc.

## C. G. VOKES & COMPANY, 38, Conduit Street, Regent Street, W.1

Telephone: Gerrard 4693.

In replying to advertisers, use Order Form enclosed.

Index to Advertisers

American Hard Rubber Co., Ltd. . . . .	488	General Radio Co. . . . .	491	Radio Instruments, Ltd. . . . .	COVER iv
Arrigoni (C. & J.) . . . .	516	Gent & Co. . . . .	492	Radio Stocks . . . . .	498
Athol Engineering Co. . . . .	501	Gil-Ray Radio Co. . . . .	498	Radions, Ltd. . . . .	499
Auto Sundries, Ltd. . . . .	505	Goswell Engineering Co. . . . .	471	Rampling (C. & A.) . . . . .	470
Autoveyors, Ltd. . . . .	502	Graham (A.) & Co. . . . .	436	Raymond (K.) . . . . .	474, 475
Beard and Fitch . . . . .	451	Harlie Bros. . . . .	516	Robinson (Lionel) & Co. . . . .	498
Bennett College . . . . .	500	H. T. C. Electrical Co. . . . .	472	Rothermel (R. A.), Ltd. . . . .	477
Bowyer-Lowe Co. . . . .	488	Hunt (A. H.), Ltd. . . . .	499, 501	"Sel Ezzi" Wireless Co. . . . .	499
Brandes, Ltd. . . . .	432	Hurlock (Wm.), Jun., Ltd. . . . .	494	Shipton (E.) & Co. . . . .	451
Bretwood, Ltd. . . . .	504	Igranie Electric Co., Ltd. . . . .	493	Siemens Bros. & Co., Ltd. . . . .	487
British Battery Co., Ltd. (The) . . . . .	506	Jackson Bros. . . . .	443	Silvertown Co. . . . .	497
British and Colonial Industries, Ltd. . . . .	504	Knight (A. W.), Ltd. . . . .	500	Simpson & Blythe . . . . .	501
British Thomson-Houston Co. . . . .	464	Knivetown Radio Products . . . . .	504	Smith & Ellis . . . . .	470
Brown Brothers, Ltd. . . . .	443	Kumfi-de-Luxe Ear Pad Co. . . . .	478	Sterling Telephone Co., Ltd. . . . .	439
Brown (S. G.), Ltd. . . . .	507	Lawler Elec. Co. . . . .	506	Stevens (A. J.) & Co. (1914), Ltd. . . . .	468
Burndept, Ltd. . . . .	Cover ii	Lighting Supplies Co. . . . .	506	Telegraph Condenser Co. . . . .	513
Burne-Jones & Co., Ltd. . . . .	494	Lissen Co. . . . .	435	Unica Cabinet Co. . . . .	490
C.A.V. Small Tools . . . . .	508	London Electric Wire Co. . . . .	478	Vandervell (C. A.) . . . . .	493
Chase Electrical Co. . . . .	500	Louden Valves . . . . .	467	Varley Magnet Co. . . . .	470
Clarke (H.) & Co. . . . .	444	McMichael (L.), Ltd. . . . .	417, 481	Verstraeten (M.) . . . . .	500
Collinson's Precision Screw Co., Ltd. . . . .	460	Metro-Vick Supplies . . . . .	484	Vokes (C. G.) & Co. . . . .	515
Cossor Valve Co. . . . .	456	Molback . . . . .	508	Ward & Goldstone, Ltd. . . . .	501
Craik & Smith . . . . .	499	Mullard Radio Valve Co., Ltd. . . . .	440	Wates Bros. . . . .	490
Curtis (Peter), Ltd. . . . .	409, 455, 459	Naylor (J. H.) . . . . .	513	Watmel Wireless Co. . . . .	493
Diamond Wireless, Ltd. . . . .	487	Neutron, Ltd. . . . .	459	Western Electric Co., Ltd. . . . .	497
Dixon (L.) & Co. . . . .	470	New London Electron Works . . . . .	480	Wilkins & Wright, Ltd. . . . .	502
Drummond Bros. . . . .	492	Oldham Accumulators . . . . .	509	Wilkinson's Wireless Stores . . . . .	516
Dubilier Condenser Co. (1921) Ltd. . . . .	463	Ormond Engineering Co. . . . .	448	Win Patents . . . . .	516
Edison Swan Elec. Co. . . . .	483	Peto-Scott Co. . . . .	478, 506		
Falk, Stadelmann & Co. . . . .	499	Pickett Bros. . . . .	470		
Finchett (C. A.) . . . . .	516	Portable Utilities Co., Ltd. . . . .	452, 503, 511		
Forno Co. . . . .	443	Power Equipment Co. . . . .	455		
Fuller's United Elec. Works, Ltd. . . . .	515	Pressland Elec. Supplies . . . . .	498		
Gambrell Bros., Ltd. . . . .	477	Radiax, Ltd. . . . .	487		
General Electric Co., Ltd. . . . .	431	Radio Communication Co., Ltd. . . . .	410		

DO YOU ALWAYS obtain FULL satisfaction when buying Wireless Goods? If not, write WILKINSON'S WIRELESS SERVICE. Estd 1922. 47, CANNON STREET, PRESTON. Over 700 different lines in stock—Opera Phones sold with a guarantee of satisfaction, p.f. at 17/6 a pair. In Matt Ebonite, our standard quality, 1d. per sq. in. WE RELY on our RELIABILITY.

Perfectly simple and simply perfect

## THE MIC-MET SUPER CRYSTAL DETECTOR

[REGD.] (PATENT NO. 221943.)

This instrument is micrometrical in principle and ensures a perfectly adjusted and rigid contact between crystal and contactor. By a combination of movements between the three knobs, any portion of the exposed part of the crystal may be contacted. For S.T. 100 and other circuits employing crystal rectification, the most efficient detector to use is the MIC-MET. Can be obtained from your local wireless dealer or direct from the manufacturers on receipt of 6s. P.O. Trade enquiries solicited.



British Make. Beware of imitations and infringements.

C. & J. ARRIGONI & CO., LTD., COMPTON PASSAGE, CLERKENWELL, LONDON, E.C.

Don't tickle the Crystal—use the

## Harlie FOOL-PROOF DETECTOR

Provisional Patent 2679124

Continuous reception in any position at all times, owing to the special design of both crystal and catswhisker, always in contact.

GUARANTEED TONE—VOLUME—PURITY

Some Novel Features:—

1. Nickel-plated detachable dust-proof cover.
2. Special "Harlie" super-sensitive crystal.
3. Ebonite wheel for rotating crystal. No fumbling about adjusting, just turn the wheel—simplicity itself.
4. Catswhisker on slider for covering whole surface of crystal. Shock-proof.
5. Nickel-plated sockets for panel mounting. Obtainable from all dealers or direct from patentees and mfrs.

PRICE COMPLETE 5/6

Generous Trade Terms. Telephone Clissold 293.

**HARLIE BROS., 183, Dalston Lane, HACKNEY, London, E.8.**



Barclay's 1020

EVERYBODY NEEDS the RADIO BEAD

Every radio enthusiast is troubled by the twisting and kinking of the flex leads of his headphones, loudspeaker, or batteries and the consequent damage resulting in inferior reception. But now there is a remedy—

**THE RADIO BEAD** is a simple accessory which clamps on to your flex leads (no disconnecting necessary) and enables you to instantly remove kinks and prevent their recurrence. Light in weight and small in cost, it prevents that frequent and often unknown cause of loss of signal strength which is so difficult to trace.

Approved by leading radio experts. SATISFACTION GUARANTEED. ESSENTIAL TO YOU. GET ONE NOW. Obtainable from all dealers. Trade enquiries invited.

**WIN PATENTS, Bridgeway House, Hammel-Smith London, W.6. Tel.: Riverside 3463.**

1/- EACH



Barclay's 1036

## 100% EFFICIENCY H.T. BATTERY. CONSTRUCTORS' IDEAL.

See Apparatus Tested, April, 1924. Why buy inefficient tiny sealed-in batteries? I offer Terminalled Giant Unit Dry Cells, 1 1/2 volts of 300 per cent. more capacity. See Photo. Cells, 4/- doz., plus carriage. 60 volt type in polished Oak Case as reported, 19/6, carriage 1/9. In card box 14/6. Every cell replaceable. Lists free. Sample Cell, 6d. 9 Volt Grid Battery, 2/6. Money back guarantee. Prompt delivery guaranteed. Direct only from Sole Maker: FINCHETT (C.A.) Old Armoury, Oswestry.

## COUPON.

QUESTIONS AND ANSWERS.

In future this coupon must be accompanied with 2s. 6d. P.O.

"MODERN WIRELESS" May, 1925.