

PITMAN'S

RADIO

YEAR BOOK

~ ~ 1927

16
NET

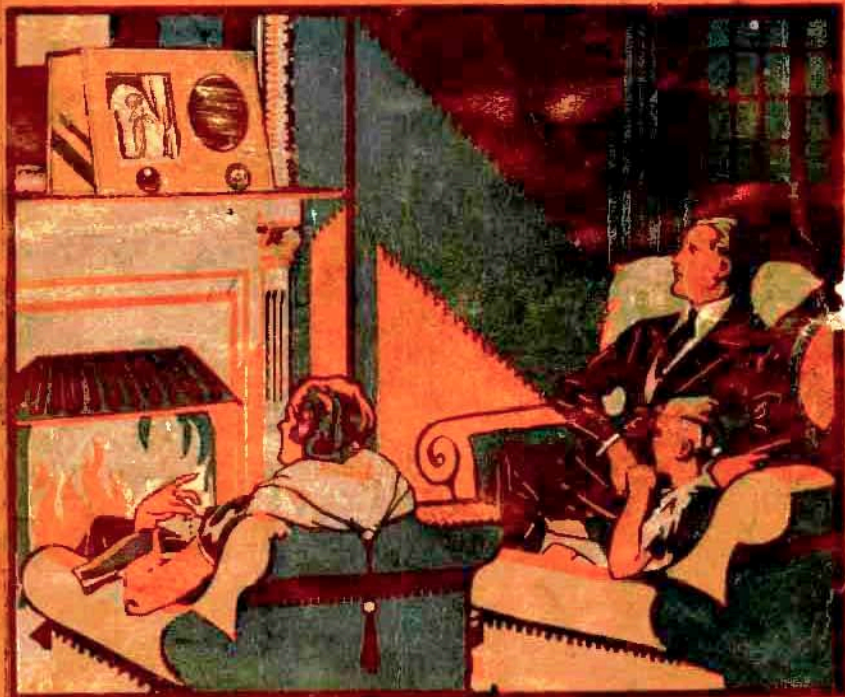

FOR MAJESTIC VOLUME, LONG LIFE, AND ECONOMY

Mullard

THE MASTER-VALVE

WITH THE WONDERFUL P.M. FILAMENT

THE STANDARD
DRAGON
AMPLION

Type A.R.19

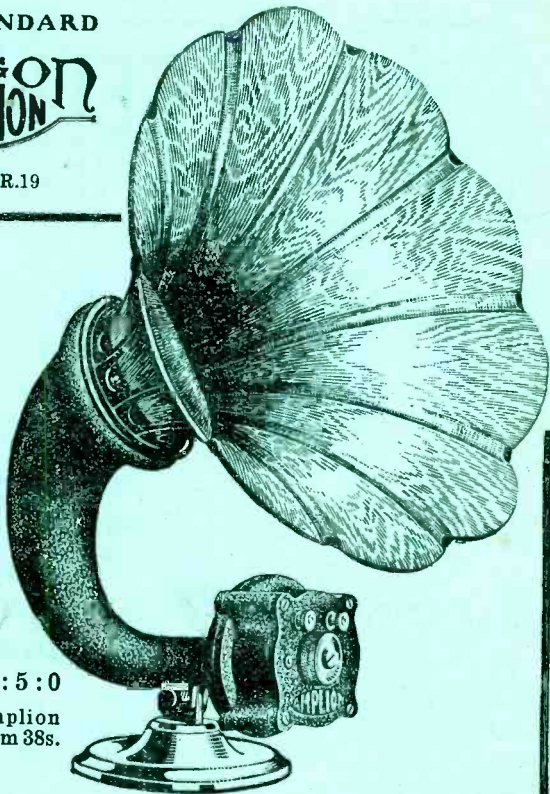

Price £5 : 5 : 0

Other Amplion
Models from 38s.

*The Loud Speaker that
made listening worth while*

Write for latest illustrated lists

ANNOUNCEMENT OF ALFRED GRAHAM & CO. (M. GRAHAM), 25 SAVILE ROW, LONDON, W.1
(5249)

10 Morris, 9, Queensway, Melton Roadway

The World's Greatest Magazine of Wireless

The Wireless Magazine

Contains each month a varied selection of first-rate articles for Home Constructors, the fullest details always being given, together with helpful diagrams and photographs. Stories and articles of general interest to the Wireless enthusiast are contributed by first-class writers.

Published about
the 25th of each
month at

1/-

Amateur Wireless

Gives week by week straightforward instructions for making every kind of Wireless Set and latest news of Wireless developments written by experts. Queries answered by post, *free of charge*.

See this week's issue. 3^d.

Published
Every
Thursday

CASSELL'S, LONDON, E.C.4



The First Essential to Perfect Reception

BROADCASTING brings into your home all that is best in music, drama, and education.

But to enjoy these to the full, you must use "HART" Batteries on your set for both Low and High Tension Supply.

"HART" Batteries alone provide that steady power to your valves which enables them to reproduce with maximum power and purity.

That is why eminent musicians like De Groot and many others personally use and recommend them.

HART

THE BATTERY OF QUALITY



There are models of "HART" Batteries for all wireless circuits. Write Dept. P.Y.B. for full particulars.

HART ACCUMULATOR CO. LTD.
STRATFORD, LONDON, E. 15

de Momi
145, Nottingham Road
Melton Mowbray

now
9, Queensway
M.M.

THE RADIO YEAR BOOK

1927 (Fifth Year)

A BOOK OF REFERENCE FOR
ALL INTERESTED IN BROADCAST RECEIVING

WITH CONTRIBUTIONS BY

J. A. FLEMING, M.A., D.Sc., F.R.S.

CAPT. P. P. ECKERSLEY

LIEUT.-COL. CRAWLEY, M.I.E.E.

JAMES SWINBURNE, F.R.S.

J. F. CORRIGAN, M.Sc., A.I.C.

NORMAN EDWARDS

JOHN L. BAIRD

AND MANY OTHER DISTINGUISHED RADIO-ENGINEERS*
AND SCIENTISTS

WITH MANY ILLUSTRATIONS

LONDON
SIR ISAAC PITMAN & SONS, LTD.
PARKER STREET, KINGSWAY, W.C.2
BATH, MELBOURNE, TORONTO, NEW YORK

1927

THE BEST AMPLIFIER
and the **CHEAPEST** both to fix and operate
IS
THE NEW NON-VALVE
MAGNETIC MICROPHONE
BAR AMPLIFIER

(Patent No. 248581-25)

**Complete
Amplifier**

PRICE

38/-

Post Free

Dry Cells Extra

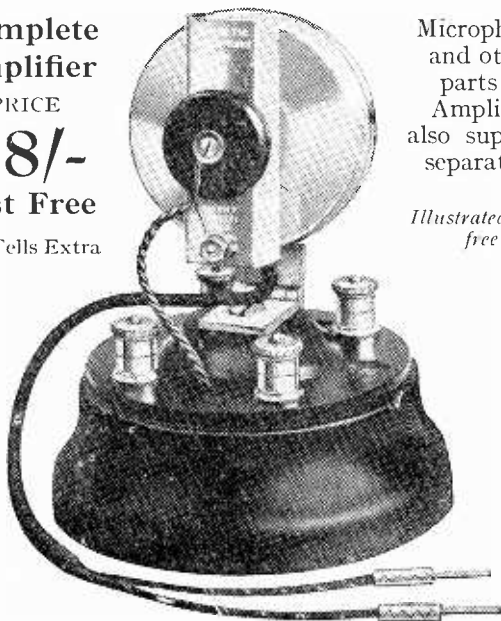

Microphone
and other
parts of
Amplifier
also supplied
separately

*Illustrated lists
free*

REALLY GOOD LOUD-SPEAKER RESULTS from **CRYSTAL RECEPTION**
of average strength. **WEAK CRYSTAL** or **VALVE RECEPTION** made **STRONG**
AND CLEAR in **HEADPHONES**. **ENABLES** even very **DEAF PERSONS**
TO HEAR from **CRYSTAL SETS**.

Not a Microphone Button. Entirely free from distortion and microphonic noises. No valves, accumulators, or H.T. Batteries. No fragile parts. Nothing to get out of order. A child can adjust it. Operates on one or two Dry Cells lasting over 3 months. **EQUALLY EFFICIENT ON VALVE SETS.**

Order from your dealer or from Sole Manufacturers and Patentees :

NEW WILSON ELECTRICAL MANUFACTURING CO., LTD.
18 Fitzroy Street, Euston Road, London, W.1

Phone: Museum 8974

PREFACE

TO THE 1927 EDITION

As foreshadowed in the Preface to the 1926 Edition of the YEAR BOOK, the British Broadcasting Company has now been taken over by the Government and will in future be administered by a body known as the British Broadcasting Corporation. We are glad to learn that the Executive will remain substantially as before—because we believe that the staff which has built up the broadcasting service to its present high standard is the one best fitted to maintain and improve the service.

Two events stand out in what might be called the Radio History of 1926—

(1) The fine work done by the Wireless for Hospitals' Fund which was started by the *Daily News* in 1925, and through the medium of which nearly 40,000 beds in London hospitals have been provided with headphones to enable patients to listen to the broadcasting during their tedious hours of suffering or convalescence.

(2) The successful demonstration by Mr. J. L. Baird of television, or seeing by wireless, as distinct from the wireless transmission of photographs or of shadowgraphs. Whether apparatus which will enable listeners to see the artists whilst they are broadcasting will be obtainable within twelve months remains to be seen, but we have the inventor's word that this is highly probable.

(3) As regards commercial wireless, the completion of Rugby and the beam stations for direct communication between this country, Canada, Australia, South Africa and India make the year 1926 one of notable progress.

Mr. James Swinburne, F.R.S., in an article entitled "A Pessimistic View of Broadcasting," gives some really original views on the subject. We leave our readers to judge how far Mr. Swinburne intends these views to be taken seriously.

Our thanks are due to many correspondents and certain reviewers for helpful criticisms and suggestions.

THE EDITOR.

TELEVISION

SEEING BY WIRELESS

By ALFRED DINSDALE, A.M.I.R.E.

The first book dealing exclusively with this subject

CONTENTS

CHAPTER I

INTRODUCTION.

CHAPTER II

WHAT TELEVISION IS—THE HUMAN TELEVISION SYSTEM—THE SELENIUM CELL—THE EXPERIMENTS OF RIGNOUX AND FOURNIER AND RHUMER.

CHAPTER III

VARIOUS ATTEMPTS TO SOLVE THE PROBLEM: SZCZEPANIK, ROSING, MIHALY.

CHAPTER IV

THE PHOTO ELECTRIC CELL.

CHAPTER V

THE PRESENT STATE OF THE ART—THE EXPERIMENTS OF MM. BELIN AND HOLWECK AND MESSRS. JENKINS AND MOORE.

CHAPTER VI

THE BAIRD "TELEVISOR"—THE PROBLEM SOLVED—TRUE TELEVISION DEMONSTRATED AT LAST.

CHAPTER VII

2 T.V., THE WORLD'S FIRST TELEVISION BROADCASTING STATION—DEVELOPMENT OF TELEVISION A ONE-MAN JOB.

Price 2s. net.

Of all Booksellers, or direct from

SIR ISAAC PITMAN & SONS, LTD.
PARKER ST., KINGSWAY, LONDON, W.C.2

CONTENTS

PREFACE	PAGE V
-------------------	-----------

GENERAL SECTION

THE BRITISH BROADCASTING CORPORATION	3
AIMS AND ACHIEVEMENTS OF THE B.B.C.	5

Land Lines Reorganized—League of Nations Broadcasts—Music Control—Great Musical Events—Broadcasts from Theatres—Croyland Abbey Bells—The New Birmingham Studio—Oxford's Broadcasting Studio—Broadcast from American Liner—The King and Changing the Guard—Daventry's Aerial—Help for Mariners—Cinema Broadcasts—Development of Radio Drama—Training of Broadcast Artists—Mass Telepathy Experiment—Chaliapine at the Microphone—Broadcasting During the Labour Crisis—Listening to the Nightingale—Derby Noises—Dual Transmission Experiments—Committee on Pronunciation—Wedding March on Loud Speakers—Cobham's Arrival Home—Westminster Abbey Transmissions—New Wavelength Scheme

RADIO HISTORY OF 1926 IN PICTURES

ADMIRAL OF THE FLEET, EARL BEATTY, WHO BROADCAST FROM 2LO	6
MR. PLUM WARNER BEFORE THE MICROPHONE	6
MR. WILKIE BARD AT 2LO	8
MISS JOSÉ COLLINS AT 2LO	8
MISS MARGARET BANNERMAN BROADCASTING FROM THE GLOBE THEATRE	10
MR. LESLIE HENSON "LISTENING IN" AT THE WINTER GARDEN THEATRE	10
SIR HARRY LAUDER AT 2LO	12
PLACING THE MICROPHONE BY THE LIONS' CAGE AT THE ZOO	14
DESCENDING A PIT SHAFT BEFORE BROADCASTING FROM THE WORKINGS	15
MESSRS. LAYTON AND JOHNSTONE AT 2LO	16
MAJOR SEAGRAVE BROADCASTING ON THE WORLD'S MOTOR RECORD	16
MR. AUGUSTUS JOHN, WHO MADE AN APPEAL FROM 2LO	18
BROADCASTING "TRIAL BY JURY"	20
RINGING BOW BELLS	20
PLACING THE MICROPHONE ON THE ROOF OF BOW CHURCH	21
DR. SALEEBY DELIVERING ONE OF HIS HEALTH TALKS	22
MR. JAMES AGATE, WHO BROADCASTS TALKS ON THE DRAMA	23
INSTALLING ONE OF THE MICROPHONES IN CANTERBURY CATHEDRAL	24
PROFESSOR W. H. ECCLES, D.Sc., F.R.S., M.I.E.E.	26

	PAGE
BROADCASTING THE CHANGING OF THE GUARD	26
THE DIVER ABOUT TO DESCEND BEFORE BROADCASTING FROM UNDER THE THAMES	28
MR. STEVE DONOGHUE BROADCASTING FROM 2LO	30
SIR ALAN COBHAM BROADCASTING FROM 2LO	31
BROADCASTING FROM THE ZOO AQUARIUM	31
MR. VIVIAN FOSTER, THE "VICAR OF MIRTH"	33
BROADCASTING AN EXPERIMENT IN MASS TELEPATHY	34
MR. HEATH ROBINSON, THE FAMOUS HUMOROUS ARTIST	34
B.B.C. WIRELESS ENGINEERING DURING 1926, BY CAPT. P. P. ECKERSLEY	36
THE WIRELESS AUNTS AND UNCLES	40
London — Liverpool — Cardiff — Nottingham — Manchester — Leeds — Bradford — Birmingham — Bournemouth — Dundee — Aberdeen	
A PESSIMISTIC VIEW OF BROADCASTING, BY J. SWINBURNE, F.R.S.	47
TELEVISION, BY JOHN L. BAIRD	50
HOW TO BUY A WIRELESS SET, BY "MENTOR"	56
WOMEN AND WIRELESS, BY "MRS. MENTOR."	60
WIRELESS IN THE HOSPITALS	64
PAST AND FUTURE, BY "MENTOR"	79
LIST OF STATIONS OF SPECIAL INTEREST TO LISTENERS	85
PERIODICAL LITERATURE	87
THE WIRELESS LEAGUE	90
TECHNICAL SECTION	
INSULATION AND INSULATING MATERIALS, BY J. A. FLEMING, M.A., D.Sc., F.R.S.	98
AMATEUR RADIO IN 1926, BY THE EDITOR OF "POPULAR WIRELESS"	102
"WHEREVER SHE GOES," BY "MENTOR"	109
THE PROBLEM OF THE OSCILLATING CRYSTAL, BY J. F. CORRIGAN, M.Sc., A.I.C.	113
RADIO AND CABLES, BY LT.-COL. CHETWODE CRAWLEY, M.I.E.E.	118
RECENT DEVELOPMENTS IN WIRELESS	125
ROUND THE FACTORIES, BY "MENTOR"	131
LIST OF RADIO SOCIETIES	148
COMMERCIAL SECTION	
TRADE DIRECTORY	156

GENERAL SECTION

THE BROADCASTING CORPORATION
AIMS AND ACHIEVEMENTS OF THE B.B.C.
B.B.C. WIRELESS ENGINEERING IN 1926
THE WIRELESS AUNTS AND UNCLES
A PESSIMISTIC VIEW OF BROADCASTING
TELEVISION
HOW TO BUY A WIRELESS SET
WOMEN AND WIRELESS
WIRELESS IN THE HOSPITALS
PAST AND FUTURE
LIST OF STATIONS
PERIODICAL LITERATURE
THE WIRELESS LEAGUE



THE RADIO YEAR BOOK

THE BROADCASTING CORPORATION

THE issue of this edition of THE RADIO YEAR BOOK synchronizes with the change over in the control of the British Broadcasting Company, which will henceforth be known as the British Broadcasting Corporation, thus preserving the magic initials "B.B.C." with, it is hoped, some of the traditions of the old Company.

In its Report, which was issued in March, 1926, the Broadcasting Committee (1925) recommended, among other things—

1. That the broadcasting service should be conducted by a public corporation acting as trustee for the national interest, and that its status and duties should correspond with those of a public service.

2. That the Corporation should consist of not more than seven nor less than five Governors, all nominated by the Crown, the first Governors to hold office for five years.

3. That the Governors should be persons of judgment and independence, free of commitments, with business acumen and experienced in affairs.

4. That the entire property and undertaking of the British Broadcasting Company as a going concern should be vested in the new body, and that all existing contracts and staff of the British Broadcasting Company should be taken over.

5. That the Postmaster-General should remain the licensing authority and be responsible for collecting the licence fees.

6. That the fee of ten shillings for a receiving licence should be maintained.

7. That the first charge on the revenue from licence fees should be the expenditure incurred by the Postmaster-General in connection with the broadcasting service; that after paying the Governors an income thoroughly



EARL CLARENDON
Chairman of the Broadcasting
Corporation.

adequate to enable them to ensure the full and efficient maintenance and development of the service, any surplus should be retained by the State.

8. That the claims of those listeners who desire a larger proportion of educational matter, though relatively few in number, should, if possible, be met.

9. That every effort should be made to raise the standard of style and performance in every phase of broadcasting, and particularly in music.

10. That although Parliament must retain the right of ultimate control, and the Postmaster-General must be the Parliamentary spokesman on broad questions of policy, the Corporation should be vested with the maximum of freedom which Parliament is prepared to concede

11. That the Corporation should present an annual report to Parliament.

The British Broadcasting Company regarded the essential recommendations of the Report as the natural result of the policy it had endeavoured to follow during the period in which it had exercised the stewardship of the broadcasting service.

Although the B.B.C. was technically a trade organization, composed of a large number of wireless manufacturers, and its Board, with the exception of the Chairman and Managing Director, was composed of manufacturers, it aimed constantly to interpret its functions as those of a public service. Although the preliminary capital required for the establishment of organized broadcasting in this country was provided by wireless manufacturing firms, the directors who represented those firms on the Board of the B.B.C. not only refrained from exploiting the broadcasting service to their own commercial advantage, but also declined to offer evidence to the Broadcasting Committee (1925) in respect of a continuation of the licence of the B.B.C. as then constituted.

In his evidence before the Broadcasting Committee (1925), the Managing Director of the British Broadcasting Company emphasized the importance of greater latitude in every respect. He suggested that while some existing restrictions might be removed, it should be left to the new authority to continue to expand its scope in consultation and agreement with other interests.

With Lord Gainford, the former Chairman of the British Broadcasting Company, as Vice-Chairman of the Corporation and Mr. J. C. W. Reith, Managing Director of the British Broadcasting Company, still in office as director-general of broadcasting, many of the former traditions will presumably be maintained.

The full list of Governors of the British Broadcasting Corporation was announced by the Postmaster-General in the House of Commons on October 25th, 1926, as follows: The Earl of Clarendon (chairman), Lord Gainford (vice-chairman), Sir John Gordon Nairne, Dr. Montague John Rendall, and Mrs. Philip Snowden.

AIMS AND ACHIEVEMENTS OF THE B.B.C.

By AN OFFICIAL OF THE B.B.C.

OWING to restricted revenue, the activities and quality of the broadcasting service have been prejudiced a good deal during the past year. The financial limitation was not due to any falling off in the popularity of broadcasting, nor to lack of enterprise on the part of the Company. On the contrary, an increase was recorded of 616,000 over the 1925 figures in the number of licences issued. The difficulty arose in this way. Sir William Joynson-Hicks, then Postmaster-General, appointed a Committee on April 24th, 1923, with Major-General Sir Frederick Sykes as chairman, to review the broadcasting position, and one important recommendation of that Committee was "that the bulk of the revenue required for the service should be obtained from the receiving licence fee . . . subject to the consideration of a reduction in the event of more revenue being received than is sufficient to carry on an adequate service." The outcome of this recommendation was the insertion of a clause in the Supplementary Agreement of October 1st, 1923, which extended the licence granted to the B.B.C. to December 31st, 1926, reserving to the Postmaster-General the right to pay such expenditure as he considered "reasonably adequate to provide a broadcasting service to his reasonable satisfaction." The B.B.C. registered a protest against the withholding of what it regarded as its legitimate proportion, namely, 75 per cent of the money subscribed by the public for the broadcasting service. The Postmaster-General thought it right, in view of the figures then before him, and in the absence of any public representation on the Board of the Company, to limit the B.B.C.'s income to £500,000 for the year. The following table contains details of the total revenue from broadcast licences, and the proportion handed over to the B.B.C. and retained by the Post Office in the past three financial years—

Date.	Amount received for licences.	Licences unexpired at end of period.	Paid to B.B.C.	Balance Retained.
31/3/24	£556,000	£297,000	£177,000	£82,000
31/3/25	£689,000	£382,000	£489,000	£115,000
31/3/26	£982,000	£580,000	£500,000	£284,000

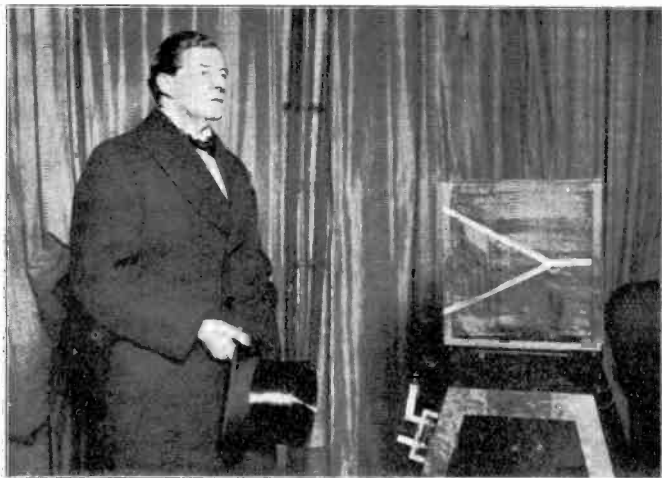

BRITAIN'S WOODEN WALLS

Admiral of the Fleet, Earl Beatty, who broadcast an appeal from
2LO on "The Old Implacable"

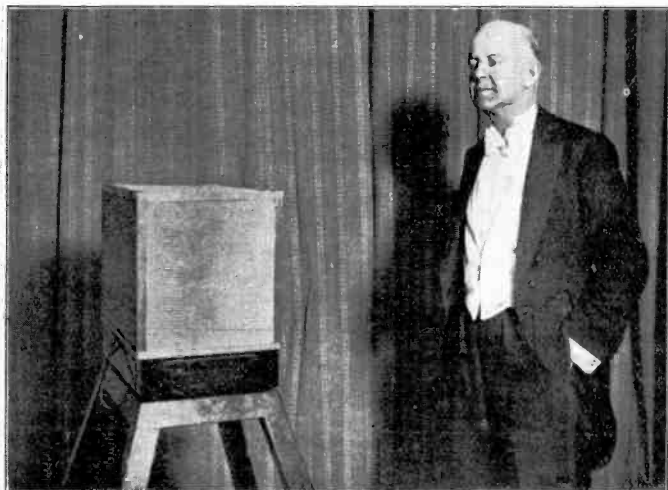

MR. PLUM WARNER

Mr. Plum Warner, who broadcast a talk from 2LO on "The 'Ashes'
are not Mythical"

In spite of the financial obstacles placed in the way of full development, the number of broadcast receiving licences has increased steadily and rapidly, as shown by the following figures—

TOTAL LICENCES			
1923	1924	1925	1926
158,871	720,895	1,348,840	2,100,000 approx.

When the broadcasting service passed into the hands of the new British Broadcasting Corporation, it was estimated that, in addition to capital assets costing approximately £315,000, which were transferred free, the Government had in hand a sum of at least £900,000, made up as follows—

(a) By the amount retained by the Post Office from the 75 per cent allocation accepted by the B.B.C. (assume 10s. licences were uniform throughout the whole period)—£70,000.

(b) By the surplus from the Post Office share from the 25 per cent allocation after deducting the expenses allowance of 1s. per licence—£320,000.

(c) By the amount in respect of unexpired licence fees at 31/12/26—£510,000.

The Broadcasting Stations.

The Stations of the B.B.C. at the 31st December, 1926, and their dates of establishment were as follows—

LONDON	14/10/22	PLYMOUTH	28/ 3/24
BIRMINGHAM	15/11/22	EDINBURGH	1/ 4/24
MANCHESTER	15/11/22	LIVERPOOL	11/ 6/24
NEWCASTLE	24/12/22	LEEDS-BRADFORD	8/ 7/24
CARDIFF	13/ 2/23	HULL	15/ 8/24
GLASGOW	6/ 3/23	NOTTINGHAM	16/ 9/24
ABERDEEN	10/10/23	STOKE	21/10/24
BOURNEMOUTH	17/10/23	DUNDEE	12/11/24
BELFAST	4/10/23	SWANSEA	12/12/24
SHEFFIELD	16/11/23	DAVENTRY	27/ 7/25

The population of the urban areas served by these stations is 21,943,000 and there is a broadcast receiving licence for every third house. The population of rural areas to a total of about 21,000,000 cannot be classified as being served by any particular station. The regional scheme of high-power stations proposed by the Company would bring the whole of the population of Great Britain and Northern Ireland within a service area of broadcasting distribution.

Land Lines Reorganized.

During the winter 1924-25, the reorganization of the land line system for simultaneous broadcasting was brought into operation and Leeds became the pivot controlling all the transmissions relayed between the South and North. Previously land line connections between one broadcast station and another

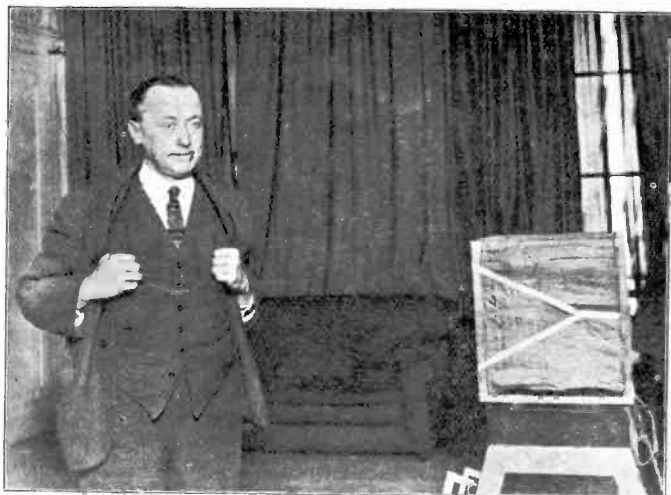

WILKIE BARD AT 2LO
Wilkie Bard, who broadcasts from 2LO

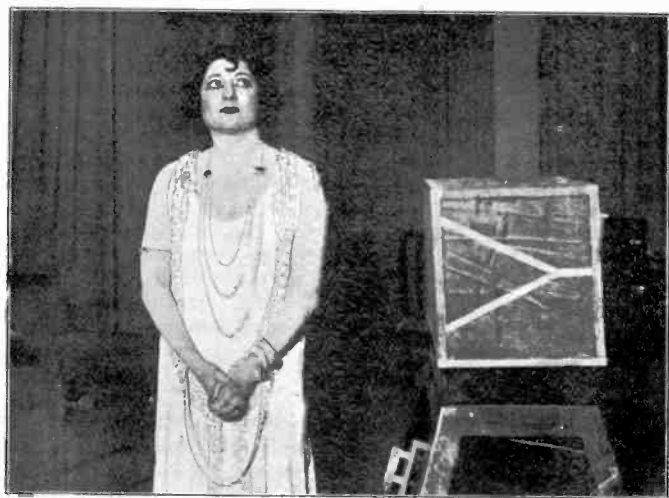

MISS JOSÉ COLLINS (LADY INNES KERR) AT 2LO

had been operated through London, except for the small inter-communication switchboard at Glasgow for linking up Scottish stations. Separate lines had been used between London and practically all other stations, save in one or two cases where stations were connected to 2LO by an alternative route. The quality of transmission had suffered through the use of several hundred miles of unnecessary land lines, which produced distortion due to the inability of certain telephone lines to work on variable frequencies. Under the new arrangement, all stations North of Leeds were linked up by land line to Leeds, instead of to London. Between London and Leeds four special lines were set apart by the Post Office for the use of the B.B.C. Generally only one line would be wanted, but spare lines were provided for alternative programmes, control purposes and emergency use. The arrangement at Leeds to send out programmes to Northern stations became much more automatic than it had been from London. Instead of the engineers in the London control room feeding other stations, the stations depending on Leeds helped themselves. The distant station made its own connection to Leeds by the manipulation of a single plug, which also controlled the necessary amplifying apparatus. The chief function of Leeds as a pivotal point has been to improve the quality of all items received from London to the same excellence as when they left London: distortion and other faults are corrected and weak signals are amplified before they are passed on, so that listeners get improved reception from many local stations as well as a general speeding up in the S.B. (simultaneous broadcast) part of the programme.

League of Nations Broadcasts.

Outstanding among the year's instances of the conquest of space were the broadcasts of the deliberations of the Assembly of the League of Nations at Geneva in March and again in September. The speeches were broadcast in March in French and English, their transmission from Geneva being a combination of wire and wireless. Telephone lines were used from Geneva to Paris, the speeches being received by the Eiffel Tower and radiated from there. They were picked up in this country at Keston and relayed to 2LO and 5XX. During the transmission and for several days afterwards, many messages were received at the B.B.C. headquarters from listeners who remarked on the exceptional clearness of reception, which in a number of cases was stated to be equal to that of the ordinary outside broadcasts from 2LO.

On the occasion of the September broadcast the results were not so satisfactory. The speeches were in French, and



MISS MARGARET BANNERMAN
Broadcasting from her dressing room at the Globe Theatre



STARS AND WIRELESS
Leslie Henson and his principal stars at the Winter Garden Theatre
listen in to "Patricia," which was being broadcast from 2LO from
His Majesty's Theatre
Mr. Leslie Henson listening in

untranslated ; they were relayed by land line from Geneva via Paris to London, except for a short interval, during which Keston picked up the Eiffel Tower broadcast. However, neither the complete land line relay nor the use of the wireless link gave such good results as were secured in March.

Music Control.

The question of efficient amplifier control had for a long time engaged the attention of the B.B.C. in connection with musical programmes, before it was finally decided to establish a section formed of officials of the Music, Engineering, and Outside Broadcast departments, to work on musical balance and control. This section was made responsible for obtaining correct balance of musical combinations in the studios, both at rehearsal and during performances. In addition, it exercised amplifier control of outstanding musical programmes and also balance and control of important outside broadcasts. Co-operation was simultaneously established with the provincial stations and considerable progress was thus made towards improving the quality of musical broadcasts. It had previously been the practice to leave the matter of control in the hands of an engineer, who only on the occasion of an important musical broadcast was provided with a copy of the score to enable him to follow with a definite degree of faithfulness the crescendo and diminuendo passages as marked ; but since the new scheme has come into operation it has been the custom for the musical expert to add his knowledge of broadcasting requirements to that of the engineers in the control room and the result is that musical transmissions now express a good deal more accurately the intentions of the composer of a particular work.

Great Musical Events.

Musically, perhaps the most important broadcast of the year from a place outside the actual studio was the concert performance—the first in Great Britain—of Rimsky Korsakoff's opera "Kitesh." at Covent Garden Opera House on March 30th, under the conductorship of Mr. Albert Coates. The performance was simultaneously broadcast from all stations of the B.B.C. and the distinguished cast of Russian operatic artists who participated were those who are to appear in the same opera at Barcelona during the year 1927. A feature of the Covent Garden performance was the publication by the B.B.C. of a libretto of the opera : more than 10,000 listeners applied for copies. The success of the innovation induced the B.B.C. to make arrangements for the issue of libretti of an important series of studio operatic performances which began on April



SCOTLAND'S COMEDIAN BROADCASTS

Sir Harry Lauder made another appearance at 2LO when he broadcast a programme of his favourites to the listening public. Both these broadcasts were among the greatest successes from 2LO

Sir Harry Lauder at the Microphone



SCOTLAND'S COMEDIAN BROADCASTS

Sir Harry Lauder at the Microphone

16th with "La Traviata." This series of operas was continued at intervals of about a month and altogether it is estimated that some 200,000 copies of the libretti were issued in the series, the operas being "Rigoletto," "The Bohemian Girl," "Faust," and "Barber of Seville," among others.

In September another bid was made to foster a desire for good music by the inauguration of a series of twelve important concerts at the Albert Hall, with Sir Hamilton Harty, Albert Coates, Richard Strauss, Sir Edward Elgar, Otto Klemperer and Bernardino Molinari among the conductors. At these concerts original musical compositions, for which prizes amounting to £1,000 were awarded by the B.B.C., were performed. The concerts, which will be continued through the early months of 1927, were broadcast from all stations of the B.B.C.

Broadcasts from Theatres.

For the first time in the history of broadcasting, a rehearsal of a new theatrical production was given from 2LO on February 22nd. One of the final rehearsals of a revue entitled "R.S.V.P.," which was later presented at a London theatre, was transmitted from the studio, the actual members of the cast for the theatrical presentation taking part in the studio performance. It may be of interest to note that as the result of the B.B.C.'s agreement with the theatres, numerous theatrical excerpts were broadcast throughout the year, chief among them being the following—

- "The Beggar's Opera" (Lyric Theatre, Hammersmith).
- "The Co-Optimists" (His Majesty's Theatre).
- "Tess of the D'Urbervilles" (Barnes Theatre).
- "Tell Me More" (Winter Garden Theatre).
- "Lionel and Clarissa" (Lyric Theatre, Hammersmith).
- "Mercenary Mary" (London Hippodrome).
- "Betty in Mayfair" (Adelphi Theatre).
- "The Ghost Train" (Garrick Theatre).
- "Henry VIII" (Empire Theatre).
- "Wildflower" (Adelphi Theatre).
- "No, No, Nanette" (Palace Theatre).
- "R.S.V.P." (Vaudeville).
- "Riverside Nights" (Lyric Theatre, Hammersmith).

In September, a masterly stroke was accomplished by the surmounting of the various obstacles which had up to that time stood in the way of enabling broadcast listeners to hear any stage performance of a Gilbert and Sullivan opera. Some time previously, the B.B.C. had secured permission to broadcast the overtures to the operas and these were warmly appreciated by listeners; but it was not until September 20th that the concession was obtained to transmit extracts from an actual stage performance, the first play to be broadcast being "The Mikado,"

which opened the Gilbert and Sullivan season at the Princes Theatre, London, on the same evening. On October 25th a half-hour's excerpt from "The Gondoliers" was relayed from the Princes Theatre.

Croyland Abbey Bells.

An innovation which was introduced in connection with the evening service transmissions from the various studios and places



LIONS ROAR BY WIRELESS

The lions at Olympia roar to oblige the microphone and to please the thousands of children who listen-in to 2LO

of worship as announced in the B.B.C. programmes was the broadcasting of the bells of Croyland Abbey, near Peterborough. The engineer who was deputed to carry out the test installed the microphone in various positions with the view of judging from which spot the best results were likely to be obtained. He found that the bells of the historic abbey were heard to the best advantage when the microphone was placed 150 feet from the belfry. The transmitting apparatus was installed inside the abbey and connected up with the microphone. On several occasions throughout the year the sweet melody of the bells of Croyland has been heard by listeners throughout the British Isles.

Largest Studio in Great Britain.

New studios and offices were opened at Birmingham in January. The new premises were very spacious, being the largest of any used for broadcasting purposes in the provinces. The main studio was 48 feet by 40 feet, and was larger than the largest studio in London. This enormous studio gave the opportunity of getting the best echo effects, according to the nature of the broadcast. New control and battery rooms were also provided.



BROADCASTING FROM A COAL MINE

The above photograph shows officials of the B.B.C. and also miners ready to descend the shaft in connection with the broadcast which took place some months ago

with large and airy offices, which were in strong contrast to the cramped and uncomfortable quarters in which broadcasting had been carried on in Birmingham since November 15th, 1922, the date on which the original station was opened. A short time prior to the opening of the new studios and offices, a more powerful transmitter had been installed in place of the old one and thus the whole of the Birmingham Studio premises and transmitter equipment had been entirely renewed in three years at an expenditure of some thousands of pounds.



FAMOUS COON PAIR AT 2LO

Layton and Johnstone, the well-known coloured duettists, appeared at 2LO and gave a selection from their repertoire

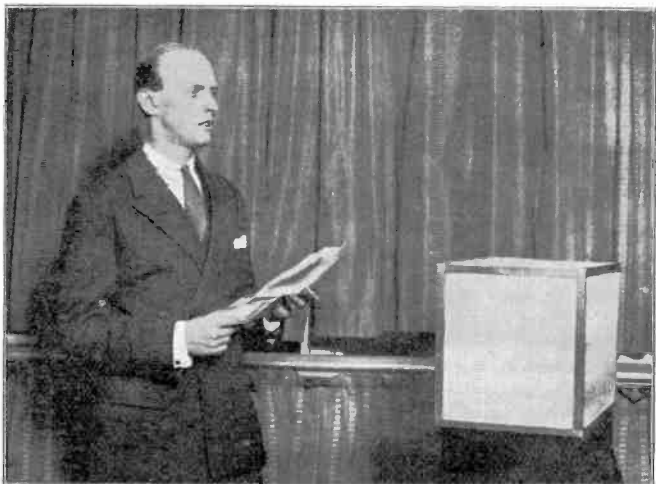

STORY OF THE MOTOR RECORD BY WIRELESS

Major Segrave, who gave his story of how he broke the world's motor records on the Southport Sands
Major H. O. D. Segrave at the microphone

Oxford's Broadcasting Studio.

The B.B.C. established a new studio at Oxford at the end of 1925, with the object of providing listeners with the opportunity of establishing contact with the best thought of the university town. From this studio have been given from time to time pianoforte recitals, madrigals, and other part songs by the Elizabethan Singers, performances by the O.U.D.S. and lectures by prominent University officials.

Broadcast from American Liner.

Readers will recall the thrilling rescue of Captain Tose and the entire crew of the British steamer "Antinoe," in mid-Atlantic, by the U.S. liner, "President Roosevelt," early in the year. The full story was told by Captain Tose from 2LO. The steps taken to enable listeners to hear Captain Fried and Chief-Officer Miller, of the "President Roosevelt," were necessarily more elaborate. These two officers were unable to land from their vessel and two telephone lines were therefore run out from the Southampton telephone exchange to the saloon of the "President Roosevelt," on the day that the ship reached Southampton, so that the proceedings in connection with the presentation of medals to the officers and to the crew of the lifeboat who participated in the "Antinoe" rescues could be relayed by land line to 2LO and 5XX for broadcasting.

The King and Changing the Guard.

With the King's approval, the ceremony of the Changing of the Guard was twice broadcast during the year and many thousands of Bank Holiday makers gathered at Buckingham Palace, attracted, no doubt, as much by the sight of the inoffensive-looking gauze box containing the microphone, standing on its pedestal in the forecourt of the Palace, as by the imposing nature of the ceremony. With his usual thoughtfulness, the King, who witnessed the Changing of the Guard and listened to the incidental music from his apartments in the Palace, sent down an order for the band to continue playing beyond the regulation time, thus giving additional pleasure to the onlookers and to the millions of his subjects throughout the Kingdom who were reliant on wireless. The transmissions were sent out from London and Daventry, as well as from other stations in cases where the wireless link was successful.

Daventry's Aerial.

The Daventry Station performed excellent work from the date of its opening in July 1925, until December of that year.

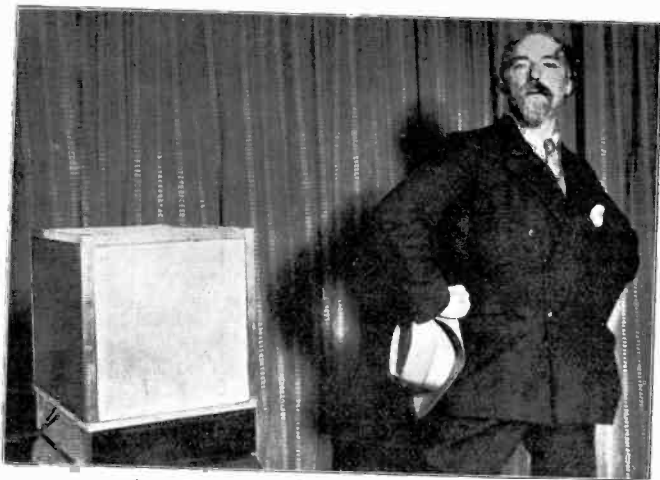

ART AND THE HOMES. CLEAR THE SLUMS

Mr. Augustus John, the famous artist, made an appeal for the clearance of the slums and protested against the overcrowding of houses with inartistic pictures and furniture

Mr. Augustus John at the Microphone

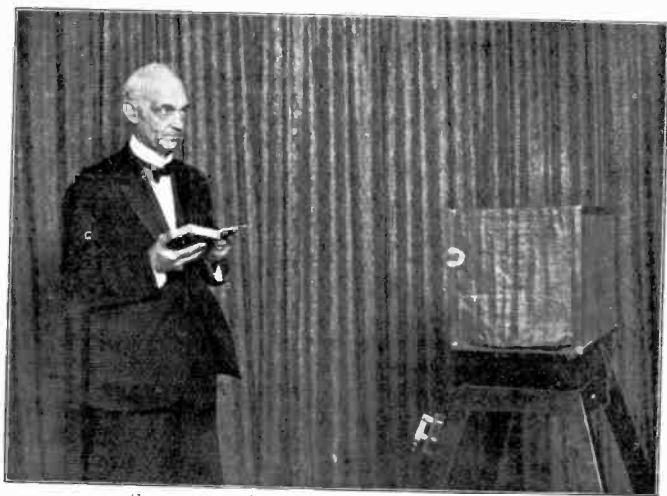

SHORTHAND SPEED PRACTICE BY WIRELESS

Lord Riddell, who broadcast from 2LO at various speeds for shorthand writers to take down

But on a winter's day in 1925-1926 it suffered a very unfortunate mishap, the exceptional frosts causing the aerial to break at two o'clock one morning just after the station had completed its transmission. The accident was due to the weight of the coating of ice which had lodged round the slender wire and cage. The engineers worked feverishly to effect a temporary repair so that the morning Time Signal and Weather Forecast could be put out. However, a further severe frost ensued and the installation again broke down. For the next few days, service from Daventry was patchy and those transmissions which could be effected were on reduced power. During the ensuing eight months a temporary aerial rendered yeoman service and the transmissions were, in fact, as good in quality as they were from the original aerial; but on August 29th, a new permanent aerial, which had taken six months to manufacture, was brought into use.

Help for Mariners.

An innovation of much practical utility was the inclusion of a special shipping forecast in the Daventry programme at the time when other stations were transmitting local news. The wish had been expressed from time to time by skippers of fishing trawlers and others engaged in inshore navigation that information respecting the nature of channels, accessibility of harbours, direction of winds, and the state of the water should be made available in this way, and all the evidence points to the fact that the forecast which the B.B.C. transmits has from the outset proved very helpful to navigation.

Cinema Broadcasts.

Two interesting experiments in connection with the cinema took place during the year. The first, a development of community singing, was held at the Prince of Wales Playhouse, Lewisham, where picture-goers joined with the Celtic Singers and Mr. Frank Westfield's Orchestra in singing well-known songs during one of the usual weekly transmissions of the music that forms a background to the screening of the pictures. The words and music of songs were thrown on the screen and sung by the audience, the time being indicated by a little white ball, which jumped from note to note. The songs chosen for this transmission, "Love's Old Sweet Song" and "Three Blind Mice," were heard in many parts of the Continent and letters of appreciation were received from as far off as Czecho-Slovakia, as well as from British warships. This was the first occasion that a broadcast of this nature had been accomplished.



BROADCASTING "TRIAL BY JURY"

Left to Right—Ernest Thesiger, Lord Riddell, Dame May Witty
Ben Webster, and Athene Saylor



RINGING BOW BELLS. THE SOUNDS OF WHICH WERE BROADCAST

The second experiment was the transmission for the first time in Great Britain of a film play. A special broadcast version was prepared of "The Greater Glory," an adaptation from Edith O'Shaughnessy's novel, "Viennese Medley." For wireless purposes the descriptions of the story-teller took the place of

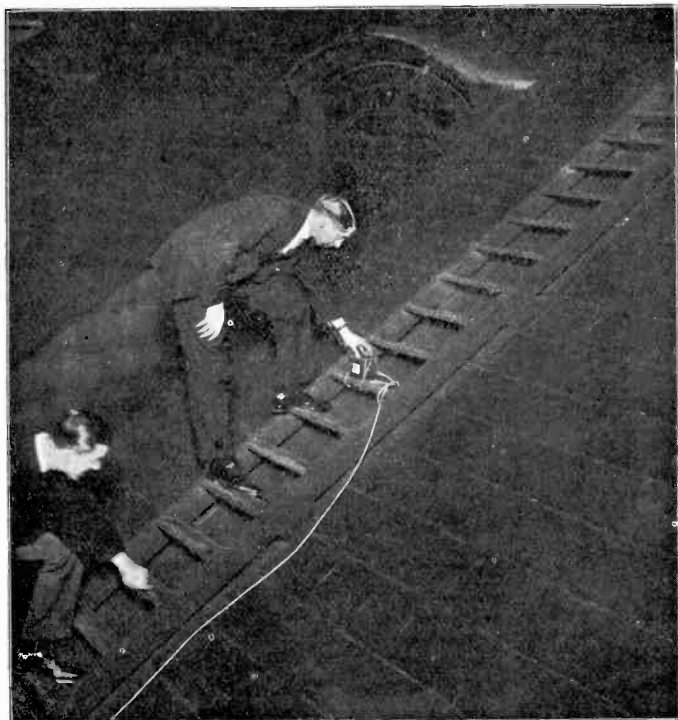

BROADCASTING BOW BELLS. PLACING THE MICROPHONE ON THE ROOF

sub-titles. Dialogue and sound effects supplied the scenes and a background of orchestral music, similar to that arranged for the film, gave suitable emotional atmosphere in the unfolding of the story. The broadcast, which synchronized with the production of the film, was given from the Manchester Station and may possibly be the first step in a method of enabling listeners to visualize a film through the medium of sound.

Development of Radio Drama.

A new development was introduced in connection with broadcast plays, when the B.B.C. decided to stimulate interest among listeners in broadcast drama by awarding a prize for the nearest

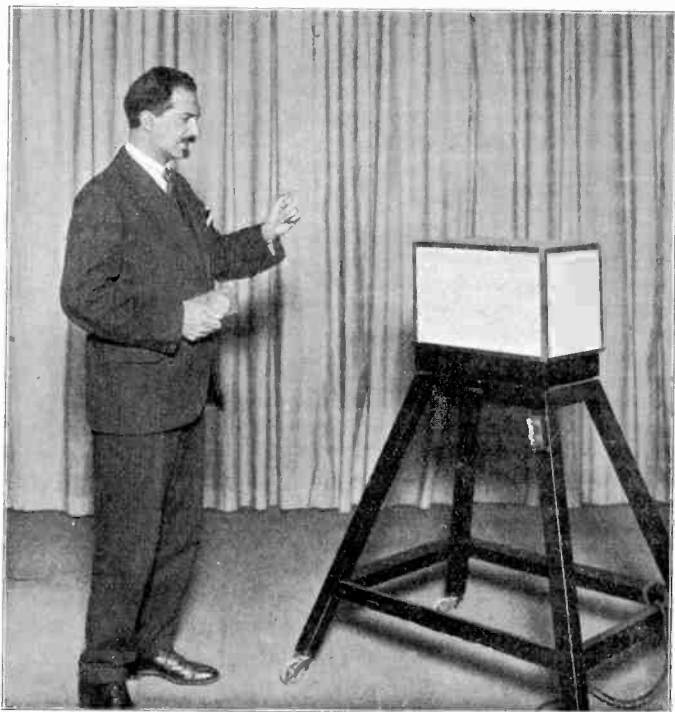

DR. SALEEBY

Dr. Saleeby is here shown before the microphone delivering one of his health talks. Dr. Saleeby is holding in his right hand a miniature of the celebrated Mona Lisa

correct solution of a mystery story entitled "The Mayfair Mystery," which was transmitted in episodes at intervals. The idea was to encourage listeners to furnish explanations of the way in which the mystery was built up and to provide their own solutions. The final episode consisted of a re-enactment of the mystery with the real solution. Competitors' attempts had, of

course, to be sent in to the B.B.C. before the final broadcast. Altogether more than 50,000 listeners took part in the attempt to win a prize of £100.

Training of Broadcast Artists.

As the result of negotiations between the B.B.C. and the



MR. JAMES AGATE

Here is shown Mr. James Agate, who has broadcast a number of talks on the drama and who is well-known as a dramatic critic and also as a writer

Royal Academy of Dramatic Art, a special course of training was instituted at the Academy in the autumn, with the object of discovering and fostering talent that could be utilized for the broadcasting medium. To ensure that students who were desirous of specializing in dramatic broadcasting should be trained under conditions resembling the actual requirements of the studio, the B.B.C. installed microphones at the Royal Academy of Dramatic Art and these were connected to loud speakers in

separate rooms. Special examinations will be held at the Academy, and the B.B.C. will award two prizes of the value of £10 each to successful students of either sex at the conclusion of each half-yearly term.



TERCENTENARY OF FAMOUS CHURCH MUSICIAN
BROADCAST FROM CANTERBURY CATHEDRAL

The first broadcast from a cathedral took place when the Tercentenary Celebration of Orlando Gibbons was sent through the ether. B.B.C. Engineers fitting up the Microphone

Mass Telepathy Experiment.

An interesting experiment was tried with a mass telepathy broadcast, in which Lady Tree, Lady Gainford, Miss Zena Dare (the Hon. Mrs. Maurice Brett) and Commander Kenworthy, among others, took part. The members of the cast, as it may be called, met in a separate room. The announcer in the London Studio endeavoured to put into the minds of the listeners six

items. The general classification of five of these was in the possession of members of the cast, i.e. a card, a number, a colour, etc. The sixth item was entirely unknown to any member of the jury. The announcer invited listeners to think of the first item: he then pressed a button, which rang a bell in the room in which the jury were assembled and, during the minute following, each member of the jury wrote down what he or she "received." At the end of the minute, the engineers switched over to a microphone in the separate room and the members of the jury announced their telepathic results to listeners. The experiment was not very successful, as in no case was any member of the jury accurate, while in some instances the answers given showed that to assert that they were obtained by telepathic means was quite outside the realms of possibility.

Chaliapine at the Microphone.

M. Feodor Chaliapine, the well-known Russian bass, made his first appearance before the microphone in this country in 1925-1926, when he sang nine songs, which broadcast exceedingly well. In view of the great singer's previous opposition to broadcasting and his refusal to broadcast in America, it was a signal honour to British listeners that he should have consented to appear before the microphone at 21.0.

Broadcasting During Labour Crisis.

One conspicuous part played by the broadcasting service during the general strike in May marks that period as, perhaps, the most important in the history of the B.B.C. since its inception. The broadcast programmes, generally, underwent little modification, considering the difficulties of transport facilities for artists and of adhering to the schedule times; but an enormous amount of additional work was involved in the broadcasting of news bulletins, and for that purpose the London station was kept working continuously, during the first few days of the strike, from 7.30 a.m. until 1.30 the following morning. When the work became more systematized, special news transmissions took place each day at 10.0 a.m., 1.0, 4.0, 7.0 and 9.30 p.m. Other bulletins, dealing with the emergency railway arrangements, were also broadcast at intervals. The total number of bulletins broadcast between 10.0 a.m. on the first day, May 4th, and 1.0 p.m. on May 18th, when the last of these special bulletins was issued, was seventy-seven.

Listening to the Nightingale.

That hardy annual, the nightingale, which has given the engineers much food for thought in connection with the attempt



PROFESSOR W. H. ECCLES, D.Sc., F.R.S., M.I.E.E.

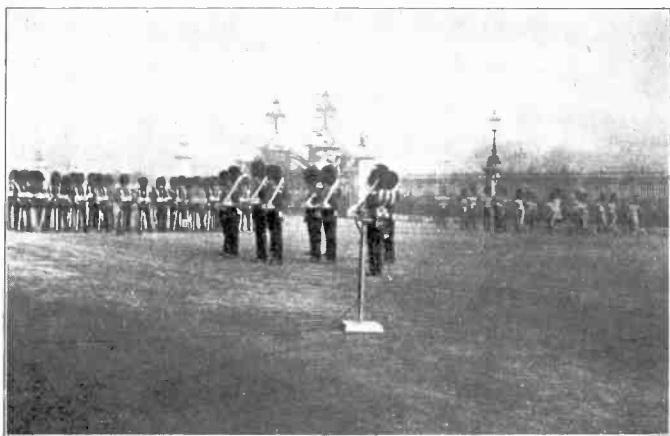

BROADCASTING THE CHANGING OF THE GUARD AT
BUCKINGHAM PALACE

[Note the microphone in the foreground]

made each year to catch his somewhat elusive song, was successfully picked up by the microphone on May 22nd. This was the second time of asking. Two evenings previous, the birds were singing splendidly, and the B.B.C. was looking forward to a successful transmission; but shortly after the line had been switched through, a party of motorists, who had heard the announcement of the projected broadcast, drove up to Oxted Woods, the point from which the transmission was to take place, and brought their car to a halt on the edge of the woods, where they kept their engine running. The noise, combined with the brilliant headlights, was sufficient to frighten the birds away and spoil the attempted broadcast. Fortunately, there was no untoward incident to mar the transmission two nights later.

Derby Noises.

On the fourth annual attempt, since the B.B.C. first conceived the idea of broadcasting from Epsom racecourse, the transmission of the Derby was last year, for the first time, successful. A microphone was installed in a special enclosure provided for the purpose at Tattenham Corner and connected to an overhead line to the Epsom telephone exchange. Another microphone, held in position by six engineers, was kept in reserve, but was not needed. The broadcast consisted of the noises made by the crowd; but these, as it happened, amounted to no more than a dull, continuous murmur. This was followed by comments on the scene by Miss Vera Lennox and Mr. Laurence Anderson.

Experimenting with Dual Transmissions.

Experimental tests with alternative programmes, which will play an important part in the framing of any redistribution scheme of broadcasting, were carried out at the end of June. For this purpose, the station at Oxford Street and the spare transmitter at Marconi House transmitted simultaneously separate programmes on different wavelengths, Oxford Street using its normal wavelength and Marconi House working on a wavelength of 460 metres. The object of the tests was to determine whether it was possible to provide two distinct programmes on different wavelengths, but at the same strength, from stations in close proximity to each other. More than ten thousand reports were received from listeners as regards their reception of the dual transmission. The results showed that while the majority of valve set users successfully separated the two programmes, a large number of crystal set users were less successful in their efforts. Nevertheless, the highest value is attached to these experiments, and that value will be effectually demonstrated when alternative programme transmissions become a regular part of the broadcasting system.



BROADCASTING FROM UNDER THE THAMES

Here the diver is seen ready to descend. The striking effect produced by hearing him give instructions to "start the pump please" and also the sound of the sirens of passing river craft, will be readily recalled by those who listened in on this particular occasion

Diver Broadcasts from Beneath the Thames.

A diving novelty was broadcast in July, when Mr. F. Shield, of Whitstable, made a descent in the Thames from the steps of the County Hall, Westminster. Mr. Shield first broadcast a talk in which he described deep sea diving, and afterwards, clad in full diving rig, explored the bed of the Thames, describing his experiences as he moved from point to point under the water. He carried in his diver's helmet a small microphone, which was connected by line attached to the head-dress to amplifying apparatus on the steps of the County Hall. Thence a line ran to the B.B.C. at Savoy Hill, where the diver's comments were further amplified and sent over another line to the transmitter at the Oxford Street station.

Committee on Pronunciation.

In July, the B.B.C. announced the formation of an Advisory Committee on spoken English, under the Chairmanship of Mr. Robert Bridges, the Poet Laureate. Other members of the Committee were Mr. Bernard Shaw, Sir Johnston Forbes-Robertson, Professor Daniel Jones, of the London University, Mr. Logan Pearsall-Smith, representing the Society for Pure English, and Mr. Lloyd James, who had previously assisted the B.B.C. in the matter of phonetics, and who is Lecturer in Phonetics at the School of Oriental Studies. The B.B.C., in forming this Committee, emphasized that it did not wish to dictate or lay down principles of pronunciation for the country; but it frequently happened that the broadcast announcers were confronted with a word in print which was seldom heard in speech. Many words were submitted to the Advisory Committee by the announcers as being the subject of differences of opinion. Others were words which had been challenged by correspondents. The decisions reached by the Committee were intended to introduce uniformity into the forms of pronunciation used by the B.B.C. announcers throughout the country. In some cases the recommendations of the Committee involved a dogmatic decision on points which might legitimately be arguable, but the introduction of uniformity at least prevented confusion.

Wedding March on Loud Speakers.

An original programme item was carried out in September. A Workington listener had written to the B.B.C. saying that both he and his intended bride were anxious to have Mendelssohn's wedding march played on the occasion of their approaching marriage. They appealed to the B.B.C. for assistance in carrying out the unique project of broadcasting the march. The programme

department thereupon asked the organist of St. Lawrence Jewry, London, to play the well-known wedding march on the day of the ceremony, starting immediately after the time signal at 1.0 o'clock. Normally, the march takes about four minutes, but the organist, Mr. Lewis Jones, consented to play the repeat which brought the period up to about six minutes. Loud



DONOGHUE'S TIP BY WIRELESS

Steve Donoghue, the popular jockey, tipped Colorado by wireless from 2LO, and also explained why he was not riding in last year's Derby

Steve Donoghue at the Microphone

speakers were installed at Workington, and the bride and bridegroom, with their guests, heard the strains of the march during the wedding breakfast. This was the first time in the history of British broadcasting that such an arrangement had been made.

Broadcasting at Work.

The B.B.C. exhibit at the National Radio Exhibition at Olympia last year was eloquent testimony to the hold that broadcasting has gained on the public imagination. A full-size replica of the main studio at Savoy Hill was erected, the measurements being 44 ft. by 24 ft., and a control room was also set up.

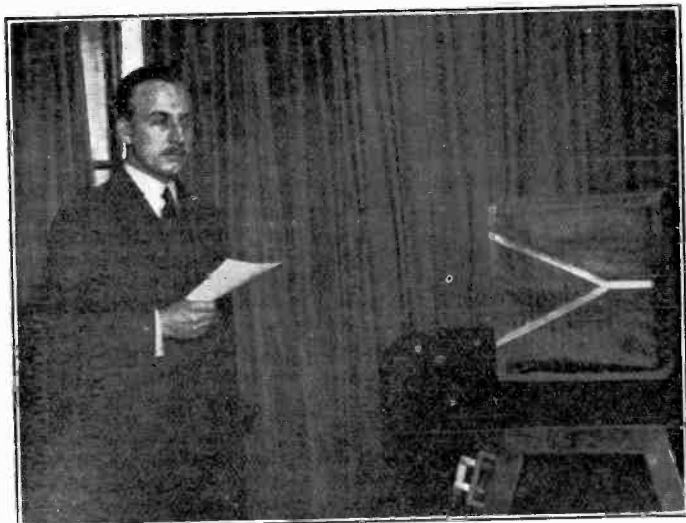

SIR ALAN COBHAM UPON HIS RETURN FROM THE HISTORIC FLIGHT TO AUSTRALIA AND BACK, GAVE A SHORT TALK FROM 2LO

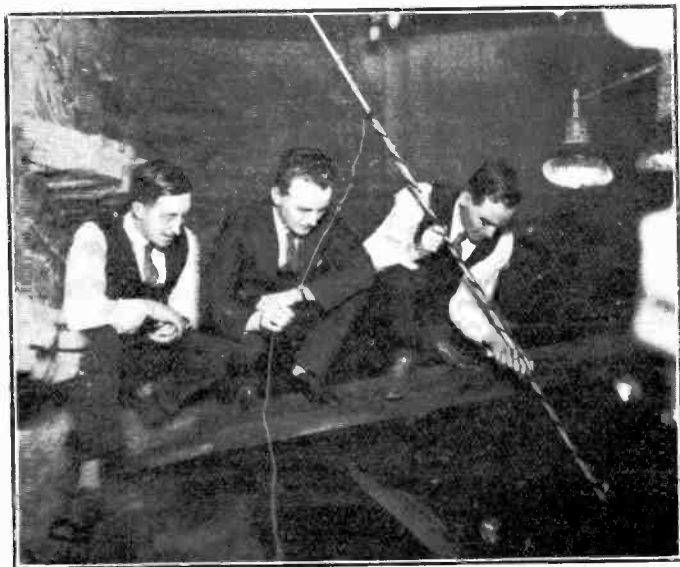

THE ZOO FISH BROADCAST
ENGINEERS PLACING THE HYDROPHONE IN POSITION

Visitors to the exhibition were thus able to witness the routine that is carried out by the announcer, the placing of artists in relation to the microphone, showing, for example, the improvement that has taken place during the last three years, and from the time when it was necessary for the broadcaster to speak close up to the microphone, the arrangement of a band to give the best acoustical effects, the movable draperies to get the best acoustics, and so on. Visitors also saw the control engineer, sitting with headphones on, holding two knobs which controlled the volume of the electrical equivalents of the sounds passing over the landlines to Savoy Hill and thence to the transmitter. Sufficient apparatus was used in the transmission of the programmes from the exhibition to give visitors a comprehensive idea of all the care and attention that are necessary to avoid breakdowns as far as possible and to ensure the best reproduction.

Cobham's Arrival Home.

The incidents connected with the arrival of Sir Alan Cobham at Westminster on October 1st, after his great Australian flight, were broadcast from the River Thames, together with the speeches of welcome to him and his reply from the Terrace of the House of Commons. The broadcast included the sounds of Mr. Cobham's machine approaching Westminster, and the speeches of Sir Samuel Hoare, Air Minister, and Sir Charles Wakefield.

Westminster Abbey Transmission.

Reference was made in the last issue of the YEAR BOOK to the difficulties attending the broadcasting of religious services from Canterbury Cathedral and York Minster. An equally difficult task was accomplished on October 7th, 1926, when evensong was relayed, for the first time, from Westminster Abbey. Prolonged study of the acoustics of the historic edifice were necessary beforehand, and it was finally decided to install the amplifiers in a little room beneath the Lay Vicars' room and near to the Unknown Warrior's grave. The external wires were run from Savoy Hill to this amplifier room and the Abbey was wired up internally with four extensions, one to the pulpit, one to the lectern, one to the organ loft, and a second to the organ loft with alternative branches running behind the choir stalls to the Minor Canons' desks, so that the microphone could be placed on either side of the choir according to the position occupied by the Minor Canon who was conducting the service. Most of the wiring in the Abbey is laid under gratings and alongside the hot water pipes, or actually underneath the paving stones. The engineers will thus be able to connect their microphones to any points they may require for future services.

New Wavelength Scheme.

One of the most important evolutions in the story of British broadcasting, as it has so far been written, took place towards the end of the year, when a new wavelength allocation scheme came into operation. Those interested in broadcasting were aware that a Union of European Broadcasting Organizations was formed in the spring of 1925 in order that the international aspect of the art might be fully discussed and arrangements made for the benefit of all European listeners. About two



(Chaloner & Macnamara)

VIVIAN FOSTER, "THE VICAR OF MIRTH"

"Yes, I think so"

hundred stations of all sorts are working, or about to work, in Europe. Stations a thousand miles apart may produce mutual interference if they work on wavelengths which differ by certain definite amounts from 200 to 8,000 periods a second. To stop this interference, all stations must work on wavelengths differing by a certain definite amount or, where the range of the station is restricted, on exactly the same wavelength. There are in the available broadcasting waveband of 200 to 600 metres, ninety-nine available wavelengths if one wavelength is separated



MEMBERS OF THE "JURY" ON THE OCCASION OF AN EXPERIMENT
IN BROADCASTING MASS TELEPATHY



MR. HEATH ROBINSON, THE FAMOUS HUMOROUS ARTIST

from another by 10,000 vibrations a second frequency. The problem, then, is to fit about two hundred stations into a wave-band where there is only room for ninety-nine, if every station is to use a different wavelength. The Union of Broadcasting Organizations, through their office at Geneva, therefore, decided to employ eighty-three exclusive wavelengths and sixteen common wavelengths. The exclusive wave, as its name implies, is for the sole use of the station to which it is allotted. The wave is separated from any other station's wave by a definite amount, so that no interference takes place and the range of the station depends only upon its power and the type of receiver used. The common wave is one that is shared by low-powered stations, designed only to serve a limited area. So far as Great Britain is concerned, exclusive wavelengths were allocated as follows—

	Metres		Metres
Aberdeen	{ 481·8	Newcastle	312·5
Birmingham		Manchester	384·6
Glasgow	405·4	Bournemouth	306·1
Belfast	326·1	Cardiff	353
London	361·4	Leeds	297
		Bradford	294·1

All other relay stations worked on a common wavelength of 288·5 metres. These wavelengths were provisional, and subject to alterations, if necessary, after the scheme has been given a fair trial.

B.B.C. WIRELESS ENGINEERING DURING 1926

By CAPT. ECKERSLEY

ANOTHER "season" opens. It is a convenient time, perhaps, to review the situation.

We in the Broadcasting Company find ourselves on the eve of a change in our constitution, but, it is to be expected, not in our policy. There has been a lot of talk of "Government Control," that, in fact, the B.B.C. is to become a sort of Government Department, that red tape will impede progress, and that nothing will get done except talking. I think the pessimists should take another look at the Broadcasting Committee's Report, where they will see that the object of the change is to remove a constitutional anomaly, and so far from putting barriers in the way of progress, this should remove any excuses for their erection.

As far as we can see, expansion and progress should go forward as before, and on the engineering side 1926 has seen the foundations dug for a great new plan.

Looking back on 1926, it is difficult to point to anything that is striking from an outsider's point of view. There was an expression used in the official communiqués during the war: "consolidating the position," and it would seem an apposite way of describing what has been done in 1926.

The maintenance service has continued, and familiarity with apparatus, less necessarily opportunist methods, and above all the willingness and intelligent co-operation of the engineering staff, have notably improved the service as far as our records show.

Thanks to the work of our company's "development" staff, a great many facts have been discovered, which, when and if the new scheme of distribution is put into force, will be extremely helpful.

At the beginning of the 1925 season, a year ago in fact, one of the chief difficulties standing in the way of getting perfect quality was the performance of transformers. In a service where quick operation and semi-automaticity in the performance of apparatus is essential, the elimination of transformers is a practical impossibility. Between the microphone and the transmitter there are, on the average, five transformers. Suppose each of these have a cut-off at, say, 100 vibrations a second of

80 per cent, then the five in cascade reduce the original value of the 100 cycle frequency from 100 to 40—a quite serious drop. Remembering that receivers use transformers with, perhaps, worse characteristics, it is no wonder that even the impulses delivered to the loud speaker are reduced to practically nothing at the higher and lower frequencies. Remembering that middle C on the piano is only 250 vibrations a second, it will be appreciated



THREE THOUSAND MILE SIGNAL

U.S. Radio House to be opened from London

Captain P. P. Eckersley, Chief Engineer of the B.B.C., who, by pressing a key in Radio House, London, opened the most up-to-date wireless fitted house in America. The house is situated at St. George Staten Island, New York. All the wires and aerial have been built in the walls, so that no wiring is shown at all

how important it is to obtain practically perfect performance in every transformer. To-day, at a sacrifice of efficiency, it is possible to deliver to the transmitter about 80 per cent of the original energy at 50 cycles per second in spite of the five transformers. This, while the public may be little aware of the fact, since loud speakers are not in general capable of dealing with the low notes, is a step forward: we only await the solution of the loud speaker problem.

Newer types of microphone have considerably improved quality. An adaptation, thanks to Capt. Round of the Marconi

Company, of the German Reiss microphone has enabled us not only to do away with a great deal of the complications incident to high magnification amplifiers used with the older types, but has also considerably improved quality by bringing in more of the bass notes in music and speech. The handiness, robustness, and reliability of this microphone has made maintenance easier, and again improved the service.

The great and growing problem of interference between European broadcasting stations has been tackled by an International Committee, on which the B.B.C. has been represented. The suggestion made by the author last spring that the less powerful stations and those in excess of the number that can be accommodated in the allotted waveband should share the same wavelength has been adopted, and the "Geneva Plan" of wavelength allocation, while it may not be ideal, is at any rate a beginning. This plan has been agreed to by the majority of European organizations, and it is hoped that its adoption, probably this October, will bring about a decrease in the annoyance caused by heterodyne interference.

In order, however, to ensure the success of the plan, it is essential that all stations should keep to their allotted exact wavelength, and methods have been adopted throughout this country whereby frequency will be accurate within at least three parts in 10,000. In certain cases an accuracy of one part in 100,000 has been achieved by an adaptation of the circuits used by the Post Office at their Rugby station, using an electrically maintained tuning fork to drive the station at an assigned frequency.

It is not impossible that these beginnings will lead to the possibility of using one wavelength for several stations transmitting the same programme, and so economizing the available spaces in the ether.

The system of linking stations together by means of the trunk telephone lines has considerably improved by the installation of new apparatus and the erection of line relay points. Thus, besides London, semi-automatic line operating boards have been installed at Gloucester for the West Country, Leeds for Northern England, Glasgow for Scotland and Belfast. If Plymouth, therefore, arranged to give a programme to Aberdeen, the systems at Gloucester, London, Leeds and Glasgow could each handle the transmission, boosting up its strength, correcting any distortions so that the quality on arrival will suffer no serious effects in spite of the great length of line. Before the installation of these systems great trouble was experienced, in spite of all the willing and excellent co-operation of the Post Office engineers, in keeping the lines free from noise and in maintaining pure quality.

Finally, one must not forget that the beginnings of Continental linking have been attempted by wire and wireless relay. The closing speeches of the League of Nations sessions were broadcast with some success in the spring of 1926; the comparative failure of the later attempt was more because of the nature of the broadcast than the technical difficulties.

It is hoped that the year 1927 will see a great deal of reorganization in the system of distribution; the year 1926 has laid the foundations for the success of the scheme.

WIRELESS AUNTIES AND UNCLES

YOUNG broadcast listeners are familiar with the voices of the Aunties and Uncles from at least one of the stations of the B.B.C. Most children have doubtless tried at one time or another to visualize the owners of the pleasant voices coming through the aether. On this account we are convinced that the photographs shown in the following pages will be of interest. When the idea of compiling this collection of photographs was first mooted, it was realized that it would only be possible by the cordial co-operation of the gentlemen concerned. We are pleased to say that our request met with a very courteous response from practically all the stations in the British Isles. In the one or two cases where photographs have been omitted, it has been occasioned by the fact that the Auntie or Uncle in question has not had a suitable photograph available. Practically all the main stations have, however, been covered. We take this opportunity of expressing our appreciation of the assistance rendered.

LONDON



(Guttenberg)

UNCLE HUMPTY DUMPTY
London



(Hay Wrightson)

UNCLE REX
London



(Bacon)

E. LYNCH-ODHAMS
London



(Pollard Crowther)

J. S. DODGSON
London

LIVERPOOL



COUSIN DORIS
Liverpool



UNCLE TOBY
Liverpool



(Dobson)
H. C. PEARSON
Station Director, Liverpool



AUNTIE MURIEL
Liverpool

CARDIFF



AUNT LILIAN
Cardiff



UNCLE WARWICK
Cardiff



(Hugo & Co.)
UNCLE FELIX
Cardiff



(H. J. Whitlock & Sons, Ltd.)
UNCLE NORMAN
Cardiff

NOTTINGHAM



UNCLE LAURIE AND AUNTIE RUBY (*E. P. Short & Son*)
Nottingham



(*E. P. Short & Son*)
UNCLE ROBIN
Nottingham



(*E. P. Short & Son*)
AUNTIE MABEL
Nottingham

MANCHESTER, LEEDS, AND BRADFORD



UNCLE JOHN
Manchester



(Hulton)
UNCLE VICTOR
Manchester



(E. P. Short)
EDWARD LIVEING
Station Director, Manchester



G. P. Fox
Station Director, Leeds and Bradford

BIRMINGHAM AND BOURNEMOUTH



UNCLE EDGAR
Birmingham



(Annan)

UNCLE BONZO
Birmingham



(Pollard Crowther)

J. G. BROADBENT
Bournemouth



UNCLE RAY
Bournemouth

DUNDEE AND ABERDEEN



AUNTIE BETTY
Dundee



UNCLE ERIC
Dundee



UNCLE BOB
Dundee



(Fred Hardie)
NEIL MCLEAN
Station Director, Aberdeen

A PESSIMISTIC VIEW OF BROADCASTING

By J. SWINBURNE. F.R.S.

It has often been said that broadcasting will improve people's taste in literature, and especially in music, and that it will, therefore, turn out to be of vast value as a means of educating and uplifting people generally. It may do no harm to look into this.

When what is called education was decreed for everybody, it was supposed that we would all be improved mentally and, perhaps, morally, and that the world would be made wiser. The real result is an enormous development of newspapers—bad newspapers, very bad newspapers, and much worse newspapers; and a tremendous output of bad fiction.

Cheap books were to make everybody literary. We used to be able to get Shakespeare complete, and, I think, the works of other poets for sixpence. No doubt many copies were sold; and a certain amount of good was done; but there is no reason to suppose that publishing classics, in cheap editions, helps the general public to educate itself up to them. Free libraries are intended to improve people; but they circulate mainly poor fiction. Free picture galleries are intended to cultivate the artistic side of the public. They are seldom over-crowded. The moving pictures often exhibit films of educational or informing value, but the majority are not of a very improving type. Though the picture palaces claim to be of great value, they are, really, frankly, money-making concerns.

Broadcasting consists of speech and music. The spoken portion may be special news, or little lectures, or speeches. The difficulty here is that the audience is extraordinarily general, that the time when most of them can listen is short, and that people can get such matter from magazines and newspapers, and can choose those they like.

As it cannot be got from magazines or newspapers, music becomes the staple produce of the stations. Before considering broadcast music, we may consider the effect of recent developments in other directions. Let us examine some of the recent changes in musical life. The two most marked are the phonograph, or gramophone, and the mechanical piano. They are both supposed to be powers of immense good in spreading musical culture. Though that can hardly be the result of machine pianos or reproducing machines, there is a great falling off of

piano-playing girls; this is a very good thing, as only those who are musical are encouraged to play now. The machine piano gives enjoyment to a large number of men who cannot play. I doubt whether any musical people enjoy hearing anyone else work a machine piano. Leaving these men aside, it is generally used for dance music, and it would be very difficult to show that it has developed musical taste or culture.

Military Bands.

Again in summer we have military bands in many of the public parks, supported by municipalities in order to give the public good music, and cultivate their taste. But the programmes of the average military band are quite beneath contempt. Presumably, the bandmasters know what their audiences like.

Demand for Jazz.

Another development is the craze for jazz music. There is no sign that machine pianos or reproducing machines have the slightest good effect on musical taste or cultivation. The bright spot is really the development of music among the boys in public schools.

The fundamental error underlying the theory of universal education, art and literature opportunities, cheap classics, and machine reproduced music, is the idea that people can be elevated or improved from the outside without any effort of their own. It is extraordinary how little effect lavish endowment has on the efficacy of education or even of research. When someone was very enthusiastic about the beautiful and perfectly appointed laboratories of a French savant, he replied: "Yes, but I get beaten every time by Ramsay, of London, working in a cellar."

Coming now to wireless, whose mission seems to be mainly the broadcasting of music; is it going to cultivate musical taste, and improve people? To begin with, people do not want to be improved. I do not want outsiders to improve me or to teach me; I want to improve other people, and teach them, and in that I am just like everybody else. Assuming that wireless is so perfect that all music, from a piano to a chorus with orchestra, is faithfully and perfectly reproduced, and music of the best kind is sent out nightly, what will be the result? No one can become a musician or even musical by merely hearing music. As a matter of fact, it is very difficult to listen to music, and only musical people can do so. Most people, even those who are quite fond of music do not listen, they merely let the music trickle through them; and no doubt many like to feel that they have heard this, or that, and we all feel superior to

those who have not heard what we have ; but that is vanity, not musicianship.

Arranging the Programmes.

How those responsible for the programmes are to choose, so as to suit everybody, is a mystery. In the case of newspapers, for example, ten million readers of all classes can choose their particular papers to suit their ignorances and prejudices. They will, generally, be not of the highest possible class. But suppose the ten million readers of all ranks, had to read one paper, how would it be edited ? Beyond pure news, it would be impossible to find matter that would interest the readers, unless it were bad enough to appeal to the taste of the majority of the ten million. If the paper were filled with improving reading, or had even a flavour of it, the readers would stop reading, or would make a fuss. How, then, are the authorities to choose their musical programmes ? It is commonly said that the public delight in good music whenever they have the chance of hearing it. If you play a movement of a Brahms symphony and a fox trot at a music hall, the audience will be enraptured with the Brahms item. This is mere popular nonsense. Even an ordinary musician, unless he has very special faculties, makes nothing of a Brahms symphony the first time he hears it ; and to a general audience, it is practically meaningless. People who want good art, good literature, or good music, have always been able to get it ; and the public has never been educated up by throwing pearls before it, however lavishly. We can be improved only from the inside. We cannot become musicians or even musical by means of machine pianos, rotating discs or cylinders ; or by sitting with telephones over our ears, or near loud speakers. No one can be improved, and he can improve himself only by hard work.

TELEVISION

By JOHN L. BAIRD,

TELEVISION may be defined as the transmission of images of scenes, or objects, to a distance by means of telegraphy, or wireless telegraphy, with such speed that they appear instantaneously to the eye.

Television has been greatly confused with photo-telegraphy, although the two subjects are quite distinct; in photo-telegraphy a photograph is sent by telegraph. This was first accomplished many years ago, and has been for some time in commercial operation.



FIG. 1. JOHN L. BAIRD
The first scientist in the world to
demonstrate television

It has also been stated that by a speeding up of photo-telegraphy until sixteen photographs per second were sent, television would be obtained. This is not the case. What would be obtained would be a cinematograph film by telegraphy or telekinematography, a quite different and much simpler thing to obtain than true television, which is the instantaneous transmission of the actual scene itself, events being seen while they happen.

The general principles by which television might be obtained have long been known.

An image of the object or scene to be transmitted is caused to traverse a light-sensitive cell, causing the current from this cell to vary in proportion to the light and shade of the image. This varying current is transmitted to the receiving station, where it controls a point of light traversing a screen in exact synchronism with the traversal of the image over the light-sensitive cell at the transmitter. If this process is repeated sufficiently rapidly, the eye will see the whole image reproduced instantly owing to persistence of vision.

The first part of the problem then was to devise optical

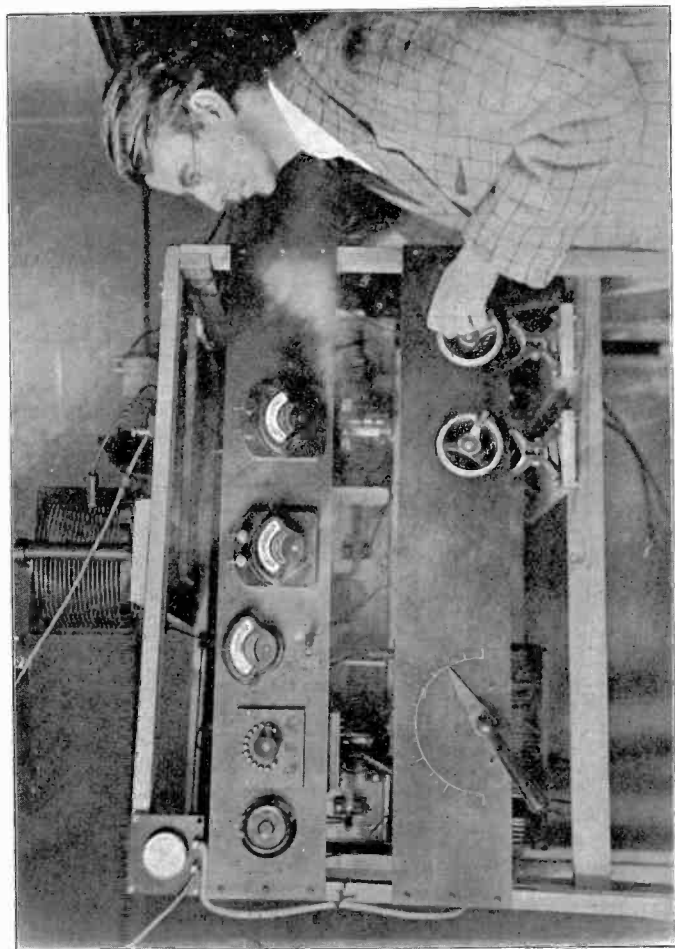

FIG. 2. THE TRANSMITTER AT 2TV

The world's first Television Broadcasting Station. 2TV has a wavelength of 200 metres and a power of 250 watt

apparatus which would cause an image of the scene to be transmitted to traverse a light-sensitive cell; that is to say, would divide the image into a great number of little sections and cause each of these sections to fall in succession on the cell. At the receiving station a similar optical apparatus could be employed to make a light point traverse a screen.

The early research workers were not long in partially solving this part of the problem, and a considerable number of inventions



FIG. 3. WIRELESS VISION DEMONSTRATED

J. L. Baird, the inventor, demonstrating the receiving "Televisor."
The living image appears on the screen similar to cinema films

were evolved. These, within limits, were quite satisfactory from the optical standpoint.

In many of these devices two mirrors vibrating at right angles to each other were employed, in others the exploring effect was obtained by shutters, and in one of the most outstanding systems, that due to Boris Rosing, a Russian scientist, the use of the cathode ray was suggested.

The early workers, however, in spite of the fact that they, to a considerable degree, solved the television problem from an optical standpoint, were unable to achieve any practical results. It was found that when an attempt was made to operate their devices, the selenium cell used was totally unable to respond to the immense speed of signalling involved.

Selenium has what is known as a "time lag" and does not instantaneously follow rapid changes of illumination.

So many hopes were wrecked on this barrier that the "time lag" of selenium became notorious in connection with television.

The development of the photo electric cell and the thermionic valve appeared to provide an alternative light-sensitive device, and in recent years many attempts have been made to substitute the instantaneously acting photo electric cell for the sluggish selenium.

When, however, the photo electric cell was used another difficulty, and a very serious one, made its appearance. The photo electric cell was unable to give a sufficient response to the exceedingly minute quantity of light available. This is a point which is not clear at first sight and requires a little consideration.

The light available at any instant is the light *reflected* from a very small area of the object being transmitted. If this object is, for example, the human face, then the light falling on the cell would be the light radiated from an area of say $\frac{1}{8}$ inch square of the face, and when it is realized that the total light reflected from a human face brightly illuminated is less than a single candle-power, the immense sensitivity demanded will be understood.

The three electrode valve provides an enormously powerful amplifier, but there is a limit to the amplification obtainable—a point being reached when irregularities in the filament emission of the first valve become audible; enormous amplifications are obtainable before this point is reached, but the current from the cell is far beneath the limiting value.

While, however, the photo electric cell proved insufficiently sensitive for television, it enabled moving shadows to be transmitted. In a shadowgraph the light is not reflected, but transmitted, so that the full light of the light source, which may be several thousand candle power, falls directly upon the cell. The



FIG. 4. THE FIRST PHOTOGRAPH EVER TAKEN BY TELEVISION

This is an untouched photograph of the image on the screen of the "Television"

cell then has only to distinguish between total darkness and a light which may be almost as intense as we can make it.

About four years ago I decided to devote my whole time to an attempt to solve the television problem. Very fortunately, at the outset, my funds were limited, so that everything in the nature of elaborate devices was out of the question, and I was compelled to reduce the problem to its simplest possible form. After some six months' work I was rewarded by the successful transmission of moving shadows. The comparative ease with which this first step was made raised hopes, which were somewhat damped when an endeavour was made to make the step from shadows to objects by reflected light. This proved a most difficult matter and it was only after some twelve months' continued research that I was able to make the step and show images of actual objects.

The results achieved were very crude, only simple black and white effects being obtainable, without detail or light and shades.

These results, however, were not shadows, but images by reflected light, a very important point. A number of demonstrations were given and quite considerable interest aroused; the results were, however, very crude, and the general opinion was that many years would elapse before it would be possible to achieve true television and transmit an image with gradations of light and shade and detail.

This opinion was not unjustified. The difference between a mere black and white outline and a true image with gradations of light and shade and detail is immense.

Optical and mechanical improvements on the very crude apparatus first employed rendered the outlines clear and sharp and well defined, but they were still only outlines. The human face, for example, appeared as a ragged white oval, and opening and shutting the mouth caused a black slot to appear and disappear. The profile could be seen, but looked like a white silhouette. No half tones were reproduced, and without half tones a true image was, of course, impossible.

The trouble lay not in the optical or mechanical part of the apparatus, but in the light-sensitive device, and most of my time was occupied in an endeavour to improve this.

It was not, however, until October, 1925, that success was achieved. Towards the end of that month, on a Friday afternoon, I experienced the only real thrill which research work has so far brought me.

The night previously, I had carried out some tests with my then latest light-sensitive device, and, according to results obtained, realized that a great advance had been made, and that, in theory, all that was required to overcome the final barrier was to fit this to

the transmitting set, but I had so often previously found solutions which, in theory, seemed perfect, prove quite futile in practice that it was not with any unbounded hopes that this latest experiment was made.

This time, however, all went well on starting up the machine. Instead of the accustomed white outline, there appeared on the screen a true image, with detail and half tones. The face first seen by television was the face of "Bill," a ventriloquist's dummy, used as a model.

These first images were very flickering and imperfect, and have been compared to the earlier cinematographs. The defects, however, are matters of mechanical, optical, and electrical detail, and are steadily being eliminated.

The question which is being continually asked is, when will television be available to the public. The answer to this question depends chiefly upon commercial factors. The step from the laboratory to the open market entails a vast amount of detail and development work. The financial side must also be organized. All these things take time, but, summing up, I will take the risk of prophesying that "Televisors" will be on sale before the end of the ensuing year.¹

The year 1927

HOW TO BUY A WIRELESS SET

PITFALLS FOR THE NOVICE

By " MENTOR "

BUYING a horse and buying a pup are both dangerous undertakings, but buying a wireless set when you do not know the difference between a heterodyne and a cabbage is—well, more dangerous still. Seriously, though, a lot of money can be easily and needlessly expended when the uninitiated sally forth to buy wireless goods. Wireless is a scientific toy, and naturally the ordinary person cannot be expected to know all about it straight away.

The first and most important thing to do, before even looking in the local wireless dealer's window, is to sit down and decide how much money is to be spent on the set. In wireless, as in everything else, you reap what you sow and get what you pay for; if good quality is paid for in the first instance it rewards the owner by giving him better quality music, longer life (its own life, you know, not the owner's), and freedom from trouble.

How Much Money ?

As a first and approximate—very approximate—guide, the following shows what money will buy in the wireless world—

Crystal set	15s. to £3
One-valve set	£3 to £9
Two-valve set	£7 to £12
Three-valve set	£12 to £23
Four-valve set	£20 to £40
Five-valve set	£28 to £50.

The above prices vary somewhat in range and, at first sight, do not look very helpful. They are extracted from some fifty advertisements in recent technical journals, and so range from the lowest-priced reasonably good quality sets to first-class luxury instruments. The prices take in everything necessary for ordinary working, except telephones or loud speaker. Cheap "junk" telephones might be bought for five shillings, or five pounds expended on a good loud speaker, so that inclusion of that item would upset the prices still more.

Size of Set Necessary.

The next point to consider is the distance from the local broadcasting station and the range of stations you will want to listen to. On that naturally depends the size of set required. A good crystal set will give reasonable reception up to 25 miles from a main broadcasting station, 10 miles from a relay station and 100 miles from Daventry. A one-valve set will give about the same results. Two valves will increase the range to, say, 60 or 80 miles from a main station and will receive Daventry, on the telephones, from almost any part of the country. Three valves will give a headphone range of 200 miles, while four or five valves will give you almost anything you want to hear in Europe.

To work a loud speaker satisfactorily two extra valves should be provided. That is to say, if local circumstances require two valves for headphone reception, four valves will be wanted to work a good sized loud speaker. The range will also depend on the type of aerial used; an indoor aerial cuts down range considerably and for a crystal set is useless, unless it happens to be within a mile or so of a broadcasting station.

"Bargains" by Post.

No doubt some of the sets offered in advertisements by firms at the other end of the country at cheap prices are reliable, but, equally without doubt, a considerable amount of rubbish is disposed of in this manner. It is a case of the good firms unfortunately having to suffer for the sins of the evildoers, but, unless the firm is well known and reliable, it is safer to hold on to your money. In any case, no firm of repute will object to sending the goods on credit, if satisfactory references are given, and the firm which insists on cash with order will probably be a firm with hard-faced tendencies should anything prove to be wrong with the set on arrival.

Another point to consider in connection with sets from afar, is the question of whether the price is for a *complete* set. The price may be just for the instrument itself and when it arrives the unfortunate buyer will have to get valves, accumulators, high-tension battery, telephones and/or loud speaker, aerial and earth. These extra items can readily swallow up £10, so that what appeared to be a "cheap" set in the first place may prove to be decidedly the reverse.

Consult Your Local Dealer.

It is far more satisfactory to walk round to your wireless shop, tell the dealer gently, but firmly, the amount of money you propose to spend, and not exceed, and let him give an estimate

of what he proposes for that amount. Any temptation to spend more than the allotted sum should be firmly repressed—however persuasive may be the argument that the little extra will "make a world of difference."

Then, having obtained some idea of what can be bought for the money, the advice of an experienced and level-headed wireless friend should be sought. Like anglers, wireless friends are not usually shy of discussing their hobby. You can take him round to the shop and let him examine the various alternatives proposed. Or if no friend is available and the wireless dealer is straightforward—as most of them are—you can ask his advice as to what to buy, on a clear understanding of "money back without question if not satisfied." Another advantage of dealing with your local man instead of the post individual at the other end of the country is that the former has a certain local reputation to maintain. But if he should let you down, you have got him there in person, bricks and mortar—somebody to growl at, at any rate.

Easy Payments.

The tendency to use the easy-payment system is growing rapidly nowadays, and has already extended to wireless sets. The deposit usually ranges between £1 and 10 per cent of the total cost, the balance being split up into twelve instalments, plus interest, spread over a year. The seller will require satisfactory references, and it must be borne in mind that, under the usual hire-purchase agreement, the set is the property of the seller until the *final* instalment is paid. So do not set out on the rocky road of "easy" payments unless there is a certainty that all the instalments can and will be paid regularly.

Choice of Alternatives.

The wireless dealer will probably ask the would-be purchaser a few technical questions as to whether he prefers this or that in a set. As this usually sounds like a Dutch viva voce examination to the novice, the following notes deal with some of the points likely to arise.

Dull or Bright Emitter Valves ?

Dull emitter valves are more expensive, but can be worked off smaller accumulators, as they consume less current, so that actually a new set can be sold more cheaply with dull emitters than with bright valves. Some experienced amateurs still cling to their old bright valves, believing that better results are obtained thereby, but for the man-in-the-street dull emitters are more satisfactory. The accumulator will last two or three

weeks per charge instead of one week with bright valves and so save money in constant re-charging.

Telephones or Loud Speaker ?

This is always a vexed question, and probably 80 per cent start off with about three sets of headphones, thinking they will never want a loud speaker. Sooner or later, the craving for one overcomes them, so they buy loud speakers, and are then left with superfluous sets of headphones—money wasted. So, unless you feel strong-willed enough to withstand this awful craving for more noise, it is better to take the bull by the horns and buy a loud speaker set in the first place.

Indoor Aerial or Outdoor ?

If facilities are available, choose an outdoor aerial every time. It seems very nice to have one of those portable sets to carry around from room to room, but a set with a good outdoor aerial will give two or three times the signal strength and prove far more satisfying to the owner in the end. If the listeners then still want to move about the house, extension wires, as explained elsewhere in this book, can always be laid to the various rooms required.

Crystal or Single Valver ?

In results, a good crystal set is about equal to a one-valve set. But the crystal is a better proposition in that it is cheaper to run (no battery recharging costs) and gives purer quality reception.

Straightforward Circuit or Complicated ?

There is a choice of having a set with a circuit constructed on what we call "straightforward" lines or a complicated set, which indulges in reflex circuits, super-heterodynes, etc. But the chief thing the new-comer wants—and he should firmly impress this on the dealer—is a set that is controlled simply and quickly, by one switch and one knob, which can be tuned in by the family and anyone without technical knowledge.

Quality.

And, lastly, but by no means least, remember that it pays to buy first-class quality in the beginning. If poor components are used, it cannot be expected of them to give the same class reception and tone as those parts which are carefully designed and properly made. To save only a few shillings by buying shoddy parts is only laying up a store of disappointment for the future. And so, impress on your local dealer that you want quality as well as quantity.

WOMEN AND WIRELESS

THE WOMAN'S VIEWPOINT

By "MRS. MENTOR"

WERE I feeling in a vindictive mood, I might start off by declaring that man, in his usual manner, has made an attempt to "corner" wireless as his own hobby and one entirely above the ken of women—but I had better not say that, because it is not strictly true. But, all the same, there is a certain popular notion about that wireless is a man's game and for men only.

When there is talk of buying a piano or a gramophone, the wife rightly has a large say in the matter, seeing that it is an article of furniture for the home. A wireless set is also a musical instrument and an article of furniture, so that the woman of to-day is taking a far greater amount of interest in wireless than she did two or three years ago.

It is rather ancient history now, but I would like to mention that the feature that impressed me most when Mentor (or should he be called *Mr.* Mentor, with due respect?) and I went to the Wireless Exhibition at Olympia last September was the large proportion of women present. And they were not mere onlookers. Many, bedecked with tortoise-shell glasses, talked freely about anti-cap switches and super-hets with all the assurance in the world.

A Cheap Entertainment.

But the women *enthusiasts* are, of course, in the minority. Most women welcome wireless because it gives a cheap form of entertainment during the day-time when the husband is out (no, I do not mean anything sarcastic by that). Personally, I am in a flat all day long (no children or dogs), and so appreciate how time can drag on one's hands after midday—as thousands of women who live lonely lives can testify.

If you leave a man alone for an afternoon, he is thoroughly tired of his own company by the time you return, and if left alone to mind house for an evening his looks grow very black indeed. With his business and the men he comes into conversation with during the day, he cannot realize that it is possible for a wife to feel lonely. Now, with the wireless, it can be switched on (if you have a loud-speaker—and one is advisable, if possible, as telephones are uncomfortable and tearing to the hair) and you can do whatever else you may be up to with the enjoyment of listening to music at the same time. I do not

understand the inside of a wireless set much—one person in a house with such inclinations is enough—but with a modern set it is usually only a question of switching on one, or two, switches when the broadcasting commences.

So I hope that any men who read this will realize—

1. That if they have not got a wireless set already, they owe it to their wives to get them one (if they are lonely and have a fancy for wireless).

2. That the wife should be permitted to have a voice in the choice of the set, and

3. That it is controlled on simple lines, and no complicated tuning is necessary.

The Ideal Hobby.

Wireless forms an ideal hobby for a man because it is one of the few pastimes which give enjoyment to the rest of the family. He can buy his set ready-made or attempt to fix it up himself, but in either case the result is the same, if he put it together properly—it will give enjoyment to family and friends to a far greater extent than collecting stamps or any extraordinary form of amusement like that.

It also keeps him at home. Whether that is an advantage or not, circumstances must decide, but in the majority of cases it is, of course. Likewise, most men are naturally home-lovers and dislike going out or away, and wireless gives them an interest in the outside world and something to occupy their minds during the evening. There is always, of course, the danger that he may develop a wild enthusiasm for the wireless, become what the Americans term a "radio bug," and neglect the odd jobs he ought to do about the house, but even that is no worse than having a golfing or angling husband.

Women and Tuning-in.

There is really no reason why a woman should not be able to work a wireless set at least as intelligently as a man. Our fingers can manipulate nuts and terminals in a way no man could dream of (watch the way they thread needles, for example—or try to). And tuning-in is not so difficult. As said above, it is better to obtain the sort of set which is controlled by one knob, but even if other things have to be manipulated as well, it is not a very difficult art, and one soon picked up.

In fact, I know of one or two women who can tune in better than their husbands. Whether this is because we are more delicately made, and so have a lighter touch, or whether it is because we just *do* these things by intuition, without studying

the theory of the thing. I will not disclose. But the fact remains and no woman need fear that the ordinary modern wireless set is beyond her control.

Safety.

There is one other point which makes some women hesitate before allowing wireless in the home. There is no danger. It is most unlikely that lightning will strike your aerial, and in proof of this there is the fact that insurance companies charge no extra premium for the wireless-equipped house. If there were danger, you may be sure they would charge for it.

Wireless and Invalids.

And for invalids, there is nothing to compare with a wireless set. If you have illness in the house and the patient is reaching that restless, convalescent stage, when books become a bore, install the wireless, even if it is only a crystal set with a picture-rail aerial. The tedious hours can be passed away listening, and time ceases to drag. Then there is the mental effect it has on the invalid. It not only takes his mind off his troubles, but, if the music is bright, as it often is, it has a cheering effect, and gives a feeling of being in touch with the world again that all helps towards recovery.

Wireless in the Home.

And, as a last word to any that read these lines, and do not (*yet*) possess a wireless set, think it over seriously—and get one. It is a delightful form of cheap entertainment, it forms a fascinating hobby, and gives something, at least, to occupy one's mind.

One of my particular vices is listening-in in bed—a delightful pastime, and, being a comfortable spot, the ideal one to enjoy music. So when you do have the wireless, which will not be long now, I hope, see that your husband, or son, or whoever fixed it up for you, lays extension wires to everybody's bedside. It will probably mean that "poor old father" will have to go downstairs last thing at night to turn the set off, but perhaps he will not mind doing that, for the sake of the enjoyment he will get himself out of listening-in. All goes well then until the inevitable night when he treads on a needle in his bare feet and imagines (as they invariably do, poor darlings!) that it has been put there maliciously, with the deliberate intention of pricking him! But even if storms like that do occur to "spoil reception," wireless in the home is beloved by all the members of the family in turn and, in my opinion, has done more than any other modern invention to make possible the "Ideal Home."

WIRELESS IN THE HOSPITALS

We have received the following message from Mr. Hugh Jones, the Managing Editor of the *Daily News*, and organizer of the *Daily News* "Wireless for Hospitals" Fund—

To the Editor of the "Radio Year Book"—

Those who suffer in our hospitals are entitled to every benefit science can give and every luxury man can afford. A generous public subscribed £34,339 to the *Daily News* fund to equip the London hospitals with wireless. From now on, a hospital without wireless is like a house without windows.

J. HUGH JONES.

A detailed account of the activities in connection with the fund will be found in the following pages.

Having visited hospitals which have been equipped under this scheme, and having heard from patients' own lips how greatly the "wireless" is appreciated, we have nothing but admiration for the way in which this courageously conceived project has been brought to a successful issue.

WIRELESS IN THE HOSPITALS

A WONDERFUL ACHIEVEMENT

ABOUT eighteen months ago wireless in hospitals was looked upon in the light of rather a novelty. A few hospitals had been equipped, chiefly with loud speakers, but the results were not altogether satisfactory. When Mr. Hugh Jones, the managing editor of the *Daily News*, was discussing this matter some time ago with the secretary of one of the largest London hospitals, he asked, "How is it that wireless has not been introduced into hospitals in any considerable or effective way?" The reply was given instantly, "Because, where it has been introduced, it has been accompanied by a loud speaker, and a loud speaker in a hospital ward is a bigger nuisance than a blessing."

The above question and answer contained the germ of what has proved to be one of the biggest ideas in connection with wireless broadcasting. Mr. Hugh Jones was quick to realize that the chief difficulty which had been in the way of the general adoption of wireless in hospitals lay in the fact that it was very rare that all the patients in any given ward would be able to listen to a loud speaker at the same time. The obvious solution to this was, of course, to provide headphones for each patient, but this introduced other difficulties, viz., (1) the question of cost, which it was readily seen would be very considerable, and (2) the difficulties from a wireless engineering point of view, as the problem presented many features, entirely novel, which had never been tackled before. The way in which Mr. Hugh Jones enlisted the active support of a very large number of influential people makes a very interesting story. Mr. Hugh Jones called the next day to see Mr. Reith, the managing director of the B.B.C., and asked what he thought it would cost to equip a hospital with wireless, wiring the hospital completely, and providing headphones at each bedside. "That is a very big and problematical question," said Mr. Reith. "When do you want to know?" Mr. Hugh Jones said he wanted to know at once. Mr. Reith smilingly picked up the telephone receiver and spoke to a number of departmental heads, and in a very few minutes worked out on a sheet of paper that, in his opinion, the job would cost from 40s. to 50s. each bed. Mr. Reith finally said, "If the *Daily News* is going to get on with this job, I will promise you every bit of assistance it is possible for the B.B.C. to give." Mr. Hugh Jones's next visit was to Lord Knutsford, the Chairman of the London Hospital, who said, "Wireless is a luxury, and we

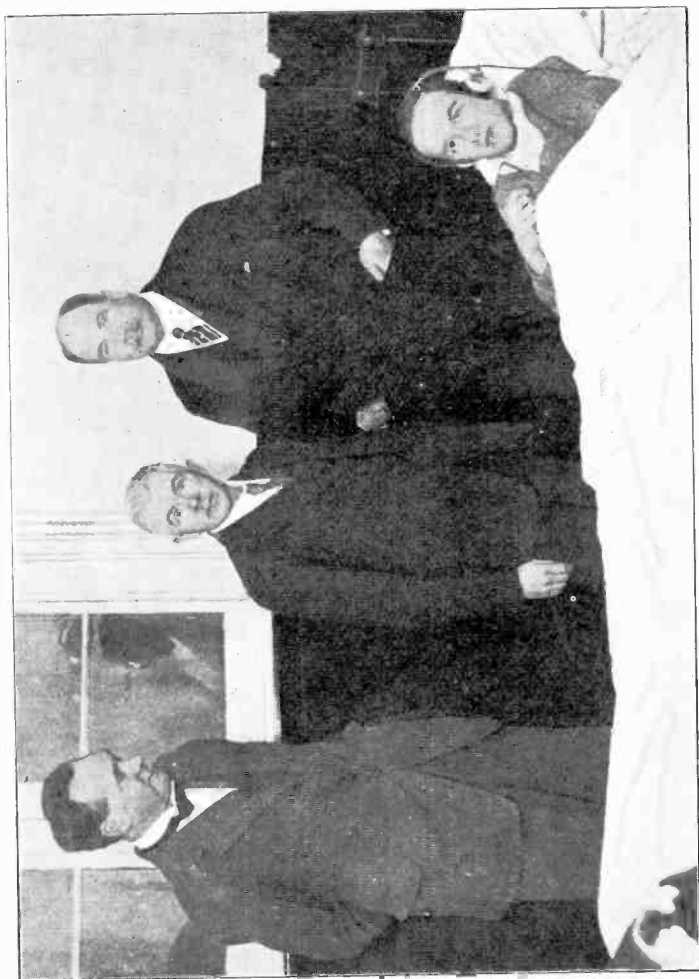

FIG. 1. MR. HUGH JONES, THE RT. HON. J. R. CHAYNES, M.P., AND THE EARL OF DERBY AT THE BROMPTON HOSPITAL FOR CONSUMPTION

cannot get the money we want for normal hospital needs, without going in for luxuries of that kind, but if the *Daily News* can get this money, without interfering with our subscriptions, I am with you, heart and soul."

After having thus ascertained the views of the Broadcasting Authorities and of the Hospital Authorities, Mr. Hugh Jones approached, on behalf of his paper, Princess Louise, Duchess of



FIG. 2. MRS. WINSTON CHURCHILL AND PRINCESS MARY
AT THE BRITISH HOSPITAL FOR MOTHERS AND BABIES

Argyll, who kindly consented to become the President of the *Daily News* Wireless for Hospitals Fund.

The Fund was launched with a gift of £500 from the *Daily News*. Mr. Jones then paid a visit to Buckingham Palace to bring the proposal to the notice of H.M. the King. Two hours after Mr. Jones's visit he received a message saying that both the King and Queen were delighted that such a beneficent project should have been launched, and that they wished to give personal donations of £100 and £50 respectively. The late Queen Alexandra then wired from Sandringham subscribing £50, and wishing the Fund all possible success. Following quickly upon this a cablegram was received from the Prince of

Wales, who was then travelling in the Orange Free State, near the Basuto Mountains. The cablegram contained good wishes for the Fund and promised that the Prince would subscribe £50 to the Fund. The Duke and Duchess of York also subscribed £25, and showed very great interest in the scheme. With such support the success of the Fund was almost assured from the



FIG. 3. THE EARL OF ONSLOW AND MRS. HUGH JONES
AT THE GENERAL LYING-IN HOSPITAL

commencement. However, the *Daily News* spared no efforts to make it not only a success, but an outstanding success. Several schemes and competitions were devised with the object of adding still further to the Fund. Commercial houses, banks, and notably the wireless manufacturers, gave active support to the Fund, which rapidly assumed very large proportions. The actual growth is shown by the list appended.

It was soon realized that expert guidance would be needed to administer the Fund to the best advantage. An advisory committee was, therefore, set up. One of their first tasks was to appoint a technical sub-committee, comprising Professor Eccles,

Mr. B. F. Crosfield, and Captain Eckersley, to draw up a standard specification, which would ensure a uniformly good quality and effectiveness in the equipment. This specification alone forms an important step forward in the history of broadcasting. One of the experts to whom it was submitted said that it was about 25 years in advance of its time. Nevertheless,



FIG. 4. BILLY MERSON AT CHARING CROSS HOSPITAL.

all the 120 hospitals which have been equipped by the *Daily News* Wireless for Hospitals Fund have been equipped to this standard specification. In addition, copies of the specification have been supplied to over 300 provincial hospitals. The specification has also been worked to in the equipping of the Pittsburg General Hospital and for equipping hospitals in China, India, Australia, and every European country. It is, therefore, true to say that in addition to the hospitals which have actually been equipped by the *Daily News* Fund, hundreds of hospitals all over the world have benefited enormously by

the pioneer work which has been done by the organizers of this scheme.

The above is a skeleton outline of the work done by the *Daily News* Wireless for Hospitals Fund during the past eighteen months.

A Tour Round the Wards.

It has been the writer's privilege to visit one or two hospitals to see the wireless installations in actual use. At Charing Cross Hospital, where the scheme was first evolved, Mr. Philip Inman, the Hospital Superintendent, kindly accorded permission and



FIG. 5. JACK HOBBS AT THE NELSON HOSPITAL

facilities for viewing the wireless equipment. The writer, after a short preliminary interview, was placed in the charge of a pleasant young lady who piloted him first of all to some of the children's wards, in which loud speakers were installed. It so happened that at the time of the visit a "School Talk" was being broadcast. As the children's ages ranged from about three months to about five years, they were not showing a very keen interest in the words of wisdom, which were issuing from the loud speaker. The sister in charge of the ward was most enthusiastic in her praise of the wireless. She said that the items the babies seemed to enjoy most were the musical items, especially tunes in which they could join by singing.

The next ward visited was a woman's ward. Here the

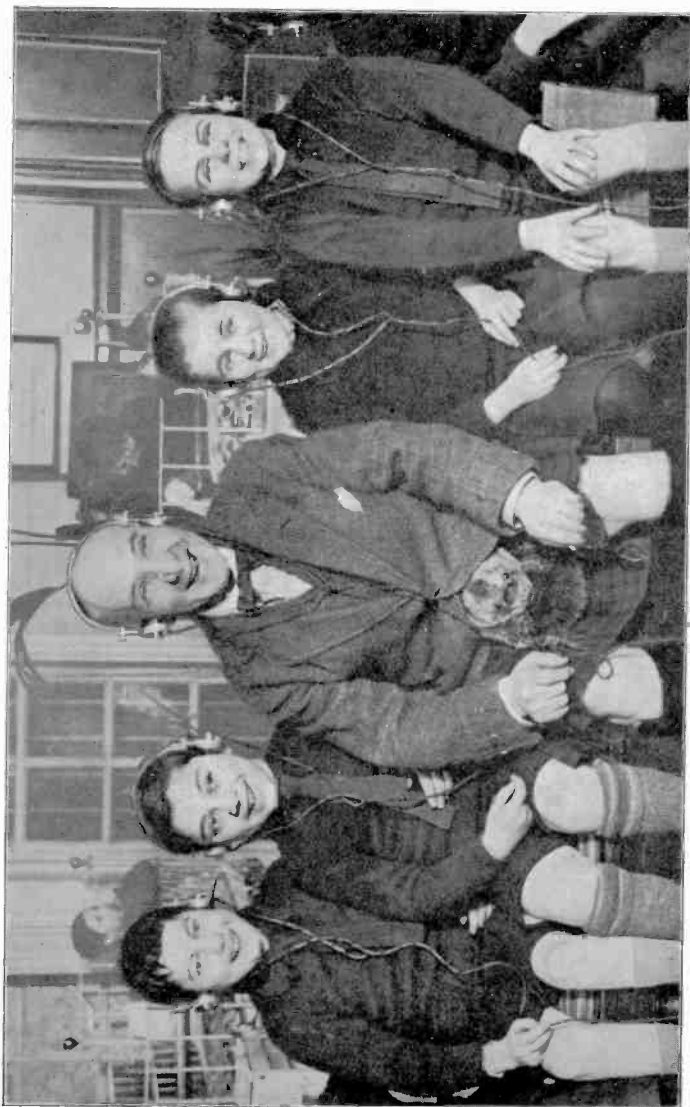

FIG. 6. SIR HARRY LAUDER AT THE CHEYNE HOSPITAL



FIG. 7. THE RT. HON. SIR WILLIAM JOYNSON-HICKS, BT., M.P.,
AT THE PRINCE OF WALES'S GENERAL HOSPITAL

writer had a chat with one of the patients. "What do you think of the wireless?" The reply was to the effect that it was an inestimable boon. Practically all the patients in the ward used the headphones regularly, especially for the musical items. The only "fly in the ointment" was that the hospital regulations were that the wireless must be switched off at 8 o'clock



FIG. 8. JOHN HENRY AND "BLOSSOM"
AT THE S.E. CHILDREN'S HOSPITAL

in the evening. It was, however, whispered that cases had been known where patients had managed to listen under the bedclothes after that time. A similar state of affairs existed in all the wards, although, owing to the size of the hospital, it was impracticable for every ward to be visited.

On this particular afternoon, the reception in some of the



FIG. 9. MRS. LLOYD GEORGE AND VISCOUNT LASCELLES AT THE WEST END HOSPITAL FOR NERVOUS DISEASES

wards was rather below normal strength, so that there was a slight strain required to catch all the words distinctly. The patient who drew the writer's attention to this, hastened to explain that she was not complaining of the wireless, but it was so very much appreciated, and usually so good, that any little deterioration was quickly noticed by all the patients in the ward. As my projected tour through the hospital included a visit to the presiding genius of the wireless, the chief engineer, I promised to mention this in the right quarter.

My guide then piloted me down to the basement, where, after some little time, the engineer was discovered. The engineer of a large hospital has a great number of varied duties. He has to be responsible for all the electrical equipment, to be able to effect minor repairs to the weird and wonderful apparatus which is used in modern hospitals, and also to see that the heating arrangements, and the other necessary adjuncts, such as lifts, are kept in perfect running order. In addition to this, since Mr. Jones's campaign has come to a successful issue, the hospital



FIG. 10. MRS. BALDWIN AT KING'S COLLEGE HOSPITAL

engineer has added to his duties that of keeping the wireless installation in perfect condition. I was, therefore, rather expecting to find the engineer would look upon the wireless installation as something of a nuisance. On the contrary, however, I found that far from considering it a nuisance, the engineer displayed a keen interest in it. He took us to the top of the building again, to his wireless cabinet, where, in a room about twice the size of a sentry box, was installed an "Ethophone" four-valve receiver, a high tension battery, accumulators, charging panel and instruments to enable him to make daily tests to ensure that the batteries were in good condition. A switch was provided to allow of the low tension

accumulator being charged, when necessary, without any disturbance to the set. Only three valves were in use at the time, as the engineer explained that it was seldom found necessary to cut-in the fourth valve. He made the necessary adjustments to increase the strength of reception for the evening programme. I noticed that the engineer had a loud speaker in the basement



FIG. 11. A CARTOON BY LOW

continually in operation, so that he could tell immediately whether the reception was satisfactory.

The tour concluded with a visit to the sunlight room of the hospital where, underneath powerful arc lamps, patients who need ultra-violet ray treatment sit in a room for perhaps two hours at a time. As the rays from the arc lamp are injurious to the eyes, all patients must wear goggles, so that reading is out of the question. In this case, the provision of a loud speaker has proved a wonderful boon. It enables patients to pass what would otherwise be a monotonous two or three hours, in a manner both beneficial and enjoyable.

Through the courtesy of the *Daily News*, we are enabled to publish the following interesting particulars connected with the Fund—

List of hospitals equipped with wireless installations under the auspices of the Fund—

	No. of Beds
All Saints' Hospital, Finchley-road, N.W.8	45
Anti-Vivisection Hospital, Battersea Park, S.W.11	60

	No. of Beds
Beckenham Cottage Hospital	43
Belgrave Hospital for Children, Clapham-road, S.W.9	66
Bethlem Royal Hospital, Lambeth-road, S.E.	220
Blackheath and Charlton Hospital, Shooter's Hill-road, S.E.3	26
Bolingbroke Hospital, Wandsworth-common, S.W.11	124
British Home and Hospital for Incurables, Streatham	139
British Hospital for Mothers and Babies, Woolwich, S.E.18	55
Brompton Hospital for Consumption	337
Cancer Charity of the Middlesex Hospital, Nassau-street, W.1	94
Cancer Hospital (Free), Fulham-road, S.W.3	153
Carshalton, Beddington & Wallington War Memorial Hospital, Carshalton Park	40
Central London Ophthalmic Hospital, St. Pancras, W.C.1	64
Central London Nose, Throat and Ear Hospital, Gray's Inn-road, W.C.1	43
Charing Cross Hospital, West Strand, W.C.2	285
Chelsea Hospital for Women, Arthur-street, S.W.3	78
Cheyne Hospital, Cheyne-walk, Chelsea, S.W.3	68
Chiswick Hospital, Netheravon-road, W.4	42
City of London Hospital for Diseases of the Heart & Lungs, Victoria Park, E.2	196
City of London Maternity Hospital, City-road, E.C.1	100
Colindale Hospital, Hendon	342
Dr. Barnardo's Home for Crippled Girls, Blackheath	15
Dreadnought Hospital, Greenwich	250
East London Hospital for Children, Shadwell, E.1	130
Elizabeth Garratt Anderson Hospital, Euston-road, N.W.1	95
Eltham and Mottingham Cottage Hospital	22
Finchley Memorial Hospital, Bow-lane, North Finchley, N.12	47
Florence Nightingale Hospital for Gentlewomen, Lisson-grove, N.W.1	50
Freemasons' Hospital and Nursing Home, Fulham-road, S.W.3	34
General Lying-in Hospital, York-road, Lambeth, S.E.1	56
German Hospital, Dalston, E.8	154
Gordon Hospital, Vauxhall Bridge-road, S.W.1	40
Grosvenor Hospital for Women, Vincent-square, S.W.1	51
Guy's Hospital, London Bridge, S.E.1	616
Hampstead General Hospital, Haverstock Hill, N.W.3	130
Hornsey Cottage Hospital, Crouch End, N.8	51
Hospital for Consumption and Diseases of the Chest, Brompton, S.W.3	337
Hospital for Diseases of the Throat, Golden-square, W.1	75
Hospital for Epilepsy and Paralysis, Maida Vale, W.9	96
Hospital for Tropical Diseases, Endsleigh-gardens, N.W.1	70
Hospital for Women, Soho-square, W.1	100
Hostel for Invalid and Crippled Women Workers, Champion Hill, S.E.5	45
Hostel of St. Luke, Fitzroy-square, N	50
Invalid and Crippled Children's Society Hospital, Plaistow, E.13	26
Italian Hospital, Bloomsbury, W.C.1	53
Jewish Home and Hospital for Incurables, Tottenham	130
Kensington, Fulham and Chelsea General Hospital, Earl's Court, S.W.5	32
King Edward Memorial Hospital, Ealing, W.5	72
King's College Hospital, Denmark Hill, S.E.5	466

	No. of Beds
Lewisham Hospital, High-street, Lewisham, S.E.13	336
London Fever Hospital, Islington, N.1	178
London Homœopathic Hospital, Great Ormond-street, W.C.1	154
London Hospital, Whitechapel-road, E.1	843
London Jewish Hospital, Stepney Green, E.1	88
London Lock Hospital and Home, Harrow-road, W.9	162
London Lock Hospital and Home, 91 Dean-street, Soho, W.1	42
London Temperance Hospital, Hampstead-road, N.W.1	115
Metropolitan Ear, Nose and Throat Hospital, Fitzroy-square, W.1	22
Metropolitan Hospital, Kingsland-road, E.8	152
Middlesex Hospital, Cleveland-street, W.1	195
Mildmay Mission Hospital, Bethnal Green, E.	52
Miller General Hospital, Greenwich-road, S.E.10	155
National Hospital for Diseases of the Heart, Westmoreland-street, W.1	46
National Hospital for the Paralyse and Epileptic, Bloomsbury	200
Convalescent Home, East Finchley	36
Nelson Hospital, Merton, S.W.20	59
"Northcourt" Hospital and Home for Sick Children, Hampstead	64
Passmore Edwards Hospital, New Southgate, N.11	77
Poplar Hospital for Accidents, Blackwall, E.14	104
Prince of Wales's General Hospital, Tottenham, N.15	185
Putney Hospital, Lower Common, S.W.15	27
Queen Alexandra's Military Hospital, Millbank, S.W.1	266
Queen Charlotte's Maternity Hospital, Marylebone-road, N.W.1	75
Queen Mary's Hospital for the East End, West Ham, E.15	158
Queen Mary's Convalescent Auxiliary Hospital for Limbless Soldiers and Sailors, Roehampton, S.W.15	500
Queen's Hospital for Children, Bethnal Green, E.2	138
Radium Institute, Portland-place, W.1	34
Roehampton Sick Sisters Hospital	16
Rosa Morison House of Recovery, Barnet	40
Ross Tropical Institute	15
Royal Eye Hospital, Southwark, S.E.1	42
Royal Free Hospital, Gray's Inn-road, W.C.1	250
Royal London Ophthalmic Hospital (Moorfields Eye Hospital), City-road, E.C.1	138
Royal National Orthopædic Hospital, Great Portland-street, W.1	180
Royal Northern Hospital, Holloway-road, N.7	220
Royal Chest Hospital, City-road, E.C.1	104
Royal Northern Hospital of Recovery, Southgate, N.14	85
Royal Waterloo Hospital for Children and Women, Waterloo-road, S.E.1	100
Royal Westminster Ophthalmic Hospital, West Strand, W.C.2	60
St. Andrew's Hospital, Dollis Hill-lane, N.W.2	47
St. Bartholomew's Hospital, West Smithfield, E.C.1	697
St. George's Hospital, Hyde Park Corner, S.W.1	342
St. John's Hospital, Lewisham, S.E.13	90
St. John's Hospital for Diseases of the Skin, Uxbridge-road, W.12	34
St. Joseph's Hospice for the Dying, Hackney, E.8	115
St. Mark's Hospital, Paddington, W.2	340
St. Mary's Hospital for Women & Children, Plaistow, E.13	60
St. Monica's Home for Sick Children, Brondesbury, Park, N.W.6	24
St. Paul's Hospital, Endell-street, W.C.2	37
St. Peter's Hospital, Covent Garden, W.C.2	46
St. Thomas's Hospital, Albert Embankment, S.E.1	560
Samaritan Free Hospital for Women, Marylebone-road, N.W.1	76

	No. of Beds
Santa Claus Home, Highgate, N.6	20
S.E. Children's Hospital	60
Shiff Home for Recovery, Cobham	100
South Eastern Hospital for Children, Sydenham, S.E.26	60
South London Hospital for Women, Clapham-common, S.W.4	117
Stoke Newington Home Hospital for Women, High-street, N.16	54
Tilbury Hospital	73
University College Hospital, Gower-street, W.C.1	427
" " " New Ear Dept.	38
Victoria Hospital for Children, Chelsea, S.W.3	130
Walthamstow General Hospital, Orford-road, E.17	50
West End Hospital for Nervous Diseases, Welbeck-street, W.1	76
West London Hospital, Hammersmith-road, W.6	190
Westminster Hospital, Broad Sanctuary, S.W.1	234
Willesden Hospital, Harlesden-road, N.W.10	102
Wimbledon Hospital, Thurstan-road, S.W.19	60
Winifred House Convalescent Home Hospital, Tollington Park, N.4	19
Woolwich and Plumstead Cottage Hospital, Shooter's-hill, S.E.18	23
Woolwich War Memorial Hospital	170
TOTAL NUMBER OF HOSPITALS	121
TOTAL NUMBER OF BEDS	15,766

The following is a list of wireless manufacturers who gave their valuable support to the Fund by their generous gifts of apparatus.

Burndept Wireless, Ltd. , Aldine House, Bedford-st., W.C.2.	Complete installation in Royal Waterloo Hospital, 100 beds.
Falk Stadelmann & Co., Ltd. , 83 Far-ringdon-rd., E.C.1.	Set and headphones.
Igranic Electric Co., Ltd. , 147 Queen Victoria-st., E.C.4.	Set for London Hospital, 842 beds.
Marconiphone Co., Ltd. , 210 Tottenham Court-rd., W.1.	Complete installation in Royal Westminster Ophthalmic Hospital, 42 beds.
Radio Communication Co., Ltd. , 34 Norfolk-st., W.C.2.	Set in St. Bartholomew's Hospital, 688 beds.
Radio Instruments, Ltd. , 12 Hyde-st., Oxford-st., W.C.1.	Set, loud speakers or necessary headphones, for Invalid and Crippled Children's Hospital, Plaistow, 26 beds.
Sterling Telephone Co., Ltd. , 210 Tottenham Court-rd., W.1.	Complete installation in National Heart Hospital, Marylebone, 46 beds
Anglo-American Radio Co., Ltd. , 210, Strand, W.C.2.	12 pairs headphones.
British Thomson-Houston Co., Ltd. , Crown House, Aldwych, W.C.2.	700 pairs headphones.
S. G. Brown, Ltd. , Victoria-rd., North Acton, W.3.	500 pairs headphones.
Cable Accessories Co., Ltd. , Tividale, Tipton, Staffs.	6 loud speakers.
Hart Collins, Ltd. , 35a Bessborough-st., S.W.1.	1 4-valve de luxe receiver.
Craies and Stavridi , Apollo House, 4 Bunhill Row, E.C.1.	25 pairs headphones.

- Peter Curtis, Ltd.**, 75a Camden-rd., N.W.1. 1 Duodyne portable receiver.
- Edison Swan Electric Co., Ltd.**, Ponders End, Middlesex. 50 pairs headphones.
- Empress Radio and Electrical Co.**, 56 Furzehill-rd., Mutley, Plymouth. 4-valve wireless set.
- Brit. L. M. Ericsson Mfg. Co., Ltd.**, 67 Kingsway, W.C.2. 50 pairs headphones.
- Fellows Magneto Co., Ltd.**, Cumberland-av., Park Royal, Willesden. 100 pairs headphones.
- Gambrell Bros., Ltd.**, Merton-rd., Southfields, S.W.18. 1 receiving set.
- Alfred Graham and Co.**, St. Andrew's Works, Crofton Park, S.W.4. 100 Amplion loud speakers.
- Lissen, Limited**, Lissenium Works, Friars-lane, Richmond. Coils and other Lissen parts to the value of £100.
- L. McMichael, Ltd.**, Hastings House, Norfolk-st., W.C.2. 50 pairs headphones.
- Metro-Vick Supplies, Ltd.**, 4 Central-buildings, S.W.1. 6 valve sets.
- H. Morser & Co.**, 94 Hatton-garden, E.C.1. 20 pairs headphones.
- Mullard Radio Valve Co., Ltd.**, Nightingale-lane, Balham, S.W.12. 500 valves.
- Osram-G.E.C. Lamp Works**, Hammersmith, W.6. 500 valves.
- Price's Battery and Radio Co., Ltd.**, 11 Hart-st., New Oxford-st., W.C.1. 6 wireless accumulators.
- Radio Service Co.**, 105 Torriano-av., Leighton-rd., N.W.5. Free charging of all L.T. Accumulators in all hospitals for a certain period.
- Edward E. Rosen & Co.**, City House, 158 City-rd., E.C.1. 6 loud speakers, 24 pairs headphones.
- O. Ruhl (1922), Ltd.**, 85 City-rd., E.C.1. 100 pairs headphones.
- Telephone Manufacturing Co., Ltd.**, Martel-rd., W. Dulwich, S.E.21. 25 pairs headphones.
- Standard Telephones & Cables, Ltd.**, Connaught House, Aldwych, W.C.2. 40 frame aerial sets, 40 aerials, 40 single stage amplifiers, 20 single valve receiving sets.
- C. A. Vandervell & Co., Ltd.**, Acton, W.3. 16 Senior loud speakers, 12 junior do., 12 Tomtit do., 12 boxes crystals, 12 boxes transformers.
- Dubilier Condenser Co. (1925), Ltd.**, Ducon Works, Victoria, N. Acton, W.3. All condensers necessary for all sets installed in hospitals under the Fund, with the exception of paper condensers, which will be supplied at cost.
- Messrs. Radions, Ltd.**, Bollington. 50 valves.
- Energo Products, Limited.** Components for 12 wireless sets.
- Crowe Brothers** 12 pairs headphones.
- S. Hyams.** 12 pairs headphones.

Gifts from manufacturers for Wireless Fund prize competitions.

- Presented by **Messrs. C. F. Elwell, Ltd.**, 138 Gordon-rd., S.E.15. Aristophone 4-valve receiver model.
- Presented by **Messrs. J. E. Hough, Ltd.** 200 Edison Bell crystal sets.
- Presented by **Messrs. Gambrell Bros.** A 4-valve Gambrell receiving set.

PAST AND FUTURE

WHAT HAS BEEN—AND WHAT MAY BE

By "MENTOR"

THIS is not going to be a tedious history of wireless, for that is an impossible topic in a short space. You know, of course, that tale of the dear old lady who, passing a naval wireless station, asked a sailor what all the wires were for. "Them wires, mum?" he replied, "Oh, that's wireless."

It is an unfortunate fact that a wireless set contains many miles of wire, and, strictly speaking, a wireless signal is any kind of signal, from a glad eye upwards, given and received without the aid of wires, so that "wireless," in its literal sense, is nothing new—even of the particular variety just mentioned.

But putting frivolity on one side, when discussing such a weighty topic, wireless telephony, as we know it to-day, is of comparatively modern growth. At the commencement of the war the ordinary man-in-the-street took not the slightest interest in wireless, except, perhaps, when he read of its life-saving services at sea. So, instead of reciting history, this is intended to be more an account of the "good old days," before broadcasting was even thought about. It is rather embarrassing to write an autobiography, for I can see that that is what this is going to develop into and still preserve one's natural bashfulness, so I hope that you, patient reader, will forgive the numerous I's dotted around the pages like cloves in an apple pudding and remember they offend me as much as they do you. (The printer has been asked to lay in a large stock of capital I's and I'm hoping there will still be some left over at the end.)

War Days.

The wireless days under discussion date back a little before the war, when a great deal of time that should have been spent studying wretched holiday-tasks was passed with a school friend in the next town. He was also a wireless fan, and at fourteen we knew quite a lot about coherers and things that one never sees nowadays except in museums.

Then the war offered a chance to be a real wireless operator in the Royal Flying Corps, as it then was, and now, of course, the R.A.F. Not quite so thrilling, perhaps, as being a ship's operator, but still, it would serve. Most of the time, as customary in

army training, was spent on cook-house fatigue and picking up bits of paper around Farnborough Barracks, but when there was no really useful work like that to do, the powers that were fell back on teaching us how to work wireless sets. (Or that is how it seemed at the time, anyway.)

In case you should be wondering what the R.A.F. want wireless for, let me point out that the chief use then was for artillery range-finding. Modern artillery, of course, is rarely lucky enough to be able to see what it is aiming at. An aeroplane, equipped with wireless, therefore flies over the target and transmits code signals, which enable the range-finder to know how many miles he is wide of the mark.

The corollary of this, needless to add, is that the first thing a battery does is to try and put the opponent's wireless operator into the next world and so blind the enemy. Wireless operators were therefore buried in dugouts and served as the eyes of the artillery until they got blown away—either by the enemy or a wrathful range-finding officer.

Just as a parenthetical note, I must mention that R.A.F. wireless operators in training were given the rank of second private. *Second private*—a degree lower than a full-blown ordinary one! Why the authorities should choose to create this specially degraded rank for us is one of the mysteries of the war, for I recollect no other form of second private in the army.

The Good Old Days.

The war over and the knowledge of wireless increased at the government's expense, it was only natural that the craving for wireless could not be overcome. An experimental licence being duly obtained, a three-valve set, complete with a Brown relay, was completed by about the middle of 1919.

But they were not really "good old days," except that there was, perhaps, more gaiety floating around the ether then. Various enthusiastic amateurs possessed transmitting licences and used to send out to us wheezy old gramophone records, sufficiently distorted to make the tune quite unrecognizable, but still enjoyable, nevertheless! We used to post off enthusiastic reports on the quality and strength of the transmission and ached for the next item to be picked up.

It was, of course, necessary to understand Morse in those dear old days to get any enjoyment out of wireless. Our treats of hearing speech and music were few and far between. I think the first station to do anything in the nature of organized transmissions was the Marconi Company's experimental station at Chelmsford. I am excepting, of course, the several amateur

transmitters who shook the ether vigorously whenever opportunity offered itself.

Dame Melba's Broadcasting.

On 15th June, 1920. Dame Nellie Melba sang from Chelmsford "Home Sweet Home," "Nymphes et Sylvains," and some item from "La Boheme" I do not recollect. But those of us who heard that wonderful voice via loud speaker or telephones felt a thrill never likely to be forgotten. From that moment, broadcasting was proved a practical event of the future, and we then began to hope and long for the broadcasting stations which papers and men were beginning to talk about.

Then—Writtle.

But the stations which stand foremost in the hearts of all pre-broadcasting enthusiasts is the immortal 2MT, the Marconi experimental station at Writtle. "This is two Emma Toc, Wrrrrrrrrrrrrrrrrrrittle, calling" still brings a thrill to many a person through the countryside, and recalls wonderful memories. Early in 1922, this station commenced to send out regular concerts of half an hour's duration, commencing at 8.0 p.m. on Tuesdays. Even still, that time remains a precious thought with many! Regulations laid it down that there should be a three-minutes' interval after every seven minutes, transmission, so that many valuable minutes of that precious weekly half-hour had to be wasted.

Capt. Eckersley, now the well-known chief engineer of the B.B.C., was in charge and his never-failing fund of spontaneous humour gave us one glorious weekly treat which made the wireless life worth living. He invariably had some surprise in store, a gramophone record played backwards, or a wonderfully humorous burlesque of some intensely serious subject. On one never-to-be-forgotten Tuesday night we were given a Night of Grand Opera; the entire company of stars, chorus, orchestra and "noises off" consisted of three individuals. How they must have worked!

"Starting Next Week."

May to November, 1922, was spent in long discussions as to who should broadcast, when and how many hours of programme should be given, etc., etc. Dame Rumour always had it that broadcasting would soon start. All through that summer it was "next week," or, occasionally, "next month," and so it dragged on till we were all convinced that it would never start at all.

At any rate, eventually the B.B.C. was founded, and on

3rd November, 1922, 2LO started work in earnest, though 14th November was chosen as the official date for the commencement of broadcasting. The Birmingham station started next day, and Manchester the following week.

Now—All Grumblers ?

And so the B.B.C. grew up and overcame its colossal difficulties in the way of collecting an efficient staff together, organizing programmes, opening fresh stations everywhere, answering criticism, and growing up at the same time. No light task, and great credit is due to the brains that made the B.B.C. an efficient organization.

But, just at the moment, there is a tendency for us all to grumble about nothing in particular. Like our old friend Oliver Twist, we ask for more, not quite expecting to get it, but always wanting. It would probably do us a world of good to have to go back to what it was like in, say, the summer of 1921. We would then soon be anxious to get back to the present programmes !

In those days we eagerly snatched at anything given us and returned due thanks for it. Now we get very indignant if the B.B.C. has a breakdown, or even if some trivial microphone trouble distorts the music slightly !

And the Future ?

But what of the future ? What has that in store for us ? We have just discovered how to make use of the ether as a means of communication. A thunderstorm causes more disturbances in the ether than broadcasting does in a whole year, so that ether waves have been surrounding us from time eternal. We have just, after all these years, learnt how to detect these waves, how to create them and how to make use of them.

So that it is not unreasonable to suppose that there are still greater discoveries ahead. Our power of vision exists owing to the fact that the retina of the eye is sensitive enough to enable us to appreciate the difference in the wavelengths of light rays. Various colours and degrees of colour cause different wavelengths. The next step in wireless will, therefore, probably be wireless television. Steps towards this discovery have already been made, years ago, and apparatus invented to transmit and receive illustrations by wireless.

But, at present, the apparatus is slow and too expensive to be a commercial proposition. So was wireless telegraphy at first ; it was regarded by the public as merely a toy of scientists, and tolerated because—well, you know, these scientific fellows must have their playthings !

But, no doubt, the day will come—it may be two years or it may be twenty—when we will be able to sit at home in comfort and *see* the Cup Final, the Derby, and other leading events in peace and quietude. Or, better still, the record of these events will be bottled up and broadcast again during the evening, for the benefit of workers who have no time during the day to sit television-gazing—or “looking in,” as I suppose we shall have to call it.

The most disturbing item in this Utopian dream is the hard economic fact that if people do not have to attend these events personally, gate receipts will dwindle and the events become impossible to hold owing to lack of funds. Perhaps the Post Office will then increase our licence fees to £10 or so a year and subsidize these events out of the takings. In other words, any such invention as broadcast television would tend to make all events pass under one public, presumably Government, control. And can a Government official run a Cup Final or a popular revue, for instance, as efficiently as private enterprise? The elimination of competition will inevitably deteriorate quality.

The Next War.

And so the prospect of broadcast television is not an exciting one; still less so is the thought of the methods which will be used by warring nations of the future. Each successive war tends to prove that the nation with the best engineers, backed by scientists, comes out on top. Air raids on civilians will presumably become common and these machines will be attacked by rays which will attempt to interfere with the functioning of some engine part, the magneto for instance. This will be promptly parried by screening or some better anti-ray device.

Wireless control will guide torpedoes and aeroplane bombers on their death missions. But delicate hydrophones and air-listening devices will detect their presence and powerful jamming waves from the defending stations will upset the control or deflect the “infernal machines” from their courses.

Which all goes to show up one comforting fact, namely, that as soon as science and engineering combine to create a new death-dealing device, human nature promptly sets man thinking out counter moves, so that the end is a form of stalemate. Which is, fortunately, our best defence for the future.

Wireless Power.

But to keep off scare-mongering topics, there are thoughts of other treats in store for us, or our children. There is wireless power, for instance. We can now transmit sufficient power to vibrate a telephone diaphragm, so that it is perfectly logical

to assume that a future step will be the transmission of sufficient power to light electric lamps and stoves. Maybe the wireless power companies of the future will "broadcast" their power or use a beam system, sending it only in the required direction. It will, presumably, not be broadcast, as that method would involve enormous waste, for it is an unfortunate fact that one cannot get more power out of Nature than is put into it. The power put into the "broadcasting" apparatus would therefore have to be considerably more than the power actually required for use by the consumers.

Then we will have a new race of "pirates"—those who tap the wireless power without paying for it. How will they be dealt with? Certainly, we of this generation never dream of going out and digging up the street at night to tap the electric light company's mains and thus get our light free of charge. Let us hope that the next generation will be equally honourable in relation to its wireless power supplies! If it is not, one can foresee troubles ahead, and a vast army of inspectors necessary.

A hazy peep through the veil that hides the future from us, therefore, does not disclose a very comforting prospect, but no doubt we will very soon, as usual, adapt ourselves to any new developments. In our declining years we will probably wonder however we managed without the latest developments, and our grandchildren will doubtless also wonder how on earth we managed to exist in such dull and uninteresting days!

One thing, though, seems reasonably certain. For the last century that witch Monotony has been driving the country-folk away from the land to the lures and lights of the towns. Wireless has changed that and in the country music and life is being introduced in a form never thought possible even ten years ago. Will the pendulum swing the other way and lead people back to the land once more? We must always remember that while manufacturing industries merely convert raw material into finished goods, the land produces fresh material each year, and is, therefore, the only true and original source of wealth to a nation—especially a nation so dependent on its land producing food supplies in times of troubles as we are. So, is wireless going to provide the means of our renewed agricultural prosperity? It is doing its bit, anyway.

LIST OF STATIONS

OF SPECIAL INTEREST TO BROADCAST LISTENERS

Name of Station	Wave-length(s)	Call Sign	Name of Station	Wave-length(s)	Call Sign
B.B.C. (Main)			" PETIT PARISIEN "	333	—
LONDON	361.4	2 LO	AGEN	318	—
DAVENTRY	1,600	5 XX	GERMANY		
ABERDEEN	481.8	2 BD	BERLIN	{ 504 571	—
BELFAST	326.1	2 BE	KOENIGSWÜSTER- HAUSEN	{ 4,600 2,900	AFP
BIRMINGHAM	481.8	5 IT	BREMEN	277	—
BOURNEMOUTH	306.1	6 BM	BRESLAU	417	—
CARDIFF	353	5 WA	CASSEL	273	—
MANCHESTER	384.6	2 ZY	DORTMUND	283	—
NEWCASTLE	312.5	5 NO	DRESDEN	294	—
GLASGOW	405.4	5 SC	ELBERFELD	289	—
B.B.C. (Relay)			FRANKFORT	470	—
BRADFORD	294.1	2 LS	HAMBURG	392	—
LEEDS	297	2 LS	HANOVER	297	—
EDINBURGH	288.5	2 EII	KOENIGSBERG	462	—
HULL	288.5	6 KII	LEIPZIG	452	—
LIVERPOOL	288.5	6 LV	MUNICH	488	—
NOTTINGHAM	326	5 NG	NUREMBERG	340	—
PLYMOUTH	288.5	5 PY	STUTTART	447	—
SHEFFIELD	288.5	6 FL	HOLLAND		
STOKE-ON-TRENT	288.5	6 ST	AMSTERDAM	{ 2,125 1,050	PCFF PA 5
DUNDEE	315	2 DE	HILVERSUM	1,050	HDO
SWANSEA	482	5 SX	SPAIN		
IRELAND			BARCELONA	{ 324 300	EAJ 1 EAJ 18
DUBLIN	397	2 RN	RADIO CATALANA	460	EAJ 13
FRANCE			OVIEDO	400	EAJ 19
RADIO PARIS	1,750	CFR	MALAGA	{ 400 325	EAJ 26 EAJ 25
ECOLE (PARIS)	458	FPTT			
EIFFEL TOWER	2,650	FL			

Name of Station.	Wave-length(s)	Call Sign	Name of Station	Wave-length(s)	Call Sign
MADRID	373	EAJ 7	AUSTRIA		
CADIZ	{ 357	EAJ 3	GRAZ	402	—
VALENCIA	{ 330	EAJ 10	VIENNA	{ 582.5	—
SEVILLE	{ 360	EAJ 24	SWITZERLAND	{ 531	
ASTURIAS	{ 400	EAJ 14	GENEVA	760	—
SAN SEBASTIAN	{ 357	EAJ 5	LAUSANNE	850	HB 2
SARAGOSSA	{ 300	EAJ 17	ZURICH	515	—
BILBAO	345	EAJ 12	AMERICA		
SALAMANCA	405	EAJ 22	SCHENECTADY	397.5	WGY
BELGIUM			EAST PITTSBURG	{ 309	KDKA
BRUSSELS	487	—	NEW YORK CITY	{ 64	WEAF
DENMARK			OAKLANDS	{ 492	WJY
COPENHAGEN	347.5	—	SPRINGFIELD	{ 405	WJZ
LYNGBY	2,400	OXE	OMAHA	{ 455	KGO
RYVANG	1,150	—	JOHN WANAMAKER	361	
HJÖRRING	1,250	—	AMERICAN TEL. CO.	331	WBZ
ODENSE	950	—	RADIO CENTRAL	331	WOAW
SWEDEN			AMERICAN RADIO CO.	526	WOO
BODEN	1,200	SASE	WILLARD STORAGE	508.2	WOO
FALUN	370	SMZK	BATTERY	492	WEAF
GOTENBURG	287	SASB	KANSAS CITY STAR	467	KFI
MALMOE	470	SASC	RADIO LIGHTHOUSE	394	KFQX
STOCKHOLM	430	SASA	AUSTRALIA		
SUNDSVALL	540	SASD	MELBOURNE	371	3 LO
ITALY			PERTH	1,250	6 WF
ROME	434	IRO	SYDNEY	1,100	2 FC
MILAN	320	IMI	CANADA		
POLAND			MONTREAL	411	CKAC
WARSAW	480	—	CALGARY, ALTA	435.8	CNRC
RUSSIA			AFRICA		
MOSCOW (CENTRAL)	1,450	RDW	CAPETOWN	375	WAMG
„ (POPOFF)	1,010	—	DURBAN	400	—
LENINGRAD	{ 310	—	JOHANNESBURGH	450	JB
REVAL	{ 940	—	INDIA		
	425	—	BOMBAY	375	2 FV

PERIODICAL LITERATURE

Below are given particulars of various publications, all of which publish articles or information of interest in connection with wireless work, either professional or amateur. Several of these journals are devoted exclusively to wireless, but each views the subject from a different angle.

Amateur Wireless. Weekly. Price 3d. Published by Messrs. Cassell & Co., Ltd., La Belle Sauvage, Ludgate Hill, E.C.4. This deals with the subject of wireless reception from the point of view of the amateur who takes a keenly practical interest in wireless, or who is engaged in experimental and constructional work.

The Broadcaster and Wireless Retailer. Trade Monthly. Price 1s. a copy. Twelve months' subscription, 7s. 6d., post free to the trade only. *Publishers:* Odhams Press, Ltd., 85-94 Long Acre, W.C.2.

Electrical Industries. Established 1901. Every Wednesday. Price 2d. Annual subscription, 12s. inland, 15s. overseas. 13-16 Fisher Street, London, W.C.1. Covers the whole of the electrical industry. Has a monthly supplement entitled *The Broadcasting Trader*. Published the first week in each month.

Electrical Times. Weekly on Thursday morning. Price 3d. Sardinia House, Kingsway, London, W.C.2. All branches of electrical engineering, including wireless.

The Electrician. Thursday afternoon for Friday. Price 6d. 154 Fleet Street, London, E.C.4. Electrical engineering in all its branches. Special attention is paid to wireless developments in the second issue each month. The paper with an up-to-date news service on all electrical matters.

The Electrical Review. Weekly. Price 6d. Deals with the whole of the electrical industry, and contains both articles and news of special interest to radio engineers and traders.

Electricity. Every Friday. Price 2d. 36 Maiden Lane, London, W.C.2. All branches of electrical engineering, including telegraphy, telephony, and wireless.

Experimental Wireless. Monthly. Price 1s. Hiffe & Sons, Ltd., Dorset House, Tudor Street, E.C.4. Of special interest to experimenters and radio engineers. *Editor:* H. S. Pecoock. *Technical Editor:* Prof. G. W. O. Howe, D.Sc., M.I.E.E.

Irish Radio Journal. Weekly. Price 2d. 34 Dame Street, Dublin. Ireland's premier and only radio weekly.

The Irish Radio and Musical Review. Monthly. Price 3d. 179 Great Brunswick Street, Dublin. The official organ of the Wireless Society of Ireland, it deals with all matters affecting the interests of radio amateurs and presents popular and authoritative articles on music subjects for those interested in the "double progress" of radio and music. *Editor:* James Kitchen, A.M.Inst.R.E.

Irish Radio Trader. Monthly. Annual subscription 3s. 34 Dame Street, Dublin.

Modern Wireless. First of the month. Price 1s. Bush House, Strand, W.C.2. Wireless.

Nature. Dated Saturday of each week : published on Friday of each week. Price 1s. St. Martin's Street, Leicester Square, W.C.2. The whole field of scientific work and progress, including both biological and physical sciences, the philosophy of science, technology in its scientific aspects, and the application of scientific methods to all public affairs.

Popular Wireless. *Editor:* Norman Edwards, M.Inst.R.E., F.R.S.A., F.R.G.S. Every Friday. Price 3d. The Fleetway House, Farringdon Street, E.C.4. The policy of the paper is to present to the reader an accurate, light, and not unduly technical survey of wireless in general, with practical constructional articles, essentially inexpensive to construct. The social side of broadcasting is also an important feature, as is also the "humour" of wireless. The scope may be said to be infinite and varied. Sir Oliver Lodge is scientific adviser to this journal.

Post Office Electrical Engineers' Journal. Quarterly: April, July, October, and January. Price 1s. 6d. Engineering Department, G.P.O., West, E.C.1, and 4 Ludgate Hill, E.C.4. The organ of the Institution of P.O. Electrical Engineers. Deals with British Post Office practice in all forms of signalling communications—telegraphy, telephones, and wireless—and electrical engineering generally.

The Radio Times. Every Friday. Price 2d. Messrs. George Newnes, Ltd., 8-11 Southampton Street, Strand, W.C.2. The official organ of the B.B.C.; a non-technical magazine for "listeners," containing articles of general interest relating to broadcasting and advance official programmes for the week.

Telegraph and Telephone Journal. About first of month. Price 4d. G.P.O. North, London, E.C.1. Deals with the work, progress, and development of the telegraph and telephone (including wireless) services.

Wireless. Tuesday of each week. Price 2d. Bush House, Strand, W.C.2. Wireless.

The Wireless Dealer. Twelfth of the month. By subscription only. 7s. 6d. per annum, 1s. per single copy. Bush House, Strand, W.C.2. Wireless trade journal.

The Wireless Constructor. Fifteenth of the month. Price 6d. Bush House, Strand, W.C.2. Wireless.

Wireless Magazine. Twenty-fifth of the month. Price 1s. Published by Messrs. Cassell & Co., Ltd., La Belle Sauvage, E.C.4. For the broadcast listener, the non-technical man, and especially for the home constructor. Deals with subjects in popular, interesting manner. Contains articles and stories of general wireless interest and makes a feature of giving its readers particulars of all the latest developments.

The Wireless Trader. Incorporating *The Wireless and Allied Trades Review.* Weekly. Annual subscription 8s., post free. The Trader Publishing Co., Ltd., 139-140 Fleet Street, E.C.4. Everything for the wireless retailer, wholesaler, and manufacturer.

The Wireless Export Trader. Monthly. Price 1s. post free. The Trader

Publishing Company, Limited. 139-140 Fleet street, E.C.4. For the radio trade and industry all over the world.

Wireless Weekly. Every Wednesday. Price 6d. Bush House, Strand, London, W.C.2. Wireless.

Wireless World and Radio Review. Every Wednesday. Price 3d. Iliffe & Sons, Ltd., Dorset House, Tudor Street, E.C.4. An illustrated journal covering every wireless interest, and appealing particularly to amateur wireless workers and home-constructors.

World Radio. (B.B.C., Savoy Hill, W.C.) Published every Friday, price 2d., by Messrs. George Newnes, Ltd., 8-11 Southampton Street, Strand, W.C.2. This journal is intended to foster public interest in international broadcasting.

B.B.C. STATION ADDRESSES

MAIN

Aberdeen. 15 Belmont Street. *Tel. No.* 2296.
Belfast. 31 Linenhall Street, Belfast. *Tel. No.* 5870-1.
Birmingham. 105 New Street. *Tel. No.* Midland 209-10.
Bournemouth. 72 Holdenhurst Road. *Tel. No.* 3460-1.
Cardiff. 39 Park Place. *Tel. No.* 2514-5.
Glasgow. 21 Blythswood Square, Douglas. *Tel. No.* 1192-4.
London. 2 Savoy Hill, W.C.2. *Tel. No.* Regent 6727.
Manchester. Orme Buildings, The Parsonage. *Tel. No.* City 9646-7.
Newcastle. 24 Eldon Square. *Tel. No.* Central 5865.

HIGH-POWER

Daventry. Borough Hill. *Tel. No.* Daventry 77.

RELAY

Edinburgh. 87 George Street. *Tel. No.* Central 9746.
Hull. 26-27 Bishop Lane. *Tel. No.* Central 6138.
Liverpool. 85 Lord Street. *Tel. No.* Bank 5018.
Plymouth. Athenaeum Chambers, Athenaeum Lane. *Tel. No.* 2283.
Sheffield. Castle Chambers, Castle Street. *Tel. No.* Central 4029.
Leeds-Bradford. Cabinet Chambers, Basinghall Street, Leeds. *Tel. No.* 28131.
Stoke-on-Trent. Majestic Buildings, Stoke-on-Trent. *Tel. No.* Hanley 1970.
Nottingham. 4 Bridlesnith Gate, Nottingham. *Tel. No.* 6944 and 6945.
Dundee. 1 Lochee Road. *Tel. No.* Dundee 5209.
Swansea. Oxford Buildings, Oxford Street. *Tel. No.* Swansea 3107.

BROADCAST RECEIVING LICENCES

On the 1st July, 1924, the new type of Wireless Receiving Licence became available on sale at a fee of 10s. per annum.

This licence will be issued to new applicants on and from that date, and will take the place of the existing broadcast, constructor's, and "Interim" Licences as they fall due for renewal. It will cover the use of any receiving set, provided that the set or parts are of British manufacture. In the case of existing "Interim" Licences it will also cover any apparatus—whatever its origin—which the holder of such licence was entitled to use. Heavy penalties are prescribed by the Wireless Telegraphy Act, 1904, on the conviction of the offence of establishing a wireless station without the Postmaster-General's Licence.

By command of the Postmaster-General.

THE WIRELESS LEAGUE

A NOTABLE MOVEMENT

It invariably happens that when a new movement springs into being the need is found of some form of voluntary association to control or direct or support its activities. So at the outset of the motoring movement the Royal Automobile Club came into existence, and later the Automobile Association. So now the Wireless League has come to life—obviously not to control the various forms of wireless activity which have suddenly developed as by enchantment—but to support them by all the means in its power and to ensure that they shall serve the highest interests of the community, and indeed, of the whole world.

The first idea of the formation of the Wireless League was conceived in the very able brains of those men who direct the *Daily Express*. They brought their new baby into the world with the flourish of trumpets which should rightly attend the birth of an infant destined to such an exalted and interesting career, and they proclaimed to wireless listeners with justifiable pride its wonderful progress in its cradle.

In the early days of motoring it was necessary for the few motorists to bind themselves together in defence against a hostile public. That was the tie that held the Royal Automobile Club together in the first few years from 1898. Such is not the case with the Wireless League, because they have no enemies. They are hurting no one and every one is on their side. But there are dangers nevertheless, and for that reason it is well to lay down at the outset the outlines of the policy it is intended to pursue. These are as follows—

1. To perpetuate, consolidate, and extend the public service character of broadcasting in the British Isles, and with that object to support centralized executive control.

2. To exercise increasing vigilance to protect broadcasting from any lowering of its standards and ideals.

3. To safeguard the essential public service against any demand for broadcasting facilities, the granting of which would endanger Imperial Defence.

4. To maintain the use of wireless broadcasting for educational as well as entertainment purposes.

5. To assist broadcast listeners in their efforts to secure efficient reception.

6. To bring to the notice of the broadcasting authorities such criticisms as may seem to be constructive, and generally to act as a link between the listening public and the authorities.

7. Generally to do all such things as are conducive to the efficiency of the service and the interests of listeners.

In these days children grow up very quickly and the time soon came for the infant to stand on its own legs. That was the time at which the child was handed over to Sir Arthur Stanley, who became the Chairman of the Wireless League.

The first step was to form a provisional committee. Help was required in many different ways and the committee was formed with that object in view. It consisted of the following—

Sir Arthur Stanley (Chairman), G.B.E., C.B., M.V.O.

Sir Lawrence Weaver (Vice-Chairman), K.B.E.

Lord Montagu of Beaulieu.

Sir Ernest Hodder-Williams, C.V.O.

Sir Frederick Radcliffe.

Sir Frederick Wise, M.P.

Sir Landon Ronald, F.G.S.M.

Sir Harry Brittain, K.B.E., M.P.

Sir Walter Windham.

Major Evelyn Wrench.

Major L. Hore-Belisha, M.P.

Mr. C. G. Ammon, M.P.

Mr. H. W. Lonsdale (Market Harboro).

Mr. H. Munro Nelson (Bristol).

Mr. H. Y. Richardson (Newcastle-on-Tyne).

Mr. J. E. Kemp (Manchester).

The Rev. Tildsley (London, Forest Gate).

It will be seen that excellent representation was secured in the House of Lords and the House of Commons. The League was also well represented in the musical world by Sir Landon Ronald; in the publishing world by Sir Ernest Hodder-Williams, and generally in every direction likely to be interested in the objects of the Wireless League. Satisfactory representation from provincial branches of the Wireless League was also secured.

The services of Professor A. M. Low, who is well known to all wireless enthusiasts, were secured as technical adviser, and the finances will be looked after by those who watched so carefully and so successfully over the £22,000,000 raised by the British Red Cross and Order of St. John during the Great War.

Over 150 branches have been formed in the United Kingdom and Ireland, and in order to decentralize the work at headquarters as much as possible, the country has been divided into fourteen areas as follows—

London County	Midlands	Northern
South Coast	South Midlands	Scotland
Home Counties	North Midlands	Wales
Western	Yorkshire	Ireland
East Coast	Lancashire and Cheshire	

the branches in each of which form an Area Committee.

These committees in their turn elect delegates to the General Council, which is the governing body of the League.

The General Council want to make the Wireless League of real use to its members. It is generally felt that an association of this kind is required, but when one is asked, "What are you going to do?" it is rather difficult to answer. One thing that has been arranged is free insurance for members. Third party claims are covered; damage to set due to fire, lightning, house-breaking, burglary, theft, and larceny up to a total of £25. Many claims have already been made and have been satisfactorily dealt with. Another is free legal defence. It is hoped that this will not be necessary in the case of many members, as it is an expensive item, and it must be clearly understood that this legal defence is only in respect of litigation arising out of their use of wireless apparatus. The Wireless League has already been able to help several of its members who were in difficulties of various sorts.

Then there is a new item, the granting of certificates to wireless repairers. The whole wireless industry is of very recent growth, and as a result there are a good number of people setting up as wireless experts and repairers who know very little indeed about their job. For the protection of members the qualifications of repairers will be inquired into and a certificate will be given to those who can show that they are properly qualified to carry out the work.

Now the League is settling down to carry out its programme, and all that is required to assure success is a large membership. If the subscription is to be kept at a very low rate of 2s. a year and the above-mentioned advantages given, and others that will undoubtedly occur, the League ought to have 200,000 members at the very least. If all who read this article will help by applying to the Head Office at Chandos House, Palmer Street, Victoria Street, S.W.1, the numbers will very soon be obtained and the League will be able to extend its operations.

A list of branches of the League is given here.

LIST OF BRANCH SECRETARIES

LONDON AREA

- Balham.** Mr. C. J. Willoughby, 35 Ravenslea Road.
Bethnal Green. Mr. J. J. Barker, 142 Mansford Street.
Blackheath. Mr. Willis Abbott, 29 Kidbrooke Park Road.
Brixton. Mr. A. G. Vaughan, 88 Acre Lane, S.W.2.
Clapham. Mr. H. E. Brown, 11 Hambalt Road.
Forest Gate. Mr. G. A. Stratford, 2 Halley Road, Green Street.
Hampstead. Mr. H. N. Cranston, 6 The Clock Tower.
Harringay. Mr. F. E. Bennett, 385 Green Lane.
Highbury. Mr. E. J. Durley, 39 Halton Mansions, Canonbury.

- Hornsey.** Mr. T. Vincent Mercer, 24 Cecile Park, Crouch End.
Kensington and District. The Hon. C. M. de Adlersparre, 37 Talgarth Road, West Kensington.
Kentish Town. Mr. A. E. Heggie, 75 Leighton Road, N.W.5.
Kew. Mr. Lionel Yates, 53 Airedale Avenue, Chiswick.
Lewisham. Mr. R. S. Darling, 5 Nuding Road, St. Johns.
Leyton. Mr. J. A. Catten, 2 Dyers Hall Road, Leytonstone, E.
Poplar. Mr. S. Butchins, 18 Merchant Street, Bow, E.3.
Queen's Park and Maida Hill. Mr. F. Batho, 37 Enbrook Street, W.10.
Streatham. Mr. E. S. Bentley, 19 Shrubby Road.
Tottenham. Mr. G. H. Hasemer, 9 Galliard Road, N.9.
Victoria. Mr. C. A. Pierotti, 21 Johnson's Place, S.W.1.
Walthamstow. Mr. H. T. Saron, 79 Ferndale Road, N.15.
Wandsworth. Mr. F. G. Edwards, 29 Baskerville Road, S.W.18.
Willesden. Mr. A. Newitt, 36 Glynfield Road, Harlesden, N.W.10.
Woolwich. Messrs. P. Smith & F. Fraser, 77 Chestnut Road, S.E.18.

HOME COUNTIES AREA

- Aylesbury.** Mr. D. Riddiford, 77 Park Street.
Barking Road, Manor Park. Mr. H. H. Warwick, 20 Grange Road, Ilford Lane, Ilford.
Becontree. Mr. W. Pearce, 3 Stevens Road, Becontree.
Cranbrook Park and Barkingside. 80 Beehive Lane, Ilford.
Croydon. Mr. C. F. Scott, 141 Dalnally Road, Addiscombe.
Harrow. Mr. E. W. Everett, 28 Greenhill Crescent, Harrow.
Kingston. Mr. S. J. Woodward, 68 Park Road, Hampton Wick.
Leigh-on-Sea. Mr. W. A. Merry, Glenbervie Drive.
Marlow. Mr. R. Platt, Quoiting Square.
Mitcham. Mr. A. C. Smith, 278 Church Road.
Newbury. Captain R. T. Hardy, "Daryngton," Benham Hill, London Road, Newbury.
New Malden. Mr. R. J. Venner, "Lynwood," Malden Hill.
Redhill. Mr. G. F. Howe, 44 Somerset Road, Meadvale, Redhill.
Slough. Mr. A. E. Peplow, Oakley Works, Bath Road.
Sutton. Mr. W. C. Smith, 234 High Street, Sutton.
Twickenham. Mr. J. W. Ronald, 31 Arragon Road, Twickenham.
Watford. Mr. W. L. Corliss, 25 Princes Avenue, Watford.
Wembley. Mr. R. W. Corkling, Bassingham Road, Alperton.
Woodford. Mr. E. J. Turbyfield, 42 Alexandra Road, South Woodford.

SOUTH COAST AREA

- Ashford, Kent.** Mr. H. A. Butcher, 5 Albemarle Road, Willesborough.
Beckenham. Mr. G. Fish, 15 Cromwell Road.
Belvedere and Erith. Mr. W. Griffin, 19 Mayfield Road, Belvedere.
Bournemouth. Mr. H. J. Bliss, 140 Old Christchurch Road.
Brighton. Miss C. Foot, 15 Prestonville Road.
Bromley. Mr. L. A. Andrews, 4 Clarence Avenue.
Burgess Hill. Mr. F. Kaye-Jones, Sheen Cottage.
Chatham. Mr. W. Seaward Gales, 1 Langdon Road, Rochester.
Dover. Mr. W. C. Winn, Messrs. Winn & Son, St. Margaret's Bay.
East Grinstead. Mr. J. Rudman, 1 Institute Walk.
Folkestone. Mr. P. A. Bennett, 26 Guildhall Street.
Gillingham. Mr. R. Harrison, 48 Charter Street.
Guernsey. Mr. C. A. Falls, Marconi Vinery, Castel.
Hove. Mr. D. J. Gadsby, "Egmont," Somerhill Road.
Hythe. Mr. C. C. Roberts, 8 Earlsfield Road, Hythe.
Newport, I.O.W. Mr. G. Dunford, 7 Lower St. James Street.
Portsmouth. Mr. Royden N. Sherwell, 6 Kings Terrace.
Ringwood. Mr. A. F. Woodward, Park View, St. Ives.

- Southsea.** Mr. W. M. Wilson, 237 Highland Road.
Speldhurst, Kent. Mr. W. G. Bennett, "Salus," Speldhurst.
Tunbridge Wells. Mr. A. L. Wickens, 10 Nelson Road.
Winchester. Mr. A. J. Fleming, 29 Jewry Street.

WESTERN AREA

- Barnstaple.** Mr. B. D. Harrison, Wrentham, Barbican.
Bath. Mr. N. King, Peasedown, nr. Bath.
Bridgwater. Mr. W. Coate, "The Elms," Wembdon.
Bristol. Mr. H. Munro Nelson, 1 Glenwood, Hillfield Park.
Dawlish. Mr. A. Avant, 26 The Strand.
Falmouth. Mr. C. Ackland, 12 Old Hill.
Laira, Devon. Mr. E. Bulfar, Post Office, Laira, Pelsmouth.
Plymouth. Mr. C. Boakes, 32 Holdsworth Road.
Redruth. Mr. W. S. Trevena, Stanley Villas, Raymond Road.
Stroud, Glos. Mr. G. Wrentmore, Bath Road.
Swindon. Mr. S. G. Archer, 52 Jennings Street.
Taunton. Mr. A. Bolshaw, The Mount, Taunton.
Totnes. Mr. W. H. Frost, 3 Antrim Terrace, Totnes.
Yeovil. Mr. J. J. Davis, Brook Street, Milbourne Port.

EAST COAST AREA

- Corby.** Mr. E. Ratcliffe, 8 Kettering Road.
Great Yarmouth. Mr. E. J. Tennant, 2 St. Andrew's Road, Gorleston.
Ipswich. Mr. C. Buckingham, 51 London Road.
King's Lynn. Mr. R. T. Little, 39 London Road.
Lowestoft. Mr. E. Plater, 153 Clapham Road, Lowestoft.
Norwich. Mr. H. A. Neve, 73 Arnes Street, Norwich.
Scunthorpe. Mr. E. Rayner, 35 Well Street.
Skegness. Mr. F. Davis, 1 Scarborough Avenue.
Stowmarket. Mr. W. G. Jackson, 103 Violet Hill Road.
Walsham-le-Willows. Mr. G. Punnett, The Avenue.
Walton-on-Naze. Mr. F. Nock, Hightree Lodge, Naze Park.

MIDLANDS AREA

- Birmingham.** Mr. J. Solomon Hill, J.P., 14 Blackford Road, Sparkhill, Birmingham.
Brownhills, Staffs. Mr. A. Poulain, Noon Building, High Street.
Coventry. Mr. F. Davenport, Highfield, Exhall, nr. Coventry.
Stratford-on-Avon. Mr. J. W. Timms, 9 Park Road.
Walsall. Mr. H. Truman, 97 Upper Bridge Street.
Warwick. Mr. A. Miles, 40 Market Place.
West Bromwich. Mr. J. Dangerfield, 25 New Street.

NORTH MIDLANDS AREA

- Bolsover.** Mr. A. Leaming, Town End, Bolsover.
Buxton. W. Runciman Shaw, "The Croft," St. Peter's Road.
Derby. Mr. Alan R. Barnett, Pelham Street Mills, Derby.
Heanor and District. Mr. G. Ford, Holme Farm, Shipley, nr. Derby.
Leicester. Mr. L. Stuart Rudkin, "Brackley," Putterworth Road, Leicester.
Mansfield. Mr. Norman Grey, 125 Nottingham Road.
Market Harborough. Mr. H. Lonsdale, 79-80 Station Road.
Nottingham. Mr. R. A. Gullick, 1 Shakespeare Street.

SOUTH MIDLANDS AREA

- Bedford.** Mr. V. A. Shearme, 22 Cornwall Road.
Cambridge. Mr. J. Bennett, 71 Hills Avenue.
Ely. Mr. Merrywest, Clare House, Market Street.
Oxford. Mr. A. W. Shirley, 133 Walton Street.

YORKSHIRE AREA

- Barnsley.** Mr. G. Barnes, Wireless House, Regent Street, South.
Bradford. Mr. W. C. Wicks, 70 Seaton Road.
Goole. Mr. G. H. Hillary, 75 Carlisle Street.
Leeds. Mr. J. Watson, 4 Armley Grange Drive, Armley, Leeds.
Rotherham. Mr. F. Davis, 67 Regent Street, Rotherham.
Scarborough. Mr. H. Frain, Snainton, Scarborough.
Sheffield. Mr. S. J. Adams, 38 Church Street, Sheffield.
York. Mr. A. E. Jones, 13 Sycamore Terrace, York.

NORTHERN AREA

- Darlington.** Mr. Seaton-Leng, 31 Stanhope Road, Darlington.
Newcastle-on-Tyne. Major H. Y. Richardson, 13 Grey Street.

LANCASHIRE AND CHESHIRE AREA

- Blackburn.** Mr. W. Stamworth, 48-52 Darwen Street.
Crewe. Mr. R. Peach, 84 West Street, Crewe.
Manchester and District. Mr. H. McMullen, 3 Fox Bank Street, Chorlton-on-Medlock.
Prescot. Mr. J. Swift, Vining Terrace, Prescot.
Preston. Mr. G. Makin, 24 Glover's Court, Preston.
Prestwich. Mr. H. Wood, Spring Bank, Church Lane.

WELSH AREA

- Abertillery.** Mr. G. J. Jones, 10 Ty Bryn Road.
Barry Island. Mr. M. Draper, Ivor Street, Barry Island.
Cardiff. Mr. F. A. Davies, 108 Newfoundland Road.
Llandrindod Wells. Mr. O. Bufton, The Lea, Duffryn.
Llanely. Mr. T. Jeffreys, Peurfard, New Road.
Port Talbot. Mr. Horace Potts, 17 Curwen Terrace.
Rhondda. Mr. H. Chick, 46 Morton Terrace, Clydach Vale.
Wrexham. Mr. W. Burrows, 11 Cunliffe Walk, Garden Village.

SCOTLAND

- Aberdeen.** Mr. J. Breen, 42 Walker Road, Aberdeen.
Dundee. Mr. J. Mackerie, 28 Seagate, Dundee.

IRELAND

- Belfast.** Mr. D. B. McCausland, Mount Vernon Lodge, Shore Road, Belfast.

THE MOTOR-CYCLIST'S LIBRARY

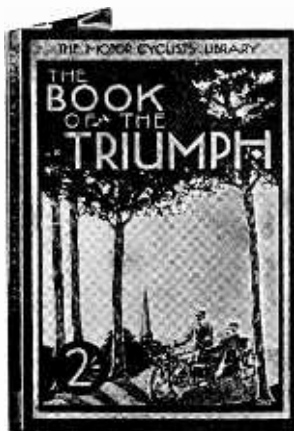

This new series is intended for all interested in motor-cycling. Each book in the Library deals with a particular type of motor-cycle from the point of view of the owner-driver. The necessary preliminaries, the essentials of good driving, running, upkeep and repair, and also useful legal and general information are all treated with special reference to the particular make of motor-cycle with which each book deals.

"Gives just the information people want."—*The Sketch*.

THE BOOK OF THE B.S.A. By "WAYSIDER."
Second Edition.

THE RALEIGH HANDBOOK. By "MENTOR."

THE BOOK OF THE DOUGLAS. By E. W. KNOTT.

THE BOOK OF THE TRIUMPH. By E. T. BROWN.

THE BOOK OF THE ROYAL ENFIELD. By "R. E. RYDER."

THE BOOK OF THE RUDGE. By A. CADE.
(*In the Press.*)

"Ripe and expert experience placed at the disposal of the novice for a trifling sum."
—*Venture*.

Each in Crown 8vo, Fully Illustrated

Price 2s. net. OF BOOKSELLERS

London: Sir Isaac Pitman & Sons, Ltd., Parker St., Kingsway, W.C.2

TECHNICAL SECTION

INSULATION AND INSULATING MATERIALS

AMATEUR RADIO IN 1926

"WHEREVER SHE GOES"

THE PROBLEM OF THE OSCILLATING CRYSTAL

RADIO AND CABLES

RECENT DEVELOPMENTS IN WIRELESS

ROUND THE FACTORIES

LIST OF RADIO SOCIETIES

A NEW HANDBOOK

FOR ALL INTERESTED IN THE CHARGING AND
UPKEEP OF ACCUMULATORS FOR WIRELESS
WORK, MOTOR-CAR LIGHTING AND STARTING
EQUIPMENT, AND COUNTRY HOUSE LIGHTING
PLANT

ACCUMULATOR CHARGING

MAINTENANCE AND REPAIRS

By W. S. IBBETSON, B.Sc., A.M.I.E.E., M.I.Mar.E.

In this book the author describes, in simple manner the actions taking place when accumulators are charged and discharged, and gives complete instructions for charging from both alternating and continuous-current circuits, together with notes on the tracing and remedying of defects.

CONTENTS: Introductory—Electrical Power—Production of Electrical Energy—Actions on Charge and Discharge—Capacity—Modern Accumulators—Battery Charging—Charging on A.C. Circuits—Diseases and Treatment—Repairs—Edison Cell—Resistance Wires—Particulars Relating to Length, Current, and Resistance—Index.

With 32 practical diagrams.

Price 3s. 6d. net,

Of Booksellers, or direct from

SIR ISAAC PITMAN AND SONS, LTD.
PARKER STREET, KINGSWAY, LONDON, W.C.2

INSULATION AND INSULATING MATERIALS

By J. A. FLEMING, M.A., D.Sc., F.R.S.

THE object of insulation is to keep electric currents or electric charges in certain assigned places and prevent them straying out of these paths. Hence its function is similar to that of hedges or fences in regard to traffic. If the currents or charges do escape, we have waste of energy, or perhaps in addition destructive effects and expensive repairs. The subject of insulating materials is, therefore, very important, and, but for the possession of these materials, there would be no electrical industry.

It is fortunate for us that our atmosphere, when dry, is a good insulator, up to a certain point, for if air had been as good a conductor as dilute sulphuric acid, it would have vastly increased the difficulties of the electrical engineer.

The definition of an electrical insulator may be taken to be a substance through which electricity, that is electrons, can only make its or their way with difficulty, or very slowly. There is no absolutely perfect insulator and no very sharply marked division between conductors and non-conductors or insulators. One of the first persons to notice clearly this distinction between substances in regard to the power of electricity to move through them was a self-taught electrical experimentalist, Stephen Gray, a pensioner of the Charterhouse, in conjunction with his friend, Granville Wheler, about the year 1729. Gray possessed a glass rod, which he electrified by friction, and exhibited its properties by making it attract light objects, such as feathers. On one occasion he tied a linen thread to his rod and attached a brass ball at the bottom, and found that when the rod was excited by friction the brass ball would then attract feathers, thus showing that the electricity had travelled along the thread. Gray and Wheler then stretched a thread horizontally, like a telegraph wire, supporting it at intervals by loops of silk, and succeeded in this manner in propagating electric attractions for a distance of 600 or 700 feet.

One of the silk threads having broken, Gray replaced it by a metal wire, with the result that the electric action now no longer travelled over the thread, but when the broken silk loop was replaced, the effect was transmitted as before. Gray and Wheler were, therefore, the first to construct an aerial line with silk loops as insulators. Further experiments showed that whilst dry cotton threads were insulators, moist threads were not so.

Gray later on discovered that lumps of resin were especially good non-conductors.

There is, however, an enormous difference between the conducting power of a metal such as copper or silver and that of one of the best insulators such as resin or sulphur.

For modern practical use it is, however, necessary that insulating materials should have good mechanical properties, that means, be capable of being worked, cut, shaped or fashioned into screws, and also have a considerable resistance to compression or tension. Unfortunately, they are for the most part, deficient in this respect as compared with metallic conductors. The majority of good natural insulating materials are either very brittle, such as sulphur, amber, resin or shellac, or else friable, like mica, or soft and easily melted, like india-rubber and gutta-percha, or fibrous and hygroscopic, like cotton and silk.

We have, therefore, been compelled to seek for insulators of better mechanical qualities by scientific research, with the result that we now possess a large number of these artificial insulators, such as ebonite, glass, porcelain, bakelite, presspahn, micanite, cellite, or acetyl cellulose, and acrolein gel, and other substances. We cannot obtain all the desirable qualities in any one material, but we have to employ that which is most suitable for the purpose. Thus when it is desirable that non-inflammability should be possessed, good well glazed porcelain or white marble is suitable, and mica is also admirably adapted for some purposes, such as commutators of dynamos and for building electrical condensers. Some of the artificial insulators, such as bakelite, which is a so-called synthetic resin, formed of phenol or cresol and formaldehyde, are capable of being moulded to shape by heat and readily worked with tools.

A material called cellite, or cellon, which is, in chemical language, acetyl cellulose, is non-inflammable, and can be prepared in thin sheets, well adapted for making condensers in place of mica. Ebonite, which is a compound of india-rubber and sulphur, can be moulded into sheets, rods or tubes, and is largely employed in electrical instrument making, but if exposed to light its surface insulation deteriorates rapidly. It is necessary, therefore, to distinguish between body and surface insulation, and in the case of outdoor insulators, such as telegraph or aerial insulators, to give them such form as shall keep part of the surface dry.

An objection to the commonly used porcelain insulator for wireless aerials is that the whole surface is exposed to rain, and therefore considerable surface leakage can often take place. The writer has accordingly designed a better form, which is made as follows: Obtain a length of ebonite tube, $\frac{3}{8}$ in. outside diameter, with a hole or bore $\frac{1}{8}$ in., cut off about an 8 in. length. Make a

square rod of hard wood 6 in. long and cut it in half, and screw the two parts together with two screws. Drill a hole a little less than $\frac{3}{4}$ in. diameter through the contact plane of the two pieces so that when slightly unscrewed and the ebonite tube put through the hole, the wood bar will grip the rod quite tightly when screwed up again. Then fit on the ebonite tube an india-rubber cork, and fix on this a 6 in. length of red fibre tube 1 in. inside diameter.

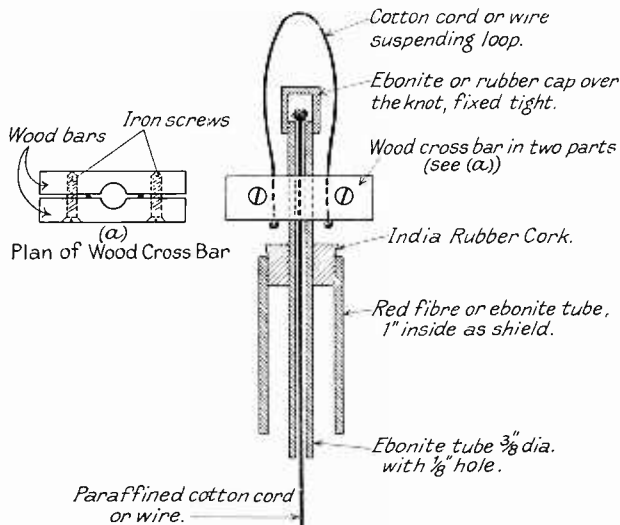

FIG. 1. SECTION OF AN AERIAL INSULATOR. (FLEMING)

Reference to Fig. 1 will show the section of the arrangement.

Drill two other holes through the wood cross bar, through which a short length of whipcord or cotton cord, previously boiled in paraffin wax, is threaded with knots at lower end. Also thread a piece of the same through the ebonite tube and fix quite tightly a little ebonite cup over the knot at the top. The result will be a useful aerial insulator (see diagram).

The insulator may be used to stretch a horizontal or sustain a vertical aerial wire, and can be used as a tie-back for any aerial.

There are three specific qualities of insulators or dielectrics, as they are also called. These are (i) the dielectric constant or specific inductive capacity; (ii) the break-down voltage reckoned in kilovolts per centimetre of thickness; and (iii) the power

dissipation at any given value of the electric force acting in the dielectric, reckoned in ergs per cubic centimetre per second. As a substitute for this last we sometimes measure the so-called power factor of the dielectric.

Insulators differ enormously in respect of these qualities, and we have to take them into account in selecting one for our purpose. Thus gutta-percha is the only insulator which can be used for insulating submarine telegraph cables, as it is not altered when in darkness and moist, but it cannot be used for insulating telephone cables because it has too large a dielectric constant, and, therefore, bestows objectionable capacity on the cable. For telephone cables, what is used is dry paper wound loosely round the copper wire and included in a lead sheath. This type of insulator would again be unsuitable for high tension electric light cables because it has too small a break-down voltage. For this latter purpose we must use india-rubber, or resin impregnated manilla paper.

The radio worker, in building sets or putting up an aerial, has especially to bear in mind the qualities of dielectrics and to avoid using india-rubber covered wire or twisted flexible, as these insulated conductors have relatively large capacity per unit of length. In the same way ebonite or celluloid should not be used in making condensers, as, though they have good dielectric qualities, they have large energy losses under high frequency currents. A condenser made with air as dielectric or insulator alone is suitable for this purpose.

AMATEUR RADIO IN 1926

By THE EDITOR OF *Popular Wireless*

IN the article which I wrote for this Journal for 1926 I began by saying that the surprising thing about radio in 1925 was that the Super-heterodyne had not become so popular as was generally anticipated, and that while 1925 was entering on its last phase, the Super-heterodyne was regarded with a certain amount of

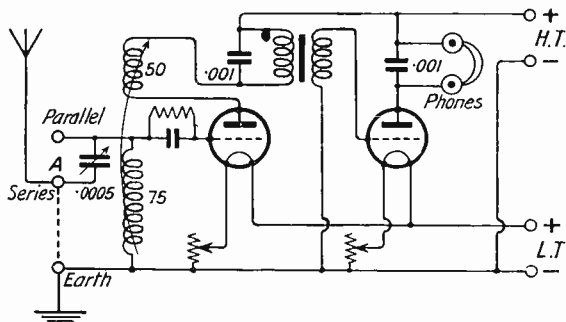

FIG. 1. DETECTOR AND L.F. CIRCUIT FOR 'PHONE D.X. RECEPTION

suspicion and distrust by the vast majority of amateurs in this country.

The Super-heterodyne.

Since I wrote the above, the Super-heterodyne, while not achieving any outstanding popularity, has certainly gained more confidence among amateurs. In particular, its progress and popularity have been helped during the last twelve months by reductions in prices of valves and other components. One of the chief reasons why the Super-heterodyne and other Multi-valve receivers have not been so popular as they might have been is because of the desire on the part of the amateur to build economically, and although there is a fairly substantial section of amateur wireless experimenters who can afford to spend £20 or £30 on a Multi-valve set, there is no gainsaying the fact that the vast majority of amateurs are not in a position to spend this amount of money on one particular receiver. The result has been that amateurs have concentrated to a large extent on one or two-valve sets for DX and loud speaker work.

A Successful Two-valve Circuit.

Figure 1 shows a type of two-valve circuit consisting of one detector and one low frequency valve, recommended by E. J. Simmonds, the well-known owner-operator of 20D, which gained considerable popularity in the early part of 1926. This particular receiver is fairly normal, and it may be classified as a general all-round circuit, giving good loud speaker signals up to twelve miles, while its telephone range is remarkable; as a DX set I have found it very satisfactory also.

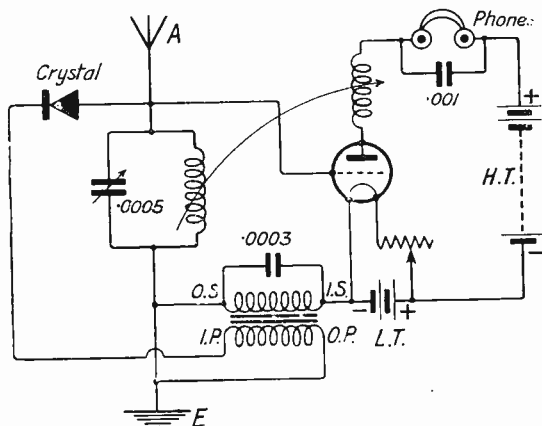

FIG. 2. TRINADYNE CIRCUIT

The Trinadyne.

There has not been much progress in Reflex receivers, and it would seem that this type of circuit is losing some of its early popularity. A circuit, however, which was extremely popular last year was the "Trinadyne." On analysis, the "Trinadyne" circuit will be found to consist of a crystal detector followed by one low frequency amplifier valve, and in addition arrangements provided whereby the valve may be caused to create a reaction effect on the aerial. This circuit is illustrated in Fig. 2.

The Filadyne.

Another interesting circuit development originated by Mr. G. V. Dowding and was termed by him the "Filadyne." This circuit is illustrated in Fig. 3. The theory underlying the operation of the "Filadyne" circuit is very interesting; the word "Filadyne" means filament force. In an ordinary valve

set the signal energy from the aerial or from the anode circuit of a preceding valve is passed on to the grid of a valve in order to influence the stream of electrons passing from the filament to the plate. By this means, rectification and/or amplification, is carried out. In the "Filadyne" circuit the signal energy is set on to the filament of the valve in order to influence the electron stream at its source. The grid is connected to h.t. plus, and is therefore enabled to disperse the space charge, a cloud of free electrons, which normally tend to congregate together around the filament. One of the results of this is that lower h.t. voltages can be used. Loud clear signals and distance sensitivity are

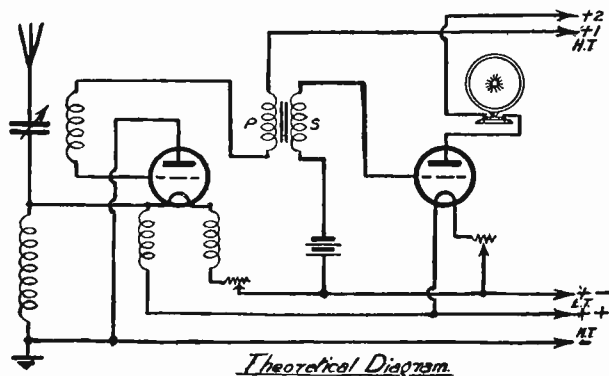

FIG. 3. FILADYNE TWO-VALVE CIRCUIT

some of the more important claims made by the "Filadyne," and a two-valve circuit which is theoretically shown in Fig. 3 will operate a loud speaker most satisfactorily at very good ranges. Tone and volume are also exceptional.

The "N" Circuit Non-Oscillating.

Another interesting development which occurred in 1926 originated with Sir Oliver Lodge, the famous British radio pioneer. For some years Sir Oliver has been working on the problem of devising a circuit which would eliminate the risk of oscillation interference with other receivers. As a result of Sir Oliver's researches, he has produced, in conjunction with Mr. Melinsky and his assistant, Mr. E. E. Robinson, the "N" Circuit. By the time these words are before the public the "N" Circuit will have been put on the market in the form of a two-valve set. The chief merits of the "N" Circuit may be

briefly summarized as follows: A two-valve "N" set compared with a two-valve standard set gives equal volume, although no reaction on the aerial is used. Radiation from the "N" Circuit has been found to be almost negligible. When the circuit is

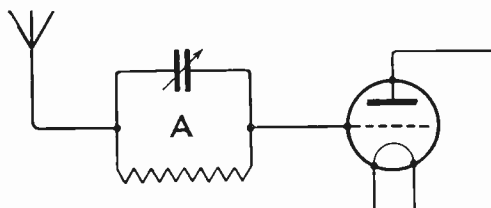

FIG. 4. LODGE "N" CIRCUIT. THEORETICAL DIAGRAM
Showing the Oscillator A connected to an aerial and to the grid of a valve, the plate-filament circuit of which may be used in the ordinary way

properly connected up it is very difficult to get it to oscillate and thus cause interference with neighbouring sets. The sensitivity of the set is also excellent, while the selectivity is well

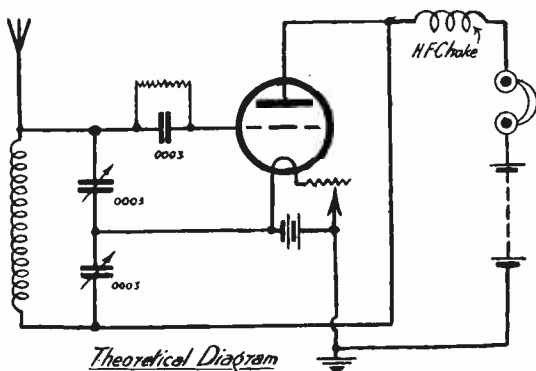

FIG. 5. COLPITTS ONE-VALVE CIRCUIT

above the average: the control, although critical on the filament, is on the whole exceedingly simple to the average listener. A theoretical diagram of an "N" Circuit is shown in Fig. 4. The chief point about the "N" Circuit to the writer's mind is that although there are many circuits which can be hooked up so that the set will not oscillate and cause interference, the

result is usually a diminution in volume and sensitivity, and such circuits usually have to incorporate several valves. But with the "N" Circuit, using only two valves, the volume and sensitivity can be obtained despite the elimination of reaction on the aerial together with the advantages of non-radiation.

Colpitt's One-valve Receiver.

The circuit shown in Fig. 5 is that of the Colpitt's One-valve Receiver. Space will not allow me to describe this circuit, but it is worthy of the attention of all amateurs who have not tried it out. As a one valver it can be thoroughly recommended to the amateur.

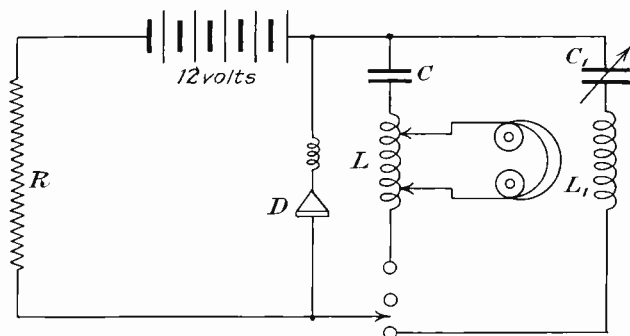

FIG. 6

Long-distance Transmission.

With regard to the progress of the amateur transmitter in 1926, much could be written. Amateurs as well known as Mr. E. J. Simmonds, Mr. Gerald Marcuse, and others, have continued their good work in connection with short wave long distance transmission. Since two way amateur direct communication with Australia on November 13th, 1925, was first effected, progress has been rapid. The well-known Australian amateur, Mr. Maclurcan, in conjunction with Mr. E. J. Simmonds, has been conducting some very interesting experiments on twenty metres, and already it has been proved that the success of these experiments has been obtained, not because of chance contact between the two stations, but because of the careful selection of wavelengths and the time chosen for the transmission.

During recent months the development of apparatus for transmission and reception of telephony on wavelengths of

twenty metres has been closely followed by many amateur transmitters, and much research has been directed to the problems associated with speech distortion and fading, so apparent on the reception of short wave telephony. This has also entailed the increasing popularity of quartz crystal control.

Oscillating Crystals.

The pioneer work of the Russian engineer Lossev, in producing oscillation and amplification by means of crystals, has created a great deal of interest among experimenters in this country. The principle

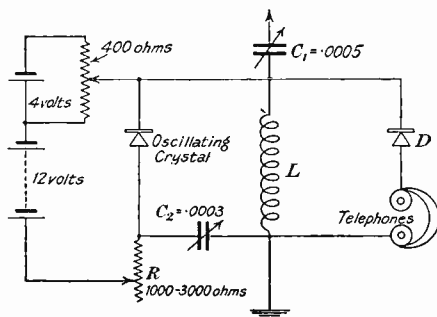

FIG. 7. A PRACTICAL OSCILLATING CRYSTAL CIRCUIT

of the crystal oscillator may be briefly described as follows: It has been found that crystals offer negative resistance, as opposed to positive resistance, to an oscillating current, and in Fig. 6 the oscillatory circuit C_1 , L_1 , and D , is caused to oscillate by first charging the condenser C_1 , which then discharges through the inductance L_1 . And as the crystal D offers a negative resistance to oscillations, these, instead of being damped out, are increased in amplitude until they reach maximum, where they remain constant. The oscillations are prevented from passing through the battery circuit R ; this resistance must not be lower than 1,000 ohms, and as it acts as a choke for H.F. oscillations, it must also have inductance.

Fig. 7 shows a practical oscillatory crystal circuit. In Fig. 7 the condenser C_1 is a .005 variable; C_2 has a value of .0003 mfd. while the battery consists of flash lamp cells with a potentiometer of 400 ohms across the last battery to give a fine adjustment to the crystal voltage. The resistance is variable, in small stages, from 1,000 ohm to 3,000 ohm.

The transformer (R_1) should have a resistance of about 2,500 ohms, and selected specimens of untreated zincite will do O.K. for the crystal.

The amateur will find a very large field for research in oscillating crystal circuits. See also page 113.

“ WHEREVER SHE GOES ”

By “ MENTOR ”

WHEN a wireless set has once been installed, it is generally kept in one room—and that, unfortunately, often the room where you do not want to be. The first stage is then to run a twin wire round into the next room for loud speaker or telephone use; then another wire is run, say, upstairs, and finally the house stands an unhealthy chance of becoming nothing but a network of wires. And that is one reason why wives do not like the wireless very much! But it is not surprising.

In wiring up a house neatly and efficiently, so that Phyllis can “ have music wherever she goes.” there are two obvious ways of doing the job. The aerial and earth are usually fixtures. So there is the method of running leads hither and thither for the aerial and earth connections and moving the set bodily from room to room; this is an example of what should *not* be done. The alternative, and the one to be recommended, is to keep the set in a given spot and run the leads for the telephones or loud speaker wherever they may be required. The former method is not practicable, because, in the first place, the tiny aerial currents will probably prove not strong enough to “ get through ” to the set, and, secondly, the capacity of the aerial circuit is altered every time a move is made. Then the possibility of damage to the valves and general wear and tear to the set in moving it about make the method cumbersome and unsatisfactory.

On the other hand, the low-frequency loud speaker currents do not in the least mind travelling long distances around the house. And so this system is by far the better one to adopt.

The First Fence.

The first obstacle to be overcome, of course, is the natural aversion the lady of the house invariably has to wires running about the house. But if you can persuade her that the job can and will be done neatly and without turning the place upside down, reluctant consent can usually be obtained.

Then we may set to work. The first point to settle is to choose the permanent spot for the set. This decided, the wiring should work from the set to the various points required, and not vice versa, as is sometimes attempted. Only by working this way can a minimum of joints be used. Joints mean possible leaks and short circuits, and so should be avoided wherever possible.

A plan of campaign should be plotted out on paper beforehand on the lines of that given in Fig. 1, which shows the ground floor of an imaginary house and the design followed. In this

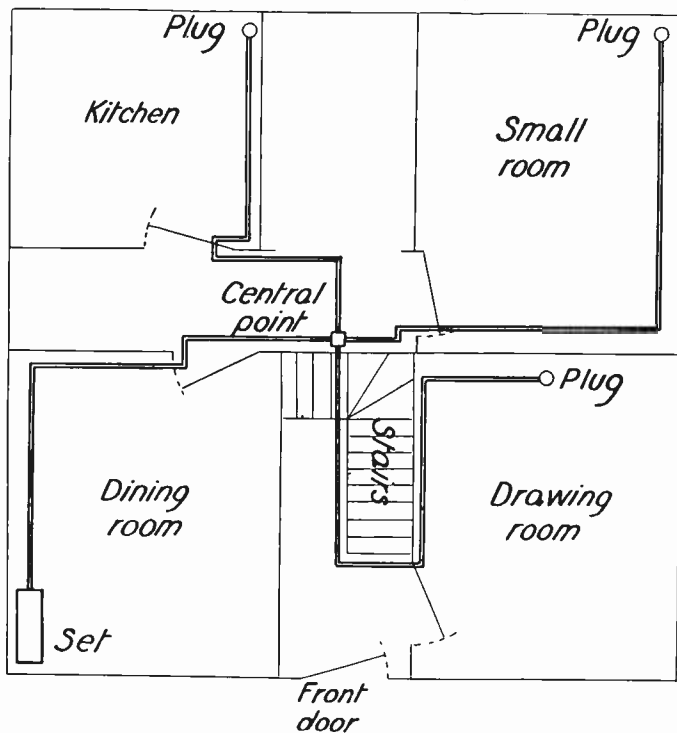

FIG. 1

the wires are shown away from the walls, for the sake of clearness, but in practice this need not be considered essential, of course.

The Central Points.

The points in each room should be laid in parallel and not in series. By this means, any one or more points can be used at the same time without interference or switches being required at the remainder of the points. A double wire should be run from the set to the foot of the stairs, or to whatever point is made the central distributing station for all the rooms on that floor.

From this point a lead should then be taken upstairs to the central point for the first floor, and so on for each story of the house where the loud speaker will ever be required. In this way, only one central joint on each landing is used, and if this joint be well soldered and insulated, efficient wear for years can be assured. Then leads can be run from the central points to the various rooms on each floor as required.

On the upper landing, leads can be taken to each bedroom; the bathroom is not recommended, as steam is bad for loud speakers. In this manner, the whole system is wired up in parallel, so that loud speaker and/or telephones can be connected to any one or more points at the same time.

Disguising the Wiring.

To make a really finished job of the wiring, the floor boards should be taken up and the wires run underneath, as is often the practice with electric-bell wires. When the wires have to be run in the same direction as the beams, or "joists," as we ought to call them technically, the work becomes a comparatively simple matter. To persuade the wires to run under the entire floor, and so save taking too many boards up, one of those long, flexible canes used for cleaning flues is useful. When the wires have to run in the same direction as the floorboards, that is, through the joists, a hole must be bored in each joist with a gimlet or bradawl. This is a long process, but not a difficult one, and does the work neatly.

A simpler and quicker system is to run the wires above floor-board level. Where all the floors of the house are covered with linoleum, they may be neatly laid underneath it, but this system is not to be recommended, as the wires necessarily get wet whenever the floor is washed, their insulation thereby deteriorating and the wires corroding. To avoid this, the wires may be neatly laid round the wainscoting, or taken up the wall, and round via the picture rail. In the latter case, invisibility can be secured if the wires can be taken up the wall behind sideboards, wardrobes, or other tall articles of furniture.

The Type of Wire.

The idea of the "central point" system is to avoid joints as much as possible. It means using a little extra wire, maybe, but the expense is saved in absence of future troubles. Wires of this nature, when once laid, usually remain for several years, so that capital outlay in the first place is not of much importance.

Only insulated wire should be used. Ordinary double-cotton covered electric-bell wire is quite suitable and to be recommended. Special twin covered wire can be obtained, and this saves the

trouble of laying two separate wires. Ordinary electric-lighting "flex" may be used, but its bulky nature and barley-sugar shape form an annoying ridge if laid under linoleum.

Loud-Speaker Fittings.

The most convenient type of fitting to use is an ordinary plug and socket, such as is used for a common or garden electric reading-lamp. One plug only is needed (for the loud speaker) and separate sockets required for each room. These should be of a different size (preferably smaller) than those for reading-lamps, or sooner or later someone will insert the loud speaker plug into an electric-light socket—with disastrous results.

The sockets may be conveniently fitted in the wainscoting, in similar manner to reading-lamp sockets, and in some rooms it may be found convenient to fit more than one socket for the loud speaker. In any case, the loud speaker should be connected to its plug by at least eight feet of flex, so that its position will not be confined within a few feet of the socket.

Comfort for Visitors.

A little and much-appreciated comfort for visitors is to fit up a spare pair of telephones (or even a small loud speaker) in the spare bedroom, so that they, if they wish to do so, may listen, as well as the rest of the family, in bed.

But the unwary and indiscreet (I know this does not apply to you, sweet reader, but perhaps you know a friend to whom it may?) must remember that if one is speaking in a room where there is a loud speaker and the visitor is listening on his telephones, he has the benefit of hearing most of what is said. And so, as a final warning, do not criticize the occupants of other rooms when the house is wired up for wireless in this way!

THE PROBLEM OF THE OSCILLATING CRYSTAL

By J. F. CORRIGAN, M.Sc., A.I.C.
(*University of Manchester*)

SINCE the publication in this country, two years ago, of the results obtained by M. Lossev and his fellow workers in the sphere of crystal oscillation-generating contacts, the crystal oscillator has been given a considerable amount of attention by experimenters of both the amateur and the professional variety. The fact that a suitable crystal contact can be made to exhibit oscillatory phenomena has been known for some time, this effect being first pointed out by Dr. W. H. Eccles as far back as the year 1910.¹ The more recent experiments of Lossev, however, have served very greatly to extend our knowledge of the oscillation-generating effect possessed by certain crystal contacts, and particularly with regard to the possible practical applications to which these effects may be put.

It is not within the province of this article to enter into a description of the crystal oscillation experiments which have been carried out by the Russian workers. In brief, however, it may be stated that Lossev and his co-workers investigated the oscillation-generating properties of natural zincite, and, in general, their published researches have formed the basis of all the experiments which have subsequently been made by other workers.

The oscillating crystal presents a two-fold problem to the interested worker in that department of radio science. Firstly, the actual causation of the crystal's oscillation-developing properties is very obscure at the present time, and that fact, coupled also with the very scanty knowledge which we have concerning the true nature of crystal rectification, presents a problem of first-rate theoretical importance to the radio scientist. On the more practical side, the problem of the oscillating crystal concerns itself with the devising of some essentially practical and thoroughly reliable means of applying the oscillating characteristics of the crystal to definitely useful purposes. Now, there are quite a number of applications which may feasibly be made of the crystal oscillator, chief among which are the production of amplification effects without the use of valves, the generation of oscillations of known frequency, the reception of continuous

¹ Vide *The Electrician*, December 16th, 1910.

wave transmissions, and possibly the transmission of telephony over considerable distances. As the reader will no doubt be aware, all these applications have been shown to be possible by the Russian experimenters, and English workers, following similar lines of investigation, have worked out many experimental circuits in which such effects can most readily be obtained.

Practical Difficulties.

It should be pointed out here, however, that in none of the above applications to which the oscillating crystal has been put has any large measure of practical success been obtained, the word "practical" here being used more particularly in its commercial sense. It is thus that the crystal oscillator, and all the various applications which are being made of it, must still be regarded as laboratory successes only, for, in many directions, much further work on the subject needs to be forthcoming before the oscillating crystal and the circuits in which the properties can be utilized can become as reliable and productive of such simply attained results as those which are derived from the use of any ordinary crystal rectification circuit.

Despite these facts, however, much prominence has been given to the subject of crystal oscillators and oscillatory circuits in the wireless press. Amateur radio experimenters have, quite naturally, been induced to try their hands at crystal oscillation work, and, in a large number of instances, with extremely disappointing results. Hence it is that, if there be any element of fashion in the radio world, the vogue of the oscillating crystal among wireless amateurs appears, at the present time, to be somewhat on the wane.

The whole subject of oscillation-generating crystal contacts, however, is fraught with many possibilities and important applications. There is no doubt that further and more intensive investigation into the problems presented by the oscillating crystal will place the whole subject on a sound and a more essentially practical basis than it rests at present. One of the fundamental practical difficulties which has yet to be overcome in crystal oscillation work is that of getting the oscillatory contact to remain perfectly stable, and to give consistent and reliable results. As things stand at present, crystal oscillatory contacts are notoriously unstable and unreliable affairs. Some of them generate the required oscillatory currents with the utmost ease, whilst others, and, perhaps, the greater number of them, only develop the oscillations after tedious adjustment. Further, even a good oscillating crystal is liable to go "dud" at a moment's notice, so to speak, owing to totally obscure causes.

Oscillating Zincite.

Although many crystal contacts have been shown to possess oscillatory characteristics in some degree, the oscillation-generating contact *par excellence* comprises that between a steel wire and a carefully selected and tested crystal of natural zincite. The Russian experimenter, Lossev, first demonstrated the great superiority of zincite over any other variety of mineral yet experimented with, and subsequent workers have almost invariably made use of this mineral for their experiments.

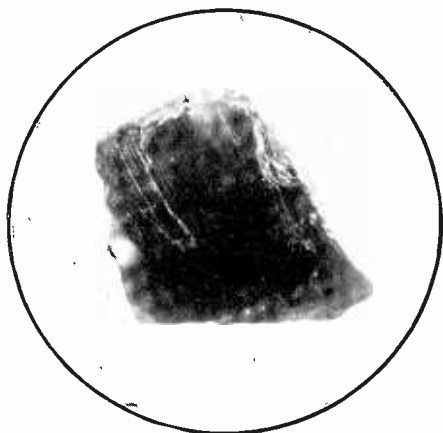

FIG. 1. A ZINCITE CRYSTAL POSSESSING GOOD OSCILLATING PROPERTIES

The zincite crystals employed by Lossev and his assistants are apparently characterized by a relatively low resistance, which greatly facilitates their oscillation-generating properties. As an example, an average zincite crystal of good quality will generally be found to possess a resistance to a small direct current of anything from 60 or 70 ohms upwards. Some of the Lossev specimens of zincite which have found their way into this country show a resistance as low as 20 ohms on suitably chosen spots.

Zincite, for oscillation purposes, should possess a dark ruby red colour and a vitreous appearance. Material which is coke-like in appearance, and which is streaked here and there with reddish veins is generally useless for the purpose. The production of suitable zincite for the generation of oscillations is thus a desirable factor in the furtherance of research into the subject,

and especially for investigations on the part of amateurs. Most shop-bought zincite is unfitted for the purpose of oscillation-generation. No wonder, therefore, that the amateur wireless "fan," working with such material, very quickly gives up his experiments in disgust. Within recent times, however, one or two enterprising firms have made successful attempts to market natural zincite, which may be relied upon to give rise to the desired oscillation effects. For instance, the specially

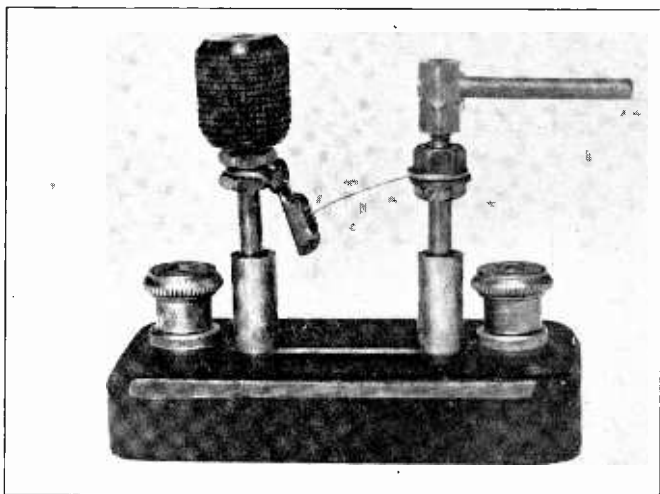

FIG. 2. THE "MILLER" CRYSTAL OSCILLATOR. (PAT. 17767)

tested oscillating zincite of Messrs. L. G. Russell, of "Hertzite" fame, is efficient and reliable material, and may be recommended for the use of any reader who is interested in the subject of crystal oscillation.

Flat Contacts.

It is probable, however, that further developments in the sphere of crystal oscillation-generating contacts will take the form of some flat contact device which will result in a greater degree of stability being given to the contact. At the present time, rectifying contacts are known which will work efficiently under relatively heavy pressures, and with large contact areas. Although the oscillating properties of such contacts have not been investigated, it is by the use of a contact

device of this type that one of the main practical difficulties attending the use of the crystal oscillator will be overcome.

If, therefore, it became possible to produce a crystal oscillator which would develop its oscillations promptly by the mere touch of a switch, which would remain permanently in an oscillation-generating condition at the will of the operator, and which would not deteriorate after use, the advent of such a device, and the numerous applications which could be made of it, would bid fair to revolutionize the sphere of crystal reception.

Crystal Regeneration.

Turning now, in brief, to the present-day oscillatory circuits, the main problem with these is not so much concerned with the getting of such circuits to assist the crystal's oscillation-generating function, as it is with the production of a circuit which will give rise to something akin to a reaction or regenerative effect, with its consequent magnification of signal intensity in the receiving headphones. Investigations have been carried out in this direction, notably by Captain H. J. Round, but the fundamental instability of the oscillatory contact, and also its unreliable action, have, so far, proved insurmountable.

Amplification, at radio frequency by means of an oscillating crystal circuit is a fairly well recognized, and in many respects, a successful fact. Results from the use of an oscillating crystal as an audio-frequency amplifier, however, have not been so promising, and the matter still requires continued investigation. The ideal of the crystal oscillation worker is to produce a circuit employing a stable oscillation-generating contact which will be perfectly controllable, and which will undertake either the function of high or low frequency amplifier, or the dual rôle of rectifier and amplifier in almost as simple a manner as that in which the ordinary "family" crystal receiving set performs its evening duties. It is a laudable ideal, but its fulfilment seems to be very far off at the present time. Like many other of the numerous electrical properties possessed by certain crystals and their contacts, the fundamental cause of the crystal's oscillatory power is unknown, and until light is thrown on this basic matter, every advance in the methods and technique of crystal oscillation may not untruthfully be regarded as a step in the dark.

RADIO AND CABLES

By LT.-COL. CHETWODE CRAWLEY, M.I.E.E.

WE are now entering on a new era in long range radio communication, and it may be of interest to consider shortly this progress in radio in conjunction with the progress being made by its great rival, the submarine cable.

Telephony.

So far as telephony over great distances is concerned, cable communication at the moment is only practicable over land areas and short sea routes, as the problem of long range submarine working is still an unsolved problem, whereas long range radio telephony is well adapted to transoceanic communication. A few years ago it was often said that long range submarine telephony was an insoluble problem, but there are now faint indications that it was probably inaccurate to say anything stronger than unsolved problem. Be that as it may, we can still certainly use the expression unsolved problem so far as long range submarine telephony is concerned, whereas during this last year it has been demonstrated to all that long range radio telephony is on the eve of becoming a practical commercial proposition. This fact was definitely proved on Sunday, 7th February, 1926, when for the first time two-way radio conversation was held between England and the United States of America, and the occasion was none the less historic for the lack of any long dissertations on the brotherhood of the two great English-speaking nations. England's epoch-making remark "Hullo New York, who is that speaking" was only surpassed by America's laconic reply, "Bailey."

Such was the inauguration of the greatest advance that has been made in telephonic conversation since the 10th of March, 1876, when Bell in Boston made his first speech by wire-telephony from one room to another, "Mr. Watson come here, I want you."

But we must not imagine that long range radio telephony grew up like a mushroom in the night. It had been growing since 1915, when speech transmitted by the American Telephone and Telegraph Company from Arlington, near Washington, was received in Honolulu and in Paris. The same company continued experiments, and in 1923 commenced, with the Western Electric Company of America and our own General Post Office, the series of experiments which resulted in the triumph of 1926, and which

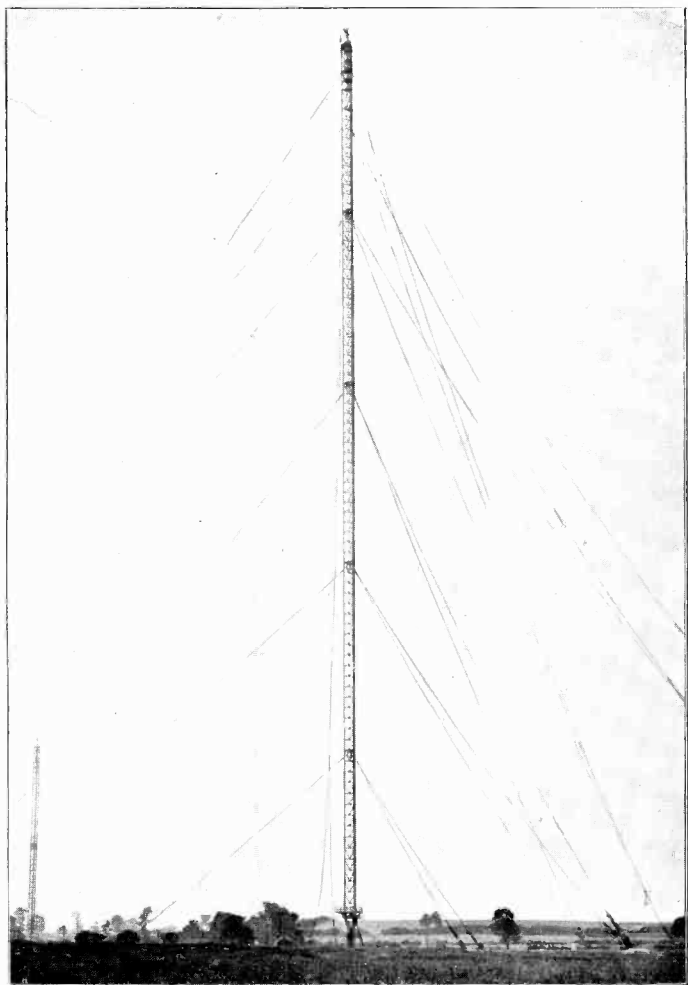

FIG. 1. AN 800-FOOT MAST AT THE RUGBY STATION

will, we hope, make 1927 notable for the birth of transatlantic radio telephony on a commercial footing.

Submarine Cables.

When we turn to long range telegraphy, the story is very different. Here we find that a network of cables had been spread all over the world long before anyone thought of radio telegraphy. The first transatlantic cable commenced commercial work just sixty years ago. Mr. Marconi filed the first British patent for



FIG. 2. THE POWER ROOM AT THE NORTHOLT STATION

radio telegraphy just thirty years ago, and seven years later inaugurated the first commercial radio service across the Atlantic. We have travelled far since then, and we must not forget that the cables had a thirty-seven years' start in what is yet but a sixty years' race. This is, however, hardly a fair comparison, as though the cables had the inestimable advantage of being commercially established for thirty-seven years before radio started, radio has had the very considerable advantage of having cable experience to help it—an advantage which it has, unfortunately, been slow to grasp. But all this is ancient history and it is easy to criticize now and talk of the "might have beens." Let us turn from these misty memories to the facts of the present day.

World Network of Cables.

There are now sixteen cables between this country and North America, and all of these, with the exception of the two Government cables, which are worked by the Post Office, and the British-owned Halifax cable are controlled directly or indirectly by American companies. In addition, a French company controls three cables between France and the United States, so that there are nineteen cables between Europe and North America. There is a French cable to South America, via West Africa, the British one from

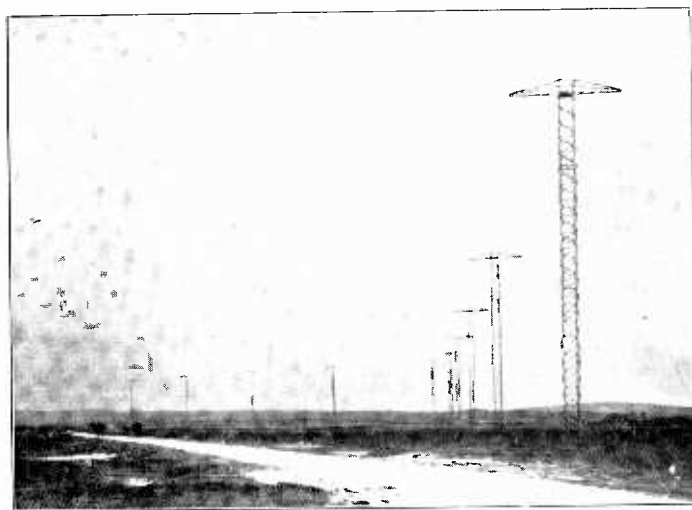

FIG. 3. THE IMPERIAL BEAM STATION AT BODMIN
(By courtesy of the Marconi Co.)

Halifax to Bermuda, the British West Indies and British Guiana, and a number of American cables between North and South America.

There are two cables across the Pacific; one, British, from Vancouver, via Fiji and New Zealand, to Australia with branches thence to the Far East; the other, American, from San Francisco, via Honolulu to the Philippines and the Far East.

Lastly, there is the great British group of cables connecting this country and Europe generally with Africa, India, and the Far East. It may be said therefore that Great Britain dominates the cable communication across the great oceans of the world, with the exception of the Atlantic Ocean, a fact which has a direct bearing on our position hitherto in long range radio.

Long Range Radio.

It was largely owing to the fact that the whole Empire was connected up by a network of British-owned cables that held us back before the war from pushing on with long range radio communication, in spite of the fact that the United States, Germany, France, and Italy had all embarked on schemes for erecting high power stations to connect up the Mother Country with her outlying possessions. With the exception of Germany, which was soon isolated, the same state of affairs continued

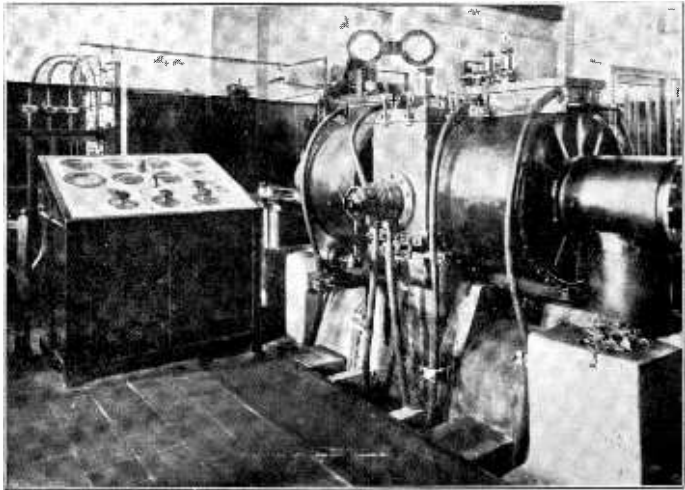

FIG. 4. AN ARC TRANSMITTER AT THE OXFORD STATION

overseas during the war, so that at its close we were still without any high power radio stations in the Empire overseas, whereas the United States, France and Italy were well provided with powerful stations in their outlying possessions.

Imperial Radio.

Our backward position in this respect was, however, fully recognized at the first Imperial Conference after the war, and the net result is that we have now at Rugby the most powerful station in the world, capable of sending messages to any part of our Empire and to our ships in any sea, as well as the beam stations which have just been completed for communication with Canada, Australia, South Africa, and India.

The completion of Rugby for all-round work with the Empire, and of the beam stations for direct communication with these Dominions and India, will always make 1926 stand out in the history of radio as the Imperial radio year.

Radio *versus* Cables.

How far this new era of long range radio will affect our great network of cables it is impossible to say. The former is still a child, the latter a lusty youth growing stronger every day,



FIG. 5. THE HIGH POWER STATION AT CAIRO

and, in our enthusiasm at the wonderful progress of radio, we must not lose sight of the fact that the progress in cables during the last couple of years has been little short of miraculous. Several new long distance cables have been laid during the last two years, and others are being, or are about to be, laid. Of the former, the most notable is the new Atlantic cable laid last summer and the new Eastern cable between Cocos Islands and Western Australia; of the latter, the second British Pacific cable, which contains the longest stretch of cable ever laid, about 3,500 miles, from Vancouver to Fanning Island. The first of this new type of fast speed cable was constructed by the Telegraph Construction and Maintenance Company of London, to the design

of the Western Electric Company of New York, and was laid two years ago between New York and the Azores.

This type of cable cannot at present be arranged for simultaneous working in each direction, as is accomplished in the older types, but even so the signalling output is about four times as great as in the older type and at only about 20 per cent increase in the capital cost.

This shows what long range radio is up against as a competitor with cables, as once a cable is laid it is able to work all day and every day if in good condition, except on the rare occasions of severe electrical storms. Radio has yet to show that it can act up to this high standard of continuity, but it must be remembered that the capital expenditure in the case of cables is far greater than in the case of radio, and, indeed, we had better leave it at that, for only "fools rush in where angels fear to tread."

RECENT DEVELOPMENTS IN WIRELESS

The Problem of Selectivity.

THE demand of the broadcast public for a higher standard of selectivity in reception appears to grow more insistent each year. In this connection it must be admitted at once that manufacturers and designers have not yet succeeded in attaining the listener's ideal of a multivalve set capable of running through the gamut of available programmes, free from mutual interference, by the mere rotation of a single tuning knob. At the same time, such a receiver may fairly be said to have been brought some stages nearer achievement by the progress that has been made during the last twelve months.

To a large extent the problem of selective reception is complicated by the fact that the number of transmitting stations is continually on the increase. It is obvious that as the density of the ether broadcast traffic grows, the more difficult it becomes to design long-range receiving sets capable of distinguishing any one given programme from the next.

On the Transmitting Side.

So far as transmission is concerned, the International Broadcasting Bureau in Geneva has already taken steps to minimize the prevailing overlap and confusion, and is busily engaged in devising further ways and means to meet the inevitable expansion of the near future, more particularly on the Continent.

Responsible experts at home are also advocating a drastic alteration of the British system of broadcast distribution. The plan most favoured at present is the installation of a comparatively small number of high-powered centres, say three or four, linked up to a subordinate network of low-powered relay stations. The latter would have an effective crystal range over a radius of from ten to fifteen miles, the object of the scheme as a whole being to ensure at least one, and in most cases a choice of two alternative programmes to every crystal set in the country, no matter where located. From the point of view of crystal users, the advantages are obvious, although the scheme, if adopted, will almost certainly render the task of receiving foreign transmissions free from interference even more difficult than it is at present to the owners of long-range multivalve sets.

Receiver Design.

For long-range reception, combined with a reasonable degree

of selectivity, it is essential to employ two or more stages of high-frequency amplification. The use of more than one HF valve, however, at once introduces special difficulties. Not only does such a set possess a pronounced tendency to self-oscillation, but it also calls for a high degree of skill in manipulation.

During the last year considerable progress has been made in overcoming both these difficulties, partly by the use of improved "balancing" methods of the kind used in the well-known Neutrodyne circuit, and partly by various modifications of the standard type of "supersonic" receiver.

As regards actual performance, there is little to choose between the Superhet and the Neutrodyne. For an equal number of H.F. stages both give approximately the same range and possess the same degree of selectivity. The supersonic receiver is generally used with a loop or frame aerial, whilst neutralized sets are somewhat more easily handled when connected up to an ordinary outside aerial or an indoor extended wire. Finally, whilst the standard superhet is limited to two tuning controls, the ordinary neutralized circuit requires as many tuning adjustments as there are H.F. stages in operation.

Neutralized Receivers.

Of the two the Neutrodyne circuit is the more economical as regards component parts. Several stages of high-frequency amplification can be stabilized and rendered easy to control by the simple addition of small, inexpensive balancing condensers, which counteract or neutralize the mischievous tendency to self-oscillation caused by the capacity coupling between the various stages across the internal electrodes of each valve.

In addition, in the latest types of receiver, the inter-valve coupling coils are specially screened to prevent direct "pick-up," and consequent interference, whilst control is simplified by combining the tuning condensers of the various high-frequency circuits in one single unit, or by gearing them together, so that they can be simultaneously operated from a single control knob.

Supersonic Reception.

The principle of the superheterodyne circuit is to utilize a frequency-changing method as a means of avoiding the self-oscillation difficulties previously referred to. Instead of operating directly upon the received radio-frequency oscillations, the latter are immediately heterodyned and converted into equivalent oscillations of considerably longer wavelength.

In this form the signal waves can safely be passed through several stages of intermediate amplification, without giving

rise to self-oscillation, before they are rectified and subsequently amplified at low-frequency. One drawback of the super-heterodyne lies in the necessity of using a local oscillator in order to secure the desired heterodyne effect. In the first place, this means an extra valve, and, in the second, the local oscillator tends to energize the receiving aerial and thereby cause local interference and disturbance to neighbouring listeners.

In the latest type of supersonic receiver these disadvantages have been largely eliminated. The first valve is arranged to act either as a radio-frequency amplifier or as a first detector simultaneously with its function as local oscillator. Moreover, ingenious reflexing methods have been devised whereby both the intermediate or supersonic frequencies, as well as the rectified low frequencies, are fed back for dual amplification, thus securing the same range with a smaller number of valve stages. In fact, the modern five-valve superhet has practically the same efficiency as the older type of circuit comprising from eight to ten valves.

Finally, disturbances due to re-radiation from the receiving aerial are prevented by balancing or stabilizing circuits inserted between the first valve and the aerial, whereby the latter is safeguarded from the local oscillating energy flowing in the valve circuits.

Re-radiating Aerials.

The increasing popularity of the valve has, it must be confessed, brought in its train an aggravation of the type of local interference caused by self-oscillation. A back-coupled single-valve set, when carelessly handled, will oscillate only too readily. In this condition it feeds a considerable amount of energy back into the receiving aerial, which is thus temporarily converted into a transmitter, and a source of annoyance to other listeners over a considerable area.

When the set comprises a tuned anode stage of amplification, it is prone to oscillate at the lower settings of the tuning condenser, even when no magnetic back-coupling is employed, so that particularly careful handling is called for if disturbance to one's neighbours is to be avoided.

Non-radiating Sets.

Apart from the balancing or neutralizing method previously mentioned, special circuits have been designed with the object of rendering it impossible for the valve energy to be communicated back to the receiving aerial, even in the most inexperienced hands. In one type of circuit the tuning condenser in the plate of the first valve is mechanically geared with a variometer in the aerial circuit, in such a way that the effective capacities of

the two circuits are automatically varied in opposite senses, so that the coefficient of capacity coupling can never attain the point at which self-oscillation sets in.

In another arrangement the tuning controls are linked up with a potentiometer slider which controls the grid bias of the first valve, so that as the danger point of oscillation is approached the grid bias is automatically made more positive, thus damping the input circuit and preventing the building-up of voltages likely to energize the aerial.

The Lodge "N" Circuit.

Mention must also be made of an ingenious non-radiating circuit recently invented by the veteran wireless pioneer Sir Oliver Lodge. Here an aperiodic aerial is used to feed the signals to a tuned loop circuit interposed between a single-point tapping on the aerial and the grid of the first valve. The loop circuit is energized by voltage impulses alone, practically no current passing into or out of the closed loop.

Owing to resonance effects, a considerable current does, however, build up inside the loop itself, and the corresponding voltages stimulate the grid in the ordinary way. The loop similarly serves to prevent the passage of any perceptible amount of energy from the valve circuits back into the aerial, and thus maintains the latter in a quiescent condition so far as re-radiation is concerned.

The Battery Problem.

There is a widespread demand amongst valve users for some more convenient and economical method of supplying high and low tension current than the wet and dry batteries now in general use. To some extent this has been met by the various rectifying and reducing units now on the market for feeding valve sets direct from the house electric supply mains. Whilst this solves the problem for those who have access to such a source of supply, there still remains a large public who are not so happily situated.

A New Low-tension Cell.

Recent investigations by a well-known French physicist, M. Féry, appear to promise a new type of battery free from the deadly "sulphation" effect to which most accumulators are so liable. By preventing air or any other oxidizing agency from affecting the surface of the negative plate, M. Féry claims to have rendered sulphation practically impossible. In his new accumulator the negative plate consists of a single layer of lead-oxide paste located at the bottom of the cell, the positive plate being placed in a horizontal position above it. The lower plate

is thus protected not only from direct access of air, but also from any oxygen bubbles generated at the positive plate. A porous layer of silica material is inserted between the upper and lower plates to protect the latter from any solid particles dropping from the positive plate.

High-tension Batteries.

As a source of high-tension for the plate supply, the wet cell or accumulator type of battery, which can be re-charged from time to time from the electric mains or otherwise, is proving a popular substitute for the older dry-cell unit, which must be discarded once it is discharged. The Darimont cell, which may perhaps be described as a half-way house between the ordinary wet and dry type of cell, is another convenient type of battery suitable for high or low tension where a heavy current consumption is not involved. Here each cell is charged by means of special chemicals and maintains its full voltage in operation. When run down it can be completely rehabilitated by inserting a second charge similar to the first.

Thermal Batteries.

Attempts have also been made to utilize thermo-electric batteries built up of metallic "couples" energized by the direct application of heat, either from an electric resistance element, or from a gas or spirit flame, for supplying valve sets with the necessary high and low tension supply. Up to the present, however, thermo-electric units have not proved sufficiently successful in practice to warrant their being regarded as a successful substitute for the older chemical or storage type. At the same time there would seem to be scope for further developments along these lines in the near future, particularly for low-consumption valves.

Circuit Components.

Marked improvements have been effected on all sides amongst the numerous components and gadgets that are in demand by the home constructor. Square-law wavelength and straight-line frequency condensers, provided in most cases with special slow motion gearing, have almost completely replaced the older circular-plate type of instrument. Tapped and screened inductance coils, with ingenious adjustments and mountings, are now produced in bewildering variety, whilst "toroidal" coils, designed to prevent direct "pick up," are also coming into favour.

Recent standardization in valve design has rendered the use of

adjustable rheostats almost old-fashioned. Barretters or fixed-value resistances are taking their place in the filament circuit, and, incidentally, simplify the operation of the set by reducing the number of controls. The older type of screw terminal is also largely being replaced by the more convenient plug or jack connection.

As regards accessories generally, mention may be made of various remote-control devices for automatically switching the receiving set in or out of action from some other room than that in which the set itself is located. Similarly, special switches are now available for earthing the aerial down-lead by a direct connection outside the house. The switch itself is operated by a simple pull-or-push knob from inside the room containing the receiver. Such an arrangement provides a greater safeguard against the possible effects of a direct hit by lightning than the ordinary indoor variety of earthing switch.

Piezo-electric Crystals.

One of the most interesting developments in recent wireless technique lies in the increasing use of oscillating quartz crystals for stabilizing wavelength in transmission. In view of the already crowded state of the ether, it is essential that every station should adhere rigidly to the exact wavelength allotted to it, thus avoiding any risk of heterodyning with its nearest neighbour on the wavelength scale.

It has long been known that quartz and certain other crystals possess the curious property of vibrating mechanically at high frequencies under the influence of an oscillating electric potential. As the potential is applied the crystal changes its shape, or becomes slightly distorted, and simultaneously develops electric charges of opposite sign on its front and rear faces. As the applied voltage is removed the crystal springs back to its normal shape, and slightly beyond, just as a stretched spring overshoots the normal when suddenly released.

This tendency to mechanical vibration can be developed into a persistent or sustained oscillation if the applied potentials are in synchronism with the natural period of vibration of the crystal, and is so used for stabilizing the frequency of an oscillating circuit, such as the master control circuit in a valve generator.

It is a comparatively simple matter to cut a quartz crystal to such dimensions that it will vibrate mechanically at the enormous speed of a million or more cycles per second, which is of the same order as the radio-frequency currents used in broadcasting.

ROUND THE FACTORIES

IN SEARCH OF 1927 NOVELTIES WITH "MENTOR"

"Two pairs of seven-league boots, please."

"Yours fit all right, kind reader? Right, then, let us start off on a round of the factories of Great Britain's wireless industry and see what is in store for us for 1927 in the way of wireless apparatus, new and interesting. I think the first thing we



FIG. 1. H.T. SUPPLY UNIT

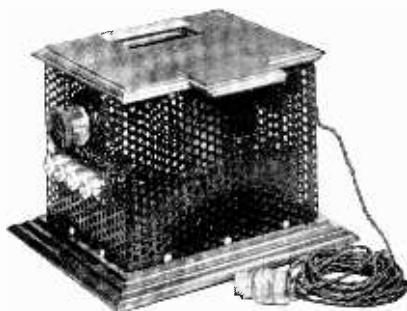

FIG. 2. THE ELVEN MAINS H.T.
SUPPLY UNIT

ought to see is the new set of trouble-savers invented for us to be able to dispense with our high-tension batteries.

Battery Eliminators.

Fig. 1 shows the H.T. supply unit made by Messrs. Philips Lamps, Ltd.; it can be operated on any number of valves and has been successfully used with a super-heterodyne of six valves. Excellent smoothing is due to the large number of condensers incorporated, and A.C. hum is rendered inaudible by earthing the apparatus by means of the earth terminal provided.

Fig. 2 shows the Elven Mains H.T. supply unit, designed for A.C. current, and is arranged to give three output voltages of

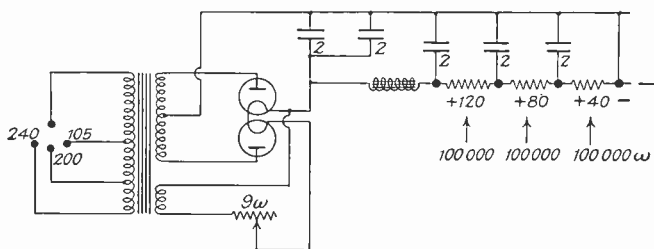

FIG. 3. INTERNAL WIRING OF THE ELVEN MAINS HIGH-TENSION UNIT

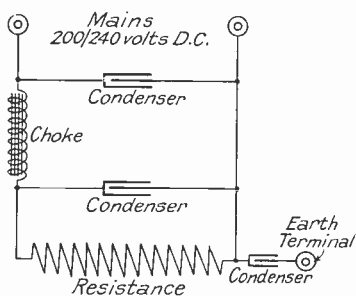

FIG. 4. RADIAC HIGH-TENSION MAINS UNIT
DIAGRAM OF CONNECTIONS

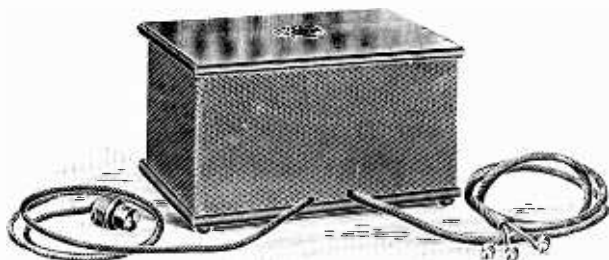

FIG. 5. BATTERY ELIMINATOR
Pye & Co.

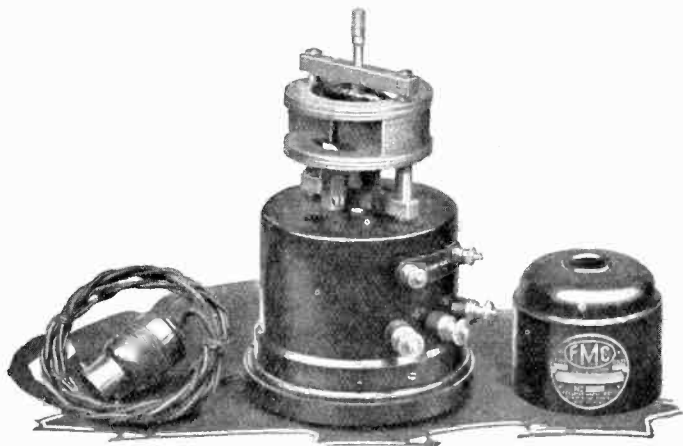

FIG. 6. THE FELLOWS RECTIFIER FOR CHARGING ACCUMULATORS FROM A.C. MAINS

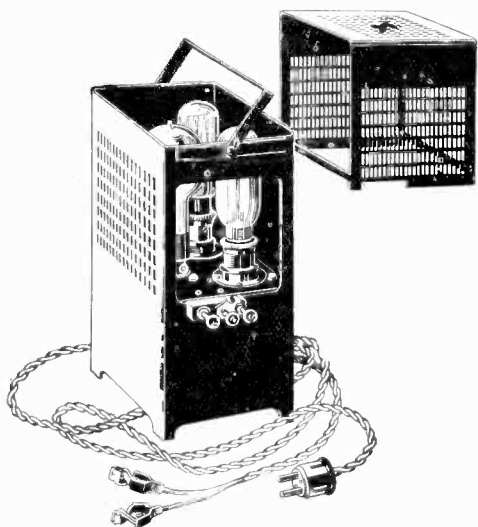

FIG. 7. THE PHILIPS RECTIFIER FOR BATTERY CHARGING

40, 80 and 120 volts. Fig. 3 shows the internal wiring of this component. The connections of the Radiax H.T. mains unit for D.C. current, are shown in Fig. 4, and Fig. 5 is an illustration of

that made by Messrs. W. G. Pye & Co.; as shown, this plugs into any lamp socket, and it is interesting to note that, at 6d. per unit, it consumes only one-tenth of a pennyworth of current per hour.

Battery Chargers.

The next step in connection with batteries is to inspect the low-tension battery chargers, which enable re-charging to be

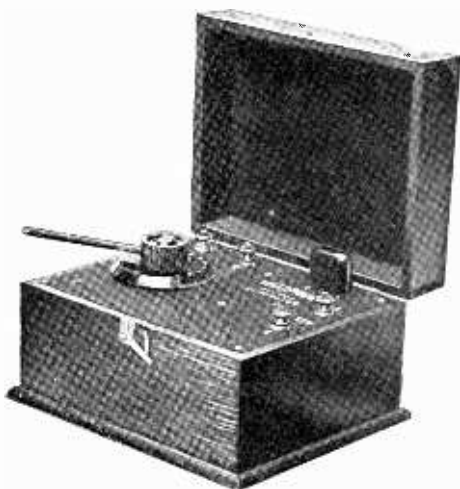

FIG. 8. THE "FELLOPHONE" LOCAL STATION ELIMINATOR

done at home. That made by the Fellows Company is shown in Fig. 6, while Fig. 7 shows that made by the Philips Lamp Co., a 6 amp. rectifier, suitable for charging batteries of from 2 to 8 volts, to be charged with an average of 6 amps., or batteries of 10 to 14 volts at a rate of 3 amps.

A Station Eliminator.

An interesting little piece of apparatus in the Fellows works, let us notice, is the Fellophone Local Station Eliminator, Fig. 8; this is not a mere wave-trap, but actually enables the local station to be tuned out, so that more distant ones may be heard.

Batteries.

To get back to batteries again, let us look at the tungstone accumulators, Fig. 9, especially designed for wireless work.

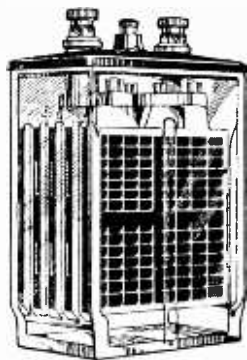

FIG. 9. THE TUNGSTONE ACCUMULATOR

The chief features claimed for this type of accumulator are its particularly robust nature and the large amount of energy put

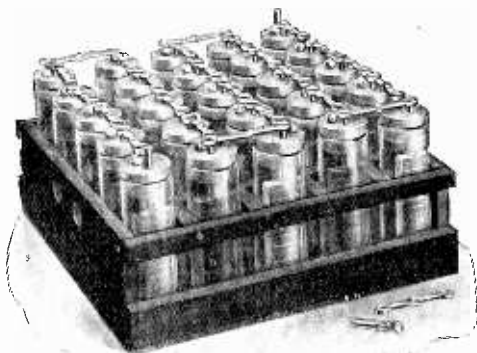

FIG. 10. C.A.V. 60 VOLT, 2 AMP. HIGH-TENSION ACCUMULATOR

out in return for that received during charging. Another important and interesting feature is that they may be easily taken to pieces for cleaning or inspection.

Fig. 10 illustrates the C.A.V. 60 volt, 2 amp. high-tension accumulator, the special construction of which eliminates inter-cell leakage, each cell being air-spaced. They are manufactured also in 30 and 90 volt units, complete with carrying case.

Many users of valve sets find that their high-tension batteries cause faulty reception by fizzling and crackling. Messrs. Siemens have just perfected a new high-tension battery, which they call the Siemens Super-Radio Battery, Fig. 11. Consisting of 36 large cells, giving 50 volts, it has an extra large capacity and is particularly suitable for export.



Siemens

FIG. 11. THE SIEMENS SUPER RADIO BATTERY

Loud Speakers.

The Amplion range remains as popular as ever, and probably their Standard Dragon, Fig. 12, is the most popular of the lot.

The Radiolux, Fig. 13, though it cannot now be really termed a novelty, is an excellent example of an artistic loud speaker, combined with first-class results.

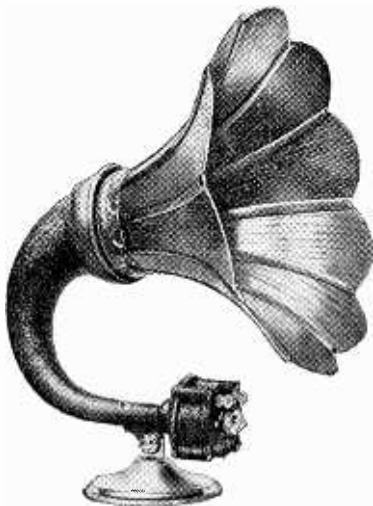

FIG. 12. THE AMPLION STANDARD
"DRAGON" LOUD SPEAKER



FIG. 13. THE "AMPLION,"
"RADIOLUX" LOUD SPEAKER

Fig. 14 shows the new C.A.V. loud speaker, of entirely new construction, with a special cone diaphragm, designed to give perfect reproduction of the bass notes without muffling the higher

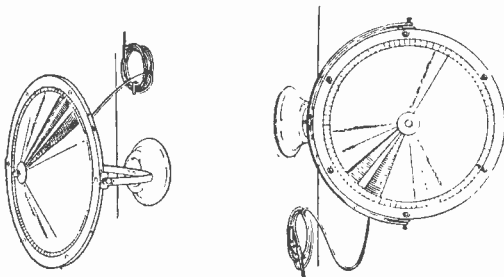

FIG. 14. THE NEW C.A.V. LOUD SPEAKER

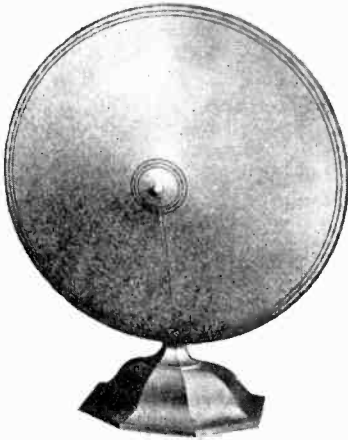

FIG. 15. MODEL B KONE
SPEAKER

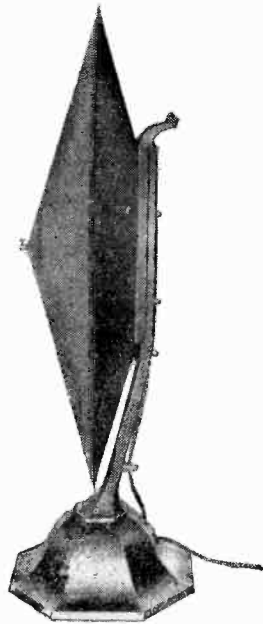

FIG. 16. SEWING METHOD OF
MOUNTING THE "KONE" LOUD
SPEAKER

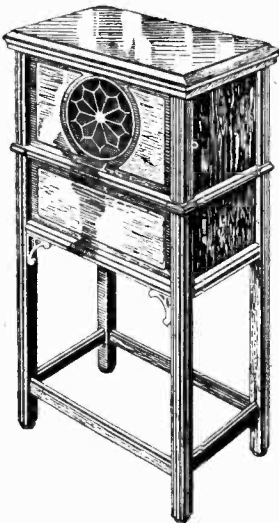

FIG. 17. THE B.T.-H. MODEL R.K.
LOUD SPEAKER

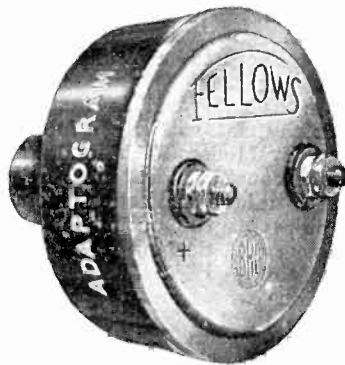

FIG. 18. THE FELLOWS
"ADAPTOGRAM"

tones. Another interesting feature is the special gymbal type mounting, which, as shown, enables the loud speaker to be mounted at any angle, which may often be necessary to suit special requirements.

In Fig. 15 we see the new Model B. Kone loud speaker, manufactured by Standard Telephones and Cables, Ltd., which, owing to the unique method of mounting the two cones (see Fig. 16) gives a splendid tonal purity over the complete scale. It is, of course, non-directional in character, so that listeners in any part of the room can hear equally well. It is wound to



FIG. 19. THE NEW WILSON ELECTRICAL CO.'S MAGNETIC MICROPHONE BAR

750 ohms resistance, and at speech frequency has an impedance of 5,000 ohms.

As a last word in luxury loud speakers, let us have a look at the B.T.-H. Model R.K. loud speaker, which consists of an audio-frequency amplifier of special design and a unique magnetic system and diaphragm. The electrical impulses at the output of the amplifier are transferred to a moving coil, floating freely in a permanent magnetic field, and actuating a conical diaphragm.

Those who want to transform their gramophones into loud speakers will be interested to come and have a look at the Fellows Adaptogram, shown in Fig. 18, which can be fitted direct to the tone arm of the machine. The well-known Amplion range also includes a special gramophone attachment.

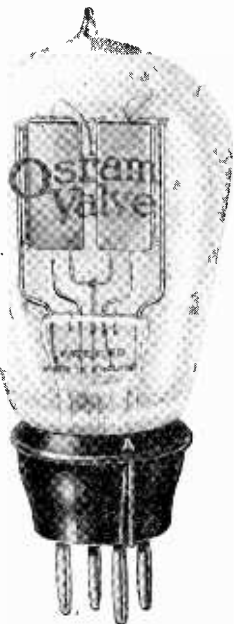

FIG. 20. THE OSRAM U.5 RECTIFYING VALVE

Crystal users who want to obtain loud speaker results will be interested in the New Wilson Electrical Co.'s magnetic microphone bar. Fig. 19, which amplifies crystal reception without the use of valves. It is sturdily built and constant in action when once adjusted and works off two dry cells of $1\frac{1}{2}$ volts each.

New Valves.

The Osram valve, type U.5, shown in Fig. 20, is something quite new in rectifying valves and incorporates the double-electrode system in one bulb, which provides for full rectification of both cycles of the A.C.



FIG. 22. THE NEW R.I. MULTI-RANGE LOW FREQUENCY TRANSFORMER

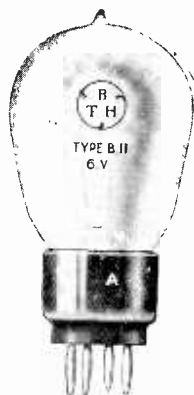

FIG. 21. THE B.T.-H. B.11 DULL EMITTER VALVE

wave, and simplifies smoothing.

The B.T.-H. Company have recently introduced four new valves, the B.2, B. 4. H. (dull emitter), B. 5 H. (dull emitter), and the B. 11, also a dull emitter, illustrated in Fig. 21. This is designed for use in the final L.F. stage, where it will amplify the strongest signal met with in ordinary reception without distortion.

It is specially suitable for outdoor or very loud speaker reception.

Transformers.

The next stage of our round includes the transformer manufacturers, and Fig. 22 shows a new low-frequency transformer,

manufactured by Radio Instruments, Ltd., and designed to enable seven different ratios to be obtained. The values of these ratios are—

1	: 1	4.5	: 1
1.5	: 1	6	: 1
2	: 1	9	: 1
3	: 1		

By using this transformer, experimenters have the opportunity of trying out the effect of different ratios in transformers, which should do much to help improve reception.

Fig. 23 shows the Ferranti inter-

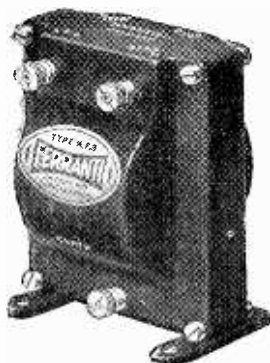

FIG. 23. THE FERRANTI INTERVALVE TRANSFORMER

valve transformer, which is housed in a pressed steel casing of pleasing appearance, and has the good point which many manufacturers forget, namely, the terminals are clearly indicated regarding the parts of the circuit to which they must be connected

Measuring Instruments.

The "Onemeter," made by Messrs. Leslie Dixon & Co., is a useful little instrument, Fig. 24, the size of a vest pocket camera, which enables measurements to be made in amperes, milliamperes, microamperes, volts, millivolts and ohms. Apart from general wireless use, an instrument of this sort is most useful for fault location.

While those who do not want to go into such minute details,

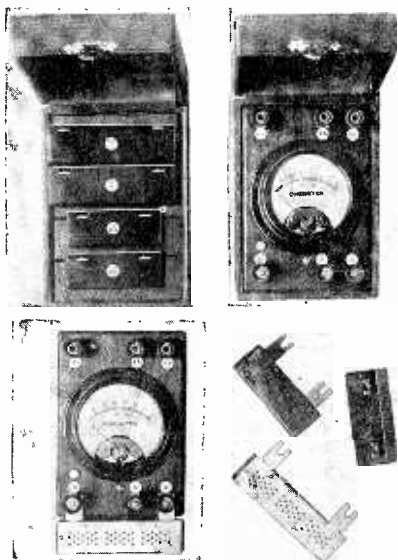

FIG. 24. THE "ONEMETER"
Made by Messrs. Leslie Dixon & Co., Ltd.

but merely want a good and compact voltmeter for measuring voltage and checking the condition of high and low tension

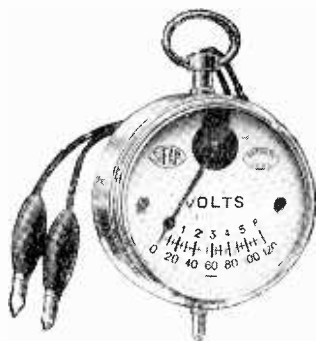

FIG. 25. THE SIFAM COMBINED
H.T. AND L.T. VOLTMETER



FIG. 26. RADIAX D.X. COIL

batteries, will do well to look at the combined H.T. and L.T. voltmeter made by the Sifam Electrical Instrument Co., as illustrated in Fig. 25.

Coils.

Radiax, Ltd., who also make a new battery eliminator, have introduced D.X. coils, Fig. 26, which are a development of their well-known Radiax low loss coils. They are tapped at three points in addition to the terminal ends in such a way as to permit of a variety of uses.

Fig. 27 illustrates one of the screened coils made by the

London Electric Wire Co. The introduction of screened coils contributes in a large measure to the prevention of oscillation outside the set, due to the fact that the screening prevents interaction of magnetic fields within the circuit.

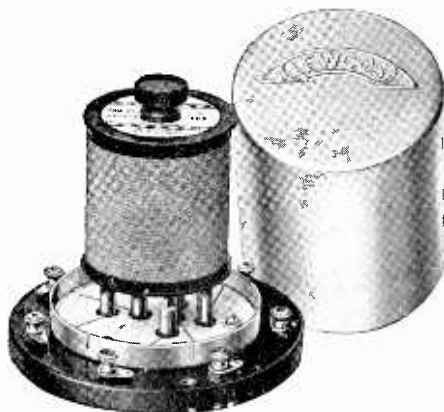

FIG. 27. SCREENED COIL
Made by the London Electric Wire Co.

Condensers.

The T.C.C. series-parallel condenser, shown in Fig. 28, is most useful as a neat method of putting the grid-leak in series

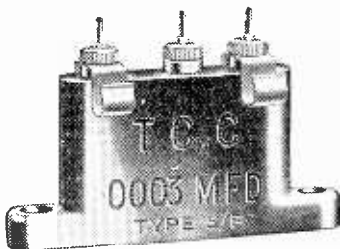

FIG. 28. THE T.C.C. SERIES PARALLEL CONDENSER

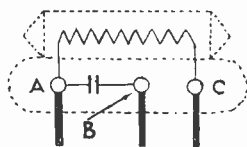

FIG. 29. CONNECTIONS OF THE T.C.C. SERIES—PARALLEL CONDENSER

or in parallel with the condenser, as shown in Fig. 29. Connecting terminals *B* and *C* places the grid-leak in parallel with the condenser.

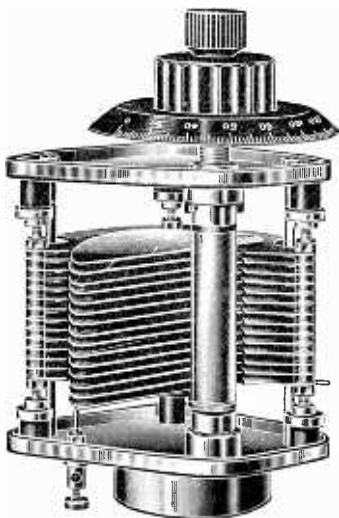

FIG. 30. GEARED CONDENSER
Made by Messrs. W. G. Pye & Co.



FIG. 31. GEARED CONDENSER
Made by Radio Instruments, Ltd.

Fig. 30 shows in detail the geared condenser made by Messrs. W. G. Pye & Co., which has absolute freedom from backlash.

while the decrement shape of the vanes ensures uniformly easy tuning over the whole of the scale.

Fig. 31 shows that made by Radio Instruments, Ltd., and with a gear ratio of 11 to 1 is specially suitable for use in connection with super-heterodyne circuits, or where extremely fine adjustment is required.



FIG. 32. THE BELLING-LEE PANEL FITTING

A Permanent Mineral Detector.

While at the Radio Instrument Co.'s works, let us notice their permanent mineral detector, which remains perfectly sensitive for an indefinite period without readjustment. It consists of a special mineral, mounted in a metal cup, contact being made with another crystal mounted on a spring plunger, which maintains correct pressure.

A Neat Panel Fitting.

The Belling-Lee panel fitting, shown in Fig. 32, gives a distinctive appearance to any instrument, while ensuring efficient connections.

Wiring Made Easy

Messrs. The New London Electron Works, Ltd., supply a

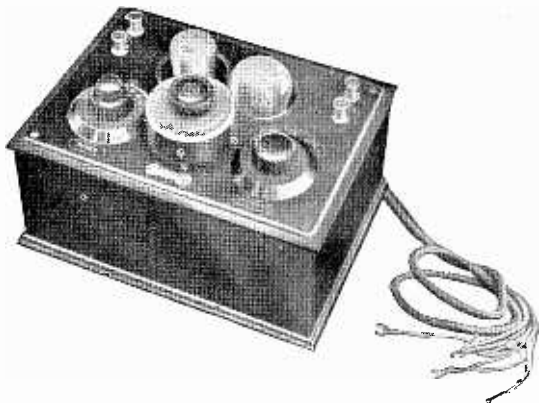

FIG. 33. THE B.T.-H. TWO-VALVE L.F. SET

very useful material for use in connecting up the components of a set.

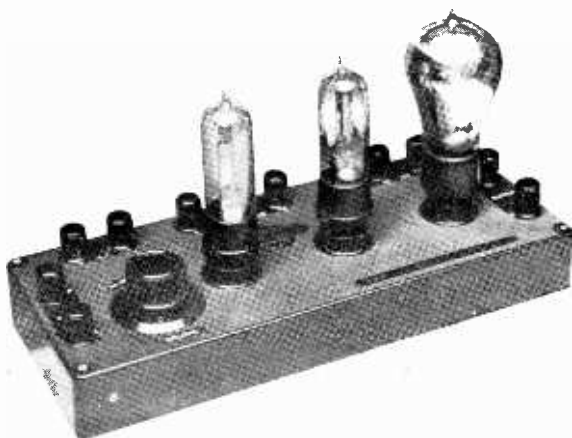

FIG. 34. IGRANIC 3-VALVE RESISTANCE CAPACITY AMPLIFIER



FIG. 35. IGRANIC NEUTROSONIC SEVEN

It consists of high grade copper strip, heavily tinned, and with a number of slotted holes throughout its length, by means of which it is secured under the nuts of the terminals. Its



FIG. 36. SHOWING THE EXTREME PORTABILITY OF THE IGRANIC "NEUTROSONIC SEVEN" AND BATTERY BOX

use renders it quite a simple matter for even the novice to connect up a set, without the need of any soldered joints.



FIG. 37. IGRANIC LOW TENSION SUPPLY UNIT

A Spring Aerial.

Messrs. Anodon, Ltd., have introduced a spring aerial, of spiral form, which will extend without slack or sagging from 10 ft. to 100 ft. They also make special earth clips and accumulator

terminal clips of special design, which overcome many of the difficulties encountered by amateurs with these parts.

Complete Sets.

To attempt to see all the complete sets made is too big a task (even with our seven-league boots—how wireless has put these things out of date, by the way!), but the selection illustrated here is of interest. Fig. 33 shows the new B.T.H. two valve L.F. set, which has been introduced to meet the demand for an

efficient receiver at a reasonably low price. It is contained in a polished wooden box, and altogether has an attractive appearance, together with good results.

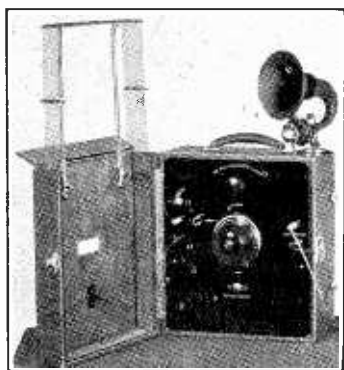

FIG. 38. VIEW OF THE "INCLUSIVE THREE" OPENED READY FOR USE

Figs. 34 to 37 show the latest products of the Igranic Electric Co., Ltd., being their Neutrosonic Seven receiver, the three-valve resistance capacity amplifier, and their low-tension supply unit. The extreme purity of reproduction obtainable with resistance capacity amplifiers is well known, although many believe that the sensitivity of such an amplifier is very much below that resulting from the use of transformers. Provided,

however, that the resistance capacity amplifier is correctly designed and that suitable valves are used, the amount of magnification can be very considerable.

Another type of receiver, Fig. 38, the M.P.A., Ltd., "Inclusive Three," is growing in popularity. The illustration, a front view, shows the set with loud speaker ready for use. By an ingenious arrangement, the closing of the case automatically cuts out all batteries, while the extending frame aerial is incorporated in the lid.

"Hart" 'Ray' Type High-tension Wireless Batteries.

Hart Accumulator Co., Ltd., has recently produced a range of accumulators bearing the above description, which are proving very acceptable to wireless users.

These accumulators have been specially prepared for the high-tension circuit of wireless receiving sets, as for this work they are

more economical in service than dry or primary batteries, over which they have many advantages. Their use ensures freedom from disturbing noises; gives stronger and better reception, and, when required, these accumulators can be recharged in a few hours at a very small cost.

The individual two-volt cells are contained in circular glass boxes with sealed lids, each group of cells being fitted in a varnished wood crate, as shown in illustration.

For the sake of convenience, these batteries

are made up into 20-volt and 30-volt groups as standard, consisting of 10 cells and 15 cells respectively, the wood crates being so arranged that each battery in its crate can be placed on top of a similar crate, so as to provide a compact assembly occupying a minimum of space.

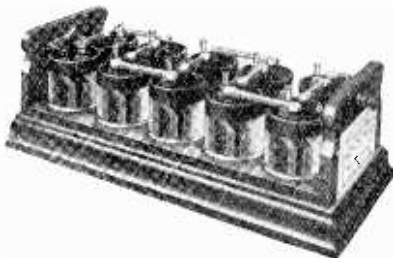

FIG. 39. HART HIGH-TENSION ACCUMULATOR
(1·25·2·5 Amp. hours)



FIG. 40
A TYPICAL P.M.
VALVE

The Mullard Radio Valve Co., Ltd.

As is well known, the Mullard Company manufacture Radio Valves of all types and powers for receiving, transmitting, rectifying and modulating, from the famous P.M. valve, which uses a current of only one-fifth of a watt, to the huge high-power Silica valve capable of 10 kw. continuous anode dissipation at 12,000 volts. The filament current for this valve is 47 amp. at 28 volts.

A typical P.M. valve is illustrated in Fig. 40.

And so to Bed.

Having completed a fairly quick round of the wireless factories of the country, we can still easily say we have not seen anything like half of the novelties to be introduced for our benefit in 1927—but certainly the selection given above gives a brief idea of the latest and best in component parts.

LIST OF RADIO SOCIETIES

PRACTICALLY all the societies mentioned below are now affiliated with the Radio Society of Great Britain. Societies marked with an asterisk were affiliated prior to January, 1923. An examination of the list will show the strides which have been made since that date. Secretaries of those societies which are not already affiliated are invited to communicate with the Honorary Secretary, the Radio Society of Great Britain, 53 Victoria Street, London, S.W.1.

Radio Society of Great Britain. *Patron*, H.R.H. Prince of Wales. *Pres.*, Sir Oliver Lodge, D.Sc., LL.D., F.R.S. *Hon. Treas.*, Prof. E. Wilson. M.Inst.C.E., M.I.E.E. *Hon. Sec.*, Maurice Child.

Aberdeen and District Wireless Society, 22 Gray Street, Aberdeen.
Ackworth School Wireless Society, Ackworth School, nr. Pontefract.
Appleby and District Radio Society, Appleby, Westmorland.
Ashington and District Radio Society, 57 Seventh Row, Ashington, Northumberland.

Associated Equipment Co., Radio Club, Blackhorse Lane, E.17.

Ayr and County Radio Society, 23 Woodfield Avenue, Ayr.

Barnet and District Radio Society, "Sunnyside," Stapylton Road, Barnet, Herts.

Barnsley and District Wireless Association, 28 Park Grove, Barnsley.

Bedford Physical and Radio Society, 48 Goldington Avenue, Bedford.

Belvedere and District Radio and Scientific Society, 110 Bexley Road, Erith, Kent.

Bergens Radio Amateur Club, Bergen, Norway.

Berwick-on-Tweed Wireless Society, 24 Bruce Gate, Berwick.

Birkbeck College Radio Society, Bream's Buildings, E.C.4.

Blackburn Radio and Scientific Society, Spring Bank, Limefield, Blackburn.

Boots Radio Society, Welfare Department, Station Street, Nottingham.

* Borough of Tynemouth Y.M.C.A. Radio and Scientific Society—*Hon. Sec.*, "Eynesbury," Cleveland Road, N. Shields.

Bournemouth and District Radio Society, Canford Hall, St. Peter's Road, Bournemouth.

Bournville Radio Society, c/o Cadbury Bros., Ltd., Bournville, Birmingham.

* Bradford Wireless Society, 14 Bankfield Drive, Shipley, Yorks.

* Brighton Radio Club—*Hon. Sec.*, D. F. Underwood, 68 Southdown Avenue, Brighton.

Brighton and Hove Radio Society, 68 Southdown Avenue, Brighton.

* Bristol and District Wireless Association—*Hon. Sec.*, 10 Priory Road Knowle, Bristol.

Bristol and District Radio Society, 46 Cotswold Road, Bedminster, Bristol.

Bromley Radio and Experimental Society, 73 Masons Hill, Bromley, Kent.

B.T.H. Radio Society, The B.T.H. Recreation Club, The British Thomson-Houston Co., Rugby.

Buckman Radio Society, 2/4/6 Whitechapel Road, E.1.

Burnham, Highbridge and District Wireless Society, 52 High Street, Burnham-on-Sea.

Burnley and District Radio Society, 13 Park Avenue, Burnley, Lancs.

Burton-on-Trent Wireless Society—*Hon. Sec.*, 66 Edward Street, Burton-on-Trent.

- Brussels Radio Club, 26 Rue de la Croix de Fer, Brussels.
 Cambridge and District Wireless Society, 102 Burrell's Walk, Cambridge.
 * Cambridge University Wireless Society—*Hon. Sec.*, Gonville and Caius College, Cambridge.
 * Cardiff and South Wales Wireless Society—*Hon. Sec.*, 37 Colum Road, Cardiff.
 Carmarthen and District Radio Society, 9 Hall Street, Carmarthen.
 Caterham and District Radio Society, Duddington, Caterham Valley.
 Cheltenham and District Wireless Association, "Netherseal," Winstonian Road, Cheltenham.
 * Cheltenham Wireless Association—*Hon. Sec.*, Winchcomb Street, Cheltenham.
 Chesterfield and District Radio Society, Beetwell Street, Chesterfield, Derby.
 * City and Guilds Wireless Society—*Hon. Sec.*, Exhibition Road, London, S.W.7.
 Cornhill Radio Club, 54 Leadenhall Street, E.C.3.
 County of London Electric Supply Co., Ltd., Wireless Society, 126 Hill Street, Peckham, S.E.
 Coventry and District Wireless Association—J. E. Bolus, 14 Coundon Road, Coventry.
 Cowes and District Radio and Research Society, Llangollen, Alexandra Road, Cowes, Isle of Wight.
 * Cowes and District Radio Society—*Hon. Sec.*, 1 Mill Hill Road, Cowes, I.O.W.
 * Croydon Wireless and Physical Society—*Hon. Sec.*, c/o H. T. P. Gee, 51 Chancery Lane, W.C.2.
 * Dartford and District Wireless Society, 146 Station Road, Crayford, Kent.
 * Derby Wireless Club, 26 Curzon Street, Derby.
 Derby Railway Institute Radio Society, Derby Railway Institute, Derby.
 Devizes Radio Club, Woodhayes, Parris Lane, Devizes.
 Dewsbury and District Wireless Society, 1 Ashworth Place, Dewsbury, Yorks.
 Dick Kerr Wireless Society, Ashton Park, Ashton-on-Ribble, Preston.
 Doncaster and District Radio Society, 18 Strafford Road, Doncaster.
 Dorking and District Radio Society, High Street P.O., Dorking.
 Dublin Wireless Club, 29 South Anne Street, Dublin.
 Dumfries and District Radio Society, 41 English Street, Dumfries.
 Dundee and District Wireless Club—*Hon. Sec.*, A. MacLeod, 13 Magdalene Yard Road, Dundee.
 * Durham City and District Wireless Club—*Hon. Sec.*, 2 Brierville, Sacriston, Durham.
 Eastbourne and District Radio Society, 11 Glynde Avenue, Hampden Park, Eastbourne.
 Eastern District Experimental Radio Society, E.D.O., 206 Whitechapel Road, E.
 * East London Radio Society—*Hon. Sec.*, King George's Hall, East India Dock Road, E.14.
 Eccles and District Radio Society, 358 Worsley Road, Patricroft, Manchester.
 * Edinburgh and District Radio Society—*Hon. Sec.*, 13 Lockharton Crescent, Edinburgh.
 Evesham Radio Society, 61 High Street, Evesham, Worcs.
 Falkirk and District Radio Society, Glenmoray, Falkirk, N.B.
 Felixstowe and District Radio Society, 3 Highfield Road, Felixstowe.
 Glasgow and District Radio Society, 38 Pollok Street, Glasgow S.
 * Glasgow and District Radio Club—*Hon. Sec.*, 93 Holm Street, Glasgow.
 * Glevum Radio and Scientific Society—*Hon. Sec.*, J. Mayall, "Burfield," St. Paul's Road, Gloucester.
 * Gloucester Wireless and Scientific Society—*Hon. Sec.*, J. J. Pittman, 12 Furlong Road, Gloucester.

- Golder's Green and Hendon Radio Society—*Hon. Sec.*, Lieut.-Col. H. Ashley Scarlett, D.S.O., 357a, Finchley Road, N.W.3.
- Grays and District Radio Society, 56 High Street, Grays, Essex.
- Great Yarmouth and District Radio Society, 4 Alexandra Avenue, Great Yarmouth.
- * Greenwich Wireless Society—*Hon. Sec.*, 39 Bargery Road, Catford, S.E. Grimsby and District Radio Society, Bramcote, Sartho Road, Grimsby.
- * Guildford and District Wireless Society—*Hon. Sec.*, 148 High Street, Guildford, Surrey.
- Guaranty Club Amateur Radio Society, 32 Lombard Street, E.C.3.
- * Hackney and District Radio Society, 110 Gladmore Road, N.15.
- * Halifax Wireless Club, 35 Commercial Street, Halifax.
- Hamilton and District Radio Society, Brices Buildings, Strathaven Road, Hamilton, N.B.
- Hampton and District Radio Society, 8 Percy Road, Hampton.
- Hampstead and St. Pancras Radio Society, 7 Eton Villas, Haverstock Hill, N.W.3.
- Harrogate and District Radio Society, 8 Church Avenue, Harrogate.
- Hastings, St. Leonards and District Radio Society, 42 White Rock, Hastings, Sussex.
- Heckmondwike and District Wireless Society, Longfield Road, Heckmondwike.
- High Wycombe and District Radio Society, 30 High Street, High Wycombe.
- Hinckley and District Radio Society, The Butts, Leicester Road, Hinckley.
- Holy Trinity Meccano and Radio Clubs, 15 Thornhill Houses, Thornhill Road, N.1.
- Hornsey and District Wireless Society, 188 Nelson Road, Hornsey, N.8.
- Horwich Radio Society, 48 Lee Lane, Horwich.
- Hounslow and District Wireless Society, 342 Hanworth Road, Hounslow.
- * Hounslow Wireless Society—*Hon. Sec.*, A. J. Rolfe, 20 Standard Road, Hounslow.
- Huddersfield Wireless Society (Y.M.C.A.)—*Hon. Sec.*, F. Simpson, 25 Back Colne Street, Aspley, Huddersfield.
- Huddersfield Radio Society, Glen Avon, Cottingham Road, Huddersfield.
- Hull and District Wireless Society, 33 De Gray Street, Hull.
- Humber Radio Society, Humber Ltd., Coventry.
- Ilford and District Radio Society, 50 Empress Avenue, Ilford, Essex.
- * Ilkley and District Wireless Society—*Hon. Sec.*, 11 Wilmot Road, Ilkley.
- Ingatestone and District Radio Society, Fryerning Lane, Ingatestone, Essex
- Inland Revenue Radio Society, C2 York House, Kingsway, W.C.2.
- Ipswich and District Wireless Society—*Hon. Sec.*, 22 Vernon Street, Ipswich.
- Isle of Sheppey Radio Society, 4 Rock Cottages, Sheerness, Kent.
- Jarrow and Hebburn Radio Society, 64 St. Rollox Street, Hebburn-on-Tyne.
- Jersey Radio Society, 54 David Place, St. Helier, Jersey.
- Johnson and Phillips Wireless Club, 99 Knight's Hill, S.E.27.
- Kensington Radio Society, 81 Cromwell Road, S.W.19.
- King's College Wireless Society—*Hon. Sec.*, G. R. Gould, 4 Bedford Place, W.C.1.
- Kingston and District Radio Society, 8 Blomfield Road, Kingston-on-Thames.
- Lambeth Field Club and Morley College Scientific Society, Physics Laboratory, Morley College, Waterloo, S.E.
- Leeds Radio Society, 24 Hessel Terrace, Hyde Park, Leeds.
- * Leicestershire Radio Society—*Hon. Sec.*, 111 Ruby Street, Leicester.
- Lewisham and Catford Radio Society, 62 Ringstead Road, Catford, S.E.

- Leys School Wireless Society, The Leys School, Cambridge.
- Leyton Radio Association, Church Army Social Centre, Russell Mansions, Goldsmith Road, Leyton, E.10.
- * Lincoln and District Wireless Society—*Hon. Sec.*, 126 West Parade, Lincoln.
- * Liverpool Wireless Association—*Hon. Sec.*, 138 Belmont Road, Anfield, Liverpool.
- * London County Council Wireless Society—*Hon. Sec.*, Room 527, County Hall, Westminster Bridge, S.E.1.
- Lowestoft and District Wireless Society—*Hon. Sec.*, L. Burcham, "Gouzlacourt," Chestnut Avenue, Oulton Broad.
- * Luton Wireless Society—*Hon. Sec.*, W. F. Neal, Hitchin Road Boys' School, Luton.
- Lyons Radio Society, Cadby Hall, Kensington, W.14.
- Lyceum Club Radio Circle, The Lyceum Club, 138 Piccadilly, London, W.1.
- Macclesfield and District Radio Society, 69 Oxford Road, Macclesfield.
- Maidenhead and District Wireless Society, 1 St. Luke's Close, Maidenhead, Berks.
- Maidstone and District Radio Society, "Romley," Postley Road, Maidstone, Kent.
- Malta Radio Society, 22 T. Sda. Mercanti, Valletta, Malta.
- Manchester Guardian* and *Evening News* Radio Society, 3 Cross Street, Manchester, Lancs.
- * Manchester Wireless Society—*Hon. Sec.*, 7 Clitheroe Road, Longsight, Manchester.
- Manchester Radio Scientific Society, 16 Todd Street, Manchester.
- Margate and District Wireless Society—*Hon. Sec.*, J. Byers, 33 Richmond Avenue, Margate.
- Merthyr Tydfil Radio and Scientific Society, 84 Brecon Road, Merthyr Tydfil.
- Midhurst and District Radio Society, Hunsdon, Midhurst, Sussex.
- Midland Railway Institution Radio Society, Midland Railway Institute, Derby.
- * Middlesbrough and District Wireless Society—*Hon. Sec.*, 45 Queens Road, Linthorpe, Middlesbrough.
- Morecambe and District Radio Club, 3 Craven Terrace, Morecambe.
- Newark-on-Trent and District Wireless Society—*Hon. Sec.*, G. T. Lindall, 6 Beech Avenue, Hautonville, Newark-on-Trent.
- Newbury and District Wireless Club, 16 Arthur Road, Newbury.
- * Newcastle Wireless Association—*Hon. Sec.*, Colin Bain, 51 Grainger Street, Newcastle-on-Tyne.
- Newcastle-on-Tyne Radio Society, 140 Northumberland Street, Newcastle-on-Tyne.
- * Newport and District Radio Association—*Hon. Sec.*, 14 Edward VII Avenue, Newport.
- Newton-in-Makerfield and District Radio Society, 139 Earle Street, Earlestown, Lancs.
- * North Middlesex Wireless Club, 100 Pellatt Grove, Wood Green.
- * North Staffs Railway (Elec. Dept.) Wireless Society—*Hon. Sec.*, P. E. Banks, 87 Spencer Road, Shelton, Stoke-on-Trent.
- North West Manchester Radio Society, "Newholme," Albyn's Avenue, Cheetham Hill, Manchester.
- Northampton and District Amateur Radio Society, 79 Knight's Lane, Kingsthorpe, Northampton.
- North Lincolnshire Wireless Society, 323 Cleethorpes Road, Grimsby.
- Norwich and District Radio Society, 32 Capp's Road, Norwich.
- Nuneaton Radio Society, 59 Earls Road, Nuneaton.
- Oldham Wireless Society, "Brentwood," Windsor Road, Oldham.

- Oxford and District Amateur Radio Society, 119 Iffley Road, Oxford.
 Paisley and District Radio Society, 33 Causeyside Street, Paisley.
 Pearl Assurance Radio Club, 252 High Holborn, W.C.1.
 Plymouth Radio Society, 15 De la Hay Avenue, Plymouth.
 Port Talbot Amateur Radio Society, 2 Evans Street, Kerfig Hill, Glam.
 Port Sunlight Radio Club, Messrs. Lever Bros., Ltd., Port Sunlight.
 Portsmouth and District Wireless Association—*Hon. Sec.*, 9 Peckham Street, Southsea.
 * Preston Scientific Society—*Hon. Sec.*, 119A Fishergate, Preston.
 Prestwich and District Radio Society, Spring Bank, Church Street, Prestwich.
 Powysland Radio and Scientific Society, Ty Coch, Welshpool, Mon.
 Radio Experimental Society of Manchester, 102 Grenville Street, Stockport.
 * Ramsgate, Broadstairs, and District Wireless Society—*Hon. Sec.*, Grove House, Addington Street, Ramsgate.
 Rugby and District Wireless Club—*Hon. Sec.*, A. T. Cave, 3 Charlotte Street, Rugby.
 Redhill and Reigate Radio Society, 111 Station Road, Redhill, Surrey.
 Redditch and District Radio Society, 98 Beoley Road, Redditch, Worcs.
 Salisbury and District Radio Society, 19 Fisherton Street, Salisbury.
 Scarborough Radio Society, 4 Carlton Terrace, Scarborough.
 Sulfridge Radio Society, 400 Oxford Street, W.1.
 * Sheffield and District Wireless Society—*Hon. Sec.*, Woodville, Hope, Sheffield.
 * Shrewsbury and District Radio Society—*Hon. Sec.*, The Mount, Shrewsbury.
 Sittingbourne, Milton, Regis and District Radio Society, 52 West Street, Sittingbourne, Kent.
 * Smethwick Wireless Society—*Hon. Sec.*, 155 Rosefield Road, Smethwick, Staffs.
 South Africa, Radio Society of, Simons Town, P.O. Box 43, Cape Town.
 South East Essex Wireless Society—*Hon. Sec.*, F. A. Mayer, Stilemans, Wickford, Essex.
 Southend and District Wireless Club—*Hon. Sec.*, D. W. Plaistow, 21 Oakleigh Park Drive, Leigh-on-Sea.
 * Southend and District Wireless Club—*Hon. Sec.*, "Lynncroft," Leigh Hall Road, Leigh-on-Sea, Essex.
 Southend and District Radio Society, Eastwood House, Rockford, Southend-on-Sea.
 South Hams Radio Society, The Ropewalk, Kingsbridge, Devon.
 South London Wireless and Scientific Society, St. John's Institute, S.E.17.
 * South London Wireless and Scientific Society—*Hon. Sec.*, St. John's Institute, Larcom Street, S.W.17.
 South Shields and District Radio Club, 66 Salmon Street, South Shields.
 Southampton and District Radio Society, "Grinston," Wood Mill Lane, Bitterne, Southampton.
 South Croydon and District Radio Society, 218 Brighton Road, South Croydon.
 South Woodford Radio Society—*Hon. Sec.*, L. R. Gaywood, 42 Alexandra Road, South Woodford, Essex.
 Stockport Wireless Society, 30 Gt. Portwood Street, Stockport, Lancs.
 St. Bride Radio and Experimental Society, 15 Larkhall Lane, S.W.4.
 Stoke-on-Trent Wireless and Experimental Society, 8 Dimsdale Parade, Wolstanton, Stoke-on-Trent.
 Stratford-on-Avon and District Radio Society, 17 Park Road, Stratford-on-Avon.
 Streatham Radio Society, 26 Salford Road, S.W.2.
 * Sunderland Wireless and Scientific Association—*Hon. Sec.*, Westfield House, Sunderland.

- Sydenham and Forest Hill Radio Society, 139 Sydenham Road, Sydenham, S.E.
- Swansea and District Radio Experimental Society, 100 Bryn Road, Swansea.
- Thame and District Radio Society, Thame, Oxon.
- Thornton Heath Radio Society, 72 Torridge Road, Thornton Heath, Surrey.
- T.O.T. Radio Association, Electric Railway House, Westminster, S.W.1.
- Tottenham Wireless Society, 42 Drayton Road, N.17.
- Tunbridge Wells and District Wireless Society, Ovenden House, Tenterden, Kent.
- Tynemouth (Borough of) Y.M.C.A. Radio and Scientific Society, Y.M.C.A. Buildings, Bedford Street, North Shields.
- Ulverston and District Wireless Society, Lund Road, Ulverston
- Vauxhall Metro. Radio Society, South Metro. Gas Co., Vauxhall, S.E.11.
- * Wakefield and District Wireless Society—*Hon. Sec.*, 11 Thornes Road, Wakefield, Yorks.
- Wallasey Radio Society, 11 Glebe Road, Wallasey, Lancs.
- * Walthamstow Amateur Radio Club, 29 Maynard Road, Walthamstow.
- * Wandsworth Wireless Society—*Hon. Sec.*, Technical Institute, High Street, Wandsworth.
- * Wanstead Wireless Society—*Hon. Sec.*, 64 Clavering Road, Wanstead Park, E.12.
- Westcliff and District Wireless Club—*Hon. Sec.*, F. Harper Shrove, Devon Lodge, Lydford Road, Westcliff-on-Sea.
- Weston-super-Mare and District Radio Society, 64 Severn Road, Weston super-Mare.
- Whitley and Monkseaton Y.M.C.A. Wireless Society, "Underwood," Windsor Gardens, Monkseaton.
- Wimbledon Radio Society, 11 Montana Road, W. Wimbledon, S.W.20.
- Windsor and District Radio Society, 6 Bolton Road, Windsor.
- Windlesham and District Radio Society, The School House, Windlesham.
- Wireless and Experimental Association, 18 Melford Road, S.E.2.
- Wireless Society of Dorsetshire—*Hon. Sec.*, I. Chapman, Abbotsford, Serpentine Road, Poole.
- * Wireless Society of Hull and District—*Hon. Sec.*, H. Lightscales, 16 Portobello Street, Holderness Road, Hull.
- Wirksworth and District Radio Society, Steeple Grange, Wirksworth.
- * Woolwich Radio Society—*Hon. Sec.*, 42 Greenvale Road, Eltham, Kent.
- Worcester and District Radio Association—*Hon. Sec.*, C. C. Hannay, 50 Waterworks Road, Worcester.
- Worthing Radio Club, 77 Lowlands Road, Worthing, Sussex.
- Working Men's College Wireless Club—*Hon. Sec.*, W. F. Matt, c/o Working Men's College, Crowndale Road, N.W.1.
- Workington and District Radio Society, 21 Belle Isle Street, Workington.
- Wrexham and District Wireless Society, Maesgwyn Cottage, Maesgwyn Road, Wrexham.
- Yeovil and District Radio Society, "Kismet," Sherborne Road, Yeovil.
- Yiewsley and West Drayton Society, 6 Providence Road, Yiewsley.
- York and District Radio Society, 15 Victoria Street, York.

The Secretary of the Radio Society of Great Britain will be pleased to answer any queries regarding the above on request.

Radio Association of Ireland. *Pres.*, G. Marshall Harris. M.I.E.E. *Hon. Treas.*, F. Barrett. *Hon. Sec.*, J. P. Murphy. *Headquarters*, 28 Harcourt Street, Dublin.

INTERNATIONAL MORSE CODE

The following table shows the signals employed in working—

INTERNATIONAL MORSE CODE SIGNALS

LETTERS

a - - - - -	n - - - - -
ä - - - - -	ñ - - - - -
á or â - - - - -	o - - - - -
b - - - - -	ö - - - - -
c - - - - -	p - - - - -
ch - - - - -	q - - - - -
d - - - - -	r - - - - -
e - - - - -	s - - - - -
é - - - - -	t - - - - -
f - - - - -	u - - - - -
g - - - - -	ü - - - - -
h - - - - -	v - - - - -
i - - - - -	w - - - - -
j - - - - -	x - - - - -
k - - - - -	y - - - - -
l - - - - -	z - - - - -
m - - - - -	

FIGURES

1 - - - - -	6 - - - - -
2 - - - - -	7 - - - - -
3 - - - - -	8 - - - - -
4 - - - - -	9 - - - - -
5 - - - - -	0 - - - - -

Spacing and length of signals—

1. A dash is equal to 3 dots.
2. The space between the signals which form the same letter is equal to 1 dot.
3. The space between two letters is equal to 3 dots.
4. The space between two words is equal to 5 dots.

The following signals may also be employed to express figures, but only in official repetitions and in the preamble, and in the text of telegrams written entirely in figures—

1 - - - - -	6 - - - - -
2 - - - - -	7 - - - - -
3 - - - - -	8 - - - - -
4 - - - - -	9 - - - - -
5 - - - - -	0 - - - - -

PUNCTUATION AND OTHER SIGNS

Full stop	(.)	-----
Comma	(,)	-----
Note of interrogation, or request for the repetition of anything transmitted which is not understood	(?)	-----
Hyphen or dash	(-)	-----
Bar indicating fraction	(/)	-----
Parentheses (before and after the words)	()	-----
Inverted commas (before and after each word or each passage placed between inverted commas)		-----
Call (preliminary of every transmission)		-----
<i>Double dash</i> (=) (signal separating the preamble from the address, the address from the text, and the text from the signature)		-----
Understood		-----
Error		-----
<i>Cross</i> (end of transmission) (+)		-----
Invitation to transmit		-----
Wait		-----
"Received" signal		-----
End of work		-----

71

BY
PROFESSOR J. A. FLEMING
M.A., D.Sc.

AN INTRODUCTION TO
WIRELESS TELEGRAPHY
. . AND TELEPHONY . .

Professor Fleming, the inventor of the Fleming valve and one of our foremost wireless experts, has written this book in simple language which will be most acceptable to the vast majority of his readers whose interest in wireless is great, but whose technical knowledge is at present small. It forms an ideal introduction to the subject for experimenters and "listeners in" who take more than a casual interest in wireless.

SOME OPINIONS OF THE BOOK

"The explanations are clear, and are assisted by many excellent diagrams."—*The Times*.

"Carries the student easily through every phase of the subject."—*The Daily Express*.

"Even those who have no apparatus will find this little volume very informing."—*Newcastle Chronicle*.

"The present volume explains the most important phases of wireless telegraphy and telephony in simple language, and is therefore eminently suitable for the general reader. The treatment throughout is non-mathematical and thoroughly interesting."—*The English Mechanic*.

Price 3s. 6d. net - - Of all Booksellers

Or direct from

SIR ISAAC PITMAN & SONS, LTD.

Parker Street, Kingsway, London, W.C.2

COMMERCIAL SECTION

TRADE DIRECTORY



TRADE DIRECTORY

ABBEY INDUSTRIES, LTD., Abbey Wood Works, Abbey Wood, London, S.E.2. *T.N.*: Woolwich 0538. *T.A.*: "Abbindries," Abwood, London.

Directors: H. Melville Smith, C.B.E., H. McL. Melville Smith, M.A., Mrs. A. H. Melville Smith, M.B.E., Major W. F. Soames, O.B.E.

ACME PRODUCTION CO., LTD., THE Britannia Works, Rolfe Street and Engine Street, Smethwick, Birmingham. *T.N.*: 151 Smethwick. *T.A.*: Multum, Birmingham.

Directors: W. J. Allen, W. D. Vick, W. H. Fulford, W. K. Coxon. *Secretary*: W. J. Allen. *Manufactures*: "Acme" Crystal and Valve Sets, Amplifiers, Parts and Components, Automatic Flashers and Signs, Electrical Specialities.

AMERICAN HARD RUBBER CO. (BRITAIN), LTD., 13A Fore Street, London, E.C.2. *T.N.*: Central 2751 and 2814. *T.A.*: Eboniseth Avenue, London.

Managing Director: V. C. Edwards. *Manufactures*: Ebonite-Vulcanite Sheets, Panels, Rods, Tubes, and Mouldings for all classes of Wireless work. Also sole manufacturers of "Radion" "Radion Mahoganite" and "Resiston" Insulating Materials.

ASHDOWN, H. E. (BIRMINGHAM), LTD., Aldridge Road, Perry Bar, Birmingham. *T.N.*: Northern 859. *T.A.*: "Segment," Birmingham.

Directors: H. E. Ashdown and H. G. Ashdown. *Secretary*: M. W. Fleming. **ASHLEY WIRELESS TELEPHONE CO., LTD.**, 69 Renshaw Street, Liverpool. *Manufactures*: "Claritone" Loud Speakers.

ATTWATER & SONS, Hopwood Street Mills, Preston. *T.N.*: 1045. *T.A.*: Attwaters.

Directors: Richard Attwater, Frederick Attwater, and Christopher Attwater. *Secretary*: Ernest Attwater. *Manufactures*: Bakelite in all forms, Ebonite in all forms, Mica and Micanite in all forms, and all Electrical Insulating Materials.

AUTOMATIC TELEPHONE MANUFACTURING CO., LTD. Liverpool—Strowger Works, Milton Road, Edge Lane. London—Norfolk House, Norfolk Street, Strand, W.C.2. *Agencies*: Manchester—Orme Buildings, Parsonage; Glasgow—260 St. Vincent Street; Birmingham—9 Livory Street; Cardiff—1 *Western Mail* Chambers; Newcastle—33 High Bridge; Dublin—17 Crow Street; Belfast—11 King Street; Leeds—Basinghall Buildings, Basinghall Street. *T.N.*: Old Swan 830. *T.A.*: "Strowger."

Directors: Sir Alexander Roger (Chairman), Sir Harwood Banner, Mr. James Taylor, Mr. D. Sinclair, Mr. Eric Taylor, Sir Max Muspratt, Bart., and Mr. E. A. Mellinger. *Secretary*: Mr. A. R. Dodd. *Manufactures*: Wireless Apparatus, including "Claritone" Headgears and Loud Speakers.

AUTOVEYORS, LTD., 84 Victoria Street, London, S.W.1. *T.N.*: Victoria 308, 309, 811. *T.A.*: Autoveyor, Sowest, London.

Managing Director: Capt. C. R. Cook. *Directors*: A. E. Chapman, S. H. Martin, L. B. Felton, R. M. Prior. *Secretary*: E. W. Dilley.

Manufacturers, Radio Engineers and Contractors. Members of B.B.C. and N.A.R.M.A.T. *Radio Call Signal*: 5 B.J.

Sole Proprietors of: Clix Specialities, Thermionic Relay Valve, Bridge Condenser. Distributing Agents for entire products of all leading British Radio Manufacturers. Specialists in Hire Service of the Western Electric Public Address System.

AVALITE, LTD., 16 Bridge Street, Burnley. *T.N.* 965. *T.A.* : Avalite, Ltd., Burnley. Electrical and Wireless Supplies.

BEDFORD ELECTRICAL RADIO CO., LTD., 22 Campbell Road, Bedford. *T.N.* : 343.

Directors : A. J. Osbourn. E. Osbourn. *Secretary* : E. C. Buttfield. Manufacturers and Factors of Wireless Apparatus and Accessories. Speciality : "Peerless Products," including Rheostats, Resicon Condensers, Switches and Fixed Resistors.

BELDAM TYRE CO. (1920), LTD., THE, Windmill Road, Brentford, Middlesex. *T.N.* : Ealing 125. *T.A.* : Beldalite.

Manufactures : Crystal Sets, Valve Sets, Amplifiers, and Components.

BELLING & LEE, LTD., Queensway Works, Ponders End, Middlesex. *T.N.* : Enfield 0498. *T.A.* : Belling & Lee, Ponders End.

Directors : C. R. Belling, M.I.E.E., E. M. Lee, B.Sc. *Secretary* : E. M. Lee, B.Sc. *Manufactures* : Wireless Apparatus, Indicating Terminals, Plug and Socket Terminals, Insulated Terminals.

BENJAMIN ELECTRIC, LTD., THE, Brantwood Works, Tariff Road, Tottenham, London, N.17. *T.N.* : Tottenham 1500 (4 lines). *T.A.* : "Benjalect, Tottlane," London.

Manufactures : Wireless Components and Accessories.

BENNETT, MACKENZIE & CO. *London Office* : 42 Finsbury Square, E.C.2. *Works* : 219 Brockley Road, Brockley, S.E.4. *T.N.* : Clerkenwell 2410 and New Cross 3589.

Sole Proprietor : B. C. Bennett. *Manufactures* : Crystal Sets—"Ben-maco" Junior and Senior Valve Sets—One, Two, Three, Four, and Five Valves, all component Parts excepting Valves, Accumulators, and Batteries.

Registered on King's Roll for employing Ex-service Men. Members of the British Broadcasting Co. All Sets manufactured approved by P.M.G.

BISHOP, W. J., & CO., 1 King's Parade, High Street, Croydon. *T.N.* : Croydon 0040.

Manufactures : Wireless Instruments and Components. *Radio Call Signal* : 6 CL.

B.N.B. WIRELESS, LTD., 65 Renshaw Street, Liverpool; also 51 William Street, Dublin; 80 Castle Street, Belfast; 33 Bridge Street, Manchester. *T.N.* : Royal 806. *T.A.* : Aerial, Liverpool.

Directors : J. McCurdy, H. D. Bloomfield. *Secretary* : W. H. Jones. *Manufactures* : Crystal Sets, Components, Gramaphix.

BOWYER-LOWE CO., LTD., THE, Radio Works, Commerce Avenue, Letchworth, Herts. *T.N.* : Letchworth 246. *T.A.* : Bowyer-Lowe Co., Letchworth.

Directors : A. E. Bowyer-Lowe, M.J.I.E.E., H. W. Widgery. *Secretary* : H. W. Widgery. *Manufactures* : Complete Receiving Sets, Components, Wavemeters, Variometers, Variocouplers, Variable Square Law Condensers, Measuring and Testing Instruments for Wireless, etc.

BRANDES, LIMITED 296 Regent Street, London, W.1. *T.N.* : Mayfair 4208-4209. *Cablegrams* : "Matchtone, London." *Code* : Bentleys. *T.A.* : "Impedence, Phone, London." *Works* : Slough, Bucks. *T.A.* : "Matchtone, Slough."

Manufactures : Receiving Sets, "Matched Tone" Headphones, Loud Speakers (Table Talker, Brandola, Ellipticon and Table Cone), L.F. Audio Transformers, Variable Condensers.

BRITANNIA RUBBER AND KAMPTULICON CO., LTD., THE. Head Office, 7 Newgate Street, London, E.C.1. *T.N.* : Central 2168. *T.A.* : "Britannia, London." *Works*, Devons Road, Bow Common, London, E.

India-rubber and Ebonite Manufacturers, established about 1850. *Manufactures* : Speciality—Ebonite for Wireless work, Sheets, Matt surfaces, all

thicknesses kept in stock .010 in. to 2 in. thick, Rods and Tubes, every size. Panels cut, no limits for size. Silver Medal for EBONITE awarded Electrical Exhibition, Crystal Palace, 1892, etc.

BRITISH EBONITE CO., LTD., THE, Nightingale Road, Hanwell, W.7. T.N.: Ealing 1560. T.A.: "Ebonitonal," Han., London.

Directors: John Hughes, J. J. Moore, Ralph G. Scott. *General Manager*: E. J. Long. *Secretary*: Richard Kellerman. *Manufactures*: Ebonite Rods, Tubes, Sheets, and Mouldings.

The only British makers of Red and Black-grained Ebonite exclusively engaged in production of high-class Ebonite.

BRITISH ENGINEERING PRODUCTS CO., 570-572 Abbey House, Victoria Street, London, S.W.1. T.N.: Victoria 4149.

Manufacturers of all classes of Wireless Sets and Accessories. Trade Name "Tonyphone."

BRITISH RADIO CORPORATION, LTD., Elm Grove Road, Weybridge, Surrey. T.N.: 593. T.A.: "Astraphone, Weybridge."

Manufactures: High Grade Wireless and Electrical Instruments for Aircraft, Commercial, Broadcasting. *Radio Call Signal*: 5 PI.

BRITISH THOMSON-HOUSTON CO., LTD., THE. *Head Office and Main Works*: Rugby. *London Office*: Crown House, Aldwych, W.C.2. T.N.: Rugby 286. T.A.: "Asteroidal," Rugby.

Directors: H. C. Lovis (Chairman), W. C. Lusk (Managing Director), The Rt. Hon. Earl Buxton, The Rt. Hon. Lord Carmichael, E. A. Carolan, C. A. Coffin, A. W. Burchard, Major-General A. de Lotbiniere, F. Fraser (Secretary), E. W. Rice, O. H. Smith, H. N. Sporborg (Chief Engineer), G. Swope, J. M. Woodward. *Secretary*: F. Fraser. *Manufactures*: Wireless Apparatus for reception of Broadcasting. *Radio Call Signal*: 2 Z1.

This Company is a director of the British Broadcasting Co.

"BROADWAY" RADIO WORKS, THE, Devonshire Road, Bexley Heath, Kent. T.N.: 186.

Proprietor: H. L. Lidington. *Manufactures*: Crystal Sets, Valve Sets, High- and Low-frequency Amplifiers, Precision Air Di-electric Condensers, Filament Rheostats, etc.

BROWN BROTHERS, LTD., Great Eastern Street, London, E.C.2. *Branches*: Aberdeen, Birmingham, Cardiff, Dublin, Dundee, Edinburgh, Glasgow, Leeds, Manchester, Marylebone, Newcastle-on-Tyne, Southampton.

Wholesale factors of Radio Receiving Sets, Components and Accessories.

Managing Directors: J. A. Thomson, E. Brown.

BROWN, S. G., LTD., Victoria Road, North Acton, London, W.3 (*Works and Head Office*); 19 Mortimer Street, London, W.3; 15 Moorfields, Liverpool; 67 High Street, Southampton (*Showrooms*). T.N.: Cliswick 312/3, 2626. T.A.: "Siddbrownix, London."

Directors: Sidney George Brown, F.R.S. *Secretary*: Mrs. S. G. Brown. *Manufactures*: Radio Telephones and Loud Speakers, and Relays (Microphone Amplifier, etc.); also Brown Gyro Compass and Cable Instruments.

BULGIN, A. F. & CO., 9-11, Cursitor Street, Chancery Lane, London, E.C.4. T.N.: Holborn 2072.

Proprietor: A. F. Bulgin, M.I.R.E. *Manufactures*: "Deekorem" Registered Trade Mark. Products including Dial Indicators, Valve Windows Vernier Dials Station Logs, Neutralizing Condensers, Transformers, Dialites, Switches, etc. Sole Distributors of "Competa" Radio Products.

BURNDEPT WIRELESS, LIMITED. *London Office*: Bedford Street, Strand, W.C.2. *Head Office and Factories*: Blackheath, London, S.E.3. Belfast: Reform Building, 6 Royal Avenue. Birmingham: Winchester House, Victoria Square. Brighton: 5 Cavendish Street. Bristol: 238 York Road, Bedminster. Glasgow: 93 Holm Street. Leeds: 12 Basinghall Street. Manchester: 61 Bridge Street. T.N.: London Office, Gerrard 9072; Head Office, Lee Green 2100. T.A.: Burnacoil, Phone, London.

Directors : Sir C. George C. Hamilton (*Chairman*), W. W. Burnham, Fel.I.R.E., A.I.E.E. (*Managing Director*), J. E. Monins, J.P., T. A. Barson, P. J. Chaplin, A.C.A. (*Secretary*), J. B. Close, C. F. Phillips, M.I.R.E., A.M.I.E.E.

Manufactures : Wireless Apparatus.

Radio Call Signals : 2FQ—2 QQ—2 YH—2 VK—5 MW.

BURNE-JONES & CO., LTD., "Magnum House," 296 Borough High Street, London, S.E.1. *T.N.* : Hop 6257.

Directors : David Burne-Jones F.R.S.A., Frank Foulger, Int. B.Sc. *Secretary* : C. H. Highmore. *Manufactures* : "Magnum" Receiving Sets, Screened Coils, Transformers, Condensers, Valve Holders, Chokes, Resistances, and other High Grade Radio Apparatus.

Radio Call Signal : 200 metres—2 FP New Cross ; 6 CW Streatham.

BURNS, J., LTD., Wangye Works, Chadwell Heath, Essex. *T.N.* : Ilford 0400 and 1590. *T.A.* : "Wangye," Chadwell Heath.

Managing Director : H. Baines. *Manufactures* : Vulcanized Fibre, Sheets, Rods, Tubes ; special shapes Turnings, Stampings, etc. ; Wireless Telephone Parts and Complete Receiving Sets.

Established since 1892 as experts in Insulating Materials.

BUTLER, H. D., & CO., LTD. *Offices* : Bank Buildings, 222 Great Dover Street, London, S.E.1. *T.N.* : Hop 3029.

Managing Director : H. D. Butler. *Manufactures* : Wireless Apparatus and Component Parts.

CARROLL, C. A. & SONS, 12 Verney Road, London, S.E.16. *T.N.* : Hop 6779.

Partners : C. A. Carroll, B. T. Carroll, C. Carroll. *Manufactures* : Radio Instruments to special order. Inventors' ideas worked out. Electrical Engineers.

CELESTION RADIO CO., THE. *Offices and Works* : 29-37 High Street, Hampton Wick, Kingston-on-Thames. *T.N.* : Kingston 2474. *T.A.* : Celestion, Kingston. *London Showroom* : 21 Villiers Street, Charing Cross, Strand, W.C.2. *T.N.* : Gerrard 0397.

CENTRAL AIRCRAFT CO., LTD., 179 High Road, Kilburn, London, N.W.6. *T.N.* : Hampstead 4403 and 4404. *T.A.* : "Aviduction, Phone, London."

Manufactures : Wireless Cases and Cabinets.

CHELMSFORD RADIO CO., THE. 76 Duke Street, Chelmsford, Essex. *T.N.* : 429.

Partners : Douglas C. Clark, Harold J. Hawkes. *Manufactures* : Complete Receiving Sets of all descriptions. *Radio Call Signal* : 5 DY. Wholesale and Retail Business.

CHLORIDE ELECTRICAL STORAGE CO., LTD., THE, Clifton Junction, near Manchester. Also Branches at 58 Dale End, Birmingham ; 219/229 Shaftesbury Avenue, London ; 1 Bridge Street, Manchester ; 22 Victoria Street, Bristol ; and 40-44 Tureen Street, Glasgow. *T.N.* : Pendleton 481. *T.A.* : "Chloridic, Pendlebury."

Secretary : D. P. Dunne, F.C.I.S. *Manufactures* : Accumulators.

Makers of the well-known Exide Batteries for Wireless, etc.

CINECHROME INSTRUMENTS, LTD. *Offices* : 8/9 Long Acre, W.C.2. *Showrooms* : 16 Garrick Street, W.C.2. *Works* : Cecile House, Crouch Hill, N. *T.N.* : Gerrard 8877. *T.A.* : "Cinechrome, Rad," London.

Manufactures : Wireless Apparatus and Scientific Instruments.

CLIMAX RADIO ELECTRIC, LTD. Quill Works, Putney, London, S.W.15. *T.N.* : Putney 2599. *Showrooms* : 257 High Holborn, London, W.C.1. *T.N.* : Holborn 2538.

Directors : P. W. Baker, R. Milward-Ellis, A.M.I.E.E., C. H. Stave.

Manufacturers and Patentees of Electric, Radio, Scientific, and Industrial Instruments and Apparatus.

C. T. COLBERY & CO., LTD., 8 and 9 Clerkenwell Green, London, E.C.1.
T.N. : Clerkenwell 2425.

Manufactures : Wireless Instruments and Accessories, Scientific Instruments.

COOKE & WHITFIELD WIRELESS, LTD., St. Paul's Buildings, 24 St. Paul's Square, Birmingham. T.N. : Central 7780. P.B.X. T.A. : "Stan-cap," Birmingham.

Directors : Howard Seymour Cooke, Horace Henry Whitfield, F.R.S.A.
Secretary : H. S. Cooke. *Manufactures* : Wireless Parts ; Dealers in Complete Instruments. Aerials erected complete. Accumulator charging. *Radio Call Signal* : 2 LG and 5 GH.

Mr. H. H. Whitfield was a winner in the Transatlantic Amateur Reception, and was awarded a special prize for the best design of circuit.

COSSOR, A. C., LTD., Aberdeen Works, Aberdeen Lane, Highbury Grove, London, N.5. T.N. : North 4340. T.A. : "Amplifiers," Phone, London.

Directors : W. R. Bullimore, B. M. Bullimore. *Secretary* : A. A. E. Corbett. *Manufactures* : Wireless Valves, Apparatus and Accessories.

COUBRO & SCRUTTON, LTD., 37 Mark Lane, E.C.3 ; 11 West India Dock Road, Limehouse, E.14. T.N. : East 5467/8/9, East 0592. T.A. : "Coubro, Fen, London."

Directors : Charles Linder, Campbell I. Scrutton. *Secretary* : A. King.
Manufactures : Wireless Masts, Spreaders, etc.

CROXSONIA CO., 10 South Street, London, E.C.2.

Principals : H. W. Croxson, A. E. Croxson. *Manufactures* : Radio Sets, "Croxsoniaphone," and Radio Panelling "Croxite." (Regd. No. 446286.)

CUNNINGHAM, LTD., 169/171 Edgware Road, London, W.2. T.N. : 5173/4 Paddington.

Managing Director : R. N. Cunningham. *Manufactures* : Wireless Receivers and Parts. *Radio Call Signal* : 5 HP. General Electrical Engineers.

DAVENPORT, G. (Wireless), LTD., 69 Dean Street, London, W.1. T.N. : Regent 1368. T.A. : Coaction, Westcent, London.

Directors : John Henderson, D.Sc., M.I.E.E., F.R.S.E. (Chairman). Gilbert Davenport (Managing Director), Cyril G. Davenport, B.Sc., John A. Robertson, R. A. Croston. *Secretary* : H. F. Vaughan. *Manufactures* : "D.W." Receiving Sets, Components, and Accessories.

Members of British Broadcasting Co. and National Association of Radio Manufacturers. Manufacturers of Wireless Receivers.

DAVIS & TIMMINS, LTD., 34A York Road, King's Cross, London, N.1.
Works : Brook Road, Wood Green, N.22. T.N. : North 0580. T.A. : "Conductivity, London."

Managing Director : G. E. Timmins. *Directors* : Wm. Negus, Esq., J.P., D.L. (Chairman). Arthur E. Pettit, W. E. Stewart, J. Kerr Bock. *Secretary* : W. Constant. *Manufactures* : Metal Thread Screws and Turned Parts in all Metals. Studs, Nuts, Spacing Washers, Valve Legs, Terminals.

DAY, WILL, LTD., 19 Lisle Street, Wardour Street, London, W.C.2.
T.N. : Regent 4577. T.A. : "Titles Westrand, London."

Directors : Wilfred E. L. Day, Horace L. V. Day. *Manufactures* : Wireless Accessories of all kinds. Crystal and Valve Sets.

DAYZITE, LTD., 18/19 Lisle Street, Wardour Street, London, W.C.2.
T.N. : Regent 4577. T.A. : Titles, Westrand, London. *Manufactures* : Portable Supersonic Sets, wholesale only.

DENT & CO. & JOHNSON, LTD., Linwood Works, Linwood, near Paisley.
T.N. : 109 Johnstone. T.A. : "Dentcompa, Linwood."

Managing Director : C. H. Johnson. *Secretary* : D. A. Wallace. *Manufactures* : "The Linwood" Loud Speakers.

DIAMOND FIBRE CO., LTD., THE. *Head Office* : High Road, South Tottenham, London, N.15. *Works* : Bridge Mills, Tovil, Maidstone. T.N. : Tottenham 2261/62. T.A. : "Dymofyber, Toleross, London."

Managing Director : Fergus N. Macechern. *Directors* : Edward M. Taylor, A. Dykes Spicer, John M. Taylor, Chas. H. Wright, William H. Taylor. *Secretary* : F. M. Toole. *Manufactures* : Condensite Celoron and Vulcanized Fibre in Sheets, Rods, Tubes, and all Component Parts. Trunk Fibre.

D.P. BATTERY CO., LTD., THE, Bakewell, Derbyshire. *London Office* : 11 Victoria Street, Westminster, S.W.1. *T.N.* : Bakewell 81 & 82. Victoria 1591 & 9605. *T.A.* : Battery, Bakewell. "Cumulose, Sowsel, London." *General Manager* : J. Waddell. *Manufactures* : "D.P.," "Kathodes," and "Hylo" Batteries.

DUBILIER CONDENSER CO. (1925). LTD., Duceon Works, Victoria Road, North Acton, London, W.3. *T.N.* : Chiswick 2241, 2242, 2243. *T.A.* : "Hivolteon, Phone, London."

Directors : Sir Arthur Lowes Dickinson, M.A., F.C.A., T. A. Evans, W. H. Goodman, J. E. Hyde, A. Mikellatos (Greek), G. C. Hans Hamilton. *Chief Engineer* : P. R. Coursey, B.Sc., A.M.I.E.E. *Secretary* : Mr. F. W. Hollings. *Manufactures* : Electrical Condensers for all purposes. *Radio Call Signal* : 5 AT.

EAGLE ENGINEERING CO., LTD., Eagle Works, Warwick. *London Depot* : 8 Great Russell Street, W.C.1. *T.N.* : 126 and 127 Warwick : London : Mus. 2848. *T.A.* : "Eagle, Warwick."

Managing Director and Chairman : R. G. Palmer. *Directors* : E. Bradley, F. C. Bradley, H. B. Palmer. *Secretary* : J. W. Mason. *Manufactures* : "Chakophone" Broadcast Wireless Receiving Sets, Accessories, and Equipment.

EAST HAM WIRELESS SUPPLIES, 429 Barking Road, East Ham, London, E.6. *T.N.* : Grangewood 1038.

Proprietor : Henry H. Lassman, F.R.A., A.M.I.R.E. *Manufactures* : Wireless Apparatus.

Radio Call Signal : 2 PX, Duplex, Telephony, and C.W., 45-150 to 200 and 440 metres.

EASTICK, J. J., & SONS. *Head Office* : Eelex House, Bunhill Row, London, E.C.1. *Works* : Eelex Works, 26/36 Lamb's Passage, Chiswell Street, London, E.C.1. *T.N.* : Clerkenwell 9282/9283. *T.A.* : "Eastick, Clerkenwell 9282, London."

Manager : J. C. N. Eastick, F.C.S., A.I.C., A.I.E.E. *Manufactures* : Variometers, Condensers, Knife Switches, Lead-in Tubes, Wireless Parts and Sets.

EBONESTOS INSULATORS, LTD., Excelsior Works, Rollins Street, Canterbury Road, London, S.E.15. *T.N.* : New Cross 1913 (5 lines). *T.A.* : "Ebonestos, Phone, London."

Manufactures : Moulded Ebonestos Insulators suitable for all classes of Electrical Work. Fire and Acid-resisting Grades a speciality.

ECONOMIC ELECTRIC CO., LTD., THE. *Registered Offices* : 10 Fitzroy Square, W.1. *Showrooms* : 303 Euston Road, N.W.1. *Branch* : *Showrooms and Works* : Twickenham. *T.N.* : Museum 1055 (Private Branch Exchange). *T.A.* : "Econetric, Eusroad, London."

Directors : Albert Holt, Cyril Holt, Reginald Holt. *Manager* : B. S. Varnals. *Secretary* : Herbert Donlin. *Manufactures* : Thermionic Valves. The "Xtraudion" Synthetic Crystal, "Rectarite." Complete Radio-receiving and Transmitting Sets and Components.

Patentees and Manufacturers of the "Xtraudion" Three-electrode Valve, Valve Bridge, and "E.E.C." Oxcillator.

EDISON BELL, LTD., Glengall Road, London, S.E.15. *Provincial Factory* : Edison Bell Works, Huntingdon. *T.N.* : Hop 0064 and 0065. *T.A.* : "Phonokino, Kent, London."

Technical Manager : Thomas Hough. *Commercial Manager* : W. F. Robbins. *Manufactures* : Wireless Sets, Component Parts, Insulators, etc. Pioneers of the British Gramophone Industry.

Manufactures: "Neutron" Products—Radio Crystal. Valves. Permanent Detectors, H.T. Batteries. Chemical Earth Compound, Soldering Fluid.

NEW LONDON ELECTRON WORKS, LTD., THE, London, E.C. (Members of the B.B.C.) *T.N.*: East Ham 1408-9. *Speciality*: Aerial Wires of high efficiency and Simple Strip.

THE NEW WILSON ELECTRICAL MANUFACTURING CO., LTD., 18 Fitzroy Street, Fitzroy Square, London, W.1.

Electrical Engineers and Scientific Instrument Manufacturers.

NEWTON & WRIGHT, LTD., 471/473 Hornsey Road, London, N.19. *Registered Offices*: 72 Wigmore Street, W.1. *T.N.*: North 1047, Mountview 1283. *T.A.*: "Neutorite, Holway, London."

Directors: R. S. Wright, M.I.E.E., E. E. Burnside, A.M.I.E.E., T. G. Wright, A.M.I.E.E. *Secretary*: J. W. Burrage. *Manufactures*: High Tension Transformers, X-ray and Wireless Apparatus, Glass Blowers and Specialists in High Vacuum Exhaustion.

Also make apparatus for Optical Projection.

NORTH-EASTERN INSTRUMENT CO., THE, Durham Road, Low Fell, Gateshead. *T.N.*: Gateshead 754. *T.A.*: "Instrument Co., Lowfell" (3 words).

Managing Proprietor: Norman Hall, A.I.Rad. Engrs. *Manufactures*: Super-grade Radio Apparatus; "Cymosite" Detector Crystal. *Radio Call Signals*: 2 RT, 2 RU.

NOTTINGHAM RADIO SUPPLIES, THE, 33 Mansfield Road, Nottingham. *T.N.*: 5944. *T.A.*: "Chantecler, Nottingham."

Director: Gordon A. Litchfield. *Manufactures*: Complete Wireless Sets, Components, and Installations. *Radio Call Signal*: 5 RK.

Everything for Wireless in stock. Manufacturers of "Chantecler" Radio Sets.

ORMOND ENGINEERING CO., LTD., THE, 199/205 Pentonville Road, London, N.1. *T.N.*: Clerkenwell 9344 (3 lines). *T.A.*: "Ormondengi, Kincross."

Managing Director: E. J. Delfosse. *Manufactures*: Brass and Steel Screws and all Wireless Parts.

PETO SCOTT CO., LTD., THE, 77 City Road, London, E.C.1, and Branches. *T.N.*: Clerkenwell 9406/7.

Managing Director: W. Scott Worthington. *Manufactures*: Complete Radio Receiving Sets, Pioneers of the Sets of Parts System. Broadcasting Sets, Accessories, Super-Heterodyne Sets, Screened Coils, and H.T. Transformers, Neutralized Sets.

PETTIGREW & MERRIMAN (1925), LIMITED, 2-4 Bucknall Street, New Oxford Street, London, W.C.1. *T.N.*: Gerrard 4248 and 4249. *T.A.*: "Merrigrew, Westcott, London."

Directors: T. Pettigrew, A.M.I.E.E., E. Merriman, A.M.I.E.E., H. C. Rose, W. P. Mackintosh, P. Brunet, O. Brunet. *Secretary*: S. H. Goodger. *Manufacturers* and *Factors* of Wireless Apparatus.

PORTABLE UTILITIES CO., LTD., THE, Eureka House, 8 Fisher Street, Southampton Row, London, W.C.1. *T.N.*: Holborn 240 or 711. *T.A.*: "Nattiness, London."

Directors: E. C. Hackness, W. F. Harkness. *Manufactures*: "Eureka" Low Frequency Transformers.

POWER WIRELESS, LTD., Wexham Road, Slough, Bucks. *T.N.*: Slough 418. *T.A.*: "Dynamic Slough."

Directors: E. J. Power, I. C. Power. *Manufactures*: Power Locking Coil Holders.

PYE, W. G., & CO., "Granta" Works, Montague Road, Cambridge. *T.N.*: 314. *T.A.*: "Pye, Cambridge."

Partners : W. G. Pye, T. A. W. Robinson, H. J. Pye. *Manufactures* : Broadcasting Receiving Apparatus.

RADIAX, LTD., Palmer Place, Holloway Road, London. N.7. T.N. : North 0428. T.A. : North 0428, London."

Managing Director : Albert E. Oakley. *Manufactures* : "Radiax" Receiving Sets, Intervalve Couplings, Low Loss H. E. Coils, Frame Aerials, Super-heterodyne Components.

RADIO COMMUNICATION CO., LTD., 34/35 Norfolk Street, Strand, W.C.2. T.N. : Central 8480 (Private Branch Exchange). T.A. : "Radioconco, Estrand."

Managing Director : Major B. Binyon, O.B.E., M.I.E.E. *Secretary* : W. H. C. Rowe, Esq., C.B.E. *Manufactures* : Marine Wireless Apparatus, Broadcasting Receiving and Transmitting Apparatus. *Radio Call Signals* : 2 AJ (Barnes).

RADIO EXPERIMENTAL CO., LTD., 117 Carver Street, Sheffield.

Manufactures : Wireless Instruments and Accessories.

RADIO INSTRUMENTS, LTD., 12 Hyde Street, New Oxford Street, London, W.C.1. T.N. : Regent 6214 (3 lines). T.A. : Instradio, London.

RADIO MANUFACTURING CO., THE, 160 Dale End, Birmingham.

Directors : E. W. Seammell, S. H. V. Abbott. *Manufactures* : Receiving Sets, Component Parts.

Provisional Patentees of Liquid Grid Leak.

RADIO, MOTORS & CYCLES, LTD., 17 Victoria Street, and 21 St. John Street, Wolverhampton. T.N. : 459. Also Bilston.

Radio Manufacturers and Retailers, Motor Car, Motor Cycle, Cycle and Accessory Agents.

RADIO WAVEORA CO., THE, 110 Greyhound Road, Hammersmith, W.6. *Show Rooms* : 83/87 Hammersmith Road, W.14. T.N. : Western 7137, and Weston 847. T.A. : "Wychwood Phone, London."

Principal : Major G. K. Field, F.R.S.A., A.M.I.E.E. *Secretary* : E. Weston. *Manufactures* : Wireless and Electrical Instruments and Accessories.

ROBINS, LIMITED. Showrooms and Retail depot, 119 Queen Street, Cardiff, also Retail depot at 18a Oxford Street, Swansea, and 111 Commercial Street, Newport, Mon.

Directors : L. R. Robins, E. H. Robins, W. Duggan. *Works and Warehouse* : Fanny Street, Cathays, Cardiff. Automobile, Electrical and Wireless Engineers.

ROTAX (MOTOR ACCESSORIES), LTD., Rotax Works, Willesden Junction, N.W.10 T.N. : Willesden 2480. T.A. : "Rodynalite," London.

Radio Productions include : H.T. and L.T. Accumulators, 2-valve, 3-valve, and Portable Broadcast Receivers, Variable Condenser and Coils in One Unit, Coils, Headphones, etc., and Accumulator Charging Transformers and Equipment.

ROTHERMEL RADIO CORPORATION OF GREAT BRITAIN, LTD., 25-26 Maddox Street, Regent Street, London, W.1. T.N. : Mayfair 0578 and 0579. T.A. : "Rothermel, Wesdo, London."

Sole Director : R. A. Rothermel. *Secretary* : F. M. Bryant.

Manufacturers, Importers and Exporters of Radio Components of all kinds.

RUSSELL LABORATORIES, Hill Street, Birmingham. T.N. : Mid. 2973. T.A. : "Hertzite, Birmingham."

Proprietor : Leslie G. Russell. Radio Crystals of every description, bulk or packed. Speciality, Hertzite. Estab'd. 1922.

SANKEY, JOSEPH & SONS, LTD., Bilston, Staffs. T.N. : 264. T.A. : "Sankey."

Managing Director : George H. Sankey. *Secretary* : Edgar J. Budd. *Manufactures* : Stampings for Radio Work and for the Electrical Trade generally.

SAVILLE, H., Delamere Works, Stretford, near Manchester. *T.N.* : Trafford Park 512.

Proprietor : H. Saville. *Manufactures* : Electrical and Mechanical Engineers and Ironfounders. *Radio Call Signal* : 6 HS. Member of B.B. Co., Ltd.

SCOTTISH WIRELESS TELEPHONE SUPPLIES, LTD., THE, 36/38 Chapel Street, Aberdeen. *T.N.* : 3553.

Directors : Joseph Johnston, William R. Clark, Mary Hutcheon. *Manufacturers and Factors of Wireless Apparatus and Accessories.*

SERVICE RADIO CO., LTD., 67 Church Street, Stoke Newington, London, N.16. *Works* : Kersley Road, N.16.

Manufactures : "Service" products, S.L.F. Condensers, Micrometer Detector, Micrometer Rheostat, Battery Lock Switch, Multiphone, Variometer, Neutrodyne Condenser, Coil Holder, Receiving Sets, etc.

SHARPIN, W. S., Wellington Works, Wellington Road, Bow, London, E.3. *T.N.* : East 3496. Member of the B.B.C.

SHEFFIELD ELECTRICAL INSTALLATIONS CO., THE, 75 Ecclesall Road, Sheffield. *T.N.* : West 37.

Director : J. K. Bell. *Manufactures* : "Seico" Wireless Receiving Sets, also of Component Parts and Cabinets. Members of the B.B. Co., Ltd.

SIEMENS BROTHERS & CO., LTD. *Head Office* : Caxton House, Westminster, S.W.1. *General Offices and Works* : Woolwich, London, S.E.18. *T.N.* : Caxton House—Victoria 9390 : Woolwich 1161. *T.A.* : "Siemens, Park, London" ; "Siemens, Woolwich."

Managing Director : H. R. Wright, Ph.D. *Directors* : G. Mure Ritchie (Chairman) ; Right Hon. Sir William Bull, Bart., M.P. ; G. Chauvin ; General Sir Hubert de la Poer Gough, G.C.M.G., K.C.B., K.C.V.O. ; Sir Walter Roper Lawrence, Bart., G.C.V.O., G.C.I.E., C.B. ; Sir John Mann, K.B.E. ; Lord Queenborough ; W. O. Smith. *Secretary* : W. Wheeler. *Manufactures* : Electrical Cables and Wires ; Telephone, Telegraph, Signalling, and Measuring Apparatus ; Batteries, Wireless Equipments, etc. *Radio Call Signal* : 2 AD.

SKETT & CO., Frederick Street, St. Paul's, Birmingham. *T.N.* : Central 879. *Manufactures* : Wireless Accessories, Sketophone Headphones, Loud Speakers, Electric Irons, etc.

SOLIDITE MANUFACTURING CO., LTD., Albion Works, North Street, Clapham, London, S.W.4. *T.N.* : Latchmere 5592 and 5593.

Manufactures : Moulded Insulation Articles in Solidite (e.g. Valve-holders, Coil Mountings, Knobs, etc.).

SOUTHEND RADIO CO., LTD., THE (Late **THE RADIO EQUIPMENT CO.**), Stileman's Works, Wickford, Essex, and 5 Central Arcade, Southend-on-Sea, (Regd. Office). *T.N.* : Wickford 5. *T.A.* : "Radio, Wickford." *Manufactures* : Broadcast Receiving Apparatus and Radio Components. *Radio Call Sign* : 2 LZ. *Trade Mark* : "Radico."

SOUTHERN RADIO SUPPLIES, LTD., 26 Junction Road, Eastbourne. *T.N.* : 882.

Managing Director : Owen H. Rely. *Secretary* : L. Morton. *Manufactures* : "Southion" Radio Receivers and other Wireless Apparatus. *Radio Call Signal* : 2 AO.

Members of the B.B. Co., Ltd.

SPAULDINGS, LTD., 40 Gloucester Street, Clerkenwell, E.C.1. *T.N.* : Clerkenwell 4671, 4672 and 4673. *T.A.* : "Vulcafibra, Smith, London."

Actual Manufacturers of : Bakelite, Vulcanized Fibre, and Leatheroid, in sheets, rods and tubes, for Wireless Apparatus. Large Stocks also of Ebonite. Special Shapes Supplied.

STANDARD TELEPHONES AND CABLES, LTD. (formerly Western Electric Co., Ltd.), Connaught House, Aldwych, W.C.2. *Works* : North, Woolwich, E.16, Hendon, and New Southgate, N.11. *T.N.* : Central, 7345 (10 lines). *T.A.* : "Relay, Strand, London."

Managing Director : H. M. Pease. *Chief Engineer* : G. H. Nash, C.B.E.

General Sales Manager : H. C. Trenam. *Secretary* : H. A. P. Disney. *Manufactures* : Telephones (Manual and Automatic), Cables for Lighting, Power, and Telephony, Switchgear, Traffic Control Apparatus, Wireless Transmitting and Receiving Apparatus, Valve Detectors, Head Receivers, Amplifiers, Loud Speakers, Public Address Systems (Wireless and Telephony), Domestic Appliances, etc. *Radio Call Signal* : 2WP.

STERLING TELEPHONE & ELECTRIC CO., LTD., Marconi House, Strand, London, W.C.2. *Sterling Works* : Dagenham, Essex. *T.N.* : Romford 160. *T.A.* : "Sterling, Dagenham."

Managing Director : W. H. Peak, O.B.E. *Chairman* : Sir Frederick J. Barthorpe, D.L. *Secretary* : B. O. Collis, F.C.I.S. *Manufactures* : Telephones, Wireless and Signalling Apparatus.

STEVENS & CO. (1914) LTD., A. J., Radio Branch, Wolverhampton.

T.N. : 1748 (7 lines) - London, 122-124; Charing Cross Road, W.C.2. *T.A.* : "Reception, Wolverhampton." *Radio Call Signal* : 5 RI. *Joint Managing Directors, Radio Branch* : H. Stevens and C. W. Hayward. *Manufactures* : Radio Instruments and Accessories.

STIRLINGS, LTD., 17 Clarence Street, Kingston-on-Thames. *T.N.* : Kingston 0712.

Managing Director : B. Stirling. *Manufactures* : "Stirling Radio" 1, 2, 3-valve Sets; also H. F. Transformers.

SYNCHRONOME CO., LTD., THE, 32 and 34 Clerkenwell Road, London, E.C.1. *T.N.* : Clerkenwell 1517.

Founder and Managing Director : Frank Hope-Jones, M.I.E.E. *Manufactures* : Time Recording Apparatus. *Radio Call Signal* : Inter-station.

Reception of Wireless Time Signals in conjunction with the Synchronome System of Electric Clocks. Proprietors of Registered Trade Marks : "Synchronome" and "Horophone."

TELEGRAPH CONDENSER CO., LTD., THE, Wales Farm Road, North Acton, London, W.3. *T.N.* : Chiswick 3444, 3445 and 3446. *T.A.* : "Telefarad, Act, Surrey."

Directors : S. G. Brown, F.R.S., Mrs. S. G. Brown, W. J. Cole. *Secretary* : W. J. Cole. *Manufactures* : All types of Electrical Condensers.

TELEPHONE MANUFACTURING CO., LTD. *Works and Head Office* : Hollingsworth Works, Martell Road, West Dulwich, London, S.E.21. *T.N.* : Sydenham 2460/2461. *T.A.* : "Bubastis, Dulcrox, London."

Manufactures : "TrueMusic" Loud Speakers, Telephones, Signalling Systems Wireless Apparatus of all description, Laryngophone.

THAMES ELECTRIC CO., LTD., THE, Electric House, 11 St. James' Road, Kingston-on-Thames. *T.N.* : Kingston 1474. *T.A.* : "Kingston 1474."

Managing Director : H. W. Woods. *Directors* : F. M. Sexton, A.R.C.S. (I), F. P. Sexton, A.R.C.S., A.M.I.E.E. *Manufactures* : Wireless apparatus.

THAMES ELECTRIC WIRELESS CO., LTD., THE, 40 Old Town, Clapham, London, S.W.4. *T.N.* : Battersea 1156. *T.A.* : "Battersea 1156."

Managing Director : W. F. Watkins. *Director and Secretary* : S. R. Horsell. *Manufactures* : "Thames" Valve and Crystal Receivers, and Accessories.

THOMPSON, T. W., & CO., Electrical Engineers, 39 London Street, Greenwich, S.E.10. *T.N.* : Greenwich 1259.

Proprietors : Thomas Wright De Lasaux, Thomas Harold De Lasaux. *Manufactures* : Dynamos, Accumulators, Switchboards, Cut Outs, Wireless Crvstal Sets.

THORNTON, FRANK, LTD., 1 Parker Lane, Burnley. *T.N.* : 952. *T.A.* : "Thornton's, Electricians, Burnley."

Chairman and Managing Director : Frank Thornton. *Manufactures* : "Thornburn" Wireless Receiving Apparatus and Wireless Accessories.

TOLO, LTD., 395 St. John Street, Clerkenwell, London, E.C.1. Wireless Retailers and Engineers.

TUNGSTONE ACCUMULATOR CO., LTD., St. Bride's House, Salisbury Square, London. E.C.4. *T.N.*: Central 8157 (4 lines). *T.A.*: "Typify," Fleet, London.

UNIVERSAL ELECTRIC SUPPLY CO., LTD., THE, 4 Brown Street, Manchester. *T.N.*: City 3409.

Secretary: A. Hitner. *Manufactures*: Dealers in Wireless Apparatus and Electrical Sundries.

VANDERVELL & CO., LTD., Acton Vale, London, W.3. Electrical Engineers. *T.N.*: Chiswick 3801. *T.A.*: "Vanteria," Act, London.

Radio Productions include Loud Speakers, L.T. and H.T. Accumulators, Transformers, Rheostats, Coils, etc.

VICTOR RADIO, LTD., VICTORIA ELECTRICAL (Manchester). LTD., Victoria Works, Oakfield Road, Altrincham, Cheshire. *T.N.*: Altrincham 1775. *T.A.*: "Lamp-light, Altrincham."

W. & M. WIRELESS CO., LTD., 531 Forest Road, Walthamstow, London, E.17. *T.N.*: Walthamstow 987. *T.A.*: "Nominatus, Walthamstow, London."

Managing Director: Ernest Wainwright. *Technical Director*: Henry A. Machen, A.M.I.E.E. *Secretary*: G. E. Wainwright. *Manufactures*: W. & M. Wireless Components, Electrical Apparatus: Stampng, Pressings, Repetition Work.

WALSALL ELECTRICAL CO., LTD., THE, 57 Bridge Street, Walsall. *T.N.*: 45. *T.A.*: "Electrical."

Manufactures: Wireless Meters.

WARD & GOLDSTONE, LTD., Frederick Road, Pendleton, Manchester. *T.N.*: Pendleton 442. *T.A.*: "Mulum, Manchester."

Directors: M. H. Goldstone, A. A. Goldstone, J. H. Ward, L. B. Goldstone. *Secretary*: A. Lowe. *Manufactures*: Goldtone Crystal and Valve Receiving Sets, High and Low Frequency and Telephone Transformers, Variometers, Wires, Charging Apparatus, Terminals, Volex Dry Batteries.

WATES BROS., LTD., 12/14 Great Queen Street, Kingsway, London, W.C.2. *T.N.*: Gerrard 575 and 576. *T.A.*: "Zywateseng, Westcent, London."

Managing Director: F. S. S. Wates. *Manufactures*: Wireless Components and Wholesale Factors.

Manufacturers of Pyramid High Tension Batteries, "Ideal" Valve Accumulators, "Bijouphone" Crystal Set, "Microstat" Filament Control, "Supra" L.F. Transformer, "Supratone" Headphones, "Supratone" 2-valve Amplifier, "K" Automatic Crystal Detectors.

WATT & WRIGHT, Aboyne, N.B.

Directors: Robert J. Watt, Walter Wright. *Manufactures*: Crystal: 1, 2, 3, and 4-valve B.B.C. Receivers: Component Parts.

WILKIN, C. J., & SON, 143 High Street (corner of Powis Street), Woolwich, London, S.E.18. *T.N.*: Woolwich 0320.

Proprietor: S. A. Wilkin. *Manufactures*: Wireless Sets and Components.

Wholesalers and Retailers of all Electrical and Model Goods.

WILKINSON, H. E., 10, 12, 14, 29, 31, and 33 Lonsdale Road, Kilburn, London, N.W.6. *T.N.*: Willesden 1336.

Proprietor: H. E. Wilkinson, M.J.I.E., M.I. Radio E. *Manufactures*: Wireless Lattice Masts, Wireless Component Parts. Radio. General and Consulting Engineers.

Dealers in Second-hand Wireless Gear, etc. General and Consulting Engineers. Accumulator Charging Constant Service.

WINGROVE & ROGERS BRITISH ELECTRIC VEHICLES, LTD. *Registered Office and Works*: Mill Lane, Old Swan, Liverpool. *T.N.*: Old

Swan, 870. *T. A.* : "Components" Liverpool. *London Branch Office* : 63 Queen Victoria Street, E.C.4. *T. N.* : City 4746. *T. A.* : "Compounded Cent" London.

Directors : C. W. Wingrove. W. Rogers, F. J. Phillips. *Secretary* : C. W. Wingrove. *Manufactures* : Component parts. *Specialities* : Coilholders, Condensers. Also manufacturers of Industrial Electric Trucks, Locos and Trailers, Controllers, Switchboards, and Switchgear.

WIRELESS INSTRUMENT MANUFACTURING CO., THE, Avenue Works, Avenue Road, Willesden Junction, London, N.W.10. *T. N.* : Willesden 986. *T. A.* : "Wireorfeuz, Harles, London."

Director : C. Lee Bapty. *Manufactures* : "Orpheus" Wireless Instruments, Accessories, Small Dynamos. *Radio Call Signal* : 2 SB.

Manufacture small Brass Parts to Order, etc.

WRIGHT & WEAIRE, LTD., 740 High Road, Tottenham, London, N.17 *T. N.* : Tottenham 3132. *T. A.* : "Writewea, Tottlanc, London."

Directors : G. A. Huxley. B.A., T. G. Weaire, J. G. Wright. *Secretary* : G. A. Huxley. *Manufactures* : High Grade Wireless Components.

ZENTH MANUFACTURING CO. (*Proprietors* : R. Lehmann & Co., Ltd.). *Zenth Works* : Villiers Road, Willesden Green, London, N.W.2. *T. N.* : Willesden 4087. *T. A.* : "Voltaohm, Willroad."

Ericsson Ericsson Ericsson Ericsson Ericsson

Reproduction that's nigh Perfection

Tone Efficiency—the most sought after radio quality is a commonplace of the Ericsson Super Tone Loud Speaker. Hearing is believing—any good dealer will demonstrate—and convince.



The Ericsson Senior Super Tone is a handsome instrument. On wood base 18 in. high. Splendid in its volume, simply delightful in its purity.



For small rooms or where great volume is not required, we thoroughly recommend the Ericsson Junior Super Tone. Wonderful volume for a small speaker. 15 in. high, complete with lead.



Ericsson Telephones — wonderfully sensitive for DX work and alone for tone in broadcast reception. Adopted as standard by the Admiralty in 1909, by the Air Board in 1917, and now used throughout the B.B.Co.'s studios. Comfortable in wear. In three resistances, 120, 2,000, 4,000 ohms.

Write to-day for fully illustrated lists of valve sets, crystal sets, components.

ERICSSON TELEPHONES LTD.
67-73 KINGSWAY, LONDON, W.C.2

Ericsson

**LOUD SPEAKERS
and TELEPHONE**

Ericsson Ericsson Ericsson Ericsson Er

A BOOK FOR WIRELESS EXPERIMENTERS

SUCCESSFUL CRYSTAL AND ONE VALVE CIRCUITS

BY

J. H. WATKINS

Wireless Correspondent of the "Daily Express"

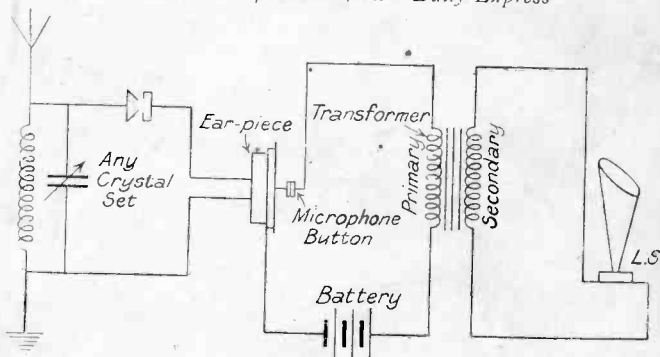

Loud Speaker Crystal Circuit

The circuits shown in this book are those which every serious amateur will be interested in testing for himself. Every circuit has been actually tested and will work, and every one has its use, either in illustrating the development of wireless reception or in serving as an indication of how to get maximum results with a minimum of apparatus.

Price **3/6** net

Of Booksellers, or

ISAAC PITMAN & SONS, LTD.
15, ABchurch LANE, KINGSWAY, LONDON, W.C.2

EDISON SWAN ELECTRIC CO., LTD., THE 123/125 Queen Victoria Street, London, E.C.4. *Works*: Ponders End, Middlesex. *T.N.*: City 9881 (7 lines). *T.A.*: "Ediswan, London."

Directors: C. F. Spencer (Chairman), A. F. Berry, John Cross, C. H. Cox, H. J. C. Johnston, J. W. Drake, E. A. Gimmingham (Technical). *Secretary*: F. V. Hasemore. *Manufactures*: Valves, Dry Batteries (H.T.), Accumulators (H.T. and L.T.), Switches, Sets and Components. etc. Royal "Ediswan" Gasfilled, Vacuum and Carbon Filament Lamps.

EFANDEM CO., LTD., THE, Fallings Park Works, Wolverhampton; 11 Fitzroy Square, London, W.1; and 28 Queen Street, Albert Square, Manchester. *T.N.*: Wolverhampton 1123/34; Museum, London, 2265; City M/C 2014. *T.A.*: "Efandem, Wolverhampton"; "Efandem Eusroad, London"; "Efandem, Manchester."

Manufactures: Dry Cells, Batteries, and Accumulators, for Wireless Receiving Sets.

EGGINTON, A. G., & SON, Hope Road, Brooklands, Sale, Cheshire. *T.N.*: Sale 352

Partners: A. G. Egginton (Senior), A. Gerald Egginton (Junior). *Manufactures*: "Accephone" Receivers. *Radio Call Signal*: 2 BTH.

ELECTRON CO., LTD., THE, Triumph House, 189 Regent Street, London, W.1. *T.N.*: Regent 5336.

ELECTRICAL SUPPLY STORES, 70 Crown Street, Halifax, Yorks. *T.N.*: 1062. *T.A.*:

Proprietor: R. Palmer. *Manufactures*: Specialists in Wireless Apparatus and Terminals. Established 1913.

ENGLAND-RICHARDS FLUID-FREE CELL CO., THE, 97 High Street, King's Lynn, Norfolk. *Sole Agents and Distributors*: Messrs. John J. Griffin & Sons, Ltd., Kemblo Street, Kingsway, London, W.C.2.

ERICSSON TELEPHONES, LTD., 67-73 Kingsway, London, W.C.2. *T.N.*: 3003 and 3004 Gerrard. *T.A.*: "Ericsson, Westcent, London." *Works*: Telephone Works, Beeston, Notts. *T.N.*: 12 Beeston. *T.A.*: "Ericsson, Beeston, Notts."

Managing Director and Chairman: W. M. Crowe. *Secretary*: J. H. Reed. *Manufactures*: Telephones, Wireless Head Phones, Loud Speakers, Valve Sets and Components.

ESSEX ACCUMULATOR CO., THE, 499 Grove Green Road, Leytonstone, E.11. *T.N.*: Wanstead 749.

Managing Director: A. J. Sheldrake. *Manufactures*: Wireless Accessories and Accumulators.

ESTLER BROS., South Molton Road, Victoria Docks. *T.N.*: Albert Dock 1871. *T.A.*: "Isolable, Canning, London."

Directors: E. P. B. Estler, H. P. C. Estler. *Manufactures*: Lightning Arresters.

General and Electrical Engineers; Iron, Gun Metal, and Aluminium Founders; Sheet-metal Workers.

EVER-READY CO. (GREAT BRITAIN), LTD., THE, Hercules Place, Holloway, London, N.7. *T.N.*: North 3306 and 0117, Mountview 0660. *T.A.*: "Eveready, Holloway, London."

Directors: C. H. C. Moller (Chairman), Magnus Goodfellow (Deputy-Chairman and Managing), A. H. Sheppard, C. H. Dade, L. P. Lightstone. *Secretary*: F. S. Johnson. *Manufactures*: Portable Electric Lamps, Dry Cells and Batteries, Accumulators, and Motor-car Accessories.

FADA RADIO, LTD., Alexandra House, 31 Kingsway, London, W.C.2. *T.N.*: Regent 7790. *T.A.*: "Fadandrea, Estrand, London." *Cables*: "Fadandrea, London."

FALE STADELMANN & CO., LTD., 83-93 Farringdon Road, London, E.C.1. *Manufactures*: Accessories of all kinds.

FELLOWS MAGNETO CO., LTD., Cumberland Avenue, Park Royal, N.W.10. T.N.: Willesden 1560. T.A.: "Quixmag," Phone, London.

Managing Director: D. V. L. Fellows. *Wireless Manager*: C. S. Harding. *Secretary*: H. C. Sawyer. *Manufactures*: Wireless Apparatus. *Radio Call Signal*: 2 ZZ and 5 CP.

FERRANTI, LTD., *Head Office and Works*: Hollinwood, Lancashire. T.A.: "Ferranti, Hollinwood." *Cables*: "Ferranti, Hollinwood." T.N.: Failsworth 161. *London Office*: Bush House, London, W.C.2. T.A.: "Ferranti, Strand, London." T.N.: City 7618.

GAMAGE, A. W., LTD., Holborn, London, E.C.1. T.N.: Holborn 2700. T.A.: "Gamage, Holborn, London."

Directors: A. W. Gamage, E. M. Gamage, J. Dunn, W. A. Vincent, J. S. Parker. *Secretary*: E. W. Malvern. *Manufactures*: Wireless Apparatus.

Have been Wireless Manufacturers since 1908. Contractors to H.M. Government during the War.

GAMBRELL, BROS., LTD., 76 Victoria Street, S.W.1. *Works*: Merton Road, Southfields, S.W.18. T.N.: Putney 3461. T.A.: "Gambreum, Wandl., London."

Directors: T. E. Gambrell, C. T. Gambrell, A. Onwood, R. Annan. *Manufactures*: "Efficiency", Inductance Coils, L.F. Transformers, Heutrodyne Condensers, Anti-capacity Switches, Coil Holders, Complete Receiving Sets, Transmitting Apparatus and Electrical and Scientific Instruments.

GENERAL ELECTRIC CO., LTD., THE. *Head Office*: Magnet House, Kingsway, London, W.C.2. Branches throughout Great Britain and in all the Principal Markets of the World. T.N.: Regent 7050 (50 lines). T.A.: "Electricity Westcent, London." *Cablegram*: "Polyphase, London."

Manufactures: Everything Electrical, including Wireless Apparatus, Telephone Equipments, Measuring Instruments, Insulating Material, etc.

GENERAL RADIO CO., LTD. *Head Office*: Radio House, 235 Regent Street, London, W.1. *Works*: Radio Works, 22/23 Allsop Street, Baker Street, N.W.1. T.N.: Mayfair 7152/3 (Private Branch Exchange). T.A.: "Algenrad, London."

Directors: W. S. Stephenson, A. Morphy, W. E. S. Wissler, B. H. Morphy. All types of Wireless Apparatus, X-ray and Electro-medical Apparatus, and Scientific Instruments.

GENT & CO., LTD., Faraday Works, Leicester. London: 25 Victoria Street, S.W. Newcastle-on-Tyne: "Tangent" House, Blackett Street. T.N.: Leicester 151. T.A.: "Gents, Leicester."

Managing Director: I. Hardy Parsons. *Directors*: H. R. Waddington, C. Skinner. *Secretary*: O. E. Kinsey. *Manufactures*: Broadcast Receiving Apparatus, Radio Sundries, including "Tangent" Radio Specialities, Tuning Coils, Low Frequency Transformers, "Discol" High-frequency Transformers, "Tangent" Head Phones, H.T. Battery Eliminators, "Talisman" Loud Speakers, etc. *Radio Call Signal*: 5 FX.

GOSWELL ENGINEERING CO., LTD., 95-98 White Lion Street, London, N.1. T.N.: North 3051.

Directors: R. C. Portway, W.A. Allingham, A. P. Barry. *Manufactures*: "Quality Radio Components," consisting of Coil Holders, Duplex Coils, Legless Valve Holders, etc.

GOULDEN, H. J., LTD., 39 and 40 High Street, Canterbury. T.N.: 139. T.A.: "Gouldens, Canterbury."

Directors: H. J. Goulden, H. G. R. Goulden, L. J. Goulden. *Secretary*: H. G. R. Goulden. *Manufactures*: "Itonaphone" Wireless Sets. Members B.B.C. *Call Sign*: 6 XU.

GRAHAM, ALFRED & CO., 25 Savile Row, Regent Street, London, W.1. *Works*: Crofton Park, London, S.E.4.: 761, Old Kent Road, London, S.E.15;

Kilmorie Road, London, S.E.23. *South London Showrooms*: 79-82 High Street, Clapham, S.W.4. *T.N.*: Regent 4626, 4627, and 4203. *T.A.*: "Sonalgra, Piecy, London."

Sole Partner: Mrs. M. Graham. *Manufactures*: "Amplion" Loud Speakers, etc.

GREENSLADE & BROWN, 187 Clapham Road, London, S.W.9. *T.N.*: Brixton 0639, Brixton 3251.

Directors: A. E. Greenslade, M.J.Inst.E., R. G. J. Brown, M.J.Inst.E. *Secretary*: N. Hammond. *Manufactures*: Wireless Components. *Radio Call Signal*: 5 GM and 5 GN.

HAMBLING, CLAPP & CO., LTD., 21 Garrick Street, London, W.C.2. *T.A.*: Gerrard 8806

Directors: A. W. Hambling, A.M.I.R.E., B. Clapp, A.M.I.R.E., C.W. Rooke. F. C. T. Lane, R. J. Frost. Members of the B.R.C. Experimental Stations. 2 MK Brondesbury, 2 KZ Purley, 23-45 metres. Wholesale Suppliers of all Radio Apparatus.

HARROD RADIO CO., 375 Queen's Road, New Cross, London, S.E.14. *T.N.*: New Cross 667. *T.A.*: "Harrod, 667 N.X."

Directors: W. Harrod, P. M. Harrod. *Secretary*: W. Harrod. *Manufactures*: Wireless Instruments and Accessories.

HART ACCUMULATOR CO., LTD. *Head Office and Works*: Marshgate Lane, Stratford, London, E.15. London: 36 Victoria Street, S.W.1. Birmingham: 165 Edmund Street. Glasgow: 107 Wellington Street. Manchester: Cuxton Hall, 88 Chapel Street. Bristol: 37 Victoria Street. York: 6 Bridge Street. *T.N.*: Maryland 1361 (4 lines). *T.A.*: "Hartmossel, Bochurch, London"

Directors: Sir John Prestige (Chairman), E. J. Clark, G. Hay, H. W. Lee, Rt. Hon. Viscount Hawarden, F. J. Holmes, M.I.E.E. *Secretary*: Jno. Breeze, F.C.I.S. *Manufactures*: Electric Accumulators of all sizes and for all purposes.

HARWELL, LTD., 28 John Street, Theobald's Road, London, W.C.1. *T.N.*: Museum 5422. *T.A.*: "Arwelidite, Holb., London." *Manufactures*: Moulded Insulation Articles, Radio Accessories, Bakelite, etc.

HAZELTINE NEUTRODYNE RADIO SETS, LTD., 147 Queen Victoria Street, London, E.C.4. *T.N.*: Central 7121. *T.A.*: "Neutrodyne, London."

Directors: G. A. Mower, U.S.A., G. R. Thursfield, A. H. Curtis, J. C. Elms, U.S.A., A. H. Corwin, U.S.A., J. C. Elms, Junior, U.S.A. *Secretary*: W. H. Ward. *Manufactures*: Receiving Sets.

HEATON WALLACE, LTD. (RADIO), 17/27 Change Alley, Sheffield; 119 New Bond Street, London; Imperial Buildings, Rotherham. *T.N.*: Cent 255. *T.A.*: "Zodella, Sheffield"; "Zodellaria Wesdo, London."

Directors: Wallace E. Heaton, London, G. W. McIntosh, Sheffield. *Secretary*: M. McIntosh. *Manufactures*: Wireless Instruments and Accessories, Scientific and Photographic Apparatus.

Proprietors of Zedel and Zedelphone (Trade Mark) Wireless Specialities. **HENDERSON, W. J., & CO., LTD.**, 351 Fulham Road, S.W.10. *T.N.*: Kensington 8983.

Directors: W. J. Henderson, A. F. Phelp, R. M. Dillon. *Manufactures*: Broadcasting Receiving Apparatus. Components of all descriptions.

HENLEY'S, W. T., TELEGRAPH WORKS CO., LTD., Holborn Viaduct, London, E.C.1. *Works*: North Woolwich, E.16; and Gravesend, Kent, *T.A.*: City 2271 (10 lines). *T.A.*: "Henletel, Cent., London."

Managing Director: Sir George Sutton, Bart. (Chairman). *Directors*: Sir Montague Hughman, W. J. Potter, R. J. Hutton, M.I.Mech.E., M.I.E.E., A. E. Salmon, A. A. Campbell Swinton, F.R.S., M.Inst.C.E., M.I.E.E. *Secretary*: H. M. Jacob. *Manufactures*: All kinds of Electric Cables and Wires and Distribution Accessories.

HESTAVOX, LTD., 32 Palmerston Road, Acton, London, W.3. T.N. : Chiswick 0586.

Directors : A. H. Rice, H. A. Rice. *Manufactures* : Loud Speakers.

HINDERLICH, A., 1 Lechmere Road, London, N.W.2. T.N. : Willesden 2668.

Manufactures : Crystals in Bulk or Packed ; Crystal Detectors ; " Ghane " Crystal Combination. Piezo-Electric Quartz, Crystals in bulk, etc. (Wholesale and Retail.) *Call Sign* : 2 QY.

HOPLEY, JOSEPH, & SON, Whitchurch, Salop. T.N. 51. T.A. : " Hopley Whitchurch."

Directors : Arthur S. Hopley, Alan H. Entwistle. *Manufactures* : Wireless Apparatus, Receivers, etc., known as Entley Radio Products.

Component part sets for amateur constructors known as Entley-Ponents.

HOUGHTONS THE WHOLESALEERS (Houghton-Butcher (Great Britain) Ltd.) *Head Office* : 88-89 High Holborn, London, W.C.1. T.N. : Holborn 2500 (9 lines). T.A. : " Bromide, Phone, London." *Branches* : Glasgow, Dublin, Manchester, Nottingham, Leeds, Swansea.

IGRANIC ELECTRIC CO., LTD., 147 Queen Victoria Street, London, E.C.4. Also at Glasgow, Manchester, and Leeds. *Works* : Bedford. T.N. : Central 7123, Bedford 232. T.A. : " Igranic," London, Glasgow, Manchester, Leeds, Bedford.

Directors : G. A. Mower, F. R. Bacon, F. L. Pierce. *Secretary* : G. R. Thursfield. *Manufactures* : Honeycomb Inductance Coils, Intervalve Transformers, Coil Holders, Filament Rheostats, Variometers, Variable Condensers, Fixed Grid Leaks, Valve Holders, Potentiometers, etc., etc.

Sole licensees under De Forest British Patents.

JACKSON, THOMAS, & SONS, Pickford Road, Bexley Heath. T.N. : Bexley Heath 21. T.A. : " Jacksons, Bexley Heath."

Partners : A. F. Jackson, P. T. Jackson. *Manufactures* : to the Trade of Wireless Parts and Components, Motor Engineers and Sheet Metal Workers.

JOHNSON & MURRELL ELECTRIC CO., LTD. Successors to Croggon & Co., Ltd. (Electrical Department). 230 Upper Thames Street, London, E.C.4. T.N. : City 4470. T.A. : " Johnson, City 4470, London."

Manufactures : Wireless Apparatus.

KENT BROS. ELECTRIC WIRE CO. & E. H. PHILLIPS, LTD., 15 Berners Street, Oxford Street, W.1. *Stores* : 43 Berners Mews, W.1. *Works* : Kew Garden, Surrey. T.N. : Museum 8200/1. T.A. : " Encosil Wesdo, London."

Directors : Arthur Kent (Chairman), Albert Kent, and E. H. Phillips (Joint Managing Directors), H. Hargreaves. *Manufactures* : Instrument Wires. Sole Agents for British Empire of " Sweetstrand " Enamelled Copper Wires.

KINE-RADIO CO., THE, 146 Sunbridge Road, Bradford, Yorks. T.N. : Bradford 5966.

Directors : F. Harwood, J. Robinson, A. Sykes, F. Needham. *Secretary* : F. Harwood. *Manufactures* : Scientific and Wireless Instruments ; K-R. Variable Condensers, Variometers, and Vario-couplers. Members of the B.B.Co.

LILLEY, S., & SON, 80 Alcester Street, Birmingham. T.N. : Mid. 2385. T.A. : " Lilley, Alcester Street, Birmingham."

Principal : A. E. Lilley. *Secretary and Manager* : P. E. Lilley. *Manufactures* : Manufacturers to the Wholesale Trade ; Wireless Sundries from the Bar, also all kinds of Stampings ; Makers of the Royal Imperial Crystal Set. *Radio Call Signal* : P. E. Lilley 2 WV. Experimental Aerial.