

THE MARCONI REVIEW

No. 44.

September-October, 1933.

Editor: H. M. DOWSETT, M.I.E.E., F.Inst.P., M.Inst.R.E.

THE RESEARCH WORK OF THE MARCONI COMPANY

FOR the past 38 years, from 1895 to the present date, the Marchese Marconi and the Research Engineers of the Marconi Company have laboured unceasingly to build up and extend the boundaries of the science and art of radio communications. Occasionally they have faced great technical difficulties and progress has inevitably been accompanied by setbacks, but on balance they have created a wonderful record of achievement and a generous proportion of the great discoveries in radio has fallen to their share.

Books which make it their business to catalogue events in radio history, and endeavour to present a perspective of the world's progress in radio are usually very fair in their references to the work of Marconi and his associates, but this cannot be said of a volume entitled "Wireless," by Dr. W. H. Eccles, F.R.S., which has been sent to us for review. This book contains statements which we regard as erroneous in fact and misleading in regard to the deductions to be drawn from them. There are also many highly significant omissions. In these circumstances we confine our remarks to those passages which, from our point of view, are open to criticism.

From a note on the wrapper we learn that the author was Vice-Chairman of the Commission which planned the Imperial Wireless Stations. The short wave beam stations by which commercial communications were first established throughout the Empire were actually planned and designed by the Marconi Company to comply with the performance specifications issued by the British Post Office, so that in a general sense one can say that the stations were planned jointly by the Marconi Company and the British Post Office.

On page 48, the author compares the elevated antenna suggested by Tesla in 1893, to half a complete Hertzian oscillator, and leaves the reader to assume that Tesla at that date proposed to use Hertzian waves. He is not told otherwise until a note on page 76 indicates that Tesla proposed to use earth waves.

Again, on page 55, the author states that Popoff publicly demonstrated Lodge's telegraphic unit in 1895 employing a single vertical wire, and conveys the impression that the vertical wire was used for signalling purposes. So it was at a later date,

but in 1895 Popoff's particular achievement was that he was the first man to erect an aerial on a building to collect and record atmospheric. These two instances should be considered in connection with the absence of any mention in the book of the work done by Marconi in 1895 when he made the first real advance in actual transmission from the time of Hertz by elevating one of the capacity areas of the Hertz oscillator above the ground replacing the other by a wire to an earth net, thereby considerably increasing the radiation, the elevated capacity area being the prototype of most medium wave and all long wave aerials of to-day. Further on in the book on page 60, the author mentions the first attempt at quantitative measurement of radiation which was made by Marconi when he used metal boxes fixed on poles at different heights and noted the increase of range obtained, but it is not made clear that these tests were carried out in 1895.

The discovery by Rutherford in 1895 that magnetised steel needles could be used in an oscillation detector is mentioned, but it is not stated that six years later in the words of Rutherford "Marconi transformed the germ of this simple device into a reliable and metrical detector which for 10 years or so gave useful service to mankind."

The author, on page 76, discusses Tesla's long distance earth wave tests carried out in 1899, which, however, are not described as such, only the wavelength being given, and states: "Evidently there was no lack of scientific opinion in favour of an attempt to communicate by wireless between places thousands of miles apart." This was not the opinion of Sir Oliver Lodge, who wrote that "When Senatore Marconi found experimentally that the waves would actually curve around the earth and reach the American Continent, physicists were surprised—it was an important discovery; and a mathematician, Mr. Oliver Heaviside, began to show how an ionised layer of air in the upper regions must be operative, and could explain it." Sir Oliver Lodge also wrote that Marconi's discovery that waves curved around the earth "constituted an epoch in human history on its physical side, and was itself an astounding and remarkable feat." On page 75, however, the author refers to the remarks of Oliver Heaviside on this subject as if they anticipated Marconi's experiments.

While the author finds it possible on page 94 to give deserved credit to a famous German company for their successful short distance work, especially as applied to shipping, no mention is made anywhere in the book of the wonderful ship-to-shore and ship-to-ship development of wireless communication carried out by the Marconi International Marine Communication Company, which from its inception up to the present time has been the largest and most successful organisation of its kind, and in the early years of wireless had almost a monopoly of the marine telegraphic services of the world.

On page 95, the author enlarges on the difficulties which attended the opening of the transatlantic radio telegraphic service between this country and Canada and the United States. He states that in the first tests between Poldhu and Newfoundland, the signals received were too feeble for carrying messages. Actually, the programme of the test did not provide for message transmission. A standard signal was all that was sent and it was heard. He states that after enlargements at Poldhu, messages were received at 1,500 miles at night and at 700 miles in daylight.

This refers to the famous "Philadelphia" tests. No enlargements of plant had been made at Poldhu, but actual test messages were transmitted and were received on board at the distances mentioned. The eminent author omits here to point out that Marconi, by discovering night effect, provided further valuable evidence in favour of the existence of a reflecting layer in the upper atmosphere.

Improvements were, however, made in due course at Poldhu, Clifden, and Glace Bay, but the final rating of the stations was not 1,000 horse power as stated, but roughly 400 horse power.

Chapter 5 which deals mainly with beam transmission is remarkable for the manner in which the Franklin beam aerial is discussed, dissected, and is finally dismissed as a Bellini array. Here the author's conclusions at least have the merit of being amusing.

In 1914 Bellini wrote a mathematical article in which he discussed the numerical extension of an arrangement of Brown aeriels already devised by Blondel. Bellini himself introduced no new principle and concluded his article by stating that "It is not possible to verify experimentally the former deductions for the transmission because we have no means of generating pure electric oscillations of suitable phases and intensities and of high frequency."

Franklin not only overcame such difficulties in his beam aerial, which involved, among other things, the invention of a bifurcating balanced feeder system, but he introduced a new principle by using the equivalent of a number of half-wave aeriels in phase in the vertical plane, thereby decreasing high angle radiation. The value of Franklin's method of suppressing the radiation from every alternate half-wave of a harmonic aerial to obtain this effect is indicated by the fact that the author describes and illustrates four other methods which have since been invented to achieve the same result. Because of this new feature and the fact that the reflector is not directly excited, the design of the aerial is not identical with that of the reflector as it is in Blondel's system, where both the aerial and the reflector are excited, and on these several counts, the Franklin aerial cannot logically be described by any other name.

On page 217 the author states that in January, 1923, the Radio Society of Great Britain advocated that short wave plant should be adopted for long distance telegraphy. This may be so, although the report of the meeting in January of that year given in the official organ of the Society states "that for the first time in the history of these Conferences no special resolutions were passed, and no new proposals for the conducting of amateur activities were outlined."

But if, in the absence of any record, the author's reference to January, 1923, must be regarded as open to doubt, it is unquestionable that Marconi's paper read before the Institute of Radio Engineers, N.Y., on June 20th, 1922, by its account of researches on very short waves and Marconi's statement of his belief that the study of short waves "is still likely to develop in many unexpected directions and open up new fields of profitable research" did stimulate short wave research in many countries.

Neither the paper quoted nor any other by Marconi is mentioned in the Bibliography of 49 references at the end of the book.

The author, on page 219, remarks that the Marconi Company followed up the amateurs' discoveries on short waves in 1923 by tests from Poldhu up to 2,300 sea miles. It is not mentioned that up to the date of the Marconi tests all recorded amateur transmissions over long distances were of the order of 200 metres down to 155 metres, and that Marconi's tests started with 96 metres and gradually worked down during that year and the early part of the following year to 25 metres.

In 1924 the Marconi Company made an offer to the Post Office for the erection of 4 short wave stations, not, as stated by the author, of the type used in Franklin's short distance experiments, but of the improved type used by Marconi and Franklin in the long distance tests between Poldhu and the S.Y. "Elettra."

On page 220 the author states "the choice lay between the erection of suitable stations with or without reflectors, by the Post Office Engineers, or by the Company as contractors." No such choice existed. At that date the Marconi Company alone had the requisite experience and sufficient belief in the new system to accept the onerous terms of the guarantee required by the Post Office, and which could not have been complied with as regards hours of working without the use of reflectors.

The author on page 223 stresses the fact that the completion of the beam stations was delayed and states that this was owing to "repeated changes in the antennæ and other high frequency circuits necessitated by the continual growth of the world's knowledge, particularly as regards the best wavelengths." It is true that improvements were introduced up to the last moment before the stations were transferred to the Post Office, but the principal causes of the delay were the more prosaic and very practical ones of:—

- (1) Obtaining suitable sites for the large aerial systems satisfactory both to the Post Office and the Air Ministry.
- (2) Designing an entirely novel mast, aerial and feeder equipment to have the necessary reliability under different climatic conditions in various parts of the world.

The author fails to mention that the postponed opening of the services was more than offset by the enormous rush of traffic as soon as the stations commenced operating, and that it increased by leaps and bounds so that the Post Office were hard put to it to meet the public demands, while the stations themselves functioned without any trouble and demonstrated that their capacity for traffic was even greater than the stringent terms of the specification called for.

Perhaps, after all, we should be grateful to Dr. Eccles for giving us an opportunity of recalling for the benefit of forgetful minds the past achievements of Marconi and the Marconi Company.

NOISE AS A LIMITING FACTOR IN AMPLIFIER DESIGN

The first part of this article, which deals with the effects of noise in high gain amplifier systems, appeared in the last number of THE MARCONI REVIEW.

The second and concluding part of the article, dealing with measurements taken on an actual amplifier, and with Appendices to the main article, is given below.

(c) It frequently happens that the characteristic of the amplifier cannot conveniently be expressed in the simple form of equation (8), this occurring when certain frequencies are accentuated or correction is used to decrease the normal drop at the upper end of the spectrum. The result in such a case is to extend the straight portion of the characteristic to a specified value, after which there is a very sudden drop to approximately the level of an uncorrected amplifier.

The procedure adopted in these cases is to determine the area under a curve representing the square of amplification with respect to frequency, the normal level being represented by unity. As, however, R also varies with frequency the curves representing the variation of square of amplification and R with frequency can be combined to form a single curve (with a normal level of unity) and the area under this curve determined. The number obtained will represent effective frequency spectrum and is substituted for $(f_1 - f_0)$ in equation (5). (Also see page 26, M.R. 42.)

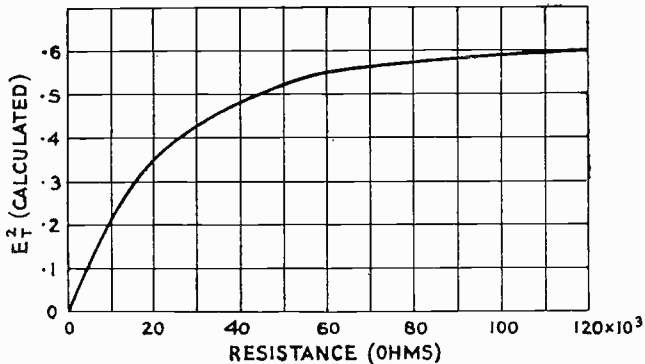

FIG. 11.

III. Measurements on 10 cycle—100 kilocycle Television Amplifier.

The amplification of the amplifier was obtained overall and stage by stage and found to be 50,000. The valve voltmeter was made more sensitive by adding a screened grid amplifier so as to provide a full scale deflection of approximately 1 volt.

The resistance to be measured was placed in the first grid and all measurements taken with screening cover in position. The noise level with $R=0$ was noted (.5 volt). This noise is due to two causes (1) shot effect from cathodes, (2) thermal effect due to electron agitation in all resistances except that of first grid. Resistances of known value were then placed in the first grid circuit and output readings taken. It should be noted that the R.M.S. voltmeter will read $E_N = \sqrt{E_S^2 + E_T^2}$ where $E_S =$ output due to shot effect, $E_T =$ output due to thermal effect only, hence by squaring the voltmeter reading and subtracting E_S^2 , E_T^2 is obtained. Fig. 11 shows the result of the tests, E_T^2 being plotted against R.

It should be noted that the curve rises in almost a straight line to $15,000\omega$. This indicates that the effective resistance of the input circuit is sensibly constant throughout the frequency range of the amplifier (the amplifier determining the

effective frequency spectrum ($f_1 - f_0$) and that E_T^2 is proportional to the resistance used. Above $15,000\omega$ the effective value of input resistance begins to decrease at

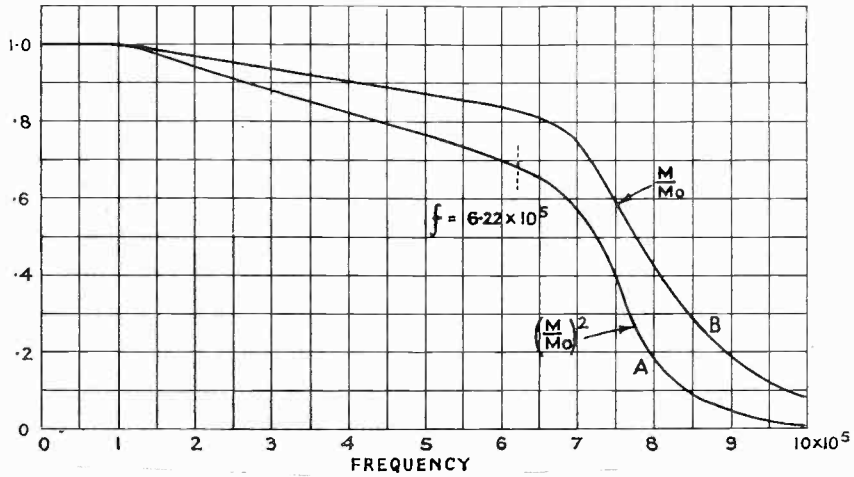

FIG. 12.

the upper frequency limit of the amplifier and as R increases the input circuit determines the effective frequency spectrum and since $R \int_{f_0}^{f_\infty} \frac{I}{I + a^2 f^2} df$ tends towards a constant value, E_T^2 will also tend towards a constant value, in this instance $.5 \text{ (volt.)}^2$

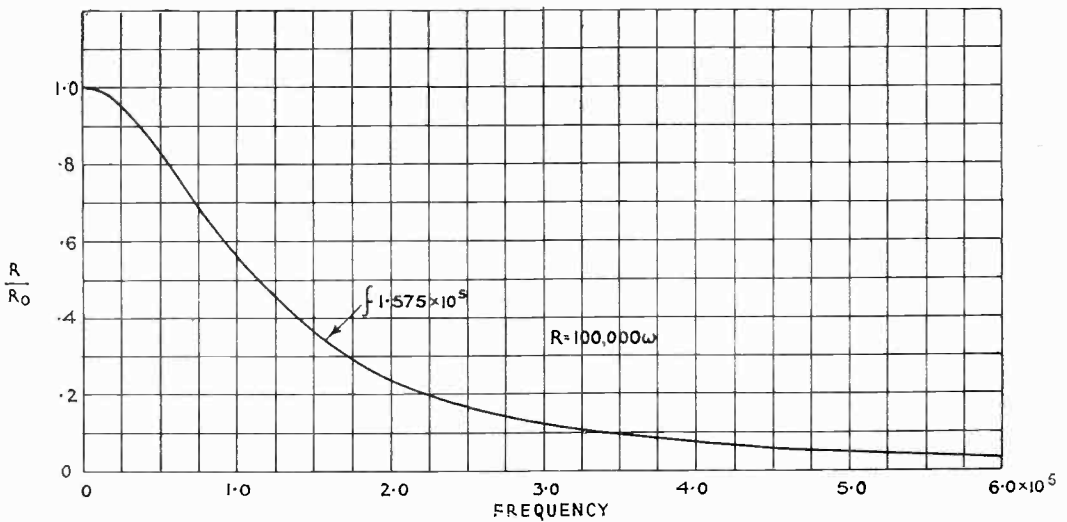

FIG. 13.

A theoretical check was made using the method described in II., (c). Fig. 12 (B) shows the characteristic of the amplifier, i.e., $\theta(f) = \frac{M}{M_0}$ while Fig. 12 (A) represents

$\theta(f) = \frac{M^2}{M_0^2}$. This curve is combined with such a curve as Fig. 13, which shows $\frac{R}{R_0}$ i.e., the effective resistance of the input circuit. This follows the law $\theta(f) = \frac{1}{1+a^2f^2}$ as shown in Section II., (A).

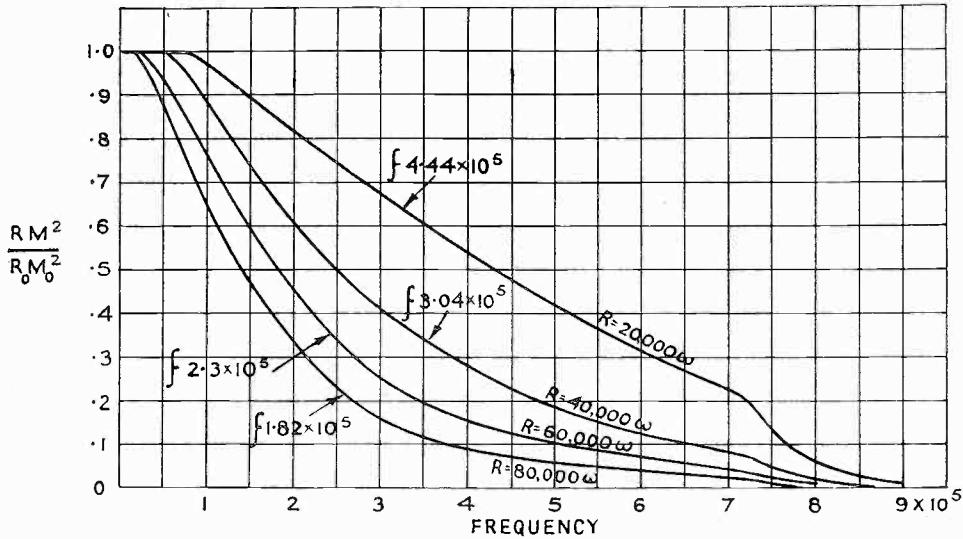

FIG. 14.

In Fig. 14 there are combined Fig. 12 (A) and curves such as Fig. 13 for various values of R_0 . Fig. 15 is similar but to a larger frequency scale for accuracy. The areas

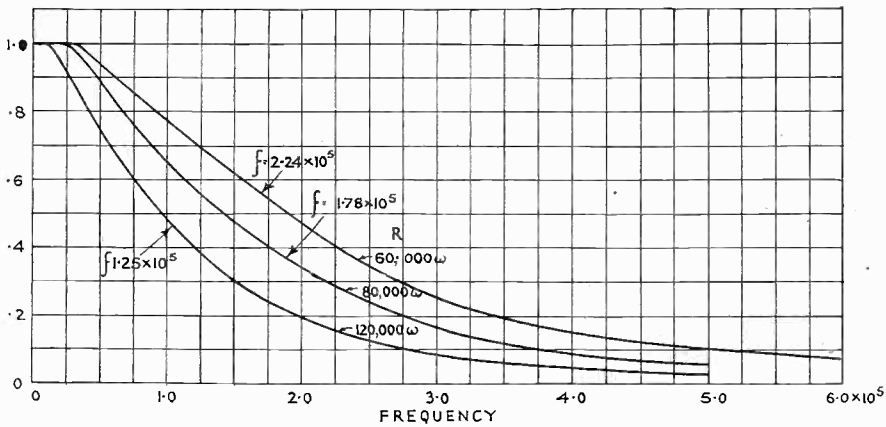

FIG. 15.

under these curves are determined and are shown against the curve to which they apply. The values are tabulated below. The area then represents the effective frequency spectrum over which thermal agitation occurs.

R	($f_1 - f_0$)
20,000	4.44×10^5
40,000	3.04×10^5
60,000	2.3×10^5
80,000	1.8×10^5
120,000	1.25×10^5
0 (Fig. 12B)	6.22×10^5

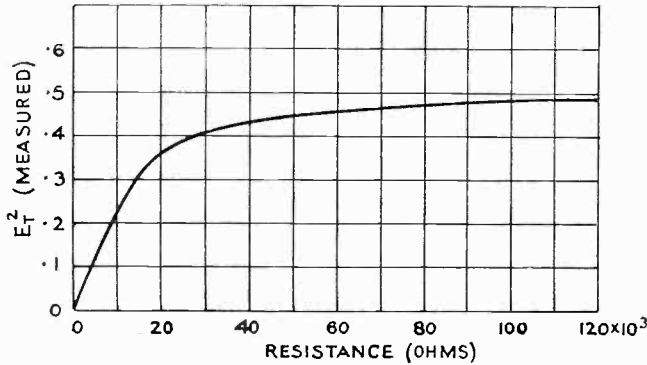

FIG. 16.

E_T^2 is now determined from equation (5) and the result is plotted in Fig. 16. This agrees very closely with Fig. 11 except that the limiting value of E_T^2 is .6 as against .5 measured. This indicates that since $E_T^2 \propto \frac{I}{C_T}$ the value of C_T ($14.2 \mu\mu\text{F}$.) taken in the calculations is too small and a more correct value is $14.2 \times \frac{6}{5}$ or $17 \mu\mu\text{F}$.

(C_T represents grid to earthed screen and cathode capacity in the valve and wiring capacities.)

The measurements obtained for Fig. 11 are tabulated below :

R	$\sqrt{E_S^2 + E_T^2}$	$E_S^2 + E_T^2$	E_T^2
0	.5	.25 (= E_S^2)	0
13,300	.74	.547	.297
27,000	.805	.648	.4
52,000	.837	.7	.45
75,000	.848	.72	.47
123,000	.86	.738	.488

Since $M=50,000$, the maximum value of E_T^2 corresponds to a voltage of $\frac{\sqrt{.488}}{50,000} = \frac{.7}{50,000} = 14 \times 10^{-6}$ volt on the first grid due to thermal effect.

APPENDIX "A 1" TO APPENDIX "A"

$$I = \int_{f_0}^{f_1} \frac{I}{1+a^2f^2} \cdot \frac{I}{1+b^2f^2} \cdot df$$

$$= \int_{f_0}^{f_1} \left(\frac{A}{1+a^2f^2} + \frac{B}{1+b^2f^2} \right) df$$

whence

$$A + Ab^2f^2 + B + Ba^2f^2 = I$$

$$\therefore A + B = I \text{ and } Ab^2 + Ba^2 = 0$$

\therefore

$$A = -B \frac{a^2}{b^2}$$

Substituting for A

$$B \left(1 + \frac{a^2}{b^2} \right) = 1$$

$$\therefore B = \frac{b^2}{b^2 - a^2} \text{ and } A = \frac{-a^2}{b^2 - a^2}$$

$$\therefore I = \int_{f_0}^{f_1} \frac{-a^2}{b^2 - a^2} \cdot \frac{1}{1 + a^2 f^2} df + \int_{f_0}^{f_1} \frac{b^2}{b^2 - a^2} \cdot \frac{1}{1 + b^2 f^2} df$$

$$= \left[\frac{-a^2}{b^2 - a^2} \cdot \frac{1}{a} \tan^{-1} af + \frac{b^2}{b^2 - a^2} \cdot \frac{1}{b} \tan^{-1} bf \right]_{f_0}^{f_1}$$

$$= \left[\frac{-a}{b^2 - a^2} \tan^{-1} af + \frac{b}{b^2 - a^2} \tan^{-1} bf \right]_{f_0}^{f_1}$$

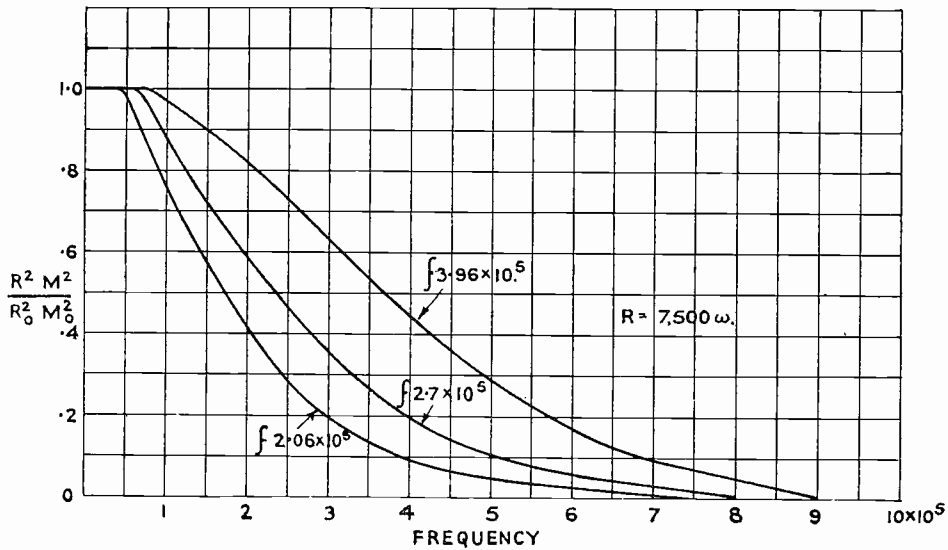

FIG. 17.

APPENDIX "B"

Shot Effect.

The commonest cause of noise in an amplifier is that known as valve-hiss or, as it is nowadays termed, Schottky—small shot—of Schrot-effect.

The passage of current in the valve circuit does not consist of a uniform flow of a continuous medium but of the movement of large numbers of individual particles whose rate of passage approaches a steady value only when their number or the time interval over which they are measured is large. The noise heard or measured at the output of an amplifier possessing sufficiently high magnification is therefore a measure of the departure from the average of the number of electrons arriving at the anode from the cathode of the first valve in a small interval of time.

Since each electron carries a definite charge (1.59×10^{-29} coulomb), and these charges are applied to the circuit at irregular intervals of time, the resulting varying

current through the anode circuit load will cause varying voltages across this load. Moreover the magnitude of the output will depend on the frequency band width, since each pulse of current due to the arrival of an electron may be split up into its component frequencies determined by Fourier analysis and only those frequencies embraced by the amplifier and/or measuring device will contribute to the measured output.

The output voltage will also be a function of the impedance of the anode load (including input impedance of amplifier) and also the anode current through it (since anode current is the result of transfer of a large number of electronic charges).

It is as well to appreciate the fundamental difference between noise due to shot effect and noise due to thermal agitation. In the former case there is a transfer of electrons from one end of the anode resistance to the other (i.e., a current is flowing), due to the potential gradient which exists. In the case of thermal agitation there is no potential gradient, i.e., movements of electrons in one direction are counter-balanced by movements of other electrons in the reverse direction or the integral of all movements in any direction over a period of time is zero, i.e., the current through the resistance is zero. The movements are analogous with Brownian movements and it is possible if the time intervals are made sufficiently small to have an excess or deficiency of electrons at any instant. The voltage due to this excess or deficiency is that which is measured. Increase of temperature increases the speed of the electrons increasing their range (Brownian movement), also increasing the probability of excess or deficiency at any instant, consequently increasing the voltage at the output. The voltage produced by thermal effect across a resistance in the anode circuit of a valve is small in comparison with that produced by shot effect due to the current flowing in it, so that the former effect may in such cases be neglected.

In connection with photo cells Schottky, also Vincent and Williams, give the following formula for shot effect:—

$$E_S^2 = 2R^2M^2e I (f_1 - f_0) \quad (\text{volts})^2$$

$$\text{or } E_S^2 = 3.18 R^2M^2 I (f_1 - f_0) 10^{-19} \quad (\text{volts})^2$$

where E_S = output voltage R = input impedance of amplifier

M = amplification e = electronic charge 1.59×10^{-19}

I = emission current.

It was assumed that noise due to shot effect in a valve is of the same form and the formula is modified to meet the requirements of the conditions under which measurements were to be taken (as in the case of thermal agitation). In this case

$$M = M_0 \frac{I}{\sqrt{I + b^2 f^2}} \quad (\text{amplification})$$

$$R = R_0 \frac{I}{\sqrt{I + a^2 f^2}} \quad (\text{anode load})$$

$$\text{whence } E_S^2 = 2R_0^2 M_0^2 e I \int_{f_0}^{f_1} \frac{I}{I + a^2 f^2} \cdot \frac{I}{I + b^2 f^2} df \quad (\text{volts})^2$$

$$\text{or } \left| E_S^2 \right|_0^\infty = 3.18 R^2 M^2 I \frac{\pi}{2(a+b)} 10^{-19} \quad (\text{volts})^2.$$

Experimental Results.

All measurements were taken with an anode current of 3.7 m.a. Hence integrating and inserting constants ($M=3,000$ approx.)

$$E_s^2 = 2 \cdot 1.59 \cdot 10^{-19} \cdot 3.7 \cdot 10^{-3} R^2 9 \cdot 10^6 \frac{\pi}{2(a+b)}$$

or $E_s^2 = 1.06 \cdot 10^{-14} R^2 f$ (volts)²

where f = effective frequency band.

f is determined by measuring the area under a curve representing variation of $R^2 M^2$ with frequency, i.e., $\frac{R^2 M^2}{R_0^2 M_0^2}$ plotted against frequency.

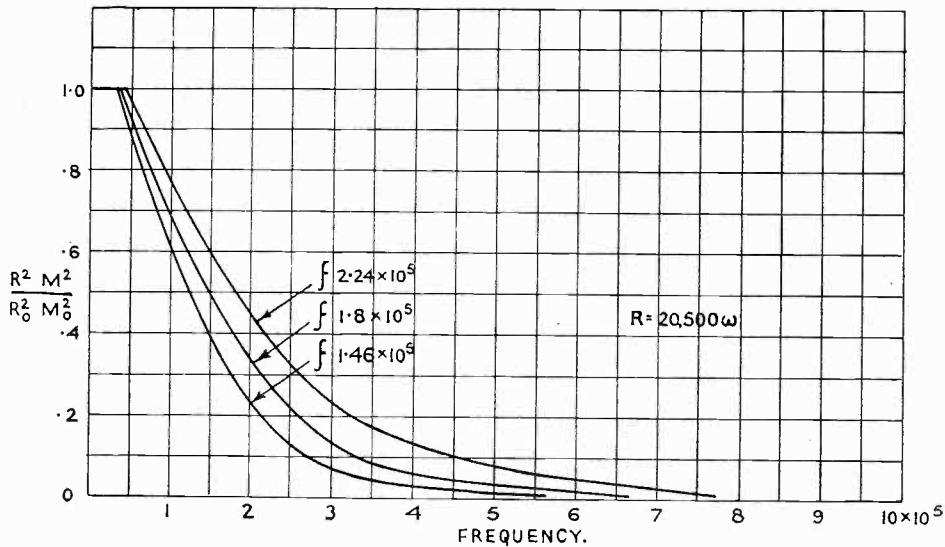

FIG. 18.

Measured and calculated results are given in the following tables. The frequency bands were altered by placing a condenser across the last stage. The effective frequency band width f is obtained from the curves of Figs. 17 and 18, which represent the frequency characteristic of the amplifier and measuring instrument for three values of added capacity.

(I.)	$R=7,500 \omega$	(Value used in standard amplifier).	
	f	E_s (calculated).	E_s (measured).
	$3.96 \cdot 10^5$.486 volt.	.49 volt.
	2.7	.401	.396
	2.06	.35	.32
(II.)	$R=20,500 \omega$		
	f	E_s (calculated).	E_s (measured).
	$2.24 \cdot 10^5$	1.0 volt.	.77 volt.
	1.8	.898	.69
	1.46	.808	.6

Table I. shows a very fair correspondence between calculated and measured values of E_s .

In Table II. calculated values of E_s are approximately 30 per cent. high throughout. This may be due to the fact that the circuit capacity in this case was taken at the same figure as in the former, the value being estimated from the

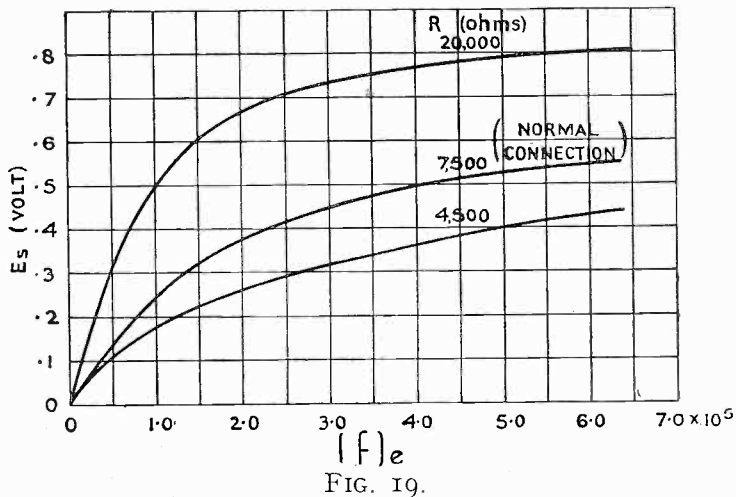

frequency characteristic of the standard amplifier. It may quite well be too low a figure for Case II. owing to the increased space occupied by the larger anode resistance.

Another source of error exists in the figures for frequency band width f . Since measurements of f are confined between 0 and 10^6 cycles and the theoretical value of

f between 0 and ∞ it follows that unless $\left(\frac{I}{I+a^2f^2} \cdot \frac{I}{I+b^2f^2}\right)$ has reached zero for practical purposes at 10^6 cycles the measured value of f will be too small by an amount equal to $\int_{10^6}^{\infty} \frac{I}{I+a^2f^2} \cdot \frac{I}{I+b^2f^2} df$. The error is negligible for values of $f < 2 \cdot 10^5$, but becomes increasingly greater when $f > 2 \cdot 10^5$, e.g., at $f = 6 \cdot 10^5$ the measured value is about 15 per cent. low and since $E_s \propto \sqrt{f}$ the calculated value of E_s will be about 7 per cent. low. Case I. will be affected by this error more than Case II.

Work by other investigators on effect of space charge in a valve in relation to shot effect indicates that considerable departure from theoretical values may be expected. In this investigation screen grid valves of M.S.4b type have been used in resistance capacity coupled circuits and the figures obtained refer to normal operating conditions for such valves. As a rough indication of the noise due to shot effect in an amplifier, the curves of Fig. 19 have been constructed from available data and show output in volts from a single stage having anode impedances (R) as shown after being amplified 3,000 times, the voltage being plotted against effective frequency band width. For the purpose of this curve the effective frequency band width $(f)_e$ is taken as that frequency at which the amplifier frequency characteristic shows a drop of 2 decibels below normal level.

Note.—Shot Effect in Photo Cell.

Noise due to shot effect in the photo cell at the output of the amplifier is of such a small order that it can be neglected. If $R=75,000\infty$ input signal $200 \mu V$. $M=50,000$ output signal 10 v. $I=3 \times 10^{-9}$ amp. $f=3 \cdot 10^5$ then noise due to shot effect in photo cell at output $=\bar{E}_s=.006$ volt.

(Noise due to shot effect and thermal effect in amplifier under these conditions $=.85$ volt.)

O. E. KEALL.

THE KERR CELL AND ITS APPLICATION TO TELEVISION

The following article deals with the general application of the Kerr effect to television reception, and, in particular, to a novel optical system as used by the Marconi Company in its latest type of Television Projector Receiver. Details of the Multiple Kerr Cell used by the Marconi Company are also given.

THE electrostatic effect on plane polarised light first observed by Kerr in 1886 has now become of widespread interest owing to its general adoption as a light valve for sound recording, picture telegraphy and television. Briefly, the effect is that when an electrical stress is applied to many liquid and solid dielectrics the substance becomes bi-refracting in the manner of a uniaxial crystal, the optic axis formed being the direction of the applied field. In the practical application of this effect a plane polarised beam of light is passed through the dielectric and then on to an analyser. In the unstrained condition the analyser is set to extinction. When the field is applied the plane polarised beam in general becomes elliptically polarised and the analyser transmits a certain amount of light. Considering the components of the elliptical vibration parallel and perpendicular to the plane of polarisation of the incident beam, then the intensity I of the transmitted beam is related to the phase difference δ between the components according to the well known formula

$$I = a^2 \sin^2 \frac{\delta}{2} \quad \dots \quad \dots \quad \dots \quad \dots \quad \dots \quad \dots \quad \dots \quad \dots \quad \dots \quad (1)$$

where a is the amplitude of the incident vibration. This only holds when the plane of polarisation is at 45 deg. to the direction of the applied electrostatic field which is the condition for maximum phase retardation for a given field strength. The relation between the field applied and the resulting phase difference is given empirically by the equation

$$\delta = KF^2l$$

or $\delta = K \frac{E^2l}{d^2} \quad \dots \quad \dots \quad \dots \quad \dots \quad \dots \quad \dots \quad \dots \quad \dots \quad \dots \quad (2)$

- where K is a constant depending on the dielectric,
- F is the applied field strength,
- l is the length of the dielectric subject to the field in the path of the light,
- E is the applied voltage, and
- d is the distance between the electrodes.

The final relation between the transmitted intensity and the voltage is given by the combination of (1) and (2)

$$I = a^2 \sin^2 K_T \frac{E^2l}{d^2} \quad \dots \quad \dots \quad \dots \quad \dots \quad \dots \quad \dots \quad \dots \quad \dots \quad \dots \quad (3)$$

where $K_T = K/2$.

The intensity is a maximum when

$$K_1 \frac{E^2 l}{d^2} = \frac{\pi}{2}, \frac{3\pi}{2}, \frac{5\pi}{2} \text{ \&c.}$$

and a minimum for

$$K_1 \frac{E^2 l}{d^2} = 0, \pi, 2\pi \text{ \&c.}$$

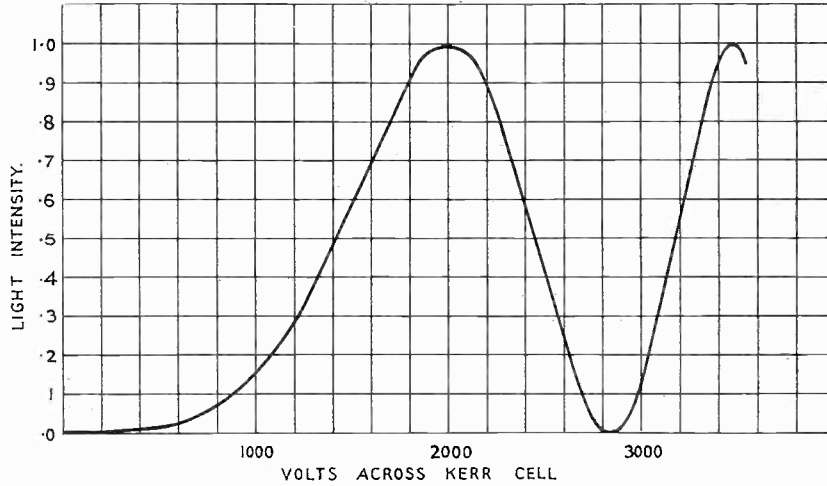

FIG. 1.

Knowing the value of E when the first maximum occurs, the curve represented by the equation (3) can be calculated. This is shown in Fig. 1, where the curve is drawn as far as the second maximum. It will be noticed that the succeeding maxima become sharper as the phase retardation increases. From the point of view of practical requirements the steeper the slope the greater the straight portion between minimum and maximum, and the more faithful the reproduction or the translation from electrical to light values. Unfortunately, the constant K varies considerably with the wavelength of the light and therefore the value of the applied voltage for maximum intensity varies with the wavelength. The difference between the "peak" voltages for, say, the blue and the red is noticeable even at the first maximum, and, of course, this difference increases with every succeeding maximum, making it impracticable at any rate for television.

Finally, the value of K is different for different substances, and since it is required that the "peak" voltage should be as low as possible, it is necessary that the constant K must be as large as possible. Nitrobenzene possesses a value of K which, so far as at present is known, is higher than that of any other substance. Consequently nitrobenzene is the dielectric generally used.

Construction of a Kerr Cell.

It was early decided by the Marconi Company that of the two types of electrode system possible, the simple or the multiple plate, the latter was the more suitable as it was more adaptable to experimental optical systems, though more difficult to construct. Since, according to equation (2), the phase retardation δ is proportional to the square of the applied voltage E , it is not affected by any change

of sign of the applied field. Hence it is possible to use an interleaved system of electrodes immersed in the dielectric, each alternate electrode being connected together. The first Kerr Cell made consisted of two sets of five plates interleaved, giving nine spaces. Nickel was the metal used as it proved to be extremely stable in nitrobenzine. Each electrode could only be supported at one end, necessitating relatively thick sheet metal to maintain rigidity. The dimensions of the electrodes were 10 mm. wide, 7 mm. in the direction of the light, and 1 mm. spacing. The two leads were taken and held rigid to two terminals, fitted in a glass plate which fitted to an all-glass rectangular cell. The sides of this cell and the top were, however, cemented together. This construction suffered from several defects. Firstly, the voltage was too high; secondly, the nitrobenzine was not pure; thirdly, the cell had to be left open to the air, and fourthly, the cement would not stand the heat. The source of light was a high intensity arc lamp, as the aim was to produce a large picture 6 feet square. The ordinary optical system was applied, the polariser and analyser being nicol prisms. The first prism suffered considerably from the heat, and therefore a pile of thin glass plates was substituted. The reflected component was used and therefore all the heat was deflected to the Kerr Cell. Despite the fact that the nitrobenzine was obtained specially redistilled, it continually broke down under relatively low voltages. It was necessary, therefore, to distil again, and this was done in the Research Laboratories of the Marconi Company. This decidedly improved matters, but many problems still remained to be solved, the chief being the container. The ideal was an all-glass sealed cell. The main points to remember were that the sides of the cell had to be plane faces, to prevent the dielectric acting as a lens and tending to destroy any image that would otherwise be formed, and to be free from strain. This second point was not noticed till later, when some very puzzling results were obtained. However, the completely glass cell was successfully accomplished after several attempts to maintain plane faces. The method at first was simply to use plates about twice the required diameter, when it was found that the centre portion remained sensibly plane. Later, when more practice was obtained, it was possible to use plates very little larger than the minimum. It so happened that the early cells showed very little signs of strain, and so passed unnoticed. Later this defect became worse, when it was observed and had to be immediately cured. This was done by annealing. The cell was heated to as high a temperature as possible, and then allowed to cool slowly, the process being repeated several times. The result in all but the very worst cases was excellent.

At the same time as this was being developed, a new optical system was designed as described in *THE MARCONI REVIEW*, May-June, 1933. This permitted the cell to remain at a relatively low temperature. In combination with this system the Kerr Cell was shown and demonstrated at the Television Society's Exhibition at the Imperial College of Science and Technology on April 5th and 6th, 1933. The same Kerr Cell had been used for some time previously, and altogether it was in use for well over 50 hours before having to be refilled.

New departures from the electrode construction and the optical system were very rapidly made shortly afterwards. Each set of electrodes were until then built up into one solid block supported only at one end. This, of course was very unsatisfactory, as the electrodes had to be very rigid and therefore relatively very thick. In the new design illustrated in Fig. 2 the electrodes were held together

with glass beads one on either side for the higher voltage cells and two on either side for the lower voltage or longer "light path" cells. Each alternate lead was welded together and the two final leads taken out through a pinch. The final result was a cell that was an all-glass sealed air-tight container filled with nitrobenzine, pure and freshly redistilled *in vacuo*. The life of these cells is practically indefinite. One cell has been used continuously for several hours at a time, and altogether for more than one hundred hours and no marked deterioration or discoloration has yet been observed.

Kerr Cell Optical Systems.

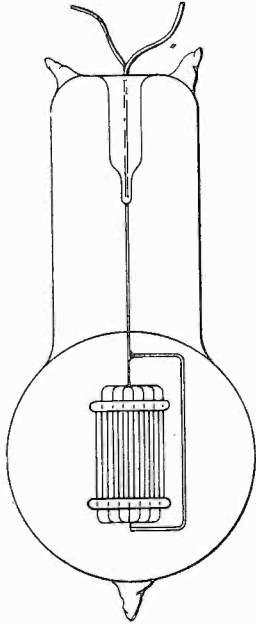

FIG. 2.

Several systems have from time to time been suggested and put into practice with varying degrees of success, but the fundamental basis of necessity remains the same. That is, plane polarised light must be produced and, after transmission through the Kerr Cell, the electrodes of which are set at 45 deg. to the plane of polarisation of the beam of light, must be analysed. The simple straightforward method is to produce plane-polarised light by means of a nicol prism, another being used as analyser. The two prisms are set to extinction. In order to understand the development of the final optical system adopted by the Marconi Company, it is necessary to comprehend fully the action of a nicol prism. This device consists of two crystals of Iceland Spar cemented together with Canada balsam. Iceland Spar is a bi-refracting crystal with one optic axis, which has the property of dividing a beam of light incident in any direction except parallel to the optic axis into two beams, each of these being polarised in planes at right angles to one another. The first crystal of a nicol prism is cut in a prismatic form and so shaped with respect to the optic axis that the two beams are deviated, but at different angles. The second crystal is the complement of the first, i.e., the two together form the natural crystal. Owing to the relation between the refractive indices of the two beams in the crystal and the Canada balsam, the beam deviated through the smaller angles continues straight through the second part, but the other is totally internally reflected at the interface and absorbed at the surface. The result is that only light polarised in one plane is transmitted by a nicol prism. Unfortunately the prism suffers from the defects (i) that only a small angle of cone of the incident beam, namely, 24 deg., is transmitted completely polarised in one plane; (ii) that owing to the necessary shape of the crystal to produce the desired effect, inclined faces are produced at the entrance and exit of the beam. The final consequences of using nicol prisms are therefore:—

- (1) The effect of the intense heat on the cement used in the prism.
- (2) Only a small angle of light can be used.
- (3) A considerable proportion of the light is lost by reflection at the inclined faces.
- (4) The complete loss of 50 per cent. of the light in the beam that is deflected and absorbed at the surface.
- (5) The high cost of prisms of a useful aperture due to the waste incurred in cutting the two parts.

The first variation on the above simple method consisted in using two piles of thin glass plates, one as the polariser and another as the analyser. The beam incident on the first is divided into two parts, one reflected and one transmitted. If the angle of incidence is correct, then the reflected beam is polarised in the plane of incidence and reflection, whilst the transmitted beam is polarised at right angles to that plane. The polarisation is only complete when the glass plates are extremely clean and free from dust and grease. To do this very great care must be taken. Approximately 50 thin glass plates were used and found to be sufficient. The reflected component was used, as relatively little light was lost in absorption. This beam was then interrupted by the second pack in a plane at right angles to the first. This arrangement should produce extinction, but owing to the incomplete polarisation at both surfaces, a certain definite minimum intensity of light is transmitted. Also the maximum intensity is reduced. There is therefore a loss in contrast, which seriously affects the detail of the received picture.

It was found that it was better to use a nicol prism as the analyser, as this ensured complete polarisation in at least one element.

The second variation is to use Thompson prisms, which have square-ended faces, but otherwise act similarly to the nicol prism. They accept a larger angle than the nicol, approximately 32 deg., but have a greater length for a given cross-section. However, they are much more expensive. Moreover, the remaining disadvantages still hold.

The chief drawback to the use of any polarising device such as the nicol or Thompson prism is the loss of 50 per cent. of the light due to the division of the incident beam of light into two components. These components are polarised in planes at right angles to one another. They can, therefore, be used together in conjunction with a Kerr Cell, as the only stipulation concerning the polarised beam, so far as affects the cell, is that the electrodes should be at 45 deg. to the plane of polarisation. The first problem to solve is how to analyse the emergent beam. With both beams available there are a few alternatives, such as extinguishing both beams separately or rotating the plane of polarisation of one beam through a right angle. Assuming this has been done, the second problem is to combine the two beams. If a mirror wheel or lens drum is used to produce scanning, an aperture or an image of one must first be formed. It is necessary, therefore, to cause the two images to overlap at the focus without adding to or increasing the angle of the cone of light.

The first method in which this was successfully accomplished was developed by the Marconi Company and described in the issue of *THE MARCONI REVIEW* for May-June, 1933. Briefly, a rectangular block of Iceland Spar cut with its optic axis at right angles to the path of the light was used to produce the two polarised beams. Owing to the method of cutting, the maximum amount of separation was obtained and found to be sufficient for a length of one inch in the path of the light. Actually a one inch cube was used close to the aperture so that there was no limitation of the angle of the cone of light received from the arc and no cemented surface to be affected by the heat. Moreover, this size of crystal costs considerably less than a nicol or Thompson prism of the same aperture. The two images formed were separately extinguished by Thompson prisms and then recombined on the screen by the use of two mirror wheels. The analysers, of course, again limited

the angle, but the recombination was complete, no loss of light being incurred except for the two mirrors required to deflect one beam to the second mirror wheel. The main disadvantage of this system was the necessary use of two mirror wheels, a minor one being the awkwardness of adjustment.

The final scheme evolved by the Marconi Company completely eliminated all the disadvantages, including expense, of the original simple system and introduced no further drawbacks whatsoever. The method is simple and compact and involves no more adjustment than previously. It consists in using Iceland Spar blocks as polariser and analyser. Fig. 3A illustrates the complete optical system.

The light from the arc is brought to a focus on an apertured plate, immediately after which is placed the first Iceland Spar crystal. A lens is then arranged to give parallel light through the Kerr Cell and a second lens brings this beam again to

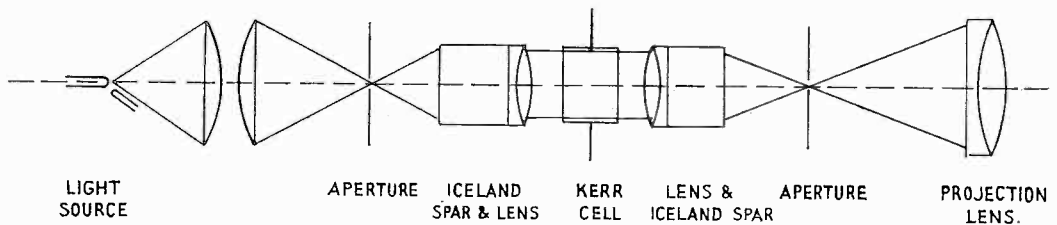

FIG. 3A.

a focus on to a second apertured plate. Between the second lens and aperture is placed another block of Iceland Spar. A projection lens then forms an image of the final aperture on the screen after reflection from the mirror wheel. The action is as follows: The two crystals are cut with their optic axes parallel to one another, in the same direction and at right angles to the direction of the beam. If the final aperture be removed, the complete image shown on the screen will, with no voltage on the Kerr Cell, consist of two spots A and B (Fig. 3B), each one being an image of the first aperture. The distance between these two images depends on the thickness of the crystals which are additive in their effects due to the exact correspondence of the optic axes of the two crystals. The light constituting these two images is plane polarised, the plane of polarisation of one beam being at right angles to the plane of polarisation of the other. As the voltage on the Kerr Cell is increased, these two images decrease in intensity and two new images A' and B' are formed. When the voltage is increased to the maximum, the intensity of the two new images is a maximum and the intensity of the two original images is a minimum. The position of the two images A' and B' will lie on the straight line joining the images A and B, but they may be anywhere between A and B. These four images, A, A', B', B, consist of two exactly similar pairs which may be either A, A' and B, B', or A, B' and A', B, according to the relative thicknesses of polariser and analyser.

The separation between the pairs is due to the first crystal and the separation between the members of each pair is due to the second crystal. Since the separation is a function of the thickness it at once becomes plain that by selecting suitable thicknesses of spar for polariser and analyser, the two images A' and B' can be made to overlap as accurately as is necessary. In actual practice the first aperture is made a small circular area large enough to surround the final required size of aperture, and the thicknesses selected such that A' and B' overlap almost exactly, and such

that A and B are separated sufficiently to allow the double image of A' plus B' to be clearly formed between them. The second aperture, a square, is then so positioned that it lies inside the circle A' plus B'. The final result on the screen is, therefore, a small square the intensity of which is a minimum when the nitrobenzene is unstrained and rises gradually to a maximum as the voltage is increased. At

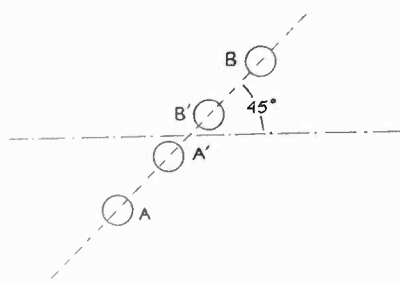

FIG. 3B.

maximum intensity the light passing through the small square aperture is formed of the components of *both* beams of plane-polarised light into which the light from the source is divided by the first Iceland Spar crystal. It was found that no very great heat was developed at the second surface of the first crystal in spite of the fact that a high intensity arc lamp was used. Under these conditions the use of simple crystals confers an additional advantage in that the surface is plane and can be cemented to its adjacent lens, which was made

into a plano-convex achromatic combination. This was done for both crystals and consequently four glass-air surfaces were immediately eliminated. This assisted considerably in reducing back reflections, which not only allowed ghost images of A and B to be partially transmitted by the final aperture, but also tended to destroy the polarisation of the light.

In the final arrangement set up by the Marconi Company the dimensions of the crystals were for polariser a one inch cube, and for the analyser a rectangular block of one inch square section and eleven-sixteenths of an inch thick. The complete system is in this way made extremely simple and compact, and utilises all the available light from the source. All the disadvantages enumerated above for the simple system are practically completely eliminated. Any angle of light obtainable from the arc is amply accepted, there are no cemented surfaces to be affected if the heat is too great for the cement, no inclined faces and much less loss of light due to absorption in the crystals. The cost is considerably less than nicol prisms of the same aperture and all the light is used. With a high intensity arc lamp, carrying 85 amps., and a 50-line mirror wheel, a brilliantly illuminated picture 6 feet square was obtained.

Operation of the Kerr Cell.

An examination of the curve illustrated in Fig. 1 relating the transmitted intensity to the applied voltage shows a very unsatisfactory state of affairs. The curve is almost flat for the first five hundred volts and then rises very slowly before the approximately straight portion is reached at about nine hundred volts, the maximum being 2,000 volts. For linear response or true reproduction of the signals into light values it is necessary to use only the straight part of the curve. If the relation is not linear then tone distortion is caused, in this particular case at the lower end of the curve. However, if only the linear portion is used, then at the minimum voltage the transmitted intensity is a relatively high percentage of the maximum intensity, and the ratio of the maximum to the minimum intensity becomes reduced. This ratio, named the "Contrast Ratio," is a measure of the contrast between the bright and dark parts of the picture and if it be reduced then the value of the picture is considerably lowered. A compromise must therefore be struck

between the tone distortion and the contrast. In actual practice it is the contrast that suffers most, since it is absolutely essential that for a good picture a true variation of light and shade is necessary. However, it is possible for a small increase in voltage greatly to increase the contrast ratio and at the same time to preserve or even to improve the linearity of the curve. Considering equation (1) we have :

$$I = a^2 \sin^2 \frac{\delta}{2}$$

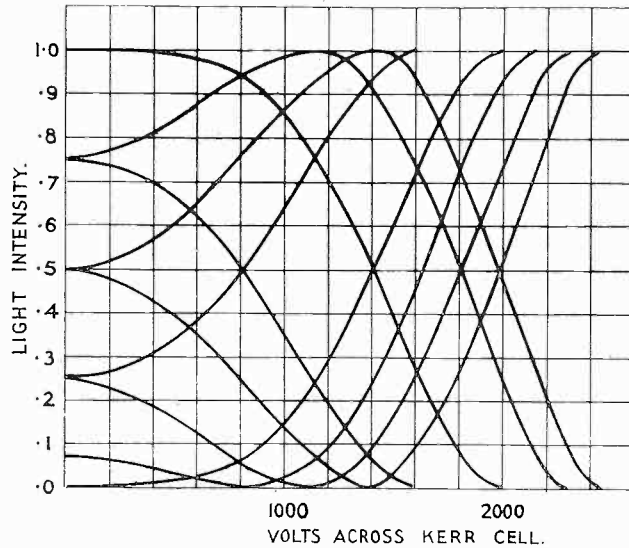

FIG. 4.

Suppose now that an arbitrary phase shift Δ be introduced between the components of the incident plane polarised beam of light parallel and perpendicular to the direction of the applied field. Then equation (1) becomes modified thus :

$$I = a^2 \sin^2 \left(\Delta + \frac{\delta}{2} \right) \quad \dots \quad (4)$$

and equation (3) becomes :

$$I = a^2 \sin^2 \left[\Delta + K_1 \frac{E^2 l}{d^2} \right] \quad \dots \quad (5)$$

It has already been mentioned that the intensity reaches the first maximum when

$$K_1 \frac{E^2 l}{d^2} = \frac{\pi}{2}$$

If E_m is the value of E when this occurs, then

$$K_1 = \frac{\pi}{2} \frac{d^2}{E_m^2 l}$$

Substituting in equation (3) we have

$$I = a^2 \sin^2 \left[\frac{\pi}{2} \frac{d^2}{E_m^2 l} \frac{E^2 l}{d^2} \right]$$

$$\text{or } I = a^2 \sin^2 \left[\frac{\pi}{2} \left(\frac{E}{E_m} \right)^2 \right]$$

and from equation (5) we get

$$I = a^2 \sin^2 \left[\Delta + \frac{\pi}{2} \left(\frac{E}{E_m} \right)^2 \right] \dots \dots \dots \dots \dots \dots (6)$$

A series of curves can be drawn from this equation with various values of Δ . These are shown in Fig. 4 for

$$\Delta = 0, \frac{\pi}{6}, \frac{\pi}{4}, \frac{\pi}{3}, \frac{\pi}{2}, \frac{2\pi}{3}, \frac{3\pi}{4}, \frac{5\pi}{6}, \pi.$$

$\Delta = 0$ and π correspond to the original curve for equation (1). In addition the curve A for $\Delta = 165$ deg. has been drawn as this represents the ultimate solution. An inspection of these curves shows how the initial slope of the primary curve $\Delta = 0$, changes with the variation in Δ . For $0 < \Delta < \frac{\pi}{2}$ the commencing

slope is upwards or positive, and for $\frac{\pi}{2} < \Delta < \pi$ the commencing slope is downwards or negative. For $\frac{\pi}{2} \Delta = 165$ deg. the initial intensity is .067, assuming $a = 1$, and

this falls to zero when $E = 800$ volts approximately. The maximum is reached when $E = 2,160$ volts, and between these two points the curve is as linear as the primary curve between 700 volts and 2,000. The contrast ratio, however, is increased enormously with considerable benefit to the received picture. The colour distortion is very little worse than the original as the peak voltage is only increased by 8 per cent. Various methods can be employed to obtain an arbitrary phase shift, such as a mica plate or any bi-refracting substance. A phase shift of 165 deg. is too high to produce without introducing colour distortion of its own, since the shift depends on the wavelength of the light. However, if the phase retardation due to the mica plate is arranged to act in the opposite direction to the retardation produced by the applied field then Δ can be made equal to 15 deg., for from equation (4)

$$I = a^2 \sin^2 \left(\Delta + \frac{\delta}{2} \right)$$

$$\text{we get } I = a^2 \sin^2 \left(\pi - \frac{\delta}{2} - \Delta + \frac{\delta}{2} \right)$$

$$\text{or } I = a^2 \sin^2 \left(\frac{\delta}{2} - \frac{\delta}{2} - \Delta \right)$$

In this way the increased colour distortion is negligible and for a slight increase in voltage a very much better picture is produced.

N. LEVIN.

THE MARCONI STABILOVOLT CURRENT SUPPLY SYSTEM

Where stable voltages are required in electric supply circuits, it has formerly been necessary to employ either storage batteries or dry cells. Circuit arrangements designed to eliminate batteries, such as rectified A.C. power supply, etc., all suffered from certain disadvantages such as dependence of output voltage on load variation of output voltage due to supply variation, high internal resistance, etc. In the glow gap divider, a device has been constructed whereby battery eliminators or any kind of current supply can be made to deliver a constant voltage. The glow gap divider is inserted between the power supply and the load circuit in much the same way as when employing a floating battery. Power supplies when stabilised by such a divider deliver voltages which vary only 1 or 2 per cent. at any condition of load between full and no load, and fluctuate only by ± 0.1 per cent. on supply voltage variations of ± 10 per cent., the voltage divisions being dependent on one another only to the order of 0.01 to 0.02 per cent. The voltage difference measured under hot and cold operating conditions is negligible. During the first half hour of operation the voltage drops only by about 1 per cent., after which period it remains absolutely unchanged. The percentage of harmonics in the super-imposed A.C. voltage for this type of current supply is also reduced to a negligible value.

By means of this device, therefore, an efficient substitute for batteries has been designed, the stabilised power supply being superior to the battery supply in that the voltage drop which occurs on discharge of batteries is completely eliminated.

The glow gap divider, as has been proved by practice, is an absolutely reliable and safe precision device with a surprisingly long life.

The following describes in detail the operation of the device and its application to correct power supply in any particular case.

Constructional Details of the Glow Gap Divider.

IN the glow gap divider the glow discharge properties of electric currents in gases are utilised. The voltage drop in such a discharge gap being practically independent of the current passing.*

In the glow gap dividers to be described below, several of these discharge gaps are connected in series. The discharge current flows from the electrode $+B_3$, Fig. 1, to electrode $-C$, passing electrodes $+B_2$ and $+B_1$ and O . The current when passing is subjected to an anode drop in $+B_3$, in each inter electrode a cathode drop when entering and an anode drop when leaving, and a cathode drop when entering the most negative electrode $-C$. By choosing a suitable gas-filling consisting of neon gas with certain additions, of a pressure of the order of a few cm., and by employing suitable metallic alloys and dimensions for the electrodes, it is found that with potentials applied to the electrodes the maximum admissible load of the tube is

* F. Schröter proposed some time ago to use glow gap dividers for stabilisation of voltage (U.S.A. Patent No. 1499078 by Messrs. N. V. Stabilovolt and Messrs. Julius Pintsch A.G.). With the actual application, however, the use of one glow discharge gap is limited, due to the fact that nowadays most apparatus requires several constant potentials, at the minimum 2, one for plate voltage and one for grid bias. *cf.* also Chapter 2. The employment of more than one glow gap enclosed in a common gas-filled container or in separate containers for stabilising potentials is protected by British Patents Nos. 313075 and 337793, owned by Messrs. N. V. Stabilovolt. *cf.* also British Patents Nos. 343511 and 347094.

practically independent of the current intensity passing. The characteristics of such a glow gap divider are shown in Fig. 4. Figs. 2 and 3 showing different designs of glow gap dividers. A table of the various Marconi-Stabilovolt glow gap dividers is given in Table A.

Type	Voltage		+B ₃ +B ₂		+B ₂ +B ₁		+B ₁ O		O —C		maximum diameter mm	lengths incl. sockets without pins mm	weights abt. grams
	between +B ₃ —C	with a current of mA	max. current	vol- tage abt.	max. current	vol- tage abt.	max. current	vol- tage abt.	max. current	vol- tage abt.			
			mA	V	mA	V	mA	V	mA	V			
STV 280/40	285 V ± 5%	30	40	70	60	70	80	70	80	70	45	130	135
STV 280/80	285 V ± 5%	40	80	70	80	70	90	70	100	70	65	135	210
STV 280/80A	280 V ± 1.5%	40	80	70	80	70	90	70	100	70	65	135	210
STV 600/200	580 V ± 5%	200	200	145	200	145	200	145	200	145	85	360	980

TABLE A.

Fig. 2 shows a section through the Type STV 280/40 glow gap divider. The electrodes are cap-shaped and are mounted on an insulating base, the outermost electrode being the most negative. The 5 electrodes are connected to the pins of a normal valve base. Fig. 3 is a view of the divider.

Glow gap divider tubes for normal applications are built to give constant potentials within ± 5 per cent. Tubes with 1.5 per cent. precision can, however, be supplied for special purposes. These figures do not refer, however, to voltage fluctuations, but merely to deviations of one tube from another. The voltage tolerance refers to the total voltage in all of the 4 gaps.

When only part of the voltage divisions are used one or more of the gaps can be short circuited without difficulty (e.g., the second glow gap divider in Fig. 12). In such a case, from the circuit point of view, the particular glow gap divider thus short circuited is identical to a glow gap divider having less gaps. It is preferable to short circuit first the most positive gap, beginning at +B₃, the surface of which being the smallest has the lowest load capacity. One may also connect in series two or more glow gap dividers in order to divide or stabilise higher voltages. Connection of glow gap dividers in parallel is, however, impossible. If it is desired to feed from one current supply several circuits connected in parallel, each glow gap divider should have its own series resistance.

It must be emphasised here that the troubles arising from the use of gas-filled rectifiers cannot occur with glow gap dividers ; in the glow gap divider all glow

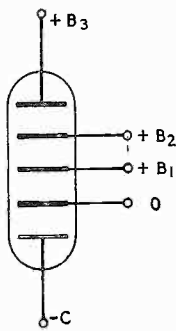

FIG. 1.

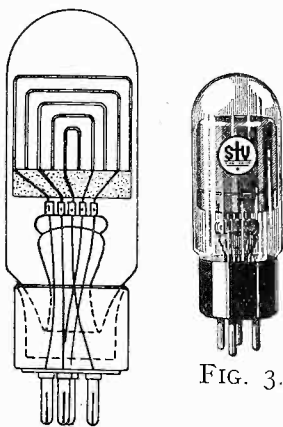

FIG. 2.

FIG. 3.

gaps are under one D.C. load, whilst in rectifiers a permanent striking and quenching takes place $2f$ times a second where f is the frequency of the alternating current. During the period of striking, the gas-filled rectifier operates for a very short time with a falling characteristic, and this, if connected to a circuit capable of oscillation, causes the well-known disturbing phenomena. The glow gap divider, however, strikes only once, i.e., when connected in circuit, and therefore cannot give rise to any oscillations.

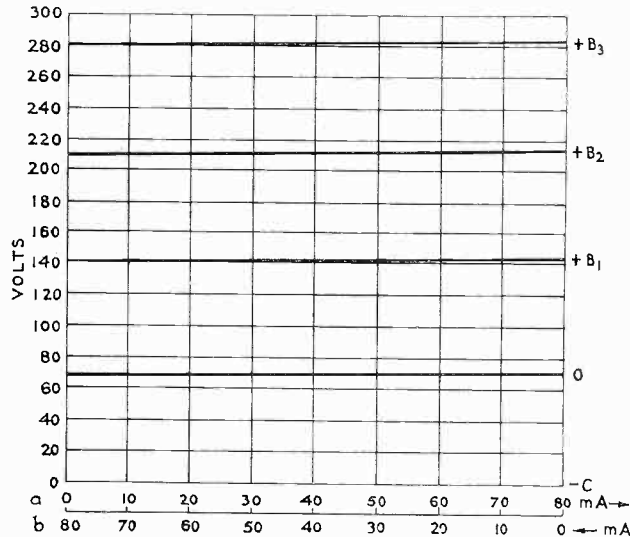

FIG. 4.

Circuit Connections of the Glow Gap Divider.

Fig. 5 shows the principal connections of a stabilised power supply. U_G is the source of supply, r is the load, so that the glow gap divider like a floating battery is inserted between the current supply and the load. When no useful load is connected to a unit equipped with a glow gap divider, this latter takes up the total current; when taking current from single gaps the amount of current passing the corresponding gaps is reduced automatically. The current in the supply mains, "the generator current," remains constant independent of whether or not the individual part voltages are loaded. In order to suppress super-imposed A.C. voltages, smoothing means LC consisting of chokes and condensers can be used. No general formula can be given for the value of LC, it being dependent on the intensity of the super-imposed A.C. voltages and on the ripple percentage required in the output voltage. It may, however, be mentioned here that the glow gap divider itself helps as a filter, this resulting from the fact that the voltage at any terminal of the glow gap divider is independent of the current flowing. R is the Ohmic resistance of the chokes including the value of the series resistance which may eventually have to be inserted. When the source of current itself possesses an internal resistance (as is the case with battery eliminators using high vacuum rectifiers), this internal resistance R should be included in the value of R . The glow gap divider has a very low internal resistance (of the same order as a storage battery), and consequently, when connected to a current supply without a series resistance in

circuit, it would take a very high current which might cause its breakdown. The value of resistance R can be derived from the formula

$$R = \frac{U_G - (U_1 + U_2 + \dots)}{I} \dots \dots \dots (1)$$

I being the value of the total feed current taken from the power supply, U_1, U_2 , etc., being the constant voltages of the glow gaps. The effect of these is to insert a back voltage to the supply voltage U_G in the same way as the back voltage occurring when changing batteries. The voltage drop in R should not be lower than half the value of the glow gap divider voltage; it can, however, be greater than this

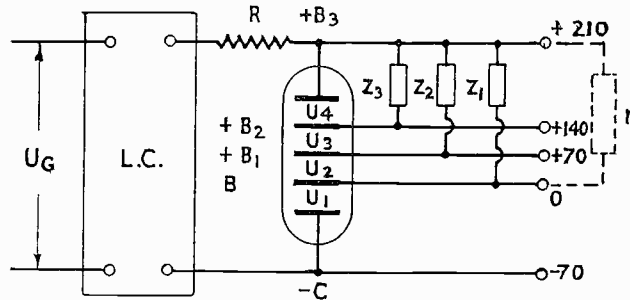

FIG. 5.

value. I should, of course, always be larger than the algebraic total of all the currents flowing into the load, i.e., a mean potentiometer current has always to pass through the glow gap divider (10 to 15 milliamperes mean). It is useful always to provide for a certain current reserve, the value of which depends on the particular application. For preliminary trial it may be said that the current taken by the glow gap divider plus the current reserve should amount to between 25 and 30 per cent. of the total current I . The lower limit of 15 milliamperes should, however, not be exceeded.

In the case where low frequency pulsating direct current is supplied from the glow gap divider, the peak value and not the average value of the current should be taken into account. The glow gap divider does not accumulate current, so that it always takes more current than it delivers. This is opposite to the case of high frequency modulation, where the A.C. component is led away through the parallel condensers.

Example: A Type STV 280/40 glow gap divider should be used with all its four gaps. The total current I is 40 milliamperes. What are the values of the supply voltage U_G and what is the value of the series resistance R ?

The back voltage of this glow gap divider is 285 volts, with a tolerance of ± 5 per cent. Consequently

$$U_1 + U_2 + U_3 + U_4 = 285 \text{ volts.}$$

As R should cause a drop of at least $\frac{285}{2}$ volts = 142.5 volts, $U_G = 285 + 142.5$ volts = 427.5 volts. We therefore choose U_G to be 500 volts. In this case, according to formula (1), R should be approximately $\frac{500 - 285}{0.04}$ or 5,400 Ohms.

The A.C. Resistance of the Glow Gap Divider.

The gaps of the glow gap divider have no resistance in the usual sense of the word, because quotient of constant voltage and variable current has a different value for each current intensity. However, the gaps have a characteristic resistance value, the so called "A.C. Resistance." When the direct current flowing in a gap is super-imposed on an alternating current, an A.C. voltage drop is caused by the

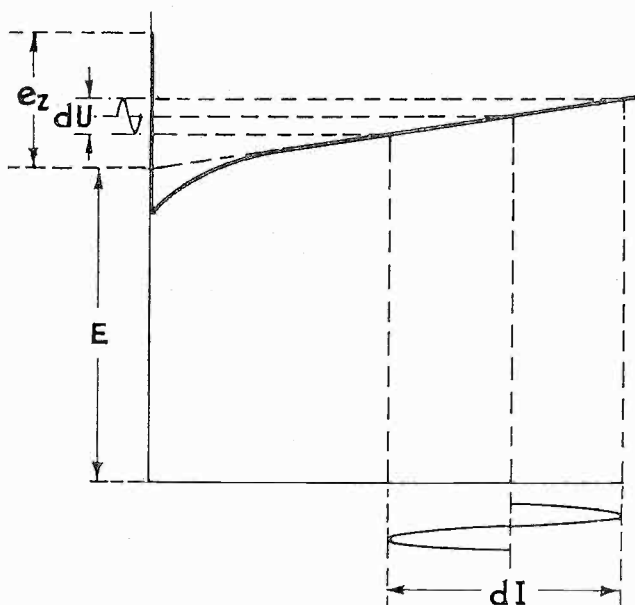
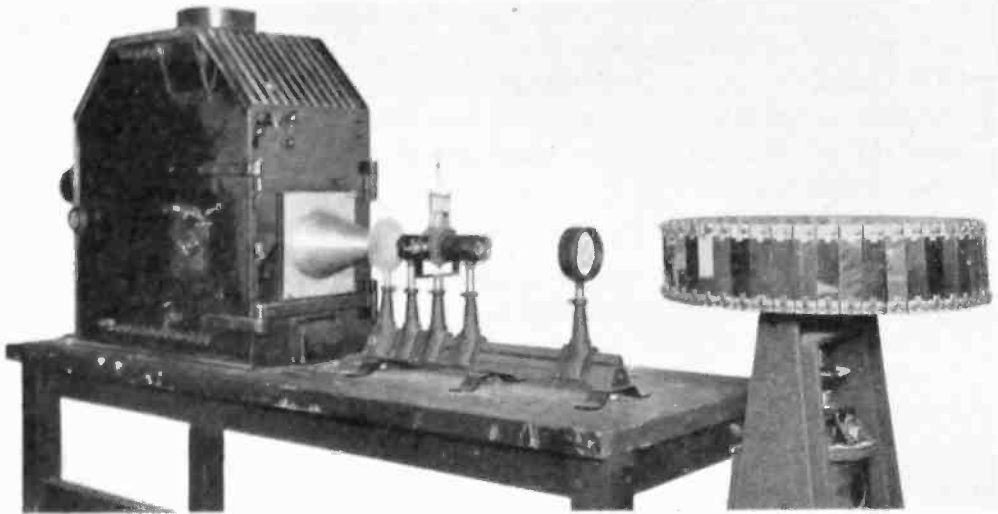

FIG. 6.

A.C. resistance of the gap (*v.* Fig. 6) $w = \frac{dU}{dI}$. In the glow gap divider the value of w is very low, about 10 to 50 Ohms according to the type. In the examples given in this paper an average value of $w=20$ Ohms has been chosen. This very low value, however, only exists for low super-imposed frequencies. It rises to about double this value for frequencies of the order of 2,500 cycles, and for higher frequencies the A.C. resistance can easily be kept to a low value by inserting in parallel condensers of relatively small capacity. For instance, a condenser of approximately $2 \mu\text{F}$ capacity at 2000 cycles has a reactance of only 40 Ohms if connected in parallel with a part gap; the combined A.C. resistance of the gap, therefore, will again be reduced to approximately 20 Ohms. When using a small condenser, the resultant impedance of the discharge gap and condenser is kept below a certain low value for all frequencies from zero to infinity. The advantage of the glow gap divider lies in the fact that its low resistance occurs with low frequencies, even of the order of 1 cycle and less. For low A.C. resistances with condensers, the low frequencies can only be established at high expense. $159 \mu\text{F}$ would be necessary at 50 cycles and $8,000 \mu\text{F}$ at 1 cycle in order to establish a resistance of 20 Ohms.

(To be continued.)

NEW MARCONI TELEVISION EQUIPMENT



(Above): Optical system of the Marconi television receiver described in pages 13-21. The components are (left to right): arc lamp; aperture; polariser; Kerr cell (a detailed photograph of which is shown on the left); an analyser; projection lens; and mirror wheel.



(Left): Marconi multiple-plated sealed Kerr cell used in the television optical assembly shown above.

MARCONI NEWS AND NOTES

AMERICA GREETES MARCHESE MARCONI

THE United States Navy joined in the celebration of "Marconi Day" in America on October 3rd, when Mr. Claude A. Swanson, Secretary of the Navy, sent the following message to Marchese Marconi at Chicago's "Century of Progress" Exhibition:—

"On behalf of the United States Navy I congratulate you on this occasion commemorating your great achievement in giving radio to the world. The Navy was quick to visualise the tremendous influence of radio communication that was bound to follow your invention, and in the very beginning set about to put it to practical use.

"Radio communication has added greatly to the happiness and safety of those that travel by air and go down to the sea in ships.

"Our debt to you is heavy and it gives me pleasure publicly to acknowledge it.

"I hope Marchesa Marconi and yourself enjoy your visit to our country. May you have many years of happiness and continuance in your valuable service to mankind."

One of the principal features of "Marconi Day" was an experiment in which moonlight from Italy was caused to light up the Chicago Exhibition. A luminous impulse from the moon was picked up at the Observatory of Arcetri, in Tuscany, the last residence of Galileo, converted by a very sensitive photo-electric cell into an electrical impulse, relayed from Italy to Chicago, and there used to operate an apparatus which lit the electric lamps of the Exhibition.

Marconi Television at British Association.

TELEVISION demonstrations by research engineers of the Marconi Company were a feature of this year's British Association Meeting at Leicester from September 6th to September 13th.

Demonstrations were given of the projection of television images on a screen five feet square, an indication of the future possibilities of the Marconi system of television for public entertainment.

For the first time, an exhibition was given of television by means of a directed light beam, which was used as the link between the television transmitter and receiver instead of the normal radio or wire link.

The " Marconi light beam link " apparatus, which had previously been demonstrated as a medium for telephony, consists of a transmitter in which the electrical impulses corresponding to the television picture signals are converted into light impulses through the operation of a specially designed sodium tube mounted in a searchlight fitting, and a new type of photo-cell receiver. The latter reconverts the modulated light impulses into terms of electric current and thus operates the television receiver in the normal way.

Marconi Stations for Norway.

IN connection with the reorganisation of the Norwegian broadcasting system, a second Marconi broadcasting transmitter has been ordered by the Norwegian Government for erection at Bergen.

The new station will have a power of 20 kilowatts in the aerial, similar to that previously ordered for installation at Trondhjem.

Both stations are being designed and built at the Marconi Works, Chelmsford, and will incorporate the most modern developments in broadcasting technique.

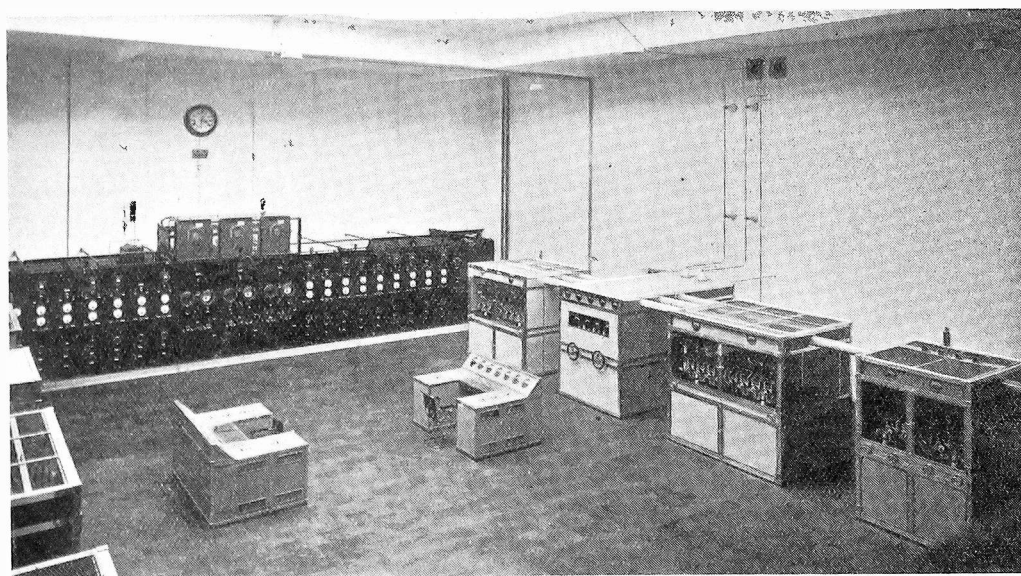

An interesting general view of the transmitter hall at the West Regional Station of the British Broadcasting Corporation, containing two of the high-power transmitters (Type P.B.) constructed by the Marconi Company.

Navigation by Wireless.

FOLLOWING the example of many of the principal maritime nations of the world, the coastal authorities in countries as distant as Uruguay, Roumania, and China are among the most recent to adopt the Marconi automatic wireless beacon as an aid to navigation for ships approaching and leaving their shores.

Automatic wireless beacons, transmitting omni-directional signals which enable ships fitted with wireless direction finders to take bearings as and when required, have now become firmly established in the confidence of navigators on account of the convenience and simplicity of utilising their services. Their value is typified by the following report received from the wireless operator of a British ship shortly after the completion of the last Marconi beacon for the Chinese authorities :—

“ The chain of wireless beacons at the entrance to the Shanghai River is now complete. During the past three months a beacon has been established on the Island of Ta-chi-Shan, otherwise known as Gutzlaff. Since July 20th, another beacon has been established at the lighthouse on the island of Shaweishan, now making three beacons to the Shanghai River approach. On approaching Shanghai River from Japan I took full advantage of this co-ordinated service.

“ The signals from the beacons are very steady and clear, and as the beacons follow each other immediately there is no waiting between the bearings. The co-ordination was perfect, and it is the finest beacon service on the Eastern route.”

A Tribute to Success.

The third beacon station referred to in the report was installed by the Marconi Company in 1930 at North Saddle Island, near Shanghai, and it was in consequence of the successful operation of this station that the Chinese authorities arranged to equip the two other important navigational points near the mouth of the Shanghai River with similar apparatus of the latest type.

The Marconi beacon transmitters are characterised by extreme simplicity in operation and ability to run for long periods without attention by skilled personnel. The entire apparatus is controlled by a master clock which switches on the transmitting apparatus at predetermined times, when the transmitter sends out a characteristic signal incorporating the call sign allotted to the beacon, after which the plant shuts down until the next call is again automatically transmitted. Provision is made so that the calls can be transmitted at comparatively long intervals during fine weather or continuously when foggy weather or unfavourable conditions of visibility prevail in the vicinity of the beacon.

Wireless for Private Aircraft.

MR. W. LINDSAY EVERARD, the Member of Parliament who has his own private aerodrome at Ratcliffe in his constituency of Melton, Leicester, is having his Dragon Moth aeroplane fitted with Marconi transmitting and receiving equipment.

This will enable him to maintain communication with the ground during his frequent flights in this country, or while flying practically anywhere over the Continent.

The apparatus is of a powerful and up-to-date type, being a specially modified model of the type of Marconi air equipment fitted in civil, military, and naval aircraft operating in all parts of the world. The transmitter has a rated energy of 150 watts and the three-valve receiver is specially designed for stable and selective operation during flight. Both are contained in a single instrument box of small dimensions and light weight.

MARCONI EQUIPMENT FOR POLICE.

A Marconi receiver, specially developed for police wireless services, installed in a motor-cycle side-car.

