

INDUSTRIAL ELECTRONICS

JULY 1964 5s 0d

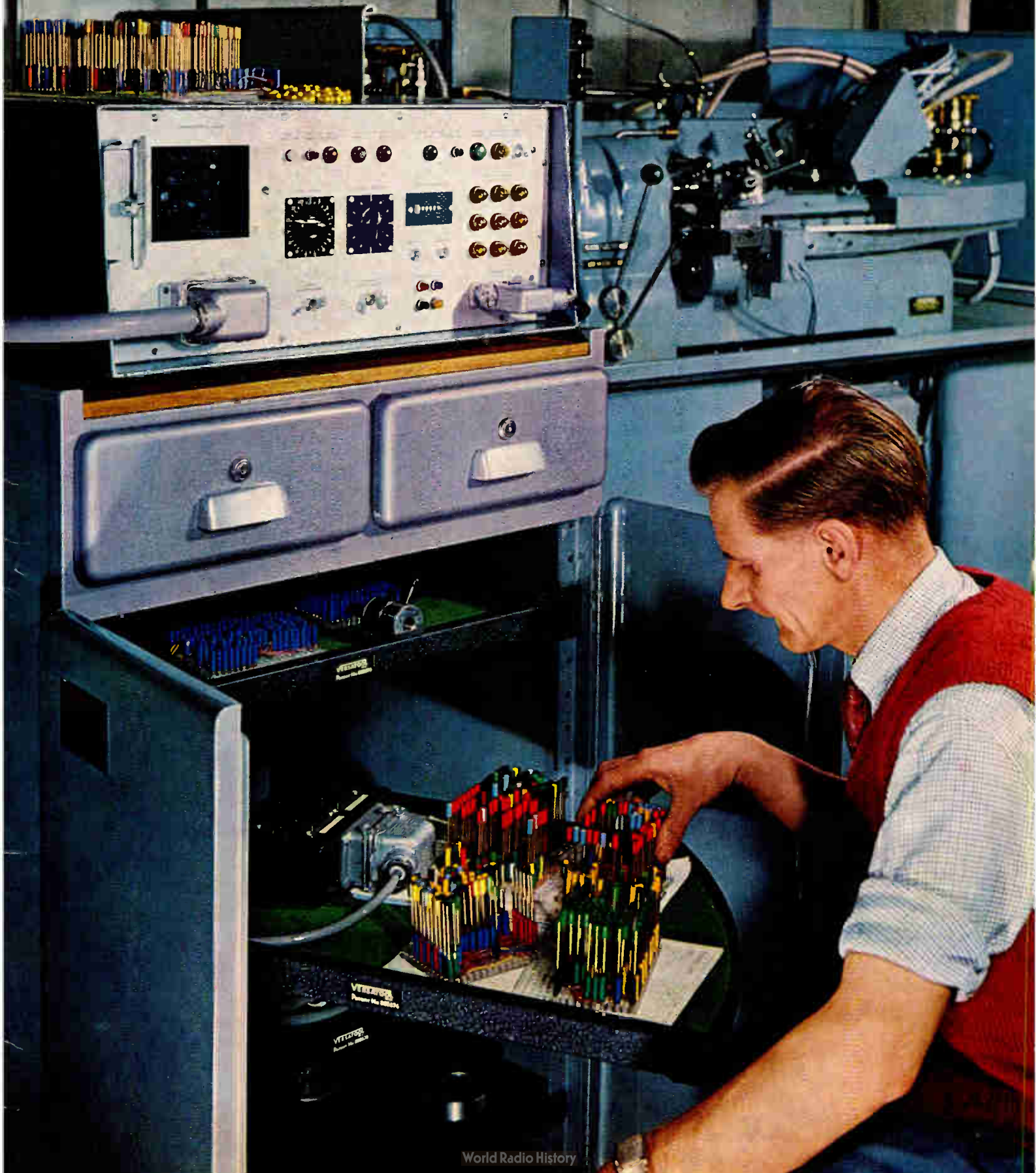

BICC

in Television

BICC manufacture every type of cable and associated product that is necessary for the transmission and reception of the visual image—including camera cables and polypole couplers, coaxial distribution cables, power cables, equipment wires and downloads. Transmitting aerial towers are supplied and erected by the British Insulated Callender's Construction Company Limited.

BICC products contribute to the development and expansion of the television industry.

British Insulated Callender's Cables Limited
21 Bloomsbury Street London WC1

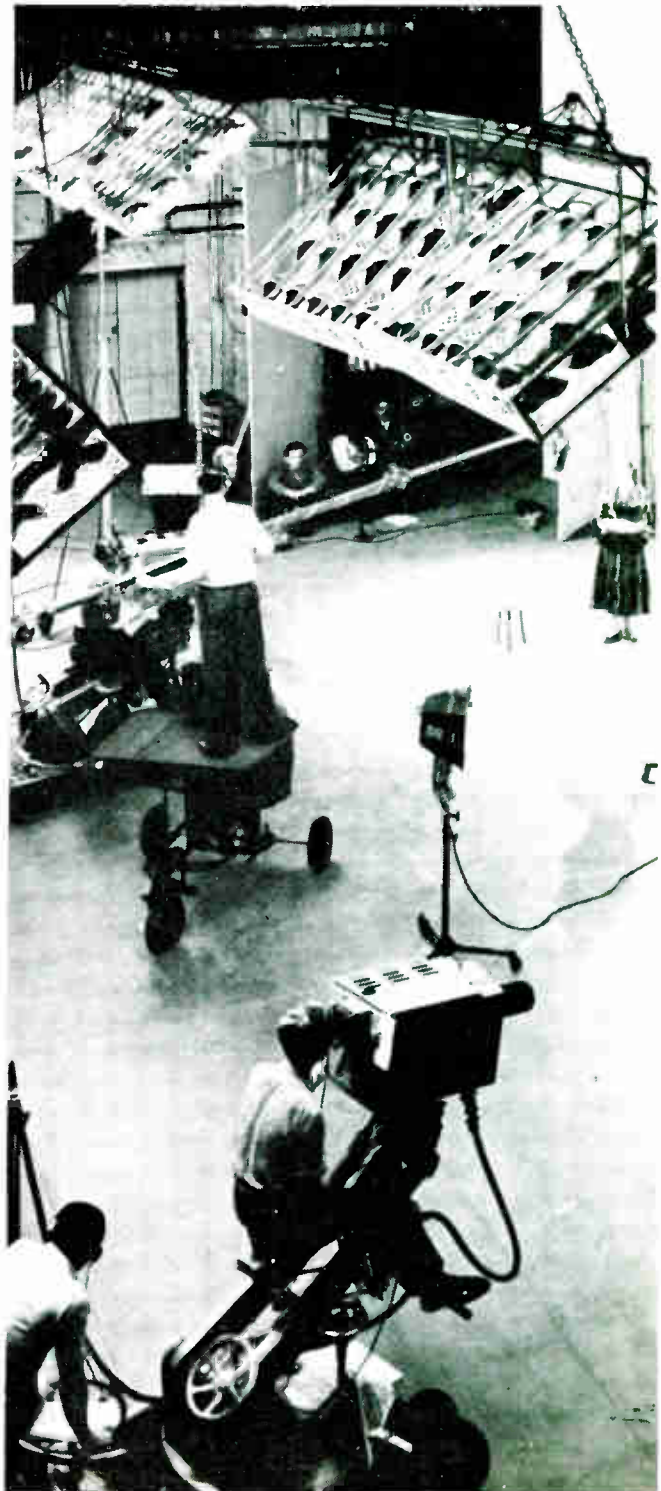
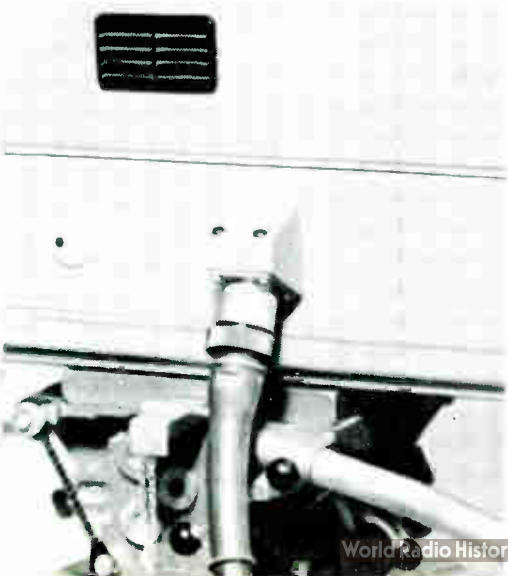
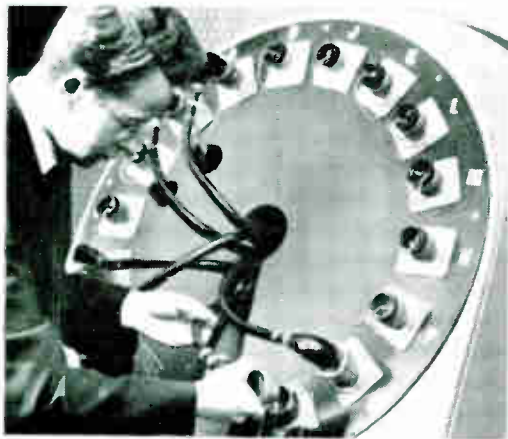
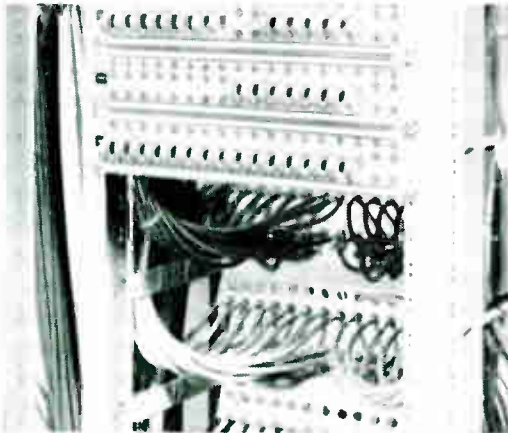
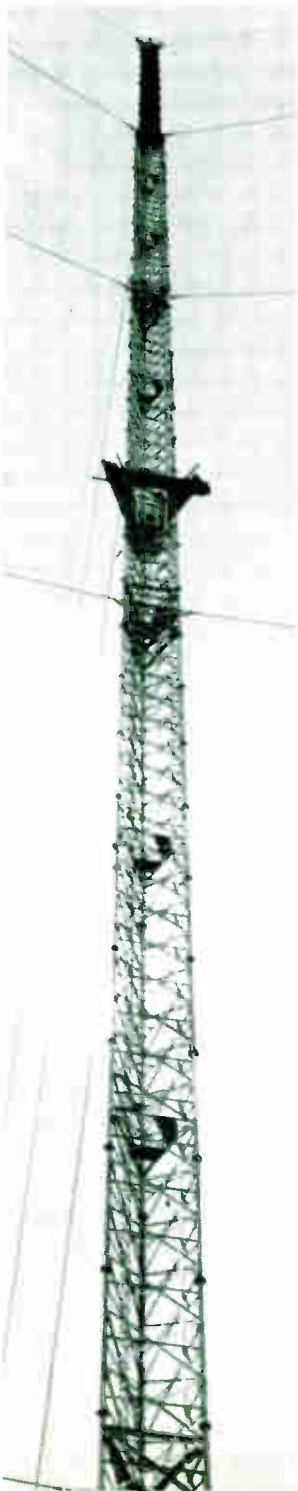

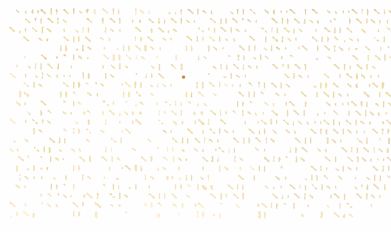

INDUSTRIAL ELECTRONICS

incorporating *ELECTRONIC TECHNOLOGY*

Volume 2 Number 7 July 1964



contents

Editor **W. T. COCKING, M.I.E.E.** 307

Assistant Editor **T. J. BURTON**

Advertisement Manager **G. H. GALLOWAY**

Comment

309 **Elliott Sequence Control System** by *G. S. Smith*

When a number of operations has to be performed in sequence and the cycle of operations repeated indefinitely, it is usually possible to arrange for this to be done automatically. It is not always economical to do this in conventional ways unless a very long production run is expected. This article describes equipment which enables the 'programme' to be varied very simply and the amount of control to be expanded or contracted as required. It is suited especially for short production runs.

313 **Inertial Navigation** by *A. R. M. Murray, B.Sc.*

The basic principles of inertial navigation are simply explained in this article. The system enables position to be found without any external aids.

316 **Data-Handling Equipment for a High-Speed Wind Tunnel**

by *F. Shaw*

In wind-tunnel experiments it is required to transfer the outputs of chart recorders to punched paper tape for subsequent feeding to a computer. This article describes the digital equipment employed for this purpose.

323 **Operability** by *R. C. Winton, B.Sc.(Eng.)*

The proper functioning of electronic apparatus depends not only upon the reliability of the equipment itself but on the operator not making mistakes. This article discusses some of the ways in which apparatus can be improved to minimize the chance of the operator making a mistake.

334 **Protecting Aircraft Distribution Systems** by *K. F. Bacon*

Bus-bar protection is now highly important in aircraft, but conventional methods are expensive and heavy with the three-phase supplies now widely used. This article describes a simple system which depends on the detection of the positive, negative and zero sequence components of voltage which appear when the supply is unbalanced.

continued overleaf

Published on the first Thursday after the 5th of each month by
ILIFFE ELECTRICAL PUBLICATIONS LTD.
Managing Director: W. E. Miller, M.A., M.I.E.R.E.
Dorset House, Stamford Street, London, S.E.1.
Telephone: Waterloo 3333.
Telegrams: Wirenger, London, Telex
Cables: Wirenger, London, S.E.1.

ANNUAL SUBSCRIPTION, HOME £3 0s. 0d.
OVERSEAS £3 10s. 0d.
CANADA and U.S.A. \$10.00.

continued

- 339 **The Electronic Counter** *by O. H. Davie*
Applications of electronic counters are not confined to the counting of objects, such as articles on a conveyor belt. They now include many measurements which can be carried out on a counting basis. As a result counters are now a commonplace in laboratories as well as factories. This article describes the principles of electronic counters and some of the applications.
- 345 **Improved Method of Measuring Aerial Gain**
by B. Collins, B.Sc.(Eng.) and B. Sykes
Due to ground and other reflections the test site has a considerable influence upon aerial measurements. This article describes a procedure by means of which it is possible largely to overcome this effect.

FEATURES

- 315 **Automatic Cake-Baking Plant**
- 320 **Direct Ultrasonic Thickness Measurement**
- 321 **Log Recorder Improves Trawler Efficiency**
- 322 **Versatile Laser Equipment**
- 325 **New Tank Gauging Development**
- 326 **Equipment Review**
- 338 **8th Automation and Instrumentation Exhibition and Conference**
- 343 **Abbey National Install a Computer**
- 344 **Versatile Line Milling Control System**
- 348 **Data Loggers for Ship Research**
- 348 **Electronics Cleans Dental Drills Faster**
- 348 **The Laser-Ophthalmoscope**
- 349 **Error Detection Equipment for Telex**
- 350 **Industrial News**
- 353 **New Books**
- 354 **Manufacturers' Literature**
- 41 *Classified Advertisements*
- 42 *Index to Advertisers*

Next Month

An article dealing with the use of telemetry in industry will appear in next month's issue. Other articles will include one describing the application of digital counters to length measurement.



OUR COVER

This month the cover picture shows the Elliott Sequence Control System fitted to a Hardinge lathe. The combination is being used for demonstration and to produce piece parts for the Mechanical Engineering Division of Elliott Brothers (London) Ltd. An article describing this versatile system is included in this issue.

TO SAVE YOUR TIME

We will assist you to obtain further information on any products or processes described or advertised in this issue. Just use the enquiry cards to be found in the back of the journal.

© Iliffe Electrical Publications Ltd., 1964

Permission in writing from the Editor must first be obtained before letterpress or illustrations are reproduced from this journal. Brief abstracts or comments are allowed provided acknowledgment to the journal is given.

For further information
circle 203 on Service Card

'METOX'

WELWYN 'METOX' METAL OXIDE RESISTORS
the widest range of METAL OXIDE FILM
resistors available today now include a
complete range to DEFENCE SPECIFICATION DEF 5115



TYPE F931

'METOX' DEF 5115 STYLE RFG-1



TYPES F252 F202 F642 F652

'METOX' DEF 5115 STYLE RFG-2



TYPES F255 F205 F645 F655 F685

'METOX' DEF 5115 STYLE RFG-5



TYPES F64 F66 F68

'METOX' DEF 5115 STYLE RFH-1

Each resistor shown is representative of a full range

WRITE NOW FOR FULL DETAILS

WELWYN ELECTRIC LIMITED

BEELINGTON | NORTHUMBRIA | ENGLAND

FACTORIES IN AUSTRALIA AND CANADA



practical planar

Three new silicon planar transistors, which maintain germanium saturation voltages over several decades of current, now make practical a wide range of amplifying, oscillating and switching applications. They are immediately available at practical prices and are backed with performance data and circuit design information.

A significant feature of these transistors is that a saturation voltage of less than +200mV at 150mA, and less than 1V at 1.0A, is achieved. These voltages are typical of germanium rather than silicon devices. The current gain – which is maintained over four decades of current – and f_T of greater than 50Mc/s, enable most general purpose applications to be readily met.

A booklet, giving performance data and circuits showing typical applications, is available on request. For price and delivery information contact Mullard at the address below.



Mullard Limited,
Industrial Semiconductor Division,
Mullard House,
Torrington Place, London WC1
Telephone : LANgham 6633

	BFY50	BFY51	BFY52	
$V_{CB} (I_E = 0)$	+80	+60	+40	V
$V_{CE} (cut-off)$	+80	+60		V
$I_{CM} max.$	1	1	1	A
$P_{tot} max. (T_{amb} = 25^\circ C)$	800	800	800	mW
$h_{FE} (I_C = 150mA)$	>30	>40	>60	
$f_T (V_{CE} = +6V, I_C = 50mA)$	>60	>50	>50	Mc/s
$V_{CE(sat)} (I_C = 150mA, I_B = 15mA)$	<+200	<+350	<+350	mV
Encapsulation	TO-5	TO-5	TO-5	

Mullard



MIS 11C

a toggle switch to fit that space?



certainly

MEC Type TS Miniature Toggle Switches the smallest switches available, 0.25 inch diameter mount 9 to the square inch Single-pole change-over with quick make, quick break action Mechanical life in excess of 40,000 operations Current rating 1A at 50 volts d.c. Two models, TS70, silver contacts, 10 milliohms contact resistance, TS71, gold-plated contacts, 6 milliohms contact resistance Temperature range 0°C to 85°C Prompt delivery.

Send for full details, price list. Miniature Electronic Components Ltd., St. Johns, Woking, Surrey. Tel. Woking 5211.

m-e-c

More precise particle-velocity measurements now possible with new Mullard image converter

The first commercially available image converter with a large-diameter photocathode has been developed by Mullard for use as the pre-amplifier tube in equipment for measuring particle velocity by observing the Cerenkov radiation. The characteristics of this image converter make it particularly suitable for the high-speed photography of random events in atomic physics where small light outputs are produced. The increased number of photons that can be collected by the large photocathode enables more precise measurements to be made.

The converter has two stages, and the decay characteristic of the fluorescent screen of the first stage has been chosen so that the image is retained long enough for an auxiliary circuit to operate an electronic shutter built into the second stage. By these means, an event exhibiting a particular characteristic can be selected from other events and recorded. Equipment incorporating this image converter provides atomic physicists with a powerful experimental tool.

Features of the image converter

Because the light output from the events to be observed by the image converter is extremely low, the photocathode has been made large to collect as many photons as possible. The minimum useful diameter of the photocathode is 150mm, and it is of the antimony-caesium, S11 type, with a minimum overall sensitivity of $30\mu\text{A}/\text{lm}$.

The fluorescent screen of the first stage and photocathode of the second stage are deposited on opposite sides of a mica sheet only $15\mu\text{m}$ thick so that the coupling between the two stages is extremely efficient. The fluorescent screen of the first stage consists of zinc oxide and releases 50% of the total light output within $1.5\mu\text{s}$. The photocathode of the second stage is also of the S11 type, and the fluorescent screen of the second stage is a zinc sulphide, metal-backed and silver-activated, P11 type, which will release 50% of the light output in $30\mu\text{s}$. The minimum useful screen diameter is 20mm.

Each stage of the image converter operates at a potential of 15kV and the potential change required to operate the electronic shutter in the second stage is approximately 2%. The resolution of the final screen is 30 line-pairs per millimetre at the centre, and the overall image demagnification is 8 times.

Fibreglass case

The tube is mounted in a Fibreglass case which acts not only as a protective cover but also as an insulating holder for the high voltage connections. The case is fitted with feet so that it can be

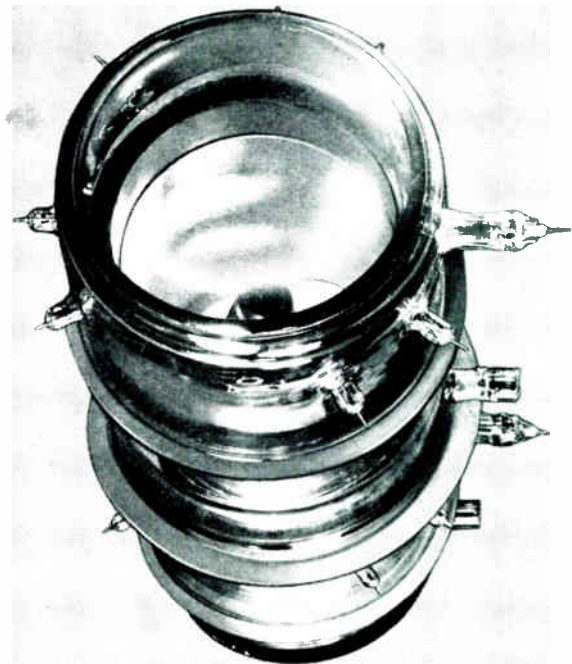

Two-stage image converter shown without Fibreglass case

firmly mounted onto an optical bench when lining-up and focusing the tube with ancillary equipment. The overall dimensions of the case are 730mm in length, with a cross-section of 378 by 312mm.

Applications

Although developed primarily for the measurement of particle velocities by observing the Cerenkov radiation, the image converter will have application in other branches of atomic physics where events produce small light outputs. It is envisaged that the equipment used typically in this work would use the two-stage image converter as a pre-amplifier tube followed by a high-gain image intensifier. The output of the image intensifier would be recorded on photographic film.

For further information on the two-stage image converter, please use the reader reply card of this journal (see reference number opposite).

What's new from Mullard

Voltage range of power-control thyristors increased to 700V

The four series of thyristors intended for use in high-current power-control circuits—the BTY87, BTY91, BTY95, and BTY99 series—have each been increased by three high-voltage types. These new types in each series have maximum repetitive peak reverse voltage of 500, 600, and 700V respectively.

The new devices in the BTY91, BTY95, and BTY99 series have the same current ratings and mechanical outlines as the other devices in the series. The maximum mean forward current of BTY91 series is 16A, that of the BTY95 series is 50A, and that of the BTY99 series 70A. The mechanical outlines used are SO-36 for the BTY87 and BTY91 series, and SO-30A for the BTY95 and BTY99 series.

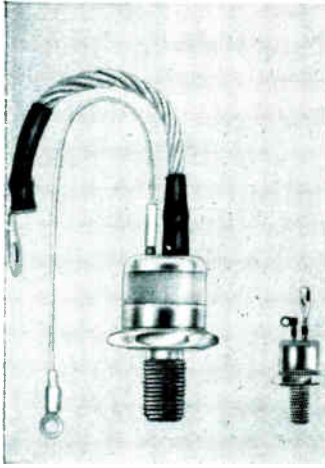

The BTY87 series is an improved version of the series of thyristors BTY42 to BTY47 inclusive, to which the three new high-voltage types have been added. The current rating of the new BTY87 series has been increased to 12A.

With the introduction of these new types, the range of power-control applications for thyristors will be considerably increased.

Silicon devices with germanium saturation voltage

Three planar transistors meet general applications requirements

With the introduction of three new planar transistors, designers will have to remember only three type numbers—BFY50, BFY51, BFY52—when selecting transistors for a wide range of professional equipment. These devices are truly general purpose, and can be used in many different circuit configurations in a wide range of amplifying, oscillating, and switching applications.

A significant feature of the devices is the exceptionally low saturation voltage. The values of 200mV for the BFY50 and 350mV for the BFY51 and BFY52, measured at a collector current of 150mA, are typical of germanium rather than silicon devices. The current gain is maintained over four decades of current, and the value of f_T , greater than 50Mc/s, enables most general-purpose applications to be readily met.

The introduction of these general-purpose devices will simplify considerably the designer's task of selecting transistors for his application. Instead of being faced with a multiplicity of type numbers for particular applications, he will be able to use a few general-purpose types for all but the most specialised applications.

Brief data for the BFY50, BFY51, and BFY52

	BFY50	BFY51	BFY52	
$V_{CB(max)}$	+80	+60	+40	V
V_{CE} (cut-off)	+80	+60	—	V
$V_{CE(sat)}$ ($I_C = 150mA$)	+200	+350	+350	mV
h_{FE} ($I_C = 150mA$)	> 30	> 40	> 60	
T_j (max)		+200		°C

HIGH-POWER TRAVELLING-WAVE TUBE FOR COMMUNICATIONS LINKS

25W saturation power output now available

A travelling-wave tube recently introduced, the YH1030, has the high saturation power output of 25W. The operating frequency range is 5.9 to 7.2Gc/s, so the tube therefore complements the existing low-power type LB6-12 which has a similar frequency range.

The YH1030 has been designed for use in the power output stages of wideband high-capacity telecommunications links. Because of the high saturation power output, the tube will deliver a useful output power of 15W at 5.9Gc/s, falling to

10W at 6.5Gc/s, and maintaining this power over the range 6.5 to 7.2Gc/s. The gain over the complete frequency range is 36dB.

The mount for the tube contains the uniform-field permanent magnet used for focusing. The alignment of this magnet is easily carried out by the adjustment of two screws. Since the YH1030 has been designed for a plug-in match of the helix to the waveguide circuit over the whole frequency band, no tuning adjustments are necessary. Replacement of the tube in equipment is therefore extremely simple.

As the magnet is completely shielded by the mount, external magnetic fields will not affect the focusing, and the tube will not affect other equipment in the vicinity.



TWO NEW LOW-COST SILICON P-N-P TRANSISTORS

Developments from OC204 series and updated BCY38 series

Two new high-voltage medium-gain silicon transistors, the BCY54 and OC207, have been introduced by Mullard. Developed from the highly successful BCY38 series and OC204 series, they are particularly suitable for pulse and audio applications, compact d.c. converters, servo process control, power switching, and relay drivers.

With a typical gain of 50 and a collector voltage of 50V, these two transistors will find special application in equipment where the full voltage of the OC205 and BCY39 is not required, but where a higher gain would be of advantage.

Updated BCY38 series

The BCY54, which is in TO-5 encapsulation, joins the recently updated BCY38 series which now has a power dissipation of 400mW in free air at 25°C, and 500mW at a case temperature of 88°C.

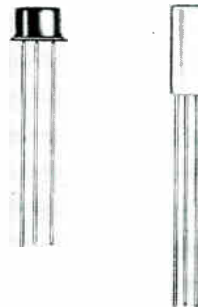

FURTHER DETAILS of the Mullard products described in this advertisement can be obtained from the address below or through the Reader Enquiry Service of Industrial Electronics using the appropriate code number shown below.

Two-stage image converter	206
Planar transistors BFY50, BFY51, BFY52	207
Travelling-wave tube YH1030	208
High-voltage thyristors	209
Silicon transistors OC207, BCY54	210



Mullard Limited, Mullard House, Torrington Place, London, WC1. Telephone: LANgham 6633

CAM 13

**millions of
tube-hours
behind
them**



**millions of
tube-hours
ahead of
them**



**confirm
Dekatron[®]
reliability
and economy**



Described as the most significant advance in the technique of slow and medium speed counting during the last decade, Dekatron tubes have logged millions of international tube-hours in thousands of equipments—signalling when a pre-set count is reached: timing to accuracies of up to 1/10 milli second: dividing or frequency measuring: providing time reference marks on pen recorders: controlling machine tools: counting pulses from photocells, geiger tubes, magnetic pick-ups: acting as sequence switches: generating pulse trains: adding and subtracting and a host of other applications.

Are you taking full advantage of the reliability, economy, long-life and versatility of these tubes. Perhaps you would like data sheets or a copy of "Dekatron applications"—if so write or phone "Tube Division", Beeston, Nottingham. Tel: 254831.

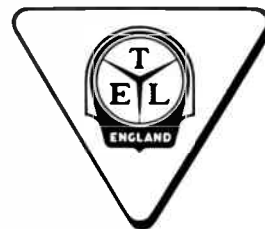

ERICSSON TELEPHONES LTD. ETELCO LTD.

A Principal Operating Company of the Plessey Group: Head Office and Main Works Beeston Nottingham. Telephone 254831. Telex 37666.
ER 83

**PNP
PLANAR PASSIVATED**

2H1254 2H1255 2H1256 2H1257 2H1258 2H1259 HT100 HT101	T0-18 Case	A unique range of double-diffused 100 Mc/s switching transistors. BV up to 50V hFE specified max/min values within range 14 - 150 V _{ce(sat)} 0.3V t _d + t _r 25nanosec
2N1254-9	T0-5 Case	
2H1254-9 Type Approved CV 7484-9		
2N1131 2N1131A 2N1132 2N1132A 2N1132B	T0-5 Case	Medium power general purpose transistors available in either TO-5 or TO-18 case style. Min f _t 60 Mc/s BV up to 60V hFE specified max/min values within range 20 - 200 V _{ce(sat)} 1.5V
2N721 2N722	T0-18 Case	

**NPN
PLANAR PASSIVATED**

2N706 2N706A 2N706B 2N707 2N708 2N753 2N914	T0-18 Case	A preferred range of 300 Mc/s transistors with excellent switching characteristics. BV up to 56V hFE specified max/min values within range 9 - 120 V _{ce(sat)} 0.4V
2N717-720A 2N870-1 2N910-2 2N956 HT400-1	T0-18 Case	70 Mc/s medium power general purpose transistor available in either TO-18 or TO-5 case style. BV up to 120V hFE specified max/min values within range 20 - 100 V _{ce(sat)} 1.5V
2N696-9 2N1613 2N1711 2N1893 2N1889-90	T0-5 Case	

The Hughes range of Silicon Transistors is centred on those types having the broadest basis of common "preference" by the various Authorities specifying world-wide Military and Aviation equipment requirements. The use of these types in your prototype equipment will avoid expensive re-design at the production stage. For commercial applications, the HT100/1 and HT400/1 complementary devices offer the opportunity of "going Silicon" at surprisingly low cost.

SPECIFY HUGHES TRANSISTORS



Write now for complete data on the full range of Hughes semi-conductor products, which also includes:— Germanium and Silicon Switching Diodes, Silicon Power Diodes and Rectifiers, Voltage Reference (Zener) Diodes, High Voltage Cartridge Rectifiers.

HUGHES INTERNATIONAL (U.K.) LTD

KERSHAW HOUSE, GREAT WEST ROAD, HOUNSLOW, MIDDLESEX. TEL: HOUNSLOW 5222.

M & P HM24

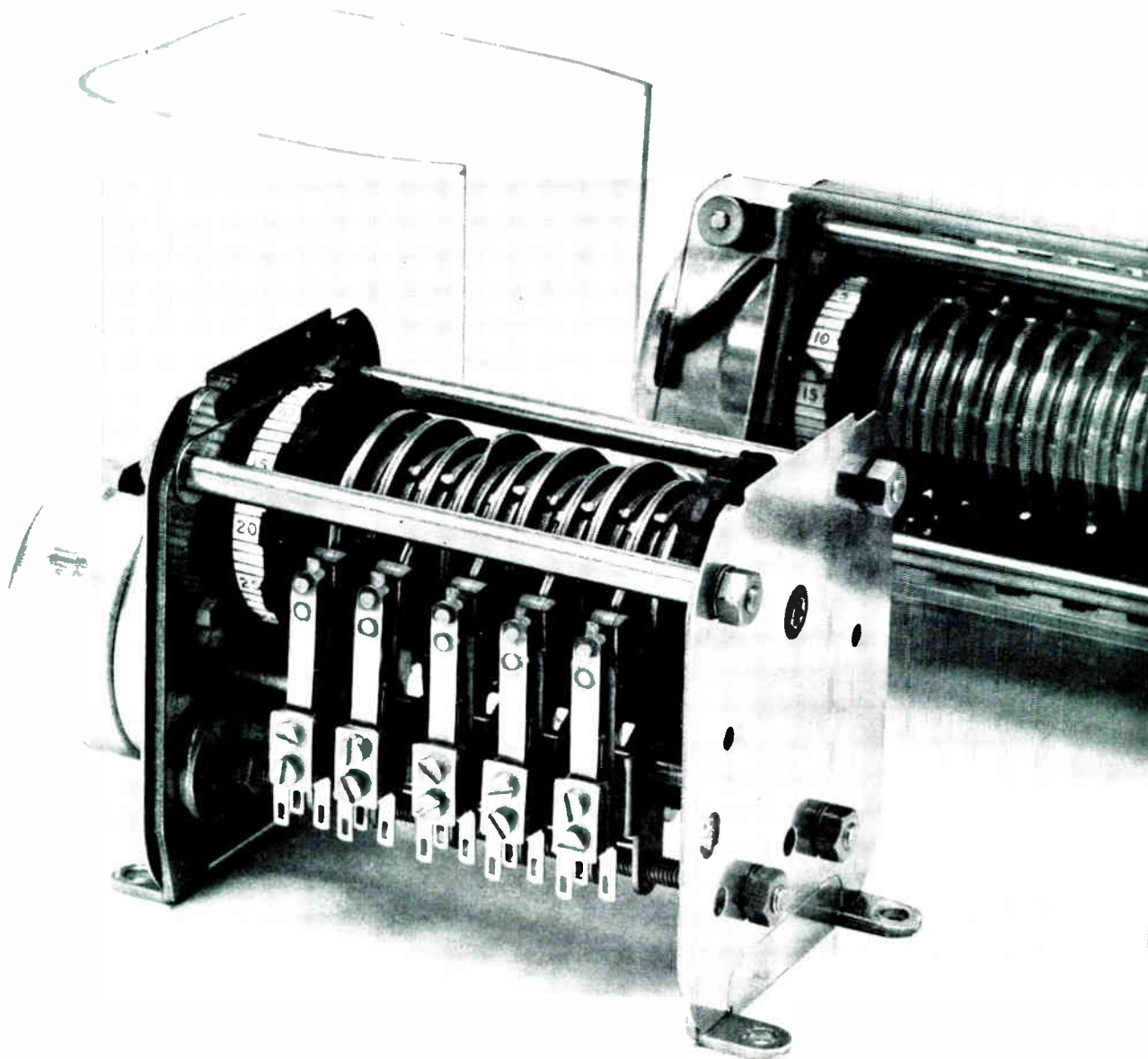

Series 800 Sequence Timer

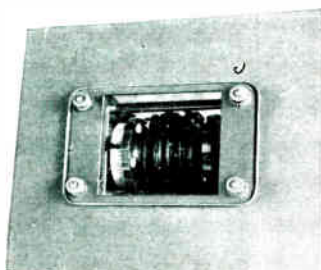

Outstanding ease of cam adjustment and indexing. Set Screws eliminated by good design. Although built to high standards of reliability and accuracy, the 800 Series are undoubtedly the most economically priced units available. A wide range of cycling times with 3, 5, 7, 9, and up to 24 cams available.

ACCURATE, ACCESSIBLE, ADJUSTABLE

MAGNETIC DEVICES LIMITED

Newmarket, England

Newmarket 3451 (10 lines) Grams : Magnetic Newmarket

**MANUFACTURERS OF RELAYS,
SOLENOIDS AND CONNECTORS**

P9087

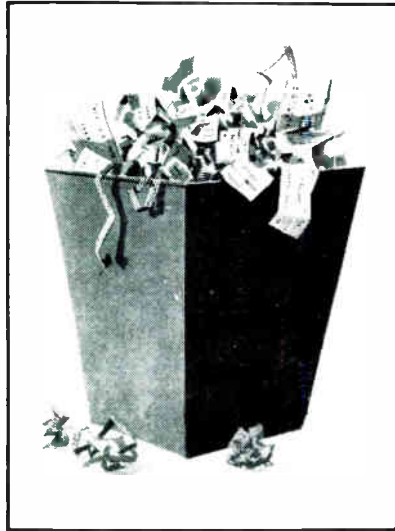

Your particular data processing problem can be solved by using an

'APTEC' electronic TRANSCODER

A.P.T. Electronic Industries Ltd., now produce coding and control systems called TRANSCODERS which enable card and paper tape readers, punches, electric typewriters and other digital equipment to be suitably applied to any given problem by use of standard modular solid state electronic circuits. Drawers containing plug-in circuit cards can be mounted in desk units for office use or in cabinets and racks for equipment practice.

Typical Applications. *Business Machines.* High speed letter copying. High speed automatic typing from tape or card information. Tape to card conversion. Card to tape conversion. Code conversion. *Computer Ancillaries.* 'On-line' input & output machines. Preparation of programme tapes. Copying and typing from tapes.

The advantages of 'APTEC' TRANSCODERS are:—

1. Your problem is considered individually.
2. Only the facilities required are incorporated.
3. Extra facilities can be added later if required.
4. Only standard mechanical devices are used, so that punches, readers, typewriters, etc., can be purchased separately from their respective suppliers.
5. All standard codings can be accommodated, with code conversion if required.
6. Slave equipment can be directly coupled.
7. Mechanical design to match existing equipment or furniture.

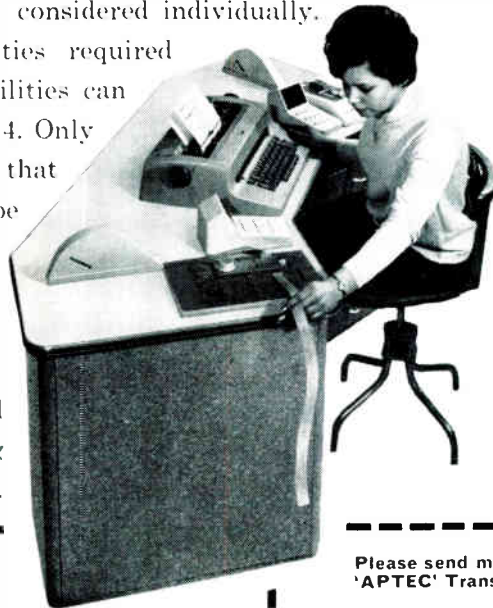

LET US PROVIDE THE MOST PRACTICAL ANSWER TO THAT AWKWARD QUESTION

Please send me details of the 'APTEC' Transcoder Systems



ELECTRONIC INDUSTRIES LIMITED

DATA PROCESSING DIVISION

CHERTSEY ROAD,
BYFLEET, SURREY
Phone: Byfleet 41131 2 3 4 PABX
Grams: APTRAN, BYFLEET

NAME _____
 COMPANY _____
 ADDRESS _____

 IE764 _____

LEE 2237

New range of AEI HALL EFFECT DEVICES now includes

FIELD PROBES

(now with thinner, more sensitive, semiconductor, encapsulated in beryllia)

Typical applications:
Direct measurement of computer magnetic field, Clip-on type ammeter, Proximity sensor, Sine-cosine function generator, Displacement transducer, Power measurement, Magnetic mapping, Multiple read-out heads for computer magnetic memory drums.



MULTIPLIERS

Typical applications:
Analogue computers, Wattmeters and volt-ampere meters, Carrier-suppressed modulators, Squaring, Harmonic analysis.



DC-AC CONVERTORS

Typical applications:
Low input impedance DC amplifiers, Regulated DC power supplies.



RF MODULATORS

Typical applications:
Double sideband suppressed carrier modulator, Contactless RF potentiometer, Frequency translation.



AEI Hall effect devices use the semiconductor Indium Arsenide and give a very stable performance over a wide temperature range.

WHAT CAN YOU DO WITH AN AEI HALL EFFECT DEVICE? Some of the known applications are listed above, but there are many others. Write now for the new leaflet which gives full specifications and characteristics of these devices; it may give you some ideas.

WRITE TO AEI SWITCHGEAR DIVISION, POWER PROTECTION & METER DEPT., TRAFFORD PARK, MANCHESTER 17, or your nearest AEI office



Associated Electrical Industries Limited
Switchgear Division

JULY 1964

STC components review

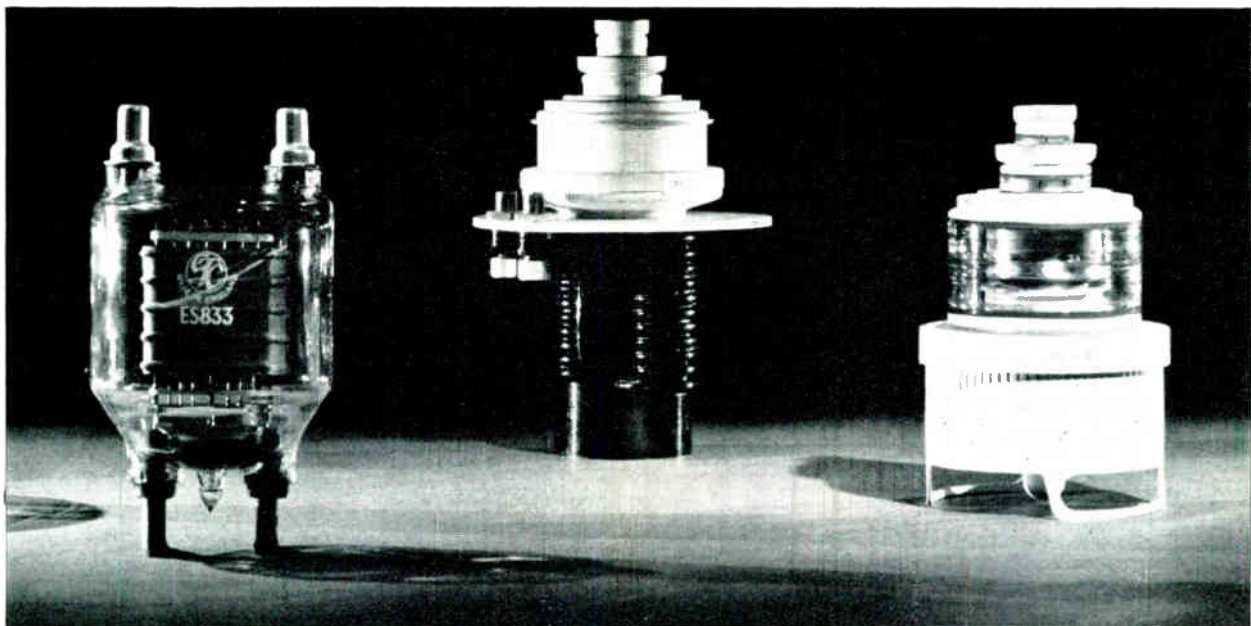

POWER TRIODES FOR INDUSTRIAL RF HEATING

The addition of several new types has extended the STC range of industrial triodes to one of the most comprehensive in Europe. Important features of these valves are high safety factors on grid and anode dissipation and large reserves of peak cathode current emission. Some valves from this range are available with a metal ceramic envelope for use at high frequencies in dielectric

heating; these are particularly suitable for grounded grid operation since their drive power requirements are very low. Cheaper, glass metal envelope versions are available for lower frequency operation. A number of valves in the range give customers a choice of anode cooling—forced-air, water and vapour cooled versions can be supplied.

ABRIDGED DATA (representative selection only)

Type	3C 150A	ES833	14D12	ES1001	15D12	3J 187E	3R 187E	3JC 187E	ESA1500	16P12
Typical Output (kW)	0.3	1.4	1.5	2.0	2.5	5.0	5.0	5.0	6.0	6.0
f_{max} (Mc/s)	60	30	60	30	60	120	120	220	40	40
μ	18	35	21	40	22	12	12	12	24	24
β_m (mA/V)	5.0	9.0	3.3	8.0	5.1	22	22	22	7.5	7.5
V_a (kV)	2.0	4.0	6.0	5.0	6.0	5.5	5.5	5.5	6.0	8.0
P_a max (kW)	0.15	0.4	0.5	1.0	0.8	3.0	3.0	3.0	3.0	3.0
Cooling	Radiation	Radiation	Radiation	Radiation	Radiation	Forced Air	Water	Forced Air	Forced Air	Water

Type	3J 192E	3J 203E	3R 203E	3JC 203E	3J 223E	3R 223E	3JC 223E	3RC 223E	LS952A	3RC 262E
Typical Output (kW)	9.0	12	12	12	25	25	25	25	40	40
f_{max} (Mc/s)	22	50	50	220	50	50	100	100	30	80
μ	19	12	12	12	12	12	12	12	24	12
β_m (mA/V)	11	32	32	32	60	60	60	60	40	60
V_a (kV)	6.5	7.0	7.0	7.0	7.0	7.0	7.0	7.0	12	7.0
P_a max (kW)	4.2	6.0	6.0	6.0	10	12	10	12	24	24
Cooling	Forced Air	Forced Air	Water	Forced Air	Forced Air	Water	Forced Air	Water	Water	Water

Write, phone or Telex for full details to STC Valve Division, Brixham Road, Paignton, Devon or London Sales Office, Footscray, Sidcup, Kent. Telephone FOOTscray 3333. Telex 21836.

CONTINUED OVER

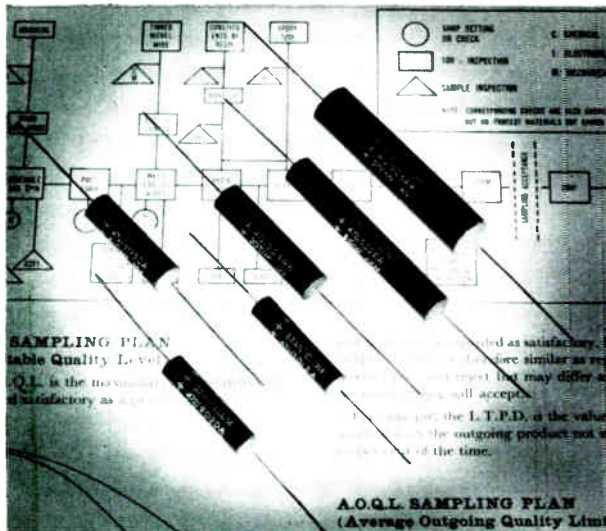

SPECIAL QUALITY TANTALUM CAPACITORS

For equipments demanding components of the highest quality and reliability, STC produce a range of Special Quality Tantalum Foil Capacitors. These are based on the STC High Temperature Tantalum range which is known, from life test data and field experience, to have inherent high reliability.

STC Special Quality Tantalum Capacitors are manufactured on a batch basis under full Quality Control. They are then formed into lots which are released only on the successful completion of extensive Acceptance Sampling (destructive) tests carried out on a statistically chosen percentage, some of these Acceptance Sampling tests extend to 1 000 hours.

Write, 'phone or Telex for Data Sheets and prices to STC Capacitor Division, Brixham Road, Paignton, Devon or London Sales Office, Footscray, Sidcup, Kent. Telephone FOOTscray 3333. Telex 21836.

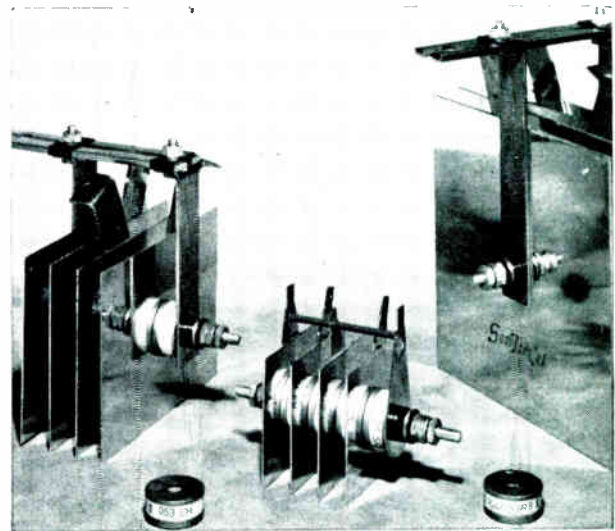

SILRINGS · SILICON RECTIFICATION USING SELENIUM STACK PRACTICE

New in Britain, SILRING rectifier stacks from STC offer the circuit designer and equipment engineer a unique combination of compactness, simplicity and low cost.

□ The SILRING stacks shown above have outputs of 4.2 kW, 2.1 kW and 9.45 kW. □ SILRING power diodes are rugged ceramic/metal case ring diodes with diffused silicon junctions. Their heavy gauge copper end-plates form the anode and cathode of the device and act as thermal conductors to the stack cooling fins. This arrangement provides maximum efficiency without overloading and consequent lowest price-per watt rectification.

□ The simplicity of stack construction enables STC to offer quick delivery of SILRING diodes in the range 50-600V_{RRM}. When assembled into stacks these diodes give outputs from 5 to 232A.

For Data Sheets and prices write, 'phone or Telex STC Semiconductor Division (Rectifiers), Edinburgh Way, Harlow, Essex Telephone Harlow 26811. Telex 81146

STC components review

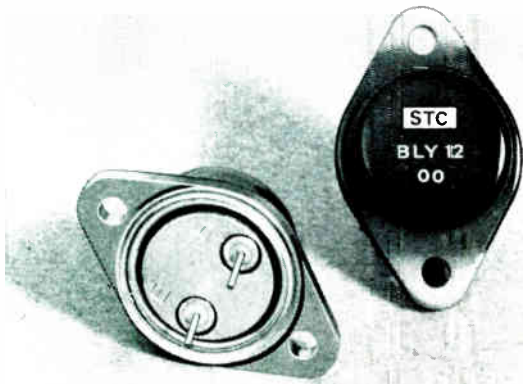

A NEW SILICON POWER TRANSISTOR

has been added to the STC range. This is the BLY12, a silicon epitaxial planar high frequency transistor with a collector dissipation of 25 watts and encapsulated in a JEDEC TO-3 package. It is suitable for use both as a high current high voltage switch and as a high frequency power amplifier up to 20 Mc/s. Delivery is available from stock.

BRIEF DATA

f_T at 100mA:.....60 Mc/s (This figure is maintained for currents approaching 1A.)

h_{FE} at 2A:.....30-100

$V_{CE(sat)}$ at $I_C=2A, I_B=0.2A$:.....1 V max.

RATINGS

V_{CBM} :.....60V

V_{CEM} :.....30V

$I_C(pk)$:.....5A

PCM :.....25 W in a heat sink

OUTLINE: JEDEC TO-3

SILICON PLANAR DOUBLE TRANSISTORS FROM STOCK

The BFY20 is a matched pair of BFY18 silicon planar transistors mounted together on a 6-lead header and encapsulated in a TO-5 case, the transistors being electrically isolated. The common mounting minimizes the temperature difference between the two transistors, making the device ideal for use in D-C amplifiers. The BFY20 is now fully available from stock.

BRIEF DATA

f_T at 10mA:.....245 Mc/s typ

I_{CBO} at 9 V:10 nA max

h_{FE} at 100 μ A:.....10 min

V_{BE} matched to within 10 mV

PCM rating:..... 600 mW total

Write, 'phone or Telex for Data Sheets to STC Semiconductor Division (Transistors), Footscray, Sidcup, Kent. Telephone FOOTscray 3333. Telex 21836.

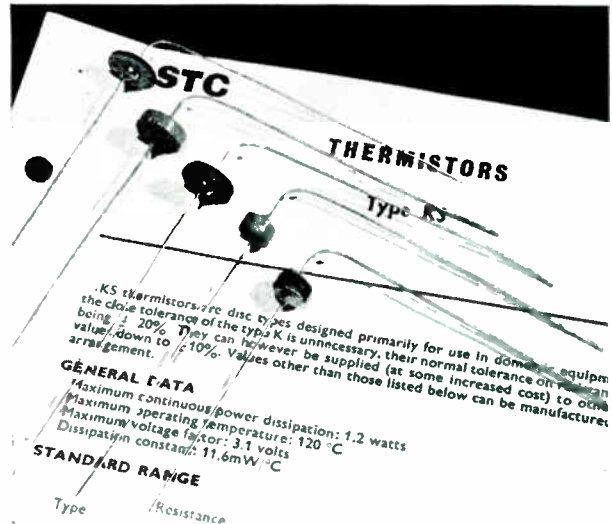

THERMISTORS-KS SERIES

For some years STC Thermistors have been used throughout the electronics and electrical industries in industrial and domestic equipment. The KS range is one of many that were originated to customers' specific requirements. If you have a problem involving the compensation, measurement or control of temperature or any other application requiring Thermistors, e.g. surge suppression, r.f. power measurement, timing devices or flow measurement, consult booklet MK 140 and/or our Applications Department.

THERMISTORS FOR TV

Television manufacturers design STC Thermistors into their scanning circuits to avoid reduced picture width which occurs with temperature increases of copper-wound scanning coils. Type KS Thermistors are suited ideally to this application. They are of rugged construction and are available in a large number of resistance values.

For full details of STC Thermistors, write, 'phone or Telex STC Semiconductor Division (Transistors), Footscray, Sidcup, Kent. Telephone FOOTscray 3333. Telex 21836.

high-grade electronic components by

STC

COMPONENTS GROUP

IT'S A SMALL WORLD

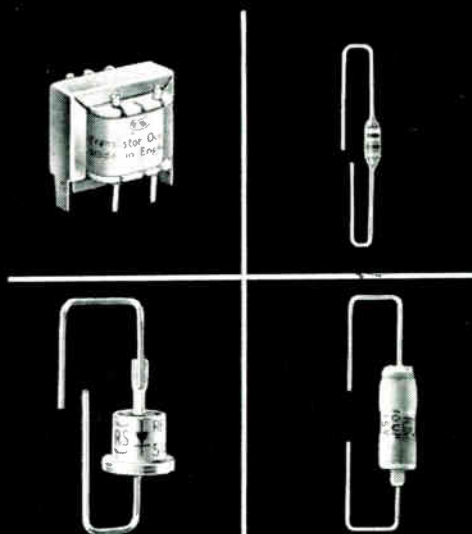

Miniature and Sub-Miniature Components from **RADIOSPARES**

Our range of "Miniature" and "Sub-Miniature" Components includes Capacitors, Resistors, Transformers, Plugs and Sockets, Wires, Indicators, etc. All are constructed with the same care, and to similarly exacting standards as their bigger brothers! All are available from Stock.

Radiospares Ltd.

4-8 MAPLE STREET · LONDON · W.1 · ENGLAND TELEPHONE: EUSTON 7232 (8 LINES)
TELEGRAMS and CABLES: RADOSPERES LONDON W.1



A NEW WAY OF MEASURING TORQUE

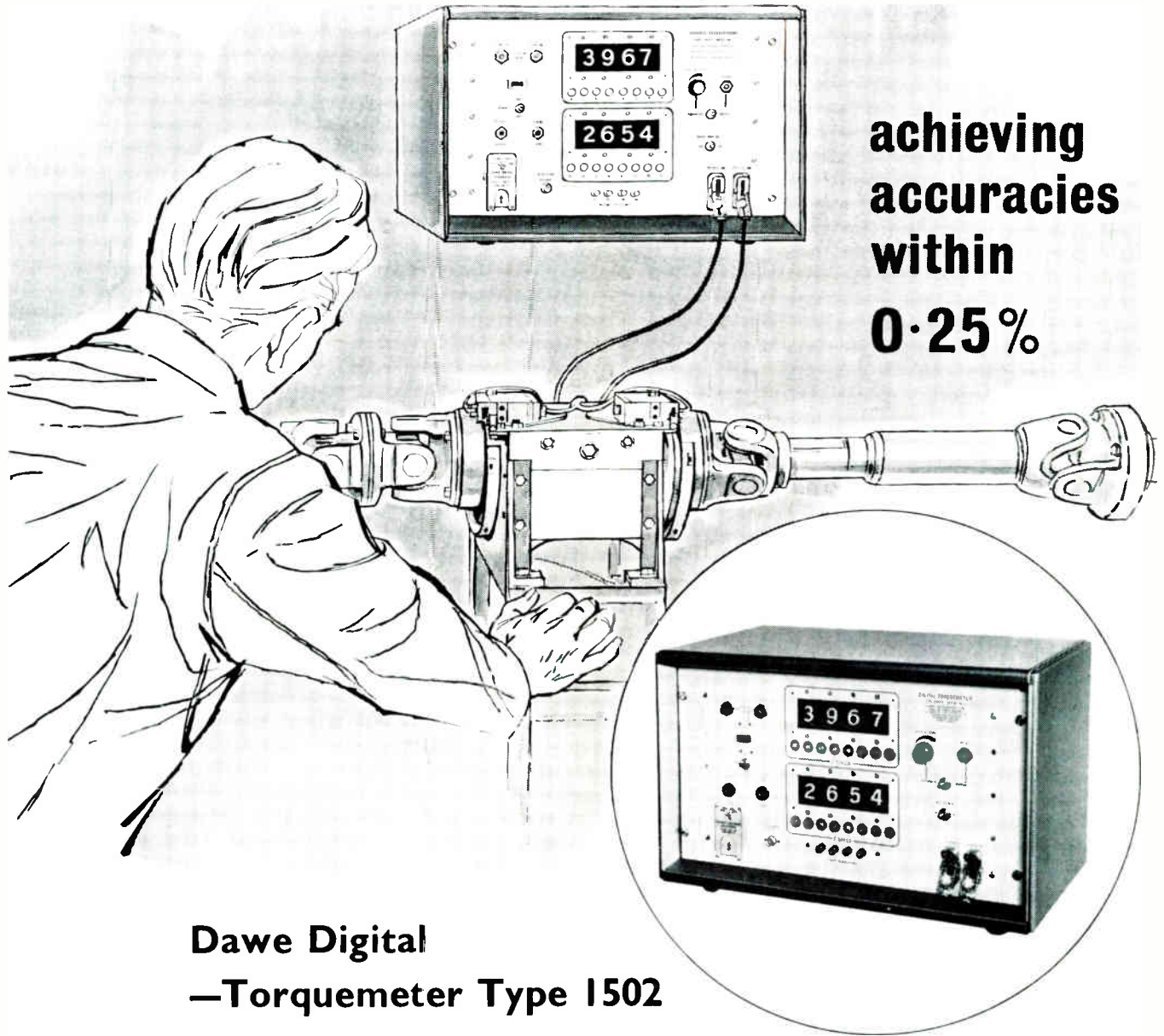

achieving accuracies within 0.25%

Dawe Digital —Torquemeter Type 1502

A MARKED ADVANCE ON EXISTING EQUIPMENT—

It takes 20 readings per shaft revolution and displays the average (obtained electronically). Under high-torque, low-speed conditions, it has distinct advantages over costly and bulky swinging dynamometer equipment.

- * Fully transistorised
- * Displays two 4-figure readings
- * Very high accuracy and resolution—typically 0.25% for a 3° twist at 500 r.p.m.
- * Simultaneous readings of speed and torque
- * Errors through torsional vibrations minimised by averaging techniques

- * Unique torque setting facility
- * Two instruments may be synchronised to give simultaneous readings
- * Facilities for print out.

Send for leaflet of this latest contribution by DAWE to measuring techniques in the marine, automotive and aeronautical industries.



Full technical data from:—

DAWE INSTRUMENTS LTD., WESTERN AVENUE, ACTON, LONDON, W.3 Tel: ACOrn 6751

A member of the *Simm* group of companies



TANTALUM CAPACITORS (CLASS W AND S)

7 DAY DELIVERY FROM THORN

You can now get Tantalum Capacitors in just seven days from Thorn.
This is a special service for Development Engineers and is not intended or available for production quantities. Only quantities of up to 25 off are offered of Class W or S capacitors.
Tolerances available: Class W -15% to $+75\%$ and Class S $\pm 20\%$.
Want to know more about these capacitors? Just read on.

TANTALUM TYPE W TANTALUM CAPACITORS consist of a sintered porous anode sealed in a fine silver case. The following qualities are inherent: * unusually high capacitance per unit volume * reliable operation over temperature range -55°C to $+85^{\circ}\text{C}$ without derating * operation at 125VDC and under * lowest leakage current of any tantalum capacitor * low power factor * long shelf and operating life.

MIL-C-3965B.

Voltage depending on capacitance: 6VDC to 125VDC
Temperature Range: -55°C to $+85^{\circ}\text{C}$
Capacitance depending on voltage: $1.7\mu\text{F}$ to $560\mu\text{F}$
Tolerance of capacitance: -15% to $+75\%$
Polar construction
Insulated or non-insulated

TANTALUM TYPE S TANTALUM CAPACITORS are small solid type units with the following qualities: * extreme reliability over wide temperature range of -80°C to $+125^{\circ}\text{C}$ * low leakage current * low loss factor * polar or non-polar construction * extremely long shelf and operating life. Meets the requirements of MIL-C-26655A.

Voltage: 6VDC to 35VDC
Temperature range: -80°C to $+125^{\circ}\text{C}$
Capacitance Polar: $0.0047\mu\text{F}$ to $330\mu\text{F}$
Tolerance of capacitance: $\pm 20\%$
Insulated or non-insulated

Convinced? Try the service and the capacitors by ringing Enfield 5353 now! And ask about other Thorn Tantalum Capacitors.

THORN ELECTRONICS LIMITED, SPECIAL PRODUCTS DIVISION
105-109 Judd Street, London, W.C.1.

SPOT ON!

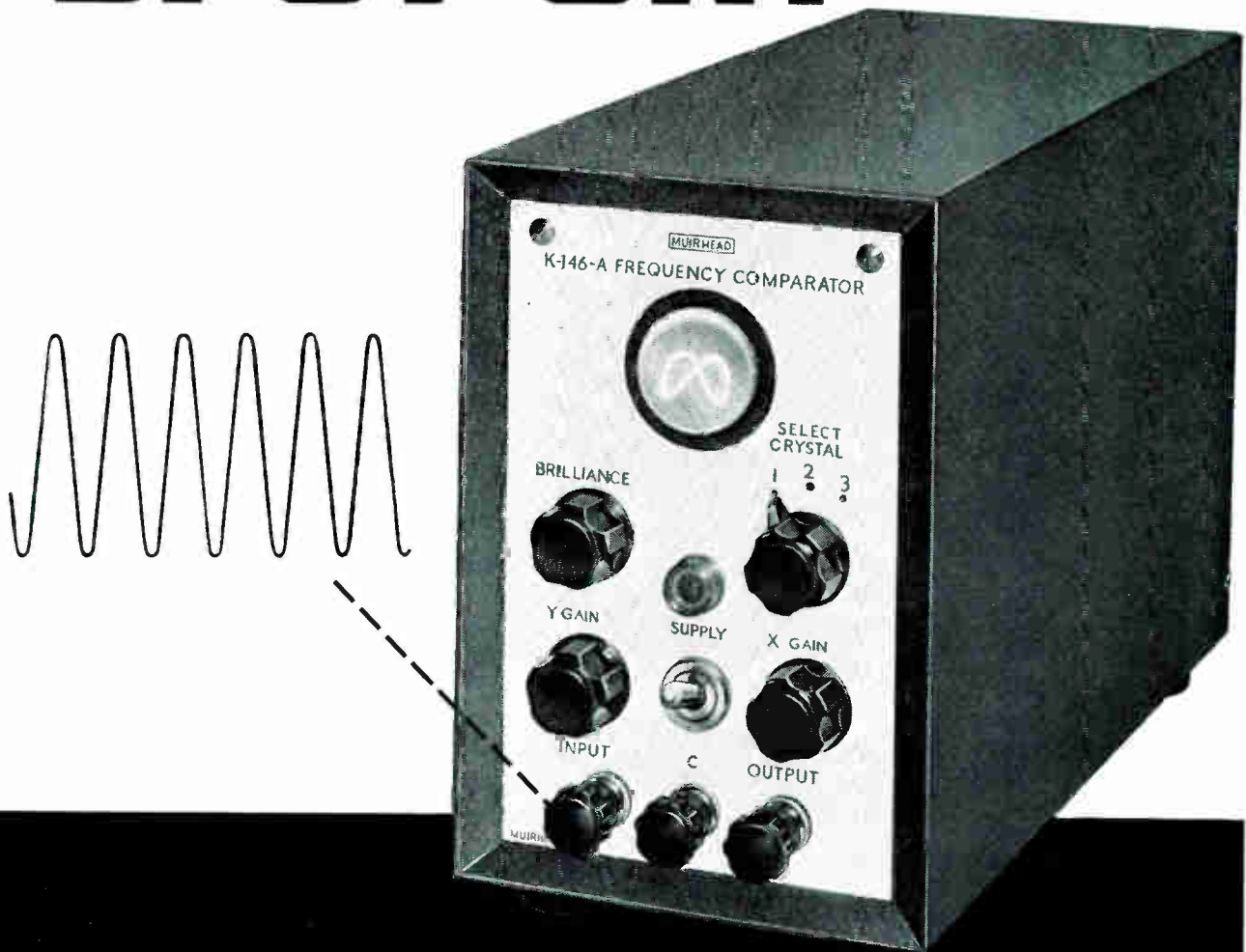

The MUIRHEAD Frequency Comparator checks oscillators to crystal accuracy— $\pm 0.005\%$. It continuously compares an internal crystal frequency with oscillator frequencies up to 250 kc/s, and displays Lissajous figures on a built-in cathode ray tube.

A 2 kc/s crystal is fitted as standard. Two alternative positions are provided for crystals of other frequencies. A front panel switch selects the required crystal.

Small and lightweight, the MUIRHEAD K-146-A Frequency Comparator is 'spot on'!

MUIRHEAD

PRECISION ELECTRICAL INSTRUMENTS

Muirhead & Co. Limited, Beckenham, Kent, England. Telephone: Beckenham 4888

Muirhead Instruments Limited, Stratford, Ontario, Canada. Telephone: Area Code 519, No. 271-3880

Muirhead Instruments Inc., 1101 Bristol Road, Mountainside, New Jersey, U.S.A. Telephone: Code 201, No. 233-6010

685



*for
high heat
insulation*

YOU'LL NEED TO KNOW ABOUT DELANCO GLASS FIBRE LAMINATES

If you need a material with a working temperature of up to 250 C very high dielectric strength and low loss properties PLUS high mechanical strength and exceptional machining properties you need look no further than the DELANCO range of glass fibre laminates, in sheet, tube, rod or in parts accurately machined to your drawings.

In fine and medium weave glass cloth base, with a bonding agent of silicone, Epoxy, melamine or phenolic, each grade having characteristics suitable for specialised applications. These applications are mainly in the electro-mechanical fields, but more recent technological advances in other fields are bringing regular enquiries for many new trades.

Class C Transformers, for example, Aircraft construction, and plating jigs, give some idea of the versatility of this material.

For machined parts only, we have one of the most modern

tool departments in the country, and all tools and fixtures are made by operators with first-hand knowledge of the materials on which these tools will be used.

Parts can be blanked, routed, milled, drilled and counter-bored, and metal tags and terminals can be fitted. Engraving on the finished parts is also done in our own works.

For further Technical Details send for Delanco Catalogue.

Delanco

for Electrical Insulation

Anglo-American Vulcanized Fibre Co. Ltd.,
Cayton Works, Bath Street, London, E.C.1.
CLE 884. Grams: Prompserv, Cent, London.
Delanco Works, Leonard Street, London, E.C.2.



Covers the very wide Frequency Range 0.2c/s to 1.22Mc/s

TRANSISTOR DECADE OSCILLATOR TYPE TG 66A

Frequency is selected by means of four in-line additive decade controls and a five position multiplier switch. The last of the additive controls is continuously variable so that any frequency may be selected with a discrimination better than $\pm 0.03\%$ or $\frac{1}{30}$ th of the specified frequency accuracy, whichever is the greater. The output source voltage of the oscillator is monitored by a meter with an expanded scale, and a continuous control is fitted so that the output may be set with a discrimination better than ± 0.05 dB.

SPECIFICATION

ACCURACY

± 0.02 c/s below 6c/s.
 $\pm 0.3\%$ from 6c/s to 100kc/s.
 $\pm 1\%$ from 100kc/s to 300kc/s.
 $\pm 3\%$ above 300kc/s.
 all measured at 25 °C.

STABILITY

$\pm 6\%$ mains voltage change produces less than $\pm 0.005\%$ frequency change up to 100kc/s.
 Change of frequency with temperature is less than $\pm 0.025\%$ per °C above 100c/s.

DISTORTION

Less than 0.15% from 15c/s to 15kc/s
 Less than 0.5% at 1.5c/s and 150kc/s

OUTPUT

Continuously variable from -94dBm. to +10dBm. into 600 ohms. Source voltage variable from 30 μ V to 5V. Output impedance 600 ohms at all settings. Meter fitted with dBm and V scales.

TEMPERATURE RANGE

-10 C to +45 °C.

POWER SUPPLY

"Mains"—100/125V, 200/250V; 50/60c/s; 6VA.
 "Batteries"—4 Self-contained type PP9, life 300 hours.

SIZE

6½" high x 10½" wide x 7" deep.

WEIGHT

12 pounds.



Price complete with batteries

£150 Leather case
 £5 extra.

Fully detailed leaflets available on our complete range of portable instruments.

LEVELL ELECTRONICS LTD.

Park Road, High Barnet, Herts.

Telephone: BARNET 5028.



COSSOR

1964

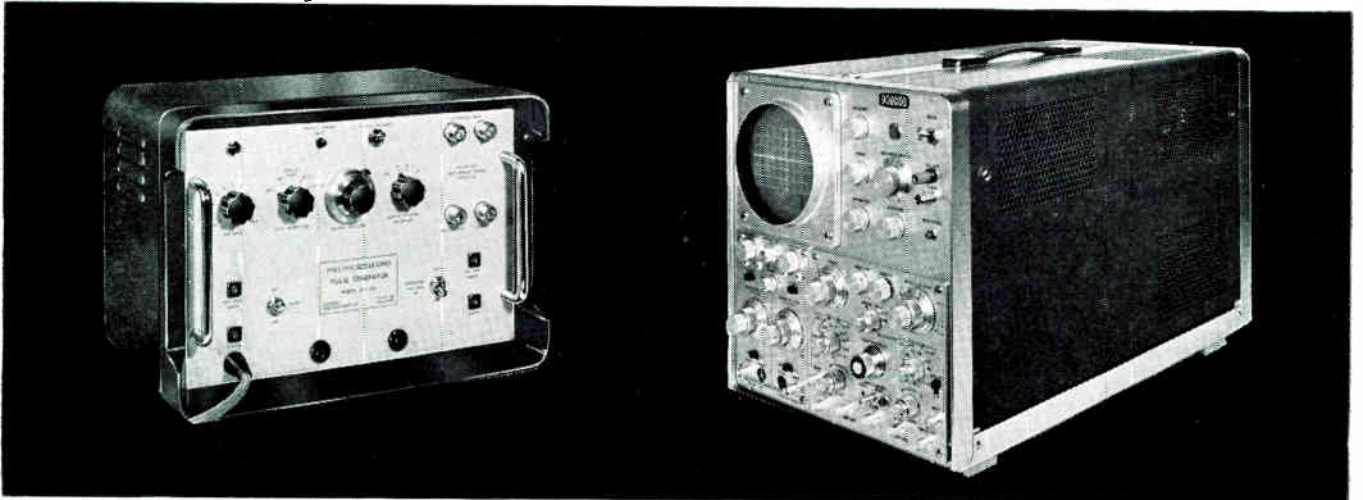

TWO NEW INSTRUMENTS FROM THE COSSOR 1964 RANGE

Setting the standard for years to come is the solid state **modular oscilloscope series CD100**. This oscilloscope which represents many years' research and development effort comprises a frame containing the C. R. T., power supplies, and an aperture which accepts two modules. Typical modules include single and dual trace amplifiers with bandwidths up to 35 Mc/s and sensitivities down to 500 $\mu\text{V}/\text{cm}$; sweep generators, some with delayed sweep; sampling units with bandwidths up to 1,000 Mc/s; swept frequency oscillator heads for spectrum analysis up to 1,000 Mc/s. Of great interest too, is the **pulse generator CG200**. The output pulse rise-time does not exceed 0.7 nanoseconds up to the maximum output of 100V and the output can be of either polarity.

COSSOR

For full specifications please write to:-

COSSOR INSTRUMENTS LIMITED

THE PINNACLES, HARLOW, ESSEX, ENGLAND. TELEPHONE HARLOW 26862

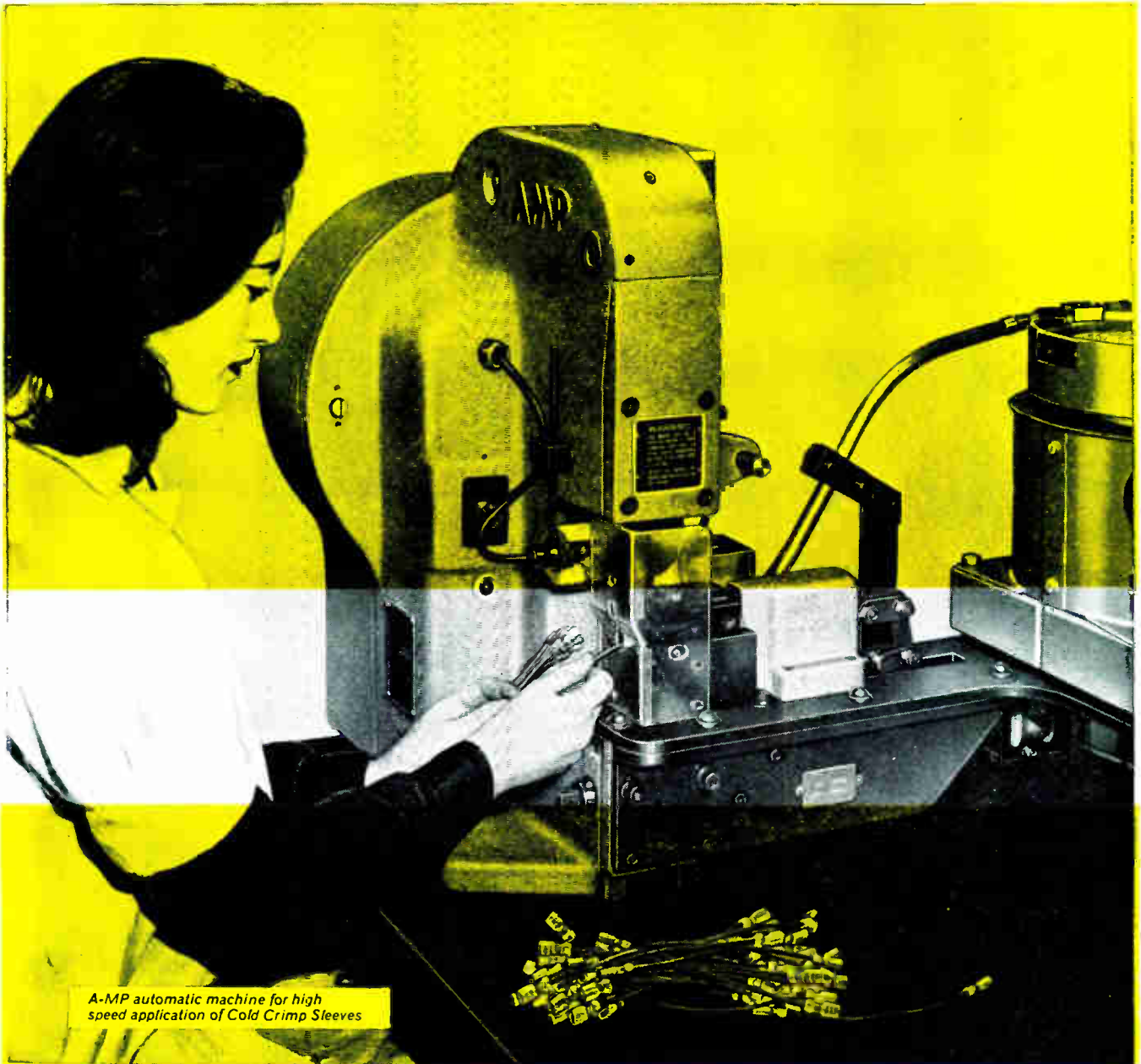

A-MP automatic machine for high speed application of Cold Crimp Sleeves

POST-INSULATE THE EASY WAY

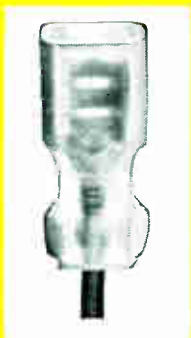

A-MP Cold Crimp Sleeves are semi-rigid PVC sleeves for post-insulating Faston receptacles and other A-MP products at lowest applied cost.

Cold Crimp Sleeves are applied by automatic machine. They are correctly located and completely reliable, with high dielectric strength and impact resistance. Production of an insulated terminal is effected in two operations, compared with five required by manual methods.

Sleeves are automatically located and crimped permanently to the wires and terminals. Incorrect fitting is impossible—sleeves cannot move after crimping.

Two operatives using A-MP Automachines—one crimping the terminals, the other the sleeves—can apply 2000 efficient and reliable insulated terminations per hour.

Write for full particulars of the A-MP Cold Crimp Sleeve system.

COLD CRIMP SLEEVES

Another AMP first

AMP
AIRCRAFT-MARINE
PRODUCTS (G.B.) LTD



AMPLO HOUSE, SAFFRON HILL, LONDON EC1 TEL: CHA 2902

A-MP products and engineering assistance are available through associated companies in: U.S.A. - Australia - Canada - France - Germany - Holland - Italy - Japan - Mexico - Puerto Rico
A-MP IS A TRADE MARK OF AMP INCORPORATED HARRISBURG U.S.A.

high quality at the right price

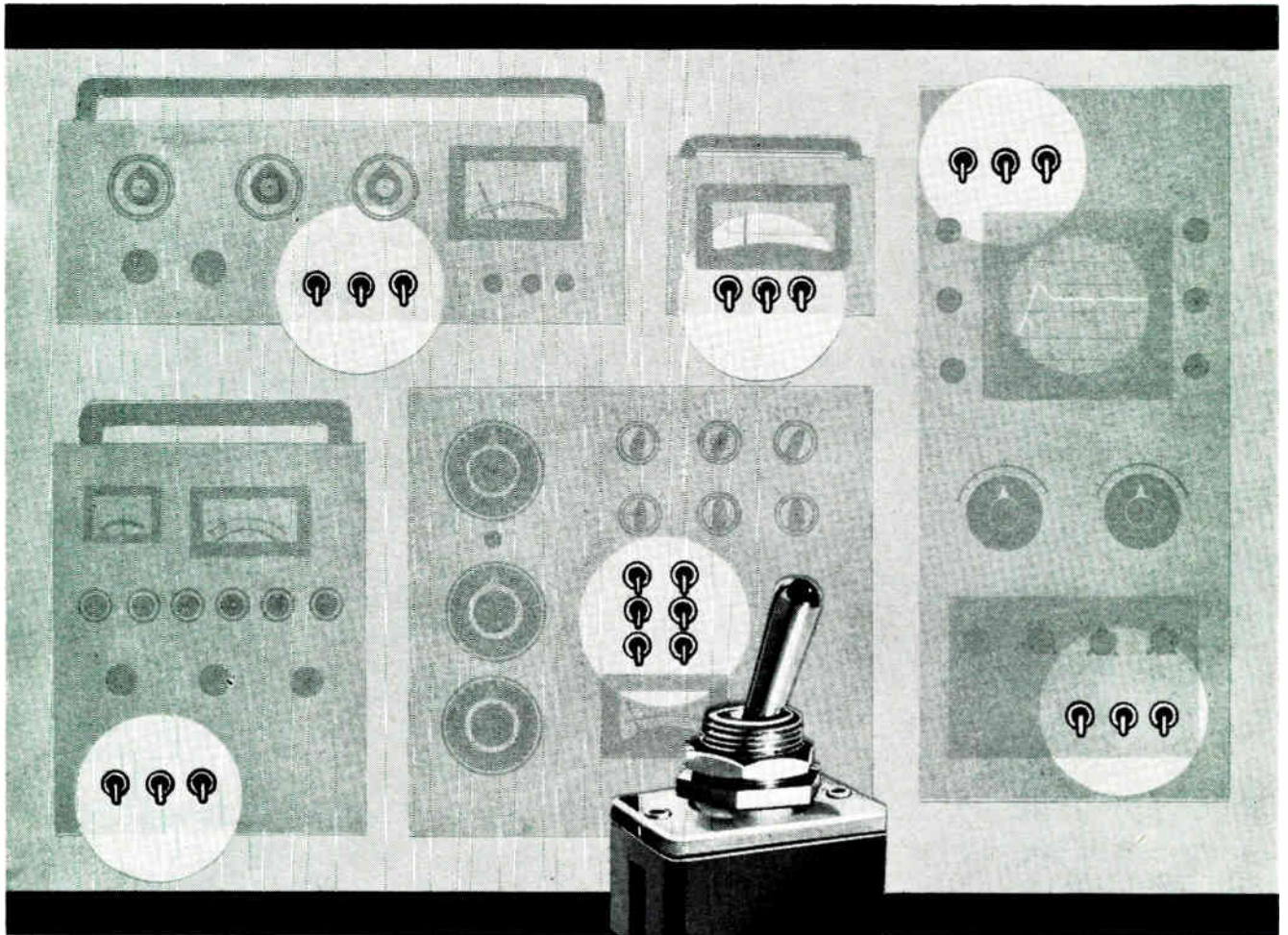

SEND FOR LEAFLET TS5 ABOUT OUR **3 AMP TOGGLE SWITCHES**



Painton & Co. Ltd

KINGSTHORPE
NORTHAMPTON

Telephone: Northampton 34251 (10 lines) . Telegrams 'Ceil' Northampton . Telex 31576

Australia Painton (Australia) Pty. Ltd. • Benelux Painton S.A. • Germany Deutsche Painton G.m.b.H. • Italy Painton Italiana S.p.A. • Sweden Svenska Painton A.B. • U.S.A. Painton Inc.

Comment

The Post Office station at Goonhilly Down, Cornwall, is being prepared for working with Syncom HS 303 satellite 'Early Bird', the first communication satellite planned to provide a regular telecommunication service between America and Western Europe. This announcement leaves unspoken and unpublished a compliment to the skill of all concerned with the station. Considering the planning, development and construction which have gone into Goonhilly the achievements so far are quite remarkable.

Access to the Goonhilly site was obtained in July 1961, and the entire installation—roads, buildings, aerial, control centre and a mass of complex equipment—was complete in time to participate in the first attempt to transmit television signals across the Atlantic via Telstar in July 1962.

During nearly two years of experiment the overall design of Goonhilly has been proved. The initial concept of an extremely rugged aerial without a protective radome and relatively simple equipment have provided about 99 per cent operation reliability. In addition, the installation cost considerably less than any comparable station.

Now, in the light of experience gained, a major extension of facilities is necessary for the transition from an experimental arrangement to a commercially-operational station. However, the modifications are only necessary to provide the flexibility and reliability expected of a commercial service.

Modifications are to be made to the existing large steerable aerial to improve the surface contour of the 85-ft dish and to increase its focal length. A second aerial of similar size and design to the first is to be erected and associated equipment for the two aerials will be installed.

Although this means that Goonhilly will be out of service for about six months while this work is in hand, other earth stations coming into operation in Europe will be able to receive transatlantic programmes and relay them to Britain through established links. This, of course, will provide an opportunity for the more-recently established earth stations to gain experimental experience.

Much of the work at Goonhilly will have to be done at speed so that the station is ready to operate with 'Early Bird' when it is launched to its operating altitude of 22,300 miles by the American Communications Satellite Corporation in the spring of 1965. However, we have no doubt that the engineers at Goonhilly will play their part in preparing their station in time for the first earth-satellite-earth commercial communication service.

Sharks

NASA has recently purchased a number of electronic shark repellors for possible inclusion in astronauts' survival kits. These devices generate electromagnetic radiation in the u.h.f. region which is believed to affect a sensory organ in the shark's nose. While other forms of marine life seem to be unaffected, sharks up to 75 feet

away from the transmitter promptly retreat, although the exact frequency which does the trick has yet to be identified.

The transistorized circuit produces a distorted square wave output with a p.r.f. of approximately one per second. The complete battery-powered transmitter unit weighs 1½ pounds and is capable of 18 hours continuous operation. The dipole aerial can be mounted

on a diver's air tank, waist belt or as flexible wires stitched along a leg of his suit.

Of more immediate importance to the tourist and fishing industries is the fact that this system could be adapted to power a network of dipoles designed to protect beaches, to keep sharks away from fishing vessels, or even to isolate complete fishing areas.

Although we have every confidence in electronics, we are not volunteering to test the efficiency of this particular piece of equipment.

Peking Exhibition

With the ever-increasing number of exhibitions being held each year we often sympathize with the sales director or manager who has to decide the worth of an exhibition to his company. This is particularly the case when, to participate in a show, equipment and staff must be shipped many thousands of miles away.

It was therefore pleasing to hear that, as a direct result of the SIMA Exhibition in Peking, British instrument manufacturers have received orders or are negotiating contracts to supply equipment to the total value of approximately £½ million. Frequently it is said that overseas business is there if one goes out for it—these exhibition results illustrate this point.

Measuring Television Audiences

The Americans seem to have gone one better than our own Post Office television detector vans with a mobile 'audience measurement' vehicle which can detect and record not only how many sets in a given area are switched on, but also to which channels they are tuned.

Aerials on the roof of the van pick up broadcast signals while a rotating aerial mounted on the bonnet scans both sides of the street to pick up the weak signals generated by the domestic receivers. The signals from the sets are then fed into a gating unit for comparison with the broadcast signals. The gate scans each channel sequentially and, if there is coincidence for four synchronous cycles, a count of one is recorded for the channel concerned. There is no possibility of counting the same set twice since, to pass through the gating system, the two signals must be in phase, and this condition can occur at only one point along the path of the vehicle.

The equipment is reported as being capable of counting between 50% and 75% of the receivers within range but, of course, it

only provides an 'instantaneous' picture of the audience distribution. So, although this system is claimed to offer a more sophisticated method of estimating television programme audiences, we feel that figures obtained in this way may in fact be statistically less meaningful than those derived from more conventional rating techniques.

Ranger Post Mortem

While the detailed causes of the failure of the Ranger VI lunar probe to send back close-up photographs of the moon remain something of a mystery, the findings of the Review Board looking into the matter have revealed weaknesses in design and test procedure that must be disturbing to the American taxpayer.

In order to account for the unscheduled switching on and off of the television system at an early stage of the flight, 'a possible but unlikely series of events' must be assumed to have occurred. During this period the telemetry signals were noisy and the television battery voltages were low indicating arcing and corona discharge. According to NASA, the switching on 'could have been caused by a vibration induced relay closure, a short or open circuit in any one of several connectors, or an electrical transient which triggered a control circuit.

The general criticisms levelled at the manufacturer included: failure to provide sufficient redundancy in the camera system; a layout which rendered exposed terminals very vulnerable to short circuiting by contamination; excessive reliance upon wired connections instead of r.f. links during ground testing; failure to test the directional aerial in conjunction with the high-power transmitters; and, perhaps most surprising of all, failure to make a complete check of the television system within 12 days of the launching.

Rather than undertake a complete re-design of the television system, which would delay the programme still further, NASA have decided to incorporate in Ranger VII a number of modifications. These will, amongst other things, minimize the likelihood of short-circuiting, permit more thorough ground tests, and provide more telemetered data on the behaviour of the system during flight.

As all this appears to be a considerable indictment against the makers of the Ranger vehicles, perhaps it may not be entirely irrelevant to mention the pressure under which prime contractors in the U.S. space programme are forced to operate in order to meet delivery dates. However, let us hope that Ranger VII will succeed in providing man's first close-up view of the lunar surface.

ROL SYSTEM 2 ELLIOTT SEQUENCE CONT EM 3 ELLIOTT SEQUENCE CONTROL SYST LIOTT SEQUENCE CONTROL SYSTEM 5 EL CE CONTROL SYSTEM 6 ELLIOTT SEQUEN

By G. S. SMITH, A.M.I.Mech.E.*

When a number of operations has to be performed in sequence and the cycle of operations repeated indefinitely, it is usually possible to arrange for this to be done automatically. It is not always economical to do this in conventional ways unless a very long production run is expected. This article describes equipment which enables the 'programme' to be varied very simply and the amount of control to be expanded or contracted as required. It is suited especially for short production runs.

FULLY automatic production lines are in operation in many of the larger industries, but they are almost entirely confined to mass-production units where continuity of production is maintained over a long period of time. Generally speaking, however, these systems are costly to install and are inflexible in use, and for these reasons they have failed to appeal to the small and medium batch producer. With the introduction of the Elliott

Sequence Control System, the demand for an economical, flexible and versatile system can now be met.

An Economic Approach

The system is designed to provide an automatic control of virtually any process involving a number of discrete operations in sequence. It is also capable of being added to at any time without the necessity of changing the initial installation. Thus it is possible to apply automatic control

*Elliott Bros. (London) Ltd.

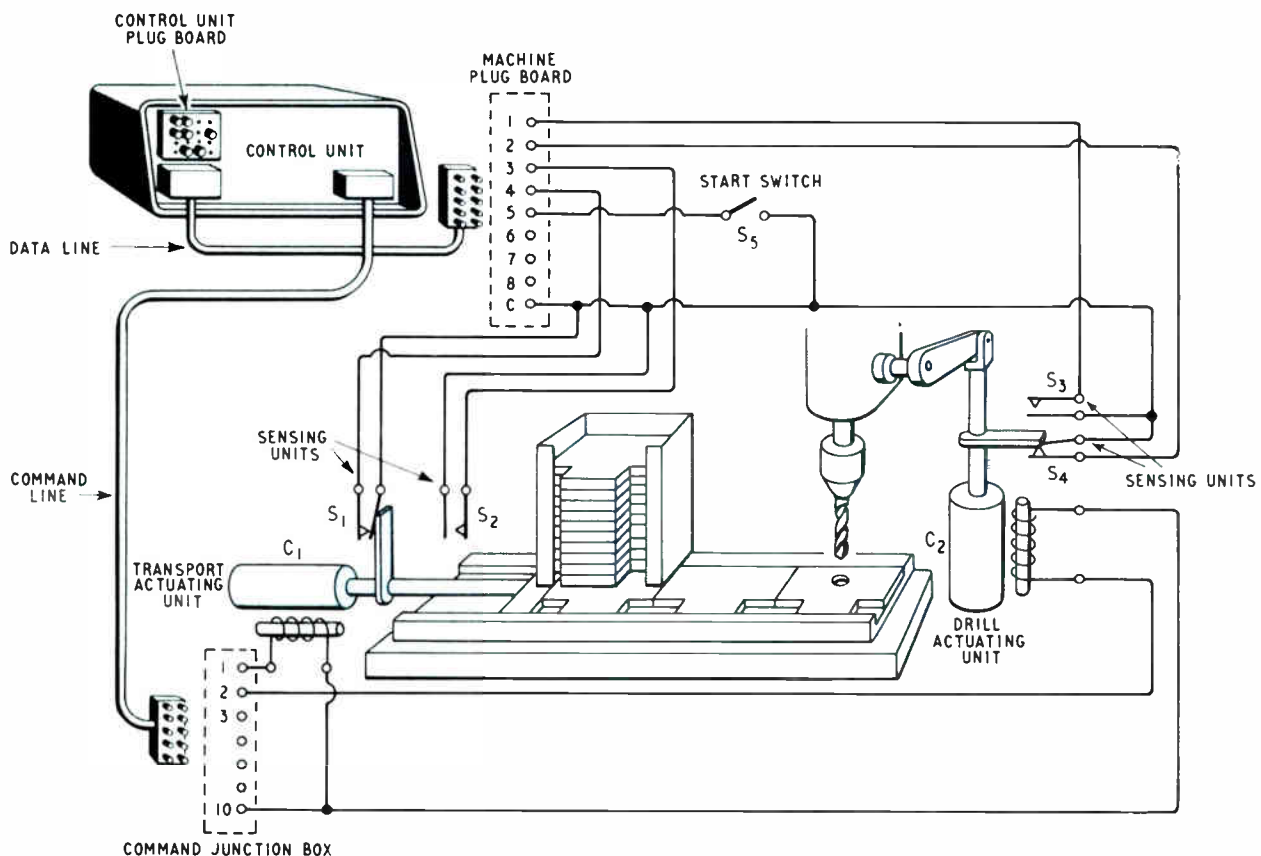

Fig. 1. Block diagram of the sequence control system

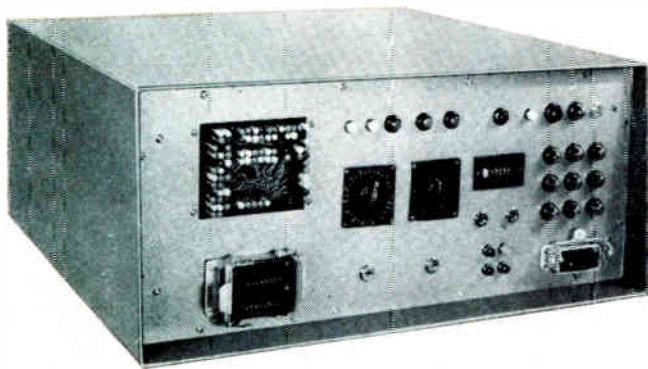

Fig. 2. Sequence control unit

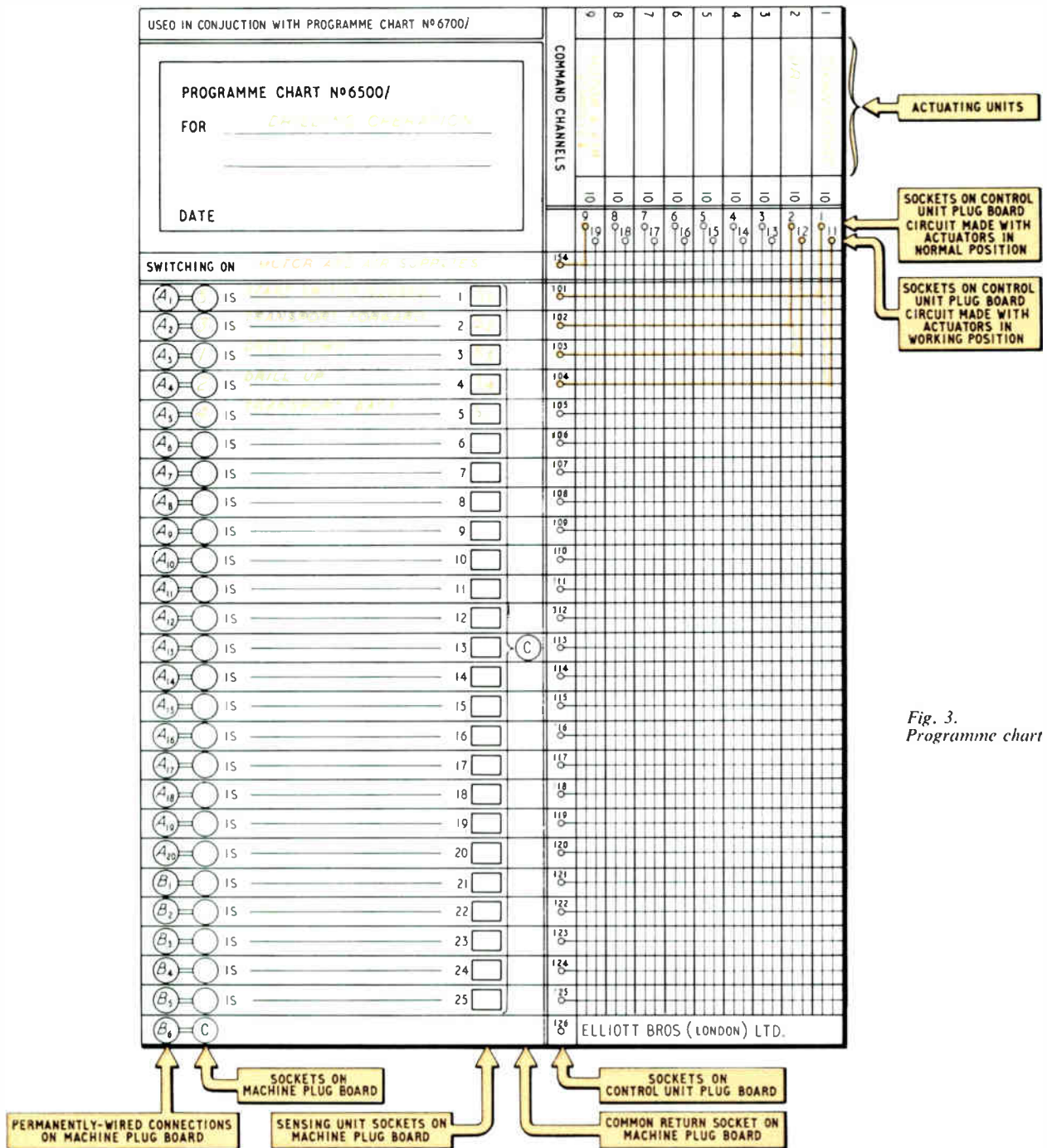

Fig. 3. Programme chart

in the first instance to a confined field of operation, and when experience indicates that expansion of the system is desirable, this can be done quite readily on the 'building-brick' principle. From this it follows that the introduction of automatic control does not require a large capital outlay, and that the gradual build-up of a fully automatic process can be kept within an economical limit. One of the factors to be taken into consideration when contemplating the introduction of an automatic process for the first time is whether the system will be capable of controlling this process for a period of time long enough to recover the cost of the system. This very often involves some long range forecasting. The Elliott Sequence Control System, on the other hand, makes it possible to apply automatic control to the process as it exists at the moment and to modify or expand the system to suit the future pattern of production.

The Sequence Control System

The system consists of four basic elements; an electronic control unit, a sensing system, an actuating system and a programme chart. The sensing system can consist of micro-switches, photoelectric cells or other types of transducer; in fact any combinations of these, providing they are capable of giving a suitable electric signal. A large range of sensing units exist and these are readily available, reliable in operation and require virtually no maintenance. Similarly the actuating system can be built up from existing standard components, either electric, electro-pneumatic or electro-hydraulic, depending upon the particular application.

Fig. 1 illustrates the relationship between these basic elements and shows in a simple form the principle on which this system is based. This illustration shows a two-action system; i.e., a drilling operation and a feeding operation. The sensing device consists of two pairs of limit switches and the actuating system of two solenoid-operated pneumatic cylinders. Cylinder C_1 feeds the component forward under the drill. When switch S_2 is made a data signal is fed into the control unit which indicates that this operation is complete. The programming in the control unit then causes a command signal to be fed to the solenoid controlling cylinder C_2 , so that the drill is lowered to perform the drilling operation. When switch

S_3 is made, the data signal thus produced is fed to the control unit to indicate that this operation is complete, and the control unit then initiates the next command signal, which is to raise the drill. At the completion of this stroke, switch S_4 produces a data signal to indicate that the drill is now raised and the control unit then initiates the next command signal which is to retract the feed arm on cylinder C_1 and switch S_1 gives a data signal. This cycle of sequences can then be repeated ad lib.

It will be obvious that Fig. 1 has been deliberately over-simplified in order to explain the principle of the sequence control system, but it needs little imagination to appreciate that by the addition of a few extra actuating members, such as a clamp for the workpiece, a photoelectric cell to count the components as they are drilled and two checks to ensure that the drill point is intact and that there are components in the hopper, then this simple drilling operation could be made into an automatic production cycle.

The Control Unit

This consists of a dust-proof steel cabinet which houses the transistorized switching unit and a power pack, and is shown in Fig. 2. The front panel contains all the control switches, the plug board and the data and command line sockets, together with a counter which registers the number of cycles of operation which have been completed. The bank of nine lights on the right-hand side of the front panel is used to indicate the particular 'line' of the programme which is in operation at any time.

The unit also provides the facility for operating each sequence of operation in a given cycle independently by means of push-button control. This is achieved by setting the hand-operated switches in the centre of the front panel to the appropriate number on the programme chart and when the 'test' push-button is depressed the actuating member will perform one action only. This feature is particularly useful when setting up a new programme and allows the length or speed of stroke of the actuator and the position of the sensing devices to be adjusted correctly.

An auxiliary programme box is also provided which is used to control operations which are not required in every cycle. A typical example would be the re-charging of a machine with raw material. A repeat test box provides the

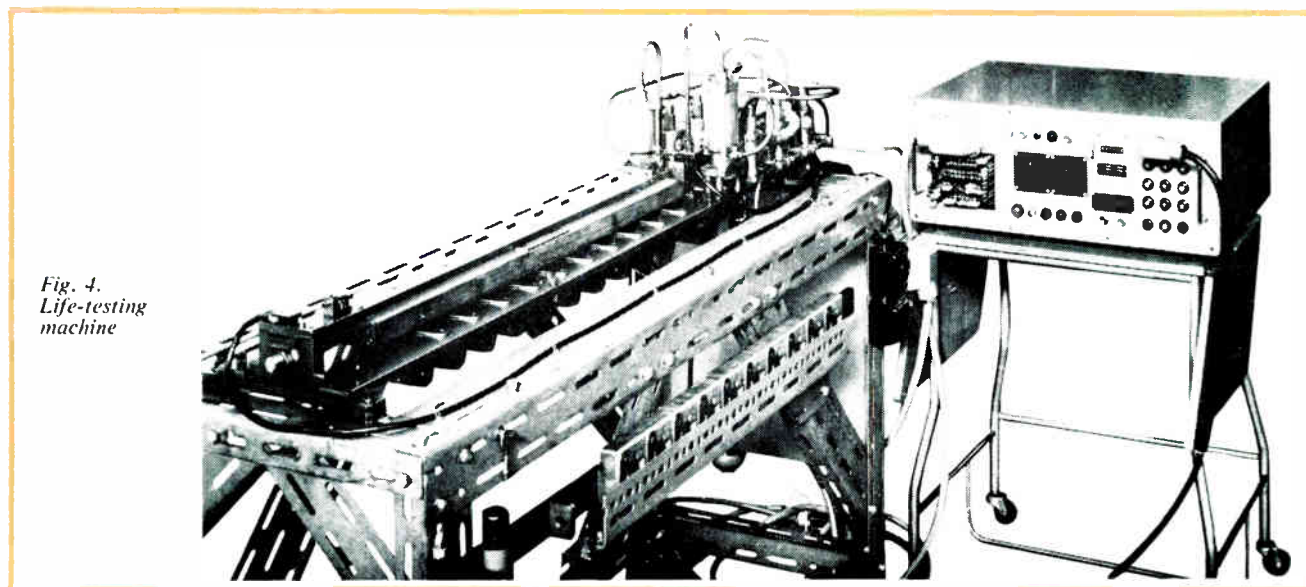

Fig. 4.
Life-testing
machine

Fig. 5. Stamping press



facility of isolating any particular function and repeating this function continuously without going through a complete cycle of operations, again a useful feature when setting up a new programme, and perhaps equally important, it greatly assists in locating the cause of any intermittent faults which are normally so difficult to track down in any piece of equipment.

Programming

The preparation of the programme follows a logical sequence and does not use a special code or 'language'. The chart shown in Fig. 3 is used to prepare the programme and the sequence of operations is written in the left-hand column in the order in which they are to be performed. These are always written in the form of a question, such that to ensure the correct functioning of the system the answer will be 'yes'. The column in the top right-hand corner is used to list the actions to be controlled. The information on the chart enables the planner or the machine operator to prepare two plug boards, one for the control unit and one for the machine.

Each plug board consists of a sheet of Perspex with equi-spaced holes in each direction which are numbered in a

fixed pattern. By placing the Perspex on a printed template which is supplied, the number of each hole can be determined, and from the programming chart, sockets are inserted in the appropriate hole number. The sockets are supplied in pairs with an inter-connecting wire. From the example shown in Fig. 3, the control-unit plug board would be prepared by inserting pairs of sockets in hole numbers 154 and 9, 101 and 1, 102 and 2, etc. Similarly the machine plug board would be prepared by inserting pairs of sockets in holes A1 and 5, A2 and 3, A3 and 1, etc.

These boards then become a permanent record of a particular programme and are easily stored for future use. The change from one programme to another is a simple operation and is achieved by removing one set of plug boards and replacing them with a new set. The electrical connections are made by inserting pins through each socket into the permanently-wired sockets in the control unit and the machine junction box.

Applications

The sequence control system can be applied to virtually any process which consists of a sequence of discrete operations, and apart from the obvious choice for machine-tool control, it is also capable of providing automatic control and co-ordination of other processes, such as mixing, heat treatment, press tools, welding, etc. Fig. 4 shows a sequence-control unit applied to a life-testing machine for mortice locks. The machine is arranged to take a batch of ten locks and subject these to a continuous locking and unlocking process, each cycle of operations being registered on the control unit counter. In the event of failure of any one lock the machine stops and the cause of the failure can be investigated.

Fig. 5 shows a conventional stamping press which has been adapted with a hopper feed. In this instance the feeding of the components is under sequence control. An interesting feature of this system is the two Perspex guards, one in front of the hopper and the other over the feed ram. These are wired into the system so that in the event of a guard being removed the cycle of operation immediately stops.

The automatic-welding machine shown in Fig. 6 has a rotary indexing table with ten assembly fixtures used for locating components prior to spot welding. The table is indexed one station automatically when each fixture has been loaded and the spot-welding operation is performed at the rear station behind the shield. Automatic checks are also incorporated to ensure that the components are assembled correctly in the fixtures.

These few examples will serve to illustrate the versatility of this system and will give some idea of the range of processes which lend themselves to sequence control.

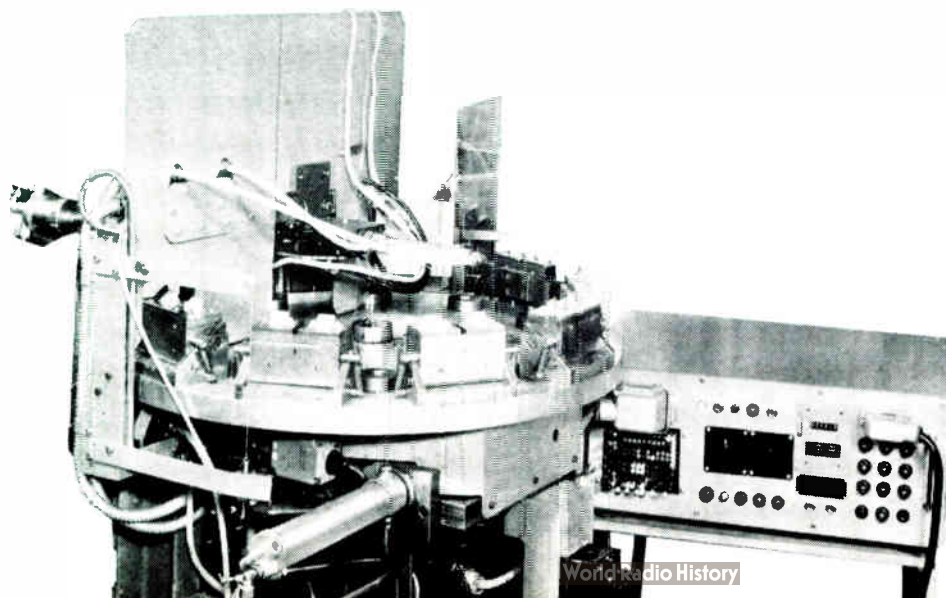

Fig. 6. Automatic-welding machine

The basic principles of inertial navigation are simply explained in this article. The system enables position to be found without any external aids.

INERTIAL NAVIGATION

By A. R. M. MURRAY, B.Sc., D.C.Ae.*

SINCE the term started to appear in fairly general usage about the time of the V2, inertial navigation has taken giant steps forward, and has found its way into many types of vehicles. The submarine *Nautilus* was fitted with an inertial-guidance system on its historic journey under the North Pole, and many other spectacular applications of inertial guidance have come to the public eye.

The hallmarks of an inertial-guidance system are that it is unjammable, accurate, self-contained, and small. These factors have made it an obviously attractive device for military applications. Its value, however, is not restricted to the military field. The fact that it is self-contained and accurate makes it an attractive proposition for civil airliners and for merchant ships such as long range tankers. When used in an airliner the system does not require ground stations in inaccessible regions of the earth. For ships, bad weather does not cause any interference as in conventional methods that use astronomical observations.

The basic idea behind inertial navigation is that if we have some means of measuring the acceleration (and also, of course, deceleration) of a vehicle, we can compute its velocity and the distance it has travelled. This idea can be illustrated by considering what happens, for example, when driving a motor car. Suppose the car is started from rest and driven along a straight flat road. The car accelerates from rest until it reaches a speed of, say, 30 m.p.h. We are aware of this acceleration by the way in which we are forced back in our seat. When we ease our foot off the accelerator pedal, and cruise at a uniform speed of 30 m.p.h. the acceleration stops and we are no longer pressed against the back of the seat. If we had some means of measuring how hard we were pushed against the seat, we could estimate the acceleration of the car. By integrating this acceleration with respect to some time standard, we should get the velocity of the car. In the case when the car is accelerated uniformly, this velocity is just the product of the acceleration and the time for which it is applied. In a similar manner we can integrate the velocity with respect to time, to obtain the distance gone.

This then is the requirement in inertial navigation: to have some means of measuring the acceleration of a vehicle

and, by two successive integrations with respect to time, calculate its velocity and the distance travelled in that time.

The requirement in a car is fairly simple, since we are only interested in the forward motion but in an aircraft, for example, the motion can be three-dimensional and we have, therefore, to measure acceleration in three directions at right angles to each other.

The word 'inertial' arises from the use of the fundamental inertial properties of two types of instruments—the accelerometer and the gyroscope. The accelerometer has the property of detecting acceleration with respect to inertial space, and the gyroscope possesses the property of detecting rotational motion in inertial space. By examining a

Production of Ferranti high precision gyroscopes and accelerometers for inertial navigation systems used in military aircraft, rockets and guided missiles, as carried out in a modern shock and dust proof building

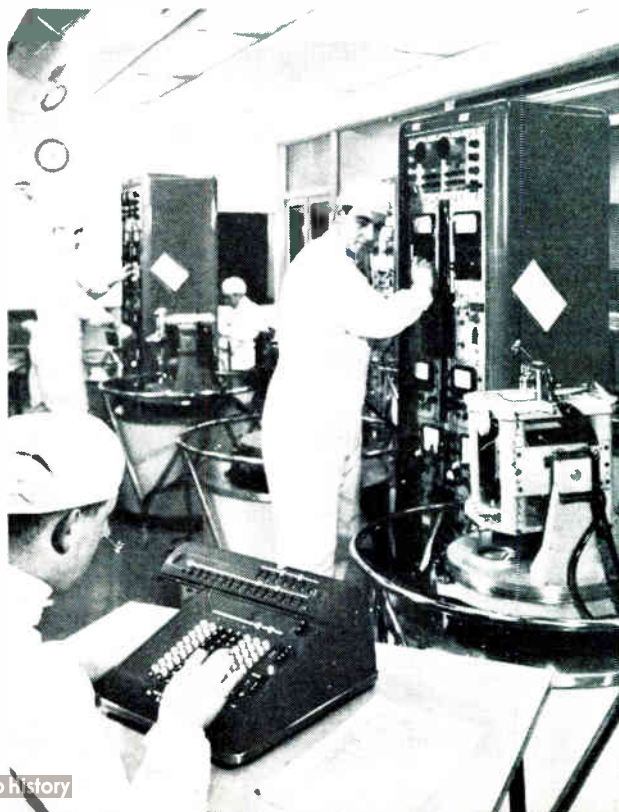

*Ferranti Ltd.

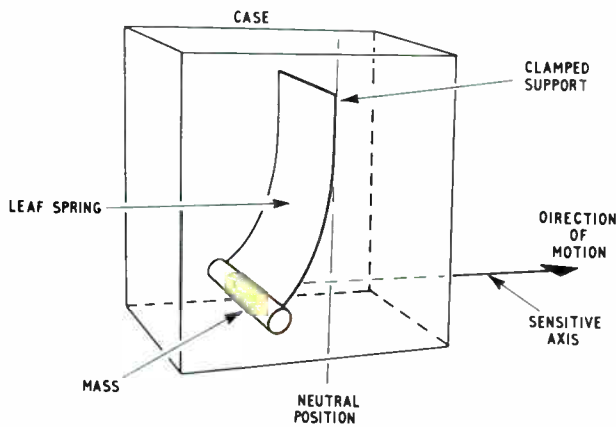

Fig. 1. Simple accelerometer. A mass supported by a leaf spring tends to 'remain behind' when the case is accelerated

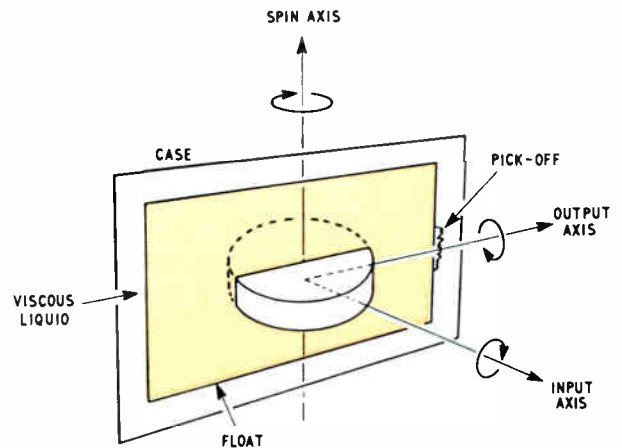

Fig. 2. In a gyroscope the rotating mass is supported in a viscous liquid

simple example of each type of instrument, the meaning of the word 'inertial' will become clearer.

Each of these examples is of a single axis device, since this is the simplest kind, and the majority of practical instruments of both types are of this form.

The Accelerometer

A simple form of accelerometer is shown in Fig. 1. It consists of a small mass supported on a leaf spring clamped at one end. If the accelerometer case is accelerated from rest in the direction shown, then the mass, as it were, remains 'inert' and is left behind; i.e., the spring deflects in the opposite direction to the direction of motion. An electrical pick-off produces a voltage proportional to this deflection, and hence to the acceleration sensed by the instrument.

The velocity and the distance travelled by the accelerometer, are then computed from this signal in the manner described above.

In general terms, the accelerometer will indicate any difference between the force acting on its case, and that acting on the sensitive mass.

Examination of this statement will show that the signal produced by an accelerometer moving over the surface of the earth contains in general a component of local gravity, in addition to the acceleration involved in moving the accelerometer relative to the earth.

To give an indication of the order of accuracy to which an accelerometer must work, suppose that immediately after the vehicle starts from rest, a bias error of $10^{-4}g$ arises in the instrument, due to some imperfection. This acceleration bias error would produce a distance error of 23 ft. after 2 minutes and 21,000 ft., or $3\frac{1}{2}$ miles, after 2 hours. These figures show that the accelerometer must indeed be a precise instrument.

If an accelerometer were being used to detect motion over the earth in a plane perpendicular to the local gravity vector, then a tilt of the input axis out of this plane of as little as 20 seconds of arc would cause the above bias error of $10^{-4}g$, and so the maintenance of accurate alignment of the accelerometer in the presence of local g is obviously most important.

The Gyroscope

The gyroscope is basically a spinning rotor (see Fig. 2). The axis of this rotor will remain 'inert' or fixed in space if no disturbing torque is applied to it. If, however, a

gyroscope is rotated about an (input) axis which is normal to its spin axis, then a torque proportional to the input rate will be generated about a third (output) axis orthogonal to the other two. In general this torque is dissipated in accelerating the gyro about its output axis and overcoming any damping and spring restraint about this axis. By supporting the rotor in a gimbal surrounded by viscous fluid within an outer case the gyro can be designed so that the damping is the dominant term. Since the viscous damping is proportional to output rate, the latter is proportional to input rate, and hence, output angle is proportional to input angle.

By arranging an electrical pick-off on the output axis a voltage is provided which is proportional to the angle through which the gyro is turned about its input axis.

This form of gyro is called a rate-integrating, or position gyro, and is the type used in inertial navigation.

Another important feature in the construction of this instrument is that it is possible actually to float the gimbal in the viscous fluid, thereby removing all load from the gimbal bearings, so that friction can be virtually removed.

Stable Platform

The accelerometers and the gyroscopes are bought together on a stable platform or table, which is supported in the vehicle by a set of gimbals, which isolate the platform from any rotational movement of the vehicle. The function of the accelerometers is to measure the motion of the platform, and that of the gyros is to maintain the platform 'inert' in some reference orientation, so that the accelerometers have a convenient set of axes in which to work.

Stabilizing a Platform

By arranging three single-axis gyros at right angles to each other, they can be made to maintain the platform in a certain orientation in space. Fig. 3 illustrates how this is accomplished.

Suppose that the platform wanders by an angle ξ about the input axis of any one of the gyros. The gyro senses this change of orientation and produces a voltage proportional to ξ . This voltage is amplified and fed to the relevant gimbal servomotor, which drives the platform round in the opposite sense to null the error angle. By using the three gyros in this manner the platform can be maintained in its orientation in space.

These gyros are also provided with an internal torque motor on the output axis. Using the servo described above,

it is then possible to rotate the platform by feeding the appropriate torquing currents to the gyro torque motors. Effectively the servos continuously null the platform to a rotating reference.

Note that, if a space-stabilized platform is placed at a point on the earth's surface, it appears to rotate with respect to the earth. This differential rotation is, of course, due to the earth rotating in inertial space beneath the platform. To navigate a vehicle over the surface of the earth in local co-ordinates this apparent motion of the platform may be undesirable. This difficulty can be overcome by feeding torquing currents to the gyro torque motors so that the angular motion between the platform and the earth is nulled. In general, the platform can be rotated in space under any desired law, by feeding the appropriate computed signals to the gyro torque motors.

Having seen how the gyro regulates the behaviour of the platform, it is now possible to see how accurate the instrument must be. If, for instance, the gyro controlling a platform about the vertical developed a drift rate of $0.08^\circ/\text{hr}$ in an airliner like the Concord travelling at say 1,500 m.p.h., then the cross-track position error due to this drift would be 1 mile after 1 hour.

Manufacture

The greatest problem in inertial navigation is to obtain accelerometers and gyroscopes of high quality, since the accuracy of a navigation system can never be better than

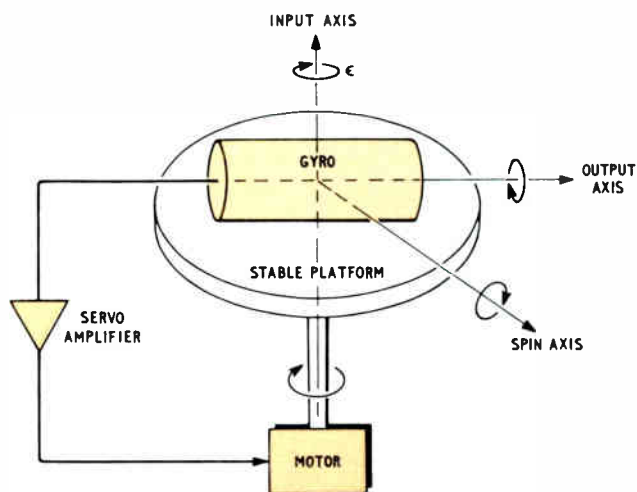

Fig. 3. A platform can be stabilized in space by three gyroscopes. Here one is shown to produce rotational stability only

that of the instruments on which it is based. To achieve and maintain the required accuracy the assembly of these instruments has to be done under conditions much cleaner than the average surgical operating theatre.

Automatic Cake-Baking Plant

To exercise efficient remote control of the baking process, twelve Westool Warner electro-magnetic brakes and clutches are incorporated in the 80-ft long Baker Perkins automatic cake-baking unit recently installed at their Osterley factory by Macfarlane Lang & Co.

The complete baking process from the raw materials to

the perfectly baked and cooled cake is regulated from one single, push-button control panel. A labour force of six is all that is needed to cope with an hourly production rate of more than 1,000 cakes.

For further information circle 37 on Service Card

General view of Macfarlane Lang's automatic cake-baking plant. (Right) The control panel

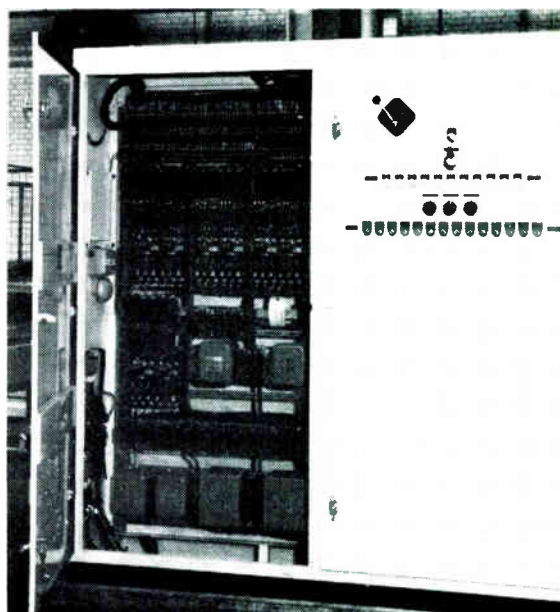
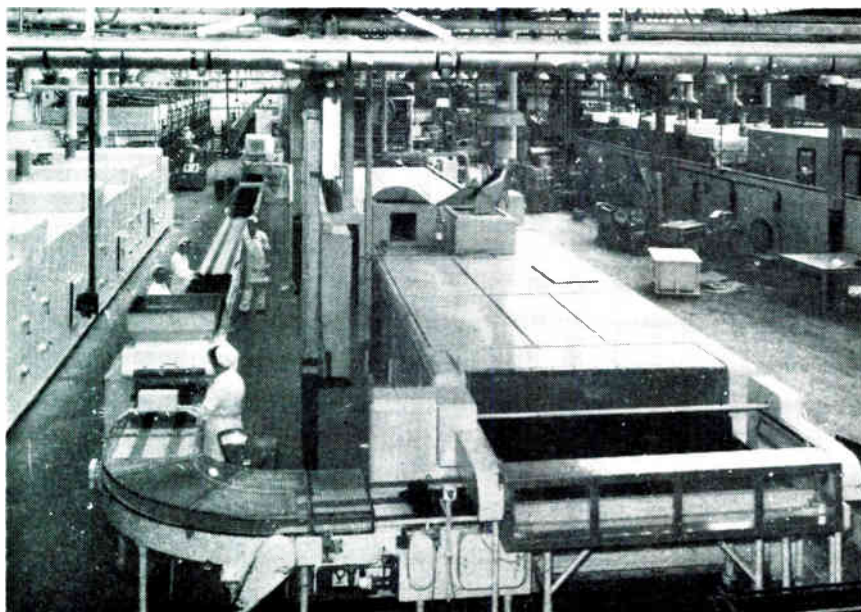

DIGITAL TECHNIQUES IN INDUSTRY

DATA-HANDLING EQUIPMENT FOR A HIGH-SPEED WIND TUNNEL

By F. SHAW*

In wind-tunnel experiments it is required to transfer the outputs of chart recorders to punched paper tape for subsequent feeding to a computer. This article describes the digital equipment employed for this purpose.

THE high-speed wind tunnel of the Hawker Siddeley Aviation Ltd., Hawker Blackburn Division, operates by the controlled discharge of a large quantity of air, pumped over a number of hours into high pressure storage tanks. The air is discharged in a few seconds. The position of the wind tunnel model is changed each second during the wind-tunnel run and the parameters (forces, torques, etc.) affecting the model are recorded during the run on a bank of 12 chart recorders with $\frac{1}{3}$ -sec rebalance times.

*Lancashire Dynamo Electronic Products Ltd.

It is required to monitor the chart recorders to an accuracy of 1 part in 1,000, and just prior to the model position change, to record the chart-recorder readings. The most suitable form of record is a punched paper tape which can be used either with a page printer to give a tabulated set of readings, or can be fed directly into a general-purpose digital computer for data analysis. Fifty-two lines of tape require to be punched each second, including the command instructions for the page printer and computer.

Functions of the Data-Handling System

The function of recording the data can be broken down into the following sections:

1. Record the readings of the pen recorders in a digital form and in a short period. The conversion of the analogue pen-recorder information to digital form is

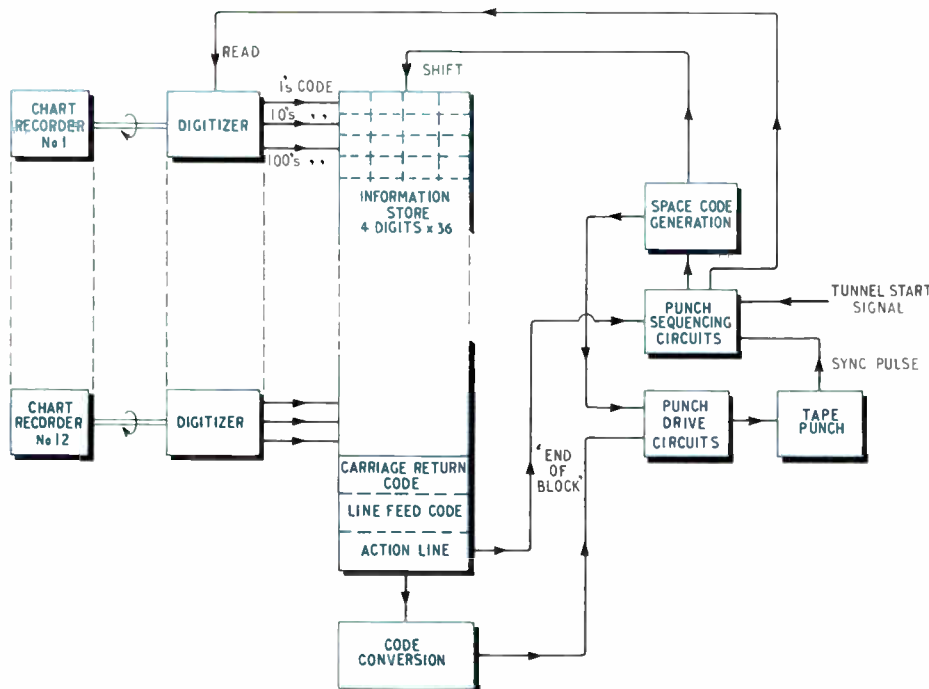
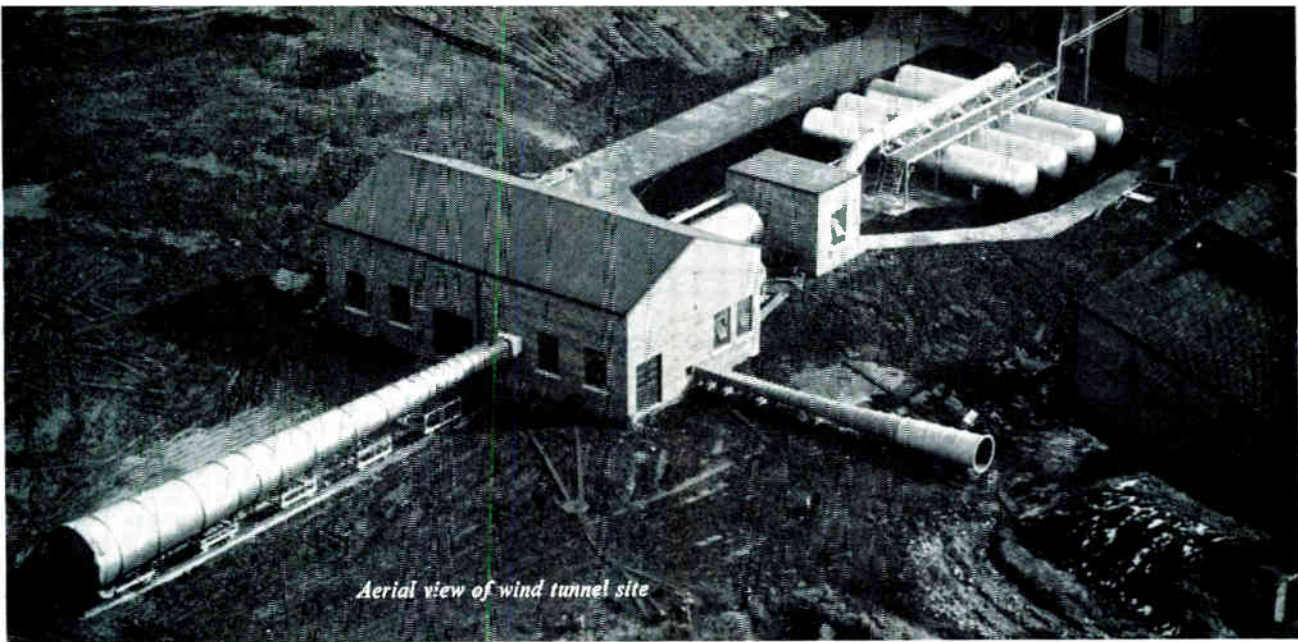

Fig. 1. Block diagram of the equipment



- achieved by driving contact-type mechanical digitizers from the recorder mechanism.
2. Store the recorded information until it is required to be transferred to the punched tape. Convert the digitizer code into that used by the general-purpose digital computer.
 3. Insert the additional codes required to achieve the desired print out from the page printer (that is, the carriage return and line feed codes) before each group of twelve recorder readings, and the space code between the individual recorder readings in a scan.
 4. Sequence the information into the tape punch and provide power for the punch drive solenoids.

The Equipment

Data Recording

A block diagram of the equipment is shown in Fig. 1. The first operation is the transfer of information from the pen recorders. The digitizers used for this function are of the multi-turn contact type using flush faced printed-circuit coded discs and gold-alloy brushes. The code used on the digitizers is a cyclic progressive binary code. This type of code has not been mentioned in previous articles in this series and is used by the digitizer manufacturer to avoid troubles associated with inaccuracy of the printed-circuit pattern on the coded disc. Only one digit of the binary code changes at any one time, thus avoiding the need for "V" scanning, which is necessary when using the more usual 8 4 2 1 binary decimal code to avoid ambiguity of reading at code-change points.

The code is shown together with the more normal 8 4 2 1 binary decimal code in Table 1. It can be seen

that the individual digits of the code have no decimal, or any other counting scale, meaning and it is therefore not possible to use the code for calculation. The code simply uses four on-off digits to represent a decimal digit, the codes being selected on the principle of one digit change only at each code change.

Information Store

The store uses the standard transistor binary units which have been described in previous articles, one for each binary digit of information to be stored.

Twelve digitizers are 'read' simultaneously, each presenting information to an accuracy of one part in 1,000; i.e., decimal numbers from 0 to 999. As four binary digits are required to represent each decimal digit, there are 12 binary digits to be stored for each digitizer. The storage required for all 12 digitizers is therefore 144 digits.

TABLE I
Binary codes used in the equipment

Decimal Digit	Cyclic Progressive Binary Decimal Code				8.4.2.1. Binary Decimal Code			
	W	X	Y	Z	8	4	2	1
0	0	1	0	1	0	0	0	0
1	0	0	0	1	0	0	0	1
2	0	0	1	1	0	0	1	0
3	0	0	1	0	0	0	1	1
4	0	1	1	0	0	1	0	0
5	1	1	1	0	0	1	0	1
6	1	0	1	0	0	1	1	0
7	1	0	1	1	0	1	1	1
8	1	0	0	1	1	0	0	0
9	1	1	0	1	1	0	0	1

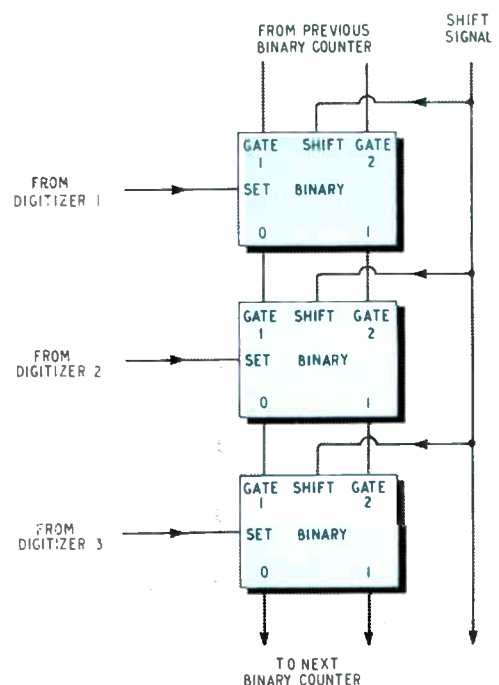

Fig. 2. Form of shift register

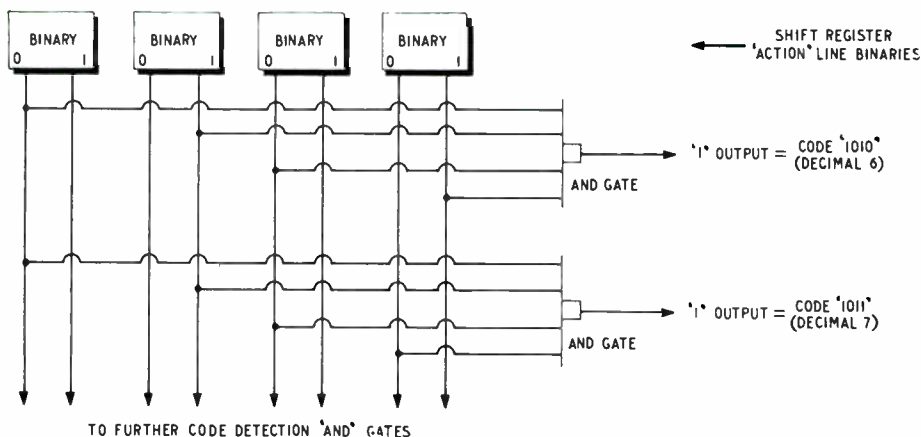

Fig. 3. Conversion of the digitizer code to decimal is accomplished with the aid of AND gates

The punched tape accommodates one decimal digit on each 5 hole line, commonly called a character. The store is constructed to hold one character per line, and is therefore 4 digits wide by 36 digits long. This layout will be seen to be the most suitable when the code-conversion and tape-punching sections are described.

Information is transferred from the digitizers to the store by wiring the set inputs of the binary counters forming the store to the digitizer outputs. When a 'read' voltage pulse is applied to the common terminal of all the digitizers, the binary counter is set into the '1' state, if the digitizer output is a '1' signal on the relevant track. If the digitizer

output is a '0' signal, the binary counter remains in the reset state.

The store is wired as a shift register, 4 digits (one character) wide, by 36 lines long. To form the shift register the '0' and '1' outputs of each binary counter are connected to the gate inputs of the corresponding binary counter in the next line of the register, as shown in Fig. 2. The shift inputs of all the binary counters are connected together.

Three additional lines are added at the bottom of the register to accommodate the carriage-return and line-feed codes and to provide a blank 'action' line in which the character to be code-converted and punched is held for the duration of the processing period.

The application of a shift pulse to the shift register transfers all the information down the register one line. If a binary '1' digit is present in one line it will be transferred to the next line. If no '1' digit is present the next line binary will be reset.

Binary Code Conversion

The conversion from the cyclic progressive binary-decimal code of the digitizer (which is the code in which the information is stored) to the '8 4 2 1' binary decimal code required by the general-purpose digital computer, is achieved in two stages. First, the digitizer code is converted to decimal digits. The code of each line of the store is recognized when it appears in the 'action' line of the register, by connecting 10 AND gates of 4 inputs each to the 'action' line binary counter. Each AND gate recognizes a decimal digit, and is wired to the '0' and '1' outputs of the 'action' line binaries so that when the relevant code appears, all the AND inputs receive a '1' signal. A '1' signal will then appear at the AND output. For example, to detect the code 1010 (decimal 6) the AND gate inputs are connected to the '0' output of the first binary counter, the '1' output of the second binary counter, the '0' output of the third binary counter and the '1' output of the fourth binary counter. Fig. 3 shows the connections.

To recognize the two additional codes, 'carriage return' and 'line feed', two further AND gates are required, all twelve being connected to the outputs of the 'action' line binary counters.

The outputs of the AND gates represent the presence of the appropriate decimal digit if a '1' signal is present and the absence of that digit if a '0' signal is present. Only one of the twelve AND gates will generate an output at any given time, of course.

The conversion of these decimal signals to the binary

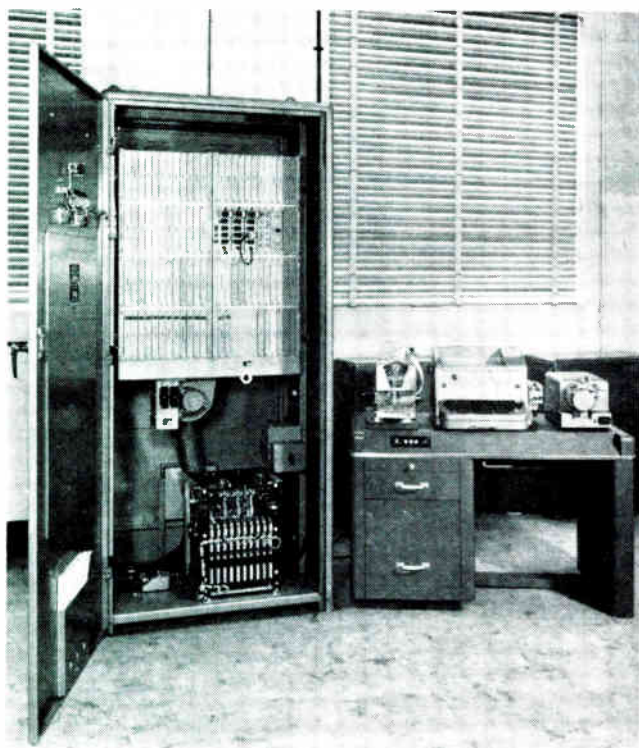

L.D.E.P. data system with Creed editing equipment and Teletype output punch

L.D.E.P. data logging system installed at the high-speed wind tunnel of Hawker Blackburn Division, Brough

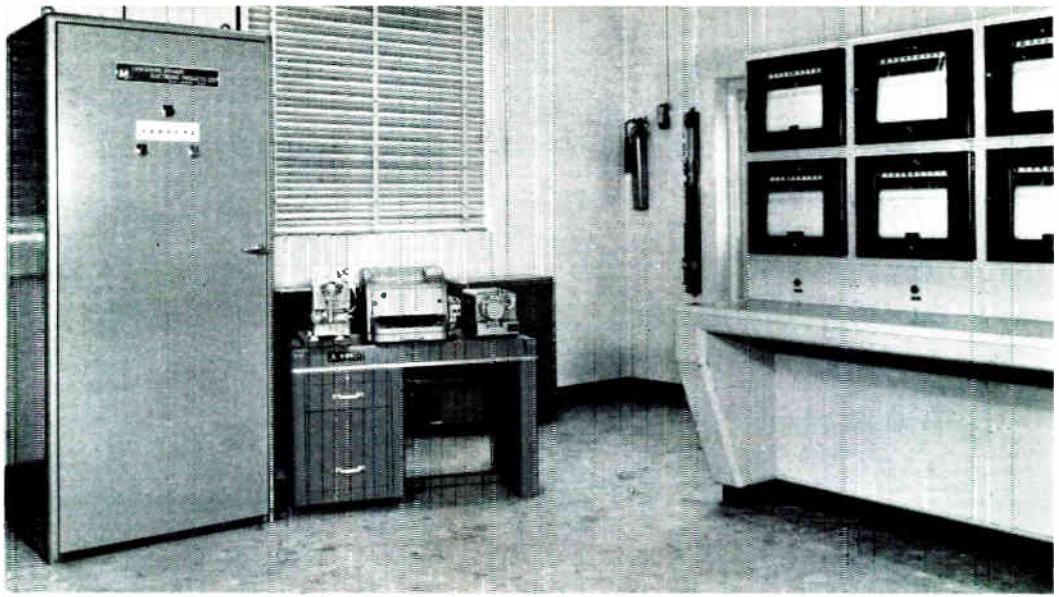

8 4 2 1 code is achieved using the OR gates shown in Fig. 4. An '8' binary digit is required if either the '8' or '9' code detecting gate has a '1' output. Similarly a '4' binary digit is required when either the '4', '5', '6' or '7' code detecting AND gates generate a '1' output.

Trigger units are required between the AND and OR gates of the code conversion to enable the decimal signals to be fed to more than one OR input.

Parity Checking

Only four tape holes per line are used to carry information. However, a standard 5-hole tape is used, the fifth hole being used to check the correct operation of the punch

and subsequent reading equipment. This is done by arranging that all characters punched on the tape contain an odd number of holes, so that a digit gained or lost in the punching or reading process is always recognized as an error. It can be seen from Table 1 that an additional hole is required when the codes for the decimal digits 0, 3, 5, 6 and 9 are punched. The additional hole is called the parity check digit, and it is generated in the decimal/binary coded decimal section of the code conversion circuits.

Insertion of Space Code

The space code is required to separate the reading of each digitizer when the tape is fed into the page printer. An obvious method of achieving the desired result is to increase the size of the information store by 12 lines and insert the space codes here. A more economical solution is to use a ring counter to count the lines of tape punched and after every three lines hold back the next line of recorder information (which will relate to the next digitizer) and insert a space code instead.

A ring counter is a number of binary counter units connected similarly to a shift register as shown in Fig. 2 with the additional connection of the final binary-counter outputs to the input gates of the first binary counter. A binary digit in the ring counter will circulate round the binary counters and not be lost from the last binary counter as is the case in a shift register.

The ring counter is four binary digits long and counts the pulses applied to the feed solenoid of the tape punch. These pulses are used to generate the shift pulses fed to the information store shift register. Every fourth shift pulse is applied to the ring counter but not the shift register. When the ring counter has a binary digit in its fourth binary counter the space code is fed to the punch solenoids by means of OR gates.

Tape Punch Sequencing

Since 52 lines per second require to be punched, a high-speed punch is required, and a Teletype Type 110 is actually used. This type of punch operates from six solenoids, one for each hole, and a feed solenoid used to move the tape to the next line. A pulse is required on all six solenoids simultaneously. The punch flywheel, which runs continuously and is clutched on to the punch mechanism when required has a magnet inserted in its outer edge which generates a synchronizing pulse on passing an induction pick-off. This pulse is used to determine the timing of the pulse fed to the punch solenoids. The pick-off is

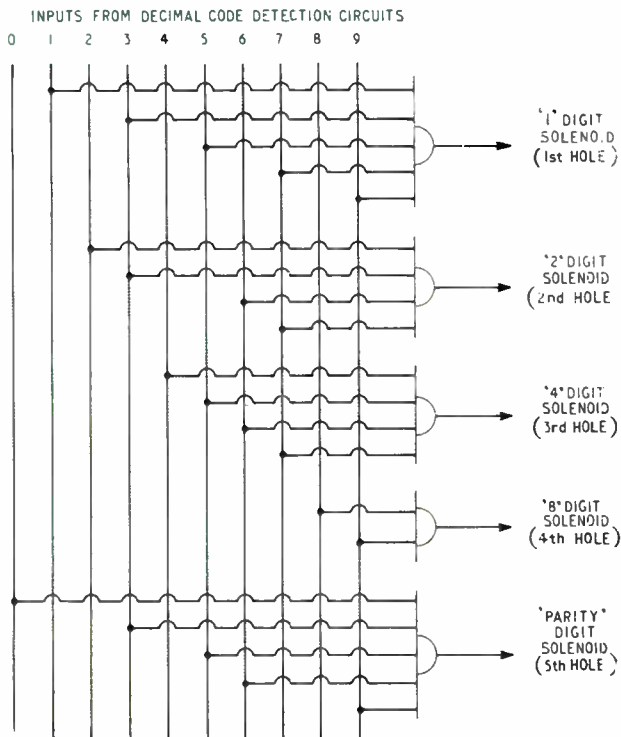

Fig. 4. Arrangement of OR gates for converting from decimal to binary-coded decimal

adjustable in position to allow for delays in the drive pulse generation circuits.

The synchronizing pulse is fed to a pulse unit which generates a pulse of 4 milliseconds duration. This pulse is fed to AND gates, thus only when this pulse is present is the information to be punched on the tape applied to the punch solenoid drive amplifiers. These amplifiers can supply up to 2 A at up to 40 V and are used at 24 V in this equipment.

Summary of Equipment Operating Sequence

For convenience in describing the equipment used in the system, the sequence of the events has not been strictly adhered to in previous sections. The following section describes the actual sequence. Fig. 1 shows the general block diagram of the equipment.

- (a) A signal is received from the wind tunnel control circuits to indicate that a new run is about to commence.
- (b) A pulse is generated and used to reset the information store. This is purely a precautionary measure in all cases except the first run after switch on, when the binary counters may be in either state. The first binary counter of the 4-digit ring counter is set by this pulse, the other 3 digits being reset.
- (c) A pulse is generated which reads the digitizers and sets the carriage return and line feed codes into the store.
- (d) A pulse is generated, which feeds a blank line of tape from the punch. This line is used to determine the start of a run of the wind tunnel and identify the digitizer readings.

- (e) A shift pulse is generated and all information is moved down the store one line.
- (f) Whenever information appears in the action line of the store, the next punch synchronizing pulse will cause the information to be punched in to the tape and another shift pulse generated to move information down the store once more.
- (g) Every fourth line of the tape will be punched with the space code and the shift to the store inhibited to permit this.
- (h) The sequence continues until the store is cleared of information. The 52 lines of tape are punched during the subsequent one second run of the wind tunnel.

Construction

The construction of the equipment is shown in the photographs of the installation. The equipment uses 72 standard plug-in logic units of 9 different types.

Monitoring is built into the equipment to display on miniature lamps the outputs of all the binary counters, the code conversion equipment and other significant points of the system.

If any fault occurs in the equipment the fault can rapidly be located to a group of units using the monitoring and these units replaced by standard spares.

Acknowledgments

The author would like to express his thanks to Hawker Siddeley Aviation Ltd., Hawker Blackburn Division, for permission to publish the information contained in this article.

Direct Ultrasonic Thickness Measurement

An ultrasonic thickness meter, believed to be the first of its kind to become commercially available in Britain, has been developed by The M.E.L. Equipment Co. (formerly Research & Control Instruments). Thickness of metal is indicated directly by a moving-coil meter instead of on a cathode-ray tube. Elimination of the c.r.t., as well as simpli-

fying operation, considerably reduces the size and cost of the instrument. Applications are in the measurement of the thickness of pipe walls, pressure vessels and other objects where there is access to one side only.

The Sonatest TE/7 is completely transistorized and weighs 9 lb, including standard dry cells. With a "Press-to-read" button ensuring that current is used only when readings are taken, at least a fortnight's operation can be expected with normal use. The dimensions are $9 \times 7 \times 4\frac{1}{2}$ in.

Operation is on the pulse transmission-reflection principle, and a selector switch gives full-scale meter deflections equal to 1, 2 or 10 in. thickness. Accuracy is to within 1%. A test block is built into the instrument and correct operation can be checked in a few seconds. Calibration, zero-set and linearity adjustments can be made from the front panel. An output is also provided for connection to an oscilloscope should this type of presentation be required.

For further information circle 38 on Service Card

The Sonatest direct-reading ultrasonic thickness meter



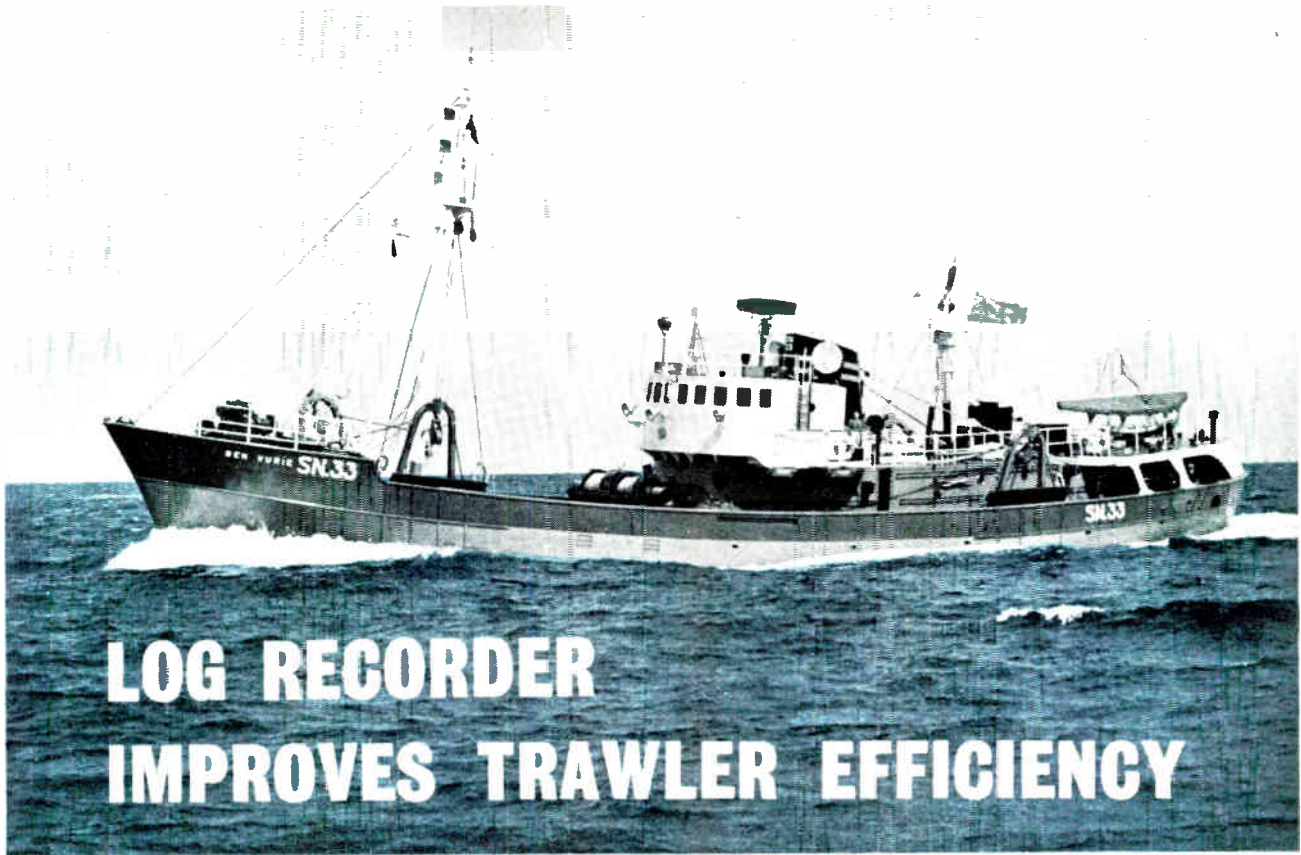

Trials recently carried out on a trawler, in which the ship's electrical Bergen Nautik Log—a combined speed indicator and distance log—has been linked to a chart recorder, have shown that this equipment can increase the vessel's catch, over a given period of time, by 10 per cent. The vessel is the trawler *Ben Vurie*, and it is owned by Richard Irvin & Sons Ltd., of North Shields. The title block illustrates the *Ben Vurie* at sea. The equipment, proved over three voyages by the *Ben Vurie*, each of ten days, is now being marketed by Marine Communications Department of Associated Electrical Industries Ltd.

The log recorder, used in this way, reveals untoward speed changes which would not be noticed and recognized when using the automatic log alone. These speed changes are often directly related to significant changes in the condition of the nets being towed.

Although engine revolutions may be kept constant, changes in a vessel's speed through the water may occur as a result of large alterations of helm, alterations of course, or changing weather and sea conditions. A record of this type of information would in any case be of value to ships at sea in analysing efficiency when steaming from point to point.

However, for ships towing, and for trawlers especially, this information is invaluable. For any change in speed other than for the known reasons already described must be due to a changed condition in the tow.

The *Ben Vurie* experiment has demonstrated that, in trawler fishing, the speed pattern on the recorder can reveal when a net is sagging or belying out, or has a broken headline or fore-end out.

During the thirty days trawling about 30 snags were detected on the recorder, and an average time saving of $2\frac{1}{2}$ hr in 24 hr was achieved or one day in ten. The skipper, Robert James Palmer, agrees that 10% time was saved or, in other words, in a given time he could catch 10% more fish with this equipment. The skipper finds from experience that he can use the log recorder effectively up to wind force 6-7 but, as he continues to use it, he can interpret snags in rougher conditions.

Figs. 1, 2 and 3 are photographs of recorder traces from the 'Ben Vurie' log

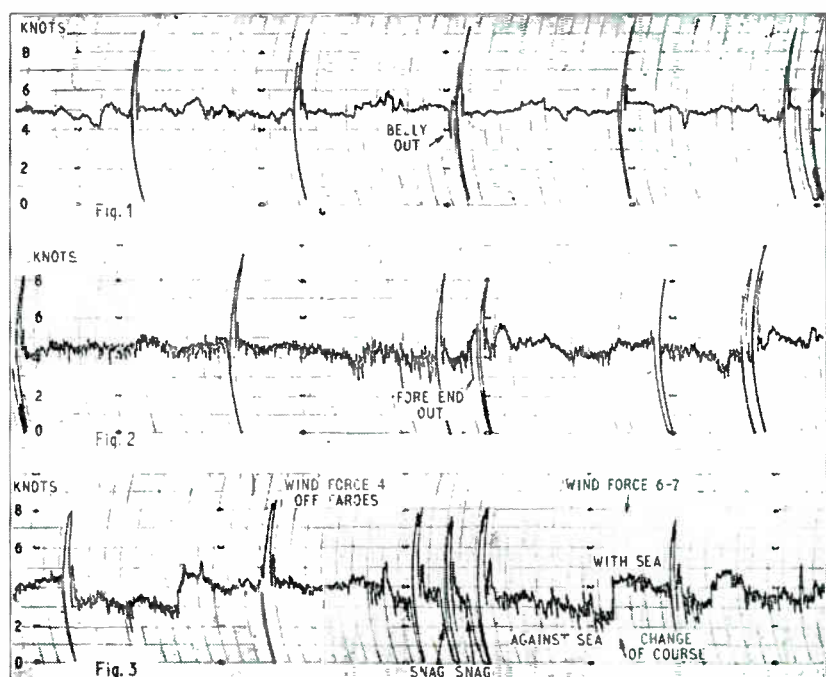

Extracts from the *Ben Vurie's* log recorder show how various faults were detected during trawling under varying weather and sea conditions.

In the recorder trace in Fig. 1, the large alterations of speed every 2½ to 3 hr show the trawler stopping, shooting a trawl, increasing speed to 9 knots or so until the strain is taken and then settling down to a trawling speed of 3 to 5 knots, depending on conditions. In the centre of the picture, a sudden unexplained drop in speed is seen, indicating a probable snag followed by slight increase in average speed, indicating less resistance from a damaged net. The trawler was stopped and nets were hauled in and a belly out was found. Since no more fish would have been caught in this net condition, time was saved and a new trawl was shot. The wind was force 3 during this event, sea slight.

The effect of rougher sea conditions can be seen on the trace in Fig. 2 and, despite these, it was possible to detect a snag which was subsequently found to have caused fore-end out; on this occasion 2¼ hr inefficient trawling was avoided.

Figure 3 gives good examples of snags occurring on two successive occasions shortly after the trawl was shot. In each case, the net was found to be slit open when hauled in; total time saved 4½ hr. Towards the right of the figure a slow drop in average speed against increasing sea and wind force 6-7 is shown, followed by an increase of speed after an alteration of course to run with the sea.

The modification of the Bergen Nautik Log and the Elliott recorder to operate together as a log recorder was engineered jointly by A.E.I. and the Electrical Measurement Division of Elliott Brothers (London) Ltd.

Versatile Laser Equipment

A versatile medium-power solid-state laser, recently announced by M.E.L., is now available as a standard catalogue item, complete with charging and control unit. The laser head is in the form of an elliptical reflecting cavity in which the flash-tube is mounted along one focus and the laser rod along the other. The head can be adapted to accommodate flash-tubes of different types and to accept plain or chisel-ended laser rods. Also, rods of different diameters or different materials can be used with suitable adaptors, and there is provision for outlet ports at both ends of the laser head. There are also facilities for attaching lenses and filters.

The rod normally fitted is of neodymium doped glass, and is ½ in. in diameter and 6 in. long. The pumping source is a 5,000-joule linear flash-tube, and the coherent light output is nominally 5 joules. The pulse length is 0.4-0.8 msec. With Q-switching attachments, this reduces to 0.1-10 µsec, and the peak power is increased approximately 100 times.

The standard laser rods have plane parallel ends with dielectric coatings having nominal reflectivities of 58%

for one end, and 97% for the other. Rods can also be supplied with one end totally internally reflecting and the other end uncoated, or with plane parallel ends uncoated for use with external reflectors.

The flash-tube has a life expectancy in excess of 7,000 flashes at 5,000 joules. Consistency of performance is assured by the use of oil-filled metallized-paper capacitors rather than electrolytic types in the stabilized charging unit.

The manufacturers state that this laser is intended primarily for research and experimental work. Outside the laboratory, the potential applications of such a medium-power device include optical rangefinding, examination of atmospheric pollution, satellite tracking and control, and guidance systems. Inside the laboratory, applications lie more in the direction of materials research such as thermal shock and thermal diffusivity measurements and spectroscopy. It is also suggested that the M.E.L. laser can be considered for the production of microchemical reactions, welding, micro-machining, plasma measurements and ophthalmic applications.

For further information circle 39 on Service Card

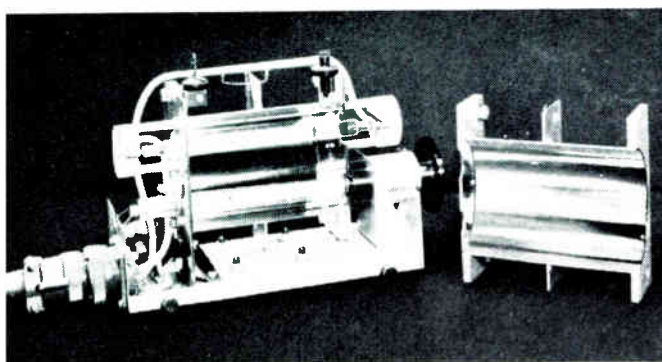

In this photograph the two halves of the elliptical cavity are separated to show the flash-tube mounted above the laser rod

(Right) The M.E.L. laser mounted on a standard optical bench

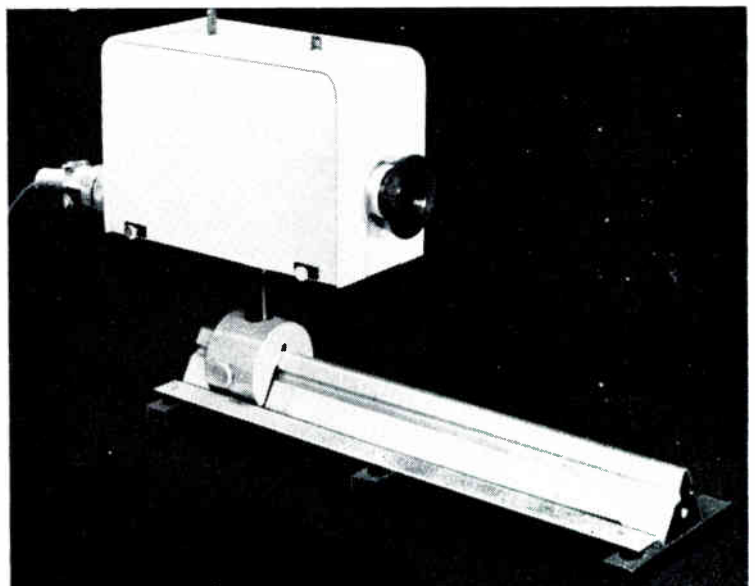

LANCASHIRE DYNAMO ELECTRONIC PRODUCTS LIMITED

designed and supplied the electronic position control and sequencing equipment for the integrated high speed forging manipulator and hydraulic press for

PARKES FORGE LTD. WIGAN

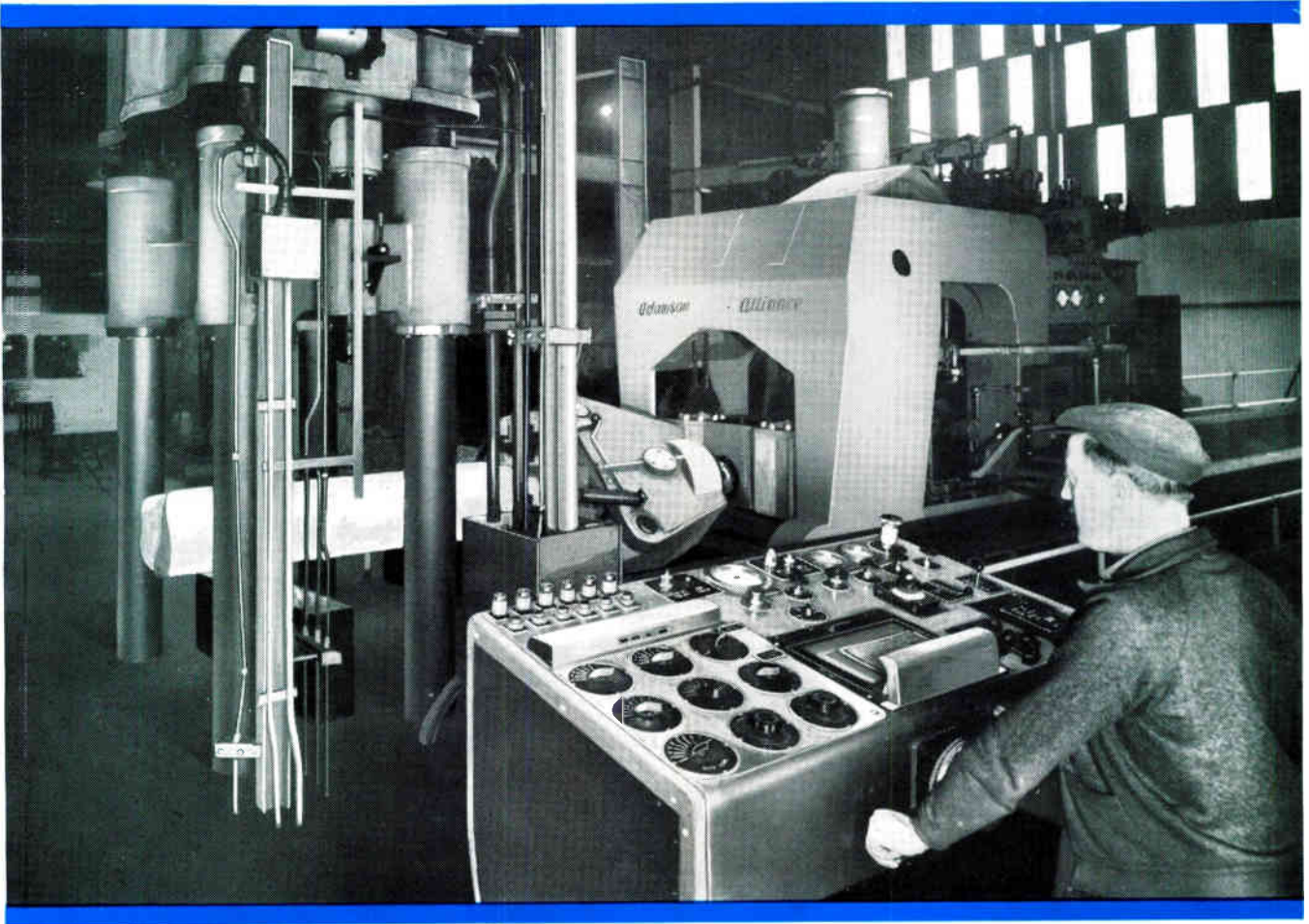

(photo by courtesy of Parks Forge Ltd.)

The LDEP equipment is constructed entirely from the standard units of the transistorised DIGITAL SYSTEM which provides unparalleled reliability and flexibility for the control of all high productivity plants.



LANCASHIRE DYNAMO ELECTRONIC PRODUCTS LIMITED, RUGELEY, STAFFS. Tel: Rugeley 371





POLYTETRAFLUOROETHYLENE

New PTFE wire and cable plant

The excellent thermal characteristics of PTFE makes the material an effective insulation for wires and cables at hot spots in all electronics

and avionics systems. To meet great and increasing demand, STC have completed the installation of a plant for the manufacture of PTFE extruded wires and cables. For further details, write, 'phone or Telex:

Standard Telephones and Cables Limited, Rubber and Plastic Cable Division, Corporation Road, Newport, Monmouthshire. Telephone Newport 72281. Telex 49368.

world-wide telecommunications and electronics

STC

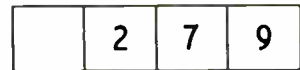

(a)

Fig. 1. Digital display for precise numerical information (a), dial able to give an accurate reading (b) or a rough, snap reading (c)



(b)

OPERABILITY

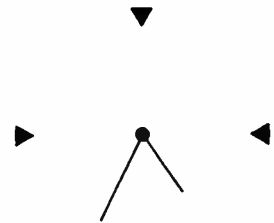

(c)

By R. C. WINTON, B.Sc.(Eng.), A.C.G.I., M.I.E.E.*

The proper functioning of electronic apparatus depends not only upon the reliability of the equipment itself but on the operator not making mistakes. This article discusses some of the ways in which apparatus can be improved to minimize the chance of the operator making a mistake.

A NEW word which we are hearing more and more frequently and which I am sure will assume increasing importance, is 'operability'. It is concerned with the relationship of the human factor to electronic equipment, and associated with an equipment's reliability, which accounts for the growing attention it is receiving. In addition, the increasing complexity of equipment and the increasing speeds at which operators have to work are emphasizing the need for improved operability.

As electronic equipment becomes more reliable the proportion of malfunctions due to errors by the human operator is increasing. The human operator presents peculiar problems because his errors occur in a random manner, so that almost all one can predict about him is that he will make a mistake sooner or later. We are certainly a long way from predicting the reliability of people in the same way in which we can statistically predict the reliability of equipment.

For this reason it is particularly difficult for designers to develop equipment which takes the human operator fully into account, since it requires them to cope with the uncertainties of human nature which cannot be dealt with by the kind of logical mathematical approach which they are accustomed to using. In addition, whereas every component can be obtained to a great variety of specifications, human characteristics are more or less uniform and unalterable.

Nevertheless, with the search for greater and greater reliability, correct operation is assuming increasing importance in the design of equipment, for we may say that if

an operator makes a mistake which prevents an equipment performing its specified function this is, in effect, just as much a lack of reliability as if a component had broken down.

The characteristic which matches an equipment to its human operator is called its operability; in order to achieve good operability we must know the relevant facts about human capabilities and shortcomings. These facts come from research in the field of ergonomics, the study of man in relation to work.

The operation of an equipment consists chiefly of two tasks, correct interpretation of the information which is presented, and correct operation of the appropriate control to achieve the desired result.

As a simple example of bad and good ways of presenting information, contrast the difficulty of reading a domestic electricity or gas meter, usually situated too high or too low in a badly-lit corner and requiring the separate reading of four or five dials, with the simplicity of reading, say, the digital display on a well-positioned, well-lit, instrument. Or contrast keeping a check on an equipment in which every meter pointer lies in the same direction to indicate normal working, with pointers whose normal positions are all in different directions. In the former case the operator can check 32 dials in the same time which he needs to check four dials pointing in random directions.

A digital display is better than a dial for giving exact numerical information [Fig. 1 (a) and (b)]. But pointers and dials can give a quick rough check [Fig. 1 (c)] as well as a precise reading, and a pointer working round a 360° scale can give a much better idea of rate of change than a purely digital display.

Looking now at control, design and layout, one can take the example of a lathe which would be most effectively controlled by a man 4½ ft. tall, with an 8 ft. arm span, and measuring 2 ft. across the shoulders. Again, research has devised a range of seven control knobs each of which

*Mullard Ltd.

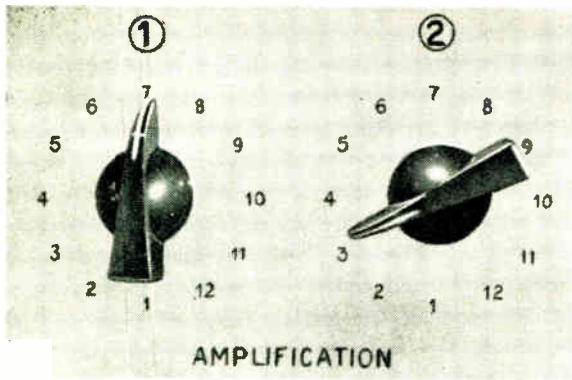

(a)

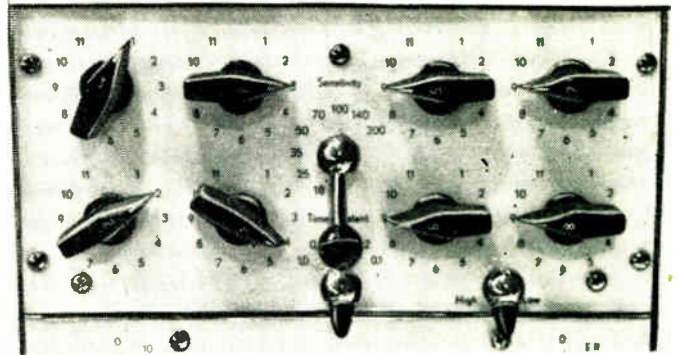

(b)

Fig. 2. Each knob position must be read individually (a) and clockface layout of numbers which enables the knob position to be seen at a glance (b)

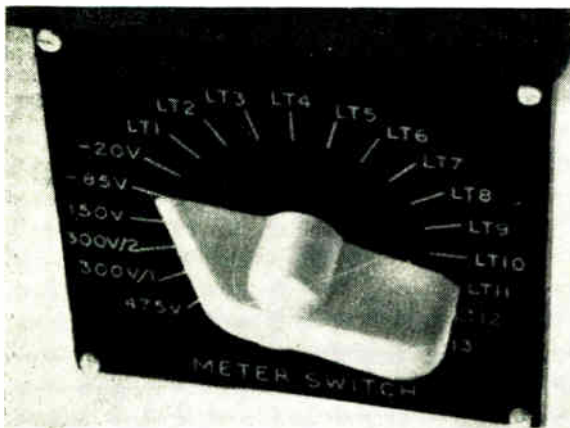

(a)

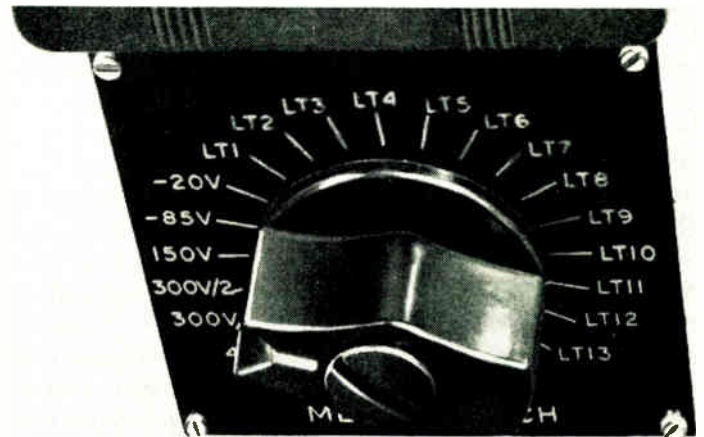

(b)

Fig. 3. Easily read knob position (a) and knob position uncertain (b)

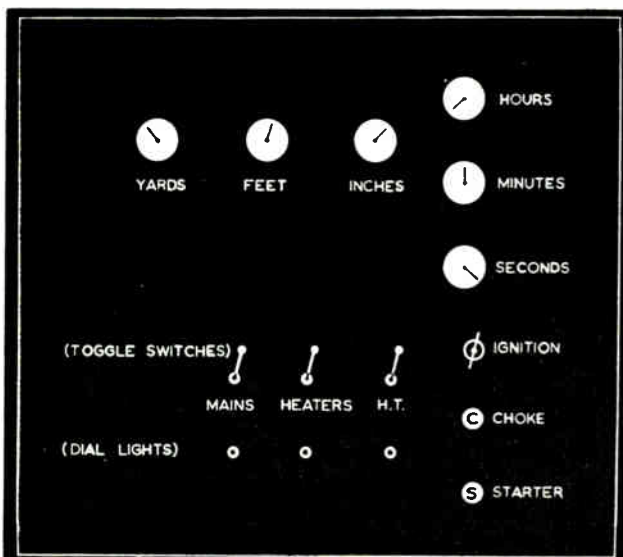

Fig. 4. Correct positioning of controls which have to be operated in sequence

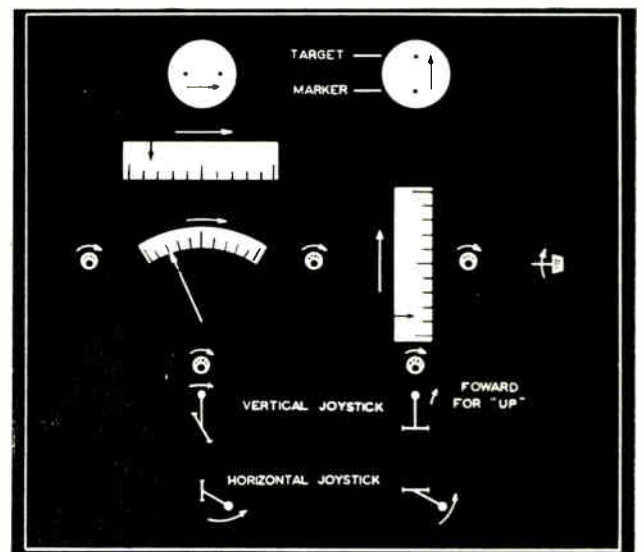

Fig. 5. Expected movement relationships between a control and a display

can be recognized by touch alone. Yet how often one sees a control panel which, for the sake of symmetry, is fitted with identical knobs on all controls.

If the positions of a rotating control are numbered, then laying out the numbers in the same position as on a clock-face enables the operator to tell instinctively what position the control is in. Figs. 2 (a) and (b) illustrate this.

Another consideration is the operator's ability to see clearly which position a control is in. Contrast, for instance, the ease of reading the position of the knob in Fig. 3 (a) with the knob in (b), which is of the wrong design for this particular position.

Control layout is equally important. Where, for instance, operation must always follow the same sequence, the controls and displays should be laid out in that order, as shown in Fig. 4. Otherwise the best grouping is according to function.

The critical moment in the operation of an equipment is when some decision is taken, and as a result some control is moved. The decision which the operator makes, the actual control he operates, and the manner in which he moves it can all be affected by his personal comfort, working conditions, lighting, interpretation of a display, and the layout and design of the controls.

Even if all the conditions are not ideal, the good operator may yet avoid mistakes in normal circumstances, although he will inevitably be working under unnecessary physical and mental tension which will make him more liable to error.

But the really testing time comes in an emergency. The operator must be made to realize promptly that something is wrong—the best warning is one which he can hear—he must determine quickly what the fault is, and then take the correct action at once. We are all more fallible in moments of emergency, and it is just in this critical situation that poor operability is most likely to lead to error.

One can quote here the cock on a steam plant which operated counter-clockwise to turn steam off, instead of clockwise in the normal manner. A large notice above the

cock drew attention to this, but in an emergency the operator acted instinctively and increased the steam supply instead of cutting it off, and this led to a severe accident.

But in my opinion the operator did not cause the accident; the man who incorporated such a cock was to blame.

The expected movement relationship between a control and a display is shown in Fig. 5. Where a joystick is intended for use by one hand only, instead of for simultaneous two-handed control as shown here, it is better placed to one side of the operator's body where his arm, preferably supported by a rest, can reach it most conveniently.

In this article I have attempted to underline the importance of considering the human operator when designing equipment, and I have given a few simple examples of how this can be done. In doing this I have touched on the fringe of ergonomics, which I believe will be given much more attention in the near future. As a result we shall see improvements in design; but however well an equipment is suited to its human operator, he will sooner or later make a mistake, since, as I have said earlier, the only certain thing about human error is that its occurrence is certain although unpredictable.

But one can go a step further than this. Because their failures are random, not everyone will make a mistake at the same time, so that man can provide his own redundancy feature, by operating equipment with a team where each member is on the look-out for the error which some other member of the team will inevitably make. Operation by a cross-checking team of this kind is the only way in which the human error can be drastically reduced, perhaps even eliminated, since experience has shown that no offer of reward, threat of punishment or strict control will completely prevent a single individual from making a mistake.

As far as I know this line of thought has not so far been followed up in the constant search for total reliability, but it seems to me that this should be the direction in which future investigation ought to go.

I am grateful to Mr. B. Shackel, of E.M.I. Electronics Ltd., for the illustrations to this article.

New Tank Gauging Development

Evershed & Vignoles, in collaboration with Alan Cobham Engineering, have successfully combined the Evershed precise tank gauge with the Cobham magnetic level indicator. The first installation was carried out on a 35-ft spherical butane storage tank at Stanlow Refinery for Shell Refining and is believed to be the first Cobham gauge in use with an electrical automatic transmitting tank gauge.

Neither component requires modification and the bob of the gauge, corresponding to the Evershed displacer, consists of a weighted soft-iron core fitted with spacers to locate it loosely in a tube of non-magnetic stainless steel, fitted vertically in the tank and sealed from tank pressure. Floating on the liquid, and guided by the tube, is an annular float containing a permanent magnet. Magnetic coupling between the bob and the float is sufficient to ensure accurate following but not enough to lock the bob within the magnetic field in the event of a mains failure at the gauge while the level is changing—a circuit within the gauge resets it when power is restored.

The advantage of this development is that the gauge head is not subjected to either tank pressure or vapour. A gauge case of normal strength is, therefore, adequate and the materials of construction within the head are in no way affected by toxic or corrosive tank contents. The head

may also be removed or replaced while the vessel is under pressure. At the same time the gauge accuracy of ± 0.1 in. is equal to that of the normal displacer-operated type.

For further information circle 40 on Service Card

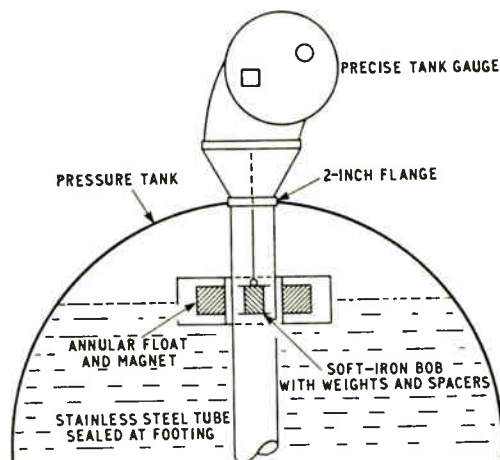

EQUIPMENT REVIEW

1. Potted Firing Circuits

Two potted firing circuits are now available from A.E.I. Electronics. These low-cost epoxy-encapsulated devices meet the demands of industry for compact units to fire thyristors used in static-control applications. The type F.C.11, costing £9 10s. is single-input, full-wave output. Type F.C.12, which costs £10 10s. is dual-input, full-wave output.

When connected to the thyristor these units form a self-contained control device. Power output is sufficient to fire the complete range of A.E.I. thyristors from 5–100 A, and the outputs of both circuits will fire thyristors requiring up to 300 mW gate power. The firing angle can be controlled over the range of 5°–179°, achieved by varying the control current from 0–5 mA with the F.C.12, and 0–15 mA with the F.C.11. The circuits operate from an a.c. supply voltage of 40–60 c/s, and draw currents of 50 mA.—*Associated Electrical Industries Ltd., Instrumentation Division, Harlow, Essex.*

For further information circle 1 on Service Card

2. Large Nixie Tube

To meet the need for a digital display tube which is visible over long distances, e.g. traffic control, teaching installations, share-prices display, etc., Burroughs have introduced a large Nixie tube—the B7037. This long-life unit has a character height of 2 in.—*Walmore Electronics Ltd., 11-15 Betterton Street, Drury Lane, London, W.C.2.*

For further information circle 2 on Service Card

3. Soldering Machine

A semi-automatic soldering machine, to be marketed by Avo, is produced by Zeva Soldering Tools, of West Germany, for whom Avo is the sole agent in Britain.

The machine is capable of small to medium batch soldering of printed

circuits, commutators, etc., and can be used to dip-solder small assemblies or quantities of small parts which can be mounted on a cradle provided. It consists of a thermostatically-controlled bath (9½ × 11¾-in. surface area), and a semi-automatically operated cradle. Time of soldering function is variable over a range of 0–10 seconds.—*Avo Ltd., Avocet House, 92-96 Vauxhall Bridge Road, London, S.W.1.*

For further information circle 3 on Service Card

4. A.C./D.C. Converter

A low-priced converter, designed primarily for use with the Digitec range of d.c. voltmeters, enables a.c. potentials to be measured accurately on any instrument operating from an input of 1 V d.c. The Wayne Kerr-Digitec a.c./d.c. converter, model 1900, operates over the frequency range 50 c/s–25 kc/s with a linearity

of ±0.05% full scale. Four input ranges are provided: 0 to 1, 10, 100 and 500 V r.m.s.; and the input impedance is 1 MΩ (100 kΩ on 1-V range).

From 100 c/s to 10 kc/s the accuracy is ±0.3% full scale (0.4% from 50 c/s–25 kc/s). The d.c. output (1 V d.c. for 1, 10 or 100 V r.m.s., 0.5 V d.c. for 500 V r.m.s.) is available at low impedance (10 kΩ) and the reading time is 1 sec.

The unit is available in a portable case to match the Digitec voltmeters, with flanges or for rack-mounting either singly or in association with a voltmeter. The portable unit is 5½ in. high, 8 in. wide, 7 in. deep, and weighs 7 lb. Price is £124.—*The Wayne Kerr Laboratories Ltd., New Malden, Surrey.*

For further information circle 4 on Service Card

5. Calibrated Spot Galvanometers

The range of Cambridge spot galvanometers can now be supplied with scales calibrated for direct measurement of d.c. voltage or current. Instruments are provided with five switchable ranges and can also be used as uncalibrated galvanometers.

Four versions are available: a microammeter with a maximum range of 0–300 μA; a milliammeter with a maximum range of 0–100 mA; a millivoltmeter with a maximum range of 0–300 mV and a voltmeter with a maximum range of 0–100 V. Each version is completely self-contained incorporating optical system, lamp and



1

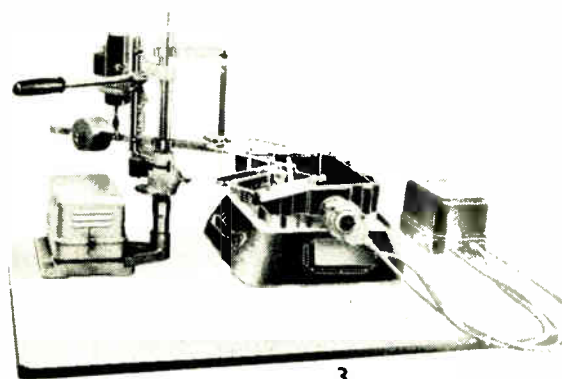

3

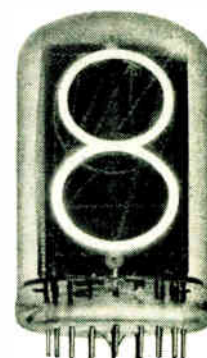

2



4



5

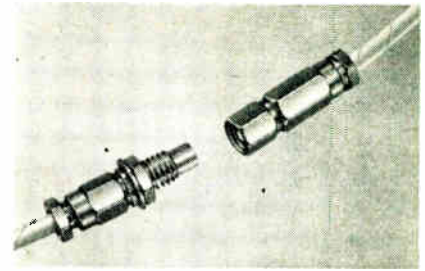

6

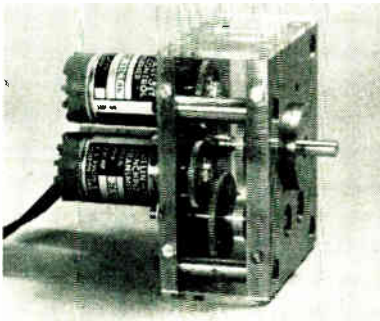

7



8



9

mains transformer. Scale length is 160 mm and accuracy $\pm 2\%$ full scale deflection.—*Cambridge Instrument Co. Ltd., 13 Grosvenor Place, London, S.W.1.*

For further information circle 5 on Service Card

6. Cable Assembly Service

The Conhex division of Sealectro now offers complete cable assemblies utilizing Conhex subminiature r.f. connectors made up to customer specifications.

A typical assembly is illustrated and incorporates Conhex types 3000 and 3003 connectors mounted on a length of RG-188/U coaxial cable. All cable assemblies are electrically tested and meet rigid quality control specifications.—*Sealectro Ltd., Hersham Trading Estate, Walton-on-Thames, Surrey.*

For further information circle 6 on Service Card

7. Packaged Servo Systems

The Servo Component Division of R. B. Pullin & Co. now provide a range of packaged servo systems comprising servo gearboxes containing all necessary servo components and gearing assembled on standard side plates.

This service is designed to provide, at reasonable cost, precision gearboxes in prototype or production quantities for use in all types of servo applications.

The units can be tailored to suit individual requirements, and are based on the use of standard servo components and procedures. A wide range of standard parts, such as gears, pinions, shafts and side plates are held as standard stock parts so that speedy deliveries can be effected.—*R. B. Pullin & Co. Ltd., Great West Road, Brentford, Middlesex.*

For further information circle 7 on Service Card

8. Electronic Galvanometer

Now available from Livingston Laboratories is a null detector with a current sensitivity of 2×10^{-9} A per scale division and a power sensitivity of 8×10^{-16} W per division.

The instrument, the Fluke model 840A electronic galvanometer, has centre-zero ranges of 30, 300 and 3,000 nA full-scale. The input impedance is 180Ω for all ranges and the input isolation from the chassis greater than $1,000 M\Omega$. The accuracy is $\pm 5\%$ of full-scale.

Other specifications are a drift of less than 5 nA/hr, a noise level of

less than 0.5 nA r.m.s., a d.c. output and battery operation. The instrument is protected against overloads up to 10 mA and is fully transistorized. Price: £78.—*Livingston Laboratories Ltd., 31 Camden Road, London, N.W.1.*

For further information circle 8 on Service Card

9. Microwave Aerial Feeds

The 'Scalar' aerial feeds manufactured by TRG and available in the U.K. through Claude Lyons are designed for parabolic microwave aerials and are claimed to feature low excess noise temperature, high aperture efficiency, good secondary patterns and broad bandwidth as compared with conventional feeds.

These feeds are available for all waveguide bands between 300 Mc/s and 140 Gc/s. Typical performance figures, for the model 871 general-purpose feed (used with paraboloids having focal length/diameter ratios between 0.25 and 0.5), are: aperture efficiency better than 50%, spillover (percentage of total energy radiated by feed not striking dish) less than 1.5%, and maximum sidelobe level of -25 dB.

The model 872 high-gain feed, for

EQUIPMENT REVIEW

aerials with F/D ratios between 0.4 and 0.5, has aperture efficiency of better than 60%, with 3% maximum spillover and -21 dB maximum side-lobe level.—*Claude Lyons Ltd., Instruments Division, 76 Old Hall Street, Liverpool, 3.*

For further information circle 9 on Service Card

10. Portable Oscilloscope

Telequipment have introduced the 'Serviscope' type D52 double-beam oscilloscope designed for laboratory use as well as for general industrial and educational applications. With a 5-in. flat-faced PDA tube operated at 3.6 kV, it weighs 24 lb and measures $8\frac{1}{2} \times 9\frac{1}{4} \times 15$ in.

The timebase provides 18 pre-set calibrated sweep speeds from 500 msec/cm to 1 μ sec/cm. Frequency response of the Y amplifiers is d.c. to 6 Mc/s at 100 mV/cm, and d.c. to 300 kc/s at 10 mV/cm (-3 dB approx.). The 9-position frequency-compensated input attenuators give direct readings from 10 mV/cm to 50 V/cm. Input impedance is approximately 1 M Ω + 30 pF.—*Telequipment Ltd., Chase Road, Southgate, London, N.14.*

For further information circle 10 on Service Card



10

11. Screw-Terminal Socket

B & R Relays have introduced a screw-terminal socket designed for use with their D03/D53 plug-in relays and their M01/M51 plug-in and hermetically-sealed plug-in relays.

It has an 8-pin socket fitted with screw terminals and has two fixing apertures at $1\frac{1}{2}$ -in. centres. Measuring 2 in. in diameter and $\frac{1}{4}$ in. deep it is moulded in black phenolic. This robust socket is especially suitable for prefabricated wiring and it also obviates the need for soldering.—*B & R Relays Ltd., Temple Fields, Harlow, Essex.*

For further information circle 11 on Service Card

12. Strip Chart Recorder

Bausch & Lomb have introduced a compact strip chart recorder, the V.O.M.-7, with a maximum full-scale sensitivity of 500 μ V.

This recorder directly measures and records d.c. voltage, current, and resistance without the need for external converters. It has a calibrated accuracy of $\pm 0.5\%$ full scale on the 500 μ V, 1 mV and 10 mV ranges; and 2% on all other voltage and current ranges.

The V.O.M.-7 measures $14\frac{1}{2} \times 11\frac{1}{4}$

$\times 4\frac{1}{2}$ in., weighs 20 lb and operates from normal mains supplies. Standard features include 5-speed chart transport, built-in event-marker, and 17 input ranges.—*Bausch & Lomb Inc., Rochester 2, N.Y., U.S.A.*

For further information circle 12 on Service Card

13. Compact Navigational Aid

The LJ-11 Micro-Loran receiver, which has recently been added to the Redifon range of marine navigational aids, is sufficiently compact ($12\frac{1}{4} \times 8\frac{1}{2} \times 12\frac{3}{4}$ in.) for easy installation in small vessels. It is fully transistorized with removable printed circuits and operates from a 24 V d.c. supply. No special aerials are needed.

The receiver measures the time difference between signal pulses received from a pair of shore stations which are selected by pushbutton tuning. This time difference, shown as a digital read-out display, is plotted as a position line on a hyperbolic-lattice chart. As there is no quadrantal error involved, neither correction nor calibration is required, and an accurate 'fix' can be obtained in about 30 seconds.

The approximate maximum range that can be obtained using the Loran system is 600-700 miles in daylight and 1,200-1,400 miles at night, independent of weather conditions. The LJ-11 allows selection from the four Loran

frequencies at present in use, as well as the 'H', 'L' and 'S' p.r.f. ranges.—*Redifon Ltd., Broomhill Road, London, S.W.18.*

For further information circle 13 on Service Card

14. Miniature Photo-electric Head

Hird-Brown announce the introduction of the UMX.1 ultra-miniature photo-electric reflection head. This unit is suitable for applications where accurate positioning of the equipment is required and is designed for positioning at a distance of $\frac{1}{4}$ in. from the material. The overall size is $1\frac{1}{4} \times \frac{1}{4} \times \frac{3}{8}$ in. and the weight is approximately 1 oz.

The photo-electric cell used is an SGS-Fairchild 2N2452, capable of operating at temperatures up to 120 °C. A series of special controls has been designed for use in conjunction with this miniature head.—*Hird-Brown Ltd., Flash Street, Bolton, Lancs.*

For further information circle 14 on Service Card

15. Solid-State J-Band Generator

The M-O Valve Co. has introduced the first of a range of solid-state microwave components. The type E3090 is a packaged semiconductor microwave generator which is claimed to have outstanding advantages over reflex klystrons in local oscillator service.

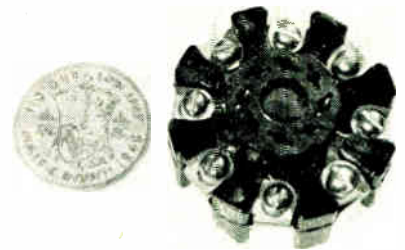

11

12



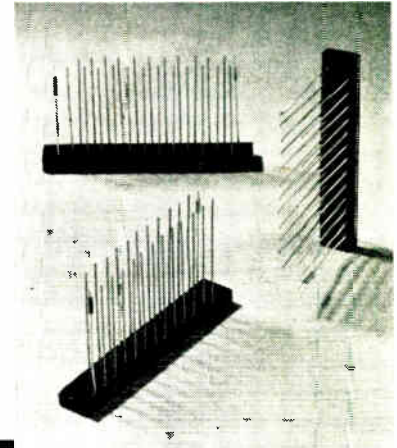
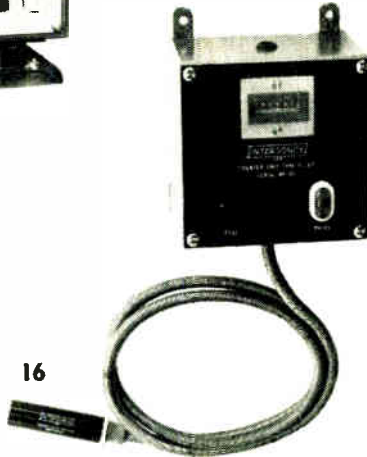
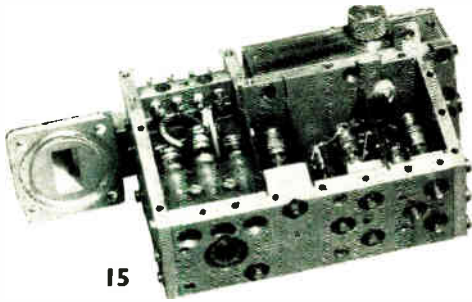
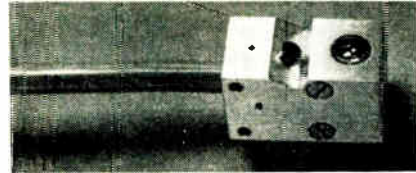

Small, light and exceptionally robust, the device is electronically tunable over 280 Mc/s, to 3 dB points, in the range 12-15 Gc/s and develops 15 mW minimum with spurious response 30 dB down over the tuning range. It operates from a small compact power supply providing 34 V.

Temperature stability is two parts in 10^5 per °C and the operating temperature range is from -20 to +75 °C. The E3090, which is ideally suited to airborne and similar applications, measures approximately $2 \times 2 \times 4$ in. and weighs 12 oz.—*The M-O Valve Co. Ltd., Brook Green Works, London, W.6.*

For further information circle 15 on Service Card

16. Batch Counting System

To provide a robust and low-priced industrial batch counting system, Intersonde have introduced the type FL87 counter unit for use in conjunction with their series QD inductive proximity switches.

The counter unit takes the form of a wall-mounting steel box measuring $6 \times 6 \times 4$ in. and containing a six-digit electromagnetic counter with manual reset, together with a low voltage d.c. power supply to energize the proximity switch. The counter unit and the proximity switch are connected by a conventional three-core

cable which may be up to a maximum of 500 ft in length.

The presence of a ferrous or non-ferrous metal object within $\frac{1}{8}$ in. of the sensing face of the proximity switch causes 24 V d.c. to be supplied directly to the counter. The maximum counting rate of the complete system is 1,500 per min although the proximity switch alone will operate at a counting rate of up to 10,000 per min.—*Intersonde Ltd., The Forum, High Street, Edgware, Middlesex.*

For further information circle 16 on Service Card

17. Multiple Capacitor Blocks

Johnson, Matthey & Co. announce the development of multiple capacitor blocks for use in the manufacture of delay lines, to increase the speed of assembly and save space. The components used are identical to the 'Silver Star' range of silvered mica capacitors. The leads from the blocks are easily handled and soldered, and are spaced at precise intervals along the block.

Typical examples are shown in the illustration: each of these is an encapsulated epoxy moulding that measures $3 \times 0.45 \times 0.2$ in. and contains 23 capacitors of 22 pF each. These are earthed on one side to a common lead that is brought out at each end of the block. In this par-

ticular size of block the capacitors can have a maximum value of 200 pF and are rated at 150 V peak. Other block sizes and capacitance values are available.—*Johnson, Matthey & Co. Ltd., 73-83 Hatton Garden, London, E.C.1.*

For further information circle 17 on Service Card

18. Electronic Thermometers

Kane-May are marketing single- and multi-range versions of the Dependatherm electronic thermometer, covering one or more temperature spans within the range of 0-200 °C or 32-350 °F. Standard probes of various designs and special probes to meet particular needs in the engineering, chemical and process industries are available. Interconnection leads between probe and instrument may be up to 50 ft. long. The instrument measures $4\frac{1}{2} \times 2\frac{1}{2} \times 1\frac{1}{2}$ in. and weighs 7½ oz.

Measurements are displayed on a $2\frac{1}{2}$ -in. dial immediately upon application of the small pencil-shaped probe to the temperature source, which may be gaseous, liquid or solid. Rapid response to temperature fluctuations facilitates the localizing of hot spots, determining surface temperature distribution, etc., without test rigs. Automatic stabilization circuits obviate pre-test balancing and ensure that the accuracy of indication is unaffected,

EQUIPMENT REVIEW

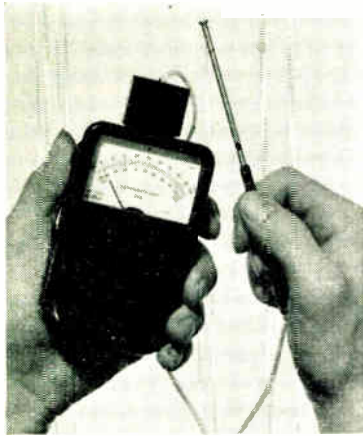

18



19

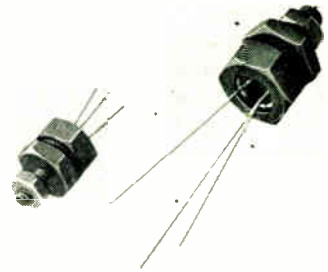

20

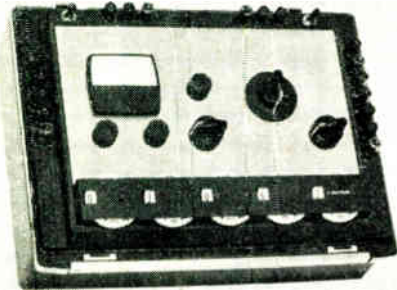

21

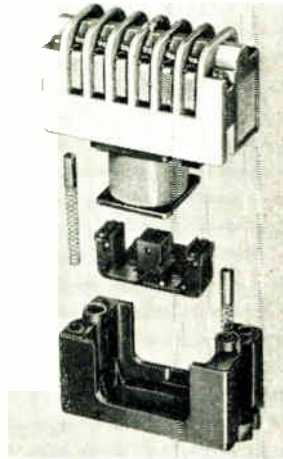

22



23

over wide limits, by the gradual decline of the battery voltage. A standard 9-V transistor type battery is employed. — *Kane-May Ltd.*, 243 Upper Street, London, N.1.

For further information circle 18 on Service Card

19. Photo-Electric Units

Herga Electric announce intermediate-range photo-electric projector and receiver units, made in aluminium alloy for conduit mounting. A range of 50 ft in daylight (100 ft with collimator) is possible.

The units are drip-proof, can be easily weatherproofed, and measure $3 \times 3\frac{1}{2}$ in. in diameter. A special feature is a viewing plate on the receiver allowing easy alignment without testgear.—*Herga Electric Ltd.*, Wallingford Road, Uxbridge, Middlesex.

For further information circle 19 on Service Card

20. Insulated Heat Sinks

Jermyn Industries have introduced insulated versions of their heat sinks 1101 (T05) and 1106 (T018). Insulation is achieved by hard anodizing on aluminium. Measurements of better than 3,000 M Ω at 85 V have been

made and the finish is said to have a thermal resistance approximately five times lower than mica.

Part numbers are respectively 1101A for T05 and 1107 for T018, and both components will be supplied from stock with E.I.D. and A.R.B. release. —*Jermyn Industries, Vestry Estate, Vestry Road, Sevenoaks, Kent.*

For further information circle 20 on Service Card

21. Voltmeter Bridge

Now available from Livingston Laboratories is the model 300 Portametric voltmeter bridge made by Electro Scientific Industries. This instrument features a differential voltmeter with five-digit resolution, an ammeter and a guarded Kelvin resistance bridge for two, three or four-terminal resistance measurements.

The basic accuracy of the instrument is nominally $\pm 0.02\%$ of reading. Voltage measurements can be made from 0 to 511.10 V d.c. in five ranges and current measurements from 0 to 5.1110 A in eight ranges. The maximum resolution on the lowest ranges is 1 μ V and 10 pA respectively. Other features are a standard cell reference, battery operation, a maximum

detector sensitivity of 5 μ V and a long term stability of ± 5 μ V.—*Livingston Laboratories Ltd.*, 31 Camden Road, London, N.W.1.

For further information circle 21 on Service Card

22. Contactor

An addition to the Ellison range of automatic control gear is the MV1 6-pole, block-type contactor, which measures $3\frac{3}{8} \times 3\frac{3}{8} \times 1\frac{3}{8}$ in. The body of the contactor is constructed of moulded plastic material and built in two sections which can easily be separated for quick coil change or inspection. The operating coil can be supplied in all standard voltages from 110 to 550 V a.c. and has a consumption of 50 VA (open) and 12 VA (closed).

The contacts, which are double-break silver-to-silver, are arranged at the top of the contactor for easy accessibility, and are rated at 6 A. These contacts can be supplied in a combination of normally-open or normally-closed arrangements.

The faces of the magnet assembly are self-aligning and fitted with shading rings for silent operation. The

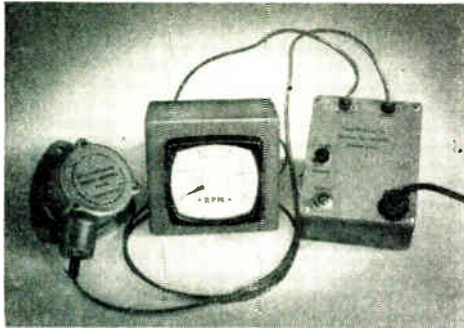

24



25

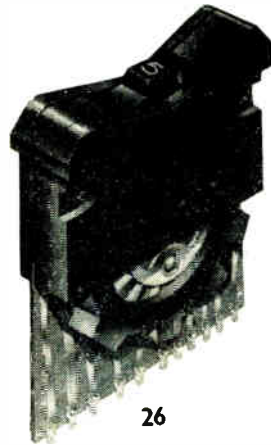

26

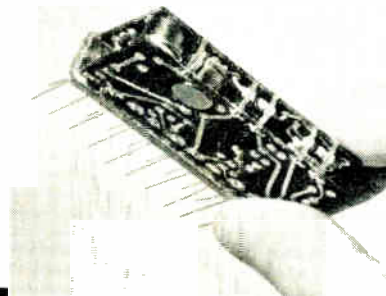

27

photograph shows an exploded view of the contactor.—George Ellison Ltd., Perry Barr, Birmingham 22B.

For further information circle 22 on Service Card

23. Miniature Encoder

S. G. Brown have introduced a miniature incremental optical encoder. The 'Minitac' is size 15 synchro base, 1.3 in. long and provides directional sensing. Resolution of 1,024 lines is currently available and other resolutions will be produced shortly.

This type of encoder provides a means of determining accurately the angular position of a shaft, its angular velocity and its angular acceleration. It gives a sinusoidal output signal corresponding to discrete angular increments of shaft position. Direction of rotation is also sensed enabling the device to be applied to a variety of control systems.—S. G. Brown Ltd., Devonshire Works, Dukas Avenue, Chiswick, London, W.4.

For further information circle 23 on Service Card

24. Industrial Tachometer

Flight Refuelling have produced an industrial tachometer with an output

available either as a pulse train, or, with a conversion unit, as a d.c. signal for application to a meter. The tachometer will measure from 3,000 to 15,000 r.p.m. f.s.d. in the range recommended by B.S. 3403. D.c. output is proportional to speed to within $\pm 0.2\%$.

The pick-up head and tachometer wheel are contained in a robust cast housing for heavy industrial applications, and the assembly is fully sealed to suit most environments. Maximum torque required to drive the tachometer is less than 1 oz/in.—Industrial Electronics Division, Flight Refuelling Ltd., Wimborne, Dorset.

For further information circle 24 on Service Card

25. Shaft Encoder

A size-18 shaft encoder, now available from Moore, Reed and Co. gives a total count of 2^{19} . Three binary discs are employed with a gear ratio of 64:1 between them. The resolution at the input shaft is 2^7 per revolution and the two low-speed discs have a count of 2^6 each. The unit, which has withstood severe environmental tests, is designated type No. 18DV-19-EP102.

V-scan brush disposition is employed on all discs to avoid ambiguity of readout, and buffer diodes are incorporated to each brush (37 diodes in all).

Connections are by header pin and the design is arranged with a crimped joint between the diode termination and the pin so that soldering to the pin can be carried out without danger to continuity within the unit.—Moore, Reed & Co. Ltd., Woodman Works, Durnsford Road, London, S.W.19.

For further information circle 25 on Service Card

26. Edge Control P.C. Switch

NSF have announced a single-pole, 10-position, edge control rotary printed circuit switch, suitable for instrumentation and control apparatus. The switch is available in single units, or ganged units of up to 4 sections, controlled by a single thumb wheel, or in stacked assemblies of up to a maximum of twelve single units. The indexing mechanism is of double-ball type, with 36 degrees indexing only and a stop is included to limit rotation to any position between 2 and 10.

Terminals are of the solder lug type; alternatively, printed circuit connectors on a 0.2-in. module can be used. Slots are provided for universal mounting to suit various panel thicknesses.—NSF Ltd., 31-32 Alfred Place, London, W.C.1.

For further information circle 26 on Service Card

27. Digital Circuit Blocks

Two new series of digital circuit blocks have been announced by M.E.I. In addition to being encapsulated in a potting compound, the blocks are hermetically sealed in metal cans and the leads are brought out through glass-to-metal seals. Maximum dimensions are $53 \times 25 \times 12.7$ mm, and 19 connecting wires are standard on all types.

The two series of units are compatible, both employing n-p-n transistors and operating from 12 V. The series 10 units use germanium transistors and the maximum permissible operating temperature is 55°C ambient. The basic flip-flop will switch in $3.5 \mu\text{sec}$.

The series 20 units use silicon epitaxial devices and have a maximum temperature rating of 85°C ambient. The silicon units also have a faster operating speed, the flip-flop being capable of switching in 50 nsec. Their higher power rating enables them to be used for driving magnetic stores, the maximum temperature then being

EQUIPMENT REVIEW

65 °C.—*The M.E.L. Equipment Co. Ltd., 207 Kings Cross Road, London, W.C.1.*

For further information circle 27 on Service Card

28. High-Speed Tape Dispenser

Document Transports Ltd. have designed a power-driven dispenser for handling large reels of paper tape at high speed. The unit, known as the type 1000 tape dispenser, has been developed for feeding paper tape to high-speed punches and readers. Its response ensures up to 1000 characters per sec without snatch or drag on the reader.

The dispenser is completely self-contained and can be plugged directly into the 230-V mains. It is portable and can be fitted to any paper tape system without modification. All the standard sizes of paper tape can be used without any mechanical adjust-

ment. This unit is particularly suitable for computers working with a large volume of input data punched on paper tape.—*Electronics Division, Scientific Furnishings Ltd., Poynton, Cheshire.*

For further information circle 28 on Service Card

29. Radioactive Gas Monitor

The portable radioactive gas monitor, type 1762A, developed by Isotope Developments, is a battery-powered, transistorized instrument primarily intended for radiation monitoring in and around nuclear reactors.

The use of a double-concentric, gamma-compensated ionization chamber enables low-level concentrations of tritiated water vapour and other radioactive gases in air to be measured even in the presence of a gamma-ray flux of a few milliröntgens per hour. Current from the chamber is measured

by a d.c. amplifier having a maximum full-scale sensitivity of 10^{-13} A.

Apart from its use in reactors, the instrument can be employed in nuclear physics laboratories and in hospitals using radioactive gas for diagnostic purposes.—*Isotope Developments Ltd., Bath Road, Beenham, Reading, Berks.*

For further information circle 29 on Service Card

30. A.C./D.C. Precision Calibrator

Ballantine Laboratories have announced an a.c./d.c. calibrator, model 421, with an output of 0 to 111 V. The a.c. may be r.m.s. or peak-to-peak at either 400 c/s or 1 kc/s. Output voltage to four significant figures is indicated digitally. Accuracy is $\pm 0.15\%$.

The principal applications are calibration of voltmeters, oscilloscopes, recorders, and other voltage-sensing devices. Model 421 is portable and the accuracy holds for operation from a wide range of mains voltages.—*Livingston Laboratories Ltd., 31 Camden Road, London, N.W.1.*

For further information circle 30 on Service Card

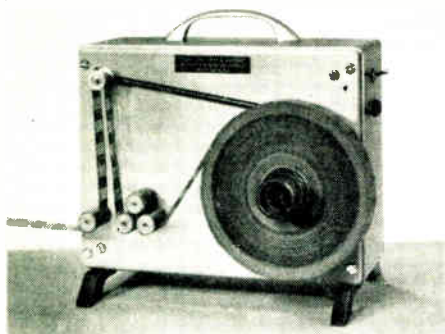

28

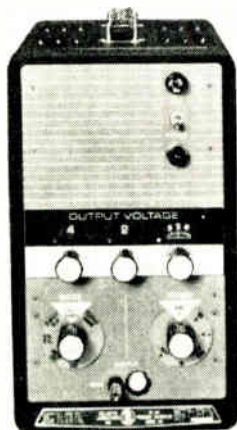

30



29



31

31. Ultra-Lightweight Headphone

A lightweight stethoscope headphone has been designed for hospital use by Hadley Telephone & Sound Systems. In its newest form the instrument weighs only half an ounce, compared with the $1\frac{1}{2}$ oz of the original headphone introduced two years ago.

The average weight of a conventional headset for use with bedhead radio is 9 oz. In this ultra-lightweight version the weight saving has been achieved largely by substituting a special moulded Y-junction for the central hinge which was a feature of the earlier model; this makes for easier sterilization of the nylon and plastic instrument. New manufacturing techniques have enabled cost as well as weight to be cut substantially—32s. 6d. compared with 65s. for the original type.—*Hadley Telephone & Sound Systems Ltd., 72 Cape Hill, Smethwick 41, Staffs.*

For further information circle 31 on Service Card

32. Rugged Magnetron

The latest addition to The M-O Valve Co. range of rugged magnetrons is an X-band valve with a peak output power of 7 kW and a warm-up time of less than 10 seconds.

This magnetron, type E3094, is capable of withstanding a swept vibration of from 20 c/s to 10 kc/s with accelerations commencing at 3 g and rising to 50 g. Under these conditions,

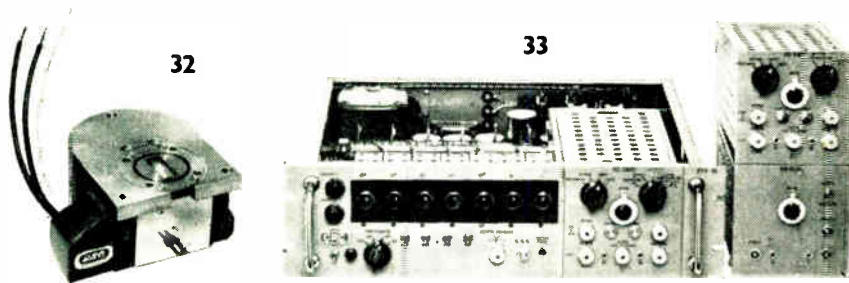

32

33

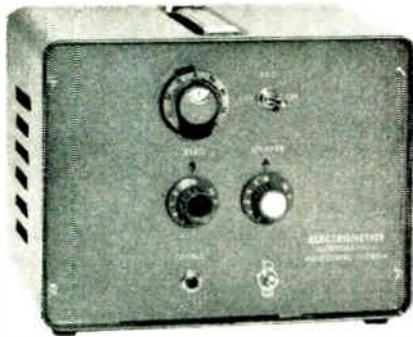

34



35

the output frequency will not change by more than ± 3 Mc/s. It is also capable of withstanding accelerations of 40 g for 10 msec. Heater supply and high voltage can be switched on simultaneously depending on the type of modulator used. Stability under high rates of rise of voltage at short pulse conditions is better than 0.1% during the first 10 seconds of operation.

The valve, which features built-in thermocouples for anode temperature measurement, can operate in an ambient temperature range of -65 to $+90$ °C and at pressures down to 200 mm of mercury. It measures approximately $4\frac{1}{4} \times 4\frac{1}{4} \times 2$ in. and weighs 4 lb.—*The M-O Valve Co. Ltd., Brook Green Works, London, W.6.*

For further information circle 32 on Service Card

33. Transistorized Scaler

A recent addition to the C.R.C. range of transistorized nuclear instruments is the type ETT 10 scaler. This instrument provides seven counting decades of which the first, together with the input circuitry, is contained in a plug-in unit. The plug-ins at present available provide resolving times of 1 μ sec, 100 nsec and 50 nsec; a 20-nsec (50-Mc/s

counting rate) unit is under development.

The main chassis includes the read-out (either 1-2-4-8 indicators or Nixie tubes), preset count facility and reset to zero. The 1- μ sec and 100-nsec plug-ins will accept positive or negative pulses between 0.5 and 5 V into 1,000 Ω and are equipped with externally-controllable gates and a test facility derived from the mains supply. The 50-nsec unit requires negative pulses between 0.5 and 5 V into 100 Ω and between 5 and 50 nsec in duration.—*Claude Lyons Ltd., Valley Works, Hoddesdon, Herts.*

For further information circle 33 on Service Card

34. Portable Telemetry Receiver

Industrial Electronics Corporation have introduced a portable telemetry receiver designed for use with transducer f.m./f.m. transmitting systems to determine amplitude, frequency and waveform. Frequency response is 20 c/s to 20 kc/s ± 1 dB and sensitivity is 2 μ V for full limiting.

The receiver consists of transistorized f.m. tuner and discriminator powered by a 24-V battery or a.c. power supply. The tuner covers the

standard 88-108 Mc/s range or, alternatively, 75-85 Mc/s. An automatic frequency control switch is included to compensate for drift in both transmitter and receiver. Depending upon the sub-carrier signal frequency, the discriminator is available on different models for 1.6, 4, 10, and 25 kc/s.—*Industrial Electronics Corporation, P.O. Box 862, Melbourne, Florida, U.S.A.*

For further information circle 34 on Service Card

35. Paint Thickness Meter

The Belix Co. has introduced a transistorized paint thickness meter built under licence to B.A.C. The instrument measures $9\frac{1}{8} \times 5\frac{1}{4} \times 7\frac{1}{8}$ in. and incorporates a probe unit which is offered to the work under test.

Contained in the probe are oscillator coils which vary in inductance according to the proximity of the metallic base of the work, the instrument giving a direct meter reading in terms of coating thickness. An accuracy of up to ± 0.0003 in. can be achieved for coatings up to 0.02 in., whilst coatings up to 0.1 in. thickness are measurable with the aid of a calibration/correction curve.

In standard form, the probe unit carries a 4-ft cable link and the instrument is powered by an internal battery.—*The Belix Co. Ltd., Victoria Road, Surbiton, Surrey.*

For further information circle 35 on Service Card

36. Conducting Glass

Conducting glass panels are now being manufactured and marketed by Thorn Electronics. These will be of interest to meter manufacturers, since the processing techniques have resulted in the production of an extremely reliable with anti-static glass suitable for instrument 'windows'. Other applications include photoconductive cells and display devices.

Using 10- or 18-oz. soda glass in any size up to 10 \times 8 in., a durable and transparent, electrically conducting film (mainly stannic oxide) is formed by chemical treatment of the glass at high temperatures. The optical transmission is between 80% and 90% of that of untreated glass and normally has a white or very light yellow colour. Some low-resistance films, however, show a slight blue coloration. With standard materials, the electrical resistance is 1 k Ω \pm 25% per square. Lower or higher resistances can be obtained, and films of a zero temperature coefficient can be made to order.—*Thorn Electronics Ltd., 105-109 Judd Street, London, W.C.1.*

For further information circle 36 on Service Card

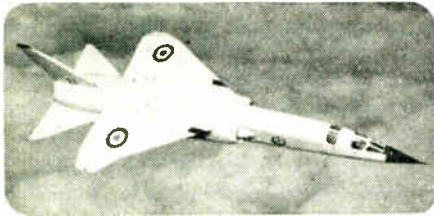

PROTECTING AIRCRAFT DISTRIBUTION SYSTEMS

By K. F. BACON*

WITH the development of large a.c. generation systems for aircraft having capacities of up to 300 kW, the problem of busbar protection has become increasingly important. Detection of busbar faults and the isolation of the offending section can be vital to the success of the mission of a military aircraft or a means of safety and reliability in a civil aircraft. However, the provision of current transformers and Merz-Price protection can be costly in terms of components and weight and is difficult where many alternative current routes are used. The complexity of the protection systems used on the ground and their size and weight render them unsuitable for aircraft use. This article describes how the use of symmetrical component networks can be used to fulfil these purposes and, in conjunction with simple semiconductor circuits, provide simple discrimination.

Symmetrical Components

It has been shown¹ that unbalanced 3-phase voltages can be resolved into three sets of symmetrical components:

- (a) A positive-sequence component, in which the phases pass through their maxima in sequence Red-Yellow-Blue.
- (b) A negative-sequence component, in which the phase order is reversed to Red-Blue-Yellow.
- (c) A zero-sequence component, in which all three voltages are in phase.

All the voltages in each component set are equal and

* The M.E.L. Equipment Co. Ltd.
Title picture Crown Copyright reserved.

120° apart (except for the zero-sequence component, where the voltages are equal and in phase). An example of this resolution is shown in Fig. 1, where the unbalanced voltage system E_A , E_B and E_C is resolved into its positive, negative and zero sequence components. It can be seen that the addition of these three components produces the original unbalanced system.

The methods of calculation to obtain the components for any unbalanced system are derived in standard textbooks (e.g., reference 2), and can be summarized as follows:

- (a) To obtain the positive sequence component for phase A, add vectorially, and then divide by 3; E_B is advanced 120° and E_C retarded 120° on E_A .
- (b) To obtain the negative sequence component for phase A, add vectorially, and then divide by 3; E_B is retarded 120° and E_C advanced 120° on E_A .
- (c) To obtain the zero sequence component, add vectorially, and then divide by 3; E_A , E_B and E_C are in phase.

From this, the important fact emerges that the zero sequence component is always associated with the supply neutral since no zero sequence component exists if the system voltages sum to zero.

This resolution into components is in fact a mathematical device which considerably simplifies three-phase network calculation. If an asymmetrical fault occurs on a three-phase distribution system, unbalance will result, and the magnitude of three components is a measure of the magnitude of the fault for any system. The presence of a zero sequence

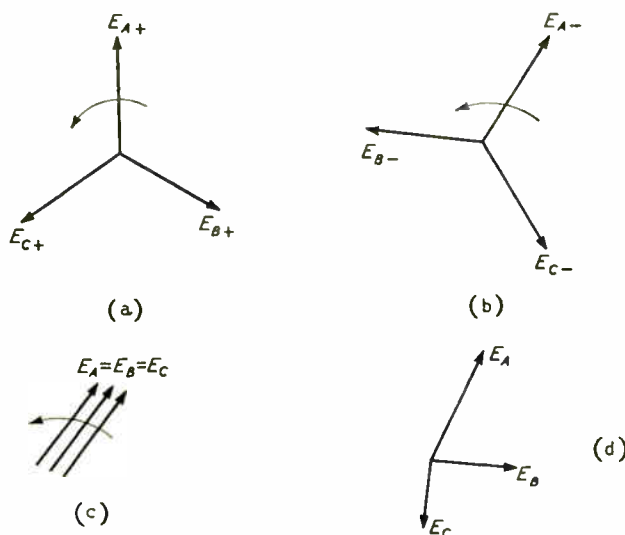
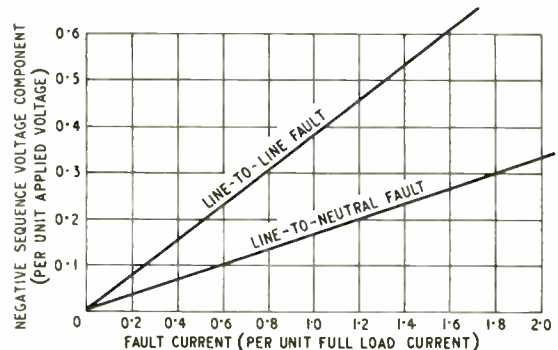

Fig. 1. (Left) Vectors for the positive sequence component (a), negative (b) and zero sequence (c), with the resultant at (d)

Fig. 2. Relation between fault current and negative sequence voltage for two kinds of fault



Busbar protection is now highly important in aircraft, but conventional methods are expensive and heavy with the three-phase supplies now widely used. This article describes a simple system which depends on the detection of the positive, negative and zero sequence components of voltage which appear when the supply is unbalanced.

component also indicates a fault between line and neutral. Electrical networks can easily perform the calculations mentioned above, and it is thus possible to determine the magnitude and nature of faults by measuring a system's symmetrical components. Such a system has been proposed in the U.S.A. for aircraft supply systems³, and has been used in this country on at least two systems.

Negative Sequence Protection

If an alternator is subjected to an asymmetrical load, a negative sequence component of output voltage will result. The value of this component will depend on the magnitude of the fault current, the characteristics of the system (e.g., the source impedance of the generator), and also upon the type of fault; i.e. line-to-line or line-to-neutral. A typical characteristic is shown in Fig. 2. It can be seen that an NSV (negative sequence voltage) protection circuit designed to trip at a certain value will operate for lower fault currents line-to-line than those line-to-neutral. This is advantageous in some systems, e.g., where the neutral currents return via earth or aircraft frame, since this might be of larger capacity than the supply cables.

A circuit which is responsive only to the negative sequence component of the system voltages is shown in Fig. 3. When three-phase supply voltages are connected to the input terminals, a voltage appears at the output which depends upon the negative sequence component of those voltages. This can be seen by considering the effect of connecting:

(a) 100% positive sequence component (i.e., normal balanced system) and

(b) 100% negative sequence component (i.e., normal phase sequence).

The vector diagrams are shown in Fig. 4. In (a) it can be seen that the voltage output is zero since the voltages across R_2 and C_1 are equal and opposite. In (b) however, because of the rearrangement of vectors V_{ca} and V_{bc} , the voltages across R_2 and C_1 are displaced by 120° , giving an output equal to $\sqrt{3}/2$ of the applied NSV. Thus, for any unbalanced system this network will only respond to the negative sequence component. (Note that this circuit may also be used for reverse phase sequence detection.)

The main disadvantage of this type of circuit is its inaccuracy when the supply frequency is changed. Its action depends upon the phase shift produced by C_1 and R_3 , and this will obviously vary with frequency, causing an output to appear when no NSV is present, and an error when it is. The former case is illustrated in Fig. 5 which shows the effect of varying the frequency. The locus of the junction of V_{c1} and V_{R3} moves in a semicircle, and a voltage output, V_o , appears at all frequencies other than the design frequency. The magnitude of V_o is plotted in Fig. 6, which shows the voltage output from the circuit with varying frequency when no NSV is present. (The design frequency is 400 c/s.)

For applications where frequency variations are important the circuit shown in Fig. 7 has been designed⁴. Such a circuit is useful, for example, in aircraft systems where a 'soft' generator drive is used. When faults are applied to such a system, the frequency may change violently at the time when the protection circuit is required. The circuit consists of two networks producing outputs V_1 and V_2 . Both networks produce errors, but these are roughly equal and in phase so that the subtraction of V_1 from V_2 results in a very small resultant error. Since the outputs from the networks with NSV applied are equal and displaced by 60° , their subtraction results in a voltage equal to either network's output. This is illustrated in Fig. 8 and 9 which show the vector diagrams for 100% PSV and 100% NSV. With 100% PSV applied, no outputs, V_1 and V_2 , appear since the voltages V_{R2} , V_{C1} and V_{R4} , V_{R5} cancel. With 100% NSV applied, outputs appear which are equal and 60° apart.

The effect of frequency changes when no NSV is applied is illustrated in Fig. 10, which shows what happens when

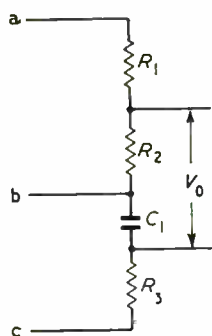

Fig. 3. (Left) Circuit responsive only to the negative sequence voltage

Fig. 4. (Below) Vector diagrams for Fig. 3 for 100% positive (a) and 100% negative (b) sequence voltage

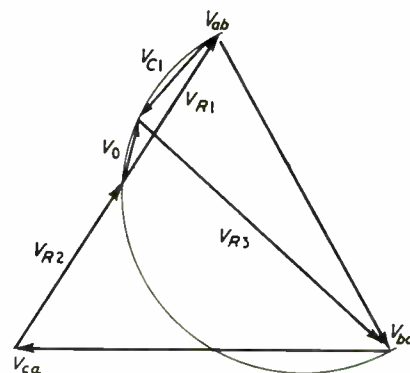
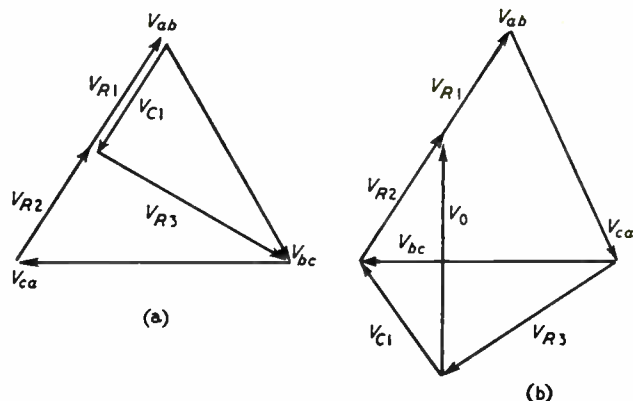

Fig. 5. Vector diagram for Fig. 3 to illustrate the effect of a change of frequency

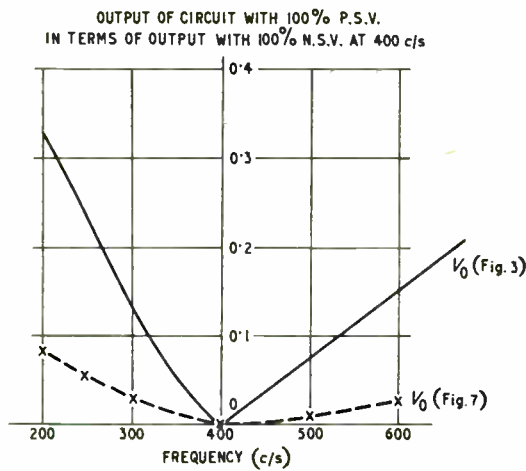

Fig. 6. Effect of frequency on the circuits of Figs. 3 and 7

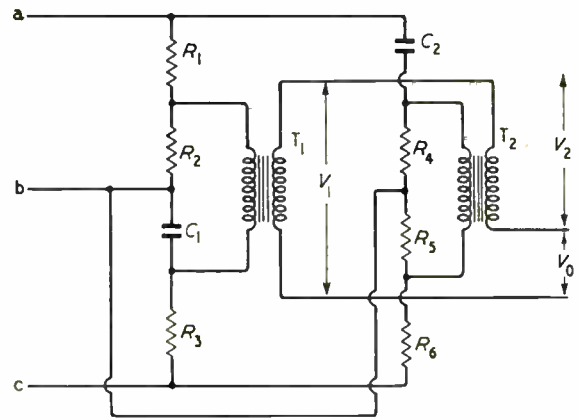

Fig. 7. Circuit in which the output is little affected by frequency

the frequency is increased. The junction of vectors V_{C1} , V_{R3} moves to A, and that of V_{R4} , V_{C2} to B. This results in outputs V_1 and V_2 from the networks, which for small deviations are in phase and equal. Thus the resultant error is zero. As the frequency deviation increases the difference in the two errors increases until the correction no longer applies. However, for all deviations likely to be encountered, the error is very small. A more detailed mathematical derivation is given in the Appendix. The dotted line in Fig. 6 shows the reduction in error.

The above case is the most important from considerations of percentage error since the output should be zero. With 100% NSV applied, a calibration error appears, but expressed as a percentage of the normal output, this is very small (e.g., at 450 c/s, for a 400 c/s circuit it is 1.3%).

Thus this simple circuit can be used to detect fault currents in electrical systems even during extreme frequency deviations. The sensing can be performed by transistor circuits such as the one shown in Fig. 11. Inverse or fixed

time delays can also be performed by semiconductor circuits so that discrimination with fuses and other protective elements can be achieved.

Zero Sequence Protection

To detect line-to-neutral faults only, zero sequence protection can be used. From what has already been said, it can be seen that, for this, a simple resistor adding circuit is all that is required for the detection of the zero sequence voltage. Such a circuit is shown in Fig. 12. The three line-to-neutral voltages are added by the resistor network, and the output is proportional to the zero sequence voltage.

Such a circuit can be used also to detect the failure of any one phase to three-phase equipments. This is normally caused by a fuse blowing or a contactor fault and can cause overheating of motors and gyros, for example, since these will continue to run on a single-phase supply, but may refuse to start if the supply is switched off and then on again. Obviously the best way of sensing such a failure

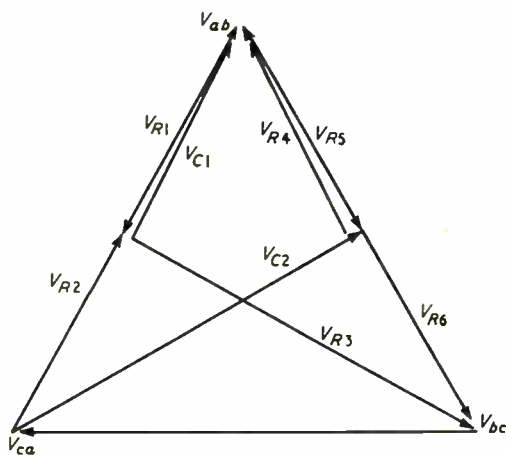
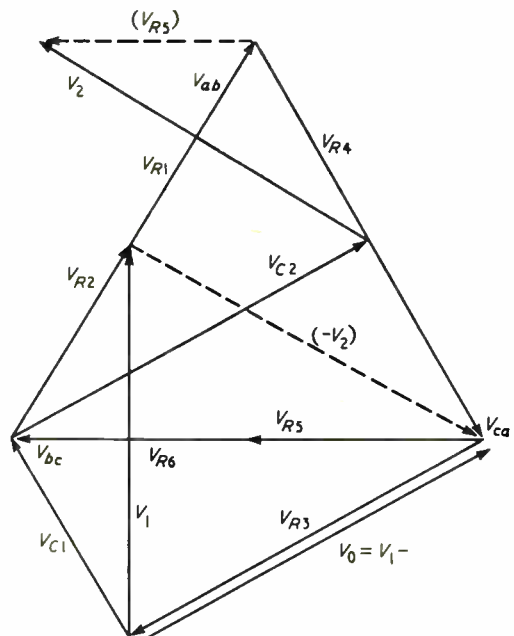

Fig. 8. Vector diagram for 100% positive sequence voltage with the circuit of Fig. 7

Fig. 9. (Right) This diagram is similar to Fig. 8 but for 100% negative sequence voltage



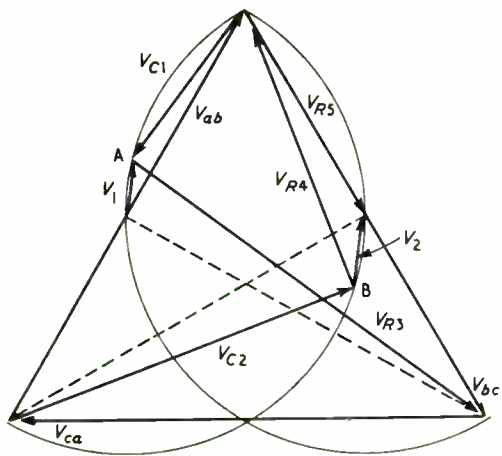
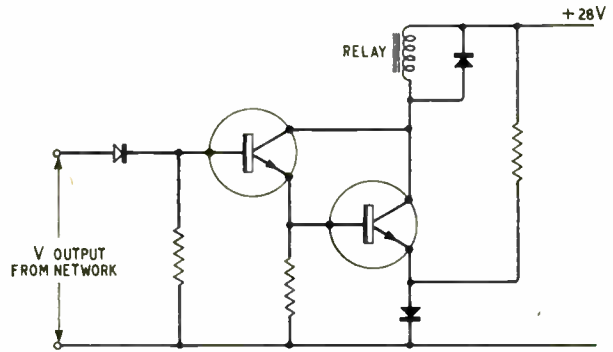

Fig. 10. (Left) This diagram shows the effect of frequency with the circuit of Fig. 7

Fig. 11. Simple fault detector



would be to connect current transformers in each line to measure the current. However, this would involve a different set of transformers for each equipment and is probably uneconomic. Line voltage cannot be sensed, since with regenerative loads, the voltage may not change very much. However, should this fault occur to any load, the zero sequence component will change; i.e., there will be a change in voltage and/or phase. This can be detected by a zero sequence network and appropriate action taken. (It is worth noting that this is a useful protection in that it protects equipment against the circumstances causing damage, since if no ZSV appears, then the equipment will not be damaged.)

Such a device is shown in Fig. 13. This shows the circuit of a phase-failure unit² being produced for 400 c/s, 200 V, 3-phase equipment, and is mainly intended for aircraft use. It operates from the supply being protected and is a completely self-contained, potted unit measuring 1½ in. × 1¼ in. × 1¼ in. The output relay is either a latched or unlatched

type depending on the application. To prevent operation during system transients and fault clearances, a one-second time delay is included. The unit is not damaged by transient voltages of up to 1.5 kV, and operates when any phase voltage falls by 30 V, or changes its phase angle by 16°.

Acknowledgments

Thanks are due to Mr. C. H. Braybrook of Mullard Research Laboratories, Mr A. Cain of The M.E.L. Equipment Co. Ltd., and Mr. J. P. Ratcliffe of British Aircraft Corporation.

The author also wishes to thank the directors of Mullard Equipment Limited for permission to publish this article.

References

- 1 'The Method of Symmetrical Co-ordinates Applied to Polyphase Networks', C. L. Fortescue, *Trans. A.I.E.E.*, Vol. 37, Pt. II, 1918.

(Continued overleaf)

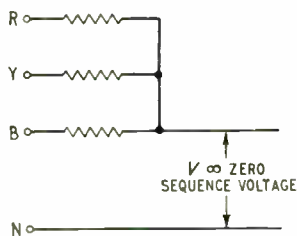

Fig. 12. For zero sequence voltage detection a simple resistor adding circuit is sufficient

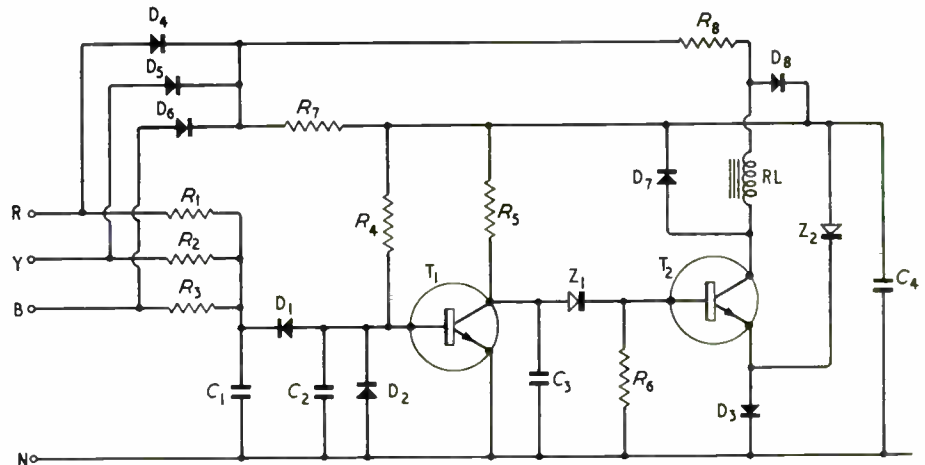

Fig. 13. Complete phase failure detector circuit

² 'Symmetrical Components' (Book), C. F. Wagner, R. D. Evans, McGraw-Hill Book Company Incorporated, N.Y. 1933.

³ 'Negative Sequence Voltage Detection on Aircraft A.C. Electric Systems', R. D. Jessee, P. F. Boggess, *A.I.E.E. Transactions*, Vol. 72, Pt. II, pp. 209-14.

⁴ 'Improvements in or relating to Negative Sequence Voltage Detectors', PHB 30998, British Patent No. 29395/60, C. H. Braybrook and K. F. Bacon.

⁵ 'Testing Three Phase Machines', PHB 31185 British Patent No. 17377/63, K. F. Bacon.

APPENDIX

Analysis of the Frequency-Corrected N.S.V. Circuit of Fig. 7

Design

From the vector diagram of Fig. 8, the following relations between the magnitudes of the voltages exist:

$$V_{ab} = V_{bc} = V_{ca} = V; \\ V_{R1} = V_{R2} = V_{C1} = V_{R4} = V_{R5} = V_{R6} = V/2; \\ V_{C2} = V_{R3} = V\sqrt{3}/2$$

Therefore, $R_1 = R_2, R_5 = R_6, R_3 = \sqrt{3}/\omega_0 C_1$, and $R_4 = 1/\sqrt{3}\omega_0 C_2$ where ω_0 is the design angular frequency.

Let $R_1 = R_4 = R_5 = 1/\omega_0 C_1$, then

$$R_1 = R_2 = R_4 = R_5 = R_6 = 1/\omega_0 C_1, R_3 = \sqrt{3}/\omega_0 C_1$$

Output with 100% N.S.V.

Referring to Fig. 9,

$$V_{ab} = V; V_{bc} = -\frac{1}{2}(1 - j\sqrt{3})V; V_{ca} = \frac{1}{2}(1 + j\sqrt{3})V,$$

where V = amplitude of each line voltage.

Then

$$V_{R2} = V/2$$

$$V_{C1} = \frac{V_{bc}}{1 + j\sqrt{3}} = -\frac{V}{8}(1 - j\sqrt{3})^2 = \frac{V}{4}(1 + j\sqrt{3})$$

and

$$V_1 = V_{R2} + V_{C1} = \frac{V}{4}(3 + j\sqrt{3})$$

Similarly

$$V_{R5} = \frac{V_{bc}}{2} = -\frac{V}{4}(1 - j\sqrt{3})$$

and

$$V_{R4} = \frac{V}{4}(1 + j\sqrt{3})$$

so

$$V_2 = V_{R5} + V_{R4} = \frac{V}{2}j\sqrt{3}$$

Assuming 1 : 1 transformer ratios, the output is thus

$$V_1 - V_2 = \frac{V}{4}(3 - j\sqrt{3})$$

so that the amplitude is $V\sqrt{3}/2$.

Thus the output voltage of the circuit is $\sqrt{3}/2$ times the amplitude of the negative sequence component. From a study of Fig. 9 it can be seen that the effect of small frequency variations on this value is likely to be negligible. In fact, it is about 1.3% for a 50-c/s change.

Output with 100% P.S.V. and Variation of Frequency

Consider a frequency change from the design frequency ω_0 to ω_1 . Let $\omega_1/\omega_0 = x$ and $R = R_1$, then

$$1/\omega_1 C_1 = 1/x\omega_0 C_1 = R/x$$

$$1/\omega_1 C_2 = 1/x\omega_0 C_2 = \sqrt{3}R/x$$

$$V_{R2} = V/2$$

$$V_{C1} = \frac{V_{bc}}{1 + j\omega_1 C_1 R} = \frac{V_{bc}}{1 + jx\sqrt{3}} = -\frac{V}{2} \cdot \frac{1 + j\sqrt{3}}{1 + jx\sqrt{3}}$$

taking

$$V_{bc} = -\frac{V}{2}(1 + j\sqrt{3})$$

$$V_1 = V_{R2} + V_{C1} = \frac{V}{2} \left[1 - \frac{1 + j\sqrt{3}}{1 + jx\sqrt{3}} \right] = \frac{V}{2} \cdot \frac{j\sqrt{3}(x-1)}{1 + jx\sqrt{3}}$$

Now

$$V_{R5} = \frac{V_{bc}}{2} = -\frac{V}{4}(1 + j\sqrt{3})$$

$$V_{R4} = V_{ab} \frac{R_4}{R_4 + 1/j\omega C_2} = \frac{V}{1 - j\sqrt{3}/x}$$

$$V_2 = V_{R4} + V_{R5} = V \left[\frac{1}{1 - j\sqrt{3}/x} - \frac{1}{4}(1 + j\sqrt{3}) \right] =$$

$$\frac{V}{4} \cdot \frac{(3 - j\sqrt{3})(1 - 1/x)}{1 - j\sqrt{3}/x}$$

The output is

$$V_0 = V_1 - V_2 = \frac{V}{4} \left[\frac{2j\sqrt{3}(x-1)}{1 + jx\sqrt{3}} - \frac{(3 - j\sqrt{3})(1 - 1/x)}{1 - j\sqrt{3}/x} \right] \\ = \frac{V}{4}(x-1)^2 \left[\frac{-3(x^2 + 4x - 1) + j\sqrt{3}(3x^2 - 4x - 3)}{3x^4 + 10x^2 + 3} \right]$$

By substituting values of x at different frequencies, the resultant output of the circuit can be calculated. This can be compared with the output from the simple circuit (Fig. 3) which is, in fact, V_1 above. The calculated values for V_1 and V_0 are given in the table below for $\omega_0 = 400$ c/s. From this it can be seen that, over the frequency range 350-450 c/s, the error has been reduced by more than ten times.

Frequency (c/s)	x	V_1 (real) per unit	V_1 (imag.) per unit	$ V_1 $ per unit	V_0 (real) per unit	V_0 (imag.) per unit	$ V_0 $ per unit
100	0.25	-0.238	-0.548	0.597	-0.007	-0.256	0.256
150	0.375	-0.248	-0.38	0.453	-0.041	-0.154	0.159
200	0.5	-0.215	-0.249	0.328	-0.041	-0.081	0.091
250	0.625	-0.163	-0.15	0.221	-0.028	-0.036	0.045
300	0.75	-0.105	-0.08	0.132	-0.014	-0.015	0.021
350	0.875	-0.05	-0.033	0.06	-0.003	-0.003	0.004
400	1.0	0	0	0	0	0	0
450	1.125	+0.045	-0.023	0.05	-0.001	0	0.001
500	1.25	+0.083	-0.038	0.091	-0.01	-0.005	0.011
550	1.375	+0.116	-0.049	0.126	-0.02	-0.005	0.02
600	1.5	+0.145	-0.056	0.155	-0.035	-0.005	0.035
650	1.625	+0.171	-0.06	0.182	-0.05	-0.008	0.05
700	1.75	+0.192	-0.064	0.202	-0.06	-0.005	0.06

The effects of circuit loading have been ignored, but experiments with transistor circuits showed these to be negligible.

8th Automation and Instrumentation Exhibition and Conference

Coinciding with the announcement that Italy has joined the Committee for Exhibitions of Measurement and Automation, comes the news that the Eighth Automation and Instrumentation Exhibition and Conference will be held in Milan on November 19th to 25th 1964. C.E.M.A., a consultative body made up of the European trade associations connected with measurement and automation, is established in Germany, France, Holland and U.K.

The conference will cover the following topics: (1) Instrumentation, transducers and instruments, electronic engineering, remote control measurement, remote control and transmission techniques. (2) The application of remote control systems in industry. (3) Automatic data evaluation. (4) New techniques of automation in chemical and physical processes, radioactive analysis, material spectrometry, gas chromatography, other methods of analysis. (5) Control and efficiency of industrial processes by use of computers.

For further information circle 41 on Service Card

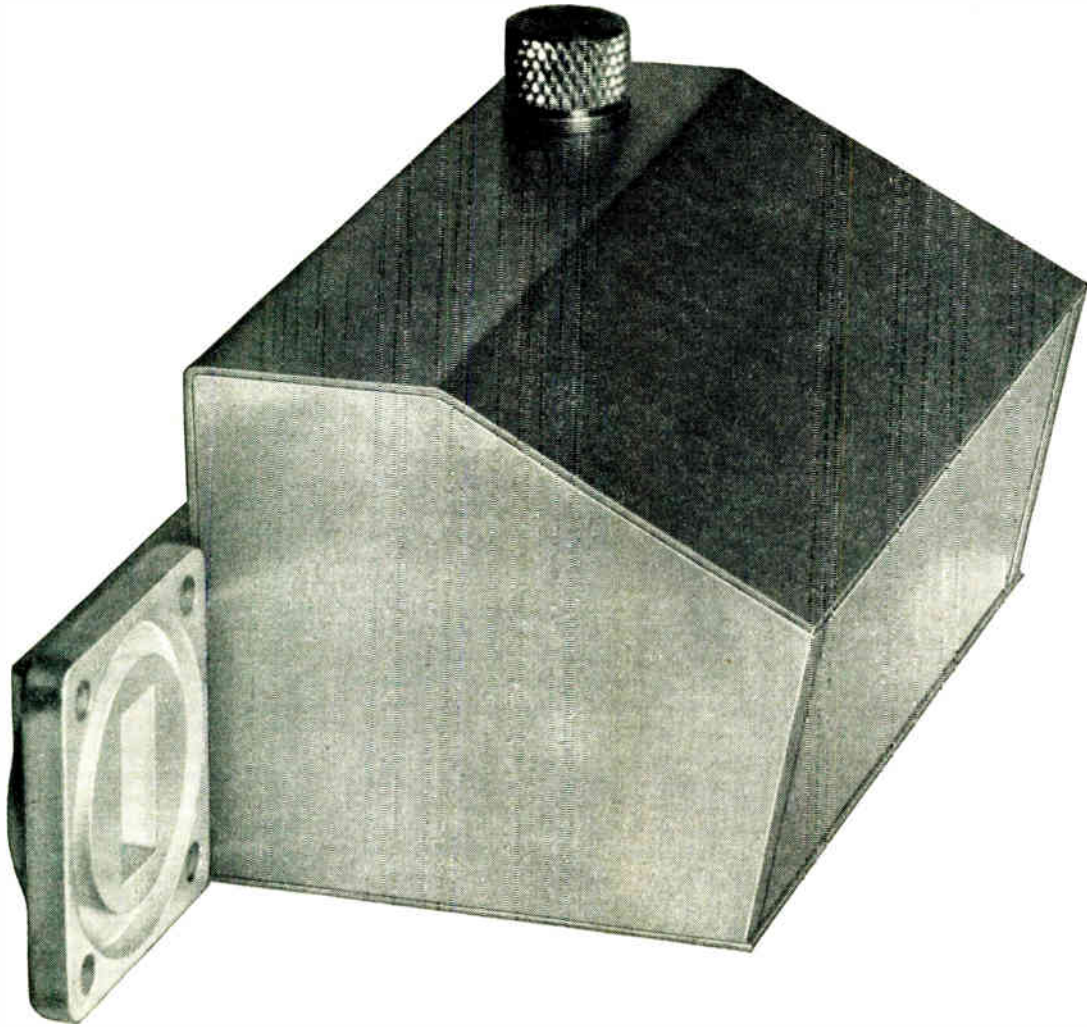

M-O V present solid state microwave power sources!

Now M-O V announce a new range of packaged semiconductor microwave generators. Small, light and exceptionally robust, they require far less elaborate power supplies than conventional reflex klystrons. J-band devices are now in production. Devices up to J-band will be available shortly—all featuring exceptionally wide electronic tuning range.

J-BAND SEMICONDUCITOR SOURCE—SPECIFICATION

Output frequency:	12–15 kMc/s
Tuning Range:	280 Mc/s electronically tuned (3dB points)
Modulation Sensitivity:	15 Mc/s/volt
Temperature Stability:	2 parts in 10 ⁶ per °C.
Power Output:	15mW min.
Spurious Response:	–30dB up to 280 Mc/s about centre frequency
F.M. Noise:	20c/s in 100 cycle bandwidth
Size:	16 cu. in.
Weight:	12 oz.

Our technical information centre is ready to help with your application problems. Write for further details on these or other M-O V products, or telephone RIVerside 3431. Telex 23435.



M-O VALVE CO LTD

BROOK GREEN WORKS · HAMMERSMITH · LONDON W6

“...the latest flower of my researches”

ALICE:

Why, Papa, you seem completely in the toils.

PAPA:

Leave speculations on appearances to the philosophers child, and release me!

ALICE:

At once Papa. But I should not have thought a pianola existed to play so lengthy a roll as this.

PAPA:

Cut away child, cut away. No pianola roll this, but programming tape – the latest flower of my researches. A beam of light, interrupted by the passage of the tape, shines through the apertures...

ALICE:

Pray stand still, dear Papa, or I shall never contrive your release.

PAPA:

Your pardon, my dear. One naturally feels elated. One might almost chortle – to borrow Mr. Carroll's most descriptive word...

ALICE:

Nearly free now, Papa. But do not I understand W. and T. Avery to use both punched tapes and cards to feed weight information into Accounting and Statistic Systems? Their advanced digital techniques, which employ photo-transistors to enable accurate scale control to function without frictional load...

PAPA:

My heart turns cold! Success vanishes like a chimera. I perceive henceforth my watchword must be that of Herr Brahms, the music composer, – Frei, aber Froh! Free, but lonely.

For many years Avery stamped industrial scales have worked in conjunction with standard punched card equipment feeding weight information into accounting and statistic systems.

Avery weight control systems with punched card equipment are operating in Britain's most advanced mills.

Digital techniques and the use of photo-transistors make it possible to achieve very accurate scale control without frictional load or delicate contacts.

For further information and advice on all aspects of the use of electronics in weighing control, write to:

W. and T. AVERY LIMITED, BIRMINGHAM 40

No. 6 of a series

THE ELECTRONIC COUNTER

Applications of electronic counters are not confined to the counting of objects, such as articles on a conveyor belt. They now include many measurements which can be carried out on a counting basis. As a result counters are now commonplace in laboratories as well as factories. This article describes the principles of electronic counters and some of the applications.

By O. H. DAVIE, M.I.E.E.*

THE modern electronic counter is a complex instrument whose applications extend far beyond the simple counting of articles passing along a production line or the revolutions of a shaft. Simple counters still have wide application in industry and, in conjunction with ingenious transducers, measure many qualities of a manufactured product. Transducers produce an electric pulse when stimulated by phenomena such as the interruption of a beam of light or the passage of nuclear radiation through opaque packets. Other transducers detect articles by their effect on a magnetic field or by the weight of the article, or its colour, as it passes along a production line. The function of the transducer is to generate an electric pulse for each piece of 'information' it receives. The function of the counter is to add together the pulses and record the result in digital form. A simple digital recorder is the electro-mechanical register employed in telephone exchanges to display the total number of calls made by a subscriber. Careful design has enabled this type of register to count 50 pulses per second, but Neher¹ in 1939 described a similar counter operating in 1/2,000th of a second. High-speed electronic counters operate in tens of nanoseconds and make use of the binary system for the adding process.

The binary system is based on a scale of 'two' instead of 'ten' as in the decimal system. With this scale a circuit need have only two states, ON or OFF, and no intermediate states exist to cause confusion or error. A circuit which switches from one steady state to another on receiving a signal and returns to its former state on receipt of a second identical signal is known as a binary counter, scale of two counter or binary divider. It generates one output pulse for each pair of input pulses. By cascading binary circuits the input frequency may be divided by 4, 8, 16 or any other power of two, n binary circuits being required to divide by 2^n .

The binary circuit has been described by many authors but an analysis in great detail is given by Neeteson for both the valve² and transistor³ versions of the circuit. Students who have not met the circuit may wish to refer to Fig. 1, which shows a simple arrangement employing two transistors and two steering diodes. When Tr_1 is conducting its collector potential is low and the potential drop along the resistance divider R_2, R_3 ensures that Tr_2 is cut off. The collector potential of Tr_2 is high and the divider R_4, R_5 ensures that Tr_1 remains conducting so that the circuit rests in one of its stable states. The two steering diodes, D_1 and D_2 are reverse biased but the potential across D_2 is much less than that across D_1 , since Tr_2 is not conducting. A positive pulse at the input makes D_2 conduct and steer the pulse to the collector of Tr_2 . The potential at this point and hence at the base of Tr_1 is reduced and the fall in current through Tr_1 causes a corresponding rise in its collector potential. This rise is transferred to the base of

Tr_2 , increasing its current and reducing further the potential at its collector. The action is cumulative and ceases when Tr_1 is cut-off and Tr_2 conducts so that the circuit now rests in its second stable state. It remains in this state until a second pulse arrives but now the potential across D_1 is less than that across D_2 and this pulse is steered to the collector of Tr_1 . The switching process is repeated and the circuit returns to its former state to complete the cycle. Output signals are taken from either collector and have a rectangular waveform of half the frequency of the input pulses. In whichever state the circuit comes to rest, 0 or 1, it will remain in or be returned to the 0 position by momentarily closing the reset switch S_1 to ensure that Tr_1 is cut off.

The Digital Display

A number of binary stages are connected in cascade and at the end of the count the total number of input pulses received is recorded by the final 'states' of the binaries when they come to rest. The states are not easy to see and some form of indicator is required. In valve circuits a neon lamp is connected across the anode load of each binary output but in transistor circuits more complex systems are necessary. The binary indicators carry the binary scale 1, 2, 4, 8, 16, etc. and the first input pulse operates the first binary and neon No. 1 glows. The second pulse resets binary 1 to its former state but in so doing operates binary 2, extinguishing neon 1 and causing neon 2 to glow. The third pulse operates binary 1 again so that neons 1 and 2 glow to indicate a count of 3. The fourth pulse resets both

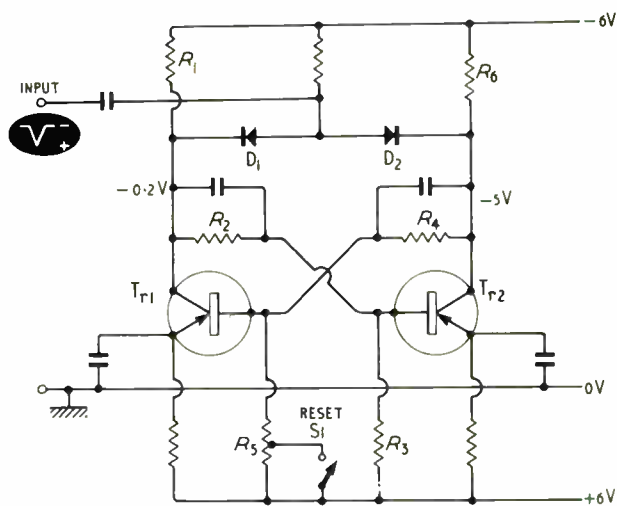

Fig. 1. Basic binary circuit

* Airmec Ltd.

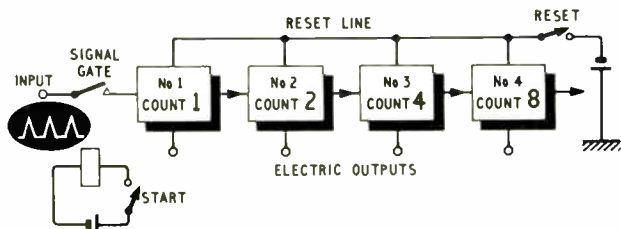

Fig. 2. Block diagram of simple counter. Each 'box' contains a binary circuit like that of Fig. 1

binaries, extinguishes their neon indicators, and operates binary 3 to indicate a count of 4. The fifth pulse operates binary 1 again so that neons 1 and 4 glow to indicate a count of 5, and so on.

The conversion from binary to decimal notation is done as the operator reads the numbers indicated by the neons and the process can be tedious with large numbers. To facilitate reading, a circuit of four binaries has been modified to reduce its normal count of 16 to 10 and pass on one pulse for every ten received. Before transistors were employed this circuit had four double triodes and five double diodes per decade and the counter became unwieldy. To reduce the power required and make portable equipment possible, several other decade counters were devised, the most successful being a cold-cathode scaling tube, the Dekatron⁵. The Dekatron makes use of the transfer of a glow discharge from a common anode to one of ten cathodes in turn and is satisfactory for pulse rates up to 4 kc/s. A modification using a mixture of helium and argon in place of neon extends the pulse rate to 20 kc/s but a high-vacuum tube based on the Dekatron raised the frequency to at least 2 Mc/s. It was described by Alfen et al.⁷ and called a Trochotron from the trochoidal path of the electron beam as it leaves the common cathode. With the introduction of transistors, however, circuit technique has turned the full circle and the original binary circuit, modified for decade counting, is preferred particularly for operation at very high speeds. The transistors drive relays and indicate their final states by lighting lamps in an in-line digital display.

A typical display unit has 10 lamps, one for each digit, and each lamp projects an image of the appropriate digit on to a ground glass screen. In another arrangement ten slabs of transparent plastic are placed in sandwich formation, one behind the other, and each is engraved with a 'dotted' character from 0 to 9. One of the 10 lamps edge lights the particular digit it is required to display. A special digit display tube is also available for this purpose. It utilizes the glow discharge between a transparent mesh and ten other electrodes in the form of digits. This tube requires less power but a higher operating potential than the normal lamps.

Modes of Operation

The range of application of electronic counters is steadily increasing and new instruments have additional features to meet new requirements. As a result the modern counter has

many modes of operation, and has developed into a counting 'system' rather than a single instrument. A basic counter is shown in Fig. 2. The pulses to be counted are applied to a signal gate which is opened by the start switch. A gate is said to be open when it permits the input signals to pass and is closed when it stops them. The pulses pass through the gate to the binary counters where their number is added irrespective of the time of their arrival and, within certain limits, of the interval between them. They continue to pass until the gate is closed and the total 'count' displayed. Finally, the reset button is operated and returns the circuits to zero ready for the next count. The maximum counting frequency of a given equipment is defined as the greatest number of equally spaced pulses (f) which are recorded consistently in a given time. The reciprocal of this figure, $1/f$, is the resolving time of the counter and defines the smallest interval between any two pulses which are recorded separately by the counter.

An electrical output showing the final state of a binary can be taken from either transistor and will have one of two definite potentials according to the state of the circuit. The potentials of a number of binaries may be combined to deliver an output signal only when a pre-determined number of pulses has been counted. This is a simple batch counter and will provide a suitable signal to operate a machine or control an industrial process. If this signal returns to close the signal gate, the counting stops automatically after a pre-determined number of pulses. These pulses may be the number of cycles of the mains supply required for a welding operation or similar process.

Period Measurement

Since the counter will control the duration of a process it may also be used to measure the duration of a process which is controlled independently. In this type of measurement a transducer generates a pulse at the start of the process and opens the signal gate. The gate allows the signal of a reference oscillator to pass to the counting circuits until it is closed by a second pulse generated at the end of the process. The number of cycles of the reference oscillator which have passed in the meantime is indicated on the display. Suitable choice of the reference oscillator frequency as, for example, 1 kc/s, enables the display to be calibrated

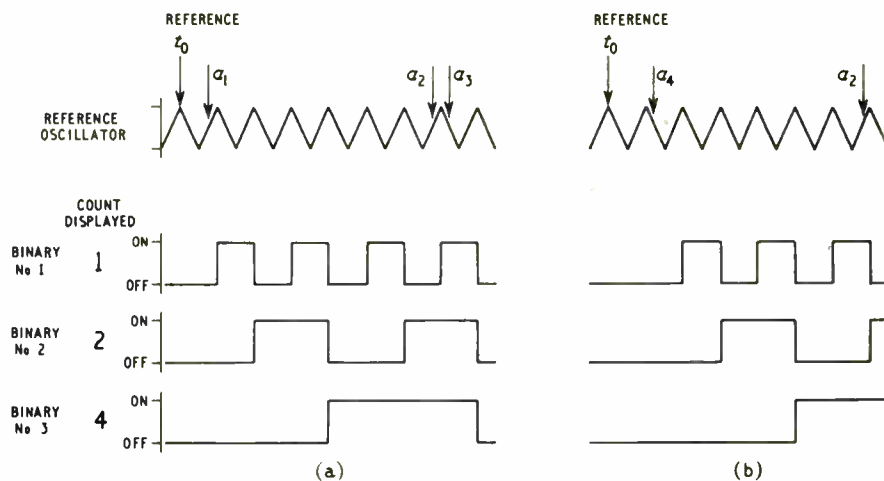

PERIOD	ACTUAL TIME IN CYCLES	No. OF PEAKS	COUNT DISPLAYED	MAX. ERROR
a_1 to a_2	6.0	6	6	0
a_1 to a_3	6.2	7	7	-1
a_4 to a_1	5.8	5	5	-1

Fig. 3. These diagrams show how it arises that all counting is subject to a possible error of ± 1

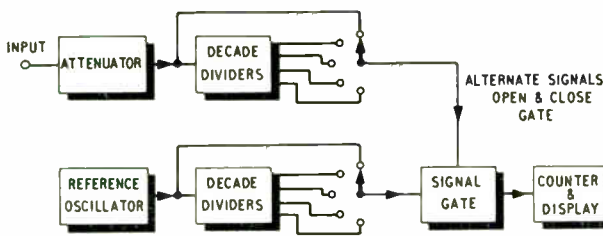

Fig. 4. Multiperiod counter. The input frequency is divided by a suitable factor and the time of one cycle of this is measured

directly in milliseconds and the counter becomes a direct-reading stop-watch. Its accuracy depends upon the reference oscillator frequency, the speed of operation of the signal gate, and the relative phase of the oscillator and the process being measured. The latter gives rise to the so-called ambiguous count.

The ambiguous count results in an error of ± 1 count irrespective of the number of counts displayed and depends on the precise points on the reference oscillator waveform that the gate is opened and closed. The process is shown by the diagrams of Fig. 3(a) in which the waveform of the reference oscillator is triangular (for clarity), and time is measured from the reference point t_0 . In the first case considered the process to be measured opens the gate at a point a_1 , approximately 0.9 cycle from t_0 and $\frac{1}{10}$ cycle later the peak of the waveform operates binary 1. The first peak is counted and more counts are registered as each peak arrives. After 6 cycles (6.9 cycles from t_0) the process stops. At this point a_2 , binary 1 reads zero; binary 2 reads 2 and binary 3 reads 4, making a total count of 6, which is correct. In the second case the process is a little longer and the gate closes at a point a_3 , 7.1 cycles from t_0 . At this point, binary 1 reads 1; binary 2 reads 2; and binary 3 reads 4, making a total count of 7. The gate, however, is only open for 6.2 cycles and the error is +0.8. This error can rise to +1.0 as the points a_1 and a_3 approach the peak of the waveform. In the third case the period is a little shorter and the gate opens at a_4 (1.1 cycles from t_0) and closes at a_2 Fig. 3(b). At a_2 binary 1 reads 1, binary 2 reads zero and binary 3 reads 4, making a total count of 5. The gate is open for 5.8 cycles and the error is -0.8. This, too, may rise to -1.0 in a similar way. The three answers which a counter may give are the true count, the true count -1 or the true count +1.

As mentioned earlier a reference frequency of 1 kc/s provides direct calibration of the period of time in milliseconds. Increasing the frequency to 10 kc/s allows the calibration to remain in milliseconds but moves the decimal point one place to the left. Similarly a frequency of 100 kc/s moves the decimal point two places, so that the ambiguous count amounts to only ± 0.01 of a millisecond. A reference frequency of 1 Mc/s provides direct calibration in microseconds.

Multiperiod Measurements

With repetitive input signals the period of a number of cycles may be measured and that of a single cycle calculated. By this means it is possible to measure the period of sine-waves of much higher frequency than would normally be possible without increasing the frequency of the reference oscillator. These multiperiod measurements are made by dividing the input frequency by a suitable factor, such as ten, and measuring one period of the divided frequency, Fig. 4. Unfortunately, the error of ± 1 count is now equivalent to ± 10 counts of the input signal and the measur-

ing accuracy is reduced. It is restored, however, by counting for ten times as long so that an error of ± 10 counts in a total ten times as great results in the same overall error. Increasing the counting time in this way restores the accuracy of the high-frequency measurements but does not reduce the resolving time of the counter.

Timing Wave

Apart from the ambiguous count the accuracy of the instrument depends upon the frequency of the reference oscillator. The frequency is controlled by a quartz crystal mounted in an oven whose temperature remains within ± 0.1 °C. In addition the crystal is designed to operate as nearly as possible at the point of its characteristic where the temperature coefficient of frequency changes from positive to negative. The overall stability of the oscillator is controlled by three parameters, the ambient temperature of the instrument, the small changes in temperature due to oven cycling and the long term ageing of the crystal itself. In good commercial counters the frequency change with temperature is approximately 5 parts in 10^9 per °C and a further 1 part in 10^8 per day is due to crystal ageing. Other variations, including oven cycling, contribute to the short term stability of the instrument and amount to approximately 1 part in 10^8 over a period of some minutes.

Pulse Time Measurements

The start and stop signals applied to a counter may arrive from the same or different sources, the so-called single or double line working. Counters suitable for both systems have two input circuits of identical performance and those intended for measuring pulse characteristics are arranged as shown in Fig. 5. The start signal passes through an attenuator to a circuit which functions as an input signal level control and a polarity selector. These two functions are different but closely related. The input level control, sometimes called trigger level, generates an output pulse when the input signal amplitude reaches any desired level with respect to earth. The polarity selector decides whether the pulse is generated on the positive slope of the waveform at this level (i.e., while the input signal amplitude is rising), or on the negative slope when it is falling. The diagram of Fig. 6 shows the effect of the circuit on a sinusoidal input signal and indicates how a definite trigger point can be selected at any part of waveform. The output pulse from this circuit opens the signal gate and allows pulses from the reference oscillator to pass to the counting circuit. The counting continues until a pulse from the stop line passing through a similar circuit closes the

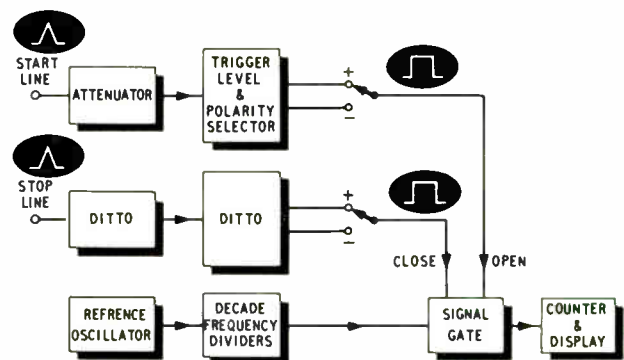
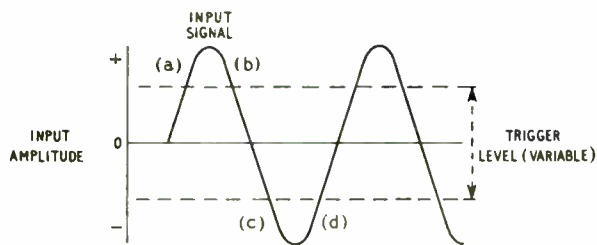

Fig. 5. A pulse on the 'start' line opens the gate while one on the 'stop' line closes it. While the gate is open pulses derived from the reference oscillator are counted



POINT (a) =	+	SLOPE	+	D.C. LEVEL WITH RESPECT TO EARTH	"	"	"	"	"
POINT (b) =	-	"	+	"	"	"	"	"	"
POINT (c) =	-	"	-	"	"	"	"	"	"
POINT (d) =	+	"	-	"	"	"	"	"	"

Fig. 6. Trigger level and polarity selection

gate and the number of cycles of the reference oscillator which have passed in the meantime is displayed.

With the aid of these two input circuits a number of pulse measurements can be made. A typical example is the measurement of rise time. The pulse is applied to both inputs simultaneously and the start line is set to open the gate when the pulse amplitude reaches 10% of its final value. The stop line closes the gate at the 90% level and the rise time (10-90%) is displayed directly by the counter. Unlike the normal oscilloscope the counter measures the rise time of a single pulse, and holds its display until reset by the operator. In a similar way the pulse duration may be measured by setting the trigger level controls of both input circuits to the 50% level and their polarity selectors to opposite signs. The gate then opens when the input pulse amplitude is rising at half its final value and closes when it is falling at this value thus giving a direct measurement of pulse duration.

Frequency Measurement

As well as measuring the period of a waveform the counter can operate in another mode to measure input frequency directly. The unknown frequency passes through a pulse shaper and is applied to the signal gate, Fig. 7, but unlike the previous modes it does not operate the gate. The gate is opened by the reference oscillator, or a signal from one of its frequency dividers, and the unknown frequency passes to the counter for a definite period of time. If this period is 1 second the unknown frequency will be displayed directly in cycles per second complete with the unit of frequency and the decimal point, as shown in the photograph.

In frequency measurement the unknown signal is continuous and measurements may be repeated at regular intervals to indicate the change of frequency with time. As the signal gate closes a pulse is passed to a delayed pulse generator (automatic reset Fig. 7) and after a suitable time, while the operator notes the results, the generator resets the display ready for the next count. A repeating display is convenient in crystal manufacture, or for observing the stability of a signal generator or the decay of a radio-active source. Rapid changes in the display can confuse the operator and sometimes the displays are extinguished during the actual counting process with only the final result being presented. Others take the process a stage further and continue to display the previous count until the present one is complete. They then change only the particular digits which require altering.

In the frequency measuring mode the counter records the number of cycles of an unknown frequency f_1 passing through the gate in a known time. The time, however, is

controlled by the reference oscillator f_2 so that, in principle, the counter measures the number of cycles of f_1 which pass in a single cycle of f_2 ; i.e., the ratio f_1/f_2 . In this mode the counter is a frequency comparator and the multiple-period technique enables the f_1/f_2 ratio to be measured with remarkable accuracy.

Self-Test Facility

A rapid means of checking the operation of the frequency dividers and counting decades, together with their control circuits makes use of the counter as a frequency comparator. The reference oscillator which controls the time for which the signal gate is open is also connected to the input as the unknown frequency. With this arrangement the unknown frequency f_1 is equal to f_2 and the ratio f_1/f_2 is unity. This ratio produces a count of 1 and does little to test the circuits but as the gate control is switched successively to each frequency divider (Fig. 7) the gate opens for successively longer periods of time. When the divider reduces the reference oscillator frequency by 10^7 then 10^7 cycles of the reference oscillator will pass through the gate and a figure of 10,000,000 will be displayed each time a count is made. This figure checks that all the dividers and counters are working properly and the display is subject only to the error of the ambiguous count.

Miscellaneous Features

In addition to the many modes of operation mentioned above other facilities are available in a normal counter. The reference oscillator output provides a standard frequency to which other equipment can be referred and the frequency dividers generate a wide range of accurately spaced pulses. Adding the outputs of two dividers produces one double amplitude pulse for every ten normal pulses and provides an electronic ruler scale for calibrating cathode-ray tube displays.

Recording rapidly-changing readings can be tedious to the operator and automatic printing devices are employed. They are driven from the electric outputs of the counting decades. The data are carried along multiway cable by signals which take the form of either an open-circuit or a direct short-circuit to earth. A typical counter may have 50 leads connecting to its printer but for transmission over long links a coding system is employed. A typical example is the one line staircase code. Each decade generates a 10-step staircase waveform in its full cycle of operation and the final output amplitude corresponds to the level of the step of the particular digit displayed. Similar data from

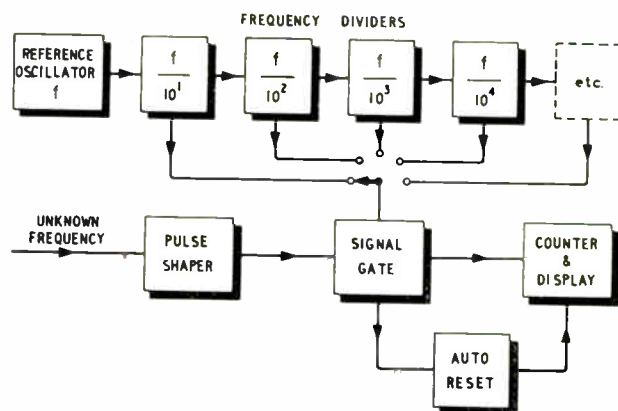
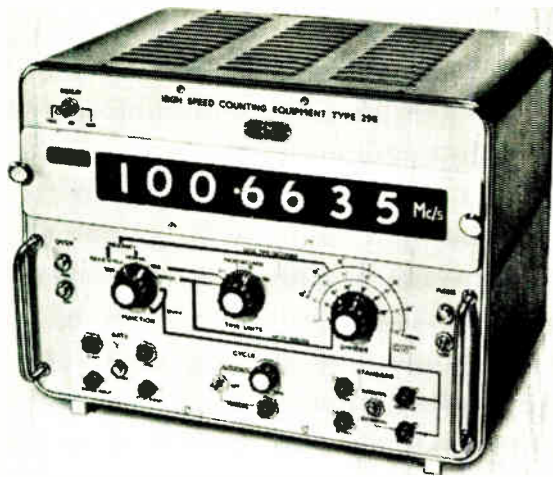

Fig. 7. Block diagram of apparatus for the measurement of frequency



One of the fastest counters commercially available, Airmec type 298. It employs transistor circuits only and measures frequency direct to 100 Mc/s

each decade are scanned in the counter in synchronism with a scanning circuit in the printer and the latter places the printing wheels in positions corresponding to the output level of each decade. At the end of the scan the print is recorded and a reset pulse travels back to the counter to return its decades to zero ready for the next count. A number of pulse code systems are in general use and are suitable for driving not only automatic printers but data handling devices, tape or punched card recorders, automatic typewriters and certain servo-mechanisms.

Another additional unit extends the frequency range of a counter by mixing the unknown input signal with a suitable harmonic of the counter's reference oscillator. The difference frequency, or beat note, is recorded by the counter and the unknown is simply the *sum* of the counter reading and the harmonic frequency selected. Converters

of this type will extend the range of a 10-Mc/s counter to approximately 500 Mc/s in 50 steps of 10 Mc/s, and will maintain counter accuracy over the entire range. Advanced techniques in high-speed circuits simplify this process and the fastest counters available today record direct to 100 Mc/s and reach 500 Mc/s in only 5 or 6 steps. Still higher frequencies are measured with a transfer oscillator. This oscillator is a very stable signal source whose harmonics are tuned to zero beat with the unknown input signal. The counter reads the oscillator frequency direct and the unknown signal is simply this reading *multiplied* by the order of harmonic used. This process will extend the range of a 100-Mc/s counter up to 10 or 20 kMc/s and in certain cases even higher.

With its many modes of operation and ancillary equipment now available, the simple counter has developed into a complex timing system of very great precision and its range of application increases steadily as new features improve its versatility.

References

- 1 Neher, H. V., 'A high speed mechanical recorder', *Rev. Sci. Inst.*, 1939 Vol. 10, pp. 29-31.
- 2 Neeteson, P. A., 'Vacuum valves in pulse techniques', Philips Tech. Library, 1959, Cleaverhume Press.
- 3 Neeteson, P. A., 'Junction transistors in pulse circuits', Philips Tech. Library, 1959, Cleaverhume Press.
- 4 Renwick, W., and Phister, M., 'A design method for direct-coupled flip-flops', *Electronic Engng.*, 1955, Vol. 27, pp. 246-250.
- 5 Bacon, R. C., and Pollard, J. R., 'The Dekatron', *Electronic Engng.*, 1950, Vol. 22, pp. 173-177.
- 6 Fraser, H. J., 'Transistorised dekatron driving circuits', *Electronic Engng.*, 1962, Vol. 34, pp. 40-41.
- 7 Alfin, H., Lindberg, L., Mulmfords, K. C., Wallmark, T., and Astrom, E., 'Theory and applications of trochotrons', *Trans. Roy. Inst. Technology*, Stockholm, 1948, No. 22.
- 8 Wells, F. H., and Page, J. C., 'Pulse counting and fast scaling circuits', *Brit.I.R.E.*, 1962, Vol. 23, pp. 231-235.
- 9 Spiegel, P., 'High speed scalers using tunnel diodes', *Rev. Sci. Inst.*, 1960, Vol. 31, pp. 754-755
- 10 Gilland, J. R., 'Transistor circuitry for radiation counting', *Rev. Sci. Inst.*, 1959, Vol. 30, pp. 479-484.

Abbey National Install a Computer

A Honeywell H-400 computer has been installed at the head office of the Abbey National Building Society, to replace an accounting machine system which, although large and efficiently organized, had reached its practical limit in keeping pace with the Society's expansion.

The Society has over 850,000 members, whose transactions are handled by 104 branches and over 750 local offices in all parts of the country. Details of daily transactions are sent to head office at Baker Street in London, where they are punched into paper tape. The data are then read into the computer which amends the basic records (maintained on magnetic tape), updates individual accounts, calculates interest and deals with all the accountancy work.

Although the Society's main reason for changing over to electronic data processing was to provide capacity for further expansion, substantial economies are ultimately expected to result from the change, with eventual benefits to all members of the Society. The speed of operation will be a major gain and members will receive prompter service in all spheres of activity.

For further information circle 42 on Service Card

Computer room at Abbey House, showing the new computer



VERSATILE LINE MILLING

CONTROL SYSTEM

A THREE-AXIS line-milling control system, which is flexible enough to be suitable for fitting to most machines and has several additional facilities not usually available, has been developed by E.M.I. Electronics from the B100 positioning-control system. This new equipment, the B100/L, offers the facility for controlling three axes of a milling machine at a feed rate which has been either manually pre-set or automatically selected from a punched tape. Switch-over from feed rate to rapid traverse movement and vice versa is also carried out by tape coding. Either five-channel or eight-channel punched tape is used. For the latter, EIA and BSI codes are available. The equipment is so designed that conversion to any future coding can be carried out on a customer's premises at very low cost.

Measurement of machine slide displacement may be either by a three-stage position analogue unit measuring on a lead-screw or rack-and-pinion, or by a two-stage unit and Inductosyns. Either English or metric measurement can be incorporated. One of the most important features inherent in this analogue system of measurement is the ability to pre-set anticipation of the coincidence point so

that the slides of the machine come to rest without overshoot.

Two sets of decade switches give full range calibrated zero shift over the table axes. These facilitate setting of the workpiece on the table without the need to align the programmed zero of the component to the zero datum of the machine. They also permit one workpiece to be loaded or removed from the worktable while a second workpiece is being machined, both workpieces being machined from the same tape merely by adding the distance between the first and second components to the zero shift dials.

B100/L control can be fitted to many conventional milling machines with very little modification to the machine tool, and in some instances it is possible for the existing drive system to be retained. When the equipment is fitted to a standard milling machine, three modes of operation are available: (1) *Manual*—the automatic control is switched out completely and the machine worked manually from its normal controls; (2) *Semi-automatic*—the dimension required for moving an axis is set on the decade dials provided, the 'One Move' pushbutton is pressed, and the machine then traverses at the pre-set feed speed to the point required. Subsequent movements are carried out in the same way; (3) *Automatic*—information is encoded on the punched tape to control the machine over the required cycle. Switching from rapid traverse to feed rate is via tape command and, where an automatic feed selector unit is fitted, this function is also encoded on the tape.

Certain optional facilities are available, including cutter diameter offset. Up to 9.9999 in.—positive or negative—may be offset, so that it is possible to programme only the outline dimensions of a component and offset completely the cutter diameter, which considerably simplifies the programming. If, however, programming of the centre line path of the cutter is necessary, this unit allows for corrections to be made for the difference between the theoretical diameter of the cutter, as programmed, and the actual diameter, which might be less because of regrinding. It is also possible with this facility to offset the cutter from the programmed path to carry out a roughing cut. The amount of offset is then removed and the finishing cut made. Other optional facilities include automatic control of turret, feed rate selection and tool or operation sequence number display.

For further information circle 43 on Service Card

The B100/L line milling control console

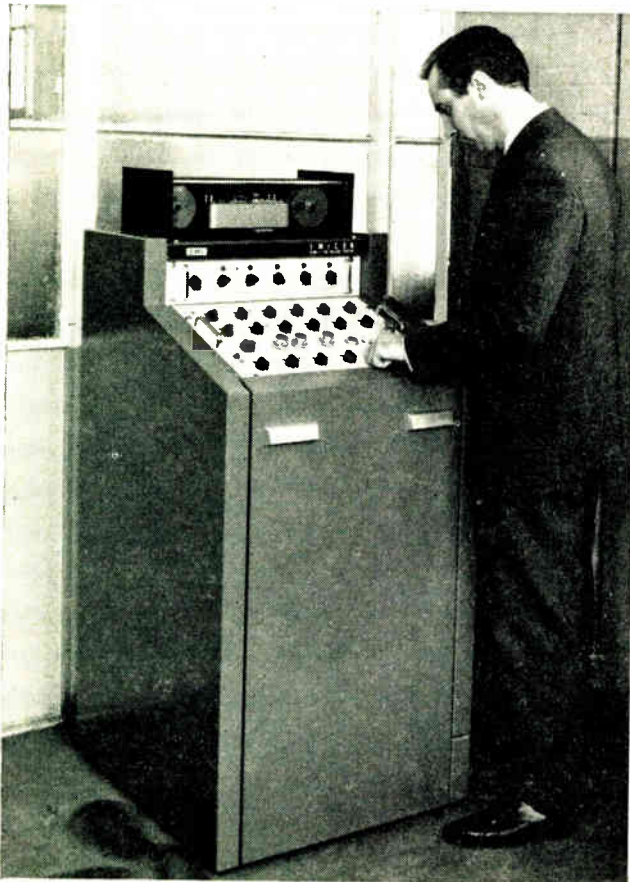

INFORMATION WANTED ?

If you require further details of products or processes described or advertised in INDUSTRIAL ELECTRONICS you will find it convenient to use the enquiry cards which will be found in the back of the journal. The sheet of cards can be folded out to enable you to make entries while studying the editorial and advertisement pages.

We don't make
supersonic jets

—but we help to
make them better

**UNION
CARBIDE**

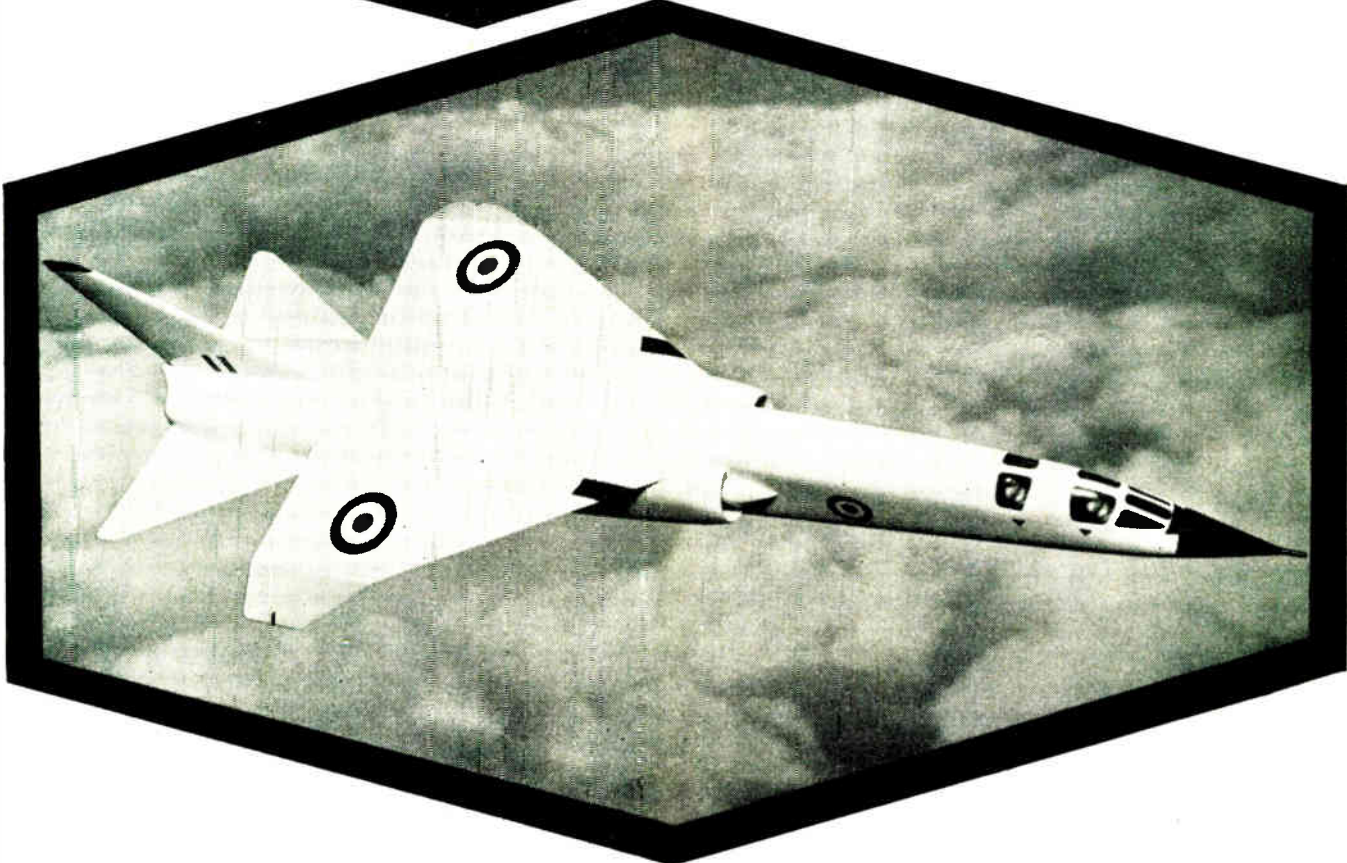

The electronic components in a supersonic jet *must* work without failure. Their selection therefore is most critical as only components of the highest reliability and closest tolerances can be accepted. The electronic system in the British Aircraft Corporation TSR2 includes Kemet solid tantalum capacitors. Kemet capacitors are also used in the British Aircraft Corporation VC10, the Hawker Siddeley ship-to-air guided missile Sea Slug, and their air-to-ground guided bomb Blue Steel—fair proof of their reliability in performing vital functions in extreme conditions. But Kemet tantalum capacitors can be more down to earth too. They are best for all terrestrial electronic equipment including computers wherever accuracy and consistent reliability are essential.

KEMET J-SERIES CAPACITORS comply with US MIL-C-26655A UK DEF/5134-A/1. EID & ARB release available.

KEMET PRODUCTS. Polar and non-Polar solid tantalum capacitors—'J' and 'N' series (standard), 'C' series (for commercial applications), 'P' series (for printed circuits); Barium Getters; Semiconductor Silicon; Silicon Monoxide; Laser/Maser Crystals; Alumina.

UNION CARBIDE LIMITED,
KEMET DIVISION, 8 GRAFTON STREET, LONDON W1.
Sales & enquiries Aycliffe Industrial Estate, Co. Durham.
Aycliffe 2180. Telex 58568.

U.K. distributors for 'J' series capacitors:
SASCO, GATWICK ROAD, CRAWLEY, SUSSEX. CRAWLEY 28700

The terms KEMET, DYNEL, UCON and UNION CARBIDE are trademarks of UNION CARBIDE CORPORATION.

CAPACITORS ANOTHER PRACTICAL PRODUCT OF



Chemicals · Cryogenics · Dynel Fibre · Electronic Components · Ferro-Alloys · Flame Plating · Molecular Sieves · Silicones & Ucon Lubricants



AVEL INSTRUMENTATION

Model 20
Low Current Leakage
Tester

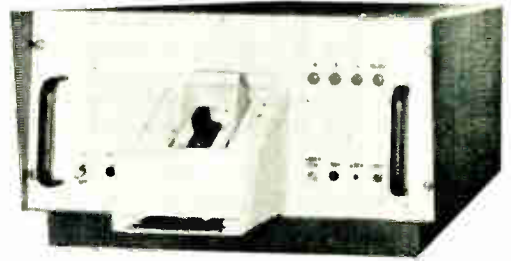
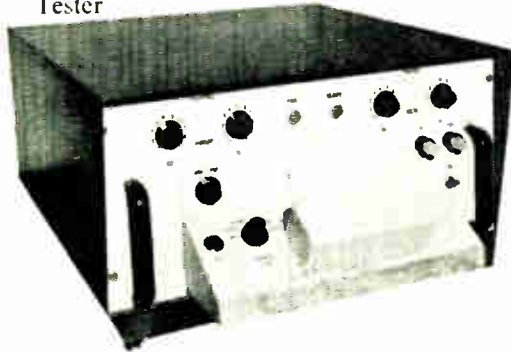

Model 10
LV CEO,R,S Tester

FAIRCHILD
SEMICONDUCTOR
(INSTRUMENTATION)

Other Models
Available:—

Series 100
Diode Sorter

Series 200
Transistor Sorter

Series 500
Multiparameter
Tester

Series 900
Card Programmed
Semiconductor
Data Logger

Series 250B
Transistor-Diode Tester
(Programmable)

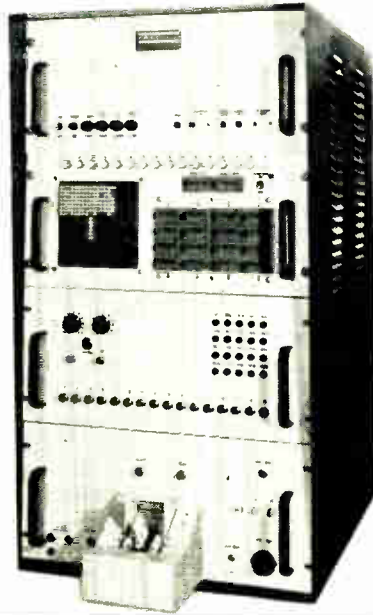

Automatic Semiconductor Test Instruments

Model 50
Direct
Reading
Pulsed
Beta Tester
(Programmable)

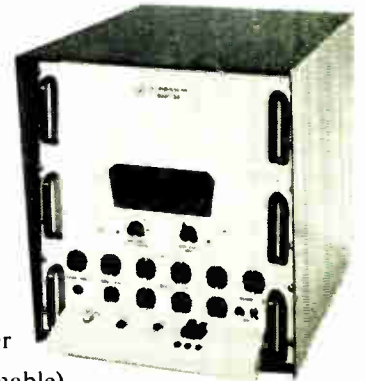

NOW MODULAR AMPLIFIERS



Many other models available.

Aveley Electric Limited

Distributors in United Kingdom for:

Measuring instruments of quality

For Further Information Write or Phone

SOUTH OCKENDON · ESSEX
TELEPHONE SOUTH OCKENDON 3444
TELEX 24120 AVEL OCKENDON

THE gain of an aerial is normally expressed in dB as the ratio of maximum radiation intensity from the aerial to the maximum radiation intensity from a half-wave dipole. The measurement is usually made by substituting a half-wave dipole for the aerial under test and noting the difference in intensity of signal. An alternative method of measurement has been proposed using integration of the horizontal and vertical radiation patterns of the aerial.

This method may, however, be highly inaccurate due to the impossibility of presenting sufficient information. The radiation pattern from an aerial is essentially a three-dimensional shape. For instance, lobes at 45° from both *E* and *H* planes cannot normally be measured and would, therefore, be ignored in the calculations. Also perhaps the most serious source of error is that losses in the aerial itself are ignored, and experience has shown that these may be considerable especially at u.h.f.

Pursuing, therefore, the established method of dipole substitution it is first of all necessary to consider the possible errors which may occur.

Impedance Matching

The normal test set up is shown diagrammatically in Fig. 1, and it will be seen that two feeders are used, one between the signal generator and radiating aerial, and the other between the test aerial and the receiver. Both of these feeders must be accurately matched to the instruments used. The calibration and reading of the signal-generator output meter is only accurate when the load on the generator is as stated

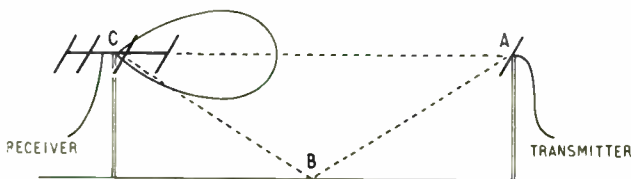

Fig. 1. Diagram of test site showing a reflection path ABC and an indication of the polar diagram of the aerial at C

by the manufacturers. This source of error can be very serious indeed if aerial tests are being carried out involving changes in frequency of operation. The output meter may effectively be reading the voltage at a point on the transmission line to the aerial although the point of connection may be inside the instrument. Variations of frequency mean, therefore, that the effective position of measurement on the line will change and the presence of any standing waves will result in variations in meter reading. The load on the signal-generator feeder is the radiating aerial, and although it is essential that this aerial should be reasonably matched to the line, it is not always possible to provide an accurate match. It is necessary, therefore, to incorporate an attenuator of the correct impedance at the connection to the signal generator to provide a correct load.

Standing waves and consequent errors of the receiver signal-strength meter reading will occur if the input impedance of the receiver is not accurately matched to the feeder from the test aerial at all frequencies used. It is almost impossible to satisfy this condition and it is, therefore, essential that another attenuator be incorporated at the receiver input to eliminate this source of error. An alternative method of dealing with this problem is to incorporate directly at the test aerial terminals a matched rectifier which converts the receiver signal to d.c. or audio which may then be conveniently fed to a remote meter. In either

Associated Aerials Ltd.

Due to ground and other reflections the test site has a considerable influence upon aerial measurements. This article describes a procedure by means of which it is possible largely to overcome this effect.

IMPROVED METHOD OF MEASURING AERIAL GAIN

By B. COLLINS, B.Sc.(Eng.)* and B. SYKES*

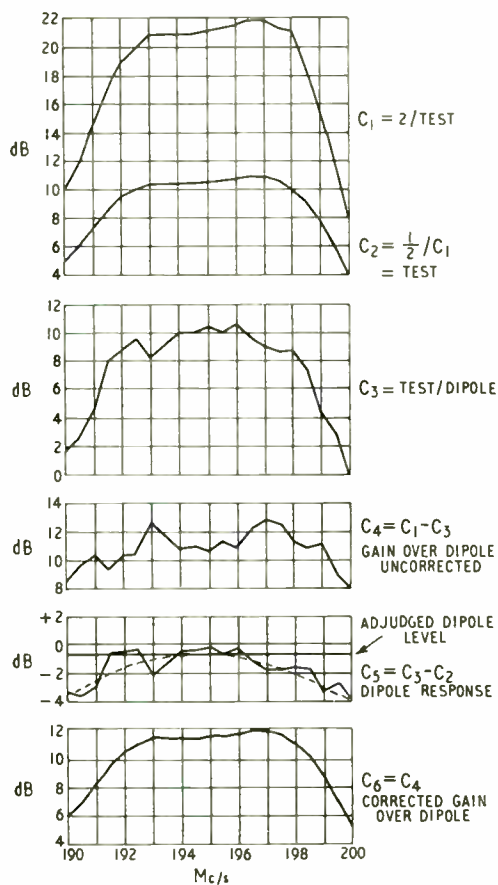

Fig. 2. These diagrams illustrate the procedure for eliminating site errors from the final result

system, however, it is essential that the test aerial operates into its designed impedance.

Drift of Test Equipment

The requirement for the output of a signal generator or the sensitivity of a receiver to stay constant throughout a day is not normally met by instrument manufacturers. The accuracy of reading of the signal generator output meter may well vary as a function of temperature, thus although throughout a series of tests the reading is held constant, the actual r.f. output may vary considerably. This fault has been found in both British and foreign types of test equipment, and adequate precautions to control these effects are essential. Two methods of control are available. Firstly, a third aerial may be set up to provide a reference signal to which the receiver may be frequently switched, although it is sometimes impossible to avoid this reference aerial having some effect upon the aerials under test. A second preferable method of calibration is by means of a link via an attenuator between signal generator and receiver. Mains-voltage variations, unless catered for in the instruments used, must be eliminated by the use of constant-voltage transformers, etc.

Aerial Feeder and Mounting

The performance of an aerial may be drastically modified by the presence of feeders and mounting structures in the plane of the elements. Testing of an aerial must, therefore, be carried out on its designed mounting structure and with the feeder in its designed position. The only alternative to this, when perhaps basic research is being under-

taken, is to ensure that mounting structures and feeders are at right angles to the plane of the elements for at least half a wavelength.

Test Site Errors

The sources of error previously listed may be overcome by attention to detail and the problems are essentially soluble. The perfect test site, however, is very often a dream and it is the purpose of the proposed new method of testing to overcome the inaccuracy caused by the imperfect test site, which is the main source of error in the measurement of aerial gain. Fig. 1 illustrates a typical test set up with the shape of the radiation pattern of the test aerial superimposed thereon. It will be seen that in addition to the direct signal path between the two aerials A and C there is a reflected signal along path ABC. The phase relationship of these signals is a function of path length or frequency and the reflected signal may augment, or diminish the signal received. The shape of the radiation pattern of the aerial under test in this case, however, will result in a considerable reduction of reflected signal, and this will thus have little effect. When, however, in an attempt to measure gain, a dipole is substituted for the test aerial there will be little or no attenuation of the reflected signal, and an entirely erroneous reading of the dipole performance will be obtained. The problem, therefore, is not so much that of measuring the performance of the test aerial but of measuring the performance of a dipole with which to provide comparison.

It is a requirement of the improved method that two identical aerials of the types whose gain it is required to measure are available. These aerials are mounted facing each other in the normal way on the test site at a minimum distance apart given by $R=4W^2/\lambda$ where R is the spacing and W is the largest physical dimension of one aerial. The frequency response of the two aerials is now plotted by recording in graphical form a plot of frequency against amplitude of received signal as shown in C_1 of Fig. 2. The response curve of one aerial will be the square root of C_1 , if this is plotted to linear ordinates; if, as is more convenient, it is plotted in dB the response curve will be half of C_1 , drawn as C_2 . Taking due precautions to maintain a constant amplitude of transmitted signal and receiver sensitivity, one of the two test aerials is now replaced by a correctly matched half-wave dipole. The frequency response of one test aerial and a dipole is then measured and is shown as C_3 in Fig. 2. An uncorrected curve of gain over a dipole may now be obtained by subtracting C_3 from C_1 and this is shown as C_4 .

Now it is known that C_2 is the response curve of one test aerial while C_3 is that of one test aerial and a dipole. Subtraction of C_2 from C_3 will therefore provide the response curve of the substituted dipole *under the conditions of test*, and this is drawn as C_5 in Fig. 1. It will be immediately noticeable that the response curve of the dipole contains considerable cyclic variation and graphically illustrates the possible error if a normal fixed-frequency substitution has been undertaken. At 193 Mc/s, for example, the gain over a dipole would be 12.5 dB, and at 195 Mc/s it would be 10.5 dB, an error of 2 dB.

Having obtained the dipole response under the conditions of test it is a simple matter to draw the average of the cyclic variations due to test site reflections and then to draw a straight line at the level of the corrected dipole curve thus obtained. It is advantageous in the interpretation of the dipole curve to use a dipole with elements as thin as possible to provide a complete response curve within the measured band which also ensures that the gain is evaluated against the dipole at resonance. Corrections may then be made to C_4 by adding the amounts by which the dipole

curve C_5 exceeds the drawn-in reference line (or subtracting the amounts by which it is below the reference line). This is shown as C_6 , and since due care has been taken to maintain the dB ordinates at the correct amplitude, C_6 represents the measured gain over a dipole of one test aerial throughout its frequency response with full compensation for site errors due to reflections.

The method may be proved algebraically as in the Appendix and an indication is also given, by the shape of the curves obtained, of the suitability of the test site for the measurement being made. An example of inadequacy of site would be shown by curve C_5 , the dipole resonance, being so irregular as to prevent correct interpretation. Nothing is lost should this occur since any measurement taken by any other method on the site used would be inaccurate in any event.

An assumption is made in the test that the curve C_1 taken between the two test aerials is accurate and not subject to errors occasioned by the test-site reflections. This is a reasonable assumption when two high-gain aerials are used since the sharpness of their radiation patterns will attenuate reflected signals to negligible proportions. Where, however, aerials of lower gain, and consequent reduced directivity, are being measured, any unwanted reflections will show as a cyclic variation of C_1 . It will then be known that the measuring site is not really good enough but a reasonable result may still be obtained by taking the average of this cyclic variation. This gives a modified version of C_1 to be used in subsequent operations.

Fig. 3 is an actual test result of a 12-element Yagi designed for wideband application at u.h.f. It will be seen that even at u.h.f. with a highly-directive aerial there is a 3.5-dB swing on the normally measured gain over a dipole,

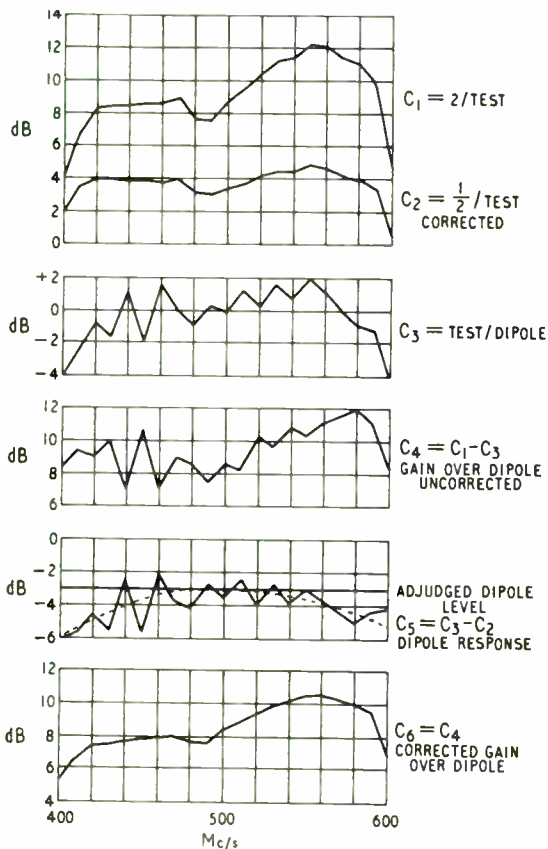

Fig. 3. Measurements on a 12-element Yagi aerial are shown here

as shown at 450 and 460 Mc/s, on the uncorrected gain curve C_4 .

Exhaustive tests have been conducted utilizing this method and it has been found that gain measurements on the same aerial days may be repeated with identical results on different days with different operators, and with different sites. Additionally, changes have been made to the aerials under test, such as altering the number of directors to give a theoretically predictable alteration in gain, and the measured results have always been as theory dictates.

The method not only provides an accurate means of measuring the gain of an aerial, but also shows immediately and unmistakably when the inaccuracies of the measuring site are too great to prevent a correct result. In practice, of course, only C_5 and C_6 need be drawn as a curve, previous calculations being carried out in tabular form. The drawing of all the curves does, however, provide a check on accuracy since C_6 must be of similar shape to C_2 and any errors will thus be immediately apparent.

Appendix

Algebraic Confirmation of the Method

True gain of test aerial = $G(f) = Y$, ordinates in dB.

Apparent gain of probe dipole = $H(f) = D$, ordinates in dB.

Curve 1 = $C_1(f)$.

Curve 2 = $C_2(f)$ etc.

$C_1 = 2Y + 2a$, Where a is an arbitrary number which depends on the output level.

$$C_2 = \frac{C_1}{2} = Y + a.$$

$$C_3 = Y + D + 2a,$$

$$\therefore C_4 = C_1 - C_3 = 2Y + 2a - (Y + D + 2a) = Y - D. \text{ Note that } a \text{ is not superimposed on } C_4.$$

$$C_5 = C_3 - C_2 = Y + D + 2a - (Y + a) = D + a.$$

Now C_5 contains errors due to site factors and due to a , the zero shift. If a smooth curve is drawn through the mean of the undulations in C_5 , then this will represent the real gain of the dipole. This should be zero at resonance and will fall off at either side of the resonance. Variations of C_5 above and below this zero line represent the imperfections in the dipole pickup and the site. The choice of the resonance point for zero relative gain removes the factor a .

$$C_5 - a = C_5' = D.$$

$$\therefore C_6 = C_4 + C_5' = Y - D + D = Y = G(f).$$

As C_6 is necessarily identical in shape to C_2 , varying from it by a constant amount, it may be thought unnecessary to produce C_6 , as the desired factor a is determined in the transformation of C_5 to C_5' ; however, an exact correspondence between C_5 and C_6 is a convenient check that no calculation error has been made.

★ FOR THE BUYER

You must have read about a number of products and processes in this issue of which you would like further details. You can obtain this information very easily by filling in and posting one or more of the enquiry cards to be found inset in the back of the journal.

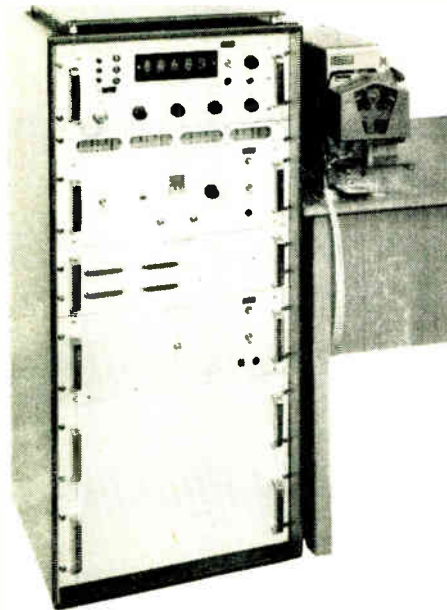

Data Loggers for Ship Research

Digital Measurements have recently supplied two digital data-recording systems to the British Ship Research Association (B.S.R.A.). One of them (illustrated) is to be used at sea in the study of the seakeeping qualities of ships. Twenty transducers, installed at various locations in the ship, deliver analogue voltage outputs corresponding to ship's speed, wave height, heave acceleration, roll, pitch and yaw angles, stresses, etc. The equipment supplied incorporates two-pole switching of the input signal and has an accuracy of 0.01% of full scale and a sensitivity of 10 μ V. The output is recorded on punched paper tape at rates of up to 16 channels per second.

The other data logger has been installed at the B.S.R.A. Structures Laboratory and is to be used to measure and record stress in large scale specimens of components of ship structures. The specimens are mounted in a test rig and loaded hydraulically, often to the point of destruction. The signals from up to 400 strain gauges mounted on the specimens are fed to the data logger and, from the recording so obtained, the distribution of stress is determined. The output is recorded by a paper strip printer at rates of 1, 2 or 4 channels per second.

For further information circle 44 on Service Card

Ultrasonics Cleans Dental Drills Faster

A Mullard ultrasonic cleaner has enabled Rotabine (Service) Ltd. to offer a 24-hour repair service for the heads of air-operated turbo dental drills.

Since turbo dental drills revolve at between 250,000 and 500,000 r.p.m. the minute bearings within the head need renewing after three months of average use. To ensure a further three months' use it is essential that all particles of dirt bigger than a few microns are removed from the replacement bearings before they are fitted in the head.

An effective and speedy method of achieving this condition is obtained by immersing the new bearings and other head components for a few minutes in an ultrasonic cleaning bath containing a suitable cleaning solution (Inhibisol—a chlorinated hydrocarbon).

Rotabine have found the Mullard Equipment Ltd. ultrasonic generator type L357 and one litre stainless steel cleaning container type L615 particularly suitable for this purpose.

For further information circle 45 on Service Card



The Laser-Ophthalmoscope

Surgeons working at the Royal Victoria Infirmary, Newcastle upon Tyne, have been collaborating with International Research & Development Co. in the design of a laser-ophthalmoscope, consisting of a miniature ruby laser built into the handle of an ophthalmoscope. This follows the treatment of animals with an experimental laser. Proto-

type instruments for the treatment of human conditions are now undergoing clinical trials and, following publication of these and other experimental results, the laser-ophthalmoscope will be made available to qualified specialists at a fraction of the cost of present photo-coagulators.

The principal use of this instrument consists in the prophylaxis or normal treatment of retinal detachments and it will also find applications in the treatment of various vascular lesions of the fundus and tumours of the eye. It has several major advantages over instruments at present available for photo-coagulation: it enables normal examination, treatment and observation to be carried out with one instrument; no pain or discomfort is caused due to the short duration of the laser pulse, which is of the order of 1 msec; the patient has no time to react to the bright light and move his eye; finally, the instrument is small, portable and can be operated from any mains supply.

For further information circle 46 on Service Card

A senior ophthalmologist checking the performance of the laser-ophthalmoscope, using a model of the eye

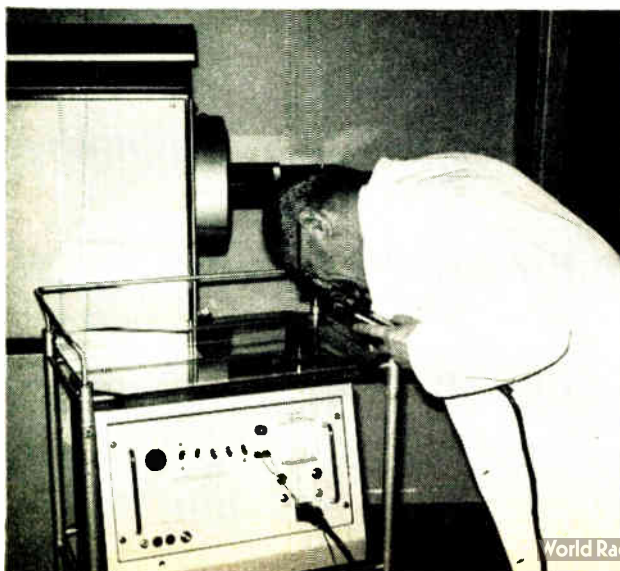

Operator bringing detection equipment into operation by pressing data key

ERROR-DETECTION EQUIPMENT FOR TELEX



USE of Telex networks by business houses and industrial organizations both at home and overseas for transmitting data relating to accounts, statistics and similar information, is growing rapidly. Although transmission speeds are slow compared with more sophisticated systems, the Telex network offers an ideal medium at reasonable cost for users who do not wish to transmit continuously over long periods each day, or to send large amounts of information.

The average error rate on British Post Office domestic telegraph circuits is between 1 in 20,000 to 1 in 40,000 characters, but an even greater degree of accuracy is often required for data transmission particularly where visual checking of the printed copy may not be possible and the information is fed automatically into business machines.

Telex network detection equipment, which will reduce to negligible proportions errors introduced in the transmission circuit, has been developed by A.E.I. Telecommunications Transmission Dept., in conjunction with the British Post Office. Besides being ordered by the Post Office, to whom A.E.I. is supplying 165 units to go into service in 1964, the new A.E.I. error-detection equipment is available to over-

seas administrations. It is for use on both-way Telex and private telegraph circuits operating at speeds of 50 bauds.

The principle of operation is based on the loop system. A message sent by a teleprinter, in addition to being transmitted through the system, is also automatically stored by the error-detection equipment at the send station. At the receiving centre the message is transcribed by a teleprinter and at the same time is sent back to the originating station where it is fed into the error-detector. In the detector both the original message which has been stored, and the message which has been received from the far terminal are compared. Any detected discrepancy causes the tape transmitter to stop, and visual and audible alarms warn the operator that an error has occurred.

Designed to stand on the table normally supplied with standard telegraph machines so that the control switches are within easy reach of the operator, the equipment is very simple to operate. The required circuit is first set-up by dialling the Telex code. Once the connection is established the error-detection equipment is brought into operation by pressing the 'data key', and transmission by teleprinter or punched tape is begun. Should an error occur correction is carried out by the 'send' operator who pulls back the tape to the beginning of the block of data containing the error, and restarts the transmitter. At the receiving terminal, incoming data whether typed by teleprinter or in tape form can be edited to remove erroneous blocks. If the information is fed into automatic data processing machines programmed to ignore incomplete blocks of data, no attention is required.

Housed in a metal case 11-in. wide, 25-in. deep, and 11-in. high, the equipment is fully transistorized. Circuit components are on printed-wiring cards secured to frames which can be withdrawn for periodic maintenance. A special extension frame known as an 'outrigger' is used to enable any chosen printed-circuit board to be operated outside the detector unit, thus facilitating maintenance. Functional testing of circuit operations can be carried out with a visual test display unit.

The unit operates from 100-120 V or 200-240 V a.c., 40-60 c/s. and consumes approximately 50 W. To date, it has been proved in ambient temperature conditions of up to 40 °C.

For further information circle 47 on Service Card

Construction of error detector showing printed circuit boards

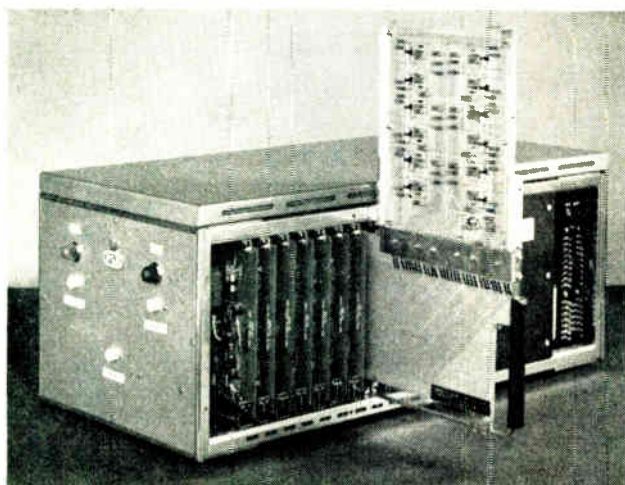



By invitation, Crypton Equipment (M.I. Group) provided full engine tuning facilities at Silverstone for a recent demonstration of imported cars. The picture shows an Alfa Romeo being guided on to the 'Road-Load' dynamometer for a high speed test. The eight Alfa Romeo models on view were all Crypton tuned before the demonstration

U.K.A.E. Nuclear Instrumentation System

Electronic instruments which measure, analyse and record radiations, are being used in increasing numbers and are employing techniques of increasing complexity. This trend, which is common to most branches of instrumentation, stems from the need to use scientists as effectively as possible. There is also an awareness that the progress of much research is limited by the capability, flexibility in application and the reliability of instrumentation.

The Harwell 2000 series unit system was developed by the Electronics Division of the United Kingdom Atomic Energy Authority's Research Group to minimize these limitations and to simplify the incorporation of advances in electronic techniques and devices. It provides for rapid grouping of units to form assemblies, with built-in ventilation, in standard 19-in. racks or on laboratory benches. This has been achieved by mechanical and electrical standardization, the latter including the adoption of standard signals for transmitting data and control information between units.

Amongst some 50 types of general-purpose units so far developed are amplifiers, discriminators, single channel analysers, coincidence units, scalars, ratemeters, clock-pulse generators, timing units and e.h.t., h.t. and l.t. power units. The majority of these are transistorized and the valve type equipment will be superseded as transistorized units, at present under development, come into production. This range of units provides assemblies which cover most nuclear counting applications in laboratories, both for routine measurement and research work.

The Harwell 2000 series system has become established within the Authority and the National Institute for Research in Nuclear Science where, over the past three years, the number of units has doubled annually. The total now approaches 25,000 items. Many of the general-purpose type Harwell units, and assemblies containing them, together with specialized units are manufactured commercially under Authority licence. They are available from the following three member firms of the British Scientific Instrument Manufacturers' Association: Dynatron Electronics Ltd., E.M.I. Electronics Ltd. (Instrument Division) and Fleming Instruments Ltd.

Audio-Visual Teaching Aids Conference

A residential conference on audio-visual teaching aids will be held at Loughborough College of Technology from the 10th to 12th September 1964. Arranged by the I.E.E. Science and General Division Professional Group on Education and Training, the conference will cover such topics as educational and teaching films, closed-circuit television, calculus programming, and teaching machines.

The aim of the conference is to bring together tutorial staff, industrial training officers, and those interested in education and training to discuss the progress that is being made in the development of aids to teaching, and the possibility of arranging for co-operation in the production of more suitable material for teaching machines than is at present available.

An introductory lecture on 'Teaching Devices' will be given by H. W. French, B.Sc., M.I.E.E., H.M.I., on Thursday evening, 10th September. The remaining programme will be devoted to short lectures, followed by discussion. An exhibition of teaching aids and laboratory equipment will run concurrently with the discussion sessions.

Further information and registration forms are available from the Secretary, the Institution of Electrical Engineers, Savoy Place, London, W.C.2. (telephone: Covent Garden 1871).

Racal Expand

Racal Electronics have announced that they are forming a North America subsidiary company with manufacturing and development facilities in Canada and the U.S.A.

The aim is to start production in the U.S.A. and Canada of a number of their better-known products by late 1964.

Racal have also formed a manufacturing subsidiary in Australia.

At home, they are also broadening their activities, and are entering the field of television transmission for the first time.

Under an agreement being arranged with Rohde and Schwarz of Munich, the company will manufacture television transmitting aerial systems under licence.

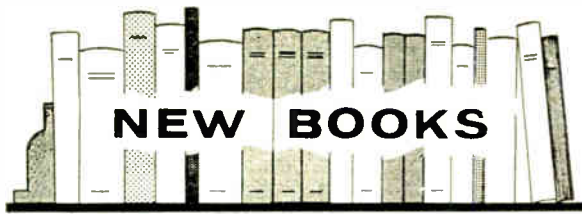

Disc Recording and Reproduction

By P. J. GUY. Pp. 232. Focal Press Ltd., 31 Fitzroy Square, London, W.1. Price 42s.

This is a fairly elementary book. In his preface the author starts by saying 'This book has been written to enable you to get the best possible reproduction from both monaural and stereophonic records. . . .' He does not, however, say who he means by 'you'! Presumably it is any and every potential reader whom he means, but it is not everyone who desires the best possible reproduction who can profit from the book. Elementary though it is, at least some technical background is needed.

The first chapter covers the start of sound recording and the second deals with the theory of sound, while the third covers microphones. Successive chapters then deal with how a disc recording is made, fine-groove recording, processing records, record reproducing systems, mechanics of disc reproduction, amplifiers, stereophonic recording and reproduction. Two chapters on various difficulties follow and cover screening and hum reduction and motor troubles.

The final seven chapters are in a less ordered sequence and deal with volume expansion, measuring response of record players and recording systems, equalizers, copying from record to tape, how to choose a record player, and copyright.

There are five appendixes at a much higher technical and mathematical level than the rest of the book.

Electronics for Students of Mechanical Engineering

By H. SUTCLIFFE. Pp. 353 + v. Longmans, Green & Co. Ltd., 48 Grosvenor Street, London, W.1. Price 37s. 6d.

The author is Reader in Electrical Engineering at the Royal College of Advanced Technology, Salford, and he intends his book for engineers who require an understanding of electronics but whose primary interests lie elsewhere. He assumes the reader to have an appropriate knowledge of mathematics and physics and to have studied previously elementary circuit theory. He claims that the book can be read by professional mechanical engineers and by second-year students of engineering.

After an introductory chapter, the reader is taken through electrical circuits, the physics of electronic devices, diodes and associated circuits, and valve and transistor circuits. A chapter on triggered electronic devices and associated circuits follows and then come chapters on transducers, carriers, modulation and demodulation, feedback and some electronic instruments. Appendixes deal with m.k.s. units, decibals and frequency response, and amplitude and phase response of systems for undistorted amplification.

The treatment is to a large extent descriptive, but there is no attempt to avoid mathematics where it is necessary. The usual j -notation is employed and the calculus occasionally creeps in. Few of the people for whom the book is intended are thus likely to meet with mathematical difficulties.

The book would seem to meet its purpose admirably.

The reader cannot expect to gain from it a knowledge of electronics without working, however. No book can give him that; but this one may provide him with an easier road than many others.

There are problems with answers, and it should be mentioned that the book is a paper-back.

Digital Storage Systems

By WILLIAM RENWICK. Pp. 212 + ix. E. & F. N. Spon Ltd., 11 Fetter Lane, London, E.C.4. Price 50s.

The main subjects covered are delay line, electrostatic, ferroelectric and magnetic-core storage. Magnetic surface recording is included and various other forms of storage, including non-erasable methods, are discussed.

The treatment is entirely non-mathematical and the book is intended as a guide to the designer of a system using digital techniques. The author stresses, however, that it is not a design text-book.

Supplement No. 1 to Glossary of Terms Used in Telecommunication (Including Radio) and Electronics: Terms Used in Wired Broadcast and Broadcast Relay

Pp. 6. British Standards Institution, 2 Park Street, London, W.1. Price 3s.

This supplement contains 26 terms and definitions concerning programme distribution by wired broadcast and broadcast relay. Many of the terms are applicable to both television and sound programmes.

Fixed Capacitors

By G. W. A. DUMMER, M.B.E., M.I.E.E., Sen.Mem.I.E.E.E., M.Brit.I.R.E. 2nd Ed. Pp. 270 + xi. Sir Isaac Pitman & Sons Ltd., Pitman House, Parker Street, Kingsway, London, W.C.2. Price 45s.

Methods of Measurement of Essential Electrical Properties of Receiving Aerials in the Frequency Range from 30 Mc/s to 1,000 Mc/s (Supplement to I.E.C. Publication 138)

Pp. 11. Available from British Standards Institution, 2 Park Street, London, W.1. Price 10s. 2d.

In this it lays down an alternative method of measuring the actual gain of an aerial based on the principle of reciprocity. The text in this supplement is printed in both French and English.

Metallurgy of Advanced Electronic Materials

Edited by GEOFFREY E. BROCK. Pp. 355 + x. John Wiley & Sons Ltd., Glen House, Stag Place, London, S.W.1. Price 115s.

This book contains the papers and discussion of the Conference on Advanced Electronic Materials which took place in Philadelphia on 27th-29th August 1962.

Testing and Calibration of Ultrasonic Therapeutic Equipment (I.E.C. Publication 150)

Pp. 17. Available from British Standards Institution, 2 Park Street, London, W.1. Price 16s 11d.

This new publication applies to ultrasonic therapeutic equipment employing plane circular transducers. It lays down, in French and English, suitable methods for calibrating the intensity and distribution of the ultrasonic beam produced by the apparatus. Therapeutic value and methods of use are not considered.

Measuring the Electrical Properties of Electronic Tubes and Valves (I.E.C. Publication 151: Parts 1 to 4)

Part 1, Pp. 5. Part 2, Pp. 5. Part 3, Pp. 9. Part 4, Pp. 13. Available from British Standards Institution, 2 Park Street, London, W.1. Prices 4s. 6d. (Part 1), 5s. 8d. (Part 2), 8s. 6d. (Part 3) and 10s. 2d. (Part 4).

Part 1 deals with the measurement of electrode current; Part 2 with measuring heater or filament current; Part 3 with the measurement of equivalent input and output admittances, and Part 4 with methods of measuring noise factor. The first three parts outline the conditions to be followed in measurement, but do not give measuring methods. The methods described in Part 4 are based on current practice. In each Part the text is printed in French and English.

Introduction to Lasers and Masers

By ALLAN LYTEL. Pp. 95. W. Foulsham & Co. Ltd., Yeovil Road, Slough, Bucks. Price 16s.

This book is of American origin and provides a very elementary account of the subject. Chapter 2 is entitled 'Quantum Electronics' but the beginner need not be deterred by this for the account is very simple indeed.

The Research and Development Engineer as Manager

By THOMAS MORANIAN. Pp. 152. Holt, Rinehart and Winston, Inc., 383 Madison Avenue, New York 17, N.Y., U.S.A. Price \$3.

The Training Revolution

By JOHN WELLENS. Pp. 136. Evans Bros. Ltd., Montague House, Russell Square, London, W.C.1. Price 12s. 6d.

Static Electromagnetic Frequency Changers

By L. L. ROZHANSKII. Translated from the Russian by ANDREW COLIN and edited by D. C. MACDONALD. Pp. 110 + xii. Pergamon Press Ltd., Headington Hill Hall, Oxford. Price 35s.

Modern Dictionary of Electronics

Compiled by RUDOLF F. GRAF. Pp. 370. W. Foulsham & Co. Ltd., Yeovil Road, Slough, Bucks. Price 45s.

Principles of Coding, Filtering and Information Theory

By LEONARD S. SCHWARTZ. Pp. 255 + xiii. Cleaver-Hume Press Ltd., 10-15 St. Martin's Street, London, W.C.2. Price 72s.

Manufacturers' Literature

Elrecco Control Time. This six-page brochure briefly describes and specifies the current range of timers produced by *Electrical Remote Control Co. Ltd., The Fairway, Bush Fair, Harlow, Essex.*

For further information circle 47 on Service Card

Vickers-Detroit Electro-Hydraulic Servo Systems. Both servo pump and servo valve systems are described in this six-page brochure. In this there is also an explanation of a technique for eliminating backlash in geared rotary drives. A particularly useful feature of the publication is a table listing 12 basic parameters concerned with the design of electro-hydraulic servo systems.

Vickers Sperry Rand Ltd., New Lane, Havant, Hants.

For further information circle 48 on Service Card

Automatic Boiler Control and Combustion Instrumentation. In this 12-page brochure a low-cost automatic boiler system is described. Component parts of the system are illustrated and specified and details of eight specific installations are included.

Smiths Industrial Division, Kelvin House, Wembley Park Drive, Wembley, Middx.

For further information circle 49 on Service Card

G.E.C. Automatic Static Exciters Type VI-IH. G.E.C. have extended their range of static exciters for industrial alternators up to 75 kVA. This six-page leaflet describes these recent additions which, unlike some exciters, require no heavy ancillary transformer or special alternator windings.

G.E.C. (Engineering) Ltd., Electrical Engineering Works, Witton, Birmingham 6.

For further information circle 50 on Service Card

Series R-100 Display Modules for Numeric Readout. A 14-page catalogue giving details of the 'Dialco' range of character display modules. These include models with neon or incandescent light sources for operation on 160 V d.c., 120 V a.c., 14-16 V and 24-28 V.

Dialight Corporation, 60 Stewart Ave., Brooklyn, N.Y. 11237, U.S.A.

For further information circle 51 on Service Card

The Problem of Road Testing. Following a survey on the road testing of motor vehicles, carried out by Crypton Equipment, they have published this 18-page booklet. This gives the salient facts of the survey. It also compares the cost of road testing a vehicle with that incurred by the use of a chassis dynamometer.

Crypton Equipment Ltd., Bridgwater, Somerset.

For further information circle 52 on Service Card

Transradio Connectors. Detailed information, illustrations and outline drawings of well over 400 r.f. connectors are included in this 148-page catalogue. The basic types covered are VMP, C, SM, NC, N, BNC, 83 UHF and BSA. This very comprehensive catalogue also includes cross reference lists of U.S. Military, British N.A.T.O., Air Ministry, Admiralty (A.P.) and Transradio code numbers.

Transradio Ltd., 138A, Cromwell Road, London, S.W.7.

For further information circle 53 on Service Card

E.M.I. Scopes WM18 & WM26. Two leaflets describing two recently-introduced E.M.I. oscilloscopes are now available. The first describes the WM18—a general purpose 50 mV/cm unit with a bandwidth (-3 dB) from d.c. to 25 Mc/s. The second leaflet gives details of the WM26—a wideband instrument with a range of plug-in preamplifiers providing differential, high-gain and dual-trace facilities, besides the normal bandwidth of 40 Mc/s.

E.M.I. Electronics Ltd., Hayes, Middx.

For further information circle 54 on Service Card

English Electric T948 Instrument Cathode Ray Tube. The T948H and T948N are new 5-in. precision c.r.t.s developed by E.E.V. for use in wideband high-speed oscilloscopes. They are completely described and specified in this well-produced 16-page booklet. The 948 is a p.d.a. tube with an X sensitivity of 9 V/cm and a Y sensitivity of 3 V/cm.

English Electric Valve Co. Ltd., Chelmsford, Essex.

For further information circle 55 on Service Card

Boonton RF Voltmeter Applications Brochure. In this 16-page booklet only one page is devoted to Boonton products. The remainder are used to describe a number of useful applications for r.f. voltmeters. H.F. transistor testing, v.s.w.r. measurements, r.f. bridge techniques and harmonic distortion studies are some of the subjects dealt with. Available in the U.K. from *Livingston Laboratories Ltd., 31 Camden Road, London, N.W.1.*

For further information circle 56 on Service Card

LEADERSHIP IN VISUAL PRESENTATION

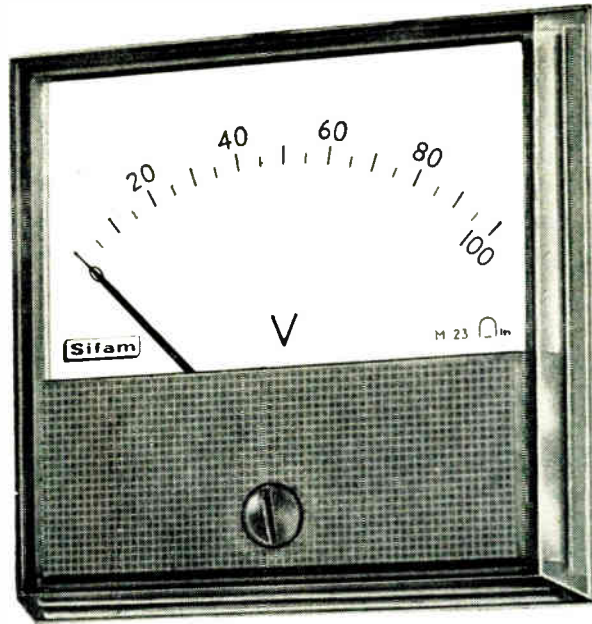

"Clarity" Type 23. 2.4 in. square. Scale length: 1.96 in.

Designers and engineers concerned with the production of modern equipment, and looking for instruments with the same contemporary approach to styling, will find their need completely satisfied in the SIFAM CLARITY Range.

Uncluttered, functional, with well-proportioned scale and body, this new range is a masterly expression of modern instrument design at its best, and represents an advance in visual presentation which has won recognition and approval from users and independent authorities alike.

Scale areas or markings can be supplied in accordance with the new British Standard recommendations, or to customers' requirements. The instruments can be supplied as Millivoltmeters, Temperature Indicators for use with thermocouples, Decibel Meters or with special calibrations to suit particular applications.

Let us arrange for a Sifam Technical Representative to show you the new "CLARITY" range or write for the new Data Sheets 106/C and 106/C1.



Instruments

SIFAM ELECTRICAL INSTRUMENT CO. LTD. Woodland Road, Torquay, Devon Telephone: Torquay 63822/3/4

CLARITY

- * The completely transparent moulded fronts permit a greater scale length for a given frontal area.
- * Interchangeable masks are available in a choice of contemporary colours to blend with customers' equipment.
- * The lance type pointer is readily visible when the instrument is read at a distance, whilst its fine point allows accurate reading of indicated values.
- * Elimination of solid surround provides both greater clarity and readability.

"CLARITY" Type 22
Scale length:
2.2 in. (56 mm)

"CLARITY" Type 32
Scale length:
2.75 in. (70 mm)

"CLARITY" Type 42
Scale length:
3.75 in. (95 mm)

CLOSE TOLERANCE

MicroCoax

MINIATURE SOLID-JACKETED COAXIAL CABLE

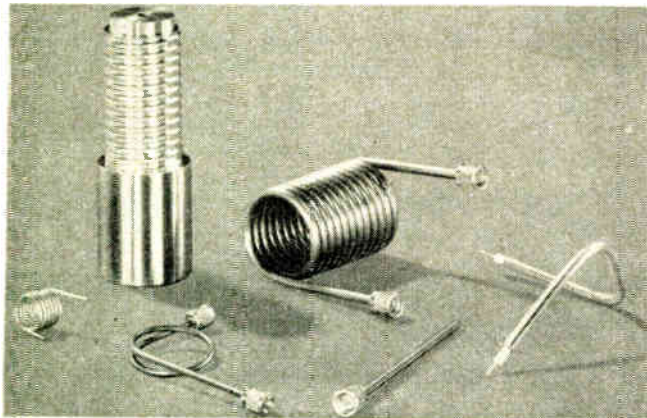
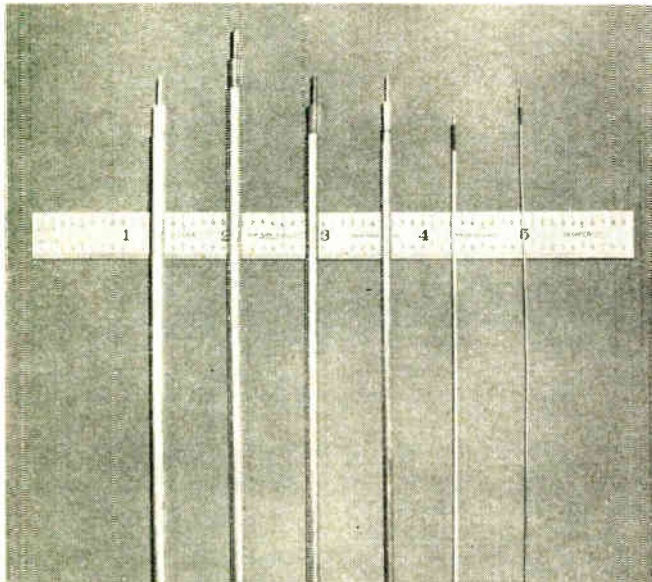

Produced by the MICRODELAY division of UNIFORM TUBES 50 ohm miniature coaxial cable provides total shielding and environmental stability. Manufactured with an outer jacket of copper, dielectric of TFE Teflon, and centre conductor of silver-plated copperweld wire. Available in sizes from 6.36 mm to .51 mm, including the 3.58 mm size (outer diameter). Other impedances and outer-jacket materials for special applications. Choice by size and by loss. For stripline or wave guide. Micro Coax strips easily . . . solders easily . . . has no fuzzy braided ends.



MICRODELAY DIVISION
UNIFORM TUBES INC.

Sole U.K. representatives

Ad. AURIEMA Ltd

125 GUNNERSBURY LANE,
ACTON W3 (Telephone ACOm 8762)

**Methods of solving
complicated problems
to derive the fullest
advantage from
modern computers**

Numerical methods for high speed computers

**G. N. Lance, M.Sc. Ph.D. M.A.I.S.
A.F.R. A.E.S.**

This book assembles the most useful numerical methods developed by research mathematicians, with the particular aim of explaining the facilities that computers offer. Most of these methods have never been published before expect to a very limited readership and all have been tested for their practical value. The book will be found invaluable by mathematicians, programmers, engineers, physicists, and scientists generally.

42s net by post 42s 11d 166 pp.

from leading booksellers

Published for

DATA PROCESSING

by **ILIFFE Books Ltd DORSET HOUSE
STAMFORD STREET LONDON S.E.1**

WESTON

MOVING COIL

RELAYS

COVER A WIDE RANGE OF APPLICATIONS



BIPCO[®]

MODULES

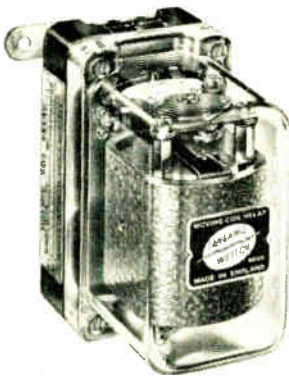

MODEL S 170
for control applications

The Model S 170, permanent magnet moving coil relay. Combines extreme sensitivity with high precision. It is eminently suitable for control applications when a relay operating within close tolerances is necessary. The minimum signal current is 5 mic A. d.c.; shunts and series resistors can be incorporated for currents and voltages up to 5 A and 250 V d.c.

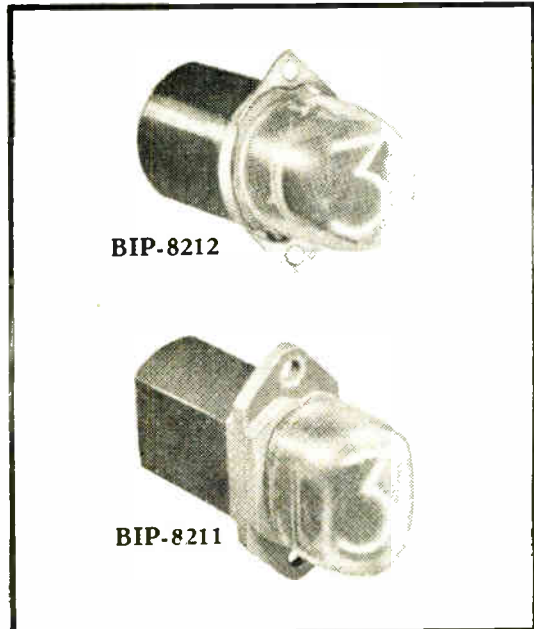

BIP-8212

BIP-8211

MODEL S 124
a miniature alarm relay with "hold-on" contacts



The Model S 124 is of the permanent magnet moving coil type and can be supplied to operate on currents as low as 2 mic A. d.c. High contact pressure is ensured by magnetic attraction between the contacts; these will "hold-on" until reset manually or by remote electrical control. Front-of-panel and flush mounting relays are available.

MODEL S 115
a miniature switching relay

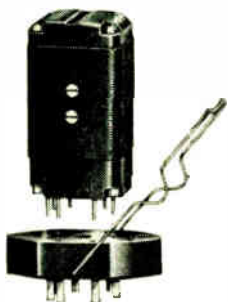

The Model S 115 functions as an "on-off" switching relay and is supplied for operating currents down to 50 mic A. d.c. Single and double coil windings are available. The relay can be mounted in any position and is magnetically self-shielding. The space occupied on the chassis is only 1½ in. x ¾ in.; weight, 1¼ oz.

BINARY DECODERS

provide decimal readout from 8-wire 8-4-2-1 binary-coded-decimal

BIP-8211 is for use with Nixie tubes 8422 (standard rectangular)

BIP-8212 for use with Nixie tubes 8421 (standard circular)

Solid state circuitry

Decoder and socket is an integral unit

Other input codes available on request, e.g. 2-4-2-1; 4-2-2-1; 5-4-2-1

WALMORE

ELECTRONICS LTD

11-15 BETTERTON STREET, DRURY LANE,
LONDON, W.C.2
Telephone: TEMple Bar 0201-5

For full details of the Weston range of relays, please write to:—
SANGAMO WESTON LIMITED
ENFIELD · MIDDLESEX
Telephone: Enfield 3434 (6 lines) & 1242 (6 lines).
Grams: Sanwest, Enfield Telex 24724



sw/185

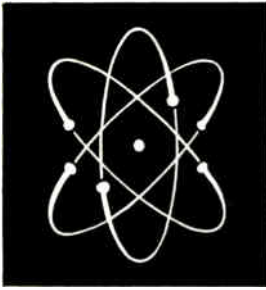

BASIC INDUSTRIAL ELECTRONICS

Alfred Haas

A new **ILIFFE** technical book

Contents

- Introduction
- Transducers
- Building blocks for electronic systems
- Automatic inspection, sorting and counting
- Automatic machine control
- Electronic heating, welding and machining
- Electronic safety devices
- Power conversion and control

35s net by post 36s 3d

208 pp. 203 illustrations 8 3/4" x 5 1/2" *obtainable from leading booksellers*

Aimed to assist those industrial engineers whose initial training did not include electronics, this new book provides a sound readable introduction to the technology of the subject. The introductory chapters cover the many and varied industrial applications followed by a description of the various devices by which mechanical movements and physical changes can be converted into electrical signals. Subsequent chapters discuss automatic inspection, automatic machine control, electronic heating, welding and machining, electronic safety devices and power conversion control. This practical book will prove invaluable to engineers without previous knowledge of the subject and also as an introduction for students of electronics.

Published by **ILIFFE Books Ltd.** DORSET HOUSE STAMFORD STREET LONDON SE1

For further information circle 241 on Service Card

revolutionary

alfaset

dry transfer system



trade marks

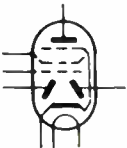

technical symbols



lettering

saves time and money in the drawing office or studio

'Alfaset'* is a completely new, absolutely dry, transfer method, you just press the image down and it will adhere to the work. When applied it will withstand the heat of most reproduction processes. 'Alfaset' is non-sticky. Sheets to your own special requirements, 8s. per sheet (minimum 25 sheets), reduced prices for larger quantities, plus a low preparation charge, in black, white and colours. Users of 'Alfaset' save up to 75% of working time. Single sheets of lettering shortly available. Sample and information gladly sent on request.

* trade mark

alfaset Ltd

Stocklake Industrial Estate Aylesbury Bucks
Telephone: Aylesbury 4272

For further information circle 242 on Service Card

PROMPT DELIVERY

Many Types
Ex Stock



PHIL-TROL SOLENOIDS

NEW! We are now able to offer Types 38, 39, 40 and 35, 36 and 37 solenoids in encapsulated versions suitable for exposed positions and with fully protected coils. We can also supply these solenoids with chromium plated and polished plungers for more rigorous conditions.

Send for full details and copy of pamphlet 108A.

The Phil-trol range of solenoids goes from miniatures to extra strong power types in both AC and DC versions.

PHILLIPS CONTROL (G.B.) LTD.

Dept. K.7, Farnborough Road, Farnborough, Hants

Telephone: Farnborough 1120

Grams & Cables: Philtrol, Farnborough, Hants

NOW from United States capacitor technology come...

SPS SUBMINIATURE ALUMINIUM FOIL ELECTROLYTIC CAPACITORS

The most modern and efficient capacitors obtainable today.

For 8 years SPS International has been producing in the U.S.A. a range of miniature lightweight capacitors designed to cope with every extreme of temperature. Now the whole benefit of this experience has been brought to the new SPS factory at Shannon, Ireland, making the same high-quality capacitors available at short notice to any part of Britain. SPS capacitors guarantee complete reliability and long life thanks to the techniques of total encapsulation perfected over a long period in the U.S.A.

Ideal for transistorized communications equipment, portable radios, hearing aids, electronic instruments, audio cross-over networks, hi-fi tuners and amplifiers, recorders, test equipment and other low voltage circuits.

CAPACITANCE—20% + 100% of rated capacity.

DISSIPATION FACTOR: Less than 8% at 50 WVDC.

D.C. Leakage: Less than 6µA after 1min. applied WVDC.

OPERATING TEMPERATURE: 65°C at rated WVDC.

Available in 42 standard ratings, with intermediate values at no extra cost. For complete technical information and assistance write or telephone SPS International Ltd., European manufacturing arm of a leading U.S. supplier of quality capacitors.



SPS INTERNATIONAL LIMITED
SHANNON AIRPORT, IRELAND. Tel: Shannon 245

NEW ULTRASONIC CONTROL SYSTEM GULTON TRANSDUCERS

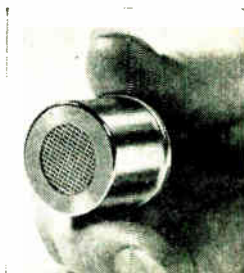

For Industrial Automation — Intruder Security Alarms — Gate, Tool and similar controls — Remote TV Controls — Model Control.

Comprehensive Application Data and Transistorised TX/RX Circuit supplied with all orders.

OFF THE SHELF — AT MANUFACTURER'S PRICES

55/- EACH OR TWO FOR £5.
Quantity prices on application.

THE BIGGEST RANGE OF ELECTRONIC EQUIPMENT, SPARES AND ACCESSORIES OF ALL KINDS FROM:—

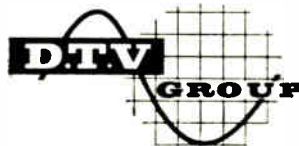

D.T.V. GROUP (DEPT. I.E.)

128 HAMILTON RD., W. NORWOOD, LONDON, S.E.27. Tel. GIP 6166 Day or Night

- Small Physical Size
- Interchangeable Receiver and Transmitter Heads
- High Q, High Efficiency
- Wide Beam Width
- Shielded non-interference Housing

JUST OUT!

D.T.V.'s comprehensive Catalogue covering a tremendous range of Industrial Electronic components, spares and accessories.

Send now for your **FREE COPY!**

"NEATWAY"



ALL INSULATED PLASTIC CABLE BANDS

Four Sizes: 2 1/4" - 7 3/8"
Self Locking



"FUSEWAY" FUSEHOLDER

12-WAY
NYLON

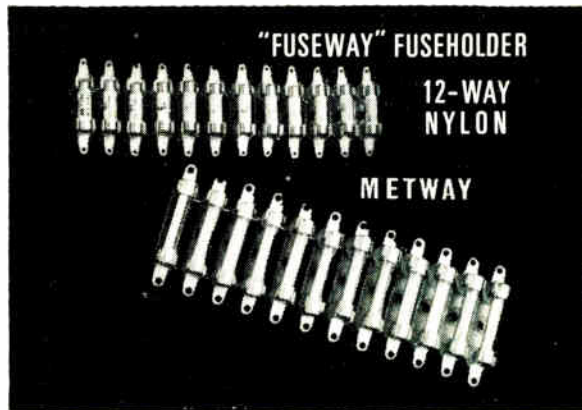

12 WAY TO CUT INTO ANY NUMBER OF WAYS

Type FK1610 for BS646/1958 Fuses 3/4" L x 0.210" DIA. 1 - 5 AMPS
Type FK1612 for BS646B/1953 Fuses 1 1/4" L x 1/4" DIA. 5 - 20 AMPS
Available with or without fuses.

● WRITE FOR LIST NO. OHS/9/264/IE

METWAY · KEMP TOWN · BRIGHTON 7

For further information circle 247 on Service Card

ROTAX NUMERICAL CONTROL EQUIPMENT

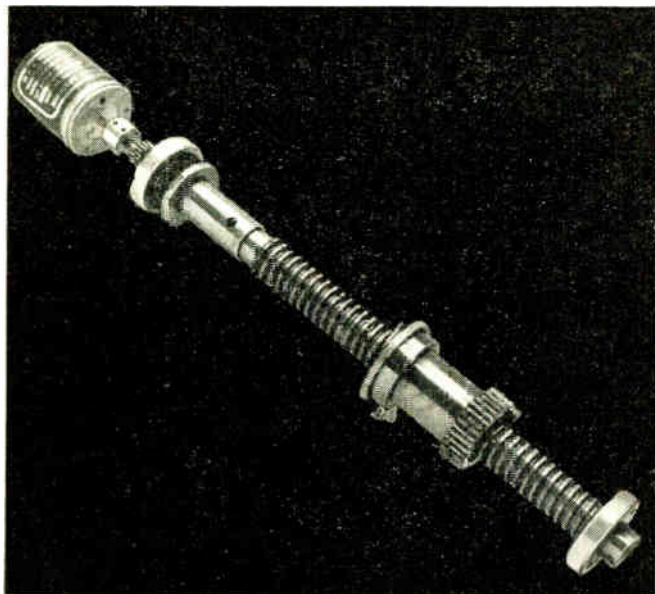

Reliable low-cost accuracy

Automatic control of machine tools demands a high degree of accuracy in sensing shaft motion and position. This requirement is achieved economically with Rotax numerical control equipment, which consists basically of a digital shaft encoder coupled to a recirculating ballscrew.

Such a combination signals increments of as little as 0.1 thou, to accuracies of 0.5 thou and less. The precision of the equipment derives from use of finely engineered Rotax ballscrew shafts—already used as measuring instruments by every major machine tool manufacturer—and shaft position signalling by photoelectric means. The Rotax shaft encoder is gearless, and thus avoids backlash, hysteresis, and vibration troubles.

The complete equipment is available to suit all machine tool applications. Ballscrew shaft lengths range up to 30 feet, and Rotax encoders cover all normally used systems—Gray, B.C.D., sine, etc.

If you're designing automatic machines that need accuracy at low cost, talk to a Rotax engineer about numerical control now, the number's Elgar 7777, Ext. 302.

ROTAX

INSTRUMENTATION DIVISION

ROTAX LIMITED, INSTRUMENTATION DIVISION,
WILLEDEN JUNCTION, LONDON N.W.10. TELEPHONE: ELGAR 7777

Contactor Type C.2839

(Patent applied for)

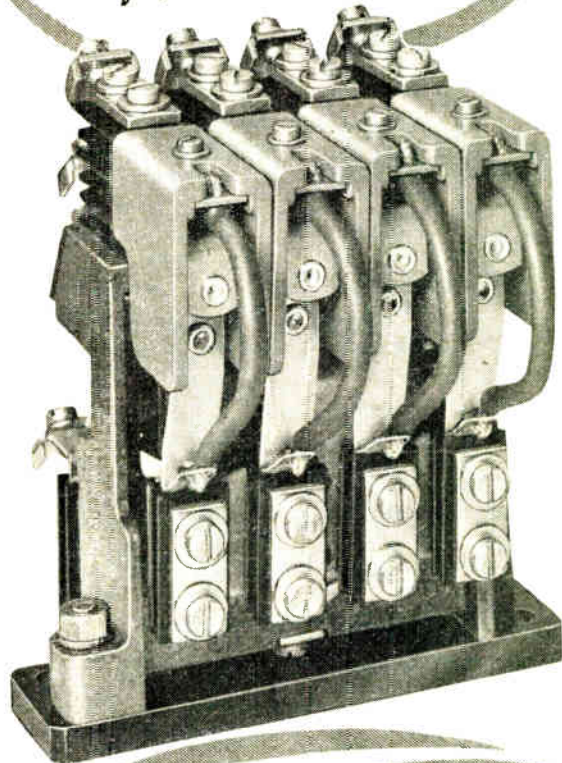

Produced with four important features in mind:
1. Maximum life and reliability 2. Low cost
3. Silent operation 4. Minimum overall size

Intended for use in applications where space is at a premium and for the control of medium power circuits up to 440v. A.C.

Hendrey Relays



HENDREY RELAYS LIMITED
390-394 BATH ROAD, SLOUGH, BUCKS.

Tel.: Burnham 609/611

Telegrams: Hendrelay, Slough

MANUFACTURING ELECTRICAL ENGINEERS,
CONTROL AND LABORATORY APPARATUS
A.R.B. and M.O.A. APPROVED DESIGN & INSPECTION

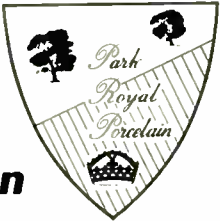

Porcelain
Steatite

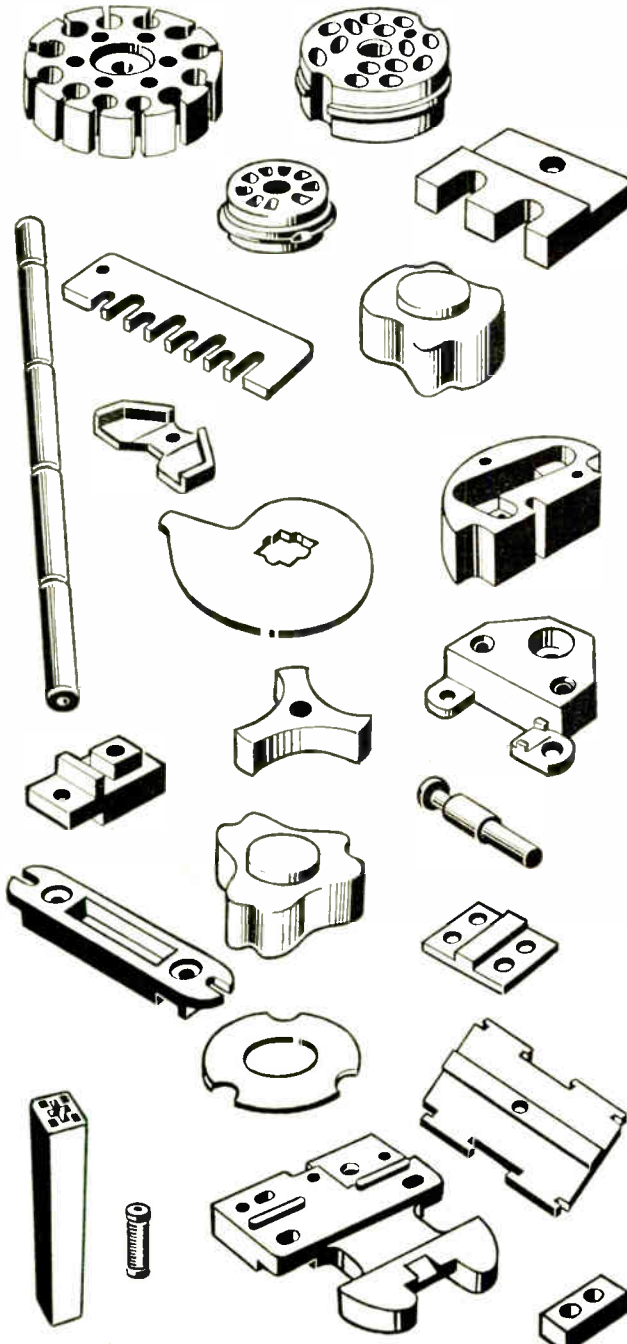

V. G. PORCELAIN CO LTD

GORST ROAD
PARK ROYAL
LONDON, N.W.10

Telephones:
ELGAR 1411/7
Telex:
London 25589

XY/T

Bryans' New XY/T Series Plotters

—present the ideal union of modern electronic and mechanical engineering techniques, giving the ultimate in reliability and recording precision. Constant servo-loop stiffness ensures stable dynamic performance irrespective of signal source impedance. The new vacuum-bed covers the whole chart area and secures any size of chart up to 17 x 11 ins.

- Accuracy 0.1% f.s.d.
- Maximum writing speed 37 in./sec.
- High Impedance floating input circuits.
- Precision chart centring.
- Solid state circuitry
- Maximum Sensitivity 200 μ V/in.
- Acceleration 290 in./sec².
- Time sweeps 0.1 to 10 in./sec.
- X & Y zero check switches
- Remote control facilities.

Additional facilities

- * Keyboard Point Plotter
- * Curve Follower
- * Symbol Printer
- * Digital/Analogue Data Translator

Full details from: Bryans Ltd.,
Willow Lane, Mitcham Junction,
Surrey. Mitcham 5134.

Bryans

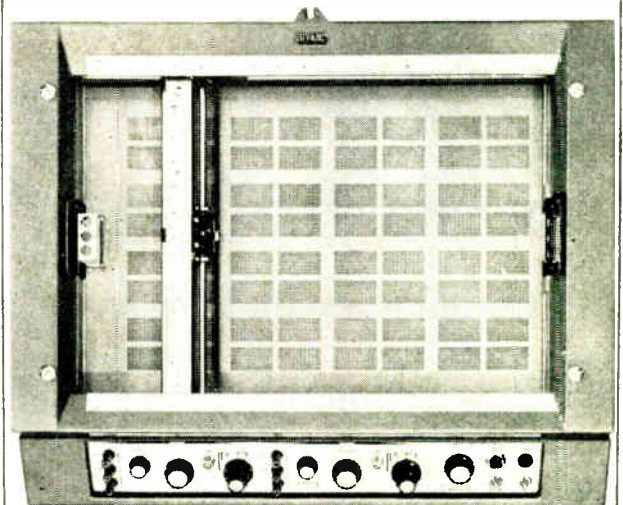

further thoughts by 'Cathode Ray'

ESSAYS IN ELECTRONICS

M. G. Scroggie, B.Sc., M.I.E.E.

This book may be regarded as a sequel to an earlier work, 'Second Thoughts on Radio Theory' but widened in scope to include electronics. The 22 essays adapted from the popular 'Wireless World' series cover a wide range of subjects including: scientific theories; what is electric current?; Kirchhoff's Laws; Flux-cutting or Flux-linking; negative feedback and non-linearity, etc. This is a book that every electronic and electrical engineer should read. It can be guaranteed that no one will fail to learn something to his advantage.

42s net by post 43s 1d 301 pp. 204 illustrations

obtainable from leading booksellers

published for 'Wireless World' by

ILIFFE Books Ltd.

DORSET HOUSE STAMFORD STREET LONDON {SE1

For further information circle 253 on Service Card

FOR IMMEDIATE SUPPLY . . .

**VOLTAGE STABILISERS
DC-AC ROTARY CONVERTORS
TRANSFORMERS
RECTIFIERS**

WRITE, CALL OR PHONE . . .

**UNIVERSAL ELECTRIC MOTOR CO.
(ENFIELD) LTD.**

43-47 RIVINGTON ST. · LONDON E.C.2
TEL: SHOREDITCH 8574

For further information circle 254 on Service Card

VITALITY BULBS
FROM 1V to 50V IN SIZES FROM 4.5mm to 18mm DIAMETER

Tested and Proven
Miniature and Sub Miniature
Indicator Bulbs: Catalogue

Vitality Bulbs Ltd.
Neville Place, Wood Green, N.22
Bowes Park 0016

NUMBER ONE IN ELECTRICAL CONNECTORS...



UHF-COAXIAL/TWINAXIAL

General Purpose Coax/Twinax. Six basic shell styles. Up to 500V Peak.

**CANNON ELECTRIC
(GREAT BRITAIN) LTD.**

168 Old Street
London E.C.1, England
Telephone: CLERKENWELL 4954



For further information circle 256 on Service Card

invaluable books
for
radio students
and technicians

**Principles
of Transistor
Circuits 2ND. ED.**

Introduction to the design
of amplifiers, receivers
and other circuits
S. W. AMOS
B.Sc.(Hons.), A.M.I.E.E.

**Principles of
Frequency
Modulation**

B. S. CAMIES

Presents the theory of frequency modulation, discussing its relationship with amplitude and phase modulation, and describes its applications in radio transmitters and receivers and radar. Written in concise form and logical sequence, this book is primarily intended for students, radio engineers and radio amateurs.

21s net by post 21s 10d

A thoroughly revised and enlarged edition of this already popular book. New sections include a description of drift transistors and details of controlled rectifiers; and among the many new and revised figures is one of a complete circuit of a transistorised V.H.F. receiver. The first two chapters deal with the basic properties of transistors, but the main emphasis of the book is on circuit design.

21s net by post 22s

from leading booksellers

published for "Wireless World" by

ILIFFE Books Ltd

DORSET HOUSE,
STAMFORD STREET, LONDON, S.E.1.

Industrial Electronics July 1964

OXLEY

PRINTED CIRCUIT SOCKETS

The OXLEY printed circuit sockets are designed for direct mounting on 1" module printed circuit board with standard .050" minimum diameter holes, and accepts our standard plug Type 50P, 156.

The mounting is arranged so that the plugs may be inserted in a plane parallel printed circuit board thus permitting close stacking of circuit boards.

Sockets can be supplied from 1 to 12 ways, colours can be in black, brown, red, orange, yellow, green, blue, violet, pink, grey and white.

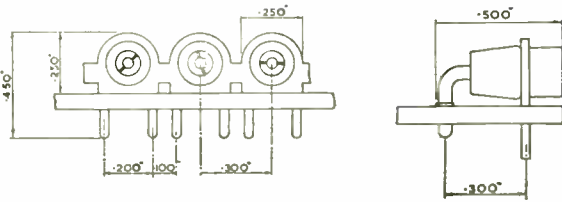
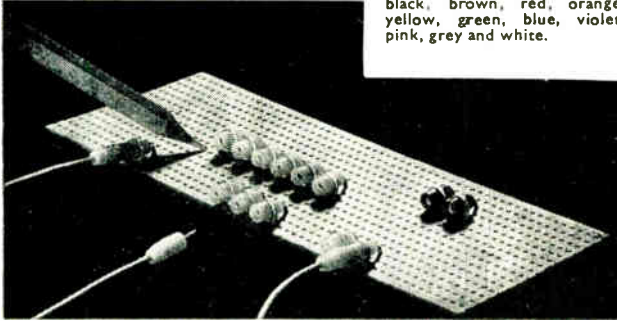

Write for technical details of these and other Oxley products

OXLEY DEVELOPMENTS CO. LTD.
ULVERSTON, LANCASHIRE Tel: Ulverston 2567

CLEAR INDICATION BY



The compact construction of K.G.M. In-line Indicators is demonstrated in this voltmeter by Digital Measurements Ltd. which displays microvolt readings. Ranging in character size from .3" to 6.25" these Indicators can be relied on to give a CLEAR INDICATION.

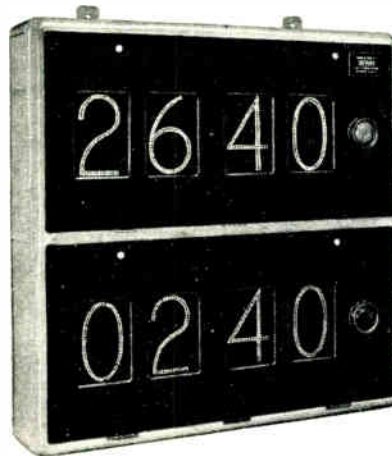

Brilliant 4" figures are the readings on this Avery coal weigher at Lysaght, Scunthorpe; another example of CLEAR INDICATION by K.G.M. In-line Indicators.

Ask for the brochure about In-line Indicators— or for information as to how K.G.M. engineers can help you to present a CLEAR INDICATION.



electronics limited
BARDOLPH RD RICHMOND
Phone: RICHmond 7171 Surrey

ELLIOTT-AUTOMATION LIMITED

SUMMARY OF RESULTS AND POINTS OF INTEREST 1963 (in approximate figures)

Group Sales	£39,000,000
Profit before Interest and Taxation	£3,780,000 <i>(being 9.7% on Sales)</i>
Profit before Taxation	£3,238,000 <i>(being 19.0% on Net Tangible Assets before giving effect to Rights Issue)</i>
of which Taxation took	41%
Preference Dividends	6%
Ordinary Dividends	23%
Retained in Business	30%
Depreciation	£979,000
Cash Flow (Retained Profits plus Depreciation)	£1,950,000
Fixed Assets Acquired (gross)	£2,950,000 <i>(excluding assets brought in by newly-acquired companies)</i>
Earnings before Tax per 5s. Ord. Share	2s. 4½d. <i>(before giving effect to Rights and Scrip Issues)</i>
Number of Shareholders*	27,500
Number of Employees in U.K.*	16,800
Factory Floor Area in U.K. sq. ft.*	2,500,000
	* Average for year

The above summary does not include figures relating to Elliott-Automation Continental S.A.

Copies of the full Report and Accounts can be obtained from The Secretary, 34 PORTLAND PLACE, LONDON, W.1.





H.M. GOVT. COMMUNICATIONS CENTRE

A CHALLENGING and PROGRESSIVE
CAREER is offered in the development of
ADVANCED COMMUNICA-
TIONS SYSTEMS and
allied techniques

H. M. G. C. C.
invites Applications
from Candidates for Appointment as
Experimental Officers or Assistant Experimental
Officers at Hanslope Park, Buckinghamshire.

Candidates for EXPERIMENTAL OFFICER appointment will normally be at least 26 years of age, hold a pass degree, Dip. Tech. or H.N.C. or have several years' experience in communications or general electronics. Salary commensurate with age and ability up to £1431 per annum.

Candidates for ASSISTANT EXPERIMENTAL OFFICER appointment will be at least 18 years of age and have passed two G.C.E. 'A' levels in scientific subjects. Salary commensurate with age and ability up to £1053 per annum.

Hanslope Park is situated in pleasant country surroundings where houses are readily available. Access to London is rapid by road or rail.

Encouragement is given to staff who wish to extend their knowledge by attending specialist courses.

Write to:-
The Personnel Officer,
H.M.G.C.C., Hanslope Park,
Wolverton, Bucks, giving age,
qualifications and a summary of experience.
Candidates and both their parents must have been British subjects at all times since birth.

CLASSIFIED ADVERTISEMENTS

FULLY DISPLAYED: 50/- per single column.
SEMI-DISPLAYED: 35/- per single column inch.
RUN-ON: 3/6 per line of approximately 7 words.
 Where an advertisement includes a Box Number Is. extra.
SERIES DISCOUNTS: 12 insertions, 15%.
 Remittances payable to "Industrial Electronics".

Copy is required by 20th of the month for insertion in the next issue. If proofs of displayed classified are wanted by 15th of the month.

Address to:
 Classified Advertisement Dept.
 Industrial Electronics
 Dorset House, Stamford St., London, S.E.1.

SERVICES OFFERED

Precision Sheet Metal Work for the Radio & Electrical Trade. Chassis, Panels, Brackets, etc. Power Press Capacity up to 100 tons. Press brake capacity up to 105 tons 8ft. x 7/32in. All spray and stove finishes. A.I.D. approved. — The Kaymet Company, Kaymet Works, Sylvan Grove, London, S.E.15. Telephone: NEW Cross 6644.

[2036]

CAPACITY AVAILABLE

AIRTRONICS LTD.

for coil winding assembly and wiring of electronic equipment, transistorised sub-units, sheet metal work. 4 Ashmead Road, London, S.E.8. Telephone: TIDEway 2249.

[2063]

SCRAP METAL

Non-ferrous Scrap Metals, all grades, Swarf, Off-cuts, etc., purchased at highest rates.

H. Barnett Ltd.,
 Victor Road, London, N.7.

Est. 1865 ARChway 5461

[2041]

SITUATIONS VACANT

THE ROYAL COLLEGE OF SCIENCE AND TECHNOLOGY, GLASGOW

Department of Electrical Engineering

CHAIR OF ELECTRONIC SCIENCE

Applications are invited for appointment to a second Chair which has now been created within the Department. The College has a long history of affiliation with the University of Glasgow and is about to become an independent university—the University of Strathclyde. The College has been designated for rapid expansion as a SISTER Institution.

The electronics work in the department is conducted in three main laboratories. One of these is devoted entirely to research. There is a staff of five, including two Senior Lecturers.

Further information can be obtained from the Secretary of the College, George Street, Glasgow C.1, with whom application should be lodged by 7th July, 1964.

[2066]

ELECTRONIC ENGINEERS

experienced in the design and development of Monochrome and colour television receivers are invited to apply for positions with a major company in the U.S.A.

Salaries range from approx. £3,000 p.a. upwards.
 Apply to TECHNICAL STAFF APPOINTMENTS LTD.
 25 Victoria Street, London S.W.1.
 Tel. ABBey 7611.

This is a free and confidential service to the applicant.

[2067]

WIREMEN/ASSEMBLERS

required by
 ELECTRONIC EQUIPMENT MAKERS.
 Good rates and bonuses.

Apply:
 E.M.S. LTD., 65 CALSHOT STREET, LONDON N.1.
 LANgham 5433

[2068]

ARTICLES FOR SALE

PHOTO-ELECTRIC CONTROLS

for industry

Quick delivery Send for Catalogues

Hird-Brown Limited

Flash Street, Bolton, Lancs.

Tel. 27311

[2027]

Nameplates, engraving, dissinking, stencils.—Stilwell & Sons Ltd., 153 Far Gosford Street, Coventry.

[2065]

INDUSTRIAL ELECTRONIC CONTROLS



We are specialists in this field, and have capacity for sub-contract work, for design and manufacture.

Brensall Electronics Ltd.

Charles Street, Bristol 1. Tel: 28167

AGENCIES

Active agents required for all areas by manufacturers and distributors of radios and other electronic equipment, full assistance given, good commission paid — Apply in writing, giving full details to Box 2069.

Old-established Industrial Electrical Wholesalers with first-class connections with Industry, Government Departments, U.K.A.E.A., Dockyards, Hospitals, Technical Colleges and Research Establishments, offers the services of its aggressive selling organisation and technical staff to manufacturers of electronic equipment seeking wide coverage with such outlets. Write Managing Director, British Central Electrical Co. Ltd., 16 26 Banner Street, London, E.C.1.

[2064]

PATENTS

Patent No. 823,590 entitled "Piezoelectric Crystal Support" is for sale or licence. For details apply to CHATWIN & COMPANY, Chartered Patent Agents, 253 Gray's Inn Road, London, W.C.1.

[2062]

Original testimonials should not be sent with applications for employment

For further information circle 260 on Service Card

an invitation

IF YOU HAVE A PRINTING PROBLEM... OF ANY SORT, LETTERPRESS, GRAVURE, WEB OR SHEET-FED LITHO, BLOCKMAKING, BINDING, you are invited to telephone FLEet Street 0246 ext 2136



that's International Printers

ORBIT HOUSE, 9 NEW FETTER LANE, LONDON EC4



Direct Reading Resistance Bridge

ONE KNOB OPERATION

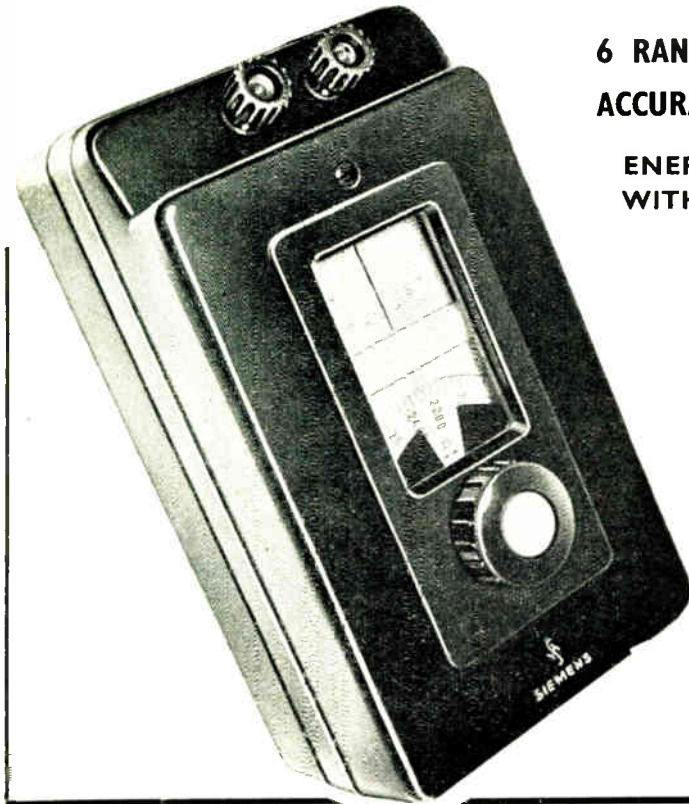

6 RANGES 40 milliohms to 50,000 ohms

ACCURACY $\pm 1\%$ or ± 5 milliohms

ENERGISED BY BUILT IN TORCH BATTERY WITH PROVISION FOR EXTERNAL SUPPLY

AUTOMATIC SWITCHING

The multiplier scale is switched automatically with the range selector

SIEMENS & HALSKE AKTIENGESELLSCHAFT
WERNERWERK FÜR MESSTECHNIK · KARLSRUHE

UK Distributors

R. H. COLE ELECTRONICS LTD.
26-32 CAXTON STREET, LONDON, S.W.1
Tel.: SULLivan 7060 Telex 23864

Index to Advertisers

Ad Auriema Ltd.	30	Electrosil Ltd.	Cover iii	Painton & Co. Ltd.	22
Adcola Products Ltd.	33	Elliott-Automation Ltd.	39	Parmeko Ltd.	Cover iv
A.E.I. Ltd. (Switchgear Division) ...	10	Ericsson Telephones Ltd.	6	Phillips Control (G.B.) Ltd.	32
Aircraft Marine Products Ltd.	21			Plannair Ltd.	34
Alfaset Ltd.	32				
Anglo-American Vulcanized Fibre Co. Ltd.	18	Hendrey Relays Ltd.	36	Radiospares Ltd.	14
Appointments Vacant	40, 41	Hughes International (U.K.) Ltd.	7	Rotax Ltd.	36
A.P.T. Electronic Industries Ltd. ...	9				
Aveley Electric Ltd.	28	Iliffe Books Ltd.	32, 38, 40, 41	Sangamo Weston Ltd.	31
Avery, W. & T. Ltd.	26	International Printers	41	Siemens & Halske Aktiengesellschaft	42
				SIFAM Electrical Instrument Co. Ltd.	29
		KGM Electronics Ltd.	39	SPS International Ltd.	35
Brensal Electronics Ltd.	41			Standard Telephones & Cables Ltd.	11, 12, 13, 24
British Insulated Callender's Cables Ltd.	Cover ii	Lancashire Dynamo Electronic Products Ltd.	23		
Bryans Ltd.	37	Levell Electronics Ltd.	19	Thorn Electronics Ltd.	16
		Magnetic Devices Ltd.	8	Union Carbide Ltd.	27
Cannon Electric (G.B.) Ltd.	38	Metway Electrical Industries Ltd. ...	35	Universal Electric Motor Co. (Enfield) Ltd.	38
Cole, R. H. Electronics Ltd.	42	Miniature Electronic Components Ltd.	3		
Cossor Instruments Ltd.	20	M-O Valve Co. Ltd.	25	V.G. Porcelain Co. Ltd.	37
		Muirhead Precision Instruments Ltd.	17	Vitality Bulbs Ltd.	38
		Mullard Ltd.	2, 4, 5		
Dawe Instruments Ltd.	15			Walmore Electronics Ltd.	31
Direct T.V. Replacements Ltd.	35	Oxley Developments Co. Ltd.	39	Welwyn Electric Ltd.	1

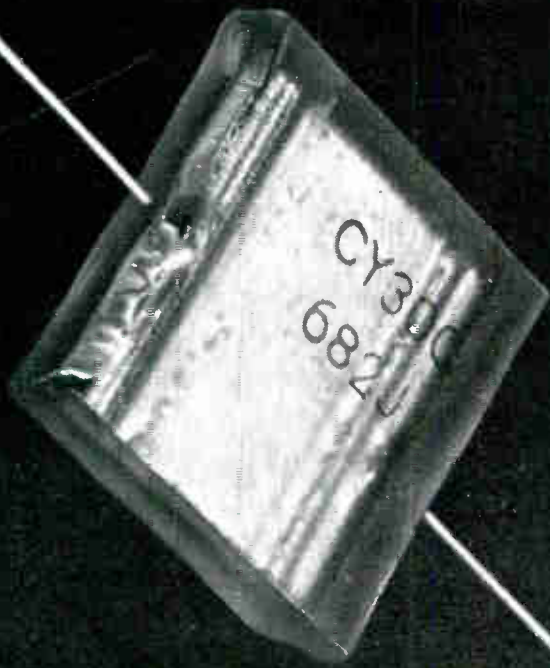

glass protects ...

CYFM
capacitors



in all
environments

— clearly the best
capacitors

C.4.

The all glass construction fused into a monolithic unit which gives complete hermetic sealing, gives CYFM Capacitors complete protection against all environmental conditions.

- Range 0.5 to 10,000 pF
- V.W. 300V & 500V at — 55°C to + 125°C
- Life: — After 2000 hrs at 125°C and 50% overload on rated voltage, capacitance change is less than 0.5%, at 1Mc or 1kc. I.R. is 10¹⁰ ohms. Dissipation factor 0.007

ELECTROSIL LIMITED

Pallion, Sunderland, Co. Durham

Telephone: SUNDERLAND 71557 Telex: 53273

For further information circle 202 on Service Card

PARMEKO

CONSTANT VOLTAGE TRANSFORMERS



Reliable and economical voltage stabilisation, continuous and automatic in action, obtained entirely by static means. Constant output voltage for a wide variation of input voltage. Output may be isolated from input and Constant Voltage Transformers have the added advantage of self protection against load short circuit.

Write for List 220 which gives full technical specifications

PARMEKO LIMITED, PERCY ROAD, LEICESTER, ENGLAND

Telephone Leicester 2225