

INDUSTRIAL ELECTRONICS

SEPTEMBER 1963 5s 0d



For further information circle 200 on Service Card



an **OPEN** & **SHUT** case **for the** **MS HYFEN** connector

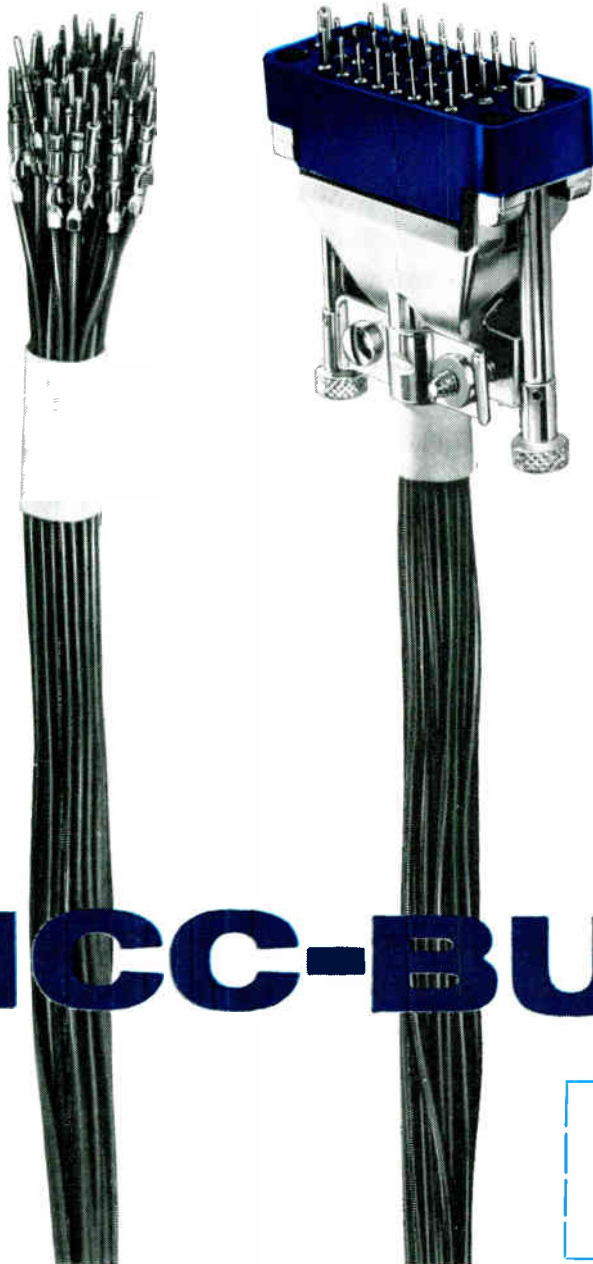

NOTE THESE FEATURES:

crimped snap-lock removable contacts / high speed assembly / factory pre-assembled hardware / fault finding and commissioning simplified / low mating forces / manual or automatic installation tooling / reduced production costs / hood accommodates multi-core cable sheath

Plated to maintain low contact resistance under the most severe conditions of environment, the miniature Hyfen connector provides reliable high-density connections. It is available in 14, 20, 26, 34, 42, 50, 75 and 104 contact sizes. The new hinged protective hood swings wide open to give full access for easy insertion, removal and inspection of contacts. BICC-BURNDY manufacture all types of connectors for the electronics industry.

BICC-BURNDY

ST HELENS LANCS

For full information on the MS HYFEN, attach this coupon to your Company's letterhead and mail it to:

BICC-BURNDY LIMITED
ST HELENS · LANCS
E.Y.



INDUSTRIAL ELECTRONICS

incorporating *ELECTRONIC TECHNOLOGY*



Volume I Number 12 September 1963

contents

Editor **W. T. COCKING, M.I.E.E.**

Assistant Editor **T. J. BURTON**

Advertisement Manager **G. H. GALLOWAY**

605 **Comment**

607 **New Load Control and Indicating Equipment** *by E. Fielder*

Load cells find many applications in industry. This article describes how they are applied in the measurement of weight and also how they can be employed in an overload alarm in a crane.

611 **Fabricating Plastic-Coated Steel** *by C. Burton*

Ordinary welding methods cannot be used with plastic-coated sheet metal. This article describes a way of welding this material which is based on projection welding with electronic control.

614 **Control of Intersetter of a Pre-Printed Web in a Newspaper Press** *by J. C. Mawer*

Colour advertisements are often printed before the news material in a newspaper. Registration problems then arise when the news is printed and are overcome by an electronic control system.

616 **Automatic Voltage Regulator for a Marine Turbo-Alternator**
by P. Fenwick

An application of a set of standard servo modules to automatic control is described in this article. The modules are used to regulate the voltage of a 750-kW marine turbo-alternator.

634 **The Double-Y₀ Shunt Stub** *by C. S. Gledhill, B.Sc.(Tech.)*

The use of open- or short-circuited stubs of a special form to obtain impedance matching over a wide band is discussed in this article. Design charts are included.

637 **Colour Television**

Three colour television systems are competing for adoption as the European standard. This article explains how they work and the differences between them.

continued overleaf

Published on the first Thursday after the 5th of each month by

ILIFFE ELECTRICAL PUBLICATIONS LTD.

Managing Director: W. E. Miller M.A., M.Brit.I.R.E.

Dorset House, Stamford Street, London, S.E.1.

Telephone: Waterloo 3333.

Telegrams: Wirenger, London, Telex.

Cables: Wirenger, London, S.E.1.

ANNUAL SUBSCRIPTION, HOME £3 0s. 0d.

OVERSEAS £3 10s. 0d.

CANADA and U.S.A. \$10.00.

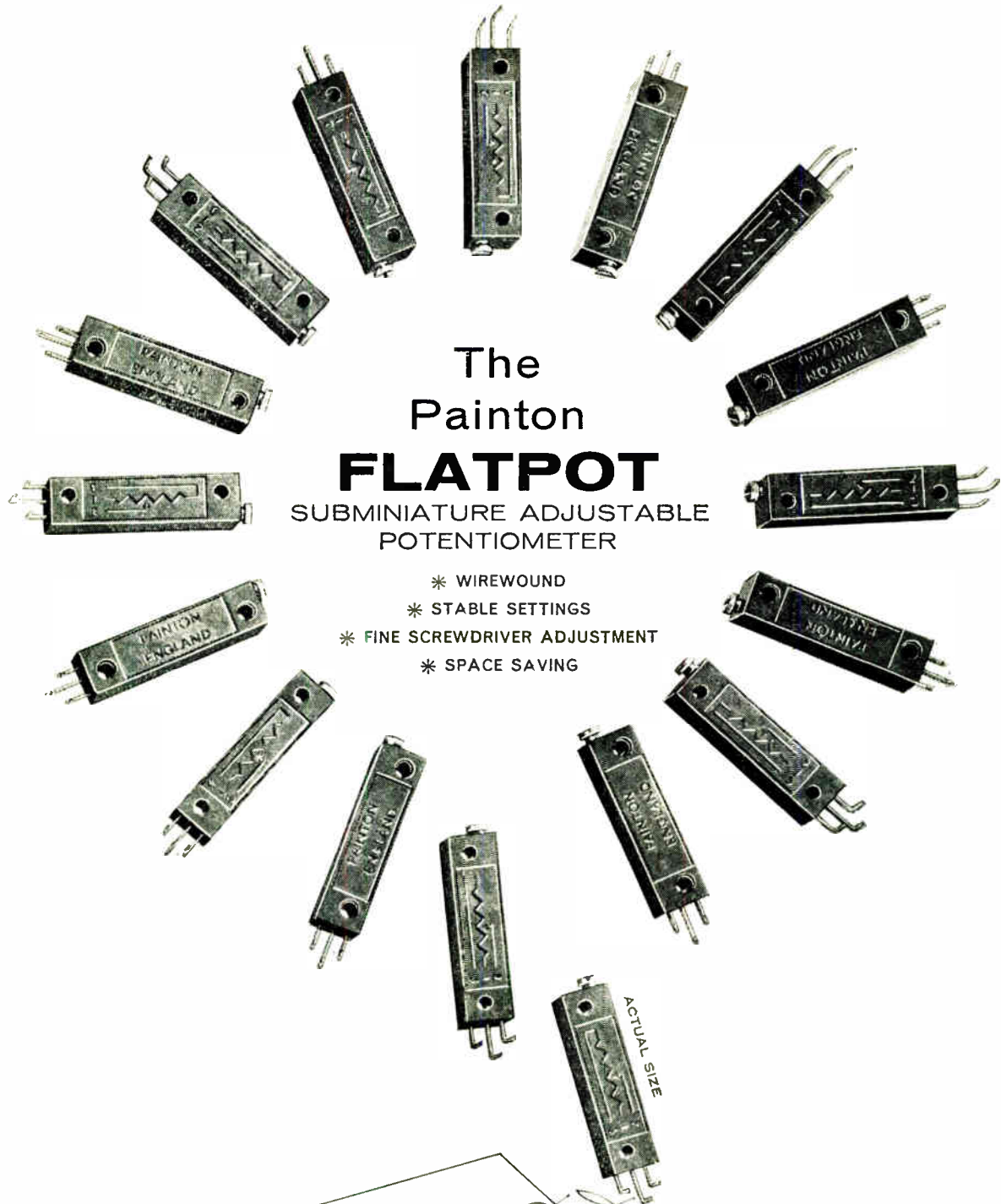

The
Painton
FLATPOT
SUBMINIATURE ADJUSTABLE
POTENTIOMETER

- * WIREWOUND
- * STABLE SETTINGS
- * FINE SCREWDRIVER ADJUSTMENT
- * SPACE SAVING

AND
QUICK
DELIVERY

Write for leaflet **FP1/2**



Painton
& CO. LIMITED
KINGSTHORPE · NORTHAMPTON
Tel: 34251 (10 lines) • Grams: 'Ceil' Northampton • Telex: 31576

NEW CANNON KPT/KSP MINIATURE DESIGNED TO MIL-C-26482

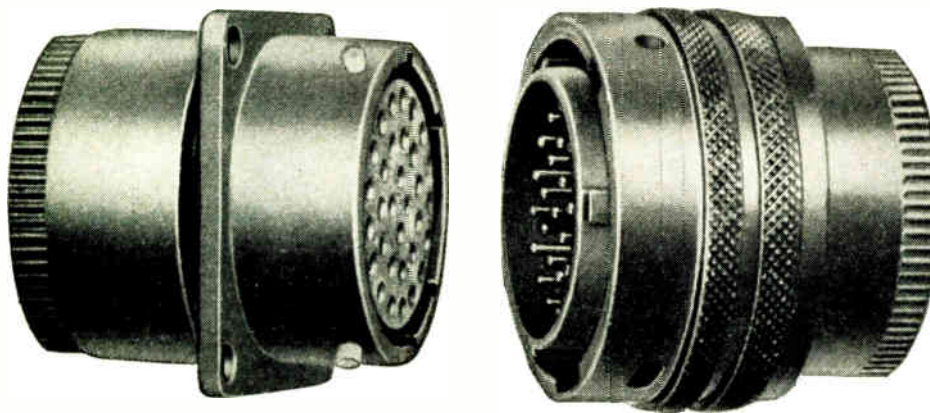

Quick disconnect plugs for aircraft, missiles, and all applications requiring miniature plugs. Our standard solder-pot versions, including hermetic seals, are completely interchangeable with all bayonet-lock plugs designed to MIL-C-26482!

ALSO AVAILABLE ARE KPTM/KSPM PLUGS WITH CRIMP SNAP-IN REMOVABLE CONTACTS AND TWO SHORE INSULATOR

Two shore resilient insulators moulded out of two different hardness materials (polychloroprene) into a homogeneous piece. The rear portion of the insulator is the softer in order that the conductors can be sealed properly, and the front portion is the harder to retain the snap-in contacts. The two shore insulator insures a continuous moisture and pressure seal from front to back to provide superior electrical performance at high altitudes. This method of sealing and contact retention offers the industry a most reliable crimp series meeting the requirements of MIL-C-26482. For comprehensive details write for catalogue KPT/KSP. And for all your connector requirements consult Cannon—the world's foremost manufacturer of plugs and sockets.

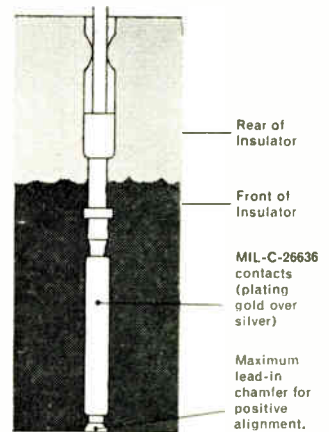

European Enquiries : Cannon Electric International Inc., Bornem, Belgium. Telephone : (03)77.06.14.
Scandinavian Enquiries : Sweden Ab Gosta Backstrom, Box 12089, Stockholm 12.
Denmark : Tage Schouboe, 7 Skyttegade, Copenhagen.
Norway : Morgenstjerne & Co., Wessels Gate 6, Oslo.
Finland : OY Chester AB, Uudenmaankatu, 23A, Helsinki.



FOR RELIABILITY

Cannon Electric (Great Britain) Limited
168-172 Old Street, London E.C.1. CLERKENWELL 4954

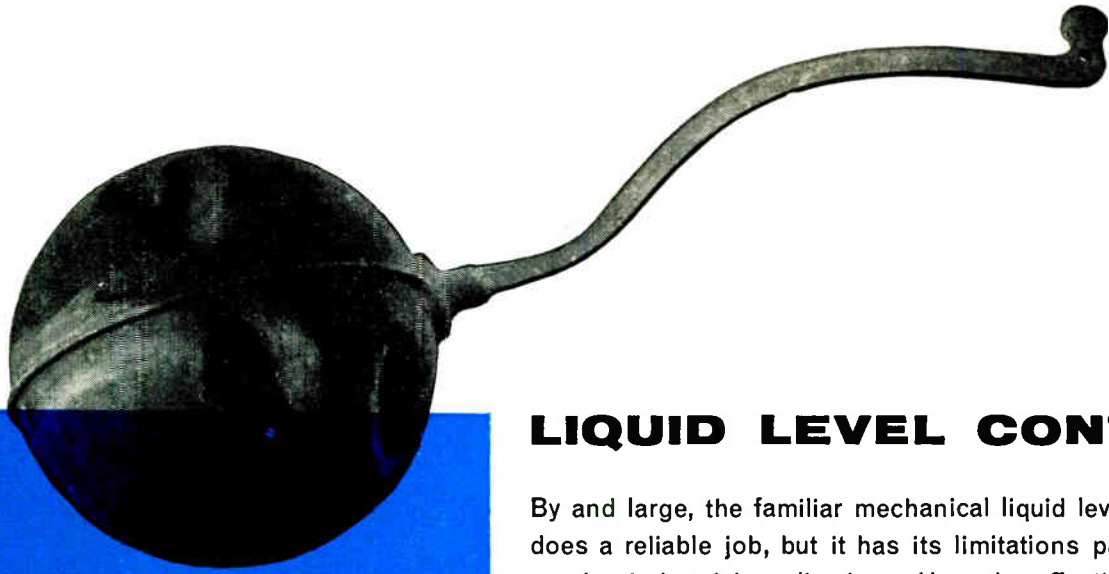

LIQUID LEVEL CONTROL

By and large, the familiar mechanical liquid level controller does a reliable job, but it has its limitations particularly in precise industrial applications. Here the effective answer is inexpensive cold cathode trigger tubes. Reliable to the point of outlasting the useful life of parent equipments, Ericsson trigger tubes meet the most exacting requirements.

Operating from rectified mains they require no special power supplies, they are not affected by severe transient overloads, they give visual indication of current flow and their characteristics remain unchanged by temperature fluctuations.

With suitable electrodes any substance capable of flow even with only a moderate degree of conductivity can be accurately maintained to predetermined levels or measured and delivered in selected quantities.

The circuit illustrates the simplicity of cold cathode trigger tube liquid level control. For more information and data please write to the address below.

GPE 120T TRIGGER TUBE

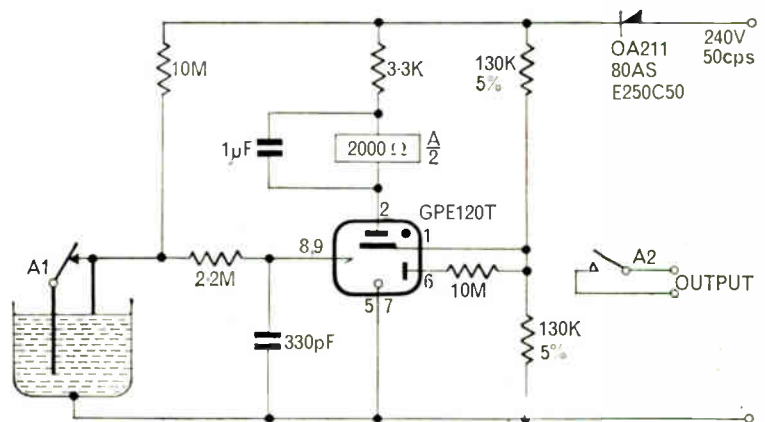

Tube Division
 Technical Services Dept.,
 Beeston, Notts. Tel: 254831.

**ERICSSON TELEPHONES LTD
 ETELCO LTD**

Mullard introduce five new power transistors

*Fourteen Germanium and Silicon
Types Provide the Widest Low-Cost Range*

The introduction of five new power transistors extends the Mullard range to fourteen types, forming the widest, most economic range available. The five new devices introduced consist of three high-current low-frequency germanium power transistors—types ADY26, ADZ11, and ADZ12—and two high-power n-p-n double-diffused silicon types—BDY10 and BDY11.

This range of low-cost devices of proven performance meets the requirements of industrial control and switching, communications, and d.c. converter applications, producing power outputs of up to 130W. The important characteristics and applications of the transistors in the range are given in the table below.

FOUR GROUPS

The fourteen devices have specific applications but can be classified into four groups of similar overall characteristics. The 'general-purpose' group consisting of the OC20, OC25, OC28, OC29, OC35, and OC36 is intended for switching, amplifying, and control applications in the industrial and communications fields. The higher-current germanium devices ADY26, ADZ11, and ADZ12 are used for audio-frequency, d.c. converter, and series regulation applications. The high-frequency devices OC22, OC23, and OC24, form a group with particular use in high-speed switching, wideband audio and ultrasonic applications. The silicon transistors, BDY10 and BDY11, are used where higher powers and operating temperatures are required.

ADVANCED PERFORMANCE IN SILICON

The double-diffusion technique used in the manufacture of the silicon power transistors gives a low bottoming voltage and a

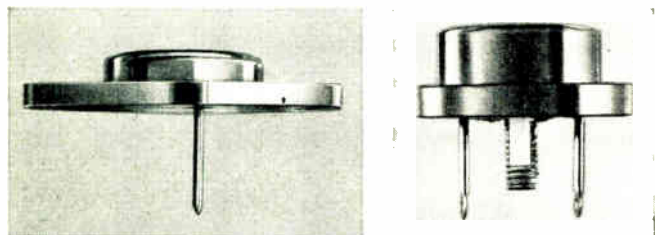

TO-3 (left) and TO-36 (right) encapsulations used for Mullard power transistors.

high voltage performance, the voltage rating of the BDY11 being 100V, together with an adequate frequency performance and maintained gain to collector currents of 4A. The typical f_t value of these two transistors is 2Mc/s. The silicon transistors can be used with the OC28 p-n-p germanium transistor in high-power, complementary n-p-n and p-n-p circuits.

For technical data on the Mullard power transistor range, please use the reader reply card of this journal (see reference number opposite).

MULLARD INDUSTRIAL POWER TRANSISTOR RANGE

Important Characteristics and Applications

- ADY26 High voltage, high power, high current, with maintained gain; for high-power d.c. converter and series regulator applications.
- ADZ11 High power, high current; for a.f. applications.
- ADZ12 High power, high current; for a.f. applications.
- BDY10 Medium voltage, high frequency, high power, n-p-n silicon double-diffused; intended for general industrial applications.
- BDY11 High voltage, high frequency, high power, n-p-n silicon double-diffused; intended for general industrial applications.
- OC20 Medium gain; very high voltage and high-current switching applications.
- OC22 High-speed switching, also suitable for high-quality audio output stages.
- OC23 High-speed switching; specially designed as pulse amplifier for driving ferrite cores.
- OC24 High-speed switching, medium-frequency transmitter and carrier telephony applications.
- OC25 Low-power transistor to bridge the gap between power and small-signal devices; for audio and driver stages, and industrial control applications.
- OC28 Close tolerance, high voltage, high current; particularly suitable for d.c. converters.
- OC29 High gain, medium voltage, high current; suitable for industrial switching, control applications and high-power industrial applications.
- OC35 Medium voltage, high current; general purpose and control applications (for example, stabilised power supply units).
- OC36 High voltage, medium gain, high current; general purpose and control applications.

What's new from Mullard

(Adtg.) *Industrial Electronics* September 1963

DOUBLE-TRIODE FOR V.H.F. CASCODE AMPLIFIERS

Neutrode Screen Eliminates Neutralisation

A special-quality double-triode has recently been introduced for television v.h.f. distribution systems. The valve, type ECC2000, is designed for use in cascode circuits in single channel, broadband, and distributed amplifiers.

The two triode sections of the valve are dissimilar, the input section being fitted with a neutrode screen. This screen reduces the anode-to-grid capacitance, reducing feedback and enabling the valve to be used in many applications without neutralisation. The output triode section is of conventional form. The valve uses a 10 pin base (B10B) which enables the neutrode screen to be earthed separately or used in a neutralising circuit.

The ECC2000 can be operated in two alternative conditions. In the low-current condition, the valve can be used as a small signal amplifier while in the high-current

condition, it can be used to produce a higher gain or a power output. The value of mutual conductance of the input triode section is 13mA/V at an anode current of 15mA, and 17.5mA/V at 27mA. For the output triode section, the value of mutual conductance is 17mA/V at 15mA and 22mA/V at 27mA.

Although intended for distribution systems, the ECC2000 can be used in other applications, in particular, in the Y amplifier of wideband oscilloscopes. A preliminary applications report and advance data are available.



OSCILLOSCOPE TUBE PROVIDES ADEQUATE BRIGHTNESS AT UNUSUALLY LOW VOLTAGE

The D13-15GH is a 5in oscilloscope tube which can be operated at potentials as low as 4kV whilst still maintaining adequate brightness of the trace. This reduction in operating voltage makes the tube ideal for use with transistor drive circuits, and although the construction is conventional, the tube is brought into the high-performance class by its tight tolerances.

Operation at this low potential is made possible by a specially developed process which enables the thickness of the aluminium backing to the screen to be considerably reduced. A gain in light output can therefore be achieved without sacrificing the familiar benefits of aluminised screens, such as maximum forward projection of the light from the screen, and freedom from voltage sticking and screen burn.

POWER TETRODE FOR S.S.B.

5kW peak output power without grid current, better than 35dB intermodulation product

A reduction in the number of driver stages required in s.s.b. transmitters is made possible by a new 5kW tetrode, type YL1120.

This has been achieved by using a unique form of grid configuration which gives the YL1120 a highly linear characteristic. As a result, 5kW of peak envelope power can be obtained without grid current or r.f. feedback and with an intermodulation product better than 35dB. Using the new valve, transmitter designers are now able to reduce the number of driver stages needed for a given power output and yet maintain the high standard of linearity required in s.s.b. transmitters. Coaxial construction is employed to increase efficiency and maintain operational stability; forced air cooling is necessary.

Under typical two-tone operating conditions at a frequency of 60Mc/s, the YL1120 requires an anode voltage of 5kV, a screen-grid voltage of 800V, and a control-grid voltage of 175V.



With these conditions, the anode current is 1.3A and the peak envelope power 5.8kW. Grid current is zero and maximum intermodulation level at all drive voltages is 35dB.

THYRATRON WITH 160A PEAK CURRENT

A new form of cathode construction makes possible an inert gas thyatron capable of passing a peak cathode current of 160A. The thyatron, type XR1-12A, is intended for industrial power control applications, particularly motor control and welding. The cooling fins ensure stability of operation over the temperature range -55 to +70°C.

The XR1-12A is rated for an average cathode current of 12.5A at a peak anode voltage of 1.5kV.



Number tube for close mounting

Mounting at $\frac{3}{16}$ in centres is possible with a new cold cathode numerical indicator tube which will still provide display numerals about half an inch high. A ten digit display can therefore be accommodated in a panel only $7\frac{1}{2}$ -in wide.

The new tube, type ZM1080, provides side viewing of the numerals 0 to 9 in a miniature (19mm dia) envelope. A built-in red filter ensures adequate visibility of the displayed numeral even in unfavourable viewing conditions. The tube can be used with simple switching or pulse circuitry.

Like other 'in-line' presentation numerical indicator tubes in the Mullard range, this tube uses the now well-established long-life techniques to ensure the best possible performance.

Reader Enquiry Service

Further details of the Mullard products described in this advertisement can be obtained through the Reader Enquiry Service of Industrial Electronics using the appropriate code number shown below.

Power transistor range ..	206
Special-quality double-triode ECC2000	207
S.S.B. tetrode YL1120 ..	208
Thyratron XR1-12A ...	209
Numerical indicator tube ZM1080	210
Oscilloscope tube D13-15GH	211



Mullard Limited, Mullard House, Torrington Place, London, W.C.1. Telephone: LANgham 6633

Quick! Simple! Efficient! Space-saving!

A bull's-eye every time with

ADDA-SHAFTS

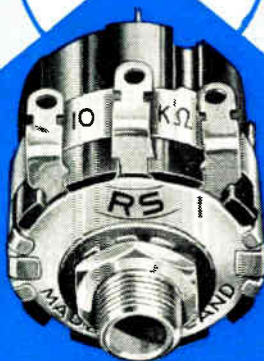

Unique Separate Spindle System
(Patented)
for all Volume Control and Potentiometer requirements

- * Spindles for "Grub-screw" and "Push-on" fittings
Pre-sets and other 'specials'
- * Control units with or without D.P. Switch. Log
or Linear Tracks



Radiospares Ltd.

4-8 MAPLE STREET · LONDON · W.1 · ENGLAND

Telephone: Euston 7232 (8 lines)

By Return
Service for
all
Electronic
Components

Telegrams: RADOSPERES, WESDO, LONDON

Cables: RADOSPERES, LONDON—WI



COMPONENTS REVIEW

SEPTEMBER, 1963

JFD TRIMMERS AND INDUCTORS

To supplement the range of high quality components manufactured by the Capacitor Division, the decision has been taken to market Variable Piston Trimmer Capacitors and other components of the JFD ELECTRONICS CORPORATION OF NEW YORK. The agency covers the United Kingdom and the other countries in the European Free Trade Area (Austria, Denmark, Finland, Norway, Portugal, Sweden and Switzerland).

The quality of JFD products is in keeping with that of STC's and they are used extensively in military, commercial and industrial projects throughout the US and Canada. A high degree of uniformity and reliability is maintained by JFD Quality Control Engineers and comprehensive environmental tests ensure conformity to the applicable requirements of MIL-C-14409A.

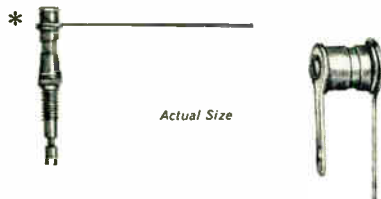

* Pin-Trim Series — world's smallest piston trimmer capacitor

VARIABLE PISTON TRIMMER CAPACITORS

These consist of a highly stable dielectric cylinder of glass, quartz or ceramic containing a piston assembly which gives a completely linear tuning characteristic. There are hundreds of standard units ranging down to the PIN-TRIM series which are the smallest piston capacitors in the world.

METALLIZED INDUCTORS

The metallized inductors utilize a silver film fired permanently on to a glass cylinder and offer the ultimate in inductor simplicity and stability. They have a high Q over a broad frequency and temperature range and unusually high stability under conditions of severe shock and vibration and over a wide temperature range.

LC TUNERS

Combining a precision variable piston capacitor with a metallized inductor, JFD LC-tuners provide an exceptionally compact tunable circuit.

DELAY LINES

There is a large selection of both Lumped Constant and Distributed Constant delay lines available for either printed circuit or conventional mounting.

Stocks of all these components will be maintained in the United Kingdom.

Write, 'phone or Telex for catalogues to STC Capacitor Division, Brixham Road, Paignton, Devon or London Sales Office, Footscray, Kent. Telephone FOOTscray 3333. Telex 21836.

HERMETIC SEALS —two ranges

Two new ranges of STC glass-to-metal hermetic seals are in full production. One range is made up of six lead-through type capacitor end seals, particulars of which are given in the table below:

Type	O/A Dia. (in.) (mm)	Lead-Through Int. Dia. (in.) (mm)	Ins. Res. at 500 V d.c. (MΩ)	Proof Voltage (kV)
H1G35 (VK35A)	0.163 4,140	0.035 0,889	30 000	1.1
H1G36 (VK36A)	0.242 6,146	0.035 0,889	30 000	1.5
H1G37 (VK37A)	0.360 9,144	0.055 1,397	30 000	2.2
H1G38 (VK38A)	0.498 12,649	0.055 1,397	60 000	3.2
H1G39 (VK39A)	0.674 17,119	0.055 1,397	60 000	3.2
H1G40 (VK40A)	0.934 23,723	0.055 1,397	60 000	5.4

The other new range of hermetic seals consists of one basic three-pin refrigerator seal available with a variety of pin lengths to suit customers' specific requirements. The pins may also be grooved at one or both ends if required. Principal details are given in the drawing and table below:

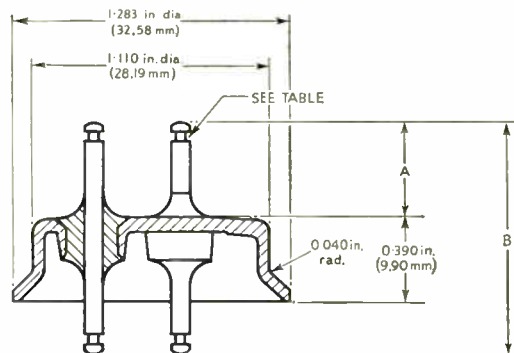

Type	Dim. A (in.) (mm)	Dim. B (in.) (mm)	Pins Grooved
H3G54 (VK54A)	0.358 9,093	1.016 25,806	None
H3G55 (VK55A)	0.406 10,312	1.062 26,974	None
H3G57 (VK57A)	0.375 9,525	1.031 26,187	Bottom
H3G58 (VK58A)	0.438 11,125	1.094 27,787	Top and Bottom
H3G62 (VK62A)	0.375 9,525	1.031 26,187	Top

Write, 'phone or Telex for Data Sheets to STC Valve Division, Brixham Road, Paignton, Devon, or London Sales Office, Footscray, Kent. Telephone FOOTscray 3333. Telex 21836.

miniature SELENIUM RECTIFIERS for low-cost reliability

STC miniature selenium rectifiers are designed for use in electronic circuits calling for a diode of good reverse/forward resistance ratio and closely controlled characteristics. When used in place of thermionic valves, these rectifiers virtually eliminate problems of heat dissipation and a.c. hum, and save the cost of provision of heater power, valve bases and associated wiring. Of small size, they are easily accommodated in circuits and are suitable for most applications including modulators and demodulators, discriminators, logical circuits, limiting diodes, asymmetrical resistors, etc.

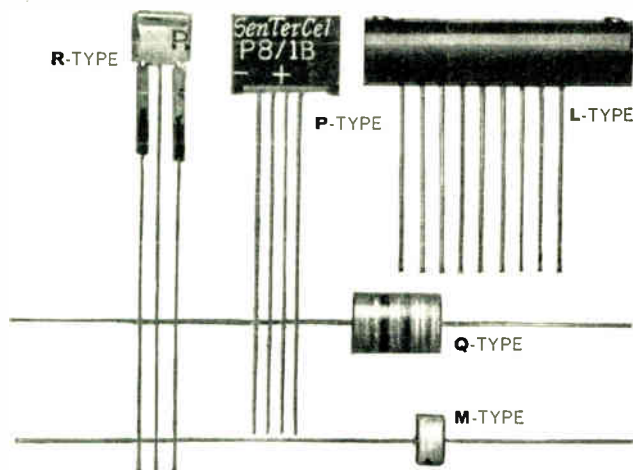

Actual size

Type	Description	Remarks
M	Single plate in aluminium case, available with insulating sleeve if required.	Half-wave devices fitted to axial leads.
T	Two aluminium case sizes. One or two plates or from three to five plates.	
Q	Up to five plates in series in moulded nylon case.	
MQ	As for Q but hermetically sealed and tropicalized ceramic case.	Available in half-wave, doubler, push pull or bridge configuration with multiple leads.
P	Up to five plates in moulded rectangular plastic case shaped for automatic insertion.	
R	A skeleton form of P for use in restricted space.	
L	Cylindrical case in two sizes for up to ten or up to twenty plates.	

The Rectifier plates are of four basic types and their characteristics and ratings offer a wide range of voltage and current selection.

Write, 'phone or Telex for data sheets and applications booklet to: STC Semiconductor Division, Edinburgh Way, Harlow, Essex. Telephone Harlow 26811. Telex 81146.

WORLD'S FASTEST GOLD CATHODE TRIGGER TUBE

The special gas mixture and structure, incorporating a biased shield electrode and priming discharge gap, enables the G1/371K tube to achieve ionization times of less than 5 μ sec and recovery times as low as 10 μ sec: figures several orders smaller than those obtained with most tubes in this category.

These remarkably short times permit the use of circuitry with small time constants, resulting in squarer wave-forms and allowing high operating speeds.

The tube may be used for a variety of purposes including square, exponential and saw-tooth pulse generators, count rate meters and in gate, flip flop and counter circuits: indeed this tube can be used in a special ring counter at input frequencies up to 100 kc/s.

The G1/371K is being used in a variety of equipments, including the STC CADF (Commutated Aerial Direction Finder) which, instead of having a mechanically rotated aerial, has aeriels electronically selected in high speed rotation. Using two or more CADF units spaced apart, a fix on an aircraft position can be displayed on a cathode ray tube immediately the aircraft transmitter is operated.



Trigger tube G1/371K

Abridged Data

Anode supply voltage	270 to 360 V
Anode maintaining voltage	180 V
Cathode current, average	2 to 10 mA
Trigger bias	0 to 165 V
Trigger voltage	
(a) for ionization within 25 μ sec	185 V
(b) for ionization within 5 μ sec	195 V
Priming gap current	0.2 to 0.5 mA

Write, 'phone or Telex for Application Report MS/118 to STC Valve Division, Brixham Road, Paignton, Devon or London Sales Office, Footscray, Kent. Telephone FOOTscray 3333. Telex 21836.

MINIFLAKE TRANSISTORS

for thin film circuits

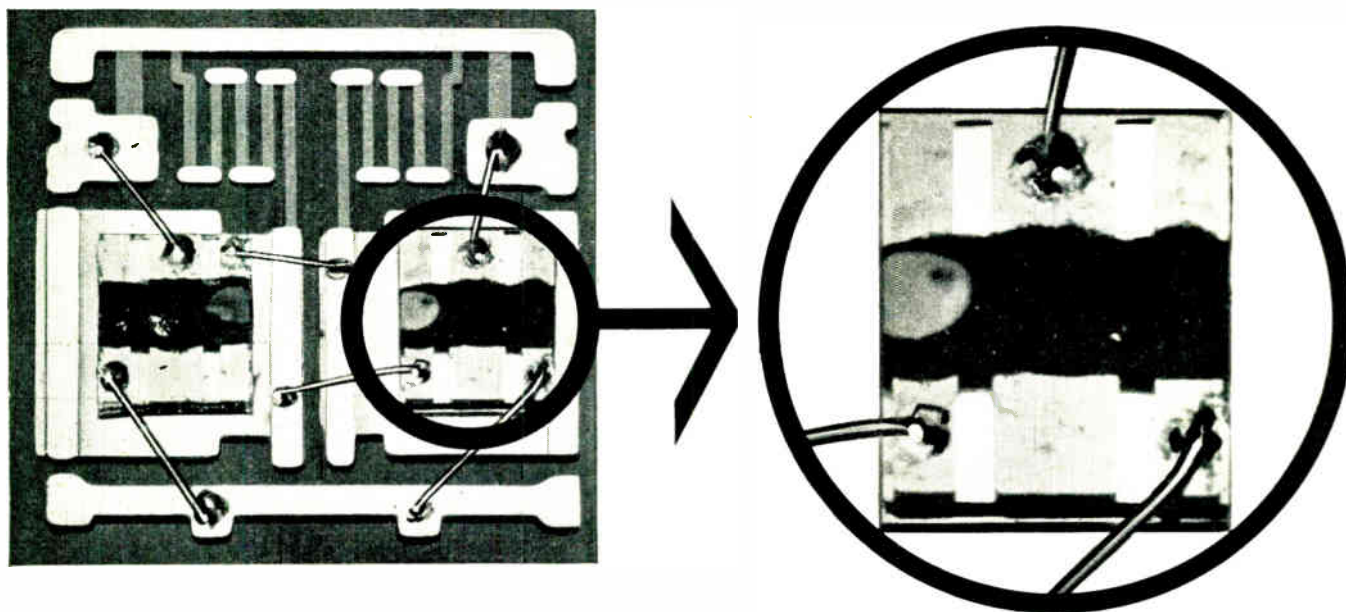

The initial range of STC MiniFlake transistors comprises types without leads for direct connexion into thin film circuits, and types with leads for use with subminiature circuitry. In either application, MiniFlake transistors do not increase the height of the circuit by more than 0.025 in. (0.635 mm). All MiniFlakes are coated with an opaque resin which prevents mechanical damage to the planar surface and eliminates photo-conductivity.

BSY32 and BSY33

These are produced without leads and are for fast switching at mean current levels up to 100 mA. Their characteristics are similar to the conventionally encapsulated BSY26 and BSY27.

BSY47 and BSY48

Having leads, these MiniFlakes are otherwise similar to the BSY32 and BSY33 respectively.

Brief Data

	BSY32 - BSY47	BSY33-BSY48
f_T ($I_C=10\text{ mA}$, $V_{CE}=9\text{ V}$, $f=100\text{ Mc/s}$)	200 Mc/s	200 Mc/s (Min)
I_{CBO} ($I_E=0$, $V_{CB}=9\text{ V}$)	25 nA	25 nA (Max)
h_{FE} ($I_C=50\text{ mA}$, $V_{CE}=2\text{ V}$)	15-60	25-120
V_{CES} ($I_C=50\text{ mA}$, $I_B=5\text{ mA}$)	480 mV	190 mV (typ)
t_{ON} ($I_C=10\text{ mA}$)	20 ns	19 ns (typ)
t_{OFF} ($I_C=10\text{ mA}$)	31 ns	35 ns (typ)

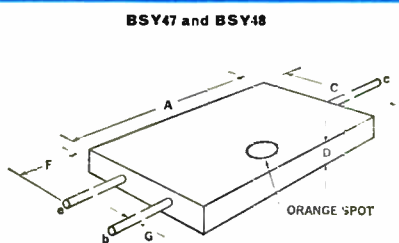
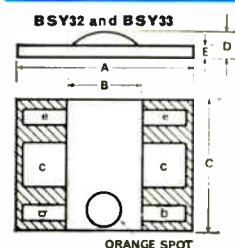

Dim	in.	mm
A	0.160	4.064
B	0.070	1.778
C	0.120	3.048
D (max)	0.025	0.635
E	0.010	0.254
F	0.5	12.7
G	0.010	0.254

For full details of STC MiniFlakes write, 'phone or Telex to STC Transistor Division, Footscray, Sidcup, Kent. Telephone FOOTscray 3333. Telex 21836.



Standard Telephones and Cables Limited

COMPONENTS GROUP · FOOTSCRAY · SIDCUP · KENT

WHO FELT THE SACK DROP



A Cossorscope is used at the new £½ million Reed Research and Development Centre at Aylesford, Kent, to indicate the strain experienced by kraft plies of half-size paper sacks during a drop test.

Cossorscopes are answering thousands of such questions throughout a wide range of industries—if YOUR problem involves visual display of electrical or mechanical phenomena, let us advise you.

COSSOR INSTRUMENTS LIMITED, The Pinnacles, Elizabeth Way, Harlow, Essex. Telephone: Harlow 26862

COSSOR

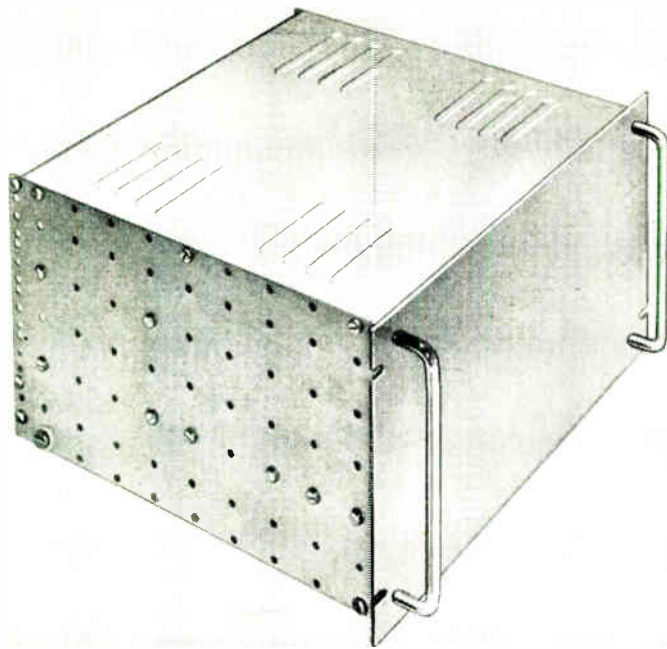

Front and rear views of typical Imkit assemblies. The rear beam when fitted as shown below provides a recessed mounting for plugs, jacks etc. Tie bars provide rigidity when dust covers are not used.

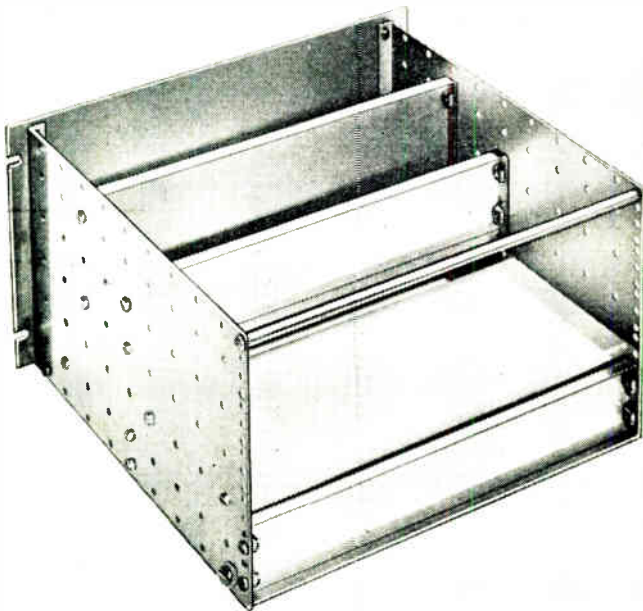

NEW **IMKIT** SECTIONAL CHASSIS SYSTEM

Offers unsurpassed versatility of chassis design and layout at really economical prices

Chassis can be fitted horizontally or vertically (or both) allowing hundreds of different mounting arrangements

Eighteen sizes of side panels and eight chassis sizes allow components to be assembled to meet your exact requirements

All parts fitted with captive nuts or drilled and tapped to allow really quick and simple assembly

Special nylon rollers facilitate movement of loaded chassis

The internationally accepted 1 3/4" module is used as a basis for all parts and Unified fixings are standard throughout

Send today for full details and prices

ALFRED IMHOF LIMITED
Dept. 1E/3 Ashley Works,
Cowley Mill Road, Uxbridge, Middx.
Telephone: Uxbridge 37123
Telegrams: Imcase-Uxbridge-Telex
Telex: 24177

IMHOF AGENTS OVERSEAS

ALGERIA E.G.E.E. Paris 19e.

AUSTRALIA Aladdin Industries Pty., Ltd., Stanmore, N.S.W.

BELGIUM Rogelec, Ghent.

DENMARK Tage Schouboe Copenhagen N.

FINLAND Teratron Company Helsinki—Helsingfors.

FRANCE E.G.E.E. PARIS 19e.

GERMANY Elek GmbH., Dusseldorf.

HOLLAND J. Th. van Reyssen, Delft.

ITALY Stuart Culley, Milan.

MOROCCO E.G.E.E. Paris 19e.

NEW ZEALAND Imarox (1962) Ltd., Auckland.

NICARAGUA Talleres Metalurgicos de Nicaragua, Managua.

NORWAY Birger Christensen Oslo.

PORTUGAL Projectos e Construcoes, Lisbon.

SOUTH AFRICA Switchcraft Pty., Ltd., Johannesburg.

SWEDEN Elektronlund AB., Malmo, I.

SINGAPORE AND MALAYA Diethelm & Co. Ltd., Singapore, I.

SWITZERLAND Walter Blum, Zurich 10/37.

THAILAND Diethelm & Co. Ltd., Bangkok.

TUNISIA E.G.E.E. Paris 19e.

U.S.A. Bud Radio Inc. Cleveland 3.

600 mc f_T Switches...
 120v V_{CB} Core Drivers...
 100 mc Amplifier...
 All Available Now with...

PHILCO SILICON PLANAR RELIABILITY

Philco's versatile line of Epitaxial Silicon Planar NPN Transistors enables you to upgrade reliability in every transistor application.

VERY HIGH SPEED SWITCHES

These Philco Types Feature Industry's Best Combination of Voltage, Switching Speed, and Beta.

TYPE†	Maximum Ratings					Characteristics								
	T_S °C.	V_{CBO} volts	V_{CEO} volts	P_T @ 25° C. mw	I_C ma	I_{CBO} max. μ a	h_{FE} min.	$V_{CE(SAT)}$ max. volts	f_T min. mc	C_{ob} max. pf	t_s max. nsec	t_{on} max. nsec	t_{off} max. nsec	
2N2710	300	40	20	360	500	0.03	40	0.25	500	4	15	20	35	
2N2651	300	40	20	360	500	0.03	25	0.25	350	4	25	35	75	
2N914	300	40	15	360	500	0.025	30	0.25	300	6	20	40 @ 200 ma	40 @ 200 ma	
2N834	175	40	30**	300	200	0.50	25	0.25	350	4	25	35	75	
2N784A	300	40	15	350	200	0.025	25	0.19	300	3.5	15	20	40	
2N708	300	40	15	360		0.025	30	0.40	300	6	25			
2N706	175	25	20*	300	50	0.5	20	0.60	200	6	60			

* V_{CER} ** V_{CES} † TO-18 case—collector internally connected to case.

ULTRA HIGH SPEED SWITCHES

TYPE*	Maximum Ratings			Characteristics									
	T_S °C.	V_{CB} volts	P_T @ 25°C. mw	I_{CBO} max. μ a	h_{FE} min.	$V_{CE(SAT)}$ max. volts	f_T min.	C_{ob} max. pf	t_s max. nsec	t_{on} max. nsec	t_{off} max. nsec		
2N709	300	15	300	0.05	20	0.30	600	3	6	15	15		
T-2877	300	15	300	0.05	20	0.30	500	3	8	15	15		

* TO-18 case—collector internally connected to case.

CORE DRIVERS/PULSE AMPLIFIERS

TYPE*	V_{CB} max. volts	f_T @ 50 ma mc	h_{FE} @ 150 ma
2N1893	120	50	40
2N1613	75	60	40

* TO-5 case—collector internally connected to case.

100 mc LOW-NOISE AMPLIFIER

Industry's Newest Silicon Amplifier Standard

TYPE	Power Gain	Maximum Noise Figure	Minimum BV_{CEO}
T-2857*	15-22db @ 100 mc	5db @ 100 mc	20 volts

The new Philco T-2857 is industry's first silicon amplifier transistor to be functionally tested at 100 mc for fixed-matched, fixed neutralized, and fixed-bias performance. This insures interchangeability in practical communications circuits.

* TO-18 case with 4 leads—collector isolated from case.

Whatever your silicon transistor application, evaluate Philco Planar Transistors.

For complete data, and new Reliability report, write or telephone

PHILCO

INTERNATIONAL LIMITED

Semiconductor Sales Division
 30-32 GRAY'S INN ROAD W.C.1 CHANCERY 3668

Write or telephone also for full details of all Philco semiconductor products

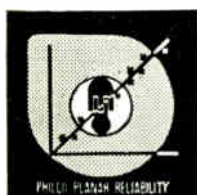



additions to the neon and incandescent lampholder range

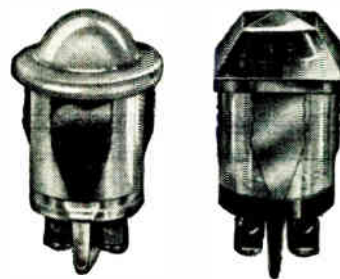

Illustrations actual size

Thorn have now extended their already wide range of SGF lampholders even further. This remarkable range of lamps covers a variety of electric, electronic, industrial and domestic applications. The component is an integral unit, with a neon or incandescent lamp built into a plastic holder. No retaining nuts or screws, simply push into close fitting recess. The neon lampholders are available in a voltage range from 70—400. Colours red, yellow, clear or green—even green neon! Incandescent versions from 4—60 volts can be supplied in a variety of coloured caps. Full details will be sent on request. Please write to:



THORN ELECTRICAL INDUSTRIES LIMITED

SPECIAL PRODUCTS DIVISION, GREAT CAMBRIDGE ROAD, ENFIELD, MIDDLESEX. TELEPHONE: ENFIELD 5353

DTV/10



The right instrument in the right place

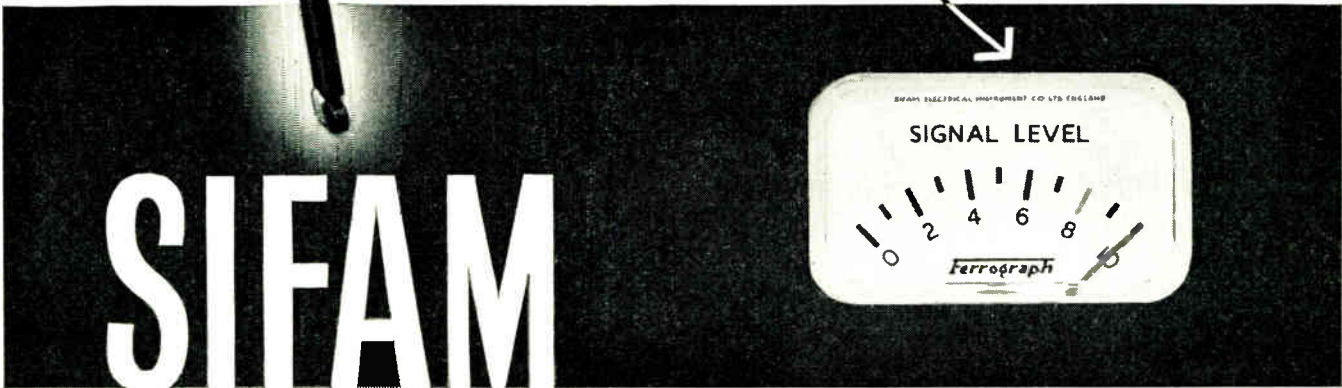

SIFAM MD 202

The SIFAM MD 202 is a new instrument with a wide field of application in industry and electronics. The MD 202 has a scale length of 1.81 ins. (46 mm.), is provided with a transparent plastic front and is intended for back of panel mounting, so that only the raised bezel appears above the panel, making an exceptionally neat and compact presentation.

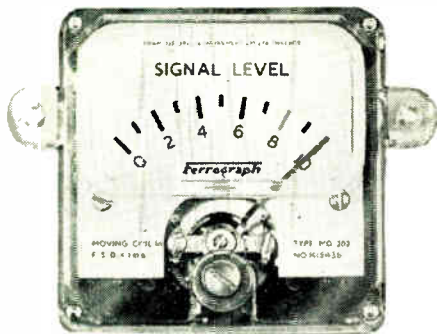

Write now for details of this new type and for information on the newest additions to the Sifam Range.



Instruments

SIFAM ELECTRICAL INSTRUMENT CO., LTD
Woodland Road, Torquay, Devon
Telephone: Torquay 63822/4

We are indebted to The Ferrograph Co. Ltd. for permission to reproduce the illustration of their Series 5 Tape Recorder, in which the SIFAM MD 202 is used as a Signal Level Meter.

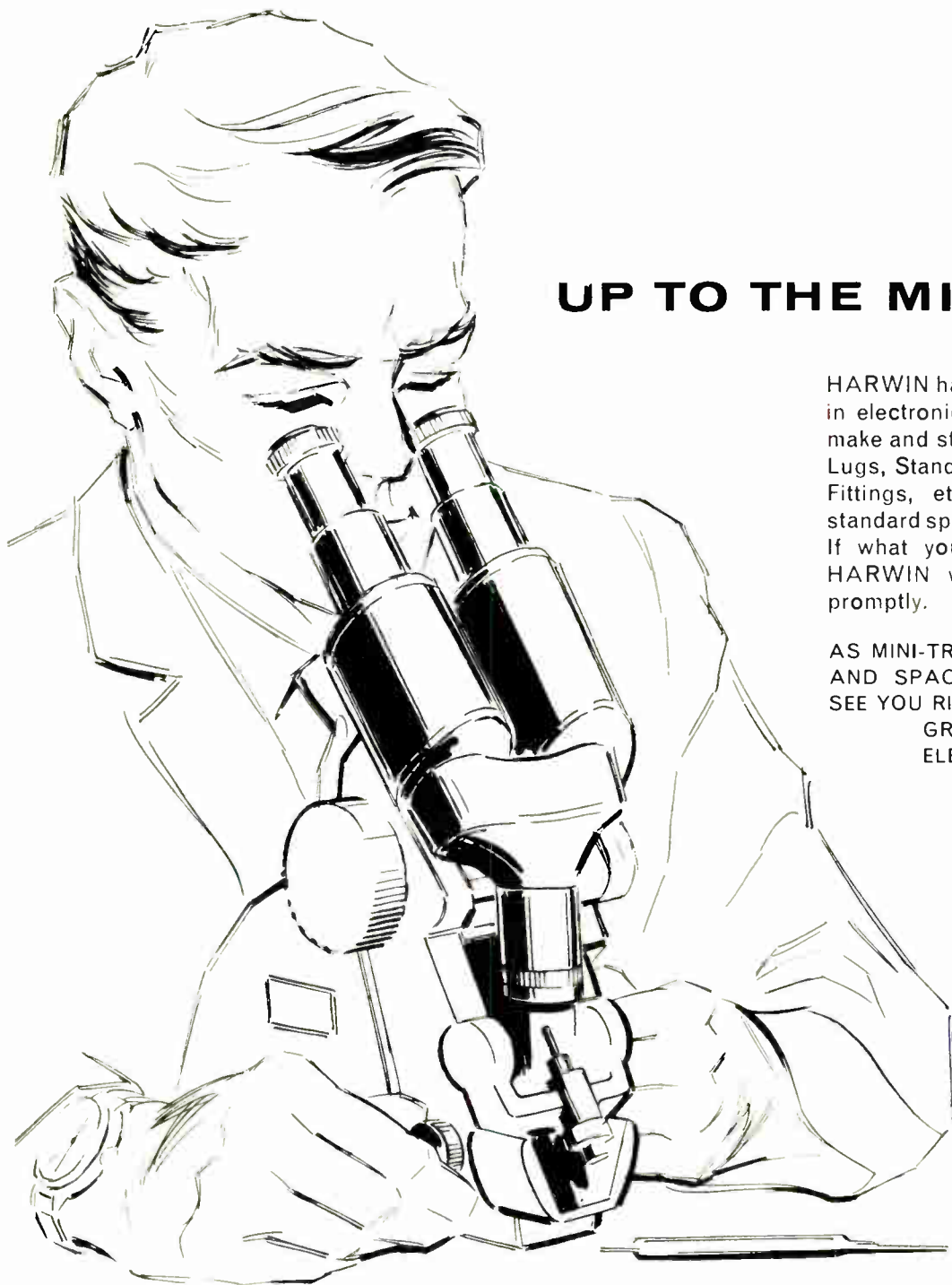

UP TO THE MINUTE...

HARWIN have been up to the minute in electronic components for years; make and stock miniature Insulators, Lugs, Stand-offs, Brackets, Chassis Fittings, etc., up to and beyond standard specifications. Off the shelf. If what you need does not exist, HARWIN will make it. Precisely, promptly.

AS MINI-TRONIC SAYS 'WHEN TIME AND SPACE ARE TIGHT, HARWIN SEE YOU RIGHT.'

GREAT FOR MINIATURE ELECTRONIC COMPONENTS.



Telephone or write:

**HARWIN ENGINEERS LTD., RODNEY ROAD,
PORTSMOUTH, HAMPSHIRE**

Telephone: PORTSMOUTH 35555 (4 lines)

HARWIN

UNCOMMON MARKET...

DELANCO Organisation's Technical Know-How masters the intricate and unusual in component manufacture

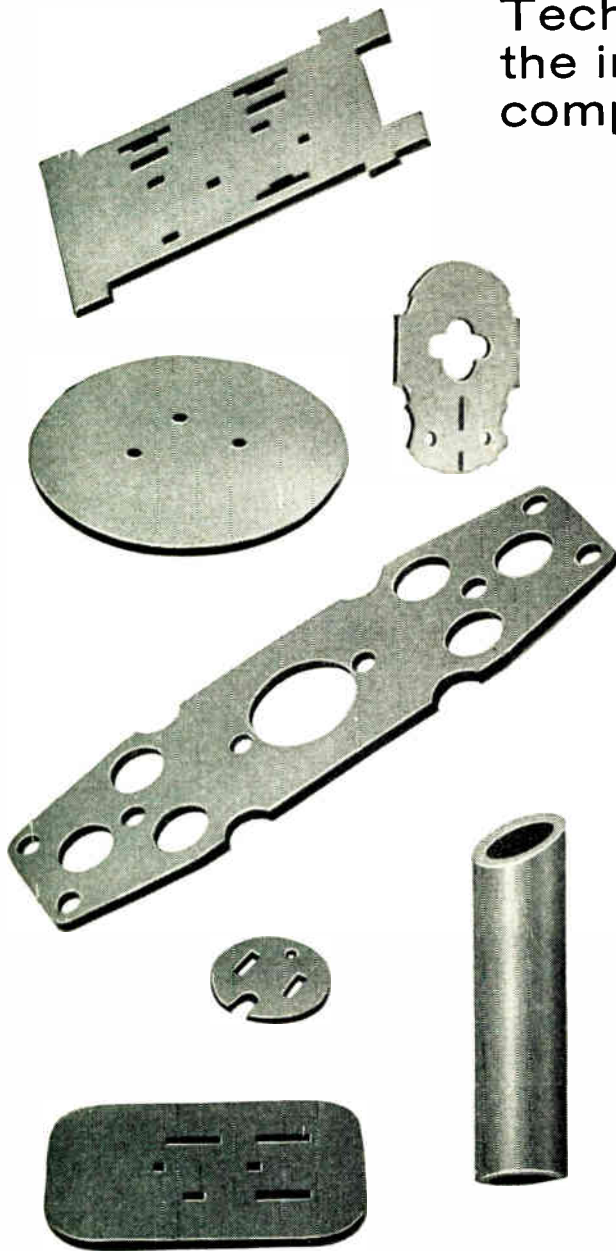

Anything uncommon in the way of design calling for the ultimate in tool design skills, is a natural for the Delanco Company. We specialize in the manufacture of components in all types of electrical insulation materials.

Vulcanized Fibre, S.R.B.P. and S.R.B.F. Epoxy glass fibre, Nylon, P.T.F.E., Presspahn, Leatheroid, Varnished cambric and in fact every material used in electrical Insulation. For heat resistance *and* insulation Mica and Micanite.

Processes include presswork, forming, routing, moulding, turning, milling and machining.

Our customers include Manufacturers of Domestic and Electrical equipment, Instruments, Motor cars, Aircraft, ships, printing and business machinery, Computers, electric motors dynamos and starters. Copper-clad laminates for printed circuitry are supplied as panels ready for printing.

Technical representatives are based throughout the country, and are available at any time to call and discuss your needs.

Technical catalogues are available and will be sent immediately on request.



Delanco

INSULATION MATERIALS AND COMPONENTS

ANGLO-AMERICAN VULCANISED FIBRE CO. LTD · Cayton Works · Bath Street · London · E.C.1
Phone: CLE 8484 · Grams: PROMPSERV, LONDON · Delanco Works · Leonard Street · London · E.C.2

Resistors are no problem - if you're a HARWIN customer

Says Mini Tronic

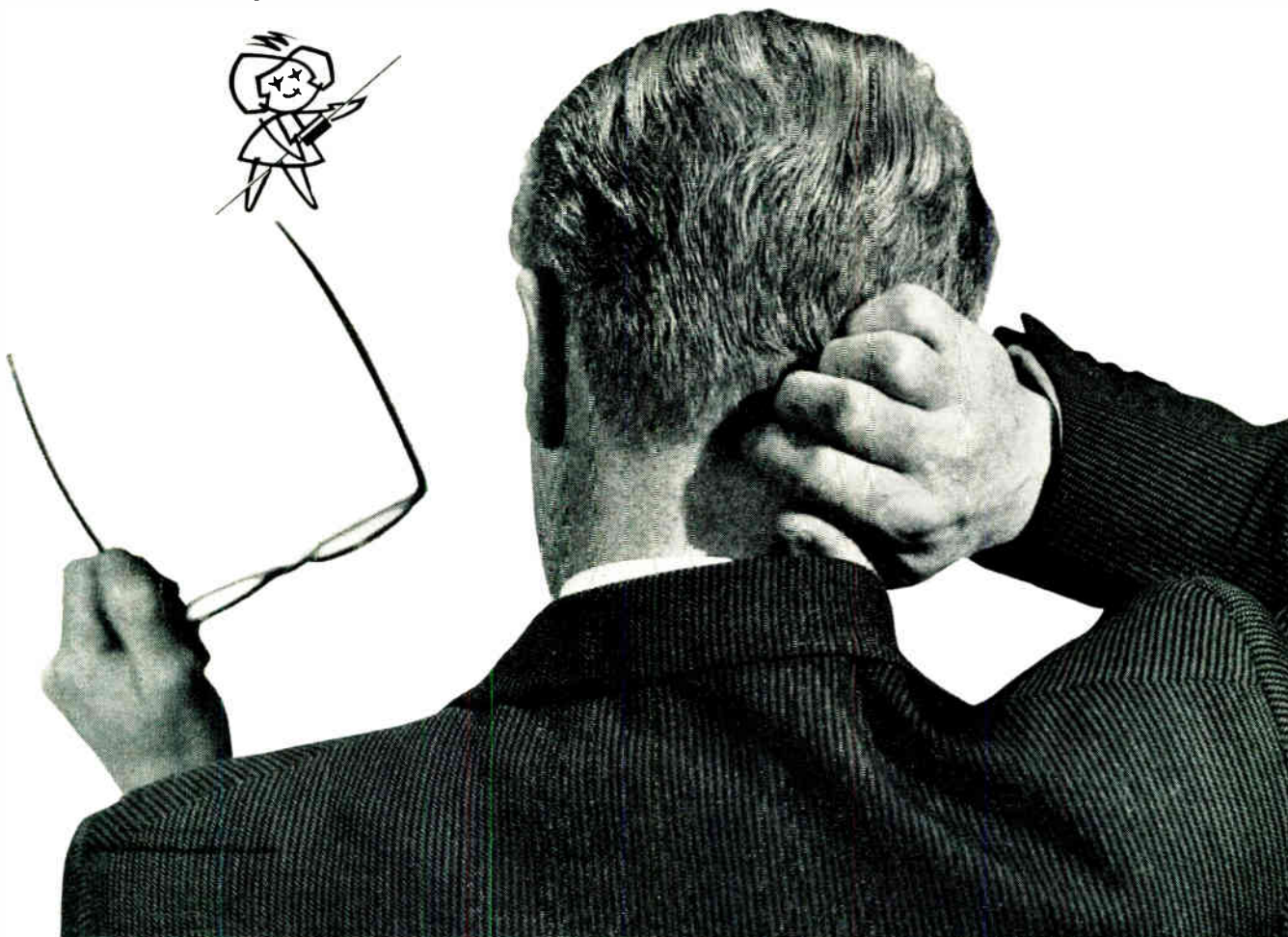

PRECISION WIREWOUND RESISTORS

Resistance Range
1 Ohm to 30 megohms
Tolerance Range
 $\pm 1\%$ to $\pm 0.015\%$
Temperature Coefficient
better than 24
parts per million.



GREAT FOR MINIATURE ELECTRONIC COMPONENTS



HARWIN have a really fine range of precision wirewound resistors with wire or lug terminations, low temperature coefficient, in either normal, encapsulated or hermetically sealed styles. Harwin Engineers' service is unsurpassed, better get in touch with them right away, for a firm price, and reliable delivery or details of our full range.

**HARWIN ENGINEERS LTD · RODNEY ROAD · PORTSMOUTH
HAMPSHIRE · TELEPHONE: PORTSMOUTH 35555 (4 lines)**

HARWIN

New range of AEI HALL EFFECT DEVICES now includes

FIELD PROBES

(now with thinner, more sensitive, semiconductor, encapsulated in beryllia)

Typical applications: Direct measurement of computer magnetic field, Clip-on type ammeter, Proximity sensor, Sine-cosine function generator, Displacement transducer, Power measurement, Magnetic mapping, Multiple read-out heads for computer magnetic memory drums.



MULTIPLIERS

Typical applications: Analogue computers, Wattmeters and volt-ampere meters, Carrier-suppressed modulators, Squaring, Harmonic analysis.



DC-AC CONVERTORS

Typical applications: Low input impedance DC amplifiers, Regulated DC power supplies.



RF MODULATORS

Typical applications: Double sideband suppressed carrier modulator, Contactless RF potentiometer, Frequency translation.



AEI Hall effect devices use the semiconductor Indium Arsenide and give a very stable performance over a wide temperature range.

WHAT CAN YOU DO WITH AN AEI HALL EFFECT DEVICE? Some of the known applications are listed above, but there are many others. Write now for the new leaflet which gives full specifications and characteristics of these devices; it may give you some ideas.

Write to: Instrument and Meter Dept., AEI, Trafford Park, Manchester 17.



Associated Electrical Industries Limited
Instrumentation Division

The first major advance in potentiometer design for years ...

After many years of research and development Reliance now announce an entirely new concept in the design of multi-turn wire wound potentiometers. This, combined with new manufacturing techniques provides extremely low inertia, low torque, high law accuracy and multiple tapping facilities for non linear functions. The unit is available in two distinct separate versions :

1. **SERIES SYN 11-00** A Synchro Mounting Unit incorporating precious metal winding and precision ball races.
2. **SERIES HEL 11-00** A $\frac{3}{8}$ " diameter Bush Mounting version, plain bearing with standard resistance windings, still retaining high electrical characteristics.

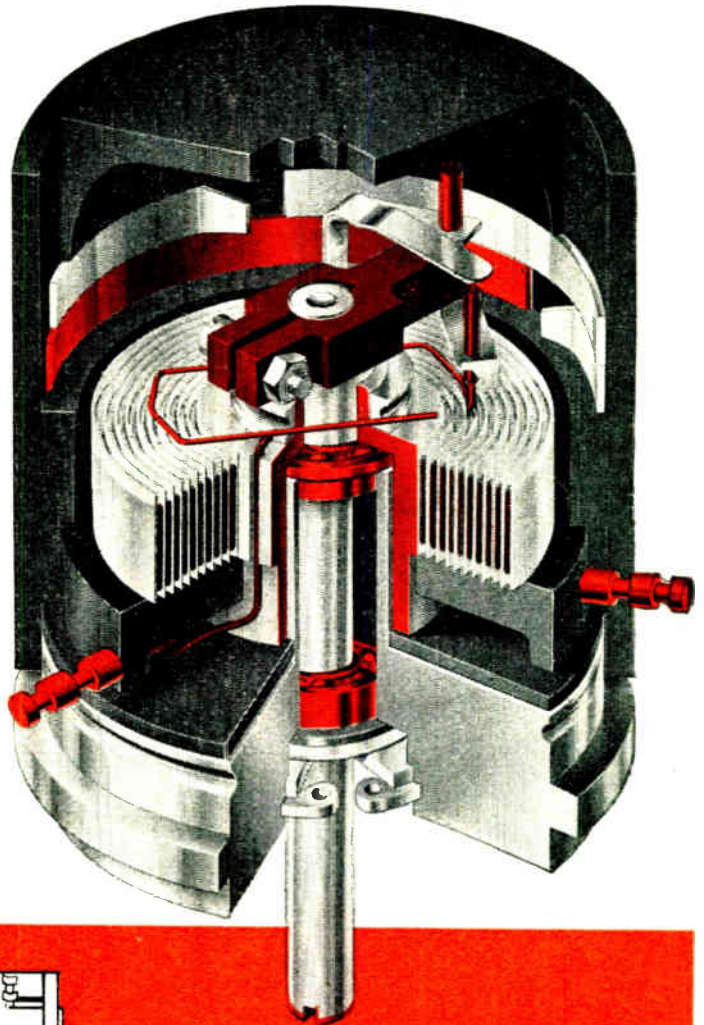

- ★ **RESISTANCE RANGE:** 20 ohms—150 K ohms.
- ★ **LINEARITY:** $\pm 0.1\%$ or $\pm 0.25\%$ absolute as required.
- ★ **TAPPING ACCURACY:** $\pm 0.1\%$.
- ★ **MOMENT OF INERTIA:** 0.0004 gm. cm. sec².
- ★ **STARTING TORQUE:** Synchro Mounting Version 3 gm cm. or better.
Bush Mounting Version 1 oz.in. nominal.
or Sealed Version 2 oz.in. nominal.
- ★ **ROTATION LIFE:** > 1,000,000/360° sweeps.
- ★ **NUMBER OF TURNS:** Any number up to 10.

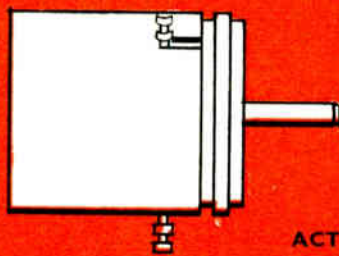

SYN 11-00 SERIES

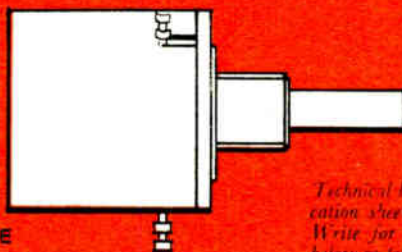

HEL 11-00 SERIES

ACTUAL SIZE

Technical brochure and specification sheets are now ready. Write for them to address below or telephone: LARKSWOOD 84947.

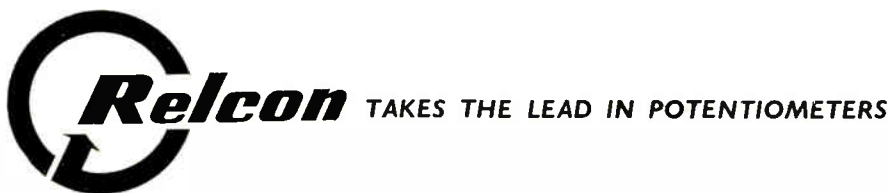

RELIANCE CONTROLS LIMITED, RELCON WORKS, SUTHERLAND ROAD, WALTHAMSTOW, E.17

Telephone No. LARKSWOOD 8404/7 · Telegrams: Reltrol, London, E.17 A MEMBER OF THE BOOKER GROUP OF COMPANIES

SOLARTRON

OSCILLOSCOPE TYPE CD 1183

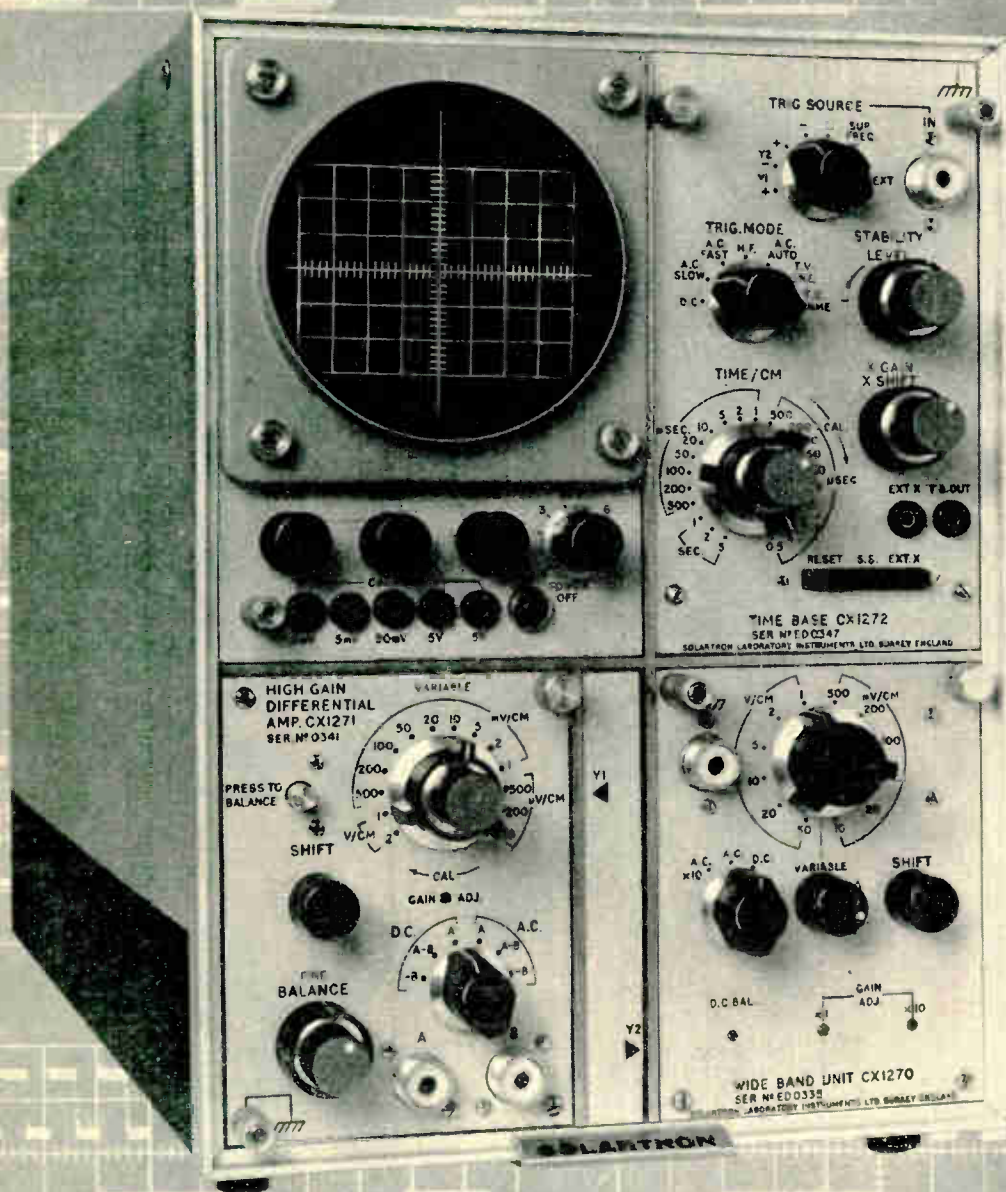

A tool for progress
in every industry

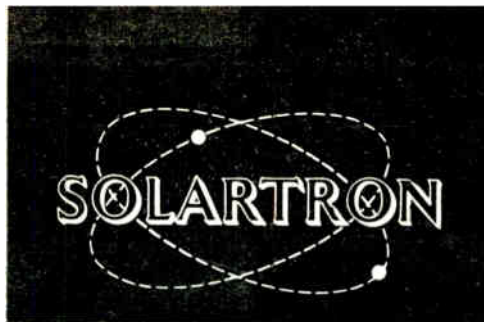

For further information
circle 227 on Service Card

OSCILLOSCOPE TYPE CD 1183

MODULAR OSCILLOSCOPE TYPE CD 1183

Pull out the time base generator and replace it with a high gain DC differential pre-amplifier!— CD 1183 now becomes a dual trace XY plotter with DC sensitivity of 100 μ V/cm on all axes. Alternatively, plug in wide band pre-amplifiers and the instrument becomes a 10Mc/s dual trace oscilloscope.

Interchangeability of X and Y units is the salient feature of this design and enables one instrument to meet the diverse requirements of strain gauge and transducer work; pulse and transient investigation; XY plotting and phase measurement.

Fully stabilised supplies and a bright, high resolution display together with an in-built square wave calibrator are typical of the high engineering standards presented.

The main unit (CD 1183) comprises the 10cm cathode-ray tube (Mullard E10—11GH); 1kc/s square wave time and amplitude calibrator (2%); power supplies and main X, Y1, Y2 deflection amplifiers. Three plug-in units are currently available:

1. WIDE-BAND PRE-AMPLIFIER CX I270

Bandwidth: DC to 10Mc/s
Sensitivity (at max. bandwidth):
100mV/cm—50V/cm in 9 calibrated ranges
max. sensitivity 1mV/cm (2.5 c/s—400kc/s)
Rise Time: 35 nsec (approx.)
Overshoot: < 1%
Measuring Accuracy: 5%

2. HIGH GAIN DC DIFFERENTIAL PRE-AMPLIFIER CX I271

Bandwidth: DC—100kc/s (-3dB)
Sensitivity: 100 μ V/cm—2V/cm in 14
calibrated ranges
In-phase Rejection: -80dB (max.)
Measuring Accuracy: 5%

3. TIME-BASE GENERATOR CX I272

Range: 0.5 μ sec/cm to 5 sec/cm in 22
switched, calibrated ranges. Variable control
with 'cal' position for continuous coverage
from 0.5 μ sec/cm to 12 sec/cm.

Accuracy: \pm 5%

Trigger: The time base can be triggered from Y1, Y2, Supply Frequency and external sources of either polarity. Modes are: AC Auto, HF (sync), DC, AC, AC LF Reject, TV Line, TV Frame. Single shot facility available in all modes.

X Expansion: Continuously variable to X10 (max. speed 0.05 μ sec/cm). X shift control allows both ends of fully expanded trace to be centred on screen.

*Please write or telephone for further information
or to arrange for a demonstration of this instru-
ment.*

THE SOLARTRON ELECTRONIC GROUP LTD (Instruments Division)

Victoria Road · Farnborough · Hants
Telephone: Farnborough (Hants) 3000
Telex: 8545 Solartron Fnbro
Cables: Solartron, Farnborough

... AIMING AT THE ULTIMATE IN RESISTOR TECHNOLOGY

... And Now
 nearest to the ultimate for
High Stability Carbon Resistors
the new WELWYN TYPE C85
 A midget addition to the Epoxy Moulded-Insulated Range

RANGE AND RATING:

WELWYN TYPE	R.C.S.C. STYLE	WATTS RATING @ 70°C	MAX. VOLTAGE	N.A.T.O. STYLE	WATTS RATING @ 70°C	MAX. VOLTAGE	MIL. R. REF.	WATTS RATING @ 70°C	MAX. VOLTAGE
C85	DEF 5115 (Draft) R.F.G.4.	1.8	200	NRN 21	1.10	200	RN55D	1.8	200

OHMIC RANGE: 10Ω—300K AT ±1%, ±2% AND ±5% TOLERANCES

C85

DIMENSIONS:

WELWYN TYPE No.	BODY LENGTH MAX.	BODY DIAMETER MAX.	LEAD LENGTH	LEAD DIAMETER
C 85	0.25"	0.125"	1½"	23.S.W.G.

STORAGE: After 12 months storage, the maximum change in resistance will not exceed 0.7%.

STABILITY: For 2,000 hours full load operation at 70°C, the typical change of Welwyn Type C85 Moulded Insulated High Stability Carbon Resistors is:—

LOW VALUES 0.2%
 MEDIUM VALUES 0.5%
 HIGH VALUES 1.0%

TEMPERATURE COEFFICIENT: -0.025%/°C (Approx)

C85

WRITE NOW FOR FULL DETAILS



WELWYN ELECTRIC LIMITED

BEDLINGTON - NORTHUMBERLAND - ENGLAND

Telephone: Bedlington 2181-9 - Telegrams: Resistor Bedlington.

FACTORIES IN AUSTRALIA AND CANADA

Industrial Electronics - September 1965

Comment

Colour television is a matter of great technical interest and the decision to introduce it in this country as soon as possible makes it a matter of great importance to the electronics industry. Its industrial applications seem likely to be small but we have no doubt that situations will arise where its use is necessary. Colour does add, as it were, another dimension to a picture and the improvement of colour television over black-and-white is quite as great as it is in photography.

In February 1964 the European Broadcasting Union is due to decide on common colour television standards for Europe. There are three rival systems known as N.T.S.C., Secam and Pal, developed respectively in the U.S.A., France and Germany. Pal, in particular, is really a modification of the N.T.S.C. rather than a completely different system.

The B.B.C. recently gave a demonstration of all three systems with monitor tubes side-by-side so that one could compare the systems by glancing directly from one tube to another. Monochrome monitors were also provided so that one could judge the compatibility of the systems.

Under these virtually laboratory conditions there was really nothing to choose between the systems either in colour or monochrome. All three gave a first-class colour television picture. Some viewers commented upon small colour differences between the different pictures. In our view, these were not so much due to the different systems as to small differences between the colour tubes used and, perhaps, to small differences in the initial adjustments. In any case, any one of the three colour pictures was, taken by itself, extremely good.

Noise and interference were introduced and, again, in our view there was nothing to choose between the systems. The effects were different, it is true, but we thought the nuisance value to be just about the same. Unfortunately, the effects of phase distortion were not demonstrated.

We do not think that the E.B.U. have an easy choice. The N.T.S.C. system has the unquestionable advantage of having been in regular use for 10 years and there is plenty of operational experience of it. The alternatives are claimed to offer better performance but are open to certain objections of their own. An unbiased outsider without practical experience of any system may well think it is all a matter of swings and roundabouts. However, the E.B.U. have undoubtedly more information to go on than has yet been made public and for their sakes we hope that one system has such decided advantages that the choice is easy, but we doubt it.

Teaching

There is a tendency in modern textbooks to economize in effort by explaining similar things together instead of taking them separately one at a time. For example, the co-called node and mesh ways of circuit analysis are commonly dealt with together.

Someone, somewhere, seems to have

had his doubts about this, for an experiment has been carried out in the U.S.A. on teaching methods. The result showed that when two similar things are taught together the student gets muddled, but has no difficulty in coping with the second of the two after the first has been learnt.

We are not in the least surprised by this, for it accords with our own ex-

COMMENT (Continued)

perience. We have long thought that much of the so-called economy of effort obtained in textbooks by explaining related things together is a false economy, that it is a theoretical economy rather than a practical one.

One favourite 'simplification' is to invoke the principle of duality. The idea is that only one-half of the subject need be taught since the second half can be obtained from the first by applying the principle of duality. It has always seemed to us that this is more laborious than learning the two halves separately and that it does not lead to nearly such a good insight into the physical nature of the matter.

We do not, of course, condemn the principle of duality out of hand. It can be very useful indeed to the advanced worker. To one who already knows both halves of the subject the principle is a simple one and is then practically useful in enabling a result achieved in one half to be transformed into the other half. It is its use as a teaching 'simplification' at which we cavil.

Equivalent Circuits

While on this subject we would like to point out an apparent discrepancy between the equivalent circuits for a generator which we have not seen dealt with in the textbooks but which must surely puzzle any thoughtful student.

A generator is represented as an e.m.f. in series with a resistance and, alternatively, as a current generator in shunt with the same value of resistance. On open-circuit there is no internal power dissipation in the former, but there is in the latter.

With a load both representations correctly give the external power in that load, but the powers dissipated in the internal resistances of the two equivalent generators are not the same nor are, of course, the powers supplied by the fictional resistanceless generators.

It follows that while the two equivalent circuits for a generator are truly equivalent for all purposes external to the generator, they are not equivalent for any calculations relating to the inside of it. Attempts to evaluate the internal dissipation may be invalid, for instance. Only under the condition of a matched load do the two become identical.

We do not think that this is generally known and this is largely because so little emphasis is laid on power and energy considerations in modern textbooks.

It follows that when it is desired to evaluate the internal dissipation of a generator some care must be taken in the choice of an equivalent circuit for it.

Telemetry

Missiles and satellites have brought radio telemetry very much to the fore in recent years, so much so that it is not always realized how great is the industrial application of telemetry. This is especially so in the case of the Central Electricity Generating Board, who have been using it for something like 30 years.

From 23rd to 27th September an International Telemetering Conference is being held in the I.E.E. Building. It is sponsored by the American Institute of Aeronautics and Astronautics, the Institute of Electrical and Electronic Engineers, the Instrument Society of America, the British Institution of Radio Engineers and the Institution of Electrical Engineers.

We notice that in the titles of papers the words 'telemetering' and 'telemetry' are both being used, the preference being for the latter, which we ourselves prefer. B.S. 204 of 1960 gives telemetry as the preferred word, so that it is rather surprising to find 'telemetering' in the title of the Conference.

In some of the literature about the Conference both words are freely employed and the reader is left in some doubt as to whether this is merely elegant variation or whether there is some really subtle difference of meaning between the two.

Satellites

It was reported on 17th July that the command apparatus in Telstar 2 has ceased to function. So far the reason is not known.

It will be recalled that Telstar 1 had a failure due to certain transistors being affected by radiation and that this was subsequently remedied by some rather clever work, as we reported in March. Since then it has gradually failed again.

So far no indication has been obtained that radiation is the cause of the failure in Telstar 2. Just a month later Telstar 2 has begun working again! Gremlins?

Syncom is now reported as being brought gradually into position. This satellite is intended to orbit in such a manner that it remains in a fixed position relative to the earth in order to act as a fixed relay station.

Cosmos 19 is another satellite launched by the U.S.S.R. on 6th August. It carries instruments to measure properties of outer space. Its initial period of revolution is 92.2 minutes and it has an apogee of 519 km with a perigee of 270 km; the inclination of its orbit to the equatorial plane is 49°.



NEW LOAD CONTROL & INDICATING EQUIPMENT

By E. FIELDER*

Load cells find many applications in industry. This article describes how they are applied in the measurement of weight and also how they can be employed in an overload alarm in a crane.

THE usefulness of the electric resistance strain-gauge load cell for measuring tensions, weights and forces is becoming widely recognized. Load cells have frequently been used with electronic amplifiers arranged to close one or more sets of relay contacts at pre-set values of load. These amplifiers, sometimes known as trip amplifiers, are widely used to give warning of the approach of dangerous conditions and to carry out control functions. If an indication of the value of the load or force being measured is required, a servo-balanced bridge-type of indicator or potentiometric recorder is generally used. These instruments can also provide warnings (by using micro-switches or other means) at pre-set points and therefore at pre-set loads but with less accuracy than that normally achieved with trip amplifiers. If load indication only is required, a digital type of voltmeter might be used.

A New Instrument

Ekco Electronics Ltd. have recently developed an instrument for use with load cells, etc., which can provide both a meter indication of load and input level warnings. It is completely transistorized and designed to work over a wide range of ambient temperatures. All electronic circuits and relays are housed in a sealed cast box. The accuracy of the meter is somewhat less than that of the self-balancing bridge type of indicator but is sufficient for most applications. The trip point accuracy is equal to that of trip amplifiers using thermionic valves. The equipment works reliably with inputs as low as one-tenth of those normally used and has the further advantage that the transducer is not energized by mains frequency power, and therefore interference from transformers, welding equipment, power carrying cables, etc., presents no problems in normal installations.

The power requirements are 13 V d.c. (nominal) at approx. 250 mA which can be obtained from an accumu-

* Ekco Electronics Ltd.

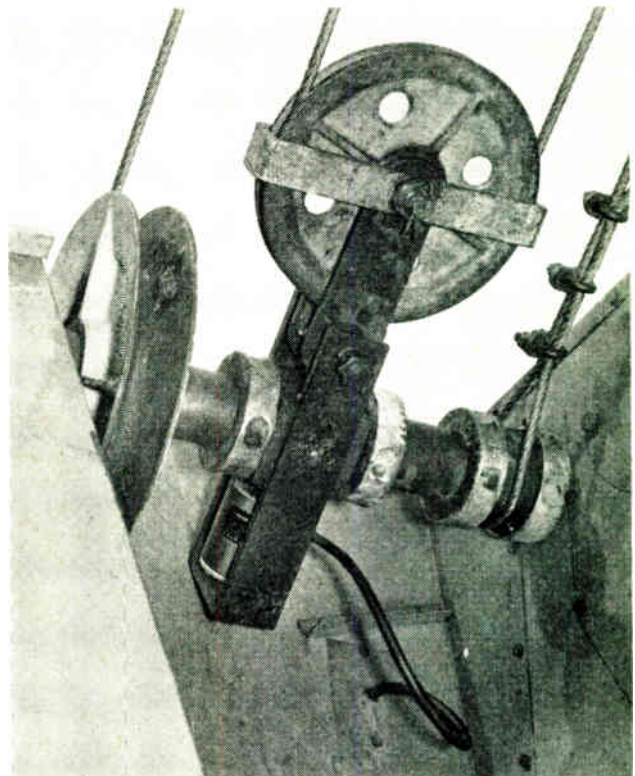

This shows the position of the load cell in relation to the hoist wire on a typical installation for crane safe load control

lator. The equipment is also available for operation from mains or other supplies.

An installation would normally consist of three units:—

1. *The transducer.* This might be a force-measuring load cell although a wide range of transducers for measuring pressure, displacement, light, temperature, etc., could equally well be used.

2. *The Amplifier Unit.* In addition to housing the amplifiers and relays, this unit also contains the oscillator which provides the power to energize the transducer. The input and output circuit arrangements are very versatile; for example, provision is made for using a number of transducers and integrating their outputs. This facility is frequently necessary in tank or hopper weighing and for weighing loads on weighbridges. Contacts of relays in the amplifier output circuits can be used to control visual and audible warnings and to carry out any other necessary control functions. Current is also provided to operate a moving-coil meter which is the load indicator normally used. This current could also be used to drive a chart recorder, to control a magnetic amplifier or to carry out any similar function. As far as possible, the equipment is fail-safe—for example, the relays are so arranged that disconnection of the transducer or failure of the power supply would cause the warnings to be given.

3. *The Indicator Unit.* The meter, warning lamps, test switch and supply switch (when used) can conveniently form one unit. Alternatively they could be incorporated in an existing control panel.

Operation of the System

The general arrangement of a typical installation is shown in Fig. 1. The load cell consists of a billet or ring of high tensile steel on to which are bonded a number of strain gauges, usually four or eight. These are connected to form a Wheatstone bridge, which is energized by a square wave from the oscillator in the amplifier unit. The electrical output of the load cell, when it is subjected to its maximum rated load, is typically 1 mV for every volt applied (1 mV/V). With this very small unbalance of the Wheatstone bridge the output is proportional to the change of resistance of the bridge arms and these resistance changes are proportional to the applied load.

The amplifier can be arranged to provide warnings at a

number of different input levels. The maximum number of levels is normally three, although more can be provided in special circumstances, for example, when no indicator is required. The main trip level has an accuracy (repeatability) of about 0.1% to 0.2% and the others an accuracy of about 1% to 2%.

The load cell itself would probably introduce an inaccuracy of about 0.1%, giving a repeatability for the main trip point of some 0.2 to 0.3% for the load cell and amplifier. This accuracy can only be achieved in practice if the mechanical part of the system (any pivots used, the load cell mountings and means of applying the force to it, etc.) is correctly designed and the installation properly carried out.

A Typical System (Fig. 2)

For the purpose of describing the working of a typical system let us assume the following requirements:

A hopper itself weighing 100 lb is to be filled with material weighing 1,000 lb. When the weight of material in the hopper has reached 900 lb, say, a warning is to be given and a signal provided to reduce the rate of flow of material into the hopper. When the weight of the contents reaches 1,000 lb a further warning is required, also a signal to cut off the flow of material and to initiate the next stage of the process. A meter indication of the weight of the contents of the hopper is also required.

A suitable load cell would be one giving an output of 1 mV/V for a load of 1,200 lb. If the supply to the cell is 12 volts and if it supports the whole weight of the hopper and its contents, its output would be 1 mV for an empty hopper, 6 mV for 500 lb, 11 mV for 1,000 lb, etc.

In the present example the warning, having the greatest accuracy, should be given when the weight of the contents of the hopper reaches 1,000 lb. The pre-set potentiometer RV_1 (Fig. 1), supplied from the oscillator, should be adjusted until the input to Amplifier 1 is zero, when the load on the cell is 1,100 lb. It will be seen that 11 mV of the appropriate phase is now permanently connected in series with the load cell output. The input to Amplifier 1 is now as follows:

- 10 mV with the hopper empty
- 8 mV with 200 lb in the hopper
- and 0 mV with 1,000 lb in the hopper

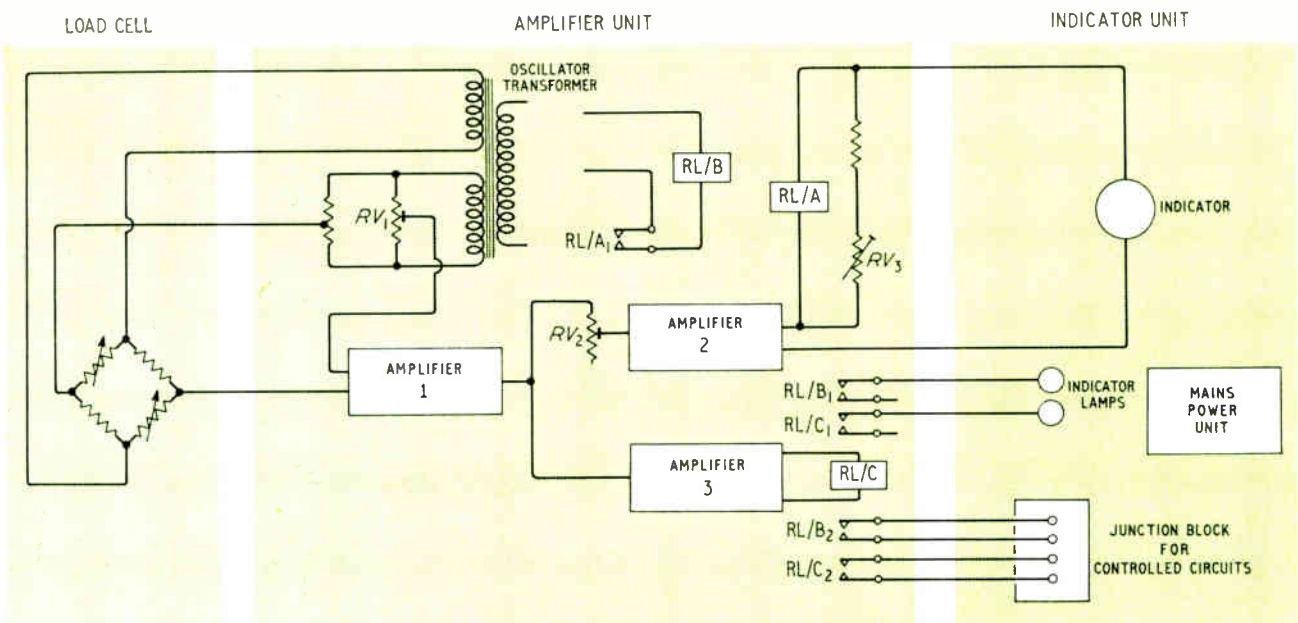
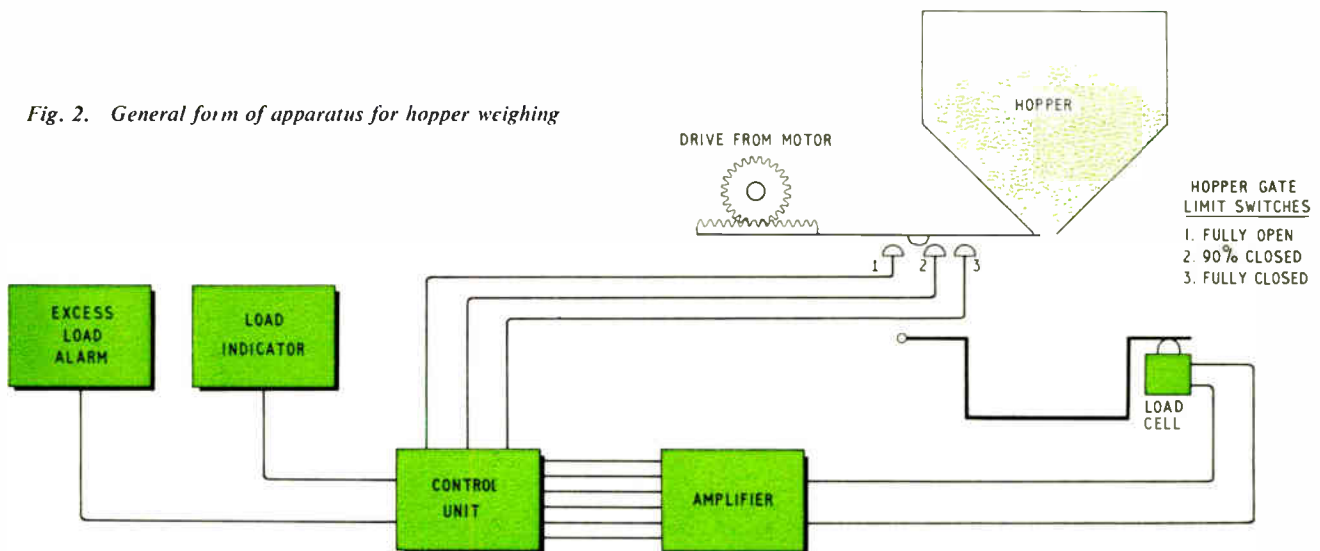

Fig. 1. General arrangement of load cell, amplifier and indicator unit

Fig. 2. General form of apparatus for hopper weighing



The input to Amplifier 1—which is the difference between the load cell output and voltage from potentiometer VR_1 is amplified in Amplifiers 1 and 3. When the input drops to zero or changes phase (which it does when the output from the load-cell bridge exceeds 11 mV in the present example) a relay in the output circuit of Amplifier 3 is de-energized and its contacts close. These contacts are used to provide the necessary warnings and to stop the flow of material into the hopper.

The output of Amplifier 1 is also connected to the input of Amplifier 2. This amplifier operates the sensitive relay RLA and the indicator (a moving-coil meter). The current in this circuit varies between 0 and 5 mA as the input to Amplifier 1 is changed. In our example we have the figures of Table 1.

Table 1

Wt. in hopper (lb)	Wt. on Load Cell (lb)	Input to Amp. 1 (mV)	Output of Amp. 3 (mA)
0	100	10	5
200	300	8	4
900	1,000	1	0.5
1,000	1,100	0	0

The scale of the meter indicates the weight in pounds, the current through the meter being zero with 1,000 lb in the hopper and 5 mA when the hopper is empty. The variable resistor RV_2 is adjusted until the meter reads zero when the hopper is empty.

The preliminary warning and slow-down signals are to occur when the weight in the hopper reaches 900 lb and this corresponds to a current of 0.5 mA in the output circuit and Amplifier 3. The precise weight at which these signals are given can be set by adjusting RV_3 .

Circuit Description

From the above, it will be noted that the main warning is given when the input to Amplifier 1 drops to zero. Its accuracy is thus almost entirely independent of the gain of Amplifiers 1 and 3 provided that this gain is adequate.

The accuracy of the indicator or of the preliminary warning is not similarly independent of amplifier gain. Thus the gain of Amplifiers 1 and 2 must be virtually unaffected by changes of supply voltage or ambient temperature. To achieve this it is necessary to use the maximum possible amount of feedback consistent with stable operation.

In each of these amplifiers a thermistor is used to reduce the effects of changes of current gain, input impedance,

etc., of the transistors resulting from ambient temperature changes. To allow for the spread in gain of transistors and the tolerances on component values, the gain of all amplifiers is pre-set in production before the feedback loops are closed.

All critical supply voltages to the amplifiers are stabilized but compensation was found necessary for the small residual variations. This compensation is achieved by arranging for the feedback over Amplifier 3 to be varied slightly by changes in supply voltage. As a result of the above measures, the output of Amplifier 3 changes by less than 1% when temperatures and supply voltages are varied within the ranges -10°C to $+40^\circ\text{C}$ and 10 V to 16 V d.c.

The oscillator and synchronous demodulator which

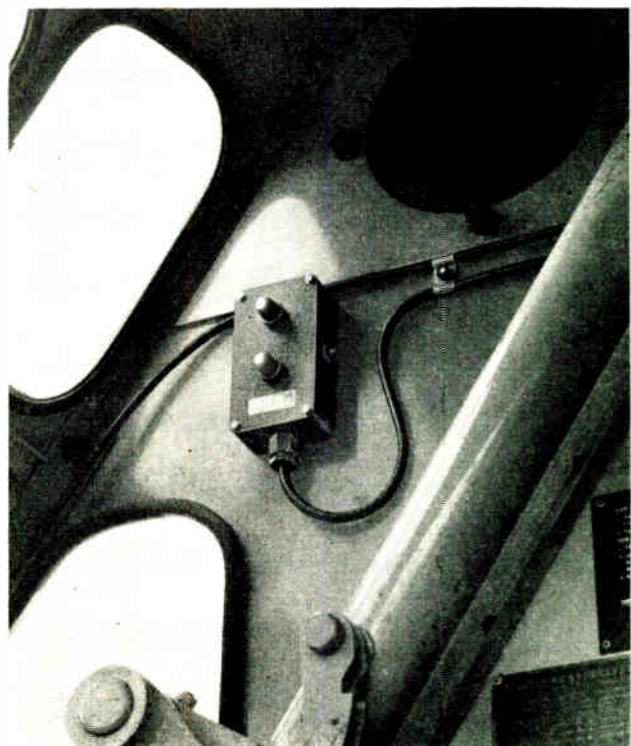

For crane safe load control the indicator normally takes the form of signal lamps to provide 'safe load' and 'overload' indication

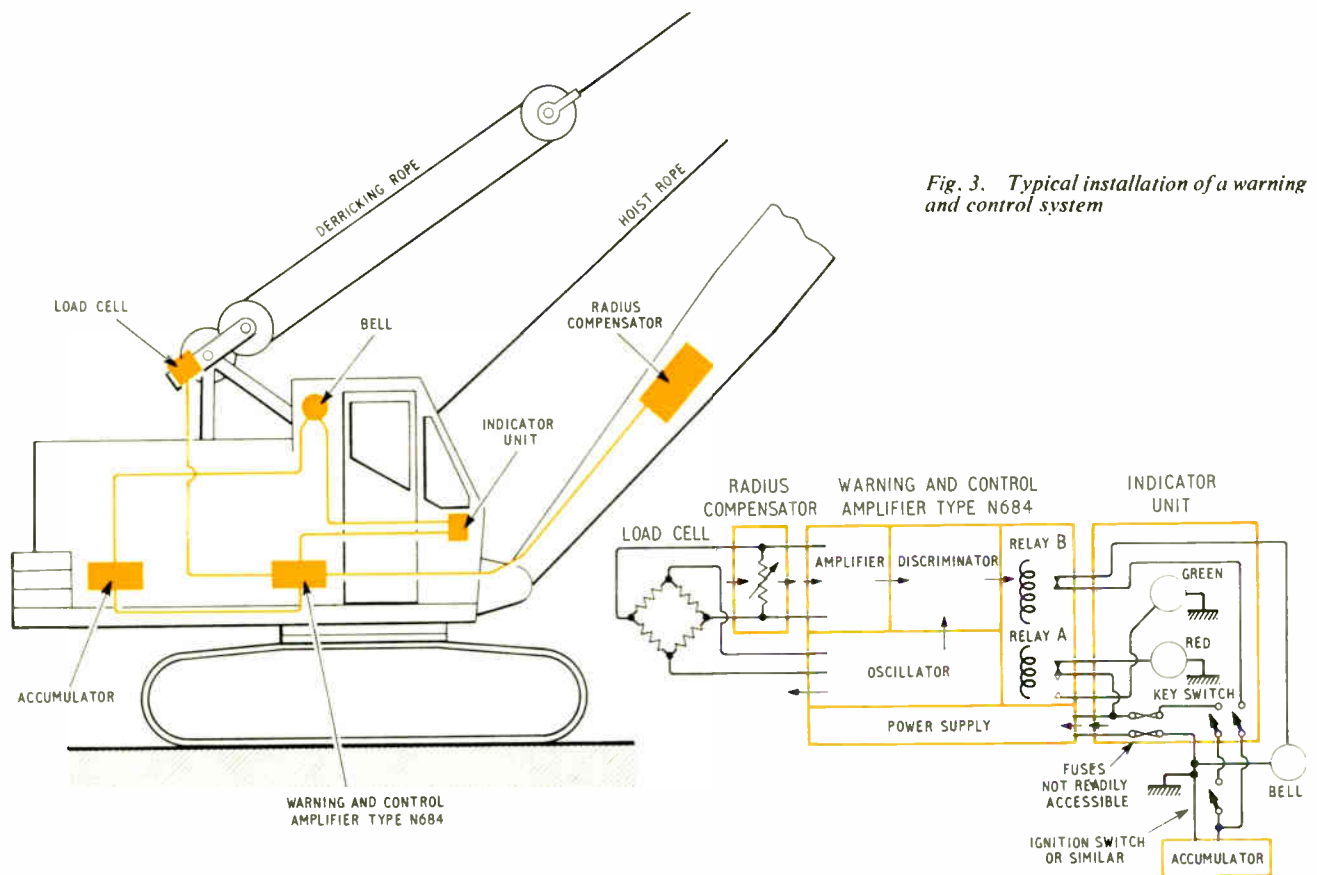

Fig. 3. Typical installation of a warning and control system

constitute the fourth sub-unit of the amplifier unit have no unusual features.

Uses of the Equipment

The most obvious use of the equipment is for the measurement and control of physical variables, an example of which is given above. Another example is an experimental installation on a chain-testing machine. The main warning can be set to occur when the tension reaches any value between 0 and 30 tons. Another pair of the relay contacts can be used to stop the motor driving the hydraulic pump and hence prevent the tension exceeding the pre-set value. In this installation the meter indicates the amount the actual tension is below the pre-set level.

In some installations it is a requirement that the input level at which the warning is to be given should be changed according to some law. This can easily be done by varying the trip setting potentiometer (RV_1) or by shunting the load cell either by a continuously variable resistance or by using a multi-position switch. This is done when the equipment is used as a safe load indicator for mobile cranes. The load which can be safely lifted is dependent upon the working radius and in this instance the angle of the jib is used to provide the necessary compensation.

A switch, similar to the conventional mercury switch, but having about forty contacts, is mounted on the crane jib, Fig. 3. Some or all of the contacts are connected to taps of a resistive chain which shunts the load-cell output terminals. As the jib moves the column of mercury short-circuits different parts of the chain, the taps being so placed that the required law is followed. When the law to be followed changes, for example, as when the jib length is changed, a new resistive chain with a different value of resistance and tap positions is substituted for the old. A

large number of different jib arrangements can thus easily be accommodated, which is not the case with previous systems. This version of the equipment has recently been granted a certificate of approval under the Construction (Lifting Operations) Regulations, 1961.

Certain features of the design and uses of the equipment revealed in this article are the subject of patent applications.

Designed for Accessibility

One of the new '2000 series' of electronic measuring instruments produced by Marconi Instruments. A feature of this precision transistorized oscillator is the hinged-panel construction which ensures ease of access to the components.

For further information circle 45 on Service Card

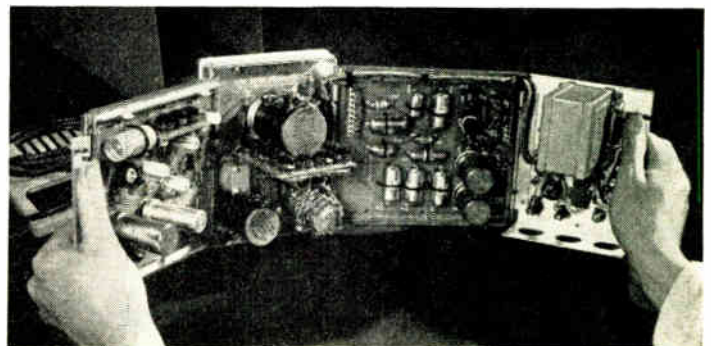

FABRICATING PLASTIC-COATED STEEL

By C. BURTON *



Twinhead welding machine for plastic-coated sheet
(Courtesy A.R.O. Machinery Co. Ltd.)

Ordinary welding methods cannot be used with plastic-coated sheet metal. This article describes a way of welding this material which is based on projection welding with electronic control.

THE introduction of plastic-coated metal, of which Stelvetite, manufactured by John Summers & Sons Ltd., in collaboration with BX Plastics Ltd., is a typical example, has led to special techniques being developed for its fabrication. This is because electrical contact can be made with the sheet only on the side which is not coated.

Stelvetite plastic-coated sheet is produced by bonding vinyl (polyvinyl chloride or p.v.c.) to sheet steel of high quality, the reverse side being electro-zinc plated or hot dip galvanized. This p.v.c. coating is durable, hard wearing, tough and resistant to humidity and climatic conditions, in addition to being resistant to oil and a wide variety of chemicals. The material can be sheared, formed, punched, deep drawn, expanded, as any other metal with little variation in tooling, and this makes the sheet an attractive one for designers in many spheres of industry. In addition, corrugated sheet and other profiles can also be obtained. Considerable use has been found for Stelvetite in the electrical industries because the vinyl film is an effective electrical insulator. Applications in this field include switchgear panels and electrical phase-shift panels. Other applications include partitioning and panelling, walls, furniture, kitchen equipment, cabinets, counters, and drums.

Stelvetite was used to line the tunnel of the 312-ft long travolator which operates between the Bank and Waterloo stations in London, 8,000 sq ft being employed. It has also been used for panelling semi-exterior areas of large L.C.C. flat blocks.

Joining Plastic-Coated Sheet

As the vinyl coating is bonded to the steel sheet, it will be understood that the use of a low input welding process, such as oxy-acetylene, is not a practical proposition. In fact, any fusion welding process will cause excessive heating which will 'bubble' the plastic surface. The heat pro-

duced by welding must, therefore, not be allowed to penetrate into the steel section as the p.v.c. coating would soften and this would spoil the embossed surface. The partial decomposition of the adhesive bonding medium together with the evolution of gases, will obviously blister the vinyl coating. On certain classes of work it is not necessary to retain the local coating; i.e. at the edges of flanged sheets. In such cases, the vinyl may, in fact, be locally removed and the material welded, using orthodox welding equipment and methods.

Resistance spot welding is obviously the most practical method of joining this material and a considerable amount of development work was carried out by John Summers & Sons Ltd. in conjunction with British resistance welding equipment manufacturers. In the main, existing resistance spot welding plant was modified and adapted to suit the special requirements of the vinyl coated sheet steel.

The most successful resistance welding method that has been finally adopted is projection welding, employing techniques designed to limit the welding time so that the vinyl coating is not overheated or damaged. Projection welding is a development of spot welding technique. In spot welding, the size and position of the weld are determined by the size of the electrode contacting faces and where they are applied to the work pieces. In projection welding, however, the size and position of the weld or welds are determined in the design of the component to be welded due to the fact that projections or embossments are raised on the work pieces at the positions where the welds have to be completed. The welding current flow is localized through these projections which collapse rapidly under the effect of heat and pressure.

This projection method is used for lap joints and the attachment of brackets, strips, nuts, studs, etc. It was soon proved that the satisfactory welding of p.v.c. coated sheet can only be carried out by carefully controlling the heat conducted away from the welding area through the vinyl coating. To minimize this effect, it is necessary to employ

* A.R.O. Machinery Co. Ltd.

Colour advertisements are often printed before the news material in a newspaper. Registration problems then arise when the news is printed and are overcome by an electronic control system.

CONTROL OF INTERSETTER OF A PRE-PRINTED WEB IN A NEWSPAPER PRESS

By J. C. MAWER*

DURING the last few years full colour advertising has been introduced into daily newspapers. This takes one of two forms, either a 'Wallpaper' type of display is used, where the advertisement consists of a repetitive pattern, so there is no need to ensure accurate registration between the pre-printed web and the printing press, or the full page register type is employed, where the advertisement is a picture which is positioned accurately on the page of the newspaper. The latter type of advertisement is rendered possible only by the use of electronic control to ensure accurate registration between the pre-printed web and the newsprint machines.

The mechanics of the printing processes are such that it is rarely possible to ensure that paper printed on a colour press, maybe hours or days before the production run on

the newsprint machines, will have a print pattern of exactly the correct length to fit into the news print-schedule. Even if this does happen there are the inevitable small variations in the newsprint machine which would result in registration being lost and the colour advertisement gradually creeping up or down the page and becoming lost in the news print printed on the same page. In order to overcome this difficulty therefore the pre-printed material is deliberately printed slightly shorter than the final newspaper page by some 20 to 30 thousandths of an inch and the paper is stretched in the printing machine to the correct length. This type of control, by accepting that there will be a difference, and it will always be in the direction necessary to be corrected by stretching the paper, has rendered full page, in register, colour advertising possible.

In practice a registration mark on the incoming material,

*Lancashire Dynamo Electronic Products Ltd.

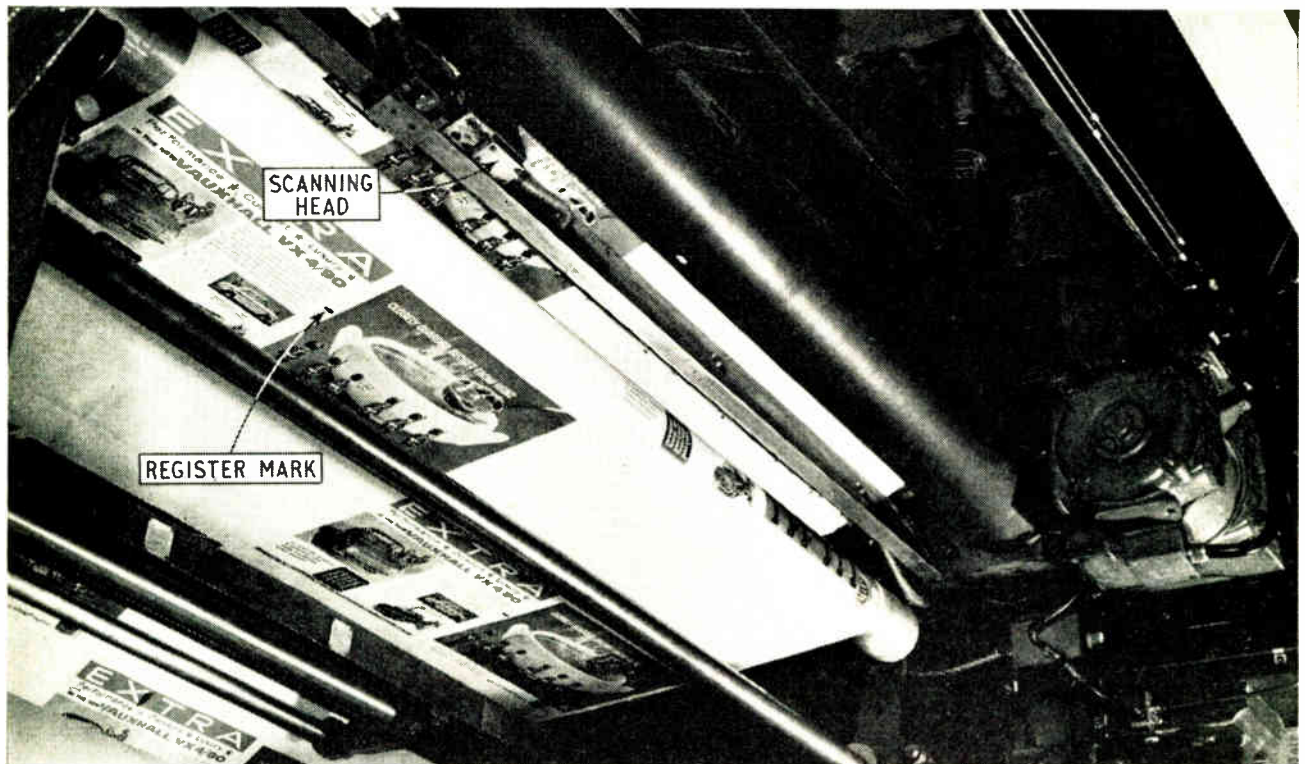

Printing press with pre-printed material being fed in. The register mark on the paper and the photoelectric scanner are shown

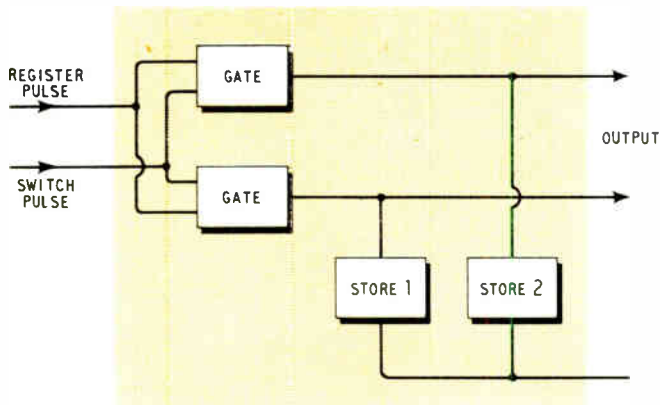

Fig. 1. The phase of the register pulse relative to the switch signal governs the current fed through the gates to the stores. Any difference between the stores is an error signal which actuates the control system

usually visible as a black bar at the side of the picture, having its length at right angles to the direction of motion of the paper through the machine, is observed photoelectrically and a comparison is made between the instantaneous position of the register mark and the instantaneous position of the printing cylinder on the newsprint press. In the photograph of a newsprint press, with pre-printed advertising matter being fed into it, the scanning head looking for the register mark can be clearly seen. The electronic circuit for measuring the instantaneous positions is shown in block form in Fig. 1, from which it can be seen that the system has two inputs for pulse trains. The first input is from the photoelectric cell scanning the pre-printed

material and checking the position of the register marks; the second input is from a special photoelectric switch driven by the printing cylinder itself. This is arranged so that as the printing cylinder reaches the correct position, the output from the switch changes from one value to another. This signal feeds two gates, one of which is always open; which one depends on the switch signal level. These two gates pass the photoelectric pulse through into one of two stores and the differential output of these two stores is the control signal. If, at the point of registration, the gates change over, then one half of the register pulse is passed to each store, thus the differential in the two stores is zero. If, however, the registration pulse occurs when the printing cylinder is in the incorrect position then it is transmitted through one gate and one store is charged more than the other, the differential output then being indicative of the error.

The error signal is amplified and used in an electronic control system to control the speed of a d.c. machine which drives (via a differential gearbox) the nip rolls which are stretching the paper. Because the paper is always slightly short this correction motor is always running in one direction, stretching the paper, and very fast and accurate control is possible.

Some hundreds of thousands of copies of newspapers have been produced with the intersetting mechanism in operation and at least one large northern newspaper now produces regular full-page registered colour advertisements twice a week. Other newspapers, mainly provincial, have used the intersetting not only for inserting colour into their pages but also for effectively doubling the capacity of their presses by printing half the paper, containing general news, and re-running the material through the same press putting in the latest news.

BRITISH GAS LASER

Ferranti are now producing what is claimed to be the first commercially-available gas laser to be made in this country. It provides an important new tool for research in such fields as laser phenomena, long-path interferometry, communications problems, surface quality control, metrology, plasma studies and data processing.

The Ferranti laser is based on the original confocal gas laser using a helium-neon mixture, and operates either at 11,530 Å or 6,328 Å, emitting a plane-polarized continuous wave with a nominal power of 10 mW. It employs an 80-cm discharge tube with silica Brewster end windows and external spherical mirrors, and it has a non-concentric, confocal configuration for ease of adjustment. Hemispherical and concentric configurations are available on request.

Excitation of the helium-neon mixture is achieved by applying crystal-controlled radio-frequency energy at 27.1 Mc/s through external electrodes on the tube. A hermetically-sealed silica chamber surrounding the laser preserves the multi-layer mirrors and also provides a thermally-stable separation for the invar mirror mounts. This minimizes the first-order frequency shift due to changes in mirror separation.

The laser is $44 \times 8\frac{1}{2} \times 5$ in. and weighs 18 lb when

complete with detachable casing. A separate power pack weighing 38 lb is supplied for the r.f. exciter unit.

For further information circle 47 on Service Card

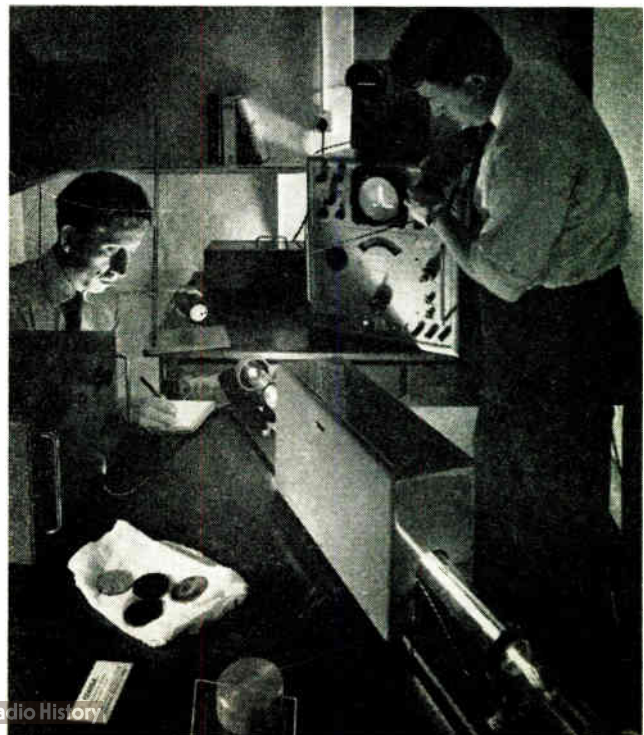

Checking the performance of a Ferranti Mk. 1 gas laser

Automatic Voltage Regulator for A Marine Turbo-Alternator

By P. FENWICK *

An application of a set of standard servo modules to automatic control is described in this article. The modules are used to regulate the voltage of a 750-kW marine turbo-alternator.

* W. H. Sanders (Electronics) Ltd.

THE use of pre-designed control elements, which in themselves are flexible in application and readily-adjustable by external methods, considerably simplifies the design of closed-loop control systems. These elements have been described in detail in *Industrial Electronics* (August 1963, p. 555) and here their application in regulating the terminal voltage of a turbo-alternator is discussed. This alternator is of the brushless type, designed and constructed by W. H. Allen, Sons & Co. Ltd., of Bedford, and is driven by a steam turbine. Its output is 750 kW at 440 V, 1,230 A at 0.8 lagging power factor, 3-phase, 60 c/s.

The field power for the salient pole alternator is obtained from a direct-coupled 3-phase a.c. exciter, the output of which is rectified by a rotating 3-phase silicon bridge rectifier. Thus, the armature of the exciter, the silicon rectifier assembly, and the alternator field system are mechanically common, and rotate together, so that there is no transfer of electrical energy via sliding contacts. This principle is not unique, but it completely eliminates the need for periodic maintenance which would be necessary on conventional brushgear, a rather irksome task particularly when there is any difficulty of access.

Regulator Specification

- (1) Voltage accuracy: $\pm 440 \text{ V} \pm 2\frac{1}{2}\%$ for no-load cold to rated-load hot.
- (2) Transient response:—initial voltage rise or dip to be not more than 15% when a 3-phase load change of 35% at zero lagging power factor is made. The recovery time to within 2½% of nominal voltage to be not more than 1½ sec.
- (3) A $\pm 5\%$ adjustment of machine terminal voltage when on auto-control to be catered for.
- (4) Power-factor load-compensation circuit to be provided to ensure adequate load-sharing for parallel running with another machine.
- (5) Regulator to meet the appropriate Lloyd's requirements for marine electrical equipment.

Regulator Requirements

Since the requirement is fundamentally to provide a relatively-constant output voltage from the alternator, and the basic starting-point hardware is the alternator/exciter combination, the minimum additional equipment needed is obviously:—

- (1) A d.c. amplifier to provide exciter field power.
- (2) A device for converting the 60-c/s output voltage of the regulated machine to a direct-current equivalent.
- (3) A reference-voltage for (2) to work against, so that (1) provides full output to within a few per cent of the required alternator output voltage.

Because the exciter requires a peak input power of about 750 watts during field-forcing conditions, and the regulator is to be built from lower-power transistorized servo-system modules as far as possible, it is necessary to use two cascaded d.c. amplifiers for item (1). The d.c. transistor amplifier is capable of a linear output of 4.5 volts at 10 mA. The logical choice for the power amplifier at the time this regulator was designed was a magnetic amplifier.

Design of Regulator

From the characteristics and parameters of the alternator and exciter the field-change requirements were calculated. This yielded the figures of Table 1.

TABLE 1

Alternator field current	72 A (no-load)	165 A (rated-load)
Exciter field voltage	18 V (machine cold)	59 V (machine hot)

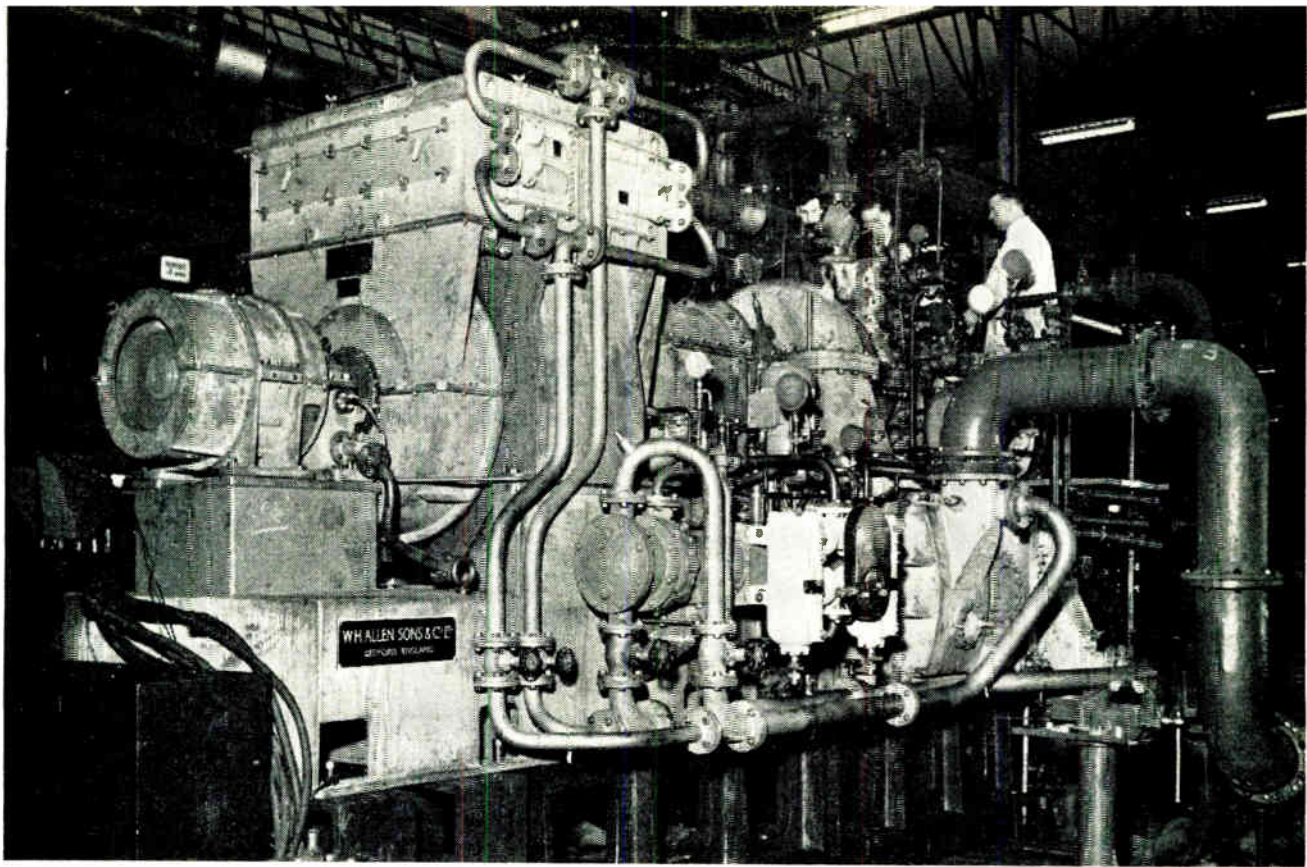

The turbo-generator to which the control system is applied

The exciter field-voltage change is 41 volts. At a nominal field resistance of 22 ohms, this represents 1.86 A change of current.

The gain of the closed-loop system, for 2½% regulation, must therefore provide a field boost of 1.86 A for $440 \times 2.5/100 = 11$ volts change of alternator output. This allows us 2½% for unknown temperature effects on the remaining components.

Maximum steady field power of exciter = $59^2/22 = 159$ watts.

A standard W. H. Sanders 4053/H/50 magnetic amplifier will give a d.c. output of 270 watts when supplied with 190 V at 50 c/s. However, since the power to the magnetic amplifier will be from the alternator itself, which is running at a nominal 60 c/s, the supply to the amplifier can be raised directly as the frequency to about 230 volts, so maintaining the same flux density in the transductor cores. This allows a nominal maximum output from the amplifier of about 325 watts. However, by having the field resistance only about 35% of the normal value for this amplifier, a peak output of 750 watts can be obtained for exciter field-forcing, and still keep within the r.m.s. current rating of the amplifier. Because of the inductive nature of the amplifier load, the r.m.s. current in the magnetic amplifier gate windings is less than that in the exciter field itself.

The magnetic amplifier is connected in a flux-reset circuit, this giving the fastest possible voltage-time response; i.e., a possible half-cycle delay of the supply frequency. The transistor d.c. amplifier will only give 10 mA output, and this is insufficient fully to control the magnetic amplifier, so a further transistor is required to give the necessary gain.

Fig. 1 shows the circuit of the magnetic amplifier and control transistor. The dots on the transductor windings indicate the electrical starts, and the plus signs on the gate and reset voltage supplies show the phasing. The action of the circuit is as follows. In a positive half-cycle the gate supply passes current through D_5 and the gate winding of element A, through the exciter field, and thence via diode D_8 . This flow of current drives the flux of element A to peak

positive saturation. In the same half-cycle, the reset voltage, V_r , drives current through D_4 , the reset winding of element B, resistor R_1 , transistor Tr_1 , and thence via diode D_3 . If the transistor Tr_1 is bottomed (i.e., has a very small impedance) there will be sufficient current flow through the control coil of element B to drive the flux to peak negative saturation. The core is said to be fully reset.

In a negative half-cycle, the gate and reset voltages are reversed, and consequently operate on the opposite cores. Now, if the transistor is only partly 'open', so that it becomes a medium-level impedance, then it will limit the current which can flow through the control coil of the transductor and will only partly reset the core, and in the following half-cycle, the gate voltage will saturate the core before the end of the half-cycle. The remaining area of the half-sinusoid will therefore pass current round the circuit, its value being mainly controlled by the resistance of the exciter field and the transductor saturated impedance. This control action, of course, will occur for both positive and negative half-cycles of supply.

The theoretical minimum voltage response of this circuit is one half-cycle of the supply frequency. A number of

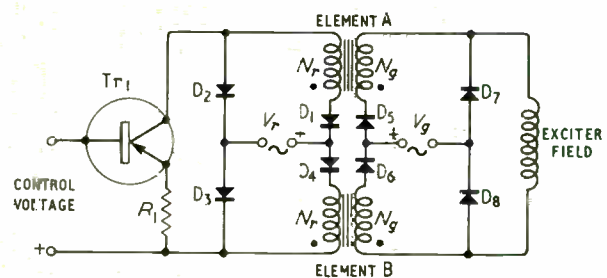

Fig. 1. Magnetic amplifier and control transistor. V_g and V_r are the (a.c.) gate and reset supply voltages while N_g and N_r are the gate and reset turns

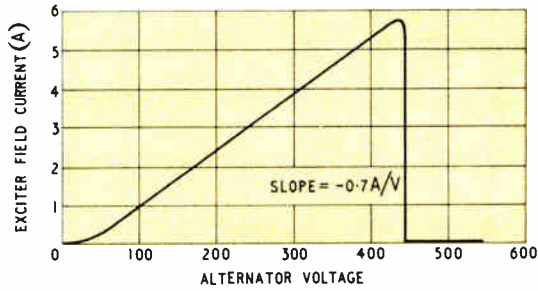

Fig. 2. Relation between alternator voltage and exciter field current

oscilloscope traces were photographed to check the theory, and since it is not possible in practice to guarantee control action at the start of a half-cycle, it was concluded that a three-quarter-cycle delay could be taken as the average response time of the amplifier. Note that full response takes place in this period of time on average.

Resistor R_1 in Fig. 1 provides negative feedback to stabilize transistor Tr_1 . The voltage gain of the transistor/magnetic-amplifier combination is -44 ; i.e., the transfer conductance is -2 A/V for a 22Ω load.

The a.c./d.c. convertor module, with a suitably-proportioned single-phase multi-winding transformer connected to two of the controlled-machine output terminals, has an incremental gain of 0.035 V (d.c.)/V (r.m.s.) on the alternator. It has a response time of not more than one half-cycle of the supply frequency.

The only remaining figure to be fixed is the gain of the transistor amplifier, connected between the a.c./d.c. convertor output and the transistor Tr_1 in Fig. 1, controlling the magnetic amplifier.

The requirement is that 11 volts change on the alternator will change the exciter field current by 1.86 A; i.e., the transfer conductance must be 0.169 A/V r.m.s.

Therefore, voltage gain of d.c. amplifier must be,

$$\frac{0.169}{0.035 \times 2} = 2.42$$

Since there is a possibility of some waveform distortion on the alternator itself, it was thought advisable to design for a considerably higher gain than this. Consequently, the d.c. amplifier gain was made about five times this value. This amplifier, which was described in the previous article, is of a basically high-gain type with feedback. The feedback resistor is fitted externally and is chosen to provide the required gain; this gain being (ohms in feedback resistor)/ $2,300$. With the feedback resistor at a nominal value of 23 k Ω , the amplifier gain is therefore 10.

This amplifier also contains a stabilized voltage which backs off the output of the a.c./d.c. convertor.

The transfer conductance between alternator voltage and exciter field current is therefore, $-0.035 \times 10 \times 2 = -0.7$ A/V and the overall static characteristic of the automatic voltage regulator is of the form shown in Fig. 2.

Stability Analysis

The complete regulating system can be represented by the block diagram of Fig. 3, where K_a is the incremental voltage gain of the alternator and T_a the incremental field time con-

Fig. 3. Block diagram representing the control system

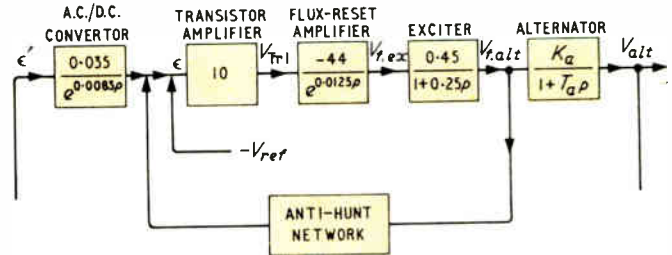

stant of the alternator. Now the a.c./d.c. convertor has a transfer function of nearly unity and its delay is at such a place in the system that it represents a time delay before the alternator voltage can be compared with the reference voltage to produce the error signal. Consequently, there is little inaccuracy introduced by assuming that the error signal is developed before going through the convertor. That is, the reference voltage is imagined shifted to the left of ϵ' in Fig. 3. Then

$$\frac{\epsilon'}{V_{alt}} = \frac{(1 + 0.25p)(1 + T_a p)(e^{0.0083p})(e^{0.0125p})}{6.93K_a}$$

At 440 V on no-load, with the machines cold, the alternator gain K_a is 33.2, and its field time-constant T_a is 2.6 sec.

Although it is well-known that a true two time-constant system cannot be unstable, the presence of the additional terms, $e^{0.0083p}$ and $e^{0.0125p}$, introduces the possibility of instability, due to the spiral nature of the stability locus caused by these factors.

However, we cannot handle the transcendental terms in their present form, since they each represent a pure time-delay, and some approximation must be made so that we can plot the complete stability locus. The presence or otherwise of these two terms, although apparently small, will make all the difference between instability and a satisfactory regulator. The system is considered to be operating in a steady-state at 60 c/s. The effect of an input change can be thought of as an input signal superimposed on a 60-c/s carrier frequency.

Now consider a device with a finite delay of a half-cycle of a 60-c/s carrier frequency. From this, one can say that an input voltage change to such a device is not reproduced at the output terminals until the next half-cycle of the carrier frequency. This represents a phase lag of 180° ; i.e., a phase-loss on the signal frequency (carrier still present) of

$$\frac{180^\circ}{2\pi \times 60} = 0.477^\circ \text{ per radian per second.}$$

The a.c./d.c. convertor phase loss is therefore $0.477^\circ \times \omega$, and the flux-reset magnetic amplifier, which gives about $\frac{1}{4}$ cycle delay at 60 c/s, is $0.716^\circ \times \omega$. These two phase lags are additive, giving a total phase loss of $1.193^\circ \times \omega$.

Substituting $j\omega$ for p , we can therefore set down the equation for the complete regulator as

$$\frac{\epsilon'}{V_{alt}} = (1.193 \times \omega)^\circ + \frac{(1 + 0.25j\omega)(1 + 2.6j\omega)}{230}$$

and this is evaluated in Table 2 for various values of ω .

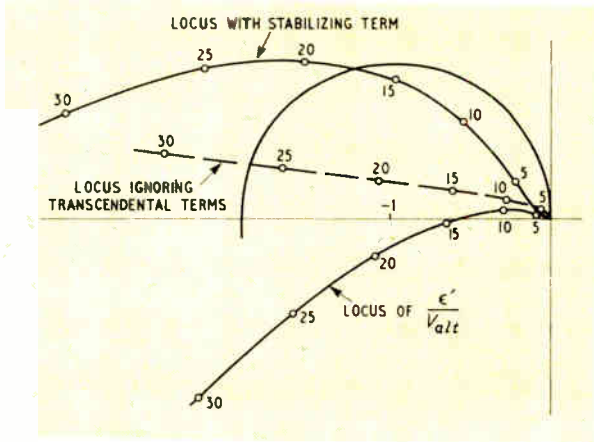

Fig. 4. Inverse Nyquist diagram showing the basic response and the effect of adding an anti-hunt circuit

Fig. 5. Form of anti-hunt circuit employed and its connection

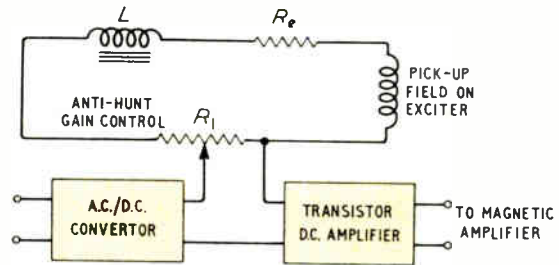

TABLE 2

ω	Response Function	ϵ'/V_{alt}
5	$/5.97^\circ + 0.00434 \times 1.6 / 51^\circ \times 13.03 / 85.5^\circ$	$0.09 / 143^\circ$
10	$/11.93^\circ + 0.00434 \times 2.69 / 68^\circ \times 26 / 87.8^\circ$	$0.304 / 168^\circ$
15	$/17.9^\circ + 0.00434 \times 3.88 / 75^\circ \times 39 / 88.5^\circ$	$0.656 / 182^\circ$
20	$/23.86^\circ + 0.00434 \times 5.09 / 79^\circ \times 52 / 88.9^\circ$	$1.15 / 192^\circ$
25	$/29.8^\circ + 0.00434 \times 6.32 / 81^\circ \times 65 / 89^\circ$	$1.78 / 200^\circ$
30	$/35.8^\circ + 0.00434 \times 7.57 / 82.5^\circ \times 78 / 89^\circ$	$2.56 / 207^\circ$

This locus is shown plotted in Fig. 4. It will also be noted that the two time-delays, although apparently insignificant at first sight, contribute to quite a large extent to making the regulator unstable.

The simplest method of stabilizing the regulator is to take a signal proportional to rate-of-change of exciter field current (or armature voltage), and amplify this signal in the transistorized d.c. amplifier. This voltage may be added in series with the signal from the a.c./d.c. convertor, or it may be added directly to one of the five other input points on the d.c. amplifier.

An additional small field on the stationary magnet system of the exciter was provided, and due to transformer action a voltage is induced in this field whenever the main field current is changing. However, because the main field is energized from the magnetic amplifier, a ripple voltage at 120 c/s appears in the pick-up field. Also, because the exciter armature feeds the alternator field via a 3-phase bridge rectifier a ripple voltage at 540 c/s is also injected into the anti-hunt circuit.

A choke/resistor circuit was designed, which almost completely attenuates the unwanted ripple voltages, and which also correctly shapes the required anti-hunt signal. This is shown in Fig. 5 and the time constant $L/(R_1 + R_2)$ is of the order of 0.24 sec.

The effective strength of the anti-hunt signal referred to the inverse Nyquist locus already plotted in Fig. 4, will, from inspection of Fig. 3, be seen to be:—

$$\left[\frac{K_f p}{1 + 0.24p} \right] \left[\frac{1 + T_a p}{K_a \times 0.035} \right] \times e^{0.0083 p}$$

where the first bracket represents the anti-hunt circuit.

As before, $j\omega$ is substituted for p , the appropriate values of T_a and K_a are taken, and allowance made for the transcendental term.

A suitable value for K_f , the voltage gain of the anti-hunt circuit, was found to be 0.0074.

In the design of the exciter field, allowance was made for the attenuation of the signal due to R_2 and R_1 .

Stability was also checked at several other values of alternator gain and time-constant, and the anti-hunt circuit gave effective stabilizing under all conditions.

Parallel-Running Compensation

In order that the machine can operate stably in parallel with others, quadrature droop compounding is used. The connections between each machine and its own a.v.r. are shown in Fig. 6.

The a.c./d.c. convertor is fed with the voltage across lines R and Y plus the voltage drop across resistor R_1 , which is fed from a current transformer in line B. The voltage across R_1 is in phase with the current in line B. Therefore, at unity power factor the voltage across R_1 is at right angles to the voltage V_{RY} , and has very little effect on the total voltage fed into the a.c./d.c. convertor. At zero lagging power factor, as shown in Fig. 6(c), the effect of the voltage across resistor R_1 is more pronounced, and since the total signal fed to the a.c./d.c. convertor is essentially constant,

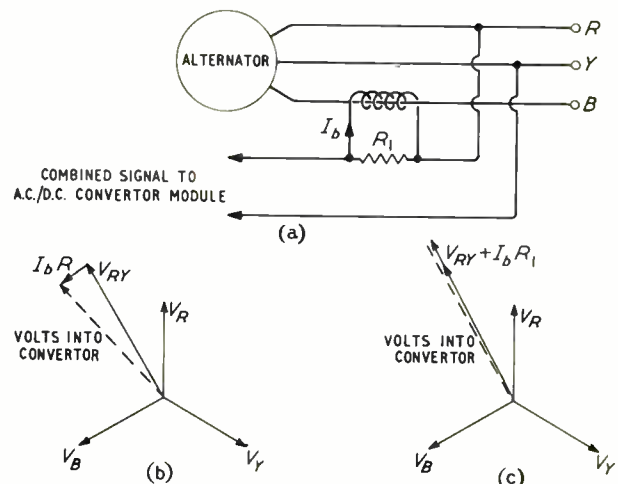

Fig. 6. Basic arrangement (a) for obtaining control when operating generators in parallel and vector diagrams (b) for unity power factor and (c) for zero lag power factor

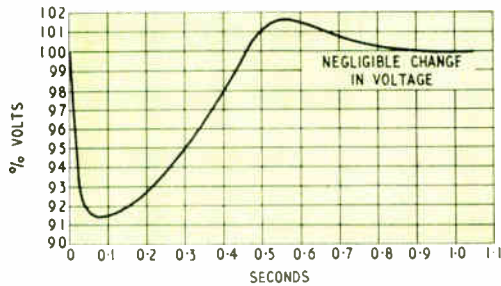

Fig. 7. Step response of regulated system

the a.v.r. will act in such a direction as to reduce the alternator excitation and voltage and thus tend to restore the power factor towards unity, the original lagging power factor being due to excessive excitation.

This method of compounding, often used with conventional alternators, also works very satisfactorily with brushless

machines. It is worth mentioning that the compounding signal must feed the a.c./d.c. convertor supply transformer (due to its synchronous nature).

The voltage level of the alternator is normally adjusted by means of a potentiometer in the d.c. transistor amplifier/error detector, this altering the value of the reference voltage. However, when machines are running in parallel, an increase in excitation on one machine will only result in its taking more reactive lagging current. Adjustment of the reference voltage can therefore be made to set the sharing of the reactive kVA. An increase in the reference voltages of all a.v.r.s will result in an increase in the system voltage level.

Response tests on the equipment yielded valuable information for the design of future regulators for this type of machine. Fig. 7 shows the results of one such test. It gives the response to a step input of 35% of rated load at 0.02 lagging power factor.

The alternator was controlled, in the steady state, to within $\pm 1\%$ of nominal voltage for all conditions of temperature and loading. The overshoot on recovery following the initial load-induced voltage change was not more than 2.1%, with rapid return to the nominal value.

SPRAY PARTICLE ANALYSER

An electronic system using closed-circuit television linked to a computer has been developed by Rank Kalee for determining the characteristics of high velocity particles such as spray droplets.

Previous methods of analysis required photography and spark illumination: the individual negatives were examined under magnification and the particles measured and counted manually. This procedure took several hours for the examination, and days to obtain adequate statistical data.

The Kalee equipment is capable of scanning, sorting and counting up to 18,000 particles in less than one minute. It will classify according to size droplets with diameters ranging from 20 to 16,250 μ .

The spray is illuminated by high intensity, short duration (1.5 μ sec) flashes from a strobe unit, and a television camera with a microscope lens system converts the light image into a video signal. A development known as 'intercept scanning', in which a vertical scan is generated at the same time as the horizontal scan, makes possible an accurate determination of particle characteristics such as location, dimensions, orientation and form.

The video pulses are referred to a single-purpose digital computer which evaluates the diameter of the particles, groups them according to size and counts the number in each group. The output is presented on meters, lamp indicators and a single-channel chart recorder. The data can, if required, be processed by a separate computer or the analyser can form part of a process control system.

This device and the basic techniques involved appear to have a wide field of application; future developments will make it possible to measure and classify particles at greater speeds and will provide a means of examining a much wider variety of samples. These may include blood cells, bacteria, photographs of molecular structures, solid suspension in liquids, bubble chamber tracks and surface flaws in metals.

For further information circle 48 on Service Card

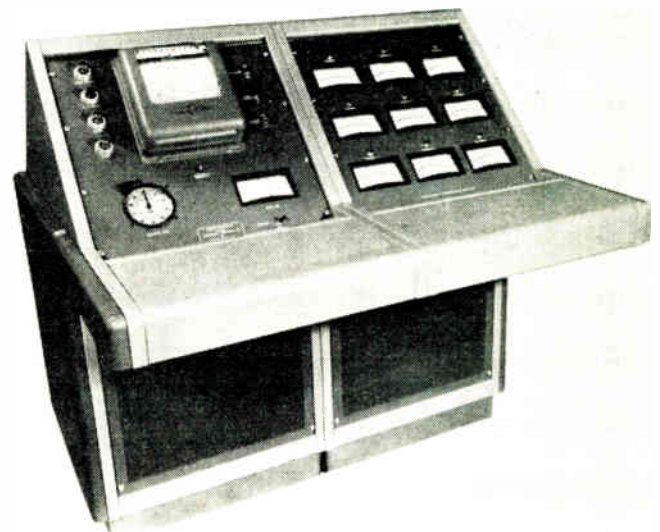

Control console showing chart recorder on the left and tally meters on the right

Television camera and strobe unit mounted on an optical bench

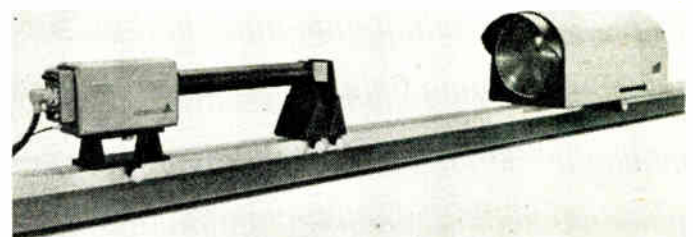

concepts, rotating-head theory, system requirements, video-signal processing, servo systems, operations and maintenance. The book is largely descriptive of the Ampex and R.C.A. video-tape recorders and it contains a great deal of information useful to anyone working with these machines.

The Engineer Buyers Guide 1963

Pp. 972. *The Engineer*, 28 Essex Street, Strand, London, W.C.2. Price 10s.

Fernsehtchnik, Part 2. Technik des Elektronischen Fernsehens

Edited by F. SCHRÖTER. Pp. 586 + xvi. Springer-Verlag, Heidelberger Platz 3, 1 Berlin 31. Price DM98.

Proceedings of the First International Congress on Diamonds in Industry

Pp. 407. Available from the Industrial Diamonds Information Bureau, 2 Charterhouse Street, London, E.C.1.

World Lists of Electronic Component Specifications 1963

Compiled by G. W. A. DUMMER and J. MACKENZIE ROBERTSON. Pp. 64. United Trade Press Ltd., 9 Gough Square, Fleet Street, London, E.C.4. Price 15s.

Manufacturers' Literature

Instruments to Repeat Angular Position. This 27-page 1963-64 catalogue, No. 2-10, includes the Theta range of angle-repeating instruments. Four basic techniques are used to produce displays and recordings of angular position: absolute encoders, incremental encoders, servomechanisms, and system error bridges. Applications, specifications and operational theory of each Theta device using these techniques is fully described. *Theta Instrument Corporation, Saddle Brook, New Jersey, U.S.A.*

For further information circle 62 on Service Card

'Sonac' Ultrasonic Sensing & Switching. A 12-page leaflet incorporating a series of sketches showing existing and suggested applications for Sonac ultrasonic devices. Details are given of the many different types, accessories and control enclosures available together with prices. *Westool Ltd., St. Helen's Auckland, Bishop Auckland, Co. Durham.*

For further information circle 63 on Service Card

'Pyrotel' Model PY-15. In this 4-page leaflet details of a new portable infra-red radiation pyrometer are given. This is Pyrotel's model PY-15 which has a focusing range of 18 in. to infinity and is available in various models to measure temperatures from 1,250 to 7,500 °F. *Pyrotel Corporation, 223 Valley Place, Mamaroneck, N.Y., U.S.A.*

For further information circle 64 on Service Card

'Roll-O-Draft'. A unique drafting system is described in this 4-page leaflet. The manufacturer's slogan—"move the drawing, not the draftsman"—indicates the purpose of this device. In operation the draftsman tapes his drawing to a continuous belt and, as the work progresses, the belt is rolled so that the area being worked on moves to the individual's ideal working position. *Stacor Corporation, 285 Emmet Street, Newark 14, New Jersey, U.S.A.*

For further information circle 65 on Service Card

STC Executive Intercom. This 6-page leaflet describes the latest STC loudspeaking intercommunication system. This system seems to provide all the facilities required of an intercom. Buttons on the desk-set can be provided to: accept, hold, transfer and cut-off the caller. Other features include priority break-in service for access to engaged extensions and automatic connection to engaged extensions when they are free. *Standard Telephones and Cables Ltd., Private Communication Equipment Division, Footscray, Sidcup, Kent.*

For further information circle 66 on Service Card

Siemens Plastic Lacquer Capacitors. A range of new self-healing capacitors, type MKL, are described in this 4-page leaflet. These professional-type components range in value from 0.1 to 10 μ F and are available with nominal voltage ratings of 50, 100 and 160 V. The 1- μ F 100 V working capacitor, No. CO105, measures 9.4 mm diameter by 21 mm. Distributed in the U.K. by

R. H. Cole (Overseas) Ltd., 26-32 Caxton Street, London, S.W.1.

For further information circle 67 on Service Card

Nelas: North-East Laser. An improved model of the first commercially available all British laser system is briefly described in this 4-page leaflet. This is being developed, produced and marketed by

International Research & Development Co. Ltd., Fossway, Newcastle-upon-Tyne 6 and Thermal Syndicate Ltd., P.O. Box 6, Wallsend, Northumberland.

For further information circle 68 on Service Card

The Concept of Modular Instrumentation. This Argonaut Associates abridged 4-page catalogue includes brief specifications for their modular group of differential pre-amplifiers, electrometers, intermediate and output amplifiers, single-ended and differential isolation units, pulse generators, calibrators and regulated power supplies.

Argonaut Associates Inc., P.O. Box 273, Beaverton, Oregon, U.S.A.

For further information circle 69 on Service Card

Sound Amplifiers and Systems for Commercial and Industrial Application. This 20-page brochure, CA-4-5/63, gives full details of Harman Kardon 'Commander' and 'Troubadour' series of a.f. amplifiers and systems. It also contains useful information for the sound engineer on how to judge and evaluate the equipment he will require for public address installations. *Harman Kardon Export Div., Dept. 6382 E, Emec Inc., 160 Terminal Drive, Plainview, L.I., N.Y., U.S.A.*

For further information circle 70 on Service Card

'Spectrochem' Grating Spectrophotometer. An instrument produced by Hilger & Watts for determining concentrations of solutions and plotting detailed absorption spectra in the range 340 to 750 μ incorporates many unique features. These are detailed in this 4-page leaflet.

Hilger & Watts Ltd., 98 St. Pancras Way, London, N.W.1.

For further information circle 71 on Service Card

Creed Model 90 Tape Verifier. In this 6-page publication, No. 135-003-2E, a 5-, 6-, 7- or 8-track tape editing device designed to provide a positive check on the accuracy of punched paper tape is described.

Creed & Co. Ltd., Telegraph House, Croydon, Surrey.

For further information circle 72 on Service Card

★ FOR THE BUYER

You must have read about a number of products and processes in this issue of which you would like further details.

You can obtain this information very easily by filling in and posting one or more of the enquiry cards to be found inset in the front and back of the journal.

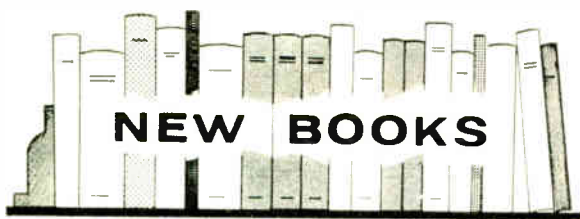

Telemetry

By R. E. YOUNG, B.Sc.(Eng.), M.I.E.E., A.F.R.Ae.S. Pp. 78 + vii. Temple Press Books Ltd., 42 Russell Square, London, W.C.1. Price 17s. 6d.

The telemetry considered in this little book is confined entirely to that employed in missiles. The introductory chapter explains the basic requirements. The second chapter on telemetry as a communication system deals with r.f. power requirements, signal-noise ratio and modulation. Under the heading radio-frequency design, transmission lines and aerials are treated as well as transmitters, receiving aerials and receivers.

Chapter 4 is on sender data handling and deals largely with transducers although some simple circuits are also included. The final chapter is on ground data handling and in its six pages it covers demultiplexing, strobing, data recording and data extraction.

It is plain from the size of the book and the ground covered that no aspect can be treated in any great detail. It at first appears unfortunate that the matters dealt with most fully are the ones, such as signal-noise ratios, transmission lines, etc., which are the best known and on which there is an abundant literature. One feels that it would have been better to treat many other aspects in even more detail than these. To have done so, however, would have resulted in a book three or four times the size.

The book does give the newcomer to the subject of missile telemetry a general view of the requirements.

Non-Linear Automatic Control

By JOHN E. GIBSON, Ph.D. Pp. 585 + xviii. McGraw-Hill Publishing Co. Ltd., 95 Farringdon Street, London, E.C.4. Price £6 8s.

A review of linear automatic control theory is the starting point of this book. Then come chapters on the basic principles of statistical design, sampled-data systems and the z-transform, numerical methods, and time-variable parameter systems. Series approximation methods for small non-linearities, graphical analysis and the second method of Liapunov are the subjects of the next three chapters, while the final three cover the describing function method and on-off servomechanisms, optimum switched systems and adaptive control systems.

The treatment is highly mathematical and there is much that is difficult going. This is not surprising when the subject is one which is notoriously difficult. The author claims that the level of treatment is exponential, both within each chapter and throughout the text. Certainly the early parts of every chapter are fairly simple and usually start descriptively.

Synthesis of Relay Switching Circuits

By VADIM N. ROGINSKIĬ. Translated by W. Chrzczonowicz. Pp. 184. D. Van Nostrand Co. Ltd., 358 Kensington High Street, London, W.14. Price 50s.

Originally published in Russian in 1959, this English edition deals with the design of switching circuits by mathematical methods. There are eleven chapters covering fundamental definitions, algebraic and other representations of circuits, the synthesis of sequential circuits,

algebraic operations on contact networks, general solutions and their transformations, switching algebra of sets, graphical method of contact network design, transformation of relay circuits, design of multi-relay circuits, sequential circuits with capacitors and mechanization of the process of structural synthesis of circuits.

The treatment, although it begins simply enough, is very far from elementary, and the reader is soon immersed in mathematics of the Boolean type. Unless the reader has, or is prepared to acquire, facility with this sort of mathematics the book will not help him much, but if he is he will find the treatment very thorough.

Letter Symbols, Signs and Abbreviations: Part 6 Electrical Science and Engineering

Pp. 51. B.S. 1991 : Part 6 : 1963. The British Standards Institution, 2 Park Street, London, W.1. Price 12s. 6d.

The first part of B.S. 1991, 'Letter Symbols, Signs and Abbreviations', was published in 1954. Since then four further sections have been issued, dealing with symbols and abbreviations for chemical engineering, nuclear science and applied chemistry; fluid mechanics; structures, materials and soil mechanics; and applied thermodynamics. Part 6 of the standard, 'Electrical Science and Engineering', has now been published.

The new standard covers not only the fundamental classical terms of electrical science but two major engineering categories—machines and power engineering, and electronics and telecommunications. So that the reader does not have to make frequent reference to Part 1, a selection of terms given there for mechanics, acoustics, heat and illumination is included.

In specialized work a wide range of subscripts is needed for use with symbols for quantities, to indicate particular attributes of the quantities. The new standard meets this need by including a number of symbols with subscripts, as well as separate classified lists of subscripts.

Abbreviations for words and phrases are widely used in electrical engineering to avoid the constant repetition of the expressions in full. The selected list of abbreviations in the new publication contains typical examples of well-established abbreviations, but it should not be regarded as exhaustive.

Masers and Lasers

By GORDON FROUP. 2nd Ed. Pp. 192 + viii. Methuen & Co. Ltd., 36 Essex Street, Strand, London, W.C.2. Price 18s.

This is one of the well-known Methuen's Monographs on Physical Subjects. To say this is to indicate the level of treatment as one in which necessary mathematics are not shirked but they do not entirely supersede explanations. There are few pages on which equations do not occur and yet the reader is not overburdened by them.

There are nine chapters. The first four cover stimulated and spontaneous emission of radiation, amplification and excitation. Chapter 5 deals with microwave amplifier systems and chapter 6 with the microwave maser oscillator. Then comes one on lasers; that is, infra-red and optical masers. The final two chapters cover experimental work and applications. There is a bibliography of 115 references and there are two appendices.

Television Tape Fundamentals

By HAROLD E. ENNES. Pp. 256. Howard W. Sams & Co., Inc., Indianapolis 6, Indiana, U.S.A. Price \$5.95.

This is Vol. 1 of a series called 'Broadcast Engineering Notebooks' and is produced in a loose-leaf format with a plastic-ring binder. There are seven sections covering basic

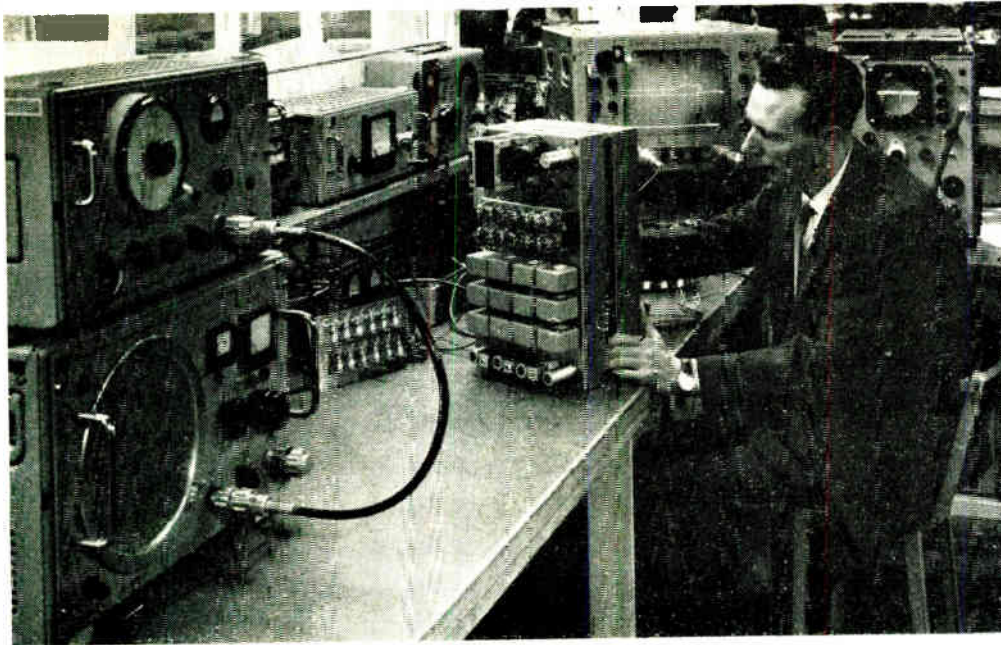

A section of the research laboratory recently established by Teleng Ltd. of Romford, Essex, to assist electronics manufacturers with the design, development and manufacture of specialized communication and control systems

The Conference of the Electronics Industry

The trade associations and the leading electronics companies have jointly formed the Conference of the Electronics Industry to provide a forum for the discussion of common problems and to present them in discussion, especially with the Government, on matters of national interest.

So that the voice of the Conference may be authoritative and its views and advice may command respect, its members have been chosen from the highest ranks of the electronics industry; they include many chairmen and managing directors of important companies.

At its inaugural meeting, held on the 15th July, Mr. O. W. Humphreys, C.B.E., vice-chairman of the General Electric Co. Ltd., was elected the acting chairman of the conference.

Courses

During National Productivity Year much emphasis has been placed on the need for an increase in knowledge and application of modern control methods in industry. As a contribution towards meeting this need, a series of one-week post graduate courses has been organized by the Department of Electrical Engineering and Electronics of Brunel College. These courses, to be run during October and November, will cover 'Automation, Control and Computers', 'Advanced Aspects of Automatic Control' and 'Design of Computer Control and Data-Handling Systems'. Further information can be obtained from the Academic Registrar, Brunel College, Woodlands Avenue, Acton, London, W.3. Telephone: Acorn 6661.

One-year courses on transistors will be held at Wandsworth Technical College starting in September 1963. Course 'A' is at post-H.N.C. level and will deal with the fundamental physics of semiconductors as well as a wide range of applications. Course 'B' is at O.N.C. level with mathematics kept to a minimum. In addition, a 10-week course on special applications of transistors will be starting on 10th October. Students for this course should normally be of at least H.N.C. standard with some basic knowledge of transistor circuitry. The address of the college is Wandsworth High Street, London, S.W.18 (Telephone: Vandyke 2355).

AutoTutor Rental Scheme

A rental plan for teaching machines was announced on 26th July by U.S. Industries Inc. Great Britain Ltd. In future AutoTutors and TutorFilms will be supplied only upon a rental basis. The scheme is intended to allow industrial organizations and schools to explore the possibilities of programmed instruction without major capital investment.

These teaching machines can be hired for £20 per month, or for two or more months at £15 per month, including delivery and maintenance. Courses of programmed instruction cover a wide variety of subjects including mathematics, electronics and computer programming; a six-reel course of general mathematics is available at a monthly rental of £3 per reel and an 11,000 image course on first-year electronics may be rented for £25 per month.

Full details of the rental scheme, which applies only in the U.K., can be obtained from U.S. Industries Inc. Great Britain Ltd., Educational Science Department, 1-5 New Bond Street, London, W.1.

Capacitors being checked for insulation resistance on a machine designed and built by E.M.I. engineers. Each capacitor is placed between the jaws of a revolving drum. A charging voltage is applied for 10 sec, then the volts-drop between the lead-out wires is measured. As the drum continues its 30-sec revolution, capacitors are ejected into bins according to their insulation resistance

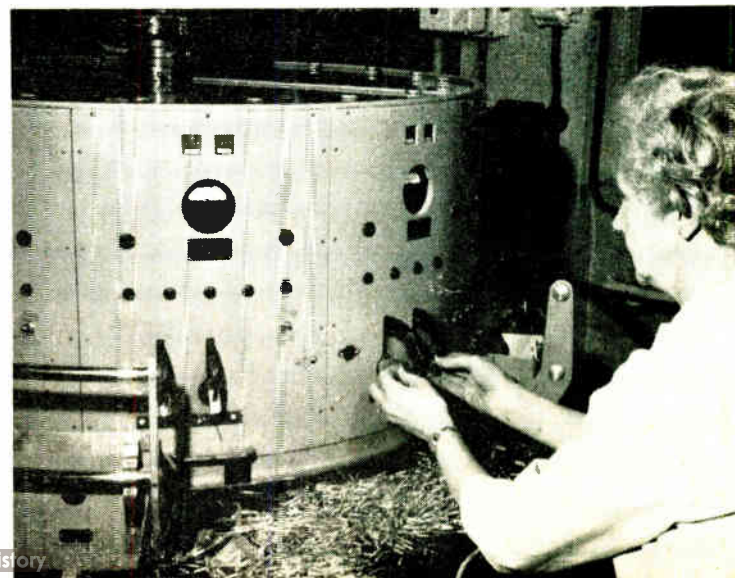



A monitoring system employing three semiconductor load cells, developed by Fairchild Controls for the Sikorsky S-64 Skycrane helicopter, enables the pilot to maintain accurate control of the torque required for lifting operations and balance engine output during flight

The activities of **Rank Taylor Hobson** are to be extended to include the marketing of products manufactured by the Kershaw Division, the Solus-Schall range of non-destructive metal testing equipment, and the metal detection and check-weighing equipment formerly marketed by Rank Cintel. H. Leeming is to become joint managing director (marketing) and J. A. Stafford joint managing director (production).

English Electric Valve Co. Ltd. announce that Messrs. Max Paul Frey of Wankdorffeldstrasse 66, Bern, have been appointed E.E.V. sole agents for Switzerland.

David Neville de Mattos, A.M.I.Mech.E., A.M.I.E.E., has moved to Sheffield to take over duties as manager of the North Midland Region of **A.E.I. Ltd.** He was previously deputy manager of the South Western Region, in Cardiff. T. Baldwin, B.Sc.(Eng.), A.M.I.E.E., has been appointed manager of the Electro Data Processing Department of the A.E.I. Industrial Group.

Roy Roper has been appointed U.K. senior sales engineer of the Merchandising Division of the **Solartron Electronic Group Ltd.**

R. H. Cole (Overseas) Ltd. have been appointed agents for the Special Valve Division of Siemens & Halske in addition to their existing agencies for the distribution of S. & H. components.

Motorola Semiconductor Products Inc. of Phoenix, Arizona, has opened its first international sales office at New Bond Street House, 1-5 New Bond Street, London, W.1 (Telephone: Hyde Park 3416). The manager of the London office is Robert A. DiMassimo.

W. Mackie & Co. Ltd. have appointed as sole agents in Sweden, Ingeniörsfirman Sandblom and Stohne Aktiebolag, Lindhagensgatan 128, Stockholm.

Anthony Goodchild and Claude Ganz have been elected directors of **Elliott Business Machines Ltd.**

Space Communications

On the 29th March, the Minister of Aviation made reference in the House of Commons to the Government's intention to 'carry out a detailed design study to determine a suitable design for a communications satellite'.

Subsequently, the Ministry of Aviation has requested the Electronic Engineering Association's co-operation on the communication/electronics aspects of the project, and to examine this subject on an industrial basis a 'Space Committee' has been formed by the Association under the chairmanship of W. D. H. Gregson of Ferranti.

The Government approach to the matter is to divide it into two phases: (1) The study of complete systems and (2) The study of necessary technical developments. System studies which have already been made by the industry will prove invaluable in the first phase, when advising the Ministry on a preferred system or systems.

The second phase, which will be a more detailed study of the technical requirements for the earth stations and satellites, will involve close liaison between Government Research Establishments and manufacturers. In some areas of research it is intended to interchange staff between the Establishments and member firms of the Electronic Engineering Association.

The new E.E.A. Space Committee will enable the industry to co-ordinate its efforts and speak to the Government with a single voice on space communications.



Personal and Company News

Agreement has been reached by **British Aircraft Corporation Ltd.** and **Marconi's Wireless Telegraph Co. Ltd.** on plans for collaboration to enable them to participate fully in the design and manufacture of complete satellite communications systems.

A. G. Stirling, M.Sc., A.M.I.E.E., A.F.R.Ae.S., has taken up his duties as manager of the Control and Instrumentation Division of **Ultra Electronics Ltd.**

At the annual general meeting of the **Scientific Instrument Manufacturers' Association** the new president for 1963-64, G. S. Sturrock, was formally installed by the retiring president, R. E. Burnett.

Harry Sellers is to be managing director of the new British company, **Tektronix U.K. Ltd.** He was previously commercial director of Livingston Laboratories Ltd.

C.T. (London) Ltd. have been appointed sole agents in the U.K. and Northern Ireland for Messrs. De Mornay-Bonardi of Pasadena, California, U.S.A. The products concerned cover a wide range of microwave equipment.

K. E. Harris has been appointed divisional manager of **Redifon Ltd.** This company has recently opened an office in Lagos, Nigeria; the area manager is C. K. Harrison.

At the annual general meeting of **The Institute of Physics and The Physical Society**, the following were elected to honorary office: Prof. M. R. Gavin (vice-president), Dr. J. Taylor (hon. treasurer), Dr. C. G. Wynne (hon. sec.).

W. Alfred Ende has been appointed managing director of **Electrosil Ltd.** He has until now been manager of Corning's Electronic Components Plant in Bradford, Pennsylvania, U.S.A.

The English Electric Valve Co. Ltd. has announced the appointment of Dr. J. C. Firmin as manager of Camera Tube Research with effect from 1st October. He succeeds Dr. R. L. Beurle, who has been elected to the chair of Electronic Engineering at Nottingham University.

Peter Tagg has been appointed to succeed Dr. James Kendall as general manager of **SGS-Fairchild Ltd.** He was previously sales manager and, in his new position, will retain special responsibility for sales in the U.K. and Scandinavia.

Paul B. Hendel, Jr., who has been managing director of **Polyenco Ltd.** since its inception six years ago, is returning to the parent company, The Polymer Corporation of Reading, Pennsylvania. He will be succeeded by C. A. Vandervell.

S. H. B. Hutchinson, A.M.I.Nuc.E., has been appointed to the board of the **SASCO** group of companies. He joined the group in 1961 and was appointed general manager in January of this year.

As a result of continued expansion, **Spemby Ltd.** are to operate their Laboratory Products Division through a separate subsidiary company known as Spemby Technical Products Ltd. with A. C. Thorne as managing director. The new company will come into full operation on 1st August.

F. V. Green of Brimar Ltd. has been elected chairman of the **British Radio Valve Manufacturers' Association** for the second year. A. J. Young, O.B.E., of English Electric Valve Co. Ltd., has been re-elected chairman of the **Electronic Valve and Semiconductors Manufacturers' Association.**

F. H. Fryer has been appointed marketing manager of **Lancashire Dynamo Electronic Products.**

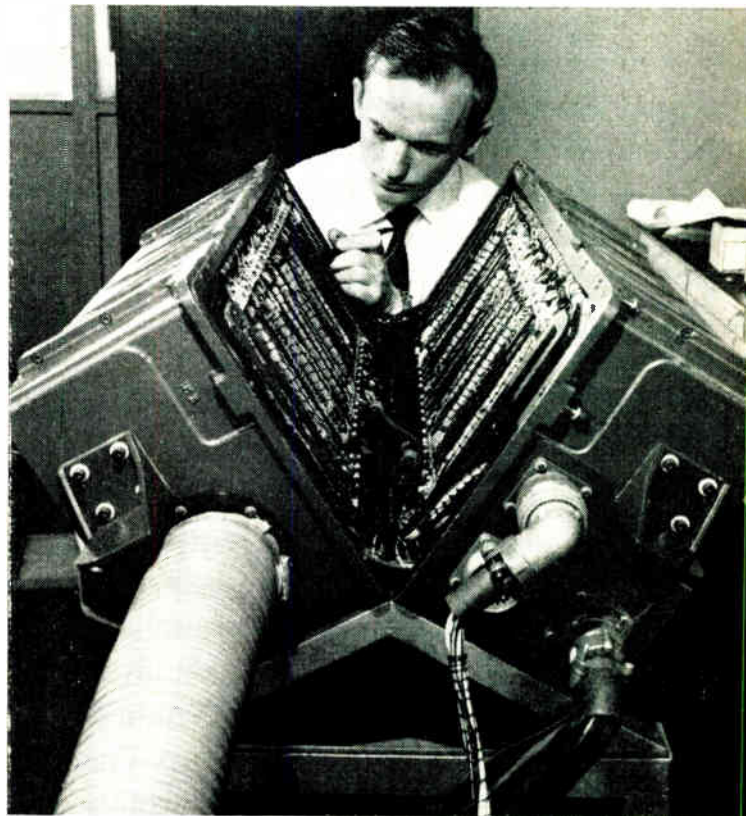

An Elliott 900 series digital computer being commissioned. These computers, suitable for a variety of on-line tasks, are incorporated in Elliott-Automation's 'Rotrac' road traffic control system recently launched at the Road Traffic Engineering and Control Exhibition

Induction Coil Prevents Damage to Press Tools

AN ingenious adaptation of the Airmec Type N263 Tool Alarm Unit by The British Oxygen Co. Ltd. has greatly reduced damage to presses used in the manufacture of 'Sparklet' CO₂ cartridges for soda siphons.

The cartridges are made by stamping blanks from steel strip and deep-drawing the blanks into cups, which are then swaged to form the neck (see Fig. 1, right to left). At the first work station a double-acting tool first cuts the circular blank and holds it clamped, while a punch descends to effect the first drawing stage. The cup so formed is stripped from the withdrawing punch and drops by gravity through the holster.

Due largely to variations in the material, it sometimes happened that a cup did not drop clear. Further components would then be rammed down on top of it, leading to jamming and rapid fracture of the die. The cost of replacement and loss in production made it imperative to find a remedy.

Limit switches were ruled out by the lightness of the component. Photocells could not be used because of the

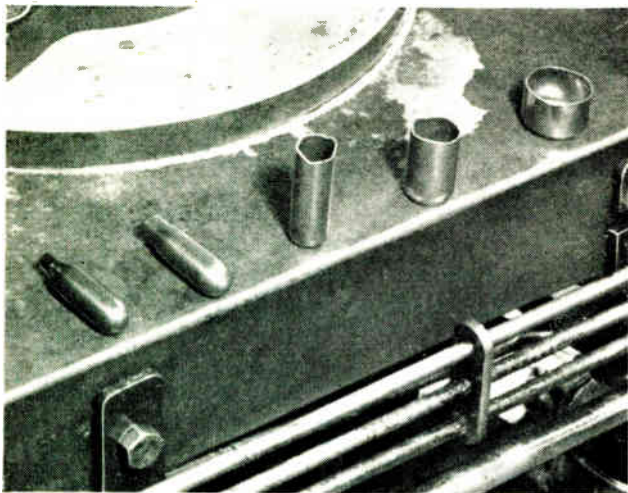

Fig. 1. Stages (right to left) in the production of 'Sparklet' CO₂ cartridges. The component at the extreme right is punched from the strip and drawn into a cup in one operation

unavoidable accumulation of lubricant. The problem was successfully solved with a modified Type N263 Tool Alarm Unit. Originally designed to detect fracture of drills, reamers, taps and similar rotary tools, it consists of a small detector coil and of a circuit for detecting changes in coil inductance. In the standard unit, the tool being monitored acts as the inductive core; if it breaks, the inductance changes and the alarm acts. At B.O.C., the unit is required to monitor the passage of a component and the unit had to be modified accordingly.

The coil was potted in epoxy resin (Fig. 2) and fitted in the bolster. The alarm circuit was also modified. In its normal form, it is designed to detect simply a change in coil inductance resulting from failure of the tool. At the B.O.C. works, the unit must detect the presence of each component as it passes through, and it must detect any pile-up of components in the ejection channel. The alarm unit must therefore be sensitive to the rapid passage of a component and it must operate if a component remains in the coil for more than a very brief period.

In normal use, the alarm unit operates changeover and make-and-break contacts, which may be used to operate



Fig. 2. The inductance coil of the tool alarm unit, potted in epoxy resin to fit the bolster of the press

alarm signals or to stop the machine when a tool breakage occurs. To achieve the required discrimination, B.O.C. designed a subsidiary relay unit which incorporates delay circuits controlled by limit switches operated by the press. Once an operating cycle has commenced, the alarm operates if no component passes through the sensing coil within a given interval. If, on the other hand, a pile-up causes a component to remain within the coil for more than a pre-determined period, the alarm will also operate. In either case, a solenoid-operated air valve is energized to stop the press, and an alarm signal lights up. At a press output of two pieces every 45 seconds, a high response speed is required to ensure stoppage before the punch makes the next stroke.

Although stoppages of the type referred to occur only

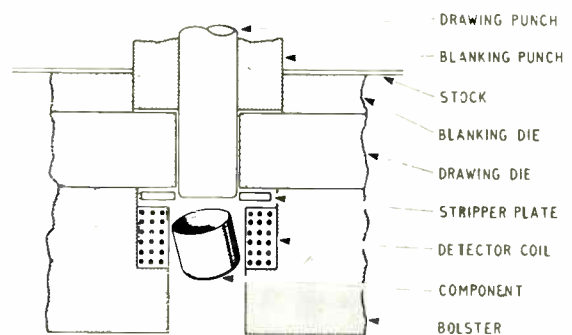
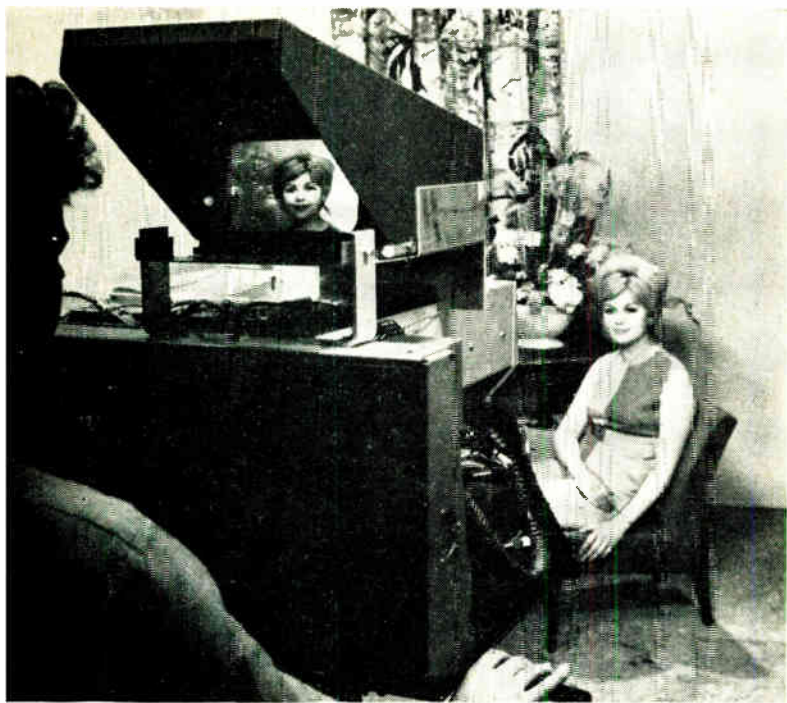

Fig. 3. Method of mounting the epoxy-potted coil shown in Fig. 2, in relation to the blanking and drawing tools

infrequently, and are due primarily to defective material, the two alarm units installed on this press have already fully justified their moderate cost. As a result of successful experience with these units, it has been decided to fit similar equipment to a second similar press which, with another, is responsible for the entire output of drawn blanks for this type of cartridge.

For further information circle 61 on Service Card



A view of the Marconi experimental colour television camera using three 4½-in. image orthicon tubes

in the usual way and then produce the usual Y' , $R' - Y'$ and $B' - Y'$ signals, the colour-difference signals only being transmitted. A major advantage is that since the Y' signal produced here is not transmitted it need not be wideband. As a result the whole of the R , G and B tubes and circuits can be narrow band. Not only this, but the registration problems of the different scans are much less severe.

E.M.I. reckon that when the camera is in production it will be cheaper than the conventional three-tube camera in spite of having four tubes and giving a better performance. It is claimed, too, to be at least three times as sensitive as the ordinary colour camera.

In a closed-circuit demonstration the new camera gave excellent pictures, both colour and monochrome, and with both the N.T.S.C. and Secam systems. However, the receivers employed are not quite standard ones. Because the luminance signal is a true one a standard N.T.S.C. receiver, being designed for the ordinary partial luminance signal, does not give of its best. The difference is but small, however, and during the demonstration the receiver modification was switched in and out. The only difference noticed was to the hue of red, which turned slightly orange with the standard N.T.S.C. receiver. The change was small and would be noticeable only on a direct comparison.

Strictly speaking, however, the adoption of this separate luminance system calls for a change in the N.T.S.C. standards.

Marconi's W.T. Co. are also working on new cameras. One of these has four camera tubes, one giving a high-quality luminance signal and the other three providing the R , G and B signals. Another camera, however, has only three tubes but still gives separate luminance. Three 3-in. image orthicons are used, one to give luminance and the other two to provide red and blue. Both red and blue channels have bandwidths limited to 2 Mc/s while the luminance channel is 5 Mc/s.

In one way of dealing with the camera outputs, Y , R and B are gamma-corrected to produce Y' , R' and B' and then the colour-difference signals $R' - Y'$ and $B' - Y'$ are formed. A green signal is not produced at all.

An alternative is to produce G from Y , R and B , then to correct all four signals for gamma, so that Y' , R' , G' and B' exist in the camera. The colour-difference signals are then formed from these. Presumably the Y' then used in forming these signals is not the Y' of the separate luminance channel, but one formed from R' , G' and B' , otherwise this alternative would end up no different from the first.

Whether three tubes or four are used, the principle of obtaining a separate luminance signal directly from one tube instead of from the combination of the signals from three tubes seems undoubtedly right. It leads directly to about three times the camera sensitivity and it so greatly reduces registration difficulties that picture definition is likely to be superior.

GRAPHIC REPRODUCTION SERVICE

Exact copies of a drawing or design can be transferred economically and accurately on to sheet material such as steel, aluminium, plastic and wood by means of a photo-mechanical process known as 'Loftline'. The cost of transferring an image directly from a 6 by 4 ft translucent master to a sheet of material the same size is approximately 4s.

To assist firms that have a limited requirement for such work, or to prove that the method is suitable for specific application, Lee-Smith Photomechanics who developed the process have established a department to handle such jobs on a service basis.

As the name suggests, Loftline was originally developed for accurately reproducing positive copies of aircraft loft-lines directly on to metal sheet and plate from which jigs, templates and other tools were manufactured. Since then the process has been employed in a wide variety of other industrial applications, e.g. in the manufacture of printed circuits, contour electrodes for high-frequency plastic

welding machines, press tools for the motor industry, and the reproduction of hull lines for boat builders.

The Loftline process is simple and can be carried out under normal subdued lighting conditions. A photo-sensitive coating solution is first sprayed on to the material and allowed to dry. Then the translucent master is held in close contact with the sensitized surface and the material is exposed to ultra-violet light. The latent image is made visible by wiping a liquid developer over the surface to produce an indelible black copy of the master design.

A precision camera is available in the service department for reproducing graphic designs at ratios other than 1 : 1. A graticule scribing machine and a loft draughting service are also available for preparing translucent originals from customers' design information. A step-and-repeat camera can be used where a design is to be reproduced repeatedly over a large surface area.

For further information circle 60 on Service Card

COLOUR TELEVISION CAMERA DEVELOPMENT

THE conventional colour-television camera has three similar tubes for producing the signals corresponding to red, green and blue in the scene being televised. Images of the scene in these three colours are produced on the tubes by a system of lenses, dichroic mirrors and colour filters. The signals, conventionally termed R , G and B , are corrected for gamma and combined in certain proportions to form what is termed a luminance signal. This is designed Y' (a prime after a letter denotes that gamma correction has been applied) and with the aid of this two colour-difference signals $R' - Y'$ and $B' - Y'$ are formed.

Ideally, Y' represents the luminance information and the colour-difference signals convey information about hue and saturation. The Y' signal alone, applied to a receiving cathode-ray tube, should produce a black-and-white picture identical with that which would be obtained from an ordinary monochrome camera.

The conventional camera has a number of disadvantages, however, and a good deal of work has recently been carried out to improve it. Compared to a monochrome camera the colour camera is insensitive, which means that the scene to be televised must be more brilliantly lit. This comes about partly because of losses in the optical system and partly because of electrical losses in the mixing of the outputs of the R , G and B tubes to form the Y signal. In practice, too, there is commonly a loss of picture detail because the scanning of the three tubes is not in precise register. Both in monochrome and in colour reproduction of a colour scene, detail depends on the Y signal, for

the colour-difference signals are always transmitted with reduced bandwidth.

There are also defects which arise because of gamma correction which affect monochrome reproduction. Gamma correction is needed because of the characteristics of the receiving c.r. tube. Technically, it might well be better to include it in the receiver but it is much cheaper to do it at the transmitting end because there will be millions of receivers to only hundreds or thousands of cameras.

With the usual arrangement the luminance signal Y' does not actually convey all the luminance information, some is contained in the colour-difference signals. The reason is that forming Y' as the sum of previously gamma-corrected R , G and B signals is not the same thing as first forming Y from R , G and B and then gamma-correcting it. The difference is of the same nature as that between $A^2 + B^2$ and $(A + B)^2$; the term $2AB$ is missing from the former.

In the development now proceeding the trend is to include a tube in the camera which produces the Y signal directly. Both three and four tube cameras are being made. E.M.I. Ltd. favour a four-tube camera. This has an image orthicon as a monochrome tube; it produces the Y signal directly and this is gamma-corrected to produce Y' . In effect, it is a normal monochrome camera and, except for losses in the optical system, is as sensitive as any normal camera of this kind. Three colour tubes R , G and B are provided and for these vidicons are used. These produce R , G and B outputs which are gamma-corrected

E.M.I. experimental colour camera with a 4½-in. image orthicon tube for the luminance signal and three vidicons to provide the colour signals. It is fitted with a zoom lens



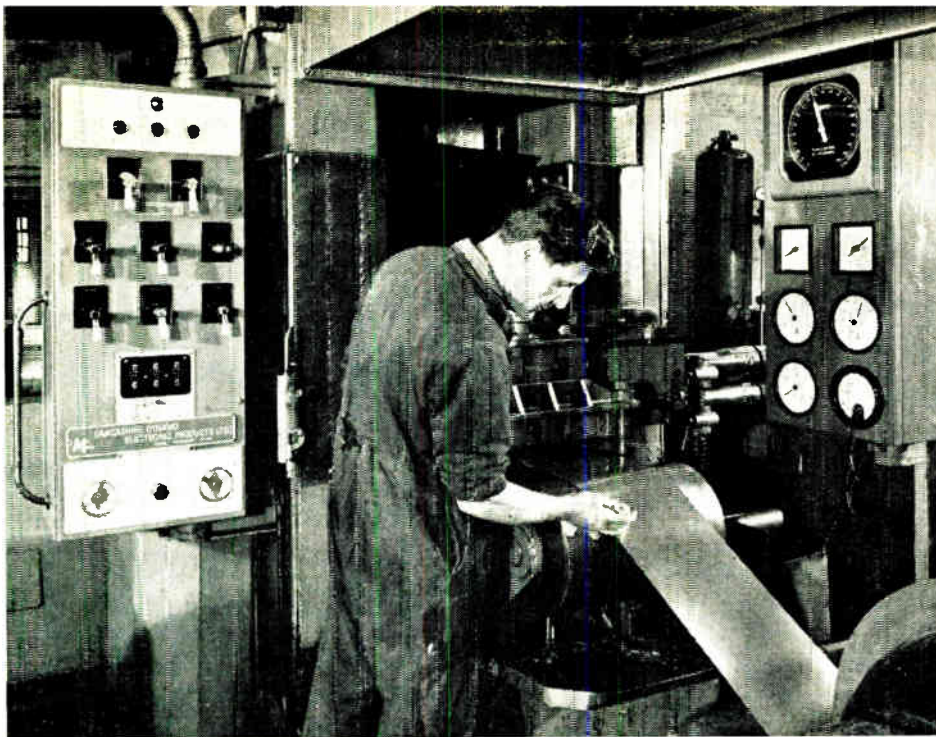

This shows an operator gauging the thickness of strip steel processed by the cold rolling mill

to control the tension in the strip over a range of 10 : 1 below a maximum of 8,000 lb and to keep the set tension constant over the build-up range of the coil which is 2.5 : 1.

The equipment is designed to cover a coil build-up range of 3 : 1. As tension in the strip is proportional to the armature current of the d.c. motor and compensation is made for motor losses, the current in the motor armature is used as a measure of strip tension.

A resistance is connected in series with the motor armature, and the voltage drop across the shunt is used as a measure of current. This voltage is then compared in a resistance network against the output of the set tension potentiometer, and any resultant error is used, after suitable amplification, to control the conduction angle of the thyatron rectifiers controlling the excitation of the coiler generator in such a manner as to maintain the armature current at the desired value.

In order to keep the tension in the strip constant over

the build up range of the coil it is necessary to strengthen the field of the motor as the coil builds up.

To obtain a strengthening of motor field during coil build up the back e.m.f. of the coiler motor is compared in a resistance network against a reference voltage, the amplitude of which varies as the set line speed varies. The error voltage produced by this comparison is used to control the conduction angle of the thyatron rectifiers controlling the excitation of the coiler motor field in such a manner that the excitation of the motor field increases as the coil builds up.

The control circuits are arranged so that the armature current of the coiler motor is regulated to within $\pm 2\%$ of maximum armature current over the full range of line speed and coil build up.

The control equipment is fully sequenced and interlocked to provide maximum protection for the mill in the event of overload, failure, etc., in any of the ancillary equipment.

ELECTRONIC THERMOMETER

The Dependatherm, manufactured by Dependable Relay, is an electronic device for taking body temperatures which eliminates the waste of time, particularly in hospitals, taken in recording patients' temperatures by the use of a normal clinical thermometer.

With this instrument temperature is recorded instantaneously on a dial when the probe is inserted into the patient's mouth, and it immediately reverts to normal, ready for proceeding to the next patient, when the probe is removed. The need for sterilization is obviated by the use of disposable cellophane envelopes which fit over the probe.

As well as for clinical use, the Dependatherm can have many industrial applications where instant recording of temperature is required. The printed-wiring connector for this instrument is made by Continental Connectors Ltd.

For further information circle 59 on Service Card

The Dependatherm electronic thermometer with probe and printed-wiring connector

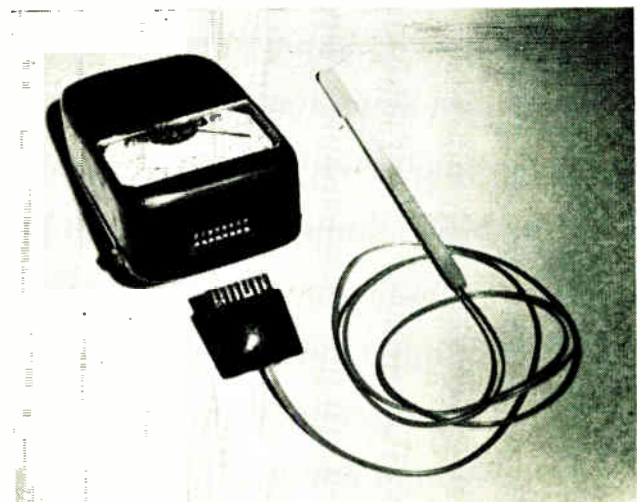

ELECTRONIC CONTROL FOR ROLLING MILL

A NEW cold rolling mill has been installed by Stourbridge Rolling Mills Ltd. at their works in Worcestershire. The mill is produced by R.W.F., of Cologne, and the electrical and electronic control equipment supplied by Lancashire Dynamo Electronic Products Ltd.

The control equipment for the mill motor is designed to provide a constant torque/speed characteristic over the speed range of 28–280 ft/min and a constant horsepower/speed characteristic over the remainder of the speed range up to a maximum speed of 700 ft/min.

In order to control the speed of the mill motor over the range 40 to 400 r.p.m., which corresponds to a linear strip speed of 28–280 ft/min, a closed-loop control system is employed, in which the output voltage of a tachogenerator mounted on the non-drive end of the motor is used as a measure of motor speed and hence linear strip speed.

The output voltage of this tachogenerator is compared in a resistance network with the reference voltage obtained from the slider of the set line speed-control potentiometer, the resultant error produced by this comparison is used, after suitable amplification, to control the conduction angle of the thyatron rectifiers controlling the d.c. generator field excitation, so as to set the armature voltage of the mill motor to the desired value; corresponding to the desired speed of the line.

During control over this range the field of the mill motor is kept constant at full excitation, hence a constant torque-speed characteristic is obtained. If it is desired to run the mill motor at a speed which corresponds to a line speed greater than 280 ft/min, it is necessary to weaken the field

of the mill motor and at the same time keep the armature voltage substantially constant, in order to obtain the constant horsepower-speed characteristic required.

In order to achieve this, the armature voltage of the motor is compared with a fixed reference voltage in a resistive network, the network being so arranged that the error signal produced by this comparison is always positive until the armature voltage reaches its maximum potential of 440 V d.c. The ratio of the resistances in the matching network for the armature control is arranged in such a manner that an increase in armature voltage is called for if the desired speed is greater than 280 ft/min.

In order to keep the armature voltage down to a maximum (slightly in excess of 440 V), the error produced by the matching network changes from a positive to a negative error at this point. The negative error is used, after suitable amplification, to decrease the conduction angle of the thyatron rectifiers feeding the mill motor field, thus decreasing the excitation of the motor to obtain an increase in speed and a corresponding constant horsepower-speed characteristic.

The control equipment is designed to regulate the line speed to within $\pm 1\%$ of maximum strip speed; i.e., ± 7 ft/min over the full load range of the machine.

Provision is made to inch the mill motor against a constant torque-speed characteristic in both forward and reverse directions of rotation at a speed up to 70 ft/min, reverse direction being obtained by reversal of the motor field polarity.

The control equipment for the coiler motor is designed

A general view of the cold rolling mill installation at the works of the Stourbridge Rolling Mills

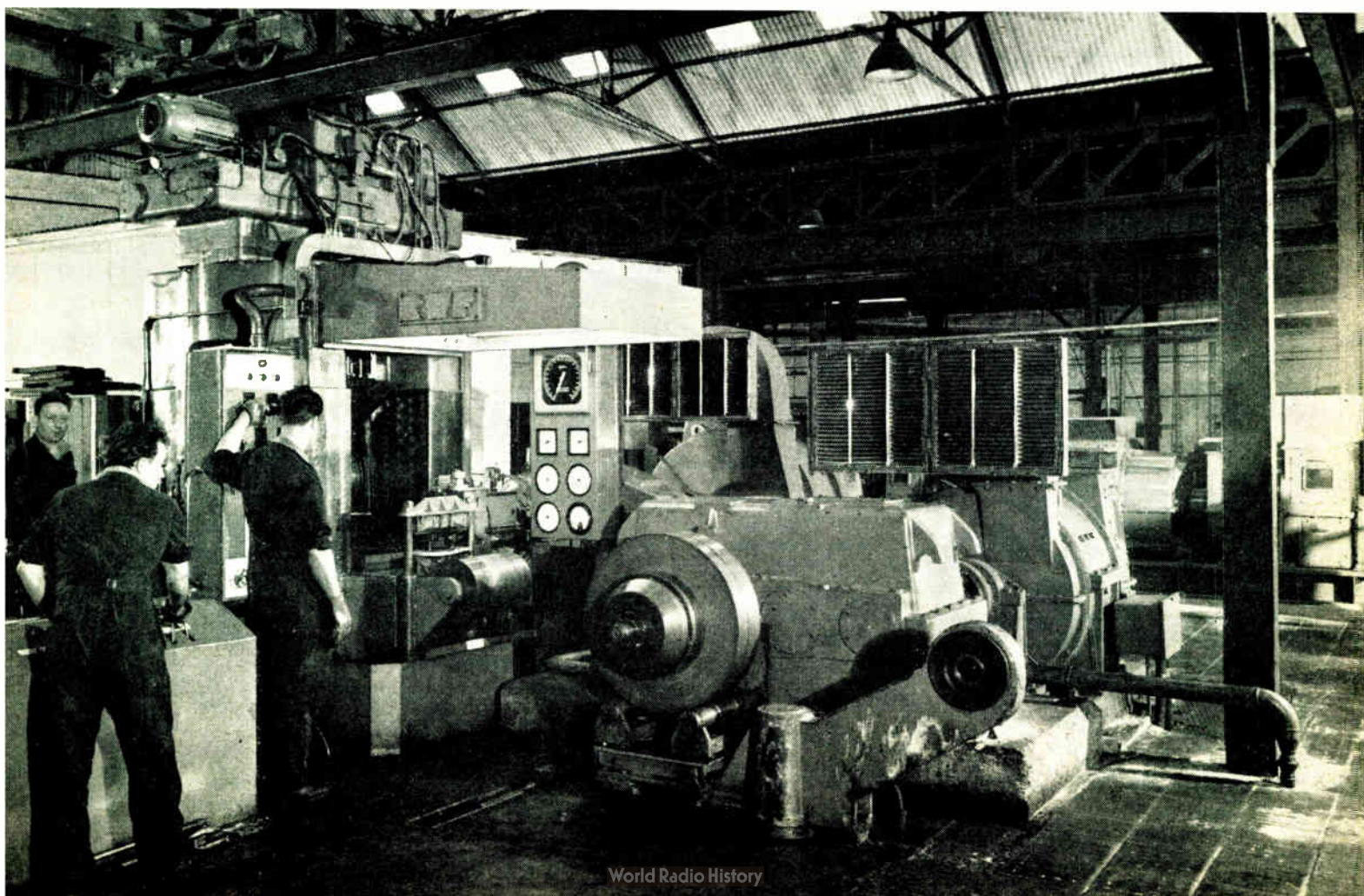

cautions Relating to Intense Radio-Frequency Radiation'.

The transmitter is designed for operation either from a.c. mains or from a 12-V car battery.

A horn—similar to that on the transmitter—is used in the receiver unit, and is coupled by a short length of waveguide to a precision attenuator and crystal detector. The signal from the crystal detector is amplified by a high-gain selective amplifier, and the output is presented on a robust meter.

The Method for Use

The method for using the equipment will vary with the application, but the basic procedure is to set up transmitter and receiver units facing each other, separated by a distance determined by the sample or thickness of the material to be measured. The attenuator knob is adjusted to give a centre-scale reading on the meter and the adjustable cursor is set to 'zero'. The sample material to be measured is then interposed between the transmitter and the receiver, and the attenuator knob is again adjusted to give a centre-scale reading. The attenuator reading is then noted and applied to a calibration chart, or graph, to obtain the level of the actual moisture content.

Calibration is carried out by plotting the known moisture content against attenuation for certain samples, but in the case of instruments which are supplied specially calibrated for a specific material, it is unnecessary to refer to a calibration chart, or graph, as the percentage moisture present can be read directly from an additional scale incorporated in the instrument.

In most cases calibrations for the readings have been established from manufacturers' information as to the actual water content of the samples used.

The meter's application can be taken further than simply confirming the water content in any material. The instrument can provide a system of continuous monitoring on a production line, or allow automatic moisture control of material or products, the design of the equipment being dependent on the type of installation for the particular process involved. Again, the electrical output from the

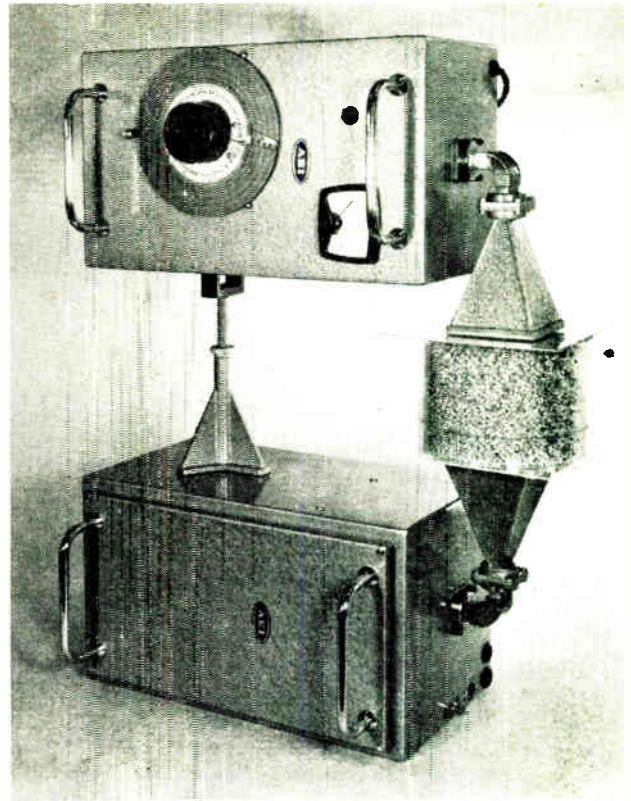

A simple set-up of the meter providing a rapid method for the measurement of moisture content in grain samples

instrument can be used directly to record variations about a fixed mean; to incorporate an alarm system where moisture in a product must be rigidly controlled; or to provide simple industrial controls, such as a reject system. A very high proportion of the total output of material on a production belt can easily be measured by the provision of a large instrument horn for the meter.

The Advantages

The meter has several advantages over existing equipment. Because of the low attenuation of most basic dry materials, the meter measures only the water in a material and nothing else. Measurements can be made in a manner which overcomes bulk density variations and, as no contact with the material is necessary, continuous measurements on a belt are possible without contaminating the material.

Measurements through comparatively large areas are also possible, therefore minimizing sampling errors; and measurements do not involve destruction of a material.

A minimum control of any sample is also necessary, the only consideration being the weight of a granular material or the thickness of a material which has a constant density.

X-Band Moisture Bridge

Where measurements of very small samples are required, an X-band moisture bridge is available which is, basically, a laboratory instrument designed to meet special demands. The principle of operation depends upon the effect of the attenuation presented by the sample on the balancing of a microwave bridge circuit. Once calibrated for the material being measured, the instrument can be read directly. While more expensive than the portable instruments, the X-band bridge can, in many applications, give quick, easy and accurate measurements which would otherwise be impracticable.

For further information circle 58 on Service Card

The laboratory testing of the moisture content of marzipan

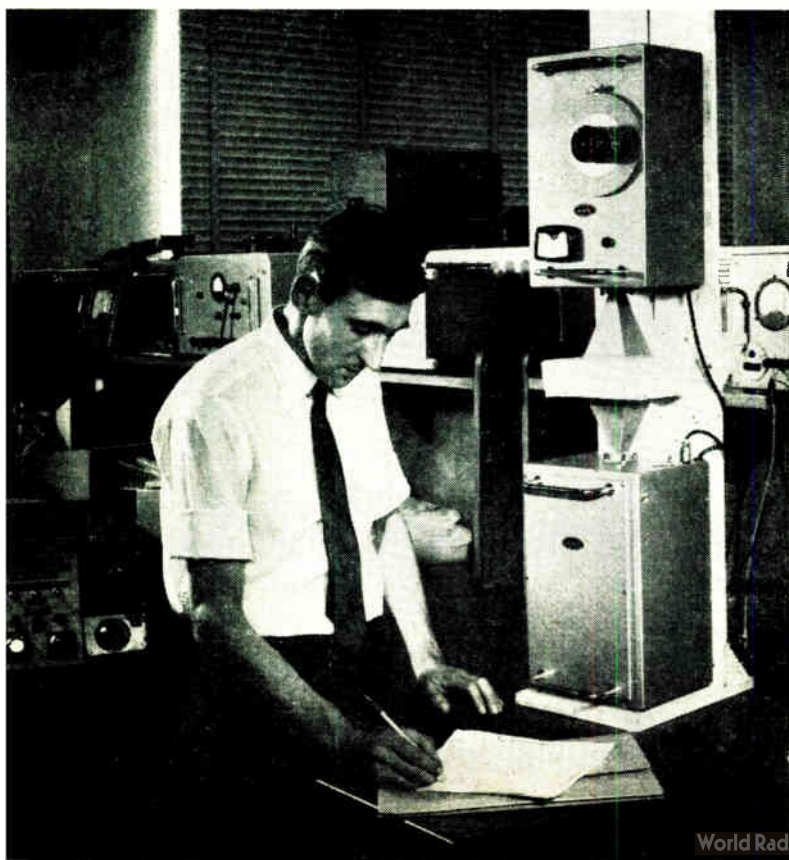

MICROWAVES MEASURE MOISTURE IN SOLID MATERIALS

AN important requirement within industry is a means of accurately establishing the moisture content of product materials either before, during or after the processing of the product concerned. The amount of water in materials ranging from foodstuffs to foundry sand, from soap to ceramics, must be confirmed if product quality is to be controlled.

While means do exist at present for establishing this the methods being adopted are very often cumbersome and do not always allow immediate, highly accurate results. Associated Electrical Industries Ltd. now offers the world's first moisture measuring instrument using microwave absorption principles, specifically designed to meet the demands of industry for equipment giving precise readings over a wide range of solids. It is a versatile, portable instrument, simple to use, which has already proved capable of highly accurate measurements, often to $\pm 0.2\%$.

Measurements with the A.E.I. instrument have already proved to be highly satisfactory over a wide range of industrial materials—foundry sand, grain, refractory clays, cellulose flakes, sand, coal, wood, shredded tobacco, soap, fertilizer, dried fruits, animal foodstuffs, minced meats—and this list by no means exhausts the range of materials on which practical experiments have proved that the moisture meter can offer accurate readings.

There are several moisture meters on the market which rely on the relationship between the resistance, or capacitance, of a material and the water content. While this relationship may hold good for moisture on a surface, the virtue of the microwave method is its ability to assess total moisture through a structure under the area covered by the meter horns.

The meter incorporates techniques already established in electronics laboratories, adapted to meet industrial needs. The principle involved is the measurement at microwave frequencies of the ratio between input and output power transmitted through a solid, in relation to the moisture contained in the solid.

The Equipment

Two types of equipment are at present available. One is an S-band moisture meter operating at a frequency of 2,450 Mc/s which is the type originally designed for the Building Research Station for use within the building industry. It has been designed for the measurement of large samples with a relatively high moisture content.

The second instrument—an X-band moisture meter—has been designed to measure samples too small, or too low in moisture content, to be measured at S-band frequencies. This meter operates at 10,680 Mc/s and is a versatile equipment equally suitable for laboratory or factory applications.

Each equipment comprises two separate lightweight and portable units, the transmitter and the receiver. With the single exception of the microwave oscillator, transistor circuits are used throughout and printed-circuit techniques have been extensively employed.

The transmitter contains an oscillator valve coupled to a short waveguide, terminating in a horn aperture. The valve is protected from external load effects, and the radiation from the aperture is well below the safety levels suggested by the Post Office in the H.M.S.O. publication 'Safety Pre-

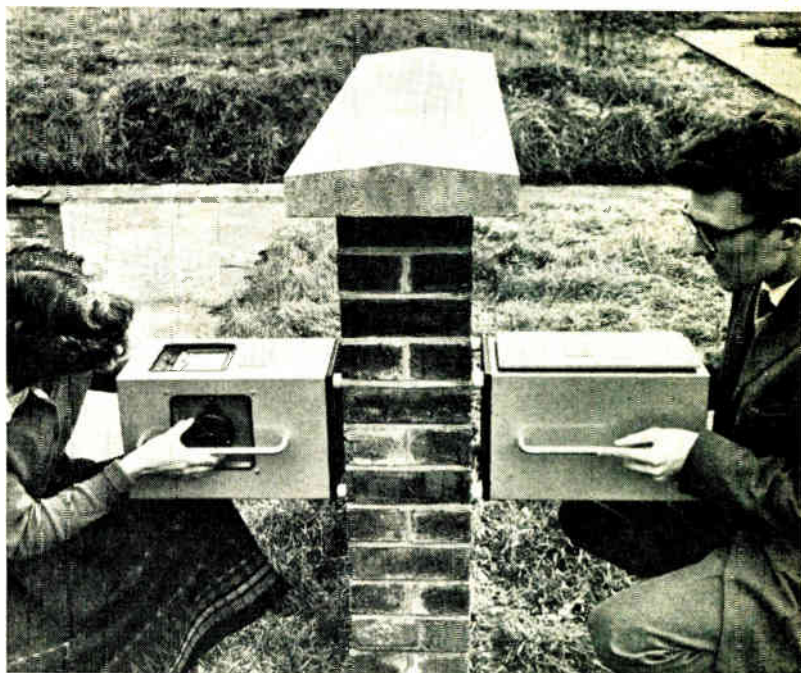

Shown here is a prototype moisture meter being used at the Building Research Station to confirm the water content in brick walls

This illustration shows the application of the meter to the investigation of bulk tobacco



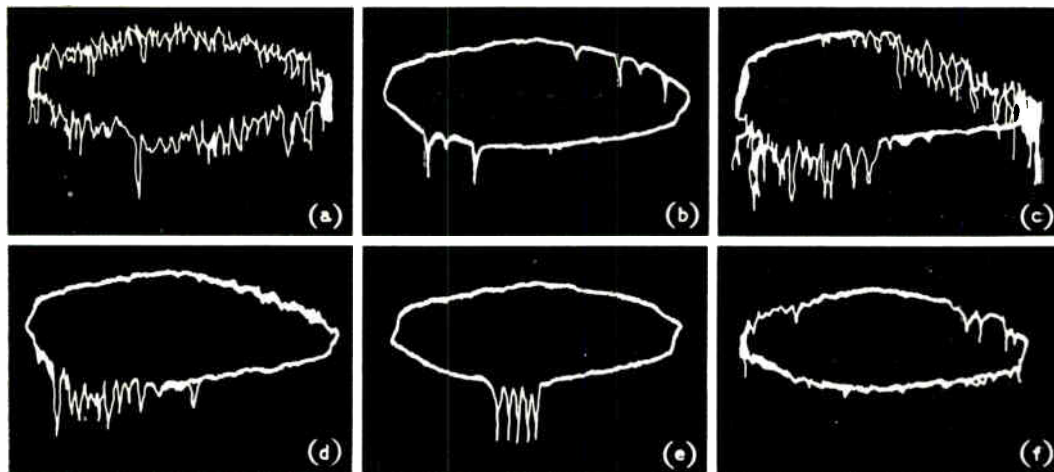

Fig. 2. Typical discharge waveforms on an elliptical display. (a) is background noise with one external discharge, (b) and (c) show internal discharges in transformer insulation, (d) illustrates internal discharges in a coaxial cable, while (e) shows external corona and (f) contact noise

sample. To do this it is essential to use a noise-free transformer to generate the high voltage. Similarly a high voltage blocking capacitor is required at the other side of the specimen (see Fig. 1). This must also be noise-free. Moreover, it is advisable to operate such equipment in an electrostatic shielding cage so that there will be no pick-up from extraneous sources.

Having applied the high voltage across the specimen and induced a discharge, the next stage is to study this. The discharges are fed through the blocking capacitor, to an amplifier with a gain of 120 dB, via a matching unit which matches the specimen capacitance to the input of the amplifier. The amplifier operates at a frequency of 500 kc/s with a bandwidth of 10 kc/s. The frequency at which it can operate is purely arbitrary but 500 kc/s was chosen because of its being a relatively clean wavelength. The bandwidth of 10 kc/s is chosen because it gives a resolution of 35 discharges per quadrant on a 50-c/s ellipse.

The output from the amplifier is then fed to the display unit, which comprises a cathode-ray tube with its associated controls, as well as a pulse generator, for calibration purposes. The normal display is a 50-c/s ellipse superimposed on which are the specimen discharges, which appear as pulses. The calibration pulse can then be varied to equal the amplitude of any of the individual discharges. The pulse so obtainable is fed via a ladder-type attenuator, which gives an output variable from 150 μ volts to 15 volts in 11 steps. The magnitude of this pulse can then be applied to a simple formula to obtain the amount of energy dissipated in the void in picocoulombs and calculated in joules by relating it to the applied voltage.

Because of this visual presentation, it is possible quickly to differentiate among the following sources of discharge.

1. External discharges
2. Internal discharges between dielectric and electrode
3. Internal discharges within the insulation
4. Discharges due to bad contacts.

Fig. 2 shows some typical discharges and their characteristic form. It should be noted that for a given material there is a critical discharge magnitude which should not be exceeded. This is obviously higher for ceramics than for paper or polythene say, but to date it is not possible to give an exact figure for a given material.

An alternative method of indicating the discharges is now available, which has been developed as a result of the application of this equipment to industrial applications, and this is the Audible Discharge Detector. This detector enables relatively unskilled personnel to carry out tests

with the same sensitivity as is obtained with the research instrument. It gives an aural indication of discharges and by calibrating it against a display unit for given conditions, the variable trip can be preset so that it will cut out when the discharge magnitude is too great. Thus for production testing of samples or continuous testing of cable, for instance, the process can go on until the detector indicates too large a discharge; i.e., too large a void. This method of quality control is used widely in industry and, although it is a purely arbitrary method of checking insulation, it is highly successful.

These detectors are being used daily by manufacturers of transformers, radio and television components, capacitors, cables, bushings, mouldings, motors and generators, insulating materials and switchgear, both in solving their insulation problems and in design and research work. In most of the cases given above the application of the high voltage across the specimen is straightforward. One merely connects one end to earth and the other to h.t., as in the case of a transformer, where measurements can be made either to earth or between primary and secondary windings.

However, in some cases it is often necessary to make an electrode or two electrodes for the specimen, in which case an added precaution must be taken. For example, in the testing of the insulation of cable it is necessary to make an annular electrode, which fits over the cable to which the h.t. is applied and the core is earthed. In this sort of configuration it is important to ensure that there is no air gap between the electrode and the specimen and the most efficient way of so doing is to immerse them in a liquid dielectric, for example carbon tetrachloride. There are many liquids one could use, but carbon tetrachloride is usually chosen because it is highly volatile. Hence, after testing the specimen it can dry itself by evaporation, thus obviating the need to wash and clean it. Such a system is used by many cable manufacturers; as the cable comes out of the extrusion plant it is fed through a bath and an h.t. electrode and monitored. Any deterioration in the quality of the insulator would then trigger the audio unit and automatically trip the plant and stop production.

The increased sensitivity and reliability of a.c. discharge detection equipment has meant that it is finding a place in a multitude of radically different types of laboratory and factory. As more and more production managers become conscious of the effort wasted on substandard components the need for such a system will increase. By testing samples before machining and components before mounting, time and effort, and hence money will be saved. This must inevitably lead to improvements in quality and reliability, two of the most important features of any product.

NON-DESTRUCTIVE VOID DETECTION IN DIELECTRIC MATERIALS

By D. M. BERNSTEIN, B.Sc., Grad.Inst.P.*

Apparatus is described for the non-destructive testing of dielectrics for voids. In one form it is suitable for continuous use in production.

THE detection of voids in dielectric materials by high-voltage discharge detection is a technique which has been developed and widely used for the electrical industry. With the more widespread use of this technique, more and more applications are coming to the fore wherein it is required to ascertain the presence of air gaps within materials non-destructively.

One of the main reasons for the improved equipment in this field is the continued expansion of the electrical industry and the tendency to work at high voltages. This means

a suitable part of the frequency spectrum, it is possible to analyse the discharge in detail.

At this stage let us consider the difference between using a.c. and d.c. high voltage for such tests. From the above brief description it can be appreciated that the discharge is all important and so ideally one would like to have time and leisure to study it. If one were to apply a d.c. voltage to the sample a discharge would be induced, but there would be only two conditions of so doing. Either a single discharge would occur when the air gaps broke down electrically or an arc would be set up. Hence, unless one can study the individual discharge at very high speed quantitative and qualitative assessment of the void is exceedingly difficult. By using alternating current, however, the discharge is constantly regenerated and can be looked at with little difficulty.

In order to make full use of this technique many precautions must be taken. The high voltage which is applied to the sample should be completely noise-free for the voltage at which the test is to be carried out, so that any noise obtained is purely as a result of discharges within the

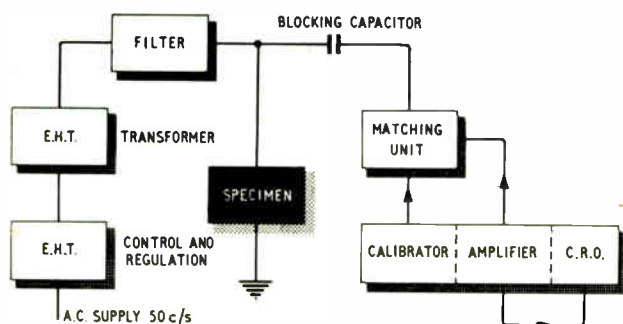
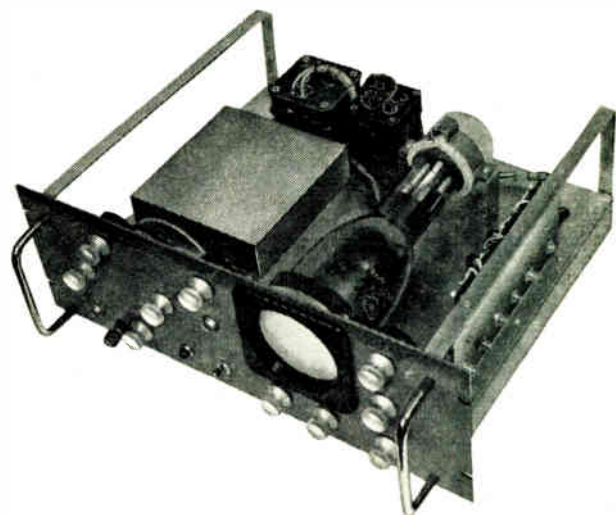

Fig. 1. General form of apparatus for high-voltage testing

that a multitude of diverse components require testing under operating conditions and preferably non-destructively.

A great deal of very advanced research and development work in this field has been carried out by the Electrical Research Association on the basis of which have been developed many highly sensitive a.c. discharge detectors. The photograph shows the fully transistorized display unit type AC.102 which is now in use throughout the world.

The principles on which this testing procedure are based are straightforward. Having selected a dielectric material for test, one applies a high voltage across it. Should there be any air gap within the sample then ionization will be induced and, by picking up the noise from this and selecting



Display unit type AC.102 is fully transistorized

* Miles Hivolt Ltd.

A Modern Aid To Metal Analysis

AS another step forward in the analytical control of their range of magnetic, expansion, spring, resistance, high temperature strength and special alloys, Telcon Metals Ltd. have installed at their Crawley factory the Hilger & Watts Fluorprint—an automatic X-ray fluorescence spectrometer developed to analyse materials rapidly.

The instrument uses a sequential system in which secondary radiation from each element in a sample, excited by an X-ray beam, is measured in turn so that a single channel electronic counting system suffices for all the elements. With this arrangement pulse height analysis is possible for elements whose lines occur in the spectrum where there is a high background, or interfering lines are present.

Programming of the instrument is a simple operation by

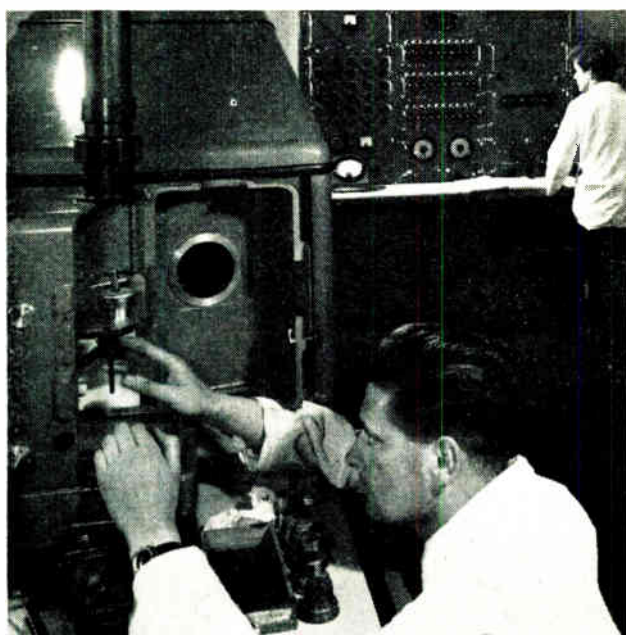

Three-metre grating direct reading Polychromator

the employment of a patchboard on which many parameters can be set independently to give required conditions for the analysis of a particular alloy. This method is very flexible and any required number of programmes can be prepared and kept ready for use. Changing the analytical programme is effected in a few seconds simply by lifting one patchboard from the instrument and inserting another in its place. Mechanical readjustment is not needed and once the analysis is started the operations are entirely automatic apart from changing the samples.

When the intensity of each spectral line has been measured its value, represented by a five figure number, is recorded automatically on a typewriter in a tabulated form, a row for each sample and a column for each element. The element intensity value is then converted to percentage by referring it to a calibration curve prepared from known standards. Up to twenty elements can be determined in any one programme at concentrations from approximately 0.1% to 99.9%.

A chart recording system is also available which enables a semi-quantitative analysis of samples to be made if desired. The instrument can be programmed to scan the spectrum of the sample continuously and from the position

of the lines in the X-ray spectrum, which is relatively simple, the elements present can be determined and the concentration assessed from the radiation intensity.

The Fluorprint suffers from the limitation that it cannot be used for estimation of elements below atomic number 12 and, at the same time, estimation of elements' contents below say 0.1% is not of very high accuracy. On the other hand, the three-metre grating Polychromator can determine accurately contents down to 0.01% and does not suffer from the limitation of only being able to estimate elements with an atomic number greater than 12. Telcon's Polychromator is therefore largely complementary to its Fluorprint and the Company has programmed the instrument which is used for any particular alloy. For the determination of trace elements down to 0.001% and even lower, a 30-in. dispersion quartz Littrow Spectrograph is employed.

The three-metre grating Polychromator is a thirty channel instrument on which up to thirty elements can be determined in an analysis. The operation is similar in principle to a conventional optical spectrograph in which a sample is excited under controlled conditions, usually by high voltage spark, the light from which is dispersed by a diffraction grating. Element lines in the resolved spectrum are then selected by suitably placed exit slits and their intensity measure. This is achieved by converting the light into electrical energy by photomultiplier tubes and storing it in integrating capacitors, there being one photomultiplier and one capacitor for each channel.

At the end of the sparking period the charge in each capacitor is read off in turn and presented as a four figure number by an automatic typewriter. The conversion to percentage composition follows normal calibration techniques. The method is fast, reliable and accurate and a typical analysis for say ten to fifteen elements can be carried out in approximately five minutes.

For the past two years the Telcon instrument has been employed on the routine analysis test control of Mumetal, Permendur and other magnetic alloys, Cu Be 50 and other Beryllium copper alloys, Calomic resistance alloy, Telcon thermoplastic Bimetals and Invar.

The large quartz spectrograph is primarily used for trace elements determinations from upwards of one part per million concentration.

Automatic X-ray Fluorprint



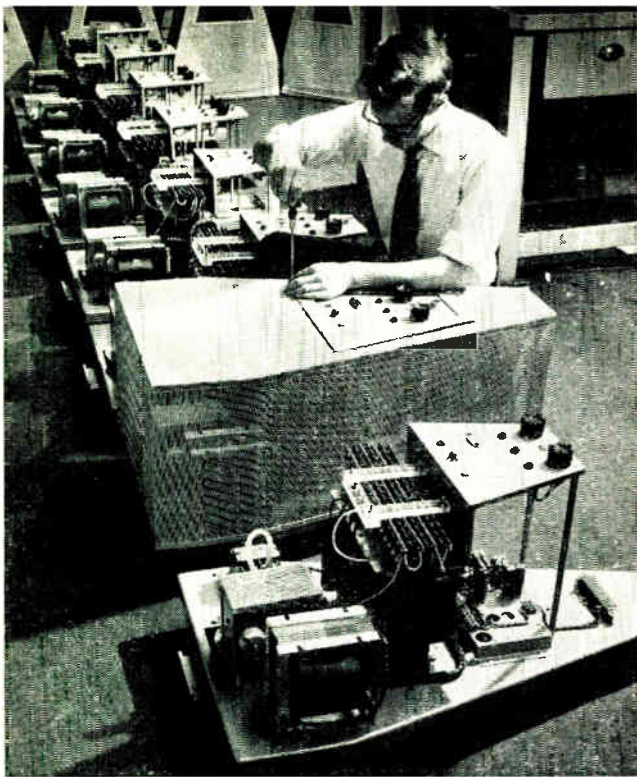

1 This microwave amplifier system, developed by Mullard Equipment Ltd., will accept any type of small signal travelling-wave tube operating in the frequency range 500 Mc/s to 26 Gc/s. It can be used as a permanent wideband amplifier installation in research or for testing t.w.t.s. The picture shows an electromagnetically focused t.w.t. being fitted into the amplifier unit.

For further information circle 50 on Service Card

2 At the University of Sussex, Telequipment S.51 Serviscopes are employed extensively in the physics laboratories. Here a class of first-year undergraduates, studying the wave nature of sound waves, are conducting experiments in ultrasonic refraction and interference.

For further information circle 51 on Service Card

3 A batch of microwave power sources for a foam plastic curing installation being prepared for despatch at an Elliott-Automation factory at Borehamwood. Microwave power not only enables the curing of plastics to be carried out in a fraction of the time taken by conventional methods, but also produces a better result with more uniform curing throughout the product.

For further information circle 52 on Service Card

4 A new form of underground speech communication in the mines of the Rhodesian Copperbelt has been installed by A.E.I. Ltd. for the Rhokana Mining Corporation. Introduced at the Mindola Shaft 2380 level, which handles up to 50,000 tons of ore a month, the system is for the control of rolling stock underground. It has increased mine efficiency, cut down the risk of collision, and has proved a valuable aid in cases of accident and emergency. Each of three locomotives on this level has a battery-operated radio, main control being from a Link House sub-station at the haulage entrances. In this picture, a Link House attendant is communicating with a loco driver. The system works over a distance of 12,000 ft at this particular mine and it is proving so successful that it is to be extended to other 'heavy duty' levels.

For further information circle 53 on Service Card

5 'Home produced' silicon controlled rectifiers provided the answer to a production problem at the Hazel Grove factory of Associated Semiconductor Manufacturers Ltd., makers of Mullard semiconductor devices. On the control panels of an alloying furnace used in the production of s.c.r.s, relays were originally used with a thermostat to switch the heating element 'on' and 'off'. However, it was found that vibration caused by the mechanical movements of the relays seriously upset the alloying process, and so they were replaced by s.c.r.s. In the picture an engineer is fitting an s.c.r. to one of the control panels.

For further information circle 54 on Service Card

6 An operator dials, and the two-way medium-speed data transmission system supplied by A.T. & E. (Bridgnorth) Ltd. links the United Power Company Ltd.'s London headquarters with the Manchester University Atlas computer. The link transmits programmes and data relating to atomic power station construction, in the form of 5- and 7-channel punched paper tape, over the public telephone network at 10 times teleprinter speed.

For further information circle 55 on Service Card

7 Britain's latest 'invisible' export is glass-sheathed copper micro-wire so fine that 100 miles weighs only one pound. This wire, produced by Glass Developments Ltd., London, has a minimum core diameter of 1μ . The picture shows an experimental assembly for winding high-stability resistors for precision electrical instruments. The manganin wire, an alloy of copper, nickel and manganese, is passing through an oiled brush to take up any tension and prevent abrasion of the glass envelope.

For further information circle 56 on Service Card

8 This experimental electric motor has no external connections. Invented by Dr. Harry E. Stockman, Professor of Electrical Engineering at Lowell Technological Institute, Lowell, Mass., this device draws its power from a narrow-beam 70-Mc/s radio signal. Its rotor is a circular loop of wire set at 45° to the vertical shaft.

9 The first public demonstration of a portable ultrasonic device for testing plastic pipe joints was carried out at a recent exhibition. The instrument, which is fully transistorized, has been developed by W. S. Atkins & Partners Research Laboratories in conjunction with Chemidus Plastics Ltd., the plastic pipe manufacturers. The picture shows visitors watching a pipe extruded from Breon rigid p.v.c. being tested.

For further information circle 57 on Service Card

3

6

9

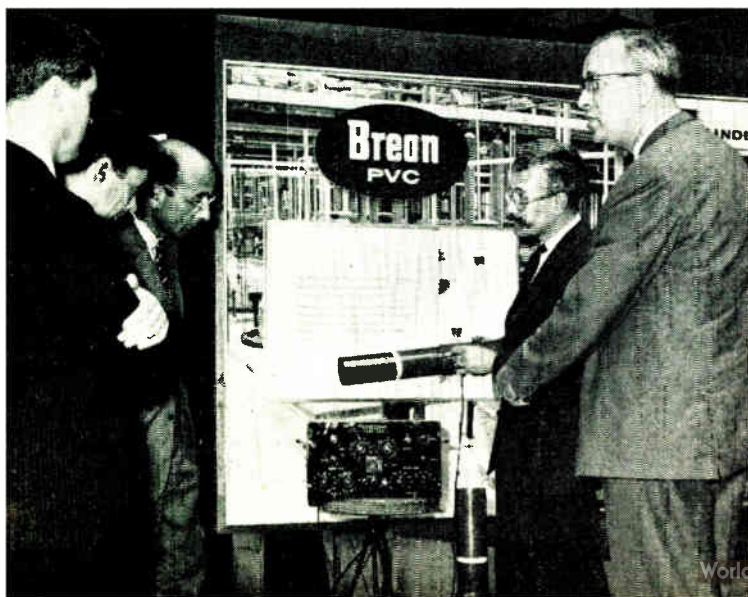
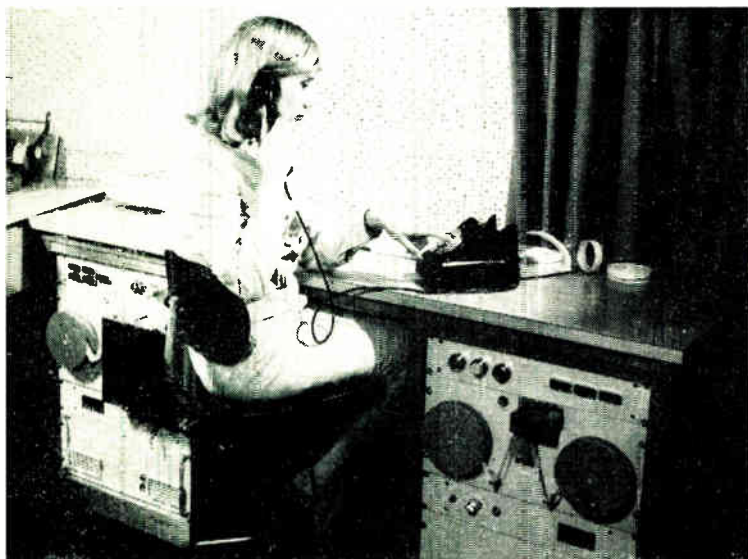

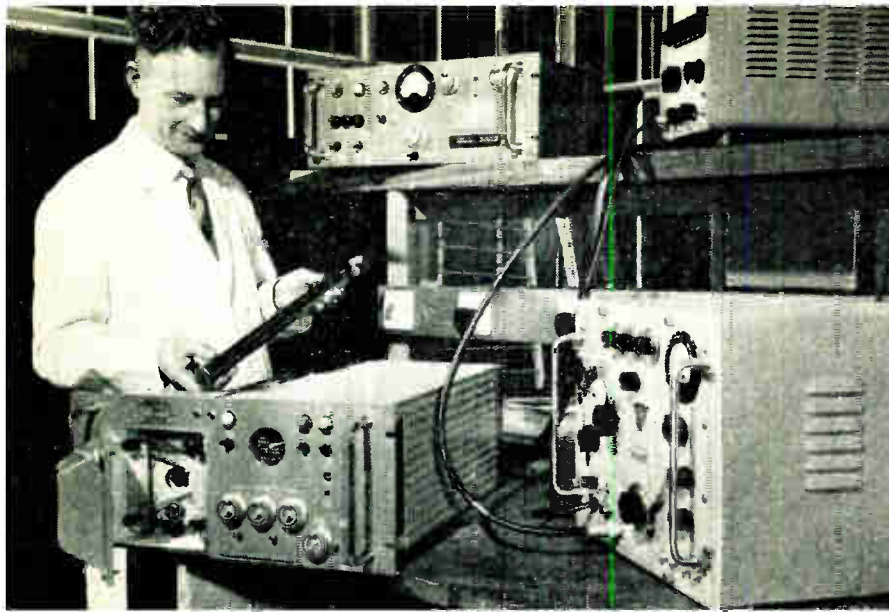

2



ILLUSTRATED
NEWS



4



5

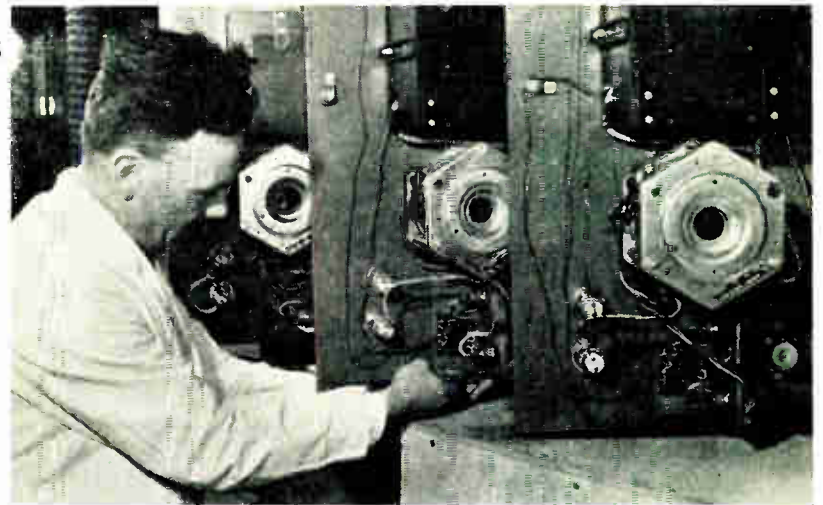

7

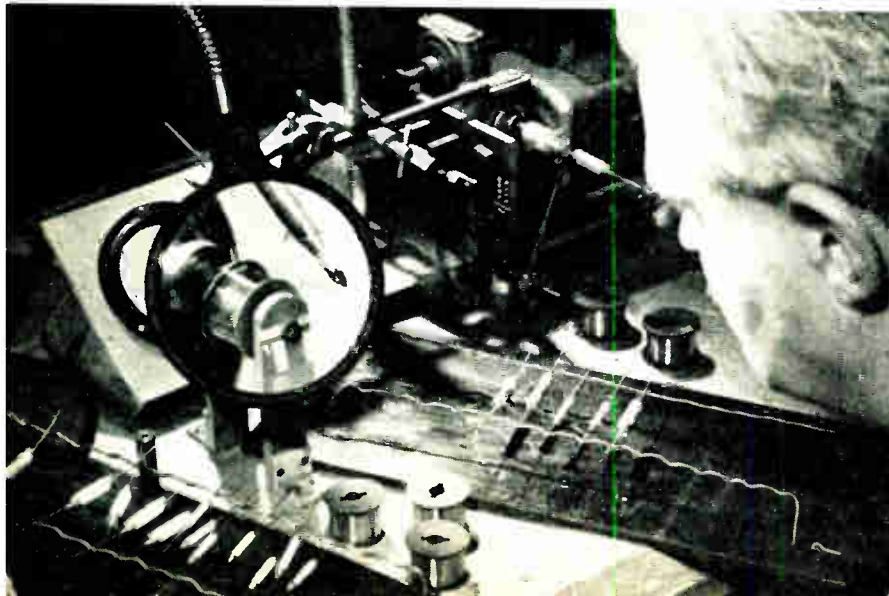

8

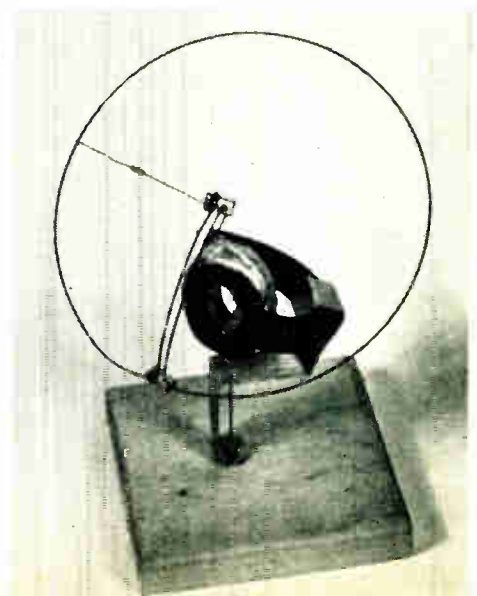

ance signals are transmitted sequentially, alternate lines being $R' - Y'$ and $B' - Y'$. At any instant, therefore, only two signals are being transmitted, the luminance and one of the two chrominance signals. As a result, only simple modulation of the sub-carrier is necessary and normally frequency-modulation is used.

At the receiving end the chrominance signals are divided into two channels, one direct and the other through a delay line which delays the signal by exactly one line period. The input signal is $R' - Y'$ and $B' - Y'$ on alternate lines. The direct output is the same. The delayed output is $B' - Y'$ and $R' - Y'$ on alternate lines. The direct-line signals correspond to the scanned lines at the transmitter; the delayed-line signals correspond to the previous lines. The success of the system depends upon there being very little difference in the picture content of any two successive lines, so that at any time the signal of the previous line can be substituted for the real signal of the line with negligible difference.

At any time, therefore, there is a $R' - Y'$ signal on one output and a $B' - Y'$ on the other, but they change over between the outputs at line frequency. An electronic switch synchronized from the line timebase sorts this out and produces two outputs, one of which is always $R' - Y'$ and the other $B' - Y'$. The usual combining network then produces the R' , G' and B' signals for application to the c.r. tube.

Theoretically, there must be a loss of colour definition with Secam because only one-half the colour information is transmitted. However, if two successive lines are in fact very nearly the same so that the effect on the received picture is very small, it is fairer to put it the other way round and to say that N.T.S.C. is transmitting redundant information.

Secam appears to be a good deal simpler in the receiver, except for the delay line, and is relatively little affected by phase so that a hue control is unnecessary. The delay line must not be confused with the one referred to in the N.T.S.C. receiver. That has to give a delay of a few microseconds at most and a short length of delay cable suffices. The Secam delay must be 64 μ sec. Attention at the moment is centred on using the transit time of ultrasonic waves in glass to obtain the delay. This entails transducers at each end and, possibly, frequency changers also.

Because of the problem of delaying the colour signals by a line period Secam is not quite as simple as it at first appears. At the present time the cost of the delay line is prohibitive, but this is largely because the demand for delay lines is very small. If Secam were adopted as a European standard the demand would eventually run into millions and it is said that with such large production the cost would fall to quite a reasonable figure. However, there must inevitably be an awkward period on the introduction of the system when the delay line is still expensive because the quantities needed are still small.

Pal

Two versions of Pal exist, a simple and a more complex system. Both are the same at the transmitting end, it is only the receivers that differ. At the transmitting end there are two differences only from the N.T.S.C. system. One is a minor one and consists of having a half-line offset, it has a quarter-line offset plus 25 c/s. This is to reduce crawling dot effects. The major difference of Pal compared with N.T.S.C. is that the phase of the I' colour signal is reversed in successive lines.

The simple receiver is much the same as an N.T.S.C. set but the phase reversal of the I' signal results in trans-

mission distortion affecting the hues of successive lines in a complementary manner. The eye averages the effect of a pair of lines and sees the average, which is nearly the correct hue. To put it crudely, if distortion makes one line too red, the next line will not be red enough because of the 180° phase change. The eye sees the too-red and the not-red-enough lines together and interprets the pair as two lines of the right red. The method is said to be satisfactory as long as the distortion is not too great.

The more complex Pal receiver is claimed to be almost immune to phase distortion. This has a delay line of the Secam type to which is applied the combined modulated colour signal. The output is then added to the input in one circuit and subtracted from it in another in order to separate the colour components. The process is analogous to the addition and subtraction of complex quantities. If the signal for one line is regarded as $A + jB$, the delayed signal of the previous line is $A - jB$, because of the phase alternation between the lines. Then addition gives $2A$ and subtraction $2jB$.

After separation envelope detectors can be used to obtain the video colour signals and a change-over switch reverses the phase of one in synchronism with the transmitter switching. This is readily synchronized from the line timebase or from the line sync pulses.

Conclusion

Colour television is a complex process and there are many more important matters than it has been possible to describe in a short article. The lines tend to be broken up into dots and so the picture background tends to have a dot structure rather than the usual horizontal line structure of ordinary monochrome television. It is not prominent and is not at all displeasing.

Under certain conditions it can become prominent and it is then a decided drawback. It is due to various interference effects between the various signals and very precise frequency relations must be established and maintained in order to minimize it.

At the present time the three systems are being carefully studied in order that one of them may be adopted as a general standard for Europe. America and Japan both use the N.T.S.C. and in favour of this one is the fact that there is a background of some 10 years' operational experience. It is not a new and untried system, its capabilities are well known not only in the laboratory but in regular broadcast use.

Its main drawback seems to be its susceptibility to phase distortion. This affects hue and makes it necessary for the receiver to have hue controls. All the user can do is to adjust these for the most natural-looking picture but he has no other guarantee that the colours are in fact the correct ones.

The other systems claim relative immunity from the effects of phase-shift and as a result, that hue controls in the receiver are unnecessary.

Industrial Electronics

Since *Industrial Electronics* started in October 1962, this issue is the 12th and would normally complete a volume. It is inconvenient to have volumes running from October to September, however, and so the first volume of *Industrial Electronics* will have 15 issues and be completed with the December issue. Thereafter volumes will run normally from January to December.

equivalent to the combined amplitude and phase modulation of a single sub-carrier. The amplitude modulation is then proportional to $\sqrt{I'^2 + Q'^2}$ and the phase modulation to $\tan^{-1}(I'/Q')$. In the modulation process the sub-carriers are removed, the I' signal is brought to vestigial sideband form, but the Q' signal is left double sideband.

This composite colour signal is then added to the luminance Y' signal and the whole modulates the vision carrier in the ordinary way. The usual sync pulses are added, of course, and an extra sync signal is included to enable the colour signals to be separated at the receiver. This takes the form of 9 cycles of the sub-carrier frequency inserted during the line back porch. It is called the colour burst signal.

In the pre-detector stages of a colour receiver the only difference from a monochrome receiver is that greater care must be taken to obtain good phase characteristics in the i.f. amplifier. At the detector output the video waveform is recovered as usual. This is, of course, the composite signal comprising the Y' signal, the colour signals in their sideband form, the sync signals and the colour burst. The whole signal is passed to a sync separator which extracts the line and field sync pulses in the usual way; it also goes to a gate circuit which extracts the colour burst. This is used to lock a local oscillator in frequency and phase. The whole signal is also applied to a delay line and to a band-pass filter. The purpose of the delay line is to keep the whole signal in step with the output of the filter which unavoidably introduces some delay.

The filter passes all the frequencies associated with the colour signals and rejects the others. As the high frequencies of the Y' signal overlap the colour frequencies these are necessarily passed as well, just as the colour signals are also passed through the delay line with the Y' signal.

The filter output is passed to two synchronous detectors which are also fed from the local oscillator synchronized by the colour burst. The local oscillator inputs to the two detectors have a 90° phase difference between them. The detector outputs are the I' and Q' signals. These are then combined with the Y' signal to produce the R' , G' and B'

signals to operate the three guns of the colour reproducing c.r. tube.

It must be stressed that in the colour demodulation process phase is very important and has a large effect on the hue of the reproduced picture. It is not the phase of the local oscillator alone which matters but the phase of the colour sidebands relative to it. Phase distortion anywhere in the transmitting-receiving chain can, therefore, affect hue. The receiver is thus fitted with a phase adjustment to the local oscillator to enable it to be brought to the correct relative phase. This must be done by observing the picture and adjusting the control for the best colouring. As the viewer has no real standard of reference he can only adjust for what he considers the most pleasing picture. Flesh tones are often the most reliable guide, although even with these the viewer does not know whether a particular face is really a pale one or deeply sunburnt!

This phase or hue control is intended to be largely a pre-set control which is adjusted when the receiver is installed. Unfortunately, however, there can be phase changes in transmission from one programme source to another. Ideally, the broadcasting authority would avoid these, but this may not be possible in practice. The hue control is thus fitted as a user control and may need adjustment when the programme source changes, just as the brightness control of a monochrome receiver sometimes needs adjusting.

This effect of phase on hue, and the need for a user control, are often regarded as the chief drawbacks of the N.T.S.C. system. It is to overcome them that other systems have been devised.

Secam

The initial stages of a Secam system are substantially the same as those of the N.T.S.C. The luminance signal Y' and the chrominance signals $R' - Y'$ and $B' - Y'$ are still formed. The difference lies in the way in which they are encoded for transmission. In N.T.S.C. the three signals are transmitted simultaneously, the chrominance signals doubly-modulating a sub-carrier. In Secam, the chromin-

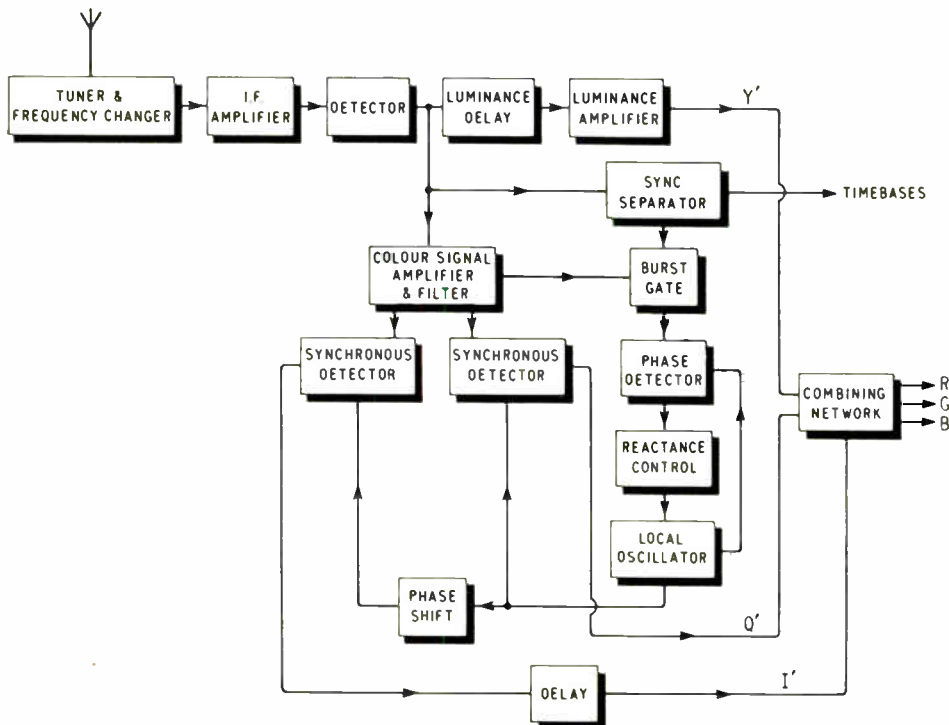

Fig. 4. Simplified block diagram of colour television receiver. The combining network is a resistance network for producing R' , G' and B' from Y' , I' and Q'

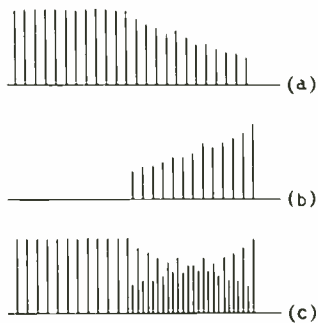

Fig. 3. The spectrum of the luminance signal is shown at (a). The vertical lines represent the frequencies at which energy is mainly present. For 625-lines they are 15.625 kc/s apart and extend from 15.625 kc/s to 5 Mc/s. The whole series thus cannot be shown clearly on a diagram. The spectrum of the colour modulated sub-carrier is shown at (b); the sub-carrier frequency is chosen so that the lines of the spectrum fall half-way between the lines of (a). The combined spectrum of (a) and (b) is shown at (c)

width and still produce a perfectly satisfactory colour picture. This cannot be done with the frame-sequential method, which is why it is now rarely adopted.

Some reduction of bandwidth can be made directly and simply. It is an experimental fact that the eye is much more sensitive to colour in large areas than to colour in small ones. In particular, it is little affected by colour at points where the intensity changes suddenly. It is the sudden changes which are responsible for detail in the picture and for its sharpness and it is these which call for the highest frequencies in the transmission.

A reduction of total bandwidth can be achieved, therefore, by transmitting a black and white picture at its full bandwidth and colour information at reduced bandwidth. A useful analogy here is to a hand-coloured photograph. Even today not all colour pictures are produced by colour photography. It is still quite common to take a black and white photographic print and colour it by appropriately painting it. The detail in the colouring is obviously much less than in the monochrome photograph itself but the overall result can be exceedingly good.

In colour television the R' , G' and B' signals are not transmitted directly, but are first processed to a different form.

The first step is to produce a monochrome or luminance signal, designated Y' , by adding together proper proportions of the R' , G' and B' signals. This can be done quite simply using resistance networks, so that

$$Y' = 0.3R' + 0.59G' + 0.11B'$$

Colour difference signals can then be formed, $R' - Y'$ and $B' - Y'$. Notice that if R' , G' and B' are all equal, as they are for any shade of white from true white to black, Y' is the magnitude of R' or G' or B' and both colour difference signals disappear. This is advantageous in reducing interference effects, for it means that the difference signals are normally of fairly small amplitude, becoming large only on highly saturated colours.

Actually, the colour difference signals are not transmitted directly but have some further manipulation to bring one of them to represent the colour to which the eye is least sensitive. In addition, the $R' - Y'$ is reduced in amplitude by 1/2.03 and the $B' - Y'$ by 1/1.14. The final signals are designated I' and Q' and are

$$I' = 0.736(R' - Y') - 0.268(B' - Y')$$

$$Q' = 0.478(R' - Y') + 0.413(B' - Y')$$

In practice, it is not necessary to form the initial colour difference signals and then transform them to the amplitude reduced I' and Q' signals. These can be formed directly as

$$I' = 0.6R' - 0.28G' - 0.32B'$$

$$Q' = 0.21R' - 0.52G' + 0.31B'$$

and, like the formation of Y' , these can be produced by resistance networks and phase-reversal stages to represent the minus signs.

It has been found that for a 625-line system, for which the full monochrome signal requires a bandwidth of 5 Mc/s, a bandwidth of only 400 kc/s suffices for Q' and 1.3 Mc/s for I' . These are actually the limits of flat response of the filters used and as the filters used do not have very sharp cut-offs, the effective bandwidths are a bit more. The I' and Q' signals are thus passed through filters to limit their bandwidths, and this alone considerably reduces the total bandwidth needed by the complete colour television signal. The reduction from something like 15 Mc/s to a nominal 6.7 Mc/s (actually probably nearer 8 Mc/s) is achieved purely by eliminating unnecessary information from the signals, unnecessary because the eye cannot appreciate it.

The next step is to combine the three signals, Y' , I' and Q' (from now on I' and Q' refer to the band-limited signals) so that they can be transmitted within a 5-Mc/s bandwidth. It is in this that the most difficult part of colour television arises and where the differences between different systems come in.

Signal Spectra

The possibility of doing this arises because a television signal does not have a continuous frequency spectrum. Because of the scanning process the frequencies are all multiples of the picture repetition frequency 25 c/s. The amplitudes of all components of the spectrum are far from equal, however. Because of the line scanning the really important frequencies are the line repetition frequency and its harmonics. The 25-c/s harmonics are there but their intensity is greatest around the line frequency and its harmonics and falls off very markedly between them. The line frequency is 15.625 c/s and so the energy of the monochrome signal is concentrated around frequencies of 1, 2, 3, 4, 5, $n \times 15.625$ c/s and there is very little half-way between these frequencies. The general form of the spectrum is sketched in Fig. 3 (a).

The spectra of I' and Q' signals are similar. If these two signals can be combined in such a way that they can afterwards be separated, the resulting signal will have a similar discrete spectra. This resultant colour signal can then be used to modulate a sub-carrier having a frequency towards the upper end of the monochrome video-bandwidth, say around 4.5 Mc/s. If its exact frequency is made an odd multiple of half the line frequency its sidebands when modulated will all fall at frequencies which are half-way between the spectrum frequencies of the monochrome signal, as in Fig. 3 (b). The two spectra will interlace and can be added together, Fig. 3 (c). In theory, they could then be separated again by a comb filter but this is hardly practical and other means are used.

Some other considerations come into the exact choice of frequency, but these will not be considered here. For 625-lines, the sub-carrier is actually 4,429,687 c/s and is obtained by multiplying one-half the line frequency by 567.

N.T.S.C.

In the N.T.S.C. system two sub-carriers 90° different in phase are produced; one is modulated in amplitude by I' , the other by Q' . The two are then added and form the combined colour signal. This can be considered as

or a microwave channel can be used to link camera and receiver, it is a practicable system. The colour discs and their synchronizing can be a nuisance, however, and a disc for a large picture tube is hardly practicable.

Bandwidth

Since it is necessary in any colour system to transmit three pictures it might seem as if the bandwidth problem was inescapable. In fact, it is not and it is possible to transmit an acceptable colour picture within the limits of a black and white bandwidth! This comes about partly because the eye responds mainly to large areas of colour and not to fine detail of colour. This results in individual colour signals, especially blue, needing less bandwidth.

Then the frequency spectrum of the signal corresponding to a black and white picture is not continuous but is broken

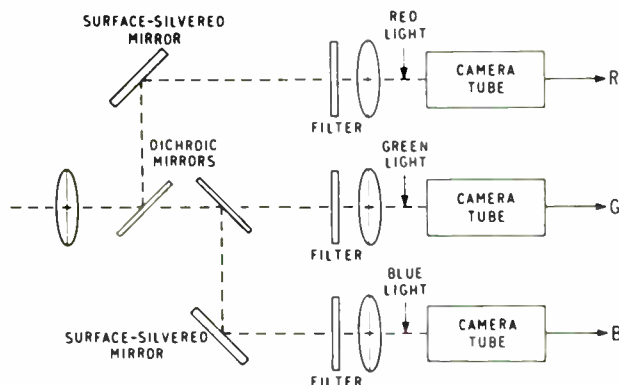

Fig. 1. General form of colour camera

by the scanning process into a multi-line structure. Energy is transmitted only around discrete frequencies within the total bandwidth, with gaps between these frequencies. The colour signals have similar spectra, and it is possible to interlace the spectra and so convey more information within a given bandwidth.

The saving of bandwidth is naturally obtained at the expense of complexity of equipment at transmitter and receiver.

The Colour Camera

Basically a modern colour-television camera has three tubes upon the screens of which the scene is focused by means of lenses and dichroic mirrors. The general arrangement is sketched in Fig. 1. The lens system brings the scene to a focus on each of the vidicon tubes. The first dichroic mirror reflects blue light as shown but passes the rest of the light. The second reflects red light, but passes the residue. Further mirrors reflect the blue and red light on to the blue and red tubes, while the green light which passes through both dichroic mirrors goes to the green tube. The properties of the dichroic mirrors are aided by further colour filters and the objective lenses, one for each tube, bring the three images to a focus on the three tubes.

In this way the picture formed on the screen of the red tube is due to the red light in the scene being televised, that on the green tube is due to the green light in the scene, and that on the blue tube to the blue light. Each tube produces an output signal in exactly the same way as does a normal monochrome vidicon camera. There are, however, three outputs corresponding to the red, green and blue components of the picture. For brevity the three outputs are conventionally referred to as the R, G and B

signals. Gamma correction is usually necessary, as it is also in monochrome, and when this has been carried out the three signals are usually referred to as R' , G' and B' , the minute sign indicating that the signals have been corrected for gamma.

These three signals applied to a picture tube, after amplification, of course, will produce a colour picture. It is possible to employ three separate c.r. tubes with red, green and blue phosphor screens and to combine the three pictures with mirrors. This virtually entails the use of a projection system and it is by no means easy to put this into effect, although in principle it is the simplest way.

Almost invariably the so-called shadow-mask tube is used. This is a single tube with a screen comprising a mosaic of red, green and blue dots. The dots are in a regular formation and each group of three, comprising one each of red, blue and green, is in a triangle. Behind the screen is a metal plate, the shadow mask, with holes in it aligned so that each hole comes behind a triad of dots. In a 21-in. tube there are 375,000 holes and over a million colour dots.

The tube has three guns which produce three electron beams at a slight angle to one another. Most of the electrons in any beam are intercepted by the shadow mask but those which do pass through a hole are constrained to a very narrow beam and, because of the angle between the three beams, the electrons from one gun fall always on red dots, those from a second gun always on green dots and those from the third gun always on blue dots. The arrangement is sketched in Fig. 2.

Since the colour dots are physically displaced from one another the three coloured pictures formed are not strictly superimposed. However, any three dots are so close together that the eye sees them as a whole, and when three are properly excited the eye cannot separate them at any reasonable distance from the screen and 'sees' white.

The scanning and focusing arrangements needed to ensure that the picture is built up properly and, in particular, to ensure that only the electrons from the red gun reach the red dots, those from the green gun the green dots, and those from the blue gun the blue dots, are quite complex. There are many rather critical adjustments which must be made when first setting up a tube. It is not necessary to go into these here, however.

If the colour signals from the camera are applied to the three guns of the colour tube a colour picture will be obtained. Three connections for the three colour signals are needed, of course, and so the total bandwidth needed is three times that of a monochrome television system. On a bandwidth basis there is thus apparently no benefit over the simpler frame-sequential system. In fact, however, it is possible to modify the signals in such a way that they can be carried by a single channel of monochrome band-

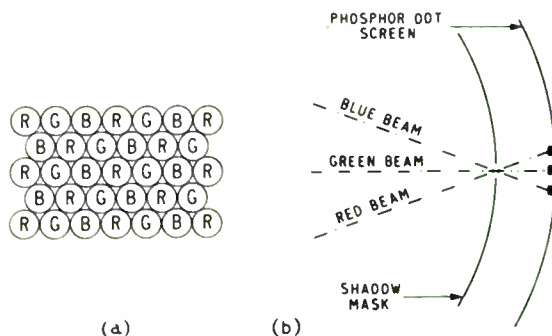
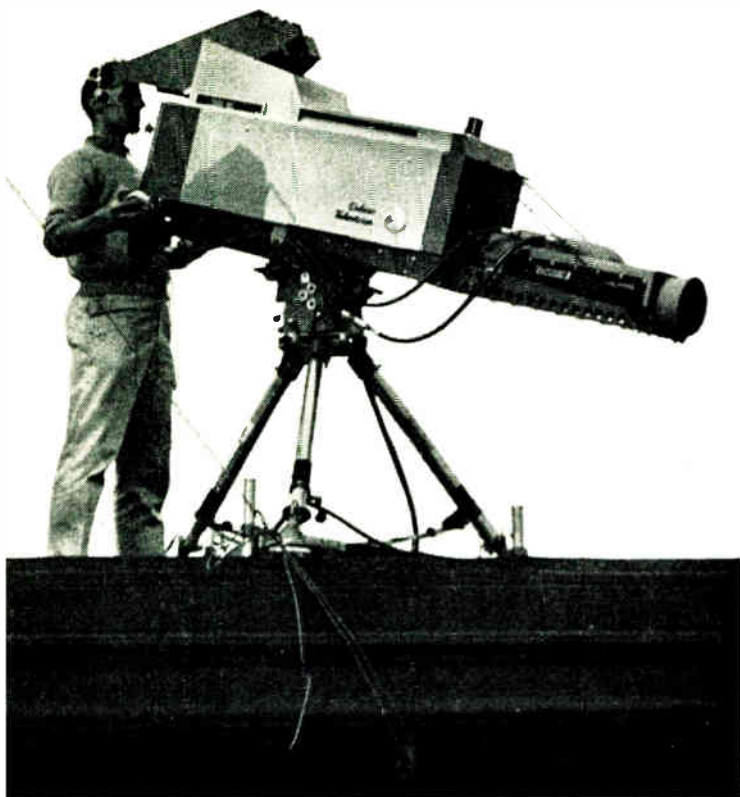

Fig. 2. Form of colour dot structure of the screen of a shadow-mask colour reproducing tube (a) and how the electron beams are constrained by the mask to fall on the right dots (b)

COLOUR TELEVISION

Three colour-television systems are competing for adoption as the European standard. This article explains how they work and the differences between them.



Marconi colour-television camera fitted with a zoom lens. The camera has three 3-in. image orthicons and is suitable for studio or outside broadcasts. It is provided with a tilting viewfinder

ALTHOUGH broadcast colour television has been in operation in the U.S.A. for some years, it is unlikely that it will be adopted in this country for some time. It will certainly not be adopted as a regular service until the change from 405-lines to 625-lines is, at the least, well under way. It is desirable that the colour television system eventually adopted for Great Britain should be the same as that employed throughout the Continent. Europe generally has no colour service and there is at the moment complete freedom of choice. Discussions are going on, therefore, in an attempt to agree internationally upon the proper system to adopt.

There are at the moment three rival systems, the American N.T.S.C., the French Secam and the German Pal. The American is the only one in regular use and it is the only one for which a large amount of practical experience exists. Relatively, the other two are experimental systems having theoretical advantages. A great deal of work is going on in making comparative tests of the three systems.

Colour television is quite complicated and not very many people, apart from those working on it, fully understand it. As a broadcast service, it has always lain so far in the future that most electronic engineers have not troubled very much about it. The position is now changing, however, and colour does not now seem to be so far ahead. It is thus becoming important that engineers generally should understand how it works and what the three rival systems are.

The Secam and Pal systems are more in the nature of modified N.T.S.C. systems than completely different ones. The first thing of importance, therefore, is to understand the N.T.S.C. system. There is plenty of literature on this and anyone who wants to go into it at all deeply is recommended to read 'Colour Television', by P. S. Carnt and G. B. Townsend (Iliffe).

Whatever the process, the good reproduction of a colour picture requires the superposition of three pictures in red, green and blue.

Frame Sequential System

The simplest colour television system is the one known as the field sequential system. With this a more or less standard monochrome television system is used as the basis. The camera has in front of it a rotating disc with coloured segments, red, green and blue. The picture tube has a similar disc in front of it which rotates in synchronism with that at the camera.

During one field, field 1, say, the camera lens is covered by a red segment and the camera is responsive only to red light in the scene being viewed. The resulting picture is passed through the television system and reproduced on the picture tube where it is viewed through the red segment of the disc at that end.

For field 2, green filters come in front of the camera lens and the picture tube, so that a picture corresponding to green light is reproduced and seen through the green filter. On field 3 exactly the same thing happens but with the blue filters. The process then repeats with field 4 red, field 5 green, and field 6 blue.

Because of the interlaced scanning system there are two fields to one complete picture in monochrome. It therefore takes six fields to build up a complete colour picture. If flicker effects are to be avoided the time available for building up the complete picture must be the same and so the field frequency must be three times as great for a colour television system of this kind as for black and white. This inevitably means that the bandwidth needed for transmission is also three times as great.

It is thus impracticable to use such a system on radio for it would at once reduce the number of television channels available to one-third. For special purposes where cables

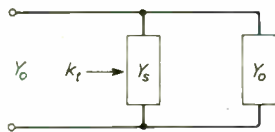

Fig. 6. Matched line shunted by a loss-less stub

Fig. 7. The short-circuited double- Y_0 stub

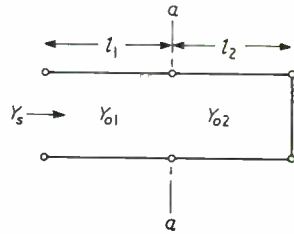
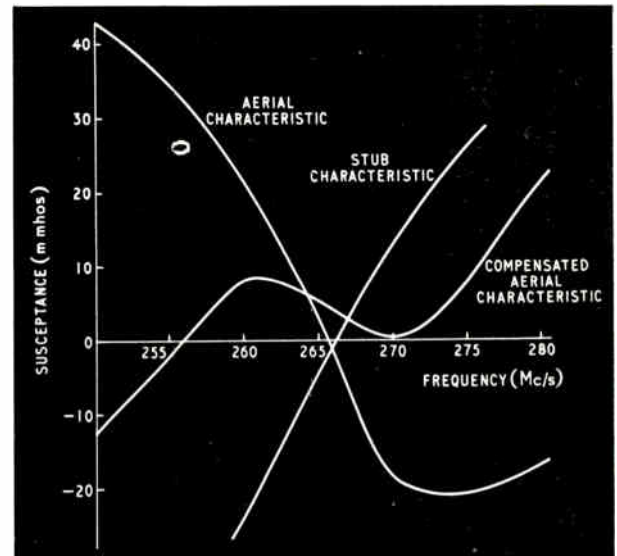

Fig. 8. Measured characteristics of the compensated aerial system



it is more convenient to consider the lossless case as one is enabled to consider frequencies of apparently zero and infinite losses as pass and rejection frequencies respectively.

Double- Y_0 Short-Circuited Stub

This is the dual of the open-circuited stub just considered and in the same way as that stub was found to correspond to the single- $Y_0 \lambda/4$ short-circuited stub so this stub can be shown to correspond to the single- $Y_0 \lambda/2$ open-circuited stub.

The design of the stub as a broad-band matching element is the same as for the open-circuit case except that from Fig. 3 suitable values of Y_{01}/Y_{02} and Y_{02} are taken in this case and secondly the length of line of characteristic admittance Y_{01} is made $\lambda/2$ at the mid-band frequency and the other length of line is made $\lambda/4$ at this frequency.

When considering this stub as a filter element shunting a matched line we find that the corresponding equation to equation (5) is:

$$L = 10 \log_{10} \left(\frac{4}{4 + \frac{Y_{01}^2}{Y_0^2} \left(\frac{Y_{01}/Y_{02} \tan \beta l - \cot \beta l}{1 + Y_{01}/Y_{02}} \right)^2} \right) \text{ dB} \quad (7)$$

For a pass frequency,

$$\cot \beta l = \pm \sqrt{(Y_{01}/Y_{02})} \quad (8)$$

and for a rejection frequency,

$$\beta l = n\pi/2, n = 0, 1, 2 \dots \quad (9)$$

so that in this case it is the rejection frequencies which occur in a fixed series. As for the open-circuited case, there is a choice of absolute values of Y_{01} and Y_{02} for a fixed ratio Y_{01}/Y_{02} but if the insertion loss is specified at one other frequency then equation (7) can be solved to fix Y_{01} .

Susceptance Compensation of a Unipole Aerial

As an example of the use of the device, the results of the susceptance-slope compensation obtained on an actual unipole aerial, $\lambda/4$ long, mounted above a solid earth plane will now be given.

Fig. 8 shows the measured variation with frequency of the susceptance of the aerial at its base, in which it can be seen that the shape of the characteristic over the band 255–270 Mc/s is ideal for compensation, being sensibly linear. An open-circuited double- Y_0 stub was constructed from copper

tube, designed to have an equal and opposite susceptance-slope to that of the aerial, and connected through a taper to a T-junction as near as possible to the base of the aerial. The aerial characteristic measured alone and the overall characteristic of stub and aerial together are also shown in Fig. 8.

It can be seen that if, say, ± 10 mmhos are taken to define the limits of bandwidth, then the aerial bandwidth before compensation is 4 Mc/s (263–267 Mc/s), being improved by the compensation to 24 Mc/s (252–276 Mc/s).

References

- 1 C. H. Westcott and F. K. Goward, 'The Design of Wide-Band Aerial Elements for 500–600 Mc/s Ground Radar', *Journal I.E.E.*, Vol. 96, Pt. 3, 1948.
- 2 Willis Jackson, 'High Frequency Transmission Lines', Methuen Monograph No. 4013/U., 1945.

Exhibitions, Conferences and Symposia

The Institute of Physics and The Physical Society has announced that its 1964 Exhibition of Scientific Instruments and Apparatus will be held in the halls of The Royal Horticultural Society, Vincent Square, London, S.W.1, from the 6th–9th January. The 1965 exhibition will be held in the first week of April, at the Manchester College of Science and Technology.

The North-West Branch of the Institute of Metal Finishing are holding a one-day 'Symposium on Precious Metals' at Belle Vue, Manchester, on 12th March 1964.

There appears to be good support for the forthcoming I.E.E. conference on 'Dielectrics and Insulating Materials' to be held in London from the 8th–10th April 1964. The conference is to be organized with the intention of encouraging as much discussion as possible: of the total time available, only a small part will be allocated to the presentation of papers.

The Institute of Physics and The Physical Society, in collaboration with the Society of Instrument Technology, is arranging a conference on 'The Measurement of High Temperatures' to be held at The Institution of Electrical Engineers, London, from the 11th–13th May 1964.

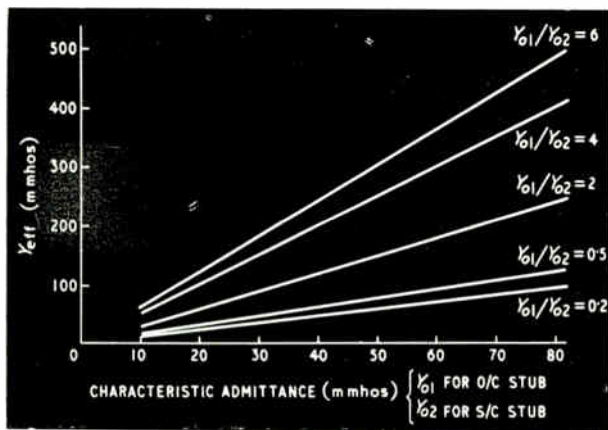

Fig. 3. The range of effective characteristic admittance obtainable from typical practical values of Y_{01} , Y_{02} , and their ratio

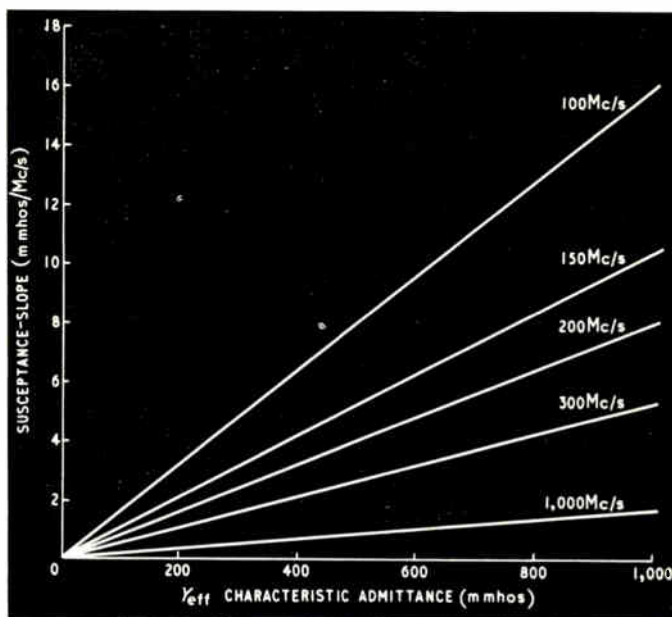

Fig. 4. The variation of susceptance-slope with effective characteristic admittance for various values of centre frequency

effective characteristic admittance for a number of centre frequencies.

The approximate equation which is equation (4) has been used to calculate the values of Y_{eff} in Fig. 3 and hence before the information can be used in design it is necessary to know the error which is involved. Therefore in Fig. 5 is shown the percentage error in Y_{eff} as given by equation (4) for percentage deviation from f_0 . This is important, as in matching stub design one must consider the susceptance-slope as constant, an assumption only valid between limits of error as shown in Fig. 5.

Double- Y_0 Open-Circuit Stub for Shunt Matching

(i) From a knowledge of the required susceptance-slope and the mid-band frequency the required value of Y_{eff} is read from Fig. 4.

(ii) From Fig. 3. suitable values of Y_{01} and Y_{01}/Y_{02} are determined.

(iii) From Fig. 5, the frequency range over which the assumption of constant Y_{eff} is sufficiently good can be estimated.

Double- Y_0 Open-Circuit Stub as a Filter Element Shunting a Matched Line

For the system shown in Fig. 6 the insertion loss L due to the stub Y_s can be expressed as $L = 10 \log_{10}(1 - |k_t|^2)$ dB, where k_t is the reflection coefficient of the parallel combination of matched load and shunt stub Y_s across the line.

That is,

$$k_t = \frac{-Y_s}{2Y_0 + Y_s}$$

where Y_0 is the characteristic admittance of the matched line. Hence, substituting the value of Y_s from equation (1) into the above equation we have:

$$L = 10 \log_{10} \left(\frac{4}{4 + \frac{Y_{01}^2}{Y_0^2} \tan^2 \beta l \left(\frac{Y_{01}/Y_{02} + 1}{(Y_{01}/Y_{02}) - \tan^2 \beta l} \right)^2} \right) \text{ dB} \quad (5)$$

The pass frequencies will occur whenever $\tan \beta l = 0$, that is, in the series n , where $n = 0, 1, 2, \dots$

The rejection frequencies occur when

$$\tan \beta l = \pm \sqrt{(Y_{01}/Y_{02})} \quad (6)$$

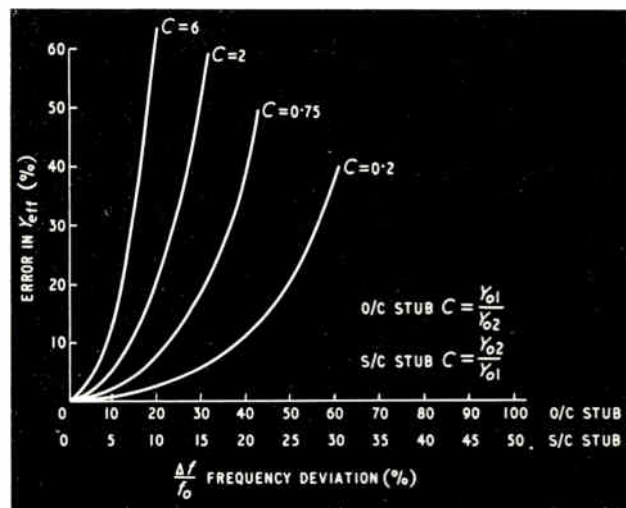

Fig. 5. The variation of error of calculated susceptance-slope with frequency deviation for typical Y_0 ratio values

and, therefore, they can be designed for, within the limits of physical realizability of Y_{01} , and Y_{02} , and are not necessarily harmonically related to the pass frequencies. Obviously, equation (6) can be satisfied for a range of absolute values of Y_{01} and Y_{02} with resulting differing transmission characteristics of the system. Therefore, for given pass and rejection frequencies, the maximum permissible insertion loss at one other point, say the edge of the pass band, must be decided upon and with this value inserted in equation (5), the equation solved to yield the value of Y_{01} . Note that the value of infinite loss obtained for the rejection condition is a fiction arising from the assumption of lossless lines, the behaviour of which is expressed in terms of tangent functions which become infinite at odd values of $\pi/2$. A practical value of insertion loss can be obtained by considering the lines to be lossy, but since this consideration of loss does not affect the frequencies at which maximum and minimum losses occur,

The use of open- or short-circuited stubs of a special form to obtain impedance matching over a wide band is discussed in this article. Design charts are included.

THE DOUBLE- Y_0 SHUNT STUB

By C. S. GLEDHILL, B.Sc.(Tech.), A.M.I.E.E.*

IN many transmission systems it is necessary to have matched conditions over wide frequency bands and in applications such as radar and television this generally implies wideband compensation of some form of aerial system¹. In one particular form of compensation namely, shunt-stub compensation, the need is often for a compensating element the input susceptance of which varies rapidly with frequency. This will be spoken of as a high susceptance-slope stub. Since for an open-circuited or short-circuited length of lossless transmission line of uniform characteristic admittance Y_0 , the input susceptance with frequency varies directly with line length and directly with Y_0 , the design of a high susceptance-slope stub often demands an inconveniently long length or an impossibly high Y_0 . See Fig. 1.

This article describes a stub consisting of two short lengths of lossless transmission line of dissimilar characteristic admittances in series, terminated in either an open- or short-circuit, called a double- Y_0 stub, and it shows that this arrangement is capable of providing a high susceptance-slope.

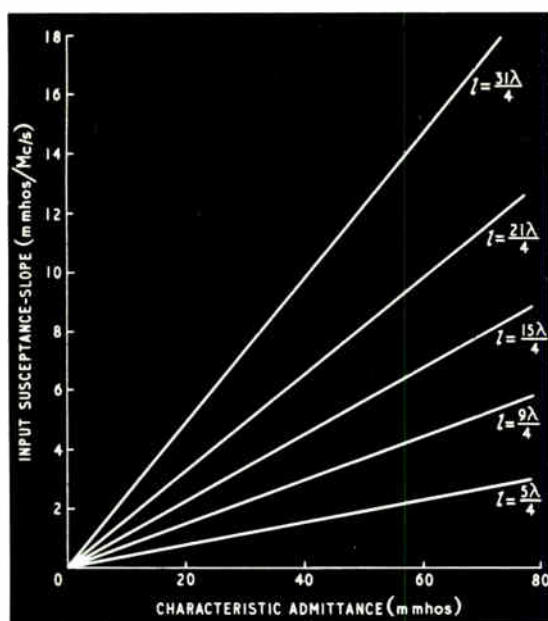

Fig. 1. The susceptance-slopes obtainable from single- Y_0 stubs of lengths as shown at the centre frequency of 200 Mc/s

Design information for the use of the stub both as a matching element and as a transmission-line filter element is given.

Since only short lengths of line of negligible attenuation are being considered, the treatment throughout is in terms of lossless lines.

Double- Y_0 Open-Circuited Stub

For the open-circuited double- Y_0 stub shown in Fig. 2, from normal transmission-line theory², the input admittance of the stub is given by:

$$Y_s = -jY_{01} \left(\frac{1 + Y_{01}/Y_{02}}{1 - (Y_{01}/Y_{02}) \cot^2 \beta l} \right) \cot \beta l \quad (1)$$

But the input admittance of a length l of short-circuited transmission line of characteristic admittance Y_0 is

$$Y_{in} = -jY_0 \cot \beta l \quad (2)$$

which is of the same form as equation (1). That is, the

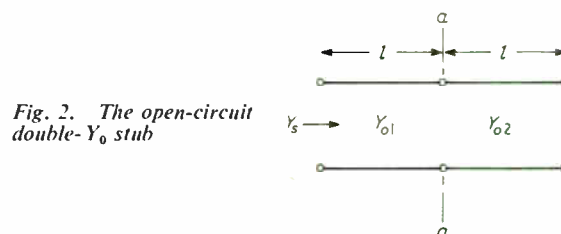

Fig. 2. The open-circuit double- Y_0 stub

double- Y_0 stub has an effective characteristic admittance of magnitude:

$$|Y_{eff}| = Y_{01} \left| \frac{1 + Y_{01}/Y_{02}}{1 - (Y_{01}/Y_{02}) \cot^2 \beta l} \right| \quad (3)$$

and this can obviously attain very high values. For small frequency deviations from f_0 , the frequency at which

$$\beta l = \pi/2, \quad \cot^2 \beta l \rightarrow 0 \quad \text{and} \quad Y_{eff} \approx Y_{01} (1 + Y_{01}/Y_{02}), \quad \text{a constant} \quad (4)$$

The range of effective characteristic admittances, Y_{eff} , obtainable for various real values of Y_{01}/Y_{02} is shown in Fig. 3, while Fig. 4 shows the variation of susceptance-slope with

* Lecturer in Electrical Engineering, Faculty of Technology, University of Manchester.

unit can be fitted in the negative phase-sequence network. Because this unit is insensitive to normal starting current it is set much lower than a normal overcurrent unit.

Instantaneous overcurrent or earth-fault protection can also be provided, the earth-fault unit having a fixed setting of 20% of secondary rating. The continuously adjustable overcurrent unit has unusually low settings of 400-800% of secondary rating and is stabilized to prevent operation from starting surges. This stability is achieved by providing the unit with a two-cycle time delay during which the peak starting current falls to within the setting range of the relay.

The relay is supplied in a standard drawout case, size 1½D.—*Meier, Relay & Instrument Division, The English Electric Co. Ltd., St. Leonard's Works, Stafford.*

For further information circle 40 on Service Card

41. Plansel Strip Markers

The Plansel range of self-adhesive markers which can be supplied with over 600 different notations is now available in the full BSI colour range.

Plansel strip markers are supplied on cards from which they can easily be removed by means of a patented tab. Whereas tubular markers involve stocks being held for the range of wires used, the same sized strip marker is suitable for all wires and cables up to ½ in. in diameter. Where complete

circumferential marking is not required they are suitable for virtually any diameter cable and tube.

These markers give a positive, permanent identification instantly visible from any angle. They are resistant to most oils, petrol and grease and can withstand temperatures up to 380 °F (special types can withstand 550 °F).—*Creators Ltd., Sheerwater, Woking, Surrey.*

For further information circle 41 on Service Card

42. 16-inch Display Tube

A high resolution, 16-in. display tube offering 25% more brightness while maintaining a spot size of 0.015 in. at 75 ft-lamberts on a typical raster display has been introduced by Raytheon.

The CK1381P2 employs electrostatic focusing and magnetic deflection. Its low-voltage electrostatic focus lens operates at or near cathode potential to afford substantially automatic focus, independent of accelerator voltage variations.

Inside its grey filter glass faceplate is a metallized high-efficiency screen for increased light output, improved contrast, and minimized screen charging effects.

Developed particularly for the display of air traffic in bright display radar systems, the CK1381P2 can also serve as the display medium for electronic output storage tubes and scan converters in other applications. The medium-persistence tube has a green

fluorescence and phosphorescence. Its 7-pin base is a standard small shell duodecal type (JEDEC B7-51).—*Raytheon-ELSI, S.p.A., via Villagrazia, N.79, Palermo, Italy.*

For further information circle 42 on Service Card

43. Phase Angle Voltmeter

Wayne Kerr-Gertsch have announced two phase-angle voltmeters, the PAV 1 and the PAV 2. Both instruments combine the functions of a phase-sensitive voltmeter, a phase-angle meter and v.t.v.m. with full-scale ranges variable from 1 mV to 300 V.

As a standard v.t.v.m., the PAV 1 has a frequency range of 10 c/s to 50 kc/s. For the phase-sensitive facilities up to three alternative centre frequencies (each variable by ±5%) can be selected. Standard values available are 400, 800, 1,000 and 1,600 c/s, the upper limit being 10 kc/s.

Voltage measurement accuracy is ±2% of full-scale on all ranges. Phase angle between the reference and signal input can be measured over the full 360° to better than ±1°.

Input impedance at the signal input terminals is approximately 10 MΩ; that of the reference input is 100 kΩ and is suitable for levels between 1 and 125 V r.m.s. Isolation transformers can be supplied for either of these inputs.

In the PAV 2 model (illustrated) the two transformers are built-in and can be switched, independently, in or out of circuit.—*The Wayne Kerr Laboratories Ltd., New Malden, Surrey.*

For further information circle 43 on Service Card

44. Direct-writing Recorder

An 8-channel direct-writing recorder that provides a 30-in. continuous display of analogue information has been produced by Brush Instruments. The unit is applicable to any analogue recording application where a full-view display of as much as 25 min of data is desired in order to monitor trends or carry out rapid analysis.

On the push-button control panel the operator can adjust attenuation, gain and pen position. Maximum sensitivity is 50 mV per chart division. Traces appear on rectilinear coordinates. Pressurized fluid writing and high-torque pen motors with position feedback control assure clear traces at all writing speeds. Overall accuracy is better than ½%.—*Aveley Electric Ltd., South Ockendon, Essex.*

For further information circle 44 on Service Card

Correction

The Cambridge Instruments 210 recorder has mV ranges, not μV as stated in the Inel 63 review (August, p. 588).



42

43

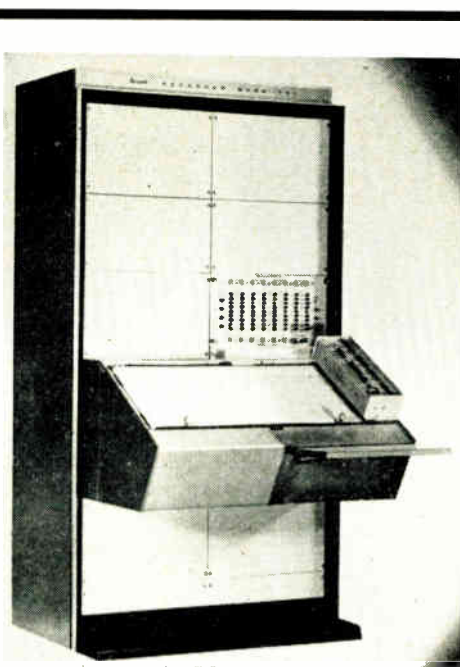
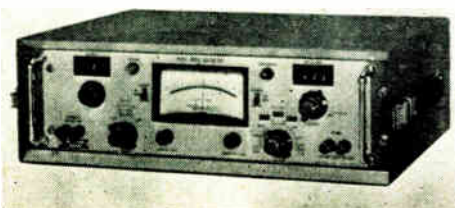

44

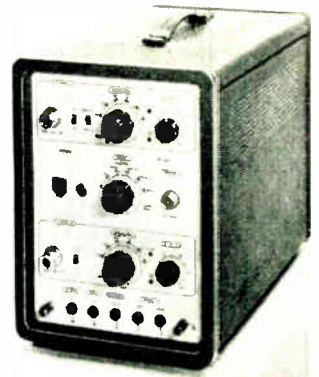
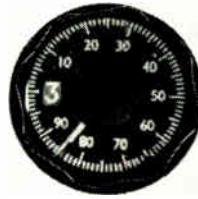

38

39

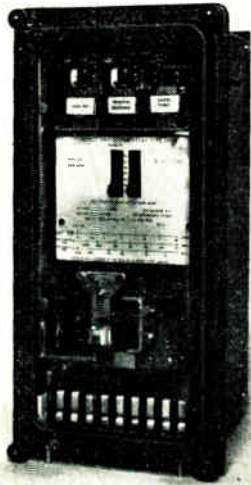

40

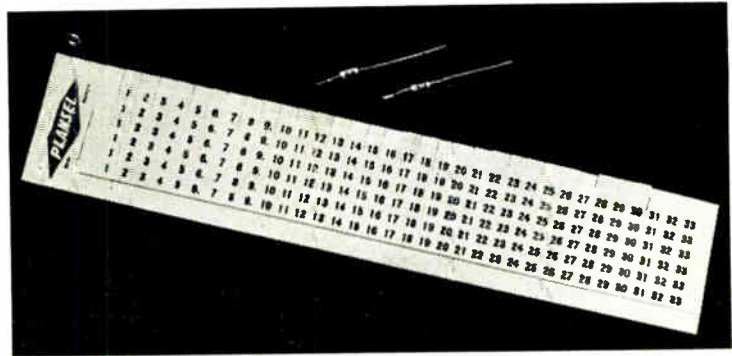

41

The easy-to-read dial is evenly divided into 100 parts with major markings and numbering at the 10-division points. A small white-painted pointer sweeps the dial face and the presentation is anti-parallax.

A digit drum registers the number of complete turns of the main dial. The maximum reading is 10 turns, but rotation in either direction is continuous so that use as an ordinary control knob is possible. A simple friction device is incorporated to lock the dial and thus prevent accidental disturbance of the selected setting.

Indicators of this type to fit spindles of $\frac{1}{8}$ and $\frac{1}{4}$ in. diameter are available. Adaptors, Allen key and locating plates are supplied with each instrument. The indicator is just over 1 in. in diameter and 1 in. deep.—*Ancillary Developments Ltd., Surrey Avenue, Camberley, Surrey.*

For further information circle 38 on Service Card

39. Electronic Switch Unit

With the Philips electronic switch, type PP1071, any single-beam oscilloscope having a bandwidth within the range d.c. to 15 Mc/s and a sensitivity

between 20 and 100 mV/cm can be used as a dual trace instrument.

In addition to its compatibility with any conventional oscilloscope, the electronic switch has the recognized advantage that accuracy does not depend on the identical performance of two c.r.t. deflection systems.

The two signals to be observed are fed to the input sockets of the unit and the switched output is connected to the oscilloscope amplifier. The input impedance of the switch is 1 M Ω in parallel with 25 pF, and the output impedance is 75 Ω .

There are two modes of switching: (i) chopped at 100 c/s or 100 kc/s, and (ii) each channel triggered alternately by the oscilloscope time base at any frequency between 3 c/s and 100 kc/s.

The gain of the switch is unity, making its input sensitivity the same as that of the oscilloscope with which it is used. The output polarity is the same as the input, but if desired the polarity of one channel can be reversed. Input attenuators are provided on both channels, and there is a pulse output for blanking the beam during switching.—*Research & Control Instruments Ltd., Instrument House,*

207 King's Cross Road, London, W.C.1.

For further information circle 39 on Service Card

40. Motor Protection Relay

The type CMM motor protection relay, produced by English Electric, has an operating curve which matches closely the heating characteristic of a motor even when the motor currents become unbalanced.

The relay current, which is a proportion of the motor current, is separated into positive and negative sequence components by filter circuits. These circuits supply two heaters which are wound over a thermistor forming part of a bridge network. By carefully choosing the value of each filter circuit component, the heating characteristic of the thermistor is made to approximate to that of the motor. Changes in the temperature of the thermistor cause the bridge to unbalance and this is detected by a sensitive polarized unit which operates at its setting to trip the motor contactor.

To protect against single phasing or heavy unbalance, an instantaneous

rear release system. The system retains crimp, snap-in contacts by metal clips inside the monobloc-type insulator. The contacts are removed with a simple plastic tool which is slipped over the wire and into the rear of the insulator. When fully inserted, the tool releases tangs on the clips and enables the contact to be easily withdrawn.

The 98 contacts are made of copper alloy plated with gold over silver. The insulator is diallyl phthalate, and the shell is made of diecast aluminium with cadmium plating. The plug is keystone-shaped for polarization, and accommodates wire sizes Nos. 20, 22, and 24.

A moisture-proof peripheral seal and a grommet cemented to the rear of the insulator provide environmental sealing for high altitude applications and the plug will operate in a temperature range of -57°F to 257°F .

A shorter grommet is available for applications where sealing is not required but the space requirement is critical. The over-all thickness of the mated plugs with the optional grommet is $\frac{1}{2}$ in. less than the standard version. —*Cannon Electric (Great Britain) Ltd.*, 168/172 Old Street, London, E.C.1.

For further information circle 34 on Service Card

35. Multiple Power Supplies

Atlantic Electronics have introduced multiple power supply units for automation, computers, communication systems, etc.

The Atlantic packs are designed as: (1) twin, triple and quadruple independent supplies, housed in a common structure; (2) combined power supplies providing all negative and positive outputs simultaneously with up to eight stabilized outputs available from one unit.

The output voltages can be either fixed or with marginal adjustment. Any value between 6 and 80 V is possible at 0.05 to 5 A; total stabilized power 60 to 120 VA. Very heavy current ratings may also be considered. Dimensions: partly enclosed, 9 by 9 by 9 in.; open chassis, 9 by 8 by 8 in. —*Atlantic Electronics Ltd.*, 739 Fulham Road, London, S.W.6.

For further information circle 35 on Service Card

36. Cable Load Indicator System

Coutant Electronics have announced a cable load indicator system which, although adaptable to many applications, was designed to measure, on site, loads in wire ropes during pre-stressing and post-stressing concrete structures. In this, a strain-gauge load cell is incorporated into a hydraulic jack and the indicator unit gives a direct read-

ing of tensile load in the wire rope.

The instrument is completely portable, powered by internal long-life batteries and contained in a strong leather case. Calibration check facilities are provided together with adjustments for zero and sensitivity.

The load cells can be specially tailored to suit customers' requirements and to date have covered load ranges up to 30 tons. Higher and lower ranges can be covered and the indicator unit can be used with any strain gauge system giving similar levels of strain.

The accuracy is 1% with a maximum strain sensitivity of f.s.d. for 0.1% strain. Price is dependent on any special features required but should be between £120 and £150 for the complete load cell and indicator system. —*Coutant Electronics Ltd.*, 711 Fulham Road, London, S.W.6.

For further information circle 36 on Service Card

37. Simple Level Controller

Fielden have introduced an instrument which provides a simple and reliable process level controller or pneumatic level transmitter. Easy and inexpensive to install, there are no moving floats, displacers, or bubbler pipes, just a robust vertical electrode which will operate indefinitely without care or attention.

The PnL.3 is a self-balancing capacitance measuring device with pneumatically operated feedback. It produces an output air pressure of 3 to 15 p.s.i. directly proportional to the change of level. It can be adjusted either to give a transmission signal covering the full variation of level in the container or to give a proportional control signal over a small variation of level. If required, it may be fitted with integral (or automatic reset) action which cancels out any offset in the proportional action.

The device is fully transistorized and is arranged for very simple maintenance. It is unaffected by ambient temperature and supply voltage variations and is suitable for use in explosive hazardous areas. A large range of probes are available to meet any specific requirement. — *Fielden Electronics Ltd.*, Paston Road, Wythenshawe, Manchester 22.

For further information circle 37 on Service Card

38. Turns Indicator

A neat, dial-type turns indicator of French design for multi-turn potentiometer spindles is now being produced under licence by Ancillary Developments. Its small size and shape make it compatible with conventional control knobs as fitted to electronic instrument panels.

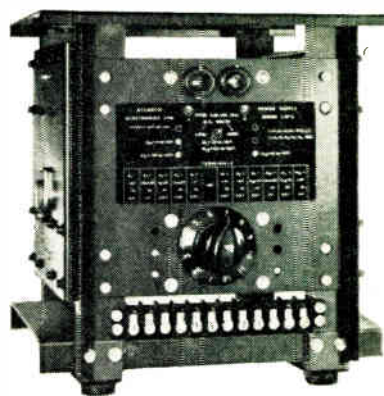

35

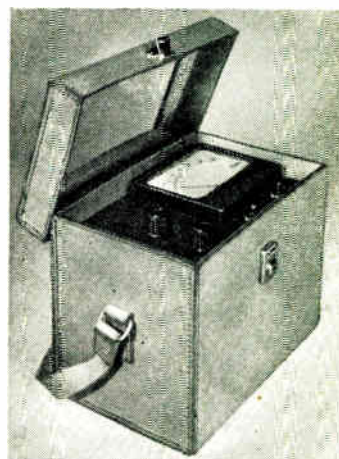

36

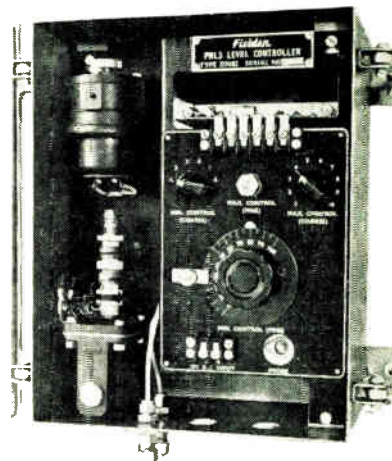

37

spacing variable in decades from 0.1 to 100 μ sec; and there is provision for extending the gate time by any required amount while still retaining full gating accuracy over the whole of the period. A frequency changer will shortly be available as an accessory to extend the frequency range up to 500 Mc/s. The counter will sell on the British market for under £1,000.—*Airmec Ltd., High Wycombe, Bucks.*

For further information circle 30 on Service Card

31. Micro-Miniature Oscillator

A micro-miniature voltage controlled subcarrier oscillator by Vector Manufacturing Co. is now being distributed in this country by Aerodata. It has been designed to convert d.c. voltages into f.m. subcarrier signals for data processing applications, especially under difficult environmental conditions.

This unit, apart from being compatible with inputs from transducers, has an excellent transient response and is well suited for high frequency commutated data. If necessary, it will accept digital inputs as well as analogue.

The input voltage scale can be 0 to 5 V, 0 to 3 V or differential, and the oscillator will operate on standard channels with centre frequencies ranging from 400 c/s to 70 kc/s. Deviations of $\pm 7\frac{1}{2}\%$ or $\pm 15\%$ are available and special units can be made with $\pm 40\%$ deviation.

The temperature range under which this item will operate is from -55°C to $+125^\circ\text{C}$ and with slight degradation of accuracy even higher operating temperatures can be satisfactorily accepted. It will tolerate a shock of 200 g for 10 msec in any direction and constant accelerations of 100 g. Dimensions are 0.855 by 0.662 by 0.132 in.—*Aerodata Ltd., 123 Notting Hill Gate, London, W.11.*

For further information circle 31 on Service Card

32. Miniature Knobs

A miniature collet-locking type of finger knob designed to the requirements of DEF.5221, and covered by a Ministry of Aviation patent, is being produced by Qualtex.

The 'Q' knob is designed for use on $\frac{3}{16}$ in. shafts having a screwdriver slot in the top and with a 0.005 in. groove round the shaft at 0.312 in. from the top.

A key in the collet head engages with the shaft slot to provide positive rotational movement, and on the top cap of the knob being screwed up teeth on the inside of the collet engage in the groove to provide a positive lock. This groove also provides indication

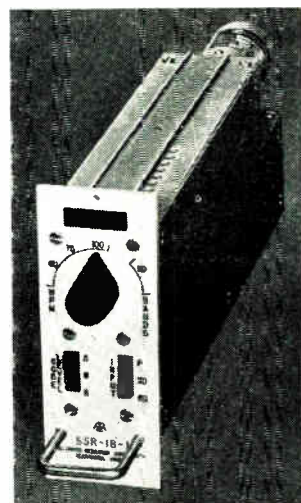

31

33

that the knob is fully home on the shaft.

Standard knobs are moulded in black nylon, but can be provided in other colours if required. A larger version is available, known as the 'Major Q', for use on $\frac{1}{4}$ in. diameter shafts, with the addition of a flush fitting polythene cap which covers the collet screw.—*Qualtex Ltd., 67a Norway Street, Portslade, Sussex.*

For further information circle 32 on Service Card

33. Teleprinter Signal Regenerator

Atlantic Research Corporation has announced the development of a digital signal generator, the Model SSR-1B-1. Designed primarily for use with teleprinter signals, this regenerator will accept incoming digital signals in badly distorted form (up to 47% distortion) and retransmit them with less than 2% distortion. The unit is comparable in price with ordinary repeaters that reshape but do not reconstruct telegraph signals.

The SSR-1B-1 regenerator samples



EQUIPMENT

review



32

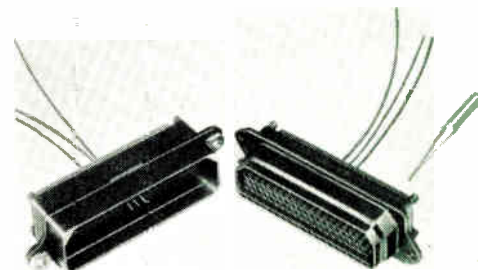

34

incoming signal pulses at their theoretical centre to determine the polarity of the pulse. This conditions the output to deliver a pulse of the sampled polarity at the proper timing. A $\frac{1}{2}$ -msec integrating network on the input makes the regenerator insensitive to short period 'noise' that may occur at the sample point. A break override feature is provided so that a steady spacing signal will be transmitted indefinitely.

Eight units mount in a panel $5\frac{1}{4}$ in. high by 19 in. wide by 12 in. deep. Standard telegraph speeds of 60, 75 and 100 w.p.m. may be selected on the front panel of the unit and other speeds may be readily substituted for these values.—*Atlantic Research Corporation, Shirley Highway at Edsall Road, Alexandria, Virginia, U.S.A.*

For further information circle 33 on Service Card

34. Rack/Panel Plug

The Cannon DPJM98 rack/panel plug is a miniature environmental plug incorporating Cannon's 'Little Caesar'



27

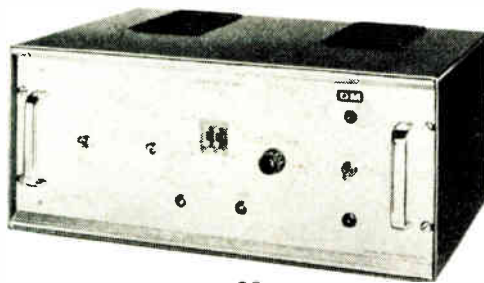

28



29

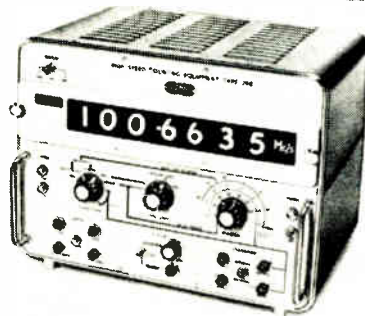

30

The scanner drive units are finished in grey enamel and are supplied as 19-in. rack-mounted assemblies; they can also be supplied in cabinets for bench operation if required.—*Digital Measurements Ltd., 25 Salisbury Grove, Mytchett, Aldershot, Hants.*

For further information circle 28 on Service Card

29. Resolver Bridges/Standards

A range of instruments for resolver system evaluation are being marketed in this country by Ad. Auriema who were recently appointed sole U.K. agents for the manufacturers, Astro-systems Inc. of New York.

The standards will generate accurate system inputs, at any angle, to resolutions of 0.001° with ±2 sec absolute accuracy. The bridges will determine resolver outputs to higher accuracy than can be achieved by resolver/vernier-table combinations.

The manual models provide single-knob/decade control with resolutions of 1°, 0.1°, 0.01° and 0.001°. The relay-controlled programmable models respond to tape, card or computer codes. All models offer the advantages which result from low output impedance and ratio-transformer stability with simpler, less critical manipulation.

The unit illustrated is a 0.1° resolution resolver bridge.—*Ad. Auriema Ltd., Empire House, 414 Chiswick High Road, London, W.4.*

For further information circle 29 on Service Card

30. Transistorized Digital Counter

Airmec have announced a fully-transistorized digital counter capable of direct counting at 100 Mc/s without auxiliary equipment. This instrument, the High Speed Counting Equipment type 298, accepts pulse or sinewave inputs in the frequency range d.c. to 100 Mc/s, and maintains an input sensitivity of better than 100 mV from 100 c/s to 100 Mc/s.

To enable its full range and accuracy to be exploited a 12-figure digital read-out is used, with automatic placing of the decimal point and automatic indication of the units of measurement. Provision is made for operation of remote read-out units, and a printer, the type 316, is available to provide permanent timed records of readings.

In addition to its basic function of measuring frequency, time, and period, the counter provides comprehensive ancillary services. It may be used as a divider for an external signal source, with division ratios variable in decade from 10 to 10⁸; standard frequency outputs at 10 Mc/s and 1 Mc/s are available at separate sockets; a pulse group output is provided, with pulse

knurled ridges on the body of the connector. At each end of the connector are miniature chucks which grip the sheath and ensure that no tensile stress is transmitted to the inner wires and their pin connections. The connector may be used in ambient temperatures of up to 150 °C.—*Research & Control Instruments Ltd., Instrument House, 207 King's Cross Road, London, W.C.1.*

For further information circle 26 on Service Card

27. Zener Diode Selector

Avo and International Rectifier have jointly produced the 'Zeniack' zener diode selector, which enables the circuit designer to select, by means of a rotary switch, any one of 11 zener diodes covering the range 3.7 to 28.9 V.

An integral meter provides two ranges for measurement of voltage and current (10 V, 300 mA and 30 V, 100 mA) and the meter may be used either in circuit with a selected zener diode to measure its voltage dissipation, or independently (zener diodes out of circuit) to measure voltage and current in an external circuit.

The instrument, together with a pair of leads and operating instructions, is housed in a case measuring 7½ by 4 by

1½ in.; weight 27 oz.—*Avo Ltd., Acocet House, 92-96 Vauxhall Bridge Road, London, S.W.1.*

For further information circle 27 on Service Card

28. Scanning Units

The scanner drive units DM5001 and DM5002 are the latest additions to the range of data-handling equipment produced and marketed by Digital Measurements.

The units give complete flexibility of scanning order and the number of channels scanned: operating modes include continuous scanning, partial scanning, single scans, etc. Preset scanning speeds of 1, 5, 10 and 25 channels per second are provided, together with a facility for the speed to be controlled by external pulses.

Additional outputs are produced coincidental with the scanning, to provide channel identification and to programme external functions such as limit switching, scaling, etc.

The scanner drive unit DM5001 provides three decades of switching outputs and will control from 100 to 1,000 signal switches. The DM5002 provides two decades of switching outputs and will control from 10 to 100 signal switches.

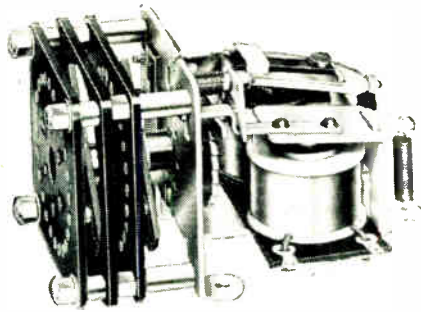

23

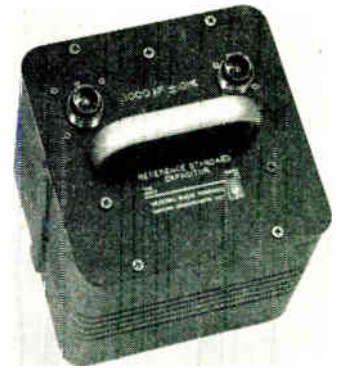

25

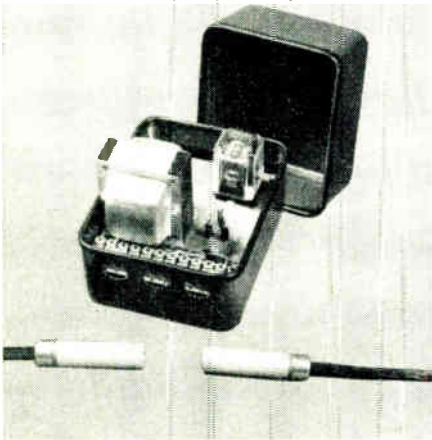

24

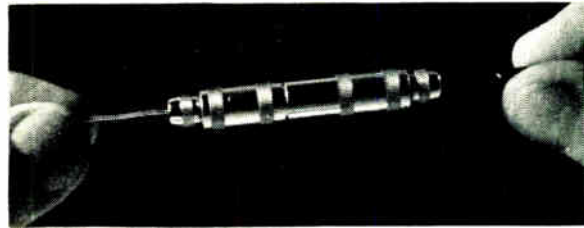

26

resistance and high mechanical strength.—*Royal Worcester Industrial Ceramics Ltd. (Components Division), Bognor Regis, Sussex.*

For further information circle 22 on Service Card

23. Stepping Relay

Rodene have extended the range of their stepping relays to include 2-bank models which, if of the continuously rotating type, can be either 2-pole/24-way or 4-pole/11-way, and if of the auto-reset type, 2-pole/20-way.

These stepping relays will operate either from d.c. or a.c. and can either rotate continuously with a spring-loaded detent to hold them securely in each position or, alternatively, have a separate reset coil, a single pulse to which will always reset the relay to zero.

When this coil is energized momentarily it latches out the pawl that normally holds the contacts in position and this pawl is held up until the next forward stepping pulse is received, thus assuring that the unit always resets fully to zero.

A further feature is that instead of the strip metal contacts normally employed in stepping relays and uniselectors, which can carry current

but not switch it, these relays have stud contacts, the fixed ones being of anti-arcing silver cadmium-oxide alloy and the moving ones of silver graphite.—*D. Robinson & Co. Ltd., 5/7 Church Road, Richmond, Surrey.*

For further information circle 23 on Service Card

24. Photo-Electric Control

The photo relay type T.P.R. is available from Electronic Controls. Maximum reliability is obtained by using silicon solid-state switching to obviate all expendable items; i.e., valves, thyratrons, etc.

The unit uses silicon transistors in a temperature-stabilized switching circuit, to operate the plug-in Thorn Pygmy power relay. These features are combined in a compact unit measuring $5\frac{1}{2}$ by $4\frac{1}{2}$ by $4\frac{1}{2}$ in. deep.

The photocell and light are housed in identical splash proof heads measuring $\frac{3}{4}$ in. diameter by 3 in. long. Operating range is up to 10 ft.—*Electronic Controls Company, Electron House, Parker Street, Bury, Lancs.*

For further information circle 24 on Service Card

25. Reference Standard Capacitor

A primary standard of capacitance, stable to within 20 parts per million

per year, has been announced by General Radio.

The type 1404-A reference standard capacitor is a 1,000-pF air capacitor made of Invar and hermetically sealed in a nitrogen-filled brass container, in turn mounted in an aluminium cabinet. The unit can be used either as a standard capacitor or, with an external resistor, as a standard of dissipation factor.—*Claude Lyons Ltd., Valley Works, Hoddesdon, Herts.*

For further information circle 25 on Service Card

26. Miniature Thermocouple Connectors

Miniature connectors for use with all types of Thermocoax cables have been announced by Research & Control Instruments. They are 9 mm in diameter and are constructed so that the polarity of the connections cannot be reversed.

One of them, the MF6, is a special version of the standard MF3 connector and will withstand temperatures of up to 500 °C. The other type, the MF5, is designed to prevent inadvertent disconnection: a snap-acting stop prevents the two parts of the connector from being separated when tension is put on the leads. They may be separated instantly, however, by pulling

19

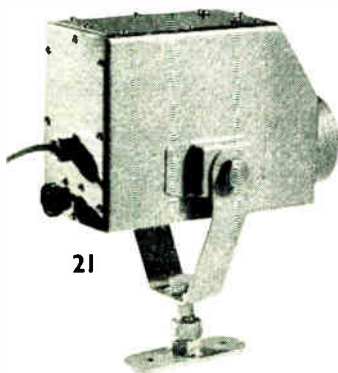
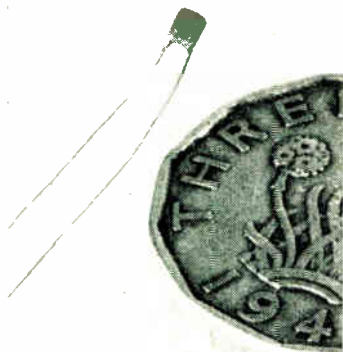

21

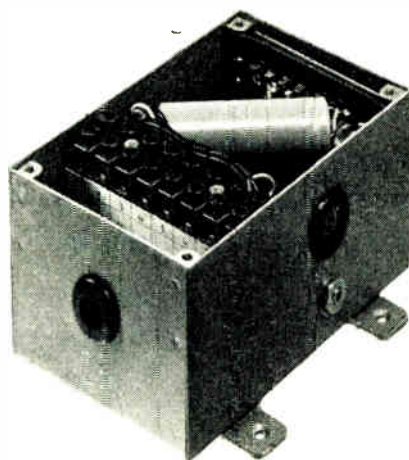

20

22

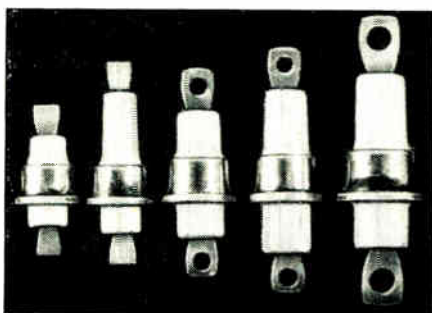

Marine Products (Great Britain) Ltd.,
Ample House, 87-89 Saffron Hill,
London, E.C.1.

For further information circle 18 on Service Card

19. Interchangeable Wafer Thermistor

Gulton Industries can now supply a wafer thermistor for use in temperature-measuring probes. This component will track a specific resistance vs temperature characteristic over a broad temperature range with close tolerance; similar types can thus be interchanged without the calibration of associated equipment being affected. Similarly, the need for padding resistors to adjust the resistance-temperature characteristic is eliminated.

The small size of the thermistor (maximum dimensions: 0.1 by 0.1 by 0.05 in.) ensures a rapid temperature response time. An epoxy-resin coating protects the material against adverse conditions.

The nominal resistances available at 25 °C are 1, 2 and 5 kΩ, each ±0.84%. The maximum resistance deviation from the specified resistance tempera-

ture characteristic at temperatures between -55 and +150 °C is 3.3%; this ensures a maximum temperature measurement error of 0.8 °C. Between 0 and 100 °C the maximum error is 0.2 °C.

The thermistor, designated type TD25, is available in production quantities.—Gulton Industries (Britain) Ltd., 52 Regent Street, Brighton 1, Sussex.

For further information circle 19 on Service Card

20. Automatic Lighting Switch

An automatic system of controlling factory and office lighting has been introduced by Teledictor.

Basically the system requires only a single unit, housing a photo-resistive cell and control circuit, but a remote cell can be provided if preferred. The unit can be used for direct switching or in conjunction with a contactor unit for loadings up to 3.5 kVA.

The cell is coupled to a transistorized Schmitt trigger circuit incorporating a time-delay in the sensitivity control. Unnecessary operation under threshold conditions and operation by transient

shadows passing over the aperture of the cell are therefore avoided. The sensitivity control is provided so that operation can be adjusted to the lighting conditions required.

The standard daylight switch is housed in a sheet steel box 6 by 4 by 3 in. with hammertone enamel finish and costs £10. Extras: remote cell, 10s.; contactor unit, £4 17s. 6d.—Teledictor Ltd., Groveland Road, Tipton, Staffs.

For further information circle 20 on Service Card

21. Vehicle Height Indicator/Alarm

To avoid the incidence of serious accidents resulting in tunnel blockages in high speed motorway tunnels, a reliable means of testing the height of tall vehicles before they enter the tunnel without having to arrest the flow of traffic has become a necessity.

The M.O.M. optical electronic height sensing and alarm system provides for this need with inexpensive and easily installed equipment comprising: a waterproof chopped-light infra-red projector with universal mounting gymbal suitable for roadways up to 200 ft wide; a waterproof receiver/amplifier with built-in optical system for wall or pillar mounting at the prescribed maximum vehicle height; and a remote alarm unit with manual reset.

The modulated light technique renders the system impervious to interference from direct light and the highly sensitive infra-red receiver, capable of operating over a distance of 1,000 ft, ensures correct operation continuing in conditions of very bad visibility. Should a fault occur the equipment 'fails-safe'; i.e., it must be operating correctly for the green light to remain 'on'.

Arrangements for alignment and focusing are extremely simple and the cost of the equipment, excluding the traffic signals, is £135.—Photoelectronics (M.O.M.) Ltd., Oldfields Trading Estate, Oldfields Road, Sutton, Surrey.

For further information circle 21 on Service Card

22. Sealed Terminals

Royal Worcester Industrial Ceramics are producing six sealed terminals with full M.o.A. qualification approval. Sizes range from 0.52 to 1.33 in. in overall length. These terminals which are suitable for oil filled C-core transformers, capacitors, sealed instruments, precision potentiometers, etc., are made in 'Electrox', a white high-alumina material.

Principal features of the terminals include a constant cross-section conductor which provides low electrical

glass, can be folded down to give extra magnification where required.

Focal distance of the headband magnifier is approximately 8 in. with a magnification of $\times 2\frac{1}{4}$. Use of the magnifying eyeglass gives approximately $\times 5$ magnification at a focal distance of 2 to 3 in.

The 'Precista' headband magnifier may be worn with all normal type spectacles and the eyeglass attachment can be fitted on either side. Price: 52s. 6d. complete.—*Southern Watch & Clock Supplies Ltd., 48/56 High Street, Orpington, Kent.*

For further information circle 15 on Service Card

16. Automatic Radio Direction Finder

An addition to the Motorola range of navigational aids marketed by Smiths is the A.R.B. Class 1 approved ADF-T-12B automatic direction finder.

The aim is to offer to the executive and light aircraft owner inexpensive equipment which will provide full radio compass facilities in the m.f. band.

This automatic direction finder is an improved and simplified version of the Motorola ADF-T-12 and employs total solid-state circuitry, conservatively-rated components and modern miniaturization techniques. It can operate with either 14- or 28-V power supplies and can run on dry batteries should aircraft power fail. It has a current consumption of $\frac{1}{2}$ A. A bearing accuracy test button is included as standard equipment. Since a warming-up period is not necessary, the equipment is ready for immediate use.

The ADF-T-12B comprises a receiver covering frequencies from 190 to 1,750 kc/s and weighing 3 lb 9 oz; a fixed loop aerial which requires no maintenance and weighs 1 lb 4 oz; and a 3-in. azimuth indicator combining an automatic goniometer and a.d.f. indicator weighing 1 lb 10 oz.—*The Aviation Division of S. Smith & Sons (England) Ltd., Kelvin House, Wembley Park Drive, Wembley, Middlesex.*

For further information circle 16 on Service Card

17. Portable Multi-Range Electrometer

The type VC99 electrometer now in full production by Thomas Industrial Automation is a portable instrument which functions as an electrometer voltmeter and as a micro-current meter.

In the first role it is able to measure potentials of either polarity from 10 to 1,000 mV with an equivalent input resistance of greater than $10^{13} \Omega$. In the second, it is capable of measuring currents from 1 pA to 30 μ A in seven ranges. The top of the range has



16



17

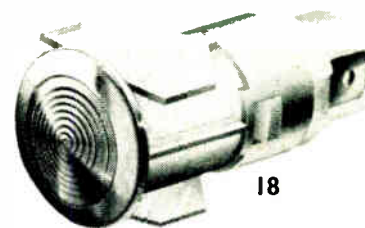

18

been arranged to overlap the most sensitive range of the conventional multimeter.

The amplifier consists of an electrometer triode valve followed by a two-stage transistorized d.c. amplifier which drives a robust meter connected across a balanced output bridge. The output circuit is designed so that the meter cannot be damaged by any overload; the input valve is protected from damage by a high value limiting resistor. Heavy negative feedback is used both to establish the gain of the amplifier and to reduce the equivalent resistance of the system when measuring current.

This battery-operated instrument is housed in a robust wooden case with a removable lid and a leather carrying handle. Dimensions: width, 8 in.; length, $10\frac{1}{2}$ in.; depth, 6 in.—*Thomas Industrial Automation Ltd., Station Buildings, Altrincham, Cheshire.*

For further information circle 17 on Service Card

18. Neon Indicator Light

A-MP have introduced a general purpose neon indicator lamp, called 'Ampillume', which is supplied ready

for installation. Internal wires, bulb and resistor are pre-assembled into the moulding and no further wiring or assembly is needed. The lamp is simply strapped into a mounting hole where it is locked securely into position by fins on the light housing; no special mounting accessories are required on the panel.

The lamps are designed to take 'Faston' receptacle terminations which have a distinct advantage over a pigtail wiring system: one size of tab is common to the complete range of lamps thus allowing the pre-assembly of harnesses.

'Ampillume' lamps are tamper proof. The lens which is part of the moulded nylon housing is shockproof and cannot break, crack or fall apart after installation. Because it is nylon it will also resist etching by grease, fats and detergents.

These lamps give uniform non-directional illumination. They are available plain or with a decorative stainless steel bezel with lens colours of natural, red, orange, amber and yellow. Normal bulb life expectancy of these lamps is 25,000 hr.—*Aircraft-*

Control Instruments Ltd., Instrument House, 207 King's Cross Road, London, W.C.1.

For further information circle 11 on Service Card

12. Photoelectric Detector

The Electronic Designs 'Photo Sensor' assembly consists of a light source and its receiver. Both units are mechanically identical and have been designed for incorporation in major electrical/electronic equipment.

For short-range switching application—less than 2 ft—the unit will readily give direct switching of 2 A when used in conjunction with a suitable relay and low voltage d.c. supply. For all normal switching applications from 2 in. to 12 ft, however, it is recommended that the Electronic Designs control box should be used; this provides 5.5 V a.c. for the light source, d.c. for the photo-cell, transistor amplifier and heavy duty relay and 240 V, 5 A a.c. via the single

pole change-over contacts on the relay providing either light 'on' or light 'off' switching.

Having a lens housing of $\frac{3}{4}$ in. fitted into a body $1\frac{1}{4}$ in. long, $\frac{7}{8}$ in. wide and $\frac{7}{8}$ in. deep, each unit is mounted on a $\frac{1}{2}$ in. thread which is 1 in. in depth. Both units can be quickly changed from right-angle to end-on-mounting by simply removing 4 screws and exchanging the position of the plate and mounting column. The receiver is supplied with an internal ambient light screen. — *Electronic Designs Ltd., 134 Chesterfield Road, Ashford, Middlesex.*

For further information circle 12 on Service Card

13. Penning Pump

The latest addition to the wide range of Mullard ultra-high vacuum devices is a Penning pump, the VPP-100, particularly suitable for use in nuclear physics and space research; e.g., to evacuate the particle acceleration

cavities of cyclotrons, and space simulation chambers.

The pumping action of the VPP-100 will begin at a pressure of 5×10^{-3} torr and continue until a pressure as low as 10^{-10} torr is reached. Over this range the pumping speed for air is approximately 100 litres/sec.

Although the anode voltage of 3 kV is normally used to operate the pump, a higher pumping speed may be obtained by increasing the voltage to 5 kV. This increase in pumping speed can be usefully applied to counteract outgassing which is often troublesome in vacuum systems at very low pressures. At a pressure of 10^{-6} torr the pump has a life expectancy of approximately 40,000 hr. The maximum operating temperature is 150 °C.

Features of the VPP-100 include all-welded stainless-steel construction, magnets that may be left in position during bake-out and interchangeable cathodes. Care has been taken to keep the stray magnetic field to a minimum. The pump is connected to a vacuum system by means of a demountable flange joint with a gold-wire seal. This seal has a 4 in. orifice and can be baked to a maximum temperature of 450 °C. Overall dimensions are 15 in. diameter and 9 in. height. Weight: 205 lb. — *Mullard Ltd., Mullard House, Torrington Place, London, W.C.1.*

For further information circle 13 on Service Card

14. Industrial Relays

CR120 type K industrial relays have been designed by U.S. General Electric to provide long, trouble-free life and rapid response, in compact, modular design.

The complete new range includes 4-pole, double-throw and 6-pole, single throw. Four-pole forms are rated at 5 A, 300 V and 6-pole forms at 50 A, 150 V.

These units are $1\frac{1}{8}$ in. wide and 2 in. long, about half the size of comparable 300-V machine tool relays.

Modular design permits simplified panel layout and offers panel makers the advantage of being able to pre-drill mounting holes. — *International General Electric Company of New York Ltd., 296 High Holborn, London, W.C.1.*

For further information circle 14 on Service Card

15. Headband Magnifier

Southern Watch & Clock Supplies have recently introduced the 'Precista' headband magnifier for intricate assembly work, etc. An additional magnifying glass, similar to a watchmaker's eye-

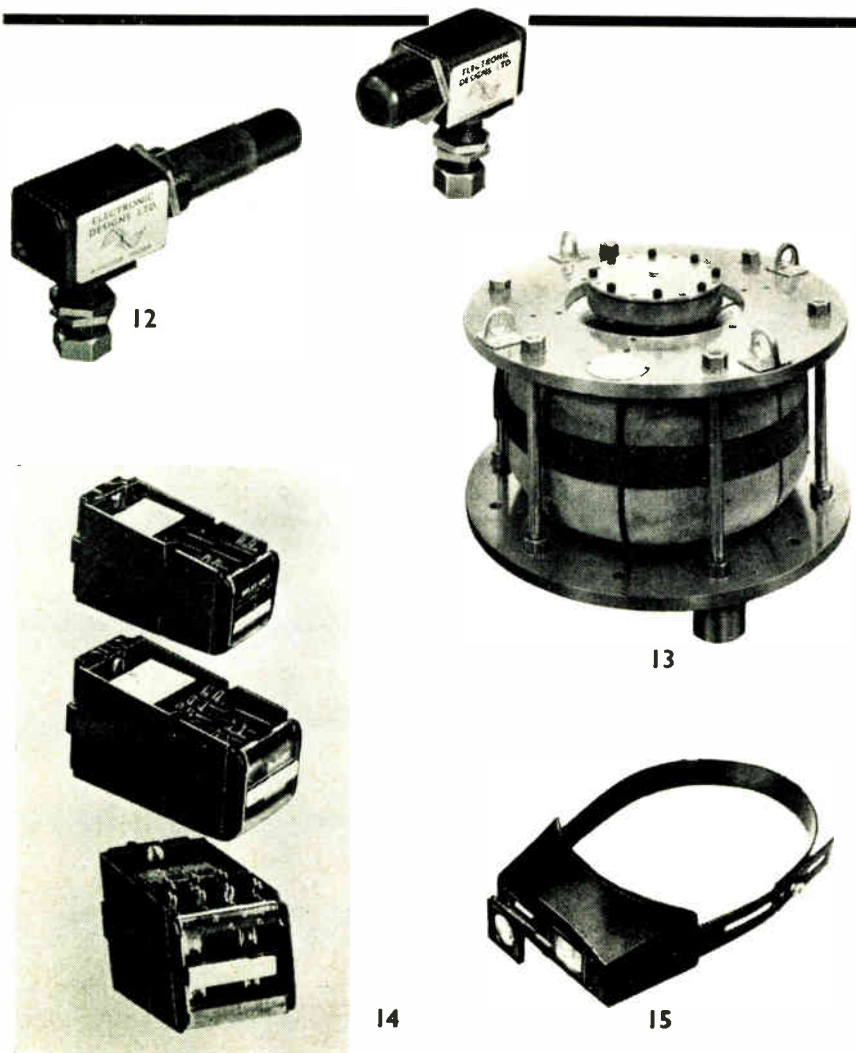

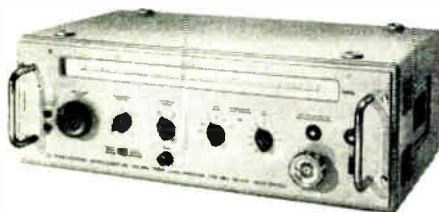

9

be applied to both experimental and production situations for checking filters, couplers, amplifiers, signal generators and a variety of instruments and coaxial-type components.

The TRB-2 measures 1 by 1 by 2½ in., and is fitted with three type N connectors and one BNC connector.—*Livingston Laboratories Ltd., 31 Camden Road, London, N.W.1.*

For further information circle 8 on Service Card

9. Sweep Signal Generator

Now being marketed in U.K. by Aveley Electric, is the type SWU 400 to 1,200 Mc/s sweep signal generator. This instrument consists essentially of a tunable coaxial oscillator whose sweep width is switch-selected and adjustable. An output for a sinusoidal deflection voltage with variable phase for X-axis deflection is provided for use with oscilloscopes. Frequency markers can be superimposed by applying the frequency output of a signal generator via a separate mixer head; for practical applications, however, the calibration of the scale is sufficient.

The signal generator can be used with an oscilloscope to determine the response curves of filters, amplifiers and other types of passive 4-terminal networks; it is also suitable for measurements on television receivers and tuners in the u.h.f. range. The variable centre-frequency sweep width can be replaced by a variable centre-frequency independent sweep width for production tests or for the adjustment of tuners.

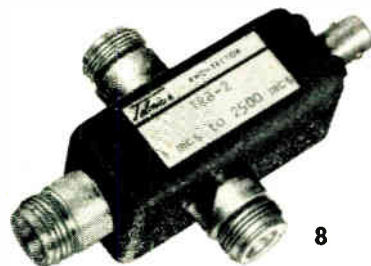

8

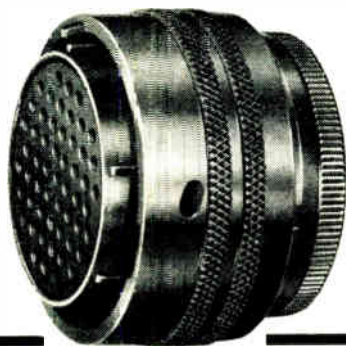

10

The built-in attenuators make it possible to cover attenuation of up to 70 dB in steps of 6 by 10 dB and 10 by 1 dB. A zero signal reference base line which permits determination of the relative voltage level is obtained by keying off the sweep signal generator output during the retrace of the oscilloscope. If the sweep voltage is cut off, the generator supplies a continuously adjustable frequency between 400 and 1,200 Mc/s at practically constant amplitude.—*Aveley Electric Limited, South Ockendon, Essex.*

For further information circle 9 on Service Card

10. Solderless Pygmy Connectors

The Special Products Division of Thorn Electrical Industries announce a range of solderless Pygmy connectors which meet specification MIL-C-26482C. This range of connectors is interchangeable with the existing PT-E range, which has received advance type approval against specification DEF-5325, pattern 105.

In addition, a mechanical orientation feature has been introduced to both the soldered and the solderless design of connectors, making it impossible to mismatch up to five different positions in each size of shell. A range of cable clamps has also been provided, as well as a full range of cable fittings designed in collaboration with the Ministry of Aviation for use with the whole range of DEF-10 cables.

The solderless connectors employ all the standard crimping, insertion



11

and withdrawal tools specified in MIL-C-2648C.—*Thorn Electrical Industries Ltd., Special Products Division, Great Cambridge Road, Enfield, Middlesex.*

For further information circle 10 on Service Card

11. Modulated Signal Generators

Two modulated h.f. signal generators have been added to the Philips range of electronic instruments. Both cover frequencies from 0.15 to 55 Mc/s and 88 to 108 Mc/s in eight ranges which are shown on a large easily-read scale, and there are special i.f. ranges for a.m., f.m. and television receiver adjustment. The frequency is accurate to within 1%.

The type PM5300 is amplitude modulated at 1,000 c/s to a depth of 30%. The output is 30 mV maximum. A continuously variable attenuator is provided and the output impedance is 75 Ω at all settings.

The type PM5320 (illustrated) is an a.m./f.m. model which will provide a signal amplitude modulated at 1,000 c/s to a depth of 30% on all ranges. Frequency modulation is provided on the 0.5, 10 and 100 Mc/s ranges at deviation frequencies of 20, 200 and 75 kc/s respectively. The carrier level is indicated on a meter and output is continuously adjustable up to 50 mV. Output impedance is 75 Ω. The f.m. deviation signals are made available externally for displaying response curves on an oscilloscope.

The PM5300 is listed at £49 and the PM5320 at £98.—*Research and*

2 per cent bandwidth is variable by at least 25 dB by means of a small voltage variation from 0 to -6 V.

These voltage variable attenuators are available at other centre frequencies, with different bandwidths and attenuation ranges. The model A1401 measures 2 by 1½ by 1⅞ in.—*Ad. Auriema Ltd., Empire House, 414 Chiswick High Road, London W.4.*

For further information circle 4 on Service Card 

5. Discrepancy Switch

A discrepancy switch with an integral solid-state discriminating circuit has been developed by Mimic Diagrams.

Used for the remote operation of contactor switchgear, pumps or similar applications, the switch is particularly useful in mimic diagrams. The discriminating circuit senses any difference between the desired and actual position of the controlled unit and, if they are not in line, illuminates the switch knob with a flashing light, thus warning of malfunction.

The discriminating circuit operates from a low voltage supply of 50 V with the flashing supply derived from a separate source. The auxiliary contact for operating the contactor, etc., is rated at 1 A, 240 V.

The unit itself consists of a wafer type switch on the spindle of which is mounted a translucent knob. Between

these are mounted the two lamps for illuminating the fascia and knob. Extending from the rear of the switch is a printed-wiring card on which is mounted the solid-state circuitry. At the extreme rear of this is the terminal plate fitted with plug and socket for the power and flashing supplies and the incoming and outgoing connections with the control gear.

The solid-state circuit consists of three silicon switching transistors and an output transistor. The unit will operate up to 50 °C ambient temperature with ±5 V tolerance. All components are under-rated to give maximum life.—*Mimic Diagrams Ltd., Maxim Road, Crayford, Kent.*

For further information circle 5 on Service Card

6. Transistorized Timer

An inexpensive transistorized time interval meter introduced by A.E.I. is capable, in standard form, of measuring up to 99.999 sec in units of 100 μsec.

The type TK is intended for such applications as the measurement of response times of relays, circuit breakers, thermal switches and other devices whose operation is 'bracketed' by suitable signals. A special feature is its ability to measure the time taken by contact 'bounce'.

A crystal-controlled pulse generator provides the basic time unit of

100 μsec. The output of this generator is gated by a control unit which is in turn actuated by 'start' and 'stop' signals from the device under examination. The 'start' signal opens the gate and releases the generator output into a series of decade counter units coupled to an indicator unit consisting of six columns of lamps. In each column there are four lamps which light individually or in combination to indicate any number from 0 to 9. From the six columns the elapsed time can be read, in tens, units, and up to four decimal places.

Accuracy of the type TK is ±0.02%. Construction is based on plug-in printed circuit boards and the instrument is housed in a plastic case. It operates from a mains supply of 115 V or 230 V a.c. 50/60 c.p.s. Dimensions are 10.2 × 9.875 × 5.6 in. and the weight is 9 lb.—*Instrument and Meter Department, A.E.I. Instrumentation Division, Trafford Park, Manchester.*

For further information circle 6 on Service Card

7. High Voltage Unit

A high voltage unit, announced by Carl Zeiss, has been designed for mobility and is suitable for high voltage supply to electrostatic spray-painting guns and similar equipment.

This unit, type HA.90, works on the high-frequency cascade principle, with selenium rectifiers in an oil bath producing a negative output. It is non-stabilized and the internal resistance has been increased to a value of 300 MΩ so as to limit the maximum current to 200 μA.—*Degenhardt & Co. Ltd., Carl Zeiss House, 20/22 Mortimer Street, London, W.1.*

For further information circle 7 on Service Card

8. V.S.W.R. Display Device

A detector device capable of producing v.s.w.r. measurement directly on an oscilloscope has been announced by Telonic.

Utilizing a bridge circuit to produce a d.c. voltage directly proportional to the magnitude of reflection co-efficient of an unknown vs a known standard the detector, designated the TRB-2 RHO-Tector, covers a frequency range of 1 to 2,500 Mc/s. Its output may be used with a null balance meter or as the vertical deflection of an oscilloscope using frequency as the horizontal axis. The oscilloscope display then provides a direct v.s.w.r. reading especially useful in production test applications.

Claimed to be considerably less expensive and more sensitive than reflectometer or directional coupler-detector systems, the RHO-Tector can

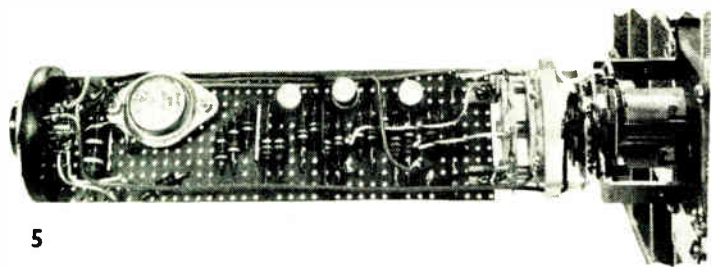

5



6

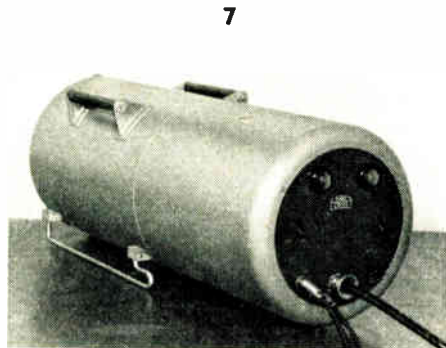

7

EQUIPMENT

review

1. Microwave Power Generators

Three microwave power generators have been introduced by Raytheon. The new PGM-10 series delivers precisely controlled microwave energy for laboratory research projects such as the production of free radicals, excitation of electrodeless discharge lamps for spectroscopy, raman spectroscopy, and interferometry.

Completely packaged in smart and durable bench-top cabinets, the Raytheon PGM-10 generators deliver 10 to 100 W of power at 2,450 Mc/s. Use of this ultra-high frequency permits the user to beam the power in clearly directed paths and its high penetration also minimizes the rate of 'cleanup' accumulation on the walls of electrodeless lamps. The latter is an important cost consideration when working with expensive isotopes, e.g. mercury 198.

The PGM-10 will accept voltages between 105 and 130 V at 60 c/s. Power consumption is 385 W. Cabinet size is 28.6 cm high by 54.8 cm wide by 37.8 cm deep. A beam-forming aerial with a 1.2 m lead is supplied with each unit.—*Sorensen Ardag, Eichstrasse 29, Zurich 3, Switzerland.*

For further information circle 1 on Service Card

2. Triple Diodes

Two triple diodes developed especially for a.m./f.m. receivers have been announced by Raytheon. In typical f.m. discriminator and a.m. detector circuits the use of triple diodes simplifies switching designs and reduces manufacturing costs.

The 6GQ7 is designed for transformer-operated sets while the similar 19GQ7 can be specified for 150-mA series-heater strings. Each valve incorporates three identical diodes electrically similar to a 6AL5. Each of the three diodes has its own cathode for greater flexibility of circuit design and mechanical layout. — *Raytheon-ELSI, S.p.A., via Villagrazie, N.79, Palermo, Italy.*

For further information circle 2 on Service Card

3. Flaw Detectors

The High Voltage Equipment Division of Buckleys (Uvral) announce the production of their Holiday Equipments type DC '0/5T' and DC '4/10' T2 designed for the detection of flaws on paint, plastic coatings, anti-corrosive coatings, etc.

The '0/5T' is suitable for coating thicknesses of 0.05 in. The output voltage is continuously variable over the range 800 V to 5 kV. The '4/10' T2 (illustrated) has an output voltage of 1 to 10 kV, again continuously variable. This unit is suitable for coating thicknesses of 0.1 in.

A neon indicator in the rubber-covered handle strikes to give a positive indication when porosity or a flaw is detected. The standard electrode

supplied is a detachable spring steel wire brush 6 in. long, splayed to 2½ to 3 in. wide. Users may easily fit electrodes of their own design. A jack socket is fitted on the front panel to allow a 500-μA meter to be used to ascertain leakage. Despite the high voltage, the current available is normally less than 1 mA.

The equipments have a power unit mounted in a transportable steel case, and have separate applicators. On the front panels are mains voltage selectors, switches, fuses, and output voltage control. To ensure that the voltage setting is not accidentally disturbed, a clamp is also fitted. These units are suitable for mains supplies of 90/120 and 200/240 V a.c. only. The power consumption is 30 W.—*High Voltage Equipment Division, Buckleys (Uvral) Ltd., The Embankment, Putney, London, S.W.15.*

For further information circle 3 on Service Card

4. Solid State L-Band Variable Attenuator

Micro State Electronics Corporation announce the availability of their solid-state L-band variable attenuator. The model A1401, constructed with Micro State diodes, is designed for maximum linearity of attenuation vs voltage. Minimum insertion loss is 0.5 dB and attenuation control over a

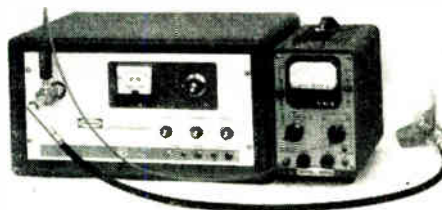

1



3



2



4

VIBRATING WIRE STRAIN GAUGE

A VIBRATING wire strain gauge designed by the Road Research Laboratory has been developed in commercial form by Deakin Phillips Electronics. This transducer, already in wide use, is intended for the accurate determination of slowly-varying internal strains in concrete, for example, those due to restrained thermal warping, expansion, contraction, shrinkage and creep.

The gauge consists of a pre-tensioned fine steel wire supported between two end-flanges, and enclosed in an acrylic tube with an electromagnetic plucking coil mounted centrally in the wall of the tube. The latter is plucked when a pulse of current is fed to the coil and causes a voltage to be induced in the coil, which is coupled to external measuring apparatus by means of a flexible lead.

As the strain in the concrete is proportional to the square of the frequency of vibration, the gauge provides a simple and inexpensive means of assessing internal strains. The low elasticity of the device ensures minimum interference with the parameters being measured and the accuracy of reading attainable, $0.5 \mu\text{in./in.}$, is unaffected by leads up to at least 500 yd long. Long-term stability is better than $\pm 1 \mu\text{in./in./yr.}$ The gauge weighs approximately $2\frac{1}{2}$ oz and is $5\frac{7}{16}$ in. in length with $1\frac{1}{2}$ in. diameter end-flanges. Nominal unloaded frequency at room temperature is 800 c/s.

With the simplest form of associated measuring equipment, the vibration signal voltage is displayed on one axis of a small c.r.t., the other axis being fed by the signal from a standard frequency source. The frequency of the latter is then adjusted to produce a Lissajou figure. Frequency discrimination to within about 0.1 c/s is possible with this method, but the accuracy depends to a large extent on the skill of the operator and this arrangement is far from ideal under adverse conditions.

A better system uses an electronic period counter in which the time interval required for a predetermined number of cycles of wire vibration is displayed in digital form. The accuracy of measurement here is determined only by the frequency standard, usually a crystal oscillator with a stability of about 1 part per million. Portable versions of this equipment are being developed.

A more sophisticated multi-channel data logging system is also being developed with a general arrangement as illustrated in Fig. 1. Strain is presented as a frequency-

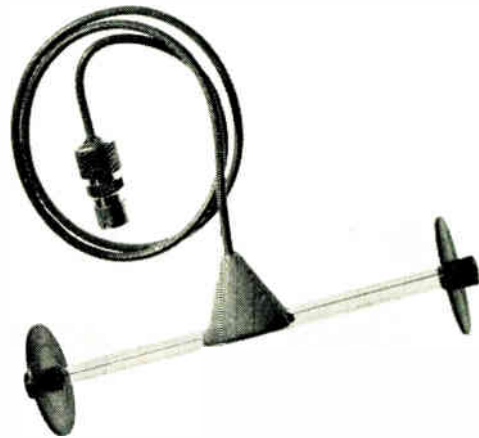

The R.R.L. vibrating wire strain gauge

dependent variable while temperature is measured on a resistance gauge.

Strain and temperature channels are scanned simultaneously and the temperature voltage outputs are converted to a proportional frequency in a voltage-frequency converter. Outputs from strain and temperature channels are selected alternately and fed to a frequency counter which displays frequency while connected to temperature channels and period while connected to strain channels.

The channels are scanned automatically in each mode at a rate of about one channel per second. Any number of channels up to a maximum of 50 of each may be preselected by means of a decade arrangement of pushbuttons. Automatic scanning of the preset number of channels can take place when the equipment is unattended, at preselected intervals of up to two hours.

Values are recorded on an electric strip printer and, when required, punched in Pegasus 5-hole code for subsequent processing by computer. A tape reader is also incorporated which works in conjunction with the printer.

R.R.L. strain gauges are at present being used to determine the characteristics of a section of pre-stressed concrete road at Winthorpe, Nottingham, and several hundred were recently utilized in an experiment to evaluate creep in concrete for a pre-stressed reactor shield running at elevated temperature. The Hammersmith flyover also incorporates many of these gauges. In addition, several experimental and research groups are using them in strain and creep investigations, both in this country and abroad.

For further information circle 49 on Service Card

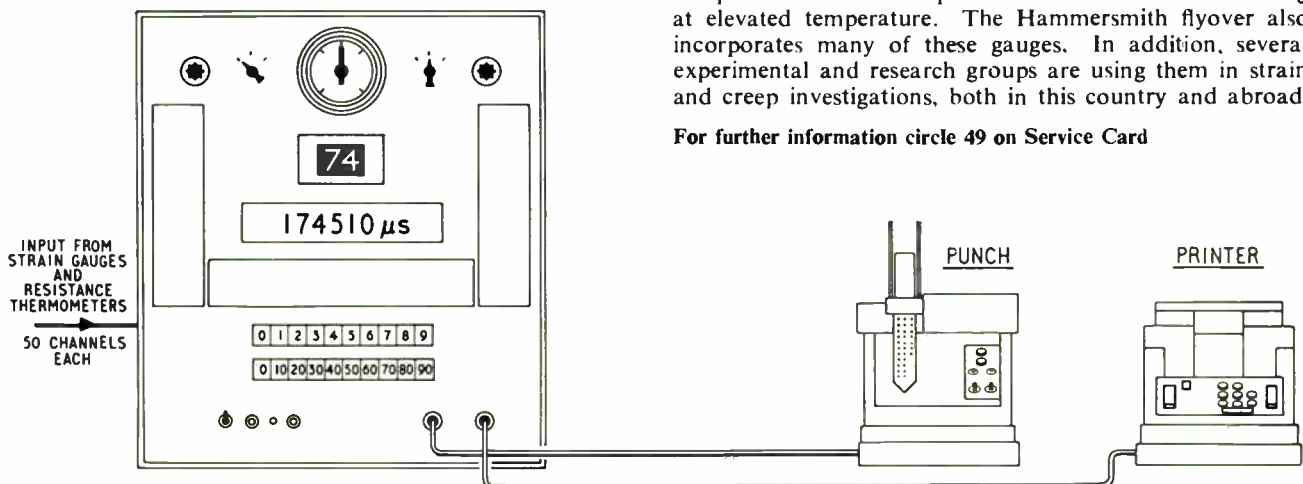

Fig. 1. General arrangement of a multi-channel strain and temperature recording system

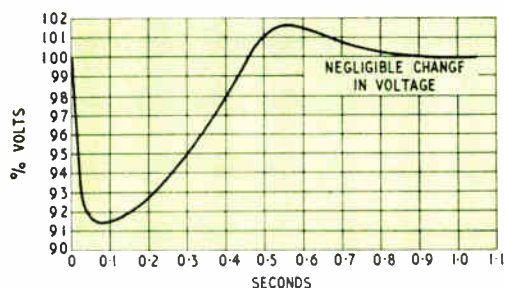

Fig. 7. Step response of regulated system

the a.v.r. will act in such a direction as to reduce the alternator excitation and voltage and thus tend to restore the power factor towards unity, the original lagging power factor being due to excessive excitation.

This method of compounding, often used with conventional alternators, also works very satisfactorily with brushless

machines. It is worth mentioning that the compounding signal must feed the a.c./d.c. convertor supply transformer (due to its synchronous nature).

The voltage level of the alternator is normally adjusted by means of a potentiometer in the d.c. transistor amplifier/error detector, this altering the value of the reference voltage. However, when machines are running in parallel, an increase in excitation on one machine will only result in its taking more reactive lagging current. Adjustment of the reference voltage can therefore be made to set the sharing of the reactive kVA. An increase in the reference voltages of all a.v.r.s will result in an increase in the system voltage level.

Response tests on the equipment yielded valuable information for the design of future regulators for this type of machine. Fig. 7 shows the results of one such test. It gives the response to a step input of 35% of rated load at 0.02 lagging power factor.

The alternator was controlled, in the steady state, to within $\pm 1\%$ of nominal voltage for all conditions of temperature and loading. The overshoot on recovery following the initial load-induced voltage change was not more than $2\frac{1}{2}\%$, with rapid return to the nominal value.

SPRAY PARTICLE ANALYSER

An electronic system using closed-circuit television linked to a computer has been developed by Rank Kalee for determining the characteristics of high velocity particles such as spray droplets.

Previous methods of analysis required photography and spark illumination: the individual negatives were examined under magnification and the particles measured and counted manually. This procedure took several hours for the examination, and days to obtain adequate statistical data.

The Kalee equipment is capable of scanning, sorting and counting up to 18,000 particles in less than one minute. It will classify according to size droplets with diameters ranging from 20 to 16,250 μ .

The spray is illuminated by high intensity, short duration (1.5 μ sec) flashes from a strobe unit, and a television camera with a microscope lens system converts the light image into a video signal. A development known as 'intercept scanning', in which a vertical scan is generated at the same time as the horizontal scan, makes possible an accurate determination of particle characteristics such as location, dimensions, orientation and form.

The video pulses are referred to a single-purpose digital computer which evaluates the diameter of the particles, groups them according to size and counts the number in each group. The output is presented on meters, lamp indicators and a single-channel chart recorder. The data can, if required, be processed by a separate computer or the analyser can form part of a process control system.

This device and the basic techniques involved appear to have a wide field of application; future developments will make it possible to measure and classify particles at greater speeds and will provide a means of examining a much wider variety of samples. These may include blood cells, bacteria, photographs of molecular structures, solid suspension in liquids, bubble chamber tracks and surface flaws in metals.

For further information circle 48 on Service Card

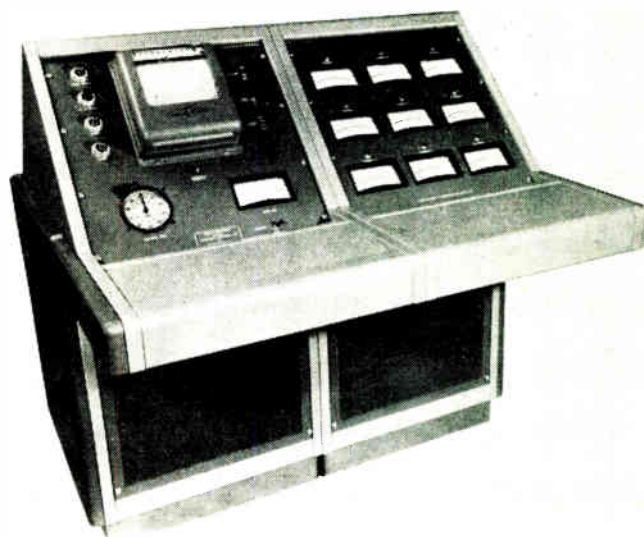

Control console showing chart recorder on the left and tally meters on the right

Television camera and strobe unit mounted on an optical bench

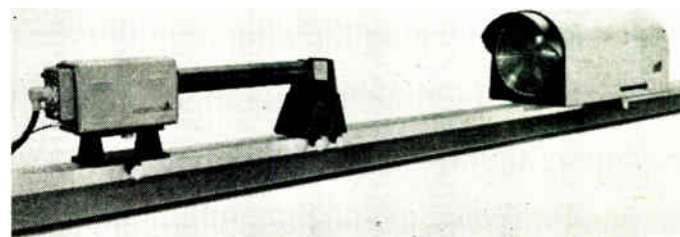

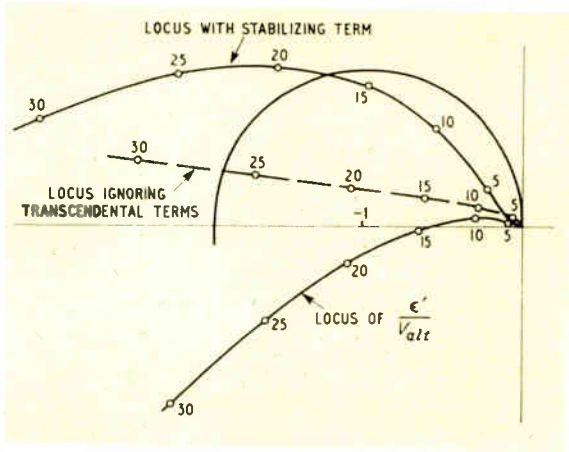

Fig. 4. Inverse Nyquist diagram showing the basic response and the effect of adding an anti-hunt circuit

Fig. 5. Form of anti-hunt circuit employed and its connection

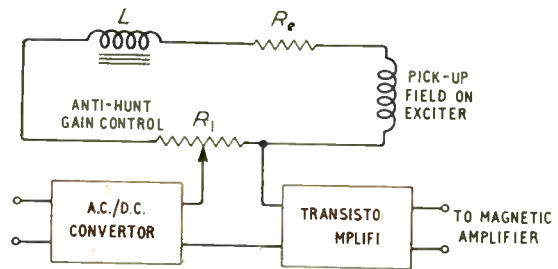

TABLE 2

ω	Response Function	ϵ'/V_{alt}
5	$/5.97^\circ + 0.00434 \times 1.6 / 51^\circ \times 13.03 / 85.5^\circ$	0.09 / 143°
10	$/11.93^\circ + 0.00434 \times 2.69 / 68^\circ \times 26 / 87.8^\circ$	0.304 / 168°
15	$/17.9^\circ + 0.00434 \times 3.88 / 75^\circ \times 39 / 88.5^\circ$	0.656 / 182°
20	$/23.86^\circ + 0.00434 \times 5.09 / 79^\circ \times 52 / 88.9^\circ$	1.15 / 192°
25	$/29.8^\circ + 0.00434 \times 6.32 / 81^\circ \times 65 / 89^\circ$	1.78 / 200°
30	$/35.8^\circ + 0.00434 \times 7.57 / 82.5^\circ \times 78 / 89^\circ$	2.56 / 207°

This locus is shown plotted in Fig. 4. It will also be noted that the two time-delays, although apparently insignificant at first sight, contribute to quite a large extent to making the regulator unstable.

The simplest method of stabilizing the regulator is to take a signal proportional to rate-of-change of exciter field current (or armature voltage), and amplify this signal in the transistorized d.c. amplifier. This voltage may be added in series with the signal from the a.c./d.c. convertor, or it may be added directly to one of the five other input points on the d.c. amplifier.

An additional small field on the stationary magnet system of the exciter was provided, and due to transformer action a voltage is induced in this field whenever the main field current is changing. However, because the main field is energized from the magnetic amplifier, a ripple voltage at 120 c/s appears in the pick-up field. Also, because the exciter armature feeds the alternator field via a 3-phase bridge rectifier a ripple voltage at 540 c/s is also injected into the anti-hunt circuit.

A choke/resistor circuit was designed, which almost completely attenuates the unwanted ripple voltages, and which also correctly shapes the required anti-hunt signal. This is shown in Fig. 5 and the time constant $L/(R_1 + R_2)$ is of the order of 0.24 sec.

The effective strength of the anti-hunt signal referred to the inverse Nyquist locus already plotted in Fig. 4, will, from inspection of Fig. 3, be seen to be:—

$$\left[\frac{K_f p}{1 + 0.24p} \right] \left[\frac{1 + T_a p}{K_a \times 0.035} \right] \times e^{0.0083 p}$$

where the first bracket represents the anti-hunt circuit.

As before, $j\omega$ is substituted for p , the appropriate values of T_a and K_a are taken, and allowance made for the transcendental term.

A suitable value for K_f , the voltage gain of the anti-hunt circuit, was found to be 0.0074.

In the design of the exciter field, allowance was made for the attenuation of the signal due to R_2 and R_1 .

Stability was also checked at several other values of alternator gain and time-constant, and the anti-hunt circuit gave effective stabilizing under all conditions.

Parallel-Running Compensation

In order that the machine can operate stably in parallel with others, quadrature droop compounding is used. The connections between each machine and its own a.v.r. are shown in Fig. 6.

The a.c./d.c. convertor is fed with the voltage across lines R and Y plus the voltage drop across resistor R_1 , which is fed from a current transformer in line B. The voltage across R_1 is in phase with the current in line B. Therefore, at unity power factor the voltage across R_1 is at right angles to the voltage V_{RY} , and has very little effect on the total voltage fed into the a.c./d.c. convertor. At zero lagging power factor, as shown in Fig. 6(c), the effect of the voltage across resistor R_1 is more pronounced, and since the total signal fed to the a.c./d.c. convertor is essentially constant,

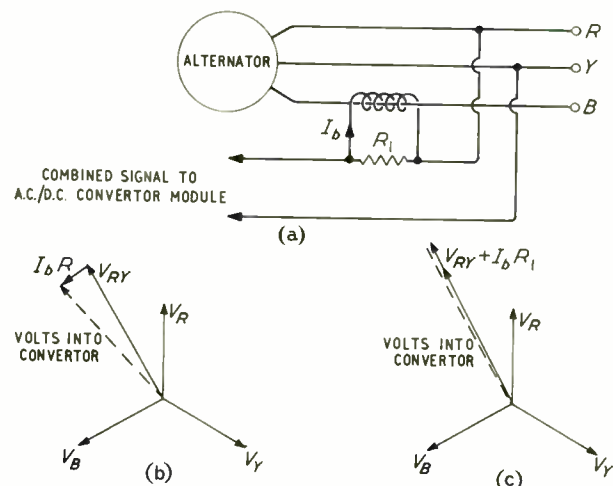

Fig. 6. Basic arrangement (a) for obtaining control when operating generators in parallel and vector diagrams (b) for unity power factor and (c) for zero lag power factor

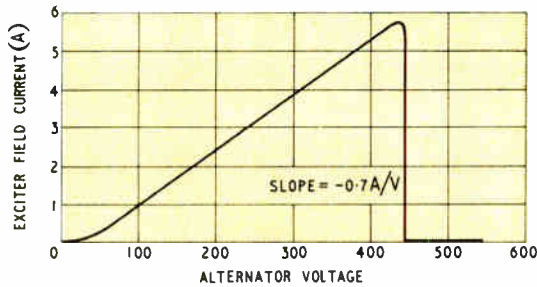

Fig. 2. Relation between alternator voltage and exciter field current

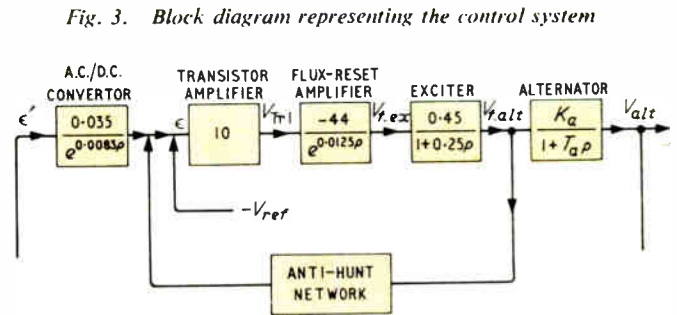

Fig. 3. Block diagram representing the control system

oscilloscope traces were photographed to check the theory, and since it is not possible in practice to guarantee control action at the start of a half-cycle, it was concluded that a three-quarter-cycle delay could be taken as the average response time of the amplifier. Note that full response takes place in this period of time on average.

Resistor R_1 in Fig. 1 provides negative feedback to stabilize transistor Tr_1 . The voltage gain of the transistor/magnetic-amplifier combination is -44 ; i.e., the transfer conductance is -2 A/V for a 22Ω load.

The a.c./d.c. convertor module, with a suitably-proportioned single-phase multi-winding transformer connected to two of the controlled-machine output terminals, has an incremental gain of 0.035 V (d.c.)/V (r.m.s.) on the alternator. It has a response time of not more than one half-cycle of the supply frequency.

The only remaining figure to be fixed is the gain of the transistor amplifier, connected between the a.c./d.c. convertor output and the transistor Tr_1 in Fig. 1, controlling the magnetic amplifier.

The requirement is that 11 volts change on the alternator will change the exciter field current by 1.86 A; i.e., the transfer conductance must be 0.169 A/V r.m.s.

Therefore, voltage gain of d.c. amplifier must be,

$$\frac{0.169}{0.035 \times 2} = 2.42$$

Since there is a possibility of some waveform distortion on the alternator itself, it was thought advisable to design for a considerably higher gain than this. Consequently, the d.c. amplifier gain was made about five times this value. This amplifier, which was described in the previous article, is of a basically high-gain type with feedback. The feedback resistor is fitted externally and is chosen to provide the required gain; this gain being (ohms in feedback resistor)/2,300. With the feedback resistor at a nominal value of $23 \text{ k}\Omega$, the amplifier gain is therefore 10.

This amplifier also contains a stabilized voltage which backs off the output of the a.c./d.c. convertor.

The transfer conductance between alternator voltage and exciter field current is therefore, $-0.035 \times 10 \times 2 = -0.7$ A/V and the overall static characteristic of the automatic voltage regulator is of the form shown in Fig. 2.

Stability Analysis

The complete regulating system can be represented by the block diagram of Fig. 3, where K_a is the incremental voltage gain of the alternator and T_a the incremental field time con-

stant of the alternator. Now the a.c./d.c. convertor has a transfer function of nearly unity and its delay is at such a place in the system that it represents a time delay before the alternator voltage can be compared with the reference voltage to produce the error signal. Consequently, there is little inaccuracy introduced by assuming that the error signal is developed before going through the convertor. That is, the reference voltage is imagined shifted to the left of ϵ' in Fig. 3. Then

$$\frac{\epsilon'}{V_{alt}} = \frac{(1 + 0.25p)(1 + T_a p)(e^{0.0083p})(e^{0.0125p})}{6.93K_a}$$

At 440 V on no-load, with the machines cold, the alternator gain K_a is 33.2, and its field time-constant T_a is 2.6 sec.

Although it is well-known that a true two time-constant system cannot be unstable, the presence of the additional terms, $e^{0.0083p}$ and $e^{0.0125p}$, introduces the possibility of instability, due to the spiral nature of the stability locus caused by these factors.

However, we cannot handle the transcendental terms in their present form, since they each represent a pure time-delay, and some approximation must be made so that we can plot the complete stability locus. The presence or otherwise of these two terms, although apparently small, will make all the difference between instability and a satisfactory regulator. The system is considered to be operating in a steady-state at 60 c/s. The effect of an input change can be thought of as an input signal superimposed on a 60-c/s carrier frequency.

Now consider a device with a finite delay of a half-cycle of a 60-c/s carrier frequency. From this, one can say that an input voltage change to such a device is not reproduced at the output terminals until the next half-cycle of the carrier frequency. This represents a phase lag of 180° ; i.e., a phase-loss on the signal frequency (carrier still present) of

$$\frac{180^\circ}{2\pi \times 60} = 0.477^\circ \text{ per radian per second.}$$

The a.c./d.c. convertor phase loss is therefore $0.477^\circ \times \omega$, and the flux-reset magnetic amplifier, which gives about $\frac{1}{4}$ cycle delay at 60 c/s, is $0.716^\circ \times \omega$. These two phase lags are additive, giving a total phase loss of $1.193^\circ \times \omega$.

Substituting $j\omega$ for p , we can therefore set down the equation for the complete regulator as

$$\frac{\epsilon'}{V_{alt}} = (1.193 \times \omega)^\circ + \frac{(1 + 0.25j\omega)(1 + 2.6j\omega)}{230}$$

and this is evaluated in Table 2 for various values of ω .

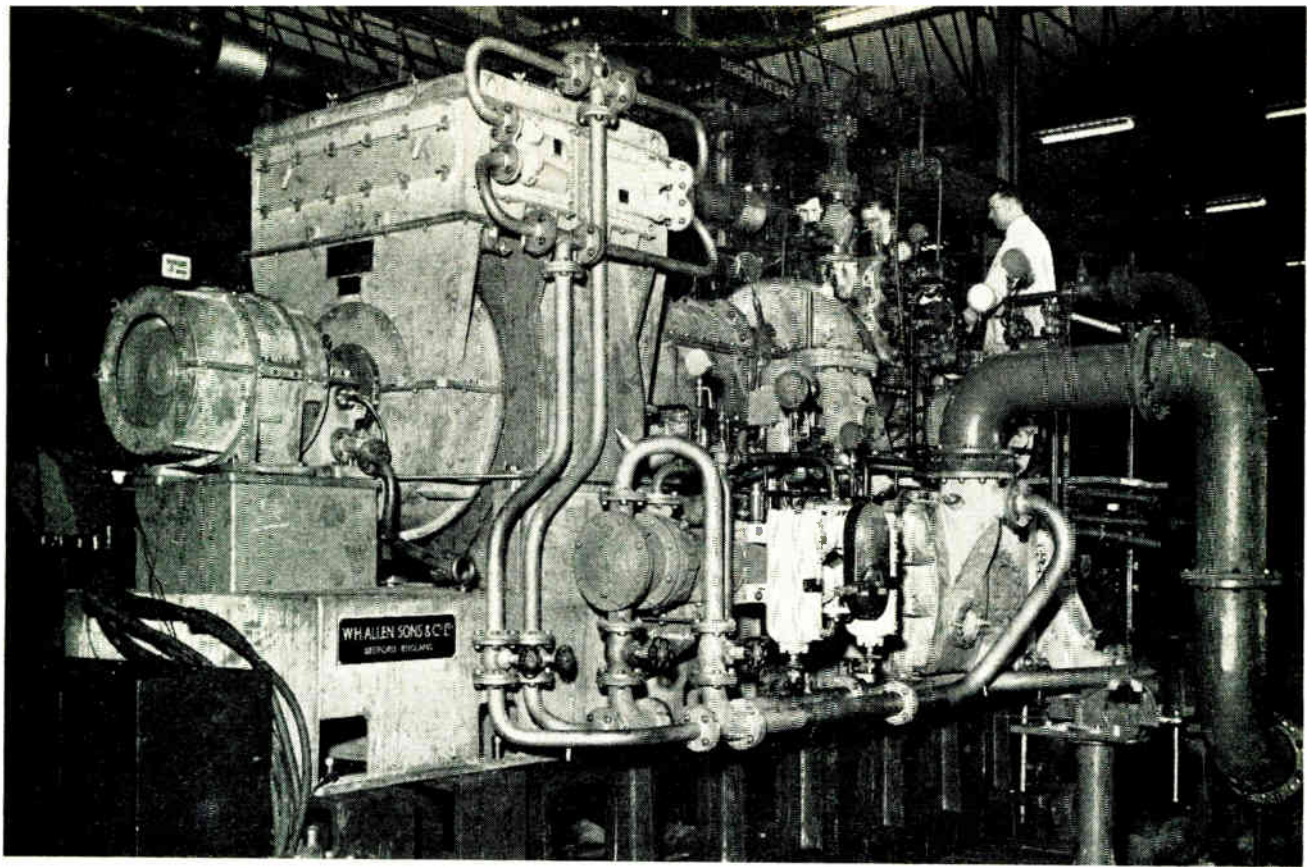

The turbo-generator to which the control system is applied

The exciter field-voltage change is 41 volts. At a nominal field resistance of 22 ohms, this represents 1.86 A change of current.

The gain of the closed-loop system, for 2½% regulation, must therefore provide a field boost of 1.86 A for $440 \times 2.5/100 = 11$ volts change of alternator output. This allows us 2½% for unknown temperature effects on the remaining components.

Maximum steady field power of exciter = $59^2/22 = 159$ watts.

A standard W. H. Sanders 4053/H/50 magnetic amplifier will give a d.c. output of 270 watts when supplied with 190 V at 50 c/s. However, since the power to the magnetic amplifier will be from the alternator itself, which is running at a nominal 60 c/s, the supply to the amplifier can be raised directly as the frequency to about 230 volts, so maintaining the same flux density in the transductor cores. This allows a nominal maximum output from the amplifier of about 325 watts. However, by having the field resistance only about 35% of the normal value for this amplifier, a peak output of 750 watts can be obtained for exciter field-forcing, and still keep within the r.m.s. current rating of the amplifier. Because of the inductive nature of the amplifier load, the r.m.s. current in the magnetic amplifier gate windings is less than that in the exciter field itself.

The magnetic amplifier is connected in a flux-reset circuit, this giving the fastest possible voltage-time response; i.e., a possible half-cycle delay of the supply frequency. The transistor d.c. amplifier will only give 10 mA output, and this is insufficient fully to control the magnetic amplifier, so a further transistor is required to give the necessary gain.

Fig. 1 shows the circuit of the magnetic amplifier and control transistor. The dots on the transductor windings indicate the electrical starts, and the plus signs on the gate and reset voltage supplies show the phasing. The action of the circuit is as follows. In a positive half-cycle the gate supply passes current through D_5 and the gate winding of element A, through the exciter field, and thence via diode D_8 . This flow of current drives the flux of element A to peak

positive saturation. In the same half-cycle, the reset voltage, V_r , drives current through D_4 , the reset winding of element B, resistor R_1 , transistor Tr_1 , and thence via diode D_2 . If the transistor Tr_1 is bottomed (i.e., has a very small impedance) there will be sufficient current flow through the control coil of element B to drive the flux to peak negative saturation. The core is said to be fully reset.

In a negative half-cycle, the gate and reset voltages are reversed, and consequently operate on the opposite cores. Now, if the transistor is only partly 'open', so that it becomes a medium-level impedance, then it will limit the current which can flow through the control coil of the transductor and will only partly reset the core, and in the following half-cycle, the gate voltage will saturate the core before the end of the half-cycle. The remaining area of the half-sinusoid will therefore pass current round the circuit, its value being mainly controlled by the resistance of the exciter field and the transductor saturated impedance. This control action, of course, will occur for both positive and negative half-cycles of supply.

The theoretical minimum voltage response of this circuit is one half-cycle of the supply frequency. A number of

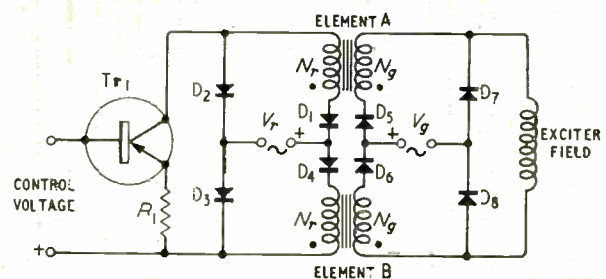

Fig. 1. Magnetic amplifier and control transistor. V_g and V_r are the (a.c.) gate and reset supply voltages while N_g and N_r are the gate and reset turns

Automatic Voltage Regulator for A Marine Turbo-Alternator

By P. FENWICK*

An application of a set of standard servo modules to automatic control is described in this article. The modules are used to regulate the voltage of a 750-kW marine turbo-alternator.

* W. H. Sanders (Electronics) Ltd.

THE use of pre-designed control elements, which in themselves are flexible in application and readily-adjustable by external methods, considerably simplifies the design of closed-loop control systems. These elements have been described in detail in *Industrial Electronics* (August 1963, p. 555) and here their application in regulating the terminal voltage of a turbo-alternator is discussed. This alternator is of the brushless type, designed and constructed by W. H. Allen, Sons & Co. Ltd., of Bedford, and is driven by a steam turbine. Its output is 750 kW at 440 V, 1,230 A at 0.8 lagging power factor, 3-phase, 60 c/s.

The field power for the salient pole alternator is obtained from a direct-coupled 3-phase a.c. exciter, the output of which is rectified by a rotating 3-phase silicon bridge rectifier. Thus, the armature of the exciter, the silicon rectifier assembly, and the alternator field system are mechanically common, and rotate together, so that there is no transfer of electrical energy via sliding contacts. This principle is not unique, but it completely eliminates the need for periodic maintenance which would be necessary on conventional brushgear, a rather irksome task particularly when there is any difficulty of access.

Regulator Specification

- (1) Voltage accuracy: $-440 \text{ V} \pm 2\frac{1}{2}\%$ for no-load cold to rated-load hot.
- (2) Transient response:—initial voltage rise or dip to be not more than 15%, when a 3-phase load change of 35% at zero lagging power factor is made. The recovery time to within $2\frac{1}{2}\%$ of nominal voltage to be not more than 1½ sec.
- (3) A 5% adjustment of machine terminal voltage when on auto-control to be catered for.
- (4) Power-factor load-compensation circuit to be provided to ensure adequate load-sharing for parallel running with another machine.
- (5) Regulator to meet the appropriate Lloyd's requirements for marine electrical equipment.

Regulator Requirements

Since the requirement is fundamentally to provide a relatively-constant output voltage from the alternator, and the basic starting-point hardware is the alternator/exciter combination, the minimum additional equipment needed is obviously:—

- (1) A d.c. amplifier to provide exciter field power.
- (2) A device for converting the 60-c/s output voltage of the regulated machine to a direct-current equivalent.
- (3) A reference-voltage for (2) to work against, so that (1) provides full output to within a few per cent of the required alternator output voltage.

Because the exciter requires a peak input power of about 750 watts during field-forcing conditions, and the regulator is to be built from lower-power transistorized servo-system modules as far as possible, it is necessary to use two cascaded d.c. amplifiers for item (1). The d.c. transistor amplifier is capable of a linear output of 4.5 volts at 10 mA. The logical choice for the power amplifier at the time this regulator was designed was a magnetic amplifier.

Design of Regulator

From the characteristics and parameters of the alternator and exciter the field-change requirements were calculated. This yielded the figures of Table I.

TABLE I

Alternator field current	72 A (no-load)	165 A (rated-load)
Exciter field voltage	18 V (machine cold)	59 V (machine hot)

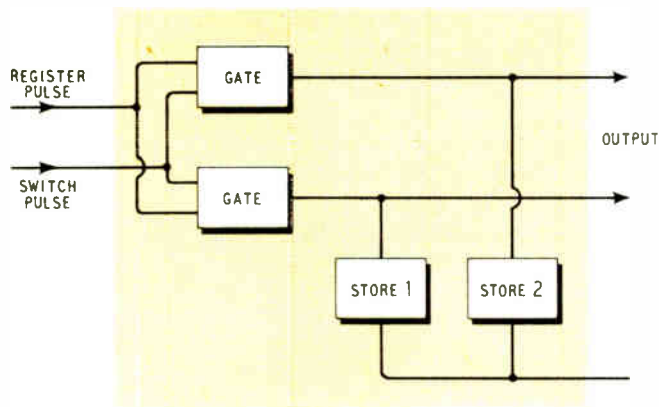

Fig. 1. The phase of the register pulse relative to the switch signal governs the current fed through the gates to the stores. Any difference between the stores is an error signal which actuates the control system

usually visible as a black bar at the side of the picture, having its length at right angles to the direction of motion of the paper through the machine, is observed photoelectrically and a comparison is made between the instantaneous position of the register mark and the instantaneous position of the printing cylinder on the newsprint press. In the photograph of a newsprint press, with pre-printed advertising matter being fed into it, the scanning head looking for the register mark can be clearly seen. The electronic circuit for measuring the instantaneous positions is shown in block form in Fig. 1, from which it can be seen that the system has two inputs for pulse trains. The first input is from the photoelectric cell scanning the pre-printed

material and checking the position of the register marks; the second input is from a special photoelectric switch driven by the printing cylinder itself. This is arranged so that as the printing cylinder reaches the correct position, the output from the switch changes from one value to another. This signal feeds two gates, one of which is always open; which one depends on the switch signal level. These two gates pass the photoelectric pulse through into one of two stores and the differential output of these two stores is the control signal. If, at the point of registration, the gates change over, then one half of the register pulse is passed to each store, thus the differential in the two stores is zero. If, however, the registration pulse occurs when the printing cylinder is in the incorrect position then it is transmitted through one gate and one store is charged more than the other, the differential output then being indicative of the direction of error.

The error signal is amplified and used in an electronic control system to control the speed of a d.c. machine which drives (via a differential gearbox) the nip rolls which are stretching the paper. Because the paper is always slightly short this correction motor is always running in one direction, stretching the paper, and very fast and accurate control is possible.

Some hundreds of thousands of copies of newspapers have been produced with the intersetting mechanism in operation and at least one large northern newspaper now produces regular full-page registered colour advertisements twice a week. Other newspapers, mainly provincial, have used the intersetting not only for inserting colour into their pages but also for effectively doubling the capacity of their presses by printing half the paper, containing general news, and re-running the material through the same press putting in the latest news.

BRITISH GAS LASER

Ferranti are now producing what is claimed to be the first commercially-available gas laser to be made in this country. It provides an important new tool for research in such fields as laser phenomena, long-path interferometry, communications problems, surface quality control, metrology, plasma studies and data processing.

The Ferranti laser is based on the original confocal gas laser using a helium-neon mixture, and operates either at 11,530 Å or 6,328 Å, emitting a plane-polarized continuous wave with a nominal power of 10 mW. It employs an 80-cm discharge tube with silica Brewster end windows and external spherical mirrors, and it has a non-concentric, confocal configuration for ease of adjustment. Hemispherical and concentric configurations are available on request.

Excitation of the helium-neon mixture is achieved by applying crystal-controlled radio-frequency energy at 27.1 Mc/s through external electrodes on the tube. A hermetically-sealed silica chamber surrounding the laser preserves the multi-layer mirrors and also provides a thermally-stable separation for the invar mirror mounts. This minimizes the first-order frequency shift due to changes in mirror separation.

The laser is $44 \times 8\frac{1}{2} \times 5$ in. and weighs 18 lb when

complete with detachable casing. A separate power pack weighing 38 lb is supplied for the r.f. exciter unit.

For further information circle 47 on Service Card

Checking the performance of a Ferranti Mk. 1 gas laser

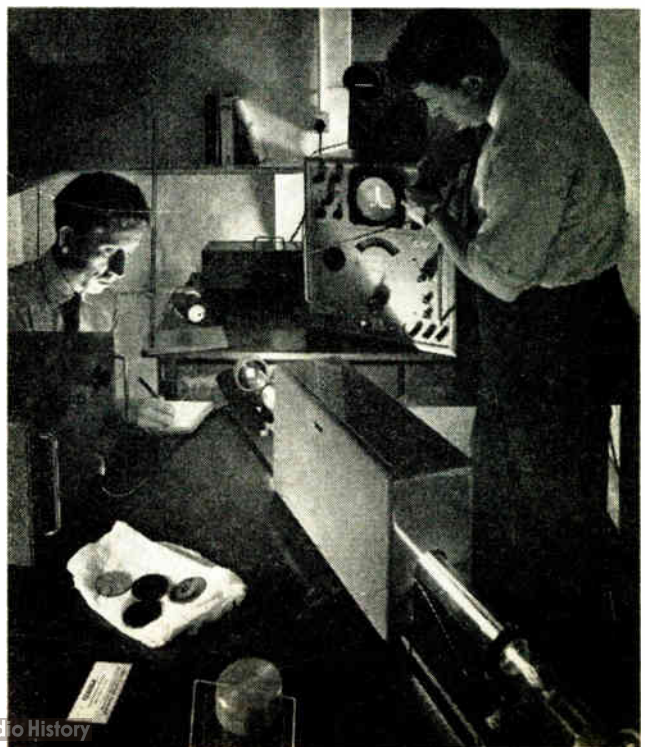

Colour advertisements are often printed before the news material in a newspaper. Registration problems then arise when the news is printed and are overcome by an electronic control system.

CONTROL OF INTERSETTER OF A PRE-PRINTED WEB IN A NEWSPAPER PRESS

By J. C. MAWER*

DURING the last few years full colour advertising has been introduced into daily newspapers. This takes one of two forms, either a 'Wallpaper' type of display is used, where the advertisement consists of a repetitive pattern, so there is no need to ensure accurate registration between the pre-printed web and the printing press, or the full page register type is employed, where the advertisement is a picture which is positioned accurately on the page of the newspaper. The latter type of advertisement is rendered possible only by the use of electronic control to ensure accurate registration between the pre-printed web and the newsprint machines.

The mechanics of the printing processes are such that it is rarely possible to ensure that paper printed on a colour press, maybe hours or days before the production run on

*Lancashire Dynamo Electronic Products Ltd.

the newsprint machines, will have a print pattern of exactly the correct length to fit into the news print-schedule. Even if this does happen there are the inevitable small variations in the newsprint machine which would result in registration being lost and the colour advertisement gradually creeping up or down the page and becoming lost in the news print printed on the same page. In order to overcome this difficulty therefore the pre-printed material is deliberately printed slightly shorter than the final newspaper page by some 20 to 30 thousandths of an inch and the paper is stretched in the printing machine to the correct length. This type of control, by accepting that there will be a difference, and it will always be in the direction necessary to be corrected by stretching the paper, has rendered full page, in register, colour advertising possible.

In practice a registration mark on the incoming material,

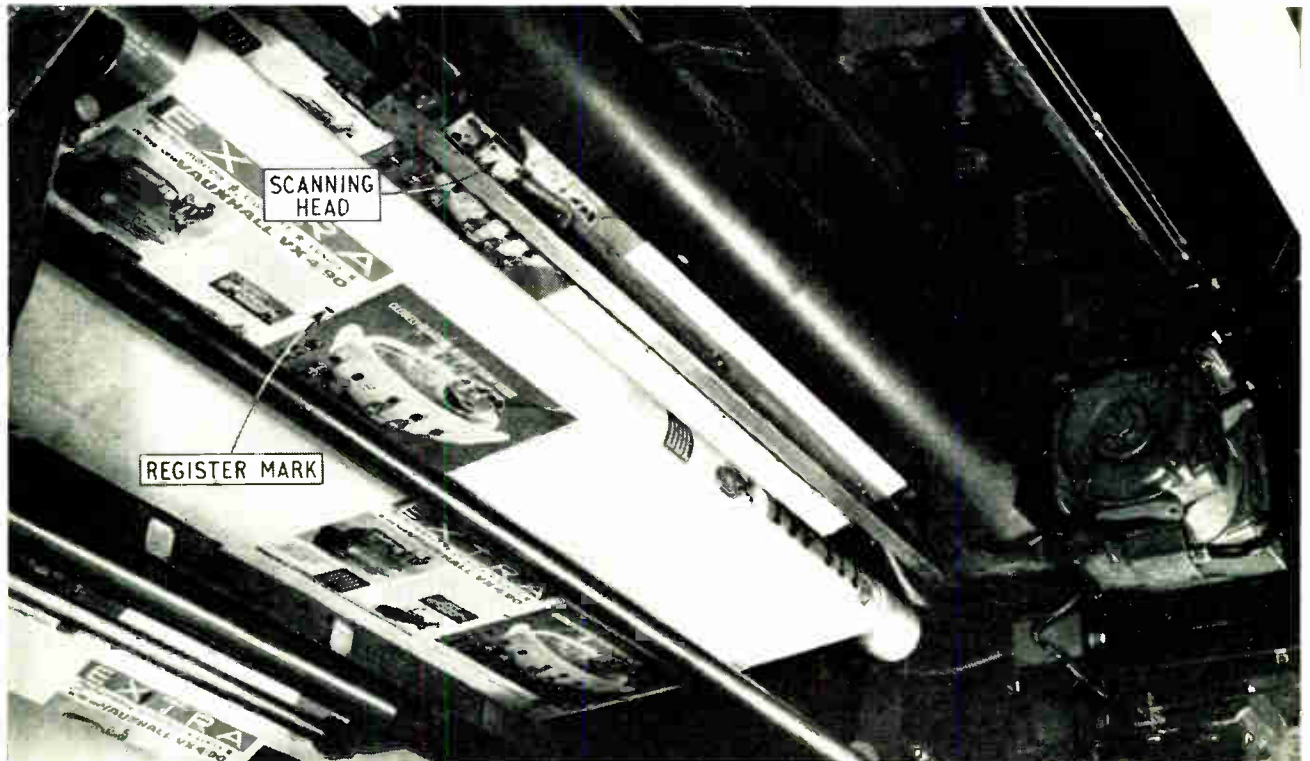

Printing press with pre-printed material being fed in. The register mark on the paper and the photoelectric scanner are shown

respect to the cathode, the ignitor having no further influence. The ignitor is a small rod tapered to one end with a rounded tip which projects into the mercury pool cathode. When a sufficiently high voltage is applied between the ignitor and the mercury pool (ignitor about 150/200 V positive) a discharge arc develops between the two and this arc spreads over the whole ignitor. When the surrounding space is sufficiently ionized and the anode is given a minimum frequency of 25 c/s discharge to the anode takes place. The main discharge comes from a small region of the mercury pool which is known as a cathode spot and which is in continuous motion. It moves away from the ignitor but does not reach the wall within a half period of the anode voltage cycle. If this were to occur there would be danger of severe damage to the wall with a possibility of its being burnt through. A number of these bright cathode spots (dependent upon the current intensity) can develop upon the mercury surface at the same time and permit the passage of very high currents of up to 10,000 amperes or more. Provided that the anode voltage is greater than the arc voltage by about 12/18 volts and also that the anode current is sufficiently large, the discharge arcs will remain and the ignitor is no longer involved.

As two ignitrons are used in reverse parallel the two

valves conduct during alternate half cycles of the applied signal when the initiation switch is closed. The rectifiers in the circuit prevent any current from flowing in the reverse direction through the mercury pool and ignitor. The normal contact for closing the ignitor circuit and the rectifiers in the circuit can be replaced by two thyratrons. The grids of these thyratrons are fed with voltage pulses synchronized with the supply voltage. The grids are supplied with a negative grid bias which is large enough to maintain them inactive unless triggered by a voltage pulse. The system is similar to a switch and voltage pulses in the primary winding of the transformer cause the thyratrons to strike and the corresponding ignitrons to conduct. As soon as an ignitron strikes it effectively reduces the voltage across the thyatron connected to it, thus cutting it off. For accurate control of starting time, short duration pulses of large amplitude are used. The simplest form of pulse generator employs a peak transformer (having a saturated core) and the required phase-shift is obtained using a phase-shift bridge. With this method of control, it is possible to achieve an extremely accurate firing point in each half cycle of the switched current. Varying the time, within each half cycle at which the initiating voltage is applied, provides control of weld time.

COMPACT ULTRASONIC TRANSDUCER/TRANSMITTER UNIT

Encapsulated ultrasonic transducer/transmitter units have been developed by Vacuum Reflex which show considerable advantages in weight and size over equipment of orthodox design.

Conventionally, ultrasonic transducers are driven by a transmitter unit located some distance from the actual transducer. With the Vacuum Reflex system a miniaturized transmitter is incorporated in the transducer assembly. The result is a simple, compact unit requiring only power supply connections.

Such units have been developed for pulse operation at peak powers up to 5 kW, and up to 500 W, c.w. A significant advantage of this system is that matched interconnecting power cables are no longer required.

Typical of this development is a unit (illustrated) for liquid-level measurement in large storage tanks. The trans-

ducer is encapsulated in a material matched to the liquid into which it transmits. The transmitter circuitry is incorporated in a 1-in. section behind the transducer face. The peak power output is 500 W and the unit is operated from a 150 V d.c. power supply.

Receiver units are also available incorporating the receiving transducer and preamplifier in one package. Typical of these is a sonar receiver 2 in. in diameter and 1½ in. deep, which operates with input signals of considerably less than 1 μV.

The availability of these units originates from the recent development by Vacuum Reflex of sonar systems requiring transducers with widely different specifications, from arrays with beamwidths of a few degrees to completely omnidirectional sources.

For further information circle 46 on Service Card

Ultrasonic transducer/transmitter unit for liquid level measurement in large storage tanks



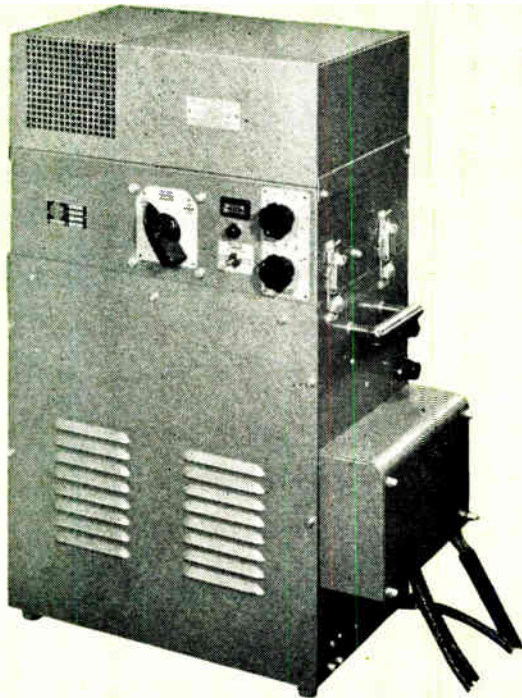

Model XE.71 synchronous control panel for use with twinhead welding machine for plastic-coated sheet

(Courtesy A.R.O. Machinery Co. Ltd.)

a projection to localize the weld area and to use an extremely short weld time.

The effect of pressure dwell on the surface of the material is critical when welding this material since, even with optimum weld time and current setting, too rapid a release of the electrodes will produce a blister on the vinyl surface due to the effect of the adhesive. On the other hand, if the dwell, or hold time, is excessive, the small amount of heat which is conducted through to the vinyl coating causes softening of the surface, which is then marked from the pressure of the electrode tip.

The ultra-short weld times require the electrodes to be part of a low-inertia system, to enable rapid pressure follow-up of the collapse of the projection. In order to increase the heat generated by the weld current, it is advantageous to use as low an electrode pressure as possible, consistent with the necessity for collapsing a projection without burning the metal. The reduction of the contact pressure increases the interfacial resistance and, therefore, a higher heat input is obtained from similar weld currents.

Due to the insulating effect of p.v.c., direct welding may not be used and it is necessary to employ series welding techniques with both electrodes on the same side of the sheet.

Projection Design

Orthodox projection design as used for non-coated sheet is not recommended for the fabrication of plastic-coated material. It is preferable to re-design the projections so that satisfactory welds, under the conditions already outlined, can be obtained. The portion of the metal raised to welding temperature during ultra-short weld times is limited to the tip of the projection, and with standard projections it is not generally possible to achieve full collapse. Shallower projections are, therefore, advocated and the use of two or three projections in a cluster produces stronger welds.

In series welding it is the general practice to weld simultaneously with both electrodes. The usual current shunt-

ing effect of the top sheet in the system is normally reduced by applying an additional shunt to the lower sheet in the form of a heavy copper backing strip. This is impossible, however, with plastic-coated sheet as the bottom shunt would be insulated and it is not possible to apply this technique to increase the current through the weld. Specially-designed transformers, however, can provide an increase in the total secondary current which can take care of the losses obtained through the shunt path. The simultaneous welding of two components such as nuts, studs or brackets is feasible where there is no direct path between the top two components. Great use is made of indirect projection welding methods for this class of work. Pressure is again applied on the same side of the sheet (i.e., the zinc coated face), but one electrode exerts force on the component into which the projection has been formed and the return electrode makes contact with the zinc-coated face of the second sheet. With the aid of this indirect method, the shunt loss is overcome as both electrodes are not in contact with the same sheet.

As a general guide to machine settings, the following figures are typical for 18 B.G. zinc-plated material:

Weld time: 1 cycle
 Electrode force: 400 lb
 Secondary current: 15,000 amperes.

Satisfactory welds can be obtained on 2 B.A. studs having a $\frac{7}{16}$ -in. diameter, $\frac{1}{16}$ -in. thick head. The projections on the head should be spaced on a $\frac{3}{8}$ -in. diameter circle and should be three in number, 0.050-in. diameter, hemispherical, and 0.025-in. high. For these welds typical settings for 18 B.G. sheet are:

Weld time: 1 cycle
 Electrode force: 200 lb approx.
 Secondary current: 8,000 amperes.

The overlap joint is regularly used in fabricating sheet metal articles and generally retained by spot welding. Projection welding has been applied satisfactorily to this type of joint by raising a projection through the vinyl face of the inner component. The raised vinyl coating is removed by cutting or by a rotary wire brush, leaving a bare metal surface on the top of the projection to provide the necessary continuity for the secondary welding current flow. The suitable projection size for the above joint is larger than that which normally applies to the gauge of material, since it is necessary to ensure that the initial pressure of the welding electrodes does not collapse the projection below the level of the surrounding vinyl. If this was allowed to take place serious burning would occur with an unsatisfactory result.

Electronic Control

As already mentioned, the necessity for using an extremely short weld time requires controls capable of producing accurate and consistent synchronous timing. The normal electromagnetic type of contactor is not accurate enough and therefore electronic control panels operating on the synchronous system and using ignitrons are essential. This electronic method of power switching where two ignitrons are connected in reverse parallel allows a very much faster rate of switching than can be obtained with a mechanical contactor. The fastest switching time of an electromagnetic contactor is of the order of 2 to 3 cycles of the 50-c/s supply frequency and these times are far too long for the welding of vinyl coated sheet.

The ignitron is a gas-filled device containing mercury vapour at low pressure and is used for heavy current rectification. The valve is fitted with an ignitor to initiate the flow of current through the device and this is maintained as long as the anode is sufficiently positive with

FABRICATING PLASTIC-COATED STEEL

By C. BURTON *



Twinhead welding machine for plastic-coated sheet
(Courtesy A.R.O. Machinery Co. Ltd.)

Ordinary welding methods cannot be used with plastic-coated sheet metal. This article describes a way of welding this material which is based on projection welding with electronic control.

THE introduction of plastic-coated metal, of which Stelvetite, manufactured by John Summers & Sons Ltd., in collaboration with BX Plastics Ltd., is a typical example, has led to special techniques being developed for its fabrication. This is because electrical contact can be made with the sheet only on the side which is not coated.

Stelvetite plastic-coated sheet is produced by bonding vinyl (polyvinyl chloride or p.v.c.) to sheet steel of high quality, the reverse side being electro-zinc plated or hot dip galvanized. This p.v.c. coating is durable, hard wearing, tough and resistant to humidity and climatic conditions, in addition to being resistant to oil and a wide variety of chemicals. The material can be sheared, formed, punched, deep drawn, expanded, as any other metal with little variation in tooling, and this makes the sheet an attractive one for designers in many spheres of industry. In addition, corrugated sheet and other profiles can also be obtained. Considerable use has been found for Stelvetite in the electrical industries because the vinyl film is an effective electrical insulator. Applications in this field include switchgear panels and electrical phase-shift panels. Other applications include partitioning and panelling, walls, furniture, kitchen equipment, cabinets, counters, and drums.

Stelvetite was used to line the tunnel of the 312-ft long travolator which operates between the Bank and Waterloo stations in London, 8,000 sq ft being employed. It has also been used for panelling semi-exterior areas of large L.C.C. flat blocks.

Joining Plastic-Coated Sheet

As the vinyl coating is bonded to the steel sheet, it will be understood that the use of a low input welding process, such as oxy-acetylene, is not a practical proposition. In fact, any fusion welding process will cause excessive heating which will 'bubble' the plastic surface. The heat pro-

duced by welding must, therefore, not be allowed to penetrate into the steel section as the p.v.c. coating would soften and this would spoil the embossed surface. The partial decomposition of the adhesive bonding medium together with the evolution of gases, will obviously blister the vinyl coating. On certain classes of work it is not necessary to retain the local coating; i.e. at the edges of flanged sheets. In such cases, the vinyl may, in fact, be locally removed and the material welded, using orthodox welding equipment and methods.

Resistance spot welding is obviously the most practical method of joining this material and a considerable amount of development work was carried out by John Summers & Sons Ltd. in conjunction with British resistance welding equipment manufacturers. In the main, existing resistance spot welding plant was modified and adapted to suit the special requirements of the vinyl coated sheet steel.

The most successful resistance welding method that has been finally adopted is projection welding, employing techniques designed to limit the welding time so that the vinyl coating is not overheated or damaged. Projection welding is a development of spot welding technique. In spot welding, the size and position of the weld are determined by the size of the electrode contacting faces and where they are applied to the work pieces. In projection welding, however, the size and position of the weld or welds are determined in the design of the component to be welded due to the fact that projections or embossments are raised on the work pieces at the positions where the welds have to be completed. The welding current flow is localized through these projections which collapse rapidly under the effect of heat and pressure.

This projection method is used for lap joints and the attachment of brackets, strips, nuts, studs, etc. It was soon proved that the satisfactory welding of p.v.c. coated sheet can only be carried out by carefully controlling the heat conducted away from the welding area through the vinyl coating. To minimize this effect, it is necessary to employ

* A.R.O. Machinery Co. Ltd.

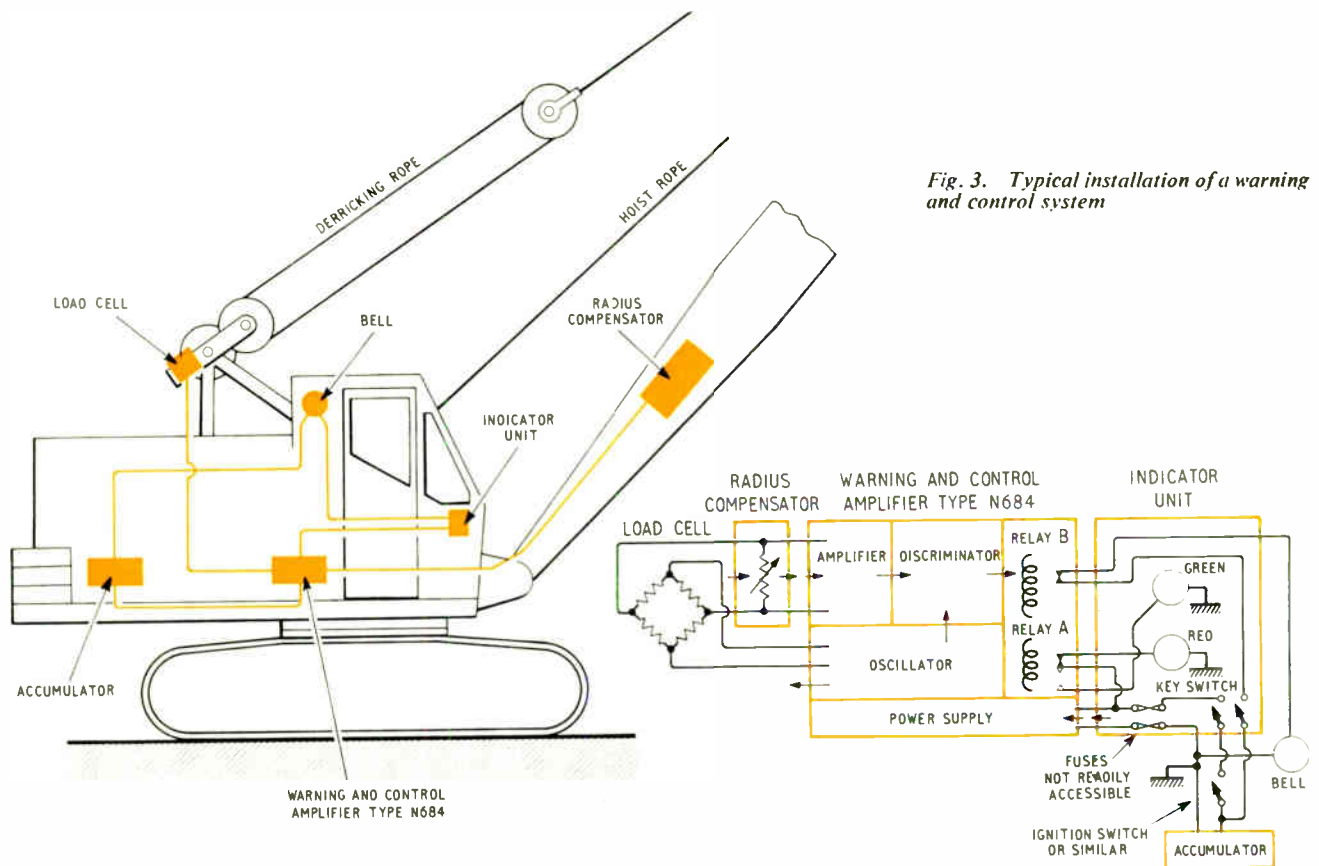

Fig. 3. Typical installation of a warning and control system

constitute the fourth sub-unit of the amplifier unit have no unusual features.

Uses of the Equipment

The most obvious use of the equipment is for the measurement and control of physical variables, an example of which is given above. Another example is an experimental installation on a chain-testing machine. The main warning can be set to occur when the tension reaches any value between 0 and 30 tons. Another pair of the relay contacts can be used to stop the motor driving the hydraulic pump and hence prevent the tension exceeding the pre-set value. In this installation the meter indicates the amount the actual tension is below the pre-set level.

In some installations it is a requirement that the input level at which the warning is to be given should be changed according to some law. This can easily be done by varying the trip setting potentiometer (RV_1) or by shunting the load cell either by a continuously variable resistance or by using a multi-position switch. This is done when the equipment is used as a safe load indicator for mobile cranes. The load which can be safely lifted is dependent upon the working radius and in this instance the angle of the jib is used to provide the necessary compensation.

A switch, similar to the conventional mercury switch, but having about forty contacts, is mounted on the crane jib, Fig. 3. Some or all of the contacts are connected to taps of a resistive chain which shunts the load-cell output terminals. As the jib moves the column of mercury short-circuits different parts of the chain, the taps being so placed that the required law is followed. When the law to be followed changes, for example, as when the jib length is changed, a new resistive chain with a different value of resistance and tap positions is substituted for the old. A

large number of different jib arrangements can thus easily be accommodated, which is not the case with previous systems. This version of the equipment has recently been granted a certificate of approval under the Construction (Lifting Operations) Regulations, 1961.

Certain features of the design and uses of the equipment revealed in this article are the subject of patent applications.

Designed for Accessibility

One of the new '2000 series' of electronic measuring instruments produced by Marconi Instruments. A feature of this precision transistorized oscillator is the hinged-panel construction which ensures ease of access to the components.

For further information circle 45 on Service Card

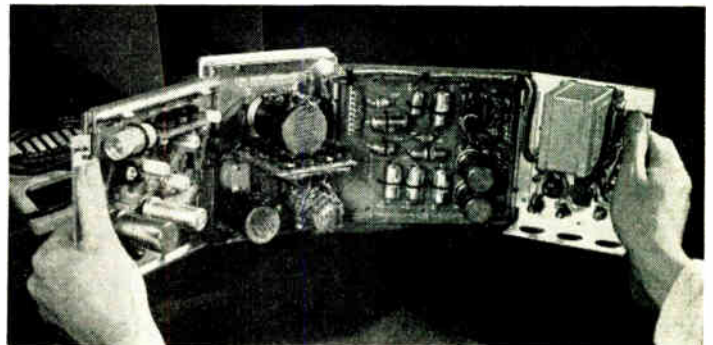
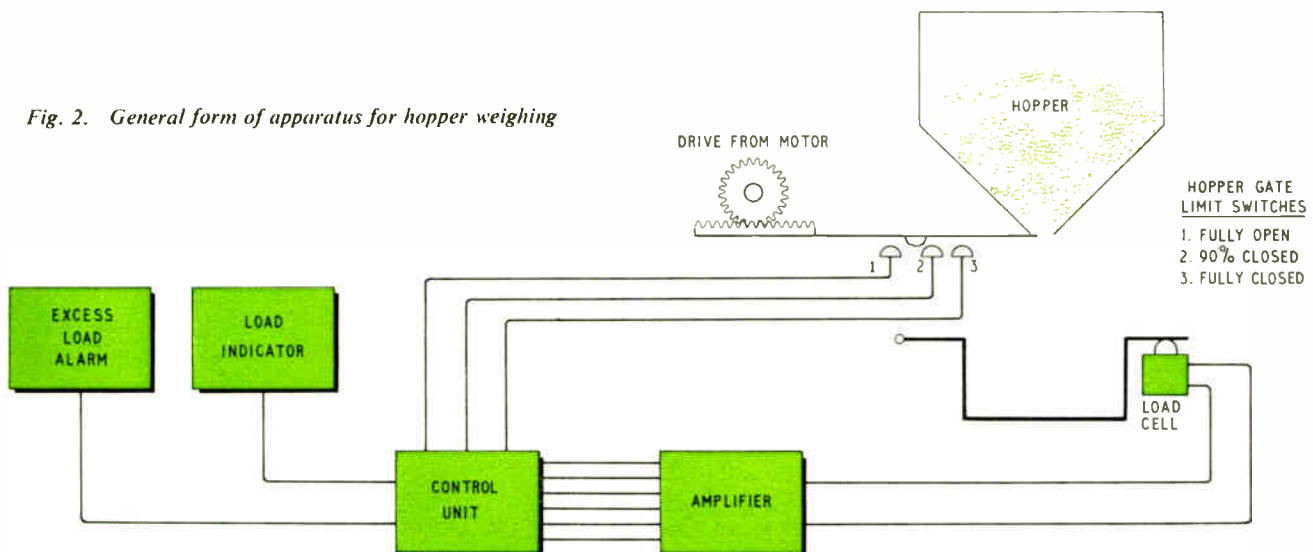

Fig. 2. General form of apparatus for hopper weighing



The input to Amplifier 1—which is the difference between the load cell output and voltage from potentiometer VR_1 is amplified in Amplifiers 1 and 3. When the input drops to zero or changes phase (which it does when the output from the load-cell bridge exceeds 11 mV in the present example) a relay in the output circuit of Amplifier 3 is de-energized and its contacts close. These contacts are used to provide the necessary warnings and to stop the flow of material into the hopper.

The output of Amplifier 1 is also connected to the input of Amplifier 2. This amplifier operates the sensitive relay RLA and the indicator (a moving-coil meter). The current in this circuit varies between 0 and 5 mA as the input to Amplifier 1 is changed. In our example we have the figures of Table 1.

Table 1

Wt. in hopper (lb)	Wt. on Load Cell (lb)	Input to Amp. 1 (mV)	Output of Amp. 3 (mA)
0	100	10	5
200	300	8	4
900	1,000	1	0.5
1,000	1,100	0	0

The scale of the meter indicates the weight in pounds, the current through the meter being zero with 1,000 lb in the hopper and 5 mA when the hopper is empty. The variable resistor RV_2 is adjusted until the meter reads zero when the hopper is empty.

The preliminary warning and slow-down signals are to occur when the weight in the hopper reaches 900 lb and this corresponds to a current of 0.5 mA in the output circuit and Amplifier 3. The precise weight at which these signals are given can be set by adjusting RV_3 .

Circuit Description

From the above, it will be noted that the main warning is given when the input to Amplifier 1 drops to zero. Its accuracy is thus almost entirely independent of the gain of Amplifiers 1 and 3 provided that this gain is adequate.

The accuracy of the indicator or of the preliminary warning is not similarly independent of amplifier gain. Thus the gain of Amplifiers 1 and 2 must be virtually unaffected by changes of supply voltage or ambient temperature. To achieve this it is necessary to use the maximum possible amount of feedback consistent with stable operation.

In each of these amplifiers a thermistor is used to reduce the effects of changes of current gain, input impedance,

etc., of the transistors resulting from ambient temperature changes. To allow for the spread in gain of transistors and the tolerances on component values, the gain of all amplifiers is pre-set in production before the feedback loops are closed.

All critical supply voltages to the amplifiers are stabilized but compensation was found necessary for the small residual variations. This compensation is achieved by arranging for the feedback over Amplifier 3 to be varied slightly by changes in supply voltage. As a result of the above measures, the output of Amplifier 3 changes by less than 1% when temperatures and supply voltages are varied within the ranges -10°C to $+40^{\circ}\text{C}$ and 10 V to 16 V d.c.

The oscillator and synchronous demodulator which

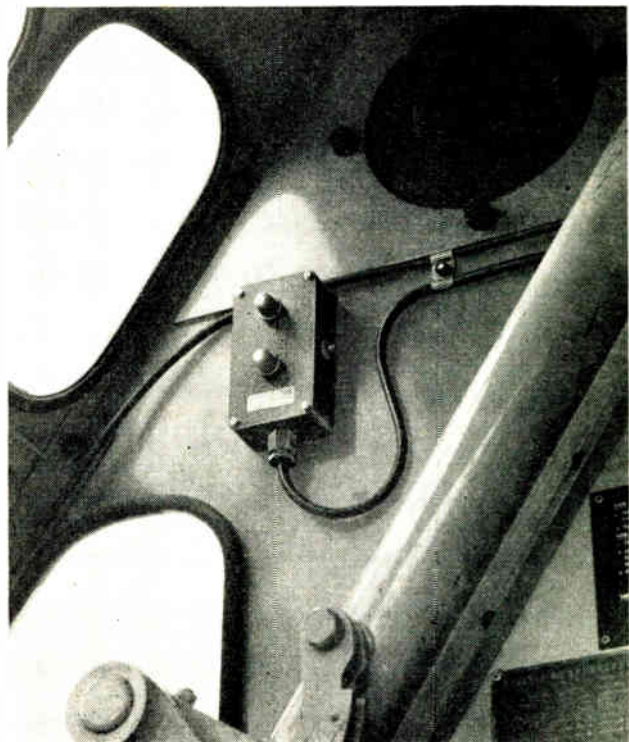

For crane safe load control the indicator normally takes the form of signal lamps to provide 'safe load' and 'overload' indication

lator. The equipment is also available for operation from mains or other supplies.

An installation would normally consist of three units:—

1. *The transducer.* This might be a force-measuring load cell although a wide range of transducers for measuring pressure, displacement, light, temperature, etc., could equally well be used.

2. *The Amplifier Unit.* In addition to housing the amplifiers and relays, this unit also contains the oscillator which provides the power to energize the transducer. The input and output circuit arrangements are very versatile; for example, provision is made for using a number of transducers and integrating their outputs. This facility is frequently necessary in tank or hopper weighing and for weighing loads on weighbridges. Contacts of relays in the amplifier output circuits can be used to control visual and audible warnings and to carry out any other necessary control functions. Current is also provided to operate a moving-coil meter which is the load indicator normally used. This current could also be used to drive a chart recorder, to control a magnetic amplifier or to carry out any similar function. As far as possible, the equipment is fail-safe—for example, the relays are so arranged that disconnection of the transducer or failure of the power supply would cause the warnings to be given.

3. *The Indicator Unit.* The meter, warning lamps, test switch and supply switch (when used) can conveniently form one unit. Alternatively they could be incorporated in an existing control panel.

Operation of the System

The general arrangement of a typical installation is shown in Fig. 1. The load cell consists of a billet or ring of high tensile steel on to which are bonded a number of strain gauges, usually four or eight. These are connected to form a Wheatstone bridge, which is energized by a square wave from the oscillator in the amplifier unit. The electrical output of the load cell, when it is subjected to its maximum rated load, is typically 1 mV for every volt applied (1 mV/V). With this very small unbalance of the Wheatstone bridge the output is proportional to the change of resistance of the bridge arms and these resistance changes are proportional to the applied load.

The amplifier can be arranged to provide warnings at a

number of different input levels. The maximum number of levels is normally three, although more can be provided in special circumstances, for example, when no indicator is required. The main trip level has an accuracy (repeatability) of about 0.1% to 0.2% and the others an accuracy of about 1% to 2%.

The load cell itself would probably introduce an inaccuracy of about 0.1%, giving a repeatability for the main trip point of some 0.2 to 0.3% for the load cell and amplifier. This accuracy can only be achieved in practice if the mechanical part of the system (any pivots used, the load cell mountings and means of applying the force to it, etc.) is correctly designed and the installation properly carried out.

A Typical System (Fig. 2)

For the purpose of describing the working of a typical system let us assume the following requirements:

A hopper itself weighing 100 lb is to be filled with material weighing 1,000 lb. When the weight of material in the hopper has reached 900 lb, say, a warning is to be given and a signal provided to reduce the rate of flow of material into the hopper. When the weight of the contents reaches 1,000 lb a further warning is required, also a signal to cut off the flow of material and to initiate the next stage of the process. A meter indication of the weight of the contents of the hopper is also required.

A suitable load cell would be one giving an output of 1 mV/V for a load of 1,200 lb. If the supply to the cell is 12 volts and if it supports the whole weight of the hopper and its contents, its output would be 1 mV for an empty hopper, 6 mV for 500 lb, 11 mV for 1,000 lb, etc.

In the present example the warning, having the greatest accuracy, should be given when the weight of the contents of the hopper reaches 1,000 lb. The pre-set potentiometer RV_1 (Fig. 1), supplied from the oscillator, should be adjusted until the input to Amplifier 1 is zero, when the load on the cell is 1,100 lb. It will be seen that 11 mV of the appropriate phase is now permanently connected in series with the load cell output. The input to Amplifier 1 is now as follows:

- 10 mV with the hopper empty
- 8 mV with 200 lb in the hopper
- and 0 mV with 1,000 lb in the hopper

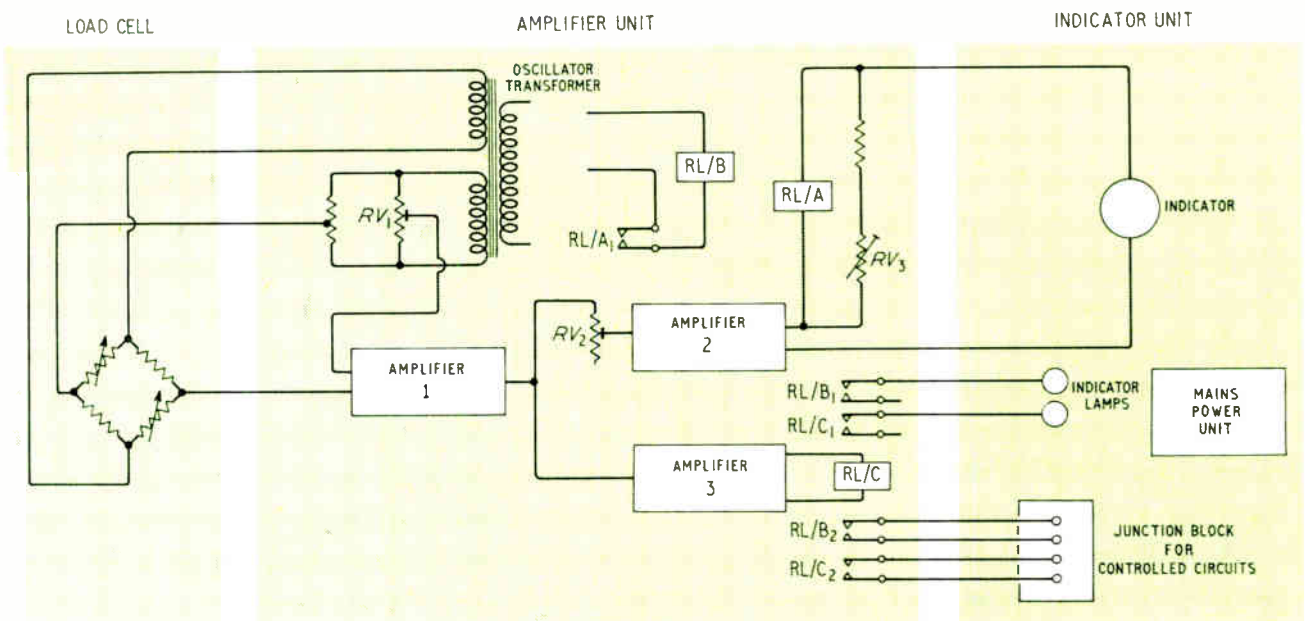

Fig. 1. General arrangement of load cell, amplifier and indicator unit



NEW LOAD CONTROL & INDICATING EQUIPMENT

By E. FIELDER*

Load cells find many applications in industry. This article describes how they are applied in the measurement of weight and also how they can be employed in an overload alarm in a crane.

THE usefulness of the electric resistance strain-gauge load cell for measuring tensions, weights and forces is becoming widely recognized. Load cells have frequently been used with electronic amplifiers arranged to close one or more sets of relay contacts at pre-set values of load. These amplifiers, sometimes known as trip amplifiers, are widely used to give warning of the approach of dangerous conditions and to carry out control functions. If an indication of the value of the load or force being measured is required, a servo-balanced bridge-type of indicator or potentiometric recorder is generally used. These instruments can also provide warnings (by using micro-switches or other means) at pre-set points and therefore at pre-set loads but with less accuracy than that normally achieved with trip amplifiers. If load indication only is required, a digital type of voltmeter might be used.

A New Instrument

Ekco Electronics Ltd. have recently developed an instrument for use with load cells, etc., which can provide both a meter indication of load and input level warnings. It is completely transistorized and designed to work over a wide range of ambient temperatures. All electronic circuits and relays are housed in a sealed cast box. The accuracy of the meter is somewhat less than that of the self-balancing bridge type of indicator but is sufficient for most applications. The trip point accuracy is equal to that of trip amplifiers using thermionic valves. The equipment works reliably with inputs as low as one-tenth of those normally used and has the further advantage that the transducer is not energized by mains frequency power, and therefore interference from transformers, welding equipment, power carrying cables, etc., presents no problems in normal installations.

The power requirements are 13 V d.c. (nominal) at approx. 250 mA which can be obtained from an accumu-

* Ekco Electronics Ltd.

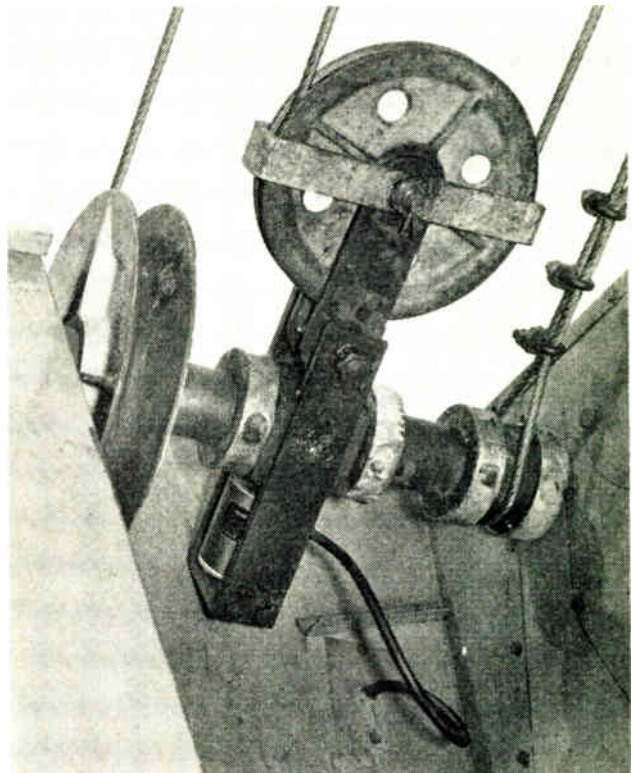

This shows the position of the load cell in relation to the hoist wire on a typical installation for crane safe load control

COMMENT (Continued)

perience. We have long thought that much of the so-called economy of effort obtained in textbooks by explaining related things together is a false economy, that it is a theoretical economy rather than a practical one.

One favourite 'simplification' is to invoke the principle of duality. The idea is that only one-half of the subject need be taught since the second half can be obtained from the first by applying the principle of duality. It has always seemed to us that this is more laborious than learning the two halves separately and that it does not lead to nearly such a good insight into the physical nature of the matter.

We do not, of course, condemn the principle of duality out of hand. It can be very useful indeed to the advanced worker. To one who already knows both halves of the subject the principle is a simple one and is then practically useful in enabling a result achieved in one half to be transformed into the other half. It is its use as a teaching 'simplification' at which we cavil.

Equivalent Circuits

While on this subject we would like to point out an apparent discrepancy between the equivalent circuits for a generator which we have not seen dealt with in the textbooks but which must surely puzzle any thoughtful student.

A generator is represented as an e.m.f. in series with a resistance and, alternatively, as a current generator in shunt with the same value of resistance. On open-circuit there is no internal power dissipation in the former, but there is in the latter.

With a load both representations correctly give the external power in that load, but the powers dissipated in the internal resistances of the two equivalent generators are not the same nor are, of course, the powers supplied by the fictional resistanceless generators.

It follows that while the two equivalent circuits for a generator are truly equivalent for all purposes external to the generator, they are not equivalent for any calculations relating to the inside of it. Attempts to evaluate the internal dissipation may be invalid, for instance. Only under the condition of a matched load do the two become identical.

We do not think that this is generally known and this is largely because so little emphasis is laid on power and energy considerations in modern textbooks.

It follows that when it is desired to evaluate the internal dissipation of a generator some care must be taken in the choice of an equivalent circuit for it.

Telemetry

Missiles and satellites have brought radio telemetry very much to the fore in recent years, so much so that it is not always realized how great is the industrial application of telemetry. This is especially so in the case of the Central Electricity Generating Board, who have been using it for something like 30 years.

From 23rd to 27th September an International Telemetering Conference is being held in the I.E.E. Building. It is sponsored by the American Institute of Aeronautics and Astronautics, the Institute of Electrical and Electronic Engineers, the Instrument Society of America, the British Institution of Radio Engineers and the Institution of Electrical Engineers.

We notice that in the titles of papers the words 'telemetering' and 'telemetry' are both being used, the preference being for the latter, which we ourselves prefer. B.S. 204 of 1960 gives telemetry as the preferred word, so that it is rather surprising to find 'telemetering' in the title of the Conference.

In some of the literature about the Conference both words are freely employed and the reader is left in some doubt as to whether this is merely elegant variation or whether there is some really subtle difference of meaning between the two.

Satellites

It was reported on 17th July that the command apparatus in Telstar 2 has ceased to function. So far the reason is not known.

It will be recalled that Telstar 1 had a failure due to certain transistors being affected by radiation and that this was subsequently remedied by some rather clever work, as we reported in March. Since then it has gradually failed again.

So far no indication has been obtained that radiation is the cause of the failure in Telstar 2. Just a month later Telstar 2 has begun working again! Gremlins?

Syncom is now reported as being brought gradually into position. This satellite is intended to orbit in such a manner that it remains in a fixed position relative to the earth in order to act as a fixed relay station.

Cosmos 19 is another satellite launched by the U.S.S.R. on 6th August. It carries instruments to measure properties of outer space. Its initial period of revolution is 92.2 minutes and it has an apogee of 519 km with a perigee of 270 km; the inclination of its orbit to the equatorial plane is 49°.

Comment

Colour television is a matter of great technical interest and the decision to introduce it in this country as soon as possible makes it a matter of great importance to the electronics industry. Its industrial applications seem likely to be small but we have no doubt that situations will arise where its use is necessary. Colour does add, as it were, another dimension to a picture and the improvement of colour television over black-and-white is quite as great as it is in photography.

In February 1964 the European Broadcasting Union is due to decide on common colour television standards for Europe. There are three rival systems known as N.T.S.C., Secam and Pal, developed respectively in the U.S.A., France and Germany. Pal, in particular, is really a modification of the N.T.S.C. rather than a completely different system.

The B.B.C. recently gave a demonstration of all three systems with monitor tubes side-by-side so that one could compare the systems by glancing directly from one tube to another. Monochrome monitors were also provided so that one could judge the compatibility of the systems.

Under these virtually laboratory conditions there was really nothing to choose between the systems either in colour or monochrome. All three gave a first-class colour television picture. Some viewers commented upon small colour differences between the different pictures. In our view, these were not so much due to the different systems as to small differences between the colour tubes used and, perhaps, to small differences in the initial adjustments. In any case, any one of the three colour pictures was, taken by itself, extremely good.

Noise and interference were introduced and, again, in our view there was nothing to choose between the systems. The effects were different, it is true, but we thought the nuisance value to be just about the same. Unfortunately, the effects of phase distortion were not demonstrated.

We do not think that the E.B.U. have an easy choice. The N.T.S.C. system has the unquestionable advantage of having been in regular use for 10 years and there is plenty of operational experience of it. The alternatives are claimed to offer better performance but are open to certain objections of their own. An unbiased outsider without practical experience of any system may well think it is all a matter of swings and roundabouts. However, the E.B.U. have undoubtedly more information to go on than has yet been made public and for their sakes we hope that one system has such decided advantages that the choice is easy, but we doubt it.

Teaching

There is a tendency in modern textbooks to economize in effort by explaining similar things together instead of taking them separately one at a time. For example, the co-called node and mesh ways of circuit analysis are commonly dealt with together.

Someone, somewhere, seems to have

had his doubts about this, for an experiment has been carried out in the U.S.A. on teaching methods. The result showed that when two similar things are taught together the student gets muddled, but has no difficulty in coping with the second of the two after the first has been learnt.

We are not in the least surprised by this, for it accords with our own ex-

HERE WE ARE AGAIN

TO REMIND YOU THAT



RELAYS AND ELECTRICAL REGULATORS

MAY BE OBTAINED FROM

KAYE ELECTRICAL LTD

11 ST. ANN'S ROAD, HARROW, MIDDX.

Telephone: HAR 1432



SWINGING ARMATURE
No. 320



ENERGISED IMPULSE
No. 184



VERTICAL CLOSED CIRCUIT
No. 120

Index to Advertisers

Adcola Products Ltd.....	36	Harwin Engineers Ltd.	15, 17	Painton & Co. Ltd.	1
Anglo-American Vulcanised Fibre Co. Ltd.	16	Hassett & Harper Ltd.	36	Parmeko Ltd.	<i>Cover iv</i>
Appointments Vacant	43	Hendrey Relays Ltd.	40	Philco International Ltd.	12
Associated Electrical Industries Ltd.	18	Highland Electronics Ltd.	41	Radiospares Ltd.	6
Avo Ltd.	29	Hughes International (U.K.) Ltd.	25	Reliance Controls Ltd.	19
Berrick Bros. Ltd.	40	Iliffe Books Ltd.	32, 42, 43	SIFAM Electrical Instruments Ltd.	14
B.I.C.C./Burndy Ltd.	<i>Cover ii</i>	Imhof, Alfred Ltd.	11	Solartron Electronic Group Ltd.	20, 21
Cannon Electric Co. Ltd.	2	Kaye Electrical Ltd.	44	SPS International Ltd.	38
College of Advanced Technology ..	43	Kuhnke, H. Ltd.	39	Standard Telephones & Cables Ltd.	7, 8, 9, 26, 27
Cossor Instruments Ltd.	10	Light Soldering Developments Ltd.	40	Telcon Metals Ltd.	41
Direct T.V. Replacements Ltd.	30, 31	Meller, Adolf Co.	42	Telequipment Ltd.	37
Ericsson Telephones Ltd.	3	Metway Electrical Industries Ltd.	39	Thorn Electrical Industries Ltd.	13
Farnell Instruments Ltd.	39	Mullard Ltd.	4, 5	Thorn Electronics Ltd.	28
Fieldtech Ltd.	34	Multicore Solders Ltd.	<i>Cover iii</i>	Wayne Kerr Ltd.	33
		Oxley Developments Co. Ltd.	41	Welwyn Electric Ltd.	22
				Westinghouse Brake & Signal Co. Ltd.	35
				Whiteley Electrical Radio Co. Ltd.	38
				Wiley, John & Sons Ltd.	42

INDUSTRIAL ELECTRONICS

Press date for the October 1963 issue is
first post 25th September 1963

CLASSIFIED ADVERTISEMENTS

Advertisement Rates. 6d. per word, minimum charge 6/-, each paragraph charged separately. Remittances payable to "Industrial Electronics", Dorset House, Stamford St., S.E.1. Series discount of 15% is allowed for 12 consecutive insertions.

Box Numbers are available at an additional charge of 2/- to defray cost of registration and postage. Replies should be addressed Box No. 0000, c/o "Industrial Electronics", Dorset House, Stamford Street, London, S.E.1.

Semi-Display advertisements with centralized lines £1/15/- per single column inch, Display advertisements £2/10/- per single column inch—no additional charge for Box Numbers. The Publishers are not responsible for clerical or printers' errors although every care is taken to avoid mistakes.

TUITION

WEST HAM COLLEGE OF TECHNOLOGY
Department of Electrical Engineering
POST-GRADUATE COURSES
commencing in September 1963

- (1) **STATISTICAL COMMUNICATION THEORY**
An evening course will be held on Mondays and Wednesdays from 7 to 9 p.m.
Part I commencing Monday 30th Sept.
Part II commencing Monday 13th Jan.

It is intended to cover the principles of a statistical approach to the analysis and synthesis of communication systems, on a basis of modern Information Theory.

- (2) **SEMI-CONDUCTOR CIRCUIT DESIGN THEORY**

An evening course will be held on Mondays from 7 to 9 p.m.
Part I commencing Monday 30th Sept.
Part II commencing Monday 13th Jan.

This course will cover the design of semi-conductor circuits from a useful, modern, theoretical approach. Tutorials and laboratory periods will be provided.

Both courses will lead to a proficiency certificate upon satisfactory completion of an examination, and assessment of general progress.

Further information may be obtained from

The Principal,
West Ham College of Technology,
Romford Road, London, E.15

[2031]

MISCELLANEOUS

High Purity

ARSENIC METAL

For electronic applications

H. F. POLLOCK & CO. (U.K.) LTD.

106 Old Broad Street, London, E.C.2

Telephone: LONdon Wall 4211

Telex: 28449

[2032]

FINANCIAL

FINANCIAL AND PROFESSIONAL HELP FOR YOUR BUSINESS

Long term loans from £10,000 upwards, together with professional advice from specialists in all fields of business administration. The service provided by Whitehead Enterprises Ltd. enables progressive businesses with a moderate record of profit to take advantage of growth opportunities while still retaining control.

For more details write to:

Whitehead Enterprises Limited
7 & 8 Chandos Street, London, W.1

[2033]

BOOKS, ETC.

"TELEVISION Receiving Equipment." By W. T. Cocking, M.I.E.E. The fourth edition of one of the most important British books on television deals in a comprehensive manner with television receiver equipment and gives many practical details and much design data. The circuits of a television receiver are split into a number of sections and a separate chapter is devoted to each. Other chapters deal with general principles, the signal, superheterodyne interference problems, special circuits, the aerial, the complete receiver, faults and servicing. 30s net from all book-sellers. By post 32s 3d from Iliffe Books Ltd., Dorset House, Stamford Street, S.E.1.

[2027]

PHOTO-ELECTRIC CONTROLS

for industry

Send for catalogues

HIRD-BROWN LIMITED

FLASH STREET, BOLTON

Telephone 27311

[2027]

For further information circle 257 on Service Card
"A generally excellent introduction
to computers"

The Post Office Electrical Engineering Journal

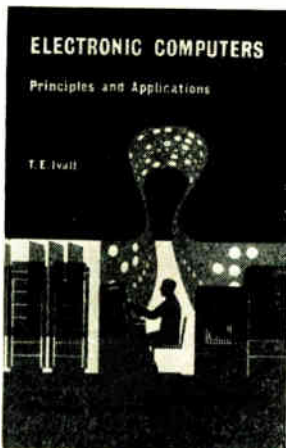

ELECTRONIC COMPUTERS

*Principles and
Applications*

by T. E. Ivall

SECOND EDITION

A non-mathematical introduction to the operating principles of electronic computers, primarily written for technicians, engineers and students with some knowledge of electronic or radio techniques. Both digital and analogue computers are covered, there is a chapter on recent developments and finally the evolution of the more "intelligent" machines of the future is discussed.

from leading book-sellers

25s net by post 26s.

263 pp. inc. 32 plates

Published for "Wireless World" by

ILIFFE Books Ltd.,

DORSET HOUSE

STAMFORD STREET LONDON S.E.1

For further information circle 258 on Service Card

COLLEGE OF ADVANCED TECHNOLOGY

Gosta Green, Birmingham 4

DEPARTMENT OF ELECTRICAL ENGINEERING

Head of Department,
E. May, M.Sc.(Eng.), A.C.G.I., M.I.E.E.

PULSE AND DIGITAL CIRCUITS

Lecturers: P. N. Nield, B.Sc., A.M.I.E.E., A.M.Brit.I.R.E.

R. K. J. Ford, M.Sc.

T. Scott, B.Sc., A.M.I.E.E.

A fifteen-week course of lectures and laboratory work on basic principles of design of pulse circuits will be held in the Department on Tuesday and Thursday evenings, commencing 29th October, 1963.

Fee for the course: 5 guineas.

Further details may be obtained from the Head of Department.



Wherever your laser research program is pointing . . . communications, medicine, metallurgy, weaponry . . . Meller's tremendous inventory of stock single crystals is available to supply your laser needs instantly.

All configurations: plain flat and parallel ends, TIR, Brewster's angle.

All types: Ruby rods to 12" □ 2% neodymium doped super-quality glass □ .5% neodymium doped calcium tungstate to 5" □ .1% samarium or .5% neodymium doped strontium fluoride □ .5% neodymium or .1% uranium doped barium fluoride □ calcium fluoride doped with .5% neodymium or .1% samarium or .05% dysprosium (up to 6") or .1% uranium.

Request current stock lists and prices from DALE ELECTRONICS, LTD., 109 Jermyn St., London S.W. 1, England.



Adolf Meller Company, Providence, Rhode Island, U.S.A.
Synthetic Sapphires • Laser Crystals • Alumina Powders

Principles of Applied Electronics

B. ZEINES, Assistant Professor, Hofstra College and Instructor RCA Institutes Inc.

Written to give the modern technical student an understanding of tube and transistor electronics. As such, the emphasis throughout is on teachability; the author assumes nothing on the part of the reader, and writes in a style that is easy for beginning students to understand and follow. 440 pages, 53s.

Differential Amplifiers:

Their Analysis and Their Applications in Transistor D-C Amplifiers

R. D. MIDDLEBROOK, California Institute of Technology

This monograph is intended to serve three purposes: to develop and to discuss the properties and requirements of differential amplifiers, including both vacuum-tube and transistor realizations; to develop a sequential method for analysis of unbalances in symmetrical circuits, to which class differential amplifiers belong; and to illustrate the properties of differential amplifiers and the sequential analysis methods of amplification to a logical progression of specific transistor d-c amplifier circuits. This is the first book to provide an extensive, detailed treatment of differential amplifiers. 127 pages, 60s.

John Wiley • Interscience
Glen House • Stag Place • London SW1

A unique new book which will solve the problem of communication



SIX-LANGUAGE DICTIONARY OF AUTOMATION, ELECTRONICS AND SCIENTIFIC INSTRUMENTS

OVER 5500
technical terms in
English, French, German
Italian, Spanish and Russian

105s net by post 107s 9d
10" x 8" 732 pp

from leading
booksellers

Compiled by a team of multi-lingual technologists fully conversant with latest terminology, this new dictionary will enable anyone, whether scientist, engineer or technologist, to read and understand the technical literature on electronics and automation control in any one of the six principal languages of which he already has a basic knowledge.

The scope of the dictionary is indicated by the fact that it contains the equivalents in each language of over 5,500 terms in the basic English glossary. Essential for libraries and professional translators, it is invaluable to everyone who must be familiar with current international developments in the far-reaching fields of automation and electronics.

Published by **ILIFFE Books Ltd.**

DORSET HOUSE

STAMFORD STREET

LONDON S.E.1

HAVE YOU A GLASS TO METAL SEALING PROBLEM?

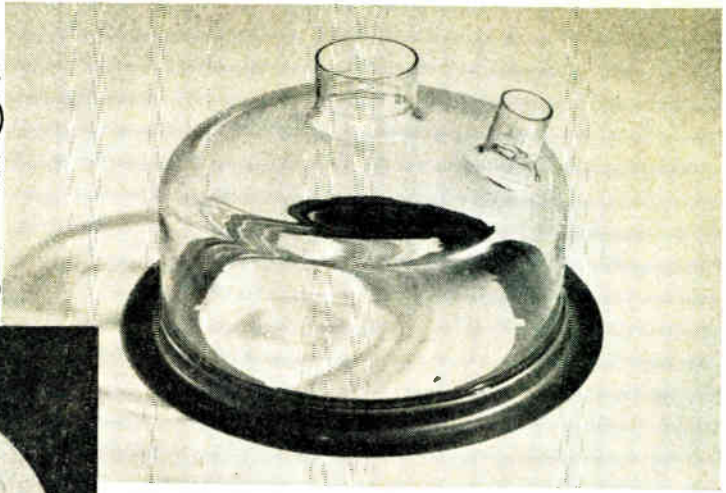
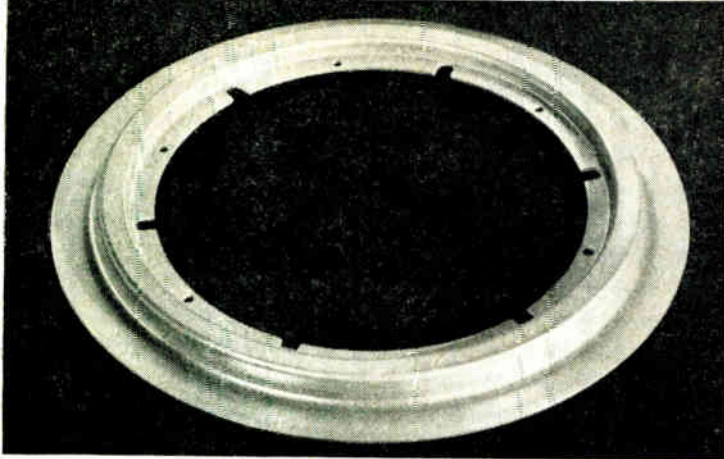

For this 9 inch diameter glass to metal sealing ring

MULLARD LTD

use TELCOSEAL 1, one of the five glass sealing alloys manufactured by

TELCON METALS LTD

These are available as strip up to 6" wide (normal production) in thicknesses down to 0.008", but widths of 10", 12" and 18" can be specially produced. All alloys can be supplied in the forms of drawn wire and rod.

For further details, please apply to:

TELCON METALS LTD

P.O. Box 12 · Manor Royal · Crawley · Sussex · Telephone: Crawley 28800 · Telex: 8748 · Telegrams: Telcon, Crawley

MEMBER OF THE **BICC** GROUP OF COMPANIES

For further information circle 252 on Service Card

Illuminated PUSH-BUTTON SWITCHES

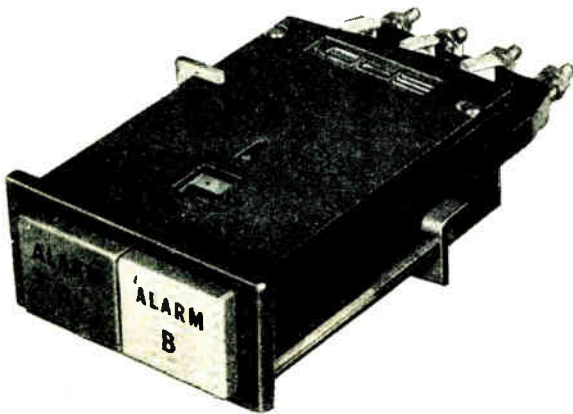

TWIN LIGHT VERSION

Up to two change/over switches 230V A.C. 6 amps, momentary or push/push, fast action. 5 colours, single or two colour screens with light barrier. Wide range of lamp voltages, Matching annunciators available. Write for full details and prices.

HIGHLAND Electronics Limited

26-28 Underwood St., N.1.

CLErkenwell 3723

For further information circle 253 on Service Card

OXLEY DEVELOPMENTS CO. LTD

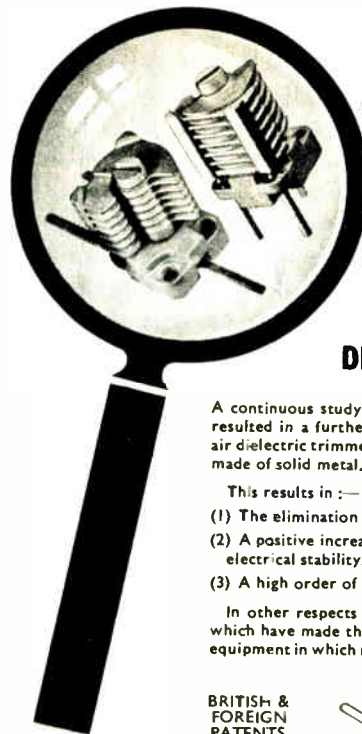

OXLEY

SUBMINIATURE AIR DIELECTRIC TRIMMERS

A continuous study in the laboratory and in the field has resulted in a further development in Oxley subminiature air dielectric trimmers, the rotor and the stator both being made of solid metal.

This results in :-

- (1) The elimination of practically all soldered joints.
- (2) A positive increase in mechanical rigidity and improved electrical stability.
- (3) A high order of consistency in capacity.

In other respects the trimmers retain all those facilities which have made them the inevitable choice of professional equipment in which reliability is the dominant requirement.

BRITISH &
FOREIGN
PATENTS

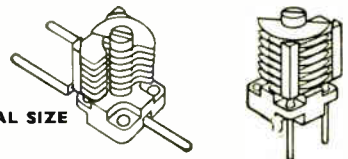

ACTUAL SIZE

Write for technical details of these and other Oxley products
OXLEY DEVELOPMENTS CO. LTD., ULVERSTON, LANCASHIRE

For further information circle 248 on Service Card

ARE YOU UP-TO-DATE WITH YOUR SOLDERING TECHNIQUE?



There is a large range of instruments (BIT sizes 1/32 in. to 13/32 in.) and accessories marketed under the names of . . .

ADAMIN and LITESOLD

Get the brochures and see for yourself what others are using!

A new Adamin mains model is the C10L, shown on a Bench stand, which we also manufacture. This model is probably the smallest mains voltage model in the world. BIT DIAMETER, 3/32 in. LENGTH, 7 in. WEIGHT, 1/2 oz. (Less Flex). HEATS IN 30 seconds.

Brochures A & L30

post free from the sole proprietors:—

LIGHT SOLDERING DEVELOPMENTS LTD.

28 SYDENHAM ROAD, CROYDON, SURREY. Telephone: CROYDON 8589

For further information circle 249 on Service Card



BLACK • SMOOTH • LONG WEARING
EXCELLENT FOR BLUE PRINTS
10H TO 8B • FROM DRAWING OFFICE
SUPPLIERS AND STATIONERS

10 1/2 d
EACH

FABER-CASTELL

Faber-Castell are also famous for slide rules and offer a wide range including student models from 27/6. Ask for literature.

Sole agent U.K.:

Made in Bavaria

BERRICK BROS. LTD., 20-24 Kirby Street, London, E.C.1



For further information circle 250 on Service Card

Contactor Type C.2839

(Patent applied for)

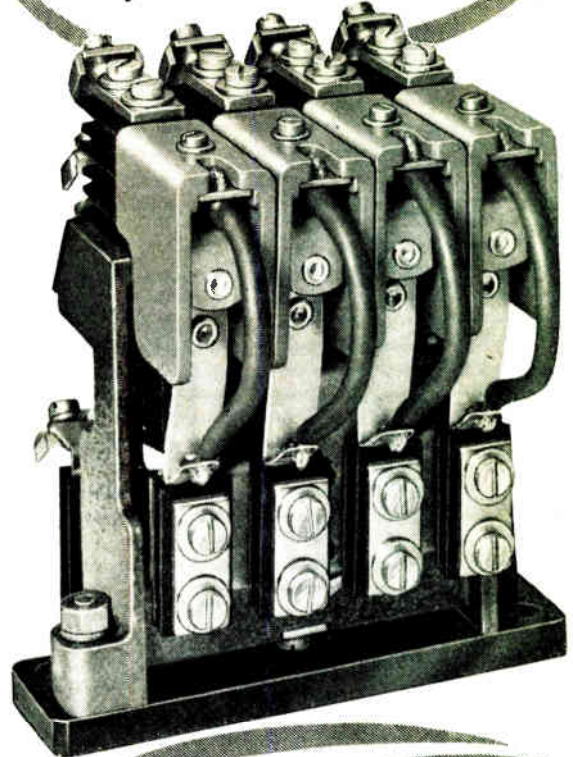

Produced with four important features in mind:
1. Maximum life and reliability 2. Low cost
3. Silent operation 4. Minimum overall size

Intended for use in applications where space is at a premium and for the control of medium power circuits up to 440v. A.C.

Hendrey Relays



(R. J. Hendrey, Founder & Managing Director)

HENDREY RELAYS LIMITED

390-394 BATH ROAD, SLOUGH, BUCKS.

Tel.: Burnham 609/611

Telegrams: Hendrelay, Slough

MANUFACTURING ELECTRICAL ENGINEERS,
CONTROL AND LABORATORY APPARATUS,
A.R.B. and M.O.A. APPROVED DESIGN & INSPECTION

TSV-70

FARNELL STABILISED VOLTAGE SUPPLY

PRECISION MADE FOR HEAVY DUTY

The Farnell TSV/70 is a heavy duty power unit providing a stabilised DC output of 0 to 70 volts up to 5 amperes, 0 to 35 volts up to 10 amperes.

The unit is fully protected against possible overload and short circuit by a current limiting and reducing device.

External feedback terminals are provided; the use of which eliminates the resistance of the lead wires by stabilising the voltage at the end of the leads. The output is monitored by a voltmeter and ammeter, the ranges are selected by an output range switch, and the level adjustable by both coarse and fine controls. Detailed Specifications will be supplied on request.

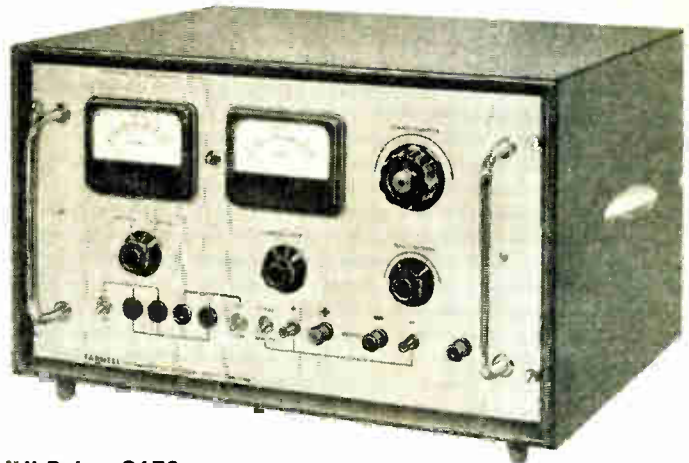

UK Price £170

ANNOUNCING THE OPENING
IN OCTOBER OF **FARNELL'S
NEW FACTORY**
AT **SANDBECK WAY**
WETHERBY, YORKS. TEL. 2691/2/3



For further information circle 246 on Service Card

KUHNKE

UNIVERSAL-RELAY

For DC- and AC-operation

Low Price



Stock Items

Max. 3 PDT contacts
Max. contact rating:
120 W / 150 VA resp.
250 volts, 6 amps.

Solder terminals
Slip-on terminals
For printed circuitry
Screw terminals

Dimensions: only 35 x 35 mm

H. Kuhnke, Ltd., 163, Stanwell Road,
Ashford, Middlesex.

PHONE: ASHFORD 52798 TELEX: 21577

For further information circle 247 on Service Card

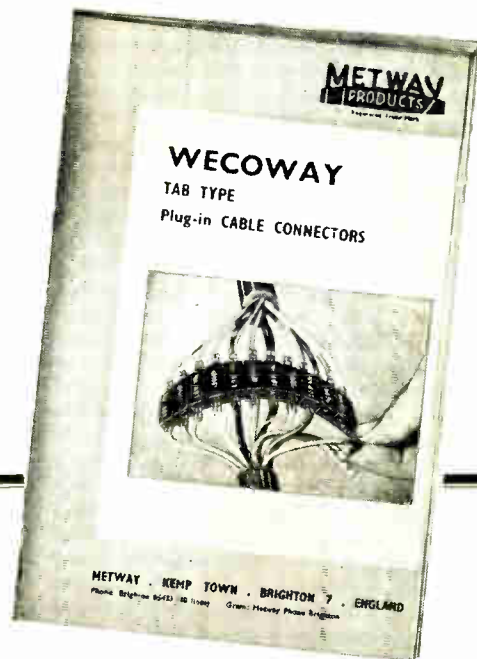

★ Have you a copy of this NEW Metway list, dealing specifically with Wecoway Connector Blocks for 'Faston' type connections? If not write now for List No. ME1/62A/1E

OBTAINABLE FROM ALL GOOD WHOLESALERS OR DIRECT

METWAY · KEMP TOWN · BRIGHTON 7

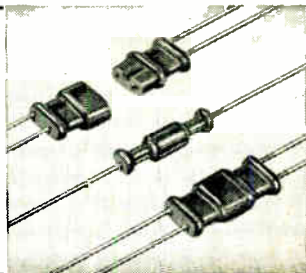
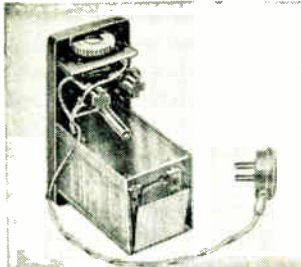
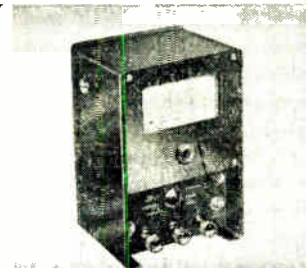
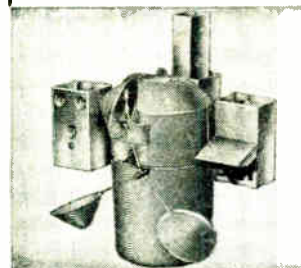
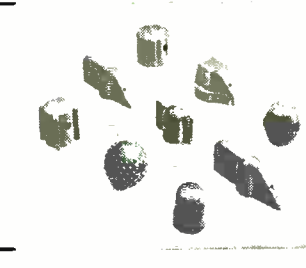
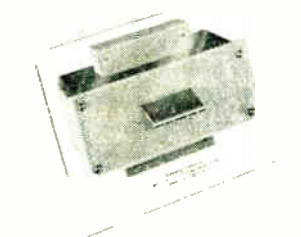
WHITELEY	
	electronic components
have built	
	a high reputation
for quality	
	and reliability

The items shown here are representative of the extensive variety of products manufactured by the Whiteley organisation. Our technical resources are available for the development and production of specialised components for the electronic industry.

Get in touch with us NOW . . .

WHITELEY ELECTRICAL RADIO CO LTD
MANSFIELD • NOFFS • Telephone: Mansfield 1762-5

WONDERFUL NEWS!

IN
ELECTROLYTIC CAPACITORS
ALUMINIUM FOIL CAPACITORS FOR TRANSISTOR AND OTHER LOW VOLTAGE CIRCUITS



TECHNICAL

CAP TOL—20%+100% of rated
DISSIPATION FACTOR extremely low—less than 8% at 50 WVDC
D.C. LEAKAGE extremely low—less than 6 UA after 1 min applied WVDC
OPERATING TEMP. 65°C at rated WVDC

ALL-MOULDED ENCAPSULATION

- ★ HERMETICALLY SEALED ALL-PLASTIC ENCASEMENT
- ★ ULTRA-SMALL SIZES WITH CAPACITIES TO 200 μ F
- ★ CLOSE TOLERANCE DIMENSIONS
- ★ LEAD SPACING TO $\pm .015$ "
- ★ HIGH RELIABILITY BY CLOSE QUALITY CONTROL PROVEN IN THE EXACTING U.S. MARKET
- ★ SURPRISINGLY LOW COST
- ★ FAST DELIVERY

SPSI

For full details write or phone:

SPS INTERNATIONAL LTD.
SHANNON • IRELAND
TELEPHONE: SHANNON 245

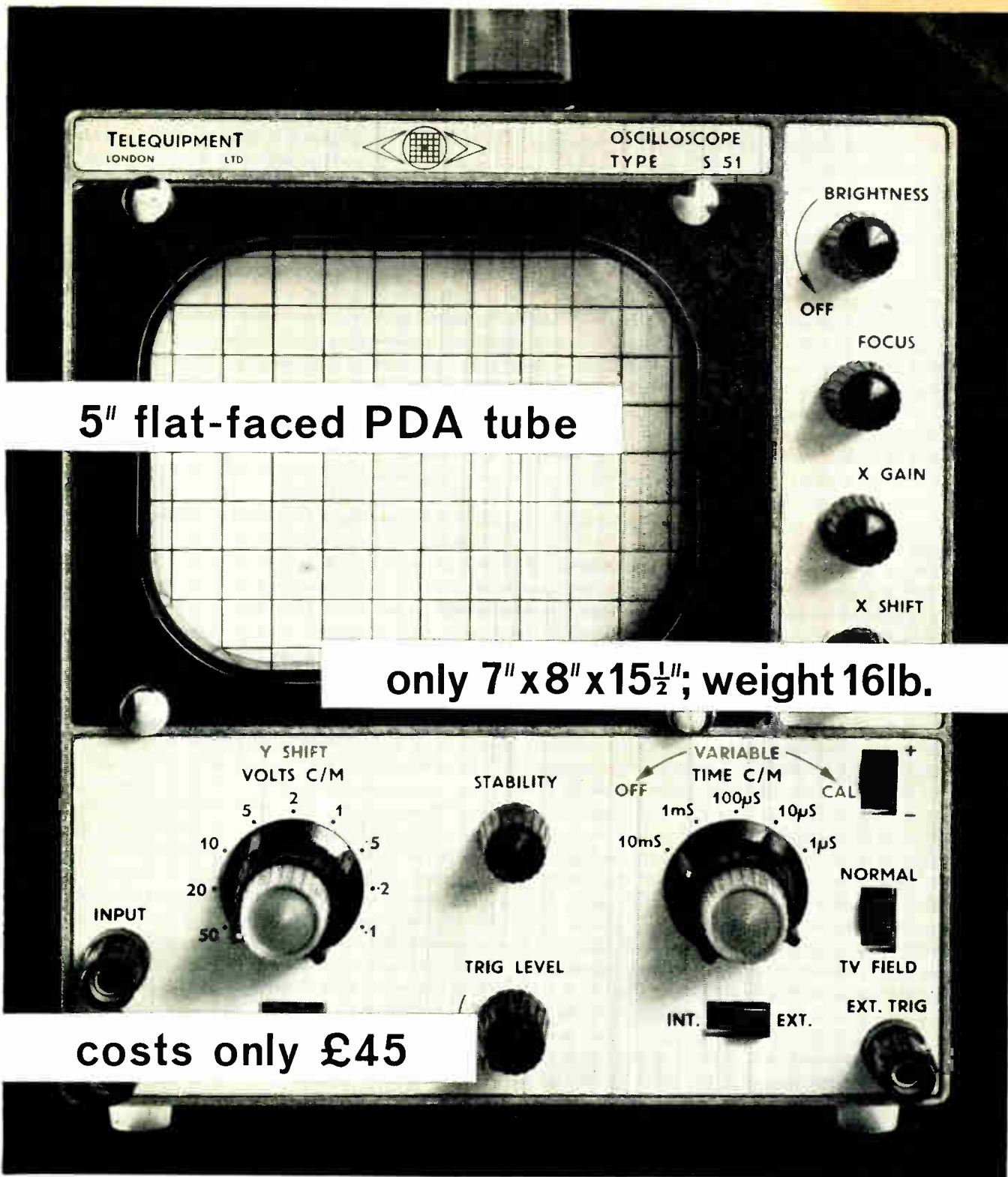

5" flat-faced PDA tube

only 7" x 8" x 15½"; weight 16lb.

costs only £45

The Serviscope* type S51 has been designed to meet the growing need for a reliable, low-cost, instrument of good general performance for industrial and educational applications. It is small in size, light in weight, strongly constructed, and has a clearly laid-out front panel for ease of operation. The exceptionally large screen can be read from a considerable distance, and is very suitable for group instruction and production control work.

Abridged specification:

- Max. Bandwidth 3 Mc/s
- Max. Sensitivity 100 mV/cm
- Calibrated input attenuator 100 mV/cm — 50V/cm
- Time base has 5 pre-set speeds plus variable control and × expansion
- Automatic, selective and TV sync. triggering
- DC coupled flyback blanking

Complete details will be sent on request.

TELEEQUIPMENT 

*Serviscope is the registered trade mark of Teleequipment Limited 313 Chase Road Southgate London N14 Fox Lane 1166

For further information circle 240 on Service Card



**HIGH EFFICIENCY
SOLDERING INSTRUMENTS**
FOR
BENCH LINE PRODUCTION

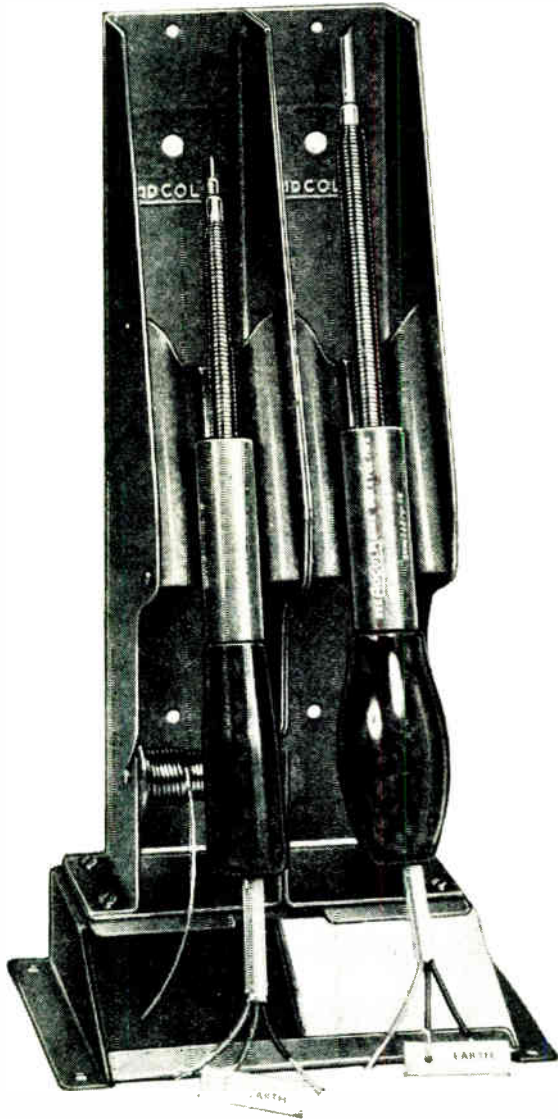

Apply direct to
Head Office Sales and Service

**ADCOLA PRODUCTS LTD.
ADCOLA HOUSE
GAUDEN ROAD
LONDON S.W.4**

Telephones
MACaulay
4272
and
3101

Telegrams
SOLJOINT, LONDON S.W.4

For further information circle 241 on Service Card



**delivery
dates ARE
important**

We know the importance of making realistic delivery promises, and abiding by them.

We know that cabinets and consoles to house electrical and electronic equipment often have to be designed and produced in a hurry and we are organised to do this. We know that a major factor in our success is the close personal contact we establish and maintain with our customers at every stage of project development. We know that tricky one-off special jobs can be a headache to some people, but we like handling them. We think we are useful people to know and we would like you to know us. *May we send you our literature?*

Hassett & Harper Ltd

REGENT PLACE BIRMINGHAM 1
TELEPHONE: CENTRAL 6418

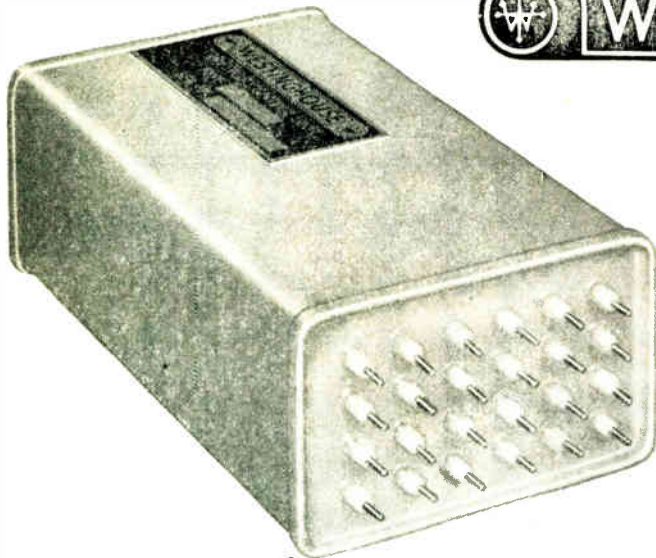

DRIVER AND CONTROLLER UNITS

FOR SILICON CONTROLLED RECTIFIERS

- * Transistorised circuitry — entirely static
- * Available for single- and three-phase circuits
- * Each driver capable of firing multiples of silicon controlled rectifiers
- * Encapsulated and shockproof
- * Low power consumption
- * Wide input tolerances
- * Wide range of operating temperature
- * Automatic control of output

and of course, a full range of
TRINISTOR silicon controlled
rectifiers is available from
Dept. 1E 9/63

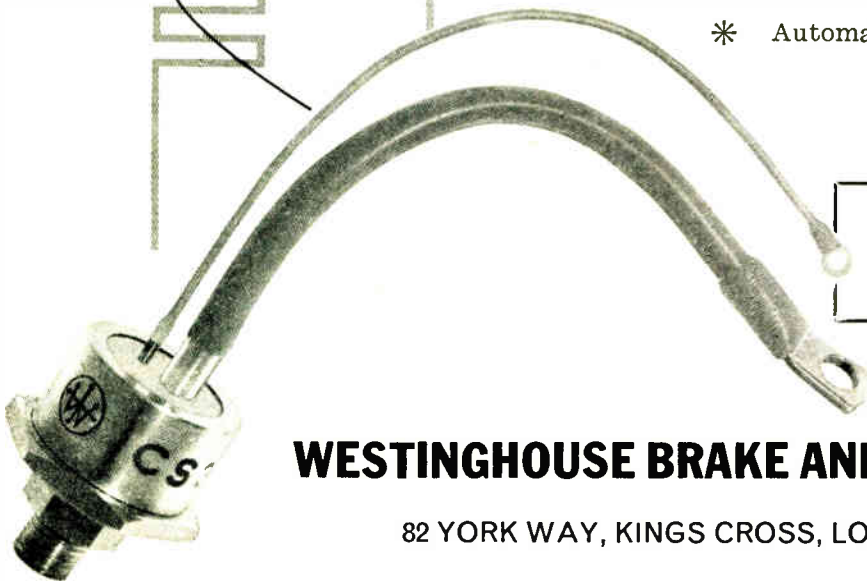

WESTINGHOUSE BRAKE AND SIGNAL CO., LIMITED

82 YORK WAY, KINGS CROSS, LONDON, N.1. TERminus 6432

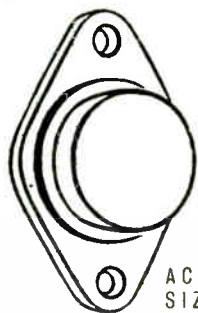

KILOWATTS SWITCHED IN MICROSECONDS

Is this the answer to your problem—fast switching of giant loads in a TO-3 package?

The Bendix D.A.P. 2N2359 is capable of switching loads of 50A at 90V in 9 microseconds, at junction temperatures of 110°C. Other ratings are given in the table below.

The diffused alloy base of a Bendix D.A.P. gives very low input resistance and high cut-off frequency while still maintaining high breakdown voltage. Result—better circuit stabilisation at high temperature, and greatly increased maximum power gain.

If this is the answer you are seeking—or for other special purpose transistors in the Bendix range—contact FieldTech Ltd., who will be pleased to furnish information.



D.A.P.

DIFFUSED ALLOY POWER TRANSISTORS

U.K. Distributors for
Bendix International Division,
The Bendix Corporation



FieldTech Ltd

LONDON AIRPORT · HOUNSLOW · MIDDLESEX
Tel: SKYport 2141 · Cables: FieldTech Londonairport · Telex: 23734

MAXIMUM RATINGS

	VCE Vdc	VCB Vdc	VEB Vdc	IC Adc	*PC W	T Storage °C	TJ °C
2N2357	60	60	2.5	50	170	-65 to +110	110
2N2358	80	80	2.5	50	170	-65 to +110	110
2N2359	120	120	2.5	50	170	-65 to +110	110

*PC is max. average power dissipation; can be exceeded during switching time.

For further information circle 237 on Service Card

Wayne Kerr Vibration Meter and Audio Signal Generator in use for carrying out fatigue tests on jet engine compressor blades at the Aero Engine Division of Rolls-Royce Limited.

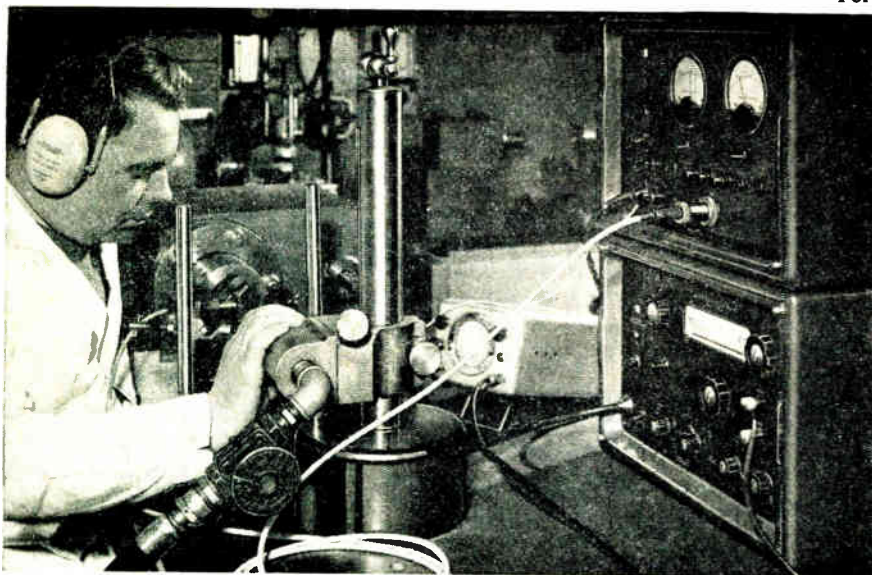

6-way Coaxial Switch JB731 for probe selection



Ideal vibration measurements

NON-CONTACTING TRANSDUCER DETECTS MICRO-INCHES!

"WEIGHTLESS" PROBES

The Vibration Meter B731A is designed around the three-terminal capacitance probe which can be used adjacent to any conducting surface. This non-contacting feature makes it ideal for measuring static and dynamic displacements, since no load is imposed on the structure. The true vibration characteristics of the structure are NOT altered as they are with the more conventional type of probe. With the aid of a measuring oscilloscope *amplitudes of vibration of less than 10 micro-inches (0.254 microns) have been measured.* Direct measurements can now be made on rotating shafts or fly-wheels, or on fragile parts where physical contact is not possible. Operation of the probe is unaffected by the presence of magnetic fields.

WIDE RANGE

Interchangeable Probe Heads provide meter readings from 50 micro-inches to 0.5 inch with full-scale values as follows:

Probe Head	in.	mm.
A1	0.001	0.025
C1	0.01	0.25
E1	0.1	2.5
F1	0.5	12.5

Other Probe Heads are available or can be made to suit particular applications. Both meters are provided with English and Metric scales. The B731A has a linear response from zero to 10 kc/s.

ACCURACY AND DISCRIMINATION

The basic accuracy of the instrument is 2 per cent of full scale deflection on both vibra-

tion and distance with a discrimination of 0.5 per cent. A 'normal' $\div 5$ switch enables the sensitivity and reading accuracy of the vibration channel to be increased by a factor of five without affecting the measurement accuracy or the distance reading.

REMOTE OPERATION

The probe head carrier is provided with a 10-ft screened coaxial cable, to allow the instrument to be used remotely from the vibrating structure. For greater separation, jacks are provided for connecting the B731A to remote meters, recorders, alarm circuits or other ancillary equipment. A current of 0-1 mA into 1000 ohms is available and, since capacitance between leads is not important, they may be as long as required.

MONITORING FACILITIES

An internal detector and filter extract the vibration (modulation) signal from the 50 kc/s carrier employed, and this signal is available at monitoring terminals. Thus, with an oscilloscope, the "shape" of vibration can be examined in detail and its frequency measured. A number of probes may be used on different parts of the structure and connected in turn to one instrument using Probe Switch JB731. This is a true coaxial switch providing immediate selection from any one of up to six probes.

BASIC CIRCUIT

A 50 kc/s oscillator supplies a reference input through a standard capacitor C_s to a high-gain feedback amplifier. The probe-structure capacitance completes the negative feedback loop (see diagram below), resulting in the amplifier output being *directly proportional to the probe/structure separation.*

The carrier will be amplitude-modulated if the structure is vibrating. Modulation and carrier are separately rectified and displayed on two meters giving peak-to-peak excursion and mean distance of the structure from the probe. Since the amplifier feedback is at ground potential, grounded structures may be examined. The probe unit is provided with a guard ring to ensure that the electric field between the structure and the inner electrode is truly linear.

DISTANCE MEASUREMENT

Where there is a requirement for the continuous monitoring of distance only, the instrument can be supplied without the vibration channel. In this form it is classified as Distance Meter DM100. The basic circuit arrangement and the probes used are similar to the Vibration Meter. The same monitoring facilities are available and vibration amplitudes can be viewed and measured using an oscilloscope. Detailed literature is available on Vibration Meter B731A, Distance Meter DM100 and Probe Switch JB731.

Please write or telephone for literature or to ask for a demonstration.

WAYNE KERR



The Wayne Kerr Laboratories Limited
New Malden, Surrey, England
Telephone MALden 2202

Wayne Kerr Corporation
1633 Race Street,
Philadelphia, 3, Pa, USA
Telephone LOcust 8-6820

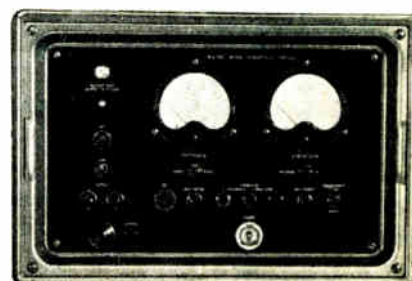

WKA1

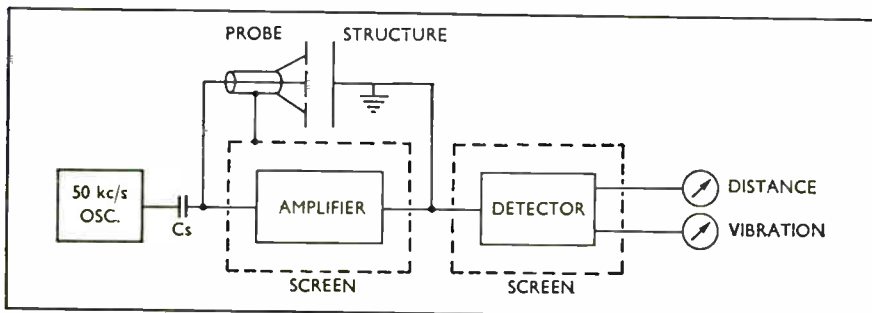

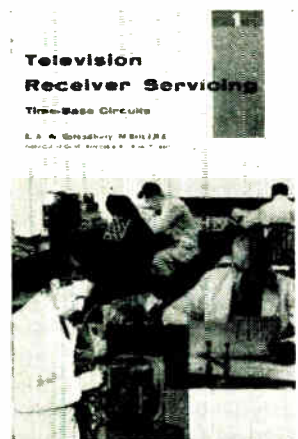
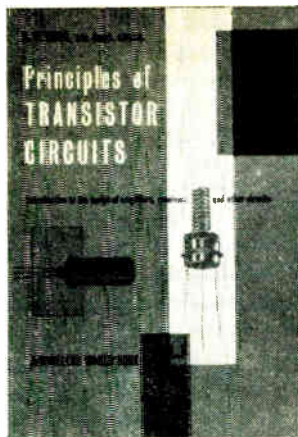

new ILIFFE books

for students and technicians

in radio, television and electronics



Principles of Transistor Circuits 2nd EDITION

Introduction to the design of amplifiers, receivers and other circuits

S. W. Amos, B.Sc., A.M.I.E.E. A thoroughly revised and enlarged edition of an already popular book. The first two chapters, which have been entirely rewritten, deal with the basic properties of transistors, but the main emphasis of the book is on circuit design.

21s. net. by post 22s. 210pp. 125 diagrams

Principles of Semiconductors

Introduction to the production and applications of semiconducting materials

M. G. Scroggie, B.Sc., M.I.E.E. Covers the many applications of the use of semiconducting materials. There are over 100 graphs and line drawings, and 12 pages of photographs illustrating the width of the semiconductor field.

21s. net. by post 21s. 11d. 156pp. inc 115 diagrams and 12pp. plates

Television Receiver Servicing

Volume 1. Time base circuits. 2nd EDITION

E. A. W. Spreadbury, M.Brit.I.R.E. This completely revised edition covers the faults occurring in the time base circuits or in other parts of the receiver affected by their operation, and shows how to locate faults and how to isolate a faulty section.

25s. net. by post 26s. 5d. 362pp. illustrated

Radio Valve Data 7th EDITION

Characteristics of 4,800 valves, transistors, rectifiers and cathode ray tubes

Compiled by "Wireless World". A completely revised and re-indexed edition which incorporates the characteristics of the latest types of valves and cathode ray tubes, with particular emphasis on semiconductors.

6s. 6d. net. by post 6s. 10d. about 160pp.



From leading booksellers

Published by **ILIFFE Books Ltd.**

DORSET HOUSE · STAMFORD STREET · LONDON, S.E.1

... all on call from the

D.T.V. GROUP GIP 6166 (P.B.X.) Day & Night Ansafone Service

DEPT. I.E., 126 HAMILTON ROAD, WEST NORWOOD, LONDON, S.E.27

★ Our new premises bring together under one roof the combined resources of an up-to-date factory, stores and offices and will result in an even better service to our many customers.

● **TERMS of BUSINESS**
C.W.O., Pro Forma or approved account.

NEW!

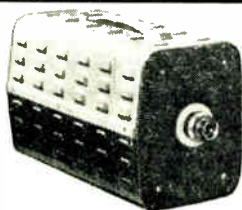

BEULAH D.808 C.C.T.V. CAMERA

● A de-luxe version of the well-known D.800 Camera

The new D.808 has:

- Automatic Light Control.
- Video Output.
- 4.8 mc/s Resolution (625 lines).
- Black Level Clamp.

... The Lowest Priced Industrial C.C.T.V. Camera with all these features!

£250 inc. lens.

DEFERRED PAYMENT TERMS AVAILABLE: £62:10s. deposit, and 24 monthly payments of £8:15s.

● C.C.T.V. CAMERAS (COMPLETE WITH LENS) AVAILABLE FROM £83:9s. complete, 7/6 p. & p.

Also

limited number of D.800 Cameras available from stock at £236:5s. complete with lens or £59:5s. deposit and 24 monthly payments of £8:5:2.

ANOTHER BEULAH FIRST!

BEULAH 1400 — 14" MONITOR

78 GNS.

BEULAH "850" — 8½" MONITOR

72 GNS.

LOWEST PRICED Transistorised Industrial T.V. VIDEO MONITORS

- Specially designed to work in conjunction with the wide range of economy type C.C.T.V. Cameras now available.
- Designed for use in either vertical or horizontal plane.
- Can be used in Cars, Aircraft, Ships, Trains, etc.
- Coaxial input is arranged for linked loop working.
- Models supplied against special order for operation from 12 v. battery.
- Smallest Transistorised Types available in the U.K.
- Housed in strong metal cases.
- Designed for continuous working.
- Six Beulah Monitors can be stacked on a shelf only 9" deep and 28½" wide.
- All controls situated at the front of the Monitors.
- Ventilation no problem in stacking—negligible heat is generated.

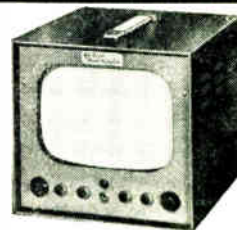

C.C.T.V. DEMONSTRATIONS DAILY IN OUR OFFICES

● D.T.V. TRANSFORMER SERVICE

When you order from the D.T.V. Group you have the advantage of access to the largest stocks in the U.K. Your specification is compared with the stock types and, if we are unable to supply, the order is immediately passed to our own Factory and an estimate is despatched to you without delay. The D.T.V. Service saves you time and money by supplying standard components wherever possible.

Examples of Stock Items:

D.T.V. 1-0058-250 WATT ISOLATION TRANSFORMER

Input 200-230-230v. Output 200-230-230v. Double wound in steel box. £6:1s.

D.T.V. 1-0059-500 WATT ISOLATION TRANSFORMER

Input 230 v. Output 230 v. Double wound in metal box. £9:1:6.

D.T.V. 1-0060-1000 WATT ISOLATION TRANSFORMER

Input 230 v. Output 230 v. Double wound. £11:1s.

Alternative input and output voltages available. State requirements when ordering. Quantity prices on application.

MAINS TRANSFORMER

Input 0-200-220-240 v. Output 300-0-300 v. at 80 mA. 1.5A. 6.3 v. 3A. 22/6 inc. postage.

GULTON TRANSDUCERS Type 1404

With these special features:

- Small Physical Size.
- Interchangeable Receiver and Transformer Heads.
- High Q. High Efficiency.
- Wide Beam Width.
- Shielded Non-Interference Housing.

FOR:

- Industrial Automation.
- Remote T.V. Control.
- Model Control.
- Intruder and Circuit Alarms.
- Gate, Tool and similar Controls.

From stock

78/- ea.

Generous quantity discounts

● THE D.T.V. GROUP ARE SOLE DISTRIBUTORS OF GULTON TRANSDUCERS ●

NEW ESSENTIAL COMPONENT KIT No. 1404K £10:7s.

Two 1404 Transducers, one 40 kc/s 5:1 Transformer, contains the seven Transistors required for both transmitter and receiver, two Transducer Plugs, one TX RX Circuit Diagram.

post free

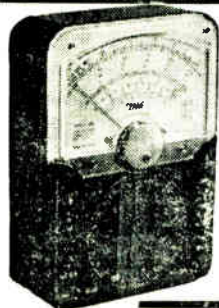
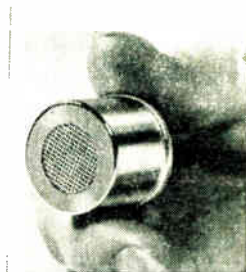

● Why use your expensive Test Meters for routine work?

... Order the MODEL 500 MULTIMETER

(Imported) 30,000 ohms per volt.

D.C. VOLTAGES: 0-0.025-1-2.5-10-25-100-250-500-1,000 v. at 30,000 ohms per volt.

A.C. VOLTAGES: 0-2.5-10-25-100-250-500-1,000 v. at 15,000 ohms per volt.

D.C. CURRENT: 0-0.05-5-50-500 mA.; 0-12 A.

RESISTANCE: X1K - X10K - X100K (60 megohms max.). Centre Scale Reading: 350 ohms - 35 K/ohms - 350 K/ohms.

DECIBELS: -20 to +56dB (0dB 1 mW, 600 ohms).

A.F. OUTPUT: Internal blocking condenser.

SHORT TESTS: Internal buzzer.

Outstanding Value at only **£8:19:6**

The D.T.V. Group are Apptd. Distributors of TELEFUNKEN VALVES

Industrial and Entertainment Types. Write or phone for complete list.

ALL YOUR ELECTRONIC EQUIPMENT — SPARES — ACCESSORIES FROM ONE SOURCE

The **BIGGEST** range of

Accessories of all kinds

ELECTRONIC EQUIPMENT

ALL YOUR ELECTRONIC EQUIPMENT — SPARES — ACCESSORIES FROM ONE SOURCE

NEW! BEULAH E.H.T UNIT 8-12 kV. D.C. R.F. UNIT

A compact, high voltage unit for Electronic and T.V. Equipment. Peak output 12 kV. at 500 microamps. The oscillator valve is a 6P25 and the D.C. is smoothed by a 20 kV. .0005 μ Fd capacitor or a 15 kV. .001 μ Fd capacitor. Ample shielding is provided to prevent radiation.

£12:10s. ea. net

D.C. required 300 v. at 30 mA./6.3 v. at 1A.

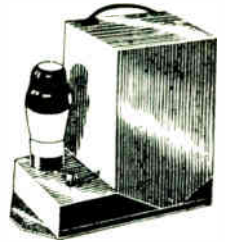

NEW!



D.909 TRANSISTOR TESTER

A low priced NPN, PNP Dynamic Transistor Tester with combined power supply

FREE!

With every D.909 we now include, free of charge, a novel Heat Shunt.

CHECKS Alpha gain — (A.C. gain) with transistors in situ.

CHECKS Beta gain — (Current gain under D.C. conditions).

The above tests are made using the Tester as a self-contained unit. Indications display on neon indicator. To convert the D.909 to the equivalent of a high priced Tester and Analyser, a facility is provided so that when the instrument is used in conjunction with a standard Multimeter, leakage currents can be measured.

In addition to the above, the D.909 provides a useful Signal Source for stage-by-stage testing of Transistor Receivers, etc. Size: 5½" x 3" x 2½".

£10

Post Free

Labour saving — Speedy — Simple! Full technical details available on request

NEW! "ZENIAC" ZENER DIODE SELECTOR

A "must" for every Design Engineer!

Ideal for development laboratories, prototype work, etc.

This new instrument offers a rapid and convenient means of determining the correct zener diode for any particular application, and enables the designer to select, at the flick of a switch, any one of eleven zener diodes

covering nominal voltages from 3.9 v. to 27 v. Two ranges are provided for measurement of voltages and current. Instrument, accessories and full instructions housed in attractive case. Size 7¼" x 4" x 1½".

£16:10s.

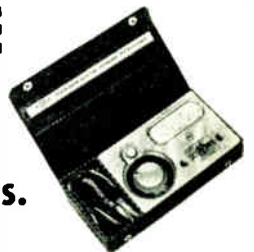

IR

RECTIFIERS

ZENER DIODE KIT

Contains 40 Zener Diodes and Design Handbook.

£20 value for

£10

• Off the shelf at manufacturer's prices!

• Don't delay that project — contact D.T.V. today!

An important addition to D.T.V. Agencies — thousands in stock!

NEW! Transistor TELEPHONE AMPLIFIER Model 300

Attractive unit in ivory plastic case, only 3" x 4" x 1½". Suction coupling unit fits on side of telephone, provides clear loudspeaker results. Fitted with volume control. **69/6** Plus 3 6 p. & p.

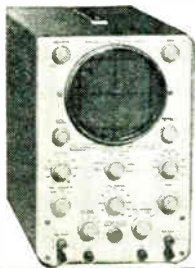

PRICE REDUCTION!

With these special features:

- Gold plated printed board.
- Wide band amplifier.
- Vertical 3 c/s — 5 mc/s.
- Rise time 0.08 μ /secs or less.
- Sweep circuit 10 c/s to 500 kc/s.

• At this new price the O12UF offers the **BEST VALUE IN LOW PRICED OSCILLOSCOPES**

Laboratory Oscilloscope

0-12U/F 5"

NOW ONLY

£43:10s.

O-12U (In Kit Form) £35:10s. Carr. extra on both prices.

ALL YOUR ELECTRONIC EQUIPMENT — SPARES — ACCESSORIES FROM ONE SOURCE

100 MΩ/V

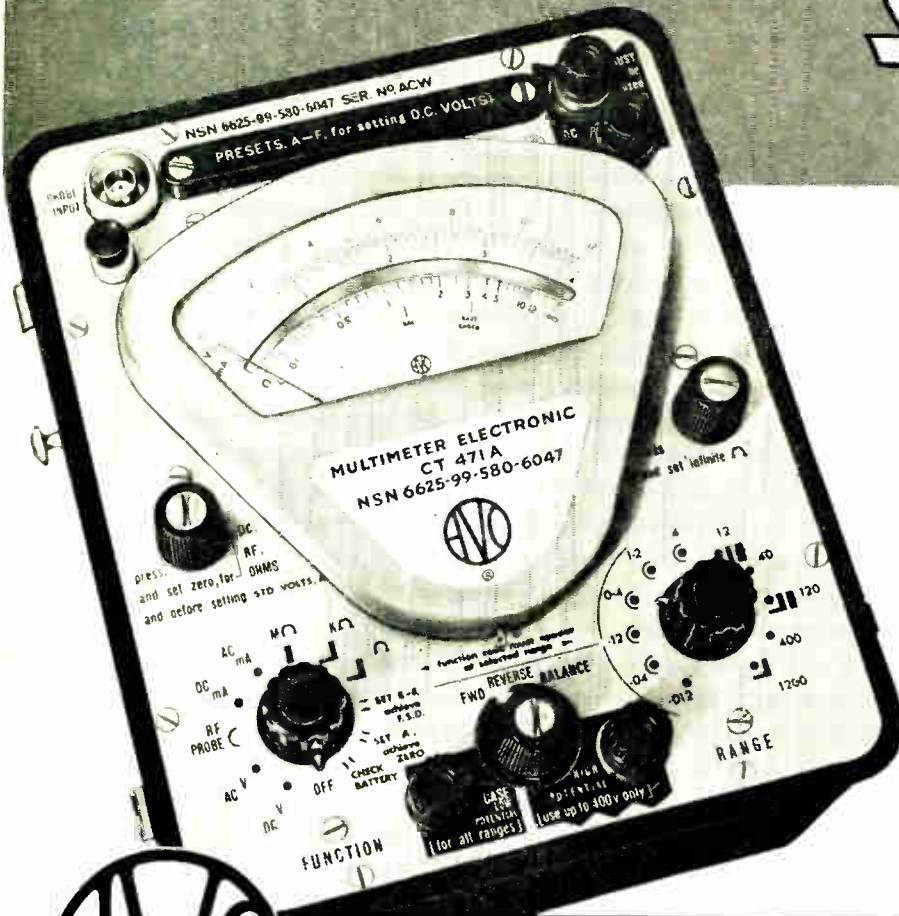

- ★ 57 Ranges.
- ★ D.C. to 1,000 Mc/s.
- ★ All voltage and current readings on only two linear scales.
- ★ 5" scale length.
- ★ 2% accuracy on d.c.
- ★ Comprehensive d.c. standardising facilities to 0.5% short term.
- ★ Battery operated.

**robust as
the AvoMeter**

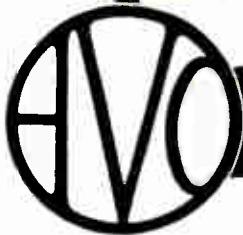

TRANSISTORISED MULTIMETER

CT471

RANGES

d.c. Voltage:
12mV to 1,200V f.s.d. in 11 ranges

d.c. Current:
12μA to 1.2A f.s.d. in 11 ranges

a.c. Voltage r.m.s.:
12mV to 1,200V f.s.d. in 11 ranges

a.c. Current r.m.s.:
12μA to 1.2A f.s.d. in 11 ranges

r.f. Voltage r.m.s.:
40mV to 4V f.s.d. in 5 ranges extending to 400V with capacitive divider

Resistance:
12Ω to 120MΩ f.s.d. in 8 ranges

A portable battery operated multi-range meter using semi-conductors throughout, of high stability and with an accuracy of $\pm 2\%$ on d.c. voltage.

Three basic scales cover all measurements. The two main scales, used for all voltage and current measurements, are linear and the third scale, used for resistance measurements, indicates increasing resistance towards full scale deflection.

Zero adjustment is effected on any d.c. range without disconnecting the meter from the circuit under test. Provision is made for centre zero operation on d.c. voltage. A

reversing facility enables both positive and negative d.c. voltages and current to be measured without reversing the connections.

Provision is made for checking the condition of the batteries and a d.c. standardising facility enables ranges up to 1.2V to be individually corrected to an accuracy of 0.5%. The battery supply is automatically disconnected when the cover is replaced on the instrument. Supplied with high impedance r.f. probe, capacitive divider (division ratio 100:1) and 50Ω and 75Ω terminating pads.

Ask AVO for Leaflet 376

AVO LTD AVOCET HOUSE · 92-96 VAUXHALL BRIDGE ROAD · LONDON S.W.1

Telephone: VICTORIA 3404 (12 lines)



Transistorised

D.C. Supply 'Brick' Units

SMALL AND COMPACT · HIGH REGULATION · LOW RIPPLE AND NOISE
ELECTRONIC OVERLOAD PROTECTION

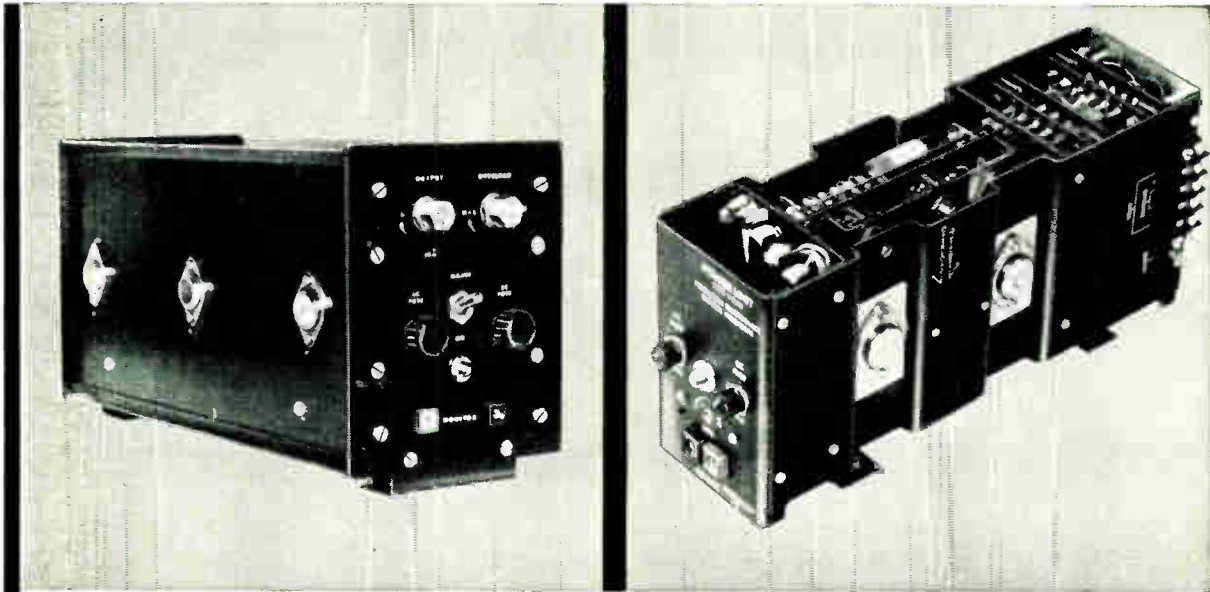

A series of extremely compact stabilised supply units with nominally fixed outputs. Voltages may be preset and changed as desired, with front panel adjustment of $\pm 10\%$. Outstanding features are: fast response electronic overload protection with automatic reset; four terminal sensing, eliminating supply lead voltage drop and enabling units to be used at longer distances from load; very low output impedance of less than 0.01Ω d.c. and less than 0.2Ω a.c. at 100 kc/s; exceptionally close regulation accuracy of 0.01%; ripple and noise less than 2 mV p-p; maximum ambient temperature of 50°C . Finished in matt black.

designed for high density stacking

Bench models of identical specifications and with full metering are available

	VQ161	VQ261	VQ301
Output Voltage \oplus D.C.	3-25v.	3-12½v.	3-30v.
Output Current	1A	2A	3A
Input Voltage Variation	$\pm 10\%$	$\pm 10\%$	$\pm 7\frac{1}{2}\%$
Dimensions	3 x 4½ x 10 ins	3 x 4½ x 10 ins	5½ x 7 x 13
Weight	8 lb	8 lb	15 lb

The substantial financial and technical resources of The Thorn Group are your assurance of the technical excellence and continued availability of all products associated with the Thorn symbol.



THORN ELECTRONICS LIMITED
105-109 Judd Street, London, W.C.1 (EUSton 4433)

Thorn Electronics Limited

TE35

STC

miniature
high-
frequency
coaxial
cables

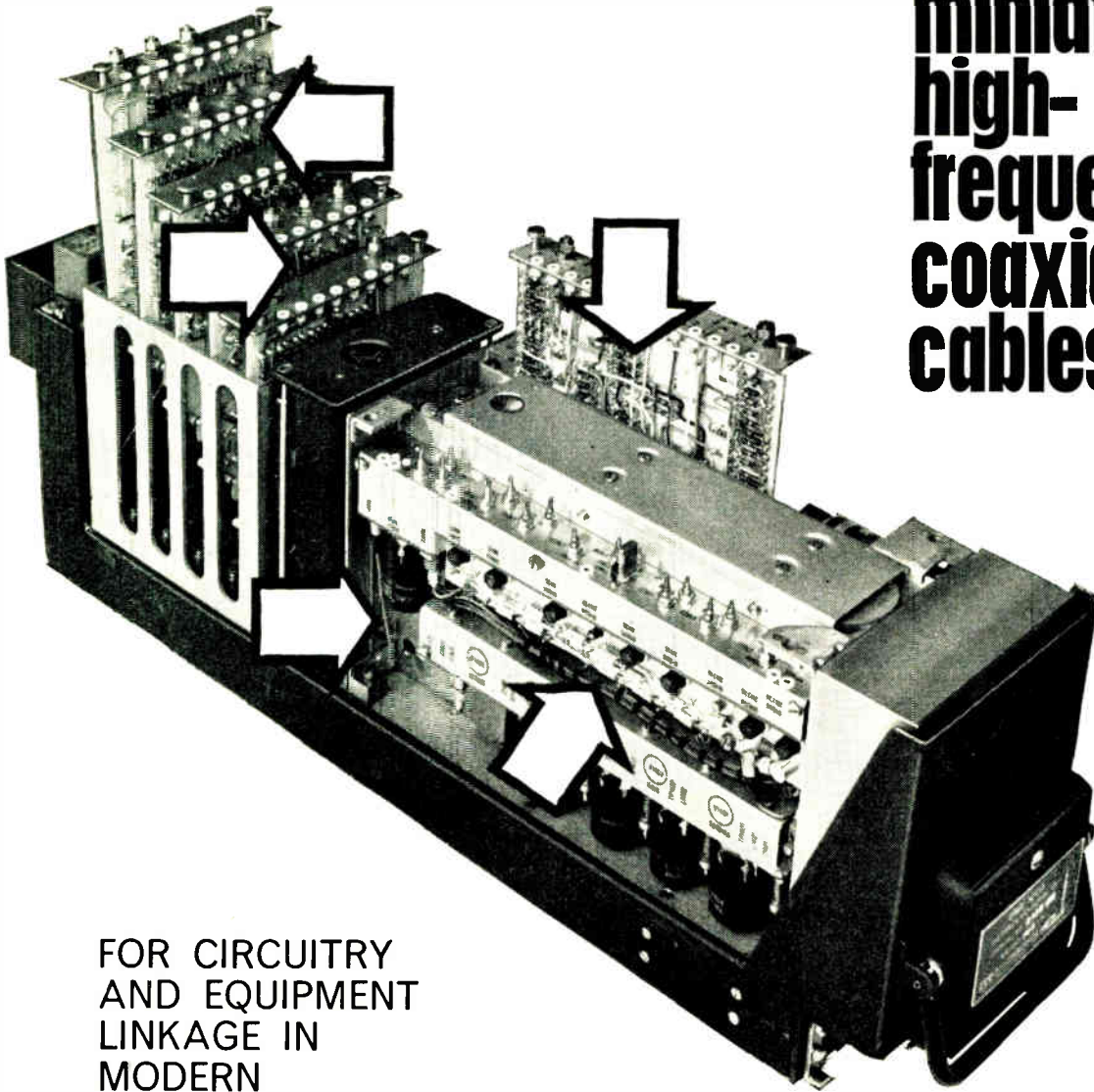

FOR CIRCUITRY AND EQUIPMENT LINKAGE IN MODERN ELECTRONICS

To meet the demand for progressive miniaturization of equipment, STC have developed several types of miniature coaxial cables, with overall diameters in the range of 0.064 in. to 0.078 in. and 50 to 75 ohms impedance. The materials utilized in the construction of these cables are: high tensile strength, silver-plated, copper-clad steel wires; a dielectric of grade 2 polythene or irradiated polythene or polytetrafluorethylene (P.T.F.E.); copper wire or silver-plated copper wire braided; fibre glass braided and nylon sheathed, or P.T.F.E. sheathed.

Write, 'phone or Telex for leaflet H/202 to:



Standard Telephones and Cables Limited

RUBBER & PLASTIC CABLE DIVISION:
CORPORATION ROAD · NEWPORT · MON · Telephone Newport 72281 · Telex 49368

50 ohms
0/dia 0.064 in.

60 ohms
0/dia 0.076 in.

75 ohms
0/dia 0.064 in.

Data Processing
Fast Data Collection
System Centralization
Multiple Outstations
Error Correction

with **STC** *Telephone Speed*

DATA TRANSMISSION SYSTEMS

- Wide variety of applications.
- Error detection and correction giving maximum throughput of accurate data.
- Round-the-clock automatic transmission and reception.
- Tapes can be punched in advance and transmitted to suit traffic conditions.
- Manual, semi-automatic or fully automatic control.
- Small specific data transmission facilities or large integrated systems.

Write, 'phone or Telex for leaflets R/137, R/145



Standard Telephones and Cables Limited

INTEGRATED ELECTRONIC SYSTEMS DIVISION
BURLEIGH HOUSE · GREAT CAMBRIDGE ROAD · ENFIELD · MIDDLESEX
Telephone ENField 5343 · Telex 21409

semiconductoritis?



Reliability + Consistent Quality + Proved Service + Fast Delivery

Why not phone or write now for Technical Data or Quotations. Alternatively, our Sales Engineers will be delighted to call and discuss your immediate or future needs.

When Semiconductoritis* strikes, prescribe Hughes... service and deliveries will improve immediately and Hughes quality control will ensure no unpleasant side-effects. Hughes prescribe from a comprehensive list of PNP/NPN Silicon planar Transistors, Silicon planar and Germanium computer diodes, Silicon power and Zener diodes and voltage variable capacitors—for immediate and regular application. Be sure, too, that Hughes research is constantly alert for new strains of semiconductoritis* and will be ready with appropriate remedies.

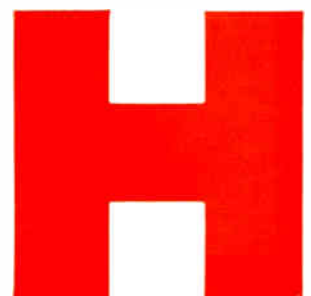

* Semiconductoritis: a production frustration caused by the failure or non-availability of solid-state components.

HUGHES INTERNATIONAL (U.K.) LTD

U.K. SALES: KERSHAW HOUSE, GREAT WEST ROAD, HOUNSLOW, MIDDLESEX. TELEPHONE: HOUNSLOW 5222
OVERSEAS ENQUIRIES: HUSINT S.A., 3 RUE AMI LULLIN, GENEVA

M & P HM18

EMIac II IS FLEXIBLE IN CONTROL

... designed for maximum ease of operation. Special attention has been paid to the grouping of elements and controls and the operational control panel (3) is positioned at eye level.

EMIac II IS FLEXIBLE IN LAYOUT

... so that it is easy to change the function of the computing elements for the purpose of adding, subtracting, multiplying and integrating.

This is done simply by changing the computer component box ('C' Box) (4) which plugs into the front of each pigeon hole.

EMIac II IS FLEXIBLE IN ACCESS

... problems can be small or large. A problem can be taken off the machine and stored whilst the computer works on another problem. The patch board (2) to which the active elements are connected and the co-efficient panel (1) can easily be removed for this purpose.

Co-efficient panel containing 24 potentiometers. 1

Patch panel to which the active elements are connected. 2

Control and display panel for individual row control. 3

18 standard pigeon holes, contain the range of active computing elements which plug into the rear. 'C' Boxes are seen plugged into the front. 4

APPLICATIONS

Because of its flexibility, the applications of EMIac are practically limitless. They include:

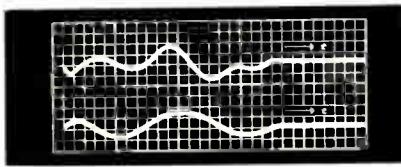

Aircraft and flight problems of every kind.

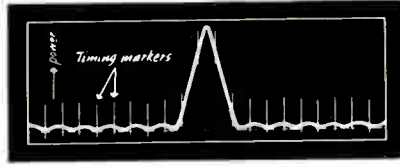

The optimization of electrical machine design.

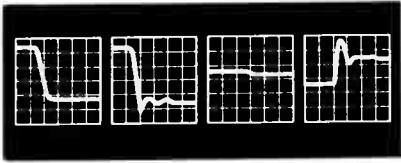

Simulation of complete chemical plant before it leaves the drawing board.

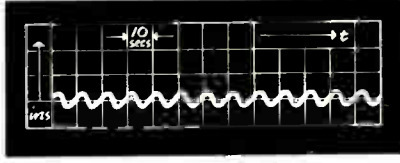

Automobile stability and suspension systems.

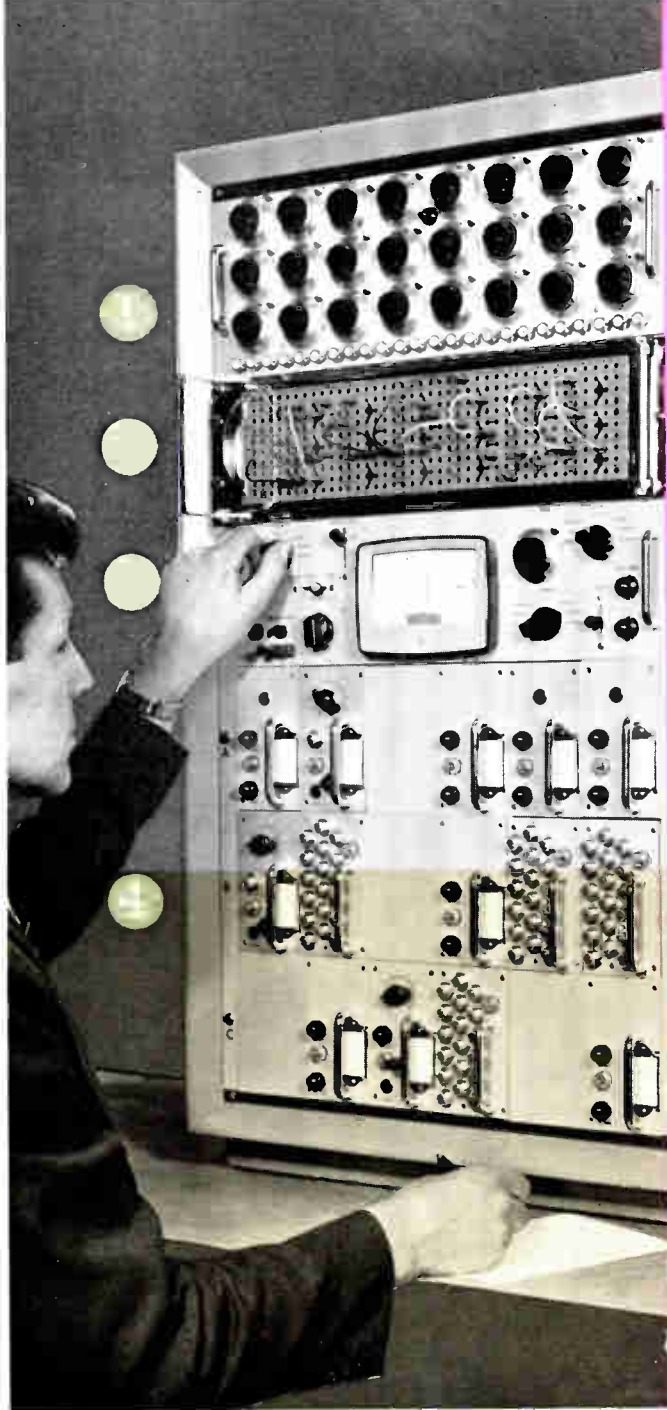

EMIac II

LOW PRICE, COMPLETE FLEXIBILITY

Reply card

- Please send me further details regarding the applications and operation of EMIac II Analogue Computer.
- Please contact me to arrange a demonstration.

NAME AND POSITION

COMPANY'S NAME

ADDRESS

TELEPHONE NUMBER - EXTN.



EMI ELECTRONICS LTD

AUTOMATION DIVISION · HAYES · MIDDLESEX

TELEPHONE: HAYES 3888

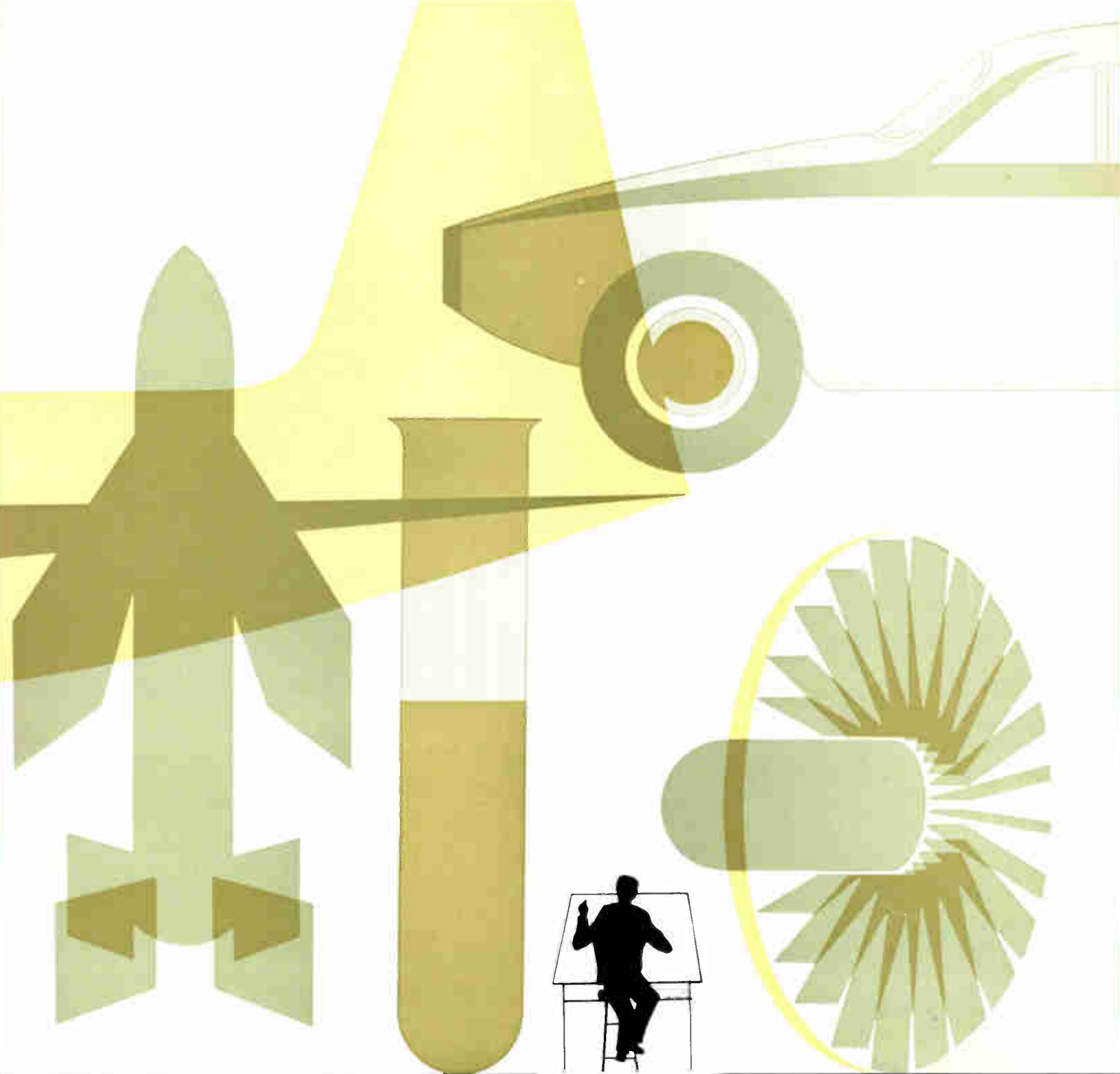

EMIac II the flexible low cost analogue computer

EMIac II is the most flexible, versatile and accurate analogue computer in its price range. The remarkable degree of flexibility has been achieved in two ways; firstly, by adopting the principle of the smallest practical module, complete and self-contained, yet designed, like bricks, to build larger installations; secondly, by providing a selection of active computing elements which can be readily interchanged.

Thus the basic 18 amplifier module forms the ideal, low-cost installation for the small engineering group or technical institute, which can be extended as required.

At the other end of the scale, an installation of 20 or more modules with a standard control console, form a single computer capable of handling the most complex computations with extraordinary speed and simplicity.

For technical details and a closer study of the applications of EMIac II in various industries, please send the reply-paid card to us. We will gladly arrange a demonstration, if required.

Postage
will be
paid by
Licensee

No Postage
Stamp necessary
if posted in
Great Britain
or Northern
Ireland

BUSINESS REPLY CARD
Licence No. SOX 64

AUTOMATION DIVISION · DEPT EC5
EMI ELECTRONICS LTD
HAYES · MIDDLESEX

REPLY CARD

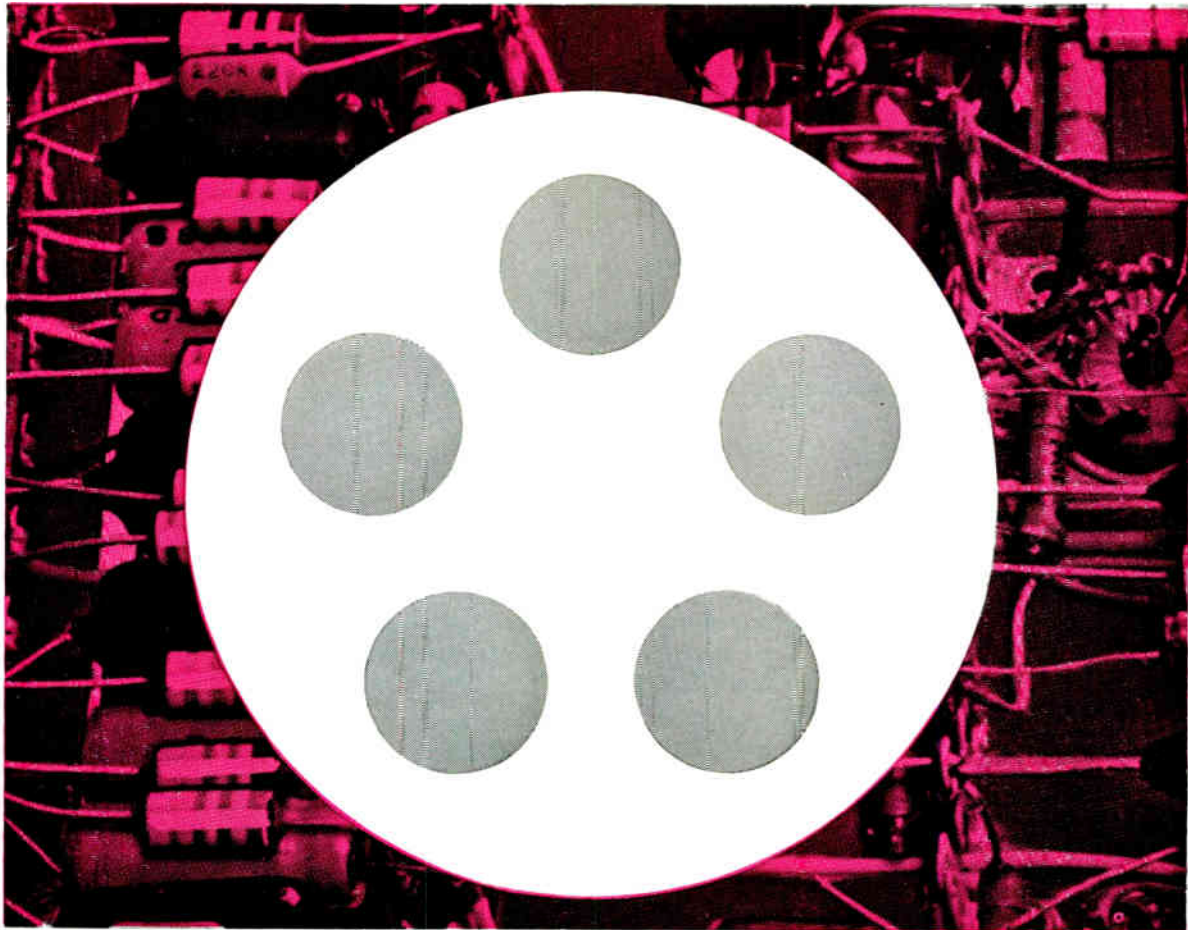

DON'T RISK YOUR REPUTATION FOR A HA'P'ORTH OF SOLDER

The reputation of any piece of electronic equipment can rest entirely on a few pennyworth of solder. That is why the finest and most dependable solder is invariably the best—invariably the most economical! It explains why Ersin Multicore is the most widely used cored solder in the U.K. Many overseas electronics manufacturers insist on Multicore, too, because extra freight or import charges are easily outweighed by complete reliability. A recent American order exceeded 180,000 dollars!

Ersin Multicore Solder contains only purest tin and lead plus five cores of extra-active, non-corrosive Ersin flux. It is without question the finest cored solder in the world!

(Multicore Solders are covered by British Patent Nos. 43319+, 075954, 744763.)

THE FINEST CORED SOLDER IN THE WORLD

MULTICORE SOLDERS LIMITED, Multicore Works, Hemel Hempstead, Herts (Boxmoor 3636)

ERSIN MULTICORE SAVBIT ALLOY

contains a little copper which prevents absorption of copper from the soldering iron bit itself. Bit wear is reduced and the bits last up to ten times longer. By keeping soldering irons in good condition Savbit increases soldering efficiency and maintenance costs are reduced. Tests on production lines throughout the world have proved it. Ersin Multicore Savbit Alloy is manufactured under sole British Licence of Patent No. 721,881.



M.U.

For further information circle 202 on Service Card

PARMEKO

Parmeko have been designing and manufacturing transformers and other electronic equipment of the highest quality for over thirty years. Only a small selection from the range can be illustrated here. Full technical information about any Parmeko product is available on request.

TRANSFORMERS AND TRANSDUCTORS



Parmeko transformers range from miniature types used in transmitter circuits to power transformers having ratings in the order of 15kVA at 50 c.p.s.

ELECTRONIC CONTROL EQUIPMENT



D.C. Amplifier

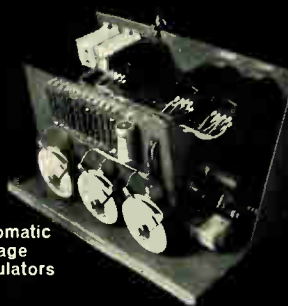

Automatic Voltage Regulators



Motor Speed Controls

ELECTRO-MECHANICAL DEVICES

Magnets Clutches and Brakes



MSM D.C. Solenoids



MSM A.C. Solenoids



PARMEKO LIMITED. PERCY ROAD, LEICESTER, ENGLAND