

# INDUSTRIAL ELECTRONICS

AUGUST 1963 5¢ 0d

London  
Madrid  
Lsoon  
Linar  
Recife - Sao Paulo  
Rio de Janeiro  
Montevideo  
Buenos Aires  
Santiago

Maslibox

DAWE

600/300 WATT  
SONICLEAN GENERATOR  
TYPE NO 1144A SERIAL NO 172  
DAWE INSTRUMENTS LTD  
MADE IN LONDON ENGLAND

DAWE

For further information circle 200 on Service Card

# BICC

# in Television

BICC manufacture every type of cable and associated product that is necessary for the transmission and reception of the visual image—including camera cables and polypole couplers, coaxial distribution cables, power cables, equipment wires and downleads. Transmitting aerial towers are supplied and erected by the British Insulated Callender's Construction Company Limited.

BICC products contribute to the development and expansion of the television industry.

British Insulated Callender's Cables Limited  
21 Bloomsbury Street London WC1

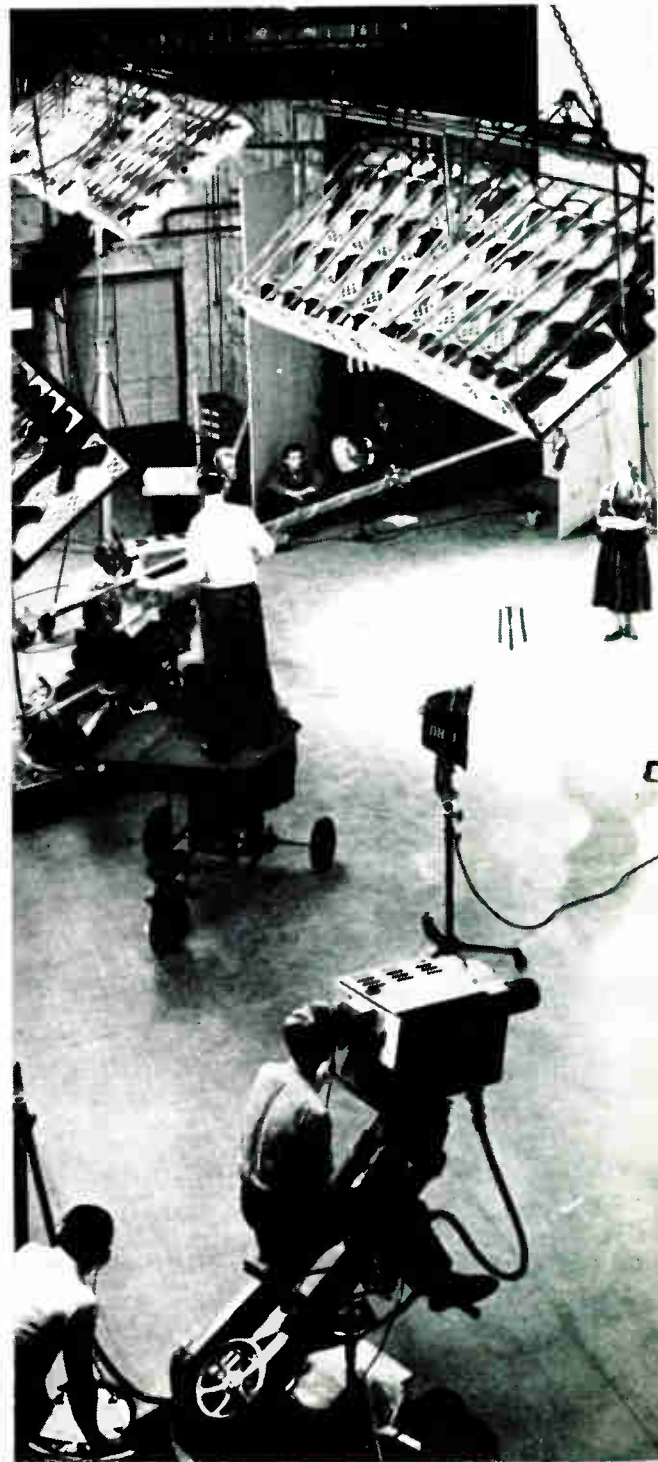
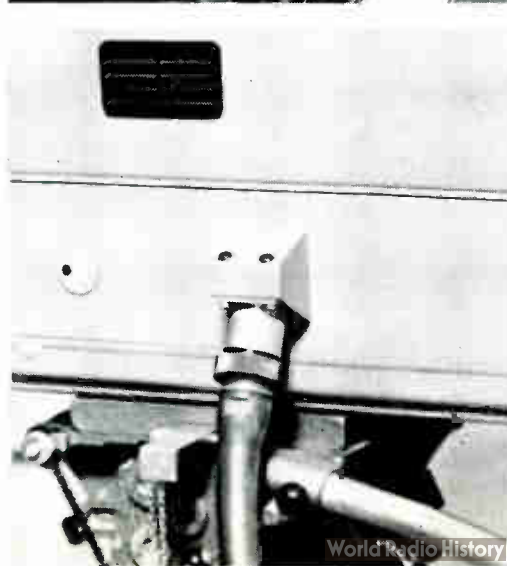
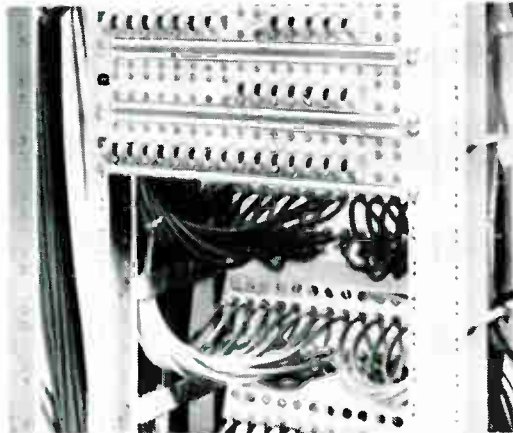



# INDUSTRIAL ELECTRONICS

incorporating *ELECTRONIC TECHNOLOGY*



Volume I Number 11 August 1963

## contents

Editor **W. T. COCKING, M.I.E.E.** 549

Assistant Editor **T. J. BURTON** 551

Advertisement Manager **G. H. GALLOWAY**

### Comment

**Cleaning by Ultrasonics** *by W. G. A. McCormick*

In suitable cases, the use of ultrasonics for cleaning not only enables better cleaning to be obtained but can greatly reduce the time and cost of the operation. This article describes the kind of equipment needed and gives examples of typical applications.

555 **Modular Construction of Electronic Servo-System Elements**

*by J. R. Musham*

This article describes a series of standard units which can be connected together in various combinations to meet a great many control-system requirements. The standardization so obtained enables control systems to be provided more quickly and cheaply.

560 **Electronic Colour Registration in Printing** *by J. C. Mower*

In colour printing successive impressions must be in very close register. This article describes a photoelectric control system which automatically maintains register.

576 **Vidicon Camera Tube with a Fibre Optic Window**

*by A. C. Dowe, B.Sc.(Eng.)*

This article describes the operation of a fibre optic window. The operation of a vidicon camera tube is then explained and finally the advantages of a vidicon incorporating a fibre optic window are discussed.

579 **A Dynamic Diode-Capacitor Store**

*by J. B. Warman and H. J. Stirling*

A basic dynamic storage circuit is described which employs capacitors as the storage elements and p-n-p-n diodes for coupling. From this basic element a versatile and flexible counter and pattern register are developed.

584 **International Exhibition of Industrial Electronics**

Apparatus exhibited by British companies or their agents at INEL 63 at Basle is described.

589 **Classification of Four-Terminal Bridge Networks**

*by K. Posel, Ph.D.*

Ferguson's classification of four-terminal bridge networks is based on the balance equations. This article indicates that the use of the convergence-to-balance expression, as opposed to that of the balance equations themselves, enables restrictions of a mathematical, as opposed to a practical, nature to be placed on the relevant bridge arms and this from the commencement of the analysis. This results in a considerable simplification in the procedures involved.

*continued overleaf*

Published on the first Thursday after the 5th of each month by  
**ILIFFE ELECTRICAL PUBLICATIONS LTD.**  
Managing Director: W. E. Miller M.A., M.Brit.I.R.E.  
Dorset House, Stamford Street, London, S.E.1.  
Telephone: Waterloo 3333.  
Telegrams: Wirenger, London, Telex  
Cables: Wirenger, London, S.E.1.

ANNUAL SUBSCRIPTION, HOME £3 0s. 0d.  
OVERSEAS £3 10s. 0d.  
CANADA and U.S.A. \$10.00.





# CHOOSE G.E.C. FOR TRANSMITTING VALVES

(The world's finest range, from the makers of the very first)

Here is a selection from our outstanding range of transmitting valves. The majority are of ceramic construction, and feature long life and close tolerance characteristics.

The TT21 is a low cost valve for high frequency communications. The 4X250B, 4CX250B, ACS5 and CAS1 meet the needs of modern television and communications transmitters up to 220 Mc/s.

The 4CX250K, with fully co-axial connections, suits low power television transmitters throughout bands IV and V.

	TT21	4X250B/ 4CX250B	4CX250K	ACS4	ACS5	CAS1
$P_{out}$ (W)	174	225	100	4100	10,000	13,000
frequency (Mc/s)	30	500	1,000	75	110	220
$V_a$ (max) (V)	1,250	2,000	2,000	5,000	7,000	7,000*
$P_a$ (max) (W)	37.5	250	250	3,000	6,000	20,000



Our technical information centre is ready to help with your application problems. Write for full data sheets on these or other M-OV products, or telephone RIVerside 3431. Telex 23435.

## M-O VALVE CO LTD

BROOK GREEN WORKS · HAMMERSMITH · LONDON W6 · RIVERSIDE 3431

# The first major advance in potentiometer design for years ...

After many years of research and development Reliance now announce an entirely new concept in the design of multi-turn wire wound potentiometers. This, combined with new manufacturing techniques provides extremely low inertia, low torque, high law accuracy and multiple tapping facilities for non linear functions. The unit is available in two distinct separate versions:

1. SERIES SYN 11-00 A Synchro Mounting Unit incorporating precious metal winding and precision ball races.
2. SERIES HEL 11-00 A  $\frac{3}{8}$ " diameter Bush Mounting version, plain bearing with standard resistance windings, still retaining high electrical characteristics.

- ★ RESISTANCE RANGE: 20 ohms—150 K ohms.
- ★ LINEARITY:  $\pm 0.1\%$  or  $\pm 0.25\%$  absolute as required.
- ★ TAPPING ACCURACY:  $\pm 0.1\%$ .
- ★ MOMENT OF INERTIA: 0.0004 gm. cm. sec<sup>2</sup>.
- ★ STARTING TORQUE: Synchro Mounting Version 3 gm cm. or better.  
Bush Mounting Version 1 oz.in. nominal.  
or Sealed Version 2 oz.in. nominal.
- ★ ROTATION LIFE: > 1,000,000/360° sweeps.
- ★ NUMBER OF TURNS: Any number up to 10.

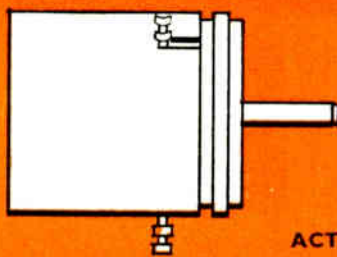
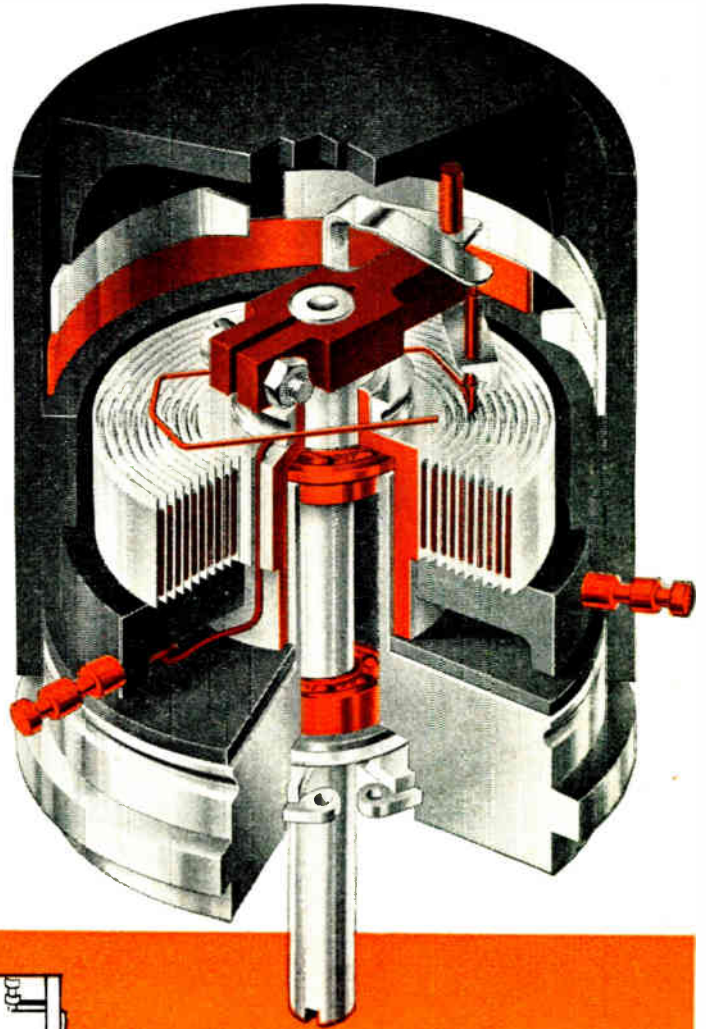

SYN 11-00 SERIES

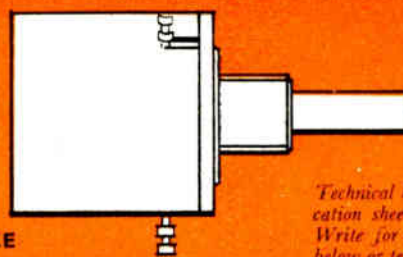

HEL 11-00 SERIES

ACTUAL SIZE

Technical brochure and specification sheets are now ready. Write for them to address below or telephone: LARKSWOOD 84047

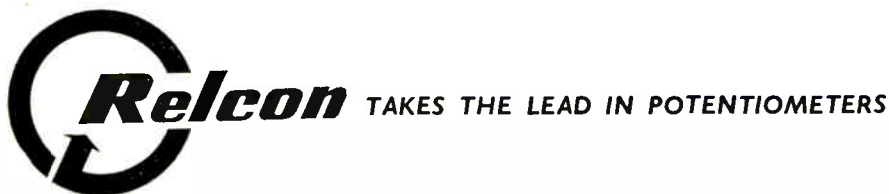

**RELIANCE CONTROLS LIMITED, RELCON WORKS, SUTHERLAND ROAD, WALTHAMSTOW, E.17**  
Telephone No. LARKSWOOD 8404/7 · Telegrams: Reltrol, London, E.17 A MEMBER OF THE BOOKER GROUP OF COMPANIES

# IT'S ONLY 2" DEEP



## The axial flow blower for confined spaces

The unique size, moderate cost and ingenious construction of the Plannette have now established it as the ideal answer to many problems in general electronic cooling and cabinet ventilation. Many thousands are in use in the U.K. and overseas.

Because the entire assembly is only 2" deep, the Plannette can be mounted either inside or on top of the cabinet, vertically or horizontally. It is particularly valuable where temperature control is difficult because of lack of space or where a blower has to be added late in the design stage.

The Plannette is available in two sizes at alternative speeds:

4½" dia. delivers: 80 c.f.m. at 0.15 s.w.g. at 2,700 r.p.m.  
40 c.f.m. at 0.04 s.w.g. at 1,400 r.p.m.  
6" dia. delivers: 150 c.f.m. at 0.25 s.w.g. at 2,700 r.p.m.  
75 c.f.m. at 0.06 s.w.g. at 1,400 r.p.m.

The motors are a.c. and may be arranged either for 230V 1-ph 50/60 cycles or 110V 1-ph 50/60 cycles.

Send for full details to:



Specialists in aero-thermal control

Plannair Limited, Windfield House, Leatherhead, Surrey.  
Telephone: Leatherhead 4091

PLA 87

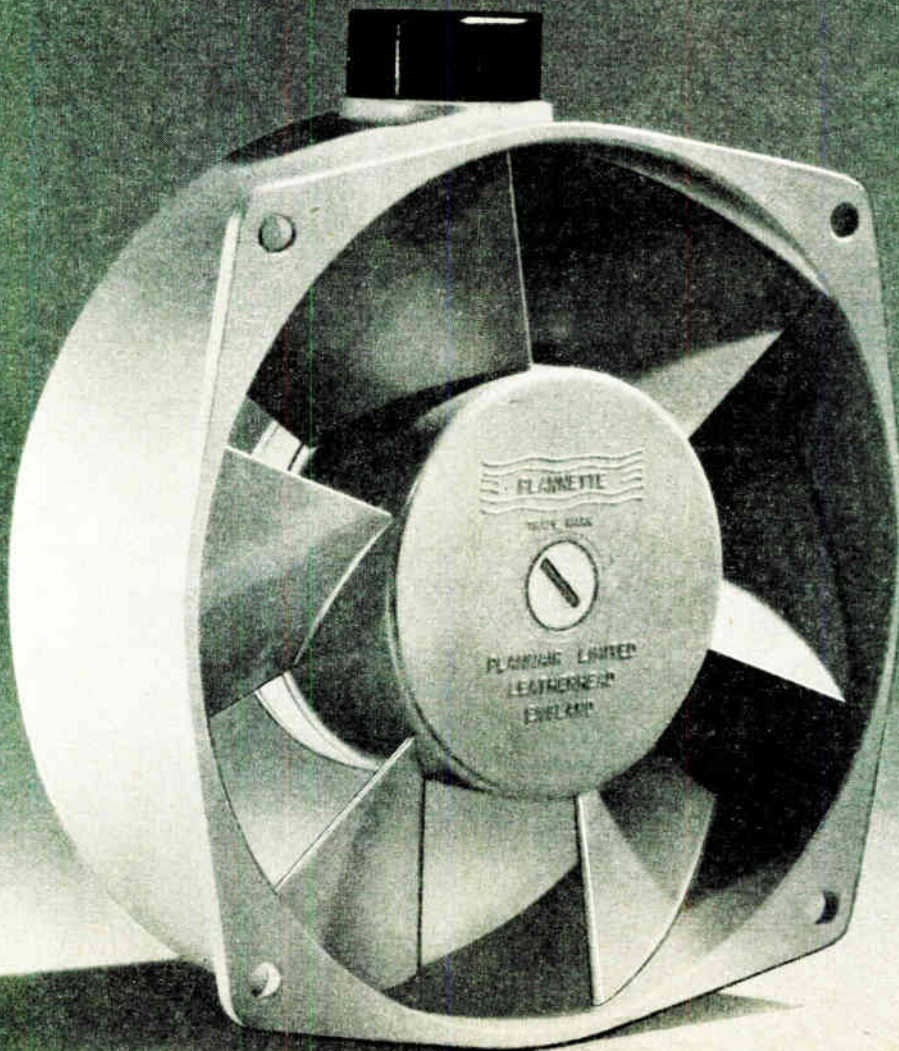

# Helical cooling technique for Mullard power triodes

## INCREASED EFFICIENCY AT LESS COST IN R.F. HEATING AND AUDIO POWER EQUIPMENT

Six industrial power triodes—for use in dielectric pre-heaters and welders, induction heaters, and vibration power amplifiers—are now available with integral helical cooling systems.

The helical cooling system has advantages over the conventional water-jacket system—in particular, a reduction in installation costs and increased cooling efficiency. The volume of cooling water is nearly half that required with the water-jacket system, enabling a substantial reduction to be made in the size of the circulating pump required. In addition, helical-cooled valves can be operated at a higher outlet temperature than those employing a water jacket so that a smaller heat exchanger is required. These factors increase the overall efficiency of the cooling system and allow the cost of the complete installation to be reduced.

### CONSTANT-POWER CHARACTERISTICS

Three of these valves have special constant-power characteristics so that with a variation in load resistance of  $\pm 50\%$ , the change in power output of the valve is less than  $\pm 15\%$ . This constant-power characteristic enables installations to be operated at maximum efficiency despite changes in load, thereby reducing processing times. In induction heating processes in particular, this characteristic stabilises the output power of the valve against the large changes that occur when the load passes through the Curie point.

### RUGGED CONSTRUCTION

Each of the six industrial power triodes has a heavy-duty thoriated tungsten filament which can provide a reserve of emission even during temporary mains voltage fluctuations of  $+5$  to  $-10\%$ , ensuring efficient operation of the valve at all times.

The grid is constructed from a special material which can withstand the temporary accidental overloads that may occur in dielectric and induction heating processes.

Of particular importance in vibration amplifiers is the adequate reserve of anode dissipation of the valve. This permits the delivery of full rated power into reactive loads, and provides a wide margin of safety when operating at extremely low frequencies.

Brief details of the range are given in the table. For further information, please use the reader reply card of this journal (see reference number opposite).

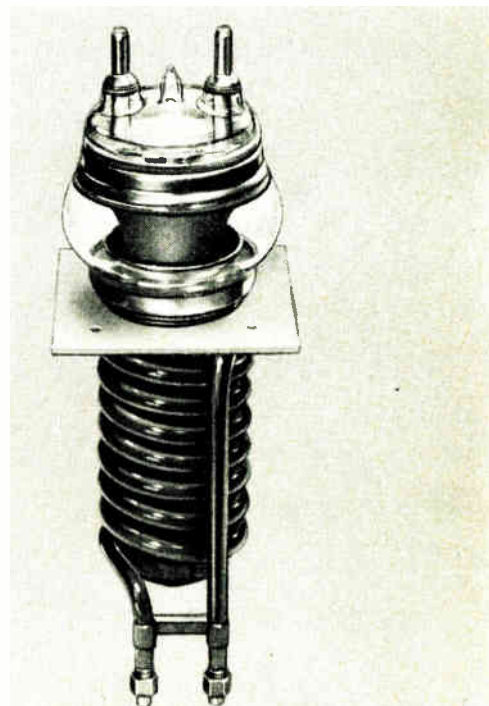

Industrial power triode, type TY8-15H, with integral helical cooling system.

Type Number	Maximum Load Power (kW)	
	Oscillator	Class AB <sub>2</sub> Amplifier (2 valves)
TY6-1250H	3.5	8
TY7-6000H	7	20
TY8-6000H	6	16
TY8-15H	14	36
TY12-20H	33	60
TY12-50H	86	200

## What's new from Mullard



**COUNTING SPEEDS  
OF UP TO 50 kc/s  
WITH NEW TUBE**

Counting speeds of up to 50kc/s are made possible by the introduction of a special gas mixture into a tube of basically the same design as the well-proven type Z504S. The new tube, type Z505S, is the

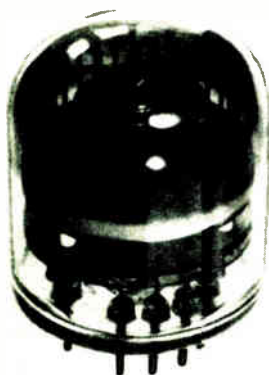

latest addition to a range of Mullard cold cathode tubes which are being increasingly used in counting, scaling, batching, and welding-control applications. Operating from a supply of 500V, the Z505S has an anode current of 800µA and provides a cathode output potential of 24V.

**EXTENDED  
RANGE OF  
SILICON P-N-P  
TRANSISTORS**

Three new 0.5A transistors together with BCY30 to BCY34 series form a compatible range of Mullard silicon p-n-p alloy-junction transistors in TO-5 encapsulation.

With good bottoming characteristics and good heat dissipation, these new types—BCY38, BCY39, BCY40—are intended for use in pulse and linear applications.

The general-purpose type BCY38 and high-gain type BCY40 operate at 32V and have similar electrical characteristics to the OC204 and OC206. The BCY39 operates at 64V which is an improvement on the value of VCB(max.) of 60V for the OC205. With a low value of thermal resistance, each transistor will dissipate over 0.5W at a case temperature of 25 C.

**Further application for  
Magnadur Magnets**

**PRINTED-WIRING MOTOR DEVELOPMENT**

Magnadur, a sintered magnet material with a high coercive force and high electrical resistivity, has established itself as the most suitable magnet material for many applications. These applications range from loudspeakers to electric motors, from door catches to echo-sounding equipment. A new use for Magnadur magnets was demonstrated recently in the design of a printed-wiring motor.

The field for this motor was produced by an annular ring of six

Magnadur magnets mounted on a mild steel backing plate. The magnetic circuit was completed by a return ring on the opposite side of the rotor.

Printed-wiring motors have the advantage of a high torque/inertia ratio and low mechanical time constant (because of the low moment of inertia of the rotor), and a smooth torque characteristic.

The magnets for this motor represent just one of the many uses for Magnadur.



**V.H.F. POWER PENTODE  
WITH QUICK-HEATING  
FILAMENT**

A low-power pentode has recently been introduced for v.h.f. mobile communications equipment. The valve, type YL1000, is intended for use as the output stage of small mobile transmitters or as a driver stage in larger transmitters. It can also be used as a master oscillator or frequency multiplier.

The quick-heating filament enables the valve to provide 70% of the output within half a second of switching on. This facility allows the valve to be switched off during 'receive' periods, thus economising on heater power and reducing the equipment temperature.

At a frequency of 175Mc/s, the YL1000 has an output power of 3.7W when used as an amplifier and 2.6W when used as a frequency doubler.

**NEW DISPLAY TUBE  
FOR TRANSISTORISED  
RADAR**

A new radar display tube has recently been introduced whose scanning power requirements are such that transistor drive circuits can be used. This tube, type F21-10LD, has a screen diameter of 8½in and a scanning angle of 40°.

The F21-10LD has a useful screen area which meets the Ministry of

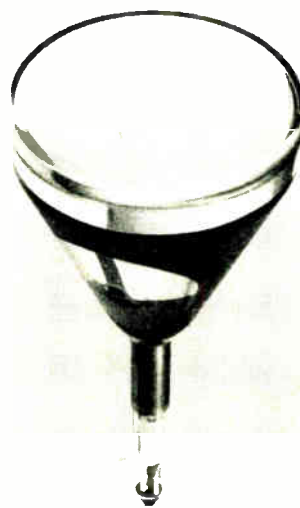

Transport requirement of 7½in. diameter for marine radar. The screen has a long-persistence phosphor, making the tube suitable for medium-range general-purpose radar systems.

**MORE POWER  
FROM THYRATRON  
ZT1011**

**Direct Equivalent of  
American C3JA**

The thyatron ZT1011 will pass an average cathode current of 2.5A at a peak anode voltage (forward or inverse) of 1.25kV. This valve was formerly type XR1-1600A which was recommended as a near equivalent of the American type C3JA, the difference between the two types being the lower cathode current of the Mullard valve. Now, life tests at the C3JA ratings have confirmed that the ZT1011 can be run at these higher ratings and is now a direct equivalent of the American type.

Where a lower cathode current (1.6A) can be accepted, the peak anode voltage of the ZT1011 may be increased to 1.5kV.



**Reader Enquiry Service**

Further details of the Mullard products described in this advertisement can be obtained through the Reader Enquiry Service of Industrial Electronics using the appropriate code number shown below.

Helical-cooled valves .....	206
Transistors BCY38, BCY39, BCY40 .....	207
Thyratron ZT1011 .....	208
Counting tube Z505S .....	209
V.H.F. power pentode YL1000 .....	210
Magnadur .....	211
Radar tube F21-10LD .....	212



Mullard Limited, Mullard House, Torrington Place, London, W.C.1. Telephone: LANgham 6633

# Encapsulation for the million!

## NOW INTRODUCED TO EUROPE- E-PAK a high speed encapsulation system for electrical components

- Simple · Speedy · Efficient · Economical
- No outlay on plant involved
- No mixing or handling of resin
- No moulds or other equipment
- Produces components of uniform size and shape
- High rates of output—lower production costs

CIBA LTD., Basle, extend a cordial welcome to you to visit STAND NO. 126, HALL 11, at the International Exhibition of Electronics, Basle, 2nd — 7th September, 1963

*For further information, please complete and despatch this coupon*

### ® Araldite E-Pak

Registered trademark

*E-Pak was developed in the USA by Joseph Waldman & Sons, Epoxy Resin Division, and the system is operated under licence in the United Kingdom by CIBA (A.R.L.) Limited.*

To CIBA (A.R.L.) Limited Duxford, Cambridge. Tel: Sawston 2121

*Please send me information on Araldite E-Pak*

NAME .....

COMPANY .....

ADDRESS .....

.....

.....

I.E.

AP779



## MINIFLAKE TRANSISTORS *for thin film circuits*

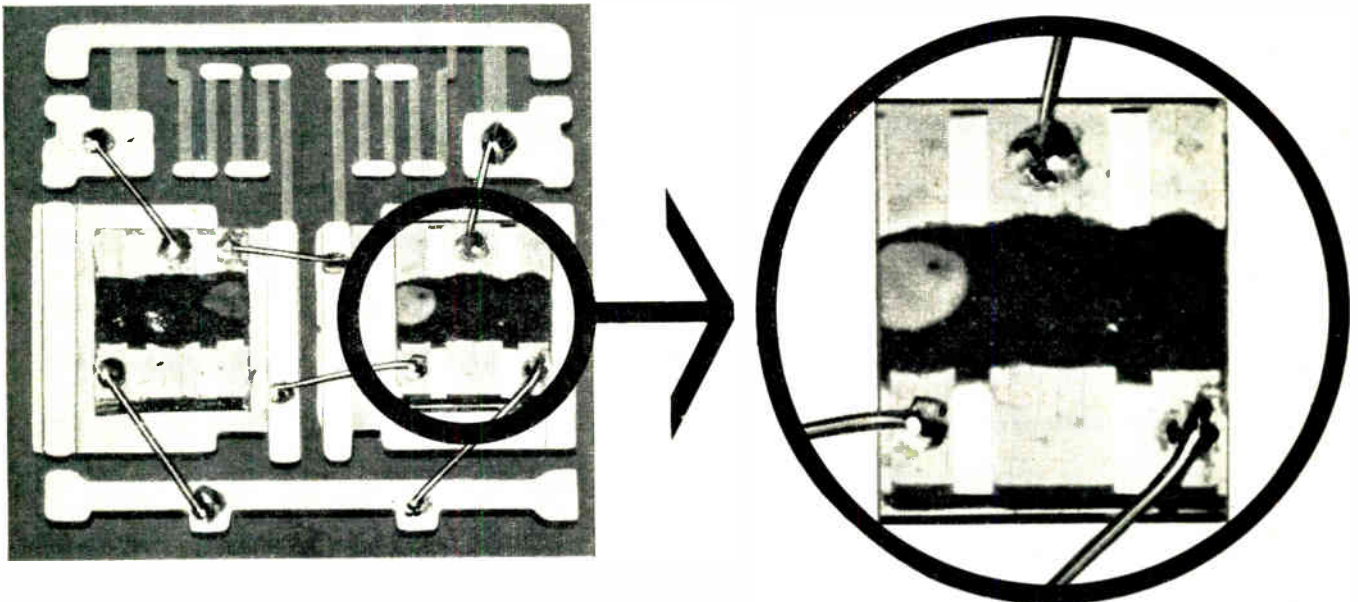

The initial range of STC Miniflake transistors comprises types without leads for direct connexion into thin film circuits, and types with leads for use with subminiature circuitry. In either application, Miniflake transistors do not increase the height of the circuit by more than 0.025 in. (0.635 mm). All Miniflakes are coated with an opaque resin which prevents mechanical damage to the planar surface and eliminates photo-conductivity.

### BSY32 and BSY33

These are produced without leads and are for fast switching at mean current levels up to 100 mA. Their characteristics are similar to the conventionally encapsulated BSY26 and BSY27.

### BSY47 and BSY48

Having leads, these Miniflakes are otherwise similar to the BSY32 and BSY33 respectively.

#### Brief Data

	BSY32 - BSY47	BSY33-BSY48
$f_T$ ( $I_C=10\text{ mA}$ , $V_{CE}=9\text{ V}$ , $f=100\text{ Mc/s}$ )	200 Mc/s	200 Mc/s (Min)
$I_{CBO}$ ( $I_E=0$ , $V_{CB}=9\text{ V}$ )	25 nA	25 nA (Max)
$h_{FE}$ ( $I_C=50\text{ mA}$ , $V_{CE}=2\text{ V}$ )	15-60	25-120
$V_{CES}$ ( $I_C=50\text{ mA}$ , $I_B=5\text{ mA}$ )	480 mV	190 mV (typ)
$t_{ON}$ ( $I_C=10\text{ mA}$ )	20 ns	19 ns (typ)
$t_{OFF}$ ( $I_C=10\text{ mA}$ )	31 ns	35 ns (typ)

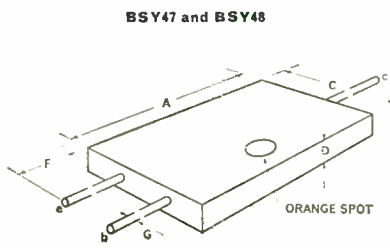
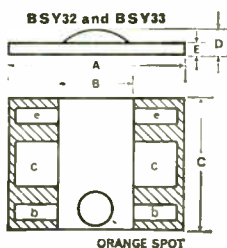

Dim	in.	mm
A	0.160	4.064
B	0.070	1.778
C	0.120	3.048
D (max)	0.025	0.635
E	0.010	0.254
F	0.5	12.7
G	0.010	0.254

For full details of STC Miniflakes write, 'phone or Telex to STC Transistor Division, Footscray, Sidcup, Kent. Telephone FOOTscray 3333. Telex 21836.

**COMPONENTS REVIEW**

# SILICON AVALANCHE RECTIFIERS TYPE RAS 310 AF

For the first time—a Silicon Rectifier which is self-protecting against voltage transients.

The avalanche property of this device has a voltage limiting characteristic that permits surges fifty times greater than the conventional silicon rectifier can withstand.

**High voltage stack construction is simplified**—avalanche rectifiers can be series connected without voltage equalizing resistors and, in many applications, equalizing capacitors are unnecessary.

## TYPE RAS 310 AF

Rated Forward Current (at 25°C)	1.25 A
Rated Crest Working Reverse Voltage	1000 V
Minimum Reverse Avalanche Voltage	1250 V
Rated Maximum Reverse Surge Power	4 kW
Rated Maximum Temperature	140°C
Standard Outline	VASCA SO-16, JEDEC DO 1, IEC 1-101

## NOW AVAILABLE FROM PRODUCTION



ACTUAL SIZE

SURGE (NON RECURRENT) REVERSE POWER

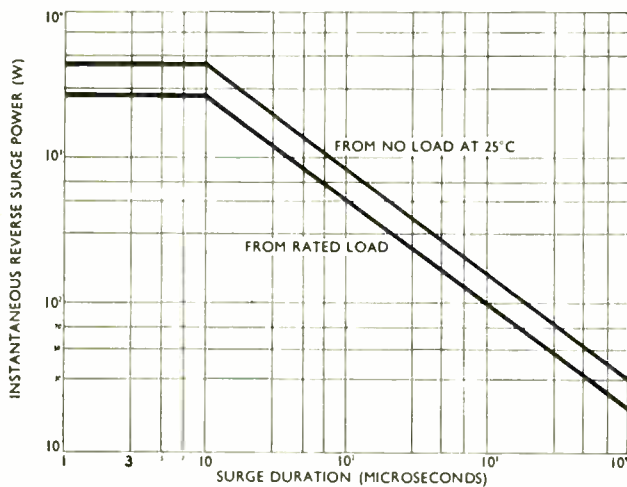

Write, 'phone or Telex for Data Sheet MF/125 to STC Rectifier Division, Edinburgh Way, Harlow, Essex. Telephone Harlow 26811. Telex 81146.

# SRDE APPROVAL FOR STC SOLID TANTALUM CAPACITORS

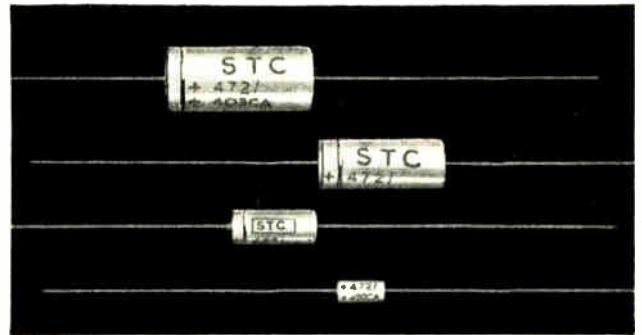

Departmental Approval Certificate Number NS. 3020, covering STC Solid Tantalum capacitors, has been granted by the Ministry of Aviation. The approval is based on a successful test programme carried out by SRDE to Draft DEF 5134-A-1 and is pending the finalization of this specification.

The STC solid tantalum capacitor series was extended recently by the addition of a 50 volt rating. Rated working voltages at 85°C are now: 50 V, 35 V, 20 V, 15 V, 10 V and 6 V d.c. This range of capacitors is manufactured entirely in the United Kingdom under full Quality Control and all units are aged for 7 days before shipment.

Capacitors to 5% and 10% tolerances are now available, in addition to the standard 20% capacitance tolerance.

- \* Designed to DEF 5134-A-1 and MIL-C-26655/2 (Styles CS12 and CS13)
- \* Temperature range: -55°C to +125°C (with voltage derating above +85°C)
- \* Humidity classification: H6 (DEF 5011)
- \* Capacitance range: 0.47 μF to 330 μF

Performance data available on request

In addition to this range, STC manufacture the following wet-electrolyte tantalum capacitors:

- TYPE APPROVED FOIL
- HIGH TEMPERATURE FOIL
- MINIATURE FOIL
- SPECIAL QUALITY FOIL

Write, 'phone or Telex for Data Sheets to STC Capacitor Division, Brixham Road, Paignton, Devon or London Sales Office, Footscray, Kent. Telephone FOOTscray 3333. Telex 21836

## MINIATURIZATION 1.5 micron dielectric

A 25 volt STANTELAC capacitor range has now been introduced. This series will be a considerable aid to development engineers who are particularly interested in the miniaturization of low voltage electronic equipment. The technique employed is an STC development based on the use of an aluminium foil coated with a synthetic resin. The thinness of this integrated dielectric is not limited by the usual considerations of handling and winding etc., and is made to suit the required working voltage. This results in an exceptionally high capacitance-to-volume ratio, particularly at lower voltages.

**ACTUAL SIZE**

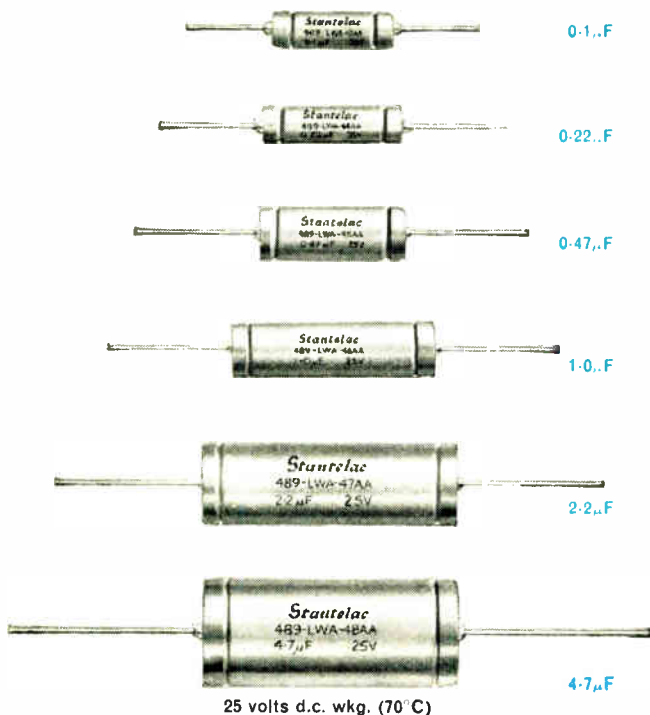

25 volts d.c. wkg. (70°C)

## PULSE MODULATOR VALVES VACUUM TETRODES

The STC range of Vacuum Pulse Amplifier Tetrodes grows steadily as does their reputation for reliable service. The latest valve to be added to the range is type 4B/550E which is a smaller version of the now very popular 4B/603E.

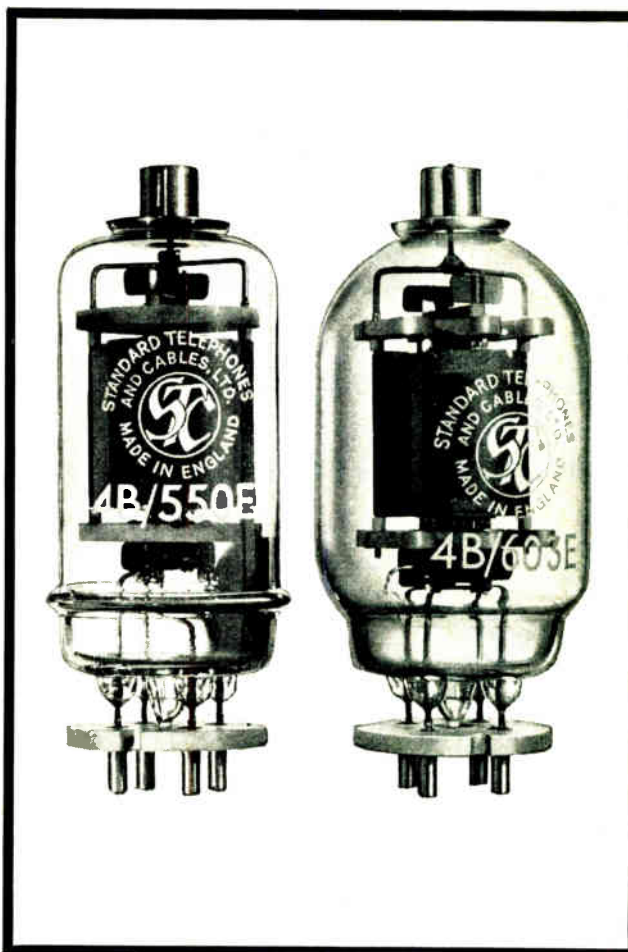

Code	3D21A	4B/550E	4B/603E	4B/602E
V <sub>h</sub> (V)	6.3 or 12.6	26	26	26
I <sub>h</sub> (A)	1.7 or 0.85	1.2	2	2
V <sub>a</sub> (kV)	3.5	12	15	20
I <sub>a peak</sub> (A)	7	10	15	15
V <sub>g2</sub> (kV)	0.8	0.8	1.25	1.25
V <sub>g1 bias</sub> (V) Typical	-150	-500	-800	-800
V <sub>g1 pulse</sub> (V) Typical	300	700	1025	1025
Equivalent Codes	CV2659		CV398	CV427

STANTELAC capacitors are ideal for use in place of foil/paper, metallized paper and polyester types to gain an improved space factor and a general improvement in electrical characteristics. The capacitors will have a wide field of application in computers, modern telecommunication equipment and in transistorized equipment generally. The 50 volt and 100 volt ranges are now well established as high quality components. These ranges have recently been expanded and now include over twice the number of capacitance values previously available.

Write, 'phone or Telex for Data Sheets to STC Capacitor Division, Brixham Road, Paignton, Devon or London Sales Office, Footscray, Kent. Telephone FOOTscray 3333. Telex 21836.

Write, 'phone or Telex for Data Sheets to STC Valve Division, Brixham Road, Paignton, Devon or London Sales Office, Footscray, Kent. Telephone FOOTscray 3333. Telex 21836.



**Standard Telephones and Cables Limited**

COMPONENTS GROUP · FOOTSCRAY · SIDCUP · KENT



## LIQUID LEVEL CONTROL

By and large, the familiar mechanical liquid level controller does a reliable job, but it has its limitations particularly in precise industrial applications. Here the effective answer is inexpensive cold cathode trigger tubes. Reliable to the point of outlasting the useful life of parent equipments, Ericsson trigger tubes meet the most exacting requirements.

Operating from rectified mains they require no special power supplies, they are not affected by severe transient overloads, they give visual indication of current flow and their characteristics remain unchanged by temperature fluctuations.

With suitable electrodes any substance capable of flow even with only a moderate degree of conductivity can be accurately maintained to predetermined levels or measured and delivered in selected quantities.

The circuit illustrates the simplicity of cold cathode trigger tube liquid level control. For more information and data please write to the address below.

GPE 120T TRIGGER TUBE

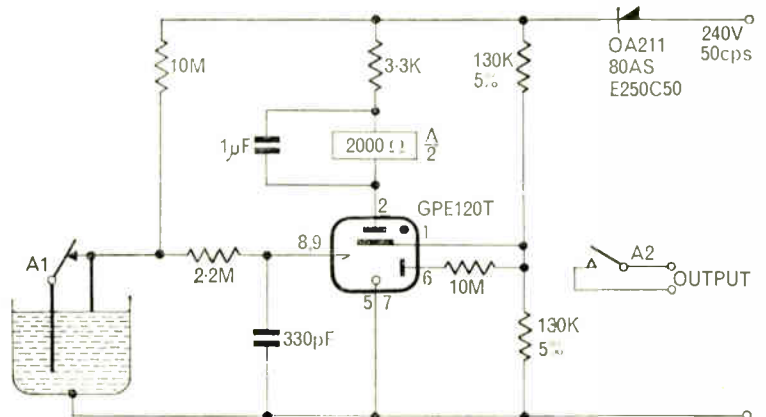

Tube Division  
 Technical Services Dept.,  
 Beeston, Notts. Tel: 254831.

**ERICSSON TELEPHONES LTD  
 ETELCO LTD**

# Let the

## INDUSTRIAL ELECTRONICS

### READER ENQUIRY SERVICE

# help you to obtain more information

Circle the code numbers of the items in which you are interested. Insert your name and address, etc., in block capitals and post the card to us.

We will communicate with the manufacturers concerned and arrange for the information you require to be sent to you without obligation.

*(No postage stamp is required if posted in Great Britain or Northern Ireland)*

#### Is this your own copy ?

Each month INDUSTRIAL ELECTRONICS will bring you news of the latest applications, the most recently announced equipment, produced by the rapidly expanding electronics industries of the world.

It is invaluable to all management and production executives, and engineers, in industry generally, who need to be informed of the latest developments in electronic aids to industry.

**MAKE SURE OF YOUR COPIES  
USE THE ORDER CARD NOW**

## INDUSTRIAL ELECTRONICS

## READER ENQUIRY SERVICE

AUGUST 1963 — For further information circle appropriate number (IF)

Editorial code number—	1	2	3	4	5	6	7	8	9	10	11	12	13	14	15
16	17	18	19	20	21	22	23	24	25	26	27	28	29	30	31
32	33	34	35	36	37	38	39	40	41	42	43	44	45	46	47
48	49	50	51	52	53	54	55	56	57	58	59	60	61	62	63
64	65	66	67	68	69	70	71	72	73	74	75	76	77	78	79
80	81	82	83	84	85	86	87	88	89	90	91	92	93	94	95
96	97	98	99	100	101	102	103	104	105						

Advertisement code number—	200	201	202	203	204	205	206	207	208	209	210	211	212	213
214	215	216	217	218	219	220	221	222	223	224	225	226	227	228
229	230	231	232	233	234	235	236	237	238	239	240	241	242	243
244	245	246	247	248	249	250	251	252	253	254	255	256	257	258
259	260	261	262	263	264	265	266	267						

I would also like details of.....

Your Name..... Position held.....

Name of Firm.....

Address.....

Nature of Business.....

PLEASE USE BLOCK CAPITALS

Postage will be paid by Associated Iliffe Press

No Postage Stamp necessary if posted in Great Britain or Northern Ireland

**BUSINESS REPLY CARD**  
Licence No. SE 591

**"INDUSTRIAL ELECTRONICS",  
DORSET HOUSE,  
STAMFORD STREET,  
LONDON, S.E.1**

AUGUST 1963

## INDUSTRIAL ELECTRONICS

### SUBSCRIBER'S ORDER FORM

#### Subscription Rates

Home £3. 0s. 0d.

Overseas £3. 10s. 0d.

USA and Canada \$10

Please supply

INDUSTRIAL ELECTRONICS monthly for the next 12 months

I will remit on receipt of invoice

NAME.....

ADDRESS.....

Postage will be paid by Associated Iliffe Press

No Postage Stamp necessary if posted in Great Britain or Northern Ireland

**BUSINESS REPLY CARD**  
Licence No. SE 591

**"INDUSTRIAL ELECTRONICS",  
DORSET HOUSE,  
STAMFORD STREET,  
LONDON, S.E.1**

# Let the

## INDUSTRIAL ELECTRONICS

### READER ENQUIRY SERVICE

# help you to obtain more information

**INDUSTRIAL ELECTRONICS**

### READER ENQUIRY SERVICE

**AUGUST 1963 — For further information circle appropriate number** (2F)

Editorial code number—	1	2	3	4	5	6	7	8	9	10	11	12	13	14	15		
16	17	18	19	20	21	22	23	24	25	26	27	28	29	30	31	32	33
34	35	36	37	38	39	40	41	42	43	44	45	46	47	48	49	50	51
52	53	54	55	56	57	58	59	60	61	62	63	64	65	66	67	68	69
70	71	72	73	74	75	76	77	78	79	80	81	82	83	84	85	86	87
88	89	90	91	92	93	94	95	96	97	98	99	100	101	102	103	104	105

Advertisement code number—	200	201	202	203	204	205	206	207	208	209	210	211	212	213			
214	215	216	217	218	219	220	221	222	223	224	225	226	227	228	229	230	231
232	233	234	235	236	237	238	239	240	241	242	243	244	245	246	247	248	249
250	251	252	253	254	255	256	257	258	259	260	261	262	263	264	265	266	267

I would also like details of.....

Your Name..... Position held.....

Name of Firm.....

Address.....

Nature of Business.....

PLEASE USE BLOCK CAPITALS

Circle the code numbers of the items in which you are interested. Insert your name and address, etc., in block capitals and post the card to us.

We will communicate with the manufacturers concerned and arrange for the information you require to be sent to you without obligation.

*(No postage stamp is required if posted in Great Britain or Northern Ireland)*

Postage will be paid by Associated Iliffe Press

No Postage Stamp necessary if posted in Great Britain or Northern Ireland

**BUSINESS REPLY CARD**  
Licence No. SE 591

**"INDUSTRIAL ELECTRONICS",  
DORSET HOUSE,  
STAMFORD STREET,  
LONDON, S.E.1**

### Is this your own copy ?

Each month INDUSTRIAL ELECTRONICS will bring you news of the latest applications, the most recently announced equipment, produced by the rapidly expanding electronics industries of the world.

It is invaluable to all management and production executives, and engineers, in industry generally, who need to be informed of the latest developments in electronic aids to industry.

**MAKE SURE OF YOUR COPIES  
USE THE ORDER CARD NOW**



**FERRANTI  
SILICON**

**Strain**

**GAUGES**

**FERRANTI**  
*First into the Future*

available **now**



- For Low Cost Systems
- High Gauge Factor
- Matched Pairs & Quads supplied

**Also available:**

*Gauges with negative response to positive loading.*

*Transducer elements.*

*Piezoresistive elements grown on to silicon substrates.*

TYPES	ZPG12 † ZPG12E	ZPG14 † ZPG14E	ZPG16 † ZPG16E	
GAUGE FACTOR	110-140	110-140	110-140	Positive
RESISTANCE RANGE	330+1.5%	560+1.5%	750+1.5%	Ohms
RECOMMENDED POWER RATING	0.1	0.1	0.1	Watts
LINEARITY WITH STRAIN	1%	1%	1%	per 1000 μ Strain
MAXIMUM STRAIN	> 3000			μ Strain
OPERATING TEMP. RANGE	- 40 to 65 or 300†			°C

† unencapsulated gauges

Write now for details:

**FERRANTI LTD** · Gem Mill · Chadderton · Oldham · Lancs · Tel: MAIn 6661 London Office: Tel: TEMple Bar: 6666 FE245 2

*Industrial Electronics August 1963*

# SANDERS SERVO SYSTEM MODULES

The Servo System Modules have been designed as standard units which can be incorporated into practically any servo system. They were shown at the 1963 Physical Society Exhibition and are now in production. The units use Silicon Semi-conductors, Transistors and Printed Circuit Board techniques wherever possible, are extremely robust and reliable and of very advanced design. Standard designs ensure low overall cost and proved reliability.

### AC/DC Converter

A high speed rectifier unit with low output ripple content, suitable for converting peak a.c to d.c. within one half-cycle of the input supply.

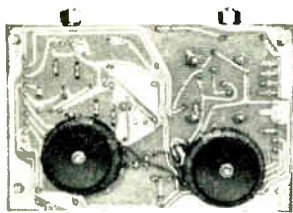

### Error Detector and D.C. Amplifier

A high gain, push-pull d.c. amplifier with common mode feedback. Includes a stabilised power supply which provides a reference voltage in addition to amplifier h.t.

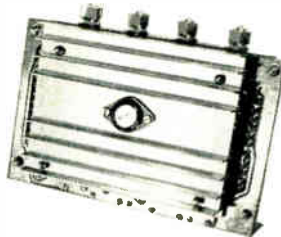

### High Power Output S.C.R. Amplifier

A Silicon controlled rectifier—high power output amplifier having a fast response time and requiring only a few milli-watts input power. Particular attention has been paid to over voltage and current protection.

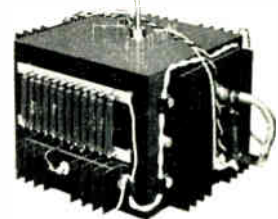

*Intelligent expansion has been the byword of the Sanders Group of Companies. The Group provides three main manufacturing facilities—Microwave, Industrial Electronics and Precision Gears—each with its own factory, development laboratory, inspection department and production plant.*



Sanders magnetic amplifier control systems are widely used in industry and the Services. Complete control systems or single transducers can be provided from standard units or custom engineered.



The latest techniques in the control of manufacturing processes are incorporated in the Sanders range of ignitron contactors and electronic timers. Standard and custom built units are in use throughout the automobile industry.



The design, development and production of precision gear chains, gear boxes, digitisers and resolvers are carried out rapidly and efficiently and a wide range is available from stock. All types of precision mechanical assemblies for servo systems can be provided.

For more detailed information please write to:

**W. H. SANDERS (ELECTRONICS) LIMITED.** Gunnels Wood Road · Stevenage · Herts · Telephone: Stevenage 981

# If it calls for transient storage then it calls for **CAWKELL**

## **REMSCOPE 741** with plug-in amplifiers

The most flexible instrument of its kind costing no more than a good ordinary oscilloscope. Unique events or high-speed transients can be stored for up to a week, with 5 to 10 minutes display whenever desired. Choice of single-beam, double-beam, or multi-trace display by means of interchangeable plug-in amplifiers:-

**2-CHANNEL  
BEAMSWITCH  
AMPLIFIER  
TYPE 741/2**  
Allows 2 simultaneous phenomena to be displayed for comparison.  
Direct coupled.  
Differential input.  
**Price: £120**

**TRACE SHIFTER  
AMPLIFIER  
TYPE 741/1**  
For easy comparison of sequential signals 2, 4, or 8 steps. Min. interval between steps 57fs.  
**Price: £75**

**Y AMPLIFIER  
TYPE 741/3**  
For normal single-beam display. Band-width 1.5 Mc/s which is consistent with writing speed.  
**Price: £38**

### **- leaders in storage instrumentation!**

When Cawkell produced the storage channels used for the 'ZETA' experiments at Harwell they became the first company to manufacture storage oscilloscopes in the United Kingdom. As leaders in the field, Cawkell are in a unique position to advise on problems involving the capture and retention of high-speed phenomena. In the photograph below, the Cawkell Remscope 741 is being used to record the angular acceleration of a diesel engine by an electric motor under arctic conditions. This information can be stored for up to a week for detailed study whenever required.

Basic price (without amplifiers)  
**£612**

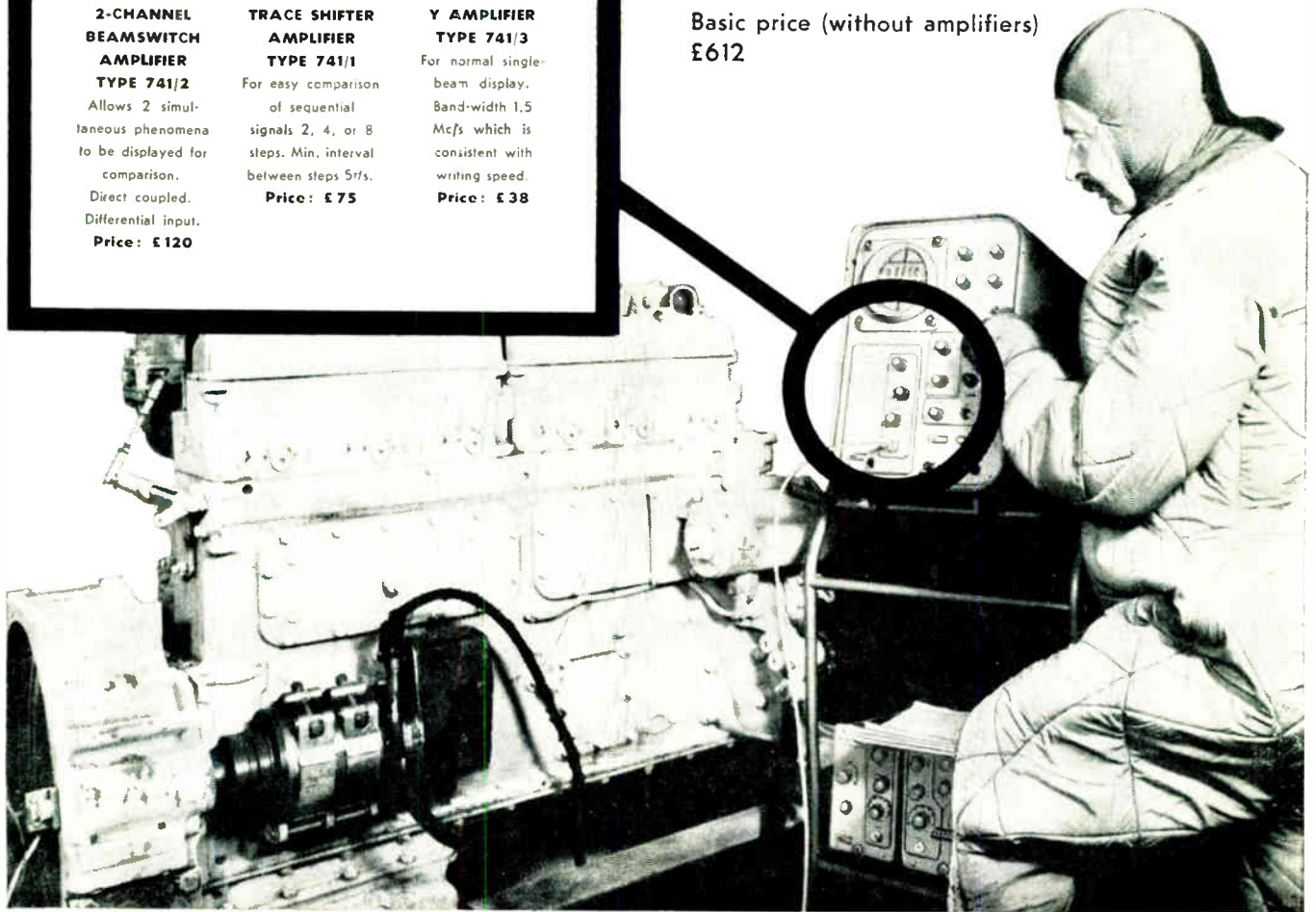

CAWKELL RESEARCH & ELECTRONICS LTD · WESTERN AVE · ACTON · LONDON W.3 · ACORN 6751 · A MEMBER OF THE *Sinclair* GROUP OF COMPANIES

For further information circle 222 on Service Card



**PATTERN 40. R.F. CO-AXIAL**

- Aluminium alloy shells with polythene insulators.
- Silver plated brass contacts, sockets with beryllium copper spring.
- Nominal 60 ohm impedance when free units are potted with suitable sealing compound, such as Okerin Wax No. 3700.
- Insulation resistance not less than 100 megohms, at 500V. D.C.
- Voltage proof 2,000V peak, working voltage 500V peak, measured at 750mm.Hg.
- Contact resistance—better than 2 milliohms and screen continuity better than 1 milliohm.
- Fulfils requirements of DEF.5322 with respect to V.S.W.R.
- Temperature range of -40°C to +85°C, Humidity requirements to DEF. 5322, Class H.1.

Write for appropriate Catalogue.

**JONES CO-AXIALS**

- Shells of brass, cadmium plated.
- Screw thread type coupling.
- Polythene, P.T.F.E., or ceramic insulators.
- Contacts machined from brass, silver plated, with solder terminations.
- Free plugs with cable entries of .250, .300 and .375.
- Inexpensive, miniature co-axial not designed for constant impedance, use should be limited for frequencies below 200 megacycles per second.

Write for appropriate Catalogue.



**UHF CO-AX & TWIN-AX**

- Silver plated brass, aluminium alloy or mazak shells.
- Solder type, silver plated brass contacts.
- Insulators of polythene or P.T.F.E.
- Six basic shell styles. Screw thread type coupling.
- Most shell styles available as co-ax or twin-ax.
- Not designed as constant impedance connectors.
- Designed for frequencies up to 200 Mc/sec and can be used with caution up to 500 Mc/sec.
- Working voltage of co-ax, up to 500V peak.

Write for appropriate Catalogue.

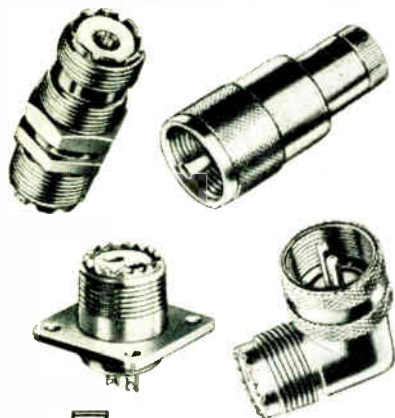

**UG CO-AXIAL, INCLUDING BNC, N, HN, MHV SERIES**

- Will accommodate large variety of co-axial cables.
- Engaged by means of bayonet type lock (BNC, MHV), or screw thread (N, HN).
- Silver plated brass shells.
- Silver plated brass, or beryllium copper contacts. Captive contact versions available.
- Designed for 50 ohm systems, but can be used with 70 ohm systems, and even 90 ohm systems, when matching is not critical.
- P.T.F.E. or polystyrene insulators.
- Weather resistant.
- Less than 1.25 V.S.W.R. at frequencies of 2,500 Mc/sec for BNC types.
- Working voltages: BNC 500V—peak, N—500V peak, HN—1,500V peak, MHV—5000V peak.

Write for RF/ALRF Catalogue.

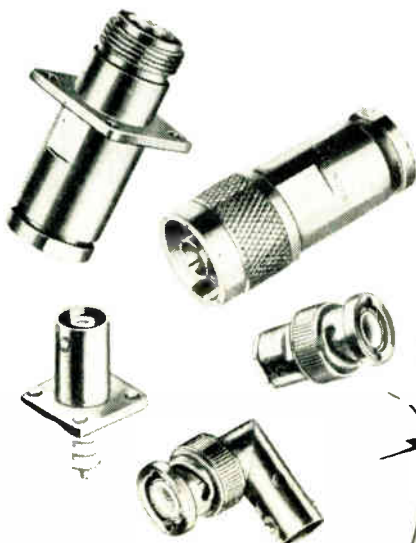

TYPICAL EXAMPLES OF

# CANNON CONNECTORS MADE IN GREAT BRITAIN

One tends to associate the symbol CANNON PLUGS with electrical connectors manufactured in the U.S.A., but in actual fact, over 60 per cent of the Cannon connectors sold in Great Britain are manufactured entirely at the Cannon factory in London.

The facilities of Cannon Electric (Great Britain) Limited, include:

connector research, development, design and engineering; a fully equipped test laboratory; machine and model shops; toolroom; injection and compression moulding machines; quality control and inspection. etc.

All the divisions of the Company are manned by highly competent, qualified personnel with many years background of technological "know-how". The Sales and Engineering Departments provide a Technical Service of the highest calibre and the Company will gladly undertake development contract work.

Cannon Electric (Great Britain) augments and supplements the activities of the parent company factories in the U.S.A., and contributes in no small way in helping to maintain the name CANNON as the world's foremost manufacturer of electrical connectors.

# CANNON PLUGS



**CANNON ELECTRIC (Great Britain) LTD., 168/172 OLD STREET, LONDON, E.C.1. Tel: CLerkenwell 4954**

European Enquiries: Cannon Electric International Inc., Bornem, Belgium. Telephone: (03) 77.06.14

Scandinavian Enquiries:  
 Sweden: Ab Gosta Backstrom, Box 12089 Stockholm 12.  
 Denmark: Tage Schouboe, 7 Skyttegade, Copenhagen.  
 Norway: Morgenstjerne & Co., Wessels Gate 6, Oslo.  
 Finland: OY Chester AB, Uudenmaankatu 23A., Helsinki.

# INDUSTRIAL ELECTRONICS

## Comment

From 2nd to 7th September there is an exhibition in Basle known as INEL 63. It is an International Exhibition of Industrial Electronics and elsewhere in this issue we deal with some of the apparatus shown by British Companies.

The advance list of exhibitors provided by the organizers appears to consist of a list of the companies who have booked space in the exhibition rather than of the firms whose products are being shown. Thus *Industrial Electronics* (Stand 10/97) appears in the list as Associated Iliffe Press Ltd.

Some British manufacturers appear under their own names, some have their own names together with those of their Continental agents, and others appear in the list completely disguised by their agents' names. As a crowning touch of confusion, some American products are being exhibited by their British agents.

It is to be hoped that all this will be sorted out in the final list and that in this the prominence will uniformly be to manufacturers' names, for these are the ones which visitors are likely to know best.

Two congresses are being run in conjunction with the exhibition. One is the International Federation of Automatic Control (I.F.A.C.), from 24th August to 4th September; the other is the Inel Congress on 5th and 6th September.

The second and smaller covers the latest developments in electronics and automation as applied to traction as well as the applications of semiconductors in electronic and power engineering. At the time of writing no details have been received about this congress.

The I.F.A.C. Congress is a much bigger one. With two exceptions only, there are four morning and afternoon sessions for seven days. In the total of 51 sessions 160 papers are scheduled to be read! The participants are from very many countries, including the U.S.S.R.

The Congress is divided into three sections by subject. The theory of automatic control has 25 sessions and 80 papers. Applications of automatic control are dealt with in 19 sessions and 57 papers, while components of control devices occupy 7 sessions with 23 papers.

### Automatic Translation

A lot of work is going on to produce a machine for translating automatically from one language to another. Most of this has been for translating from Russian into English. Now comes news that I.B.M. are working on one for translating Chinese into English.

Chinese is a particularly difficult language for there are thousands of characters and the linguistic rules are very complex. Special typewriters are used to type the text in Chinese

characters and these at the same time punch three rows of holes in paper tape. These holes provide the machine coding for the character. It is said that operators who do not understand Chinese can still be trained to do this at a rate comparable to ordinary English typing.

The actual translation is done by a computer which depends on a rapid-access store containing half-a-million instructions.

At the moment the automatic trans-

## COMMENT (Continued)

lation machine seems to be far from commercial application, either as a machine which one can buy or, more likely, as the modus operandi of a translating bureau. There is little doubt that this will come in time, however.

### Oral Translation

Useful as the automatic translator would be in turning a written text in one language into another, it would be much more useful to have a machine which would deal with the spoken word; that is, an oral translation machine. Disregarding practicabilities, we should like a small portable device, rather like a hearing aid but perhaps as big as a camera, into which we could speak in English and its loudspeaker would produce the equivalent in French or German or any other desired language. By turning a switch, it would then translate in reverse so that we could hand the microphone to our foreign friend and listen to him in English.

There would certainly be an enormous market for such a device. As yet it is but a dream even with a full-size computer to help. The pocket translator is a complete impossibility in the foreseeable future. It is unlikely that it will forever be impossible, however. When we know how to achieve oral translation with unrestricted equipment, simplification and miniaturization will follow.

The oral translator will not necessarily function on the same lines as the present translation machines. The computer part of it which does the actual translating will probably be much the same, but the input and output devices will be entirely different.

The first attempts will probably be with the aid of a standard translating machine using written texts, to this would be added a recorder and reproducer. The recorder would accept a spoken input and produce from it a typewritten version in the same language. A recorder of this sort would alone be a very useful device. The reproducer would read aloud from a typewritten text. This also would be useful elsewhere, especially for the blind.

In the true oral translator, however, the typewritten texts would not be needed. The heart of a translator, the computer, works on pulses. Arrangements have to be made for the typed material to produce the input pulses and for the output pulses to operate a teleprinter. There seems no reason why the amplified speech current output of a microphone should not be treated to produce the input pulses without the intermediary of a typewritten text.

In the end quite a lot would be different, for if writing disappears so does spelling and the computer programme would be quite different.

It is usual to end any look into the future such as this by saying that it will come but not in our time. Development now proceeds at such a rate, however, that we hesitate to say that it will not be in our time. It may very well be in our time!

### Packaging

There was a symposium on electronic circuit packaging in the U.S.A. last year and the proceedings have just appeared. In this connection, packaging does not mean, as one might think, packing apparatus for safe transport. It means what most people would call the mechanical design of apparatus. It is applied to a sub-unit of an equipment, to an assembly of sub-units, and to complete apparatus.

When the electrical side of a design has been finalized and the circuits and component parts are known these parts must be 'packaged' into a whole, perhaps directly or more likely through sub-sub-units into a sub-unit, sub-units into a unit, and units into a whole.

### Cordwood

In the same symposium the term 'cordwood assembly' was freely used and so far we have failed to find out precisely what is meant by it. In one case it is used to describe a form of assembly in which tubular resistors and capacitors are stacked parallel to each other to form a solid block and their leads are terminated on two parallel printed-wiring boards. Each individual component lies between the two boards and at right angles to them. However, we are not certain if 'cordwood' is confined to this sort of assembly or whether it has a more extended meaning.

### British Exports

The extent of British exports of valves and semiconductors is not always realized. For the first quarter of this year it totalled £2,992,204. Complete cathode-ray tubes accounted for £689,900 of this and semiconductor devices of all kinds amounted to £590,746.

A direct comparison with 1962 is difficult because there has been a revision in the headings of the export list, but B.V.A. and V.A.S.C.A. give the increase over 1962 as 30%, while for transistors it was 50%.

In suitable cases, the use of ultrasonics for cleaning not only enables better cleaning to be obtained but can greatly reduce the time and cost of the operation. This article describes the kind of equipment needed and gives examples of typical applications.

## CLEANING BY ULTRASONICS

By W. G. A. McCORMICK\*

**M**ENTION of cleaning processes normally conjures up mental pictures of scrubbing, boiling, agitation, soap or detergents and water. In ultrasonic cleaning there is scrubbing, agitation and water or some other solution.

Cleaning by ultrasonics basically depends on two factors, agitation and choice of cleaning solution. The installation normally consists of an ultrasonic generator and an ultrasonic cleaning tank, both of which vary in detail depending on the application for which they are used. A typical type of industrial cleaning unit is the 600/300-watt Dave Type 1144A Ultrasonic Generator which is used in conjunction with Ultrasonic Cleaning Tanks Type 1163, ranging from 5½ to 14¾ gallons capacity.

The generator, fed from the normal mains electrical supply, produces ultrasonic oscillations which are then applied to the transducer elements attached to the underside of the ultrasonic cleaning tank. The transducers convert the electrical oscillations into mechanical vibrations, thereby producing ultrasonic waves. These mechanical vibrations pass through the cleaning solution contained in the tank, causing rapidly fluctuating pressures to be set up, resulting in the formation and subsequent collapse of minute bubbles or cavities. This process is known as cavitation. On the collapse of the cavities, very high pressures are produced in their immediate vicinity, which result in a scouring action at the surface of the work to be cleaned, detaching fine solid particles while, at the same time, dispersing them in the cleaning solution. This scouring action is extremely effective and penetrates into inaccessible regions, such as crevices, indentations, holes, pores, inside surfaces, etc., where normal brush cleaning would be ineffective.

Ultrasonic cleaning can eliminate hand scrubbing and can be applied to remove insoluble soils that cannot be satisfactorily removed by more conventional methods.

### Choice of Frequency and Transducers

Cavitation in the cleaning liquid can be produced at all audible frequencies and at inaudible (ultrasonic) frequencies up to several megacycles per second. The actual watts per square inch required to ensure cavitation in a liquid will vary considerably with different liquids, the amount of gas in the liquid and other factors. For a given set of conditions, the power required to produce cavitation will, however, rise rapidly as the frequency exceeds about 50 kc/s. If the energy level is not high enough to produce cavitation

there will, of course, be no appreciable ultrasonic cleaning action.

Factors such as these, and the materials available for transducer manufacture, govern the choice of the most efficient operating frequency. The oldest methods of generating ultrasonic vibrations are probably those using piezoelectric quartz crystals and magnetostrictive metal laminations. Quartz crystals are probably more efficient, since quartz has very low electrical and mechanical losses. However, it requires very high voltages, particularly at the lower ultrasonic frequencies. Being also a very expensive material, it is, therefore, not commercially suitable for ultrasonic cleaning equipment.

Magnetostrictive vibrators have, however, been used for many years to generate sonic and ultrasonic waves. Such transducers, if properly designed, are robust, will withstand relatively high temperatures and provide very high vibration amplitudes. The limitation of this type, when applied to ultrasonic cleaning, is that the ratio of power input to transducer radiating area is relatively high. Magnetostrictive transducers are more commonly used on applications other than ultrasonic cleaning where high localized amplitudes are required.

The transducers shown, Dave Type 1164, are manufactured using piezoelectric ceramic materials. With these materials it is possible to operate at 25 kc/s and provide efficient cleaning at low power levels. This type of transducer offers many advantages over other methods, the

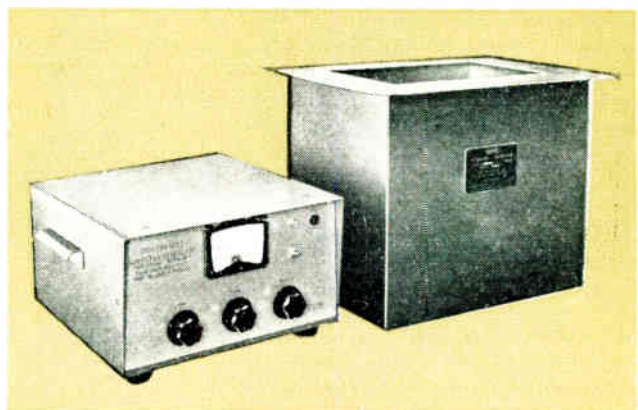

Typical medium power Dave Soniclean ultrasonic generator and ultrasonic cleaning tank with built-in transducers

\* Griffin & George Ltd., formerly Dawe Instruments Ltd.

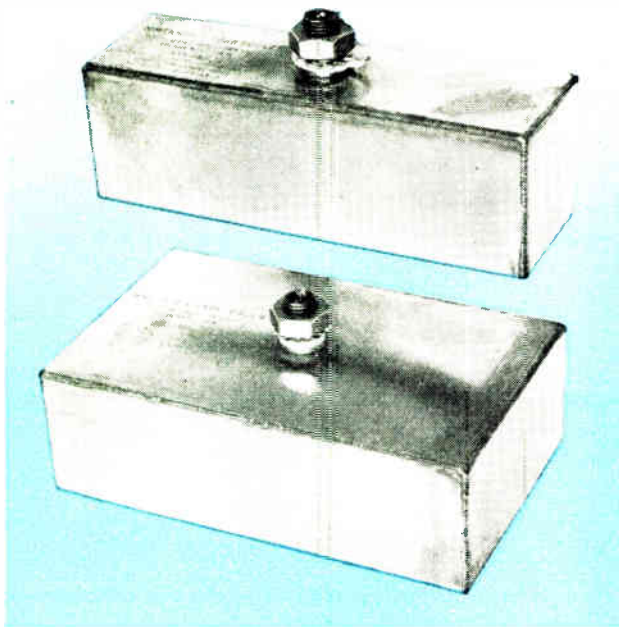

*Typical piezoelectric immersible transducers from the Dawe range, encased in welded stainless steel*

most important being the much higher conversion efficiency combined with high operating temperatures.

The active element (piezoelectric ceramic) of this type of transducer has the property of expanding in the same direction as an applied voltage of given polarity, and contracting when the polarity of the applied voltage is reversed. This active element will, therefore, vibrate at the same frequency as the applied voltage. The amplitude of this vibration will be at a maximum when the frequency of the applied voltage is the same as the natural (resonant) frequency of the ceramic element.

For a given applied voltage, with the transducer immersed in liquid, the amplitude of vibration at resonance may be ten times as high as the amplitude far from resonance. Since power input per unit area is proportional to the square of the amplitude, it is important to operate transducers at, or near, their resonant frequency to obtain efficient operation. Power output will increase proportionally to the square of the applied voltage; the desired power output could, therefore, be obtained at frequencies off resonance, but electrical losses in the transducer would be excessive.

As will be seen in the illustration, the piezoelectric ceramic is housed in an all-welded stainless steel casing for both electrical and mechanical protection. It is important that the radiating surface of the transducer be immersed in liquid when energizing power is applied from the ultrasonic generator. Experimental tests have shown that for ultrasonic cleaning applications pulsed operation will result in improved performance based on the average power output

of the generator, since the peak power on pulses from the generator is several times higher than its average power output rating. This technique also uses the greater power handling capacity of this type of transducer to maximum advantage.

### Applications of Ultrasonic Cleaning

The standard range of ultrasonic cleaning equipment, consisting of a wide variety of generators from 80 to 2,000 watts output, coupled with ultrasonic cleaning tanks from 5 pints to 29½ gallons, covers a large field of applications throughout the industry, including cleaning of ball-bearing parts, watch and instrument movements, complex castings, metal tubes, fountain-pen parts, hydraulic components, electrical contacts, printed circuits, valve parts, connectors, motor stators and rotors, switches, etc.

Apart from considerations of higher cleaning efficiency with the use of ultrasonics, economies can play a large part in decisions to install this type of plant. The B.O.A.C. Engineering Branch at London Airport have in fact achieved a considerable saving in skilled labour through use of ultrasonic cleaning and, thereby, increased the volume of overhauled parts through their Component Overhaul Unit.

To maintain the high standard of reliability associated with B.O.A.C., their aircraft are taken out of service at set times for periodic maintenance and overhaul. This involves removal of components, which are then stripped down, cleaned and overhauled. Since many delicate parts are involved, skilled operators must carry out all work of cleaning as well as overhauling. By installing the Dawe unit illustrated in the front cover picture, a saving of about



*Cleaning jewellery using the Dawe type 1141A transistorized Soniclean*

*(Photo by courtesy of Slade & Kempton (Jewellery) Ltd, of Hatton Garden)*





*The Dawe Soniclean Surgical Instrument Cleaner being used at the Royal Hospital for Sick Children, Edinburgh*

50%, skilled-labour time was achieved on the cleaning operations; also, the cleaning fluids consumption per week was reduced from 20 gallons to about 4 gallons.

A further saving was achieved on reclamation of certain expensive electrical items. Under conditions of manual cleaning certain components such as armatures, etc., could not be thoroughly cleaned without risk of damage. As a result, a considerable number of such units had to be scrapped. On only one of these items the total loss per year amounted to about £3,000. Use of ultrasonic cleaning enabled not only thorough cleaning but with no risk of damage, and a very high percentage of these components are now reclaimed.

A specialized cleaning unit, the Dawe Type 1141B, has been specially designed as a self-contained unit for rapid cleaning of small or delicate parts. This has found great use in the cleaning of jewellery. It is an inconvenient paradox that the final polishing operation on jewellery of gold and other precious metals, to produce a brilliant and lasting shine, is one of the dirtiest sequences in the whole production story. Polishing is generally carried out by buffing on a high-speed rotary mop which has been impregnated with an abrasive grease containing jewellers' rouge. This material, which in use gets mixed with fine grindings of oxidized metal and worn-off fragments of calico mop, fills all the fine interstices in the jewellery with a black paste which is difficult to remove. Prior to the use of ultrasonic cleaning, removal of this deposit called for tedious scrubbing with brush, soap or detergents and water. This sometimes resulted in scratches requiring further polishing and subsequent cleaning, at best a slow business which frequently caused bottlenecks in production lines. With ultrasonic cleaning the firm of Slade & Kempton (Jewellery) Ltd., of Hatton Garden, found that up to 400 assorted items of jewellery which formerly took one man a full day to clean by hand could be dealt with by Soniclean equipment in about ten minutes.

Nowhere is absolute cleanliness more important than in the operating theatre. It would appear to be relatively easy

to keep surgical instruments clean by constant scrubbing and washing, but if closely examined a brown film of hard proteinous matter can often be seen in box joints, serrated jaws and locks. Debris which is not removed by scrubbing is baked on during subsequent sterilization and provides a surface to which further deposits will readily adhere.

After many tests carried out with standard industrial equipment, the first ultrasonic surgical instrument cleaner was designed and built for the Department of Health for Scotland. The equipment is fabricated entirely of stainless steel and has two tanks, each 12 × 16 × 12 in. deep. One tank, for cleaning, has ultrasonic transducers mounted on the underside, giving an unobstructed interior; the other, for rinsing, is provided with a separately controlled spray. The generator driving the transducers is mounted within the

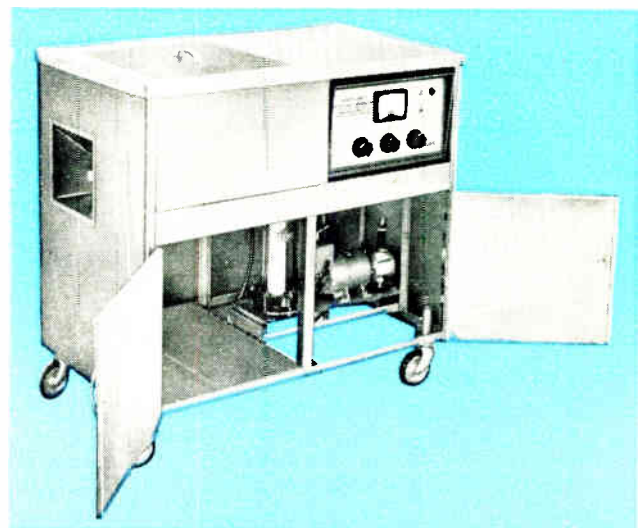

*New Dawe mobile ultrasonic cleaning unit incorporating full facilities for filtering cleaning fluids*

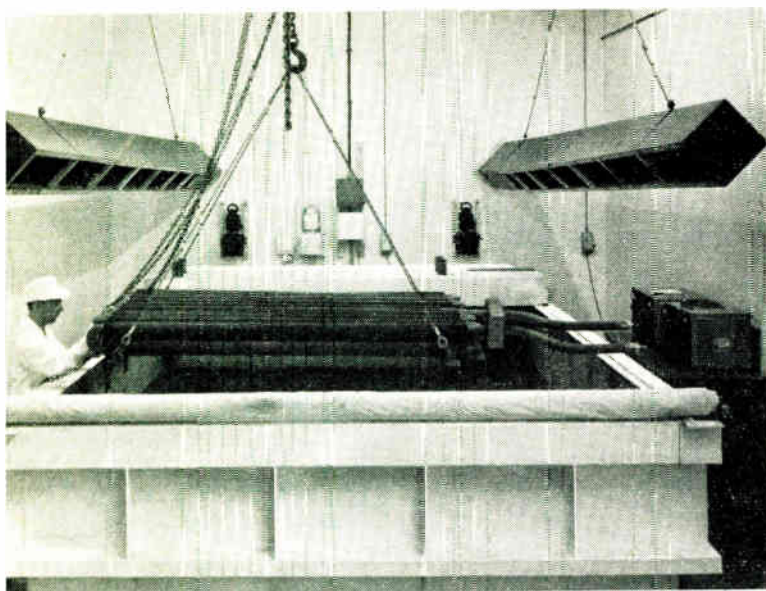

*Heat exchangers weighing 2 tons being lowered into ultrasonic cleaning tank. The two Dawe generators on the right provide all the ultrasonic power*

*(Photo by courtesy of International Combustions Ltd., Derby)*

stainless steel cabinet, thus making a completely self-contained unit.

The tank containing the ultrasonic transducers is filled with water, to which is added a small quantity of an ordinary detergent. The soiled instruments are put into a stainless steel basket, which is placed within the tank; the lid is then closed and the generator switched on. After a few minutes the generator is switched off and the basket of instruments is transferred to the other tank. Here they are thoroughly rinsed with hot water coming from the spray. Since the two tanks are not connected in any way, baskets of instruments can be washed and rinsed simultaneously.

Equipment such as the Type 1170C Surgical Instrument Cleaner can also effect a considerable financial saving.

Opinions vary, but it is generally agreed that at least one hour is required to clean 100 instruments by hand. Using the ultrasonic cleaner the same number of instruments can be washed, rinsed and dried in 6-7 minutes. Installed in a central cleaning room, the equipment is capable of handling the instruments from four to five operating theatres without delay.

A further industrial application of ultrasonic cleaning equipment is in the field of metal degreasing. The purpose of this operation is to remove oil and grease from metal surfaces before surface treatment, finishing processes, etc. One of the most powerful grease solvents known is trichloroethylene and this is the basis of the metal degreasing process by I.C.I. Ltd. This company has had many years' experience in metal degreasing, and while most degreasing problems can be solved by the use of an orthodox trichloroethylene liquid or vapour process, the addition of ultrasonic vibrations to trichloroethylene is often necessary where the highest standard of cleanliness is required. To this end, I.C.I. have produced a ULV range of degreasing plants incorporating Soniclean ultrasonic cleaning equipment. All the plants provide boiling liquor, cool liquor and vapour treatment, plus the additional cleaning provided by ultrasonic vibrations.

A recently introduced mobile ultrasonic cleaning unit incorporating Soniclean 600/300-watt generator, a Type 1173 ultrasonic cleaning tank (incorporating heaters) together with built-in filter unit, is the most versatile in the range. It is completely mobile and, being of all stainless steel construction, is suitable for either surgical or industrial applications.

The limit of applications for ultrasonic cleaning have not yet been reached. Volume of bulk size of units to be processed has up to now been no drawback and results obtained on larger components processed show greater cleaning efficiency coupled with labour saving and reduction in costs. A typical example is the cleaning of large heat exchangers used in nuclear power stations. The heat exchanger illustrated weighs about 2 tons and is being lowered into an ultrasonic cleaning tank measuring  $17\frac{1}{2}$  ft  $\times$  10 ft  $\times$   $2\frac{1}{2}$  ft deep, holding 1,500 gallons of solvent. Two 4-kW Soniclean generators energize 14 transducers.

## VERSATILE DATA ACQUISITION SYSTEM

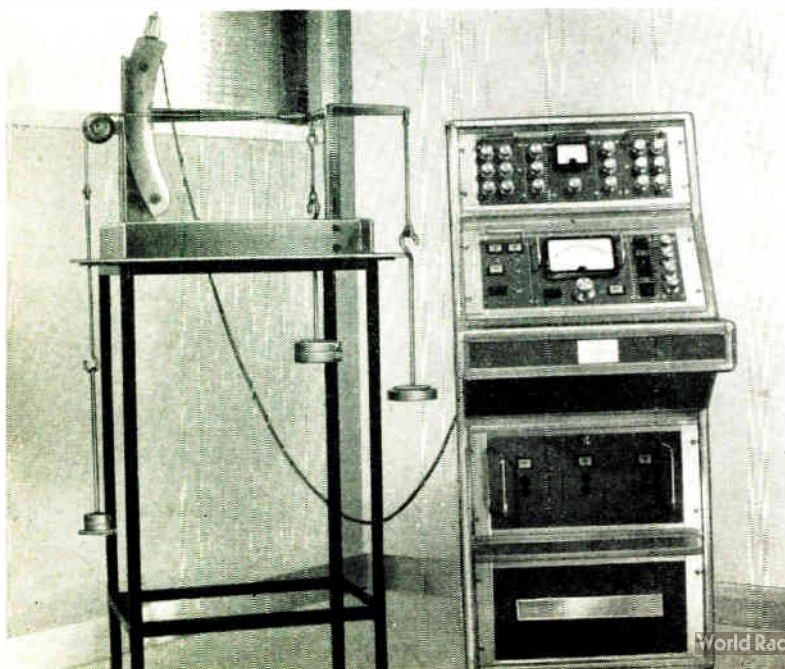

A data acquisition system recently installed by Norris Brothers at Northampton College of Advanced Technology is employed with their three-component strain gauge wind tunnel balance. The system, which has to combine accuracy, reliability, versatility, and low cost, is designed on a module basis to facilitate modification and expansion for individual requirements.

The equipment accepts output signals from the strain gauge balance via a signal conditioning unit and channel selector; frequency response is from d.c. to 20 c/s. but up to 10 kc/s is available if required. Channels are selected by push-buttons interlocked to eliminate simultaneous operation.

*Three-component strain-gauge balance (left) and data acquisition console (right)*

For further information circle 47 on Service Card

# Modular Construction of Electronic Servo-system Elements

By J. R. MUSHAM\*

This article describes a series of standard units which can be connected together in various combinations to meet a great many control system requirements. The standardization so obtained enables control systems to be provided more quickly and cheaply.

**I**N the control systems industry, more often than not, units are manufactured in small numbers. Manufacturers are, therefore, faced with the difficulty of meeting customers' individual and widely-differing requirements with the minimum of special design and development work. To assist in this process, it is useful and time-saving to have at hand certain of the more commonly occurring circuits in the form of modular building bricks. In deciding the types of unit most suited to this form of construction, it is useful to consider a breakdown of common electrical servo systems.

## Typical Servo Systems

The main requirements for an electrical servo system are:—

- A means of detecting the quantity to be controlled and converting it into an a.c. voltage or current.
- A means of converting the a.c. voltage or current into a d.c. equivalent. This conversion is necessary because the great majority of error-detecting means are d.c. operated, and most systems will function adequately by controlling the mean or peak function of the quantity to be controlled.
- A means of measuring the quantity to be controlled, comparing it with the required value, and deriving the difference or error.
- A pre-amplifier with means for inserting signals from other parts of the system, in particular, integral or differential functions.
- A power amplifier to feed the system actuator, e.g., a machine field or motor armature.
- A power supply unit to provide the other units with their necessary a.c. or d.c. supply voltages.

## Detectors

The means of detecting the quantity to be controlled is usually a current transformer, potential transformer, d.c. transformer, thermo-couple, pressure transducer or magnetic amplifier. These items are largely produced by

\* W. H. Sanders (Electronics) Ltd.

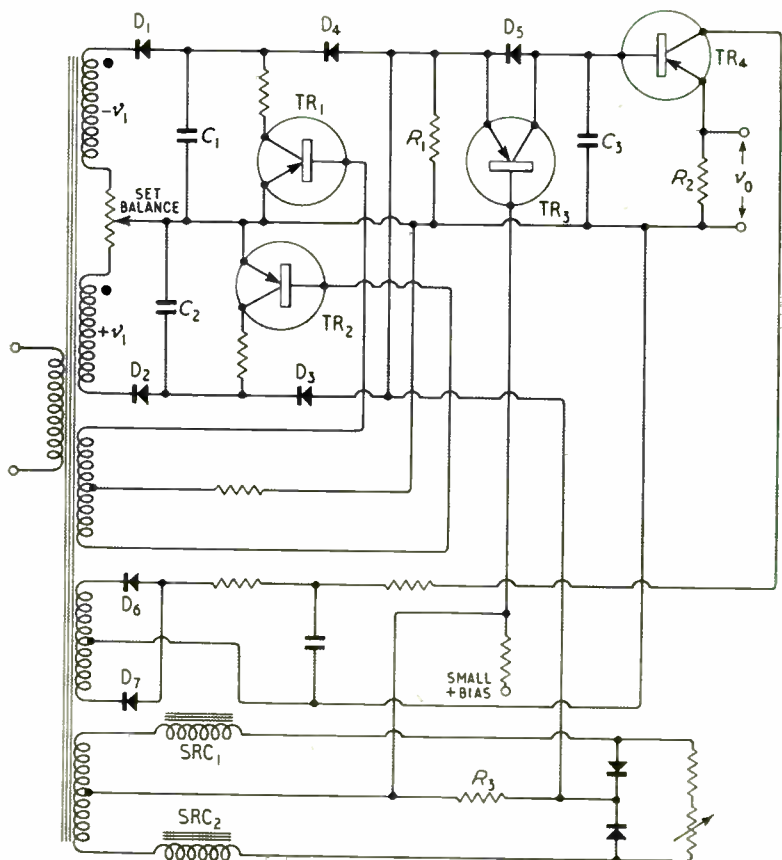

Fig. 1. Basic circuit of a.c. d.c. converter

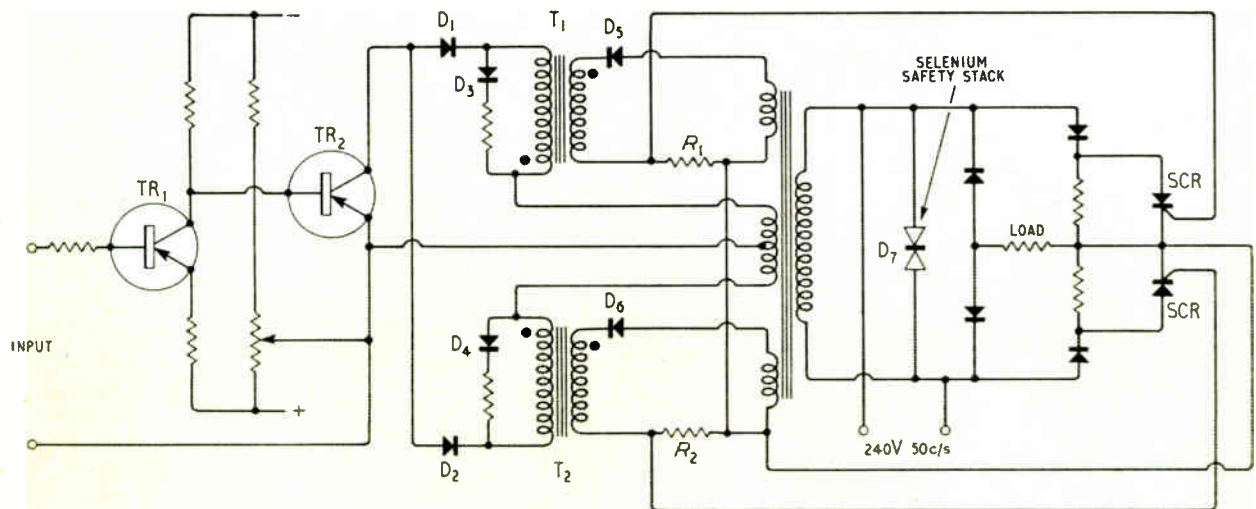

Fig. 5. High-power amplifier. The transistor input stages control the magnetic amplifier which in turn governs the silicon controlled rectifiers

## Power Amplifiers

Two types of power amplifier meet most requirements. A low-power amplifier is needed for driving magnetic amplifiers, etc., and this must have an output of reversible polarity, and a high-power amplifier is wanted for driving d.c. motors, machine fields, etc.

### Low-Power Amplifier

This is a simple transistor amplifier designed to be driven by the push-pull output of the d.c. amplifier and error-detector unit of Fig. 3. The circuit is shown in Fig. 4 and the base-emitter junctions of  $TR_1$  and  $TR_2$  are forward-biased through  $D_1$  and  $D_2$  to avoid a dead zone in the amplifier characteristic. The output load is represented by  $R_L$  and if  $Input_1$  goes negative with respect to virtual earth the supply voltage  $V_1$  drives current through the load in the direction of the arrow. If  $Input_2$  goes negative and  $Input_1$  positive the current reverses and is then driven by  $V_2$ .

The input needed for maximum output is  $\pm 5$  V at 12 mA, and the inputs must be at  $-0.1$  to  $-0.5$  V with respect to earth. The maximum output is  $\pm 0.5$  A into a 10-ohm load and is linear up to  $\pm 0.4$  A. Two isolated d.c. supplies are required, each with a mean output of 15 V at 0.75 A from a full-wave rectifier. The unit is rated for operation at temperatures up to  $70^\circ\text{C}$ .

### High-Power Amplifier

This unit is based on a voltage-controlled flux-resetting magnetic amplifier and the circuit is shown in Fig. 5. The advantage of this type of circuit is that, being a.c. driven, the time response is genuinely one half-cycle of the input voltage. The magnetic amplifier itself is conventional and is controlled by the two input transistors  $TR_1$  and  $TR_2$ . Silicon-controlled rectifiers are used at the output and a considerable number of safeguards for them have been incorporated in the main amplifier circuit. The circuit is made to fail safe, for the output developed across the gate resistors  $R_1$  and  $R_2$  disappears when the input signal is removed. If required, current limiting can be provided by additional windings. Diodes are connected in series with the s.c.r.'s to support the peak inverse voltage during the off half-cycle, in order to prevent avalanche conduction in the reverse direction, and CR networks suppress transients which could damage the diodes.

When current limiting is provided it is capable of shutting off the s.c.r.'s within one half-cycle. This is usually fast enough, for most s.c.r.'s will withstand 10–20 times their rated current for this short period.

The upper limit of power output depends on the s.c.r.'s used but can be 80 kW, while the input needed is only 2 mW and the input voltage for full output is 3 V. An s.c.r. gate signal of 8 V at 100 mA is provided, continuing to the end of the firing half-cycle with a firing range of  $12$ – $170^\circ$ . Up to  $\pm 40\%$  changes of mains voltage are permissible with negligible change in the firing angle, and the unit is suitable for operation at temperatures up to  $70^\circ\text{C}$  with suitable derating of power output.

## Typical Applications

### Automatic Voltage Regulator on a Power Alternator

The block diagram of a system designed to regulate the voltage of a power alternator is shown in Fig. 6 and it can be seen that out of the four units employed only one had

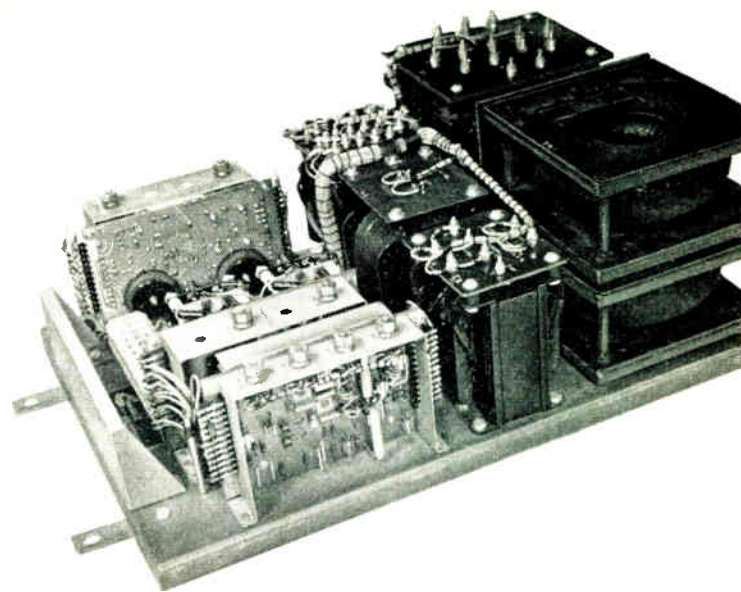

Module assembly for the voltage regulation of an alternator

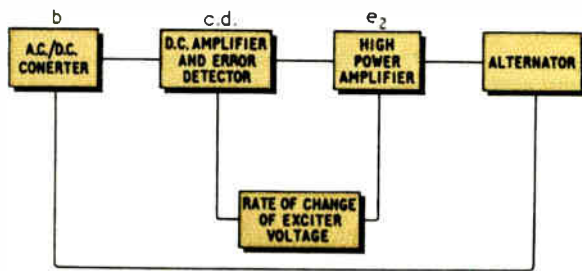

Fig. 6. Block diagrams of control circuit for an alternator

to be designed for the job. This means a considerable saving of time and money and, consequently, many 'one-off' jobs become a practical proposition.

The regulator enables the alternator to provide an output of 1 MVA at a full-load regulation at zero power factor lagging of 0.35%. The recovery time from no load to full load at zero power factor is 1 sec.

#### Hydraulic Position Servo

The arrangement of this control system is shown in Fig. 7. If a differential drive is required for the servo

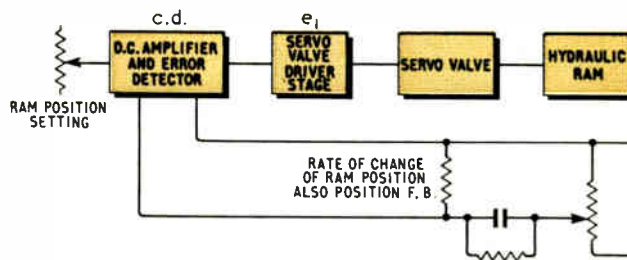

Fig. 7. Servo system for a hydraulic ram

valve, it can be obtained from the error-detecting and pre-amplifier unit and fed to the servo valve through an additional amplifier which needs only two transistors.

These are only two of the many applications for which the modular system is suitable. As already stated, it is a system which enables most problems to be solved easily and with a minimum of special apparatus. Printed-circuit construction is used for all the units except the high-power amplifier; this takes the form of a potted block with heat sinks attached to the sides.

## ELECTRONIC AIDS IN THE NEW THAMES TUNNEL

Electronics will be used to facilitate control of the new Dartford-Purfleet tunnel under the Thames. The tunnel, which is just under a mile long, will join the road systems of Kent and Essex.

The console in the control room, situated in the administrative block on the Dartford side of the river, has already been completed. On this console are two closed circuit television monitors, conveying a picture from seven points, five in the tunnel and two just outside. This enables the officer in charge to see what is going on anywhere in the tunnel and its immediate approaches and is particularly valuable in the event of an emergency.

Other information displayed on the console includes automatic counting of traffic; photometric readings of the visibility in the tunnel, worked from remote light meters; atmospheric readings, with separate indication of smoke and carbon monoxide content; performance of the ventilation and pumping machinery; the location of accident or fire when an alarm has been given; and light indicators repeating the emergency traffic signals.

The visibility and atmospheric readings are among the most important routine indications: upon them depend the control of the ventilation and lighting in the tunnel. The remote controls for these and other services are located on a wall behind the console.

Technicians putting the finishing touches to a console

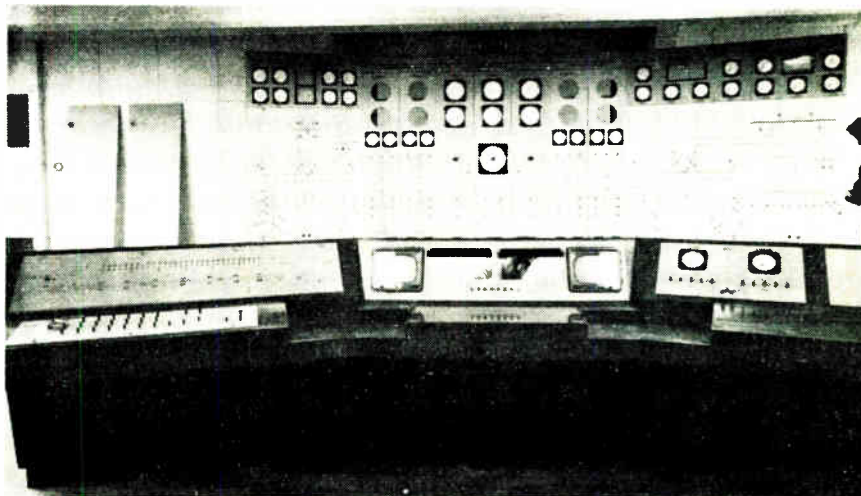

In colour printing successive impressions must be in very close register. This article describes a photoelectric control system which automatically maintains register.

# Electronic COLOUR REGISTRATION in Printing

By J. C. MAWER\*

**B**EFORE outlining some of the methods used to provide automatic registration of colours in colour printing it is, perhaps, pertinent to give a brief outline of the method of printing colour. Colour prints are made up of a number of impressions of single colours which are printed over each other to form the final picture. This is done in a multiple printing press, which is, very diagrammatically, shown in Fig. 1. From this it can be seen that the paper to be printed is fed through several consecutive printing presses, each printing its own colour. In between each press the paper is fed over various drive and tension rollers. All the presses are driven by a common line shaft, or are driven at identical speeds, so that theoretically there is no reason for the impressions by the first press not to line up with the impressions by the subsequent presses.

However, without some form of control the impressions by the consecutive cylinders are not necessarily exactly super-imposed; i.e., they are out of register. This is due to paper stretch, shrinkage, slight discrepancies in the printing rollers themselves, and differences in the amount of pressure each draw roll puts on the paper. While these discrepancies are usually quite small they are, nevertheless, highly visible in the finished print. A trained printer can see differences as small as 1/1,000th of an inch quite easily, while 1/64th of an inch is very visible even to the layman.

It is, therefore, necessary to measure the difference between consecutive prints and in some way to correct this error. In multiple colour printing the usual method of correcting the error is to insert a loop in the paper between each printing press and control this loop by moving a roller at the apex of the loop to increase or decrease the amount of paper in the loop and hence move the register between consecutive presses. In some other registration processes it is possible to use differential gearboxes to insert correction. This is accomplished by connecting the differential gearbox between the two sections where the register is to be controlled, and driving one section from the main motor. The second section is then driven through the differential gearbox at a constant speed, but when it is required to correct register the third shaft of the differential box can be operated, and this will cause the relative positions of the two machines to be adjusted. In electrical terms, the phase angle between the two is varied.

Having described the mechanism of the press and reasons for requiring to control error, we can now turn to the electrical devices used to measure this error. Fig. 2 is a sketch of a piece of material which is being colour printed. It

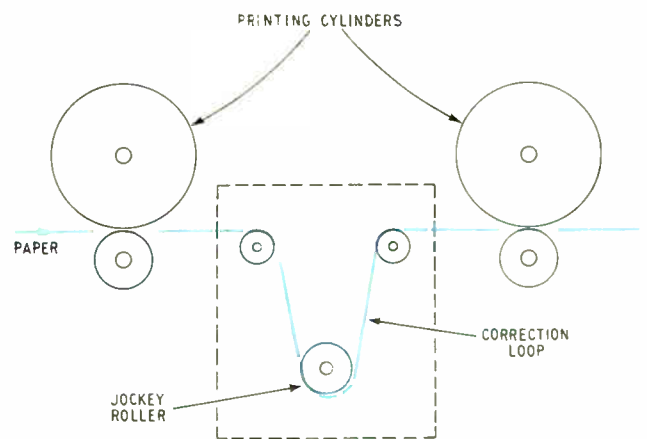

Fig. 1.—Diagrammatic representation of a multiple printing press

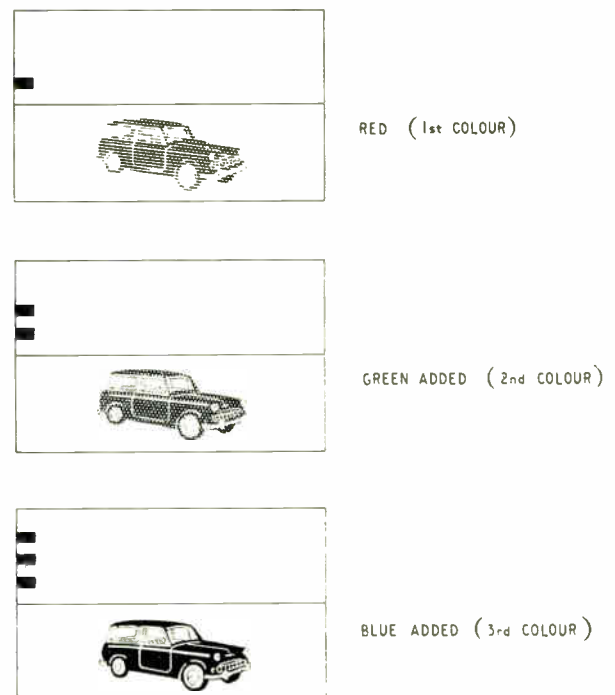
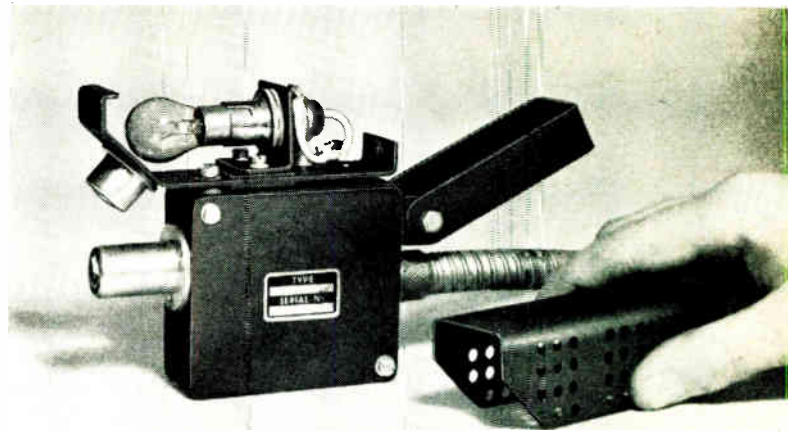

Fig. 2.—Pictures for a three-colour process showing the registration bars

\* Lancashire Dynamo Electronic Products Ltd.

will be noticed that there are bars shown (in different colours) in some inconspicuous place on the page. This is usually in the 'gutter' between the two sides of a page in a newspaper, and in fact these marks can often be seen by removing a page from a newspaper or periodical printed in this way. The marks are always in the form of short bars, the length of the bar being at right angles to the direction of motion of the paper during printing. In some systems the bars are placed side by side, while in others they are spaced along the direction of motion of the printing. In either case the bars are observed photoelectrically and the position compared either with each other or with the position of one or more of the printing cylinders.

The photoelectric scanning units, one of which is shown in a photograph, contain a light source and photocell unit; a lens focuses the light from the light source on to the paper so that the scattered light from the material is then collected by a second lens focused on the photocell. The presence of a printing mark changes the quantity of light reflected and this, in turn, changes the current through



*Photoelectric unit with the lamp cover removed*

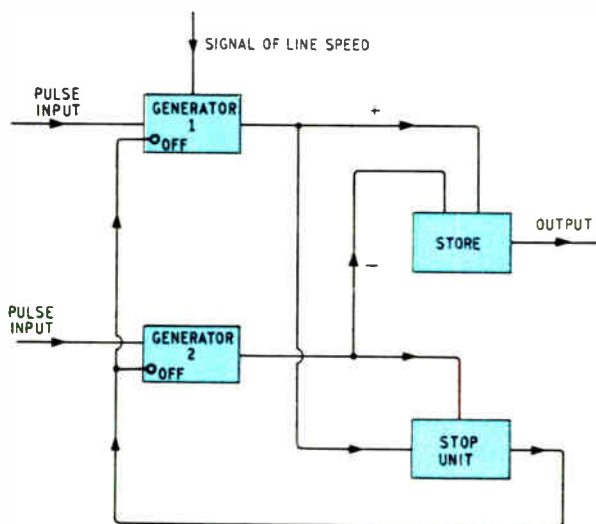

*Fig. 3.—Block diagram of the registration control apparatus*

the photocell so that a pulse can be generated indicative of the fact that the registered mark has been observed by the head unit. Either digital or analogue techniques may be used to determine the relative position of one pulse to another. The analogue system will be described here. (The digital system was described in the June issue, when the problem of registering printed material into a running press was discussed.)

In block form the circuits used to determine error are shown in Fig. 3. It can be seen that there are two pulse input circuits, and for correct registration these two pulses should occur at the same instant. Each pulse switches on a current generator, one giving a positive signal and the other a negative. The output of each generator is fed into the store, and a circuit is arranged so that when both generators are energized they actuate a reset circuit, which resets the generators and they are both switched off. Thus, if the two pulses occur coincidentally, the generators are switched on and almost instantaneously switched off again and the net signal to the store is approximately zero. If, however, one signal arrives before the other then one generator is on for a longer period and the next signal in the store has a magnitude indicative of the duration between the arrival of the two signals, and a polarity indicating which signal arrived first. If the magnitude of the current signals is controlled by the speed of the printing machine then the magnitude of

the signal in the store is directly indicative of the amount of error present. This process is repeated every time register marks are printed on the web, which is usually once per impression or, if the printing machine produces more than one impression per revolution, then once per revolution of the press. Thus a continuous signal is available for indicating error.

Once an error signal has been obtained, the mechanical processes are well enough understood to enable correction to be inserted, and the problem is virtually solved as far as the control engineer is concerned. A wide variety of control techniques may be used, ranging from relays which are switched on when the error signal is present and continue inserting correction until the error signal disappears, to a full three-term control system within the loop, controlling the position of the roller in the paper loop. The most commonly employed system controls the speed of the correcting motor to be equal to the error signal so that zero error equals zero speed but as soon as an error is present correction commences at a speed proportional to the amount of error. Some amount of rate information is usually fed into the system also, so that the rate of approach of the error to zero slows the system down in order to minimize hunting.

## ABRACADABRA

EDP; DMC; MAD: Electronic Data Processing; Digital Micro-Circuit; Magnetic Anomaly Detection. These and more than 1,200 other abbreviations are included in the second edition of a glossary prepared by Raytheon and entitled ABRACADABRA (Abbreviations and Related ACronyms Associated with Defence, Astronautics, Business and Radio-electronics).

With the increasingly complex nomenclature of today, such abbreviations are not merely a convenience but an essential shorthand. This booklet is a handy reference to those in current use, mainly in the U.S.A. To the original list of nearly 400 terms have been added about 900 ABRACADDENDA, many of which reflect recent organizational changes in the U.S. Armed Forces.

**For further information circle 48 on Service Card**

# Experimental Shorthand Transcription Machine

IBM has developed an experimental machine which can automatically transcribe Stenotype, a form of shorthand, into typewritten or printed English. Stenotype is a very fast machine shorthand used widely in the United States for courtrooms and other places where accurate transcription of normal-speed speech is essential. The transcription system automatically converts Stenotype notes into finished copy, punctuated, capitalized, hyphenated and paragraphed.

This experimental system has two possible applications. Firstly, the transcription of Stenotype; although this system can be written at speeds as high as 175 and 200 words a minute, one hour's shorthand may take four hours to transcribe. Machine transcription is virtually instantaneous. Secondly, the use of Stenotype as a rapid means of encoding alphabetic information for machine processing.

The system uses the same basic machine developed by IBM for automatic language translation. The 'dictionary' of Stenotype and English equivalents is contained in the form of black marks on a glass or plastic disc; the disc can contain up to half a million words, any of which can be found in an average of 1/30th of a second. Stenotype is basically phonetic but most ambiguities due to homonyms can be easily recognized by the machine by storing the most common contexts. Proper names are spelled out phonetically, but those most usually met with can, of course, be included in the dictionary.

## The Transcription System

In its present form, the automatic transcription system makes use of a 'memory' in which photographic techniques

are used to obtain storage of an enormous amount of information in a very small space, and with reasonably short access time. Information is stored in the form of tiny black rectangles on an 11-in. diameter disc of glass or plastic. The total number of rectangles is approximately 70 million.

The rectangular spots represent binary information—that is a spot followed by a transparent area represents 0, and a transparent area followed by a spot represents 1. In Stenotype transcription, as in most other systems concerned with words, six binary digits are used to represent one letter. Thus the letter 'e' might be 101001 and 'b' might be 110101, and so forth. In the memory, the '1's' and '0's' are represented by the sequence of black spots and transparent areas.

Various instructions can be coded in a similar way. For Stenotype transcription, every entry in the memory consists of a code representing a possible combination of Stenotype symbols, followed by a code representing the English equivalent and, usually, some additional instructions.

To identify an input word, the memory is searched in descending order of input word length. This arrangement prevents a portion of a long word from being mistakenly identified as a shorter word with which it begins, such as 'otherwise' and 'other'. The arrangement provides a number of important advantages for language translation and for Stenotype transcription. However, Stenotype transcription is complicated by the lack of any form of spacing between the phonetic Stenotype symbols. Thus

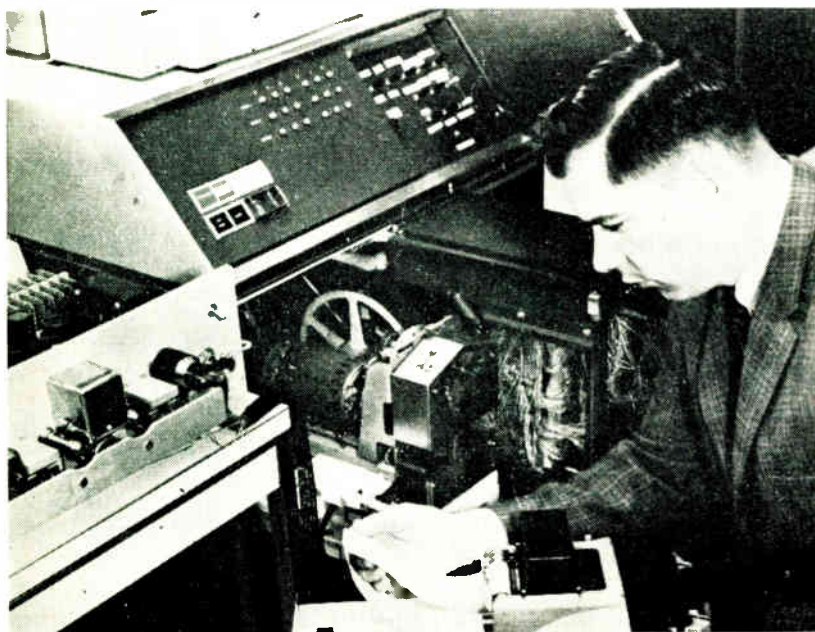

*This shows a modified Stenotype machine connected to a paper tape punch which produces coded tape according to the keys which are operated. The punched-tape is 'read' by the machine on the left and translated into English by the computer-like equipment in the background*



the system produces 'overhear' for 'over here', 'inadequate' for 'in adequate', 'accompany' for 'a company' and so forth. The problem can be readily solved by adding an end-of-word key to the Stenotype keyboard, but it has been found that this reduces the operator's speed by about 15 per cent.

This problem has been partially solved by including in the machine memory the most common short phrases in which such ambiguous combinations of words appear. For example, a phrase such as 'a cute girl' might be included since 'a cute' is frequently followed by 'a girl'. The machine would then never mistake 'acute' for 'a cute' in this context. The technique resolves the majority of ambiguities of this type.

An improvement soon to be incorporated in this system will resolve most of the remaining ambiguities. Each word in the memory will contain grammatical information, and the machine will be able to recognize the part of speech of the words on both sides of the ambiguous expression. Thus 'overhear' would usually be followed by an article, pronoun or plural noun. While 'over here' is more likely to be followed by a comma or full stop, and preceded by a verb.

### The Stenotype System of Shorthand

The Stenotype system is a machine form of shorthand in which English words are converted into printed phonetic symbols. The most widely used Stenotype machine is based on a coding method developed almost fifty years ago by W. S. Ireland. The machine contains 23 keys, any combination of which may be struck simultaneously. The fact that the keys can be struck simultaneously, along with a phonetic system of coding that eliminates much redundancy, is the key to the speed of Stenotyping. A minimum of one syllable is printed by each stroke, and a large number of abbreviations of common words and phrases is provided in the coding system.

Similar approaches have since been developed for machine shorthand in a number of other languages besides English.

The output of a Stenotype machine is a 3-in. wide paper tape on which the 22 symbols available are printed. (The 23rd key is a kind of shift key which permits the numerals 0-9 to be printed.) Each key prints its character in a separate column on the paper tape. This greatly simplifies

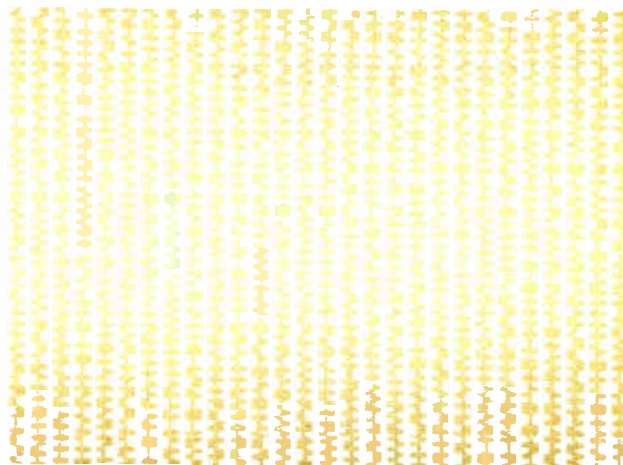

*A close-up of the coded tracks of a 'dictionary' disc*

an input device which may eventually be incorporated in the automatic transcription system, since no character recognition device will be necessary. With each character printed in a separate column, the mere appearance of a mark in one of the columns determines which character is meant.

In the experimental Stenotype transcription system reported by IBM the Stenotype machine is wired into a paper tape-punching machine, since punched paper tape is the only form of input now used with the automatic translation system.

The fact that any number of Stenotype keys can be struck at the same time permits an enormous number of possible combinations. Technically  $2^{23}$  or roughly 8.4 million combinations are possible. This large number of possible combinations along with the very large storage capacity of the memory, permits the system to do many things in addition to simple transcription of Stenotype code. For example, any kind of standard output sentence, phrase or paragraph can be simulated by a Stenotype code expression.

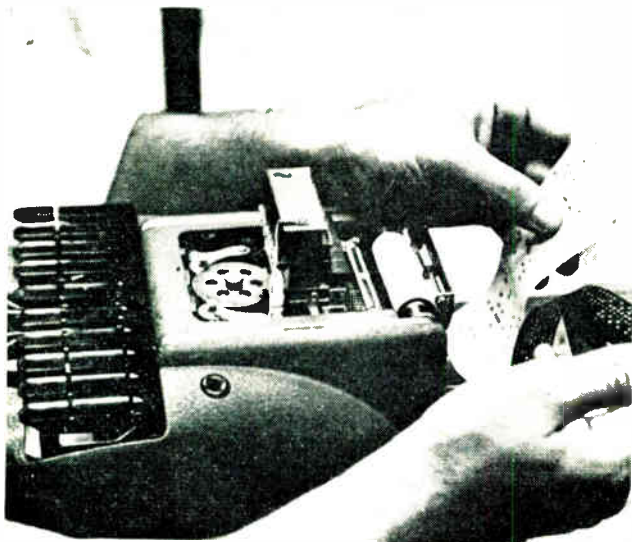

*A close-up of the modified Stenotype machine showing the punched paper tape produced*

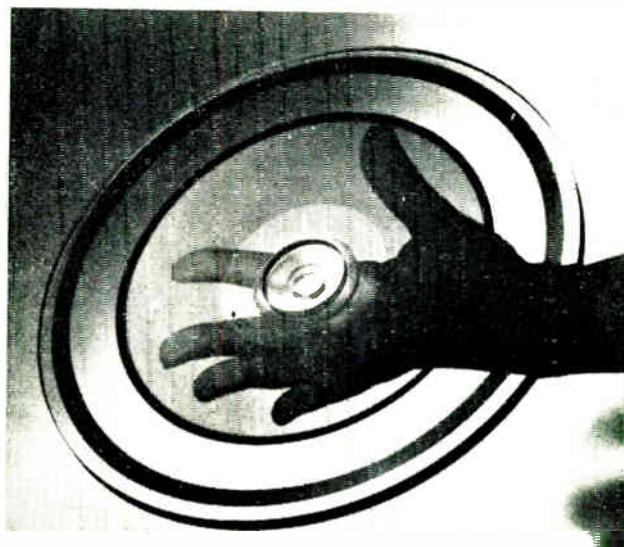

*A coded 'dictionary' disc as used in the Stenotype translation system. These discs may be made of glass or plastic*

# EQUIPMENT



# review

## 1. Oscilloscope Camera

The Southern Instruments 70-mm camera type M.1227 provides a simple means of recording waveforms displayed on a cathode-ray oscilloscope. It is a single shot instrument fitted with a bloomed Dallmeyer f/3.5 lens. Repetitive waveforms are photographed with a brief exposure, and transient waveforms are recorded by exposing the film for one X sweep initiated by the transient.

All working parts are mounted on an aluminium casting and the whole is enclosed with an upper and lower cover. The upper cover is easily removed to give access to the film cassettes for loading and unloading the camera.

For continuous recording, which requires only the Y deflection of the oscilloscope, the camera is coupled to the drive unit type M.1228. This mains-operated attachment provides six continuous feed speeds between 1 and 50 in. per sec.—*Southern Instruments Ltd., Frimley Road, Camberley, Surrey.*

For further information circle 1 on Service Card

## 2. Miniature Relay

Dewhurst & Partner announce the introduction of an inexpensive and robust miniature unit type relay, known as type EC06, with three normally-open poles rated at 6 A and two normally-closed poles rated at 2 A, all at 550 V a.c.

The double-break solid silver-to-silver contacts have a mechanical life expectancy exceeding 5 million operations, and the relay is rated for severe switching duty. It is suitable for incorporation in compact specialized relay panels required for automation, etc., and the clean lines and small size permit up to 20 relays to be butt mounted in a square foot of panel space. A damp and dust protecting enclosure for single relays is available.

Standard coils cover voltages in the ranges 230-250, 396-425 and 426-455.

all at 50 c/s. Non-standard coils are available at a small extra charge.—*Dewhurst & Partner Ltd., Melbourne Works, Hounslow, Middlesex.*

For further information circle 2 on Service Card

## 3. Solid-State Cryogenic Timer

Tempo Instrument's model 90217 is a 0.05 to 1 sec solid-state electronic timer which is capable of operating over the temperature range of  $-196^{\circ}\text{C}$  to  $+55^{\circ}\text{C}$ . The unit is adjustable by means of an external timing resistor, operates from 20 to 31 V d.c. and incorporates a static output switch cap-

able of delivering up to 500 mA to an external load.

The unit measures 2.5 by 2.5 by 4.05 cm. The components are supported in a low density potting material which enables the device to meet high shock and vibration requirements.

Variations of this device include: time delays up to 100 sec; output current as required up to 2 A; single pulse output; delay on drop-out logic; repetitive square wave output.—*Ad. Auriema Ltd., 414 Chiswick High Road, London, W.4.*

For further information circle 3 on Service Card

## 4. Transistorized Proximity Switch

Electronic Machine Control have developed a transistorized proximity switch which will sense both metallic and non-metallic objects at a rate of 800/min without physical contact. A metal object with a surface area of 1 by 1 in. can be sensed at a distance of  $\frac{1}{2}$  in. and a p.v.c. object 1 by 1 by  $\frac{1}{2}$  in. at a distance of  $\frac{3}{16}$  in.

Because of its small size the most obvious application for this device is as a limit switch, but it can be used equally well in any control system

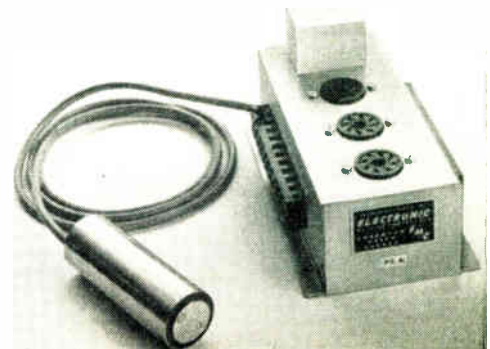
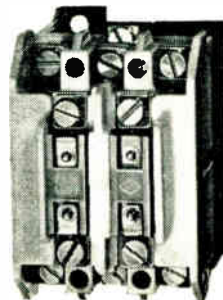
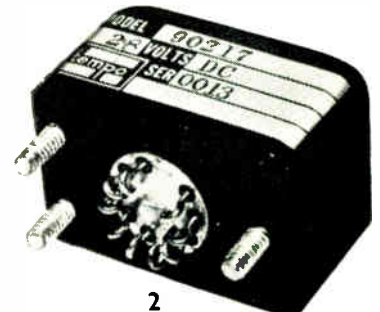
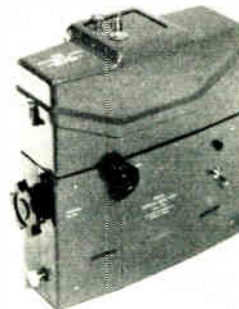



5

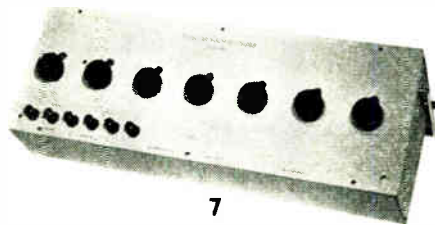

7

6

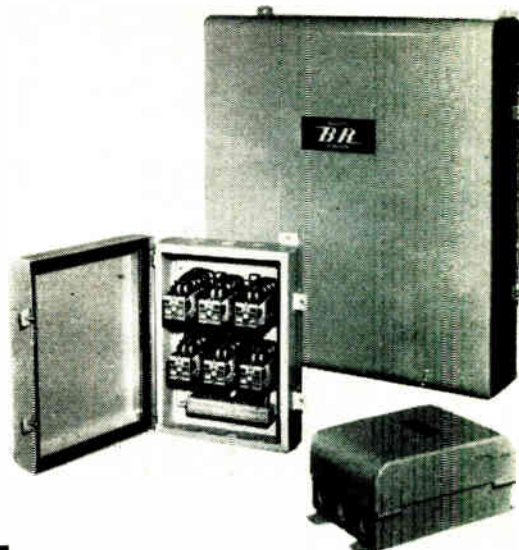

where sensing and indexing are required, e.g. machine tool control, interlock systems, bottling, etc.

On the left of the photograph is the sensing head (4 in. long by  $1\frac{1}{8}$  in. diameter) which houses a crystal-controlled transistor oscillator; on the right is the chassis containing a transistorized amplifier which operates the relay. This power supply relay unit can be supplied for use with either 1 to 4 or 1 to 8 sensing heads.—*Electronic Machine Control Ltd., Mayday Road, Thornton Heath, Surrey.*

For further information circle 4 on Service Card

### 5. Ultrasonic Sensors

As an addition to their range of Sonac ultrasonic sensing and switching equipment, Westool have announced a series of dry level assemblies to sense the level of solids in industrial bins, hoppers and special containers. The assembly consists of a matched pair of stainless steel sensors. These are unaffected in operation by dust, light and vibration.

The sensors are designed for easy fitting through the bin walls or can be specially mounted if required. The beam path is limited to a range between 18 in. and 10 ft. Dependent on the method of fitting, they can be supplied with an amplifier giving either an instantaneous or a delayed response; the latter is the most commonly used to allow for loose material dropping through the sensor beam.

Various control amplifier enclosures are now being supplied for all Sonac assemblies. These enclosures can be splash-proof, dust-proof or weather-proof depending upon environmental conditions. They can also be

fitted with thermostatically-controlled heaters to enable the equipment to work in environmental conditions below the 40 °F limit on the standard amplifiers.—*Westool Ltd., St. Helen's Auckland, Co. Durham.*

For further information circle 5 on Service Card

### 6. Wall-Mounting Equipment Boxes

B. & R. Relays are supplying a range of wall-mounting boxes in four basic sizes to house complete relay and associated electrical equipment.

Manufactured in pressed steel, the boxes are robust, splash proof and dustproof, and can be fitted with locks if required. The standard finish is grey enamel but other colours can be supplied. The wall mounting base is fitted with external fixing lugs, and with top and bottom knockouts for a variety of conduit sizes. The 9 by 6 in. and 12 by 9 in. (base area) boxes come in 16 s.w.g.; the two larger sizes which are in 12 s.w.g. are 18 by 15 in. and 24 by 21 in. The doors of the boxes are hinged and detachable. In the 9 by 6 in. version, doors with  $4\frac{1}{2}$  or 7 in. depth can be supplied. The 12 by 9 in. and 18 by 15 in. come in three depths,  $4\frac{1}{2}$ , 7 and 10 in., while the largest size 24 by 21 in. is available in 7 or 10 in. lid depths.—*B. & R. Relays Ltd., Temple Fields, Harlow, Essex.*

For further information circle 6 on Service Card

### 7. Inductive Voltage Divider

The Tinsley inductive voltage divider is a high precision ratio standard which may be used as the ratio arm of an a.c. bridge or as an accurate a.c. volt-

age divider. It is suitable for operation over a range of frequencies from 50 c/s to 2 kc/s.

The accuracy of the ratio is better than 5 parts in 10 million if the frequency is within 20% of the nominal value. At 1 kc/s the minimum input impedance is 70 k $\Omega$  and the maximum output impedance approx. 3  $\Omega$ ; the effective series inductance is 20  $\mu$ H. Maximum input voltage is 0.2 times the frequency up to a maximum of 200 V.

The coils of the divider are wound on high permeability toroids; under ideal conditions they have a stability approaching 1 part per 100 million. Coils, switches and terminals are built into a metal box  $22\frac{1}{2} \times 8 \times 6$  in. The total weight is 21  $\frac{1}{2}$  lb.

The advantage of constructing a bridge from close-coupled inductive elements of this type is that the ratio of voltage division depends upon the turns ratio, which is constant, rather than upon the properties of the materials used; thus the precision and stability are greater than those of the corresponding resistance ratio arm.—*H. Tinsley & Co. Ltd., Werndee Hall South Norwood, London, S.E.25.*

For further information circle 7 on Service Card

### 8. U.H.F. Planar Triode

A u.h.f. planar triode providing high cathode-current service from low frequency to 3 Gc/s has been announced by the Machlett Laboratories, an affiliate of Raytheon.

The rugged ML-8403 is a high- $\mu$  valve employing ceramic-to-metal construction: it is designed as a grid-pulsed, anode-pulsed, or c.w. oscil-



10

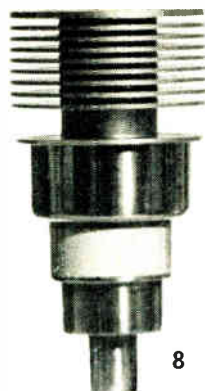

8

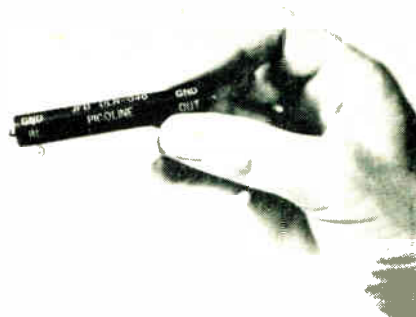

9



11

lator: frequency multiplier or amplifier.

As a c.w. oscillator and amplifier, maximum ratings include a d.c. anode voltage of 2 kV, d.c. grid voltage of -150 V and anode dissipation of 100 W. Maximum ratings as an anode-pulsed oscillator and amplifier include a peak anode pulse supply voltage of 3.5 kV a.c. As a grid-pulsed oscillator and amplifier, maximum ratings include a pulse length of 6  $\mu$ sec, duty factor of 0.0033, d.c. anode voltage of 2 kV and peak anode current from a d.c. supply of 5 A.—*Raytheon-ELSI, S.p.A., Villagrazia, Palermo, Italy.*

For further information circle 8 on Service Card

### 9. Subminiature Delay Lines

The Picoline range of subminiature delay lines announced by JFD are intended for use in the v.h.f. and lower u.h.f. ranges, replacing coaxial cable by a general rule of an inch of Picoline to a foot of cable.

Ten standard models are offered in 1  $\mu$ sec increments from 1 to 10 nsec (tolerance:  $\pm 0.2$  nsec), but special versions in a variety of case styles can be supplied with  $\frac{1}{2}$  nsec steps. Picolines have a linear phase characteristic

and, from 3 dB down, bandwidth is in excess of 300 Mc/s.

These shock and vibration-resistant units of metallized glass construction feature a rise time of less than 1 nsec and have a temperature coefficient of delay of approximately 20 p.p.m./ $^{\circ}$ C over a temperature range from -55  $^{\circ}$ C to +125  $^{\circ}$ C.—*JFD Electronics Corporation, 6101 16th Avenue, Brooklyn 4, N.Y., U.S.A.*

For further information circle 9 on Service Card

### 10. Cable Reeling Unit

V. L. Martin have announced the 'Marcaddy' constant-tension cable reeling unit, fitted with the 'Tensator' constant-torque spring. This gives a large number of winding turns, and packs the cable into a very small space, while the recoil tension is evenly maintained throughout extension.

Electrical continuity from the fixed to the moving parts of the unit is obtained by a sturdy slip-ring and brush housing, the whole drum assembly being at earth potential. P.t.f.e. bearings enable the cable drum to react instantly to quick movements of coil or recoil. The outer case, which is only 10 $\frac{1}{2}$  in. in diameter, is made of a robust plastic moulding,

and the complete unit weighs 7 lb plus cable. Models are made for handling 30 ft and 50 ft of 3-core 23/0076 cable at 5 A, and 30 ft of 3-core 70/0076 cable at 15 A.

The three types available are: ceiling fixing, machine fixing, and portable, supplied with or without cable. The ceiling fixing model is suitable for portable hand tools, etc. The machine model has a swivel pedestal suitable for fixing on mobile equipment. The portable version is complete with floor skids, socket and handle, making it suitable for any application where an extension lead is required.—*V. L. Martin & Co. Ltd., Witley Works, Witley Gardens, Southall, Middlesex.*

For further information circle 10 on Service Card

### 11. Stray Field Meter

A magnetic stray field meter, designed for the measurement of alternating magnetic fields of frequencies between 50 and 500 c/s, has recently been announced by the Carl Zeiss Foundation of Western Germany.

This instrument, the SFM.2, is suitable for checking stray alternating fields of more than  $5 \times 10^{-3}$  A/cm which may, for example, cause blurr-

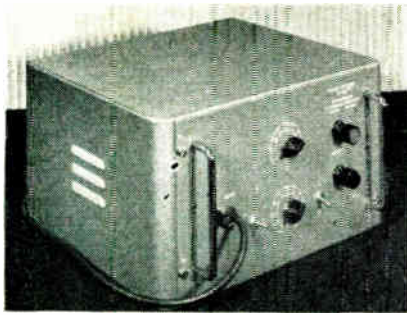

12

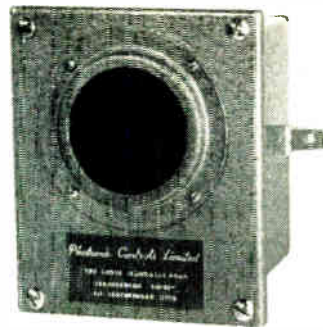

13



14

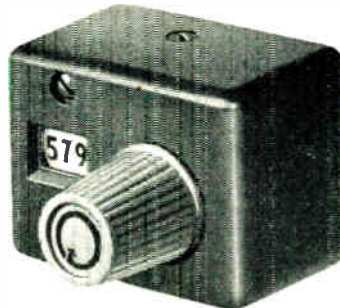

15

ing of the image in electron optical devices.

The field to be measured induces in the search coil a voltage which is amplified and rectified in a portable battery-operated multi-step transistor amplifier. The resultant current, which is proportional to the rectified alternating voltage at the input, is indicated on a meter calibrated directly in field intensity units (A/cm).—*Degenhardt & Co. Ltd., Carl Zeiss House, 20/22 Mortimer Street, London, W.1.*

For further information circle 11 on Service Card

## 12. Phase Shift Unit

An instrument specially designed to provide an output at 240 V 50 c/s with phase angle variable through the full 360° in 1° steps is now available from Robinson and Partners.

Using transformers with their primary windings Scott-connected across a 3-phase supply, the output voltage is completely isolated from the input. Multi-tapped secondary windings are switched to give the output phase required. This system provides a low internal impedance, the output voltage at full load and any power factor being maintained within 7% for any output phase.

Two standard models, having ratings of 100 VA and 500 VA with a single variable phase output are offered, but polyphase units or models with different voltage and power ratings can be made to specification.—*F. C. Robinson & Partners Ltd., Davies House, 181 Arthur Road, London, S.W.19.*

For further information circle 12 on Service Card

## 13. Inexpensive Lighting Control

Photronic Controls have developed the type LU/4 artificial lighting control suitable for both indoor and outdoor monitoring. The price: 5 gns.

This self-contained unit is housed in a waterproof cast-aluminium case 6 by 5 by 4 in. The plug-in photocell monitors the daylight through a glass window in the lid of the unit and when the pre-set level is reached a relay action is obtained to switch the artificial lighting 'on' or 'off'. A robust relay is employed which is capable of switching 1,500 W; for loads in excess of this figure an additional contactor can be fitted.

A sensitivity control is incorporated in the unit so that the operating point can be set by the installer to suit site conditions, and there is a built-in differential which is automatically set to ensure that the equipment does not

'hunt' as clouds pass over the sun.—*Photronic Controls Ltd., Randalls Road, Leatherhead, Surrey.*

For further information circle 13 on Service Card

## 14. Transistor Moisture Meters

Two instruments, the model AB60 portable transistor moisture meter (illustrated) and the model AB61 transistor moisture meter are announced by Kappa.

Intended for measurements on materials of reasonably small and uniform particle size, and substances that are easily handled, such as powders, seeds, tea, rag tobacco, grain, etc., the model AB60 is fitted with a removable container for testing samples of up to 300 c.c. maximum.

Measurements on materials of a bulky nature, such as coffee beans, raw sugar, nuts, tobacco leaf, copra, etc., and substances that require the testing of a larger sample to ensure that the measurement is truly representative of the bulk, are afforded by the model AB61. This unit can be supplied with one of three standard container sizes, the largest providing a maximum sample volume of 2,700 c.c.

For materials of reasonably constant composition and texture, the accuracy can be expected to be between 0.05 and 0.4%, in the 0 to 20% range, 0.2 and 0.5%, in the 20 to 30% range, 0.3 and 0.7%, in the 30 to 40% range, and between 0.5 and 1.0%, in the above 40% moisture range.

Good discrimination to change in the dielectric constant of the sample, and hence moisture content, is achieved with a sharply tuned heterodyne detection circuit. The reading obtained is indicated on a manually-operated dial that provides a single scale calibration of 900 arbitrary divisions. Both instruments may be operated by internally mounted long-life batteries or by 110 to 125 V or 200 to 250 V, 50 to 60 c/s mains supplies.—*Kappa Electronics Ltd., 159 Hammersmith Road, London, W.6.*

For further information circle 14 on Service Card

## 15. Digital Indicator

Reliance Controls are offering a simple robust digital-dial position indicator, for use with multi-turn components, e.g. helical potentiometers, variable capacitors, etc.

Precise gearing gives good repeatability of readings with no possibility of backlash between knob and component shaft. The collet shaft grip prevents burring by grub screws and thus obviates jamming.

Rotation is continuous with 10 turns

equalling 3.600. The numerals represent full turns, tenths and hundredths. Dimensions: height, 1.39 in.; width, 1.8 in.; depth, 1.08 in.; overall depth including knob, 1.825 in. The melamine housing and knob are available in black, grey or red.—*Reliance Controls Ltd., Relcon Works, Sutherland Road, Walthamstow, London, E.17.*

For further information circle 15 on Service Card

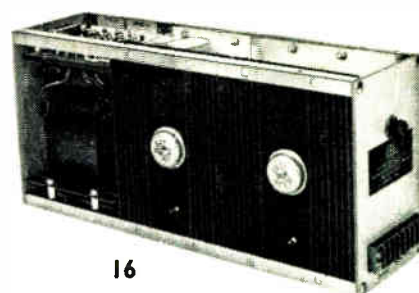
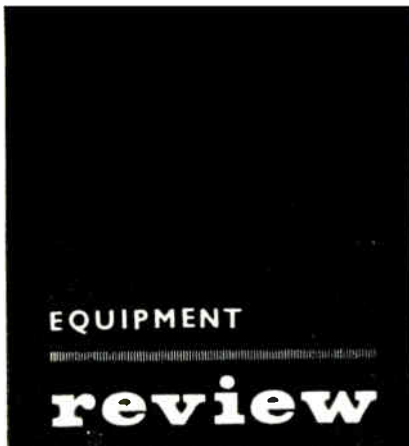

16

## 16. Power Supply Modules

The Electrotech Instruments Division of Coutant Electronics have recently added a new series to their range of modular stabilized power supplies.

Most of the 'E' series offer electronic protection against short-circuit conditions, and have a stability ratio of 5,000 : 1. Output resistance is 2 m $\Omega$ , ripple and noise 200  $\mu$ V peak-to-peak.

By the use of new design techniques in the high gain d.c. control amplifier a very low output impedance has been achieved, typical figures being 100 m $\Omega$  at 200 kc/s and 10 m $\Omega$  at 25 kc/s. Under constant conditions of mains, load and ambient temperature the random drift is less than 50 parts per million (0.005 per cent of output).

Single or twin isolated outputs are available in the voltage range of 6 to 60 V and currents up to 30 A are standard. The mechanical arrangements allow maximum flexibility for chassis or front panel mounting. Prices range from £22 for the  $\frac{1}{2}$  A unit.—*Electrotech Instruments Division, Coutant Electronics Ltd., 711 Fulham Road, London, S.W.6.*

For further information circle 16 on Service Card

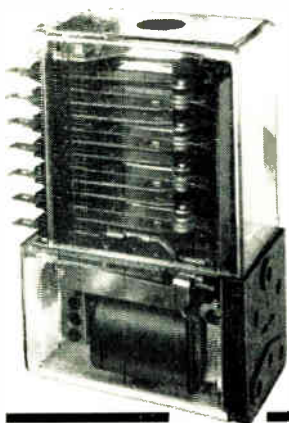

17

## 17. Heavy Duty Relays

Magnetic Devices have extended their range of relays by the introduction of a laminated-frame, heavy-duty unit.

The whole contact assembly is mounted on a base plate which is attached to the coil and frame assembly with four screws. Each moving blade consists over most of its length of two blades riveted together in two places. The fact that the two blades are of different lengths and therefore of different fundamental frequencies, tends to damp out resonance of the moving blade. This reduces contact bounce and extends the working life of the blade. Hence any contact assembly can be fitted to any relay without further need of adjustment.

Various contact arrangements are offered, with a maximum of 24 blades. Loads of 20 A at 250 V a.c., 10 A at 500 V a.c. or 5 A at 100 V d.c. may be

switched. The coil and frame assembly has an oilite bearing for the armature spindle and a simple spring clip release for easy removal of the coil.—*Magnetic Devices Ltd., Newmarket, Suffolk.*

For further information circle 17 on Service Card

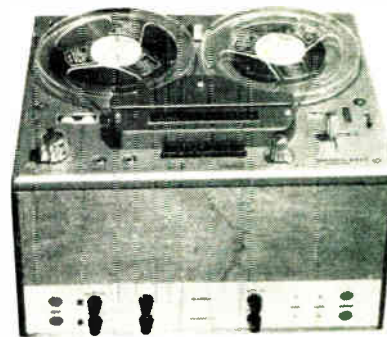

18

## 18. Low Cost Tape Instrumentation

The high cost of magnetic tape recording systems of instrumentation standard often precludes their use by many in research, industry and education who could employ instrumentation recording to advantage. The Elliott-Tandberg system is claimed to offer a very high performance at a cost of only £550 complete.

The equipment provides two channels, either or both giving frequency modulation or direct recording as selected by means of a push-button. The f.m. mode permits data in the band from d.c. to 2.4 kc/s to be recorded and reproduced with an overall accuracy of 1%.

Three tape speeds are available: the frequency-modulation system operating at a tape speed of 7 $\frac{1}{2}$  in./sec and 12-kc/s carrier has a frequency response ( $\pm 1$  dB) of d.c. to 2.4 kc/s; at 3 $\frac{1}{2}$  in./sec and 6-kc/s carrier the response is d.c. to 1.2 kc/s; at 1 $\frac{1}{2}$  in./

sec and 3-kc/s carrier it is d.c. to 600 c/s. On 'direct record/reproduce' the frequency response at 7 $\frac{1}{2}$  in./sec tape speed is 40 c/s to 16 kc/s; at 3 $\frac{1}{2}$  in./sec it is 40 c/s to 10 kc/s; and at 1 $\frac{1}{2}$  in./sec the frequency response is 55 c/s to 5 kc/s.—*Elliott Brothers (London) Ltd., Chobham Road, Frimley, Nr. Aldershot, Hants.*

For further information circle 18 on Service Card

## 19. Coaxial Connector

The major features of a coaxial connector introduced by General Radio are a v.s.w.r. below 1.01 up to 9 Gc/s, good repeatability, and low leakage and insertion loss.

The type 900 uses butting contacts aligned to within 0.001 in. by a centring gear ring and held tightly together by an outer locking nut. Any two connectors, although identical, mate and lock. It is designed for use on rigid, air-dielectric,  $\frac{3}{16}$ -in., 50- $\Omega$  line.

The inner-conductor contact consists of six solid silver-alloy segments, independently sprung. Upon mating, these contacts are forced back and spread, making a wiping contact both with one another and with the inside of the inner conductor. The inner conductor is supported by a press-fit Teflon bead, shaped to compensate for discontinuity capacitances. The outer



19

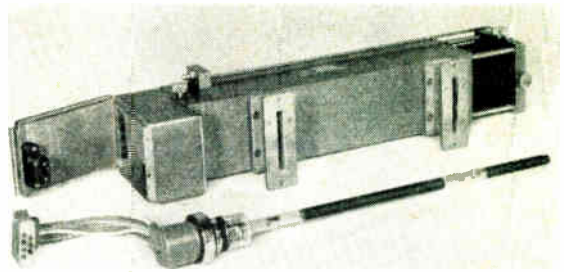

20



21



22

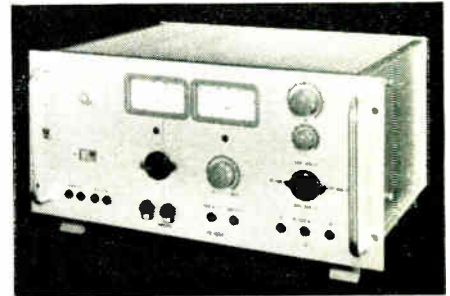

23

conductor is of solid coin silver. The butting contact of a pair of outer conductors results in a connection similar to a waveguide joint.—*Claude Lyons Ltd., Valley Works, Hoddesdon, Herts.*  
For further information circle 19 on Service Card

## 20. Travelling Wave Tubes

English Electric has completed development of two travelling-wave tubes for use in 1800 channel microwave link equipment.

These tubes, known as the N1046 (illustrated) and the N1052, cover an overall frequency range of 3.6 to 7.2 Gc/s with a gain of 40 dB at a working output power of 10 W, 20 W saturated. Their noise factor is typically 25 dB. Two associated periodic permanent magnet mounts, N4024 and N4063, have been produced for the N1046 tube, both of which are physically identical except for the size of the waveguide. When this tube is used in mount N4024 (illustrated) the frequency band covered is from 3.6 to 4.2 Gc/s and with mount N4063 the coverage is 4.4 to 5.0 Gc/s.

The N1052 t.w.t., covering the higher frequency range of 5.8 to 7.2 Gc/s, is available with a p.p.m. mount N4062.

Both tubes require relatively low power supplies. This factor, combined with the use of permanent magnet

mounts, makes them suitable for use in transistorized equipment.—*The English Electric Valve Co. Ltd., Chelmsford, Essex.*

For further information circle 20 on Service Card

## 21. All-Diffused Avalanche Rectifier

A 1,200-V all-diffused avalanche rectifier is now available from A.E.I. This 10-A silicon rectifier has rigidly specified maximum and minimum avalanche voltage characteristics, providing protection against voltage surges to itself and associated circuit components.

It is able to operate in the avalanche region indefinitely, without damage, where it will absorb momentary power surges. The rectifier does not require de-rating in the reverse blocking direction, as it is self-protecting against voltage transients. Thus, a 1,200-V p.i.v.-controlled avalanche rectifier is equivalent to a 2,500 to 3,500-V p.i.v. conventional rectifier in many circuits, as safety factors are unnecessary.

The type SLZ 1203A protects other circuit components by its surge clipping characteristics and simplifies series operation of rectifiers in high voltage applications, as no shunting resistors are required.—*Associated Electrical Industries Ltd., Electronic Apparatus Division, New Parks, Leicester.*

For further information circle 21 on Service Card

## 22. V.H.F. Portable Radio-Telephone

British Communications Corporation have introduced a lightweight portable radio-telephone using transistors throughout and re-chargeable batteries.

Known as the BCC 40/45, it is designed to G.P.O. and international standards and provides speech communication over distances of approximately 1 to 6 miles.

Features of the set include: ease of operation, the provision of 5 or 6 channels within any of the v.h.f. bands with the choice of p.m. or a.m. operation, and a high sensitivity. The sensitivity is 1.6  $\mu$ V for 20 dB signal-to-noise ratio on p.m. and 10 dB on a.m. The radiated power is 350 mW on a.m. and 400 mW on p.m.

Housed in a robust case, the unit measures 8 x 5 x 2½ in. and weighs only 4½ lb. The battery provides a continuous 12 hours of operation with an average send-receive ratio.—*British Communications Corporation Ltd., Neasden Lane, London, N.W.10.*

For further information circle 22 on Service Card

## 23. Laboratory Power Supplies

Philips have announced two stabilized d.c. power supply units. Their main range is 0 to 500 V positive, and they have supplementary stabilized low-current outputs of 0 to 85 V negative

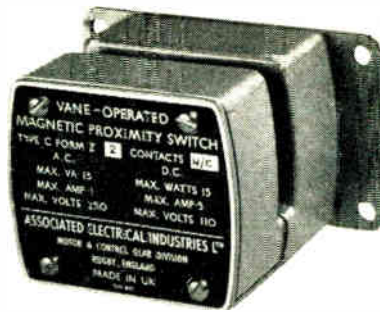

24

and 150 V negative, as well as un-stabilized 6.3-V a.c. outputs.

The maximum current rating of the 500-V range of one of the units, type PE4830, is 150 mA, and the internal resistance is 0.5  $\Omega$ . The maximum 500-V output with the other unit, type PE4831 (illustrated), is 300 mA; internal resistance: 0.25  $\Omega$ .

High stability is claimed for both units, their output varying by not more than 1 part in 10,000 for input fluctuations of  $\pm 10\%$ . Hum is 1 mV.

The units are fitted with current and voltage meters, and are fully protected against overload. Valves are generously rated to ensure maximum reliability and life. Rack-mounting and cabinet versions are available ex-stock.—*Research and Control Instruments Ltd., Instrument House, 207 King's Cross Road, London, W.C.1.*

For further information circle 23 on Service Card

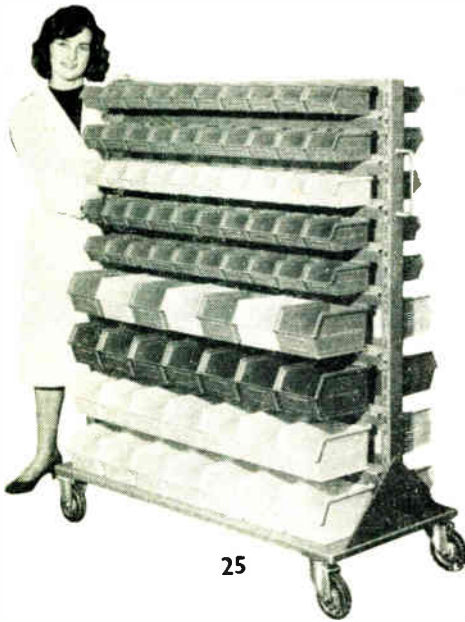

25

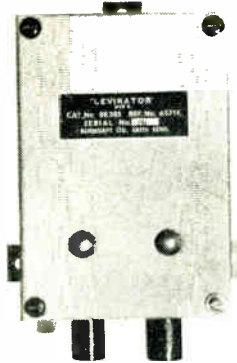

26

## 24. Vane-Operated Proximity Switch

A totally enclosed, vane-operated magnetic proximity switch, with sealed contacts and no external moving parts, has been introduced by A.E.I. The switch, known as the type C, can be immersed in suds and similar non-corrosive liquids and the contacts are suitable for light electrical ratings, including such applications as static switching, electronics, dry reed and miniature relay control systems.

Operation of the switch depends on shielding the contacts from a magnetic flux produced by a permanent magnet. This shield can be a vane of mild steel, or other magnetic material, fixed to the moving part of the apparatus or machine on which the switch itself is fitted.

The speed of contact response is less than 1 msec from the time the vane reaches the tripping point. Repetitive accuracy of the tripping and reset points is  $\pm 0.003$  in., given good vane guidance through the slot. Contact life is up to 100 million operations.

Maximum contact ratings are 250 V, 1 A, 15 VA a.c., and 110 V, 0.5 A, 15 W d.c. The contacts are available as either normally open or normally closed and in each case the slot, through which the vane passes, may be either  $\frac{1}{8}$  in. or  $\frac{1}{4}$  in. wide. The switch can also be supplied with a separately excited biasing coil to give an unusually small operating differential.—*A.E.I. Motor and Control Gear Division, Rugby, Warwick.*

For further information circle 24 on Service Card

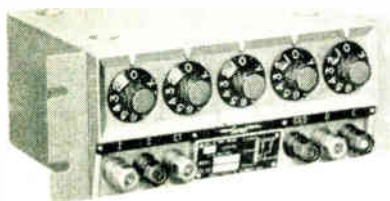

27

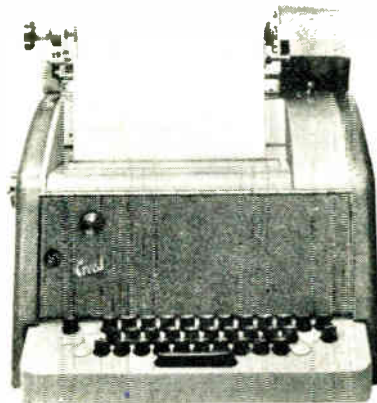

28



29



30

## 25. Mobile Dispenser

Fix Equipment announce an addition to their range of storage and materials handling equipment. The 'R' type of



trolley consists of a mobile platform fitted with horizontal rails for holding plastic containers, and is intended as an answer to the problem of dispensing small parts from store to assembly areas. The trolley and containers allow for up to 200 different parts to be carried at a time. The containers, in four bright colours, give a visual guide to contents or coding of parts. Price: from £24 15s. 0d., containers extra.—*Fix Equipment Ltd., 4 South Lambeth Place, Vauxhall, London, S.W.8.*

For further information circle 25 on Service Card

## 26. Inexpensive Level Controller

The type BE 305 'Levikator', announced by Burndept. is an electronic floatless level controller. This unit is claimed to offer the cheapest and least complicated automatic level control for any aqueous, acid or alkaline solution and can be used with other liquids, powders and solids provided they are conductive.

The unit consists of a mains-powered control unit, relay and single or dual probes for one or two level control. The circuit employs a thyatron, which is triggered when the substance in the tank touches the probe: a relay is then operated to complete an alarm or supervising circuit.

Designed for continuous duty in industrial applications, the Levikator's chassis is easily removed for servicing and, as the operation of the float is entirely electronic, no mechanical maintenance is required.

The instrument is isolated from the mains by a double-wound transformer with an interposed earthed screen. In the event of mains failure the Levikator fails safe.—*Burndept Electronics, Ltd., High Street, Erith, Kent.*

For further information circle 26 on Service Card

## 27. Compact Voltage Divider

A new addition to the Wayne Kerr-Gertsch range of ratio transformers is the RatioTran RT 60 which comprises five switched decades for the precise division of a.c. voltages in the frequency band 50 c/s to 10 kc/s. Although of compact dimensions (3½ in. high and adaptable for half-rack mounting), its performance is comparable with that of larger units. It accepts input levels of up to 0.35 × frequency, with an upper limit of 350 V. Resolution is in steps of 0.001%.

This general-purpose instrument is ideal for such applications as checking resolvers and servos, voltmeter calibration, computer testing and transformer turns ratio measurements. Alter-

natively, it can form part of a specialized test console. In either application, two units can be operated in cascade when additional resolution is required.—*The Wayne Kerr Laboratories Ltd., New Malden, Surrey.*

For further information circle 27 on Service Card

## 28. Paper Winder for Teleprinter

The introduction of a page winder for the automatic rewinding of teleprinter copy is announced by Creed.

Identified as the 'Model Seventy-five', this accessory overcomes the problem of the untidy accumulation of paper that occurs at teleprinter positions where operations do not call for the removal of individual messages. It will be especially useful, for example, in monitoring applications where a printer is employed to provide a continuous page record of all transmitted and received traffic.

Designed in a style complementary to existing equipment, the winder is a compact, motor-driven unit which automatically adjusts its take-up speed to that of the associated teleprinter and caters for both continuous and intermittent operation. The capacity of the unit is sufficient to take a full standard roll of 100 yd of single-ply message paper and the rewound rolls may be removed quite easily in a few seconds.

The winder is suitable for machine or wall mounting and is intended primarily for use with the Creed model Seventy-five Teleprinter (as shown in the photograph) where the paper supply remains stationary.—*Creed & Company Ltd., Telegraph House, Croydon, Surrey.*

For further information circle 28 on Service Card

## 29. Miniature Environmental Chambers

Electrothermal Engineering announce the introduction of their range of stabilized thermal chambers.

FC.7902, with a cavity of 5 by 2½ by 1½ in., is intended for use when temperature sensitive components, complete printed-circuit boards, crystal units, etc., require to be stabilized at fixed temperatures up to 85 °C. The chamber operates from 28 V d.c. and is thermometer-controlled by a transistor switching unit.

FC.7921 (illustrated) is a miniature environmental test chamber with a 6-in. cube cavity. It is fitted with two removable shelves, glass doors and cable access for internal connection. A separate controller, in conjunction with a thermistor probe, permits setting up to any temperature in the range 40 to 145 °C within fine limits. The

chamber operates from standard a.c. mains supplies and is suitable for bench testing and evaluation purposes when space is limited.

FC.7902 is priced at £28 complete with switch unit and FC.7921 at £57 10s. 0d. with associated temperature controller.—*Electrothermal Engineering Ltd., 270 Neville Road, London, E.7.*

For further information circle 29 on Service Card

## 30. Crimping Tool

A wide range of removable connector contacts can be fitted by means of the Erma-Buchanan crimping tool. The crimping operation is completely controlled once the appropriate positioner is placed in the tool head. It assures correct alignment between indentors and contact barrel and serves as a positive stop for the indentors, thereby controlling indent depth. A ratchet mechanism is built into the tool, ensuring completion of the crimping operation. No adjustments by the operator are required.

Three contact positioners are supplied with the tool, the two not in use being conveniently stored in the handle. This gives a coverage of all types of contacts with standard crimping barrels and wires up to No. 12 a.w.g. Moreover, each contact will accept a wide variety of wire sizes without need of packing sleeves or specially bored barrels. Additional inexpensive positioners can be provided to suit non-standard contacts for wires down to No. 30 a.w.g.—*Erma Ltd., Mount Pleasant, Alperton, Wembley, Middx.*

For further information circle 30 on Service Card

## 31. High Resolution Vidicon Tube

An addition to E.M.I. Electronics' range of one-inch vidicon camera tubes, the type 9677, has a considerably higher resolution than a standard tube when operated at the same final anode voltage and with the same scan and focus coils.

This improved performance may be used to give higher definition pictures (given adequate bandwidth) or to give pictures with a greater signal-to-noise ratio. At 5 Mc/s on a 625-line system the new tube gives over double the depth of modulation of a standard vidicon.

Unlike that of a standard vidicon, the resolution of this tube is not reduced by excess beam current, so the beam control can be preset to the level necessary to discharge any likely overload signal; this operating feature is particularly important in television studios and in cameras employing automatic sensitivity control.

The tube is suitable for operation in

32

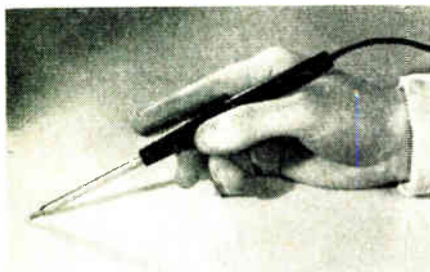

transistorized cameras as it is fitted with a low wattage heater. A further unusual feature is the absence of picture rotation as the electrical focus is varied. This facilitates the adjustment of three-vidicon colour cameras using this tube.—*E.M.I. Electronics Ltd., Hayes, Middlesex.*

For further information circle 31 on Service Card

### 32. Miniature Soldering Iron

Only 8 in. long and weighing under 2 oz., the 'Miniscope' soldering iron, marketed by Enthoven Solders, is especially suitable for use whenever fast heat transfer or higher than normal soldering temperatures are required.

This instrument is safe and simple to operate using a pen-holder grip, the index finger being used to depress the switch lever to the 'on' position; this lever is spring-loaded so that the iron is switched off automatically when not in use.

The required power supply is 2.5 to 6 V a.c. or d.c.; a 4-V transformer is an optional extra. The heating time is about 5 sec and the current drain is 20 A.—*Enthoven Solders Ltd., Upper Ordnance Wharf, Rotherhithe Street, London, S.E.16.*

For further information circle 32 on Service Card

### 33. Video Patch Plugs

Cannon video patch plugs in a wide variety of configurations are available, ranging from dual connectors with coaxial circuits on  $\frac{1}{4}$ -in. centres to patch cable assemblies 4-ft long,

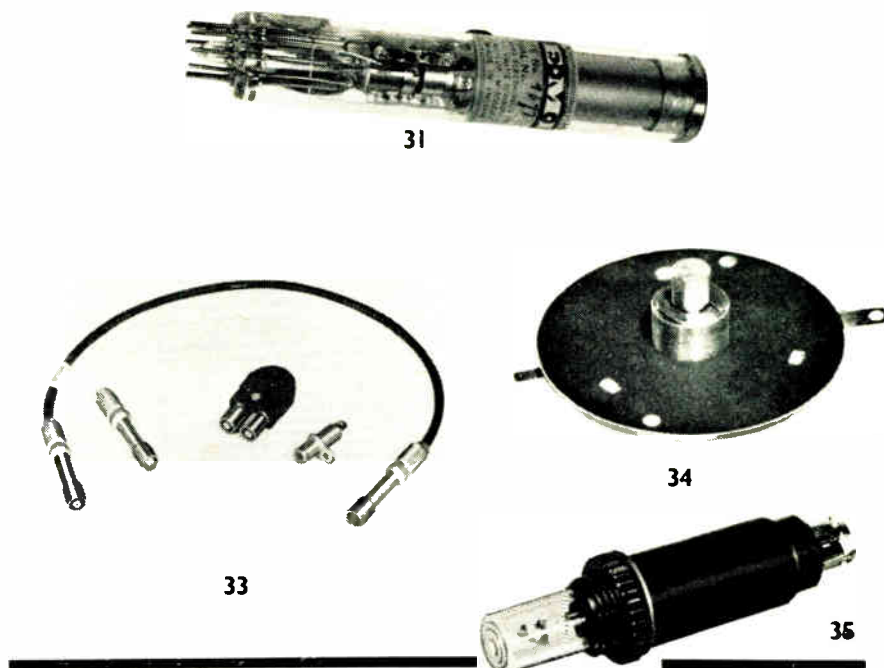

31

33

34

35

Single or dual plugs, single or dual panel jacks, and short or long patch cords are available together with a cable adapter kit.

Designed originally for use with 75  $\Omega$  RG-59/U cable, these plugs can be readily adapted for use with 75  $\Omega$  RG-11/U cable through the use of the adapter kit.

Cross talk and noise are held to a minimum by the gold plating of metal parts and the individual earthing of circuits. R.f. shielding is provided in both the dual plugs and the dual panel jacks.

Aside from video uses, any equipment which requires rapid changing and/or interconnecting of circuits is an application for these patch plugs.—*Cannon Electric (Great Britain) Ltd., 168-172 Old Street, London, E.C.1.*

For further information circle 33 on Service Card

### 34. Metallized Ceramic Vane Capacitor

Plessey has introduced a miniature ceramic dielectric variable capacitor. A special feature of the type 83 is that the vanes are metallized directly on to the ceramic; this form of construction is simple, rugged and inexpensive, and has the added advantage of complete freedom from microphony. Being semi-sealed, the unit also resists the ingress of dust and dirt.

This is a single-section unit primarily intended as a replacement for conventional air-spaced or plastic dielectric tuning capacitors in medium and long wave broadcast receivers. Two

versions are currently available, 300 pF and 500 pF, both having a diameter of 1.5 in. over the case, which is mounted on a circular 2-in. SRBP panel. Minimum capacitance is less than 20 pF and power factor at 1 Mc/s less than 0.002.

Both the capacitance law (normally linear) and the maximum capacitance can be varied to suit customer applications. If required without stops the case size can be reduced to  $1\frac{1}{4}$  in. diameter.—*Havant Components Division, The Plessey Company (UK) Ltd., New Lane, Havant, Hants.*

For further information circle 34 on Service Card

### 35. Lighted Pushbutton Switch

Dubesco announce the release of their Grayhill series 40 lighted pushbutton switch which is available with either a 20 V incandescent lamp or a neon lamp.

This unit, with an independent switch and lamp circuits, has a life expectancy of 500,000 operations at the rated load. The button is pushed to make and the contacts will break 1 A at 115 V a.c. resistive; contact resistance is approximately 3 m $\Omega$  and the breakdown voltage between mutually insulated parts is 1 kV a.c.

The switch fits into a hole 25/64 in. in diameter by means of a knurled mounting nut. Button travel is approximately 0.067 in. and the actuating force is 16 oz.

A range of coloured buttons can be supplied and the hot-stamping of letters or numerals on the end of the

button is available by special order.—*Dubesco Laboratories Ltd., 5 Violet Hill, London, N.W.8.*

For further information circle 35 on Service Card

### 36. Radiation Detector

Roberts Electronics, who have been marketing the Ramcor power density meter for the detection and measurement of hazardous r.f. radiation levels, now introduce a similar density meter designed for remote operation. The aerial is mounted in the hazardous field connected by a 25 or 50 ft cable to the 'Densimeter', permitting measurements to be made by the operator in a safe area.

This new instrument is available with five aerials to cover the frequency range from 200 Mc/s to 10 Gc/s, and can measure power density from 0 to 20 mW/cm<sup>2</sup>. The unit is very light, portable, battery operated and has an accuracy of  $\pm 0.5$  dB.—*Roberts Electronics Ltd., 17 Hermitage Road, Hitchin, Herts.*

For further information circle 36 on Service Card

### 37. Marker Relay

The Electro-Mechanical Division of S.T.C. is now marketing a compact marker relay developed by their associates, Bell Telephone Manufacturing Co., of Antwerp. Size complete with mounting plug is  $3\frac{1}{8}$  by  $1\frac{1}{8}$  by  $1\frac{3}{8}$  in. above the socket (the socket adds  $\frac{1}{4}$  in. to length).

The relay provides for sequential switching of 12 circuits with an addi-

tional signal contact. Its nylon rotor reduces lubrication requirements and ensures a life of 5 to 10 million complete cycles. Operation speed under self-interruption is 60 steps per sec, the maximum rate using impulse drive being 35 steps per sec. The mounting socket incorporates a supporting and locking security yoke.

This relay has many applications wherever circuits with one common lead have to be switched sequentially, impulses recorded, batches counted, etc. Currents up to 0.5 A 60 V d.c. (non-inductive) can be safely handled by the silver alloy contacts.—*Electro-Mechanical Division, Standard Telephones and Cables Ltd., West Road, Harlow, Essex.*

For further information circle 37 on Service Card

### 38. Positioning Screwdriver

The 'Tenax' screwdriver, incorporating a positioning device which engages and holds screws firmly in position, is being distributed by Henri Picard & Frere.

In a range of six patterns, the positioners have practical applications in all industries where awkward screw placings are likely to be encountered. The tools are of particular use for removing screws without risk of their falling into some inaccessible part of the equipment or machinery.

The positioners are robust, yet neat in design. A slim, spring-loaded tube fits over the shaft of the screwdriver: when pushed forward, the blade is cleared to allow a screw to be placed

in the counter-sunk recess. This, as well as the subsequent release of the screw, is a simple, quick, one-handed operation. The portion of the blade projecting beyond the attachment is sufficient to permit the screwdriver to be used in the normal manner, but the positioner may be detached by unscrewing the tube section.

In addition to models for holding flat and round design slotted head and Philips pattern screws, special positioners working on the same principle for use with nuts and bolts are also available.—*Henri Picard & Frere Ltd., 34/35 Fournival Street, London, E.C.4.*

For further information circle 38 on Service Card

### 39. Photo-Electric Tape Reader

A low-cost, bi-directional photo-electric perforated tape reader, designed for applications where tape is read at speeds up to 300 characters per second, has been announced by Digitronics.

All solid-state, complete with self-adjusting brakes, the model B2500 utilizes silicon photo-diodes, and offers single speeds at 100 to 300 characters per sec.

Ideal for applications which include machine tool controls, numerical controls and slower speed digital instrumentation, this unit accommodates paper or Mylar tape 0.004 to 0.005 in. thick. It can be adjusted to operate with tapes from 0.0025 to 0.008 in. thick, and tapes with up to 40% transmissivity are acceptable.

The reader is available in either desk or panel mount. The panel mount is



36

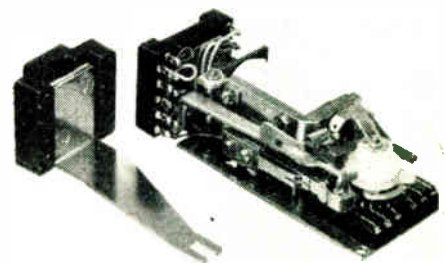

37

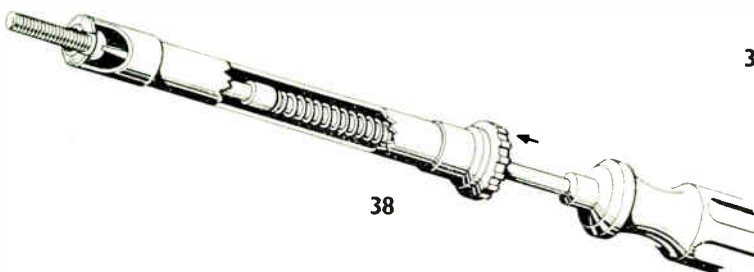

38



39

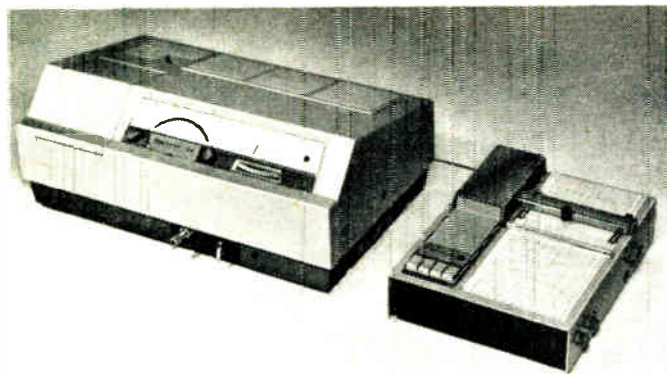

40

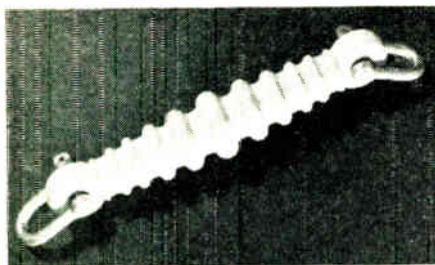

41

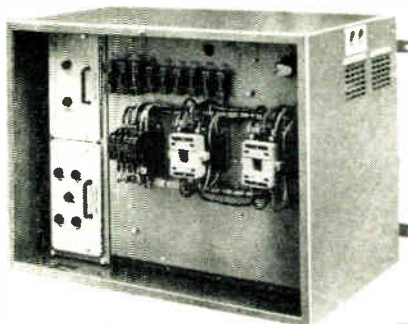

42

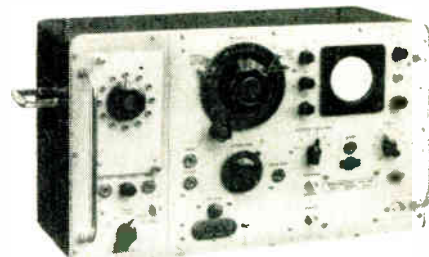

43

suitable for a standard 19 in. rack. Dimensions without rack adapter: height, 6 in.; width, 10 in.; depth behind front panel, 11 in.; extension forward of front panel, 2 $\frac{1}{4}$  in.; panel thickness,  $\frac{1}{8}$  in.; rack adapter thickness,  $\frac{1}{8}$  in.; height, 7 in.—*Digitronics Corporation, Albertson, N.Y., U.S.A.*

For further information circle 39 on Service Card

#### 40. Spectrophotometer and Recorder

The manufacturers claim that accurate chemical analysis measurements can now be performed in less than half the time with the Beckman DB spectrophotometer and recorder. The use of a double-beam system eliminates most of the adjustments necessary for individual readings with conventional instruments. Fast differential analyses can be made without the time factor involved in manual recording.

The model DB ultraviolet spectrophotometer is a double-beam/single-beam direct-reading instrument, designed for rapid transmittance and absorbance measurements in the 205 to 770 m $\mu$  spectral range (using hydrogen and tungsten lamp sources). With its wide wavelength range and ease of operation, the model DB is particularly suitable for qualitative analysis, quantitative analysis and reaction rate

study. When used with the recorder, it becomes a low-cost ratio-recording spectrophotometer.

The potentiometric strip-chart recorder is an instrument designed to monitor and record d.c. signals in the 0 to 100 mV range, and has a full-scale range infinitely variable between 10 and 100 mV. With a variety of sensing elements, this 5-in. recorder can plot such variables as frequency, speed, pressure, strain, temperature, flow and pH. The unit stands horizontally on a bench or table adjacent to other instruments, or can be mounted vertically on the wall to conserve space.—*Beckman Instruments Ltd., Glenrothes, Fife, Scotland.*

For further information circle 40 on Service Card

#### 41. Marine Aerial Insulator

A fibreglass aerial insulator introduced to the range of marine equipment marketed by A.E.I. has good hygroscopic properties and a negligible coefficient of expansion.

It will withstand a breaking strain greater than 1,900 lb and, when its surface is wet, has a peak working voltage greater than 25 kV at 500 kc/s.

This insulator conforms to all relevant tracking and arc resistance tests, and is supplied with shackles fitted to

the eyelets at each end. Overall dimensions (without shackles) are: length 12 in., diameter 2 $\frac{1}{4}$  in.—*Marine Communications Department, A.E.I. Telecommunications Division, Woolwich, London, S.E.18.*

For further information circle 41 on Service Card

#### 42. Variable-Speed Motor-Control Unit

Lancashire Dynamo has produced a compact variable-speed motor-control unit, the Transidyne series TWL.11, designed for use with motors ranging from 1 to 3 h.p. The entire control system is housed in a compact wall-mounting cabinet 26 $\frac{1}{2}$  by 19 $\frac{7}{8}$  by 18 in. deep (illustrated). The M.G. set is conventionally constructed on a bed-plate for separate mounting.

The 'Transidyne' equipment uses a transistorized control system which reduces the electronic circuit to a minimum. A fully closed-loop servo system is employed in which either the motor armature voltage or a tachometer signal is used as a measure of the motor speed. This is compared to the required speed, set by the speed-control potentiometer, and any resulting error is used to adjust the output of the generator and hence the motor speed.

In the case where an armature feed-

back system is used, a further correction signal is employed, being proportional to the motor load, thus ensuring close control and holding of the desired motor speed irrespective of load variations. In this arrangement the zero to full-load speed holding is within  $\pm 1\%$ . In the case of the tachometer feedback system, the regulation is  $\pm 0.3\%$ .

A 20:1 speed range with constant load characteristics is normally available, but can be increased (with limit on motor output) where required. A full range of control features is provided, including reversal, inching, tacho-feedback, etc.—*Lancashire Dynamo Electronic Products Ltd., Rugeley, Staffs.*

For further information circle 42 on Service Card

### 43. Wobuloscope

The Metrix Wobuloscope type 232 is intended for setting up r.f. and i.f. stages of television and f.m. receivers up to and including the discriminator. The instrument covers from 5 to 230 Mc/s and from 470 to 860 Mc/s. This makes it suitable for all standards of television and f.m.

A quartz-controlled marker generator is incorporated: the 12-position turret may be fitted with pairs of crystals corresponding to sound and vision frequencies on up to 12 channels, and two separate quartz oscillators working at 1 and 10 Mc/s provide markers every 1 Mc/s up to 50 Mc/s. A built-in oscilloscope fitted with a high gain amplifier displays the response curve of the receiver under test.—*Bemex Instruments Ltd., 54 Victoria Road, Surbiton, Surrey.*

For further information circle 43 on Service Card

### 44. Small Current Measuring Equipment

Equipment designed to an N.P.L. specification to measure currents in the range  $10^{-10}$  to  $3 \times 10^{-15}$  A has been announced by Grundy & Partners.

This system works by measuring the time required for the current to charge a standard capacitor to a pre-determined voltage. Time and voltage are printed out at the end of each integration and the equipment will recycle up to 10 times.

Housed in two standard 19 in. instrument cases 3 ft high, the equipment comprises an electrometer, a transistorized programming unit, an 8-decade transistor timer fed by a 100-kc/s oscillator (accuracy: 1 part in  $10^6$ ), a 5-digit voltmeter (accuracy:  $\pm 0.02\%$  or 1 bit), and a printer.—*Grundy & Partners Ltd., 3 The Causeway, Teddington, Middlesex.*

For further information circle 44 on Service Card

### 45. Standard Frequency Divider

A solid-state standard-frequency divider for the delivery of plant frequency standard outputs to calibration benches, production lines and engineering laboratories is now available from Specific Products.

Designated as model SFD, the new unit is capable of providing outputs to as many as 14 remote stations. Due to the modular construction of the system, only the modules needed for each station are required. The system is fail-safe and foolproof and is claimed to have absolute phase lock and station isolation.

The model SFD uses a one-frequency narrow-band cable, d.c. power on a

coaxial centre conductor, solid-state circuitry throughout and short-proof current logic. Available in a bench mounting case (model SFD-6) or a rack mount model (model SFD-6R), a typical installation would include the divider, remote station isolation amplifier, decade scalars and wave shapers used in conjunction with a power supply and distribution amplifier.—*Sylvan Ginsbury Ltd., 8 West 40th Street, New York 18, N.Y., U.S.A.*

For further information circle 45 on Service Card

### 46. 'C' Band Waveguide Duplexer

The Canadian Westinghouse WD2A waveguide duplexer is designed to provide isolation between a 6-kW c.w. transmitter and a parametric amplifier receiver. The unit is tunable from 4.4 to 5.0 Gc/s with a receiver/transmitter spacing of 200 Mc/s.

Tuning is achieved by calibrated micrometers for maximum flat response. Low insertion loss (0.2 to 0.4 dB, dependent on frequency) makes it suitable for operation at high c.w. power. For power in excess of 2 kW, water cooling is required on the transmit filter section; under these conditions units have been tested to 7 kW without failure.

Featuring an advance in c.w. power handling capabilities, these duplexers are now in service with tropospheric scatter equipment. The design gives good rejection (around 20 dB) to transmitter harmonics. The dry weight is 12 lb 14 oz.—*Electronics Division, Canadian Westinghouse Co. Ltd., 286 Sanford Avenue North, Hamilton, Ontario, Canada.*

For further information circle 46 on Service Card

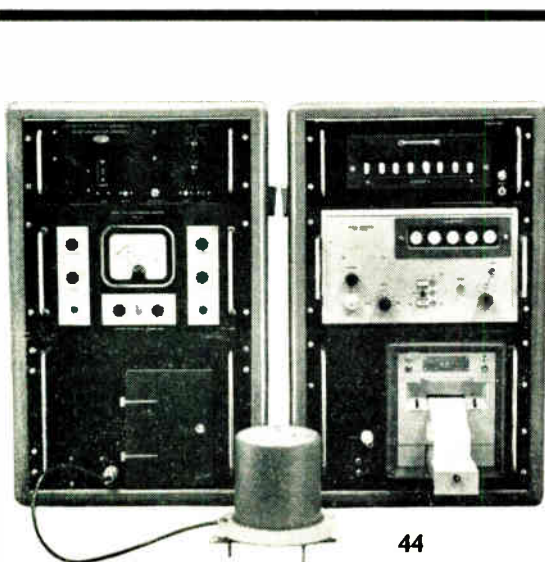

44



45

46

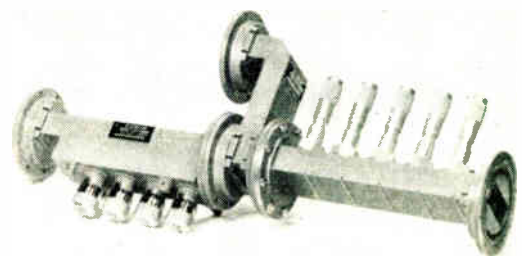



The author adjusts receiver controls as the E.M.I. type 8 closed-circuit television camera, without using a lens, transmits a picture of a transparency mounted in direct contact with the fibre optic window of the type 9686 tube

## Vidicon Camera Tube with a Fibre Optic Window

By A. C. DAWE, B.Sc.(Eng.),  
A.C.G.I., A.M.I.E.E.\*

This article describes the operation of a fibre optic window. The vidicon camera tube is then explained and finally the advantages of a vidicon incorporating a fibre optic window are discussed.

**A**N optical fibre is a fine strand of optical quality glass of high refractive index coated with a glass of lower refractive index. Light rays which enter the fibre at an angle to the axis of less than about  $60^\circ$  are repeatedly reflected from the walls as they travel down the fibre until they are finally emitted from the far end of the fibre at the same angle to the axis as at the input. The transmission efficiency is high and in flexible systems where special combinations of glasses are used this figure could be as high as 80% for a 3-ft length.

Complete optical images can be transmitted, element by element, by a tight bundle of fibres, provided the ends of the fibres are in the same relative position at both ends of the bundle. A bundle in which there is a specific relationship between the fibre ends at both ends of the bundle is called a coherent bundle. It is possible to taper bundles of fibres and a coherent tapered bundle can be used as an image magnifier.

In a fibre optic window, a very large number of short length fibres are fused together parallel to one another and normal to the polished window surfaces.

Fig. 1 shows a section of the fibre optic window used in the new E.M.I. vidicon tube type 9686. It will be seen that the coating glass is very thin and that the fibres are nearly touching each other, so giving a light transmission area of little less than a normal glass window. Each fibre is nearly 6 microns in diameter and about 2 mm in length, so that the transmission efficiency of each fibre is nearly 100%. The window diameter is about 1 in. Fig. 2 shows a micro-photograph of a portion of the window surface of the 9686 vidicon.

Fig. 1 also shows the path of a light ray in one of the fibres. It can be seen that the angle of the emergent ray to the fibre axis must be the same as the angle of incidence  $i$ . The maximum angle of incidence is computed in the Appendix for a fibre of refractive index 1.72 with a coating of refractive index 1.48. The angle is  $61^\circ$  and so the total acceptance angle of the window is in excess of  $120^\circ$ .

### Vidicon Tube

A vidicon is a small, relatively inexpensive television camera tube, which is employed in nearly all industrial television cameras and widely used in television broadcasting. The majority of vidicon tubes are about 6 in. long and 1 in. in diameter, although tubes are available with diameters as small as  $\frac{1}{2}$  in. and up to 2 in. Fig. 3 shows a typical 1-in. vidicon tube.

\* E.M.I. Electronics Ltd.

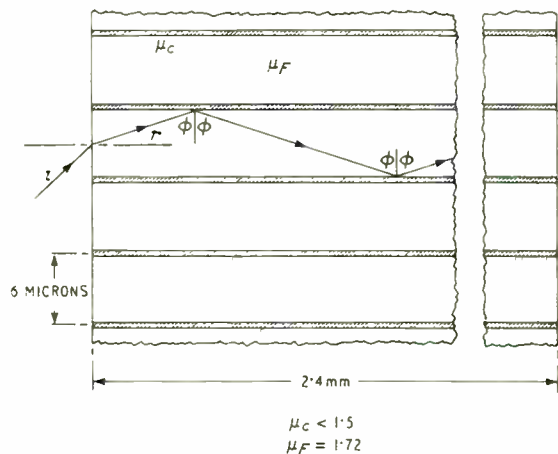

Fig. 1. Section of fibre optic window for E.M.I. vidicon type 9686

On the inside of the window is a transparent conductive coating, called the signal plate, which is connected to the signal electrode ring at the junction of the window and the tubular envelope. Deposited on the signal plate is a layer of photoconductive material constituting the sensitive target. This material has a high resistance in the dark but the resistance falls with increasing illumination.

An electron gun, mounted at the other end of the tube from the window, gives a beam of low velocity electrons. This beam is focused and scanned across the target by external magnetic coils in conjunction with a suitable wall anode electrode and ion-trap mesh. A positive voltage is applied to the signal plate via a signal resistor and, in the dark, the effect of the low velocity scanning beam is to stabilize the surface of the target at gun-cathode potential so that a potential difference is set up across the target. Where light falls on the target a more conductive path is established, current flows across the target and the potential of the illuminated elements rises towards the signal plate potential. When the scanning beam reaches the illuminated elements, it restores them in turn to gun-cathode potential and, because of the capacitive coupling between each element and the signal plate, generates a chain of current pulses in the signal resistor which constitutes the video signal.

The normal target area of a 1-in. vidicon is  $\frac{1}{2}$  in.  $\times$   $\frac{1}{8}$  in., but nevertheless there is little difficulty in resolving 1,200 black and white lines per picture width (i.e., 900 television line resolution).

#### Fibre Optic Vidicon

The E.M.I. fibre optic window vidicon type 9686 is shown in Fig. 4. It has the dimensions of a standard 1-in. tube and has a fibre optic window in place of the normal glass window. The tube also differs from earlier standard tubes in that the gun has a low wattage heater (6.3 V, 95 mA) to reduce the total power consumption.

The scanned target area is  $\frac{1}{2}$  in.  $\times$   $\frac{1}{8}$  in. and there are, therefore, about 2,100 fibres per picture width. When tested with a test chart and lens focused to give an image on the front face of the window, the limiting resolution is about 1,000 lines per picture width (i.e., 750 television line resolution), which is quite adequate for most purposes.

The great advantage of the type 9686 tube is that it can be very easily and efficiently coupled to any light image emitting tube which is also fitted with a fibre optic window, e.g., image intensifier, X-ray image intensifier or a cathode-ray tube, by simply bringing the two windows into intimate contact and adjusting their positions to get the best resolution. The need for focusing is removed, but the image magnification is unity unless a coherent tapered bundle of fibres is used between the two tubes. The great advantage, however, is that the efficiency of light transfer from one tube to the other is over 80%. This can best be illustrated by considering an  $f/1.9$  lens coupling two tubes with an image magnification of unity.

$$\text{Image brightness} = \frac{BT}{4f^2 (M + 1)^2} \text{ foot-candles}$$

where  $B$  is the brightness of the object in foot-lamberts

$T$  is total transmission of lens, say 80%,

$f$  is lens aperture (1.9)

$M$  is linear magnification (1)

therefore image brightness =  $B/72$

Even when using an  $f/1$  lens, the object brightness would be reduced by 20 times, whereas there is only about one-third of this reduction with the fibre optic window and no lens.

Another very interesting type of application for the

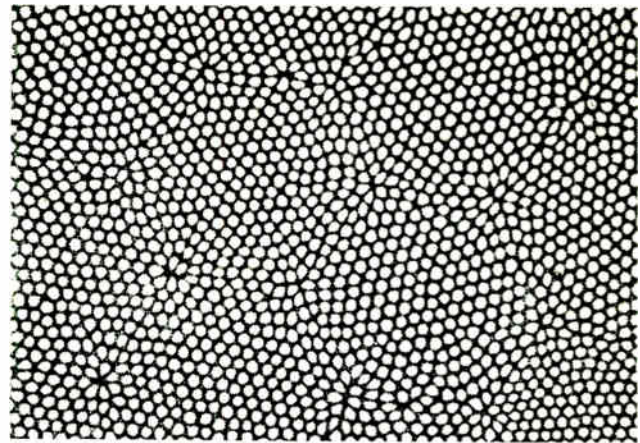

Fig. 2. Microphotograph of the fibre optic window surface

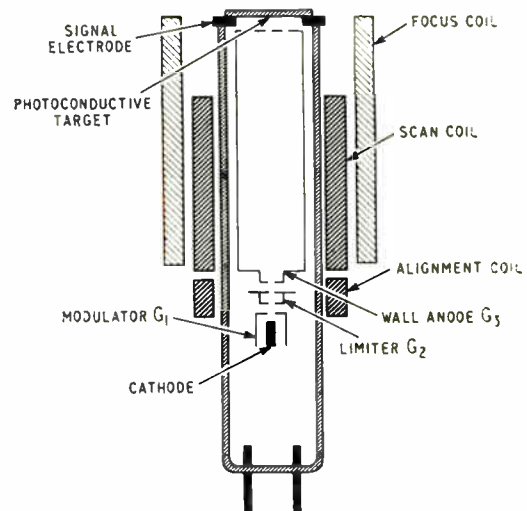
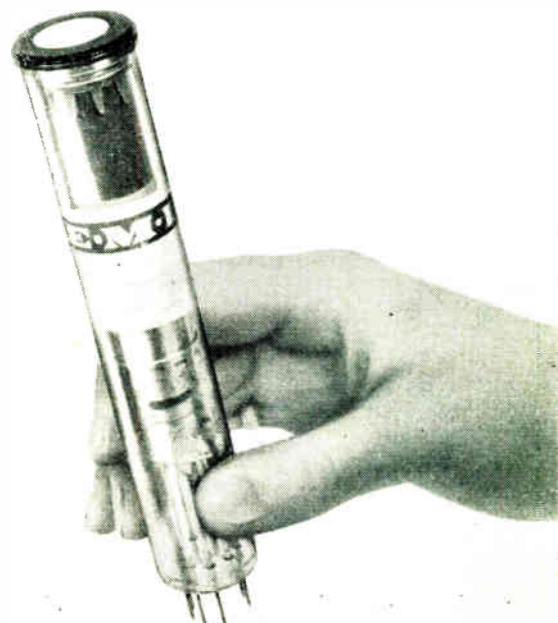

Fig. 3. Diagrammatic arrangement of 1-in. vidicon with scan and focus coils

Fig. 4. Photograph of E.M.I. vidicon type 9686 with fibre optic window



fibre optic vidicon is the production of hard ultra-violet images by means of a suitable phosphor deposited on the outer surface of the fibre optic window, and this has been proposed for satellite astronomy.

An obvious application is coupling the tube to a long flexible coherent bundle of fibres for use as an endoscope.

Finally, the fibre optic window does not prevent the tube from being used with a lens in the normal way, provided the image is focused on the outer surface of the window. An acceptance angle of over  $110^\circ$  is adequate for almost any practical lens system.

The fibre optic window used in this tube has been developed and manufactured by the George Elliott Laboratories, Sunbury-on-Thames, Middlesex, in co-operation with A.W.R.E., Aldermaston.

The author wishes to express his thanks to the George Elliott Laboratories for their valuable assistance and to

A.W.R.E., Aldermaston, for the photograph shown in Fig. 2. Thanks are also expressed to the directors of E.M.I. Electronics Ltd. for permission to publish this article.

#### Appendix

Referring to Fig. 1, if  $i$  and  $r$  are the angles of incidence and refraction and  $\mu_F$  and  $\mu_C$  are the refractive indices of the fibre and its coating,

$$\sin i = \mu_F \sin r = \mu_F \sin (90 - \phi)$$

and for total internal reflection to occur it is necessary to have

$$\phi > \sin^{-1} \mu_C / \mu_F$$

Therefore,

$$\begin{aligned} \sin i_{max} &= \mu_F \sin (90 - \sin^{-1} \mu_C / \mu_F) \\ &= \sqrt{(\mu_F^2 - \mu_C^2)} \end{aligned}$$

With  $\mu_F = 1.72$  and  $\mu_C = 1.48$ ,  $\sin i_{max} = 0.875$  and  $i_{max} = 61^\circ$

## MASS SPECTROMETER FOR QUANTITATIVE GAS ANALYSIS IN HIGH VACUUM SYSTEMS

IN many research projects and manufacturing processes carried out in a vacuum it is often necessary to analyse the residual gases in the system in addition to measuring the total pressure. The 'Speedivac' Omegatron mass spectrometer provides a comparatively inexpensive method of identifying the component gases without deterioration of performance due to distortion of the head electrodes after hot degassing. In the Omegatron

importance when it is used on an ultra-high vacuum system. The envelope can be sealed directly to a Kovar outlet tube for connection to metal vacuum systems. The magnet, of about 5,000 gauss, is mounted on a special table possessing three degrees of freedom so that it can be positioned precisely with respect to the axis of the head.

To operate the Omegatron and to ensure that the best possible performance can be obtained from it, a convenient and comprehensive system of control and indicating equipment has been developed. The control system comprises: a power unit which accurately establishes and maintains the correct head operating parameters, particularly the ionizing current which is controlled to within  $\pm 1\%$  over the range 0.5 to 50  $\mu\text{A}$ ; a signal generator for the application of the necessary scan frequencies to the r.f. electrodes; a variable time constant d.c. amplifier, with a maximum sensitivity of  $10^{-13}$  A f.s.d., to indicate ion collector current, and a 'Speedivac' model 1 Ionization-Pirani gauge for general measurement of pressure in the range 1 to  $10^{-7}$  torr. A pen recorder, with a second pen for frequency marking, can be supplied although a suitable existing recorder can be used.

**For further information circle 49 on Service Card**

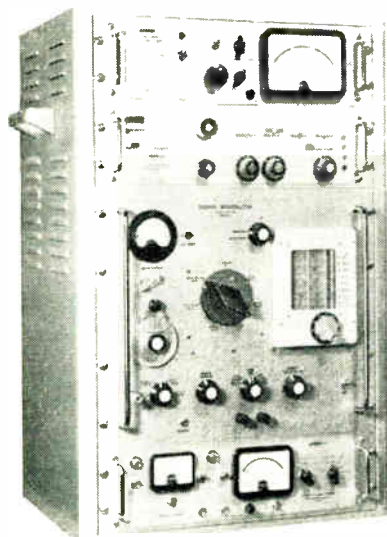

*The Omegatron control unit*

this problem has been solved by the use of high quality ceramics in an accurately aligned 'stack' structure. The use of a low temperature lanthanum boride coated rhenium filament and platinum-iridium electrodes also contribute to long term stability.

The mass range of the instrument is 1 to 200 a.m.u. and the sensitivity is about 15/torr for nitrogen. The resolution gives complete separation up to mass 44 and very good separation up to at least mass 60. The pressure range is  $10^{-5}$  to  $10^{-11}$  torr. Baking can be carried out to  $450^\circ\text{C}$  and complete degassing by eddy-current heating to  $900^\circ\text{C}$ . The volume of the glass head is only about 80 c.c., which is of considerable

*The 80 c.c. glass head*

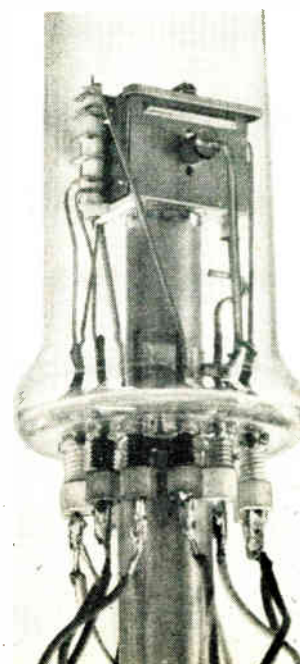



A basic dynamic storage circuit is described which employs capacitors as the storage elements and p-n-p-n diodes for coupling. From this basic element a versatile and flexible counter and pattern register are developed.

## A DYNAMIC DIODE-CAPACITOR STORE

By J. B. WARMAN, M.I.E.E.\* and H. J. STIRLING\*

THE basic dynamic diode-capacitor store stems from a reversal of the normally accepted design philosophy for counters and shift registers. Conventionally, these employ a switching diode or triode as the storage device, the conducting or non-conducting state indicating the yes-no condition. Capacitors are used to couple between stages. However, the dynamic diode-capacitor store under consideration uses capacitors to store the information, the yes-no condition being indicated by their relative charges. The stages are interconnected by p-n-p-n diodes.

Use is made of the two stable states of the p-n-p-n diode characteristic. First, the off or high-impedance state provides the necessary isolation between adjacent stages and secondly the on or low-impedance state provides coupling between adjacent stages when it is desired to transfer information from one storage capacitor to the next.

Reference to Fig. 1 will afford a clearer understanding of the properties of the p-n-p-n diode. In the off state, at voltages appreciably less than the breakdown value, the device has a very high impedance. This corresponds to region I. As the voltage approaches the breakdown value,  $V_s$ , the slope vanishes (region II) and the slope of the curve becomes negative (region III). This high negative resistance persists until the diode saturates and a small positive resistance results (region IV). The device is now 'on' and the voltage drop,  $V_m$ , is very low.

When biased in the reverse direction the device exhibits a high impedance (region V) until the voltage reaches a critical value,  $V_{ZB}$ , whereupon the curve assumes a negative slope (region VI). The curve then assumes an almost zero slope (region VII) with the voltage across the device,  $V_M$ , fairly high.

The p-n-p-n devices available will switch on in less than 50 nps. However, the switching voltage is, to some extent, dependent upon the rise-time of the applied pulse. It has been found that for batches of diodes having a nominal strike voltage of 100 V, the voltage at which the individual diodes strike may be as low as 80 V when the applied switching pulse has a rise-time of 100 V per microsecond. To obviate this, a rise-time of 10 V per microsecond has to be employed. With this order of rise-time all devices strike within 5% of their nominal rated voltage. This facet obviously limits the upper speed of recurrent operation of a p-n-p-n diode.

### Basic Storage Element

The basic storage element shown in Fig. 2 comprises essentially a p-n-p-n diode, SD<sub>1</sub>, and two capacitors, C<sub>1</sub> and

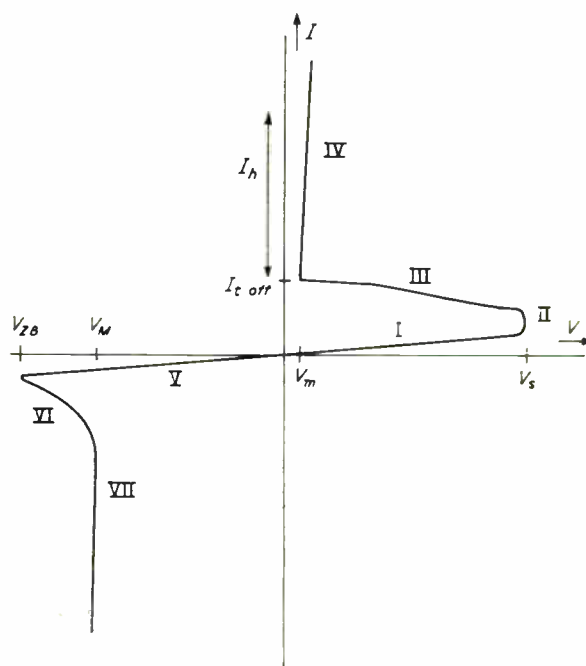

Fig. 1. Characteristic curve of a p-n-p-n diode

C<sub>2</sub>. Assuming that both capacitors are initially uncharged and that  $C_1 = C_2$ , the following sequence of operations takes place.

(i) Switch S<sub>1</sub> is closed, so applying the storage voltage,  $V_{st}$ , to capacitor C<sub>1</sub>, which charges until the voltage across it is  $V_{st}$ . This raises the anode voltage of SD<sub>1</sub> to  $+V_{st}$  volts (which must be less than its strike voltage,  $V_s$ ).

(ii) Switch S<sub>1</sub> is opened and S<sub>2</sub> closed to apply the transfer pulse,  $V_t$ , to the junction of capacitor C<sub>1</sub> and resistor R<sub>1</sub>. This causes the voltage at the anode of the diode to rise to  $V_t + V_{st}$ .

(iii) Provided  $V_t + V_{st} > V_s$ , the diode switches to its low-impedance state. The resulting current flow through the diode causes capacitor C<sub>1</sub> to lose its charge and C<sub>2</sub> to gain an equal

\*Advanced Development Laboratories of Associated Electrical Industries (Woolwich) Ltd.

amount of charge. Because  $C_1 = C_2$ , the fall in voltage across  $C_1$  equals the rise in voltage across  $C_2$ . Thus, if the voltage across  $C_1$  falls from  $V_{st}$  to  $V_{C1}$  while that across  $C_2$  rises from zero to  $V_{C2}$ :

$$V_{C2} = V_{st} - V_{C1}$$

This assumes that the voltage across the diode remains constant at  $V_m$  while the holding current,  $I_h$ , decays exponentially until  $I_h = I_{t\ off}$ . At this point the diode switches off. In practice  $V_m$  is not constant but the slope resistance of the on characteristic is small and may be ignored.

Now the anode voltage =  $V_t + V_{C1}$

and the cathode voltage =  $V_{C2}$

therefore  $V_m = V_t + V_{C1} - V_{C2}$

Thus:

$$V_{C2} = \frac{1}{2}(V_{st} + V_t - V_m) \quad (1)$$

$$V_{C1} = \frac{1}{2}(V_{st} - V_t + V_m) \quad (2)$$

(iv) When the transfer pulse ceases the anode voltage of the diode falls to  $V_{C1}$  and the cathode voltage remains at  $V_{C2}$ .

If the amplitude of the transfer pulse is chosen to be:

$$V_t = V_{st} + V_m \quad (3)$$

then equations (1) and (2) reduce to:

$$V_{C2} = V_{st}$$

$$V_{C1} = 0$$

Thus, by using a pulse of controlled amplitude it is possible to transfer the voltage ( $V_{st}$ ) stored on capacitor  $C_1$  to the capacitor  $C_2$ . It is assumed that the duration of the transfer pulse,  $V_t$ , is greater than the information transfer time.

The foregoing explanation is valid for any form of switching diode whether of the cold-cathode or semiconductor type. However, the maintain voltage,  $V_m$ , for a p-n-p-n diode is usually less than 1 V and is negligible compared with the strike voltage,  $V_s$ , which for convenience may be nominally 100 V. Then, in equation (3)  $V_m$  can be disregarded and  $V_t \approx V_{st}$ .

It would appear that  $V_t$  can be  $\frac{1}{2}V_s$ . However, in practice, a voltage approximately 10% higher than this is required to cater for the tolerance on  $V_s$ . Thus, for a diode having a strike voltage of 100 V,  $V_t$  should be approximately 55 V.

### Practical Counter

Any desired number of basic storage elements may be connected in tandem, as shown in Fig. 3. The transfer pulses  $P_1, P_2$ , etc., are applied sequentially. A storage charge,  $V_{st}$ , is applied to capacitor  $C_1$  by closing the switch  $S_1$ . When pulse  $P_1$  is applied to capacitor  $C_1$  via resistor  $R_1$  the charge

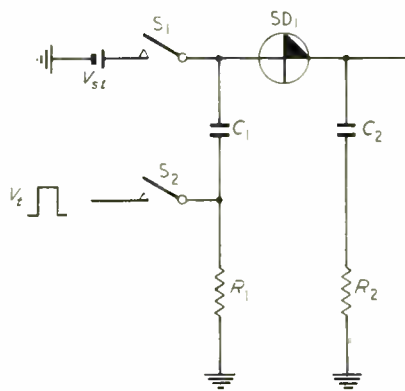

Fig. 2. Basic storage element

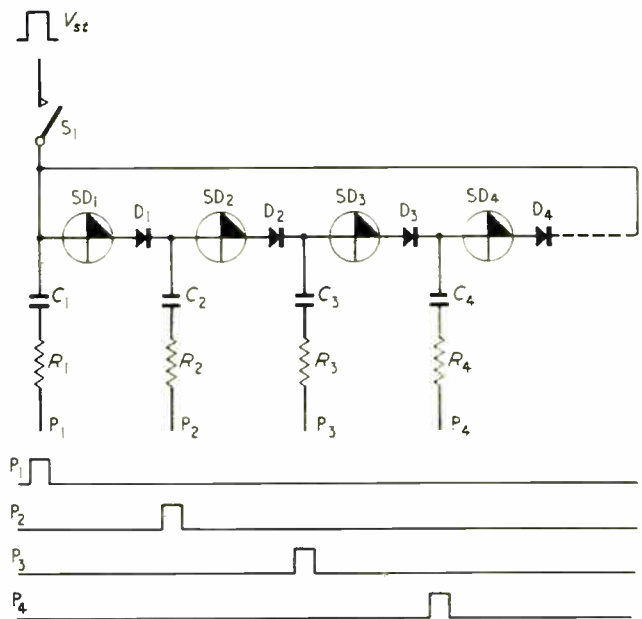

Fig. 3. Practical counter circuit

is transferred to capacitor  $C_2$  as previously described. Similarly when pulse  $P_2$  is applied to capacitor  $C_2$  the charge is passed to  $C_3$  and so on. If the last stage is connected back to the first, a ring counter is produced. Any charge that is introduced into the circuit via  $S_1$  will then circulate for as long as the transfer-pulse trains are applied. The circuit thus provides a dynamic store with periodic access like a delay-line circulating system or a track of a magnetic drum store.

It will be noticed that the counter circuit of Fig. 3 deviates from the circuit of Fig. 2 in as much as the transfer pulses are applied in series with the resistors  $R_1, R_2$ , etc., instead of in parallel. These resistors limit the peak current excursions when the p-n-p-n diodes initially switch on. If these resistors were not included, the diodes might be damaged by surges in excess of the maximum rated forward current for the device.

The circuit of Fig. 3 employs as many transfer-pulse generators as there are stages. However, the number of pulse generators can be reduced to two. Resistors  $R_1, R_3, R_5$ , etc., are connected together and fed by one pulse generator and  $R_2, R_4$ , etc., are connected to the second generator.

The diodes  $D_1, D_2$ , etc., are included because the reverse Zener breakdown of the p-n-p-n diodes is often less than their forward breakdown voltage, as shown in Fig. 1. If, for example, the additional diode  $D_1$  was omitted and the value of  $V_{ZB}$  for  $SD_1$  is less than the value of  $V_s$  for  $SD_2$ , the transfer pulse voltage may be clamped by the Zener effect of  $SD_1$  and fail to strike  $SD_2$ . The diodes  $D_1, D_2$ , etc., are chosen to have a higher reverse breakdown voltage than  $V_s$ , thus obviating the danger.

### Compensating Actions in the Chain

The ring counter described above may appear to be impracticable due to the assumption that all stages have identical components, thus producing perfect transfer. This would be true but for certain compensating actions which operate.

The description of storage and transfer actions given above, assumed that the maintain voltage,  $V_m$ , is identical for all devices used in the chain, and that  $V_t$  is the same for each stage. In practice, however, these quantities may vary from stage to stage. Consequently, equation (3) is not satisfied; the previous capacitor is left charged either positively or nega-

(continued on page 581)

# SPECIFY RELIABILITY WITH...

**H** Rugged, sub-miniature  
all glass construction

**H** High conductance

**H** Low leakage

**H** Operation up to 200°C

**H** 

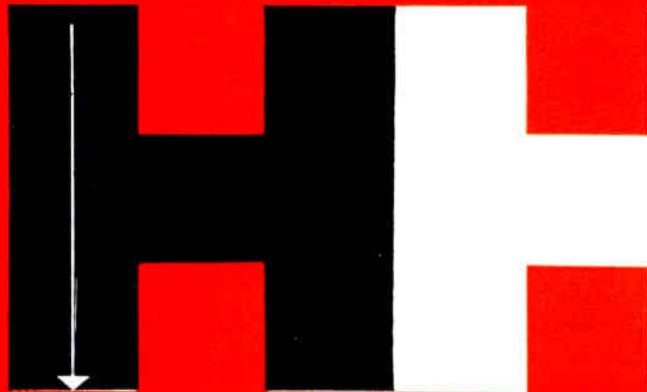

**HUGHES INTERNATIONAL (U.K.) LTD**

## Silicon General Purpose and Computer Diodes

- Extremely low reverse leakage over wide temperature range
- Max. average power dissipation 200mW
- Nominal capacitance at -10V 5pF
- Operating and storage temperature range -65°C to 200°C

CV7040  
CV7332

### GENERAL PURPOSE DIODES

Type	P.I.V.	Maximum Average Rectified Current (mA)	Max. Reverse Current " 25°C (μA)	P.I.V. (μA) 100°C
HS1020	200	165	0.020	2.0
HS1001	150	120	0.050	5.0
HS1004	50	120	0.050	5.0
HS1007	150	90	0.050	5.0
HS1010	50	90	0.050	5.0

- Low capacitance
- Typical recovery time . . . 1.5 nanosec
- Typical stored charge . . 60pC
- Max. Power dissipation (25°C) . . . 250mW

### DIFFUSED PLANAR COMPUTER DIODES

Type	Maximum Inverse Voltage	Minimum Forward Current (mA @ 1V)	Max. Reverse Current " 25°C (μA)	Max. Reverse Current " V	Maximum Capacitance (pF @ 0V)
1N251	30	5	0.1	10	—
1N252	20	10	0.1	5	2
1N914	75	10	0.025	20	4
1N914A	75	20	0.025	20	4
1N916	75	10	0.025	20	2
1N916A	75	20	0.025	20	2

- Typical recovery time (to 1mA) 0.5 nanosec
- Max. capacitance at 0V 1pF
- Max. power dissipation 75mW

### ULTRA FAST RECOVERY COMPUTER DIODES

Type	Min. Breakdown Voltage " -100μA	Maximum Average Rectified Current (mA)	Max. Reverse Current " 25°C (μA)	Max. Reverse Current " -5V (μA) 100°C
HD5000	20	12	0.2	2.0
HD5001	20	12	1.0	10.0
HD5004	15	12	1.0	20.0

**WRITE NOW** for complete data on the full range of Hughes semi-conductor products, which also includes: Silicon Power Diodes and Rectifiers ● Germanium Point-contact and Gold-bonded Diodes ● Voltage Reference Devices ● High Voltage Cartridge Rectifiers ● Voltage Variable Capacitors ● PNP and NPN Silicon Transistors — or ask for a Sales Engineer to call.

**HUGHES INTERNATIONAL (U.K.) LTD**

KERSHAW HOUSE, GREAT WEST ROAD, HOUNSLOW, MIDDLESEX TEL: HOUNSLOW 5222  
M C & P HMI

# GETTING THE MEASURE OF CLEANING...



Cleaning an intricate meter recording mechanism with the aid of the DAWE SONICLEAN Type 1160 Tank and Transducer Assembly and Type 1150A Generator.

## by Ultrasonic action

Ultrasonics are not the answer to every cleaning problem, but they do give outstanding results in both speed and thoroughness when cleaning metal parts prior to electroplating, protective coating, and other finishing processes. The ultrasonic action not only works simultaneously on all surfaces of the object being cleaned but reaches into all crevices, indentations, holes, pores and complex contours that are inaccessible in the normal way. Dawe produce a wide range of ultrasonic cleaning tanks (from 5 pints to 22 gallons capacity) and an associated range of ultrasonic generators. The technical sales department is always ready to advise you on your exact power and capacity requirements.

# DAWE

Full technical data from:—

**DAWE INSTRUMENTS LTD., WESTERN AVENUE, ACTON, LONDON, W.3 Tel: ACOrn 6751**

A member of the *Simms* group of companies

tively and the succeeding capacitor is left charged to a voltage different from that originally on the preceding stage. Now,

$V_m$  and/or  $V_{st}$  high, or  $V_t$  low, gives positive potential left on previous capacitor.

$V_m$  and/or  $V_{st}$  low, or  $V_t$  high, gives negative potential left on previous capacitor.

Also from equation (1):

$V_m$  and/or  $V_{st}$  high, or  $V_t$  low, gives low potential left on subsequent capacitor.

$V_m$  and/or  $V_{st}$  low, or  $V_t$  high, gives high potential left on subsequent capacitor.

If, for example, one diode has  $V_m$  high, then the voltage left on the subsequent capacitor will be low, but a positive voltage is left on the previous capacitor which supplements the voltage produced next time the stage is operated. Thus a measure of compensation is obtained as a charge is caused to rotate repeatedly round the ring.

Similarly, since the turn-off current of the diode is not zero, the previous capacitor in the chain will be left with a greater or lesser positive charge depending upon the value and variation of  $I_t$  off.

If the storage capacitors leak, then the stored voltage gradually falls. This leakage continues all the time the charge is circulating, since it must at any time be on one of the capacitors.

When the voltage stored on a capacitor falls below  $V_t - V_m$ , a negative potential is left behind when transfer takes place. This is subject to the compensating actions described above. For example, assume that leakage causes the p.d. across capacitor  $C_2$  (Fig. 3) to fall to  $V_{st} - dV$ . Then, from equations (1) and (2):

Transfer to  $C_3$  gives

$$\frac{V_{st} - dV}{2} + \frac{V_t - V_m}{2}$$

And left on  $C_2$  is:

$$\frac{V_{st} - dV}{2} - \frac{V_t - V_m}{2}$$

Now  $V_t - V_m = V_{st}$  [equation (3)]

∴ Transfer to  $C_3$  gives  $V_{st} - \frac{dV}{2}$  on capacitor  $C_3$

Transfer to  $C_3$  gives  $-\frac{dV}{2}$  on capacitor  $C_2$

It will be seen that although the stored potential has decayed by  $dV/2$  the potential on the other unmarked capacitor has also decreased by  $dV/2$  relative to the adjacent unmarked capacitors. This is, of course, an important condition for the continued cyclic rotation of the charge.

This indicates that as the capacitors continue to leak so the potential of the whole counter chain, on the side of the capacitors remote from the pulse sources, falls. There must be a limit to this negative excursion and it will be apparent that stability is achieved when the leakage of all the negative charges on the unmarked capacitors equals the leakage of the positive charges from the marked capacitors. If  $N$  = number of storage elements in a counter chain which is circulating one marking, then:

Approximately positive voltage on marked capacitor

$$= \frac{(N-1)}{N} V_{st}$$

Approximately negative voltage on unmarked capacitors

$$= V_{st}/N$$

The foregoing compensating actions of the counter chain may give rise to a negative potential being acquired by the storage capacitors. This can be obviated, as shown in Fig. 4, by the use of additional diodes  $D_{11}$ ,  $D_{12}$ , etc., to clamp the negative excursions to earth. With these diodes incorporated, the voltages about the circulating loop are more suitable for feeding to other circuitry which may be tied to constant potentials. Alternatively only diode  $D_{11}$  need be provided to clamp  $C_1$ . This has the effect of restoring the voltage level

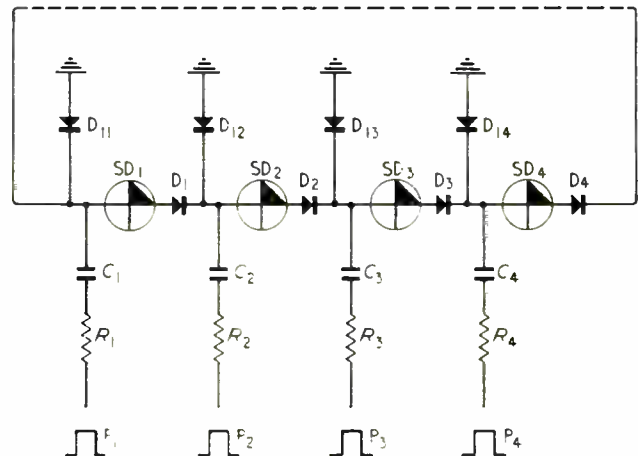

Fig. 4. Clamping negative excursions along the counter chain

to earth once every cycle. The voltage drift on other stages of the chain cannot now be greater than that attributable to one revolution of the counter.

### Modes of Operating the Counter

The counter already discussed employs transfer pulses having a positive excursion with respect to earth and stores positive charges which are shifted from left to right along the chain. However, several variations in polarity of both transfer pulse and the stored charge are possible.

Consider the circuit of Fig. 3 and assume that the transfer pulses  $P_1$ ,  $P_2$ , etc., have a negative excursion with respect to earth, all other circuit conditions being unaltered. If capacitor  $C_1$  is charged positively, when pulse  $P_1$  is applied, the anode voltage of p-n-p-n diode  $SD_1$  is reduced substantially to earth (since  $V_t = V_{st}$ ).  $SD_1$  does not switch on and when  $P_1$  ceases the anode voltage rises to  $V_{st}$  again. When  $P_2$  is applied, however, the cathode voltage of  $SD_1$  falls towards  $-V_t$ . This, together with the anode voltage of  $+V_{st}$ , is in excess of the strike voltage of the diode, which switches on. The resulting current discharges capacitor  $C_1$  and charges  $C_2$  so that, when pulse  $P_2$  ceases,  $C_2$  is left with the positive charge originally stored by  $C_1$ . Thus, by using negative transfer pulses, positive charges are shifted from left to right along the chain as in the case previously discussed.

Next consider the counter still employing negative transfer pulses but applied in the reverse order to the previous examples. This is shown in Fig. 5 where the pulse applied to  $C_4$ , for example, occurs before that applied to  $C_3$ . Assume a negative charge is present on capacitor  $C_1$ , all other capacitors being uncharged. The voltage on capacitor  $C_1$ , and hence the cathode voltage of  $SD_3$ , is at  $-V_{st}$  volts. When transfer pulse  $P_1$  is applied to  $C_1$ , the cathode voltage of  $SD_3$  is driven more negative towards:  $-V_{st} - (-V_t)$ . This exceeds the strike voltage of  $SD_3$  and the device switches on. Capacitor

$C_3$  now charges negatively while  $C_4$  discharges positively. Thus when  $P_1$  ceases, capacitor  $C_1$  is left uncharged while  $C_3$  is charged negatively to  $-V_{st}$  volts. Thus, by employing negative transfer pulses, a negative charge stored on a capacitor is shifted from right to left along the chain. This is the reverse of the information transfer direction of the two previous cases.

One final example is obtained by inverting the pulses of Fig. 5 but retaining the same pulse sequence. If a negative charge is stored on capacitor  $C_4$ , transfer pulse  $P_1$  will be ineffective because it will merely raise the cathode voltage of  $SD_3$  to earth. However, the application of  $P_2$  raises the anode voltage of  $SD_3$  towards  $+V_t$  volts which, together with the cathode voltage  $-V_{st}$ , strikes diode  $SD_3$ , so transferring the negative charge from  $C_4$  to  $C_3$ . Thus, the direction of information transfer is again right to left.

It can now be seen that by employing the same basic counter circuit the transfer pulses may be of positive or negative polarity and the stored information can also be positive or negative. However, if the cycling charge is positive, the direction of rotation will be from left to right, whereas if a

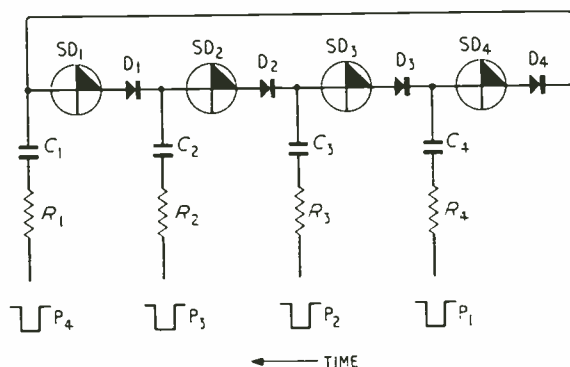

Fig. 5. Counter using negative transfer pulses

negative charge is cycling, this will pass from right to left along the chain.

### Cyclic Pattern Register

It has already been shown that a counter chain storing positive charges transfers the stored information from left to right. If now the direction of rotation of the transfer pulses is made opposite to this (i.e., from right to left), the counter becomes a cyclic pattern register. This is shown in Fig. 6(a).

Ignoring the 'read/write/erase' circuit of Fig. 6(b), consider diode  $D_1$  to be connected back to  $SD_1$  as shown dotted. Assume a positive charge is written into capacitor  $C_1$  just before transfer pulse  $P_1$  occurs. The charge will remain on  $C_1$  while pulses  $P_1$ ,  $P_2$ ,  $P_3$  are applied. When  $P_3$  is applied, however, the charge is transferred to  $C_2$  where it remains until the next  $P_3$  pulse occurs. On application of  $P_3$  the charge is transferred to  $C_3$  and so on. Thus any pattern of markings present in the register will be shifted one position down the chain by one complete cycle of pulses. It follows from this that any pattern of markings will be shifted once around the loop by  $N - 1$  pulse cycles, where  $N$  is the number of stages in the register.

It is a simple matter to evolve various forms of pattern register to utilize positive or negative transfer pulses together with positive or negative storage charges.

An additional circuit element may be connected in series with the return loop to provide write, erase and output facilities. This is shown in Fig. 6(b). The same read, write and erase stage may also be employed in the counter circuits previously discussed by inverting polarities, if necessary.

In order to regenerate pulses around the loop, switch  $S_1$  must be closed to provide a positive bias of  $+V_T$  volts on the anode of  $SD_5$ . If there is a positive charge on capacitor  $C_4$ , the following sequence of operations takes place:

- (i) Pulse  $P_1$  reverse biases diode  $D_6$  and strikes  $SD_4$ .
- (ii) The charge on  $C_1$  is now fed via  $SD_4$  and  $C_5$  to raise the anode voltage of  $SD_5$  from  $+V_T$  volts to  $+2V_T$  volts.
- (iii) Diode  $SD_5$  strikes, so charging capacitor  $C_1$  to  $+V_T$  volts (since  $V_T = V_{st}$ ). An output pulse of the same amplitude is also derived at the junction of resistor  $R_4$  and capacitor  $C_1$  which is provided to lengthen the pulse.
- (iv) At the end of pulse  $P_1$  capacitor  $C_5$  is discharged via diode  $D_6$  and resistor  $R_6$  to earth.

If it is desired to erase a particular marking, switch  $S_1$  is opened at the appropriate instant, so removing the positive bias on the anode of  $SD_5$ . The positive voltage from  $C_4$  is then insufficient to trigger  $SD_5$ , so the marking is not regenerated into capacitor  $C_1$ . To insert a marking, switch  $S_1$  is left closed and  $S_2$  closed prior to pulse  $P_1$ . Pulse  $P_1$  is then applied via capacitor  $C_6$  to strike  $SD_5$  and insert a marking into  $C_1$ . An output pulse can also be obtained from this stage. The output pulse is capable of driving 1 to 2 mA into the base of a transistor.

The foregoing explanation has assumed, for simplicity, that the control of the write/erase circuit is affected by means of mechanical switches. In practice, it is usual to use electronic gating circuits.

### Positive and Negative Charges in a Dynamic Counter

It has been shown that the same counter can be used to store positive or negative charges. It is interesting to consider the conditions pertaining when there are a positive and a negative charge present in the same counter at the same time.

Consider the circuit of Fig. 6(a) and assume that capacitor  $C_4$  is storing a negative charge and  $C_2$  storing a positive charge. Now the positive charge is attempting to transfer from left to right whereas the negative charge is attempting to move from right to left. The following sequence takes place:

- (i) Pulses  $P_1$  and  $P_1$  are ineffective.
- (ii) Pulse  $P_2$  raises the anode voltage of  $SD_3$  to  $+V_t$  volts.
- (iii) Diode  $SD_3$  experiences a voltage greater than  $V_s$  (since the cathode is already at  $-V_{st}$ ) and strikes.
- (iv) The voltage on  $C_1$  rises and that on  $C_2$  falls, so transferring the negative charge from  $C_4$  to  $C_3$ .
- (v) The anode of  $SD_2$  is already at  $+V_{st}$  volts. Therefore, as the voltage on the cathode falls to  $-V_{st}$ ,  $SD_2$  strikes before pulse  $P_3$  is applied to  $C_2$ . Thus, the negative charge is not stored on  $C_3$  but passes immediately to  $C_2$ .
- (vi) If now the capacitor  $C_1$  is storing a positive charge a similar action again takes place, with the negative charge 'jumping' without being transferred by the transfer pulses.

Thus a positive and a negative charge stored in the same counter cannot pass one another without causing a misoperation of the circuit.

It is interesting to note that if cold-cathode gas diodes were employed as the coupling elements instead of p-n-p-n diodes, the positive and negative charges could pass one another in opposite directions. This arises because  $V_m$ , in a gas diode, is considerable (say 60-80 volts). Then in equation (3)

$$V_t \neq V_{st} \text{ and } 2V_{st} < V_s$$

Therefore the stored charges stabilize to a lower value and may be caused to transfer past each other. Similar conditions could be reproduced with semiconductors by introducing a

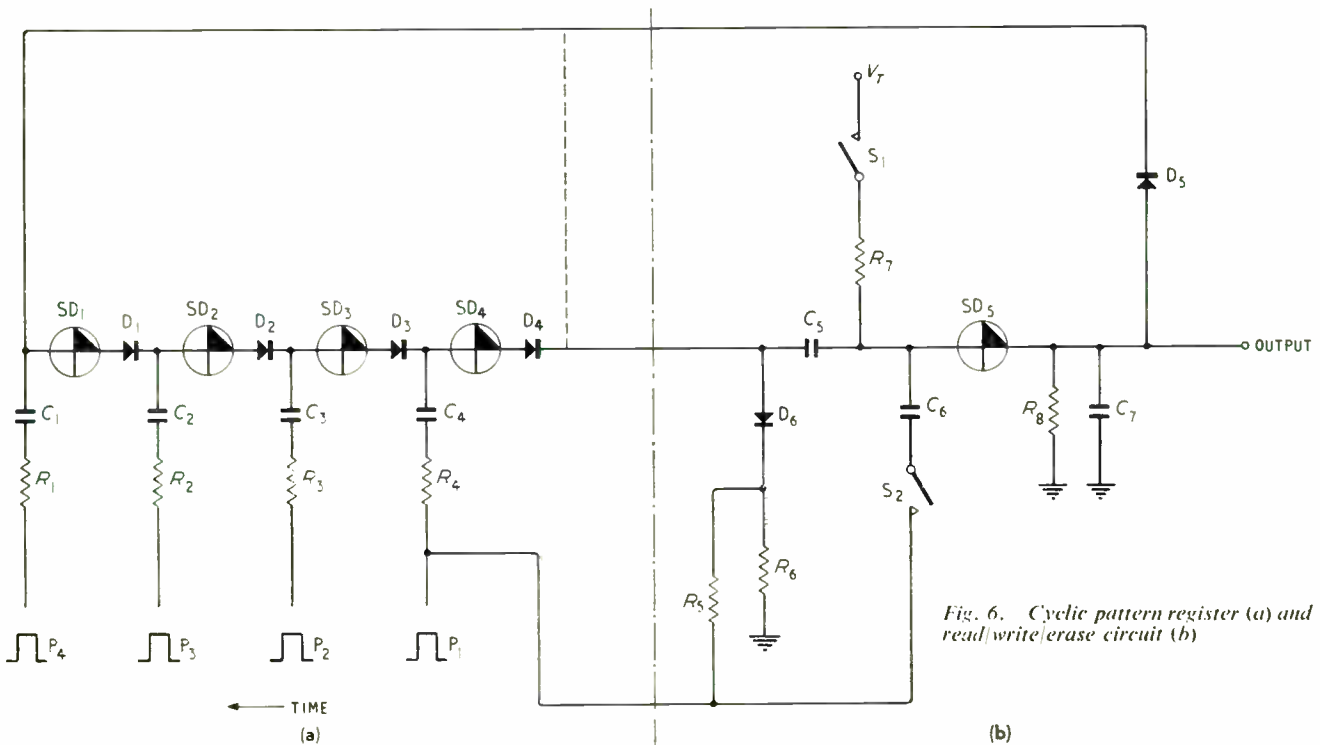

Fig. 6. Cyclic pattern register (a) and read/write/erase circuit (b)

Zener diode in series with each p-n-p-n diode. This would increase the effective maintaining voltage of the diode assembly to be similar to that of a cold-cathode diode.

#### Counter Circuit Terminated in a Mismatch

If the counter is terminated at each end in a resistor instead of a capacitor, the circuit behaves rather like a mismatched delay line.

Consider the circuit of Fig. 7 which employs the basic counter circuit of Fig. 2 except that each end is terminated in a resistor. If a positive charge is applied to capacitor  $C_1$  it is transferred from stage to stage down the chain from left to right. When the charge reaches the last capacitor, pulse  $P_3$  strikes  $SD_4$  and  $C_3$  discharges to earth through  $R_{m1}$ . When pulse  $P_3$  ceases, the voltage on both sides of  $C_3$  must fall by  $V_i$  volts so leaving the anode of  $SD_3$  at  $-V_i$  volts which equals  $-V_{st}$ . Thus,  $C_3$  is now charged negatively and this charge progresses, by pulse stepping, back down the chain from right to left. When it reaches capacitor  $C_1$ , pulse  $P_4$  strikes  $SD_4$  and the capacitor discharges through resistor  $R_{m2}$ . When  $P_4$  ceases,  $C_1$  is left with a positive charge which travels back along the chain from left to right.

It must be noted that only one marking can be present in the chain at any time since positive and negative charges cannot pass one another. If, however, cold-cathode diodes are used, patterns of markings can be made to pass in either

direction as indicated earlier. This reflective store may be used as a pattern register.

#### Conclusions

In shift-register systems employing capacitors and semiconductor devices it is usual to attribute the storage function to the semiconductor device and the transfer function to the capacitor. It might be thought that a reversal of this would result in systems where the storage time is limited by capacitor leakage. The circuits described show that this need not be so, it being possible to employ the active switching elements so as to give regeneration of the charge. Power is consumed primarily to overcome capacitor leakage and so may be very small, especially at low cyclic speeds.

It is improbable that this type of circuit offers sufficient advantages to justify its replacing more conventional cyclic storage circuits in use at this time. However, the circuit is very simple in construction because the switching diodes of a chain are connected in series, with capacitors tapped along the length. Such circuits should be very suitable for automatic assembly or composite manufacture. If this issue arises it is important to realize that this converse of the normally accepted technique can give rise to useful circuits.

#### Acknowledgment

The authors are indebted to the Director of Engineering of Associated Electrical Industries (Woolwich) Ltd., for permission to publish this paper.

#### References

- J. L. Moll, M. Tannerbaum, J. M. Goldey and N. Holonyak, 'PNPN Transistor Switches'. *Proc. I.R.E.*, Vol. 44, p. 1174, 1956.
- W. Shockley: 'Unique Properties of the Four-Layer Diode'. *Electronic Industries*, Vol. 16, p. 58, August 1957.
- G. E. McDuffie and W. L. Chadwell: 'An Investigation of the Dynamic Switching Properties of Four-Layer Diodes'. *Communications and Electronics*, No. 47, p. 50, March 1960.
- J. E. Flood and J. B. Warman: 'The Design of Cold-Cathode Valve Circuits'. *Electronic Engineering*, Vol. 28, p. 529, December 1956.
- J. B. Warman: British Patent No. 841844.

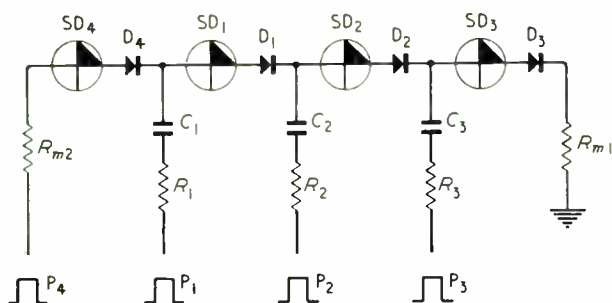
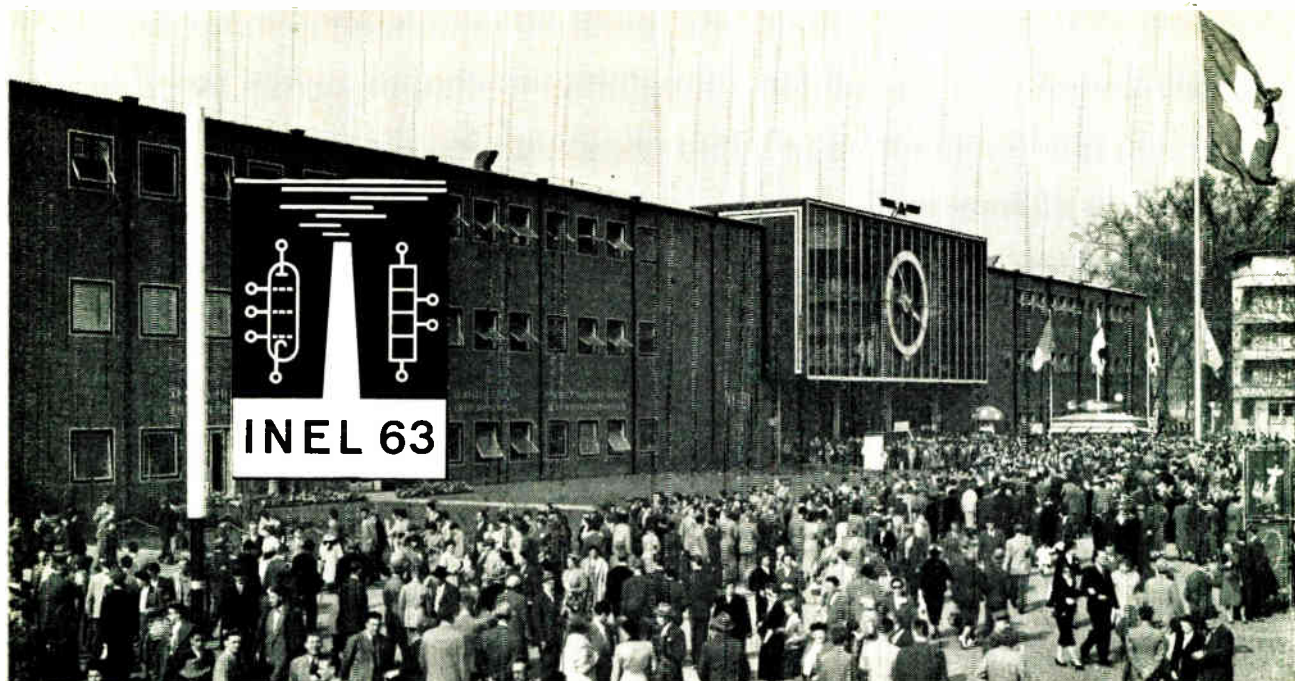

Fig. 7. Counter terminated in a mismatch



# INTERNATIONAL EXHIBITION OF INDUSTRIAL ELECTRONICS

**BASLE, SWITZERLAND**

**2nd to 7th SEPTEMBER**

*Some British Companies are themselves exhibitors, others are represented by their Continental agents and their products are shown on the agents' stands. Some British companies are agents for U.S. manufacturers. The list has been compiled from the latest list provided by the Exhibition Organizers.*

Firm	Stand No.	Agent	Firm	Stand No.	Agent
A.B. Metal Products	13/351	—	Imperial Metal Industries	11/165	Dr. Ing. Koenig A.G.
Advaru Components	13/378	Seyffer & Co. A.G.	Industrial Electronics	10/97	—
	13/381	—	Johnson, Matthey	13/371	Dewald A.G.
A.E.S. Electronics	17/571	—	Levell Electronics	13/371	Dewald A.G.
Analytical Measurements	13/332	Endress	Linton & Hirst	11/165	Dr. Ing. Koenig A.G.
A.P.T. Electronic Industries	13/324	Silectra	Lintronic	13/342	—
Ardente Acoustic Laboratories	11/189	Telion A.G.	Claude Lyons Ltd.	13/378	Seyffer & Co. A.G.
Automation Engineering Systems	17/571	—		13/381	—
Avdel	11/165	Dr. Ing. Koenig A.G.	Mallory Batteries	13/432	K. Hirt Elektronik
Avo	11/241	—	Marconi Instruments	13/378	Seyffer & Co. A.G.
				13/381	
The Barden Corp. (U.K.)	11/252	—	McMurdo	13/355	Egli, Fischer & Co. A.G.
Cambridge Instrument Co.	13/324	Silectra	M.E.C.	13/355	Egli, Fischer & Co. A.G.
Celestion	13/355	Egli, Fischer & Co. A.G.	Muirhead	RH/461	—
Colvern	13/355	Egli, Fischer & Co. A.G.	Nagard	13/444	J. Baerlocher
Continental Connectors	13/396	Metronic Verkaufs A.G.	Polar	13/355	Egli, Fischer & Co. A.G.
Cybernetic Developments	11/254	—	Pye Ling	13/386	Raschi
			Pye Telecommunications	13/371	Dewald A.G.
Datum Metal Products	11/201	—	Pye T.V.T.	13/371	Dewald A.G.
Dowty Rotor	13/321	Adr. M. Eschler Urania-Accessoires	Racal Instruments	13/378	Seyffer & Co. A.G.
		Filmo S.A.		13/381	
E.M.I. Electronics	13/376	H. Huber & Co. A.G.	Rank Cintel	13/324	Silectra
Evershed & Vignoles	11/225	Omni Ray A.G.	Reliance Controls	13/396	Metronic Verkaufs A.G.
	11/131	—			
	11/136	—	W. H. Sanders Electronics	13/444	J. Baerlocher A.G.
Ferranti	13/390	—	Satchwell Controls	11/158	Trüb, Täuber & Co. A.G.
Fielden Electronics	11/225	H. Huber & Co. A.G.	Servomex Controls	11/131	Omni Ray A.G.
			Short Bros. & Harland	17/568	—
Gardeners Transformers	13/429	Dam	Standard Telephones & Cables	11/165	Dr. Ing. Koenig A.G.
Goodmans Industries	13/386	Roschi	Steatite & Porcelain Products	11/165	Dr. Ing. Koenig A.G.
Hallam, Sleigh & Cheston	13/334	—	Telequipment	13/371	Dewald A.G.
Harrison	11/135	Infranor	Thorn Electrical Industries	11/231	—
Hatfield Instruments	13/341	Ema A.G.			
De Havilland Aircraft	13/332	Endress	Venner	13/405	Venner A.G.
Henry & Thomas	13/429	Dam	Vero Electronics	11/145	Traco
Hewlett-Packard	13/335	Hewlett-Packard S.A.	Westinghouse	13/366	—
A. H. Hunt Capacitors	13/396	—			



**T**HE first INEL exhibition opens at Basle, Switzerland, on 2nd September to show to the world all that is new in electronics and closes its door on 7th September.

Truly international, this exhibition includes about 400 firms from 16 different countries. Besides various groups of components and measuring devices, the latest applications of electronic valves and semiconductors in light-current engineering and electronic application in power engineering, automatic control and computing will be displayed.

To the industrial user, electronics generally means a piece of equipment that will do a job of work more quickly, accurately or more efficiently than conventional devices or methods. This down-to-earth approach is reflected in many of the exhibits of the British companies or their agents. Complete equipments designed for specific purposes are to be displayed on most stands.

The Servomex Controls portable oxygen analyser type D.C.L. 101 (50) serves to illustrate this trend. Here is an oxygen analyser which is able to compete with standard chemical absorption methods for accuracy, but which is also quick, clean, and above all, simple to use.

This instrument is battery powered and, therefore, completely portable. It makes use of a paramagnetic susceptibility measuring cell. In the instrument a silica dumb-bell is suspended in a non-uniform magnetic field and experiences a torque which is proportional to the oxygen content of the surrounding gas. This torque is balanced against a restoring torque due to current flow in a coil wound on the dumb-bell. The balance condition is achieved by adjusting a calibrated 10-turn potentiometer to 'zero' the position of a light beam reflected from the dumb-bell. The zero position is initially determined by passing pure nitrogen (or other oxygen-free gas) into the measuring cell. The range covered is 0 to 100% oxygen content at 0.1% accuracy.

Another complete device, wire diameter gauge type WG-1 (51), is to be demonstrated by International General Electric Company of New York Ltd. This gauge is designed for use in industries concerned with the continuous measurement of the diameter of wires, rods or filaments. The whole gauge is built as a compact unit measuring about 9-in. high  $\times$  7.5-in. wide by 14.5-in. long. There is a housing built up at each end of the gauge base with a gap between for the unimpeded passage of the wire to be measured. In one housing there is a lamp and lens assembly which projects a beam of parallel light across the gap to the other housing. A mask in the gap divides the light into an upper measuring beam, which is adjustable, and a lower fixed reference beam. After the light enters the second housing, the upper beam falls on a measuring photocell and the lower beam falls on a similar reference photocell. The two photocells are connected so that their output voltages oppose each other.

In the 'operate' position the wire passes through the measuring beam. If the diameter deviates from that required, the light falling on the measuring photocell varies and the output meter directly indicates the variation of diameter in mils. This is the basic unit and other units can be added to provide alarm and automatic control facilities.

Control of another kind—levels of liquids—is provided by the Fielden Electronics new electro-pneumatic level controller or transmitter type PNL3 (52). It is a simple self-balancing capacitance measuring device with pneumatically-operated feedback. It produces an output air pressure of 3 to 15 p.s.i. exactly proportional to the change of liquid level. A knob control provides adjustment to give a transmission signal covering the full variation of level in the container or conversely to give a proportional control signal over a small variation of level in the container. Being a capacitance-type level controller only a

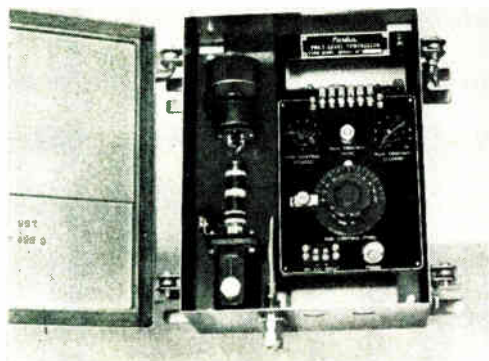

*The Fielden Electronics level controller type PNL3*



*Shorts control system analyser*



*This batch counter type CB11 is one of the many devices to be shown by Thorn Electrical Industries (94)*



*Shown here is the Verner frequency counter type TSA3334*

vertical probe in the container is required; a range of these is available to meet any specific requirement.

Automatic temperature control is an accepted technique in industry and is now even more acceptable by using transistor circuitry to improve reliability and reduce the size of the electronic control unit. Hatfield Instruments temperature controller type LE460 (53) typifies the developments in this field. This is a robust industrial type instrument for providing close control of any oven temperature up to 1,000 °C.

In this a bridge network is energized with an a.f. signal and the output is amplified and fed to a phase-sensitive detector which operates a relay via a further transistor amplifier. One arm of the bridge is made temperature sensitive and is placed in the oven to be controlled. This is completely self-contained, in a cabinet measuring 9.75 × 8.5 × 3.75 in., with the exception of the sensing element and the contactor to switch the heating elements. With this, control of temperature is maintained to less than 0.1 °C of that required.

Control systems for temperature, humidity, etc., are to be the main items shown by Satchwell Controls. Typical of these is the 'Duotronic' temperature and humidity controller (54) for the control of heating, ventilating and air-conditioning plants.

This uses an electronic circuit to amplify signals produced by temperature or humidity change and to apply proportional plus integral correcting action.

In operation, elements in the humidity and temperature detectors form part of a Wheatstone bridge. A change in the element resistance, due to temperature or humidity, produces an out-of-balance signal which is amplified to provide a correcting control signal. Thus there is no permanent deviation from the pre-set control point.

In most modern closed-loop control systems servo components are used in many ingenious ways but when it comes

to displaying these at exhibitions ingenuity seems to take a holiday. Fortunately this is not true in the case of the proposed Evershed & Vignoles display. An interesting servo-controlled demonstration is to illustrate the use of their servo components. A pointer on a dial is driven by an a.c. servomotor-generator which is controlled by an electronic amplifier. The motor-generator is mounted on a special servo gearbox having a spring-loaded split gear to eliminate backlash between the magstrip and pointer. When operating as a position control system, the pointer position is determined by a knob on the control panel. With a switch on the panel in the 'scanning' position the servo becomes a velocity-controlled system and the pointer rotates at a pre-set constant speed. In this system the output from the tacho-generator is compared with a fixed reference voltage and the difference fed into the amplifier to control the motor.

For measuring the performance of automatic control systems Short Brothers & Harland are showing their control system analyser (56).

This analyser employs the method of steady-state frequency response. The test system is excited by sinusoidal oscillations of known amplitude and frequency. At each selected frequency the system steady-state response is analysed in terms of gain and phase difference.

The instrument is made up of two sections—an oscillator to drive the test system, and a phase-sensitive voltmeter which determines the amplitudes of the in-phase and quadrature components of the system output waveform.

#### Instrumentation

At an exhibition of this nature the coverage must be broad since it caters for the industrial user and potential user of electronic equipment and devices. It is therefore

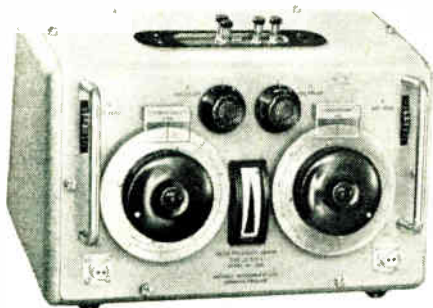

The Hatfield r.f. bridge type LE300

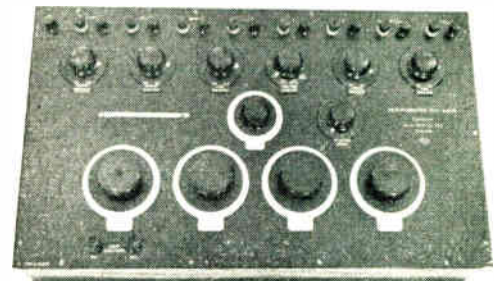

Shown by Cambridge Instruments this latest version of their Microstep potentiometer has been developed for very high precision voltage measurement. It has a discrimination of 1 part in  $2 \times 10^6$  and gives readings in steps of 0.1  $\mu$ V up to 2 V on a single range (57)



For the accurate measurement of frequency, time interval, period, phase lag and ratio Rank Cintel are showing this Systron model 1032 counter-timer. Ranges covered include frequency, 0 c/s to 2.5 Mc/s; period 1  $\mu$ sec to 10 sec; time interval 1  $\mu$ sec to 10 sec; ratio A : B =  $10^6$  max (input A = 0 to 2.5 Mc/s, input B = 0 to 1 Mc/s) (55)

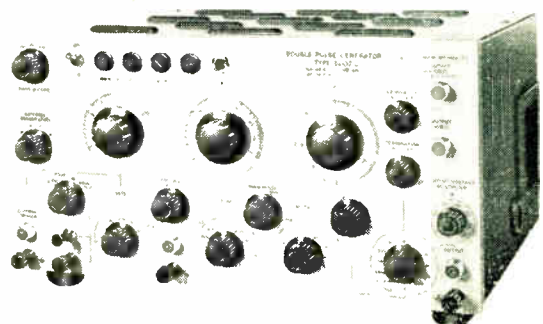

This illustrates the Advance Nagard double-pulse generator type PG5002C

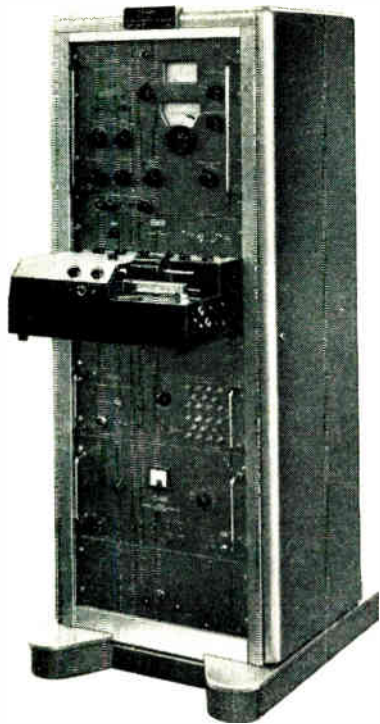

One of the working demonstrations on the Muirhead stand will be noise and vibration waveform analysis using this type K-101-A analyser

to be expected that electronic instrumentation will form a large proportion of the show, as indeed it appears to. Many of the instruments to be shown can operate as test devices and functional devices on a production line and often it is difficult to classify them precisely.

For instance the Venner Electronics frequency counter TSA3334 (58) could be used in a laboratory for general functions or in a production plant by service engineers concerned with frequency measurement or shaft speed determination. This instrument is claimed to be the smallest in-line readout frequency meter available anywhere in the world. The display is on four brightly illuminated in-line indicators and the frequency range extends to 1.1 Mc/s.

Racal Instruments are also very concerned with electronic counters and are to display a range of these for various applications. Typical of their range is the SA.532 batch counter (59). This is a transistorized batch/pre-set counter designed specially for industrial applications which include batching articles, pre set counting and length measurement. It operates at batching speeds of up to 25,000 per second and batches of up to 9,999 or 99,999 with a pre-batch warning facility.

Typical of the general purpose counter-timers is the Levell Electronics type TMS1B (60). This is a transistorized digital counting instrument for the measurement of signal frequencies and time periods. The ranges covered are 1 c/s to 3 Mc/s and 3  $\mu$ sec to 27.77 hr. The counter has five decades operating on a 1-2-4-8 code.

Advance Components and their Nagard Division are displaying and demonstrating most of their current ranges of instruments including the Nagard double-pulse generator type PG5002C (61).

This provides single or double square pulses which may be selected as either negative or positive in potential with respect to earth. With a single-pulse output a continuously adjustable repetition frequency range of 0.1 c/s to 1 Mc/s



The Components Group of Standard Telephones and Cables are including static and working displays of their range of semi-conductors. A highlight of the display will be a working demonstration of their latest integrated semiconductor elements (62). Illustrated here is the set-up which will be used to demonstrate S.T.C. solid circuits in the form of 10 Mc/s logic units



This shows one of the two digital voltmeters which are to be featured by Digital Measurements. Both models provide 5-digit, in-line readout plus polarity indication, binary coded output signals and 6 modes of operation; the total conversion time is 20 msec. Model DM2020 (63), illustrated here, has an accuracy of 0.01%, a sensitivity of 10  $\mu$ V, a range from 0.19999 to 1999.9 V and a maximum input impedance of >10,000 M $\Omega$

is obtained which is effectively extended to 2 Mc/s using a double-pulse output. The triggering facilities of the 5002C are comprehensive.

For triggering an oscilloscope timebase a pre-pulse is provided, either positive or negative, having a pulse width of 0.2  $\mu$ sec and a minimum amplitude of 20 V. The delay between the pre-pulse and a single main pulse may be adjusted between 0.2  $\mu$ sec and 2 sec. With double-pulse operation the same delay exists between the pre-pulse and the second main pulse.

For the first time in Switzerland, Muirhead will show its full range of instruments including oscillators, analysers and bridges. The K-101-A automatic recording wave analyser (64), which analyses complex waveforms of noise and vibration in the frequency range 10 c/s to 19 kc/s, will be demonstrated.

Thorn Electrical Industries are to be well represented by the products of their many divisions. Included in their range of transistorized television test equipment are two units for studio engineers. The first is a line-up generator based on the B.B.C. units type GE4 508. This is known as PLUGE (65) and it generates a video test signal for setting up studio picture monitors. The second unit is type WH11 (66) dot and graticule generator and is designed as a multi-standard test unit for accurately assessing the linearity of television scan systems.

here but, for reasons of personal preference, are called instead the 'adjacent-balancing arm' and the 'opposite-balancing arm' types respectively.

### Preliminary Considerations

#### Convergence to Balance

The four-terminal electrical bridge configuration is shown in Fig. 1. It is known<sup>1</sup> that no matter to which pair of opposite terminals the supply oscillator (of zero output impedance) is connected, and to which remaining pair the detector (of infinite input impedance), the relation between the input voltage to, and the output voltage from, the bridge is given by

$$V_{out}/V_{in} = (Z_1 Z_3 - Z_2 Z_4) / [(Z_1 + Z_2)(Z_3 + Z_4)] \quad (1)$$

The only manner in which zero output voltage can occur for finite input voltage and finite components is that which causes the numerator of equation (1) to become zero. This numerator therefore plays rather an important part and is denoted  $\delta$  henceforth, i.e.,

$$\delta = Z_1 Z_3 - Z_2 Z_4 \quad (2)$$

The manner in which the bridge converges to balance is thus the manner in which this quantity  $\delta$  approaches zero. Equation (2) for  $\delta$  is henceforth called the 'characteristic equation' of the bridge.

#### Stipulations on the Ideal Bridge

The requirements to be met by what may be termed the 'ideal' bridge were, as far as the author is aware, first proposed by Ferguson, although not enunciated in precisely the form they are to be used here.

In the general case each of  $Z_1, Z_2, Z_3$  and  $Z_4$  will be complex so that the characteristic equation will have a real and a  $j$ -component, i.e.,

$$\delta = \alpha + j\beta \quad (3)$$

where each of  $\alpha$  and  $\beta$  are functions of the constituents of each of the bridge arms.

As the characteristic equation occurs in symmetrical form, any of the impedance arms may be chosen as the unknown being measured; let it be  $Z_1$  in this analysis where

$$Z_1 = R_1 + jX_1 \quad (4)$$

and  $X_1$  may be either positive or negative.

The first condition on the ideal bridge is that each of the quantities  $\alpha$  and  $\beta$  appearing in equation (3) shall be a function of *only one* of  $R_1$  or  $X_1$ . Thus  $\alpha$  may be a function of either, *but not both*, of  $R_1$  or  $X_1$ ;  $\beta$  must then in turn contain the remaining component *only* of the unknown. The object of this condition is primarily to allow of the simple expression of the unknowns  $R_1$  and  $X_1$  in terms of the remaining arms of the bridge, and to avoid the necessity of solving simultaneous equations.

The second requirement to be met by the ideal bridge concerns the manner in which  $\delta$  is brought to zero. From equation (3) it is seen that for  $\delta$  to be made zero each of  $\alpha$  and  $\beta$  must individually be brought to zero, and in this regard this second condition requires that each of  $\alpha$  and  $\beta$  be capable of being made zero independently. The latter is then a stipulation that there has to appear in the expression for  $\alpha$  any one constituent of the bridge impedance arms (other than, of course, the unknowns themselves) which does not simultaneously appear in the term  $\beta$ , and conversely there should simultaneously feature in  $\beta$  any one constituent which does not also appear in the expression for  $\alpha$ .

The implications of the above two requirements are then the following. First, using a Utopian detector of infinite sensitivity and also continuously variable balancing arms

it should be possible to balance the bridge in only two operations, one in which  $\alpha$  is brought to zero quite independently of any considerations of  $\beta$ , and the second in which  $\beta$  itself is made zero. In practice, of course, more than two such operations must be expected, first, because of the detector's finite sensitivity and secondly because of the difficulty of obtaining completely continuously-variable arms. Nevertheless the bridge converges to balance in extremely rapid fashion.

The second implication is that each of these bridge balancing arms determines only one component of the impedance being measured. As variable impedance arms are obtainable to an accuracy normally lower than that associated with a fixed element, this means that, other conditions being equal, the measurement of each component of the unknown is achieved more accurately if in the equation for its determination there features only one variable arm and not two.

The argument may be proposed at this stage that there are many bridge configurations which will permit of a balanced state but which do not comply with the requirements on the ideal bridge mentioned above, and as such why should these arrangements be excluded from further consideration. The answer here is possibly to see how far one may proceed while holding out for the most stringent specifications, and then to re-consider the issue depending on what emerges. If only a few possibilities are forthcoming then the conditions above must be relaxed; if on the other hand there are found to be many which do fulfill the stipulations the question can be side-stepped.

#### Further Considerations of the Characteristic Equation

The contents of the last section may become clearer upon considering a specific case. The unknown has already been specified by equation (4); in addition let each of the remaining bridge arms be of the general form  $R + jX$ , where the sign of the letter  $X$  will be taken as positive for the moment. Equation (2) becomes

$$\begin{aligned} \delta &= (R_1 + jX_1)(R_3 + jX_3) - (R_2 + jX_2)(R_4 + jX_4) \\ \text{i.e., } \delta &= R_1 R_3 - X_1 X_3 - R_2 R_4 + X_2 X_4 \\ &\quad + j[X_1 R_3 + R_1 X_3 - X_2 R_4 - R_2 X_4] \quad (5) \end{aligned}$$

Consider equation (5) in the light of the stipulations of the previous section. With regard to the first of these conditions it is seen that the real portion of  $\delta$ , that is  $\alpha$ , contains a term involving the unknown  $R_1$  as well as one involving  $X_1$ . With regard to the second requirement it is seen that there is no constituent of any of the bridge arms which appears only in  $\alpha$  and not in  $\beta$ , and vice versa.

The important conclusion is therefore reached at this stage that the four-terminal electrical bridge in which an *impedance* features in each of the arms *does not satisfy the requirements of the ideal bridge*; modifications are thus necessary. There are two different methods by which these modifications can be achieved. The first, termed the 'adjacent balancing arm' method for reasons to be seen later, is considered next and the second, denoted the 'opposite balancing arm', is investigated later.

### The Adjacent Balancing-Arm Method

#### Restrictions on the Impedance $Z_3$

Equation (5) is seen to be constructed in such a form that  $\alpha$  contains terms involving products of *like* components of opposite arms while  $\beta$  those of products of *unlike* components of the same opposite arms. This is fortunate in that if *one* of  $R_3$  or  $X_3$  is made zero, only one component of the unknown impedance appears in  $\alpha$  and only the other in  $\beta$ . Thus one method of satisfying the first condition is for the arm *opposite to the unknown to be made either purely resistive or purely reactive*. Each of these two possibilities is to be

## Classification of FOUR-TERMINAL BRIDGE NETWORKS

Fig. 1. The general four-terminal electrical bridge network

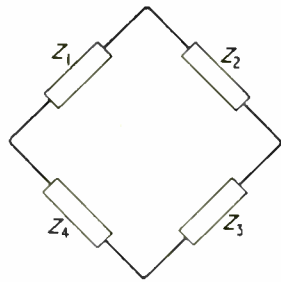

Fig. 2.  $X_2$  zero

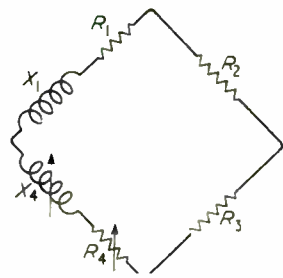

Fig. 3.  $R_2$  zero

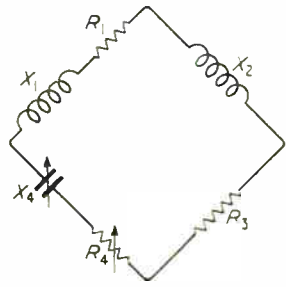
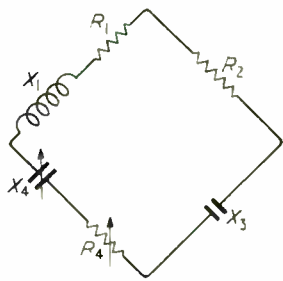

Fig. 4.  $X_2$  zero



considered in turn, and in each case the methods of fulfilling the second requirement on the ideal bridge must be investigated.

### $X_3$ made Zero

The characteristic equation then becomes

$$\delta = R_1R_3 - R_2R_4 + X_2X_4 + j(X_1R_3 - X_2R_1 - R_2X_4) \quad (6)$$

To meet the second requirement it is seen that either  $R_2$  or  $X_2$  on the one hand, or  $R_4$  or  $X_4$  on the other, must be made zero. There are no other possibilities. In other words, any one of the arms adjacent to that containing the unknown must be restricted to be purely resistive or purely reactive. It makes no difference which of the two adjacent arms is so chosen, as each of them merely serves to connect the unknown impedance to its opposite arm of the bridge.  $Z_2$  will thus be arbitrarily chosen here to be the adjacent arm not permitted to be a complex impedance. Again two cases arise which must be considered separately, first that in which  $X_2$  is zero and secondly that where  $R_2$  is zero.

### $X_2$ made Zero

Equation (6) becomes

$$\delta = R_1R_3 - R_2R_4 + j(X_1R_3 - R_2X_4) \quad (7)$$

Here  $R_4$  is seen to appear only in the real portion of  $\delta$  and  $X_4$  only in the  $j$ -component; as such the second condition is fulfilled and these two elements become the balancing

variables of the bridge. Equating like components of equation (7) yields at balance, when  $\delta$  is zero,

$$R_1 = R_2R_4/R_3 \quad (8)$$

and

$$X_1 = R_2X_4/R_3 \quad (8a)$$

Equation (8a) immediately shows that, as the ratio  $R_2/R_3$  is positive, the reactance  $X_4$  must be of the same type as that being measured, that is  $X_1$ .

It is to be noted that in view of the derivation of this type of bridge both the balancing variables feature in the same bridge arm. It is of course also to be pointed out that there exists no other possible combination of balancing elements, as  $R_4$  was the only constituent to appear in the  $\alpha$  of equation (7) and not in the  $\beta$ , and conversely for  $X_4$ . The resulting bridge configuration for  $X_1$  taken as positive is shown in Fig. 2.

### $R_2$ made Zero

Equation (6) now becomes

$$\delta = R_1R_3 + X_2X_4 - j(X_1R_3 - X_2R_4) \quad (9)$$

Again  $X_1$  and  $R_1$  are seen to be the only permissible balancing arms. Equating like components of equation (9) yields at balance

$$R_1 = -X_2X_4/R_3 \quad (10)$$

and

$$X_1 = X_2R_4/R_3 \quad (10a)$$

Equation (10a) shows that as  $R_4/R_3$  is positive  $X_2$  is to be a reactance of the same type as the unknown  $X_1$ . Equation (10), as  $R_1R_3$  is positive, indicates that  $X_2$  and  $X_4$  are of opposite type: hence  $X_1$  and  $X_4$  are reactances of opposite type.

The resulting bridge configuration for  $X_1$  positive is shown in Fig. 3. The above two sections have resulted for the case where  $X_3$  was zero. The instance of  $R_3$  zero must now be considered.

### $R_3$ made Zero

The characteristic equation (5) becomes

$$\delta = -X_1X_3 - R_2R_4 + X_2X_4 + j(R_1X_3 - X_2R_1 - R_2X_4) \quad (11)$$

The last two terms in the  $\alpha$  and in the  $\beta$  of this equation are seen to be respectively the same as those appearing in equation (6), and therefore the remedy which was suitable to make the latter equation obey the second condition likewise applies in this case. Thus  $X_2$  is first to be made zero and then  $R_2$ .

### $X_2$ made Zero

Equation (11) becomes

$$\delta = -X_1X_3 - R_2R_4 + j(R_1X_3 - R_2X_4) \quad (12)$$

$R_4$  and  $X_4$  are again the only permissible balancing arms, resulting in the equation at balance being

$$X_1 = -R_2R_4/X_3 \quad (12a)$$

and

$$R_1 = R_2X_4/X_3 \quad (12b)$$

whence from equation (12b)  $X_4$  and  $X_3$  are reactances of the same type, and from equation (12a)  $X_1$  and  $X_3$  are reactances of the opposite type; and hence  $X_1$  and  $X_4$  are reactances of the opposite type.

The resulting bridge configuration for the case of  $X_1$  positive is shown in Fig. 4.

### $R_2$ made Zero

Equation (11) becomes

$$\delta = -X_1X_3 - X_2X_4 - j(R_1X_3 - X_2R_4) \quad (13)$$

## Classification of FOUR-TERMINAL BRIDGE NETWORKS

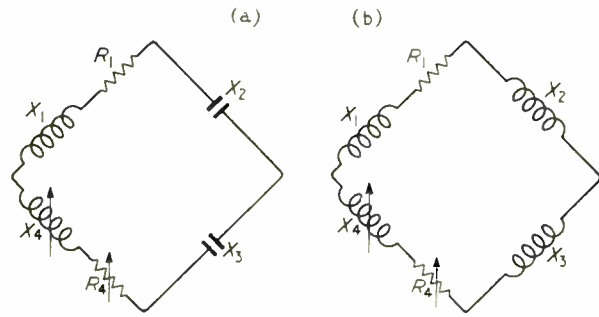

Fig. 5a.  $R_2$  zero,  $X_3$  negative Fig. 5b.  $R_2$  zero,  $X_3$  positive

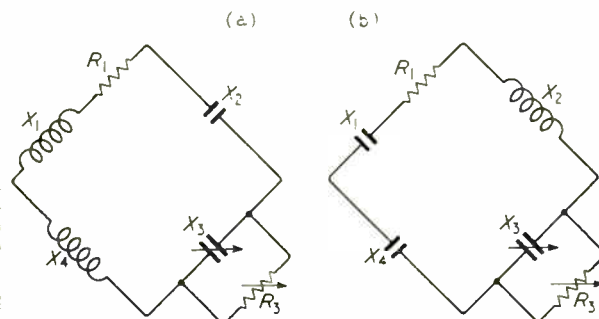

Fig. 6a and 6b.  $R_2$  and  $R_4$  simultaneously zero

Again  $X_4$  and  $R_4$  are the only permissible balancing arms resulting in the equations at balance

$$X_1 = X_2 X_4 / X_3 \quad (13a)$$

and

$$R_1 = X_2 R_4 / X_3 \quad (13b)$$

whence from equation (13b)  $X_2$  and  $X_3$  are reactances of the same type, and hence from equation (13a)  $X_1$  and  $X_4$  are reactances of the same type. It should be noted, however, that in this instance there is no condition relating any of  $X_2$  or  $X_3$  to any of  $X_1$  or  $X_4$ . Thus two different bridge configurations emerge from this case, and are shown in Fig. 5(a and b) for the case of  $X_1$  positive.

### Resumé

This section has enabled the characteristic equation to satisfy the first condition imposed on the ideal bridge by the method of restricting the impedance arm opposite to that containing the unknown impedance being measured to be either purely resistive or reactive. It has been shown that for the second requirement to be met this has resulted in one arm adjacent to the unknown similarly being restricted from being a complex impedance and has then caused the only two permissible balancing variables to be found in the remaining arm adjacent to the unknown impedance. Hence the designation of this type of bridge as the 'adjacent-balancing arm' category.

In many cases, however, it is found inconvenient to have the two variable elements in series, as is the situation with the configurations derived in this section. As the input frequency applied to the bridge is increased in value, it is found that the operator's body-capacitance to earth plays an increasingly important role in the successful operation of the bridge. One method of eliminating this latter effect is for each of the balancing arms to have a direct connection to earth: this is then seen to be impossible when the two variable arms

are in series and in the same arm of the bridge, as they are here.

This consideration places importance on that category of bridge in which the balancing variables are capable of being in parallel; the possibility of such a class of bridge is then to be investigated. This is the subject of the following section.

## The Opposite-Balancing Arm Method

### Choice of Balancing Variables

The previous section automatically commenced on the assumption that each of the bridge arms consisted of elements in series. Under these circumstances the determination of the eventual bridge balancing variables was a derived, as opposed to a specified, topic. In this instance, however, for the reasons advanced at the end of the previous section, the balancing variables are to be specified initially as definitely having to be in parallel. It then remains to see which arm, if any, of the bridge is then the most convenient for this parallel combination.

This is possibly achieved most conveniently by considering the expression of the unknown impedance  $Z_1$  in terms of the remaining general impedances under balance conditions. Thus, from equation (2) with  $\delta$  zero,

$$Z_1 = Z_2 Z_4 / Z_3 \quad (14)$$

from which it is immediately apparent that it is most convenient from the viewpoint of mathematical manipulation if the parallel balancing variables are to be found in the arm 3. Denoting the latter by  $R_3$  and  $jX_3$  respectively the characteristic equation (2) becomes under these circumstances

$$(1/Z_3)\delta = R_1 - jX_1 - (R_2 - jX_2)(R_4 - jX_4)(1/R_3 - 1/jX_3) \quad (15)$$

i.e.,

$$(1/Z_3)\delta = R_1 - (R_2 R_4 - X_2 X_4) / R_3 - (X_2 R_4 + R_2 X_4) / X_3 - j[X_1 - (R_2 R_4 - X_2 X_4) / X_3 - (X_2 R_4 - R_2 X_4) / R_3] \quad (16)$$

Under balance conditions  $\delta$  is to be zero, but  $Z_3$  will be finite; the right-hand side of equation (16) may therefore be considered in the same manner as previously despite the presence of the multiplier involving  $Z_3$  on the left-hand side of this equation. This follows since it is the alteration of the right-hand side of this equation which is to result in  $\delta$  being zero at balance.

The different structure of equation (16) as compared with that of the corresponding equation (5) for the 'adjacent-balancing arm' type of bridge is immediately apparent. First, it is seen that without the use of any further impositions the unknown  $R_1$  appears in only the  $\alpha$  portion of the equation and the unknown  $X_1$  in only the  $\beta$ . Secondly, the second term in the  $\alpha$  expression is seen to differ from the second in the  $\beta$  component in denominator only; this property applies also to the third term in each component. This latter feature yields the clue to the method of handling this characteristic equation.

By hypothesis  $R_3$  and  $X_3$  are to be the balancing arms, and thus only one of these should feature in the  $\alpha$  of equation (16) and only the other in the  $\beta$ . To remove  $X_3$  from the  $\alpha$  which, according to the reasoning above, simultaneously eliminates  $R_3$  from the  $\beta$ , the term  $X_2 R_4 - R_2 X_4$  in equation (16) must be made zero. There is obviously more than one method of achieving this, but the two which have the most far-reaching effects on the remaining portion of the equation are those which either (a) make  $R_2$  and  $R_4$  zero simultaneously or (b) make  $X_2$  and  $X_4$  zero simultaneously.

Conversely to remove  $R_3$  from the  $\alpha$ , and simultaneously  $X_3$  from the  $\beta$ , the term  $R_2 R_4 - X_2 X_4$  must be made zero. There again exist numerous methods of achieving this, but none more powerful than those which either (i) make  $R_4$

and  $X_2$  zero simultaneously, or (ii) make  $R_2$  and  $X_4$  zero simultaneously.

Stating these conditions in an alternative fashion, it is seen that the remaining opposite arms of the bridge, that is those not containing the unknown impedance or the balancing variables, are to be restricted to be either purely resistive or purely reactive. The four combinations mentioned above are now considered separately.

#### $R_2$ and $R_4$ Simultaneously Zero

Equation (16) becomes under these circumstances

$$(1/Z_3)\delta = R_1 + X_2X_4/R_3 - j(X_1 - X_2X_4/X_3) \quad (17)$$

The balancing arms have been specified by hypothesis and therefore there is no derivation required. At balance, when  $\delta$  is zero, there follows

$$R_1 = -X_2X_4/R_3 \quad (17a)$$

and

$$X_1 = X_2X_4/X_3 \quad (17b)$$

whence from equation 17(a)  $X_2$  and  $X_4$  must be reactances of opposite type, and hence from equation (17b)  $X_1$  and  $X_3$  must be reactances of opposite type.

It is to be noted that there exists no relation between any of  $X_2$  and  $X_4$  and any of  $X_1$  and  $X_3$ . Hence two bridge configurations result from this case depending upon the types allotted to  $X_2$  and  $X_4$  in turn. For the case of  $X_1$  positive the resulting configurations are shown in Fig. 6(a) and (b).

#### $X_2$ and $X_4$ Simultaneously Zero

Equation (16) becomes

$$(1/Z_3)\delta = R_1 - R_2R_4/R_3 - j(X_1 + R_2R_4/X_3) \quad (18)$$

with the resulting equations at balance, when  $\delta$  is zero,

$$R_1 = R_2R_4/R_3 \quad (18a)$$

and

$$X_1 = -R_2R_4/X_3 \quad (18b)$$

From equation (18b) the reactances  $X_1$  and  $X_3$  are seen to be of opposite type. The resulting bridge configuration for the case of  $X_1$  positive is shown in Fig. 7.

#### $R_4$ and $X_2$ Simultaneously Zero

Equation (16) becomes

$$(1/Z_3)\delta = R_1 - R_2X_4/X_3 - j(X_1 - R_2X_4/R_3) \quad (19)$$

leading to the two equations at balance

$$R_1 = R_2X_4/X_3 \quad (19a)$$

and

$$X_1 = R_2X_4/R_3 \quad (19b)$$

Here  $X_4$  and  $X_3$  are seen to be reactances of the same type, and likewise  $X_1$  and  $X_3$ ; that is  $X_3$  and  $X_1$  are similarly like reactances.

All previous bridge configurations thus far have been illustrated for the case of the unknown  $X_1$  being positive; in this instance, however, it is of greater importance to indicate the result for  $X_1$  negative, and this is shown in Fig. 8.

#### $R_2$ and $X_4$ Simultaneously Zero

Equation (16) becomes

$$(1/Z_3)\delta = R_1 - X_2R_4/X_3 + j(X_1 - X_2R_4/R_3) \quad (20)$$

whence at balance

$$R_1 = X_2R_4/X_3 \quad (20a)$$

and

$$X_1 = R_4X_2/R_3 \quad (20b)$$

From equation (20a)  $X_2$  and  $X_3$  are seen to be reactances of the same type, and from (20b)  $X_1$  and  $X_2$  are also reactances

of the same type. Hence  $X_1$  and  $X_3$  are like reactances. The resulting configuration, again for the case of  $X_1$  negative, is shown in Fig. 9. The close relation between Figs. 8 and 9 is to be noted.

#### Resumé

The main point of interest at this stage is the difference in approach between the methods adopted in this section and those used in the previous one of causing the bridge characteristic equation to satisfy the requirements initially stipulated.

Dealing first with the last section, it was seen that representing each arm of the bridge by a series impedance caused the characteristic equation, in this case equation (5), to fulfil neither the first nor the second of the conditions on the ideal bridge. Attempting initially to have the first condition satisfied attention was paid to the arm 3, whence it was shown that restricting this arm from a series impedance to either a pure reactance or a pure resistance produced the required effect. With this first requirement satisfied, attention was then paid to methods of fulfilling the second. At the end of this procedure there eventually emerged the bridge-balancing variables, which were the two series constituents of an arm adjacent to that containing the unknown.

Considering now this section, it was seen that upon the initial specification that the balancing variables had to be in parallel, arm 3 emerged as the most convenient, for mathematical reasons, to house the latter.

Thus the first similarity between the two approaches arises in that arm 3 was in each case the first to receive attention.

However in this section, the placing of the two parallel variables in arm 3 caused the characteristic equation, equation (16), automatically to satisfy the first of the ideal conditions and thus the investigation had at that stage to consider merely means of fulfilling the second. As in the last section, this was again achieved by restricting certain arms to be pure resistances or reactances.

In view of the remarks of this section, it is seen that one

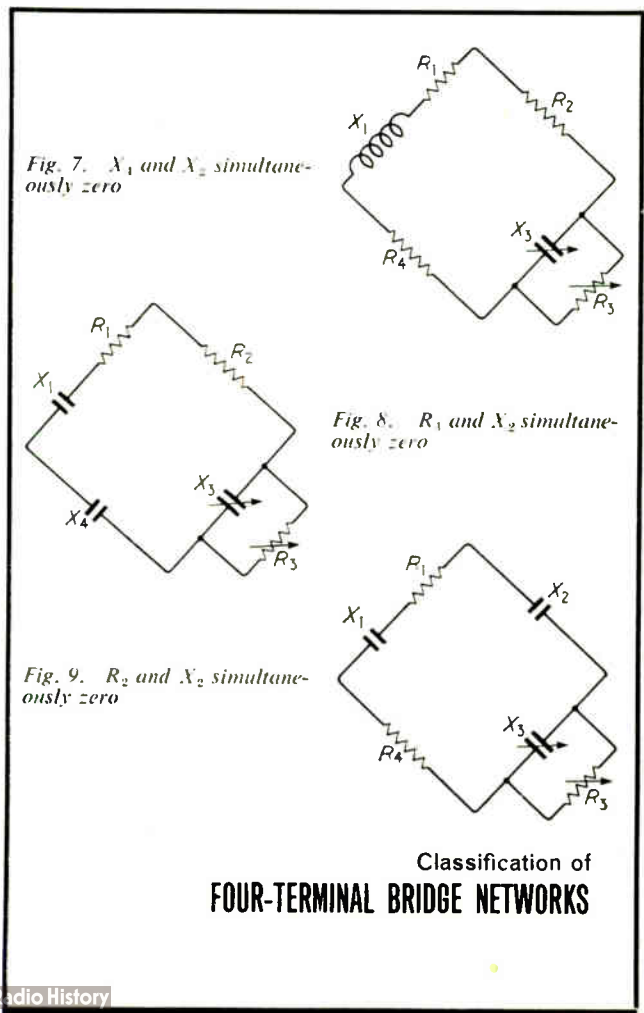

Classification of  
FOUR-TERMINAL BRIDGE NETWORKS

method of simple recognition whether a given four-terminal bridge configuration satisfies the requirements of the 'ideal' arrangement is to pay attention to the arm *opposite to that containing the unknown*. If this arm is neither a pure resistance or reactance, or each of these in parallel, the mode of operation of the bridge is not what has been termed in this article the 'ideal'.

### Conclusions

The whole of the derivation of the generalized classification of the four-terminal electrical bridge, both as presented here and as proposed by Ferguson, has hinged on the two initial stipulations to be met by what was termed the 'ideal' bridge. These latter warrant elaboration, especially since in an instance of this type there might be grounds for the accusation that the initial requirements to be met by the bridge were so chosen as to be capable of resulting in a generalized theory, or alternatively that the former were laid down only after the latter had been completed!

It must be stated at the outset that the ideal electrical bridge has obviously to meet far more than the two requirements mentioned in detail. At the same time, however, the author would express the personal opinion that whatever these additional conditions may be, the first two in order of importance are those which have been used as the basis of the generalized classification presented here and by Ferguson. The additional considerations involved with regard to the satisfactory operation of an electrical bridge<sup>1,2</sup> pertain to the positiveness with which the balanced condition is obtained, in other words the sensitivity of the configuration, secondly to the degree of stability and reproducibility of this balanced state, and thirdly to the role played by second- and higher-order terms.

In this latter regard the author would stress at this stage that the effect of component residuals and such second-order quantities has been completely overlooked in this article.

Ferguson's aim in presenting his classification of four-terminal bridge methods was to provide some basis of correlation of what had evidently appeared up to 1933 to be merely a compartmentalized collection of separate bridge configurations. This present article has in turn, by using the convergence-to-balance expression as opposed to the balance equations themselves, attempted to simplify Ferguson's approach to, and arguments in, such a correlation. In this regard it merely remains to point out that Fig. 4 is Owen's method for the determination of an inductive impedance, that Fig. 7 is Maxwell's method for the same

measurement and that Figs. 8 and 9 are Schering's bridge for capacitance and dissipation factor determination. The remaining bridge configurations are theoretical possibilities and as such can be used in those circumstances where any additional practical considerations as may arise can be satisfactorily fulfilled.

### Frequency Dependence of the Balance Equations

The two prime conditions which the 'ideal' bridge was to meet are given early in this article. It is seen that nothing is said there regarding the frequency dependence or independence of the balance equations of the resulting configurations which obeyed these two conditions.

In the author's opinion, the advent of the electronic counter has removed virtually all the disadvantages previously assigned to those bridge networks whose balance equations contained a frequency term; according to the arguments of this article the latter are then to be correctly classed as 'ideal' provided prime conditions of this article are fulfilled.

It is to be noted, however, that all the balance equations of the 'ideal' four-terminal configurations derived here are frequency *independent*. Such a coincidence is rather remarkable, and it is therefore to be investigated whether such frequency independence is an initial property of all four-terminal bridges or whether it is actually a consequence of the two conditions imposed on the 'ideal'.

This question proves more difficult to answer than might appear at first sight. It is easy to see how the application of the two conditions, for example to equation (5), has confirmed the frequency independence of the resulting balance equations; the author has not yet been able, however, to ascertain whether this property would still have existed in the absence of these conditions, or alternatively if there are any other which would have resulted in the same frequency independence of the balance equations.

### References

- <sup>1</sup> Posel, 'A new treatment of the resistance-capacitance parallel-T network'. *Proc. I.E.E.*, January 1963, pp. 126-138.
- <sup>2</sup> Posel, 'The derivation of a generalised bridged-T configuration for the measurement of an inductive impedance', *Electronic Technology*, August 1962, pp. 307-313.
- <sup>3</sup> Ferguson, 'Classification of bridge methods of measuring impedances', *Transactions of the American Institute of Electrical Engineers*, September 1933, pp. 861-867.
- <sup>4</sup> Hague, 'Alternating Current Bridge Methods', Sir Isaac Pitman and Sons (London) 1943.

## RADIO FOR MARSHALLING YARDS

Efforts being made by British Railways to reduce running costs and overheads by speeding the turn-round of rolling stock will be helped at Tyne, Tees and Healey marshalling yards in the north-east by the installation of a u.h.f. radio communication system for the control of locomotives when shunting.

The equipment, which has been developed by the Electronic Apparatus Division of Associated Electrical Industries Ltd., in collaboration with A.E.I.-G.R.S. will enable speech communication to be made between a locomotive and the control centre. Instructions can thus be given without delay so that valuable time is saved in turning round rolling stock. At present the system is installed on some nineteen locomotives.

Known as the A.E.I. type 700, this u.h.f. communication system has been designed to G.P.O. specification W.6303. It operates in the 450-470 Mc/s band and is continuously rated.

The system permits one-way return speech from locomotive to the control centre. Orders to the locomotive and various cab signalling tones are transmitted from the control centre through an inductive loop system designed by A.E.I.-G.R.S. Ltd.

Each locomotive has a transmitter on its own individual

frequency, where sufficient frequencies can be made available by the Post Office, working to its own receiver channel via a wide-band aerial amplifier at the control centre. The equipment is fixed in a cradle with anti-vibration mountings to withstand the heavy jolting on shunting locomotives.

For further information circle 78 on Service Card

### INFORMATION WANTED?

If you require further details of products or processes described or advertised in INDUSTRIAL ELECTRONICS you will find it convenient to use the enquiry cards which will be found in the front and back of the journal.



Corona voltage stabilizers, from left-to-right, types SC1, SC3, SC2 and SC5

This article presents various methods of stabilizing low-current high-voltage power supplies of the kind often needed for electronic instruments. They are based mainly on the corona stabilizer tube.

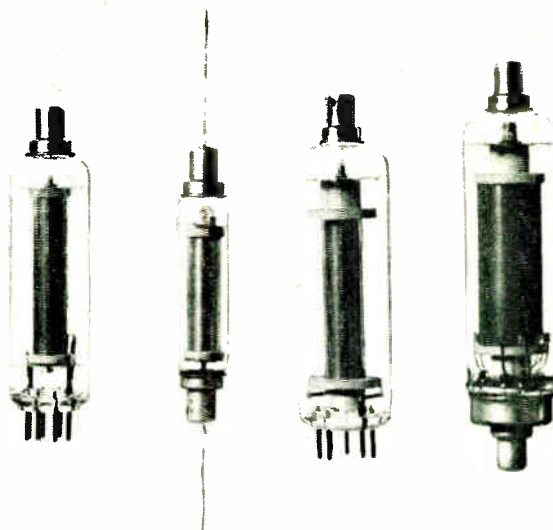

## Stabilized High-Voltage Supplies

By J. P. HOLLAND, A.M.Brit.I.R.E.\*

THERE is a growing need for stable high-voltage supplies in modern electronic equipment. One reason for this is the application in industrial instruments of techniques which were formerly used only in the laboratory. Manual voltage control may be quite satisfactory for the skilled experimental user, especially when the emphasis is on simplicity and cheapness. It will not, of course, serve in industrial measuring instruments, which have to be used by comparatively unskilled people, or by those whose skills lie in other directions. Such instruments must, as far as possible, work by themselves.

Examples of devices needing stabilized e.h.t. supplies are Geiger-Müller tubes, gas chromatographs, photomultipliers and high-voltage insulation testers. Experts in particular fields of instrumentation will know of many others. The current required is usually quite small, of the order of 1 mA or less. Some form of shunt stabilizer is particularly useful in such cases.

### General

By way of illustration, four typical circuits of this kind will be given. They were the subjects of a working display unit on high-voltage stabilization shown on the stand of The M-O Valve Co. Ltd., at the Institute of Physics and Physical Society Exhibition, January 1963. All were designed to stabilize against mains supply-voltage variations of  $\pm 7\%$ , and output currents from zero to full load. Close tolerance resistors are generally necessary in this class of circuitry. These designs allow for changes of up to  $\pm 10\%$  from the nominal values, which, it will soon be apparent, restricts the range of output current obtainable from a particular circuit. The design figures and measured performance of each circuit will be given, so that the relative merits of the different methods may be compared.

The four example circuits each operate from an e.h.t.

supply with a no-load voltage of nominally 4 kV, and give outputs in the range 2 to 3 kV. In principle, however, the methods, or extensions of them, may be applied to any voltage.

It is generally advisable, as the electronic devices concerned have a finite life, to incorporate a voltmeter in the circuit. This has been done in the four examples. The meter in each case reads 3 kV f.s.d., and consists of a 50- $\mu$ A movement with a series resistor multiplier. Account is taken of the meter current.

Another point which applies to each of the four circuits is that the value shown for the input resistor  $R_1$  includes the internal impedance of the power supply. This total, like the other resistances, must be within 10% of the value shown for the circuit to function as designed.

### Simple Corona Stabilizer Circuit

The corona stabilizer, as its name implies, utilizes the corona mode of discharge in a gas. The electrode system comprises a thin wire anode, surrounded by a metal cylinder which forms the cathode, and operates in a hydrogen atmosphere. The cathode is not activated, and the operating voltage depends on the geometry of the system and the gas pressure. Ionization occurs in a luminous region which forms a sheath around the anode wire—the place where the field is most intense.<sup>1, 2</sup>

The corona stabilizer is used in much the same way as the glow discharge tube, but at considerably higher voltage and lower current. For example, the SC series marketed by The M-O Valve Co. Ltd., covers the range from 350 V to 6,800 V, at tube currents of up to 1 mA.

The striking voltage of a corona stabilizer is generally less than 10% above the operating voltage. Because a large

\* The M-O Valve Co. Ltd.

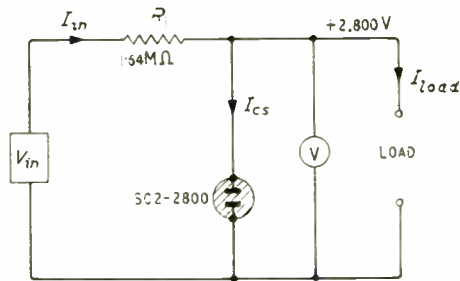

Fig. 1. Simple corona stabilizer circuit

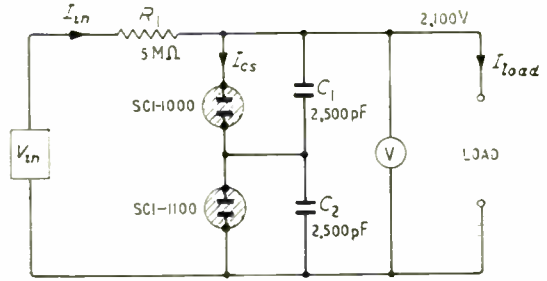

Fig. 2. Corona stabilizers in series

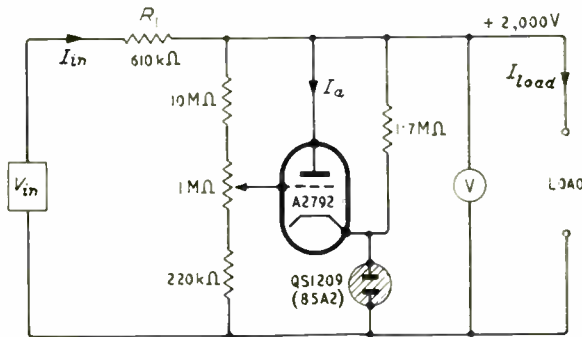

Fig. 3. Triode shunt stabilizer

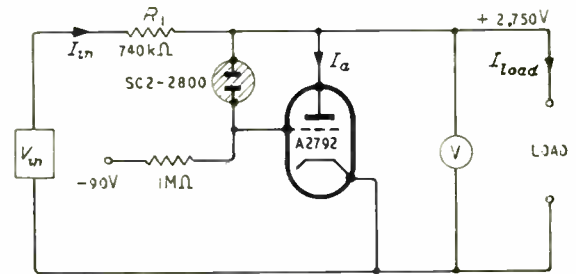

Fig. 4. Corona stabilizer as reference for shunt triode

input resistor ( $R_1$ ) is needed to give a reasonable degree of stabilization, in practice the available voltage is always ample for striking.

The first and simplest of the example circuits is illustrated in Fig. 1. Table 1 shows the design data for 7% high and 7% low mains, at no-load (NL) and full-load (FL) output current. The voltage and current symbols correspond to those in the figure.

The design procedure consists of Ohm's law calculations, which need not be described. It is important that the corona stabilizer current  $I_{cs}$  should not be allowed to go outside the permitted range for the SC2 series, namely 0.025–1 mA (continuous), even when  $R_1$  varies by  $\pm 10\%$ , and allowing for the  $\pm 2.5\%$  tolerance on the stabilizer voltage. Voltage variations due to tube impedance may be ignored, as they prove to be in the 'right' direction. In effect, one assumes for calculation purposes that the tube has zero impedance.

The minimum and maximum operating currents for a corona stabilizer exist because below this range the discharge may become intermittent, while at higher currents the discharge tends to change to the glow mode, resulting in a negative impedance which causes relaxation oscillations.

The measured variation in output voltage for  $\pm 7\%$  mains changes and the full range of output current is 70 V overall, a typical performance for this simple circuit.

### Corona Stabilizers in Series

The SC series of corona stabilizers extends from 350 to 6,800 V. When a higher voltage is required, two or more tubes may be connected in series. This may also be done in order to obtain a supply with intermediate tapings, or to derive an odd voltage using standard tubes.

An example of series connection is shown in Fig. 2, and Table 2 gives the design conditions.

This circuit combines an SC1-1000 and an SC1-1100 to give an output voltage of 2,100 V. As these tubes have a lower operating current than the SC2 series, the available output current is lower than in the first example.

Table 1: Design Conditions for Circuit of Fig. 1

$V_{in}$ (V)	$I_{in}$ (mA) (NL and FL)	$I_{cs}$ (mA) (FL)	$I_{rs}$ (mA) (NL)	$I_{load}$ (mA)
4280	0.90	0.50	0.85	0.35
3720	0.56	0.16	0.51	0.35

Table 2: Design Conditions for Circuit of Fig. 2.

$V_{in}$ (V)	$I_{in}$ (mA) (NL and FL)	$I_{rs}$ (mA) (FL)	$I_{cs}$ (mA) (NL)	$I_{load}$ (mA)
4280	0.436	0.201	0.401	0.20
3720	0.324	0.089	0.289	0.20

Table 3: Design Conditions for Circuit of Fig. 3 (2,000 V Output)

$V_{in}$ (V)	$I_{in}$ (mA) (NL and FL)	$I_a$ (mA) (FL)	$I_a$ (mA) (NL)	$I_{load}$ (mA)
4280	3.74	1.40	2.40	1.00
3720	2.81	0.47	1.47	1.00

Table 4: Design Conditions for Circuit of Fig. 4

$V_{in}$ (V)	$I_{in}$ (mA) (NL and FL)	$I_a$ (mA) (FL)	$I_a$ (mA) (NL)	$I_{load}$ (mA)
4280	2.00	1.05	1.85	0.80
3720	1.24	0.29	1.09	0.80

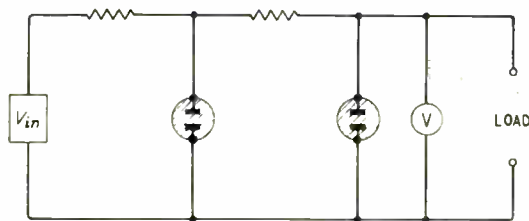

Fig. 5. Corona stabilizers in cascade

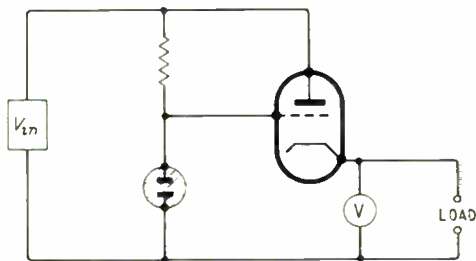

Fig. 6. Corona stabilizer with cathode follower

The overall voltage change for full mains and load current variation is 20 V. The restricted current and the consequent larger value of  $R_1$ , compared to the first circuit, are reasons for the better performance.

An important practical point concerning the use of tubes in series is the necessity for the capacitors  $C_1$  and  $C_2$  (Fig. 2). Their value is not critical, but if they are omitted the circuit is prone to relaxation oscillation. This appears to be due to small changes in the voltage drop of one tube affecting the other in such a way as to increase its current momentarily to a larger value. It is an empirical fact that two valves which individually do not exhibit relaxation oscillation, nevertheless can oscillate at random frequency when connected in series.

### Triode Shunt Stabilizer

The corona stabilizer circuit gives a fixed output voltage. Of course, to supply a low-current device such as a Geiger-Müller tube or an ionization chamber, the output may be varied with a resistive potential divider. However, for a variable low impedance e.h.t. supply, one requires some form of hard valve circuit, such as that shown in Fig. 3, which uses a shunt stabilizer triode, the A2792. Table 3 gives the design data for operation at 2,000 V output.

The circuit of Fig. 3 may be used at output settings other than 2,000 V, but the available output current depends on the voltage. For instance, it is approximately 3 mA at 1,000 V and zero at 2,500 V. The circuit is designed so that the anode current of the A2792 does not fall to zero, and the anode dissipation rating of 6 W is not exceeded, in any conditions. This includes not only mains variation of  $\pm 7\%$  and the full range of output current, but changes in the resistors of  $\pm 10\%$  from nominal values.

The overall change in the 2,000 V output is 50 V, for full mains and load current variation.

### Corona Stabilizer as Reference for a Shunt Triode

Although the previous circuit is useful and versatile, its stabilization performance is not ideal, owing to the

attenuating action of the grid potential divider. The feedback may be increased by replacing the upper limb of the divider with a corona stabilizer. This leads to the circuit of Fig. 4, in which the feedback is almost 100%. Here, the corona stabilizer, connected between anode and grid of the A2792, carries a nearly constant current of about 90  $\mu$ A, and acts as a voltage reference. The output voltage will be slightly less than the corona tube drop, the difference being the negative bias for the triode. Table 4 shows the design figures.

The voltage variation in this circuit is too small to measure by means of the output voltmeter. In fact, the output impedance may be shown to be  $1/g_m$ , or about 500  $\Omega$ , which is very low, by usual standards, for a 2,800-V supply.

### Other Circuits

There are many other possible high-voltage stabilizer circuits. For example, two corona tubes may be used in cascade, the second one being of lower voltage than the first (Fig. 5). The stabilization against supply variations is then very much better than in the simple circuit of Fig. 1. On the other hand, the output impedance is no better than with a single tube.

One useful circuit (Fig. 6) employs a corona stabilizer as a reference for a series valve or cathode follower. This can give a larger output current than the shunt valve circuit of Fig. 4, but needs an insulated heater supply.

Conventional series-stabilizer methods may be used at high voltage also. Again there is the need for an insulated heater supply, and the circuit is more complex, but these points are offset by the very low output impedance.

Sometimes a high-voltage high- $\mu$  triode is required for e.h.t. stabilizer operation and no valve specifically made for the purpose proves to be available. In such cases a pulse modulator pentode or tetrode, such as the A2426/CV4082, with the screen-grid connected to cathode, may be found suitable. As this application would involve characteristics which are not controlled by the valve manufacturer, a rather wide variation in those characteristics should be expected, but this is often acceptable.

### Conclusion

There must inevitably be many gaps in this brief survey of a large subject. Nevertheless, it is hoped that the techniques presented will prove helpful by indicating possible lines of approach to individual problems in the field of high-voltage stabilization.

### References

- <sup>1</sup>Cohen, E. and Jenkins, R. O., "The Characteristics and Applications of Corona Stabilizer Tubes". *Electronic Engineering*, Vol. 32, No. 383, January, 1960.
- <sup>2</sup>Cohen, E. and Jenkins, R. O., "The Corona Discharge and its Application to Voltage Stabilisation". *The Proceedings of The Institute of Electrical Engineers*, Vol. 107, Part B, No. 33, May, 1960.

### ★ FOR THE BUYER

You must have read about a number of products and processes in this issue of which you would like further details. You can obtain this information very easily by filling in and posting one or more of the enquiry cards to be found inset in the front and back of the journal.

# CAPACITANCE CONTROLS IN FLUID HANDLING

The use of capacitance probes in the control of fluid level is described in this article. Attention is drawn to special cases, such as drainage control, where the use of two probes can obviate damage in unusual conditions.

CAPACITANCE devices are widely applicable where pump or valve operation is required at certain pre-determined high and low levels within a container. In this respect they are comparable with several other types of electronic detecting equipment, conductivity, photo-electric and ultrasonic. A special advantage, however, is that it is comparatively straightforward to arrange for control action affecting the level of liquid or solid material in a container to be related to the contents level in another where this second level is subject to variation.

This is because capacitance devices inherently provide for continuous measurement over a chosen range, whereas the other types of equipment determine the presence of contents only at fixed points. With a capacitance probe

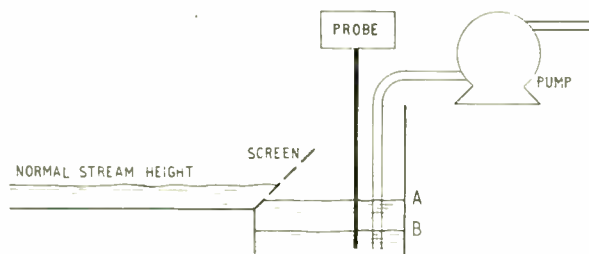

Fig. 1.—Simple control of water level in a drainage sump. The pump is switched on when the level rises to A and off when it falls to B

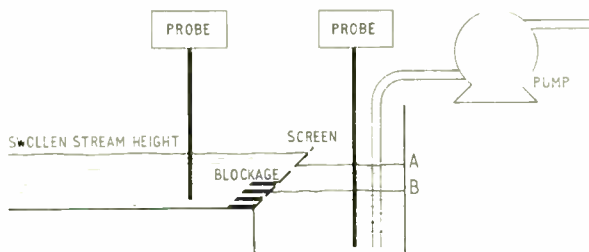

Fig. 2.—Under flood conditions the screen may become partially blocked and may be damaged if the sump levels are controlled as in Fig. 1. By using a second probe the control levels can be raised to prevent such damage

mounted vertically in a container, the level of contents is detectable at any time: the probe may, in fact, be likened to a dip-stick. With a conductivity device, the level is detected at the tips of the electrodes, and with photo-electric and ultrasonic apparatus at the level at which the light or ultrasonic beam is arranged.

Continuous measurement is, of course, obtainable with ultrasonics by an 'echo' arrangement, but the comparison here is with the mode whereby a beam is interrupted by container contents.

Control arrangements whereby the contents level of one container may desirably be related by means of capacitance devices to the level in another are found in industry generally and, notably, in land-drainage pumping and lock-gate

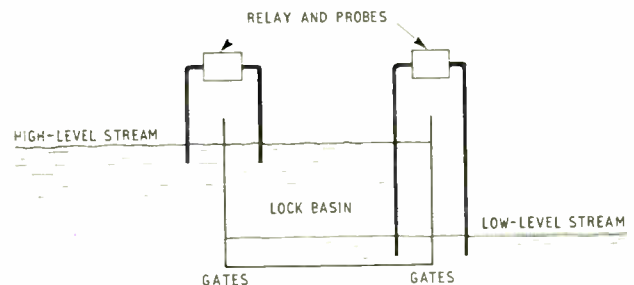

Fig. 3.—A pair of probes can be used to detect when the water levels on each side of a pair of lock gates are equal and so prevent any attempt to open the gates before equal levels have been reached

control. The essential component in a capacitance control is the probe, comprising a mild-steel rod with a sheath of insulating material. The rod forms a live electrode and whatever surrounds the probe the earth electrode. Capacitance between the two electrodes is measured by a radio-frequency bridge circuit in the relay box.

With the probe placed vertically in a container, control action can be obtained according to the length of probe immersed in the contents. Thus an inlet valve can be opened to replenish the container when the contents level drops to the bottom of the probe, and similarly it can be closed as the level reaches the top. There will be a difference in capacitance between the conditions of slight and almost complete immersion of the probe, and it is a simple



Capacitance probe

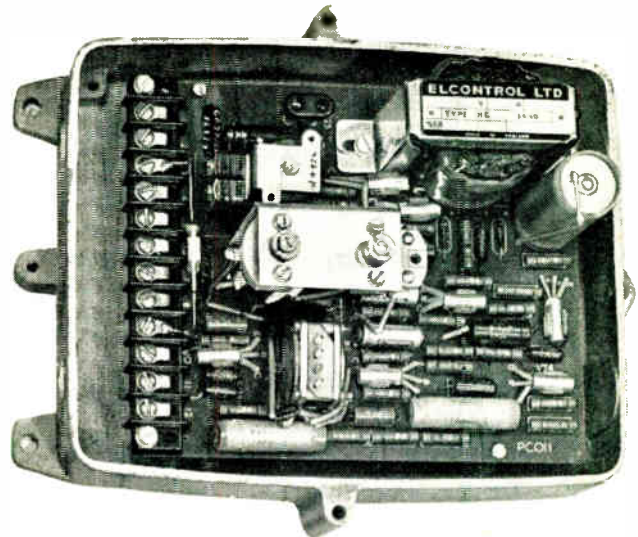

Elcontrol DLC electronic level control with cover removed

matter of setting the control so that valve opening and closing occurs at the desired levels.

A simple arrangement of this kind is acceptable when no other conditions need be taken into account. In the case of land-drainage pumping, however, there is a variable factor to be reckoned with. Fig. 1 depicts a culvert leading to a sump from which water is pumped. There is a screen to prevent trash such as leaves and twigs from falling into the sump. With a capacitance probe—or indeed any other control device—the pump will be brought into operation when the height of water in the sump rises to level A, and be cut out when the level drops to B, say 24 in. lower.

So long as the height of water in the culvert remains the same, within reasonable limits, this control arrangement will function without trouble. But with the coming of a storm, much more trash is borne by the water than usual and the lower part of the screen becomes blocked. The result is that the water rises in the culvert and pours into the sump mainly through the upper part of the screen. With the same kind of control as provided for normal conditions, water is pumped out of the sump and the entire sump side of the screen is deprived of hydraulic support. Because of this, and the build-up of pressure against a large area of the screen on the culvert side, breakages are liable to occur, leading not only to costly repairs but also a failure of the drainage system at a time when it is most needed.

With capacitance equipment, this difficulty can be overcome by having a probe in the stream on the culvert side of the screen in addition to that in the sump (Fig. 2). This detects the stream level and, when a rise occurs, the operation of the probe in the sump is suitably compensated. The high and low levels thus become relative not to invariable points in the sump but to stream height. When conditions are normal, the high and low pumping levels may be similar to those of a single-electrode arrangement, but should stream height increase due to screen blockage, the sump is evacuated not to the same depth but to the selected differential below stream height. In effect this means that the screen is not deprived of hydraulic support and breakage is obviated.

For lock-gate control, the application is similar except that the equipment is required not to control level differentials but indicate equal water levels on each side of the gates (Fig. 3). Opening lock gates when there is too much difference between water level places undue stresses on

motor gear or mechanical linkages. By the most common existing methods, checking levels may be done visually—that is by a man simply looking at the water on each side of the gates—or by comparing readings on individual indicators. Either involves liability to human error, particularly in bad weather.

A simple capacitance-relay installation can exclude the factor of human error. The relay may be connected to two vertical electrodes arranged one on each side of a pair of gates, and an indication is given when the water levels are the same. Furthermore there is automatic compensation for tidal influences. If desired, the relay can be directly connected to the gate motor to start it automatically at the correct moment.

## MULTI-WAY CABLE TESTING



Illustrated here is one stage of telephone cable testing at the Prescott factory of British Insulated Callender's Cables Ltd. The sequence of checks includes those for continuity, resistance, insulation resistance, mutual capacitance and capacitance unbalance. In order to speed up this test programme and to record the results, fully transistorized equipment with electric typewriters have been installed.



### Personal and Company News

**Evershed and Vignoles Ltd.** have announced the following board changes: Ivor Bowen, G.M.G., M.Sc., F.R.Ae.S., has joined the board and will act as part-time consultant to the company; D. D. Walker, M.A., M.I.E.E., while continuing to be an active director, has relinquished his position as joint managing director. Allan R. Pike, B.Sc.(Eng.), M.I.E.E., has been appointed commercial director.

The new headquarters of the **General Electric Co. Ltd.** is 1 Stanhope Gate, London, W.1. (Telephone: Hyde Park 8484).

**R. A. McMahon** has retired after 29 years' service with the Electrical Research Association.

**Plessey Overseas Ltd.** is to become a principal operating company of the Plessey Group, with the prime function co-ordinating under one management the overseas manufacturing resources of Automatic Telephone, Ericsson and Garrard.

Lord Hill of Luton has been appointed by the Postmaster General to be chairman of the **Independent Television Authority** from 1st July, in succession to the present acting chairman, Sir John Carmichael.

**E.M.I. Electronics Ltd.** have transferred certain sales activities to different divisions. The newly-formed Automation Division has taken over the systems work of the Industrial and Instrument Divisions, and sales of packaged goods are grouped together under the Instrument Division, which will continue to handle sales of closed-circuit television equipment.

**British Aircraft Corporation Ltd.** have announced two new appointments: E. L. Beverley, D.F.C., as civil aircraft contracts manager, and F. W. Higginson, D.F.C., D.F.M., as sales and service manager of the Guided Weapons Division.

The **Rank Organization** is combining the professional cinema, furnishings and closed-circuit television equipment marketing operations of the Rank Kalee Division with those of Rank Audio Visual with permanent headquarters at Woodger Road, London, W.12.

J. S. Skinner has retired as chairman of **Remington Rand Ltd.** The new managing director is M. G. Lovatt.

**Morganite Resistors Ltd.** have announced the appointment of J. H. Wood as general sales manager of the Electronics Division, D. A. Forrest as general sales manager of the Electrical Division, and A. J. Flower as sales office manager.

D. A. Pitman has resigned from the board of **Electronic Instruments Ltd.** in order to form a company specializing in the sales and service of medical instruments.

*Apparatus used at the Caswell Research Laboratory of the Plessey Co. Ltd. for testing microminiature solid circuits. The silicon slice contains 100 solid circuits and the close-up shows point probes contacting base and emitter of a transistor*

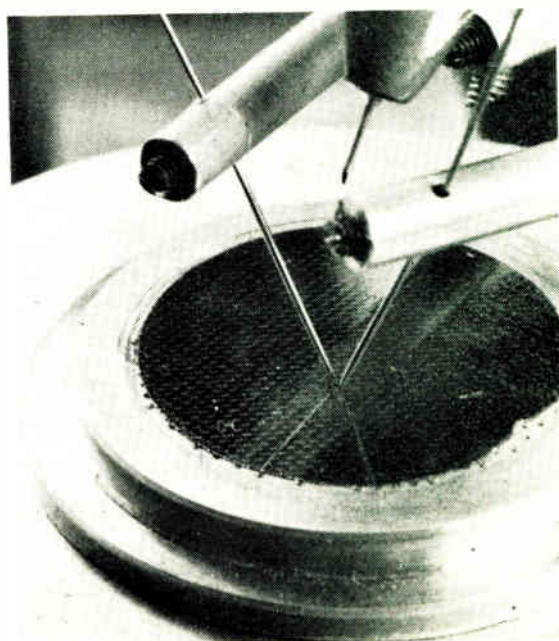
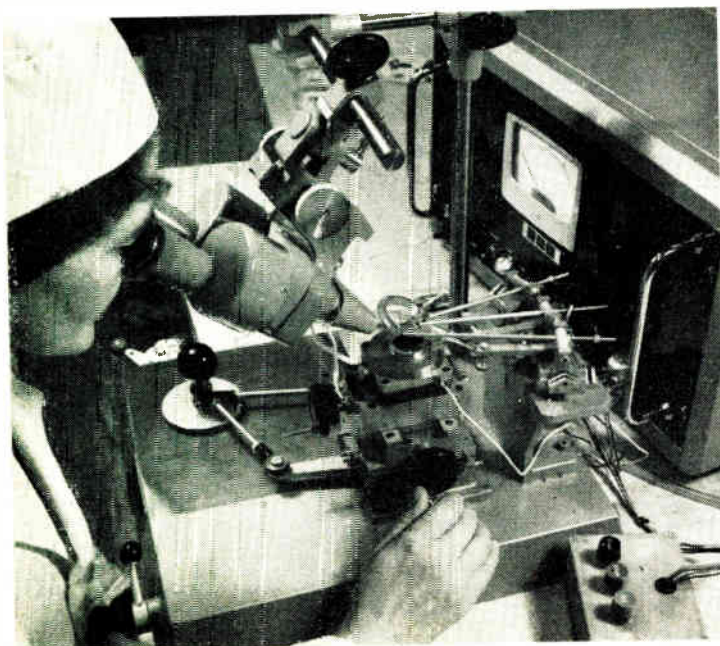

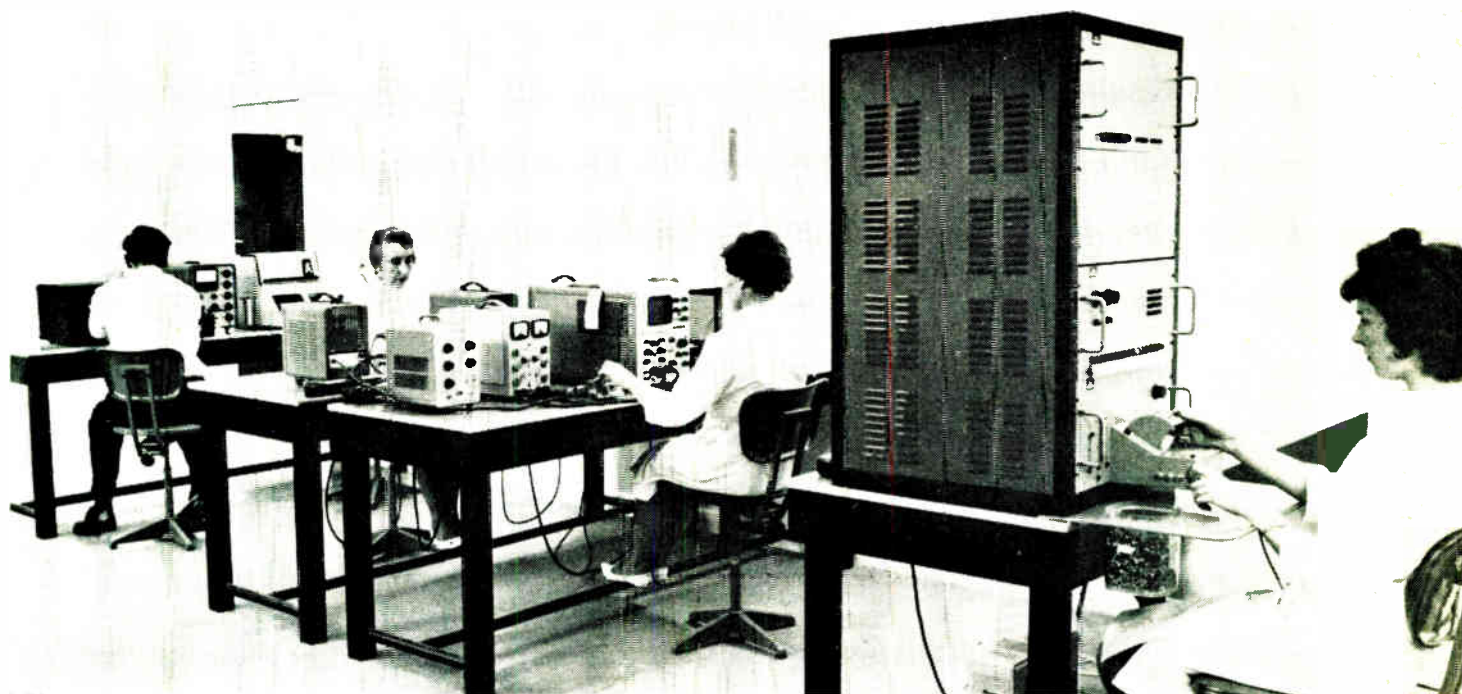

*Silicon planar transistors manufactured by SGS-Fairchild at Ruimslip are tested for 16 primary parameters automatically. The test set has 16 lamps. If the transistor passes the tests all 16 lamps go out; if it fails any, one or more lamps remain alight*

The Transistor Division of **Standard Telephones and Cables Ltd.** has been amalgamated with the Rectifier Division to form a single Semiconductor Division. The manager of the new division is J. M. Wilson, formerly manager of the Rectifier Division.

An agreement has been signed between **Painton & Co. Ltd.** and the Waltham Precision Instrument Co. Inc. (Camblock Division) for the exclusive manufacturing and marketing rights for a range of terminal blocks to be known as Painton Camblocks.

H. Fanning has been appointed sales engineer for the Technical Division of **Chilton Electric Products Ltd.** and will represent the company in Scotland. He will also represent Chilton Solenoid (U.K.) Ltd. as sales engineer for the same area.

Group Captain D. P. Hanafin, C.B.E., D.F.C., A.F.C., has taken up a civilian appointment with the instrumentation company of **S. Davall & Sons Ltd.**

R. G. B. Benson has been appointed chief engineer at **Expert Industrial Controls Ltd.**

Allan Appleby has been appointed chief electronic engineer of **S.E. Laboratories (Engineering) Ltd.**

The **B.B.C.** has announced the retirement of F. G. Chadder, O.B.E., senior superintendent engineer.

D. A. Clark has been appointed administrative assistant to D. J. Taysom, chairman and managing director of the **Brush Crystal Co. Ltd.**

E. F. Duncan, A.M.I.E.E., has been appointed divisional director and general manager of the Accessories Division of **British Insulated Callender's Cables Ltd.**

Hugh Veysey has been appointed general manager of the Publicity Department of **A.E.I. Ltd.** in succession to Sir Arthur Elton who is resigning to rejoin the board of Film Centre Ltd.

The Industrial Electronics Division of the **International General Electric Co. of New York Ltd.** has moved to Boulton Road, Reading, Berks. (Telephone: Reading 82468).

**Southern Instruments Ltd.** announce the appointment of John R. Bell as sales manager of their Instrumentation Division.

**Graham Clifford**, secretary of the Brit.I.R.E., has returned from a tour of India where he discussed the constitution of an Indian Division.

### Obituaries

David C. Dance, sales engineer for Miniature Electronic Components Ltd., died on 23rd May following a motoring accident. Company representation for the south of England is now carried out by John R. Wood.

George Partington, chief engineer of Marconi's Broadcasting Division, died on 13th June. A prolific inventor and designer, he was perhaps best known for his work on the development of television cameras.

E. F. Stephenson, chief engineer of The Rotameter Manufacturing Co. Ltd. (Elliott Automation Group), has died after a short illness.

The death occurred on 9th June of Leonard Satchwell founder of The Rheostatic Co. Ltd. His name is well known for the invention, in 1927, of the magnetically controlled micro-gap switch.

### Television Advisory Committee

Changes in the membership of the Television Advisory Committee have been made following the appointment of Prof. Sir Willis Jackson, D.Sc., M.I.E.E., as chairman. The three members from the radio industry are C. O. Stanley, C.B.E., Dudley Saward, O.B.E., and F. N. Sutherland, C.B.E. Representing general interests are Lord Aberconway, R. A. L. Cohen, O.B.E., and Roger Falk, O.B.E., all from industry and commerce. Also on the committee are three senior officials from the Treasury, the M.O.A. and the G.P.O., and the directors general of the B.B.C. and I.T.A. The terms of reference of the committee are: 'to advise the P.M.G. on the development of television and sound broadcasting at frequencies above 30 Mc/s. and related matters'.

### European Marketing Organization

Euro-Center Marketing Systems Ltd. have announced the establishment of the first 'Euro-Center' in Brussels. The object of these centres, which are to be opened in the main commercial and industrial towns in Europe, is to facilitate the entry of British firms into European trade. A comprehensive marketing service is offered for under £500 p.a. The address of the head office is 1 Westminster Palace Gardens, Artillery Row, London, S.W.1.

### Symposia, Conferences and Exhibitions

A Symposium on Instrumentation is to be held this year at Brunel College, Woodlands Avenue, Acton, W.3, on 17th, 18th and 19th September.

The Systems Engineering Section of the Society of Instrument Technology is holding an all-day symposium on 'The Use of Redundancy in System Design' at the Northampton College of Advanced Technology on Friday, 14th February 1964.

The Professional Group for Line and Radio Communication Systems of the Electronics Division of the I.E.E. is arranging an International Conference on Transmission Aspects of Communication Networks to take place from Monday to Friday, 24th to 28th February 1964.

The 1964 Electrical Engineers Exhibition is to be held at Earls Court, from 18th to 25th March, with a late night to 9 p.m. on Tuesday, 19th March.



*The picture shows a trolley with a built-in lamp standard for the E.M.I. Electronics Ltd. stroboscope type 6. This has a xenon discharge tube and a range of 300-60,000 flashes a minute*

For further information circle 79 on Service Card

### Army Link with Electronics Industry

A scheme to assist suitably qualified technicians in their transition from the Army into industry, agreed recently between the War Office and the Electronic Engineering Association, came into effect on 1st July. The pilot scheme is confined initially to the Royal Corps of Signals, but it is hoped to extend it in the near future to include R.E.M.E. This idea will, no doubt, be of interest to other sections of industry and the armed forces.

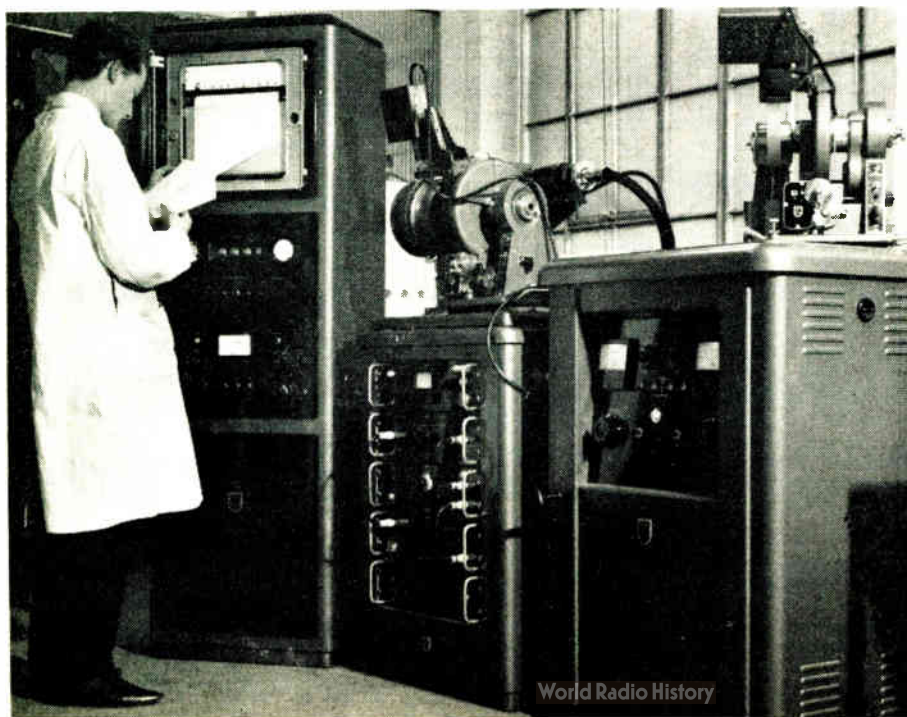

*X-ray spectrometer in a new laboratory of Research Control Instruments Ltd. The laboratory will carry out a certain amount of work on a contractual basis and it also is available to demonstrate X-ray instruments and advise on their use*

For further information circle 80 on Service Card



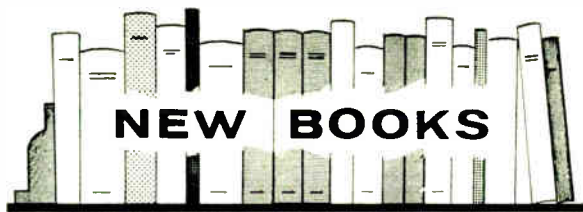

### Models of Transistors and Diodes

By JOHN G. LINVILL. Pp. 190 + x. McGraw-Hill Publishing Co. Ltd., 95 Farringdon Street, London, E.C.4. Price 62s.

A model of a semiconducting device is something different from an equivalent circuit. It is, in fact, a kind of circuit which represents the device but the elements of it are intended to represent physical processes. The elements of the model are not confined to the usual resistances, capacitances, inductances and voltage and current generators from which the normal equivalent circuit is built up.

The elements of a model are storances, combinances, diffusances, mobilities, driftances to represent the storage, re-combination, diffusion, mobility and drift of charge carriers in the semiconductor. They have this difference from the elements of equivalent circuits, they are just paper symbols of defined meaning for the properties of the semiconductor whereas equivalent circuit elements are not only this but also represent real elements in their own right. The equivalent circuit is a paper representation of the real thing, it is true, but all its elements exist as individual components and it is possible to assemble the physical elements of an equivalent circuit into a piece of apparatus which will function in the same way as the real thing.

If a perfect equivalent circuit existed it would be possible to assemble its elements into a closed box and if the real device were put into another it would be impossible to distinguish between them by making measurements at the accessible terminals. This is not true of the models of this book. A resistor having the property of resistance exists as a physical thing; a driftor having the property of driftance does not so exist.

The explanations given in this book of how semiconducting devices work are exceptionally clear but it is very doubtful if they are helped by the model elements. They are all strange to the newcomer and added to the difficulty of understanding a semiconductor he has that of trying to remember what all the strange new symbols mean. It may well be, of course, that when they have become as familiar as the ordinary circuit symbols they will be as helpful.

The book ends with the transmutation of some of these models into familiar equivalent circuits.

### Microwave Engineering

By A. F. HARVEY, D.Phil., B.Sc.(Eng.), M.I.E.E. Pp. 1,313 + xlii. Academic Press Inc. (London) Ltd., Berkeley Square House, Berkeley Square, London, W.1. Price £12 10s.

The twenty-six chapters of this enormous book take one from wave propagation in circuits to techniques of radio and radar astronomy. There is very little connected with microwaves that is not at the least mentioned.

The book is primarily a reference book and one for those who already possess a fair knowledge of the subject. It is tersely written and the size of the book comes about because of the enormous amount of material included and not because of any prolixity on the part of the author.

There are copious bibliographies and the reader is thereby referred to other publications for more detailed information.

The treatment is by no means entirely theoretical and a great deal of useful practical material is also included.

### Radio-Interference Suppression on Marine Installations

Pp. 42. B.S. 1597 : 1963. British Standards Institution, 2 Park Street, London, W.1. Price 10s.

In this new edition of the standard, the scope has been extended to cover frequencies within the range 15 kc/s to 300 Mc/s, and stipulates limits within this range for the intensity of the interference-producing voltages developed at the terminals of the ship's aerials.

The requirements and test conditions for suppression components, particularly capacitors, used on board ship have been revised and extended to bring them into line with current practice.

General guidance on the steps to be taken to reduce radio-interference, covering such aspects as the radio receiving installations, electrical machinery and appliances, the wiring installations, aerial systems and ship's rigging, has been revised and extended and is now set out in appendices.

### Supplement to the Elsevier Dictionaries of Electronics, Nucleonics and Telecommunication

Compiled by W. E. CLASON. Pp. 633. Elsevier Publishing Co., P.O. Box 211, Amsterdam. Price £5.

The basic dictionary comprises terms in alphabetical order with their definitions. These are in English on the left-hand pages. One the right-hand pages are the French, Spanish, Italian, Dutch and German equivalents of the terms. The terms are all numbered sequentially.

The second half of the book comprises a list in alphabetical order of the language concerned of the terms with the corresponding number of the term in the English half. An English user has need only of the first half, where he finds his term alphabetically, and is at once presented with the definition and foreign equivalents. A foreign user must first turn up his word in the appropriate section of the second half to find the serial number and then refer to the first half by this number, where he finds the English and other foreign language equivalents. The definition is provided only in English.

For example, a Spanish user turns first to section E (Español) in the second half. There he looks up 'aislador de entrada', say, and finds the number 1341. Turning to this number in the first half, he reads 'lead-in insulator' and has an English definition and the other foreign language equivalents.

### Sell's Automation, Electronics, Nuclear Engineering Buyer's Guide

Pp. 314 + v. Business Dictionaries Ltd., 133-137 Fetter Lane, Fleet Street, London, E.C.4. Price 21s.

This buyer's guide comprises an alphabetical list of manufacturers' names and addresses as well as classified sections and indexes for general engineering and instrumentation. The indexes give no page or other references and appear to be merely a list of the alphabetical headings of the classified sections.

### Ultrasonic Technology

By RICHARD G. GOLDMAN. Pp. 304 + x. Chapman & Hall Ltd., 37 Essex Street, London, W.C.2. Price 88s.

This book is of American origin and, apart from the introduction, its five main chapters cover the nature of

sound, ultrasonic transducers, power applications, testing and examination, and the measurement of time and distance. The longest chapter is that on transducers followed closely by the one dealing with testing.

Most kinds of transducer are clearly explained, and even fluid jet methods of generating ultrasonics are included. The treatment is mainly explanatory, but a little algebra is used.

The book forms a good introduction to the subject. It is obviously intended for readers with a good background knowledge of electronics.

### British Standards Yearbook 1963

Pp. 711. British Standards Institution, 2 Park Street, London, W.1. Price 15s.

The bulk of this yearbook is devoted to a list of British Standards and Codes of Practice with a description of the contents of each. I.S.O., I.E.C. and C.E.E. publications are also included. There is a detailed subject index.

### Communications in Space

By ORRIN E. DUNLAP, Jr. Pp. 175 + xi. Harper & Row Ltd., 35 Great Russell Street, London, W.C.1. Price 35s.

### Der Transistor

By H. SALOW, H. BENEKING, H. KRÖMER and W. V. MÜNCH. Pp. 426 + viii. Springer-Verlag, Heidelberger Platz 3, 1 Berlin 31. Price DM82.

### Les Hyperfréquences

By ROGER RIGAL. Pp. 331. Editions Eyrolles, 61 Boulevard Saint-Germain, Paris 5e. Price F60.50.

## Manufacturers' Literature

**Belling & Lee Technical Catalogue.** To provide for the filing of future information, Belling & Lee have adopted a loose-leaf style for their new technical catalogue. It is now available to senior designers and engineers, on application from their head of department.

Initially the catalogue includes 88 pages covering, by thumb-indexed sections, plugs and sockets, terminals, circuit protection devices, shielded enclosures and suppressors, and a numerical index.

*Belling & Lee Ltd., Great Cambridge Road, Enfield, Middlesex.*

**For further information circle 81 on Service Card**

**What is a Capacitor . . . why Tantalum?** An interesting 8-page leaflet in the form of a simple introduction to solid tantalum capacitors. Supporting this are a number of data sheets on tantalum capacitors.

*Union Carbide Ltd., 8 Grafton Street, London, W.1.*

**For further information circle 82 on Service Card**

**Jastac Fixing Techniques.** A 4-page leaflet giving details of a method for the insertion and fixing, by punch-through tags, of a range of components such as solder tags, terminal pins, insulating bushes, etc. With this method component tags can be punched into metal plates or laminates without the necessity for pre-punching or drilling holes.

*J. & S. Engineers Ltd., 1A London Road, Crayford, Kent.*

**For further information circle 83 on Service Card**

**Automatic Plating Plant.** This 32-page booklet describes various systems, types of plant and ancillary equipment used in automatic electroplating today.

*The International Nickel Company (Mond) Ltd., 20 Albert Embankment, London, S.E.1.*

**For further information circle 84 on Service Card**

**Mullard Valves and Tubes for Industry Communications and Radar: Abridged Data on Current Types.** This 40-page brochure highlights the principal performance characteristics of Mullard devices and tabulates them in order of their performance.

*Mullard Ltd., Government and Industrial Valve Division, Mullard House, Torrington Place, London, W.C.1.*

**For further information circle 85 on Service Card**

**Brush Engineered Chart Paper.** Describing the range of Brush chart paper for all types of direct writing recorders, this 4-page brochure also includes small samples of charts for ink, electric, pressure-thermal and forced-fluid recorders. Available in the U.K. through

*Aveley Electric Ltd., South Ockendon, Essex.*

**For further information circle 86 on Service Card**

**Westinghouse Application Report: Trinistor Three-Phase A.C. Regulators.** In this application report AR9 several circuit arrangements using Trinistor silicon controlled rectifiers for the control of 3-phase power are discussed, for loads containing resistance and inductance. A comparative assessment is made of the circuit characteristics.

*Westinghouse Brake and Signal Co. Ltd., 82 York Way, London, N.1.*

**For further information circle 87 on Service Card**

**SGS-Fairchild Transistor Application Reports APP-49 & APP-58.** The 8-page report APP-49 is entitled, and deals with, 'The Design of High Speed All Transistor Logic Circuits'. In 7 pages APP-58 covers 'Class-C High Frequency Amplifier'.

*S.G.S.-Fairchild Ltd., 23 Stonefield Way, Victoria Road, Ruislip.*

**For further information circle 88 on Service Card**

**Dubilier 'Terecap' Plastics Film Capacitors.** This 4-page leaflet lists the relevant details of one of the latest Dubilier capacitors using polyethylene terephthalate dielectric. The normal units range from 1.0 to 0.0001  $\mu$ F at various working potentials from 125 to 400 V d.c.

*Dubilier Condenser Co. (1925) Ltd., Ducon Works, Victoria Road, Acton, London, W.3.*

**For further information circle 89 on Service Card**

**Elliott-Automation in Aviation.** A 20-page brochure in which brief details are given of the equipment and systems produced by Elliotts for aviation. Also included is a useful list of the addresses and telephone numbers and functions of the E-A companies and divisions in aviation.

*Elliott-Automation Ltd., 34 Portland Place, London, W.1.*

**For further information circle 90 on Service Card**

**The Haynes Plastics Extrusion Monitor.** A monitor which automatically measures and records wall thickness and concentricity of plastics tubes during extrusion is described in this 4-page leaflet. The instrument is electronic and needs no access to the inside of the tube. Distributed in the U.K. by

*Research and Control Ltd., 207 King's Cross Road, London, W.C.1.*

**For further information circle 91 on Service Card**

**Reel-Type BTM Magnetic Tape Units.** Designed to operate over a standard range of transfer rates between 20,000 and 100,000 characters sec, these tape units are available in several configurations. Features include: pneumatic capstan, bin buffer storage of tape and use of motorized reels. Produced by Bell Telephone Manufacturing Company. An 8-page brochure describing the units is available in the U.K. from

*Standard Telephones and Cables Ltd., Integrated Electronic Systems Division, Burleigh House, 101-145 Great Cambridge Road, Enfield, Middlesex.*

**For further information circle 92 on Service Card**

**Fairchild Semiconductor Condensed Catalog.** Listed in this 12-page booklet are details of SGS Fairchild transistors, diodes, micrologic products and test equipment. Distributed in the U.K. by

*S.A.S.C.O. Ltd., Adastral House, Nutfield, Redhill, Surrey.*

**For further information circle 93 on Service Card**



## How to be an accurate forecaster

# SHORTS' CONTROL SYSTEM ANALYSER CAN TELL YOU IN ADVANCE HOW ANY AUTOMATIC CONTROL SYSTEM WILL PERFORM IN SERVICE

Accurate forecasting of the performance of control systems in the prototype stage can be an enormous saver of time and money. This Control System Analyser has become standard equipment in the aircraft and missile industries, in light and heavy engineering, and in chemical, nuclear and marine engineering.

As well as its use in design, it is also a valuable means of quality control in the production of control systems. It is built by the Precision Engineering Division of

Short Brothers & Harland Limited—  
Europe's leading manufacturers of  
analogue computers.

**SEE THE  
CONTROL SYSTEM ANALYSER  
AND EDUCATIONAL COMPUTER  
AT STAND 568, HALL 17**

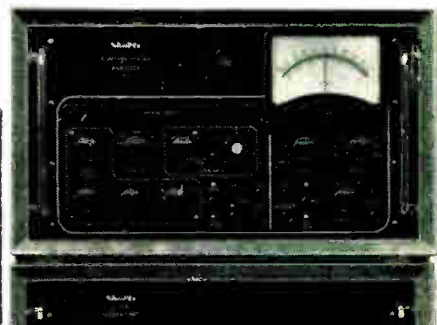

## **SHORT BROTHERS & HARLAND LTD.**

LONDON · BELFAST · ROCHESTER · GATWICK

FOR ANALOGUE COMPUTERS,  
SIMULATION, PRECISION ELECTRONICS

COMPUTER SALES DEPT. (IE), BERKELEY SQUARE HOUSE, LONDON W.1. TELEPHONE: MAYFAIR 9541



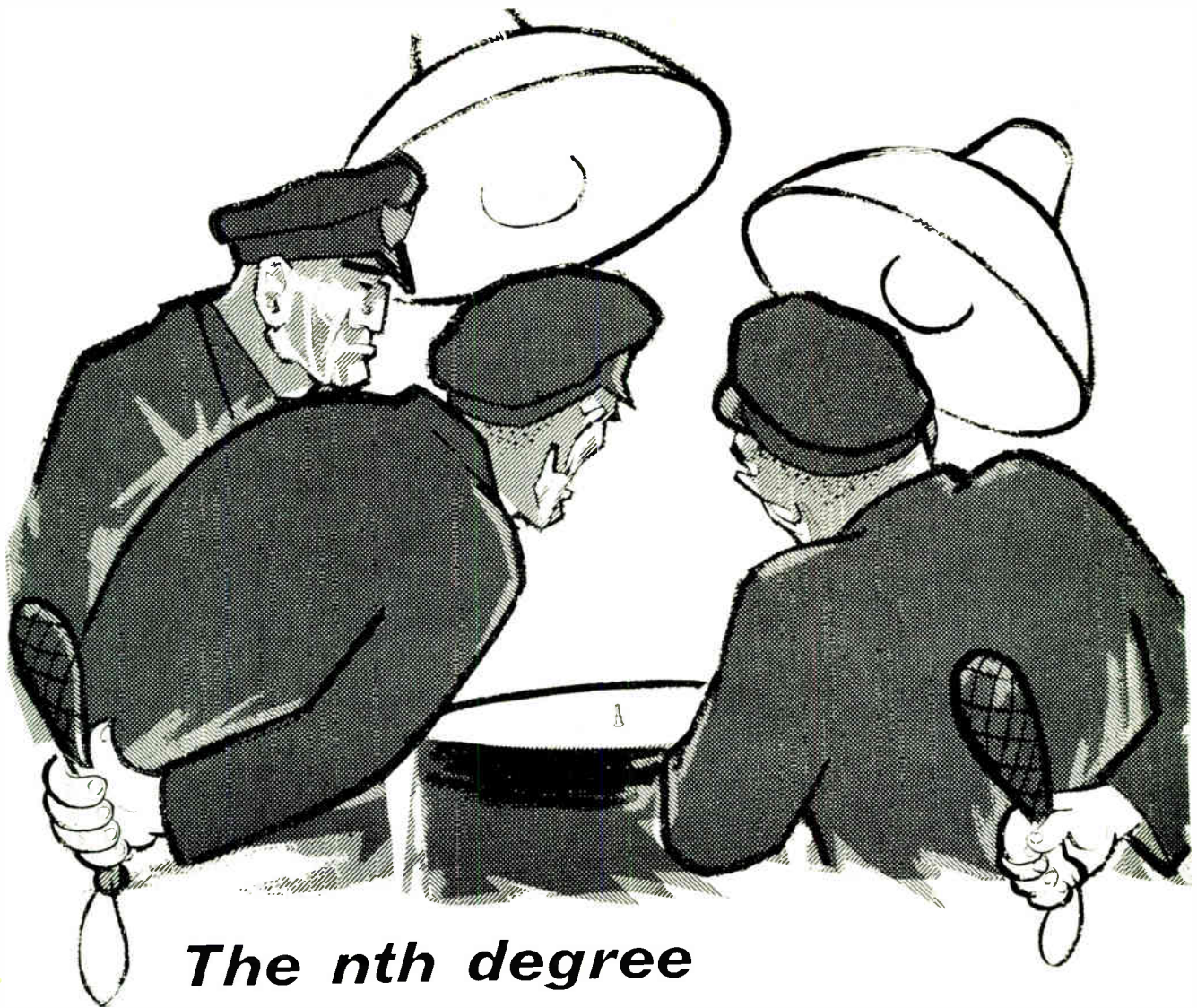

## The nth degree

The consistent 'nth' degree precision of HARWIN Components results from stony-hearted 'third degree' examination. The menacing glare of HARWIN inspectors brooks no compromise. **You** get Components you can rely on. Insulators, Lugs, Stand-offs, Brackets, Terminal Boards, Chassis Fittings, etc. And when HARWIN promise them, you get them.



As Mini-Tronic says:  
 'When time and space are tight,  
 HARWIN see you right'  
 Just telephone or write

**HARWIN ENGINEERS LTD · RODNEY ROAD · PORTSMOUTH  
 HAMPSHIRE · TELEPHONE: PORTSMOUTH 35555 (4 lines)**

**GREAT FOR MINIATURE ELECTRONIC COMPONENTS**

# WONDERFUL NEWS!

## IN ELECTROLYTIC CAPACITORS

ALUMINIUM FOIL CAPACITORS FOR TRANSISTOR AND OTHER LOW VOLTAGE CIRCUITS

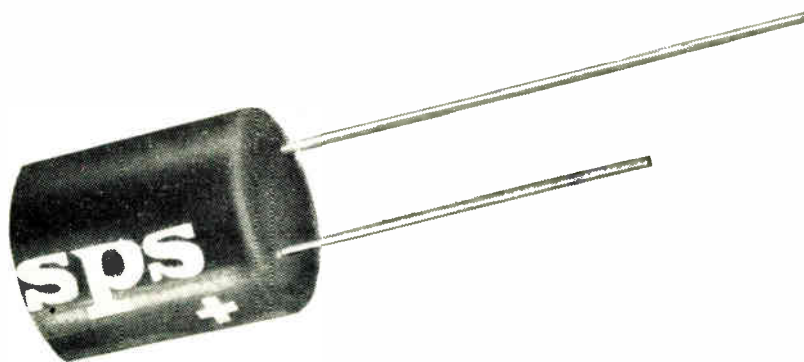

## ALL-MOULDED PLASTIC ENCAPSULATION

- ★ HERMETICALLY SEALED ALL-PLASTIC ENCASEMENT
- ★ ULTRA-SMALL SIZES WITH CAPACITIES TO 200  $\mu$ F
- ★ CLOSE TOLERANCE DIMENSIONS
- ★ LEAD SPACING TO  $\pm .015''$
- ★ HIGH RELIABILITY BY CLOSE QUALITY CONTROL PROVEN IN THE EXACTING U.S. MARKET
- ★ SURPRISINGLY LOW COST
- ★ FAST DELIVERY

# SPSI

### TECHNICAL

CAP. TOL. - 20% + 100% OF RATED

DISSIPATION FACTOR EXTREMELY LOW -  
LESS THAN 8% AT 50 WVDC

D.C. LEAKAGE EXTREMELY LOW - LESS THAN 6  $\mu$ A  
AFTER 1 MIN APPLIED WVDC

OPERATING TEMP. 65°C AT RATED WVDC

## SPS

INTERNATIONAL LTD.  
SHANNON AIRPORT  
IRELAND

SHANNON 245

FOR FULL INFORMATION WRITE OR PHONE:

# Resistors are no problem - if you're a HARWIN customer

Says Mini Tronic

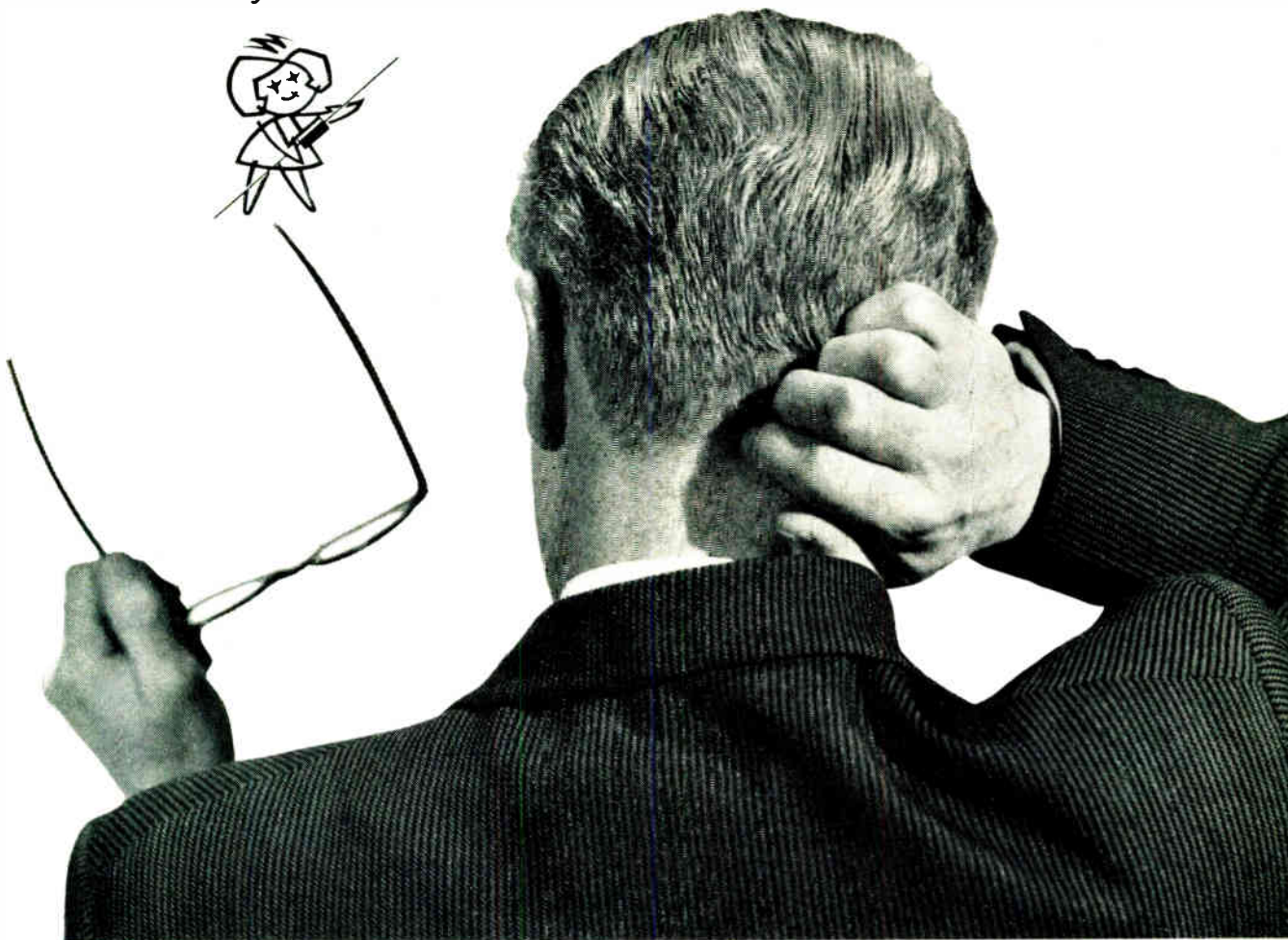

## PRECISION WIREWOUND RESISTORS

Resistance Range  
1 Ohm to 30 megohms  
Tolerance Range  
 $\pm 1\%$  to  $\pm 0.015\%$ .  
Temperature Coeffi-  
cient better than 24  
parts per million.



**GREAT FOR MINIATURE ELECTRONIC COMPONENTS**



HARWIN have a really fine range of precision wirewound resistors with wire or lug terminations, low temperature coefficient, in either normal, encapsulated or hermetically sealed styles. Harwin Engineers' service is unsurpassed, better get in touch with them right away, for a firm price, and reliable delivery or details of our full range.

**HARWIN ENGINEERS LTD · RODNEY ROAD · PORTSMOUTH  
HAMPSHIRE · TELEPHONE: PORTSMOUTH 35555 (4 lines)**

# HARWIN

# INSTRUMENTATION SYSTEMS .....

## CUSTOM BUILT *but off the shelf*

High grade, versatile instrumentation on the Modular Principle provides for custom-built systems with off-the-shelf facility. With this philosophy in mind, Digital Measurements Limited have developed a wide range of data acquisition equipment which singly, or in combination, meets the highest standards of accuracy and reliability demanded by modern industrial and scientific processes.

The present range includes high resolution digital voltmeters, a.c./d.c. converters, multi-channel scanning equipment, paper punch drive units, serializers and solenoid-operated typewriters, and is steadily being expanded and diversified. An experienced design team is available to evaluate requirements and engineer appropriate individual systems.

D.M. instrumentation combines functional design and precision engineering with realistic pricing and fast delivery. Full details are available on request.



up to 1,000 inputs with the D.M. 5002 Scanner Drive Unit

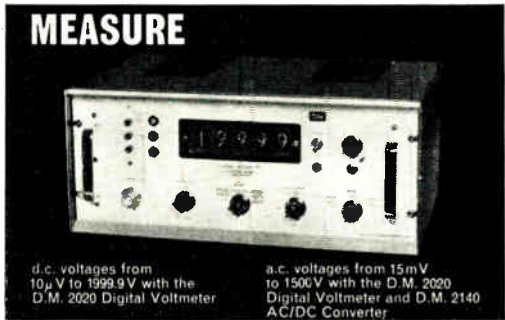

d.c. voltages from 10 $\mu$ V to 1999.9V with the D.M. 2020 Digital Voltmeter

a.c. voltages from 15mV to 1500V with the D.M. 2020 Digital Voltmeter and D.M. 2140 AC/DC Converter



B.C.D., or decimal one-in-ten inputs, to any 5 to 8 hole punched tape code with the D.M. 5021 Punch Drive Unit



one-in-ten decimal-coded outputs for in-line printers and typewriters with the D.M. 5022 Typewriter Drive Unit

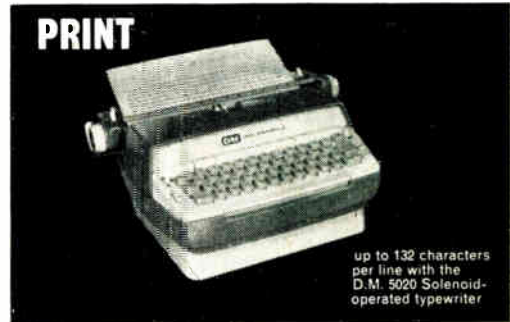

up to 132 characters per line with the D.M. 5020 Solenoid-operated typewriter



**DIGITAL MEASUREMENTS LIMITED**  
25 Salisbury Grove, Mytchett, Aldershot, Hants  
Telephone: Farnborough 3551



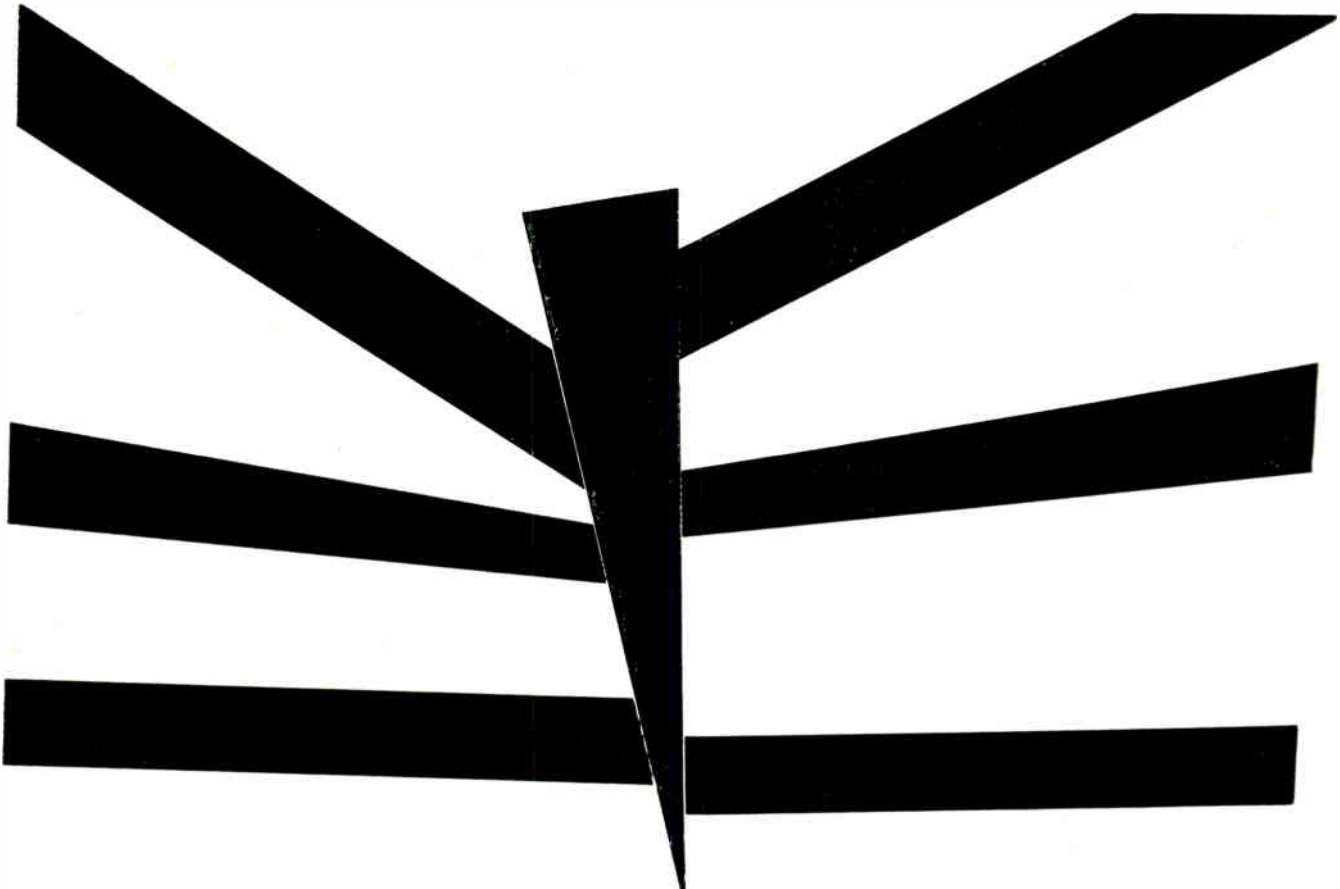

Actual size

## best measure pressure with a CEL transducer

- ★ 0.25% accuracy
- ★ Rationalised output
- ★ Small sample volume
- ★ Compact construction
- ★ Price £36

First of a new series of CEL precision strain gauge transducers, Type XT33 incorporates, as standard, features normally offered as expensive optional extras.

**Abridged Specification**

Non-linearity & Hysteresis	- - -	$\pm 0.25\%$
Output (rationalised)	- - -	- 20mV f.s.d.
Temperature effect	- - -	- 0.02%/°C

Six ranges from 0-1000 to 0-10000 psi.

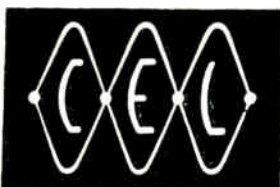

**COUTANT ELECTRONICS LIMITED**  
TRANSDUCER DIVISION

711 Fulham Road · London · SW6 · Renown 5385

# EXTRA! NEW "UNIVERSAL" TRANSISTOR



# UP TO 40% SILICON TRANSISTORS NOW ON THE MARKET

## Prices REDUCED on ALL 2N2102 family

RCA MEETS UNPRECEDENTED DEMAND FOR 2N2102, FIRST "UNIVERSAL"  
TRIPLE-DIFFUSED PLANAR SILICON TRANSISTOR.

RCA now announces mass-production availability of the 2N2102, the "universal" triple-diffused planar silicon transistor designed for widest possible application in military and industrial equipment. It can replace up to 40% of all silicon transistors now on the market and will cover a vast majority of your Small-Signal and Medium-Power Applications.

The RCA 2N2102 features high switching speed, high pulsed beta ( $h_{FE}$ ) at  $I_C = 1$  amp, and controlled beta from  $I_C = 10\mu\text{a}$  to 1 ampere. It has high breakdown-voltage ratings, high dissipation ratings, low saturation voltages and low output capacitances.

RCA's line of triple-diffused silicon planar transistors now includes the 2N699 and 2N1613.

Call your RCA Representative today or write

**RCA Great Britain Ltd.** Sales Division, Lincoln Way,  
Windmill Road, Sunbury-on-Thames, Middlesex

**RCA-2N2270, New Economy Version of RCA "Universal" Triple-Diffused Planar Silicon Transistor Now Available in Production Quantities.**

Now you get many of the performance and versatility features of RCA's 2N2102 in a new economy version, the RCA 2N2270. The 2N2270 offers one of the greatest price/performance values in transistors today. The 2N2270 features operation at high junction temperatures—up to 200°C...very low output capacitance—15 pf max...high minimum gain bandwidth product—60 Mc...useful in applications from dc to 20 Mc...JEDEC TO-5 package.



**THE MOST TRUSTED NAME IN ELECTRONICS**

# UNCOMMON MARKET...

DELANCO Organisation's Technical Know-How masters the intricate and unusual in component manufacture

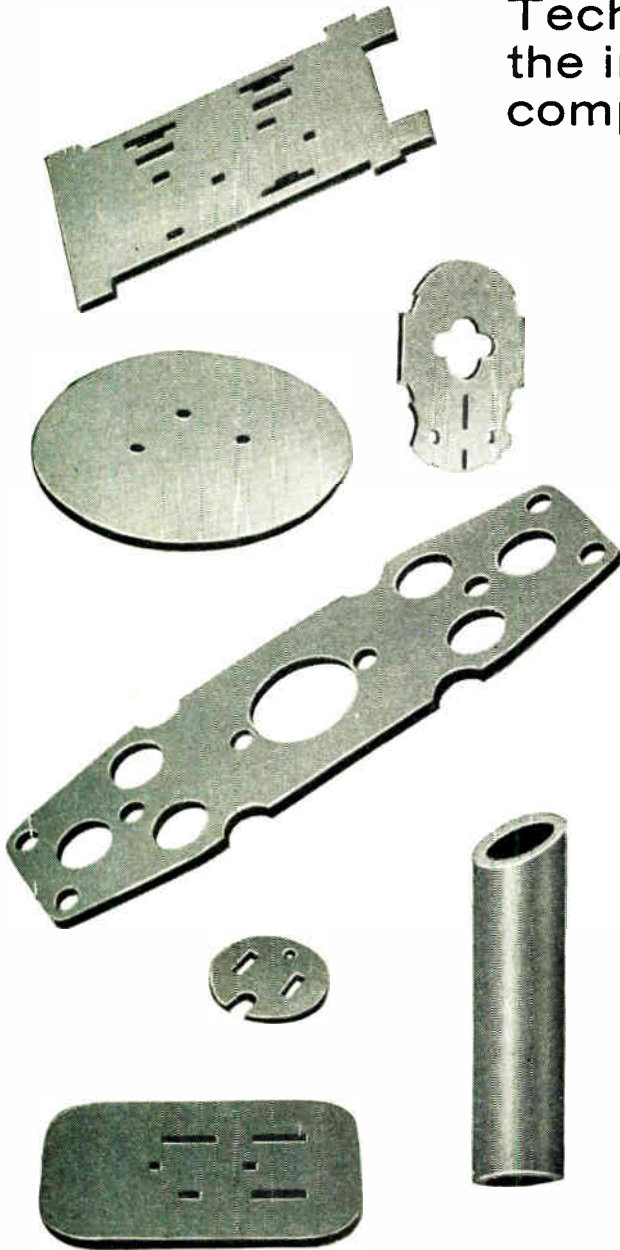

---

Anything uncommon in the way of design calling for the ultimate in tool design skills, is a natural for the Delanco Company. We specialize in the manufacture of components in all types of electrical insulation materials.

Vulcanized Fibre, S.R.B.P. and S.R.B.F. Epoxy glass fibre, Nylon, P.T.F.E., Presspahn, Leatheroid, Varnished cambric and in fact every material used in electrical insulation. For heat resistance *and* insulation Mica and Micanite. Processes include presswork, forming, routing, moulding, turning, milling and machining.

Our customers include Manufacturers of Domestic and Electrical equipment, Instruments, Motor cars, Aircraft, ships, printing and business machinery, Computers, electric motors dynamos and starters. Copper-clad laminates for printed circuitry are supplied as panels ready for printing.

Technical representatives are based throughout the country, and are available at any time to call and discuss your needs.

Technical catalogues are available and will be sent immediately on request.

---



## **Delanco**

INSULATION MATERIALS AND COMPONENTS

---

ANGLO-AMERICAN VULCANISED FIBRE CO. LTD · Cayton Works · Bath Street · London · E.C.1  
Phone: CLE 8484 · Grams: PROMPSERV, LONDON · Delanco Works · Leonard Street · London · E.C.2

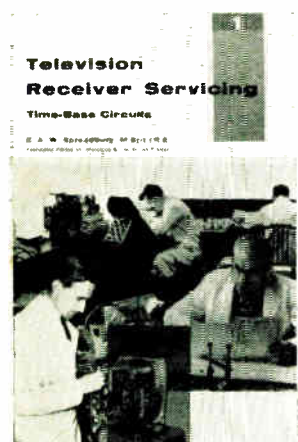
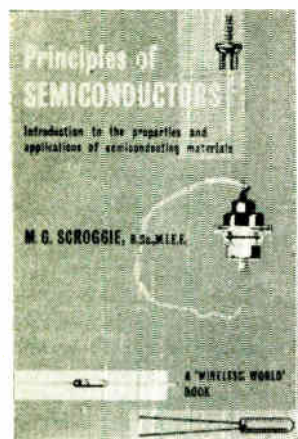
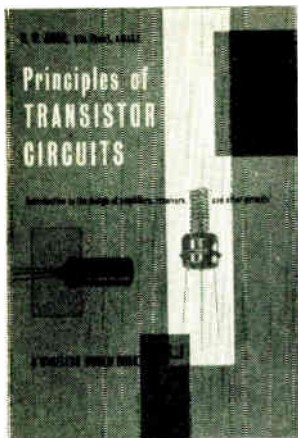

# new ILIFFE books

for students and technicians

in radio, television and electronics



## Principles of Transistor Circuits 2nd EDITION

Introduction to the design of amplifiers, receivers and other circuits

*S. W. Amos, B.Sc., A.M.I.E.E.* A thoroughly revised and enlarged edition of an already popular book. The first two chapters, which have been entirely rewritten, deal with the basic properties of transistors, but the main emphasis of the book is on circuit design.

21s. net. by post 22s. 210pp. 125 diagrams

## Principles of Semiconductors

Introduction to the production and applications of semiconducting materials

*M. G. Scroggie, B.Sc., M.I.E.E.* Covers the many applications of the use of semiconducting materials. There are over 100 graphs and line drawings, and 12 pages of photographs illustrating the width of the semiconductor field.

21s. net. by post 21s. 11d. 156pp. inc 115 diagrams and 12pp. plates

## Television Receiver Servicing

Volume I. Time base circuits. 2nd EDITION

*E. A. W. Spreadbury, M.Brit.I.R.E.* This completely revised edition covers the faults occurring in the time base circuits or in other parts of the receiver affected by their operation, and shows how to locate faults and how to isolate a faulty section.

25s. net. by post 26s. 5d. 362pp. illustrated

## Radio Valve Data 7th EDITION

Characteristics of 4,800 valves, transistors, rectifiers and cathode ray tubes

*Compiled by "Wireless World"*. A completely revised and re-indexed edition which incorporates the characteristics of the latest types of valves and cathode ray tubes, with particular emphasis on semiconductors.

6s. 6d. net. by post 6s. 10d. about 160pp.



From leading booksellers

Published by **ILIFFE Books Ltd.**

DORSET HOUSE · STAMFORD STREET · LONDON, S.E. 1

For further information circle 235 on Service Card

**KUHNKE**

## UNIVERSAL-RELAY

For DC- and AC-operation

Low Price

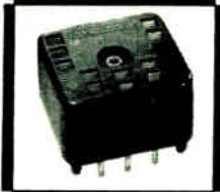
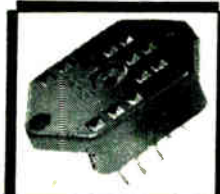

Stock Items

Max. 3 PDT contacts  
Max. contact rating:  
120 W / 150 VA resp.  
250 volts, 6 amps.

Solder terminals  
Slip-on terminals  
For printed circuitry  
Screw terminals

Dimensions: only 35 x 35 mm

H. Kuhnke, Ltd., 163, Stanwell Road,  
Ashford, Middlesex.

PHONE: ASHFORD 52798 TELEX: 21577

For further information circle 236 on Service Card

**OXLEY  
DEVELOPMENTS  
CO. LTD.**



**OXLEY**

**SOLDERLESS  
WRAPPED  
JOINTS**

**CHARACTERISTICS**

Chassis thickness ... 16-18 SWG — 048 064" — 1.2/1.6 mm  
Capacity ... Less than 1.5 pF  
Operating temperature ... -55°C to +200°C

The Oxley "Barb" solderless wrapped connector is a speedily assembled lead through, of outstanding electrical and mechanical characteristics.

The spill is nickel flashed and solder dipped and spun to British P.O. Specification No. M38. Insert the bush in a .156 dia. plain hole in the chassis, and press the barbed spill firmly but slowly through the bush; the latter expands, particularly on the far side of the chassis, and results in the insulator becoming an integral part of it. In addition to its excellent qualities, a considerable saving of time is effected in assembly. Supplied in sealed packets of 100 and 1000.

ACTUAL SIZE



BRITISH  
& FOREIGN  
PATENTS

Write for Technical Details of these and other Oxley products.

OXLEY DEVELOPMENTS CO. LTD ULVERSTON, LANCs.

Industrial Electronics August 1963

For further information circle 237 on Service Card

## The 'SINCOMAX' technique

has made possible the production of these single-unit magnetic circuits which offer many advantages. This MUREX development in which a magnet alloy such as Alcomax III, and soft iron in powder form are pressed simultaneously in a die of desired shape. During subsequent sintering, magnet material and iron become alloyed together at the interface to form a single unit of high bond-strength.

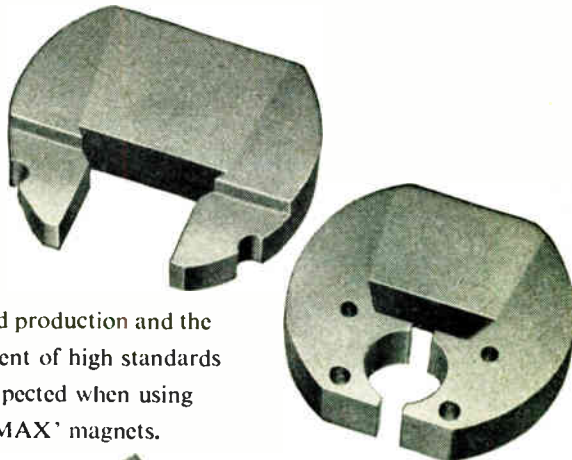

Simplified production and the achievement of high standards can be expected when using 'SINCOMAX' magnets.

A few of the advantages derived from employing this type of unit are:

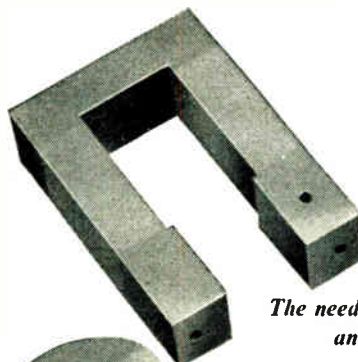

*Pole tunnels and fixing holes can be machined in the iron section.*

*The need to grind adjacent magnet and pole faces is eliminated.*

*Fixing of pole pieces is not necessary.*

*The absence of air gaps between magnet and pole pieces results in a more efficient magnetic circuit.*

*A stable bond of great mechanical strength is achieved between magnet and iron sections.*

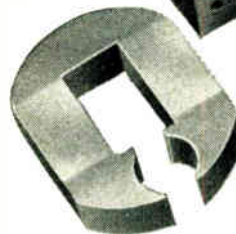

A leaflet giving details of physical and magnetic characteristics can be sent on request. Technical personnel are available to give advice on the application of Sincomax and other permanent magnet alloys.

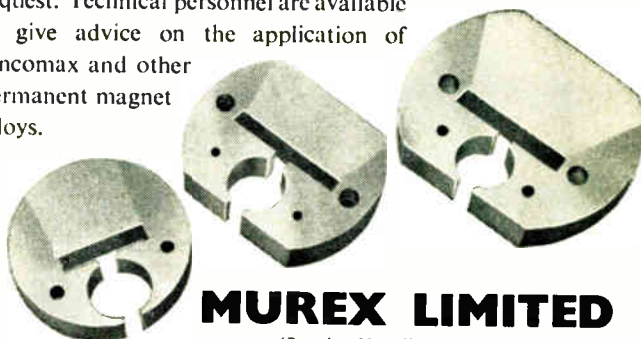

**MUREX LIMITED**

(Powder Metallurgy Division)

Rainham, Essex Rainham, Essex 3322

Telex 28632 Telegrams: Murex, Rainham-Dagenham Telex.

London Sales Office: Central House, Upper Woburn Place, W.C.1. Tel. EUston 8265

For further information circle 238 on Service Card

**ADCOLA**  
REGISTERED TRADE MARK  
(Regd. Trade Mark)

## Soldering Instruments and Equipment

Illustrated

$\frac{3}{16}$ " BIT INSTRUMENT (List No. L64) IN PROTECTIVE UNIT (List No. 700)

ALL VOLT RANGES  
6/7 to 230/50  
VOLTS



BRITISH & FOREIGN PATS.  
& REG. DESIGNS, ETC.

Traditional British Quality and Workmanship  
**ADCOLA PRODUCTS LIMITED**

Head Office, Sales and Service

**ADCOLA HOUSE, GAUDEN ROAD, LONDON, S.W.4**

Telephones MACAULAY 3101 & 4272

Telegrams SOLJOINT LONDON S.W.4

AUSTRALIAN OFFICE: 673 WHITEHORSE ROAD, MONT ALBERT,  
MELBOURNE, VICTORIA

For further information circle 239 on Service Card

<b>INDUSTRY'S</b>	<b>MOST</b>
<b>Flexible</b>	<b>FAILURE</b>
<b>ALARM</b>	<b>SYSTEM</b>
<i>is made by</i> <b>THORN</b>	

Designed for the widest possible industrial use, this extremely flexible system gives visible and audible indication both of the nature and the location of a fault in all types of production processes. It may be used with any flow failure or pressure sensitive switch, or any other device which will change the conditions of an electrical contact. The modular form of construction enables the equipment to be panel mounted, free standing, or mounted at angles to suit any viewing point. It can be added to at any time for moderate cost.

- Modular construction
- Primary fault indication
- Transient fault lock (manual reset)
- Signalled fault clearance
- Automatic or manual test facilities

**INEL 63**  
**Basle Switzerland**  
**2nd-7th September**  
**STAND 231**



**THORN ELECTRONICS LIMITED**

105/109 Judd Street, London, W.C.1 (EUSon 4433)

**Thorn Electronics Limited**

TE41

# TOMORROW'S PROCESS INDUSTRIES WILL NEED

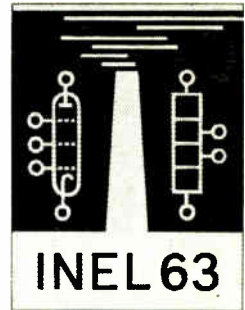

Basel Switzerland  
2nd-7th Sept 1963

## The completely new, integrated line of solid-state electronic instrumentation

Supplemented by other General Electric products, GE/MAC instrumentation can fit a wide range of applications throughout the steel, electric, utility, chemical, food, petroleum, cement, paper and other process industries—wherever automation demands quality instrumentation.

All circuits in GE/MAC instruments use completely solid-state electronic elements, providing high reliability and lowering your maintenance costs significantly.

Visit our stand at the INEL Show to discuss and inspect GE/MAC together with our complete range of instrumentation, which will include: 'Big Look' Panel Meters; Wire Diameter Gauges; Halogen Leak Detectors; Sealed Relays.

### YOU WILL FIND US ON Stand 183



INTERNATIONAL GENERAL ELECTRIC CO. N.Y. LTD., INDUSTRIAL ELECTRONICS DIVISION  
BOULTON ROAD · READING · BERKSHIRE · ENGLAND · TELEPHONE: READING 82468

For further information circle 241 on Service Card

## A unique new book which will solve the problem of communication



# SIX-LANGUAGE DICTIONARY OF AUTOMATION, ELECTRONICS AND SCIENTIFIC INSTRUMENTS

OVER 5500  
technical terms in  
English, French, German  
Italian, Spanish and Russian



Compiled by a team of multi-lingual technologists fully conversant with latest terminology, this new dictionary will enable anyone, whether scientist, engineer or technologist, to read and understand the technical literature on electronics and automation control in any one of the six principal languages of which he already has a basic knowledge.

The scope of the dictionary is indicated by the fact that it contains the equivalents in each language of over 5,500 terms in the basic English glossary. Essential for libraries and professional translators, it is invaluable to everyone who must be familiar with current international developments in the far-reaching fields of automation and electronics.

105s net by post 107s 9d  
10" · 8" 732 pp

from leading  
booksellers

Published by **ILIFFE Books Ltd.**

DORSET HOUSE

STAMFORD STREET

LONDON S.E.1

Industrial Electronics August 1963

29

For further information circle 242 on Service Card

## ARE YOU UP-TO-DATE WITH YOUR SOLDERING TECHNIQUE?



A new Adamin mains model is the C10L, shown on a Bench stand, which we also manufacture. This model is probably the smallest mains voltage model in the world. BIT DIAMETER, 3/32 in. LENGTH, 7 in. WEIGHT, 1/2 oz. (Less Flex). HEATS IN 30 seconds

Brochures A & L30  
post free from the sole proprietors:—

### LIGHT SOLDERING DEVELOPMENTS LTD.

28 SYDENHAM ROAD, CROYDON, SURREY. Telephone: CROYDON 8589

For further information circle 243 on Service Card

### Tension Gauge

*Kontaktor*

For checking and adjusting springs of all kinds; especially to adjust contact pressures on relay springs for automatic telephone stations, to check pressures and tensions on switches, brushes of motors, and in the production and service of Radios, TV, Record Changers, Tape Recorders, Typewriters, Pianos, Cameras, Projectors, Calculators, Dial Indicators and gauges of all kinds.

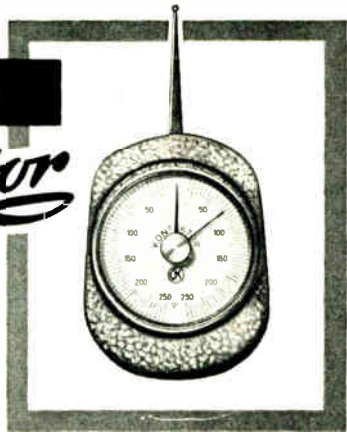

dia. of dial	36 mm	dia. of dial	72 mm
size	000 0.3-3g	size	5 50-500g
..	00 0.6-6g	"	6 100-1000g
..	0 2-15g	"	7 200-2000g
..	1 3-30g	"	8 300-3000g
..	2 5-50g	"	9 400-4000g
..	3 10-100g	"	10 500-5000g
..	4 20-250g		



**GEORG KARSTENS GMBH**  
7304 RUIT/Stuttgart - W. Germany  
Cables: Gekarstens Stuttgart - Telex 07-23 498

Mfrs. of Measuring Tools and Instruments - Cylindrical Grinders

For further information circle 244 on Service Card

### PROMPT DELIVERY

Many Types  
Ex Stock

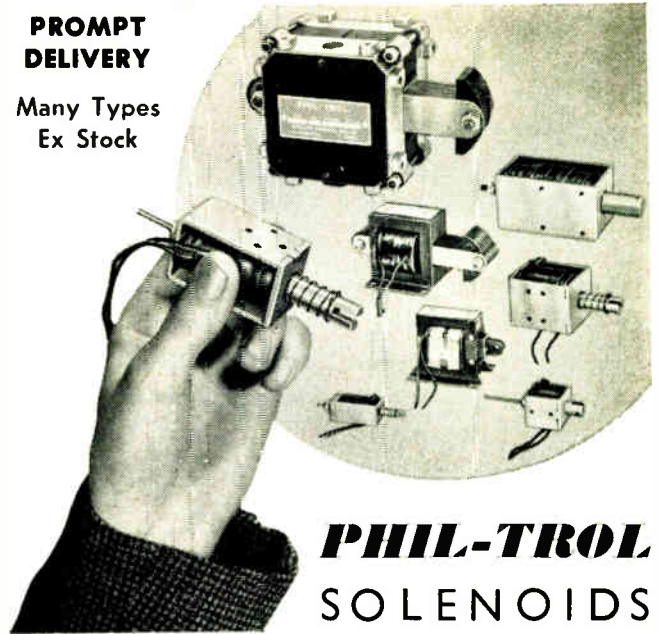

## PHIL-TROL SOLENOIDS

COMPLETE RANGE—MINIATURE TO POWER A.C. and D.C. Stocks maintained in power laminated core, mains voltage A.C. types and the smaller sizes in 6, 12, 24, 48, 115 and 230 volts, continuous, intermittent (25%) and impulse duty (6%) ratings. Push or pull, spring return and change-over switch models available. Send for leaflet No. 108a.

### PHILLIPS CONTROL (G.B.) LTD.

Dept. G.7  
Farnborough Road, Farnborough, Hants  
Telephone: Farnborough 1120. Grams & Cables: Philtrol, Farnborough, Hants

For further information circle 245 on Service Card

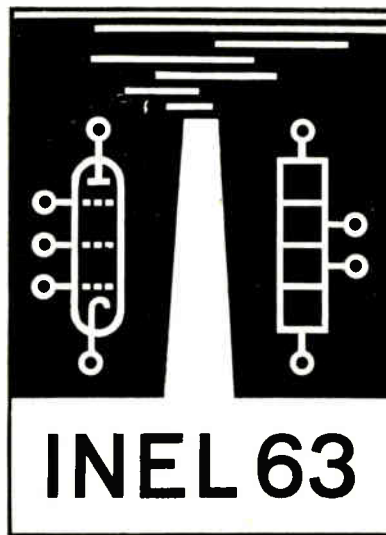

## International Exhibition and Congress of Industrial Electronics

September 2-7, 1963

In the halls of the Swiss Industries Fair Basle/Switzerland

To be held during the same period the IFAC Congress International Federation of Automatic Control August 28 to September 4, 1963



# INDUSTRIAL ELECTRONICS

Press date for the September 1963 issue is  
first post 21st August 1963

## CLASSIFIED ADVERTISEMENTS

**Advertisement Rates.** 6d. per word, minimum charge 6/-, each paragraph charged separately. Remittances payable to "Industrial Electronics", Dorset House, Stamford St., S.E.1. Series discount of 15% is allowed for 12 consecutive insertions.

**Box Numbers** are available at an additional charge of 2/- to defray cost of registration and postage. Replies should be addressed Box No. 0000, c/o "Industrial Electronics", Dorset House, Stamford Street, London, S.E.1.

**Semi-Display advertisements** with centralized lines £1/15/- per single column inch, Display advertisements £2/10/- per single column inch—no additional charge for Box Numbers. The Publishers are not responsible for clerical or printers' errors although every care is taken to avoid mistakes.

### PATENTS

Patent No: 823,590 entitled "Piezoelectric Crystal Supports" is for sale or licence. For details apply to CHATWIN & COMPANY, Chartered Patent Agents, 253, Gray's Inn Road, London, W.C.1.

[2030]

### MISCELLANEOUS

#### PHOTO-ELECTRIC CONTROLS for industry

Send for catalogues

**HIRD-BROWN LIMITED**  
FLASH STREET, BOLTON  
Telephone 27311

[2027]

### BOOKS, ETC.

"LONG-WAVE and Medium-wave Propagation." by H. E. Farrow, Grad.I.E.E., B.B.C. Engineering Training Department. The main features of propagation at low and medium frequencies, 30-3,000kc/s, and in particular the broadcasting bands 150-285kc/s and 525-1,650kc/s, are explained. There are sections on aerials, ground and sky-waves attenuation due to earth losses, recovery effects, mixed path propagation, synchronized group working, ionospheric reflection, fading and low-power installations. 4s 6d net from all booksellers. By post 4s 10d from Iliffe Books Ltd., Dorset House, Stamford Street, London, S.E.1.

"RADIO Designer's Handbook." (4th Edition.) Editor: F. Langford-Smith, B.Sc., B.E., Senior Member I.R.E.(U.S.A.), A.M.I.E.(Aust.). A comprehensive reference book, the work of ten authors and twenty-three collaborating engineers, containing a vast amount of data in a readily accessible form. The book is intended especially for those interested in the design and application of radio receivers or audio amplifiers. 55s net from all booksellers. By post 57s 9d from Iliffe Books Ltd., Dorset House, Stamford Street, S.E.1.

"TELEVISION Receiving Equipment." By W. T. Cocking, M.I.E.E. The fourth edition of one of the most important British books on television deals in a comprehensive manner with television receiver equipment and gives many practical details and much design data. The circuits of a television receiver are split into a number of sections and a separate chapter is devoted to each. Other chapters deal with general principles, the signal, superheterodyne interference problems, special circuits, the aerial, the complete receiver, faults and servicing. 30s net from all booksellers. By post 32s 3d from Iliffe Books Ltd., Dorset House, Stamford Street, S.E.1.

"ABACS or Nomograms." By A. Giet. Translated from the French by H. D. Phippen and J. W. Head. Most engineers have made use of nomograms at some time in their careers, and are fully alive to the fact that they are a very convenient tool when the same formula has to be solved repeatedly for several sets of variables. It is fair to say, however, that only a small proportion of even those who habitually employ nomograms know how to construct them for their own use. Most of the comparatively small literature on the subject is written for mathematicians and is extremely difficult for the practical engineer to comprehend. This book is essentially practical, and not only demonstrates the many and varied applications of the abac or nomogram, but shows how even those without highly specialised mathematical knowledge may construct their own charts. 35s net from all booksellers. By post 36s from Iliffe Books Ltd., Dorset House, Stamford Street, London, S.E.1.

"WIRELESS Servicing Manual" (9th Edition). By W. T. Cocking, M.I.E.E. A carefully revised edition of the handbook known since 1936 as an invaluable, comprehensive guide for radio servicemen and others. Completely up to date, it deals in a lucid, practical way with the problems that arise in the repair, maintenance and adjustment of modern wireless receivers. All recent developments in receiving equipment have been incorporated and the servicing of frequency-modulated v.h.f. receivers—a development of great importance to all servicemen—is thoroughly covered in a completely new chapter. Here is a work of proven value to professional and amateur, written by a widely known authority on modern radio engineering. 17s 6d net from all booksellers. By post 18s 8d from Iliffe Books, Ltd., Dorset House, Stamford Street, London, S.E.1.

"RADIO Circuits: A step-by-step Survey." By W. E. Miller, M.A.(Cantab.), M.Brit.I.R.E. Revised by E. A. W. Spreadbury, M.Brit.I.R.E., associate editor of WIRELESS & ELECTRICAL TRADER. This established introduction to superheterodyne receiver circuits has been greatly enlarged and brought completely up to date with the inclusion of transistor and f.m. receivers; there are new chapters covering battery receivers and car radio sets, while the modern a.m./f.m. receiver is fully described. Mathematics and obscure theoretical considerations are entirely omitted, and over 80 easy-to-follow circuit diagrams are explained in a simple but practical manner, splitting up the circuit into sections and working from the aerial terminal through to the loudspeakers. 15s net from all booksellers. By post 15s 10d from Iliffe Books Ltd., Dorset House, Stamford Street, London, S.E.1.

"TELEVISION Engineering: Principles and Practice." Vol. III: Waveform Generation. By S. W. Amos, B.Sc.(Hons.), A.M.I.E.E., and D. C. Birkinshaw, M.B.E., M.A., M.I.E.E. The third volume of a comprehensive work on the fundamentals of television theory and practice, written primarily for the instruction of B.B.C. Engineering Staff. This volume gives the application in television of sinusoidal, rectangular, sawtooth and parabolic waves and shows the mathematical relationship between them. The main body of the text is devoted to the fundamental principles of the circuits commonly used to generate such signals, the treatment being largely descriptive in nature and therefore less mathematical than that of the previous volume. The work is intended to provide a comprehensive survey of modern television principles and practice. 30s net from all booksellers. By post 31s from Iliffe Books Ltd., Dorset House, Stamford Street, London, S.E.1.

"LAPLACE Transforms for Electrical Engineers." By B. J. Starkey, Dipl.Ing., A.M.I.E.E. A presentation of the theory of the Laplace transformation in which a physical vocabulary rather than a purely mathematical one is used as far as possible in an attempt to attain the utmost simplicity. This method of analysis has become of increasing importance to electrical engineers in many fields during recent years, and the work is designed to provide a thorough treatment of the subject in a language with which they will be familiar. 30s net from all booksellers. By post 31s 2d from the publishers: Iliffe Books Ltd., Dorset House, Stamford Street, London, S.E.1.

"RADIO Interference Suppression: As Applied to Radio and Television Reception." By G. I. Stephens, A.M.I.E.E. 2nd Ed. An up-to-date guide to the various methods of suppressing electrical interference with radio and television reception. Many practical applications are given, particular attention being paid to the problem of interference at television frequencies. Other chapters deal with the design and choice of suppressor components, methods of locating the source of interference, and suppression at the receiver itself. 10s 6d net from all booksellers. By post 11s 2d from Iliffe Books Ltd., Dorset House, Stamford Street, S.E.1.

"BASIC Mathematics for Radio and Electronics." By F. M. Colebrook, B.Sc., D.I.C., A.C.G.I. Revised and enlarged by J. M. Head, M.A. (Cantab). Presents in readable form a complete course in basic mathematics for engineering students of all kinds and leads on to the more advanced branches of mathematics of increasing importance to radio engineers. In this edition the chapter covering the application of mathematics to radio has been revised and enlarged, while new subjects covered include Stability, Linear Differential Equations, Elementary Statistics, Short Cuts to Numerical Calculations and an Introduction to Matrices. Will be invaluable to those requiring a refresher course as well as to those without previous knowledge of the subject. 17s 6d net from all booksellers. By post 18s 6d from Iliffe Books Ltd., Dorset House, Stamford Street, S.E.1.

"ADVANCED Theory of Waveguides." By L. Lewin. Sets out various methods of treating problems arising in work on this complex subject. The author has selected for discussion a number of topics as representative of the field in which the centimetre-wave engineer is engaged, many of the examples being concerned with the rectangular waveguide. 30s net from all booksellers. By post 31s from Iliffe Books Ltd., Dorset House, Stamford Street, London, S.E.1.

### SITUATIONS VACANT



are seeking applications from men aged  
27 - 35 who wish to be considered for  
the newly created position of

## ELECTRONICS AND INSTRUMENT DESIGN ENGINEER

It is expected that the successful candidate will hold a degree or its equivalent in Electrical Engineering. He will have had basic works training plus several years' experience in the Industrial Applications of Instrumentation and Electronic control of machinery and production processes.

The person selected will work in conjunction with a team of Design Engineers participating in the automation of the Company's processes and equipment, but will be primarily responsible for his own function to a Senior Graduate Engineer.

The starting salary will not be less than £1,850 per annum.

In addition the Company operates a Social Security Scheme embracing non-contributory pension, life assurance and sickness benefits.

Applications giving brief details of experience and qualifications to date and requesting an application form should be addressed to:—

Personnel Officer (T), PETFOODS LIMITED, Melton Mowbray, Leics.

For further information circle 246 on Service Card

# REDUCE DEVELOPMENT COSTS OF SEMI-CONDUCTOR CIRCUITRY



The extensive use of temperature sensitive semi-conductor devices in modern electronic circuitry has demanded the testing in the development stage of these circuits under elevated temperature conditions.

The LAB-OVEN allows a unit under test to remain undisturbed on the base while its temperature is raised to the controlled level or dropped to room ambient. Furthermore, wires for power supplies, test instruments, etc., may extend from the unit, and although these may prevent the oven closing down completely, this will not affect the working temperature, since the unit under test is raised by the thermally insulated platform inside the oven, and the hot air level will be brought down to cover the unit. Moreover, quick changes of components may be effected with a soldering iron without the necessity of removing the test unit, nor is time lost in waiting for the oven to recover its temperature, since the hot air trapped inside the oven may be immediately lowered over the test unit.

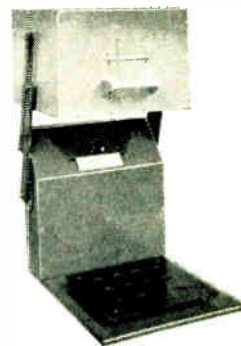

## WITH CONTRONICS LAB-OVEN

### SPECIFICATION OF STANDARD MODEL

Overall size: 19½" deep × 16" wide × 16" high.  
 Oven Cubic Capacity: 1 ft. Cube approx.  
 Temperature Control: Transistorised Thermostatic regulator 15°C.-100°C. plus or minus 1°C.  
 Temperature Gradient: Approximately 2°C.  
 Thermometer: Side fitting mercury thermometer.  
 Heating Element: 275 watt element.

PRICE £58 . 0 . 0

We shall be glad to advise on your own Control problems, for we design and manufacture Electronic Equipment to customers' specialised requirements. Standard units include:—Photo-electric relays, High-speed Batching Counters, Mis-feed protection Controls, Infra-red alarms, Daylight Intensity Switches, Electronic Tachometers, Proximity relays, Time Delay relays, Sequential Timers.



# CONTRONICS

LIMITED

Blackdown, Nr. Aldershot, Hants. Tel. Deepcut 236

Suppliers to the U.K.A.E.A., G.P.O., etc. and leading companies in the Industry

For further information circle 247 on Service Card

## LAPLACE TRANSFORMS FOR ELECTRICAL ENGINEERS

By *B. J. Starkey, Dipl. Ing., A.M.I.E.E.* A presentation of the theory of Laplace transformation in which a physical vocabulary rather than a purely mathematical one is used as far as possible. This method of analysis has become

of increasing importance to electrical engineers in many fields, and the work is designed to provide them with a thorough treatment of the subject in a language with which they will be familiar.

30s. net BY POST 31s. 2d.

From leading booksellers, published by **ILIFFE Books Ltd.**, Dorset House, Stamford Street, London, S.E.1

### Index to Advertisers

Adeola Products Ltd.....	28
Anglo-American Vulcanised Fibre Co. Ltd. ....	25
Appointments Vacant .....	31
British Insulated Callender's Cables Ltd. ....	Cover iii
Cannon Electric Co. Ltd.....	14
Cawkell Research & Electronics Ltd. ....	13
CIBA (A.R.L.) Ltd. ....	6
Contronics Ltd. ....	32
Coutant Electronics Ltd. ....	23
Dawe Instruments Ltd.....	16
Digital Measurement Ltd. ....	22
Ericsson Telephones Ltd.....	10
Erie Resistor Ltd.....	Cover iv

Ferranti Ltd. ....	11
Harwin Engineers Ltd.....	19, 21
Hughes International (U.K.) Ltd.....	15
Hunt, A. H. (Capacitors) Ltd.....	Cover iii
Iliffe Books Ltd. ....	26, 29, 32
Inel 63 .....	30
International General Electric Co. N.Y. Ltd. ....	29
Karstens Georg GMBH .....	30
Kuhnke, H., Ltd.....	27
Light Soldering Developments Ltd. ....	30
Marconi Instruments Ltd.....	13
M.O. Valve Ltd.....	1

Mullard Ltd. ....	4, 5
Murex Ltd. ....	27
Oxley Developments Co. Ltd.....	27
Petfoods Ltd. ....	31
Phillips Control (G.B.) Ltd. ....	30
Plannair Ltd. ....	3
R.C.A. (Gt. Britain) Ltd.....	24
Reliance Controls Ltd. ....	2
Sanders, W. H., Ltd. ....	12
Short Bros. & Harland Ltd.....	17
SPS International Ltd.....	20
Standard Telephones & Cables Ltd. ....	7, 8, 9, 18
Thorn Electronics Ltd. ....	28

Printed in Great Britain for the Publishers, Iliffe Electrical Publications Ltd., Dorset House, Stamford Street, London, S.E.1, by The Chapel River Press Ltd., Andover, Hants. Distributed in U.S.A. by Eastern News Company, 306 West 11th Street, New York, 14

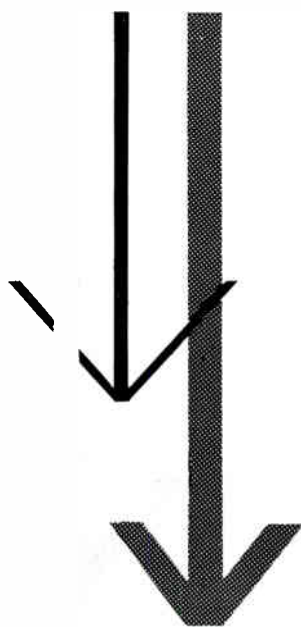

another  
FIRST  
for  
**HUNTS!**

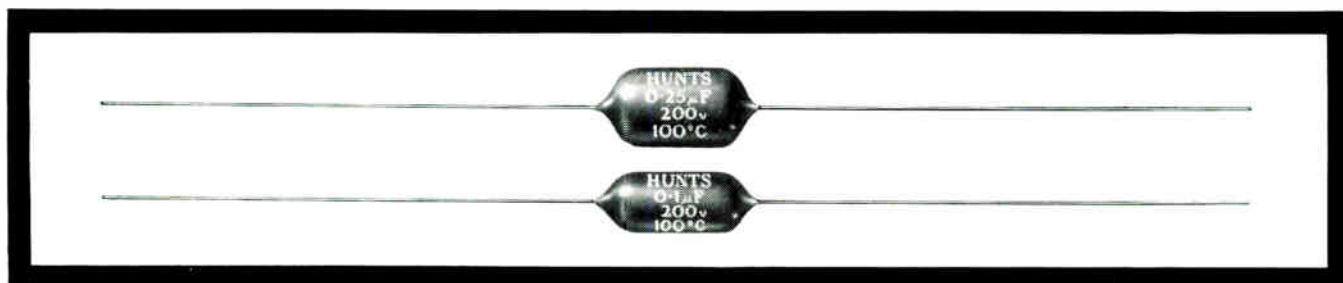

## NEW DIPSEAL\*W45 range

Hunts new 'Dipseal' process gives designers and service engineers a *new kind* of capacitor—a proven, reliable metallised paper unit in a tough resinous housing. New 'Dipseal' W45 tubulars are as small as or smaller than their thermoplastic cased equivalents; their humidity performance is better; and the hard *thermosetting* resinous housing is unaffected by heat, making soldering safe and easy. Find out more about the new W45 and other Hunts 'Dipseal' ranges. Full particulars will be sent freely on request.

TYPE W45 STANDARD RANGE		
D.C. Working Voltage	Capacitance Microfarads	Dimensions
200	0.1 to 1	18.5 to 34 x 7.5 to 12mm
400	0.025 to 0.5	$\frac{3}{4}$ " to $1\frac{11}{32}$ " x $\frac{5}{16}$ " to $\frac{1}{2}$ "
Temperature Range: -55°C to +100°C		Capacitance Tolerance $\pm 20\%$ , (To order) $\pm 10\%$

- \* Better humidity performance than thermoplastic cased units.
- \* Far cheaper than metal cased units.

# HUNTS

## A. H. HUNT (Capacitors) LTD.

Wandsworth, London, S.W.18. Tel: VANdyke 6454  
Factories also in Surrey, Sussex and North Wales

For further information circle 202 on Service Card

**THIS** is  
*micro-miniaturisation!*

**ERIE** *★* **microcaps**

A NEW SERIES OF  
**MICRO-MINIATURE**  
**H I G H V A L U E**  
**D I S C C E R A M I C O N S \***

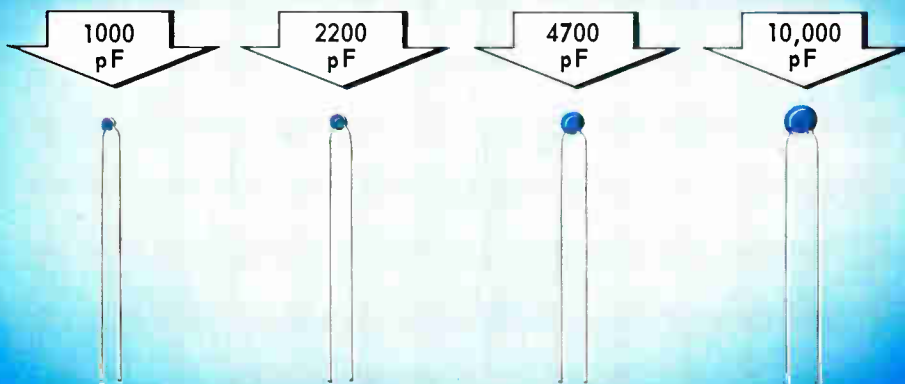

Dimensions, 1000pF : 0.08in (2,03mm)  
 2200pF : 0.10in (2,54mm)  
 4700pF : 0.14in (3,56mm)  
 10,000pF : 0.20in (5,10mm)  
 Lead Diameter : 0.010in (0,254mm)  
 Capacitance Tol : -20 +80%  
 Working Volts : 30V d.c.  
 Flash Test : 90V d.c.  
 Leakage Resistance : 10,000Mohms  
 Power Factor : 3% max.  
 Dielectric : K7004  
 Operating Temp : -40°C +85°C

These illustrations show the ACTUAL size of ERIE 'microcaps'-the latest British development in the field of micro-miniature components. ERIE 'microcaps' are an important addition to the 'Ceramicon' range of tubular, disc and plate capacitors designed to meet-or anticipate-the needs of the Electronics Industry. The co-operation of the ERIE Customer Service Department is available to assist with enquiries on 'microcaps' or any other of the wide range of ERIE components.

**ERIE RESISTOR LIMITED**  
 SOUTH DENES, GT YARMOUTH  
 Telephone: 4911      Telex 1720

Factories:  
 Gr. Yarmouth and Tunbridge Wells, England, Trenton, Ont.,  
 Canada; Erie, Pa., U.S.A.



\*Registered Trade Marks