

# INDUSTRIAL ELECTRONICS

JANUARY 1963

5s 0d

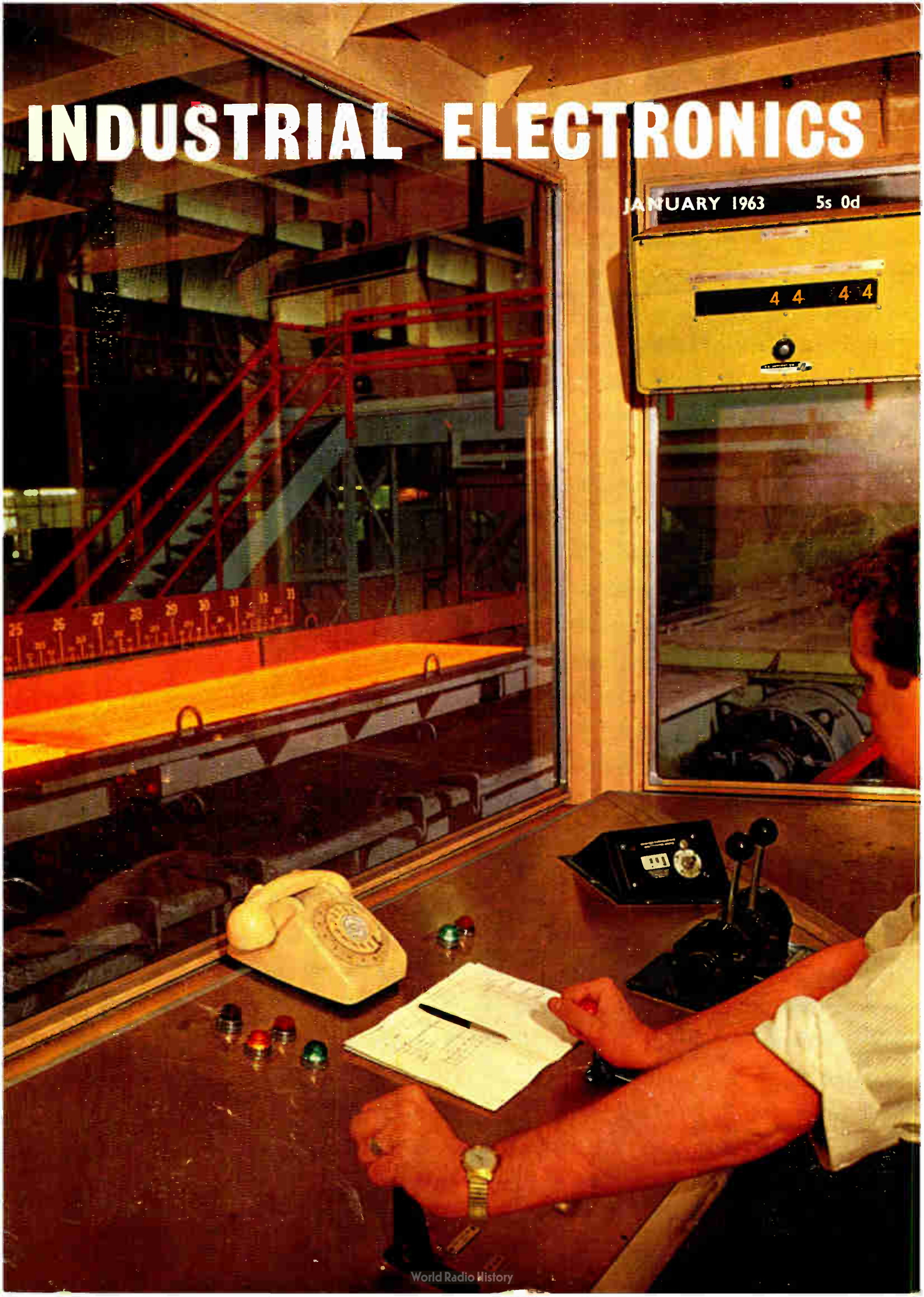





# LOOK—NO CONTACTS!

## NORBIT STATIC SWITCHES for automatic control systems NEVER NEED MAINTENANCE

No maintenance, no 'sneak circuits', operation in *any* position, constant speed and a life unaffected by the number of operations.

These are only some of the many reasons why electrical and electro-mechanical engineers, in increasing numbers, are using Norbit static switches instead of relays in a wide variety of automatic control and alarm applications, from lift systems to food processes.

Since they use no moving parts contactless Norbit switches need no adjustments, no cleaning and suffer no mechanical wear or variation in operating speed. Time wasting 'cut and try' methods are also eliminated during system design—using Norbits you can plan your complete system on paper and know that what you plan will work in practice.

Furthermore, one basic Norbit gives you any switching function you need. No contacts, no sparking, no heat to dissipate,

unaffected by detrimental atmospheres—dust, abrasive particles, humidity, corrosive fumes, hazardous atmospheres—the reliability of Norbit static switches has been proven in practice and by exhaustive quality testing.

**Here's all you need to know** How does the Norbit switch if it uses no contacts? Just regard the Norbit as a switch which does not open or close, but one which either conducts or does not conduct. Furthermore, there's *no need* for you to know any electronic theory to understand Norbits and apply their many advantages.

**Free to the practical engineer** Write for a free copy of 'Static Switching Simply Explained'. This booklet gives you a completely non-mathematical explanation of Norbit static switches—what they can do and how they can be used. Write today for this practical guide to contactless switching using Norbits.

**MULLARD EQUIPMENT LIMITED**

MANOR ROYAL, CRAWLEY, SUSSEX  
Telephone Crawley 28787

# INDUSTRIAL ELECTRONICS

incorporating *ELECTRONIC TECHNOLOGY*

Volume I Number 4 January 1963

## contents

Editor **W. T. COCKING, M.I.E.E.** 185

Assistant Editor **T. J. BURTON** 187

Advertisement Manager **G. H. GALLOWAY**

**Comment**

### Measurement of Bulk Flow and Mixing

*by Denis Taylor, M.Sc., Ph.D.*

Radioisotopes form a convenient way of checking the effectiveness of mixing processes, such as are needed in preparing cattle food, and of the bulk flow of liquids and the detection of leaks, as in oil pipe lines. This article describes how these things can be done and the kind of radioisotopes that are used.

### 191 The Metron Depth Sounder *by K. T. W. Jones*

The echo-depth sounder described in this article takes a fresh sounding every  $1\frac{1}{2}$  seconds and displays the true depth for each sounding. It is thus able to respond quickly to sudden changes of depth.

### 196 Personal Centralized Dictation System *by D. G. Alderson*

In this article one of the modern centralized dictation systems is described. Details are given of the system along with the methods of installation and the economic advantages.

### 198 Epitaxial Silicon Devices *by A. A. Shepherd, M.Sc., Ph.D.*

The use of epitaxial techniques in the manufacture of silicon transistors and diodes is described. High gain-bandwidth products and rapid switching are obtainable.

### 212 Spencer Works

In this article some details of one of the most highly automated steel plants in the world are given. The overall concept of the first stage of automation is discussed and the systems used to provide control for the metal slab mill and the hot strip rolling mill are described. Other electronic equipments used in the plant, such as that for the intercommunication system, are also described.

### 218 Ultrasonics for Sensing and Switching *by G. Millward*

Wide applications exist for control in industry using ultrasonic waves to detect the presence of objects and provide electrical signals for operating control mechanisms. Applications include sizing, detecting breaks, safety, positioning, counting and controlling levels of liquid and materials.

### 224 Frequency-Modulated Oscillator *by R. C. Foss*

A method of producing linear deviation over a wide deviation range in an LC oscillator is described. The centre-frequency is defined by a tuned circuit and a practical circuit gives 30 kc/s  $\pm 7\frac{1}{2}\%$  linear deviation.

*continued overleaf*

Published on the  
first Thursday after the 5th of each month by  
ILIFFE ELECTRICAL PUBLICATIONS LTD.  
Managing Director: W. E. Miller M.A., M.Br.I.I.R.E.  
Dorset House, Stamford Street, London, S.E.1.  
Telephone: Waterloo 3333.  
Telegrams: Wirenger, London, Telex  
Cables: Wirenger, London, S.E.1.

ANNUAL SUBSCRIPTION, £3 0s. 0d.,  
CANADA and U.S.A. \$8.50.





# *All* **KINGS and QUEENS**

## among the **SUB-MINS!**

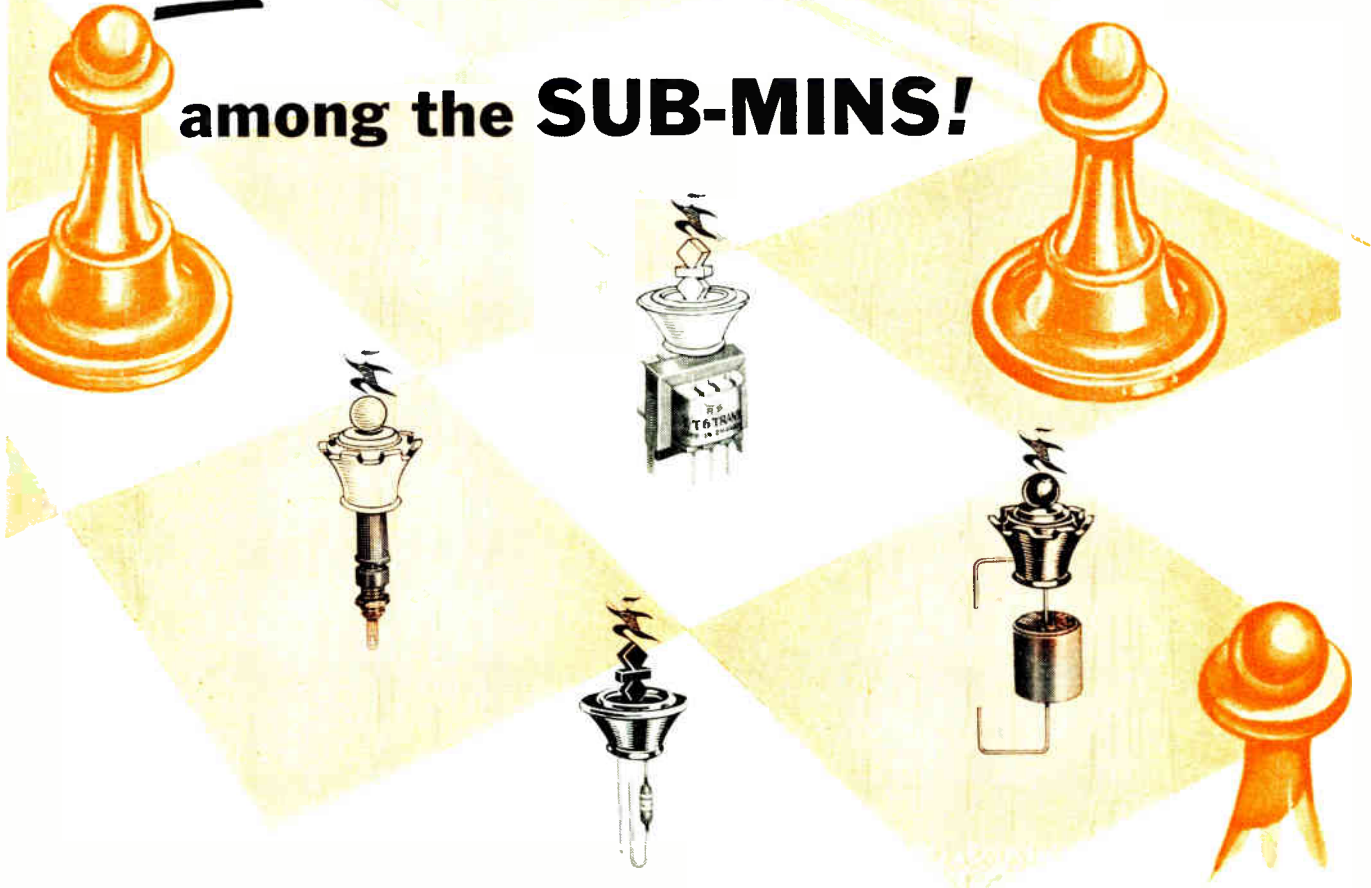

– Miniature and Sub-Miniature Components

from **RADIOSPARES**

For **ALL**  
your  
**Electronic**  
components

Our range of “Miniature” and “Sub-Miniature” Components includes Capacitors, Resistors, Transformers, Plugs and Sockets, Wires, Indicators, etc. All are constructed with the same care, and to similarly exacting standards as their bigger brothers!

***Radiospares Ltd.***

4-8 MAPLE STREET · LONDON · W.1 · ENGLAND

Telephone: **EUSton 7232 (8 lines)**



TELEGRAMS: RADOSPERES, WESDO, LONDON

CABLES: RADOSPERES, LONDON, WI

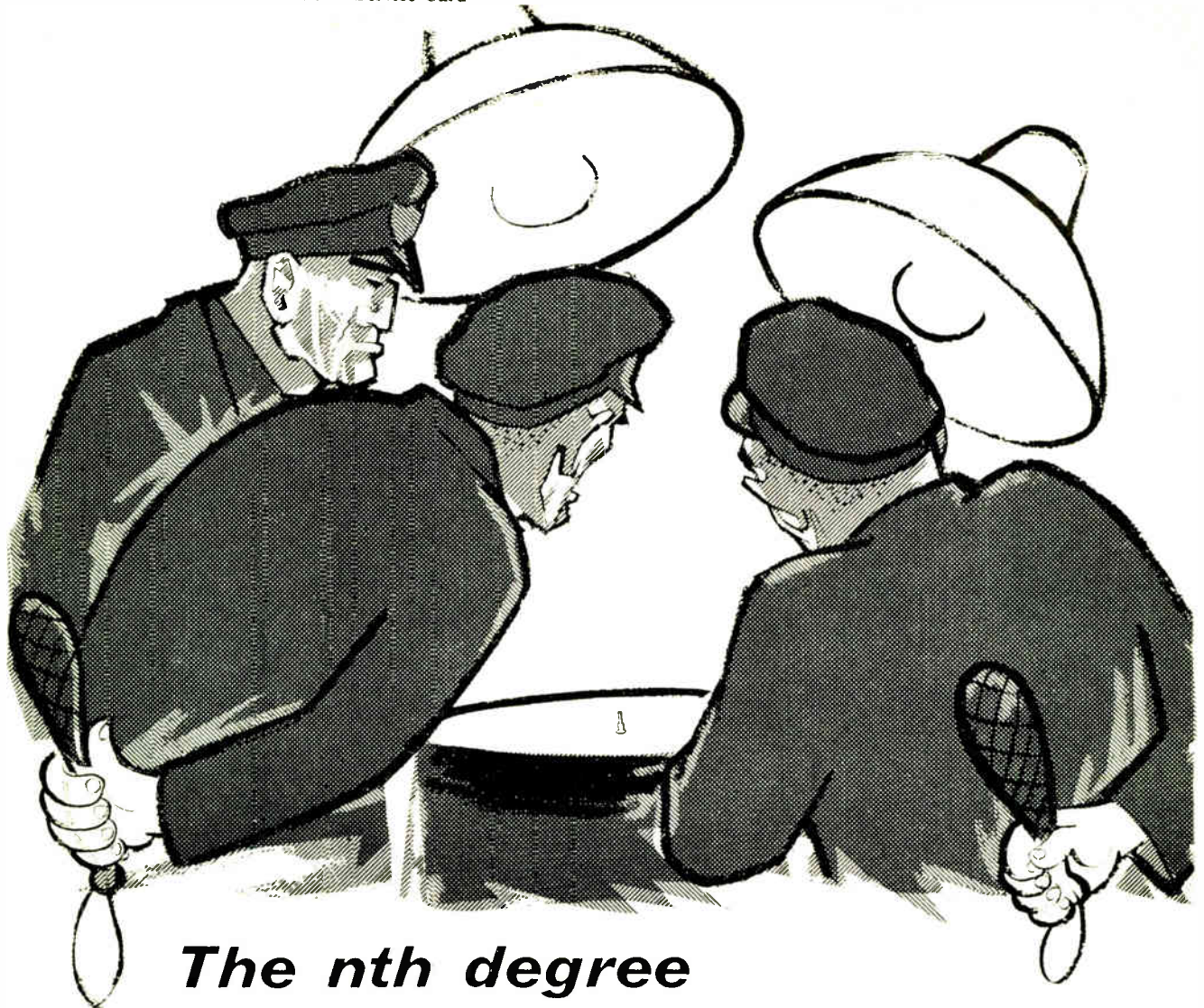

## *The nth degree*

The consistent 'nth' degree precision of HARWIN Components results from stony-hearted 'third degree' examination. The menacing glare of HARWIN inspectors brooks no compromise. **You** get Components you can rely on. Insulators, Lugs, Stand-offs, Brackets, Terminal Boards, Chassis Fittings, etc. And when HARWIN promise them, you get them.



As Mini-Tronic says:  
*'When time and space are tight,  
 HARWIN see you right'*  
 Just telephone or write

**HARWIN ENGINEERS LTD · RODNEY ROAD · PORTSMOUTH  
 HAMPSHIRE · TELEPHONE: PORTSMOUTH 35555 (4 lines)**

**GREAT FOR MINIATURE ELECTRONIC COMPONENTS**





# COMPONENTS REVIEW

JANUARY, 1963

## IEC FERRITE POT CORES

STC are introducing a range of Ferrite Pot Cores which conform in dimensions to the International Electro-technical Commission proposals for standard Ferrite Inductor Cores.

The first of such cores, size 18 mm × 11 mm, is now in production. Samples are available from stock, and are offered in three standard permeability levels; two of which are provided with an inductance adjustment assembly which lies completely within the confines of the Ferrite Core. A typical example is described in the table below.

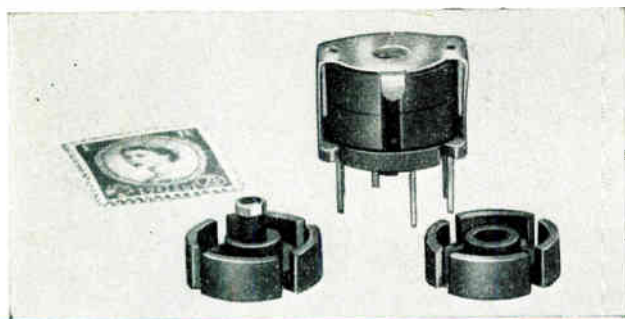

### TYPICAL CORE CHARACTERISTICS

Code	Core size	Specific Inductance Nano Henries per turn with- out adjustor	Effective Perme- ability	Nominal Air Gap	Temperature Coefficient
E/18/11/A SA 500	18 mm × 11 mm dia. × height	160 ± 3%	73 ± 3%	0,275 mm	Less than + 120 P.P.M. per °C be- tween 10 C to 60°C
E/18/11/C SA 500	18 mm × 11 mm dia. × height	315 ± 3%	145 ± 3%	0,1 mm	Less than + 240 P.P.M. per °C be- tween 10 C to 60°C
E/18/11/F SA 500	18 mm × 11 mm dia. × height	2 800 ± 25%	1 300 ± 25%	Nil	Less than + 2 000 P.P.M. per °C be- tween 10 C to 60°C

The cores, with air gaps, are provided with an inductance adjustment assembly which enables the inductance to be set, using a non-magnetic screw-driver, after assembly of the coil. This provides a minimum adjustment range of 8% and a maximum of 16% through 5 turns of the adjusting screw.

### TYPICAL Q VALUES

Code	Inductance	Frequency	Q
E/18/11/A SA 500	3 Milli Henries 500 Micro Henries	100 Kc/s 200 Kc/s	400 400
E/18/11/C SA 500	1.5 Henries 25 Milli Henries	10 Kc/s 30 Kc/s	100 300

Coil former, terminal plates and spring clamp can be supplied if required.

For full details of these new ferrites, write, 'phone or Telex STC Magnetic Materials Division, Edinburgh Way, Harlow, Essex. Telephone Harlow 21421. Telex 81146.

## STC NOW MARKET JFD PRODUCTS

To supplement the range of high quality components manufactured by the Capacitor Division, the decision has been taken to market Variable Piston Trimmer Capacitors and other components of the JFD ELECTRONICS CORPORATION OF NEW YORK. The agency covers the United Kingdom and the other countries in the European Free Trade Area (Austria, Denmark, Finland, Norway, Portugal, Sweden and Switzerland).

The quality of JFD products is in keeping with that of STC's and they are used extensively in military, commercial and industrial projects throughout the US and Canada. A high degree of uniformity and reliability is maintained by JFD Quality Control Engineers and comprehensive environmental tests ensure conformity to the applicable requirements of MIL-C-14409A.

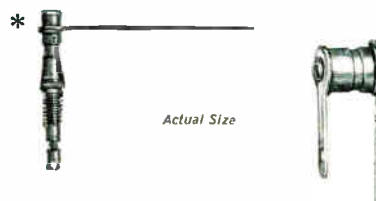

\* Pin-Trim Series — world's smallest piston trimmer capacitor

### VARIABLE PISTON TRIMMER CAPACITORS

These consist of a dielectric cylinder of glass, quartz or ceramic containing a piston assembly which gives a completely linear tuning characteristic. There are hundreds of standard units ranging down to the PIN-TRIM series which are the smallest piston capacitors in the world.

### METALLIZED INDUCTORS

The metallized inductors utilize a silver film fired permanently on to a glass cylinder and offer the ultimate in inductor simplicity and stability. They have a high Q over a broad frequency and temperature range and unusually high stability under conditions of severe shock and vibration.

### LC TUNERS

Combining a precision variable piston capacitor with a metallized inductor, JFD LC-tuners provide an exceptionally compact tunable circuit.

### DELAY LINES

There is a large selection of both Lumped Constant and Distributed Constant delay lines available for either printed circuit or conventional mounting.

Stocks of all these components will be maintained in the United Kingdom.

Write, 'phone or Telex for catalogues to STC Capacitor Division, Brixham Road, Paignton, Devon or London Sales Office, Footscray, Kent. Telephone Footscray 3333. Telex 21836.

# FRAME GRID VALVES FOR WIDE BAND AMPLIFIERS

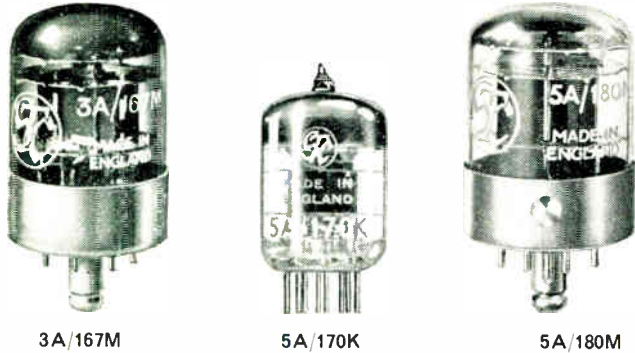

TYPE	3A/167M (CV5112)	5A/170K (CV3998)	5A/180M
Figure of Merit	370	185	180
$g_m$	47	16.5	32 mA/V
$I_a$	40	13	26 mA
$P_a \text{ max}$	6.5	3.3	6 W

The STC range comprises 3 valves, a triode and two beam tetrodes all of which are characterized by a high mutual conductance in ratio to capacitance yielding a high Figure of Merit.

Type 5A 170K is suitable for multistage, high gain amplifiers. Where a higher power level is desired Type 5A 180M may be used.

Triode 3A 167M is particularly suitable for cascode connexion and cathode follower applications. A combination of these two circuits is illustrated below.

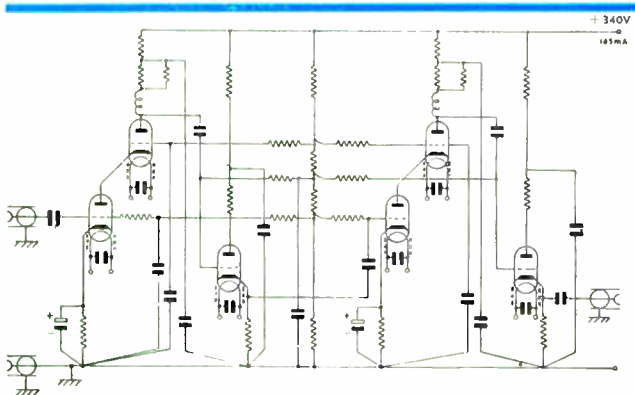

6 valves type 3A 167M in a wideband, low noise amplifier (5.5 kc/s to 37.5 Mc/s). Voltage gain 200. Details on request.

Write, 'phone or Telex for Data Sheets to: STC Valve Division, Brixham Road, Paignton, Devon or London Sales Office, Footscray, Kent. Telephone Footscray 3333. Telex 21836.

# COLD-CATHODE STABILIZERS

## LOW VOLTAGE STABILIZERS

In addition to direct equivalents to the popular 75, 108 and 150 volt stabilizers of U.S.A. origin, the STC range also includes two especially useful low voltage stabilizers.

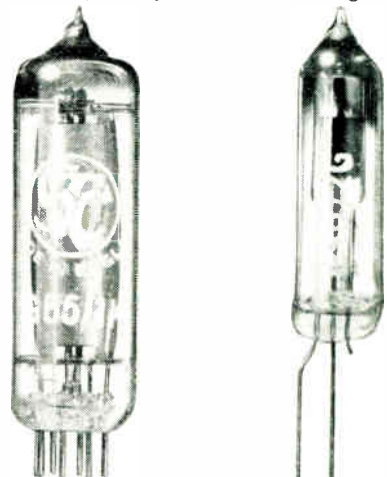

Type G55/1K (CV5298)      Type G50/2G (CV2208)

Type G55 1K is an addition to the range OA2, OB2 having similar external dimensions and connexions but a stabilizing volt of 55V with a regulation of typically 3 volts in the current range 2 to 30 mA.

Type G50/2G is a subminiature type with a 10:1 ratio between maximum and minimum current (3 to 0.3 mA) and stabilizing voltage of typically 54V.

## HIGH VOLTAGE CORONA STABILIZERS

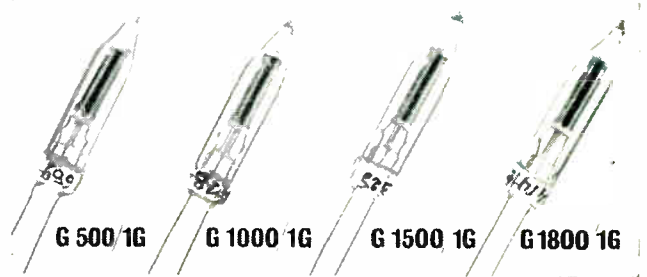

A range of 4 subminiature types is available.

STC Type	Stabilizing Voltage (V)	Maximum Current (mA)
G500/1G	500	55
G1000/1G	1000	100
G1500/1G	1500	100
G1800/1G	1800	100

Write, 'phone or Telex for Data Sheets to STC Valve Division, Brixham Road, Paignton, Devon, or London Sales Office, Footscray, Kent. Telephone Footscray 3333. Telex 21836.





## THREE NEW RELAYS

### TYPES 24 AND 25

These miniature industrial relays and sockets are now available in quantity. They are interchangeable in form, fit and function with well-known continental types. For maximum economy, the preferred configuration is 2-changeover contacts (Type 24) or 4-changeover contacts (Type 25), with coil voltages as required.

To ensure optimum reliability of performance, silver/gold contacts are used together with a cover formed from non-gassing plastic. For a.c. operation, suitable STC quality rectifiers are available; voltages should be specified with order.

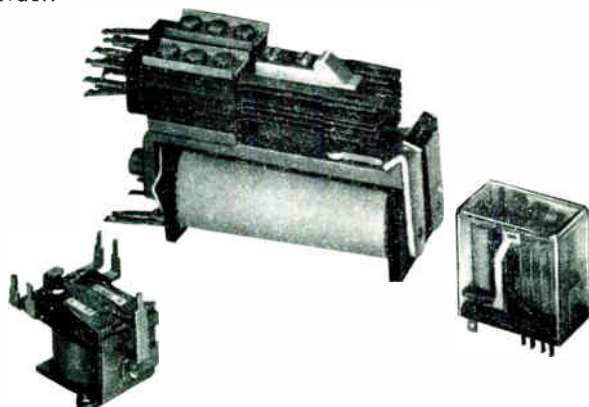

### TYPE 11200 TWIN RELAY

These are, basically, 2 × PO 3000 Type relays, but special flat coils are fitted, together with two special armatures each operating one springset. One or two windings can be supplied for each core. For 50 V d.c. working, 1 000–2 000 ohms coils are used but they are available from 5–3 000 ohms if required. The Type 11200 twin relay is recommended where price and space-saving are important considerations.

### TYPE 11301 'DOLLAR' RELAY

A d.c. relay for general use where space and cost are important and where high current capacity is not required. 'Dollar' relays are available for 6, 12, 24, 48 or 60 volts working with coil resistances from 100–6 000 ohms. They have one changeover contact which will switch either 0.3 A at 50 V d.c. or 1.0 A at 50 V d.c. depending on contact material.

### OTHER TYPES

Other types in the STC ranges include reed switches and relays, PO 3000 Types and PO 600 Types. PO 3000 Types are available in quantity with ten days delivery.

Write, 'phone or Telex for STC relay literature and prices to STC Electro-mechanical Division, Edinburgh Way, Harlow, Essex. Telephone Harlow 26811. Telex 81146.

## BAY31 SILICON EPITAXIAL PLANAR DIODE FOR FAST SWITCHING

### NEW RANGE

The BAY31 is the first of a new range of silicon epitaxial planar high performance diodes. It is specially designed for use in logic circuits working at frequencies of up to 10 Mc/s. Exceptional ruggedness and standardized dimensions make this diode eminently suitable for use on printed circuit boards.

- LOW COST
- HIGH SPEED
- HIGH FORWARD CONDUCTANCE
- LOW REVERSE LEAKAGE CURRENT
- PLANAR EPITAXIAL CONSTRUCTION
- RUGGED DESIGN
- DO-7 OUTLINE



### CHARACTERISTICS (AT 25 °C)

$I_R$ (Max) at -10V	100nA
$V_F$ (Max) at 30mA	1.0V
* $t_{rr}$ (Max) to 1mA	5.0ns
*( $I_F = 10mA, V_R = -6V, R_L = 100 \Omega$ )	

### MAX. RATINGS

$V_R$ (mean, peak or transient)	15V
$I_F$ (mean)	100mA
$I_F$ (peak)	200mA
$P_{tot}$	200mW
T (operating)	100 °C

### DIMENSIONS:

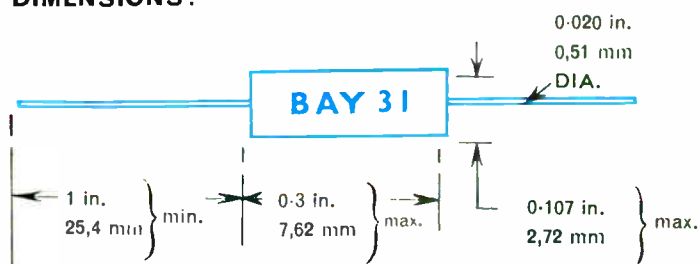

Write, 'phone or Telex for advance Data Sheet to STC Transistor Division, Footscray, Sidcup, Kent. Telephone Footscray 3333. Telex 21836.

## MINIATURE SILVERED MICA CAPACITORS

### MODULAR DESIGN

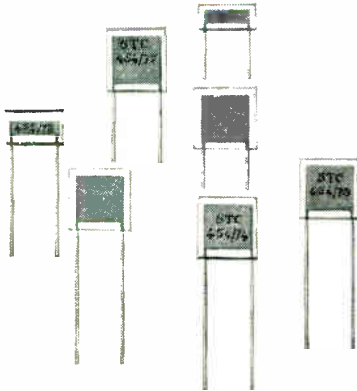

Two new series of STC moulded mica capacitors are now available. Designed for modular circuitry, they have at least one major dimension standard throughout the range.

Range 454-LWA-71 to 77, shown above, covers from 4 pF to 40 000 pF (at 125V d.c.) in seven mould sizes of constant length 0.49 in. (12.5 mm).

In common with the other STC moulded mica series these are high stability capacitors designed to conform to DEF5132. They meet the requirements of humidity classification H6 in the temperature range  $-55^{\circ}\text{C}$  to  $+100^{\circ}\text{C}$  and have a temperature coefficient between  $-20$  to  $+50$  ppm/ $^{\circ}\text{C}$ .

The other modular series—454-LWA-66 to 68—covers from 1 000 pF to 15 000 pF (at 350V d.c.) in three mould sizes which vary in thickness only. They have a standard length of 0.7 in. (17.8 mm) and a constant height of 0.5 in. (12.7 mm). Other working voltages are available.

### STANDARD DESIGN

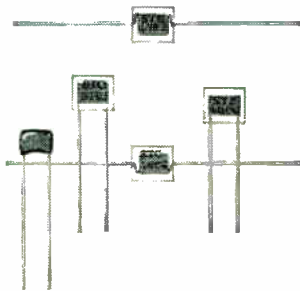

The standard range covers from 4 pF to 100 000 pF at 350V and is produced with both a resin dipped and a resin moulded finish. Also available for 125V and 750V wkg. The range has been extended to include the new subminiature size shown above.

Write, 'phone or Telex for Data Sheets to STC Capacitor Division, Brixham Road, Paignton, Devon, or London Sales Office, Footscray, Kent. Telephone Footscray 3333. Telex 21836.

## SafeTstaCs FOR THE PROTECTION OF SEMI-CONDUCTOR CIRCUIT ELEMENTS

The application of the non-linear voltage-versus-current characteristics of a selenium plate to the problem of surge suppression is well known. The STC click suppressor FSX5A and the Q type assembly with plates in opposition are two examples of this technique.

In the past, the concern has been with ranges of a magnitude consistent with the power handling capacity of STC miniature plates, but the demand for surge protection of silicon power devices calls for stack assemblies of larger plate sizes.

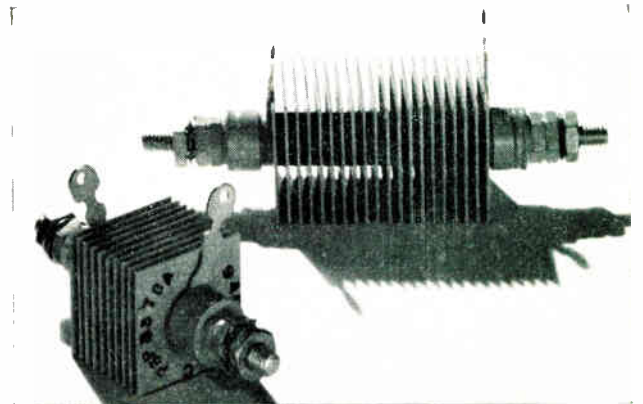

A stack of selenium plates assembled in the conventional push-pull arrangement—ignoring the centre tag—is connected across the transformer secondary and effectively clips voltage transients to the safe value of the associated silicon devices. Other assemblies can be used to protect from the d.c. side, and a push-pull with additional half-wave is recommended for use with silicon controlled rectifiers.

In general, the selenium stack is cheaper than other forms of protection; it is not a tuned device and its protection is therefore practically independent of frequency; it is compact and is, of course, extremely rugged.

In order to exploit these advantages more fully, a series of special codes is used and a leaflet is available which lists these codes against a.c. input voltages and safe c.w.v. ratings. The range of surge protection selenium assemblies are marketed as Safety Stacks under the trade name SafeTstaC.

Write, 'phone or Telex for Advance Leaflet to STC Rectifier Division, Edinburgh Way, Harlow, Essex. Telephone Harlow 26811. Telex 81146.



**Standard Telephones and Cables Limited**

COMPONENTS GROUP · FOOTSCRAY · SIDCUP · KENT



For further information circle 213 on Service Card

## ENCAPSULATED AND CURED AT ROOM TEMPERATURE

... in minutes with easy-to-use Silastomer® silicone rubber.

In three simple operations and with no special equipment you can encapsulate components in silicone rubber. This silicone rubber—Cold-Cure Silastomer—sets at room temperature and offers you all the well-known properties of oven cured Silastomer. Easy and quick to use, Cold-Cure Silastomer is available in three different viscosities to suit different processing techniques. The remarkable properties of Cold-Cure Silastomer include:

- Operating temperature range  $-50^{\circ}\text{C}$  to  $+250^{\circ}\text{C}$
- Outstanding electrical insulation
- High thermal conductivity
- Effective protection against moisture, dust, oxidation, weathering, ozone, corona and mechanical shock.

*Free Sample* Write for a free sample and for our booklet on Cold-Cure Silastomer which gives full information on properties and applications.

\*Silastomer is the registered trade name of a comprehensive range of silicone rubbers made and marketed by Midland Silicones Ltd.



**MIDLAND SILICONES LTD** *first in British Silicones* (Associated with Albright & Wilson Ltd. and Dow Corning Corporation)

68 Knightsbridge, London, SW1 Tel: KNightsbridge 7801 Area Sales Offices: Birmingham, Glasgow, Leeds, London, Manchester Agents in many countries

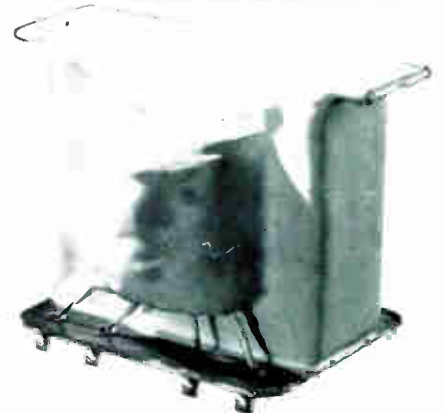
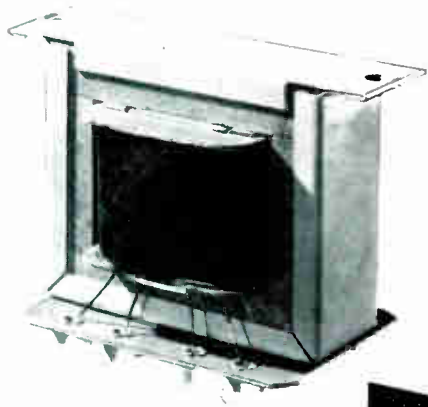

For further information circle 214 on Service Card

**What this was  
to Newton  
the Elliott 503 computer  
can be to you**



The new Elliott 503 computer, companion to the famous 803, is probably the finest computer of its class ever built.

The 503 is remarkably fast, extremely versatile, and surprisingly easy to operate. It starts where the highly successful 803 leaves off. It's a computer to unlock doors, chart new continents, discover new planets of thought.

**ELLIOTT 503**

**Computer**

**ELLIOTT COMPUTING DIVISION, ELLIOTT BROTHERS (LONDON) LIMITED, ELSTREE WAY, BOREHAMWOOD, HERTFORDSHIRE**

A member of the Elliott-Automation Group 

**The first British computer to incorporate ALGOL**

ALGOL has been developed to simplify programme preparation and also to supply the obvious demand for an internationally acceptable computer language. A basic computer language like ALGOL is not only practical but necessary for the computer of tomorrow —and even today. *The first British designed computer equipped to use ALGOL is the Elliott 503.*

But this is only one of the 503's many advantages which are unique among medium-sized computers. Here, briefly, are some of its other special features:

100,000 arithmetic operations per second. Compatibility with the popular 803. Large magnetic core store. Auxiliary magnetic core storage of almost unlimited capacity. Direct connection of high-speed input and output equipment. Time-sharing of peripheral data-transfers.

Isn't it time you found out more about the Elliott 503?



ANOTHER WORLD BEATER IN THE LEKTROKIT RANGE

# LEKTROKIT RACK SYSTEM

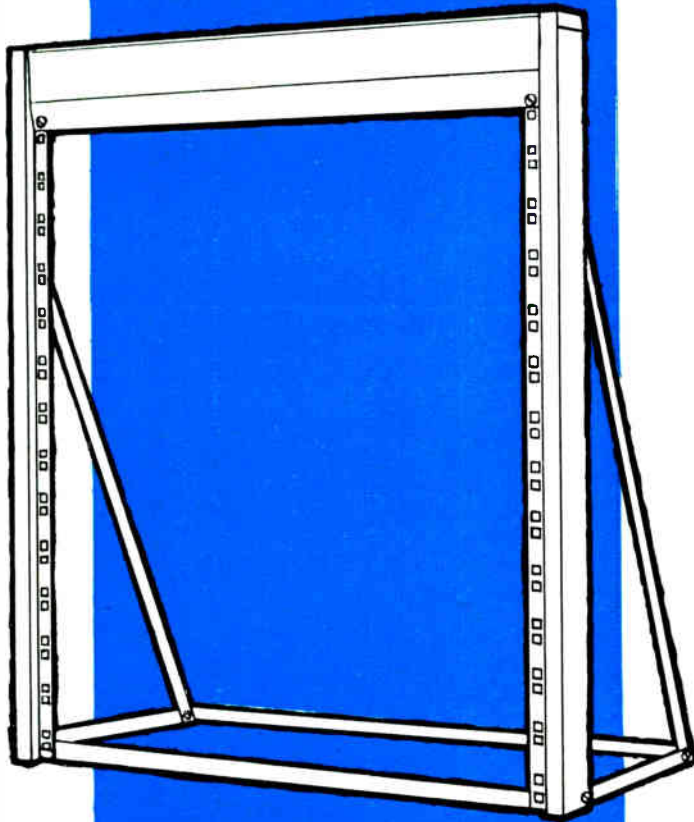

The Lektrokit Rack Construction System is a natural extension of the widely used Chassis Construction System and comprises a range of simple and inexpensive component parts, from which standard equipment racks can be constructed quickly and cheaply.

SPECIAL FEATURES of the Lektrokit Rack System include:

- ★ Assembled racks and trolleys are light in weight but strong and of pleasing appearance.
- ★ Complete versatility – static racks for floor or bench mounting, mobile racks and trolleys, can all be constructed from the same limited range of components.
- ★ Unlimited expansion potential of the assembled racks, laterally as well as vertically.
- ★ Parts are supplied singly or in kit form.
- ★ The components are low priced and can normally be supplied ex-stock.

For full details of the Lektrokit Rack System write for the new illustrated 24-page Rack System Handbook, sent free of charge and without obligation.

Please send my free copy of the  
**NEW RACK SYSTEM HANDBOOK**

Also send a copy of the  
**CHASSIS SYSTEM HANDBOOK**

Name \_\_\_\_\_  
 Company \_\_\_\_\_  
 Address \_\_\_\_\_

Detach and send to :—

# A.P.T

**ELECTRONIC  
INDUSTRIES  
LIMITED**

**CHERTSEY ROAD, BYFLEET, SURREY**  
**PHONE : BYFLEET 41131/2/3/4 PABX GRAMS: APTRAN, BYFLEET**

# NEW FROM BRUSH

## NPN SILICON

# PLANAR EPITAXIAL TRANSISTORS

These transistors have been designed primarily for fast-switching applications in both computer logic circuits and high frequency amplifiers. Typical performance curves are available.

BRUSH NPN SILICON PLANAR Transistors represent advanced design and manufacturing techniques that make possible high performance devices with outstanding reliability. The PLANAR process produces VERY LOW LEAKAGE and lends itself to the most advanced SURFACE PASSIVATION techniques. The EPITAXIAL process produces VERY LOW SATURATION RESISTANCE.

### FEATURES

- Sealed in an inert Helium atmosphere
- No effective leakage assured by 100% mass spectrometer test
- Unique lead attachment process eliminates lead embrittlement
- Withstand in excess of 20,000G centrifuge
- 100% Stabilization for 100 hours at 300C
- Power ageing at or beyond rated dissipation

#### TYPES IMMEDIATELY AVAILABLE

2N706	2N708	2N919	2N834
2N706A	2N743	2N920	2N835
2N706B	2N744	2N921	
2N707	2N914	2N922	

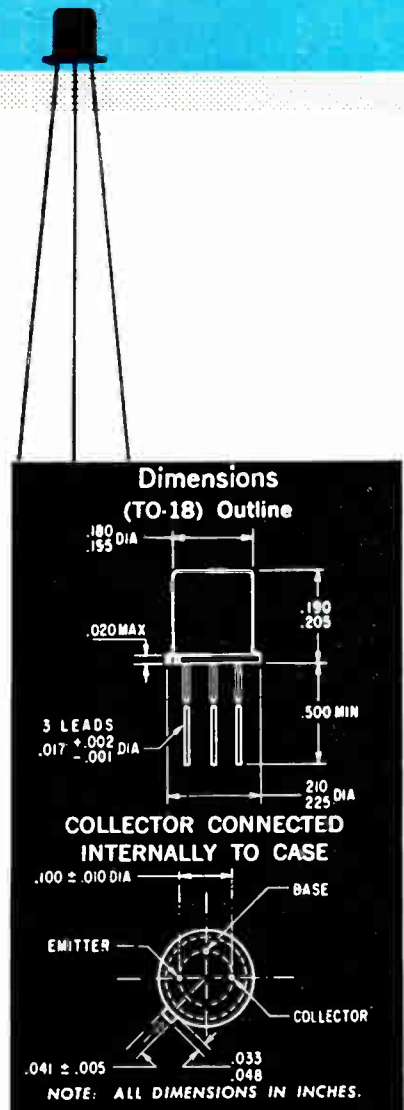

COMPETITIVE PRICES AND DATA AVAILABLE FROM

# BRUSH CRYSTAL



SEMICONDUCTOR DIVISION

Brush Crystal Co. Ltd Hythe Southampton Telephone: Hythe 3031 Telegrams: Brudev Hythe Southampton



# specify

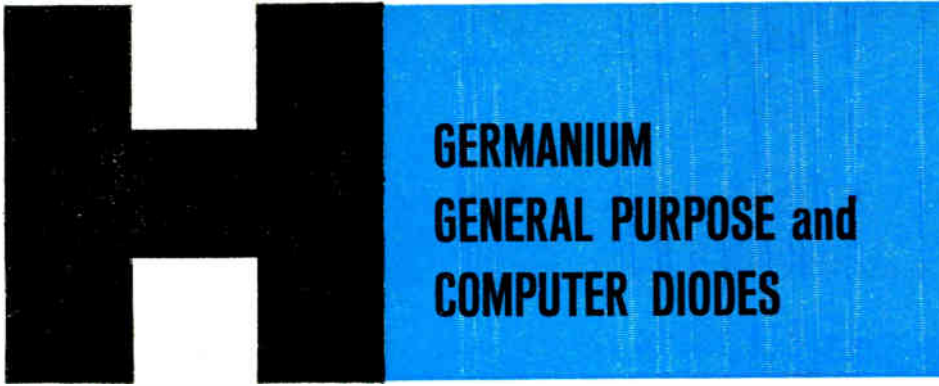

- Reliability
- High conductance
- Low leakage
- Fast recovery characteristics
- Rugged, sub-miniature all-glass construction
- Operation up to 90°C
- Low cost

## point-contact general purpose diodes

### HG10

High forward conductance  
 Max. average power dissipation 80mW  
 Nominal capacitance at -10V 0.2pF  
 Operating and Storage temperature range -60°C to 90°C

Type	P.I.V.	Max. D.C. or Mean Forward Current (mA at 25°C)	Min. Forward Current at 1V (mA)	Max. Reverse Current at -50V (μA at 25°C)
*HG1005	100	45	5	50
†HG1008	100	45	5	100
HG1012	75	45	5	100

TYPE APPROVED \*CV 7041 †CV 448 & †CV 7130

## gold-bonded computer diodes

### HG50

Extremely high forward conductance  
 Stored charge at 10mA 400pC  
 Nominal capacitance at -10V 0.4pF  
 Max. average power dissipation 80mW

Type	Min. Breakdown Voltage	Max. D.C. or Mean Forward Current (mA @ 25°C)	Max. Forward Voltage at 100mA	Max. Reverse Current at 25°C (μA @ V)
HG5003	100	100	0.8	25 -50
*HG5004	70	100	0.8	25 -50
HG5008	40	100	0.8	25 -30
HG5085	Transistor base protection diode V <sub>f</sub> at 100 mA (25°C) ..... 1.0V max. I <sub>b</sub> at -1.0V (45°C) ..... 5μA max. P.I.V. .... 5V Max. DC Current (25°C) ..... 100 mA			

TYPE APPROVED \*CV 7127

## fast recovery computer diodes

### HD18

High forward conductance  
 6 Nanosec typical recovery time  
 Nominal capacitance at -1V 1.5pF

Type	P.I.V.	Max. Forward Voltage		Max. Reverse Current @ -10V (25°C)
		@ 10 mA	@ 100 mA	
HD1810	50	0.45	0.75	5μA
HD1840	30	0.45	0.70	10μA
HD1841	20	0.45	0.70	20μA
HD1870	15	0.42	0.70	15μA
HD1871	10	0.42	0.70	20μA (@ -5v)



**WRITE NOW** for complete data on the full range of Hughes semi-conductor products, which also includes:—

- Silicon General Purpose and Computer Diodes
- Silicon Power Diodes and Rectifiers
- Voltage Reference Devices
- High Voltage Cartridge Rectifiers
- Voltage Variable Capacitors
- PNP and NPN Silicon Transistors

—or ask for  
 a Sales Engineer to call



**HUGHES INTERNATIONAL (U.K.) LTD**

KERSHAW HOUSE, GREAT WEST ROAD, HOUNSLOW, MIDDLESEX

TEL.: HOUNSLOW 5222 M & P HM12



**UNIVERSALLY**

### **COLD CATHODE TUBES PROVE THEIR RELIABILITY**

Day and night, somewhere cold cathode tubes in hundreds of equipments are signalling when a pre-set count is reached: timing to accuracies of up to 1/10 millisecond: dividing or frequency measuring: providing time reference marks on pen recorders: controlling machine tools: counting pulses from photocells, geiger tubes, magnetic pickups: acting as sequence switches: generating pulse trains: adding and subtracting: stabilising voltages and many other applications. If you would like more information about cold cathode tubes send for descriptive booklets.

Tube Division,  
Technical Services Department,  
Beeston, Nottingham. Tel: 254831

**ERICSSON TELEPHONES LIMITED  
ETELCO LIMITED**

# Let the

## INDUSTRIAL ELECTRONICS

### READER ENQUIRY SERVICE

# help you to obtain more information

Circle the code numbers of the items in which you are interested. Insert your name and address, etc., in block capitals and post the card to us.

We will communicate with the manufacturers concerned and arrange for the information you require to be sent to you without obligation.

*(No postage stamp is required if posted in Great Britain or Northern Ireland)*

#### Is this your own copy ?

Each month INDUSTRIAL ELECTRONICS will bring you news of the latest applications, the most recently announced equipment, produced by the rapidly expanding electronics industries of the world.

It is invaluable to all management and production executives, and engineers, in industry generally, who need to be informed of the latest developments in electronic aids to industry.

**MAKE SURE OF YOUR COPIES  
USE THE ORDER CARD NOW**

## INDUSTRIAL ELECTRONICS

## READER ENQUIRY SERVICE

**JANUARY 1963** — For further information circle appropriate number

Editorial code number—		1	2	3	4	5	6	7	8	9	10	11	12	13	14	15	
16	17	18	19	20	21	22	23	24	25	26	27	28	29	30	31	32	33
34	35	36	37	38	39	40	41	42	43	44	45	46	47	48	49	50	51
52	53	54	55	56	57	58	59	60	61	62	63	64	65	66	67	68	69
70	71	72	73	74	75	76	77	78	79	80	81	82	83	84	85	86	87

Advertisement code number—		200	201	202	203	204	205	206	207	208	209	210	211	212	213		
214	215	216	217	218	219	220	221	222	223	224	225	226	227	228	229	230	231
232	233	234	235	236	237	238	239	240	241	242	243	244	245	246	247	248	249
250	251	252	253	254	255	256	257	258	259	260	261	262	263	264	265	266	267

I would also like details of.....

Your Name..... Position held.....

Name of Firm.....

Address .....

Nature of Business.....

PLEASE USE BLOCK CAPITALS

Postage will be paid by Associated Iliffe Press

No Postage Stamp necessary if posted in Great Britain or Northern Ireland

**BUSINESS REPLY CARD**  
Licence No. SE 591

**"INDUSTRIAL ELECTRONICS",  
DORSET HOUSE,  
STAMFORD STREET,  
LONDON, S.E.1**

JANUARY 1963

## INDUSTRIAL ELECTRONICS

### SUBSCRIBER'S ORDER FORM

#### Subscription Rates

Home and Overseas £3. 0s. 0d.  
USA and Canada \$8.50

Please supply  
INDUSTRIAL ELECTRONICS monthly for  
the next 12 months

I will remit on receipt of invoice

NAME .....

ADDRESS .....



Postage will be paid by Associated Iiffe Press

No Postage Stamp necessary if posted in Great Britain or Northern Ireland

**BUSINESS REPLY CARD**  
Licence No. SE 591

**"INDUSTRIAL ELECTRONICS",  
DORSET HOUSE,  
STAMFORD STREET,  
LONDON, S.E.1**

# Let the

## **INDUSTRIAL ELECTRONICS**

### **READER ENQUIRY SERVICE**

# help you to obtain more information

**INDUSTRIAL ELECTRONICS**

### **READER ENQUIRY SERVICE**

**JANUARY 1963 — For further information circle appropriate number**

Editorial code number—	1	2	3	4	5	6	7	8	9	10	11	12	13	14	15
	16	17	18	19	20	21	22	23	24	25	26	27	28	29	30
	31	32	33	34	35	36	37	38	39	40	41	42	43	44	45
	46	47	48	49	50	51	52	53	54	55	56	57	58	59	60
	61	62	63	64	65	66	67	68	69	70	71	72	73	74	75
	76	77	78	79	80	81	82	83	84	85	86	87			
Advertisement code number—	200	201	202	203	204	205	206	207	208	209	210	211	212	213	
	214	215	216	217	218	219	220	221	222	223	224	225	226	227	
	228	229	230	231	232	233	234	235	236	237	238	239	240	241	
	242	243	244	245	246	247	248	249	250	251	252	253	254	255	
	256	257	258	259	260	261	262	263	264	265	266	267			

I would also like details of.....

Your Name..... Position held.....

Name of Firm.....

Address.....

Nature of Business.....

**PLEASE USE BLOCK CAPITALS**

Circle the code numbers of the items in which you are interested. Insert your name and address, etc., in block capitals and post the card to us. We will communicate with the manufacturers concerned and arrange for the information you require to be sent to you without obligation.

*(No postage stamp is required if posted in Great Britain or Northern Ireland)*

### **Is this your own copy ?**

Each month **INDUSTRIAL ELECTRONICS** will bring you news of the latest applications, the most recently announced equipment, produced by the rapidly expanding electronics industries of the world.

It is invaluable to all management and production executives, and engineers, in industry generally, who need to be informed of the latest developments in electronic aids to industry.

**MAKE SURE OF YOUR COPIES  
USE THE ORDER CARD NOW**

Postage will be paid by Associated Iiffe Press

No Postage Stamp necessary if posted in Great Britain or Northern Ireland

**BUSINESS REPLY CARD**  
Licence No. SE 591

**"INDUSTRIAL ELECTRONICS",  
DORSET HOUSE,  
STAMFORD STREET,  
LONDON, S.E.1**

# 'ENGLISH ELECTRIC'

For further  
information  
circle 219 on  
Service Card

## New English Electric Vacuum Variable Capacitors Early delivery from wide range



A TYPE



IE TYPE



JD TYPE

An entirely new series of  
Vacuum Variable Capacitors has  
now been introduced by  
**English Electric Valve Co. Ltd**  
giving

- 40 ampere (r.f.) rating (r.m.s.)
- capacitance range covering  
5 to 750 pF
- up to 20 kV (peak) operation



UB TYPE

Vacuum Variable Capacitors have  
many advantages over conven-  
tional air or gas-filled capacitors  
including:

- Compactness
- Extremely low power factor
- Low self-inductance and stray  
capacitance
- No electrostatic dust precipi-  
tation on plates
- Ease of installation
- Self-healing properties in  
cases of accidental voltage  
overload

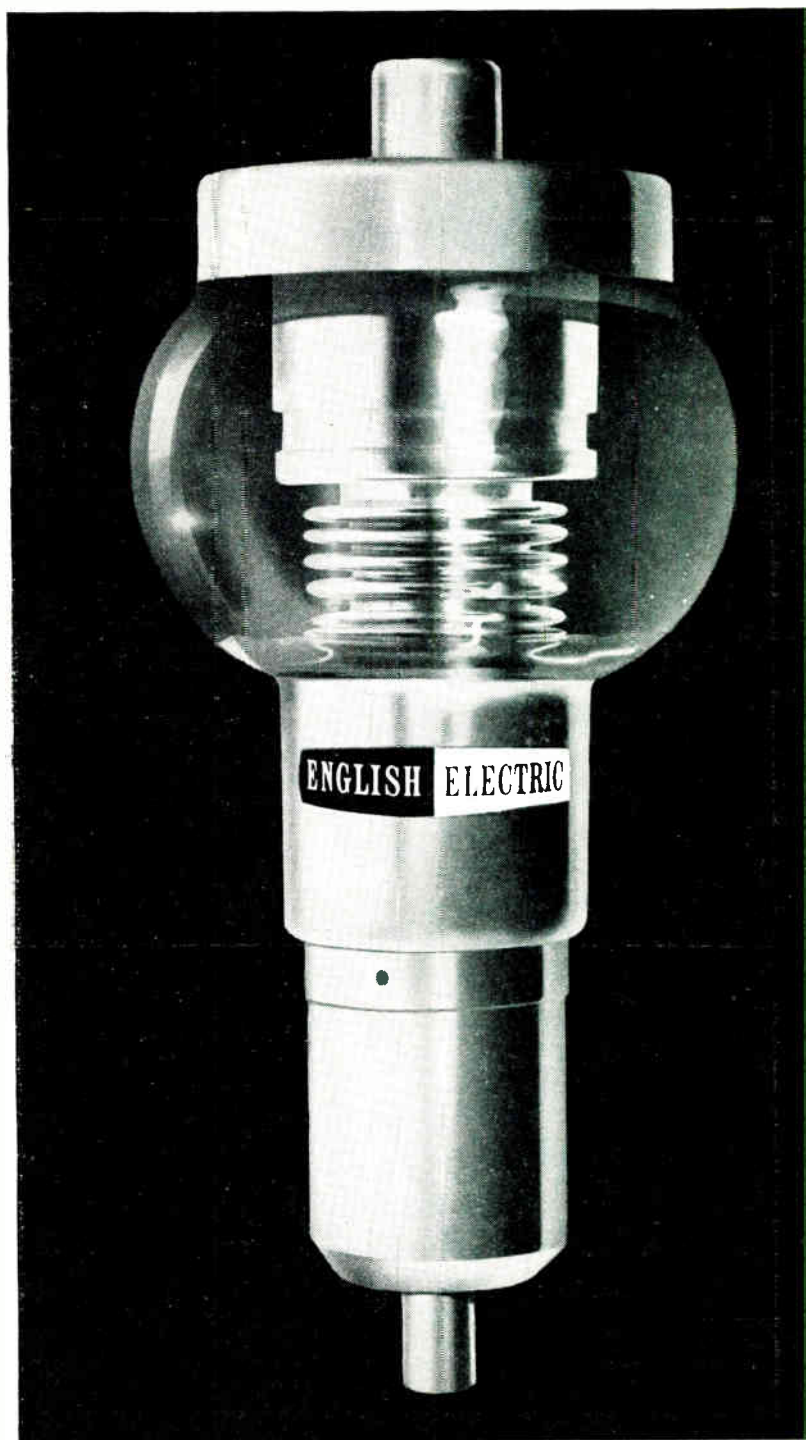

Further information on this new  
series and the complete range of  
types, with capacitances up to  
2000pF, is available on request.  
Enquiries are also invited for  
special designs, to suit individual  
requirements.

## English Electric Valve Company Limited

AGENTS THROUGHOUT THE WORLD

Chelmsford, England. Telephone: Chelmsford 3491

**SOLARTRON**

**DECADE PULSE GENERATOR  
TYPE GO 1005**

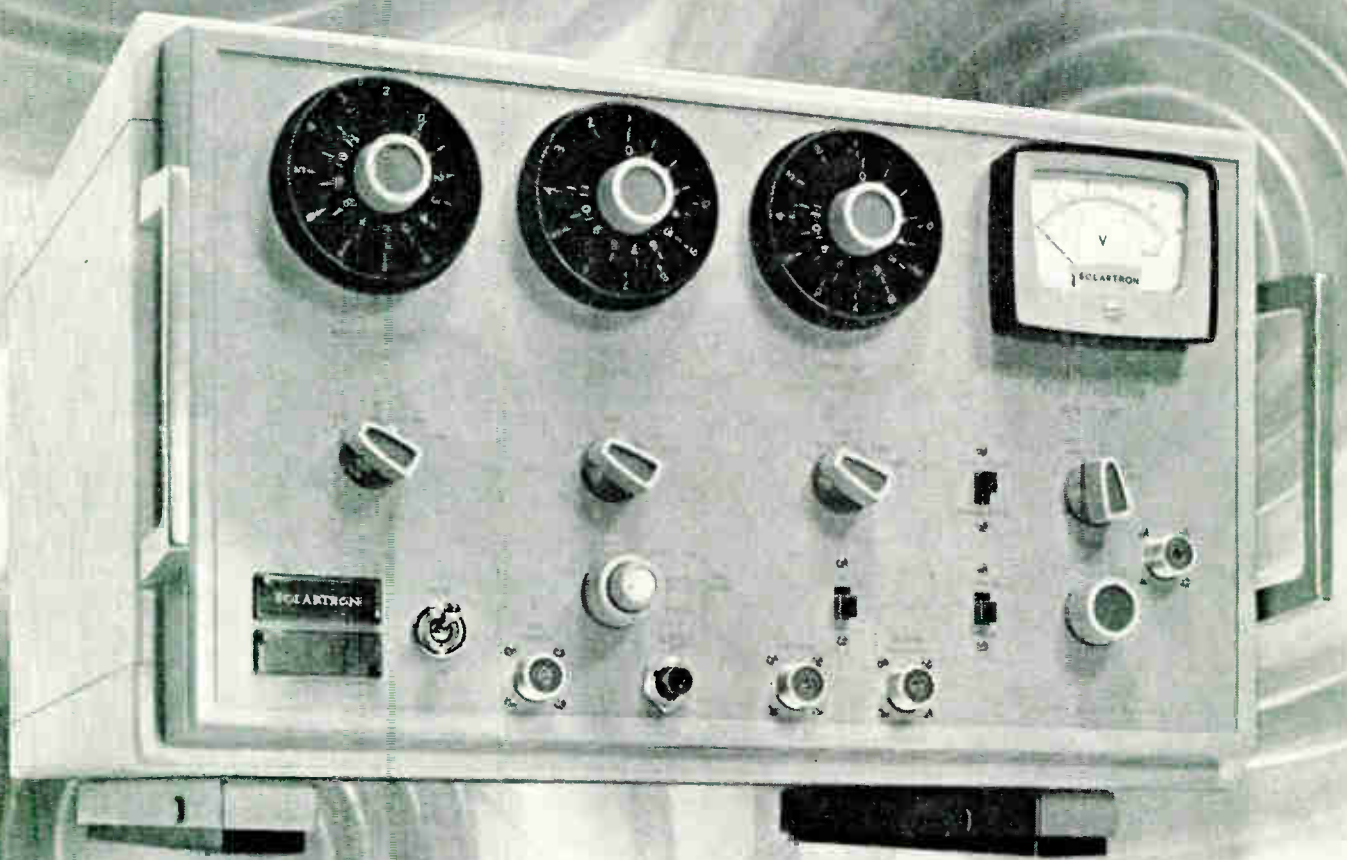

**A tool for progress  
in every industry**





For further information  
circle 221 on Service Card

## SIGNAL SOURCES

### PULSE GENERATORS

Solartron Pulse Generators provide D.C. coupled rectangular pulses with fast rise and fall times and negligible overshoot. Incrementally graduated controls for pulse duration, period and delay ensure high resolution and repeatability of setting; whilst retaining extreme simplicity of operation.

**DECADE PULSE GENERATOR GO 1005.**  
Pulse repetition frequency 10 c/s – 1 Mc/s  $\pm 5\%$ .  
Pulse duration 250 nsec – 100 msec  $\pm 5\%$ .  
Pulse amplitude 0.7 V to 100 V  $\pm 3\%$ .  
Rise time 0.3 volts, 20 nsec.  
Pulse delay time 250 nsec – 100 msec  $\pm 5\%$ .  
Direct monitoring of pulse amplitude by means of a 3½" moving coil meter.

**PULSE GENERATOR GO 1101.**  
Pulse repetition frequency  
10 c/s – 500 kc/s  $\pm 10\%$ .  
Pulse duration 1  $\mu$ sec – 100 msec  $\pm 10\%$ .  
Pulse Amplitude 0.5 V – 100 V  $\pm 10\%$ .  
Rise time 0.3 volts less than 10 nsec negative going – less than 20 nsec positive going.  
Delay time 1  $\mu$ sec – 10 msec  $\pm 10\%$ .  
This unit also provides a square wave output from the internal period generator, and will square suitable triggering wave forms.

### SINE WAVE OSCILLATORS.

Wide range of sine wave oscillators are available within frequency range from 0.01 c/s to 800 Mc/s.

**WIDE RANGE OSCILLATOR CO 546.**  
Frequency range 25 c/s – 500 kc/s  $\pm 1.5\%$   
or 1 c/s in five switched ranges.  
Harmonic distortion less than 1%.  
Hum level less than 0.1% of maximum output.  
Output level continuously variable 0–10V r.m.s.  
Output attenuator 0–60 dB in  
1 dB steps 600 ohms impedance.

**R.C. OSCILLATOR CO 1004.2**  
Frequency range 10 c/s – 1 Mc/s  
in five ranges Accuracy  $\pm 2\frac{1}{2}\%$ .  
Harmonic distortion less than 1%.  
Modulation with hum less than 0.3%.  
Balanced output up to 20 V r.m.s. from  
each side into loads greater than 20 k $\Omega$ , –up  
to 10V r.m.s. into loads of 600 ohms or greater.

**LF DECADE OSCILLATOR OS 103.2**  
0.01 c/s – 10 kc/s.

**STABILISED AMPLITUDE SIGNAL  
GENERATOR DO 905**

350 kc/s – 50 Mc/s.

**PRECISION SIGNAL GENERATOR D1001**  
50 kc/s – 860 Mc/s.

### THE SOLARTRON ELECTRONIC GROUP LTD. (Instrument Division)

Victoria Road, Farnborough, Hants.

Telephone: Farnborough (Hants) 3000

Telex 8545 Solartron Fnbro.

Cables: Solartron, Farnborough.

M & P S138



# RADAR DISPLAY UNIT

TYPE 3A

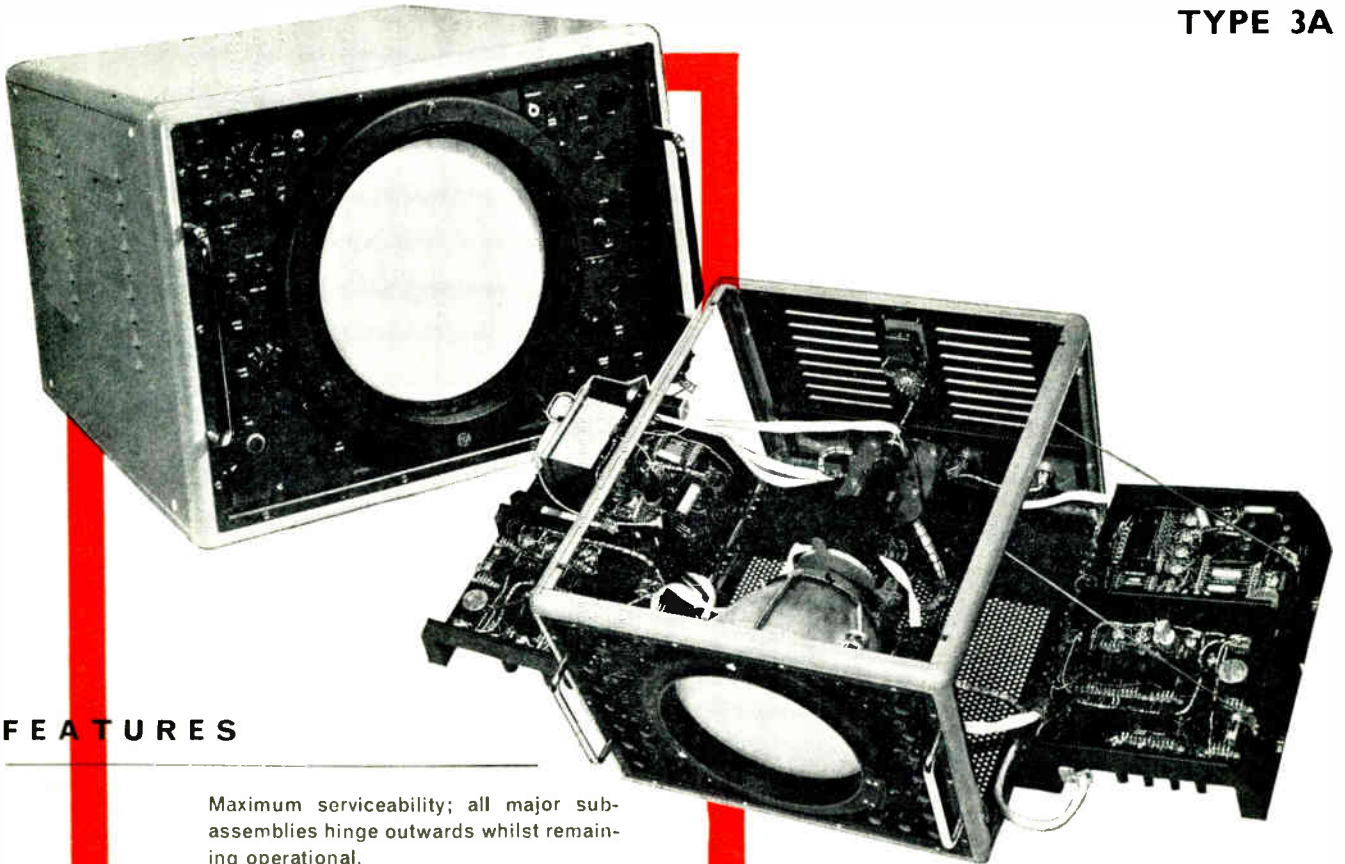

## FEATURES

Maximum serviceability; all major sub-assemblies hinge outwards whilst remaining operational.

Range continuously variable from 10 n.m. to 100 n.m. plus switched range extension.

Two independent shift systems allow centred or offset display instantly.

Rotatable parallel line cursor with 1" circumference etchings.

Cursor can be locked to provide fixed plotting surface.

Three independent sets of range marks facilities.

Additional channel for negative mixed video.

The Type 3A is a general compatibility Radar Display of great flexibility although designed primarily for ATC use, it is also ideally suitable for Radar Simulators, Harbour Approach Systems etc and in any application where a PPI or offset display is required. The 12" orange overlay tube permits daylight viewing.



**THE MOST TRUSTED NAME IN ELECTRONICS**

**£600**

**ex factory  
Sunbury-on-Thames**

FOR FULL DETAILS AND SPECIFICATION PLEASE WRITE OR PHONE  
**RCA GREAT BRITAIN LIMITED**, Sales Division, Lincoln Way, Windmill Road, Sunbury-on-Thames  
ASSOCIATE COMPANY OF RADIO CORPORATION OF AMERICA. Telephone: Sunbury 5511

## Comment

It has long been a principle of mass production that any individual part must be interchangeable with any other similar part. Where mating parts must fit well this often entails manufacturing both of them to close tolerances, so that any part may mate with any other with acceptable accuracy.

The practical drawback to this normal mass-production technique is the high cost of the machinery needed to produce close tolerance parts. It has recently been reported that the American motor-car industry is abandoning the technique and is now using cheaper machinery to produce relatively wide tolerance parts. These are subsequently sorted, and it is claimed that a better fit in mating parts is obtained more cheaply.

The sorting process, of course, is an automatic one and naturally involves precision measuring apparatus. It may be objected that the saving is more apparent than real, that it merely substitutes precise measurement for precise manufacture. However, the measurement is needed in any case and the real change is the extension of grading and sorting beyond the simple 'pass' and 'reject' categories which are all that are needed in normal mass production.

The new method is one which we think we shall hear more of. It is clearly one in which electronics may be expected to play a major part. It will often come into the measuring methods and will usually be involved in the control of the sorting.

One difficulty could arise with the system. If two machines are producing two mating parts they will not be precisely alike, for the two parts are different. The variations of size are thus also likely to be different. But unless the distributions are the same for each there will be some parts for which no mates can be found and which must consequently be rejected.

Considerable care in design and operation is likely to be needed to keep such rejects at an acceptably low level. Here a simple form of automatic control might help. It should not be difficult to count the numbers coming off each machine in the various sizes. A difference between the outputs of the machines would be an error signal which could be used to alter their adjustment to obtain equality.

Sorting and selection instead of precision manufacture is no new thing in the electronics industry, of course. It is used, for example, in resistor manufacture. With the preferred-number system no resistor need be rejected because its value is wrong. It always falls into an acceptable category.

## Automation

It is generally accepted that the present trend towards automation will continue and probably accelerate. Some people are getting very worried about the social effects, for they envisage that certain kinds of labour may become no longer needed, with resulting unemployment. Others argue that there is no

problem, for labour displaced from one occupation can be re-trained for another.

A conference on the subject was recently held in London by the American Foundation on Automation and Employment Ltd., but, at the time of writing, no report of its deliberations has appeared.

Our own view of the matter is that



## COMMENT (Continued)

there will be no real difficulty as long as automation is not introduced too quickly. The proper rate will vary from one industry to another and it will also depend upon whether automation is introduced primarily to increase production or to reduce labour. In the first case there should be no problem; in the second there is bound to be one unless automation is introduced so slowly that displacement of labour occurs at the natural rate of retirement from the industry.

It is a good thing that serious attention is being directed to the matter, however, for the difficulties are likely to be much less if everything is considered well in advance. We are not underestimating the difficulties when we call them transitional ones, for the individuals concerned they may be permanent.

In problems of this nature it sometimes helps to consider limiting cases. Suppose automation were carried so far that most goods could be manufactured with little or no human intervention. There would then be no need for most people to work and the problems would be of distribution.

It would then be a topsy-turvy world, in which unemployment would be desirable and in which the government of the day would be endangered by rising employment!

### Relay

A successor to Telstar was successfully launched on 13th December. This is Relay. Its transmitter radiates 9 W, four times the power of Telstar, and apart from the telemetry and coding apparatus, all equipment is duplicated. It is built to provide a one-way television channel but two-way speech channels.

Its orbit is expected to have a perigee of 700 miles and an apogee of 4,000 miles, and to provide about an hour's visibility from Europe and America. It is fitted with a timer to render the apparatus inoperative after a year. This is so that when it has served its experimental purposes, and is no longer wanted, it will not produce interference with future satellites. Apparently some existing satellites have radio equipment which is functioning too long and proving a nuisance!

### Semiconductors

We referred last month to semiconductors and said that 'new devices are pouring out and it is hard to keep track of them'. Another has been announced this month!

It is termed a heterojunction diode by I.B.M. who have developed it. A vapour growth process is used to make it and n-type germanium is grown on n-type gallium arsenide and grows with the same crystal structure.

It is claimed to have a switching time of the order of a picosecond and to be able to handle currents of the order of 50 mA. Since both materials are n-type, conduction is by electrons and hole-storage problems do not arise.

### Lasers

We also mentioned lasers last month. Again a new one is announced, also by I.B.M. It comprises a gallium arsenide diode (this material seems to be becoming fashionable!) at liquid helium temperature. The diode emits coherent light *continuously* when a current above a certain value is passed through it. The current density is about 100 A/cm<sup>2</sup> and there is an output of 10–25 mW of light at 8,400 Å for an electrical input of 50 mW.

### 'Physical Society' Exhibition

The annual exhibition of The Institute of Physics and The Physical Society opens on 14th January at the Horticultural Halls. It is the 47th exhibition and this year the method of selecting exhibits has changed. Originally it showed mainly scientific and research items, with the emphasis strongly on experimental and sample models. Over the years it has changed and the emphasis has more and more been on standard production equipment.

This year's change is an attempt to bring the exhibition back more towards its early character. 'Any U.K. firm wishing to participate was entitled to submit up to six detailed descriptions of exhibits (or six from each division of a large firm); these proposals were then scrutinized by a panel of expert referees on whose recommendation the offers were accepted or rejected.'

As a result, some past exhibitors have dropped out, but in spite of this the number of manufacturing firms exhibiting has increased from 91 to 118 and the total number of exhibitors from 137 to 145. There is a reduction in the total number of exhibits, stands are to be smaller and gangways wider. This last will certainly be a most welcome improvement.

# MEASUREMENT OF BULK FLOW AND MIXING

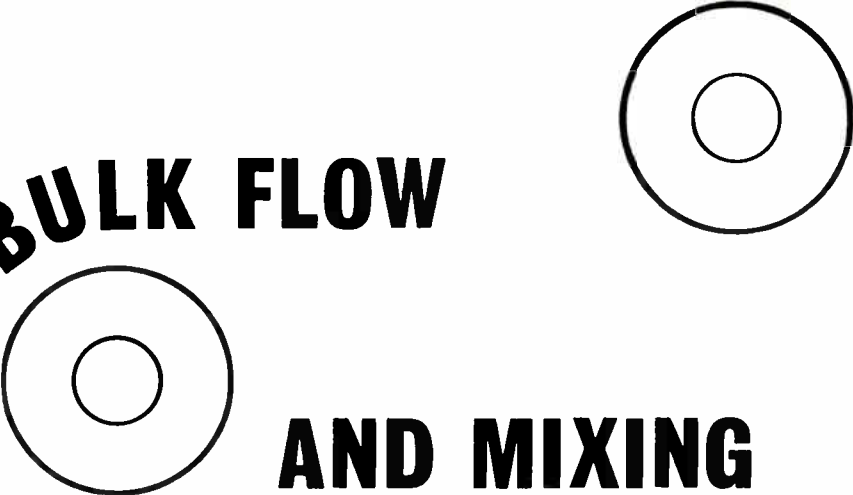

Radioisotopes form a convenient way of checking the effectiveness of mixing processes, such as are needed in preparing cattle food, and of the bulk flow of liquids and the detection of leaks, as in oil pipe lines. This article describes how these things can be done and the kind of radioisotopes that are used.

By DENIS TAYLOR, M.Sc., Ph.D., M.I.E.E.\*

THE thorough mixing of materials on the industrial scale can be very difficult. It can be even more difficult to demonstrate that it has been achieved. This is particularly true of the admixture of a very small, but statutorily necessary, amount of mineral to a large bulk of cattle food, to cite one important practical case. Fortunately, radioisotopes are ideal tools for dealing with this class of problem. One ingredient of the mineral is made slightly radioactive by the addition of a small amount of a radioactive version of this ingredient; i.e., a radioactive isotope of the element in question. An indication of uniform concentration of this tracer throughout the contents then indicates uniform mixing.

It is usual to choose a gamma-emitting isotope as this will permit the course of the mixing to be followed without the necessity of taking and analysing samples. This is possible because gamma-radiation is very penetrating and can be monitored by external means. It is also necessary to choose a radioisotope having a short half-life, so that the radioactivity has decayed to an insignificant quantity before the cattle food is put on the market. The half-life is the time in which the amount of radioactivity has decayed to half its initial value. If this time is  $T_{1/2}$ , then after a time  $T_{1/2}$ , only half the activity remains. After a further time of  $T_{1/2}$  ( $2T_{1/2}$  altogether) the activity remaining will be only  $\frac{1}{4}$  of the initial activity. After three half lives (i.e.,  $3T_{1/2}$ ) the activity remaining is only one eighth of the initial activity. In general after  $nT_{1/2}$  the activity remaining is  $(\frac{1}{2})^n$  of the initial activity.

Returning now to our cattle food problem, manganese 56 ( $Mn^{56}$ ) can be used. This has a half-life of 2.58 hours and emits gamma-radiation of energy 2 MeV. Hence, after 3 days (i.e., 72 hours or  $72/2.58 = 27.21T_{1/2}$  for  $Mn^{56}$ ), it follows that the activity remaining after this time would be  $(\frac{1}{2})^{27.21} = 0.000006\%$  of the initial activity. Tests can therefore be made by estimating the amount of tracer ( $Mn^{56}$ ) in each bag of cattle food using a gamma-ray detector. This measurement will show whether the correct amount of mineral has been included. After storage for a few days (as the calculation shows) effectively no radioactivity remains. The photograph on p. 190 shows some typical measurements being made.

Fig. 1. Type of display on a pen recorder obtained when detecting a leak in an oil pipe line

\* Director, Plessey Nucleonics Ltd.

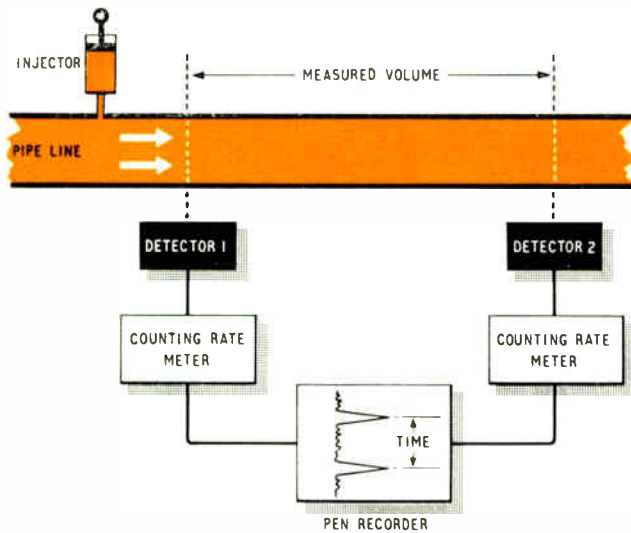

Fig. 2. Flow rate is measured by injecting an isotope into the line and measuring the time interval between the responses of the two detectors

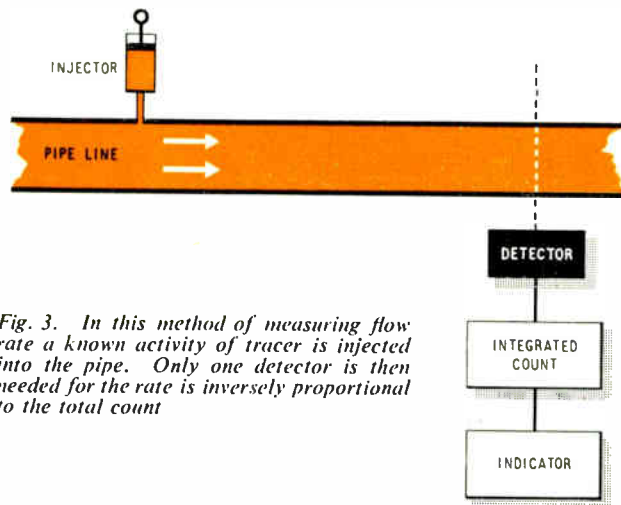

Fig. 3. In this method of measuring flow rate a known activity of tracer is injected into the pipe. Only one detector is then needed for the rate is inversely proportional to the total count

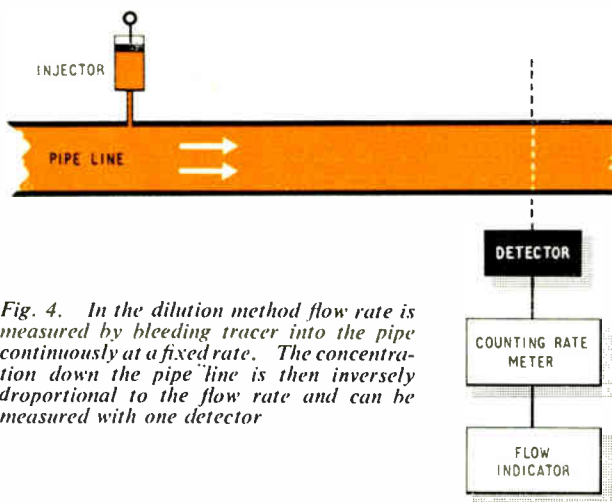

Fig. 4. In the dilution method flow rate is measured by bleeding tracer into the pipe continuously at a fixed rate. The concentration down the pipe line is then inversely proportional to the flow rate and can be measured with one detector

The method is also applicable to the mixing of liquids, colloids including greases, slurries, gases, as well as dry solids. A detector external to the mixer, or dipping into the fluid, can provide a continuous measurement of the mixing and this is preferred in some cases.

Apart from the use of radioisotopes in process control for checking the correct mixing of ingredients in a mixture, tracers are employed a great deal to study the effectiveness of new techniques, before putting them into practice. Thus, radiiodine  $I^{132}$  ( $T_1 = 2.4$  hours) has been used to determine the mixing efficiencies in a grease plant.

### Detection of Leaks

In the case of flow measurement, nuclear methods have also been employed both for investigational purposes and for providing control instrumentation. Thus, tracers can be used conveniently for determining the type of flow (i.e., whether viscous or turbulent), locating leakage and determining its magnitude as well as providing information about the degree of mixing taking place.

One problem of considerable practical importance is that of finding leaks in water mains. Radioactive tracers can be employed for this purpose. It is usual to employ a gamma-emitting isotope which is injected into the line with the line blocked so that the water flows only from the leak. It is left in this condition for about half an hour. Following this the radioactive solution is moved along to another section of the main (see J. L. Putman and S. Jefferson, 'Application of Radioisotopes to Leakages and Hydraulic Problems', *Proceedings Inter. Conf. Peaceful Uses of Atomic Energy*, Vol. 15, pp. 147-150, August 1955) by replacing it with fresh water so that only the radioactivity which has leaked out is still present in the soil. Small bore holes which have been prepared earlier close to each point in the main are now employed. Suitable gamma-sensitive radiation detectors (enclosed in steel tubes for protection) are now pushed down these holes in the vicinity of the suspected points and a radioactivity check made. If radioactivity is found in the soil then a leak is indicated.

Putman and Jefferson recommend the use of radio-sodium ( $Na^{24}$ ) and a level of activity of 0.8 microcurie per litre (corresponding to one-tenth of a maximum permissible level in drinking water). Leaks of the order of 5 millilitres per hour can be detected by this method, but generally the leaks of interest are many times larger than this, of the order of 100 millilitres per hour, and so are very easily detected.

In general water mains being tested are not connected to the public water supplies, but when they are, precautions are taken to ensure that the radioactivity cannot reach the public even though the activity is well below the maximum permissible level which has been laid down as 'safe'. It is also usual to chlorinate water used for these tests to guard against bacterial infection and also to make the radioactively contaminated water so unpalatable that no-one is likely to drink it. Of course, with sodium 24, the half-life is only 15 hours, so that after 15 hours half the activity has disappeared, and after 30 hours only one-quarter of the activity remains. It follows that after one week the activity will have fallen to  $(\frac{1}{2})^{168/30} = (\frac{1}{2})^{11.2} = 0.00048$  of the original activity.

Another problem of a similar nature is that of detecting leaks in buried oil pipe lines. The main difference between this and the previous problem is that the pipe lines may stretch over very long distances, often without access. The method used for water mains is not then applicable and the usually accepted method is to detect the radioactivity from inside the pipe. This involves pumping along the pipe under pressure a quantity solution of radioactive material, followed by the oil. At a later stage (usually about 1 hour afterwards) a detector unit is pulled along the pipe line. Wherever radioactive contamination has leaked out of the pipe the



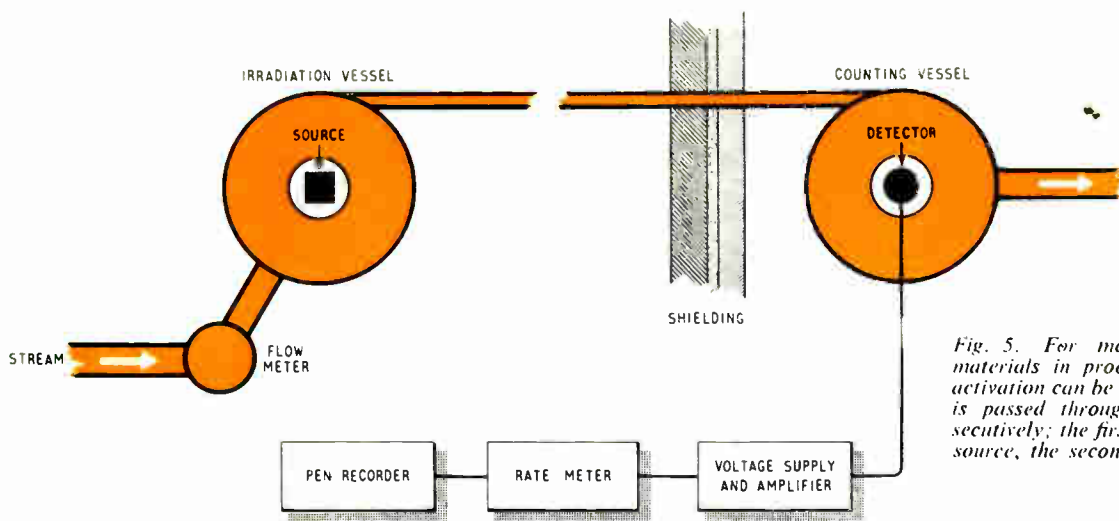

Fig. 5. For monitoring particular materials in process control neutron activation can be used. The material is passed through two vessels consecutively; the first contains a neutron source, the second a detector.

radiation counters in the instrument package (Geiger counters or scintillation counters) detect these as it is pulled along the pipe line, and, therefore, call attention to these leaks. There remains the problem of calibrating the system so that the exact location of the leak or leaks can be determined. This is usually accomplished by placing small pieces of radioactive cobalt ( $\text{Co}^{60}$  which emits gamma rays) at regular intervals along the length of the pipe line. These provide position markers. Fig. 1 shows the type of display obtained on the pen recorder to which the instrument package is connected. The larger pulses are the position markers and the one small pulse is, in fact, due to the leak. The exact location of the leak can be inferred from this record by interpolation between two position markers.

Radioactive tracer methods have also been employed for the determination of flow-through and hold-up times of sewage in settling tanks of sewage treatment plants. Bromine<sup>82</sup> (half-life 36 hours) and Na<sup>24</sup> (half-life 15 hours) have been used for measurements of this sort and the study of flow characteristics. The considerations affecting the choice of radioisotope are the water solubility and a half-life which is long enough to carry out accurate experiments extending over several hours. It is necessary as already explained, that the amount of activity must not present any danger of radioactive pollution. This means choosing a material of relatively short half-life so that the activity quickly disappears. It also means using as little activity as possible. The activity must preferably be sufficiently small so that the level of

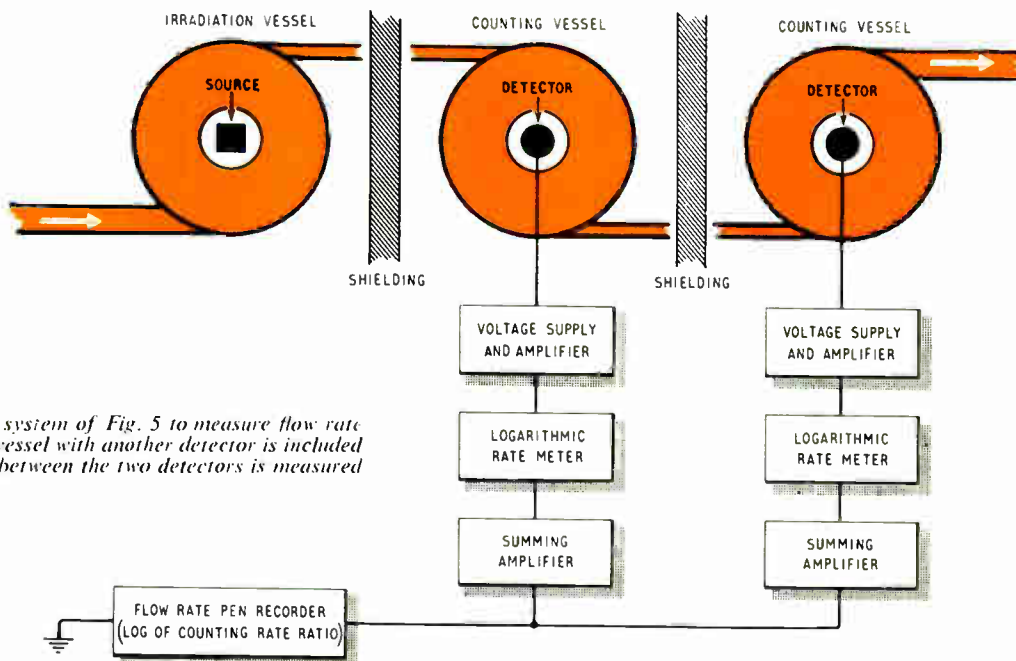

Fig. 6. An extension of the system of Fig. 5 to measure flow rate also is shown here. A third vessel with another detector is included and the reduction of activity between the two detectors is measured.



Checking the mixing of cattle food

activity in the water is below the maximum permissible level.

Radioactive tracers have also been used for studying the siltation in tidal estuaries. Measurements of siltation can be of considerable assistance in controlling the siltation in navigable rivers, which is a matter of considerable economic importance.

#### Measurement of Flow

Nuclear techniques may also be used for the measurement of flow and flow rates in process-control applications. There are several possible methods. Thus, it is possible to time the passage of the injected tracer between two points in the pipe line separated by a known volume. The flow rate is obtained by dividing the volume between the observation points by the time between the peaks of activity registered by the counters. This method is illustrated in Fig. 2.

An alternative method which uses only one counter and eliminates the need to know the volume of any part of the pipe is illustrated in Fig. 3. In this method the flow rate is obtained from the integrated count during the passage of a known activity of tracer down the pipe. The flow rate is inversely proportional to the total count (total number of gamma-ray detections registered by the counter), and the factor of proportionality which depends on the size and construction of the pipe is easily determined. Furthermore, it is found that at constant flow rate the integrated count is independent of the tracer concentrations along the stream and so the method is capable of good precision. Further, this method is often employed in process-control applications, because it is readily adaptable to the continuous monitoring of flow rates.

Still another method is the so-called 'dilution method'. In

this, the tracer is bled continuously into the pipe line at a fixed rate. Then, at a measuring point down the pipe line as shown in Fig. 4, the concentration of the tracer in the pipe line is inversely proportional to the flow rate. For very accurate work samples of the liquid may be taken from the pipe and their activities measured. However, for many applications it is reasonable to use a gamma-emitting tracer and measure its activity with the aid of a detector external to the pipe line. This method is also applicable to continuous monitoring of flow rate.

For monitoring mass flow it is sometimes convenient to use the above method of measuring volumetric flow and combine the measurements with a suitable method of monitoring the density of the liquid. This density may be measured (see 'Nucleonics and Industry', *Industrial Electronics*, October 1962) by measuring the gamma-ray absorption of the liquid. This involves using a gamma-emitting source and a gamma-sensitive detector with the pipe carrying the liquid between them.

#### Activation Methods

As explained in the previous article, neutron-activation (neutron bombardment to induce radioactivity) can be employed in process control to monitor particular materials. For the method to be applicable, the element which it is desired to monitor, must under neutron bombardment produce a gamma-emitting isotope of relatively short half-life. Silver, for example, on neutron bombardment yields  $\text{Ag}^{110}$  which is radioactive and decays with the emission of 0.66 MeV gamma-rays and has a half-life of 24.2 seconds. Selenium yields  $\text{Se}^{77m}$  which decays with the emission of 0.16 MeV gamma-rays and has a half-life of 17.5 seconds.

Fig. 5 shows schematically the type of apparatus used. There are two vessels for irradiation and counting respectively, equipped with baffles or stream guides. They provide fluid reservoirs, the first containing at the centre a neutron-emitting radioactive source and the second a suitable gamma-sensitive detector. The electronic circuit connected to the detector is designed to respond only to the gamma-rays appropriate to the material to be monitored (e.g. 0.66 MeV gamma-rays in the case of silver and 0.16 MeV gamma-rays in the case of selenium).

Since activity is introduced into the process streams to monitor the content of the stream, the apparatus can be extended using the methods already discussed to monitor in addition the flow rate if required. Fig. 6 shows one system of this sort. The timing in this case is done by monitoring the reduction in activity in passing from the first measuring vessel to the second measuring vessel. The author has shown elsewhere ('Radioactivity and Process Measurements', *Proc. I.E.E.*, January 1963) that the flow rate is given by:

$$\text{Flow Rate} = \frac{0.693 \times \text{Volume}}{T_{\frac{1}{2}} \times \log A_1/A_2}$$

Where  $A_1$  = activity measured by first counter  
 $A_2$  = activity measured by second counter  
 $T_{\frac{1}{2}}$  = half-life of radioisotope monitored.

Hence, it follows that using logarithmic counting-rate meters in the counting channels and displaying the logarithm of the counting-rate ratio on the pen recorder, the recorder can be calibrated directly in units of flow rate.



The echo-depth sounder described in this article takes a fresh sounding every  $1\frac{1}{2}$  seconds and displays the true depth for each sounding. It is thus able to respond quickly to sudden changes of depth.

# THE METRON DEPTH SOUNDER

By K. T. W. JONES\*

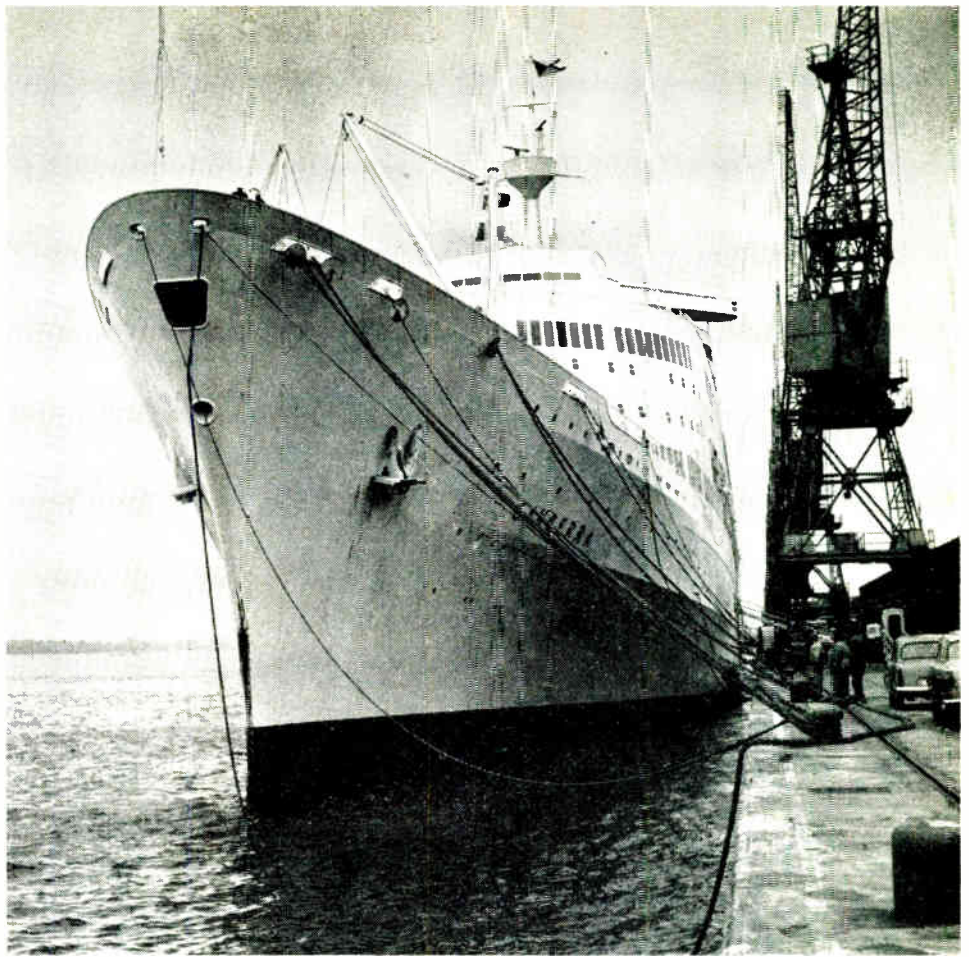

*The Canberra is one of the larger ships fitted with the 'Metron'*

SINCE the adoption of echo-sounding as a means of depth indication at sea there has existed a need for a device which would give a steady indication of the depth beneath a ship by means of a simple pointer on a circular scale. Such a device, called the 'Metron', is now being fitted in ships of many types ranging from trawlers to large ocean liners.

The 'Metron' takes a sounding every  $1\frac{1}{2}$  seconds and an important point is that the depth indicated by the pointer is the true depth for each sounding (not an average for a number of soundings), therefore any sudden change of depth is shown within  $1\frac{1}{2}$  seconds of its occurrence. The system is automatic thus requiring no manual adjustment other than the operation of a range selector.

The installation consists of five principal units:—

- (a) A high-power pulse transmitter
- (b) A hull-mounted transducer unit
- (c) An amplifier integrator unit
- (d) A range selector unit
- (e) An indicator dial unit.

The transmitter and the amplifier integrator, having no operational controls, can be installed out of the way while the range selector can be fitted in a convenient operating position. The main indicator dial is usually fitted in the wheelhouse or chartroom but a large number of auxiliary indicators can operate simultaneously in other parts of the ship.

It is felt that the manner in which this system functions will be of interest to the reader but in case he is unfamiliar with echo-sounding the basic principle is as follows. At a certain instant a pulse of high-frequency sound is emitted from a transducer sited in the bottom of the ship—this pulse travels to the ocean bed whence it is reflected back to the ship, picked up again by the transducer, converted to an electrical pulse, and amplified. As sound travels at a known velocity in water, the echo-sounder measures the time lapse between transmission of the pulse and reception of the echo, this being a measure of the distance to the ocean bed.

A sounding pulse may give rise to quite powerful echoes from objects other than the ocean bed, e.g. a shoal of fish, furthermore a re-echo may occur due to the returned pulse being reflected by the surface of the sea back to the bottom again and then back to the ship a second time after a further time lapse. The strengths of

\* Marconi's Wireless Telegraph Co. Ltd.



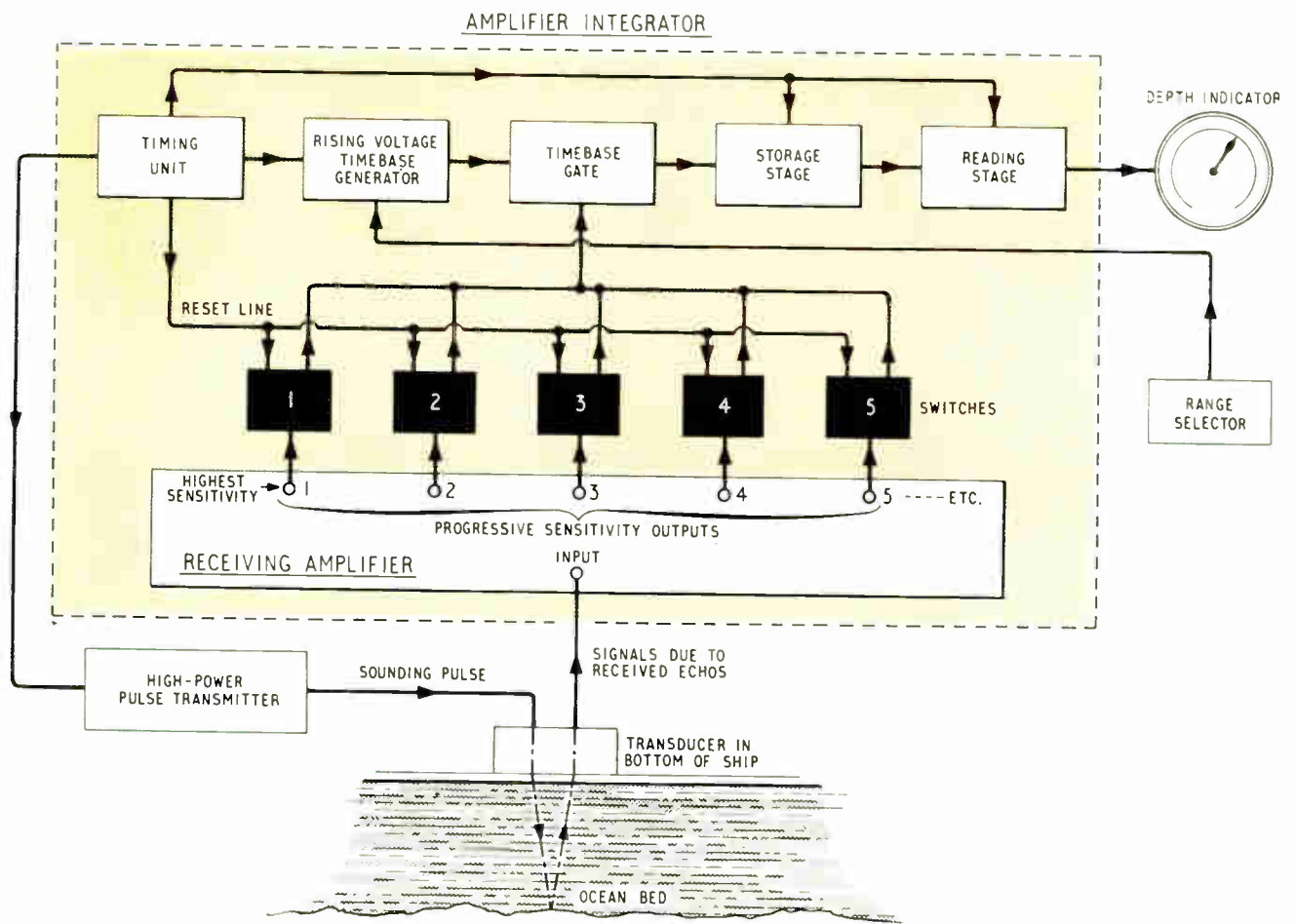
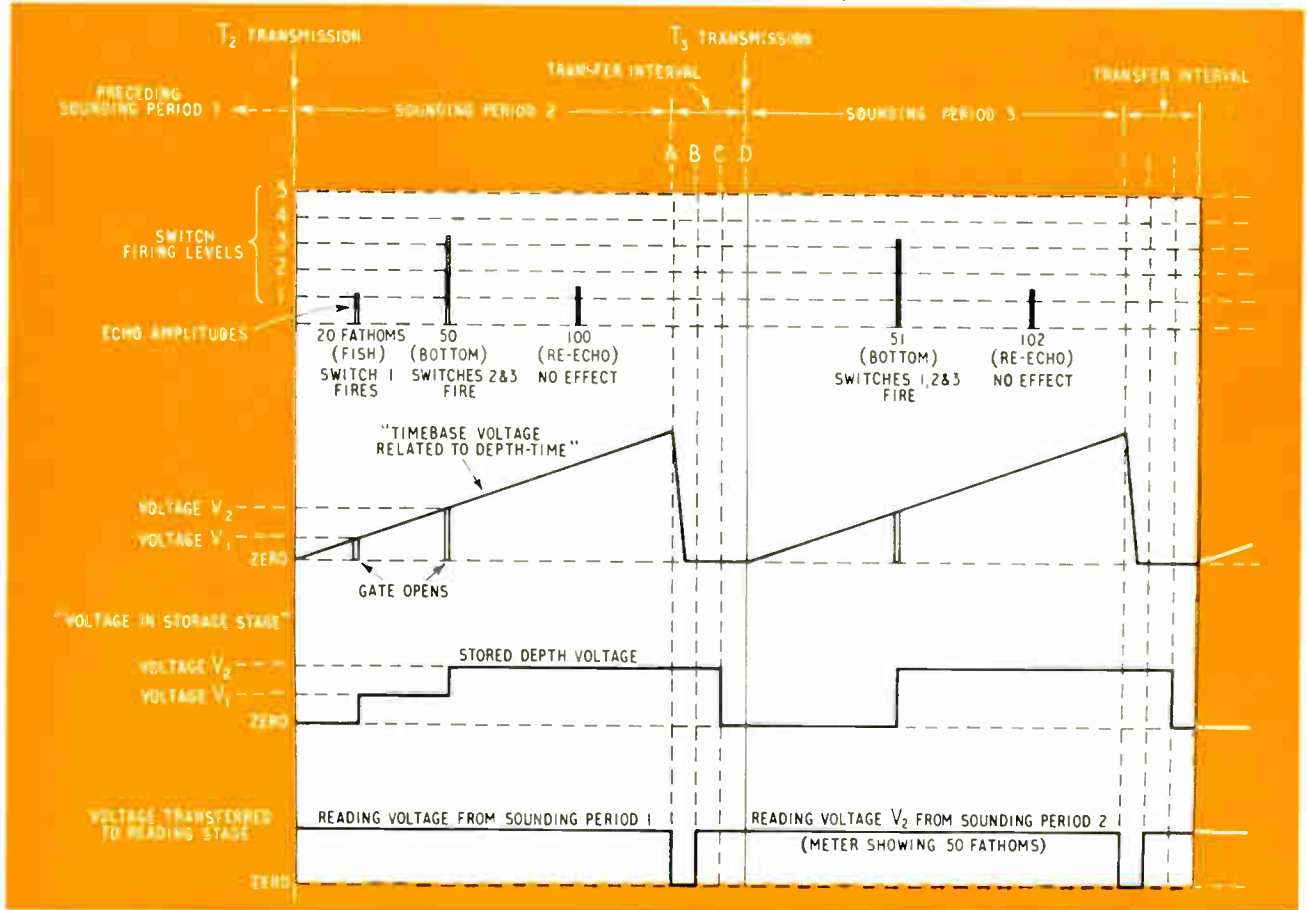

Fig. 1. Block diagram of the 'Metron' system. The multiple outputs from the amplifier together with the electronic switches enable only the strongest echos to be selected for display

Fig. 2. These diagrams show the timing sequence of the 'Metron'



the received echoes vary greatly according to the distance to the bottom, the nature of the bottom (i.e., whether rock, sand or mud) and the roll of the ship, but the main echo from the ocean bed is always stronger than echoes from fish or re-echoes from the bottom. The 'Metron' therefore has to deal with a wide range of signal strengths but at the same time it must select the most powerful echo in any series of echoes resulting from a transmission pulse. It is the function of the amplifier integrator to select the most powerful echo, measure the time lapse between transmission of the pulse and reception of this echo and to present this as a depth indication on the dial unit.

### Basic Operation

Referring to the block diagram in Fig. 1 it will be seen that the amplifier integrator contains a receiving amplifier with a number of output points numbered 1, 2, 3, etc. The amplifier has a large overall gain but the outputs are taken from points of progressive amplification levels. Each output point is connected to a separate electronic high-speed switch. The switches (also numbered 1, 2, 3, etc.) are all identical and each consists of a bistable thermionic valve circuit which will be fired by a specific voltage from the amplifier output point to which it is connected. Thus a very weak echo would fire only switch 1, a stronger echo would fire switches 1 and 2 and an even stronger one would fire switches 1, 2 and 3 and so on. Each switch can be fired only once in a sounding period for, being bistable, it will remain fired until it is deliberately reset. This is done at the instant of commencement of the next sounding period, by the action of the timing unit which simultaneously initiates the transmission pulse and the timebase waveform, the voltage of which at any instant is related to depth-time. The action of a switch (or switches) firing will open the timebase gate for a very short, controlled, time during which period the timebase voltage, existing at that instant, is passed to the storage stage where it is maintained. At the end of the sounding period the stored voltage (the magnitude of which is related to depth) is transferred to the reading stage where it will produce a steady depth reading on the indicator dial.

Referring to Fig. 2, let us suppose that, following the transmission  $T_0$ , three echoes are received as shown; i.e., the first is a weak signal at 20 fathoms from a shoal of fish, the second a strong signal at 50 fathoms from the ocean bed and the third a re-echo at 100 fathoms—stronger than the first but weaker than the second. The first signal will just fire switch 1 which opens the timebase gate and passes the voltage  $V_1$  to the storage stage. The second signal, being stronger than the first, will fire switches 2 and 3 and again open the timebase gate, passing the now higher timebase voltage  $V_0$  to the storage stage. As switches 1, 2 and 3 are now out of action, the third signal, being weaker than the second, cannot fire a switch and therefore does not open the timebase gate. The level of the stored voltage will therefore remain at the level resulting from the firing of switches 2 and 3 which occurred at the instant of reception of the echo from the ocean bed. If, following the next transmission  $T_3$ , no echo were received from the fish, then the echo from the bottom at say 51 fathoms would fire switches 1, 2 and 3 (as shown in Fig. 2) and again the re-echo would have no effect.

The number of switches available and their relative sensitivity spacings has been carefully chosen to cover the maximum variations of signal strengths encountered over the full working range of the equipment under all working conditions. It can be clearly seen that the strongest echo in a series (which is always the main echo from the ocean bed) is the one which determines the level of the voltage in the storage stage at the end of the sounding period.



*A close-up of the 'Metron' indicator fitted to the Canberra*



*Another view of the depth indicator showing also the radio-telephone on the right*

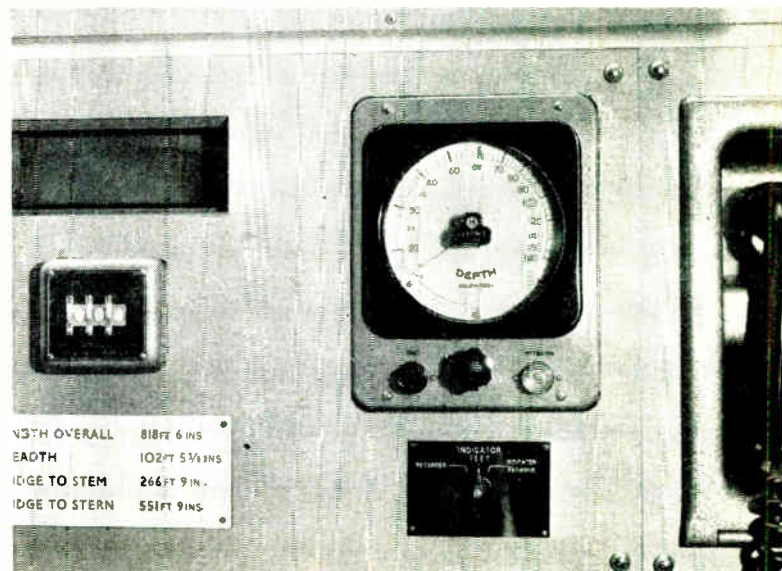



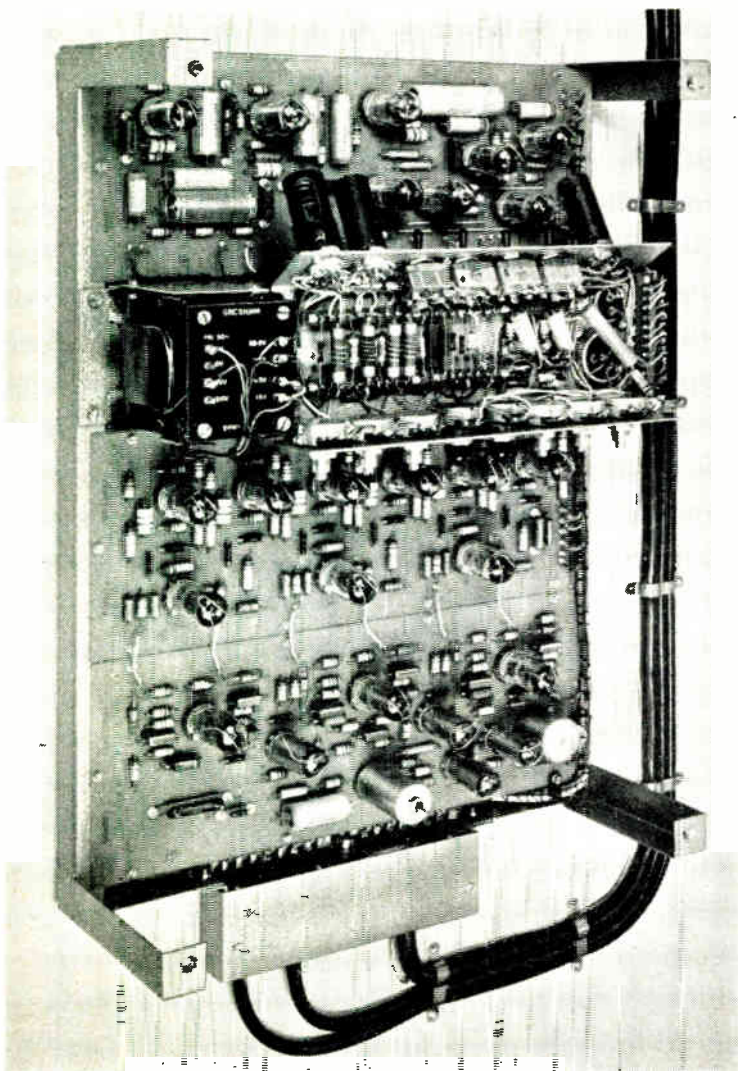

*The interior of the amplifier integrator unit*

Referring again to Fig. 2 it will be seen that following the sounding period there is a short transfer interval during which several operations are performed by relays in the timing unit (Fig. 1). The operations, designated A, B, C, and D, are as follows:—

- (A) The timebase voltage is discharged to zero. The reading voltage due to sounding period 1 is also discharged to zero to prepare for the transfer of the new, and possibly, different depth voltage from the storage stage due to echoes received during sounding period 2.
- (B) The new voltage derived during sounding period 2 is now applied from the storage stage to the reading stage where it will produce a steady depth indication while sounding period 3 is in progress.
- (C) The voltage in the storage stage, having now been applied to the reading stage, is discharged to zero to prepare for the acceptance of a fresh voltage during sounding period 3.
- (D) The new transmission pulse  $T_3$  is initiated, the new timebase waveform is commenced and all the electronic switches are re-set to their unfired condition.

The above series of events is repeated after every sounding period and thus every depth sounding is indicated within  $1\frac{1}{2}$  seconds.

Both the storage and the reading stage circuits can sustain their stored voltages for very long periods and therefore during the short sounding interval of  $1\frac{1}{2}$  seconds there is no detectable voltage drop. The reading stage contains a storage circuit and valve-voltmeter circuit, the voltmeter of which is the actual depth indicator. It will have been noticed that during the transfer interval there is a period between 'A' and 'B' when no voltage is present at the indicator but as this period is in fact only a few milliseconds the pointer does not dip. The indicator presents a very steady reading which smoothly follows the changes of depth.

The 'Metron' is designed to work in depths up to 300 fathoms but in order to ensure freedom from interference, due to spurious water noises and bad weather conditions, it uses a transmitted pulse-power considerably higher than usual for echo-sounders working to similar depths. The system actually employs the same transmitter as is used with the now well established Marconi 'Seagraph III' recording type echo-sounder which will give reliable soundings in depths up to 1,300 fathoms. It is anticipated that much of the demand for the new 'Metron' will be for installation with the 'Seagraph III' recorder in both new and existing fittings as owners would be able to take full advantage of the fact that the single transmitter will operate with either the 'Seagraph III' recorder or the 'Metron' to provide a choice of recorded or instantaneous indications.

As a navigating instrument the 'Metron' is unique—the large dial can be read at a glance from a distance and similar remote display dials can be placed at vantage points anywhere in the ship. Furthermore, as the system is completely automatic, it may be left running unattended continuously if desired. The 'Metron' was developed by Marconi's Wireless Telegraph Co. Ltd. for the Marconi International Marine Co. Ltd.

## IMAGE RETAINING PANEL

An interesting discovery of a particular type of phosphor layer combining the property of electroluminescence under d.c. excitation with a wideband energy-sensitive effect has been made by Thorn Electrical. This has resulted in the production of the Image Retaining Panel (I.R.P.) which appears to contradict much of the existing theory of electroluminescence, to which it is closely related.

In effect, the I.R.P. is like an electrically operated photographic plate which glows as soon as light strikes it, and will hold the illuminated image for at least 30 min or until the panel energizing current is switched off. If, for example, a simple object such as a door-key is rested on the plate in a darkened room, and the light is switched on for a few seconds, a silhouette image of the key will be 'printed' on the plate, the remainder of which glows with a yellowish light. Switching off the energizing current will 'clean-off' the image.

Although visible light is the most easily demonstrated energy source, the I.R.P. responds also to X-rays, near infra-red, ultra-violet and nuclear radiation.

At present it is quite within the theoretical capabilities of the I.R.P. to show an immediate X-ray picture of part of the human body. Other possibilities include infra-red detection, electron microscope image production with reduced radiation, radioactivity detection and Laser alignment.

The I.R.P.s are now going into quantity production. The sizes are 3 in. × 3 in. and 6 in. × 4 in. and they operate from a d.c. supply of 60 to 120 V, 5 to 30 mA.

**For further information circle 37 on Service Card**



APPLICATIONS  
ILLUSTRATED

## Magnetic Tape Recorders



▲ To collect information about noise levels in central London a noise survey is being conducted by D.S.I.R. and the L.C.C. Two vans, each fitted with recording equipment, are sampling noise levels for 100 sec once an hour over a 24-hour period at each of 540 locations. Noises are automatically recorded on magnetic tape which is later analysed. This picture shows a recording van being set up at the Albert Embankment

MAGNETIC tape recorders are firmly established for conventional sound recording both in domestic and professional spheres. They are also being used in industry to record sound phenomena and thereby provide simply records which can be analysed or used at a later date. Presented here are a number of interesting applications of professional-type tape recorders.

For further information circle 38 on Service Card

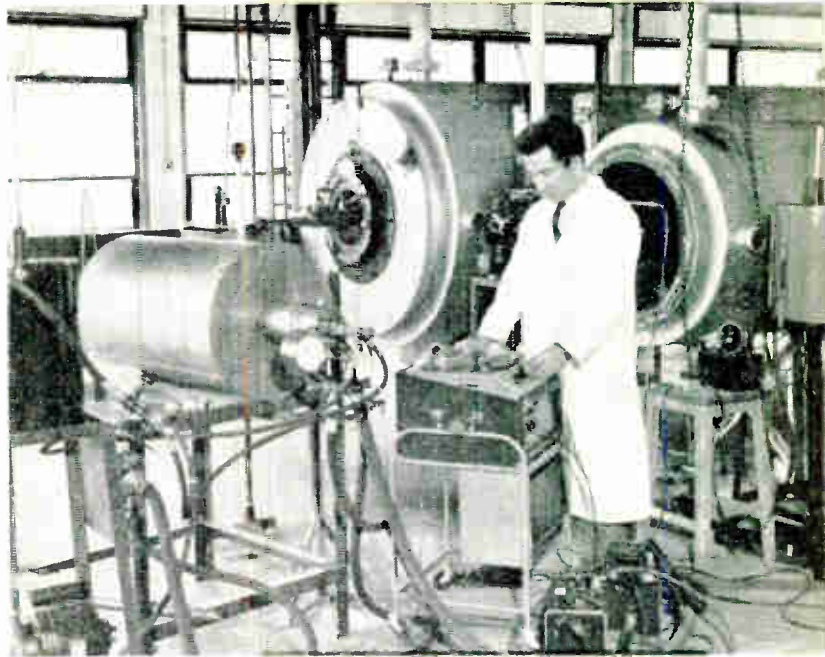

▲ The progress towards the silencing of industrial oil burners has been facilitated by the use of tape recorders. This picture shows an experimental burner, under development, being checked for noise level. The equipment can record noise intensities from 50 to 150 dB. Recordings are subsequently analysed to indicate at which frequencies the noise predominates

Illustrated here is a tape recorder being used by A.P. Films in the production of their children's television series 'Fireball XLS'. All the characters' voices are initially recorded on to tape and played back in conjunction with an electronic mouth movement device to ensure perfect synchronization of sounds and movements

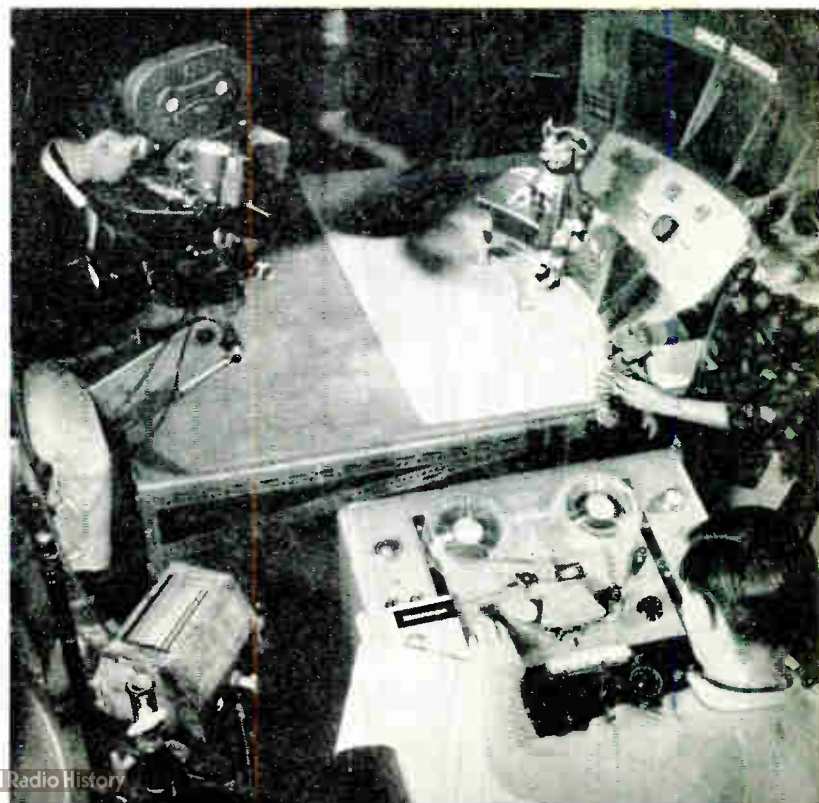

# Personal Centralized Dictation System

In this article one of the modern centralized dictation systems is described. Details are given of the system along with the methods of installation and the economic advantages.

**I**N all but the very conservative companies, the dictation machine is accepted as a modern aid and is found in many shapes and forms. Some offices simply use dictating machines when the shorthand typist is busy, while others employ copy typists in each separate office who work with dictating machines most of the time. An accepted and efficient method of using dictating machines and of employing typists is to form a self-contained department which handles most of the typing for the company. In that department there is installed a bank of dictating machines which are available to dictators either through the internal telephone system or separately wired dictation points. This is normally referred to as the 'Bank' system.

## The 'Bank' System

With the normal 'Bank' system there is no direct contact between the typist and the dictator; any queries arising from the recorded dictation are usually dealt with by the supervisor of the typists. To dictate, one picks up the internal or dictation telephone and is connected automatically to one of the vacant machines and as no contact is made with the typist, every minute detail must be recorded by the dictator. Replacing the receiver signals end of dictation on the machine and an attendant operator removes the recording and re-loads the machine with a blank magnetic disc, tape or belt, or whatever is being used in that particular system. The supervisor evenly distributes the work to the typists and normally checks the finished work before it is returned to the dictator.

## Eminent 'Personal' System

While the 'Bank' system can meet the needs of many organizations with the short straightforward type of letter it has its limitations particularly when the correspondence is complex and when typists refuse to become impersonal units in a 'letter factory'.

One solution is the recently-developed Eminent 'Personal' Centralized Dictation System which is being marketed by Clarke & Smith Office Equipment Ltd. With this the dictator is brought into direct contact by 'phone with the typist who will transcribe the work and instructions can be given to the typist before dictation on to magnetic tape commences.

## How the System Works

Each typist in the typing department is provided with two interconnected tape recorders which are mounted on a frame one on top of the other with a control panel alongside. The control panel with the aid of signal lamps is self-instructing, and audible signals attract the typist's attention to the fact that the dictator wishes to speak to her or has finished dictating. A flick of a switch transfers the dictator to the second machine. At no time is it necessary to remove the reels of magnetic tape from the machines. Another advantage gained by using two machines is the speed with which urgent work can be transcribed. The typist can monitor a correspondent and at a suitable point in his dictation transfer him to the second machine and start typing the first part before the dictator has finished. In addition to the control panel, there is a 3-figure digital counter fitted to each machine which indicates to the typist the position on the tape of various correspondents' dictation.

To use the dictation facilities, one picks up the telephone, dials a number and is connected via the supervisory panel to a typist. The typist answers and makes a written note of the dictator's name, instructions, etc., and then connects the correspondent to one of her machines. The dictator may

\* Clarke & Smith Office Equipment Ltd.



By D. G. ALDERSON\*

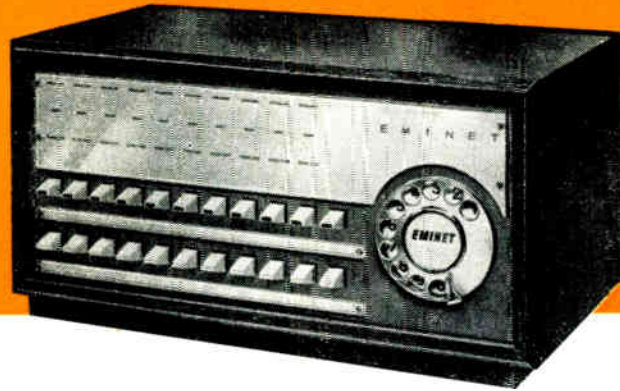

stop and start the recording by dialling 1, or by pressing the receiver button, also listen to the recording made by dialling 3 or call the typist by dialling 0; corrections are made in the usual way by re-recording over the part to be erased. The Even Work Distribution unit is a device in the supervisory panel which is situated on the desk of the supervisor/typist to route calls automatically and sequentially to the typists and thereby provide an even distribution of the calls. The panel also provides facilities for by-passing any typist who is fully loaded or temporarily not available.

It also indicates by lights which units are switched out, which are receiving dictation, and which unit is the next one due to receive dictation via the Even Work Distribution Unit. A built-in telephone rings if all units are engaged and the dictator is rung back when a unit becomes available. Any dictator can be connected to a particular typist for confidential or specialized work.

The system also provides for after-hours dictation when the typists have gone home. Before leaving the office each unit can be switched to receive dictation directly; four

hours' continuous dictation is available on each unit and the machines are switched off except when in use.

#### How the System Can be Installed Over Existing Telephone

Normally the system is connected to the internal telephone circuit. In this way each internal telephone becomes a dictation point. Using this method an average system can be installed in about one day.

#### By Direct Access

An alternative method is to install a direct access line-finder exchange specifically for the dictation system. With this plug and socket telephone dictation points are connected to the line-finder exchange with a single-pair cable.

#### Mixed Internal Exchange—Direct Access

Executives who spend a great deal of their time dictating would be difficult to contact if they were constantly using the internal telephone for dictation. For this situation one solution is to give each of these heavy dictators a separate telephone for dictation which is connected through a direct access line-finder exchange to the typing department. Both of the direct access and internal systems are linked to one supervisory panel to ensure an even distribution of work.

#### Benefits of the 'Personal' System

In the last 12 surveys carried out by Clarke & Smith Office Equipment Ltd. the average output for shorthand typists is less than 200 lines a day per typist. An efficient typist using the 'Eminent' system can produce 600 lines of type per day. This means that five efficient typists using this centralized system can produce the same output as 10 to 15 shorthand typists.

Compared with the 'Bank' system, the 'Personal' system of centralized dictation has economical advantages. First, no attendant is needed to change and transport the recording media. Secondly, the distribution of work is handled automatically through the Even Work Distribution unit; this means that a full-time supervisor is unnecessary; a supervisor/typist usually suffices. Thirdly, it is easier to secure and retain staff for the personal-type system because the work is more interesting and generally regarded by both staff and management as a greater secretarial responsibility.

#### Cost

The 'Eminent' personal dictation system is sold on a 3-, 5- or 7-year combined rental and maintenance contract. With an average system, over a 7-year period, the inclusive rental/maintenance cost works out at approximately £3 per unit per week. On rental terms, full allowance for tax rebate can be claimed.



Illustrated here is the twin tape recorder unit with the control panel and shown above right is the Even Work Distribution unit



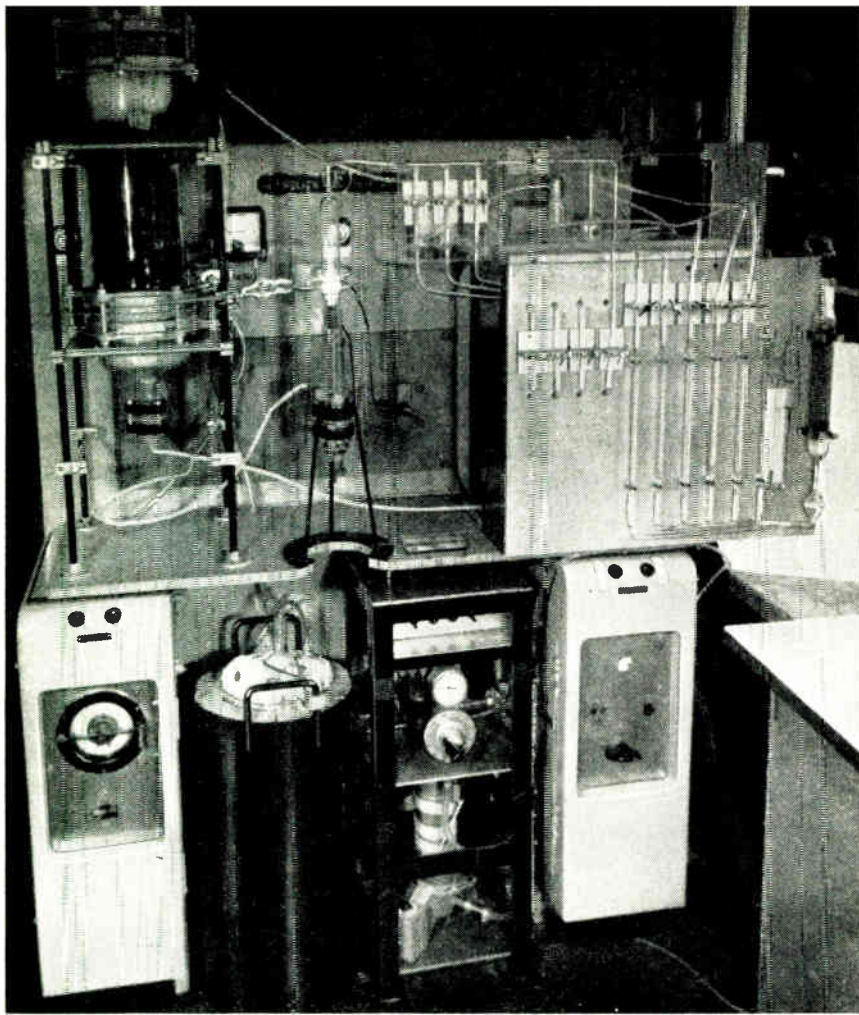

*Epitaxial deposition apparatus*

The use of epitaxial techniques in the manufacture of silicon transistors and diodes is described. High gain-bandwidth products and rapid switching are obtainable.

## EPITAXIAL SILICON DEVICES

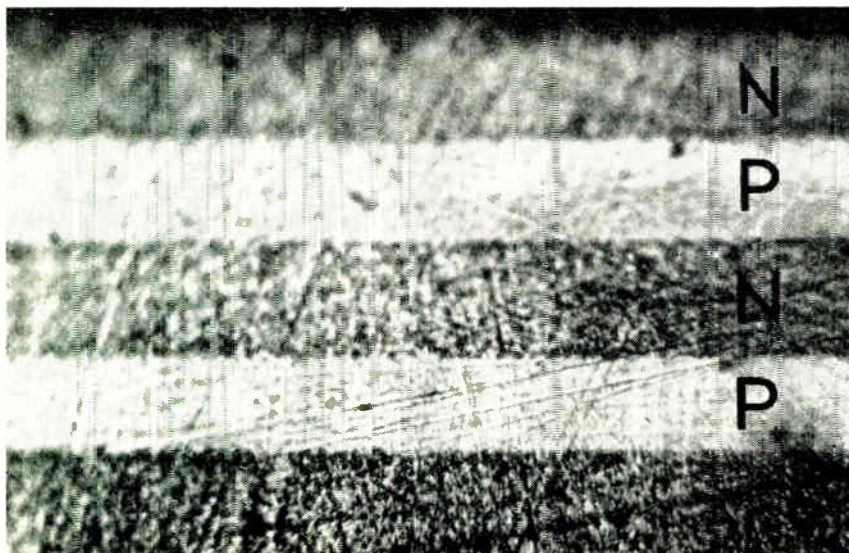

By A. A. SHEPHERD, M.Sc., Ph.D.\*

*Cross-section of silicon slice carrying four epitaxial depositions. The n-type regions show up because a staining technique is used*

SINCE silicon devices became available to the circuit engineer about 1952, their use has become more and more widespread. Silicon devices possess many advantages over their germanium counterparts, and among the most important of these is their ability to work at high temperatures. In applications where the devices are not used to the limit of their ratings, the increased margin of safety offered by the use of silicon is attractive, since a higher degree of reliability is likely to be achieved.

### Preparation of Material

In preparing the starting material for the fabrication of silicon devices, a single crystal of the material with closely-controlled impurity concentration is required. The most commonly used method for the formation of the crystal is that of growth from a liquid silicon melt.

The melt, contained in a crucible, is held just above its freezing point (1,420 °C). A single-crystal seed is held above the melt, and the lower end of the seed is dipped into the melt. As the seed is slowly withdrawn, a single crystal grows on to it. The shape of the crystal can be controlled by adjusting the temperature of the melt, and the rate of withdrawal.

Another common method of producing single-crystal material is the 'floating zone' process in which a polycrystalline rod is held vertically with a seed crystal touching the lower end. A short molten zone is formed at the junction of the seed and the rod, and the molten zone is slowly passed up the rod, which is thus converted to a single crystal. The molten zone stays in position due to the very high surface tension of liquid silicon.

To produce devices from material in the form obtained from either of the above processes, thin slices are cut from the crystal. These slices, which are usually uniform throughout in impurity concentration (and electrical resistivity), are subsequently processed into devices. During the processing, one or more p-n junctions are introduced into the device, for example, by diffusing in impurities of the opposite type from those in the starting material. If the concentration of the diffusing impurity exceeds that of the impurity in the base crystal, a junction is formed. Because of the higher concentration of impurity in the surface diffused layer, this layer is usually of much lower resistivity than the base material.

In some devices, however, it is advantageous to make a p-n junction, or a junction between two layers of material of the same type, in which the surface layer is of higher resistivity than the substrate. Until recently this was a most difficult problem. The advent of the epitaxial growth technique in silicon during the last two years has made it possible to produce crystal geometries of this type with ease, and with very good control over both the thickness of the surface layer, and its resistivity.

In the epitaxial growth process, a single-crystal surface layer is deposited direct from the vapour phase on to the single-crystal substrate, which is usually in slice form. The crystalline orientation of the surface layer is the same as that of the substrate, and the layer in fact forms an extension of the underlying crystalline lattice.

The most commonly used technique for the growth of epitaxial layers of silicon is that of reduction of silicon tetrachloride (SiCl<sub>4</sub>) by hydrogen at the heated surface of the silicon substrate. The chemical reaction involved is



In practice, other side reactions occur, leading to by-products other than gaseous HCl, but this does not materially affect the process. To produce epitaxial layers of silicon, the substrate slice is heated in a quartz enclosure to a temperature

of about 1,250 °C (usually by r.f. heating), and a mixture of SiCl<sub>4</sub> and hydrogen is allowed to flow over the surface. The reduction mechanism leads to the slow growth of silicon on to the substrate. Conditions are chosen so that the thickness of the slice increases at a rate of about one micron per minute. In this way, epitaxial layers in the thickness range from one or two microns to at least fifty microns can be grown with good control. This is the range of layer thickness which has been of most interest in device fabrication.

As well as controlling thickness, it is necessary to control the impurity concentration in the growing layer. The required impurities may be introduced into the layer via the SiCl<sub>4</sub> vapour stream. By mixing a minute amount of a Group III or Group V halide with the vapour, the epitaxial layer can be 'doped' either p-type or n-type, and by careful control over the amount of dopant introduced, the resistivity of the epitaxial layer can be held within close limits.

A typical epitaxial deposition apparatus is shown in a photograph and in another is shown a cross-section through a silicon slice, on to which four successive epitaxial depositions have been made. The layers have been doped alternately p- and n-type, and are each ten microns thick. They are shown up on the specimen by a staining technique which colours the n-type regions.

### Epitaxial Silicon Transistors

The first type of silicon transistor to come into general use was the n-p-n grown junction transistor, in which the three layers were formed during the melt growth process. The crystal was then cut into n-p-n bars and the appropriate connections were attached. The configuration is as shown in Fig. 1.

Although these transistors are capable of fairly high-frequency operation, the resistance in series with the collector junction is high. This is due to the relatively long length of n-type collector body material which must be of fairly high resistivity (a few ohm-cm) in order to make the collector junction capable of withstanding the required operating voltage, which is typically 20 V. This type of transistor is, therefore, inefficient as a switch, and has limited usefulness as a power amplifier due to the high collector series resistance ( $R_{cs}$ ).

A later type of silicon transistor which shows considerable improvement in  $R_{cs}$  is the double diffused n-p-n mesa type, in which the starting point is a thin slice of silicon which forms the collector body. The base and emitter regions are formed by successive diffusions and the configuration is shown in Fig. 2. For high-frequency types, the collector junction area is reduced by etching to give the 'mesa' geometry. Due to the fact that the collector body of this type of transistor has a thickness of only about 0.005 in., the value of  $R_{cs}$  is much lower than that of the grown junction type, and these transistors make quite good switches.

A major improvement, however, can still be made by using the epitaxial process in the construction of the device. The starting point in this case is a composite slice of material which forms the collector body. It consists of a very low resistivity substrate (typically 0.002 ohm-cm n-type) which is of similar thickness to the collector body of the mesa transistor, on top of which an n-type epitaxial layer of about 1 ohm-cm is grown. This layer is about 10 microns thick. Diffusions are then made into the epitaxial layer to form the base and emitter regions. Because of the very low resistivity of the substrate, the value of  $R_{cs}$  is drastically reduced, while still maintaining good collector-voltage characteristics due to the 1 ohm-cm n-type region adjacent to the collector junction. In the latest types of epitaxial switching transistor, the planar technique of junction protection is also used, in which the junctions are covered by a

\* Ferranti Ltd.



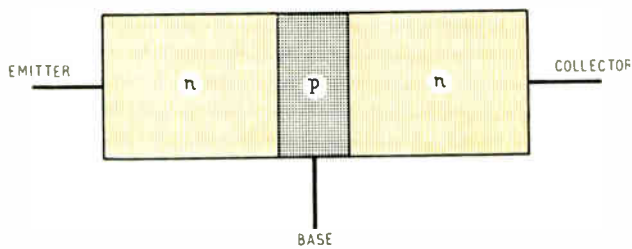

▲ Fig. 1. Silicon grown junction transistor

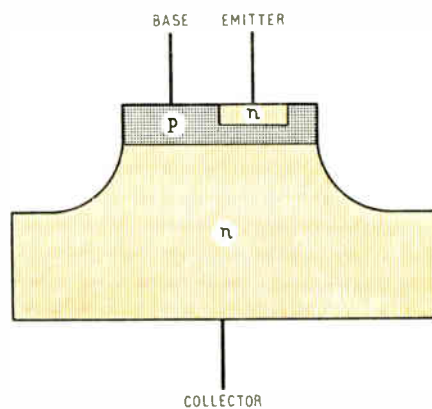
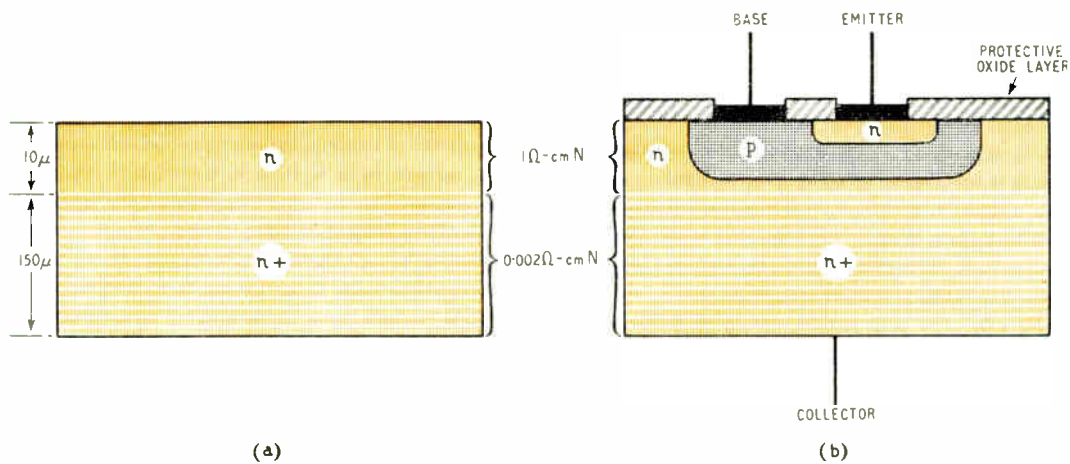

Fig. 2. High-frequency silicon mesa transistor



▲ Fig. 3. Structure of planar epitaxial switching transistor

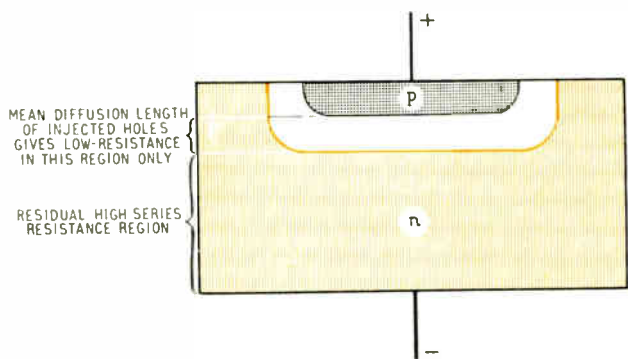
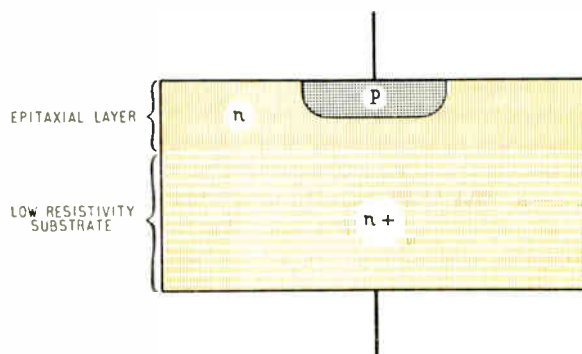

Fig. 4. Forward-biased diode with low minority carrier lifetime

Fig. 5. Fast-switching diode using epitaxial techniques





silicon dioxide layer at the surface (see Fig. 3). This technique promises to give extremely good reliability. A typical transistor of this type is the planar epitaxial ZT1708, which has a typical gain-bandwidth product of 350 Mc/s, a switching speed at 10-mA levels of typically 15 nanoseconds, and a value of  $R_{cs}$  at 10 mA of less than 20 ohms. If some sacrifice of switching speed is made, the epitaxial technique can achieve values of  $R_{cs}$  in this type of transistor as low as 6 ohms. The typical value for a similar non-epitaxial mesa transistor would be about 40 ohms.

### Epitaxial Fast-Switching Diodes

In making a fast-switching diode, the minority carrier storage must be reduced to a minimum, so that when the diode is instantaneously reverse-biased after it has been passing forward current, a high impedance state is reached in a few nanoseconds. To achieve this kind of performance it is necessary artificially to lower the minority carrier lifetime in the diode material. This means that the mean diffusion length of injected carriers during forward conduction is small, leading to a high series resistance in the structure (see Fig. 4).

To overcome the problem of high forward-voltage drop in the diode caused by the high series resistance, epitaxial material can be used in the same way as for the transistor. This results in a configuration shown in Fig. 5, in which a low-resistivity n-type substrate carries a higher resistivity n-type epitaxial layer into which the p-type region is diffused.

In this way, the fast switching properties of the diode may be retained without the disadvantage of a high forward-voltage drop. Using these techniques, diodes which switch in a few nanoseconds at 200-mA current levels, with a forward-voltage drop of less than 1 V can be made.

The examples given above show some of the ways in which the new technique of epitaxial growth has been used to make very great improvements in the properties of silicon devices.

Two other areas in which the technique of epitaxial growth has been used are those of solid-state circuits, and variable-capacitance diodes for frequency multipliers. It is to be expected that in the near future many other types of device will benefit from the use of this powerful new method of material preparation.

## FIBRE OPTICS FOR HIGH-SPEED PHOTOGRAPHY

At the 6th International Conference on High-Speed Photography at The Hague J. S. Courtney-Pratt of Bell Laboratories described a camera which uses an assembly of glass fibres embedded in a matrix to conduct light to a photographic plate. The fibres are coated at one end with a phosphor that converts X-rays to visible light. The matrix and the rapidly-moving plate beneath it acts as a high-speed recorder.

Basically, the arrangement consists of the phosphor as a light source, the object to be photographed, the fibre-filled matrix and the movable photographic plate. The matrix is approximately 3 in. square and 1 in. thick. Each fibre consists of an inch-long, 0.001 in.-diameter, rod of flint-glass surrounded by a thin sheath of crown glass whose lower index of refraction provides total internal reflection. This sheath is in turn coated with a second sheath of opaque glass and the closely-packed array of 32,000 fibres is held in the matrix by an opaque epoxy resin.

This arranged, the fibres efficiently transmit light from the image to the photographic emulsion held close to the opposite side of the matrix. Under continuous illumination, each fibre produces a line whose density varies with the illumination on the image. The plate needs to be displaced only the width of a fibre to permit subsequent exposure of entirely new patterns of light and dark areas. This short distance (about 1 mil) combined with rapid movement of the plate (a maximum of 36 ft per sec) gives the extremely high speed action.

The plate is mounted on a trolley which moves in a track by a compressed air arrangement.

To get recognizable photos it is necessary to 'decode' the pictures from the composite plate. This is done by realigning the plate in accordance with a recognizable pattern originally exposed and slowly pulling it through the same physical sequence. The result is a 'slow motion' repro-

duction which can be observed directly or copied by conventional camera techniques.

The first fibre-optics image-dissection camera was designed at Bell Laboratories for high-speed X-ray photographs. However, the technique is also useful over the visible spectrum, and it has been used for photographing the emission from the end of a ruby optical maser. Other applications include the study of the formation of electric sparks and the examination of fatigue in a metal.

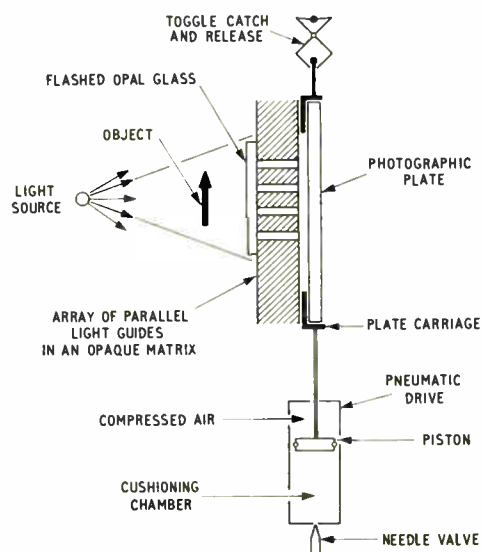

General arrangement of image-dissection camera using fibre optics

# EQUIPMENT

# review

## 1. Long-shaft pH Meter

THIS INSTRUMENT has been developed by Ludwig Seibold of Vienna for pH measurements in deep vats with low liquid levels, or in fully enclosed vessels with small apertures. This model GET/L pH meter can be equipped with one of the alternative Seibold shock-resistant unit-electrodes, and, being battery powered, it is fully portable. The long shaft has a reach of 3 ft and can be inserted in holes down to 1½-in. diameter.

The normal measuring range is between pH 2 and pH 12 at temperatures up to 60 °C. Under shop-floor conditions an accuracy of ±0.1 pH is normally attained.

A special version of the Model GET pH meter designed for penetration into semi-solids is also available.—Distributed in the U.K. by *The H. G. Stevens Co. Ltd.*, 16 Coverdale Road, London, N.W.2.

For further information circle 1 on Service Card

## 2. Digital Clock

A 3-IN. diameter panel mounting instrument for use in automatic recording of time or controlling by time has been produced by Bryans Aeroequipment.

The unit is basically a synchronous clock with normal dial presentation, the gear section of which is used to operate a number of multi-position switches. These switches are used to provide electrical outputs in digital form at pre-set intervals. For example, the ten-minute shaft drives a pair of brushes around a ten-section switch track to provide an output at one-minute intervals from 0 to 9 min and the hour shaft drives a pair of brushes around a six-section track to provide an output at ten minute intervals from 0 to 5 tens-of-minutes.

Two models are available, one giving an output every 0.5 min over 24 hr and the other providing an output

every 0.5 sec over 24 hr.—*Bryans Aeroequipment Ltd.*, 1 & 15 Willow Lane, Mitcham, Surrey.

For further information circle 2 on Service Card

## 3. Pocket Signal Generator

FOR ENGINEERS, radio and television servicemen who require a small and convenient input signal generator for testing or fault finding, Electronic Machine Control have produced the 'Pensource' range of pocket signal sources. These instruments look like conventional pen torches but are, in fact, pocket signal generators, giving approximately ½-V output. They are made in several ranges, 500 c/s square

wave audio and 465 kc/s modulated i.f. being two of the various combinations available. Basically each unit is a transistor oscillator potted in a case. The supply to the oscillator is provided by a 1½ V battery and under normal conditions of use should last approximately four to six months.—*Electronic Machine Control Ltd.*, Mayday Road, Thornton Heath, Surrey.

For further information circle 3 on Service Card

## 4. Transistor Level Indicator

PARKINSON COWAN are now using transistor and printed circuit techniques in the 'Telytone', one of their range of telemetering instruments. Telytone, suitable for use in both the water and gas industries, provides audible indication of water levels and gas holder heights. It operates over G.P.O. telephone lines and transmits a simple code of high and low tone pips.

The tones are now produced by two transistor oscillators, one at 1,860 c/s indicating feet and the other at 1,040 c/s denoting inches. This meets revised Post Office requirements and adds to the reliability of the equipment. Previously the two tones (750 c/s and 400 c/s) were produced by vibrating reed generators.

The position indicator switch is now a printed component, so that less torque is required to operate it and the



1

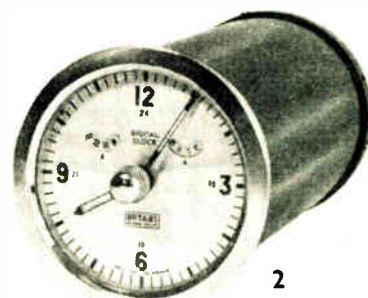

2

3

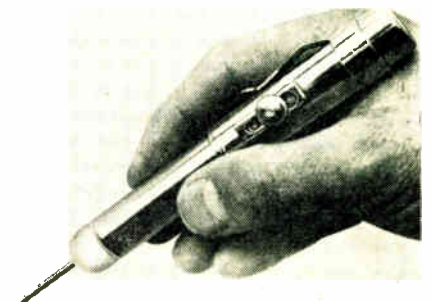

contact life is increased.—*Parkinson Cowan Measurement, 7 Fitzalan Street, London, S.E.11.*

For further information circle 4 on Service Card

### 5. Transient Voltage Detector

A COMPACT, portable unit for detecting and recording transient over-voltages—or spikes, as they are often termed—has been developed by Allen West.

Known as the 'Spiketector', it will give immediate visual warning of the presence of any transient spikes above a pre-set value, and will count spikes up to a maximum of ten per second.

The unit is powered by a self-contained 22½/27 V battery. There are three input voltage settings, giving three transient recording ranges—up to 50 V for work on transistor and low p.i.v. diodes, and up to 500 V and 5 kV for general purpose work and high p.i.v. diodes. Input impedances are respectively 100 kΩ, 1 MΩ and 10 MΩ. The detecting level is set by a ten-turn knob and dial, directly calibrated on an open scale.—*Allen West and Co. Ltd., Brighton 7, Sussex.*

For further information circle 5 on Service Card

### 6. Cable Sleeves and Markers

A RANGE of cable sleeves and markers has been announced by Hellermann. When placed over the cable

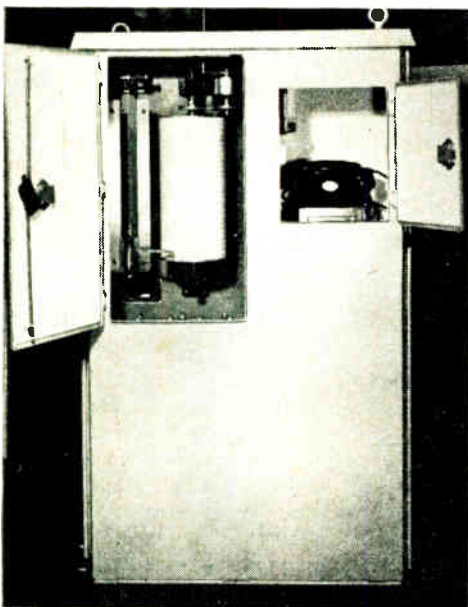

4

(terminal or irregular-shaped object) and heated for a few seconds they shrink to grip tightly and conform evenly to the shape of the object. They are known as the Helashrink range.

Helashrink is produced in a special polyethylene to provide a continuous operation temperature range -55 °C to 135 °C (and for short period up to 300 °C) and in p.t.f.e. with a continuous range of -65 °C to 260 °C (and for short period up to 365 °C).

An additional and important advantage of Helashrink is the added strength at stress and connection points that it provides.

Helashrink is produced in four types and a range of colours and sizes; heating devices are also available.—*Cable Accessories Division, Hellermann Ltd., Gatwick Road, Crawley, Sussex.*

For further information circle 6 on Service Card

### 7. Coefficient-Setting Potentiometer

A MINIATURE voltage-variable potentiometer that permits precise, automatic coefficient setting in analogue computer applications, without gear trains, etc., has been made available by Computer Controls.

The device, known as the Servomotor-Pot Series 'CP', combines a galvanometer, carbon-film potentiometer and amplifier. The potentiometer wiper arm is connected to the moving coil. By driving the moving coil, the wiper can be set to any position on the potentiometer track and the friction is sufficient to maintain the setting when the drive is removed; in this way it is possible to set and hold a d.c. voltage ratio indefinitely to within 0.01%. The potentiometer power rating is 0.75 W and the resolution is virtually infinite; 8 standard total resistance values from 1 kΩ to 50 kΩ are available.

The unit measures 1.75 in. × 1.5 in. and it is mounted on a plug-in octal base.—*Computer Controls Ltd., Buckingham Street, London, W.C.2.*

For further information circle 7 on Service Card

### 8. Optical Shaft Encoders/Tachometers

THE TYPE RI-12M 'Digitak', one of the miniature optical shaft position encoders and pulse tachometers has just been announced by the Wayne-George Corporation, U.S.A. These analogue-to-digital transducers are manufactured in a Size 15 synchro-mount (1½-in. diameter by 1-in. long) with up to 4096 (2<sup>12</sup>) counts per revolution. Models are available with single direction or bi-directional counting and with zero reset. Output is 100 mV minimum into a 10-kΩ load.

The Type RI-12M 'Digitak' incre-



5

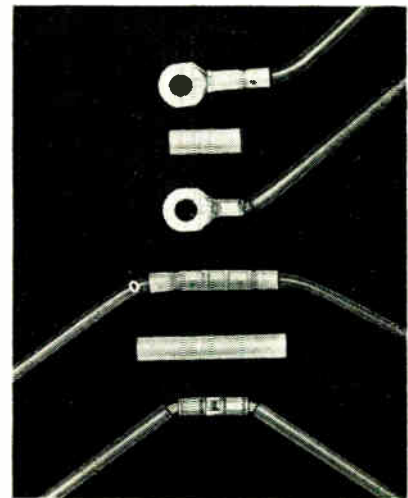

6

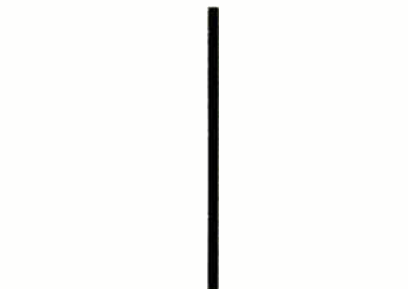

7

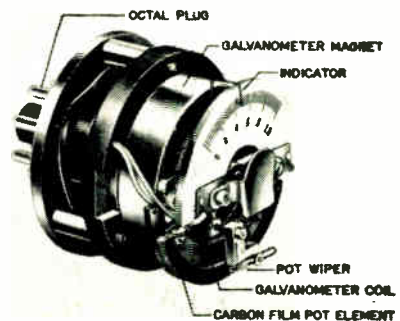



EQUIPMENT

review



8

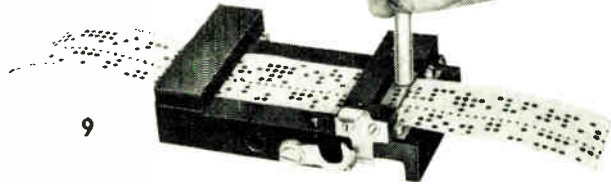

9

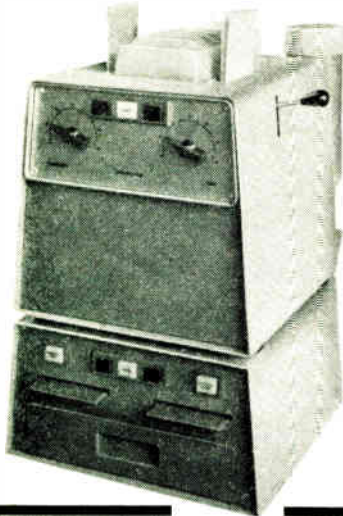

10



11

mental encoder and tachometer features high performance in stable platforms and in machine tool motion control under conditions of shock, vibration and elevated temperatures. The optical techniques used eliminate contacting surfaces such as brushes and provide for an extremely long life. The lamps used are rated at 50,000 hours (mean time before failure) continuous operation.—Wayne-George Corporation, 322 Needham Street, Newton 64, Mass., U.S.A.

For further information circle 8 on Service Card

### 9. Tape Correcting Punch

THE LATEST Creed Unipunch caters for the correction of 6- 7- and 8-track tapes.

In operation, the incorrect tape code combination is located over a die plate (pins engage with the sprocket feed holes for perfect register), two tape retaining latches are clipped down and the required code holes are individually punched out. A hardened steel tip hand punch ensures a cleanly punched hole.—Creed and Co. Ltd., Telegraph House, Croydon, Surrey.

For further information circle 9 on Service Card

### 10. Automatic Micro-Film Copier

TO MAKE micro-film easier to use, Minnesota Mining has introduced a card-to-card copier, the 'Filmsort Uniprinter 086'.

The 3M aperture card system of micro-film usage is built around the mounting of individual frames of micro-film into automatic data-processing cards. To enable users to maintain complete master and security files at all times, perfect copies of these aperture cards for issue can be made on 'Filmsort Duplicards' copy cards by an unskilled operator.

With this machine, daily production in card units is comparable to the square footage of paper produced by a conventional paper printer.

The two exposure chambers and two development chambers can be operated simultaneously, but are all independent. Exposure is regulated by a timing device which is pre-set by the operator; development is accomplished automatically by the vapour from concentrated ammonia, any excessive fumes being absorbed by a filter unit. Completion of the exposure and development cycles is indicated by coloured lamps.

Use of this machine at the reference file enables copies of micro-filmed information to be made in a few seconds in a form convenient for handling and at a fraction of the cost of paper prints.—Minnesota Mining & Manufacturing Co. Ltd., 3 M House, Wigmore Street, London, W.1.

For further information circle 10 on Service Card

### 11. Digital Voltmeter

A LOW PRICE three digit voltmeter, the Dynascan 111/DVM, is now available in the U.K. through Livingston Laboratories.

Using solid-state circuitry the instrument has four ranges from 1 V to 1 kV full scale, is accurate to  $\pm 0.1\%$  of reading  $\pm 1$  count and has an input impedance of 11 M $\Omega$  on all but the 1 V range. Readout time is dependent on the applied voltage but is not greater than 1 sec, while display time can be varied from 200 msec to 20 sec. A display 'hold' facility is also incorporated and a feature of the circuit is that a new reading can be taken, without switching from the 'hold' position, by depressing a reset button on the front panel. As an optional extra the



12



13



14

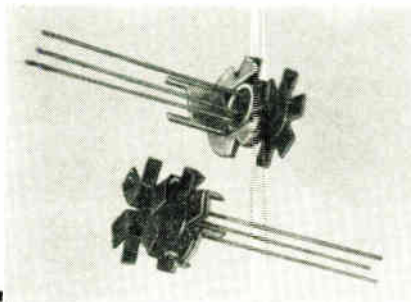

15

voltmeter can be supplied with a printer output drive and an a.c./d.c. converter is available with a range of 20 c/s to 40 kc/s and an accuracy of 0.25%.

Price of the Model 111 digital voltmeter is £180.—*Livingston Laboratories Ltd., 31 Camden Road, London, N.W.1.*

For further information circle 11 on Service Card

## 12. Solenoid Operated Typewriter

DIGITAL MEASUREMENTS announce the development of a low-cost typewriter suitable for printing-out digital information.

The machine comprises a Smith-Corona Marchant Type 200 electric typewriter which is modified by adding solenoid operation of all numeric and control keys. These include plus and minus signs, decimal point, tabulation, carriage return/line feed, and colour shift.

A 240-V a.c. 50-60 c/s supply is required for the typewriter mechanism. The solenoids operate on 150-200 mA at 24 V d.c. and are fully suppressed for operation from transistor circuits. Contact changeover output enables

suppression of inputs during carriage return. The carriage length is 12 in., giving 132 characters per line.

Solenoids controlling certain extra keys may be provided at additional cost. Special characters on individual keys and type faces other than the standard elite are also available.

Normal operation of the typewriter is in no way affected by the addition of the solenoid system.

This instrument is designed to print-out, automatically, digital information from voltmeters, and other signal sources, when combined with suitable serializing equipment. It is therefore compatible with the range of data logging equipment such as scanners, digital voltmeters, etc., marketed by Digital Measurements. Its cost is £185.

—*Digital Measurements Ltd., 25 Salisbury Grove, Mytchett, Aldershot, Hants.*

For further information circle 12 on Service Card

## 13. Differential Synchro

A SYNCHRO is now available which fulfils the function of two standard type machines. Manufactured by Ketay this Size 12 is electrically similar

to the Size 11, but differs in that the stator is mounted in a housing which can be rotated.

The stator is connected by collector rings and brushes to the terminal block on the outer housing. The inner housing (stator) carries a 360° gear, which can be driven through slots in the outer housing. The electrical output of the Size 12 synchro therefore depends on the difference between the angular displacements of the rotor and stator with respect to the outer housing.

The principal electrical control synchro variants normally available in the Size 11 frame are also available in the Size 12 machine, so that control transmitters and control transformers can have the added differential function. All mechanical parts of the new synchro are in stainless steel, and the mounting spigot diameter, shaft and terminal arrangement are identical to the Size 11.—*Ketay Ltd., Eddes House, Eastern Avenue West, Romford, Essex.*

For further information circle 13 on Service Card

## 14. Pressure Transducer

A PRESSURE transducer which uses four resistors in a bridge circuit to measure pressure up to a maximum of 10,000 p.s.i. is now being produced by Coutant Electronics.

Known as the 'Resistostriuctive Pressure Transducer Type CP.12/1/CON', it has a full scale accuracy that is better than 1% and with a 40-V bridge input the output is 3 V at 10,000 p.s.i.; the output is linear over the entire range.

The transducer is approximately 1½-in. long and ¾-in. diameter and termination is by a ¼ B.S.P. thread; the price is £28.—*Coutant Electronics Ltd., 711 Fulham Road, London, S.W.6.*

For further information circle 14 on Service Card

## 15. Transistor Cooler

A HEAT dissipating device that is equally effective for vertically- or horizontally-mounted transistors is now available from Stewart Aeronautical.

Constructed of phosphor bronze with cadmium plating, passivation, and matt black finish, to British services specifications, the design of the cooler ensures maximum heat transfer from the transistor by firmly gripping its can and establishing solid contact with the bottom flange on the transistor can. The fin design ensures turbulence of air flow which increases the heat dissipation. A low-cost version for non-service applications is also available, using treated aluminium.

To facilitate mounting of transistors and coolers on to printed-circuit



boards, an additional feature of this device is an auxiliary plate which clamps the bottom flange of the transistor can firmly between itself and the cooler. As well as increasing heat transfer, this provides firm fixing at centres on a 0.1-in. grid on to the printed-circuit board.

Tests with transistors in JEDEC TO-5 cans have shown that the power handled without exceeding maximum operating temperature is, in most cases, at least doubled by using this cooler.

It is now available for standard JEDEC TO-5 encapsulations—other JEDEC sizes will be available shortly.—*Stewart Aeronautical Supply Company Limited, Adastral House, Nutfield, Redhill, Surrey.*

For further information circle 15 on Service Card

### 16. Pneumatic Humidity Transmitter

RECENTLY ANNOUNCED by Hydrodynamics Inc. is a pneumatic humidity transmitter which will convert relative humidity values of 1-6-99% to a pressure signal of 3 to 15 p.s.i. for driving pneumatic receivers to indicate, record or control humidity.

The 'Universal' model for controlled environments, when used with narrow-range, high-resolution humidity detectors, will provide an output signal with no lag which is proportional to the detector calibration and accurate to  $\pm 1.5\%$  R.H. over the temperature range 40 to 120 °F.

In fluctuating environments, where high resolution is not required, a temperature-compensated model, used in conjunction with wide-range detectors, produces a signal directly proportional to the relative humidity and accurate, over the temperature range 40 to 120 °F, to  $\pm 3\%$  R.H. (below 90%) and  $\pm 4\%$  R.H. (above 90%).

The unit weighs 23 lb, measures 16 by 12½ by 6½ in., operates from 115 V, 60 c/s mains supply and requires a nominal air supply of 20 p.s.i. (filtered). There is a built-in voltage stabilizer.—*Hydrodynamics Inc., 949 Selim Road, Silver Spring, Maryland, U.S.A.*

For further information circle 16 on Service Card

### 17. Double-Lever Switch

A DOUBLE-LEVER switch is being produced by Arcoelectric which may be used for independent switching of two 1-kW resistive loads or, alternatively, to provide a switching action which ensures that a second circuit cannot be made until the first circuit is made. A typical application of the switch is in fan heaters where the heater must not be on without the fan.

The full rating of 250 V a.c., 13 A

(resistive) or 3 A (inductive) may be applied to one pair of contacts. Fixing is by means of two 4 B.A. (or 6 B.A.) inserts at  $\frac{1}{16}$  in. centres.—*Arcoelectric Switches Ltd., Central Avenue, West Molesey, Surrey.*

For further information circle 17 on Service Card

### 18. Miniature Resistors for Printed Circuits

A RANGE of miniature high-stability metal-film resistors is announced by Plessey. Known as the 'Type P', these resistors are rated at  $\frac{1}{4}$  W in ambient temperatures up to 70 °C and have leads spaced to fit the standard 0.1-in. printed circuit module.

Resistance values from 100  $\Omega$  to 100 k $\Omega$  are available in the E 24 scale of preferred values corresponding to the normal tolerance on resistance of  $\pm 5\%$ , although  $\pm 2\%$  tolerance is available to special order. Resistors up to 1.2 k $\Omega$  may be supplied with resistance adjustment carried out by axial grinding and are suitable for high-frequency applications up to 1,000 Mc/s. Spacing between termination is only 0.3 in. with a body diameter of 0.1 in. and the temperature coefficient of resistance is less than 100

p.p.m. per °C.—*Resistor Division, The Plessey Company (U.K.) Limited, Cheney Manor, Swindon, Wilts.*

For further information circle 18 on Service Card

### 19. Pneumatic Time Relay

NOW AVAILABLE from Shawford Control is a range of three very compact reversible pneumatic time relays by CEMA. In their simplest form, these relays incorporate a solenoid, a microswitch and a closed-circuit pneumatic system with an adjustable bleed.

One of the most important features of the series is the closed-circuit pneumatic system. Since the system is completely sealed, these relays can be used in industrial environments.

Energizing the solenoid causes the armature to retract from the plunger of the pneumatic system, thus allowing it to move downwards and trip the microswitch. The delay between armature retraction and tripping can be varied, by a readily accessible screw, between 0.1 and 60 sec.

To reverse the action (i.e., for the delay to occur on de-energization) it is only necessary to rotate the coil through 180°. The microswitch is



16

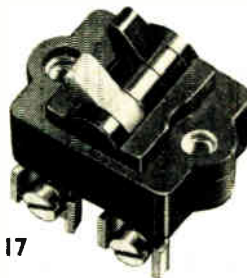

17

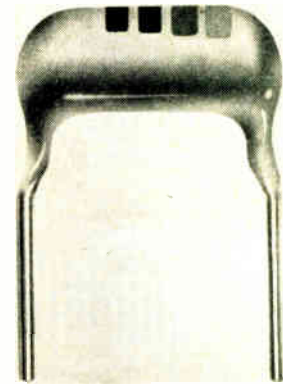

18

EQUIPMENT

review



immediately re-set on re-energization.

The second of the series incorporates an additional microswitch at the opposite end of the coil. On energization, this switch is immediately tripped and, after the required delay, the other switch is tripped by the pneumatic system. As with the first type, the reverse action can be obtained by rotating the coil through 180°.

The third of the series is equipped with a microswitch and pneumatic system at each end of the coil. On energization, the bottom microswitch is immediately tripped, and after the required delay, the top switch is actuated by its pneumatic system. On de-energizing, the top switch is immediately re-set, and after the required delay, the bottom one is actuated.

The series is available with coils wound for all commonly used a.c. voltages.—*Shawford Control Gear Co. Ltd., 715 Tudor Estate, Abbey Road, Park Royal, London, N.W.10.*

For further information circle 19 on Service Card

## 20. Photo-electric Counters

THE RANGE of photo-electrically operated counting equipment manufactured by Hird-Brown has been extended by the introduction of four new standard counters, with capacities of 1,000, 1,500, 2,400 and 3,000 maximum counts per minute respectively. These units operate by sensing the presence of items to be counted with a photo-electric cell and transferring the signals to a counter.

The counter display unit is a robust, plug-in unit with a six-digits display 4-mm high. Features include almost noiseless operation and the ability to reset to zero, manually or electrically.

Power consumption is approximately 20 W; the unit is continuously rated.

A choice of 14 photo-electric cell and lamp units is available to operate at distances varying from 0.3 in. to 75 ft (0.8 mm to 23 m). Where necessary, the counter can be separately mounted from the control and as many as needed can be fitted together, both vertically and horizontally.

Prices, complete with photo-electric cell and lamp, vary from £29 10s. for the 1,000/minute counter to £41 5s. for the 3,000/minute unit. Delivery is 3 to 4 weeks.—*Hird-Brown Ltd., Flash Street, Bolton, Lancs.*

For further information circle 20 on Service Card

## 21. Six-contact Relay

A MINIATURE plug-in relay with up to six change-over contacts is being distributed in the U.K. by Kuhnke Ltd. The contacts are  $\frac{1}{16}$ -in. diameter, made of hard silver and rated at 30 W

d.c. working and 40 VA a.c. working. The maximum current rating of the contacts is 1 A and the maximum voltage rating is 125 V a.c. or 110 V d.c. Six standard coils are available for operation from 6 to 110 V d.c. The relay measures  $2\frac{3}{8} \times \frac{3}{8} \times 1\frac{3}{16}$  in. and weighs  $2\frac{1}{4}$  oz; a plastic dust cover is supplied with each unit.—*H. Kuhnke Ltd., 163 Stanwell Road, Ashford, Middlesex.*

For further information circle 21 on Service Card

## 22. Oscilloscope Recording Cameras

TWO ADDITIONS to the 'Oscillo-tron' range of camera systems have recently been announced by the Beattie-Coleman Co.

The K-5, in the standard version, will take as many as 13 exposures on each frame with a dual ratio of either 1:0.9 or 1:0.7. Horizontal or vertical format can be selected by rotating the back of the camera. A direct binocular (non-reversed) view of the display is provided while recording. Accessories include data-recording back and 4 by 5 in. film adaptor.

There are three alternative versions of the KD-5: (1) with a 35-mm electric

pulse magazine for single-frame recording, (2) with a 35-mm continuous-flow magazine and (3) with a Polaroid back for 10-sec prints. While recording, a parallax-free view is provided via a dichroic mirror. Written data can be recorded by means of a data chamber which can be connected to a digital counter and a 24-hour clock, synchronized to record on the same frame as the trace. As with the K-5, either vertical or horizontal format can be obtained by rotation. There is provision for remote control and a wide range of ancillary equipment is available.—*Ad. Auriema Ltd., 414 Chiswick High Road, London, W.4.*

For further information circle 22 on Service Card

## 23. Vacuum Variable Capacitors

ENGLISH ELECTRIC VALVE CO. have announced the introduction of an additional range of vacuum variable capacitors.

This range comprises 11 different types, each capable of handling a maximum current of up to 40 A r.m.s. (up to 27 Mc/s). These have capacitance ranges from 5–50 pF to 15–750

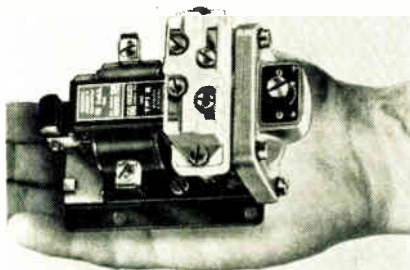

19

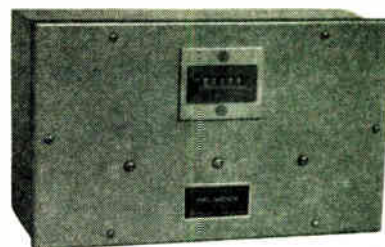

20

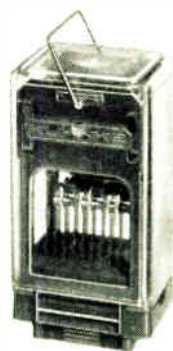

21

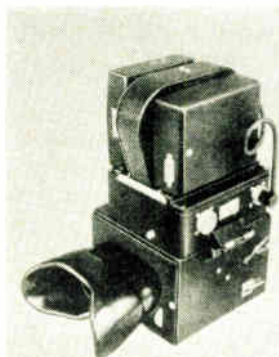

22

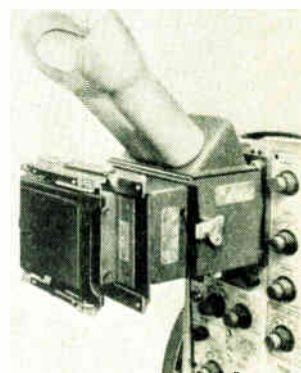

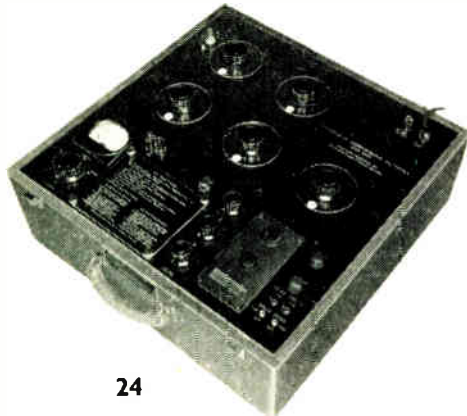

24

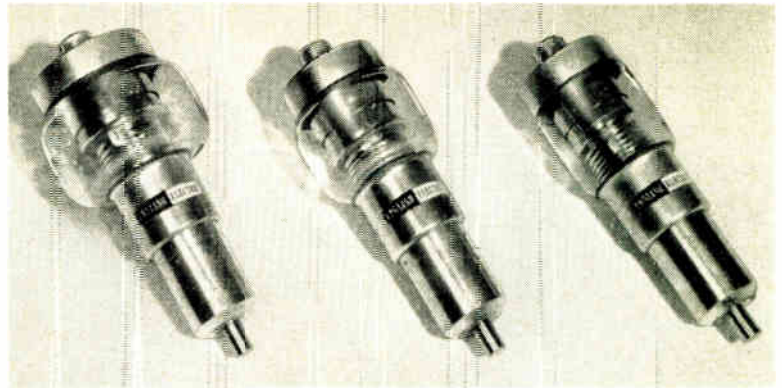

23

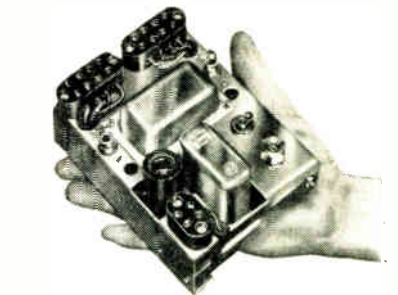

25

26

pF and operate up to maximum peak r.f. voltages ranging from 10 to 20 kV.

By standardizing many of the components any of these capacitors can be supplied within a few weeks from receipt of the order.—*English Electric Valve Co., Ltd., Chelmsford, Essex.*

For further information circle 23 on Service Card

## 24. Differential Thermocouple Voltmeter

A DIFFERENTIAL thermocouple voltmeter, designed to simplify the calibration of voltmeters and precise measurement of voltages, has been made available by Engelhard Industries, Inc., U.S.A.

The unit, Model 35700 DTVM, has an extended voltage range and facilities for calibration of meters with errors as great as 5%. Voltages at any setting from 1 to 1,011 V, either d.c. or 5 c/s to 1 kc/s a.c., can be measured with a 0.03% accuracy. Other a.c. voltages from 1 to 600 V at 5 c/s to 30 kc/s, from 600 to 800 V at 5 c/s to 20 kc/s, and from 800 to 1,011 V at 5 c/s to 10 kc/s can be measured with 0.05% accuracy. These accuracies are in percentage of the reading and not in percentage of full scale deflection.

Additional features that facilitate operation include: readings are

directly in volts without multiplying factors; calibration errors of meters under test are given directly in percentage of reading without computation; accessory potentiometer or other equipment is not required; only one operation is required for each measurement; exceptional stability allows observation of voltage changes as small as 0.02% over a period of several hours with the voltage changes read directly in percentage of change.—*Instruments and Systems, 850 Passaic Avenue, East Newark, New Jersey, U.S.A.*

For further information circle 24 on Service Card

## 25. On/Off Indicator Tube

A GLOW discharge tube, the TG121A, has been introduced by the Fuji Communication Apparatus Mfg. Co. of Japan. This is a unique device and is expected to find wide application where visual indications are required.

The TG121A is a cold cathode device and is controlled by a signal of 4 to 5 V—a voltage level easily available from transistors. A useful feature is that the visual indication automatically disappears when the signal is removed.

Very long life and stable character-

istics are claimed for the tube.—*Walmore Electronics Ltd., 11-15 Bette-rtion Street, London, W.C.2.*

For further information circle 25 on Service Card

## 26. Liquid Level Controller

THOMAS INDUSTRIAL have produced an advanced version of their 'Resistron' liquid level controller which is suitable for use with any liquid having a specific resistance of not more than 50 kΩ/cm cube. Applications include not only the control of water levels in tanks, sumps, etc., but also the control of certain acids and even such slurries as wet sand.

The Resistron Type RS500/C can act as a high and/or low level controller and, when used with instruments having high internal resistance contact assemblies, it can serve as a positive-action relay and so provide heavy current switching facilities if required. The circuit is designed to 'fail-safe' under all operating conditions and electrolysis is prevented by a small a.c. potential on the electrode.

The standard model is for use with mains supplies of 110 V, 240 V and 440 V; 40 to 60 c/s. A wide range of rigid electrodes can be fitted and a new flexible electrode is also available, in



lengths up to 25 ft, for use in situations where horizontally-mounted electrodes are not practicable, e.g. below ground level. The dustproof wall-mounting case is in sheet steel or cast iron. Dimensions:  $7\frac{1}{8}$  by  $5\frac{7}{16}$  by  $4\frac{1}{8}$  in.—*Thomas Industrial Automation Ltd., Station Buildings, Altrincham, Cheshire.*

For further information circle 26 on Service Card

## 27. Encoding Servo

THETA INSTRUMENT report the availability of an encoding servo-mechanism, Model PPR-22, which converts the output of synchros and resolvers to digital code and displays their angular position.

The Model PPR-22 is a panel-mounted servomechanism and decimal

encoder combination which drives a lamp-bank to display visually the position of a remotely located synchro or resolver. Not only does the Model PPR-22 afford a clear, 4-digit readout, but it simultaneously produces a direct decimal code to drive printers, alarm circuits, and other digital devices.

Featuring full accuracy in the presence of harmonics and high null voltages, the encoding servo is also independent of carrier phase shift and carrier frequency variations.

The brief specifications for the unit are as follows: Angular accuracy, 6 min.-of-arc. Range,  $0^\circ$  to  $360^\circ$ , continuous. Slewing speed,  $180^\circ$  in 4 sec. Frequency of operation, 60 c/s to 10 kc/s, continuous. Output, 4-digit lampbank display plus 25-V level decimal code. Size, 3 in. diameter  $\times$

10 in. long. Weight, 3 lb. — *Theta Instrument Corporation, 520 Victor Street, Saddle Brook, New Jersey, U.S.A.*

For further information circle 27 on Service Card

## 28. Magnetic Tape Eraser

SOON TO BE introduced by General Kinetics Inc. in their range of TPM (tape preventive maintenance) equipment is the Model K-80 magnetic tape eraser designed to deal with standard reel diameters from 3 to 15 in. and tape widths of up to 2 in. The erasure time per reel is 1 min and the erasure level is 80 to 95 dB below maximum signal level.

The K-80, which is capable of continuous operation without overheating, 'cleans' standard tapes by rotating them in a high flux-density alternating field which is gradually reduced. Three magnet coils are employed, each with a separate monitor lamp.

The unit weighs 75 lb and is intended for use with a 117 V, 60 c/s supply. Average current consumption is approximately 7 A (maximum 14 A). The upright model is 23 by 22 by 15 in. and the horizontal model is  $11\frac{1}{4}$  by 21 by 19 in.—*General Kinetics Inc., 2611 Shirlington Road, Arlington 6, Virginia, U.S.A.*

For further information circle 28 on Service Card

## 29. High-Power Solid-State Supply

GENERAL ELECTRIC CO. (U.S.A.), have introduced industry's highest rated SCR (silicon controlled rectifier) power supply for adjustable d.c. voltage applications. The solid state d.c. power supply, called Silcomatic, will be used to supply d.c. motor armatures in metal-rolling, paper-making and mining.

The Silcomatic is rated up to 1,500 kW at 500 V; other models with ratings at 700 V will be introduced later this year. — *International General Electric Co. of New York Ltd., 296 High Holborn, London, W.C.1.*

For further information circle 29 on Service Card

## 30. Illuminated Pushbutton Switches

DIALCO have announced a new range of illuminated pushbutton switches and matching indicator lights. The single-pole single-throw switches are silent in operation and require only light pressure. Ratings: 3 A, 125 V a.c.; 3 A, 30 V d.c. (non-inductive); insulation 1,250 V a.c. Solid silver is used for the two fixed contacts and the bridging member; the contacts can also be gold-plated.

The switching mechanism is com-



27



28

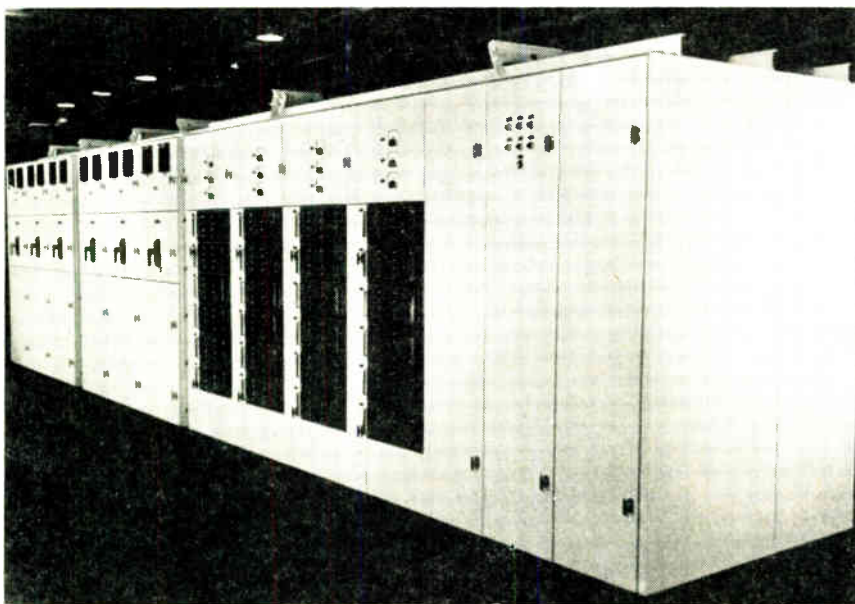

29



pletely independent of the lamp circuit which uses the T-1 $\frac{1}{2}$  midget flanged base lamp (available in a wide range of voltages from 1.3 to 28 V).

The switches have a minimum o.d. of  $\frac{3}{8}$  in. and in panels up to  $\frac{1}{4}$ -in. thick they can be mounted from the rear in a  $\frac{1}{2}$ -in. clearance hole. The same clearance is required to mount the indicator lights from front or rear (in fact,  $\frac{3}{8}$ -in. is sufficient when mounted from the front). Both switches and lights can be keyed to the panel for anti-rotation.

The interchangeable round and square lens caps come in a wide range of colours and may be hot-stamped or engraved as required. The caps are free to rotate and can thus be aligned after the switches and indicators have been fixed in position.—*Dialight Corporation, 60 Stewart Avenue, Brooklyn 37, N.Y., U.S.A.*

For further information circle 30 on Service Card

### 31. Transistor Television Monitors

BEULAH ELECTRONICS have introduced two transistor video television monitors for use in conjunction with industrial closed circuit television systems.

The first, type 1400, has a 14-in. screen while the second, type 850, has an 8 $\frac{1}{2}$ -in. screen. Both monitors are designed to operate with a 1.5 V peak-to-peak sync-signal, but will still provide good frame and line locking when the sync signal is reduced to 0.75 V. They are supplied for mains operation, but models are available to operate from a 12-V battery; the power consumption is 30 W. The type 850 measures 11 $\frac{3}{4}$  × 9 × 9 in. Types 1400 and 850 cost 75 gns and 65 gns, respectively.—*Beulah Electronics, 138 Lewis-ham Way, London, S.E.14.*

For further information circle 31 on Service Card

### 32. Hygrometer Recorder

A VERSATILE humidity monitoring recorder is now available from Hygro-dynamics, Inc., for industrial and scientific applications such as the inspection of conditioned spaces, work areas, storage rooms and other applications where material in process or storage is hygroscopic and thus is affected adversely by improper humidity conditions. The recorder is a semi-portable, compact unit which can provide continuous monitoring of humidity and temperature conditions for up to 10 days, or it can be used for on-spot checking at any location where 115-V, 60 c/s power is available.

The two-trace strip-chart recorder monitors humidity and temperature, or two humidities or two temperatures,

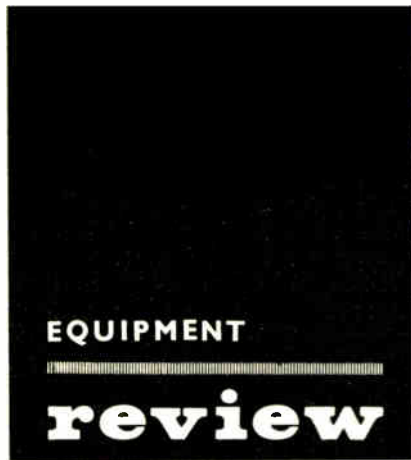

ON



AMP

30



31

when used with Hygro-dynamics' precision humidity-temperature detectors.—*Hygro-dynamics, Inc., 949 Selim Road, Silver Spring, Maryland, U.S.A.*

For further information circle 32 on Service Card

### 33. Laboratory Measuring Oscilloscope

MARCONI INSTRUMENTS announce the introduction of their latest precision laboratory measuring oscilloscope, Type TF 2200, for the investigation of complex waveforms. It has a bandwidth of d.c. to 35 Mc/s, at 50 mV/cm sensitivity, without distributed amplifiers. Three plug-in pre-amplifiers—single-trace, dual-trace, and TV-differential—adapt the Y-input circuit to cover almost all possible requirements.

Other features of the instrument include: 12 nsec rise-time for less than 1% overshoot; 10 nsec/cm writing speed; sweep delays from less than

1  $\mu$ sec to 5 sec for detailed waveform examination or line strobe; two position frequency roll-off; simplified triggering controls.

Two methods of time and voltage measurement are provided. An internal calibrating signal enables the X- and Y-amplifiers to be set against a graticule ruled in centimetre squares, which will permit measurements to an accuracy of  $\pm 3\%$ . Alternatively, calibrated shift potentiometers may be used to displace the trace relative to a reference point (slide-back system), which gives an accuracy improved to  $\pm 2\%$ .

The cathode ray tube presents a 5-cm display, and normally has a P2 (green) phosphor. Long-persistence tubes may be used to take advantage of the very low sweep speed available from the time base. The tube face is of 5-in. diameter, and a post-deflection accelerating potential of 10 kV is used.

Provision is made for the use of

*Industrial Electronics January 1963*



32

33

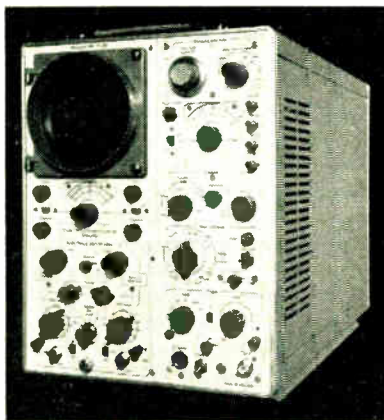

34

35

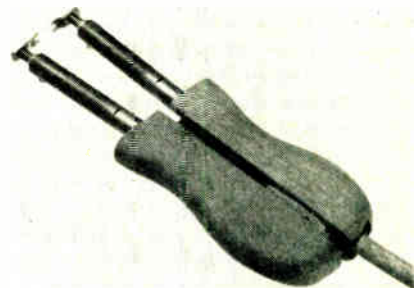
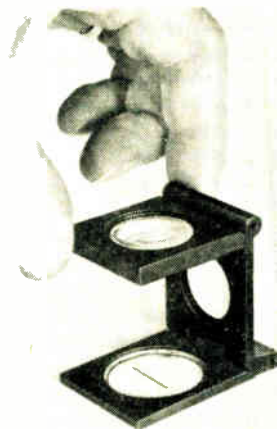

36

probes, cameras and special graticules. All controls are on the front panel, and they are coloured and clearly identified so that operational simplicity is attained; apart from changing the pre-amplifier plug-in units and probes, all modes of operation may be selected by switching, without the use of external links.—*Marconi Instruments Ltd., St. Albans, Herts.*

For further information circle 33 on Service Card

### 34. Neon and Incandescent Lampholders

THE Special Products Division of Thorn Electrical announce that several additions have been made to their range of SGF signal lampholders.

Basically the unit consists of a neon or incandescent lamp built into a plastic holder, the complete unit being disposable.

No retaining nuts or screws are required, since the unit clips easily into

a close-fitting recess. An alternative version is available using Spire speed nuts.

The neon lampholder is available in potentials from 110–380 V. Colours available are red, yellow, or green; a clear version can also be supplied.

Incandescent versions are available in potentials from 4–60 V with a variety of coloured caps.—*Thorn Electrical Industries Ltd. (Special Products Division), Great Cambridge Road, Enfield, Middlesex.*

For further information circle 34 on Service Card

### 35. Interchangeable Graticule Pocket Magnifier

A POCKET magnifier with interchangeable graticules with scale lengths from  $\frac{1}{2}$  in. up to 1 in. is now being produced by Graticules Ltd.

The magnifier can be folded flat and is made of black anodized aluminium. Change over of the graticules is by

means of a split ring. The graticules are available in a wide range of patterns and include photo-etched and red filled versions.—*Graticules Ltd., 57/60 Holborn Viaduct, London, E.C.1.*

For further information circle 35 on Service Card

### 36. Novel Wire Stripper

WHEN STRIPPING PVC covered wire it is sometimes difficult to avoid damaging the core in the process. To overcome this hazard Labgear have brought out a stripper with electrically-heated prongs which enable the p.v.c. to be removed more easily than is possible with the usual type of stripping tool.

Of rugged construction throughout, it has spring-loaded wooden handles and operates from a 12-V supply. A suitable transformer is available.—*Labgear Ltd., Cambridge.*

For further information circle 36 on Service Card

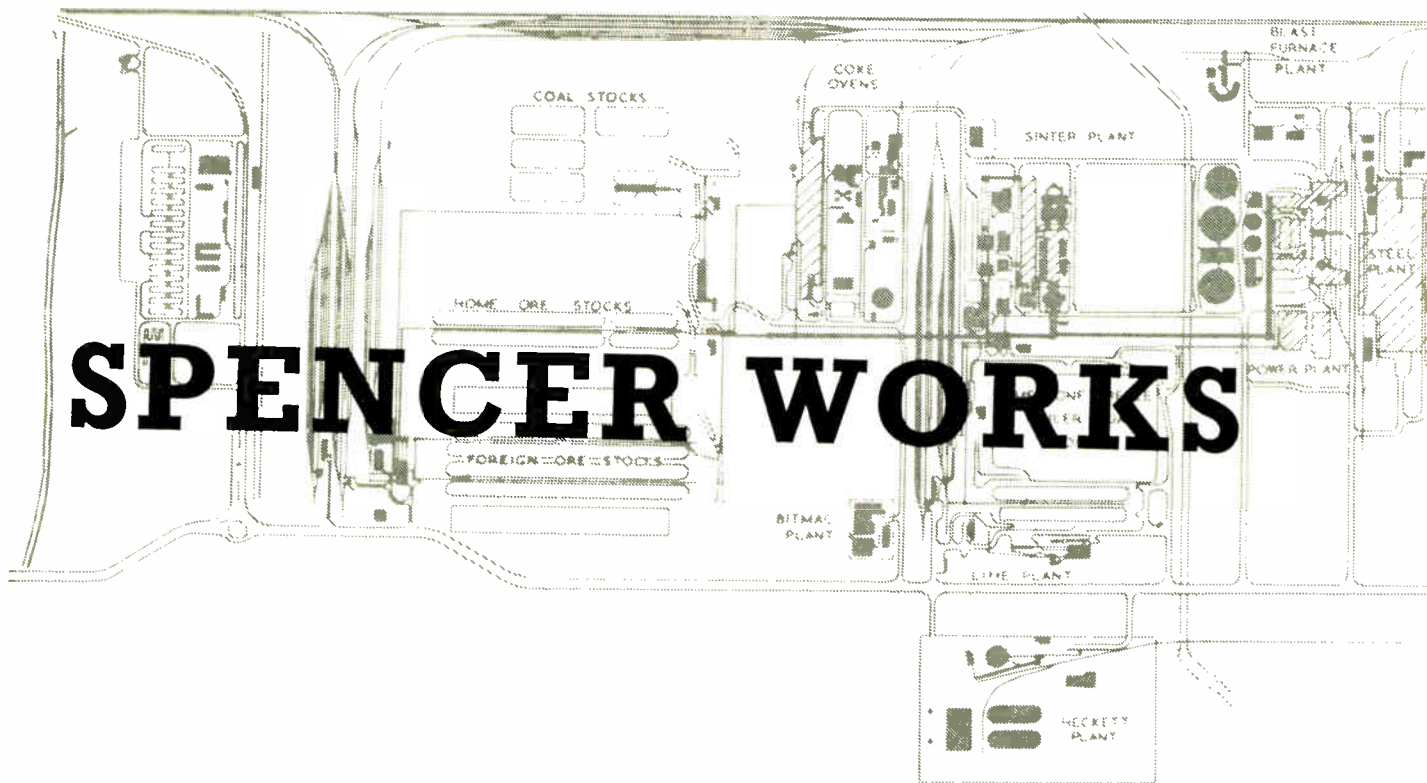

In this article some details of one of the most highly automated steel plants in the world are given. The overall concept of the first stage of automation is discussed and the systems used to provide control for the metal slab mill and the hot strip rolling mill are described. Other electronic equipments used in the plant, such as that for the inter-communication system, are also described.

ONE of the largest and most ambitious single industrial undertakings in this country is the Spencer Works of Richard Thomas & Baldwins Ltd., which was officially opened last October. This works will produce about 1,500,000 tons of ingot steel a year and most of this will be processed into strip and sheet steel.

This is the first industrial plant of its size for which the design of an integrated system of automation has proceeded in parallel with the design of the plant itself. Elliott-Automation was commissioned to draw up a plan for the complete automation of all processes.

Although the first stage alone has at present been authorized, it will, in itself, make Spencer Works one of the most highly-automated plants. Due to become fully operational later this year, this first stage encompasses the information-handling systems for the control of the entire finishing end of the production process, from the pouring of the steel into moulds to final despatch of the finished products.

When considering the type of automation to be incorporated in the plant there were two possible approaches. First, a system based on one huge central computer that would record and control every event throughout the process and, secondly, a system based on a control hierarchy in which the electronic control is arranged in levels somewhat like the management arrangement of a company. The first approach was discarded for many reasons. The cost of such a computer would be enormous and the consequences of a computer failure disastrous. In any event, no such computer existed! Therefore the second approach was employed to provide a management-like control system comprising a number of equipments each operating at a



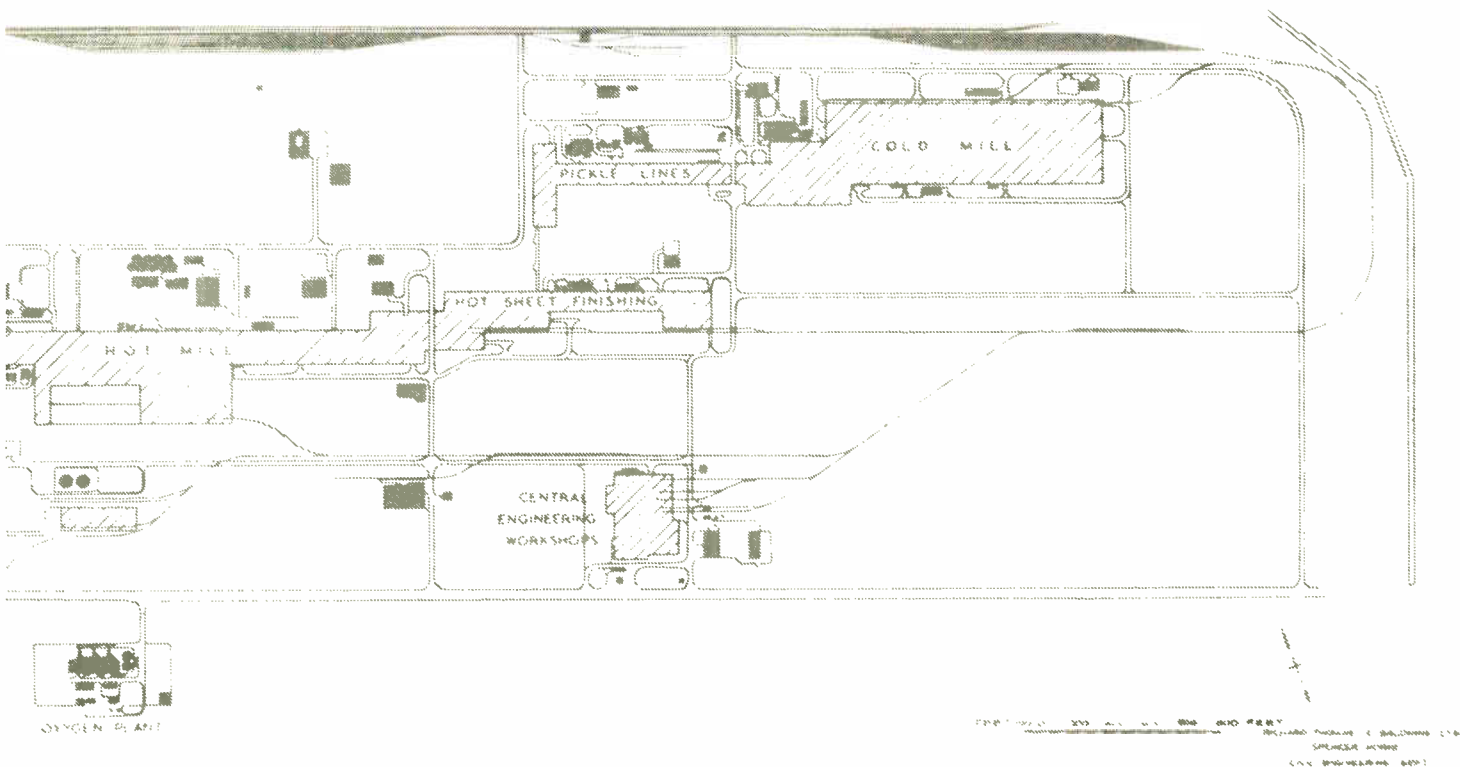

defined level. Fig. 1 illustrates the hierarchy control principle. (This principle is discussed more fully in an article in the October issue of *Industrial Electronics*: 'Step-by-Step Automation', pp. 11 to 13.) The primary advantage of such a system is that it can be built up as needed stage by stage, starting with the control of a single process and eventually taking in the whole plant. In addition the system is versatile in that it can be designed to provide complete and automatic control of a process or, as in the case of the Finishing End Scheduler in Spencer Works, part-automatic control with an operator feeding information into the system and acting upon instructions from it.

### The Control System

Although the manufacture of strip steel requires many separate processes, the production plant can be broken down into two major sections, the first being concerned with the production of steel slabs from the raw materials and the second dealing with the manufacture of strip and sheet material from steel slabs. The processes in these two major sections are, of course, different, and lend themselves to two different forms of control. The production of strip and sheet material is an almost continuous process, whereas the manufacture of slab steel includes a number of discrete processes and is non-continuous. Therefore, complete or closed-loop automation has been applied to the hot-strip rolling mill and open-loop automation that requires the intervention of humans has been applied to the slab production processes.

The complete control system basically comprises three inter-linked electronic digital computers, two Elliott 803s and one General Electric 412 computer (Fig. 2). One 803,

called the 'Finishing End Scheduler' is the master computer and controls, and provides instructions for, the other two computers which, in their turn, control sections of the plant and feed back information to the master computer. The master computer accepts the customer order requirements, issues the necessary production schedules, collects information on the material being rolled by the hot strip mill, via its computer, and receives production reports fed in from the slab mill. This information defines in detail the steel quantity, dimensions and quality at each stage of the production process. The master computer uses the feedback information to check the steel that is produced against the planned schedules and then issues appropriate instructions to other sections of the plant.

In any vast production plant, particularly those dealing with basic materials, it is impossible to adhere strictly to a planned schedule of production. Many unforeseeable factors bring about changes in the schedule. Therefore, in an automated plant the system must be flexible enough to cope with these changes and at the same time re-plan or up-date the master schedule to achieve the most economical production. The Spencer Works installation does this and uses the ingot-slab control computer, an Elliott 803, to provide the necessary information to up-date the master schedule. Most of the basic information is fed into the ingot-slab computer by operators at each stage of production; 20 keyboards are located in the plant for this purpose. The operators in the slab mill also receive instructions from this computer. (Elsewhere in this issue the collection of plant data is more fully described.)

The task of the hot strip mill control computer, the G.E. 412, is to execute automatically the final rolling pro-

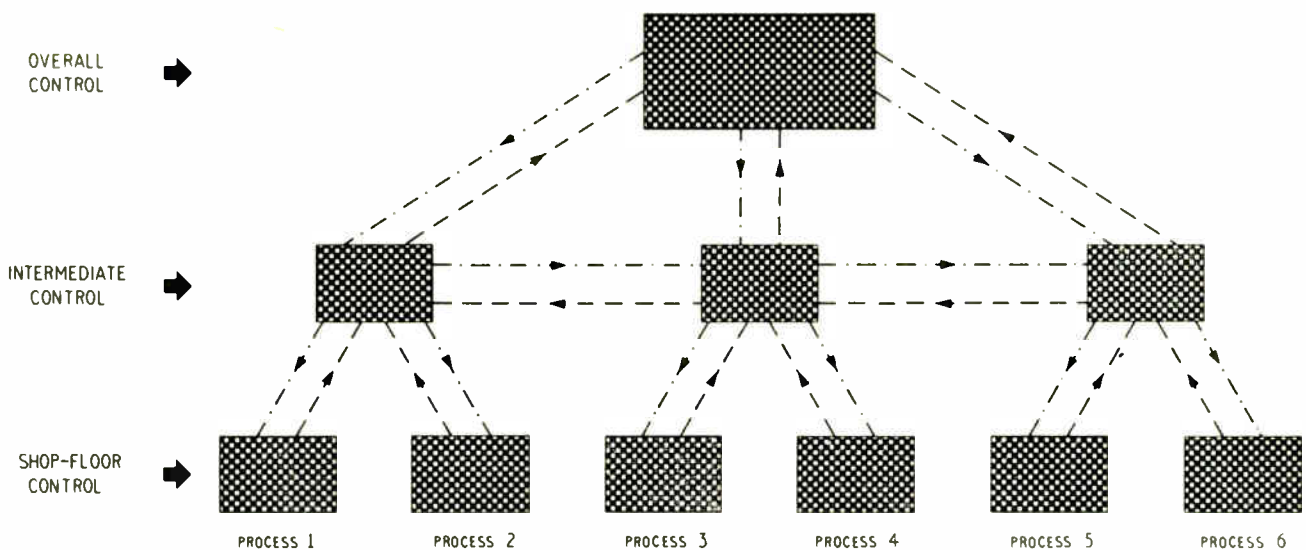

Fig. 1. This diagram illustrates the hierarchy control principle

gramme prepared by the master computer on the basis of the latest progress reports from the slab mill. It will report back the specifications of each coil produced, enabling the master computer to take corrective action by amending subsequent rolling schedules to replace any coil rolled off specification. This controller is allowed some margin for decision, but for much more limited decisions than those made by the master computer. If the target programme is difficult to meet because, for instance, the slab is too cold to roll as required, it rolls it to standard stock size. It reports all actions to the master computer so that a re-scheduling can be carried out to replace the material not produced.

### General Services—Communications

While the automation equipment in a plant such as Spencer Works is bound to attract a great deal of attention, it is only part of a complete manufacturing unit which also includes many more-conventional electronic equipments which play their part in maintaining production efficiency. For instance, without a first-class intercom-

munication system to provide services over the 3½-mile long plant, efficient production would become impossible. And so, both general communications systems and types for specialized tasks have been provided for plant operation by the Electronic Apparatus Division of Associated Electrical Industries Ltd. In the former category are direct-wire telephone systems, A.E.I. 'Clearcall' loudspeaker systems, and loud-hailing systems. The heavy-duty direct-wire industrial telephone equipment is installed in most areas throughout the plant. The loudspeaker systems are installed in various operational areas with a number of microphone stations around each area. Loud-hailer systems are provided for use over very large areas—such as the half-mile by quarter-mile stock yards—and are arranged so that all, or a particular part of an area can be selected to receive information.

Specialized equipment provided by A.E.I. includes apparatus to provide two-way communication with heavy mobile plant such as cranes and boom stackers where cable connection is not feasible, flameproof loudspeaking telephone equipment for areas where explosive gases may be present, a signalling system between the blast-furnace control centre and the turbo-blowers, and a personnel alarm system for the blast-furnace area.

Two types of communication equipment are fitted for use with mobile plant. A carrier frequency injection system provides multi-channel communication between a number of moving equipments and a control point. Speech signals from each unit and control are superimposed on a high-frequency carrier and injected into the conductors of the plant power supply. Each mobile unit has its own channel and conversation with control is private. For boom stackers, the carrier equipment is remotely controlled over telephone wires from a central point. An audio-frequency inductive-loop system is installed to enable overhead travelling-crane operators to hear transmissions over the plant operational loudspeaker system in the area, and to talk-back over the system and to other cranes.

In this plant there are 21 basic operational areas in four main control zones. For each of these, one of the systems described or a combination of systems has been provided to cater for its particular needs.

Altogether A.E.I. have provided 65 main communication systems to aid plant operations, and 30 systems for use by maintenance personnel.

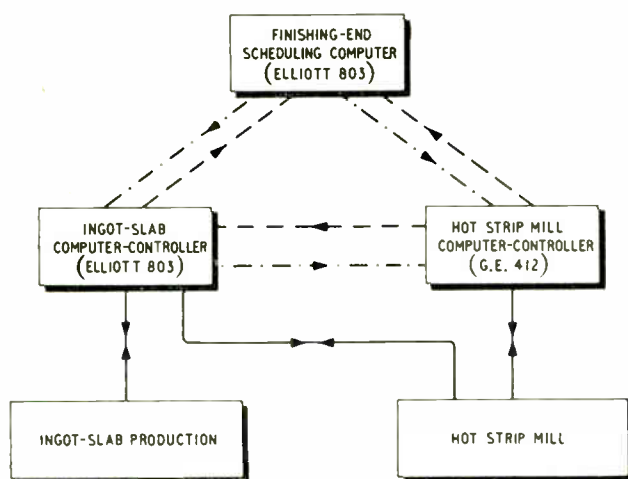
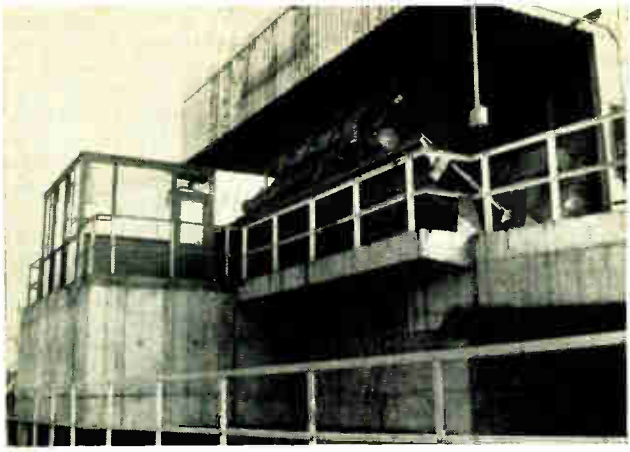
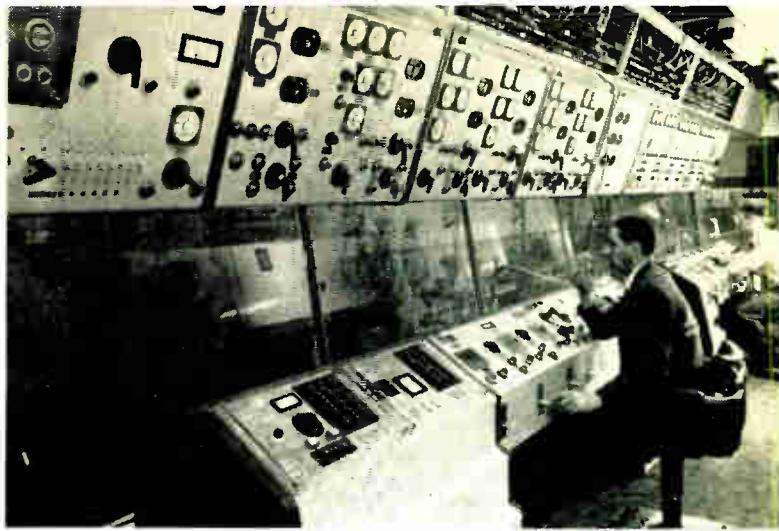

Fig. 2. Simplified schematic diagram of the control system





One of the Avery Tippler Weighbridges where the raw material is weighed and fed on to conveyors. The operation is automatic and fully integrated with the mechanical handling system



The main control pulpit for the hot strip finishing mill. The main drives and much of the control equipment for this mill were supplied by G.E.C. (Engineering) Ltd

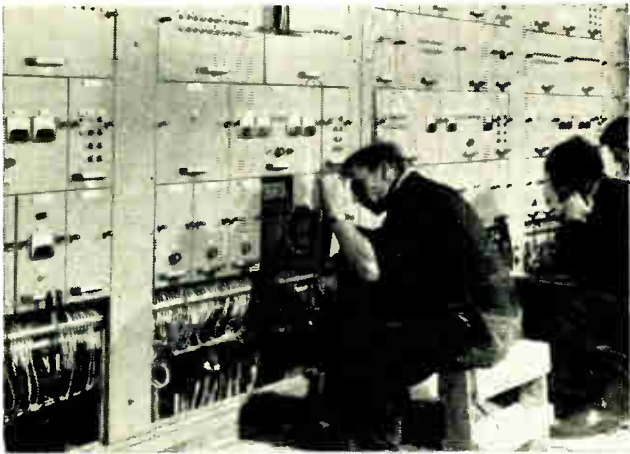

This illustrates the final connection of the automatic gauge control computer in the hot strip mill. B.I.C.C. cables are used throughout the equipment

Hot coils of steel being weighed straight off the strip mill. This is an Avery electronically-controlled system in which weighing and printing-out is fully automatic

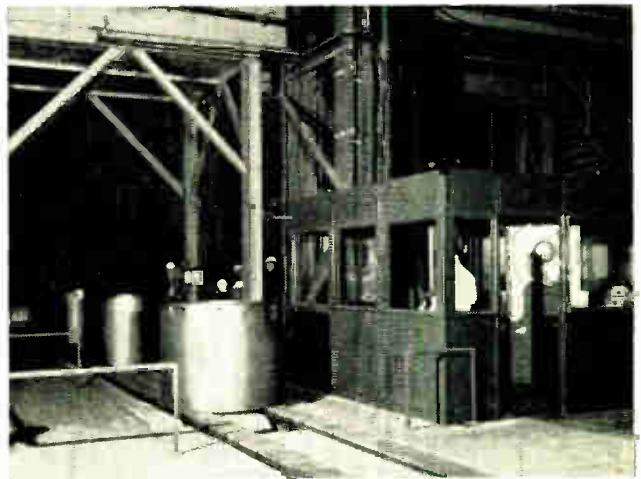

Shown here is a microphone access point to the A.E.I. 'Clearcall' loudspeaker system on the pickle line. The operator has both hand- and foot-operated controls

One of the two high-speed temper mills. The main and auxiliary drives, control equipment and rectifier-inverter units for these temper mills were included in the G.E.C. contract

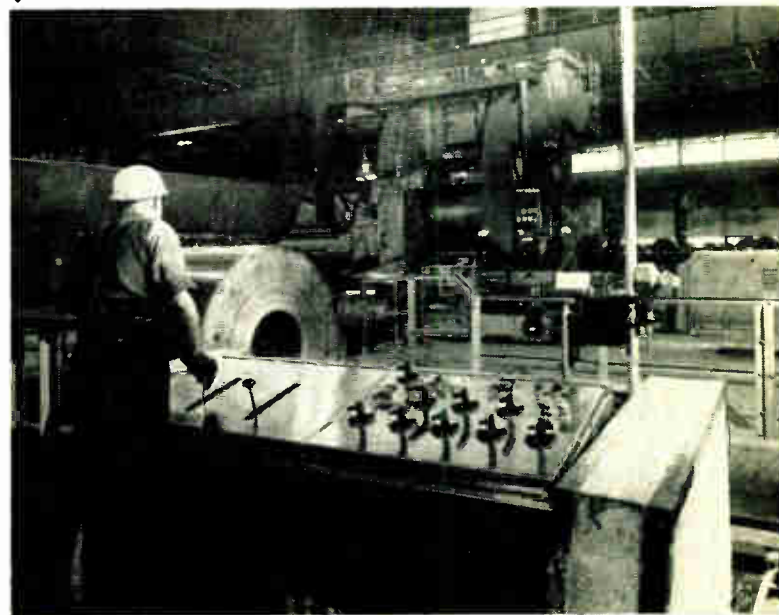
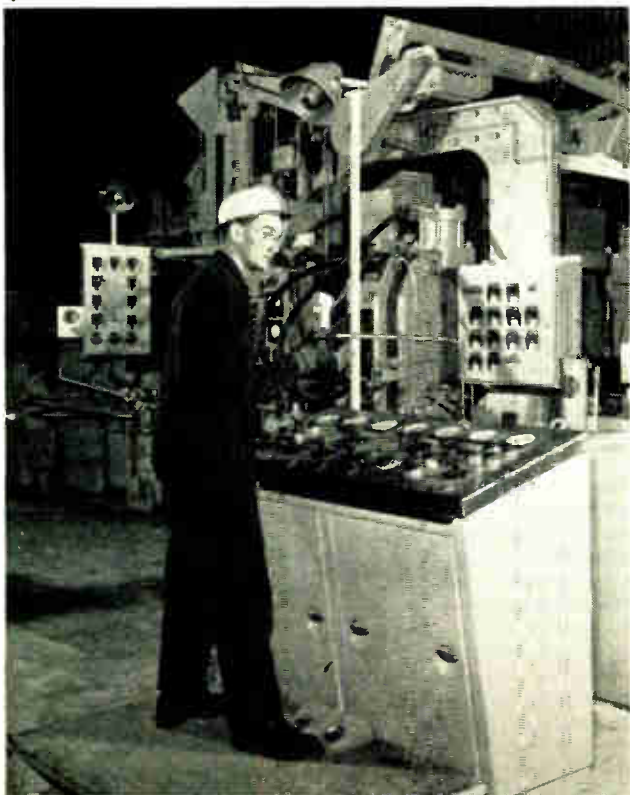





*Shown is a 5-way A.E.I. telephone unit in the coke wharf section of the plant*

### Slab Detection

Photo-electric slab detection equipment, using a modulated light signal, has also been supplied by A.E.I. to indicate the position of a slab of steel in the reheat furnace. A 100-c/s light beam derived from a static device is projected across the furnace from a heavy duty water-cooled projector lamp unit via tubes and removable heat-proof windows fitted into the walls of the furnace. A corresponding water-cooled receiver unit housing a photo-conductive cell is mounted opposite in a similar manner. When no slab is present at the detection point the light beam falls on the receiver unit and the signal derived is amplified to operate a relay and indicator. The photo-conductive cell amplifier employed is only sensitive to the light modulation frequency of 100 c/s and is unaffected by the infra-red radiation from the slab and furnace.

### Weighing Equipment

Throughout the plant there are many examples of how the accuracy of modern weighing methods facilitates checking and testing at every important stage in an industrial process. Much of the weighing equipment supplied by W. & T. Avery has been specially designed to work in conjunction with the mechanical-handling and electronic-control systems.

*This picture shows a console in the coal-handling control room. It provides direct-wire telephone communication between all key personnel in the area and gives the operator loud-hailing facilities to all or selected sections of the area. Carrier frequency 2-way communication with the operator of the boom stacker in the coal stockyard is also provided*



Over 50 weighing points are concerned directly with the steelmaking process, while at least 30 more points are installed in the plant to provide indirect services to the production unit. These points are constructed with an appropriate form of weighbridge and associated recording equipment so that the relevant information may be fed back to the master computer. One of these points is the 'Tippler Weighbridge', where incoming ores are weighed. The trucks are locked on to the weighbridge, the load recorded and the whole assembly is tipped and the contents emptied on to conveyors. The integrated control system is designed for automatic operation, but facilities are provided so that the operation can be carried out manually.

The specific design of these many weighing points varies with the type of load to be handled, but typically a point comprises a weighbridge which is connected to a weighing scale with a conventional dial and pointer. Connected to the pointer spindle is an analogue generator which produces an output that is proportional to the weight being measured; the output is fed to a digitizer which converts the analogue quantity to a digital form suitable for the electronic recording and control systems.

### Other Equipment

In such a complex installation as Spencer Works vast quantities of electronic equipment are incorporated in the heavy electrical and mechanical plant to aid the control of the various processes. G.E.C. (Engineering) Ltd. has supplied heavy electrical and mechanical plant to the value of about £2½ million and included in this are many electronic equipments such as large power supplies, magnetic amplifiers and control equipment.

Typical of these are the magnetic amplifiers which are used to control the strip coiling machine, and also the mercury arc rectifiers and associated circuits used in the hot strip mill. To control the speed of the mandrel of the strip coiler, the amplifier matches a signal that is proportional to the metal strip tension against a signal that is proportional to the armature current of the mandrel motor. As the diameter of the coil on the mandrel builds up the increase in armature current is automatically limited by controlling the motor flux. Also when the mandrel is running light, before the strip has begun to wrap on to it, the control amplifier is driven into saturation by the tension reference signal and under this condition the motor field is set a value producing the high speed of the mandrel required to make the first wrap of the strip.

Control of the mercury arc rectifiers associated with the hot strip mill, the rotary crop shear and the two single-stand temper mills is accomplished by transistor grid drive units. These units provide the rectifier grids with rectangular pulses; the phase of the grid voltage can be changed virtually instantaneously. For each stand of the hot finishing mill, the signal from the control computer is amplified by a final d.c. push-pull transistor stage which then feeds the grid drive units.

The rotary crop shear is a figure eight system, basically a closed loop speed control, with additional positional and overriding current limit features. The drive for the grid drive unit is supplied via a modulated d.c. transistor pre-amplifier coupled to split transistor push-pull output stages.

With the temper mills a multi-machine busbar system is controlled by a magnetic pre-amplifier driving the grid drive units through a push-pull transistor output stage.

In this necessarily brief article some details of Spencer Works have been given to illustrate the use of electronic devices in one of the most modern steel plants in the world. It is hoped that plant will help Britain to maintain, and perhaps improve, her position in the competitive steel markets of the world.

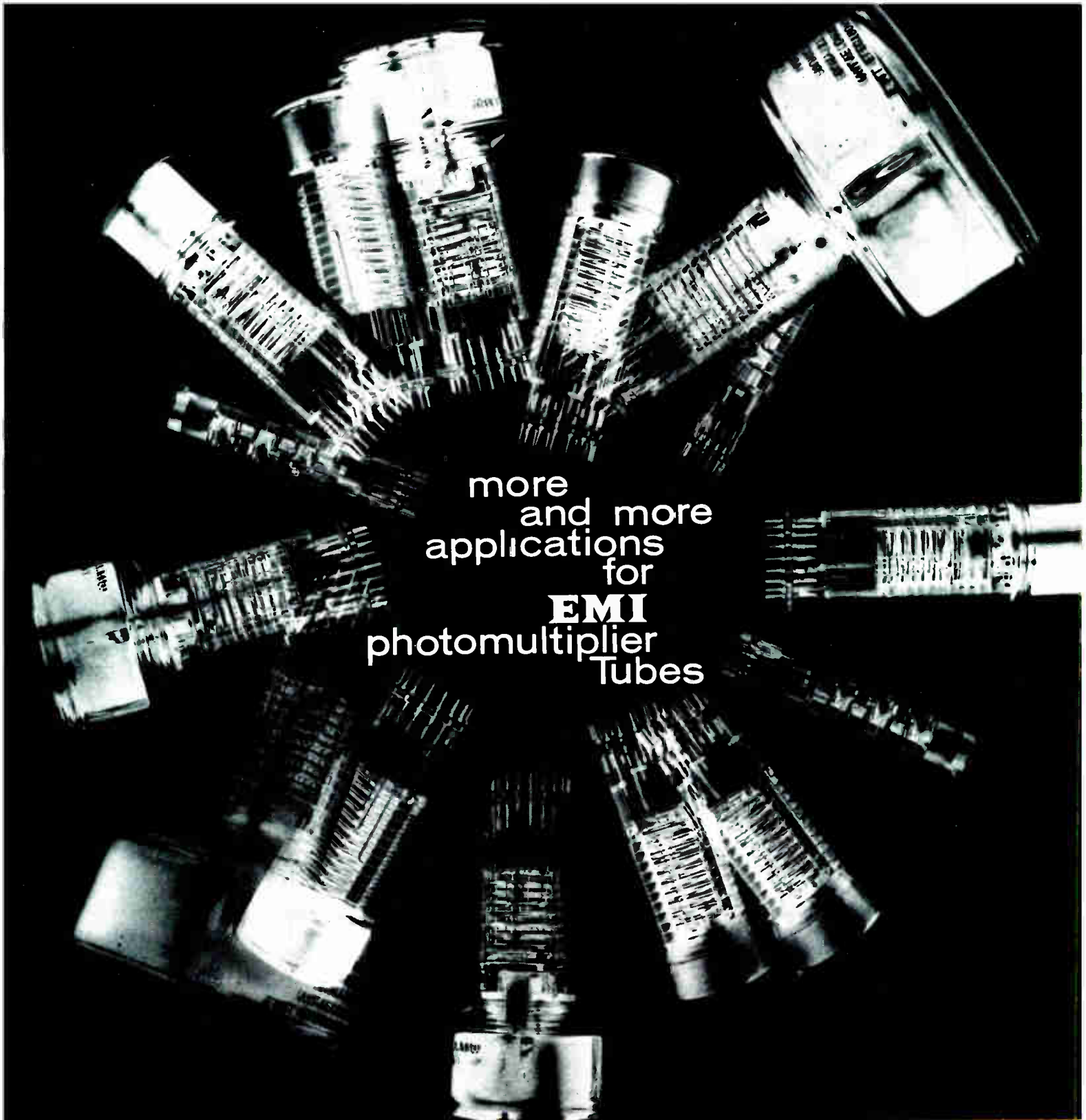

more  
and more  
applications  
for  
**EMI**  
photomultiplier  
Tubes

**REPLY CARD**

My interest is in.....  
..... Tubes

My application is.....  
.....

Please send further details and keep me posted with  
information on new developments.

Name and Title .....

Company .....

Address .....

Telephone..... Extension .....

**REPLY CARD**

My interest is in.....  
..... Tubes

My application is.....  
.....

Please send further details and keep me posted with  
information on new developments.

Name and Title .....

Company .....

Address .....

Telephone..... Extension .....



# EMI PHOTOMULTIPLIER TUBES

The EMI range of photomultipliers is one of the largest in the world. Tubes are available from 1"—12", in a broad spectral response range from ultra-violet to infra-red, supplied with glass and quartz windows and with various types of photocathode for specific applications.

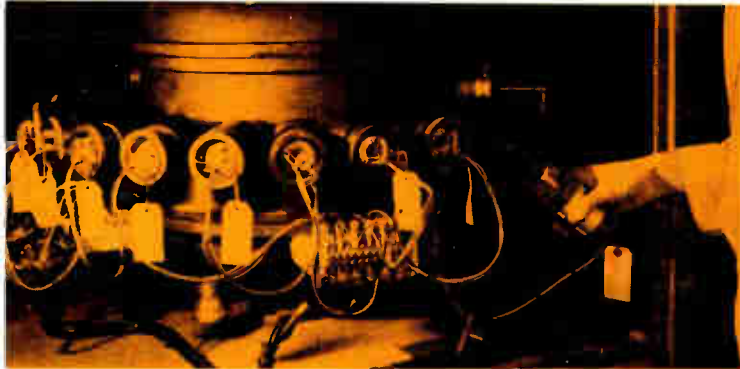

A view of the polychromator in the Hilger and Watts direct reading vacuum spectrograph which facilitates the rapid automatic analysis of carbon, phosphorus, sulphur, manganese, silicon and other elements in steel. EMI type 6256B Photomultiplier tubes were chosen for this application by virtue of their stability and excellent dark current characteristics.



A typical curve of energy resolution of  $\text{Co}^{60}$ , using a 3" x 3" thallium activated sodium iodide crystal coupled to an EMI type 9530 Photomultiplier tube. In order to obtain good resolutions the photomultiplier tube must have good photosensitivity, high collection efficiency of photoelectrons into the first dynode, and a uniform cathode. EMI tubes are noted for these qualities.



Spectrophotometers in the Perkin-Elmer range depend for their accuracy upon the quality of the incorporated photomultiplier tubes. These must be highly stable and have good photosensitivity and low dark currents. The characteristics of the EMI type 9529 are ideally suited to this application.

For further information please send the reply paid card to EMI

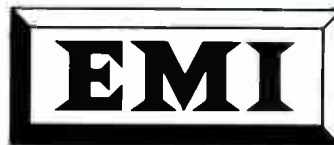

**EMI ELECTRONICS LTD**

VALVE DIVISION · HAYES · MIDDLESEX · ENGLAND  
TELEPHONE: HAYES 3088 · EXTENSION 2165

Postage will be paid by Licensee

No postage stamp necessary if posted in Great Britain or Northern Ireland

Postage will be paid by Licensee

No postage stamp necessary if posted in Great Britain or Northern Ireland

**BUSINESS REPLY CARD**  
Licence No. SOX 64

**EMI ELECTRONICS LTD**  
VALVE DIVISION · DEPT. EC5  
HAYES · MIDDLESEX · ENGLAND

**BUSINESS REPLY CARD**  
Licence No. SOX 64

**EMI ELECTRONICS LTD**  
VALVE DIVISION · DEPT. EC5  
HAYES · MIDDLESEX · ENGLAND





## Ultrasonic Flaw Detector

A

FOR the non-destructive testing of metals ultrasonic flaw detectors are being widely used in industry. The two most popular applications are: (1) flaw detection in metals and (2) measurement of the thickness of metals. In both applications the principle of operation is the same. A generator produces an ultrasonic output signal pulse which is fed to a transducer that converts the electrical energy into acoustical energy. By applying the transducer to the surface of a metal object, pulsed ultrasonic compression waves are transmitted through it and are reflected when they meet a physical discontinuity such as a flaw or the reverse side of the metal. A second transducer alongside the first one will pick up the reflected signal. By timing the period from the transmitted pulse to the received pulse, and by knowing the speed with which the waves travel through the metal, it is possible to obtain accurately the distance from the surface to the discontinuity of the metal. One form of 'timing unit' is an oscilloscope in which the timebase is calibrated.

One or two applications of the Solus-Schall ultrasonic flaw detector type USK4 are illustrated here.

For further information circle 39 on Service Card



B

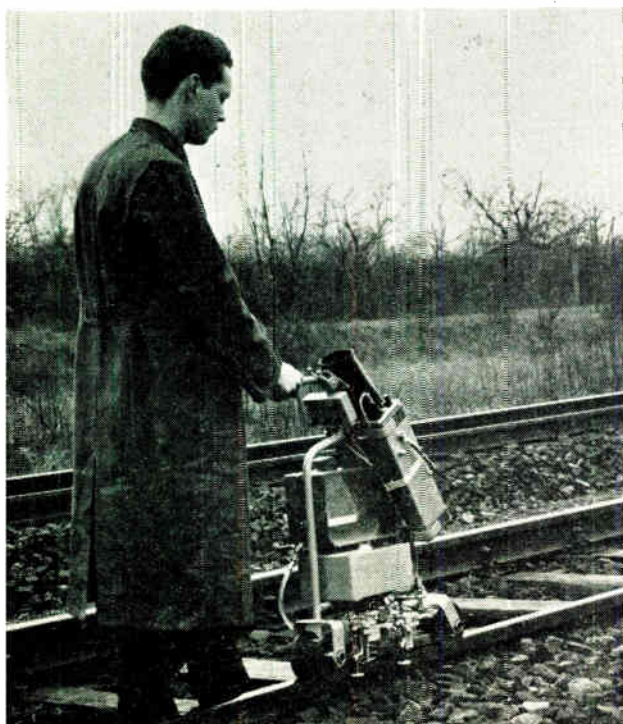

C

(A) Here the ultrasonic flaw detector is being used to measure the wall thickness of a metal tank and also to detect cracks starting from rivet holes

(B) With a suitable attachment the flaw detector can be used to check metal plates

(C) The applications of this type of metal flaw detector are limited only by the ingenuity of the attachments required to make contact with the object under test. This picture shows the unit on a movable rail tester

By G. MILLWARD, A.M.I.N.E., A.M.I.R.E., M.I.T.E., A.M.I.P.R.E.\*

# ULTRASONICS

## for sensing and switching

Wide applications exist for control in industry using ultrasonic waves to detect the presence of objects and provide electrical signals for operating control mechanisms. Applications include sizing, detecting breaks, safety, positioning, counting and controlling levels of liquid and materials.

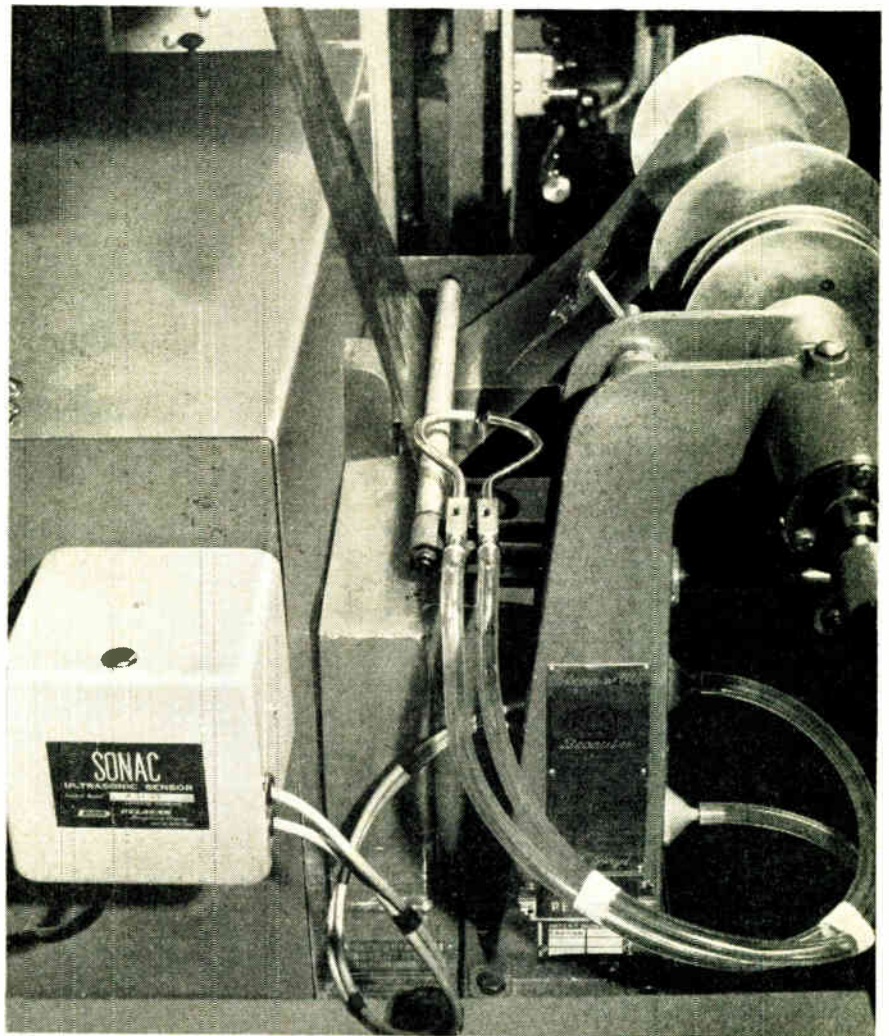

*This overwrapping machine has coupler sensors with tubing extending to both sides of the wrapping material*



To provide web break detection two sensors on each side of the paper are used in this printing machine

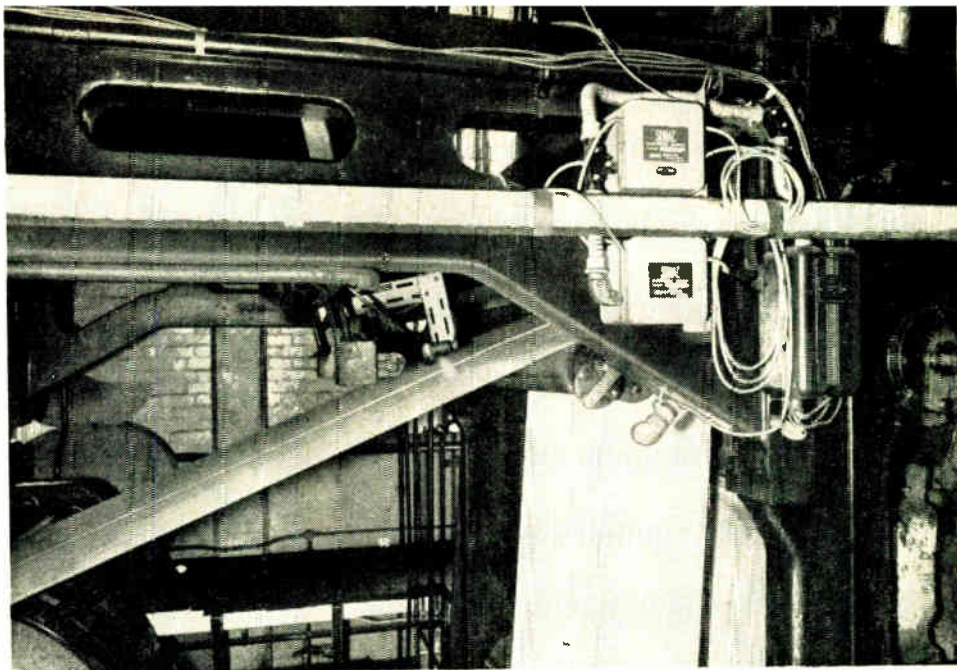

**T**HE unique properties of ultrasonic waves have been applied to industry, signalling, medicine, and many other fields. Vibrational waves of a frequency above the hearing range of the normal ear are referred to as ultrasonic, and the term, therefore, includes all waves of a frequency of more than about 20 kc/s. The presence of a medium is essential to the transmission of ultrasonic waves and almost any material that has elasticity can propagate them. This propagation takes the form of a displacement of successive elements of the medium. The system described here is concerned primarily with the passage of sound-type waves through air.

A simple sound wave as it travels outward from its source loses strength rapidly as the distance increases. This decrease in the strength of sound waves along a path can be greatly affected by discontinuities within the path. The strength of the sound wave at any point along the path is a function, to a major extent, of the distance from the point of origin. The introduction into the path of any material capable of absorbing some of the sound energy or reflecting it away from the original path can be measured. This change in the normal weakening or attenuation of sound along a path can be used to operate electronic circuitry.

Ultrasonic waves generated by rapid pressure changes of frequencies above the audible region have a number of advantages over other means of detection. They are not affected by dust, steam, smoke, industrial contamination, ambient light and vibration. They are invisible and will detect the presence of solids or liquids, ferrous or non-ferrous metals, opaque or transparent materials. The waves can be focused into beams, directed through small diameter holes down to 0.03 in. or piped along tubes so that they can be transmitted round corners or along complex routes in plant or machinery. Objects may be fast or slow moving, large or small at a wide range of distances.

A system based on these principles and thoroughly proved in America is now marketed in the United Kingdom by Westool Ltd. This Sonac equipment, in its method of application, operates in a similar manner to photoelectric detecting systems where the interruption of a light beam by an

object causes a photocell to operate a relay. Instead of a light beam, however, ultrasonic waves of about 38 kc/s are used. The beam of ultrasonic energy is transmitted by one of the electromechanical sensing heads and received by the other. Both are interchangeable in function. Intersection of the ultrasonic beam by some object or material causes a relay in the amplifier to close and this, in turn, can be arranged to control an external device such as a counter.

#### Acoustic Feedback Principle

In the ultrasonic detecting equipment, one of the sensors, connected to the input of the amplifier, can be considered as a microphone or acoustic receiver, while the other sensor, fed from the output of the amplifier, can be considered as a loudspeaker or acoustic transmitter. The two sensors are positioned to face each other, as shown in Fig. 1(a), and the electrical gain of the amplifier is increased by a manual control potentiometer, until it is sufficient to compensate for the losses of energy in the acoustic path and in the electrical circuit. Small random disturbances in the acoustic path or in the amplifier result in pressure waves being fed back from transmitter to receiver and the cumulative action round the loop produces an oscillation. With Sonac equipment the oscillation occurs at a frequency well above the audible range (that is, above 20 kc/s) and no sound can be heard issuing from the transmitter.

When an object, or quantity of material, is placed in the acoustic path it reflects or absorbs some of the ultrasonic energy. As a result, there is a reduction in the energy reaching the receiver and the electrical signal fed into the amplifier is diminished in amplitude. The electrical gain of the amplifier, offset by the manual control, is then insufficient to make up for the reduction of signal strength due to the loss of ultrasonic energy, conditions for cumulative action no longer exist and the oscillation stops completely. Absence of the oscillatory signal in the amplifier then causes the relay to operate and to switch on any external device that may be connected. When the object or material is removed from the acoustic path, the original conditions necessary to maintain a cumulative action are restored and the oscillation

\* Westool Ltd.



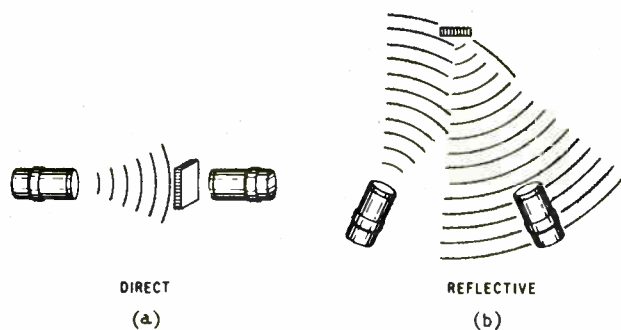

Fig. 1. The direct use of sensors is shown at (a); an object between them forms an obstacle to the waves. The reflective use is illustrated at (b); here the object acts as a reflector to enable the waves from the transmitting sensor to reach the receiver

starts again by the process already described. The relay is then operated in the reverse direction and the external device is switched off.

### Methods of Operation

Sonac can be used in four basic ways.

First, the sensors can be installed to provide a direct path in which an obstruction between the sensing heads breaks the acoustic path, thereby de-energizing the output relay. The relay operates the desired external function (light, buzzer, switch, etc.). Although ultrasonic waves are transmitted from one general-purpose sensor to the other general-purpose sensor at 50° angle, an object large enough to cover the active area of the second sensor will break the beam for a short path length.

Secondly, the direct path method can also be used to sense the removal of an object from the beam. With the object obstructing the beam, the output relay is de-energized. When the object is removed, the acoustic path is completed, which energizes the relay.

The third and fourth ways in which Sonac can be used are with sensors located to provide a reflective path as in Fig. 1(b). As with the direct path, the reflection beam can be used in two ways with the relay energized to sense objects or with the relay de-energized to sense the removal of objects from the beam.

In this method the sound waves omitted from one sensor are reflected from an object to the second sensor to provide the acoustic path. When the object is removed from the path, the relay is de-energized. Conversely, when objects establish a path, this energizes the relay. The reflection method is particularly advantageous for counting or sensing small objects.

### Sensors

The basic Sonac amplifier unit can be used with various sensors depending upon the application. For general-purpose applications sensors emit waves within an angle of about 50° and are of two types. One is for detecting small fast-moving objects and the beam need be interrupted for only 20-50 msec; the other is for large slow-moving objects and a 0.5 sec beam interruption is needed. The distance between the sensors can be anything from about ¼ in. up to 20 ft.

A different category of sensor is what is termed the focalizer. As its name implies it produces a much narrower beam, about 20° on one axis and 10° on the other at right-

angles. A sketch is shown in Fig. 2. These sensors are intended for distances up to 30 ft or where the sensors must be located near a wall or other reflecting object.

A third type of sensor is the coupler type. This has an adaptor enabling a length of ¼-in. tubing to be connected to it to carry the wave to the desired place. Up to 6 ft of tubing may be used. When both sensors have such tubing the air path between the open ends should not exceed 2 in. Both the focalizer and coupler types are available in quick- and slow-acting models.

### Liquid Level Control

A recent addition to the Sonac range is the single probe liquid level control system. The probe is a small, hermetically sealed unit made from stainless steel. When any liquid touches its face feedback stops and a single-pole double-throw relay in the control amplifier de-energizes, providing either 'On' or 'Off' operation of the control system. Since this is an ultrasonic system, any liquid will be sensed by the probe. It is not limited by the physical properties of the liquid such as variation in pressure, conductivity or density. The probe will control levels within 0.005 in. Droplets of thin film clinging to the face will not prevent the relay from pulling in as liquid level drops.

The versatility of Sonac and its performance, even under unfavourable conditions, make it applicable in many diverse industries and some instances will now be given.

### Application

#### Coal Industry

In the Durham, Scottish and Yorkshire Coalfields, operations such as the level control of coal in hoppers and bunkers, positioning of mine cars inside cages, controlling wagons into tipplers, can now be controlled with restricted manpower. In this application a major advantage is that the system is unaffected by dust.

#### Plastic Bag Making Machinery

In an attempt to increase and control the production of plastic bags, Dewey & Almy Ltd. have recently designed a machine using Sonac to count the output from each machine. As the equipment will sense opaque or transparent materials this was favoured over other counting devices.

Coupler sensing heads were used in this application to enable the sound beam to be piped to the appropriate part of the machine. This enabled the amplifier sensing heads to be mounted free from the operating mechanism.

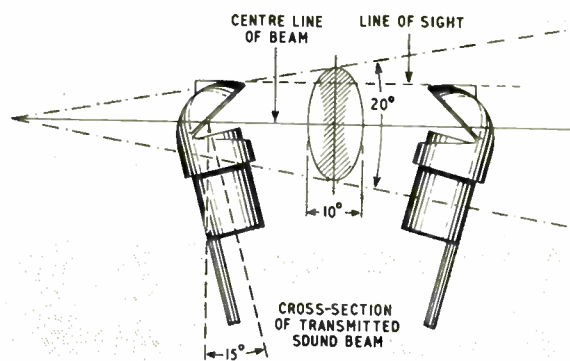
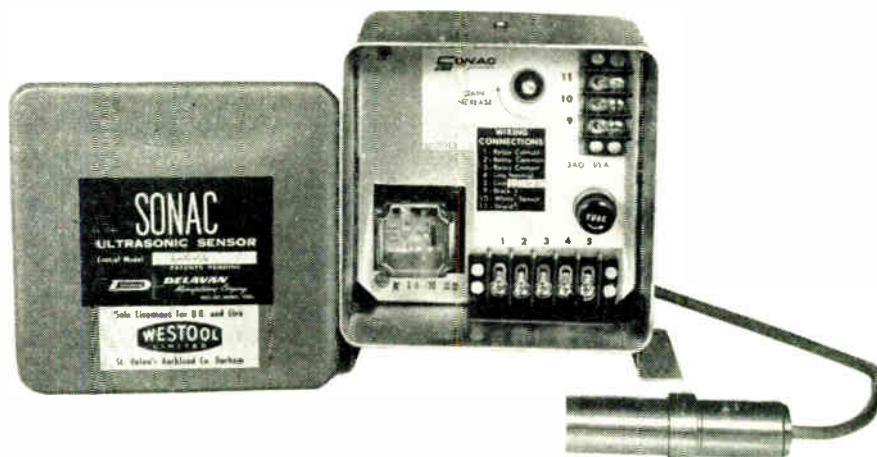

Fig. 2. Focalizer sensors give an elliptically shaped beam of 10° and 20° minor and major axes respectively

Sonac unit with a single sensor for liquid-level detection. An accuracy of 0.005 in. is claimed with a response time of 25 msec



### Paper Web Break

In the Hazell Watson & Vineys Ltd. works at Aylesbury, there is a Goss high-speed printing press. In view of the very high cost of a failure due to the web breaking or to undue sag in the web the fitting of Sonac to this machine has saved considerable expense.

This application uses two separate units, one on either side of the web.

Other applications within the paper industry include edge control, thickness measurement (i.e. sensing a join or increase or decrease in thickness), conveyor control, positioning and bin level control.

### Packaging Industry

Bowater Packaging Ltd. require to line-up the edge of sheets of cardboard before they are slit with their universal slitter and scorer machine.

The system in use employs the coupler type assembly where both sensors are mounted on an arm with a pipe connection, so that this arm can be positioned on the machine in such a manner that the outlets from the pipes will be  $\frac{3}{4}$  in. inside the board, about 3 in. apart.

This system gives the greatest amount of flexibility and enables the sensors to be moved from one side of the machine to the other or to any intermediate position in order to line up with the edge of the sheet being slit.

On their Deritend slotter machine they required to measure the height of a stack of slit boards. For this the focalizer type of Sensor was used.

The counting of boards on this machine is done with the coupler sensors fitted to short lengths of tube, the sensors being mounted on one of the movable guides on the slitter and so arranged that a beam is projected across the trailing corner of the slit board which gives a signal when the board drops off the guide finger.

### Rubber Industry

The Firestone Tyre & Rubber Co. Ltd., Brentford, had the problem of detecting the height of stock pile-up on a conveyor. As Sonac is not affected by dust or industrial contamination this was an ideal application.

Endless rubber slab stock tends to break and roll itself up on the carrying conveyor. This equipment was consequently fitted to detect the height of the stock pile-up and provide a signal.

Another application which is in use by another tyre manufacturer is to the cutting of wheel rims to length. This unit

replaces photoelectric cells which had been troublesome because the lens readily became contaminated by oil.

### Liquid Level

The Brewery, Paper and Chemical Industries are only a few of a number of industries using this type of liquid level control, although it is a new addition to the range.

A well-known detergent manufacturer is using Sonac to detect the presence of a liquid in a vessel before a further liquid is added. Failure to do so would result in a dangerous explosion.

The Brewery Industry will find ultrasonic methods advantageous because they are not affected by foam which forms on top of the beer.

In the paper-making industry level controlling of pulp fibres in a paper-making stock chest is one application for which Sonac can be used. One manufacturer is using it in a stock chest with a 6 to 7% pulp-fibre consistency and the relay is arranged to switch off the pump motor when the pulp fibre comes into contact with the probe.

The drying out of pulp fibre sticking on the face of the sensor when the level falls below the probe does not affect its operation.

### Conclusion

The speed, flexibility, accuracy and maintenance-free operation of this type of unit makes it an ideal detecting and sensing device which can be fitted to high-speed automatic and semi-automatic machinery.

At present 43 different industries are using the system, out of which there are 20 basic applications. Continuous developments open up numerous other possibilities for using Sonac as a switching and detecting device.

### ★ FOR THE BUYER

You must have read about a number of products and processes in this issue of which you would like further details. You can obtain this information very easily by filling in and posting one or more of the enquiry cards to be found inset in the front and back of the journal.



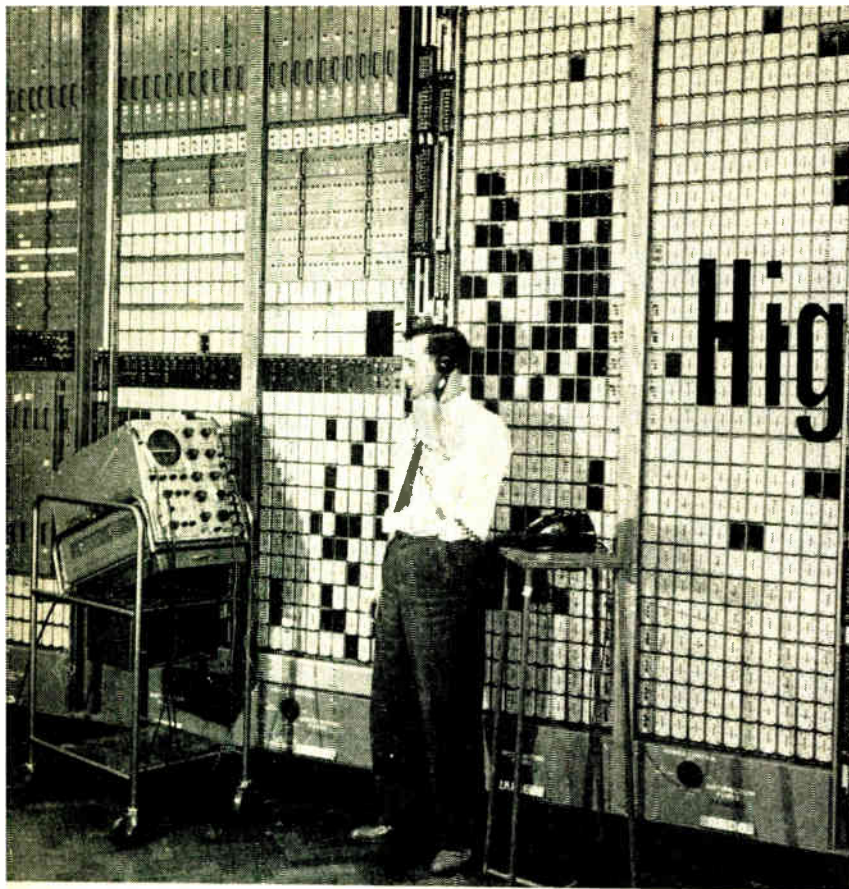

◀ This illustrates the subscribers' incoming line terminations (centre and right) with the time division multiplex equipment (centre and left)

# Highgate Wood

## ELECTRONIC TELEPHONE EXCHANGE

**I**N modern business the telephone is accepted as an essential service and with the introduction of trunk dialling facilities it is rapidly replacing the letter for certain forms of long-distance communication. As additional telephone facilities are provided so the usefulness of the telephone increases and although with the existing electro-mechanical exchanges additional services can be provided, many of these are not practical because they require the intervention of operators and/or extra, costly equipment. Electronic telephone exchanges, however, can make the provision of additional facilities economically and technically possible.

The first electronic telephone exchange to go into public

service in the United Kingdom was opened by the Postmaster General, the Rt. Hon. Reginald Bevins, M.P., on 12th December.

The exchange, Highgate Wood, London, of 800 lines, operates on the principle of time-division multiplex using pulse amplitude modulation. Setting-up and register functions are also time-shared. This is believed to be the first exchange employing this combination of multiplexing and modulation techniques to be used for public traffic anywhere in the world.

This time-division multiplex system is one in which a single highway through the exchange—the physical path through wires and switches—is able to carry a number of simultaneous telephone conversations.

In the electronic exchange, the caller is directly connected with his correspondent for only one-hundredth part of the time, each of the remaining 99 periods of time remaining available to carry another conversation. The switching rate, however, is so fast—10,000 times a second—that there is no audible break in the conversation: a single syllable may be broken into many hundreds of pulses. Despite this, speech quality is considerably higher than is required for ordinary telephone working, with a substantially flat response from 300 to 4,200 cycles per second. (Frequencies required for normal telephone working are 300–3,400 c/s.)

### Why Electronic Exchanges?

When using the present electro-mechanical exchange equipment an uninterrupted electrical path is required between the caller and the subscriber being called. This means that a separate highway through the exchange (i.e. a pair of cables and the associated switches) is required for each telephone conversation. However, with the new electronic exchange equipment it is possible to carry up to

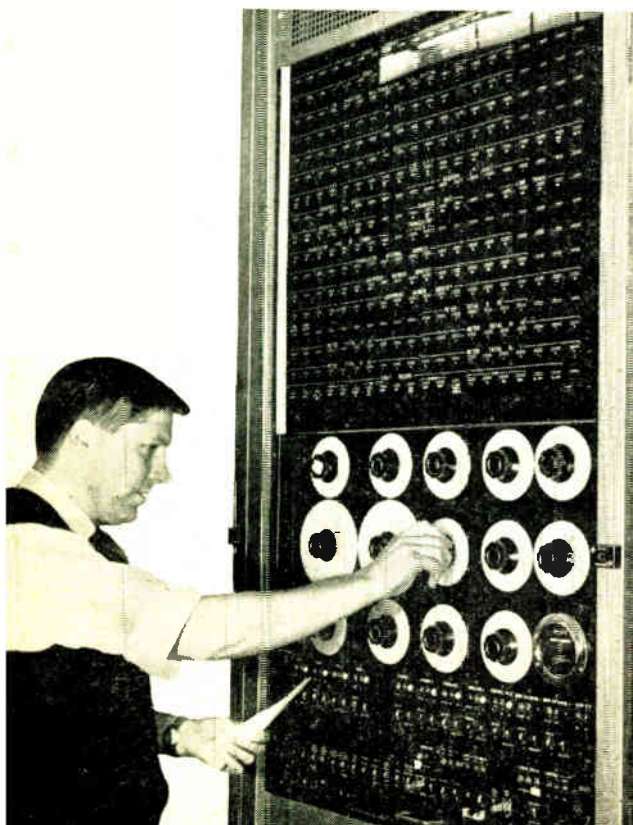

◀ A main feature of the system is a magnetic drum 'memory' store in which all the permanent factors relating to each line are stored. Also temporary information for the routing of calls is stored on the drum. This picture shows an engineer 'writing' information on to the drum tracks



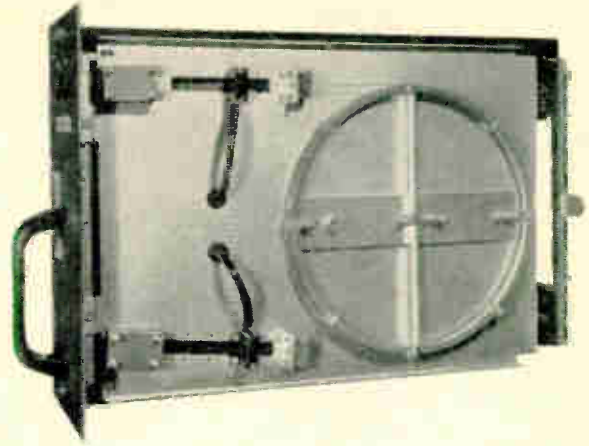
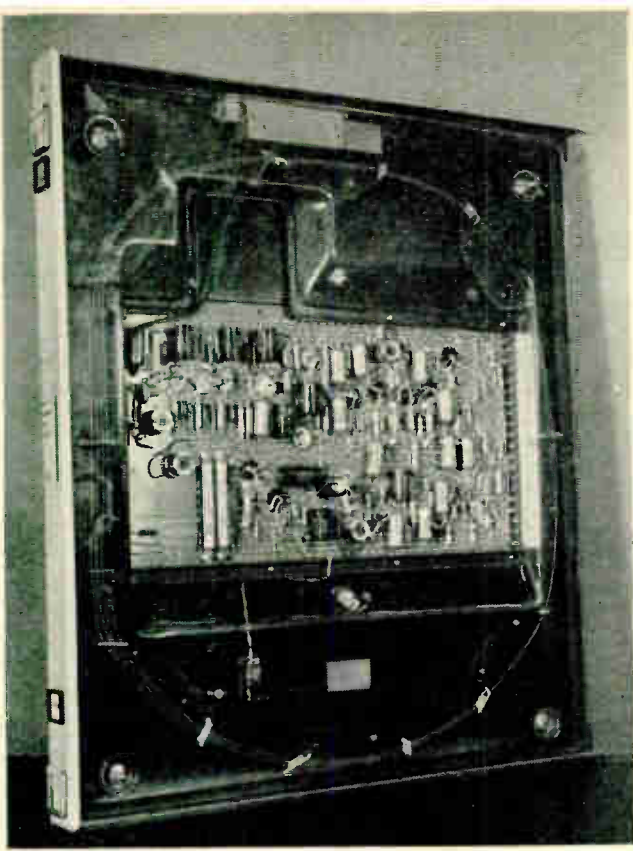

Many control functions in the exchange are based on 900  $\mu$ sec delay lines. These delay lines are also used to store information required by the setting-up equipment for the routing of calls. One of the delay lines is illustrated above and clearly shows the input and output transducers connected to the wire forming the delay line. A second type with its associated transistor circuit is shown on the left

one hundred simultaneous calls on a single highway.

Apart from the obvious advantages of time-sharing the internal exchange highways, the electronic exchange has many other advantages. It will work much more quickly than conventional ones, requires less maintenance, and can offer scope for new and improved facilities. For example, by dialling an appropriate code number subsequent incoming calls can be routed to another number. Also, abbreviated dialling can be provided for frequently-called numbers. In addition, the electronic exchange makes possible, technically and economically, the provision of many other facilities.

#### Future Installations

Highgate Wood is in the nature of an advanced field experiment, following the success of a small exploratory installation at the G.P.O. Research Department at Dollis Hill, London, in 1959. Three further electronic exchanges of more sophisticated type are now being built. Two of these, Pembury and Goring-on-Thames, will replace manual exchanges and the third, at Leighton Buzzard, will replace an early type of automatic exchange.

Two of these exchanges are based on slightly different applications of the time division pulse amplitude modulation principle. The one at Leighton Buzzard, however, is based on space division switching.

They will be, essentially, trials of potential production systems, and, unlike Highgate Wood, will not have conventional stand-by exchanges.

#### Design and Construction

The design and construction of the new electronic exchanges are the result of an extensive programme of co-operative research and development between the Post Office and the five principal British manufacturers of exchange equipment. The co-ordinating body in this work has been the Joint Electronic Research Committee, set up in 1956, on which are represented the Post Office and the five firms—Associated Electrical Industries Ltd., Automatic Telephones and Electric Co. Ltd., Ericsson Telephones Ltd., the General Electric Company and Standard Telephones and Cables Ltd.

Here the register equipment for the Highgate Wood Exchange is being checked before delivery

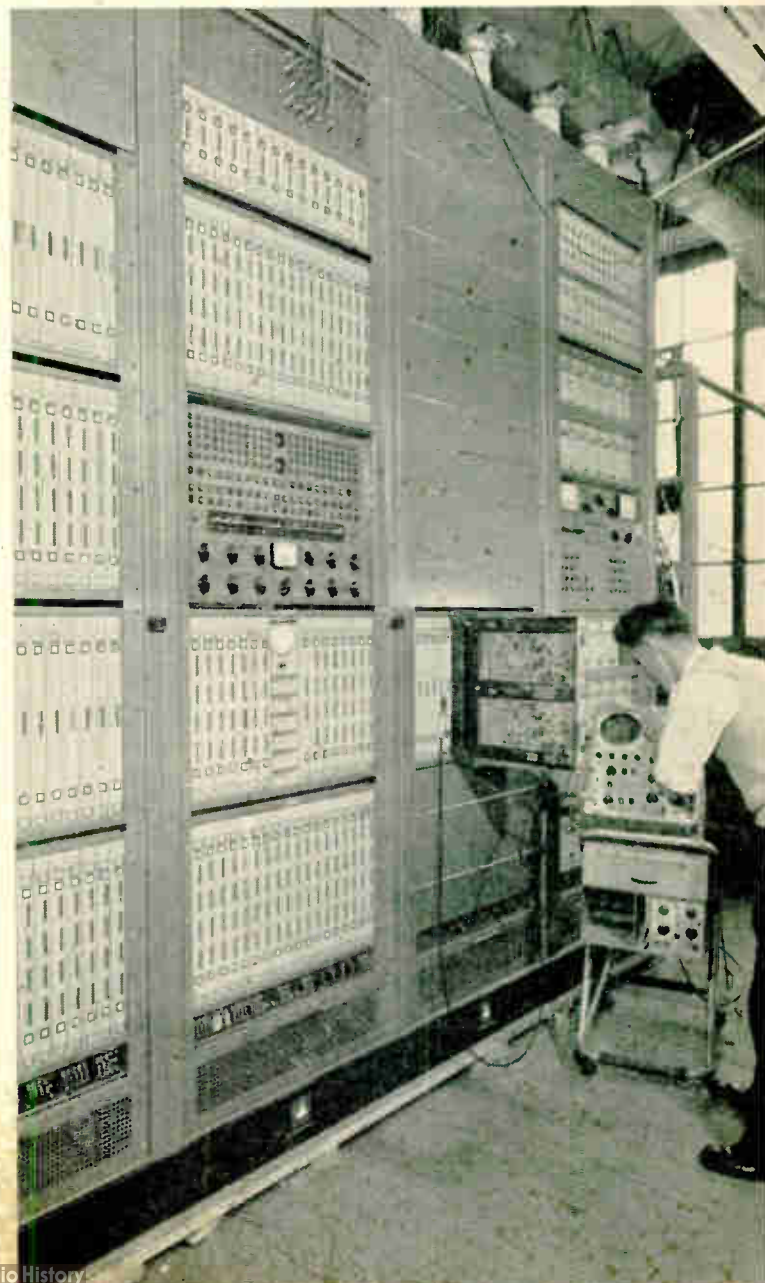



A method of producing linear deviation over a wide deviation range in an LC oscillator is described. The centre-frequency is defined by a tuned circuit and a practical circuit gives 30 kc/s  $\pm 7\frac{1}{2}\%$  linear deviation.

# FREQUENCY - MODULATED OSCILLATORS

By R. C. FOSS \*

TO transmit data in telemetry and general data systems, frequency-modulated carriers and sub-carriers are frequently used. Some types of transducer, for example, a variable inductance transducer, readily lend themselves to the direct generation of a frequency-modulated carrier. Other transducers, for example thermocouples, give a d.c. signal output which, after amplification if necessary, must be fed to a frequency-modulator capable of producing a suitable carrier. The accurate transmission of information requires a modulator with a linear deviation characteristic and good frequency stability.

To some extent frequency drift is permissible if a calibrating signal is used to give a reference level at frequent intervals. Where the modulator continuously handles signal information, however, as in a simple single-channel equipment, frequency drift gives rise to error. If the maximum deviation of the modulator is, say, 10%, a frequency drift of only 2% gives an apparent drift in the transmitted information of 20% of maximum signal. Clearly a wide deviation for a given frequency stability helps to minimize this error and deviations of  $\pm 7\frac{1}{2}\%$  or more are frequently used.

To produce frequency-modulated sub-carriers in the range 1-200 kc/s, voltage-biased multivibrators of various types have been commonly used. Multivibrators may be made to have excellent linearity over a wide deviation range but their frequency stability is not outstanding. Over a temperature range of 20°C to 80°C a frequency drift of 1 to 2% is not particularly easy to achieve; recourse to empirically adjusted temperature-compensating devices may be necessary.

An LC oscillator may be expected to achieve better frequency stability because its frequency is governed by phase-frequency relationships which may be made less dependent on temperature and supply voltage variations than the voltage-time or magnetic-flux-time relationships in multivibrators. When a frequency modulator was required which was to give an output of 30 kc/s  $\pm 7\frac{1}{2}\%$  linear deviation with a centre-frequency stability over the range 20°C to 80°C in the region of 0.5%, it was therefore decided to try to use an LC oscillator with its tuned circuit defining the centre-frequency.

Perhaps the most usual way of frequency modulating an LC oscillator is to vary the effective value of one or both reactive elements in the tuned circuit. It was felt that such an approach would not give the required linearity or frequency stability. An alternative technique<sup>1</sup> has been successfully used in frequency-modulated broadcast transmitters. An LC oscillator with two regenerative paths is used, the two paths having differing phase characteristics. The input signal, by

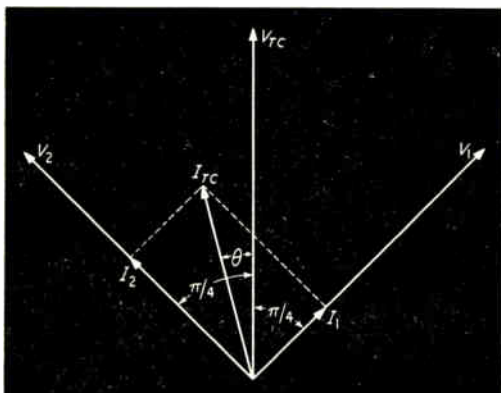

Fig. 1. Vector diagram of f.m. oscillator

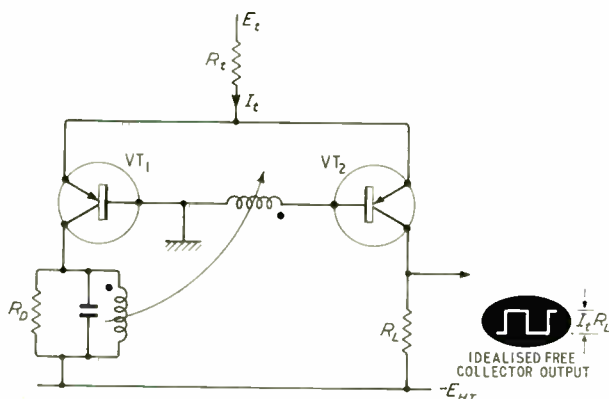
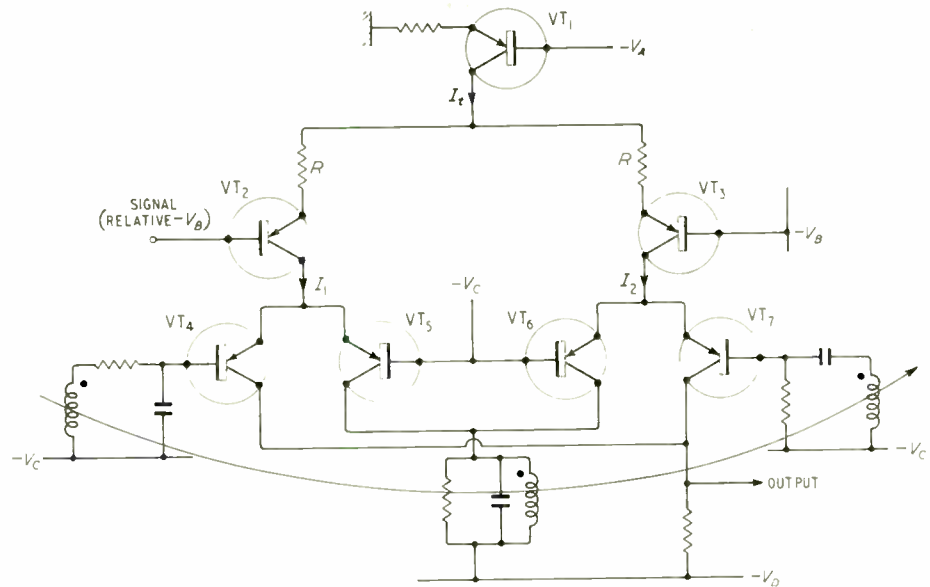

Fig. 2. Basic long-tailed-pair oscillator

\* E.M.I. Electronics Ltd.

Fig. 3. Basic circuit of f.m. oscillator



altering the division of the feedback between these paths, produces a phase shift in the total feedback. The oscillator frequency is then determined by the phase-frequency characteristic of the tuned circuit, oscillations occurring at the frequency at which the total phase-shift around the regenerative loop is zero. A similar technique has been used with a strain-gauge transducer using the phase-frequency characteristic of an LC filter section.<sup>2</sup>

### Basic Vector Diagram

To produce a phase change  $\theta$  in the regenerative loop of the oscillator and a corresponding change in frequency  $\Delta\omega$ , which are functions of the input signal,  $V_{IN}$ , a vector phase-shift method with the diagram as shown in Fig. 1 may be used. The vector  $V_{TC}$  is the voltage across a parallel-tuned circuit. Vectors  $V_1$  and  $V_2$  lag and lead  $V_{TC}$  by  $\pi/4$  respectively.  $I_1$  and  $I_2$  are in the same phase as  $V_1$  and  $V_2$  but with magnitudes dependent on  $V_{IN}$ .  $I_1$ , say, decreases while  $I_2$  increases for an increase in  $V_{IN}$ . It is convenient to make:

$$I_1 = I_t/2 - G V_{IN}, I_2 = I_t/2 + G V_{IN} \quad (1)$$

where  $I_t$  is a constant and  $G$  is a constant with the dimensions of conductance.

The vector  $I_{TC}$  is the sum of  $I_1$  and  $I_2$  and so has an angle  $\theta$  relative to  $V_{TC}$  depending on  $V_{IN}$ . The deviation  $\Delta\omega/\omega$  is therefore determined by  $V_{IN}$ , the constants  $I_t$  and  $G$  and the  $\theta/\omega$  relationship of the tuned circuit.

The deviation relationship between  $\Delta\omega/\omega$  and  $V_{IN}$  is more linear than might be imagined at first sight. The law relating  $\theta$  with  $V_{IN}$  is clearly a tangent law with  $\theta$  changing less for a given change in  $V_{IN}$  as  $\theta$  tends to  $\pi/4$ .

From Fig. 1, by the geometry

$$\theta = \pi/4 - \tan^{-1} \frac{I_1}{I_2}$$

Substituting for  $I_1$  and  $I_2$  from (1) and rearranging

$$\theta = \tan^{-1} \frac{G V_{IN}}{I_t/2} \quad (2)$$

Fortunately the law relating  $\omega$  and  $\theta$  in the tuned circuit also approximates to a tangent law, but in the opposite sense;  $\omega$  changes more rapidly with change in  $\theta$  as  $\theta$  tends to  $\pi/4$ :

$$\theta \simeq \tan^{-1} \frac{2Q\Delta\omega}{\omega} \quad (3)$$

the usual relationship for a tuned circuit<sup>3</sup>.

Therefore:—

$$\frac{\Delta\omega}{\omega} \simeq \frac{G V_{IN}}{Q I_t} \quad (4)$$

Thus the deviation law is ideally linear between limits reached when  $G V_{IN} = I_t/2$  and  $\theta = \pi/4$ . These limits are given by:—

$$\text{Max. deviation} = \pm \frac{1}{2Q} \times 100\% \quad (5)$$

### Basic Oscillator

An oscillator which is well suited to adaptation for the present purpose is the long-tailed-pair oscillator<sup>4,5,6,7</sup>. Because this oscillator, despite its many virtues, is not well known, a brief account of its features may not be out of place here. A simple oscillator of this type is shown in Fig. 2. Suppose for the moment that a sinusoidal voltage exists across the parallel-tuned circuit. If the turns-ratio of the collector-base coupling is such as to give, say, 1 V peak at the base of  $VT_2$ , the tail current in  $R_t$  will be switched between  $VT_1$  and  $VT_2$  in a time short compared with the time for one half-cycle of oscillation. Thus the current waveform fed to the tuned circuit is approximately square with peak-to-peak amplitude given very nearly by  $I_t \simeq E_t/R_t$  neglecting  $V_{BE}$  relative to  $E_t$  and taking  $\alpha$  for  $VT_1$  as unity. The component of  $I_t$  at fundamental frequency is found by Fourier analysis to be:—

$$I_{pk} = 2I_t/\pi$$

Thus the peak value of the sinusoidal voltage across the tuned circuit whose existence was initially assumed is given by:—

$$V_{pk} = 2I_t R_D/\pi$$

Where  $R_D$  is the dynamic resistance at resonance of the tuned circuit together with any applied load.

The features of this oscillator which make it of general value as well as suitable for the present purpose are:—

- It may be designed to operate by simple theory without direct dependence on transistor parameters.
- The waveshape exciting the tuned circuit is fed from a high impedance source which does not load the tuned circuit to any significant extent.
- The magnitude of the current exciting the tuned circuit is directly proportional to  $I_t$ .
- An auxiliary output largely isolated from the regenerative loop may be taken from the free collector of  $VT_2$ .

To realize the vector diagram shown in Fig. 1 this circuit may be adapted as shown in Fig. 3. Two feedback windings are coupled to the tuned circuit and feed CR circuits giving a  $\pi/4$  phase-lead and a  $\pi/4$  phase-lag respectively. These leading and lagging voltages are applied to long-tailed-pair



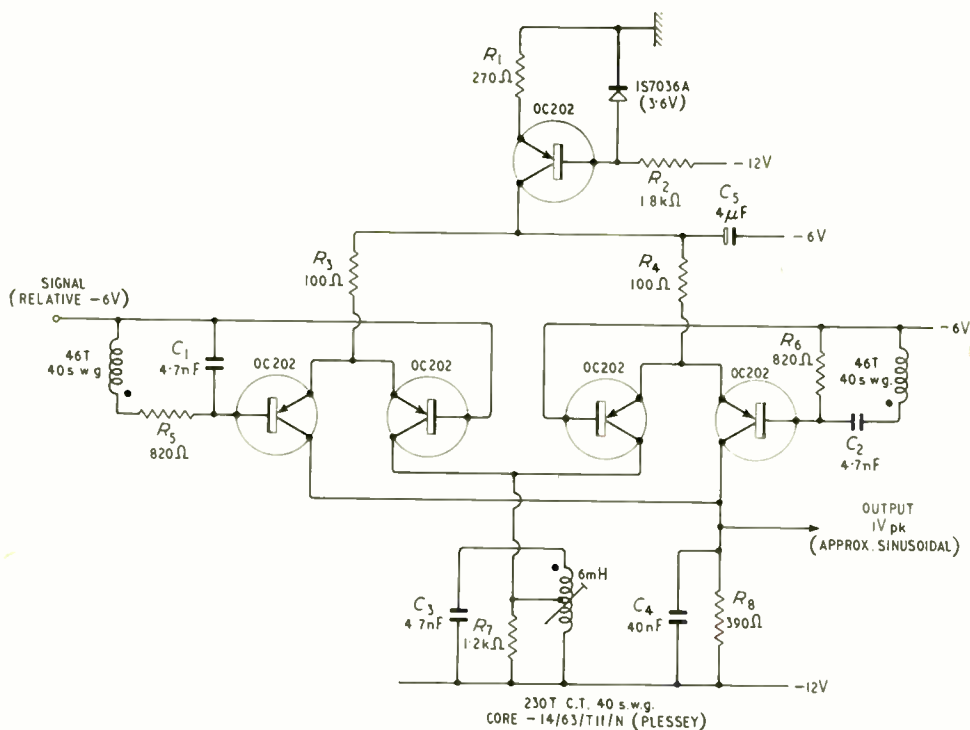

Fig. 4. 30 kc/s f.m. oscillator

current switches  $VT_1$  and  $VT_5$  and  $VT_6$  and  $VT_7$ . The current outputs of  $VT_5$  and  $VT_6$  are fed to the tuned circuit completing the regenerative loop. The input signal is applied to  $VT_2$  and  $VT_3$ , a further long-tailed-pair acting as a differential amplifier with emitter resistors largely defining the mutual conductance of the stage.

The constant tail current  $I_t$  is thus divided between  $VT_2$  and  $VT_3$  according to the value of  $V_{IN}$  relative to the signal reference level at the base of  $VT_2$ .

Thus:—

$$I_1 = I_t/2 - GV_{IN}, I_2 = I_t/2 + GV_{IN}$$

Where  $G$  is approximately  $1/2R$ .

The currents  $I_1$  and  $I_2$  are here the values of tail current switched by the pairs  $VT_4$  and  $VT_5$  and  $VT_6$  and  $VT_7$  respectively. The component of current at fundamental frequency fed to the tuned circuit is the vector sum of  $2I_1/\pi + 2I_2/\pi$ . Thus apart from the scalar factors  $2/\pi$  the circuit completely realizes the basic vector diagram. Two current vectors leading and lagging by  $\pi/4$  respectively and with amplitudes set by the input signal as in equation (1) are derived and added into the tuned circuit. Strictly,  $V_1$  and  $V_2$  and hence  $I_1$  and  $I_2$  vary a little about the phase angle  $\pi/4$  as the frequency changes. Both this effect and the approximation in equation (3) have negligible result in practice for deviations up to a maximum of about 10% with  $Q$  for the tuned circuit about 4 giving a safety margin.

### Practical Circuit

A circuit of the type shown in Fig. 3 was built and it was found that the performance was largely as expected from the theory given in the preceding paragraphs. The deviation characteristic was not sufficiently symmetrical due to small additional delays in the regenerative loops. This difficulty was overcome by slightly reducing the phase-shift time-constants.

In this form the circuit was not entirely suitable for the intended application for two reasons. The principal difficulty was that the supply voltage available,  $12\text{ V} \pm 1\text{ V}$  with  $V_{IN}$  relative to about  $-6\text{ V}$ , left insufficient supply voltage for the oscillator. It was also desired if possible to reduce the number of transistors required.

The practical circuit shown in Fig. 4 succeeds in dispensing with the separate differential amplifier and has been found to be satisfactory for the present purpose. The two  $100\text{-}\Omega$  resistors  $R_3$  and  $R_4$  serve as tails, for the current-switching pairs, the two feedback paths being isolated by the  $4\text{-}\mu\text{F}$  capacitor,  $C_5$ . A constant total tail current of about  $10\text{ mA}$  is established by the tail transistor and Zener diode (the temperature coefficients of  $V_{BE}$  and the  $3\text{-V}$  Zener diode tend to cancel). This current divides between the switching pairs in proportions set by the relative signal and bias levels of the opposite pairs. The sum of the two current vectors is fed to the tuned circuit which uses low-temperature-coefficient components. To minimize the physical size of  $C_3$  it is convenient to obtain the desired dynamic resistance and  $Q$  with a tapped winding. The dynamic resistance at resonance is very nearly  $R_7$  which sets the working  $Q$  at about 5.

At the risk of pulling the oscillator frequency a nearly sinusoidal output may be taken from the oscillator tuned circuit. It is, however, preferable to make use of the outputs from the free collectors of the switching pairs. Because the voltage swing at the bases is comparable with the voltage across  $R_3$  or  $R_4$  the output current waveform from each of these collectors departs appreciably from the variable amplitude square wave observable with a circuit as in Fig. 3. An approximately square output voltage may be obtained from either free collector by feeding the output current into a  $3\text{-V}$  Zener diode.

Alternatively, as is shown on the diagram, the two free collectors together may be connected to a load resistor  $R_8$  and an integrating capacitor  $C_4$  to give an approximately sinusoidal output. If necessary this waveshape could be improved with an additional low- $Q$  tuned-circuit or suitable filter.

### Performance

In the intended application, the input signal  $V_{IN}$  is derived from a feedback amplifier with low output resistance. Initial tests showed that source resistances of up to  $100\text{ }\Omega$  gave no apparent change in performance, so all subsequent tests were made with this value of source resistance.

The deviation characteristic of the oscillator is shown in

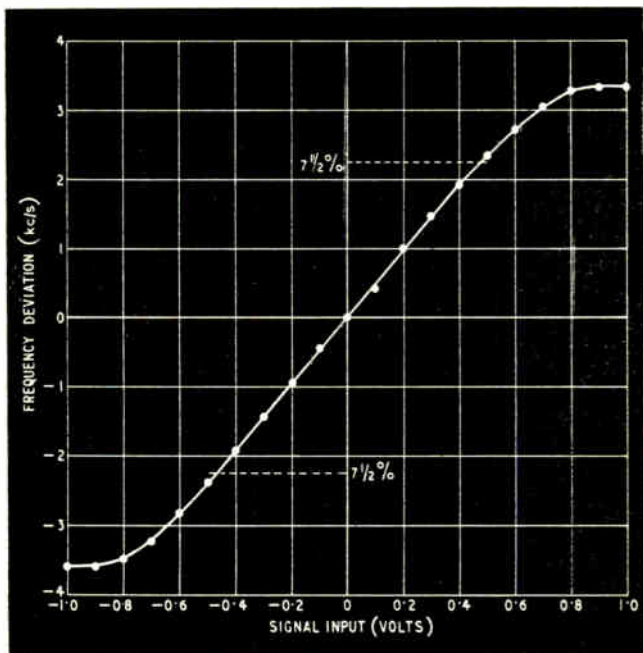

Above: Fig. 5. Deviation characteristic of oscillator. Centre frequency 30 kc/s

Fig. 5. The maximum departure from a true straight line between  $\pm 7\frac{1}{2}\%$  deviation of any experimental point is less than 60 c/s; i.e., about 0.2% of centre frequency. With an alternating input signal the oscillator was tested with a pulse-counting discriminator and carrier and demodulator filters. The frequency response of the complete channel as shown in Fig. 6 was in effect that of the demodulator filter. Tests with a filter having a higher cut-off frequency showed some visible distortion in a sinusoidal signal with maximum deviation only at frequencies above 500 c/s.

Tests were made of oscillator drift with changes in ambient temperature and changes in supply voltages at both the centre frequency and at points near the deviation limits. The effects of changes in the -12-V supply and in the -6-V signal reference level are shown in the table. The effect of a  $\pm 1$ -V

#### Drift of f.m. Oscillator

Supply Voltage	11	12	13	Volts
Frequency ( $-7\frac{1}{2}\%$ dev.)	27.75	27.68	27.69	kc/s
Frequency (0 dev.)	29.98	30.00	30.00	kc/s
Frequency ( $+7\frac{1}{2}\%$ dev.)	32.33	32.36	32.36	kc/s
Reference Voltage		5.6	6.6	Volts
Frequency ( $-7\frac{1}{2}\%$ dev.)		27.74	27.88	kc/s
Frequency (0 dev.)		30.00	30.01	kc/s
Frequency ( $+7\frac{1}{2}\%$ dev.)		32.26	32.29	kc/s

change in the 12-V or a 1-V change in signal reference level is to give less than 0.1% change in centre frequency. Heating the oscillator from 20 °C to 80 °C was found to give a maximum change in frequency of 170 c/s. This is less than 0.6% of centre frequency and represents less than 4% of the total maximum signal excursion.

#### Conclusions

An LC oscillator has been described which may be linearly frequency-modulated over a wide deviation range and has a good centre-frequency stability without recourse to empirical temperature compensation. The linear deviation range is

Below: Fig. 6. Frequency response of f.m. channel comprising—Frequency-modulated oscillator, pulse counting discriminator, carrier and demodulator filters

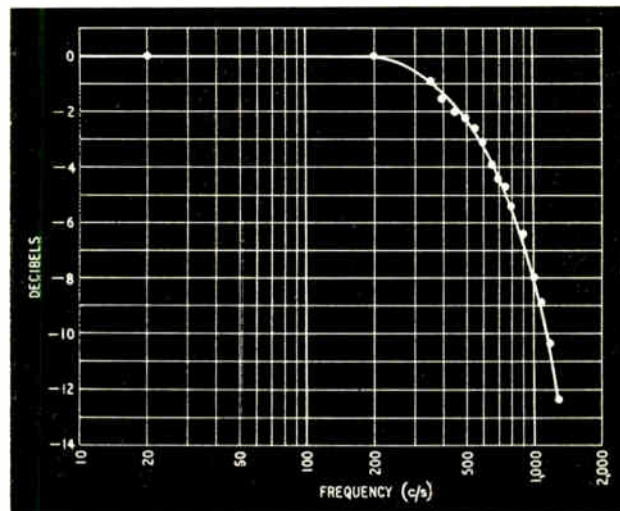

less than can be achieved with a biased multivibrator but the frequency stability is superior because a tuned circuit defines the centre-frequency. An advantage of the circuit described is its toleration of variations in signal reference level. In other words its sensitivity to push-push signals at the opposite pairs of bases is small. This is useful where the reference level of the signal is not well defined or where a balanced signal floating over a limited range must be accommodated. The circuit should be ideal for operation from a bridge type of transducer for example. With unbalanced signals either sign of deviation is obtainable.

Clearly alternative circuits could be used to realize the vector diagram in Fig. 1. An alternative vector diagram uses a fixed in-phase vector and a variable quadrature phase vector to achieve variations in  $I_{TC}$  phase in the same way. This arrangement, giving a tangent law to this variation, is as equally suitable for use with the phase-frequency characteristic of a tuned circuit as the arrangement of Fig. 1.

#### Acknowledgments

In the course of work described in this paper the author was greatly helped by discussions with Mr. F. W. Cutts, Mr. C. G. Dailey and Mr. J. A. Simpson of E.M.I. Electronics.

#### References

- White, E. L. C., 'A Frequency Modulator for Broadcasting Transmitters using Overall Negative-Feedback', *Proc. I.E.E.*, Vol. 106, Pt. B, No. 28, July 1959.
- Foster, W. H., 'Phase-Shift Oscillator for Strain Gauges' in 'Modern Transistor Circuits' published by McGraw-Hill.
- Skilling, H. H., 'Electrical Engineering Circuits', published by Wiley.
- Vanderlyn, P. B., and White, E. L. C., British Patent 540,941.
- Baxandall, P. J., 'Transistor Sine-Wave L/C Oscillators', *Proc. I.E.E.*, Vol. 106, Pt. B, Supp. No. 16 (Transistor Convention).
- Foss, R. C., 'Waveform and Switching Circuits with Long Tails', Paper read before the London Graduate and Student Section of the I.E.E., 16th April 1962.
- Foss, R. C., and Sizmur, M. F., 'LC Oscillator Design', *Wireless World*, Nov. and Dec. 1962.



# collection of PLANT DATA FOR ON-LINE

**T**HE Spencer Works of Richard Thomas and Baldwins at Newport, Monmouthshire, was, in the words of their managing director, Mr. H. F. Spencer, 'designed to be the most advanced steelworks in the world'. To this end a new approach was devised for the solution of the problems associated with industrial automation—that of a Control Hierarchy (see Fig. 1)—a concept based on specific levels of control which is equally applicable to a wide variety of industrial plants.

One of the main attributes of an electronic computer is its ability to process large quantities of information rapidly, tirelessly, and with consistent accuracy. By inter-connecting a number of such computers to form a control hierarchy, after the pattern of a management organization, an extremely efficient information and data handling system is formed. From the data describing the state of the plant collected and analysed by the system, it is possible to provide

management with adequate, accurate and up-to-date information on the various processes on which they are able to base their decisions.

## Plant Data

It is immediately evident that the value of such an information-handling system is dependent on the accuracy of the input data and on the speed with which that data can be made available for processing. In a plant such as a steelworks the vast majority of this data originates in such a manner that it is impossible or impractical to obtain it automatically. Therefore reliance must be placed to a large extent on the operators to assemble the data and present it to the information-handling system for processing.

The data prepared by the operators will form a 'message' describing, for example, a particular operation or the state of a unit in the plant. In order to allow the information-handling system to recognize the message each one must

© Process Computing Division, Elliott Brothers (London) Ltd.



◀ This photo shows one of the scanners with its doors open to show the logical units

By J. F. ROTH, B.Sc., A.M.I.E.E.\*

# COMPUTER PROCESSING

In some processes data cannot be collected automatically and must be inserted manually into a control system. This article describes one way of doing this—the way adopted in a new steelworks.

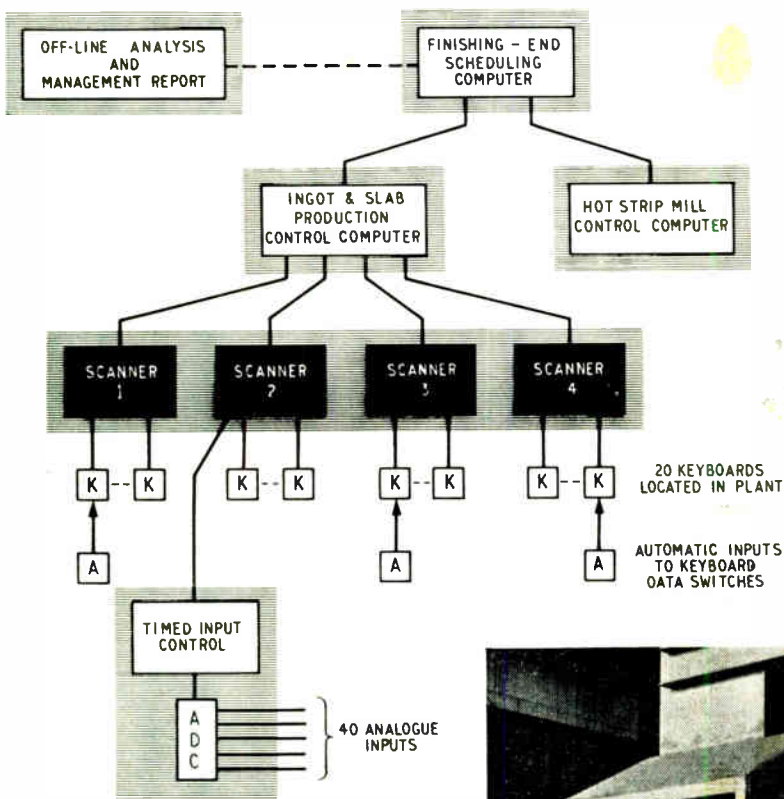
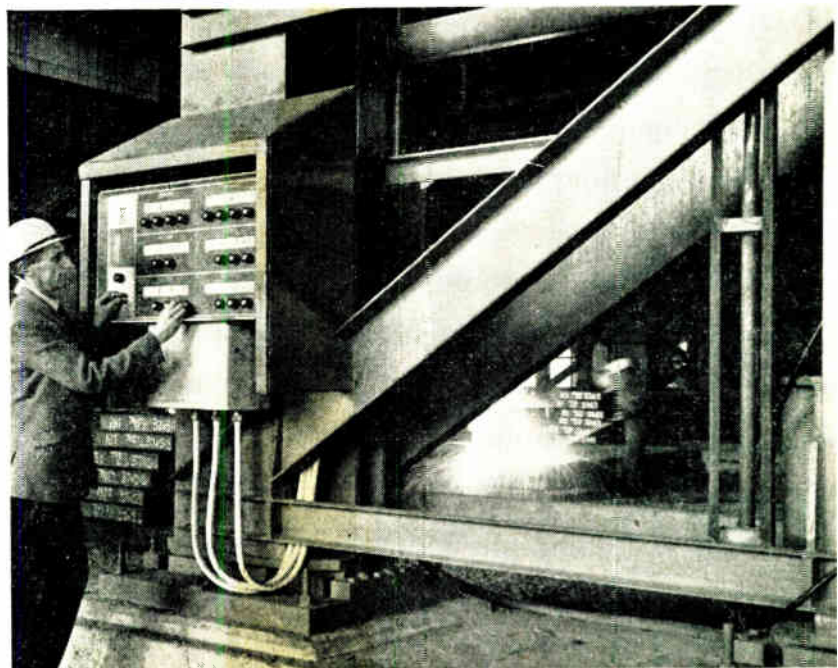

Fig. 1. General arrangement of information and data-handling control hierarchy showing the message input channels

The photograph shows one of the keyboards installed in the works with an operator inserting information





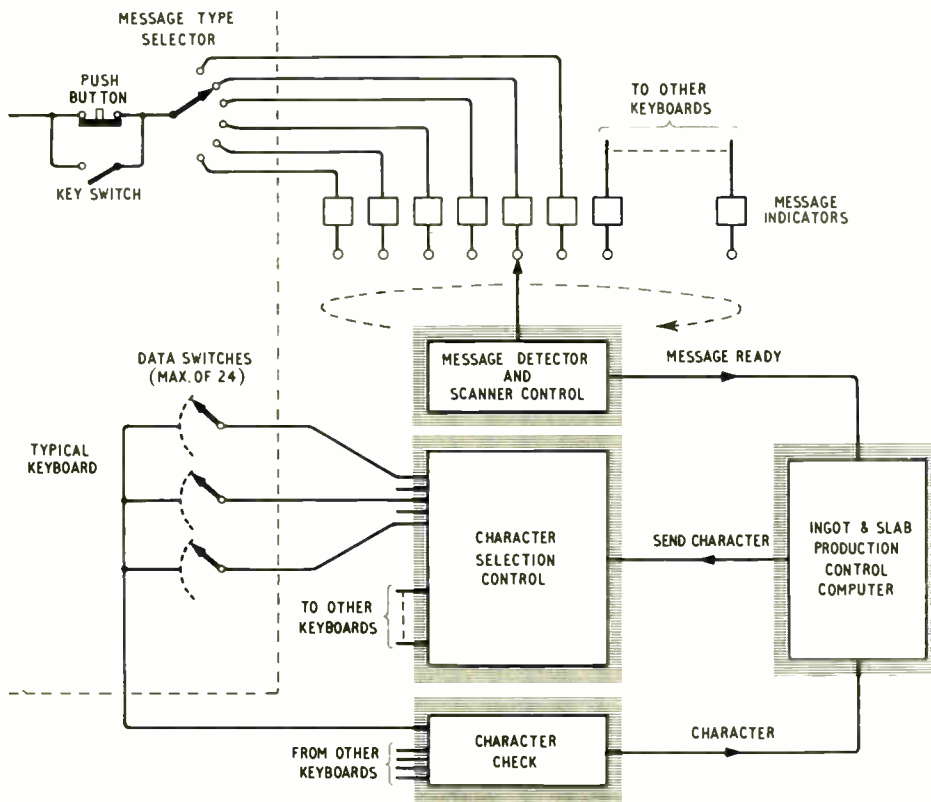

Fig. 2. Block diagram of scanner and keyboard

## Collection of Plant Data for On-Line Computer Processing

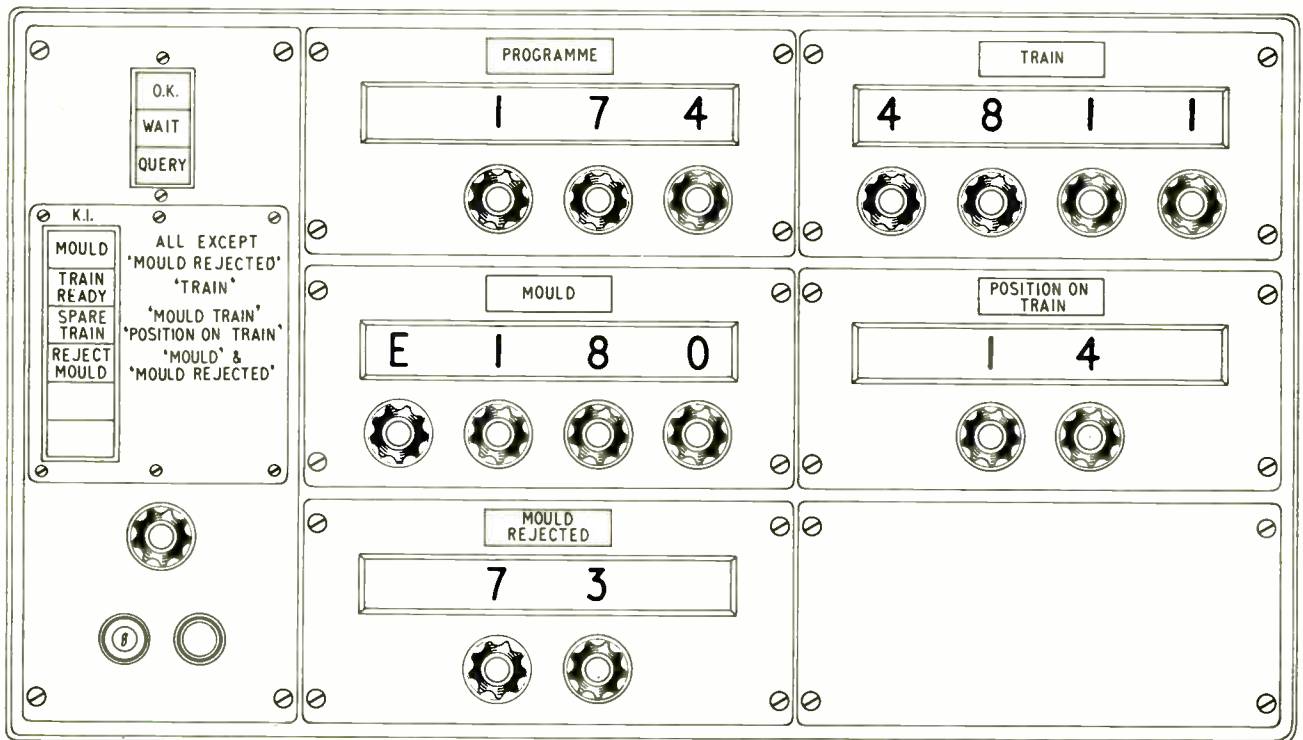

Fig. 3. The keyboard is of modular construction so that units can readily be changed to provide different facilities

include a unique label, and within the store of the computer are held processing instructions for each message. The instants in time when the various operators have messages ready for insertion are completely random, and, of course, the messages must be immediately dealt with as soon as they are ready.

### Message Collection

The organization of the process for determining when a message is ready, arranging for the computer to be available to assimilate the message, and then actually collecting the message is performed by a fixed programme scanner which is one of the lowest levels of the hierarchy system. A schematic block diagram of a typical arrangement is shown in Fig. 2.

The operators prepare the messages on keyboards which are placed at convenient locations on the production floor, and have been designed to provide the flexibility necessary to accommodate the wide variety of message types. Each keyboard can originate up to six types of messages and has for each type provision for a maximum of 24 decimal digits of associated data.

A detail of a typical keyboard is shown in Fig. 3 where it can be seen that the data switches are made from modular units and thus the differing requirements of the various keyboards can be readily accommodated. This arrangement provides a simple method of varying the quantity of data should this be found necessary. The message type that the operator wishes to assemble is indicated by the selector switch placed at the centre of the left-hand panel and against each position is shown the data switches which have to be set for the particular message. As only those data switches which are relevant to the message are collected by the scanner it is necessary that the fixed programme holds a list of which switches are read for each message.

Having now selected the message type and set the relevant data switches, the operator must inform the scanner that a message is ready. This is done by pressing the button at the bottom of the left-hand panel of the keyboard. A key-switch is also fitted next to the push-button which can inhibit its action and in this way protection is available against any unauthorized message entry.

### Scanner Operation

There is provision in the scanner for the input of up to 32 message types and each is allocated a separate channel. The action of pushing a button on a keyboard is to set an indicator against the particular message type. The scanner normally operates in a cyclic mode examining each of the message type indicators in turn. As soon as it finds one which has been set, the scanning operation stops and the computer situated at the next higher level of the hierarchy is immediately informed that a message is waiting to be collected. The computer will then organize itself to accept the message, a process which will almost certainly involve the temporary cessation of the operations it was currently doing. Under the control of the computer, the characters forming the message will then be collected one at a time by the scanner and sent to the computer.

It will be appreciated that the switches on the keyboard must not be moved while the message is being collected and therefore it is essential to give the operator an indication of when the process is complete. This is done by the three indicator lamps at the top of the left-hand panel of the keyboard. Normally the 'OK' indicator is illuminated and this shows that the keyboard is available to the operator on the shop-floor for the setting up and insertion of another message. As soon as the push-button is pressed 'OK' goes

off and 'WAIT' comes on and while this second indicator is illuminated none of the switches on the keyboard may be altered.

When the whole message has been transferred to the computer a series of checks is performed on the data to ensure that the operator has not made a mistake in setting his switches. If the results of these tests are satisfactory, 'WAIT' is extinguished and 'OK' re-illuminated. On the other hand if an error is detected, instead of 'OK' re-appearing, the operator sees 'QUERY'. He can then check and correct this message and re-insert it. Should the computer reject the message a second time it would be necessary to initiate an alarm in the control room and call the attention of the supervisor to the apparent discrepancy. In this way it can be seen that the supervisor is relieved of the routine functions and thus has the time available to deal rapidly with abnormalities as they occur.

### Fault Conditions

In an information-handling system of this nature precautions must be continuously taken to avoid the introduction of errors due to external interference. For this reason, for example, a code with considerable redundancy is used for reading the data switches, thus providing automatic indication of an error in reading. Similarly provision must be made to deal with the situation that will arise should some part of the data-handling system fail. The scanner is, therefore, provided with the ability to detect whether the computer to which it sends the process information is functioning correctly. If it finds that this is not the case, the scanner immediately transfers to a stand-by mode of operation wherein all the information is punched out on paper tape. In this way the information is not lost, and when the computer is working again it can catch up from the paper tape.

### Other Data Sources

The method by which data is entered by the operator has been explained in some detail. This is, as previously mentioned, not the only way of originating a message. Where plant information can be directly measured the data switches can be automatically 'set'. A further extension would be to allow the action of the particular plant process to 'press' the push-button, and in this way completely automatic entry of plant information can be obtained. Should the measured parameter be a slowly changing function a regular measurement of it will be required and a timer can be used to actuate the message input at regular intervals. The data source can be either digital as has been assumed in the discussion above, or analogue when an analogue to digital converter will be necessary.

Using these techniques, an extremely versatile method of collecting data describing the various operations and actions in an industrial plant is available. The data can then be transferred to the higher levels of the information and data-handling control hierarchy to enable this powerful management tool to perform its functions.

### INFORMATION WANTED ?

If you require further details of products or processes described or advertised in INDUSTRIAL ELECTRONICS you will find it convenient to use the enquiry cards which will be found in the front and back of the journal.



# Distortion Correction in Complementary Transistor Amplifiers

By

G. W. HOLBROOK, B.Sc., M.Sc., Ph.D.

and

M. W. ALARY, B.Sc.\*

The value of complementary p-n-p and n-p-n transistors in amplifiers is limited by the non-linear distortion arising due to crossover effects at low signal levels and by the lack of symmetry experienced at higher signal levels. By inserting non-linear resistive networks in the input circuits substantial improvements in non-linear distortion can be achieved with only minor decreases in gain.

THE usefulness of complementary p-n-p and n-p-n transistors in amplifiers<sup>1</sup> is often limited by the lack of symmetry which occurs even in so-called matched pairs. In addition, any approach to ideal class B conditions inevitably leads to crossover distortion, particularly at low signal levels. This has been minimized<sup>2</sup> by the use of high-impedance driving sources, which tend to mask the rapid change of input impedance of these circuits at low signal levels.

It has been previously shown<sup>3</sup> that non-linear distortion in single-ended transistor amplifiers can be minimized by the use of non-linear resistive elements in series with the input to the final stage. Similar methods have also been employed<sup>4</sup> to correct normal push-pull amplifiers operating under class A or class AB conditions. The following paragraphs indicate that the same approach can be adopted to minimize the odd-order harmonics produced by symmetrical non-linearity and also the even-order harmonics produced by asymmetrical non-linearity, due to a mismatch between complementary transistors.

The transfer characteristic of a transistor amplifier can be displayed by plotting the relative values of collector current  $I_c$  against base-emitter voltage  $V_{be}$ . Although this particular characteristic is one which is not normally quoted by manufacturers, it has been shown by Armstrong<sup>1</sup> that such a display is more indicative of the performance of an amplifier than are some of the conventional characteristics of transistors. Fig. 1 shows the relative values, in terms of load current, for p-n-p and n-p-n matched transistors in which  $V_1$  is the signal voltage applied to the common junction of the two bases after the bias voltages  $V_{be1}$  and  $V_{be2}$  have been adjusted to give zero-signal collector currents of 0.5 mA in each collector. It will be noted, by comparison with the line PQ, that the transfer characteristic is anything but linear. For low signal voltages the slope of the  $I_c/V_1$  curve is comparatively low, giving rise to crossover distortion of the output waveform. For higher values of input voltage the characteristic becomes more linear but it is very evident that there is a significant mismatch between the positive and negative regions which will inevitably give rise to even-order harmonics in the output waveform.

Although the non-linearity shown by Fig. 1 is very evident, a more striking and useful display is achieved by plotting the value of transfer resistance,  $R_t$ , against input voltage. Transfer resistance can be defined for a single-ended amplifier as  $R_t = V_{be}/I_c$  and for the push-pull circuit shown in Fig. 1 as  $R_t = V_1/I_L$ .

The curve AB of Fig. 2 ( $R_g = 0$ ) illustrates the variation of  $R_t$ , for the conditions outlined in Fig. 1. It will be noted that the transfer resistance rises rapidly for low values of  $V_1$ , in the crossover area, and becomes lower and more constant for higher input voltages of either polarity. As a comparison, a truly linear transfer characteristic, as illustrated by the line PQ in Fig. 1, would correspond to a constant value of  $R_t = 30$  ohms in Fig. 2.

The effect of adding a resistor,  $R_g$ , in each base lead is illustrated by the line CD which shows the corresponding values of  $R_t$  and  $V_1$  for  $R_g = 600$  ohms. While a general increase in  $R_t$  is brought about by such an arrangement, the percentage change in  $R_t$  over the complete range of  $V_1$  is considerably less than in the line AB where  $R_g$  is effectively zero. Thus it is evident that any linear increase in the input resistance of the transistor results in an overall improvement in the linearity of the amplifier as a whole, at the expense of a decrease in amplification as exemplified by the general increase in  $R_t$ . This illustrates the masking effect of linear resistance added to the input of the amplifier.

If a non-linear resistor is added in the input circuit then an even greater correction can be obtained. For example, if  $R_g$  tended toward zero at low input voltages and approached 600 ohms at higher values of input, then a compromise between the characteristics of the lines AB and CD would be achieved. Ideally, a constant value of  $R_t$ , representing completely linear amplification, would result if a non-linear resistor, complementary in value to the input resistance of each transistor, could be connected in each base lead.

Typical ideal  $R_g$  characteristics are shown in Fig. 3, which illustrates the relative values of resistance and voltage required to achieve a constant value of  $R_t$  in the previous circuit. It will be noted, at low values of voltage, that the value of the non-linear resistor is required to approach zero in value, while a maximum value is required at higher voltages. This figure also illustrates the unequal values of

\* Nova Scotia Technical College, Halifax, N.S.

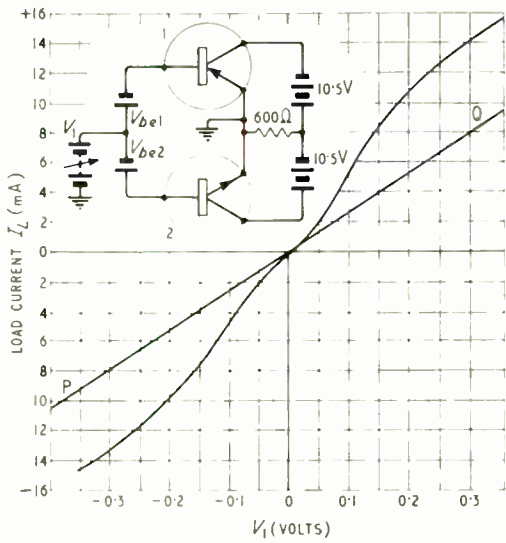

Fig. 1. Load current of complementary symmetry amplifier

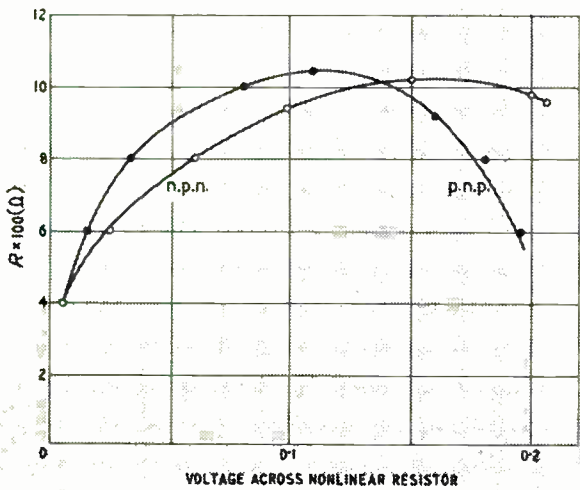

Fig. 3. Required correction characteristic for  $R_L = 38 \Omega$

input resistance required at corresponding voltages for each of the n-p-n and p-n-p transistors.

A practical circuit which achieves a compromise toward this ideal is shown in Fig. 4, in which the resistance  $R_g$  in the base lead of each transistor is replaced by a network composed of biased diodes and linear resistors. The diodes  $W_{2a}$  and  $W_{2b}$  are normally in the forward-bias condition, the bias voltages  $V_a$  and  $V_b$  being obtained by tapping the base-bias resistor on either side. An input signal of either polarity will cause one or other of these diodes to move into the reversed-bias or high-resistance condition which achieves the increase in  $R_g$  required for linearity. For higher values of input signal the diodes  $W_{1a}$  and  $W_{1b}$  are changed from their quiescent reversed-bias condition to a final forward-bias condition resulting in a decrease in  $R_g$  for large signals. The combined effect of the biasing voltages  $V_a$  and  $V_b$  and the input signal are modified by the resistors  $R_{1a}$ ,  $R_{2a}$ ,  $R_{1b}$  and  $R_{2b}$  to provide a smooth transition between forward and reverse bias, or vice versa, as the signal is imposed.

Fig. 5 is indicative of the improvements that can be achieved

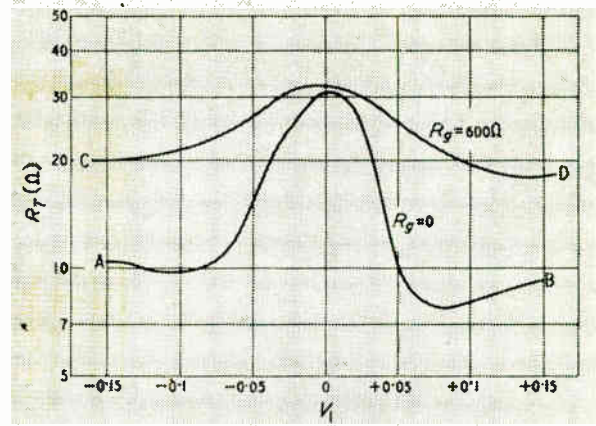

Fig. 2. Complementary symmetry  $R_L$  characteristics

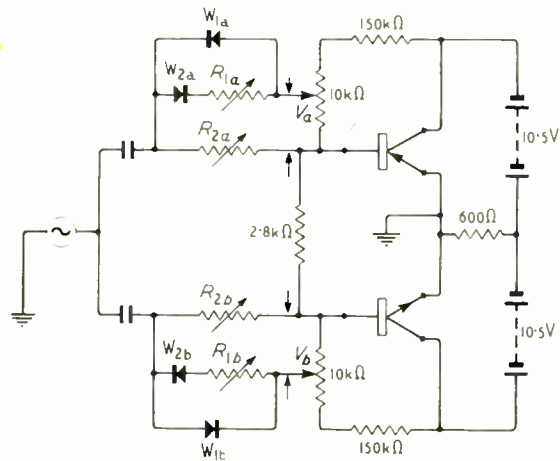
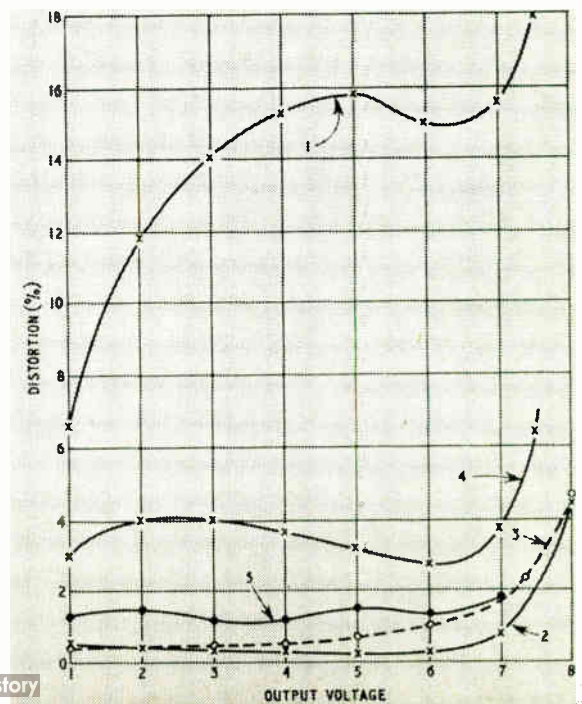

Fig. 4. Complementary symmetry amplifier with correcting network

Fig. 5. Curve (1) no correction (2) optimum correction (3) partial correction (4) no correction but  $R_g$  adjusted for the same gain as with correction (5) random transistors





by the correcting network described above. In all cases the input signal was obtained from a 600-ohm resistive source and the initial no-signal collector currents were established at 0.5 mA. Curve No. 1 shows the gross distortion arising with no correcting network in the circuit and indicates that the ultimate overload, or crash point, is at an output of about 7.5 volts for the pair of matched transistors previously considered. Curve No. 2 indicates the improvement in distortion that can be achieved by adjusting the variables in Fig. 4 for minimum distortion at an output of five volts. Curve No. 3 results when only partial correction is applied by employing only the rectifiers  $W_{2a}$  and  $W_{2b}$  and their associated resistors. This condition corrects for non-linearity only in the lower ranges of signal voltages, as can be seen by comparison with Curve No. 2.

Curve No. 4 serves as a datum condition in which correction is attempted by the use of linear resistors in place of the two correcting networks. These linear resistors were adjusted to give the same loss of gain, 6 dB, as that suffered under the conditions of Curves Nos. 2 and 3 and serves as a means of comparing the merits of these two methods of correction. Curve No. 5 indicates the typical improvements that can be achieved by a random selection of unmatched pairs.

A convenient method of assessing the efficacy of any correcting network is to determine a Figure of Merit, defined as:—

$$M = \left[ \begin{array}{l} \text{Reduction in distortion} \\ \text{achieved by network} \end{array} \right] - \left[ \begin{array}{l} \text{Loss of gain} \\ \text{caused by network} \end{array} \right] \text{dB}$$

Table 1 shows the actual and relative values of  $M$  achieved in Fig. 5 for an output voltage of five volts in each case.

It is evident from these results that substantial improvements in non-linear distortion can be achieved in this type of amplifier by employing individual correcting networks in the base lead of each transistor. Although it is necessary to adjust the correcting network to achieve optimum conditions for each pair of transistors inserted in the circuit it is not necessary to have all the six variables shown in Fig. 4 continuously adjustable. The resistors  $R_{1a}$ ,  $R_{2a}$ ,  $R_{1b}$ ,  $R_{2b}$  can be replaced by resistance boxes in the initial setup and five percent preferred values of resistors substituted after optimum con-

TABLE 1

Curve	Condition	$M$ based on Curve No. 1 (dB)	$M$ based on Curve No. 4 (dB)
2	Optimum correction of matched pair	32	19
3	Partial correction of matched pair	24	16
4	Correction by linear resistor	8	—

ditions are determined. The two potentiometers controlling  $V_a$  and  $V_b$  are, however, required as continuously adjustable elements. A convenient visual method of determining the efficacy of any correcting device has been described elsewhere<sup>3</sup> and this method was employed almost continuously during the investigation. Due to the individual adjustments required, this method of correcting non-linearities is limited to cases where low values of distortion, without feedback, are of paramount importance and the effort of individual adjustment can be justified.

#### References

- <sup>1</sup> H. L. Armstrong, 'How to design transistor amplifiers', *Canadian Electronic Engineering*, Vol. 13, pp. 29-31, March 1959.
- <sup>2</sup> J. J. Faran and R. G. Fulks, 'High impedance drive for the elimination of crossover distortion', *Solid State Journal*, pp. 36-40, August 1961.
- <sup>3</sup> G. W. Holbrook, 'Continuous CRO display simplified amplifier distortion testing', *Canadian Electronic Engineering*, pp. 41-43, October 1959.
- <sup>4</sup> G. W. Holbrook, 'Correction of non-linearities in transistor amplifiers', *I.R.E. Transactions on Audio*, Vol. AU8, pp. 103-104.
- <sup>5</sup> G. W. Holbrook and E. P. Todosiev, 'Correction of non-linear distortion in transistor amplifiers', *Canadian Electronic Engineering*, Vol. 5, No. 10, pp. 35-41, October 1961.
- <sup>6</sup> R. D. Lohman, 'Complementary symmetry', *Electronics*, pp. 140-143, September 1953.

## EFFLUENT CONTROL

An increasing number of industrial concerns are having to meet the requirements of Local Authorities in respect of the quality of the effluent discharged from their plants.

In practice a manually-operated plant can rarely efficiently maintain the discharged effluent quality within the specified limits required by the Statutory Authorities, whereas an automatic effluent control system can hold the quality within specified limits with the advantage of economy in both labour and dosing materials.

A range of industrial electrode systems is available from Electronic Instruments Ltd. to suit each individual application. A typical arrangement for straightforward acid/alkali effluents is to have a system fitted with pH responsive electrodes. The signal from this system is then fed to a pH meter which provides an electrical output proportional to its reading. This output signal can be fed to either an electrical or pneumatic controller. An adjustable set point is provided on the controller and should the measured pH deviate from this point a valve is opened or closed so as to adjust the amount of neutralizing reagent added.

For further information circle 40 on Service Card

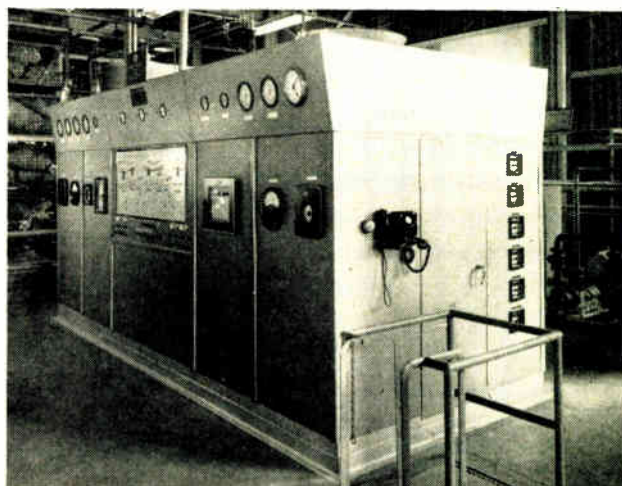

A typical effluent control equipment is shown here



## High Definition Radar

FOR SEA OR RIVER USE

*This 10-ft aerial produces a horizontal beamwidth of  $0.75^\circ$  at half-power points and better than  $1.8^\circ$  at  $-20$  dB points. It has a forward gain of 33 dB*

Decca Radar Limited have introduced two marine radar equipments which have been developed for use in very confined waters. Known as Types HD 404 and HD 434 they provide river radar standards of performance and clarity at close range and yet are designed to meet the requirements of the British Ministry of Transport type approval specifications for normal marine radar.

These radar equipments are designed for sea-going vessels, such as coasters and ferries, which require to navigate for considerable distances in rivers and canal systems to reach inland ports. Equipment of this type is also suitable for use as a second radar in larger vessels.

Both of the radar sets are 20-kW equipments with 9-in. relative motion displays. Type HD 404 uses a 6-ft aperture

parabolic cylinder aerial while Type HD 434 incorporates the more advanced 10-ft slotted waveguide array. The shorter of the two switchable pulse lengths is of only  $0.05$   $\mu$ sec and ensures very high-range discrimination. The close range performance is good and the display has several closely grouped short-range scales to permit the most suitable to be selected in any locality. The minimum range is less than 15 yd. with range discrimination of less than 10 yd on the  $\frac{1}{4}$  or  $\frac{1}{2}$  n.m. range scales. To increase the warning ahead provided on the short-range scales, off-centring to half tube radius is provided. The long pulse of  $0.3$   $\mu$ sec gives a full radar picture on the longest range scale of 24 n.m. for open sea use.

For further information circle 41 on Service Card

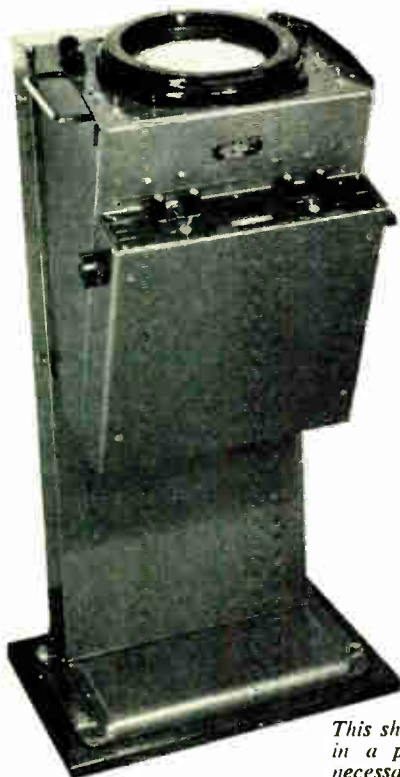

*This shows the 9-in. display unit in a pedestal mount with the necessary controls*



*The 6-ft scanner which has a beamwidth of  $1.2^\circ$ . It can be driven by a  $\frac{1}{2}$ -horse power motor and maintain normal performance in relative wind speeds of up to 80 knots*





### Personal and Company News

Professor Sir Willis Jackson, D.S.C., M.I.E.E., F.R.S., has been appointed chairman of the Television Advisory Committee in succession to Sir Charles Daniel, K.C.B., C.B.E., D.S.O.

Howard A. Greenwald has joined the Univac Computer Division of Remington Rand Ltd. as assistant to the general manager. Lt. Col. James J. Wise, O.B.E., has also joined this division as manager of the U.K. Headquarters Planning and Services Department.

G. H. Wilson, C.B.E., has resigned from his positions of chairman and managing director of Laurence, Scott and Electromotors Ltd. P. M. Tapscott, B.A., becomes chairman, J. B. Wormald, M.I.E.E., becomes managing director and W. McCraith, B.Sc., A.M.I.E.E., A.M.I.Loco.E., has been appointed a local director.

Dawson Donaldson, B.Sc., M.I.E.E., has become chairman of the Commonwealth Telecommunications Board in succession to Sir Ben Barnett, K.B.E., C.B., M.C.

The Scientific Instrument Manufacturers' Association has changed its address to Sima House, 20 Peel St., London, W.8.

Elliott-Automation have announced that The Rheostatic Co. Ltd. is to change its name to Satchwell Controls Ltd. as from 1st January 1963.

Automatic Control Engineering Ltd. and Hartons Installations Ltd. are negotiating a merger and a jointly-owned new company is being formed — A.C.E.-Hartons Ltd.

International General Electric Co. of New York Ltd., the British subsidiary of U.S. General Electric, has formed an Industrial Electronics Division.

Gulton Industries (Britain) Ltd. have moved to 52 Regent Street, Brighton 1, Sussex (Telephone: Brighton 680004).

A.E.I. Automation Ltd. has received an order for an alarm analyser for the Oldbury 560-MW nuclear power station. It includes a 1010 digital computer and an input signal scanning device. Such apparatus is called for because there is the possibility of up to about 3,000 input alarm signals!

Gerard de Verteuil, formerly controller of Schlumberger Overseas S.A., has been appointed controller and secretary of The Solartron Electronic Group Ltd. Alexander G. Scott, formerly chief accountant and controller of Solartron, has been appointed controller and secretary of Schlumberger.

*The aerial of the S.T.C. instrument landing system is about 160 ft long and 18 ft high. It is placed 1,000 ft beyond the 'stop' end of the runway*

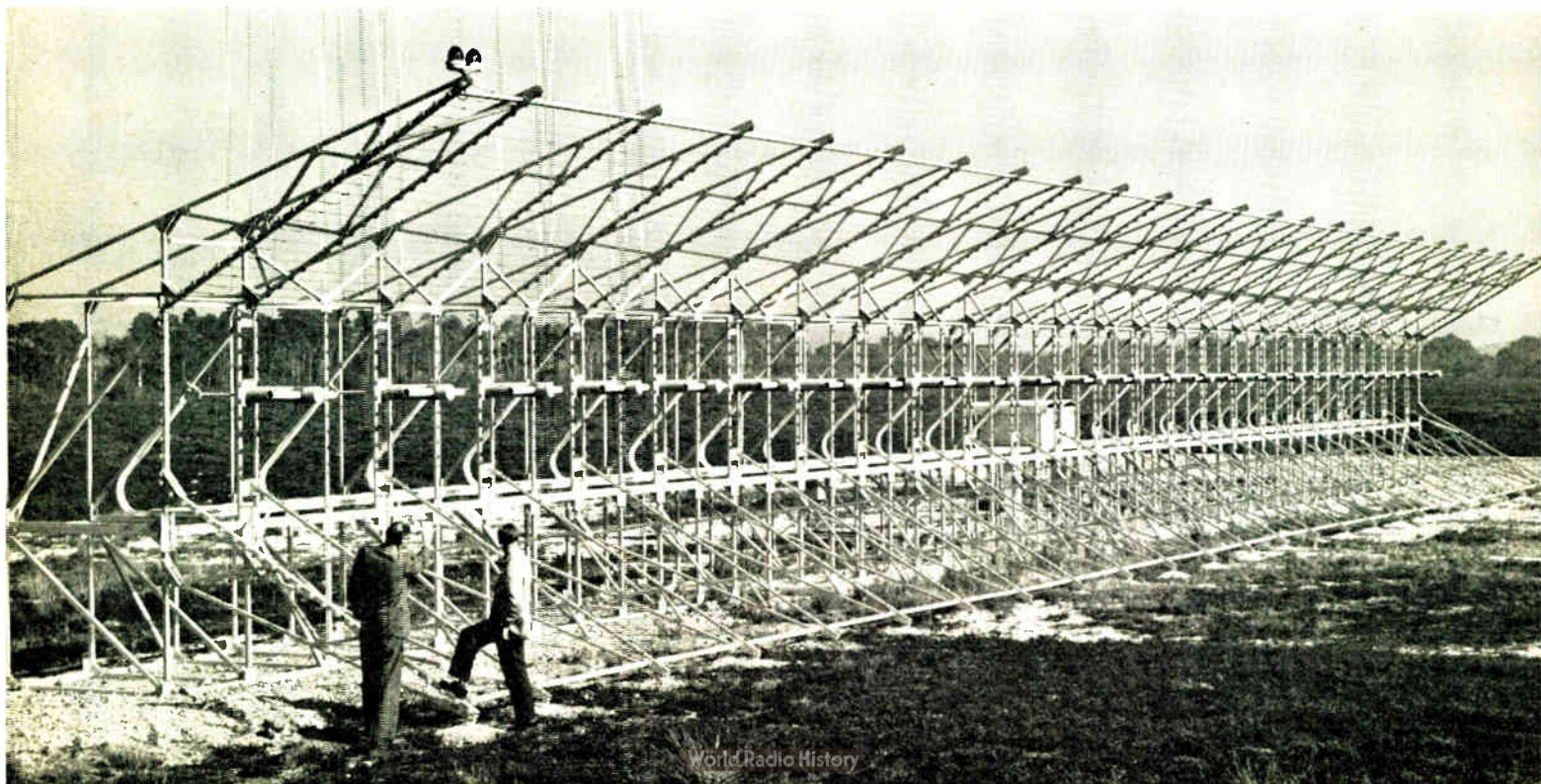





*Closed-circuit television installed by Thorn Electrical Industries at a branch of the Westminster Bank. One picture shows a statement of account presented on a monitor in the manager's office, the other shows the transmitting end, also with a monitor. The statement is placed face downwards on a glass panel beneath which the camera tube is mounted*

**For further information circle 42 on Service Card**

**International Systems Control Ltd.** can now supply mobile computer centres incorporating the Thompson Ramo Wooldridge T.R.W. 330 digital computer. Housed in a 40-ft trailer, it provides a complete process-control room. One has recently been leased to Phillips Petroleum Co.

**G. E. Baker, B.Sc.(Eng.), A.M.I.W.M.,** has been appointed manager of the A.E.I. Electronic Apparatus Division at New Parks Factory, Leicester.

**S. G. S. Fairchild** have leased a factory for the manufacture of transistors and integrated semiconductor circuits. The company's address is now, Stonefield Way, Victoria Rd., South Ruislip, Middlesex.

**Major William Logan,** sales director of Avo Ltd., has been elected chairman of the nucleonic group of the Scientific Instruments Manufacturers' Association.

**Southern Analytical Ltd.** announce that their Polarotrace cathode-ray polarograph has been standardized by the U.S. Food and Drug Administration for certain analyses.

**David Barker,** formerly public relations manager of Creed and Co. Ltd. has become European area director of public relations at I.T.T. Europe Inc. in Brussels.

**Hird-Brown Ltd.** have moved to Flash Street, Bolton, Lancs. (Telephone 27311).

*In a new method of plating thin wire developed by Ultra Electronics Ltd. the wire is held under tension between two driven chucks in a small lathe. While rotating it is sprayed with an electrolyte from a nozzle maintained at a different potential from that of the wire. Wires up to nine inches long and down to 0.001 in. diameter can be treated. The method has been developed to plate wires with magnetic alloys for use in computers*

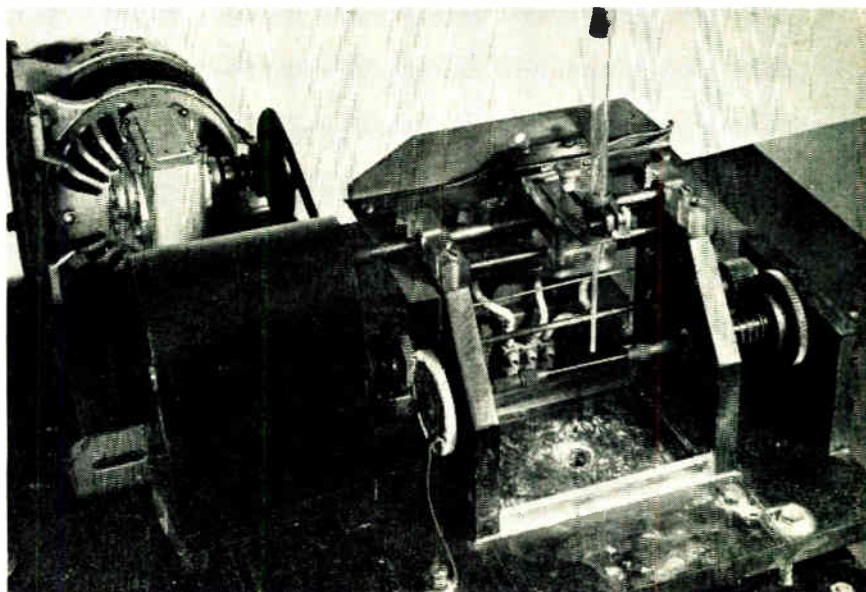



## PERSONAL AND COMPANY NEWS (contd.)

**A. Salmon, Ph.D., B.Sc., F.Inst.F., A.M.I.E.E.**, has been appointed deputy sales manager of the Scientific Apparatus Department of A.E.I. Instrumentation Division.

**D. A. Hurst** has been appointed technical sales engineer to **Chilton Electric Products Ltd.** and **J. A. Thistlewood** becomes production manager.

**Industrial Components, Ireland, Ltd.**, a wholly-owned subsidiary of the Raytheon Co., is opening at Shannon to manufacture electronic components. It will be managed by **Joseph D. Cornelius**.

**N. L. Keen** has been appointed managing director of **Hellermann Deutsch Ltd.**, a member of the Bowthorpe Holdings Ltd. group.

**Sifam Electrical Instrument Co. Ltd.** have appointed **Jeffery A. Thomas** sales manager and **E. R. Steed** technical representative for the Midlands area.

All home and export enquiries for **Portland Plastics Ltd.** should be addressed to the sales manager, **A. E. Lloyd-Dodd**, Bassett House, Hythe, Kent (Telephone: Hythe 67481).

**Westool Ltd.** have appointed **Modern Plant Ltd.**, Crumlin Road, Dublin, to be their Eire representative.

**Victor Breeze**, managing director of **Allen West & Co. Ltd.**, has now retired at the age of 78.

*Pye closed-circuit television apparatus is used in the Central Electricity Generating Board Station at Bradwell. Similar equipment has been fitted to the Civil Nuclear Power Station at Latina, near Rome. The camera can be lowered by a winch 80 ft into the core of the reactor to enable channel walls and fuel elements to be inspected. The camera is 42½ inches long but only 3½ inches in diameter*

For further information circle 43 on Service Card

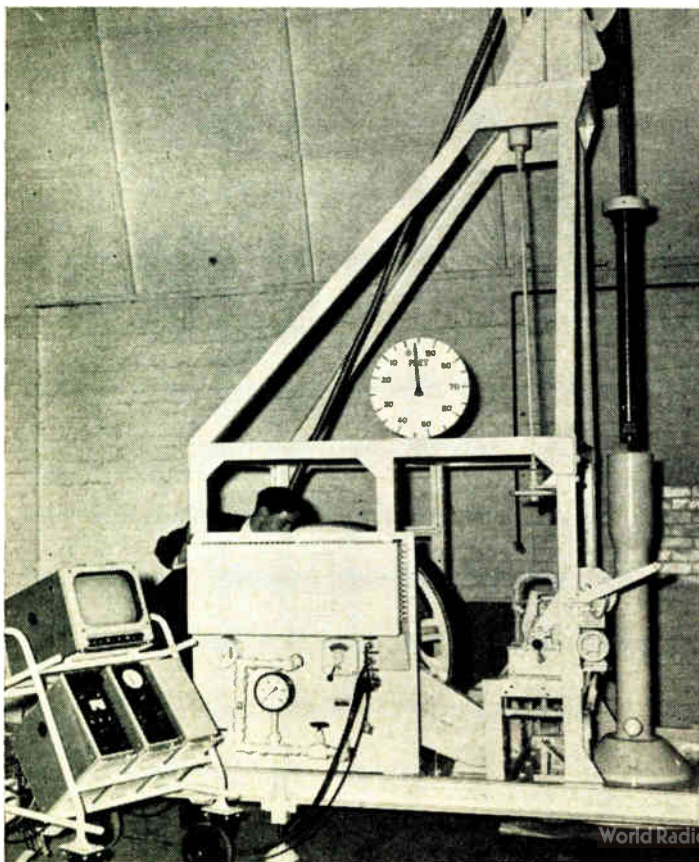

## Telstar

There have recently been reports that the apparatus in Telstar has ceased to function correctly. It has now been announced that it is only the command function that has ceased to operate. This was arranged to enable the receiver to be turned on and off as required by signals from the ground in order to conserve the batteries. This cannot now be done and the receiver is functioning continuously. The telemetry apparatus, which is one of the most important parts of Telstar, is not affected at all.

## Road Traffic Control

**Decca Radar Ltd.** are developing a range of electronic apparatus for the measurement and control of road traffic. Traffic crossing detectors are fitted in a road and provide information on vehicle speed, flow and concentration. The signals can be fed to a central point by telephone lines, so that the detector can operate unattended. The apparatus can be used to make traffic surveys for planning purposes.

It is also possible to interconnect a number of such detectors with a computer the output of which is connected back to control traffic lights. In this way a system can be built up to control traffic over an area automatically.

## International Telemetering Conference

A conference sponsored by the American Institute of Electrical Engineers, the American Rocket Society, the Institute of Aerospace Sciences, the Institute of Radio Engineers, the Instrument Society of America, the British Institute of Radio Engineers and the Institution of Electrical Engineers will be held during the week starting 23rd September 1963 at the Institution of Electrical Engineers, London. At the same time there will be an exhibition of telemetering equipment.

## Digital Data Link

A new data-transmission system is in operation between the G.E.C. establishments at Witton and Erith. It is expected to reduce from 16 hours to 1½ hours the time taken to transfer information. It is, however, designed to achieve a very low undetected error rate rather than high-speed transmission, and it is claimed that this rate can be as low as one in 14 million. Frequency-shift modulation is used.

## Solid Circuits

A conference on solid circuits and microminiaturization is being held by the West Ham College of Technology, Romford Road, Stratford, London, E.15. It will be held on 6th and 7th June 1963. Further information is obtainable from the Electrical, Electronic and Control Engineering Department.

## H.F. Communication

The Electronics Division of the Institution of Electrical Engineers is holding a convention on h.f. communication on 25th—27th March 1963.

## Correction

In the article 'Semiconductor Photocells', p. 129 of the December issue, the captions to Figs. 2 and 4 were transposed.

# Correspondence

## Thin-Film Transistor

Sir.—Your article on the thin-film transistor in your November issue gives an illustration showing the use of a semiconductor which is stated in the text to be cadmium sulphide. It is important to be clear that this semiconducting material is a layer of micro-crystalline cadmium sulphide and therefore substantially different from the single crystal cadmium sulphide which has been used for other experiments on space-charge limited currents (see for example the article on cadmium sulphide crystals in the March 1962 issue of *Electronic Technology*).

A feature of micro-crystalline films is that a gold film can be used for the source electrode. The original article states that 'with a suitable low resistance contact at the source,

current densities of the order of hundreds or thousands of amperes per square centimeter can be drawn through the cadmium sulphide film in spite of its normally high resistance'. For single-crystal cadmium sulphide a suitable low resistance contact would be obtained by means of indium. It appears from the published characteristics that the current densities actually obtained were of the order of one or two milliamps per square millimeter of the electrode surface and therefore less than one ampere per square centimeter, in contrast to the suggested hundreds or thousands of amperes per square centimeter which could be obtained with a suitable contact. But in the thin-film transistor the current flows laterally along the film, so that the current density on the film is much greater than that at the electrode surface, so the latter is not critical.

With regard to the hysteresis loops in some of the contacts, I believe such loops are also common in the passage of space-charge limited currents through single crystal cadmium sulphide.

Director of Research,  
AMF British Research Laboratory,  
Reading,  
Berks.

D. A. BELL.

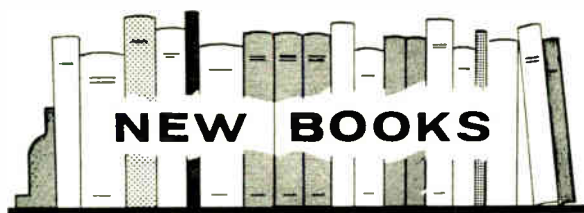

## Semiconductor Device Physics

By ALLEN NUSSBAUM. Pp. 340 + xi. Prentice-Hall International Inc., 28 Welbeck Street, London, W.1. Price 50s.

Intended for the science student and engineer in industry, this book has eight chapters covering quantum physics, thermostatics and statistical physics, energy bands and carrier statistics, the theory of junction devices, periodic structures and energy bands, irreversible thermodynamics, transport theory and semiconductor parameters.

The treatment is mathematical but explanations and analogies are used wherever practicable and help greatly to an understanding. More detailed explanations would have helped even more but, of course, would have made the book larger.

The subject is a difficult one and the treatment, although not as simple as one would like, is perhaps as simple as one as is possible. The book is most certainly a useful one.

## Basic Radar, Part 1

Pp. 92. The Technical Press Ltd., 112 Westbourne Grove, London, W.2. Price 16s.

The primary function of this book is as a basic training manual for the Royal Electrical and Mechanical Engineers and it has been developed by a special electronics training

investigation team in conjunction with Technical Training Command of the Royal Air Force and Decca Radar Ltd. It follows the pattern so successfully developed in earlier 'basic training' books. It is profusely illustrated and the text is very clear. It gives an overall picture of what modern radar can do and an outline of how it does it.

It is intended that the student should follow Part 1 of 'Basic Radar' by all three parts of 'Basic Electronic Circuits' and only then turn to Parts 2 and 3 of 'Basic Radar'. Part 2 shows how the elementary circuits of 'Basic Electronic Circuits' are built-up into the subsidiary circuits of radar, such as display systems, and Part 3 explains how, in turn, these are put together to form a complete radar system.

## Physical Electronics

By CURTIS L. HEMENWAY, RICHARD W. HENRY and MARTIN CAULTON. Pp. 396 + xiv. John Wiley and Sons Ltd., Gordon House, Greencoat Place, London, S.W.1. Price 62s.

This book is intended as an introductory course for electrical engineering and physics students. The author considers that it would normally precede a course in electronic circuit theory and practice, but not everyone will agree with him on that. Indeed, since equivalent circuits are included the reader must have at least some prior knowledge of circuit theory.

The starting point is 'particles and waves' and on p. 7 the reader is introduced to the Heisenberg uncertainty principle, on p. 9 to wave functions and on p. 10 to the Schrodinger equation. The authors can hardly be accused of 'padding'. The treatment is so brief, in fact, that it is doubtful if anyone coming fresh to these things will gain much useful knowledge of them.

Chapter 2 deals with bound particles, 3 with statistics, 4 with electron emission and 5 with charged particle dynamics. Classical vacuum devices, by which is meant



valves, come next, followed by a discussion of induced currents, a.c. power and equivalent networks. Assemblies of particles, gaseous processes, gaseous devices and the liquid state and plasmas are the headings of succeeding chapters. Then come the band theory of solids, semiconductors and semiconductor devices and the book finishes with chapters on the physics of electron beams and modern amplifiers.

The treatment makes free use of mathematics up to the level of the calculus, but it is not one which could fairly be described as highly mathematical.

#### **Synthesis of Optimum Nonlinear Control Systems**

By HARRY L. VAN TREES. Pp. 102 + ix. The M.I.T. Press, Massachusetts Institute of Technology, Cambridge, Massachusetts, U.S.A. Price \$4.

The subject of this book is an important one and its title is just what most control engineers want to do. It is a complex subject, however, and the treatment is by no means easy. Probably few engineers will be able to make much of it without help from mathematicians.

#### **It's Easy to Use Electronic Test Equipment**

By LARRY KLEIN and KEN GILMORE. Pp. 186. John F. Rider Publisher, Inc., 116 W. 14th Street, New York 11, N.Y., U.S.A. Price \$4.

#### **Taschenbuch der Nachrichtenverarbeitung**

By K. STEINBUCH. Pp. 1521 + xvi. Springer-Verlag, Heidelberger Platz 3, Berlin-Wilmersdorf, Germany. Price DM 98.

#### **Electronic Data-Processing Equipment and Methods**

By ALBAN and LAMB. Pp. 20. Charles Knight and Co. Ltd., 11-12 Bury Street, St. Mary Axe, London, E.C.3. Price 3s. 6d.

#### **Repairing Home Audio Systems**

By E. EUGENE ECKLUND. Pp. 320 + vii. McGraw-Hill Publishing Co. Ltd., 95 Farringdon Street, London, E.C.4. Price 54s.

## **Manufacturers' Literature**

**Arcoelectric Switches and Signal Indicator Lamps.** This latest 20-page catalogue (list No. 134) by Arcoelectric describes in detail their current range of switches and signal indicator lamps; prices are also given.

*Arcoelectric Switches Ltd., Central Avenue, West Molesey, Surrey.*

**For further information circle 44 on Service Card**

**'Airmax' Blower Fans.** A.K. Fans have issued 13 catalogue sheets describing part of the standard range of 'Airmax' miniature blowers for forced cooling in military and commercial electronic equipment. These range from a 1-in. cube to a 7½-in. diameter blower.

*A.K. Fans Ltd., 20 Upper Park Road, London, N.W.3.*

**For further information circle 45 on Service Card**

**Digitron Display Tubes.** The Digitron is a glow discharge, character display tube with up to 10 characters which can be made to glow by selection by external circuitry. This 14-page booklet describes the tube, its operation and methods of driving the tube.

*Ericsson Telephones Ltd., Tube Division, Beeston, Nottingham.*

**For further information circle 46 on Service Card**

**Mark 3 Electronic Instruments.** A 6-page leaflet describing a single 2-, 3-, 4-, 6-, 8-, 12-, or 16-point strip-chart indicating recorder for the measurement of all variables which can be expressed in terms of an electrical signal.

*George Kent Ltd., Luton, Beds.*

**For further information circle 47 on Service Card**

**Creed High Speed Tape Winder.** The winder described in this single-sheet leaflet provides automatic tape winding facilities for data processing systems and operates at speeds up to 6 in./sec.

**Projector Printer.** In this 4-page leaflet a printer is described which provides means whereby received teleprinter messages may automatically be displayed on to a screen, in greatly magnified form.

Both of these leaflets are published by:

*Creed and Co. Ltd., Telegraph House, Croydon, Surrey.*

**For further information circle 48 on Service Card**

**Thorn SGF Signal Lamps.** This 12-page booklet describes the range of Thorn SGF signal lamps which are integral units with neon or incandescent lamps built into a plastic holder. No retaining nuts or screws are required for fixing; the units push into close-fitting recesses.

*Thorn Electrical Industries Ltd., Special Products Division, Gt. Cambridge Road, Enfield, Middlesex.*

**For further information circle 49 on Service Card**

**Inco-Mond Carbonyl-Iron Powders.** This 24-page publication provides comprehensive charts and tables of the fundamental magnetic, chemical and physical properties of Inco-Mond Carbonyl-Iron powders.

*The International Nickel Company (Mond) Ltd., 20 Albert Embankment, London, S.E.1.*

**For further information circle 50 on Service Card**

**Varian Recorders.** This folder gives brief details of a range of eight portable pen recorders which are distributed in the U.K. by:

*Livingston Laboratories Ltd., 31 Camden Road, London, N.W.1.*

**For further information circle 51 on Service Card**

**D.C. Amplifier.** Information is given in this 4-page leaflet on a new Record d.c. amplifier unit which can be used to increase the sensitivity of indicators, recorders, relays, etc.

*The Record Electrical Co. Ltd., Broadheath, Altrincham, Cheshire.*

**For further information circle 52 on Service Card**

**Cambridge CO., Equipment for Flue-Gas Analysis.** In this 8-page illustrated brochure, information is given in respect of both individual instruments and complete flue-gas analysis systems. Installation details are also included.

*Cambridge Instrument Co. Ltd., 13 Grosvenor Place, London, S.W.1.*

**For further information circle 53 on Service Card**

**Radiovisor Alarm Muting Relay.** This single-page leaflet describes a device which will silence an audible alarm but retain a visual indication until the alarm condition is corrected.

*Radiovisor Parent Ltd., Stanhope Works, High Path, London, S.W.19.*

**For further information circle 54 on Service Card**

**Manual Core Test Jigs.** A 2-page leaflet gives details of a series of mechanical test jigs for analysing a wide range of miniature magnetic cores.

*Computer Instrumentation Corporation, Route 38 and Longwood Avenue, Cherry Hill, N.J., U.S.A.*

**For further information circle 55 on Service Card**

**E.M.I. Photomultiplier Tubes.** Full technical specifications of E.M.I. photomultiplier tubes are included in this 16-page publication, with characteristics given in both graphical and tabular form. A selection chart is provided which indicates the most suitable tube for a given requirement.

*Valve Division, E.M.I. Electronics Ltd., Hayes, Middlesex.*

**For further information circle 56 on Service Card**

**ADCOLA**  
REGISTERED TRADE MARK  
(Regd. Trade Mark)

**HIGH EFFICIENCY  
SOLDERING INSTRUMENTS  
FOR  
BENCH LINE PRODUCTION**



Apply direct to  
Head Office Sales and Service

**ADCOLA PRODUCTS LTD.  
ADCOLA HOUSE  
GAUDEN ROAD  
LONDON S.W.4**

Telephones  
**MACaulay**  
4272  
and  
3101

Telegrams  
**SOLJOINT, LONDON S.W.4**

Industrial Electronics January 1963

**WHITELEY**

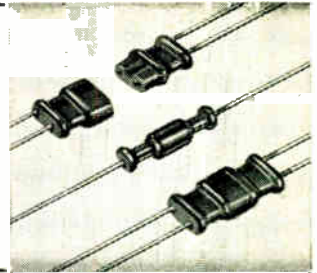

**electronic  
components**

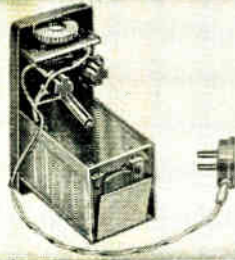

**have  
built**



**a high  
reputation**

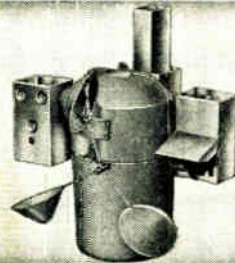

**for  
quality**

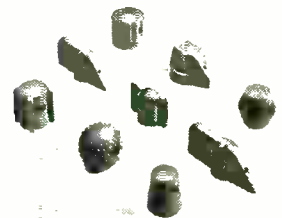

**and  
reliability**

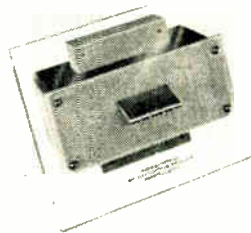

The items shown here are representative of the extensive variety of products manufactured by the Whiteley organisation. Our technical resources are available for the development and production of specialised components for the electronic industry.

*Get in touch with us NOW...*

**WHITELEY ELECTRICAL RADIO CO LTD**  
MANSFIELD · NOTTS · Telephone: Mansfield 1762-5



1

Improved accuracy,  
now  $\pm 0.1\%$ .

2

Faster—  
about 60 volts/sec.

3

True RMS sensing  
immune to  
waveshape changes.

4

Temperature  
compensated  
(Pat. applied for)

5

Continuous servo—  
no creeping towards  
balance and  
NO NOISE.

6

Tropicalised,  
DEF spec. quality.

7

Wide/narrow  
range facility.

8

Price unchanged  
since 1953.

## counts toward supremacy in A.C. Stabiliser design by

# SERVOMEX

Servomex A.C. stabilisers are true RMS instruments—they **have** to be to reach the new precision of 0.1%—any rectifier measuring device being upset by distorted waveform of the supply voltage, or of the load current. Servomex Technical leadership makes these new models better than ever and Servomex production know-how gives you a de-luxe instrument at no extra price.

*Write for data sheets and a copy of "Technical Notes" on A.C. Stabilisers.*

**SERVOMEX CONTROLS LIMITED**

**Crowborough, Sussex. Crowborough 1247**

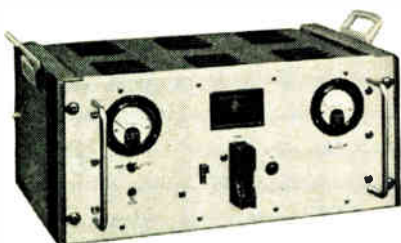
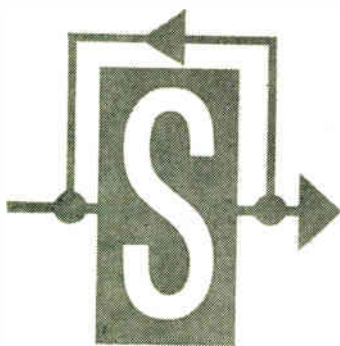

AC.2 Mk. III £99 in U.K. AC.7 Mk. II £143 in U.K.  
Wooden Ends £4 extra



## ELLIOTT PROCESS INFORMATION AND COMPUTING SYSTEM

in the computer room at Spencer Works

*Photograph by courtesy of Richard Thomas and Baldwins Ltd.*

Manufacturers of :—

PROCESS  
COMPUTING  
DIVISION

**ARCH** Computing Modules and Systems

Digital Operations Recorders

Data Acquirers

Data Loggers

Alarm Scanners

Elliott Process Information and Computing Systems





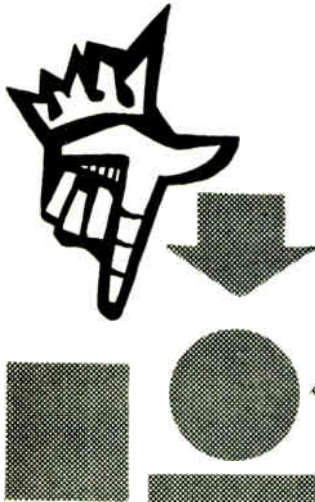

ELLIOTT - AUTOMATION LTD., ELSTREE WAY, BOREHAMWOOD, HERTS. Telephone : ELStree 2040







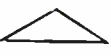













# - compare

## NEW PHILCO 2N2400 SERIES MADT'S\* WITH ANY COMPARABLY PRICED SWITCHES!

-   
much higher avalanche voltage for improved reliability—freedom from latching.
-   
Higher Beta for improved design margins.
-   
Lower  $V_{SAT}$  requires less dissipation—easier circuit design.
-   
Tighter  $V_{BE}$  spreads mean more design flexibility—more fan-in and fan-out.
-   
Lower  $C_{ob}$  means faster switching at low currents.
-   
Higher  $f_T$ .

	PHILCO 2N2400	2N711	PHILCO 2N2401	2N711A	PHILCO 2N2402	2N711B
<b>MAXIMUM RATINGS:</b>						
$V_{CBO}$	-12 v	Same	-15 v	Same	-18 v	Same
$V_{CES}$	-12 v	Same	-15 v	-14 v	-15 v	Same
$V_{CEO}$		NONE		-7 v		-7 v
$V_{EBO}$	-1 v	Same	-1.5 v	Same	-2 v	Same
Dissipation	150 mw	Same	150 mw	Same	150 mw	Same
<b>ELECTRICAL CHARACTERISTICS:</b>						
$I_{CBO} (V_{CB} = -5v)$	3 $\mu$ a max	Same	1.5 $\mu$ a max	Same	1.5 $\mu$ a max	Same @ -10 V $V_{CB}$
$h_{FE} (V_{CE} = -0.5 v, I_C = -10 ma)$		20 min		25 min		30 min
$h_{FE} (V_{CE} = -0.5 v, I_C = -50 ma)$			40	40 @ -0.7 $V_{CE}$	50	40 @ -0.7 $V_{CE}$
$V_{CE} (SAT) (I_C = -10 ma, I_B = -0.4 ma)$		0.50 v max		0.30 v max		0.25 v max
$V_{CE} (SAT) (I_C = -50 ma, I_B = -2 ma)$			0.30 v max	0.55 v max	0.25 v max	0.45 v max
$V_{BE} (I_C = -10 ma, I_B = -0.4 ma)$		0.34 min 0.50 max		0.34 min 0.50 max		0.34 min 0.45 max
$V_{BE} (I_C = -50 ma, I_B = -2 ma)$			0.38 min 0.48 max	0.45 min 0.75 max	0.38 min 0.48 max	0.45 min 0.70 max
$C_{ob} (V_{CB} = -5 v, I_E = 0, f = 4 mc)$		7.5 pf max		6.0 pf max		6.0 pf max
$f_T (V_{CE} = -7v, I_C = -10 ma)$	150 mc min	Same @ -5 $V_{CE}$		150 mc min @ -5 $V_{CE}$		150 mc min @ -5 $V_{CE}$
$t_{on} (max)$	75 nsec	100 nsec	75 nsec	Same	75 nsec	Same
$t_s (max)$	140 nsec	200 nsec	120 nsec	Same	100 nsec	Same
$t_f (max)$	130 nsec	150 nsec	110 nsec	Same	100 nsec	Same

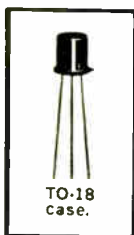

\* Micro Alloy Diffused-Base Transistor

New Philco 2N2400, 2N2401 and 2N2402 high-speed low-cost switching transistors are available in production quantities.

The 2N2400 series is readily available from

## PHILCO INTERNATIONAL LTD

Semi-Conductor Sales Division

30-32 GRAYS INN ROAD W.C.1 CHANCERY 3668

Write or telephone also for full details of all Philco semiconductor products



# Electro-Magnetic COUNTERS

## MODEL 442

6 figures — adds or subtracts

Resettable by hand — or non-resettable

Standard Model — up to 500 counts per min

High Speed Model — up to 1000 counts per min

Standard Voltages

DC	12v	24v	48v	110v
AC	115v	230v	50c/s	115v 60c/s

Base or Panel Mounted

Panel size — 1.781 in (45.3 mm) × 1.250 in (31.8 mm)

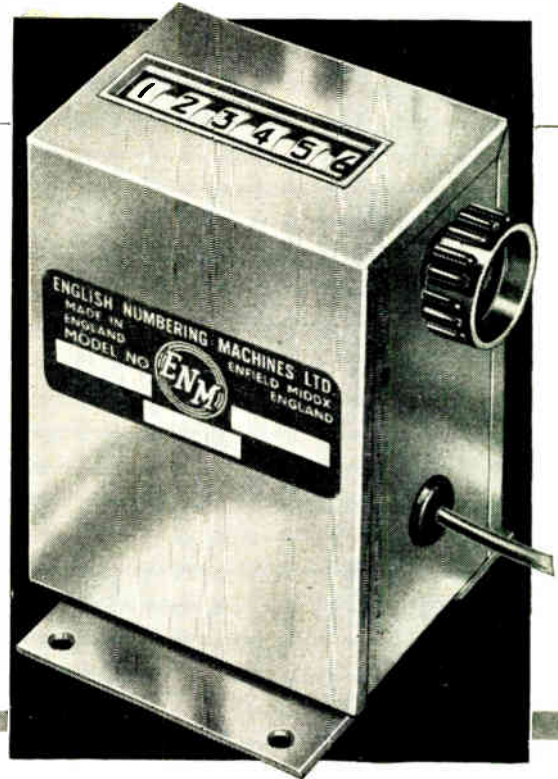

### VISUAL OR PRINTING ADDING AND SUBTRACTING

## MODEL 443

Adds or subtracts — or adds and subtracts

Manual or Electric Reset, or non-reset

Standard Models — up to 2100 counts per min

High Speed Models up to 3000 counts per min

Standard Voltages

DC	12v	24v	48v	60v	110v
AC	115v	250v	50c/s	115v	60c/s

Panel mounted only

Panel size — 1.812 in (46.0 mm) × 2.75 in (69.0 mm)



Write or telephone HOWard 2611 for fully descriptive literature

# English Numbering Machines Ltd

DEPT E10 QUEENSWAY ENFIELD MIDDLESEX

Tel HOWard 2611

Grams Numgravco Enfield



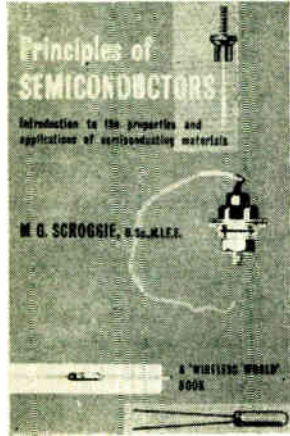
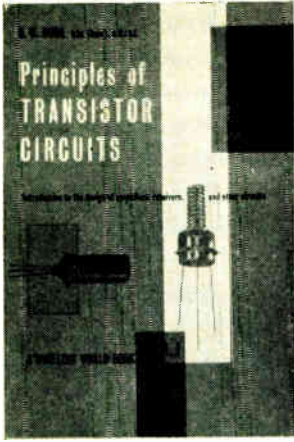

# new ILIFFE books

for students and technicians

in radio, television and electronics



## Principles of Transistor Circuits 2nd EDITION

Introduction to the design of amplifiers, receivers and other circuits

*S. W. Amos, B.Sc., A.M.I.E.E.* A thoroughly revised and enlarged edition of an already popular book. The first two chapters, which have been entirely rewritten, deal with the basic properties of transistors, but the main emphasis of the book is on circuit design.

21s. net. by post 22s. 210pp. 125 diagrams

## Principles of Semiconductors

Introduction to the production and applications of semiconducting materials

*M. G. Scroggie, B.Sc., M.I.E.E.* Covers the many applications of the use of semiconducting materials. There are over 100 graphs and line drawings, and 12 pages of photographs illustrating the width of the semiconductor field.

21s. net. by post 21s. 11d. 156pp. inc. 115 diagrams and 12pp. plates.

## Television Receiver Servicing

Volume 1. Time base circuits. 2nd EDITION

*E. A. W. Spreadbury, M.Brit.I.R.E.* This completely revised edition covers the faults occurring in the time base circuits or in other parts of the receiver affected by their operation, and shows how to locate faults and how to isolate a faulty section.

25s. net. by post 26s. 5d. 362pp. illustrated

## Radio Valve Data 7th EDITION

Characteristics of 4,800 valves, transistors, rectifiers and cathode ray tubes

*Compiled by "Wireless World".* A completely revised and re-indexed edition which incorporates the characteristics of the latest types of valves and cathode ray tubes, with particular emphasis on semiconductors.

6s. 6d. net. by post 6s. 10d. about 160pp.



From leading booksellers

Published by **ILIFFE Books Ltd.**

DORSET HOUSE · STAMFORD STREET · LONDON, S.E.1

# POLAR

## *Terminal Strips and Stand-off Insulators*

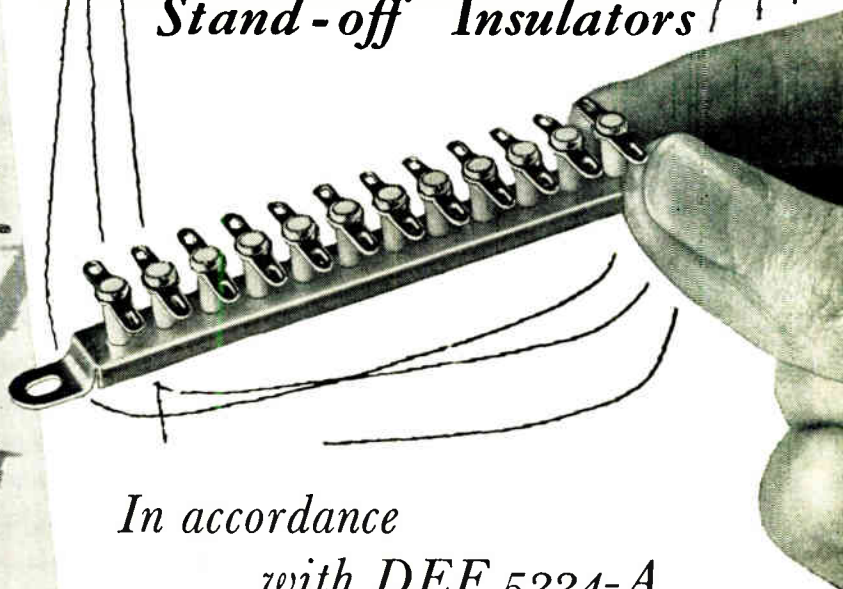

*In accordance  
with DEF 5334-A*

Suitable for all forms of assembly, these high efficiency inexpensive Terminal Strips and Stand-off Insulators are available in a wide range of sizes.

The Stand Off Insulators are mounted by means of Screwed Stems or Tapped holes. Connections may take the form of Tags, Spills or Screwed Stems.

Terminal Strips in Cadmium plated steel with pillars of sintered aluminium oxide, are available in several types with  $\frac{5}{32}$ "  $\frac{1}{4}$ " or  $\frac{3}{8}$ " spacing between terminals.

Insulation resistance better than 10,000 megohms.



Samples and Prices on application to Department I. E.

## WINGROVE & ROGERS LTD.

HEAD OFFICE: Domville Road, Old Swan, Liverpool, 13.

Phone: Stoneycroft 2265 Grams & Cables: Components Liverpool

LONDON OFFICE: Broadway Court, London, S.W.1. Phone: ABBey 2272



**ALLSCOTT**

**ECONOMIC  
Electronic  
Supervisory  
Systems**

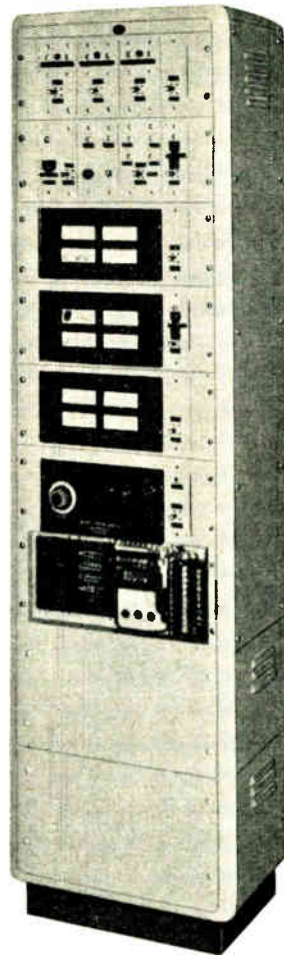

Plant and Instrumentation Engineers can now save cost, space and time in setting-up a wide variety of measurement and control systems

From the extensive range of basic units which includes scanning equipment, timers, discriminators, alarms, detectors, etc. (to name a few), systems can be assembled for numerous applications.

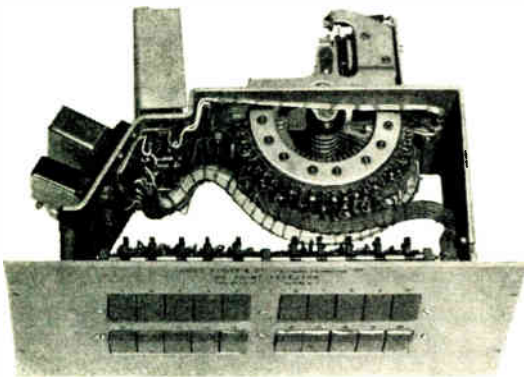

*The illustration is of the basic switch unit in the scanning equipment series—three of these are shown incorporated in the rack*

*Applications include —*

- Automatic Inspection**
- Warning and Timing Systems**
- Data Distribution**
- Function Plotting**
- Multi point temperature recording and control**

These are only a few. From the range of standard units a low-cost system for most purposes can be devised

**Complete Control - Measurement - Warning Systems in compact 'build-up' Units**

**James Scott (ELECTRONIC ENGINEERING) Ltd**

**68 BROCKVILLE STREET,  
CARNTYNE INDUSTRIAL  
ESTATE, GLASGOW, E.2  
TEL: SHETTLESTON 4206**

DEPENDABLE

# Delanco

## COPPER CLAD LAMINATES

the **+** material  
for

# PRINTED CIRCUITS

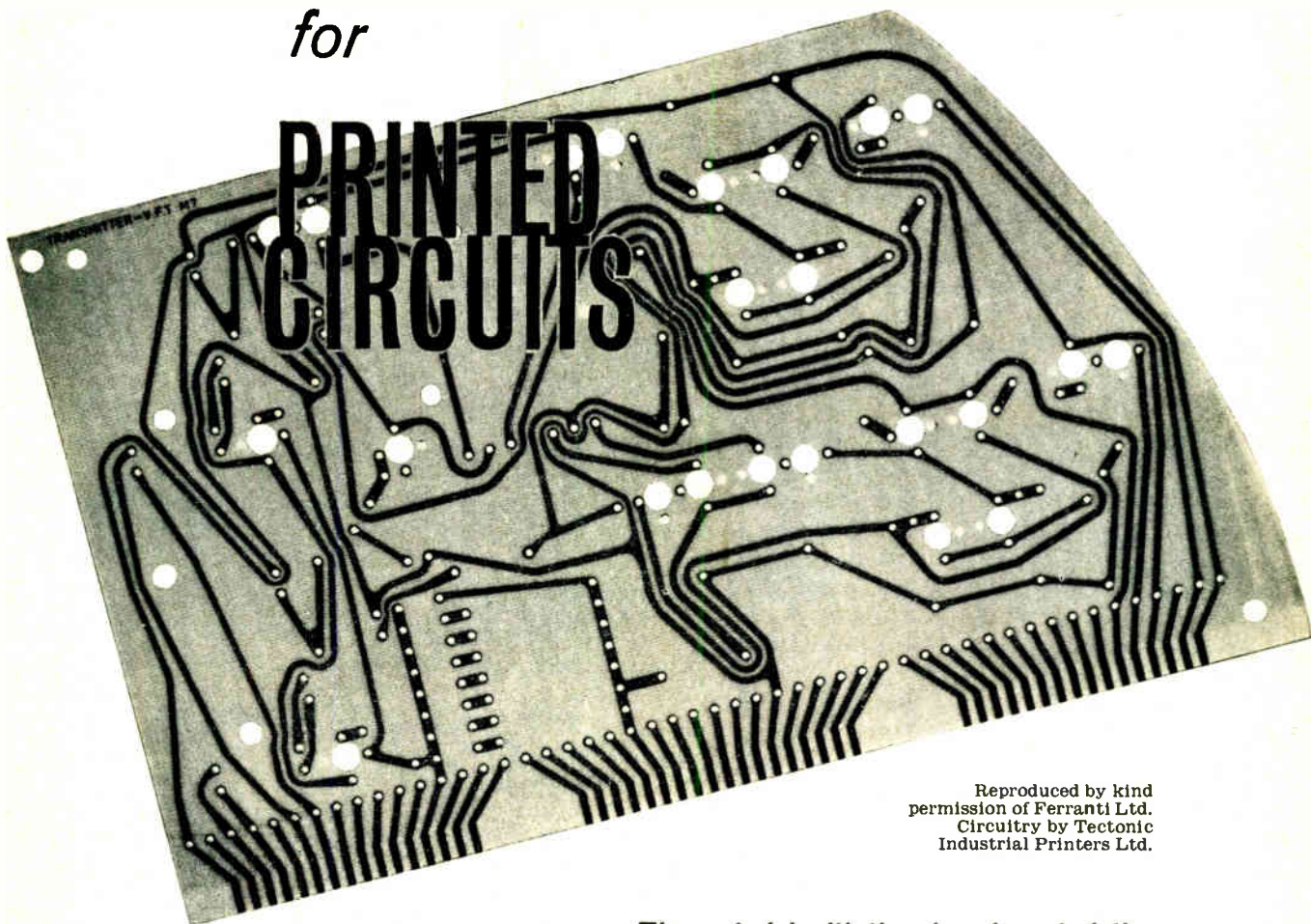

Reproduced by kind permission of Ferranti Ltd. Circuitry by Tectonic Industrial Printers Ltd.

### *The material with the plus characteristics*

For applications where ministry specifications and others demand a material with characteristics far above the commercial range of copper clad laminates for printed circuitry, Delanco epoxy-glass base, and Teflon base, the materials with the "Plus" characteristics will fill the need. Demand for

this material is growing, but production is keeping in step, and most requirements can be executed ex stock, and price is competitive. It will pay you to investigate our claims, so send for sample, with grade details and test report. Both single and double sided are available. In sheet, or cut panels.

WRITE NOW FOR DELANCO TECHNICAL BULLETIN OF



# Delanco

COPPER CLAD LAMINATES

ANGLO-AMERICAN VULCANIZED FIBRE CO. LTD • Cayton Works • Bath Street • London • E.C.1  
CLE 8484 • Grams: PROMSERV CENT, LONDON • Delanco Works • Leonard Street • London • E.C.2



**STANDARDS LAB**

**SERVICING**

**RESEARCH**

**INSPECTION**

**DEVELOPMENT**

**GOODS INWARD**

**PRODUCTION**

# THE TRANSFER STANDARD . . .

. . . an essential link

An essential link between your Standards lab, Research and Development Depts., and the equipment and components in your production line. The Bradley D.C. Signal Generator has proved itself to be a convenient method of calibrating and checking in the shortest possible time. Simple decade operation allows voltages from 1 millivolt to 500 volts to be selected with 0.5% accuracy.

Resolution on each of four voltage ranges is 0.2%. Square wave outputs at 1 c/s or 50 c/s are available, producing positive, negative or balanced pulses up to 50 volts peak. Four accurate constant current outputs are provided, ranging from 10 micro-amperes to 10 milli-amperes. The Bradley 123 gives positive overload indication; and is short-circuit proof on all ranges. For full technical data write to:-

**G & E BRADLEY LIMITED**



Electral House, Neasden Lane, London, N.W.10. Telephone: Dollis Hill 7811. Telegrams: Bradelec London N.W.10. Telex: 25583

# STC

CABLES TO

# DEEF

# 10

MINIATURE ELECTRIC  
CABLES

Catalogue No. H/110

# 12

EQUIPMENT WIRES  
PVC, POLYTHENE OR  
PTFE INSULATED

Catalogue No. H/112

# 14

RADIO FREQUENCY  
CABLES

Catalogue No. H/108

---

These cables and wires are manufactured strictly in accordance with government specifications at the STC works at Newport, Monmouthshire, where nominal quantities are held in stock.

*Write, 'phone or Telex for the appropriate catalogue quoting the reference number shown above.*



**Standard Telephones and Cables Limited**

**RUBBER & PLASTIC CABLE DIVISION**  
CORPORATION ROAD · NEWPORT · MON. · Telephone NEWPORT 72281 · Telex 49368



# CORREX CORRECTOR

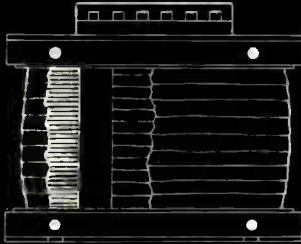

Designed for situations where high percentage regulation is not necessary, the **CORRECTOR** is Phoenix's answer to demand for a general purpose heavy duty component at an economical price. Percentage regulation is between 10% and 85%, load ranges from 125 W to 7 kW single phase.

# CORREX A.C.R.

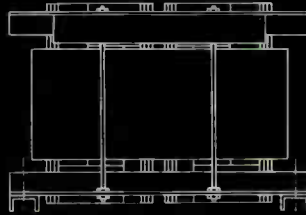

Like the Correactor, the **A.C.R.** comprises three coils about a shellform core of laminated silicon iron. It has been designed for situations where wider output control range is required and higher power is to be used. Percentage regulation is between 10% and 93%, load ranges from 8 kW to 60 kW single phase.

# CORREX TOROIDAL REACTOR

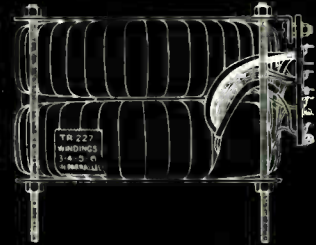

**TOROIDAL REACTORS** are offered specifically for precision installations where higher power gains are called for. Power gains in the order of  $10^5$  are available with toroids. Toroidal Reactors can also be made to customers' own specifications. Maximum percentage regulation is 98% overall. Toroids are powered up to 60 kW single phase.

*All these reactors are designed to operate on D.C. control, which can be varied by only small potentiometers in remote positions. Used in conjunction with CORREX Magnetic Amplifiers, they can be operated from signals on standard equipment down to  $8\mu\text{A}$ . There are no moving parts, so no maintenance is needed.*

## UP TO DATE COMPONENTS FOR STEPLESS CONTROL OF VOLTAGE, POWER, HEAT AND LIGHT IN ANY SITUATION

**RELIABLE  
LONG-LIFE  
DEVICES WITH  
STEADY  
CHARACTERISTICS  
DESIGNED FOR  
PROCESS CONTROL**

# CORREX



## MAGNETIC AMPLIFIERS

*All CORREX MAGNETIC AMPLIFIERS have no thermionic or moving parts. They are all housed in dust-proof cases with streamlined adaptability to any situation. Very little servicing is required. They are aptly suited to the needs of the work-study conscious, modern planners. The compact and sturdy construction of these components and their variety of application make them so: their prices are competitive, too.*

Five components, in the **M.A.420/430** range, are auto-excited single-ended stages of toroidal construction. They are used as driver stages for Saturable Reactors through variable D.C. output control. Voltage is set by bias control from a small transformer and selenium bridge rectifier.

For instrument and process control amplification, the **M.A.412** can be used with thermo-couples, photo-cells etc. This is a two-stage push-pull unit with cascade connection. It has been developed to harmonise in a number of applications with all other CORREX equipment of this kind.

Newest among these Magnetic Amplifiers is the versatile **M.A.437**, driving a Post Office type 3000 relay at close differential. This is intended to trigger a function on a variable monitored control signal and also from signals too small to drive a conventional relay. Minimum operational signal for the **M.A.437** is  $80\mu\text{A}$ .

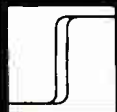

**PHOENIX TELEPHONES LIMITED**  
GROVE PARK LONDON, N.W.9  
Telephone: COLindale 7243, Telegrams: PHONO FENIX LONDON, N.W.9.  
**SATURABLE REACTORS      MAGNETIC AMPLIFIERS**  
**TRANSFORMERS & TOROIDS      SPECIALISED CONTROL**  
**EQUIPMENT**

**A.I.D. &  
C.E.G.B.**  
Approved

**CORREX MEANS  
ECONOMY IN  
PLANNING  
AND PRICE** I.E.I.

# Let the

## INDUSTRIAL ELECTRONICS

### READER ENQUIRY SERVICE

# help you to obtain more information

Circle the code numbers of the items in which you are interested. Insert your name and address, etc., in block capitals and post the card to us.

We will communicate with the manufacturers concerned and arrange for the information you require to be sent to you without obligation.

*(No postage stamp is required if posted in Great Britain or Northern Ireland)*

### Is this your own copy ?

Each month INDUSTRIAL ELECTRONICS will bring you news of the latest applications, the most recently announced equipment, produced by the rapidly expanding electronics industries of the world.

It is invaluable to all management and production executives, and engineers, in industry generally, who need to be informed of the latest developments in electronic aids to industry.

**MAKE SURE OF YOUR COPIES  
USE THE ORDER CARD NOW**

## INDUSTRIAL ELECTRONICS

JANUARY 1963 — For further information circle appropriate number

Editorial code number—	1	2	3	4	5	6	7	8	9	10	11	12	13	14	15
16	17	18	19	20	21	22	23	24	25	26	27	28	29	30	31
32	33	34	35	36	37	38	39	40	41	42	43	44	45	46	47
48	49	50	51	52	53	54	55	56	57	58	59	60	61	62	63
64	65	66	67	68	69	70	71	72	73	74	75	76	77	78	79
80	81	82	83	84	85	86	87								

Advertisement code number—	200	201	202	203	204	205	206	207	208	209	210	211	212	213
214	215	216	217	218	219	220	221	222	223	224	225	226	227	228
229	230	231	232	233	234	235	236	237	238	239	240	241	242	243
244	245	246	247	248	249	250	251	252	253	254	255	256	257	258
259	260	261	262	263	264	265	266	267						

I would also like details of.....

Your Name..... Position held.....

Name of Firm.....

Address .....

Nature of Business.....

PLEASE USE BLOCK CAPITALS

Postage will be paid by Associated Iliffe Press

No Postage Stamp necessary if posted in Great Britain or Northern Ireland

**BUSINESS REPLY CARD**  
Licence No. SE 591

**"INDUSTRIAL ELECTRONICS",  
DORSET HOUSE,  
STAMFORD STREET,  
LONDON, S.E.1**

JANUARY 1963

## INDUSTRIAL ELECTRONICS

### SUBSCRIBER'S ORDER FORM

#### Subscription Rates

Home and Overseas £3. 0s. 0d.  
USA and Canada \$8.50

Please supply  
INDUSTRIAL ELECTRONICS monthly for  
the next 12 months

I will remit on receipt of invoice

NAME .....

ADDRESS .....



Postage will be paid by Associated Iliffe Press

No Postage Stamp necessary if posted in Great Britain or Northern Ireland

**BUSINESS REPLY CARD**  
Licence No. SE 591

**"INDUSTRIAL ELECTRONICS",  
DORSET HOUSE,  
STAMFORD STREET,  
LONDON, S.E.1**

# Let the

## INDUSTRIAL ELECTRONICS

### READER ENQUIRY SERVICE

# help you to obtain more information

**INDUSTRIAL ELECTRONICS**

### READER ENQUIRY SERVICE

**JANUARY 1963 — For further information circle appropriate number**

Editorial code number—	1	2	3	4	5	6	7	8	9	10	11	12	13	14	15		
16	17	18	19	20	21	22	23	24	25	26	27	28	29	30	31	32	33
34	35	36	37	38	39	40	41	42	43	44	45	46	47	48	49	50	51
52	53	54	55	56	57	58	59	60	61	62	63	64	65	66	67	68	69
70	71	72	73	74	75	76	77	78	79	80	81	82	83	84	85	86	87

Advertisement code number—	200	201	202	203	204	205	206	207	208	209	210	211	212	213			
214	215	216	217	218	219	220	221	222	223	224	225	226	227	228	229	230	231
232	233	234	235	236	237	238	239	240	241	242	243	244	245	246	247	248	249
250	251	252	253	254	255	256	257	258	259	260	261	262	263	264	265	266	267

I would also like details of.....

Your Name..... Position held.....

Name of Firm.....

Address.....

Nature of Business.....

**PLEASE USE BLOCK CAPITALS**

Circle the code numbers of the items in which you are interested. Insert your name and address, etc., in block capitals and post the card to us.

We will communicate with the manufacturers concerned and arrange for the information you require to be sent to you without obligation.

*(No postage stamp is required if posted in Great Britain or Northern Ireland)*

Postage will be paid by Associated Iliffe Press

No Postage Stamp necessary if posted in Great Britain or Northern Ireland

**BUSINESS REPLY CARD**  
Licence No. SE 591

**"INDUSTRIAL ELECTRONICS",  
DORSET HOUSE,  
STAMFORD STREET,  
LONDON, S.E.1**

### Is this your own copy ?

Each month INDUSTRIAL ELECTRONICS will bring you news of the latest applications, the most recently announced equipment, produced by the rapidly expanding electronics industries of the world.

It is invaluable to all management and production executives, and engineers, in industry generally, who need to be informed of the latest developments in electronic aids to industry.

**MAKE SURE OF YOUR COPIES  
USE THE ORDER CARD NOW**

# ultrasonic flaw detection in metals

**The first fully comprehensive book to appear in this field**

This book covers what is now one of the most important branches of the new science of non-destructive testing. The use of ultrasonics extends from the examination of material before initial working to the subsequent periodic examination of components and structures after installation to detect flaws caused by such factors as metal fatigue or irradiation. The equipment can be made light and portable or can be incorporated into flow lines so that a quality check can be made on every piece-part at any stage of manufacture. It can be adapted to normal C.R.T. display, continuous pen recording or the automatic rejection of defective parts. This work will be invaluable to all engineers connected with quality production. Above all it gives the Test Inspectorate the "know-how" which otherwise would take many years of personal experience to acquire.

## Theory and practice

B. Banks, A.M.Inst.W., Hon. F.N.D.T.S.  
G. E. Oldfield, A.Met., A.I.M.  
H. Rawding, A.N.D.T.S.

### Contents

*Fundamentals of Ultrasonic Testing*  
*Probes and Probe Systems*  
*Instrument Principles*  
*General Inspection Techniques*  
*Inspections of Forgings, Stampings and Castings*  
*The Testing of Welds*  
*The Testing of Sheet and Plate*  
*Ultrasonic Thickness Measurement*  
*Recent Developments and new Techniques in Ultrasonics Flaw Detection*

**63s net** by post 64s

256 pp. plus 30 pp. of plates

obtainable from leading booksellers

Published for WELDING AND METAL FABRICATION by

**ILIFFE Books Ltd.** DORSET HOUSE

STAMFORD STREET LONDON S.E.1

For further information circle 237 on Service Card

**An essential book for  
research workers and  
designers . . .**

## MICROWAVE DATA TABLES

by **A. E. Booth, M.I.R.E., GRADUATE I.E.E.**

This book forms an accurate and labour-saving aid for computations involving basic microwave quantities which occur continually in design and development work on waveguides and similar transmission lines, such as decibel relationships, guide and free-space wavelengths, voltage standing-wave ratio, and voltage or power reflection coefficients. Printed on stout paper and strongly bound to withstand constant usage in design office or laboratory, it contains 26 tables comprising over 23,000 separate computations. The figures in the tables have been computed on a Pegasus electronic digital computer to the limit of practical measuring accuracy.

**27s. 6d. net**  
by post 28s. 8d.

**Over 23,000 separate computations**  
from leading booksellers

Published by  
**ILIFFE Books Ltd.,**  
Dorset House, Stamford Street, London, S.E.1

For further information circle 238 on Service Card

**KUHNKE**

## K 6 - RELAY

plug-in type

up to 6PDT  
contacts

D.C. operated  
coil

stock delivery

low prices

miniature dimensions

**2. 1/8" × 25/32" × 1. 3/16"**

Please ask for literature describing our full range of relays

**H. KUHNKE LTD.**

**163 Stanwell Road, Ashford—Middlesex**

Telephone: Ashford 2798 Telex: 21577  
Telegrams: Kunwith Telex London

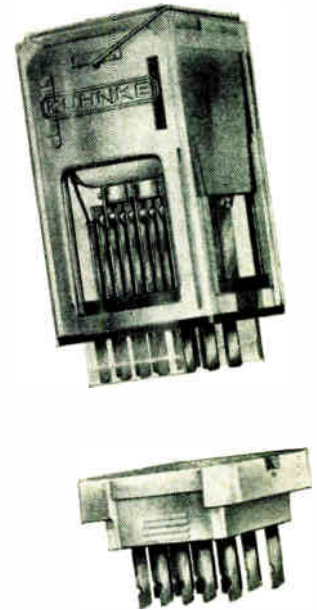



## WHAT IS HAPPENING IN ELECTRONICS IN 1963 ?

See for yourself by visiting the

# 6<sup>th</sup> international exhibition of electronic components

FROM 8th – 12th FEBRUARY 1963  
IN PARIS (PORTE DE VERSAILLES)

The largest display in the world covering the field of electronics

All components, valves and semi-conductors, measuring, testing and electro-acoustic equipments



Send now for full information and literature :

**FÉDÉRATION NATIONALE  
DES INDUSTRIES ÉLECTRONIQUES**

23, rue de Lübeck - PARIS 16<sup>e</sup> - PASsy 01-16

UNDER THE PATRONAGE OF THE F.N.I.E.

# 3<sup>rd</sup> international congress of quantum electronics

Organised by the  
French section of the I.R.E. and by the S.F.E.R.

FROM 10th – 15th FEBRUARY 1963

Unesco House  
Information: 7, rue de Madrid PARIS 8<sup>e</sup>

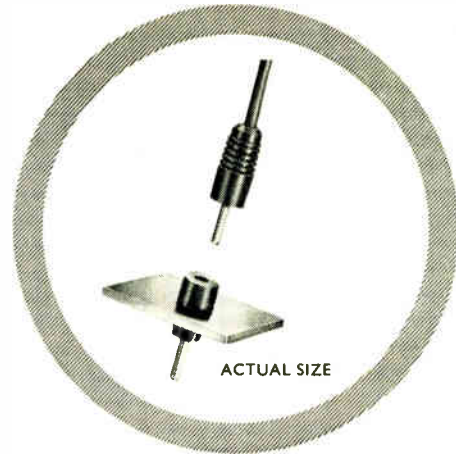

## BARB PLUGS AND SOCKETS

The Oxley plugs and sockets are rapidly assembled connectors of outstanding electrical and mechanical characteristics. The design of the bush making maximum use of the elastic and insulating properties of polytetrafluoroethylene.

The socket tube is a one piece component, heavily silver plated (with an optional gold flash) slit longitudinally to exploit the elastic properties of the insulating bush so providing the necessary retention of the plug under the most arduous conditions.

To fit .156" dia. chassis hole.

Both plugs and sockets supplied : Black, Brown, Red, Orange, Yellow, Green, Blue, Violet, Grey and White. Packed in sealed packets of 100.

Further details supplied on request.

# OXLEY

OXLEY DEVELOPMENTS CO. LTD., ULVERSTON, LANCs.

For further information circle 241 on Service Card

An introduction to the operating principles of computers

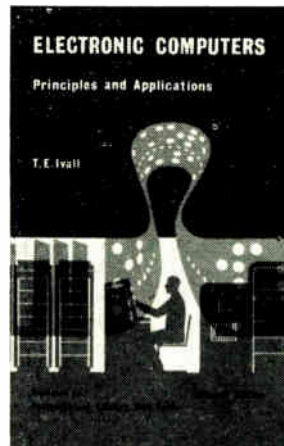

*for students  
engineers  
technicians*

## ELECTRONIC COMPUTERS

**T. E. Ivall**

*Principles and applications*

**25s net**

by post 26s

263 pp. including 32 plates

**2ND EDITION**

Obtainable  
from leading booksellers

Published by

**ILIFFE Books Ltd.**

Dorset House, Stamford Street

London, S.E.1

A non-mathematical introduction to the operating principles of electronic computers, primarily written for technicians, engineers and students with some knowledge of electronic or radio techniques. The treatment has been made as general as possible in order to give a broad background picture of the whole field of computing, from which the reader can pass on to more advanced and specialised studies.

# INDUSTRIAL ELECTRONICS

Press date for the February 1963 issue is  
first post 23rd January 1963

## CLASSIFIED ADVERTISEMENTS

Advertisement Rates. 6d. per word, minimum charge 6/-, each paragraph charged separately. Remittances payable to "Industrial Electronics", Dorset House, Stamford St., S.E.1. Series discount of 15% is allowed for 12 consecutive insertions.

Box Numbers are available at an additional charge of 2/- to defray cost of registration and postage. Replies should be addressed Box No. 0000, c/o "Industrial Electronics", Dorset House, Stamford Street, London, S.E.1.

Semi-Display advertisements with centralized lines £1/15/- per single column inch, Display advertisements £2/10/- per single column inch—no additional charge for Box Numbers. The Publishers are not responsible for clerical or printers' errors although every care is taken to avoid mistakes.

### SITUATIONS VACANT

KWAME NKURUMAH UNIVERSITY  
OF SCIENCE AND TECHNOLOGY  
GHANA

FACULTY OF ENGINEERING  
Vacancy:

#### PROFESSOR AND HEAD OF ELECTRICAL ENGINEERING DEPARTMENT

Applications are invited for the vacant post of Professor and Head of the Electrical Engineering Department in the Faculty of Engineering to be filled now but not later than September, 1963.

The Faculty of Engineering—Civil, Mechanical and Electrical Departments—provides 4 year degree courses leading to B.Sc.(Eng.) and courses leading to Diplomas in Engineering (equivalent to H.N.D. Courses). In the past the Courses led to the examination of B.Sc.(Eng.) external London.

Applications from candidates who possess a degree in electrical engineering and extensive relevant experience will be considered; preference will be given to candidates who possess higher Degrees and or who held similar appointments.

The successful candidate will be expected to assume full responsibility, under direction of the Dean of the Faculty, for the work of the department—there are 3 Senior Lecturers and 5 Lecturers on the strength of the department; candidates will also conduct, promote and supervise research projects (Staff and Post-graduate Students).

Basic salary attached to the post—5 year contract renewable—is £4,000-£4,400 apart from Children's and car allowances.

Other Conditions of Service and further details and forms available on application to the Assistant Registrar, Kwame Nkrumah University of Science and Technology, 15 Gordon Square, London, W.C.1 or Registrar, Kwame Nkrumah University of Science and Technology, Kumasi, Ghana. Application forms to be returned not later than 20th January, 1963. Interviews will be held, in London, mid February, 1963 or earlier if required. [2011]

#### CENTRAL ELECTRICITY GENERATING BOARD SOUTH EASTERN REGION RESEARCH AND DEVELOPMENT DEPARTMENT ELECTRICAL BRANCH

Applications are invited for the following vacancies:—

##### AUTOMATIC CONTROL AND DYNAMIC RESPONSE:

Interesting work is being carried out concerning the automatic control and dynamic performance of large turbo-alternators and boilers and this work is being extended to the new West Thurrock Generating Station near Grays, Essex. The project will require close co-operation with the Station Superintendent and his staff and will form part of an extensive programme embracing the dynamic response and testing of power plant. Applicants should possess qualifications leading to Corporate Membership of the Institution of Electrical Engineers and an Honours Degree will be a considerable advantage. The successful candidates will be expected to live within a reasonable distance of West Thurrock.

##### VACANCY NO. SE.380W/62R—Assistant Electrical Engineer

Salary within the range £1,360/£1,830 per annum according to qualifications and experience, but an exceptional candidate may be appointed within the range £1,625/£2,205 per annum.

##### VACANCY NO. SE.381W/62R—Assistant Electrical Engineer

Salary within the range £685-£1,250/£1,500 per annum according to qualifications and experience, but an exceptional candidate may be appointed within the range £1,360/£1,830 per annum.

##### INSTRUMENTATION AND MEASUREMENT:

This Section is located at the laboratories, Cockfosters, Barnet, Herts. The work is of a very wide interest and is related to all aspects of the Electricity Supply Industry. Candidates should possess qualifications leading to Corporate Membership of the Institution of Electrical Engineers or the British Institution of Radio Engineers and a degree will be an advantage. Previous experience in the application

of new and novel techniques of measurement problems is desirable.

##### VACANCY NO. SE.382W/62R—Assistant Electrical Engineer

Salary within the range £685-£1,250/£1,500 per annum according to qualifications and experience, but an exceptional candidate may be appointed within the range £1,360/£1,830 per annum.

Applications on standard forms obtainable from the Regional Personnel Officer, Ergon House, Horseferry Road, S.W.1, should be returned to arrive not later than 12th January, 1963. [2009]

OIL Exploration. Holders of H.N.C. with Electronics, or higher qualifications, are offered a permanent career in Geophysics. From Headquarters in the U.K. we operate at home and on the Continent but more frequently in remote areas. Actively developing methods, mainly Electronic, in which your initiative may play its part, add technical zest to a life that can be adventurous. Ability to get along with men of other nationalities is of prime importance. Please write to Box No. 5146. [2001]

### TUITION

#### MIDDLESEX COUNTY COUNCIL TWICKENHAM COLLEGE OF TECHNOLOGY Principal: J. P. Wolfenden, M.Sc., M.I.E.E. PRINTED CIRCUIT TECHNIQUES

A Course of twelve lectures on Printed Circuit Techniques will be held on Tuesday evenings commencing at 7.00 p.m. on 15th January, 1963.

This course is planned for Electronic Engineers concerned with circuit development involving the use of printed circuits.

All the lecturers will be experts drawn from industry. Fee 30s.

Brochures and application forms are available from The Principal, Twickenham College of Technology, Egerton Road, Twickenham, Middlesex. Telephone: POPesgrove 6656-9. [2010]

#### CHELSEA COLLEGE OF SCIENCE AND TECHNOLOGY Manresa Road, London, S.W.3

##### DEPARTMENT OF PHYSICS POSTGRADUATE COURSE IN PHYSICS SEMICONDUCTOR DEVICES

A course of twelve lectures will be given on Tuesdays at 6 p.m., beginning 8th January, 1963, by Dr. A. K. JONSCHER.

The course is intended to provide the physical background necessary for the understanding of the operation of semiconductor and allied devices.

Entry forms and further particulars from the Secretary to the Department. [2013]

### NOTICES

#### WEST HAM COLLEGE OF TECHNOLOGY A NATIONAL CONFERENCE on SOLID CIRCUITS and MICROMINIATURIZATION

will be held on the 6th and 7th June, 1963 by the Department of Electrical Engineering.

The aim of this Conference is to bring together the Manufacturer and user of Solid Circuits.

Further information and application forms are available from:

The Head of the Department of Electrical Engineering, West Ham College of Technology, Romford Rd., London, E.15. [2012]

### BOOKS, ETC.

"ADVANCED Theory of Waveguides." By L. Lewin. Sets out various methods of treating problems arising in work on this complex subject. The author has selected for discussion a number of topics as representative of the field in which the centimetre-wave engineer is engaged, many of the examples being concerned with the rectangular waveguide. 30s net from all booksellers. By post 31s from Iliffe Books Ltd., Dorset House, Stamford Street, London, S.E.1.

Swedish Radio-TV company with growing international market seeks for its further work in

## colour-TV development

a qualified tele-engineer with several years' experience from independent and successful research work.

All the resources of a modern enterprise together with good terms of employment offer the prospect of success and wellbeing at work and leisure.

If you are interested in the post, a short and informal reply with your qualifications, age, salary status, earliest starting date and references will suffice for a first contact, addressed to "Colour TV", Box No. 5179, c/o "Industrial Electronics".



For further information circle 242 on Service Card

# A GUIDE TO INSTRUMENT DESIGN

Produced by the Scientific Instrument Manufacturers' Association  
of Great Britain (SIMA) and the British Scientific  
Instrument Research Association (SIRA)

The Scientific Instrument Manufacturers' Association and the British Scientific Instrument Research Association, being aware of the vital importance of good design in instruments, have combined to produce what they hope will be the authoritative book on the subject. The various chapters have been written by experts in the field of instruments and they have been carefully compiled to cover all modern aspects of design. The chapter headings and authors are as follows: Introductory, J. Thomson, M.A., D.Sc., F.Inst.P., M.I.E.E.; Limitations on Instrument Performance, Professor H. F. Trewman, M.A.(Cantab.), M.I.E.E., M.I.Mech.E., M.Brit.I.R.E.; Mechanical Design, G. Birkbeck; Optical Design, W. T. Welford, Ph.D., D.Sc., A.Inst.P.; Electronic Design, R. E. Fischbacher, B.Sc., A.R.C.S.T., A.M.I.E.E.; Nucleonic Design, T. P. Flanagan, M.Sc., A.Inst.P., A.M.I.E.E.; Intrinsic Safety, R. J. Redding, M.I.E.E.; Reliability of Instruments, R. J. Redding, M.I.E.E.; Integrated Design, J. Thomson, M.A., D.Sc., F.Inst.P., M.I.E.E.

Approximately 450 pp.

Crown Quarto, cloth bound

Price £3. 7s. 0d.

(including postage, packing, etc.)

Printed and published for the Associations by

## TAYLOR & FRANCIS, LTD.

RED LION COURT, FLEET STREET, LONDON, E.C.4

For further information circle 243 on Service Card

### LAPLACE TRANSFORMS FOR ELECTRICAL ENGINEERS

By *B. J. Starkey, Dipl.Eng., A.M.I.E.E.* A presentation of the theory of Laplace transformation in which a physical vocabulary rather than a purely mathematical one is used as far as possible. This method of analysis has become

of increasing importance to electrical engineers in many fields, and the work is designed to provide them with a thorough treatment of the subject in a language with which they will be familiar.

**30s. net** BY POST 31s. 2d.

From leading booksellers, published by **ILIFFE Books Ltd.**, Dorset House, Stamford Street, London, S.E.1

#### Index to Advertisers

Adcola Products Ltd. ....	19	F.N.I.E. ....	32	Phoenix Telephones Ltd. ....	30
Anglo-American Vulcanised Fibre Co. Ltd. ....	27	Harwin Engineers Ltd. ....	2	Radiospares Ltd. ....	1
Appointments Vacant ....	33	Hughes International (U.K.) Ltd. ..	11	R.C.A. (Gt. Britain) Ltd. ....	16
A.P.T. Electronic Industries Ltd. ..	9	Iliffe Books Ltd. ....	31, 32, 34	Scott James ....	26
Bradley, G. & E. Ltd. ....	28	Kuhnke, H. Ltd. ....	31	Servomex Controls Ltd. ....	20
British Scientific Instrument Research Association .....	34	Midland Silicones Ltd. ....	7	Solartron Electronic Group Ltd. ..	14, 15
Brush Crystal Co. Ltd. ....	10	Mullard Equipment Ltd. ....	Cover ii	Standard Telephones & Cables Ltd. 3, 4, 5, 6, 29	
Elliott Bros. (London) Ltd. ....	21	Oxley Developments Co. Ltd. ....	32	The Telegraph Condenser Co. Ltd. ....	Cover iii
Elliott Computers Ltd. ....	8	Parmeko Ltd. ....	Cover iv	Whiteley Electrical Radio Co. Ltd. ..	19
English Electric Valve Co. Ltd. ....	23	Philco International .....	22	Wingrove & Rogers Ltd. ....	25
English Numbering Machines Ltd. ....	21				
Ericsson Telephones Ltd. ....	12				

# NEW!

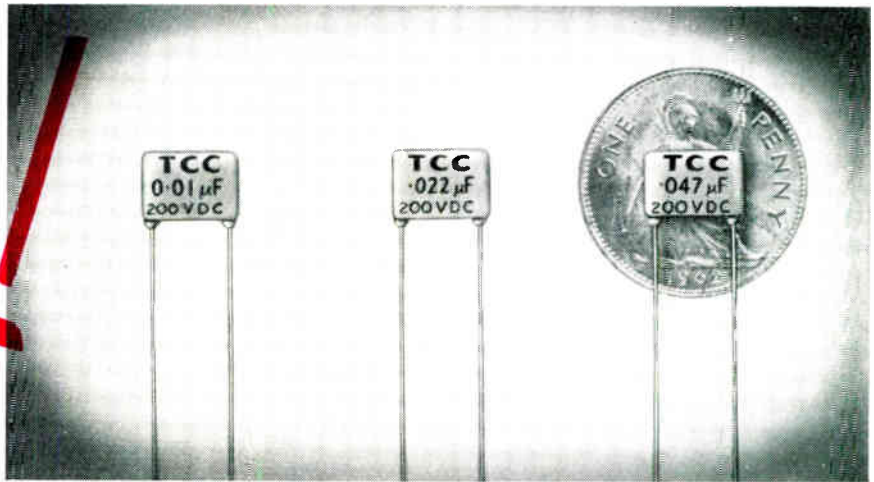

## MINIATURE METALLIZED POLYESTER CAPACITORS

These small moulded metallized polyester capacitors are ideally suited to the applications to printed wiring panels and transistorised circuits. The use of the new dielectric material and unique construction combine the advantages of small physical size and superior electrical characteristics which meet the requirements of H.5 DEF.5011 Specification.

### CONSTRUCTION

The windings are virtually non-inductive and the wire terminations are soldered direct to the metal electrodes eliminating contact resistance and ensuring the minimum possible inductance.

- Cap. Tolerance:**  $\pm 20\%$
- Rating — Working:** 200V. D.C. at 85 C.
- Test:** 400V. D.C. for 2 secs. at  $+ 20$  C.
- Power Factor:**  $\leq 0.01$  at 1,000 cps. at  $+ 20$  C.
- Temperature Rating:** Suitable for working at  $+ 85^\circ\text{C}$ . without derating.
- Insulation Resistance:** 50,000 megohms at  $+ 20^\circ\text{C}$ .
- Terminations:** 22 SWG solder coated parallel wires for slide mounting.
- Finish:** Insulated — special non-cracking heat resisting thermosetting compound providing good insulation and good protection against the ingress of moisture.

Capacitance $\mu\text{F}$	Dimensions		T.C.C. Type No.
	H.	T.	
0.01	$\frac{11}{32}$ " 9 mm	$\frac{7}{32}$ " 5.5 mm	PMX1
0.022	$\frac{11}{32}$ " 9 mm	$\frac{7}{32}$ " 5.5 mm	PMX2
0.047	$\frac{11}{32}$ " 9 mm	$\frac{7}{32}$ " 5.5 mm	PMX3
0.1	$\frac{13}{32}$ " 10 mm	$\frac{17}{64}$ " 7 mm	PMX4

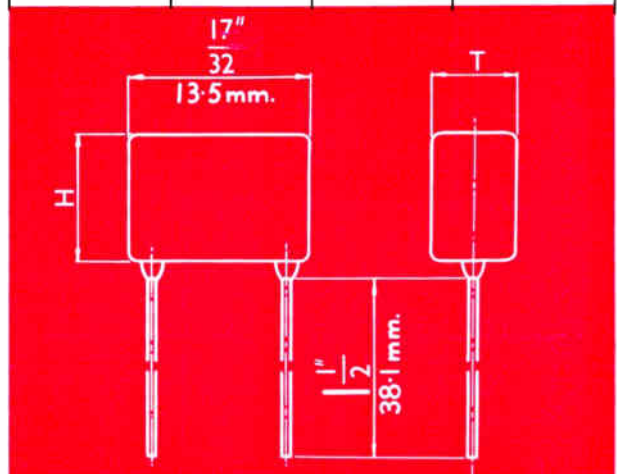

**THE TELEGRAPH CONDENSER CO. LTD**  
 RADIO DIVISION · North Acton · London W3 · Tel: ACO rn 0061



# PARMEKO

Parmeko have been designing and manufacturing transformers and other electronic equipment of the highest quality for over thirty years. Only a small selection from the range can be illustrated here. Full technical information about any Parmeko product is available on request.

## TRANSFORMERS AND TRANSDUCTORS



Parmeko transformers range from miniature types used in transformer circuits to power transformers having ratings in the order of 15kVA at 50 c.p.s.

## ELECTRONIC CONTROL EQUIPMENT



D.C. Amplifier

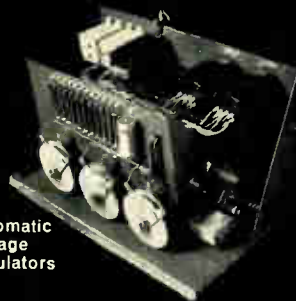

Automatic Voltage Regulators

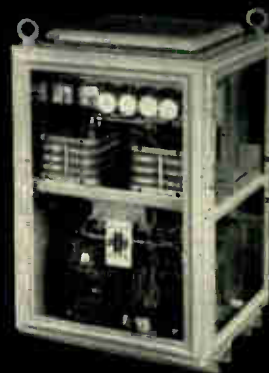

Motor Speed Controls

## ELECTRO-MECHANICAL DEVICES

Magnetic Clutches and Brakes



MSM D.C. Solenoids



MSM A.C. Solenoids



PARMEKO LIMITED, PERCY ROAD, LEICESTER, ENGLAND