

# hifi+

REPRODUCING THE RECORDED ARTS

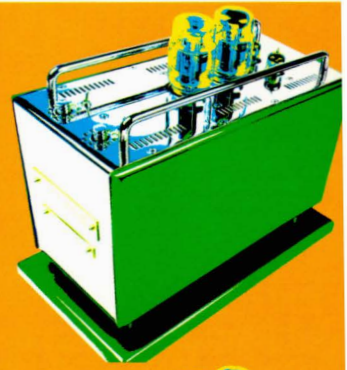

▷ **Floating**  
*Kuzma's standard setting Airline passive parallel tracker*



▷ **Bias**  
*Brazilian all-star Audiopax Model 88 moves the tube goalposts*

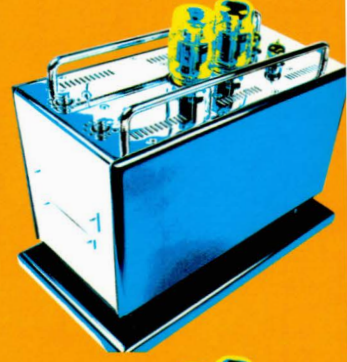

▷ **Muscle**  
*Nordost's new power cords - deliver the keys to Valhalla*

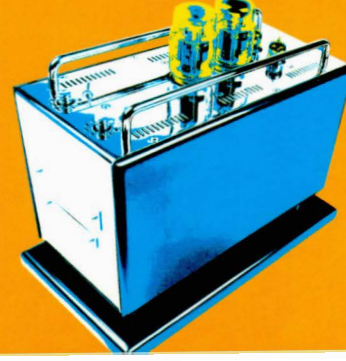
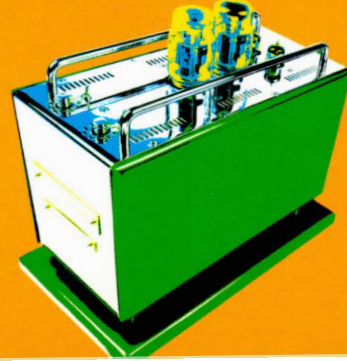
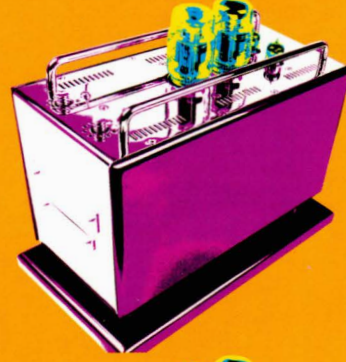



# Maximise your CD Collection

Ayre

The Astonishing CX-7 CD Player is the second in a new series of unprecedented, high performance, high value components from Ayre.

To maximise the performance from CD's, the CX-7 incorporates an extremely sophisticated multi-stage digital filter system. The first filter "upsamples" to 176.4KHz at 24 bits. The second filter "oversamples" to 1.4112MHz at 24 bits.

This coupled with a unique Segmented Architecture, differential current output DAC and fully balanced, zero feedback analog circuitry. Results in a sound that combines breathtaking transparency with beguiling musicality.

For the past decade Ayre products have won numerous awards worldwide and gained an enviable reputation for producing highly musical designs.

The new CX-7 breathes life into CD's.



CX-7 CD Player

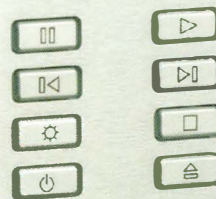

To find out more about the CX-7 and the name of your nearest authorised dealer please contact

Path Premier

Dormer Road, Thame Industrial Estate, Thame, Oxfordshire OX9 3UD

Tel: +44 (0) 1844 219000 Fax: +44 (0) 1844 219099

Email: [premier@path.co.uk](mailto:premier@path.co.uk)

**PATH**  
*Premier*



**Editor**  
Roy Gregory

**Contributors**  
David Ayers  
Chris Binns  
Mark Childs  
Richard Clews  
Martin Colloms  
Richard S Foster  
Alvin Gold  
Simon Groome  
Jason Hector  
Andrew Hobbs  
Jimmy Hughes  
Jason Kennedy  
Scot Markwell  
Mike Mercer  
Paul Messenger  
Reuben Parry  
Alan Sircom  
Chris Thomas

**Photography**  
Simon Marsh  
Jimmy Hughes (London Show)

**Cartoonists**  
Dave Davies  
Thomas Divita

**Illustrator**  
Steve Lucas

**Design**  
Creative Byte  
Poole, Dorset  
Tel. 01202 690990  
E-mail. info@creativebyte.co.uk

**Printed By**  
JPS Litho Ltd.  
Poole

**Hi-Fi+ is published eight times  
a year by; Hi-Fi+ Publishing Ltd**

**The Editorial Office  
can be contacted at;**  
Hi-Fi+ Editorial  
Unit 12, Albany Business Park  
Cabot Lane  
Poole, Dorset  
BH17 7BX  
United Kingdom  
Tel. (44)(0)1202-659380  
Fax. (44)(0)1202-659540  
Net. www.hifiplus.com

**Advertising;**  
Rebecca Bird  
Tel/Fax. 0208 763-1277  
Email. sales@hifiplus.com

All Rights Reserved.  
Not one word of Hi-Fi+ may be reproduced without the written consent of the Editor. We are perfectly happy to co-operate, but we don't want quotations to appear out of context.

# John Michell

## (1936 – 2003)

With the passing of John Michell the UK hi-fi industry has lost one of its real gentlemen. Universally liked and respected, John was unusual in an industry where opinions all too often divide.

He was born and grew up in Borehamwood, the town to which he returned after National Service in the Navy and an engineering apprenticeship in Finchley. Setting up on his own, he soon found specialist work with the local car and film industries, including constructing models for Stanley Kubrick's *2001 – A Space Odyssey*. But it was when took over production of the Transcriptor's Hydraulic Reference turntable that he took his first steps into the world of audio. Other models soon followed (the Electronic Reference, Prisma, Focus One) along with the Focus One tonearm, a low-mass uni-pivot that revealed for the first time, John's ability to apply innovative engineering solutions to hi-fi problems. Indeed, many of the features found on current state-of-the-art arms like the Graham and VPI JMW, first saw the light of day on the Focus One.

But the real watershed occurred in 1981, with the arrival of the GyroDec. A three point suspended design, with a skeletal sub-chassis and mass-balanced armboard, it set new standards of engineering and style in an industry still to move beyond wood finishes. The new turntable soon became the basis for each deck the company made, evolving at the same time as it spawned cheaper (Syncro and Mycro) and ultimately, a more expensive model in the shape of the Orbe. The latest versions of both the GyroDec and Orbe remain in production today, continuing to evolve and extend their performance.

Along the way, John also got involved in electronics, producing the revolutionary Iso phono-stage and striking Alecto amplifiers. Again, the electronics survive under the Trichord banner, and longevity has been key to every product that Michell produced.

John became ill at the beginning of 2000, but his condition was treated successfully and he continued to work. But he also started the process of handing the reins to his daughter Julie, who has watched over the administration and finance of the company for the last 28 years. Helped by the many, long serving members of staff, she and her husband Steve have been running things since the beginning of 2003, allowing John to devote himself to the design process he loved so much. The results are the new TecnoDec, TechnoArm and TechnoWeight, and he has left Steve with many ideas to keep Michell Engineering at the forefront of analogue reproduction. The company will continue, maintaining the superb standards of engineering that have become synonymous with the Michell name, but the founder will be sadly missed.

John is survived by his wife, two daughters and five grandchildren.





# "We're talking about a future classic"

July 2002 / VS55 / Hi Fi News Ken Kessler

"More than any other CD player,  
the CD3 is the machine that renews my  
enthusiasm, wrapping me up completely  
in the musical event"

November 2002 / CD3 / Suono Mario Berlinguer

## ARC ANGELS

### "Sets a new standard of quality"

December 2002 / SP16/VS55 / Suono Mario Berlinguer



**HI-FI CHOICE**  
EDITORS CHOICE AWARD

AUDIO RESEARCH  
LS25 MKII/VT100 MKIII  
PRE/POWER AMPLIFIER

"If you yearn for that intangible  
'something' that many modern amps  
miss, then you must hear the VS110"

March 2003 / VS110 / Hi Fi News Dave Berriman



Audio Research apply the technology gained from their Reference 2 preamplifier and Reference 600 series amplifiers to every model in their range, right down to the entry-level designs. The SP16 preamplifier, VS55 and VS110 power amplifiers and the new VS155 integrated amplifier are not only packed with knowledge gained from the company's legendary flagship models, but herald a change in the way reasonably priced high end is perceived. Joining these classics are the state-of-the-art CD3 CD player and 150M multi-channel amplifier. For details of the full range and your nearest dealer, contact Absolute Sounds.

**Audio Research: not a cautious choice, but a considered one.**

**audio research**  
HIGH DEFINITION®

absolute sounds ltd

58 Durham Road, London SW20 0TW  
T: +44 (0)20 89 71 39 09 F: +44 (0)20 88 79 79 62  
www.absolutesounds.com info@absolutesounds.com





# Contents

## Equipment+

### Regulars

- 6 Letters
- 14 Columns

### Equipment Reviews

- 26 An Unattainable Goal...  
A short history of passive linear-tracking tonearms.
- 30 Kuzma Airline Air-Bearing Tonearm
- 38 The Nordost Power Cords
- 48 Eben X-3 Loudspeaker
- 54 JBL K2 S5800 Loudspeaker
- 60 Revel Performa F50 Loudspeaker
- 64 Jmlabs Micro Utopia Be Loudspeaker
- 70 Audiopax Model 88 Valve Mono-blocks
- 78 Rogue Audio Zeus Valve Power Amp
- 82 Korato KVP10 Pre-amp and Renaissance Mono-blocks
- 88 Krell SACD Standard Digital Disc Player
- 94 Sonneteer Brontë Integrated Amp and CD Player
- 98 The Chord Signature Interconnect and Speaker Cables
- 102 Analogue Pic-n-Mix  
JMH reviews the Rega RB-1000 tonearm, plus the Lyra Argo and Koetsu Black Moving-coil Cartridges

### The Real Deal

- 104 Project 1 Xpression Turntable and Tube Box Phono-Stage

### Audio Smorgasbord

- 115 Duende Creatura tube dampers, equipment supports from Harmonix and Eben, plus JMH on replacement counter-weights for Rega tonearms and more on the Reference 3A speakers and Naim NAP 300.

## Music+

- 126 Popular and Contemporary Music
- 133 Audio Fidelity  
Rebirth of a record label?
- 139 Classical Music
- 144 Music on New Formats
- 149 Audiophile Music Reviews
- 151 The History Man...  
And a surprising confession!

### Departments

- 114 Subscriptions
- 125 Back Issues
- 138 Binders
- 143 Advertisers Index

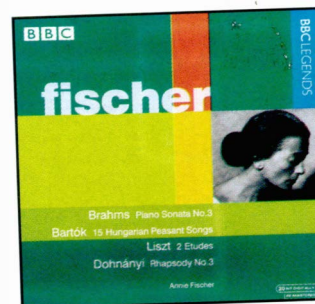
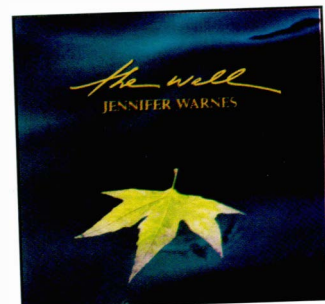





Pssst.. Prepared to try something a bit different?



Duevel speakers are winning more and more friends as customers realise how brilliant these difficult to ignore speakers are!



Another Chinese line, Consonance looks set to sweep aside better known brands both in styling and sound.

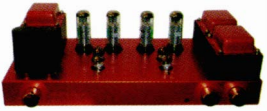

The UK's very own Papworth, with their bargain Class-A valve integrated.



The Heart modified Marantz CD with tube output stage is a genuine bargain.



From Serbia, the Korato line of valve amps are incredible value for money. Audiophile quality at pocket money prices (almost!).

We can't bear the thought of a little leftover space in our ads. Every last tiny corner has to be filled right up with useful information to maximise our investment in this costly medium. So we fill it up, further and further, till almost all the white is gone.

## We're quite sad to notice

that a lot of our fellow retailers seem to have forsaken the ways of true two channel high fidelity and been seduced down the path of multi-channel surround sound systems. Sure, the films might be good, but the sonic merits of these digitally-processed many-speakered marvels can be summarised on the back of a postage stamp (not that we'll be seeing those for much longer the way things are going). Meanwhile, truly decent sounding audiophile gear is blossoming, especially in the current climate of revival of the Vinyl LP.

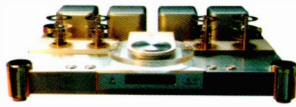

The Shanling CD player is a superb example of the quality coming out of China nowadays.



From our old friends, EAR, comes the beautiful 864 MM/MC phono preamp



The Klimo Beltaine monoblocks, from Germany, with outboard power supplies are about as purist audiophile as it gets!



Stax, legendary headphone manufacturers, present their valve driven Omega electrostatic 'phones.



Aha! Bit misleading this one - The Sonneteer Byron CD - fabulous sound, and not a tube in sight!



The famous Musical Fidelity X-CAN valve headphone amp, now in v3 form.

Benefits of dealing with Walrus (apart from the very best sounding gear) -We don't believe in "hard sell", you decide in your own time. In-house service on many items, sometimes while you wait. We understand audiophile equipment, especially vinyl playing and valve amps inside out, and have many years experience to draw on. Big accessory range. Interest Free Credit on many lines, subject to approval. And so on, and on .

Walrus has never, ever, dreamt of being seduced by all this multi-channel nonsense, we prefer to leave that to others. Of course we like a good film as much as anyone, but we love realistically reproduced music much more. And as the ultimate, most engaging reproduction usually comes from vinyl sources amplified by a decent valve amp, this is what we unashamedly do. An ever increasing number of satisfied customers thankfully agree and tell us we are cutting edge in audio reproduction. Funny old world, eh?

We are your local...



...Turntable Specialist!

Do you ever get the nagging feeling that our adverts aren't entirely serious? Heaven forbid! Us, not serious? You cannot be serious (J. McEnroe). We are seriously serious guys. Serious about our shop, our products, our wine, and above all, our customers!



air tangent amazon amphon amplifon apollo furniture argento audible illusions audio physic audiovalve breuer dynamic brinkmann cabasse cartridge man cawsey chord electronics clearaudio clearcover decca london dnm duevel dynavector ear yoshino ecosse es lab final lab graham slee hadcock heart incognito infinity jbl k2 klimo korato lavardin loricraft lyra michell engineering morch musical fidelity neat acoustics nordost nottingham analogue opus 3 origin live ortofon papworth pluto rega turntables ringmat roksan shun mook shanling shelter sme sonneteer spendor stax sugden sumiko tci cables tivoli audio tom evans townshend audio transfiguration trichord trigon van den hul voodoo wireworld xlo





We don't think so.



The Gryphon Mikado dedicated CD player

It's not a new format  
It's a new dimension





# Incoming!

Please address letters to the Editor at Hi-Fi+, Unit 12 Albany Business Park, Cabot Lane, Poole, Dorset, BH17 7BX.  
or via the web-site at [www.hifiplus.com](http://www.hifiplus.com)

Dear Sir,

First many thanks for a superb magazine. The balance between hardware and software is excellent. Please continue. Over the past 12 months you have looked at many aspects of the Linn LP12. As an LP12 owner I have found these articles fascinating but would ask you for one more article to complete the set. Like many LP12 owners my arm is an Ittok LV11. I know that this can be improved by re-wiring but I am unsure which one to go for. Linn offer a re-wiring but this is expensive compared to, say, the Incognito re-wire. Is it worth the extra money and what effect does it have on the sound? Are there any other re-wire options? The Linn re-wire is nearly £300.00. At this price it is getting close to the cost of the new Michell arm. Would I be better changing the arm entirely? If so which arms work well with the LP12. My budget is a maximum of £500.00 plus whatever I can get for the Ittok.

The rest of my system is an Audio Innovations 500 with a Border Patrol PSU and Castle Chester Speakers. I am not planning to change any other element of my system as I am very happy with the sound and only want to 'tweak' to make it as good as possible. With this system would the changes be significant? Or would my money be better spent elsewhere? I use the AI phono-stage with a Goldring 1042.

Just to make you jealous, my local charity shop sells all vinyl at 10pence a time. I have had some superb bargains from them, including white gold EMI ASD's and wide band Decca SXLs from the 2000 series. Therefore one option for my £500.00 is 5000 LP's

Yours Sincerely

**Peter Fassam**

West Sussex

*Rewiring the Ittok is by far the most sensible course open to you, and I'd definitely go for the Incognito option. Don't be fooled by the price – the Cardas wire used is quite superb, and combined with the improved continuity will deliver real sonic and musical benefits over either the standard or upgraded Linn cable. Get the wiring professionally installed (Moth – 01234-741152) and the arm re-installed and set up by someone who really knows about LP12s (a shop that dealt with them when they were selling ten a week) and you should get added value from all the records you own plus the 3000 odd you'll still be able to afford! Ed.*

Dear Sir

I really enjoyed the prize-winning article "Less is More" by Steve Dickinson. He writes well and with humour. His article fully deserves to win a prize. I am left, however, with one major concern. Steve explains clearly why he would probably not enjoy a more expensive system as much as he currently enjoys his present system. Guilt and the middle class work ethic would eat into his pleasure. And his desire to justify the expense of the system would leave him listening to the system rather than to the music. What a shame. To write such a good piece, win such a desirable and expensive prize (a complete set of Nordost Valkyrja cables) and then to enjoy his music less as a result. So out of the kindness of my heart I would like to offer to help out. When Steve finds himself sitting at home listening to the wide bandwidth, wide and deep imagery and clear transient response of his system all he needs to do is give me a call. I will be happy to offer a good home to his new Nordost cables thus allowing Steve to rediscover his enjoyment of Alice Cooper, Frederic Chopin or even John Cage.

**Julian Hermele**

Via e-mail

Dear Sir,

Regarding CT's outstanding review of the Spectral amplifiers. I too had the Spectral 12/100S; Now I have purchased the 15... and subsequently I strongly urge you to hear the new combination and review it for yourselves plus other 12/100S owners.

All I can say is, of all the equipment I have tried/heard over the years the 15/100S combination is simply the very best, ever. Totally lifelike and totally addictive, the 15 elevates the 100S to a totally new level. Please, please review this combo for other 12/100s users and prospective high-end amplifier purchasers.

Regards

**Andy Jerram**

Via. E-mail.

PS Can you tell me why no one else has reviewed this combination or indeed any other Spectral stuff except Hi-Fi+?

*We'd love to review the DMC15 – and the 30, and the*





*for the love of music...*



Avalon Acoustics



Cardas



Karan Acoustics



Phonomena



conrad-johnson



Tri-Planar



McCormack



Avalon Music Systems

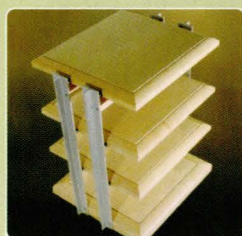

finite elemente



Muse Electronics



Kuzma

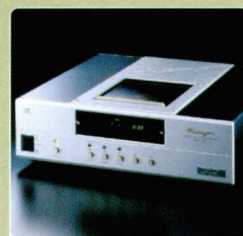

Reimyo by Harmonix



Magnum Dynalab

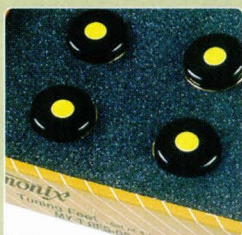

Harmonix

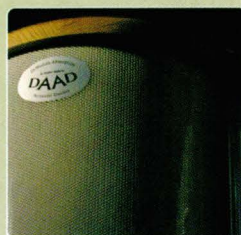

Acustica Applicata (DAAD)

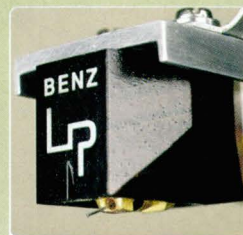

Benz-Micro

Acustica Applicata (DAAD) • Avalon Acoustics • Avalon Music Systems • Benz-Micro • Cardas  
conrad-johnson • Esopower • finite elemente • Harmonix • Karan Acoustics • Kuzma • Magnum Dynalab  
McCormack • Muse Electronics • Phonomena • Reimyo by Harmonix • Sonographe • Synthesis • Tri-Planar

*Distributed Exclusively by*

**AUDIOFREAKS**

DISTRIBUTORS OF FINE AUDIO + HOME ENTERTAINMENT EQUIPMENT

tel: 020 8948 4153 fax: 020 8948 4250 email: info1@audiofreaks.co.uk [www.audiofreaks.co.uk](http://www.audiofreaks.co.uk)





*The Chord Blu  
CD Transport*

*Yes, it does  
sound as  
good as  
it looks.*

**P**roof indeed that beauty is more than skin deep – cast your eyes and ears on the new Blu CD Transport from Chord Electronics.

Blu is our first source component and when teamed with the award-winning DAC64 it provides CD reproduction like you've never experienced before.

To find out more about our hand-crafted audiophile Choral series, please contact us on 01622 721444, email [sales@chordelectronics.co.uk](mailto:sales@chordelectronics.co.uk), or visit [www.chordelectronics.co.uk](http://www.chordelectronics.co.uk)

**CHORD**

Chord Electronics Limited



► *DMA150, as we share your high regard for the company's products. However, the importer doesn't feel that our reviewers, their systems or the rooms they inhabit are up to the task. The 12/100S combination was actually purchased by CT who subsequently asked permission to review it. We are not normally willing to review products without the active support of the distributor or manufacturer, however in this case I'm beginning to wonder whether it's justified – an indication of respect for the product rather than its importer. Ed.*

Dear Sir,

I found Issue No 26 and the Jimmy Hughes review on the Tube Technology Fusion 64. very interesting. I currently have a Naim CDX which has been my front end source for over three years now. It's a good player with many strengths. However, since I got back into vinyl I can't ignore my general lack of interest in CD. I find myself playing more and more records these days:

it's a more relaxing sound and so much easier on the ears! It simply blows the CD away in terms of musical performance. This brings me to the purpose of this letter. Should I bail out of CD all together! (tricky considering the amount I've collected over the years) and invest totally in vinyl or consider something like the CD64 which according to the review goes some way towards addressing some of the problems associated with the 44.1kHz 16 bit format. I understand there are certain issues to take into account, one being the availability of vinyl. Can you seriously make it work with vinyl as the only source?

Regards

**S Phyll**

Via Email

*Given your existing investment in CDs and the hardware to play them, you really need to ask yourself how important that music is and whether it's even possible to replace it on vinyl. A lot will depend on the music you listen to. Classical and jazz is readily available on records, both new and second-hand, the very nature of the music making the search for a specific piece easier and less important to your enjoyment.*

*All those different versions and compositions to choose from. Pop is another matter. Although an increasing number of contemporary recordings are issued on vinyl, there was a 12 to 15 year hiatus when virtually nothing came out on LP. If those years and that music are important to you then you'll need to retain a digital front-end of some sort. Otherwise dive right in and wallow in the value and choice delivered by secondhand records. They're often so cheap that experimentation becomes virtually risk free, which doesn't half broaden the horizons. If you find yourself playing less and less CDs then you could always consider downsizing to a basic universal player like the Philips*

*DV963SA. At £400 it plays everything except DVD-A and sounds pretty good into the bargain. Ed.*

Dear Editor

I found Jimmy Hughes' article in Home Truths (Issue 25) regarding his experience of the press launch of SACD most interesting. It gave me a strong feeling of déjà vu. The reason for this was that way back, when CD was about to be launched, I was involved in very early market research and a demonstration of this, then new format. I came away from a very slick demonstration, with more questions than answers. Foremost was why the sound from stereo LP sounded much better to me. I think it fair to say that at first look it took many years to be "won over" by the new format. In the end the majority of us, (but still not all), became converts for many varied reasons. It remains my preferred format simply because of the availability of the choice of music. (Yes Jimmy I cannot deny the DAC-64 also helps sound quality). Two decades on we are faced with new formats which offer (in theory) a big leap forward, but again a marked reluctance, by many of us, to commit and join in the fun. Perhaps too much has been made of the "format war" between SACD and DVD-A. I know that this has frightened off many friends from the purchase of players. The thought of the "hardware" implications, for surround sound, fills them and me with dread. I do though believe that the future may well be with the multi-format machines now available in increasing numbers and at decreasing cost. I intend, at some time, to invest in one these for use mainly in the replay of music DVDs, as well as films. The question is, what will the reproduction of SACD and DVD-A be like through my stereo system from such a player?

This is where you and the rest of the team come in to play. Up until now the emphasis of most reviews has been on the surround sound, and not the stereo playback, of these wonder machines. What I would like to know is how do they sound in stereo, and are they worth investing in from this standpoint? Can an acceptable standard of reproduction be obtained from a machine that handles just about everything? Let's agree to forget about their CD reproduction as most of us have that sorted! As far as the current discs go I get the feeling that many reviewers prefer the reproduction in enhanced stereo to that of surround sound. If so let us know.

Hi-Fi+ is just the magazine to investigate and emphasize this aspect of this era of reproduction of the recorded arts. Remember "England Expects" (as well as the rest of the country).

Best wishes

**Mike Blackmore**

*I couldn't agree more, which is why the Krell SACD Standard review in this issue takes the form it does. It also represents* ►

*the first player in our experience that does all its available formats equal justice. Perhaps critically, that involves no cross format compatibility in that it doesn't offer DVD-V or DVD-A, but hey, progress is where you find it. Universal players do represent the way forward, but in this respect the danger for stereo replay is that it becomes the poor cousin to surround, dependent on a two-channel fold-down of the 5.1 mix. Fear not – we'll be reporting accordingly. Ed.*

Dear Sir,

Having been an avid reader of your magazine for nearly two years, I thought I would be brave and write direct on a rather knotty hi-fi issue (well knotty to me anyway). Balanced or single-ended connections?

This is, of course, assuming I know what single-ended means. Perhaps I could ask for a basic explanation of the possible cable connections between pre & power amps (as the most basic example I can think of), then ask which is best.

The reason for asking this seemingly straightforward question? (Indeed it should be a fairly straightforward answer as well, but I bet it isn't.) I am trying to take out one of the numerous variables in hi-fi equipment selection.

As you know there is so much choice, so many variables, so much information, so much advice and so many vested interests that the poor punter gets confused. Which is why I am appealing to you. Through reading your magazine in general and the reviews in particular, you appear to be detailed in your analysis; fair in your observations; objective in your assessments; and yet honest enough to say what YOU LIKE and to explain why. This is helpful. It does not make decisions for me - I still want to listen for myself etc - but it tends to guide and cut out some of the enormous choice! On the "balanced cable or not" conundrum I am very confused. At present I have the Advantage CD playing direct into Advantage mono-blocks - their handbooks, which are sparse to say the least, do stress the importance of using the balanced circuits "because they are better"... but they provide "normal" sockets as well "just in case". Fair enough. Then I look at Tom Evans products - not a balanced connector in sight. Does that mean he thinks they are sonically worse? He seems to think RCA connectors are best - do you know if this a) true and b) if so, why? Then suddenly with his new power amps (the Soul) he gives us the option of balanced or single-ended (and even special RCAs as an extra option). How can you connect balanced cables to the Vibe?

Another supplier whose equipment I would like to try is Hovland - all their connectors appear to be single-ended. Yet most of the American heavyweights (Boulder, Krell, Mark Levinson) seem to have balanced only connections. You get the picture ... being someone who wants his hi-fi to make

(enjoyable) music and is definitely not technical (at all) ...this is confusing.

I would really appreciate a comprehensive answer to this question, but realise that there must be a lot of demands on your time - maybe it could appear as one of the magazines technical reports.

I would like to add that I find your magazine enjoyable, informative, well balanced, well presented and mature. This is in stark contrast to most of the other hi-fi offerings - so please keep up the good work. I am really keen to try the Soul M30 monoblocs - have you tried them yet? What would your opinion be of a direct connection from a CD player? Would my Advantage CD1 be "good enough"? (questions, questions)

And then there's Spades or Bananas - ( amp to speakers connections that is) - is one better, and if so which?

Kind regards

**Kerry Warnock-Horn**

PS As your favoured CD player appears to be the Wadia 861, I wonder if you have had a chance to review the "SE" version.

*Wow... Well, let's start at the beginning. Your suggestion regarding a technical piece on balanced versus single-ended connection is already in the works. MC is currently working on a piece examining the state of the art in digital conversion, to be followed by an examination of the very question that concerns you. He'll give you the technical low-down, but in the meantime, here's the benefit of my experience. Generally speaking I prefer single-ended connection to balanced, feeling that it delivers more sprightly dynamics and greater overall dynamic range. In comparison, balanced connections tend to sound flat and sat on. The exception is where you are dealing with fully complimentary circuits (like those in the Levinson Reference, Gryphon and Classe Omega). These do sound significantly better via balanced connections. In the case of the Advantage electronics, start by discovering whether their circuitry is fully complimentary. If so then try balanced connection – otherwise stick to single-ended.*

*For your information, Tom Evans does prefer single-ended connection. Perhaps he would grace us with his reasoning? The balanced option on The Soul exists mainly to broaden its compatibility, particularly in the US market. As you have observed, there is no balanced output option on The Vibe. As regards your other questions: the Wadia 861 will be going away for Christmas to receive its SE upgrade and I'll be reporting accordingly. On the whole, I'll take spades over bananas because you tend to get a more direct connection in more circumstances. However, it's down to materials and construction if you want optimum quality. Keep it small and simple: copper is the best material: avoid fancy plating. Ed*





# Absolute Analogue®

Address: PO Box 30429, London, NW6 7GY  
Tel / Fax: +44 (0)20 8459 8113  
Email: Absolute\_Analogue@email.msn.com  
Website: www.absoluteanalogue.co.uk

"...very much a state of the art contender"  
*Roy Gregory, Editor, Hi-Fi+*

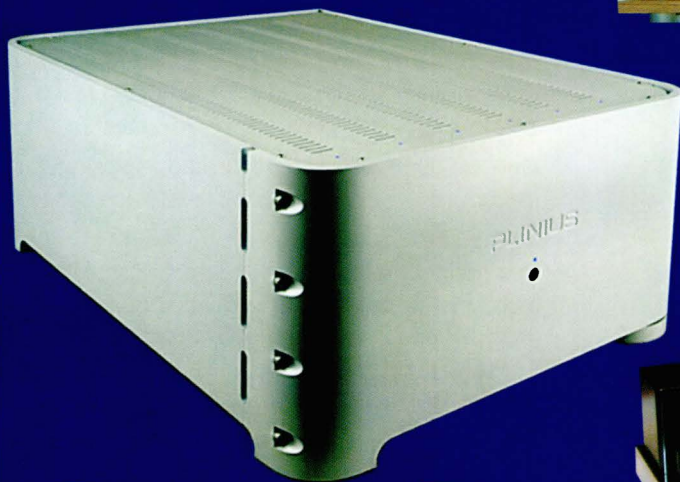
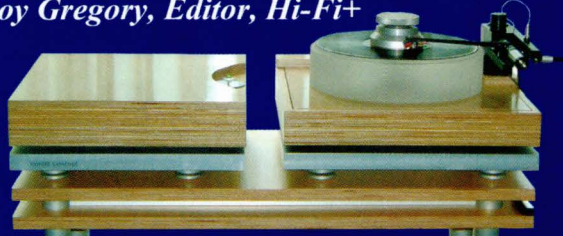

"in my experience, the best built  
and best sounding multichannel  
amplifier available" *Robert Harley,  
Editor-in-Chief, The Perfect Vision*



Hi-Fi+  
PRODUCT  
OF THE  
YEAR

Hi-Fi+  
EDITOR'S  
CHOICE

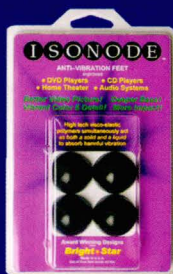

# Get it right!



**New!**

*gilmore*  
AUDIO

## WHAT GREAT SOUND LOOKS LIKE



Linda O'Neil

Model 2  
Left Channel

Mark Gilmore

### **RESPONSIVE!**

The 60-inch, custom-made, 0.3 mil ribbon is the most responsive ribbon driver available, rivaling the transparency and delicacy of the finest electrostats.

### **DYNAMIC!**

One of the few home audio speakers able to reproduce live-concert sound levels and dynamics.

### **GOT BASS!**

The four, custom-made, free-air, long-throw, twelve-inch, planar-dynamic-hybrid woofers move a lot of air. Incredible bass without a subwoofer! (-3dB @ 17 HZ)

### **COHERENT!**

Unlike other planar designs, the ribbon & woofer topologies are equivalent, resulting in exceptional coherency.

### **HUGE SOUNDSTAGE!**

At 66 inches tall, 1 inch thick and 33 inches wide, these planar dipoles are an impressive line source and produce a huge soundstage.

### **VERSATILE!**

From the most delicate solo piano to the most intense heavy metal, no other speaker communicates the emotion of live performance better.

### **ACCURATE!**

The panel is made from Corian® and is essentially non-resonant at audio frequencies. The drivers exhibit exceptionally low distortion.

### **UNIQUE!**

Classic Beauty. Peerless Sound. Nothing looks or sounds like the new Gilmore Audio speaker. There are two models and many colors to choose from.

Manufactured exclusively in the United States.

VISIT US IN VEGAS JANUARY 8-11, 2004 • THE EXPO St. Tropez, Room 1201 • CES Alexis Park, Room 1501

GLACIER AUDIO IS THE INTERNATIONAL  
SALES & MARKETING AGENT  
& MASTER DISTRIBUTOR FOR  
GILMORE AUDIO & ATMA-SPHERE

[www.glacieraudio.com](http://www.glacieraudio.com) • 406-257-0145 (USA)

  
*Elegant Systems For Audiophiles*



# Countdown to



**20 - 22 February 2004**  
10am - 5pm every day  
at the Marriott City Centre  
Hotel, Lower Castle St.,  
Bristol

#### GETTING TO THE SHOW

By train: Temple Meads Station is a short distance from the Marriott and is accessible by bus, foot or taxi.

By car: from the M4 take J19 (M32 - Bristol). Follow signs for City Centre and RAC signs to the Show.



Easy local parking in Broadmead and Bond Street NCPs.

# SOUND & VISION

## THE BRISTOL SHOW

**NOW  
IN ITS 17<sup>TH</sup>  
YEAR**

**See and hear all the latest products under one roof...**

**ACOUSTIC ENERGY:** the official launch of 4 new models!

**CYRUS:** come & learn about quality multi-room and the Cyrus Link.

**DENON:** unveil their fourth Universal SACD/DVD-A Player 51; the technologically groundbreaking DVD-A11 with DVI-HDCP output.

**ELAC:** launch the 200 Series - 5 new JET tweeter loudspeakers.

**LIVING VOICE:** the OBX-R2 loudspeaker system making its debut.

**LOEWE:** presenting their latest LCD, Plasma and DLP televisions, and the stylish new XELOS SL flat panel TVs.

**MERIDIAN:** come and see the new G Series, their first new range in 10 years!

**MISSION:** a surprising new loudspeaker package is promised.

**QUADRASPIRE:** the launch of some major new products.

**REGA:** the all new R9 loudspeakers and possibly more...

**REVOLVER:** 2 new loudspeaker models.

**SONUS SYSTEMS:** a new SE range of support furniture.

**TOTEM ACOUSTIC:** unveiling of the Rainmaker, a fabulous compact loudspeaker.

**WA LOUDSPEAKERS:** stunning speakers carved from Cotswold Limestone!

**WHAT HI-FI? SOUND & VISION MAGAZINE:** there in person to answer all your questions about Hi-fi, Home Cinema and more.

**GREAT DEALS AND SPECIAL OFFERS AVAILABLE ONLY AT THE SHOW - PLUS YOUR CHANCE TO WIN SOME SUPERB PRIZES IN THE SHOW COMPETITION**

ORGANISED BY

**audio**  
EXCELLENCE

**audio**T

in association with

**WHAT HI-FI?**  
SOUND AND VISION

#### Admission

**Adults £7.00; Students/OAPs/UB40s £3.50; Accompanied children under 16 free**

**BRANDS ON SHOW INCLUDE:** Acoustic Energy, Alphason, Anthony Gallo Acoustics, Apart, Apollo, Arcam, Argento, Artison, Atacama, Audionet, Audiopax, Audiophile BASE, Audioquest, Audiovector, Ayre Acoustics, B&W, Bantbridge, Beyer Dynamic, Black Rhodium, Bryston, Cabasse, Canton, Celestion, Ceratec, Cherished Record Company, Chord Electronics, Clearaudio, Clearlight Audio, Creek, Cyrus, Dagetti, Denon, Dezorel, Diverse Vinyl, Dynaudio, Ecosse, Eichmann, Elac, Epos, Exposure, Fergushill, Focal JM Lab, Fujitsu, Future Glass, Gamut, Goldring, GPA, Grado, Graham, Heco, Hi-Fi World Magazine, Inca Design, InFocus, Isotek, Ixos, Ixotica, Jamo, KEF, Klegg Audio, KM Acoustics, Lafayette Electronics, Lexicon, Living Voice, Loewe, Lyra, Magnat, Marantz, Mark Levinson, Meitner, Meridian, Michell, Miller & Kreisel, Milty, Mission, MJ Acoustics, Monitor Audio, Moon, Mordaunt Short, Music Works, Myryad, NAD, Naim Audio, Never Connected, Niro, Nordost, One for All, Onkyo, Optimum, Opus, Ortofon, Parasound, Perfect Sound, Perigee, Pioneer, PMC, Polk, Primare, ProAc, Profigold, Project, PSB, PURE Digital, Purist, QED, Quad, Quadraspire, Rega, REL, Revel, Revolver, Roksan, Ruark, Runco, Russound, Sennheiser, Shakti Audio Innovations, Shun Mook, Sim 2, Sonus Systems, Sony, SoundStyle, Spendor, Stands Unique, T+A, TAG McLaren Audio, Tannoy, Teac, Techlink, The Chord Company, Tivoli Audio, Totem Acoustic, Transfiguration, Trichord, Trinity Audio, True Colours Industries, Tube Technology, van Den Hul, Veda Products, Velodyne, Vertex AQ, Vibe, Vienna Acoustics, Vivadi, Vivanco, Vivante, Vogels, VPI, WA Loudspeakers, Waterfall, Wharfedale, What Hi-Fi? Sound & Vision Magazine, Wilson Benesch, Yamaha and many more...

For the very latest information on new product launches check [www.bristolshow.co.uk](http://www.bristolshow.co.uk)

# Speakers Corner

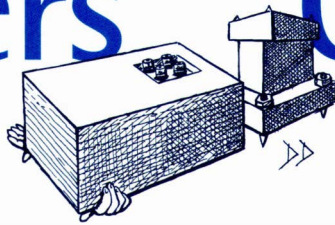

by Paul Messenger

What is a subwoofer? It sounds like a stupid question, because the answer looks obvious. A working definition based on the current commercial offerings could well be: 'a compact bass-only speaker with built-in amplifier, widely found in home cinema sound systems'.

However, let's take a rather closer look at the job that it does, and ignore the current stereotype. A subwoofer is really just a bass-only speaker, and while it tends to be perceived as a compact self-powered box intended to be used alongside two or five small satellites, it hasn't always been that way.

Prior to the home cinema era (which began around 1990), there were probably more passive than powered subs around – especially if you include the packaged stereo '3-box' sub/sat combos which first appeared during the 1980s. The latter were certainly cute to look at, and nice and discrete to fit into the lounge too, but they were relatively costly to make, and in essence were usually just a repackaging of a 3-way stereo pair.

Powered subs evolved for a number of reasons, mostly to do with home cinema. Other contributing factors were that electronics became cheaper; they offered much greater flexibility than passives; and don't give the system amplifier an extra load to drive.

Although REL has always had its own rather different (and arguably more honourable) agenda, the prime marketing reason behind using a subwoofer has always been so that it can be tucked away, preferably out of sight, in the interests of making the loudspeakers as discreet as possible.

The psycho-acoustic rationale is that the ear doesn't detect directional information about low frequency sounds, so it's perfectly feasible to separate the bass out from the rest of the stereo (or multi-channel) music (or movie soundtrack) signal, without messing up the imaging.

All that is true, but it's actually only part of the story. I've tried – and indeed reviewed – many different subwoofers down the years, and a number of stereo and multi-channel sub/sat combos too, and have always suffered uncertainty about where to site the subwoofer. Find a place that works well when I'm sitting in my usual seat, and I invariably find it much less satisfactory in other parts of the room – too boomy here; too lean there.

However, such a situation doesn't seem to arise when the system's bass is being supplied by a pair of large full-range conventional speakers. The implication is that a single point source is not the best way to deliver even bass into the listening room – something which my regular far-field room measurements have only served to confirm.

For some time now I've therefore held the opinion that someone contemplating spending, say, £1,000 on a good quality subwoofer, would be much better opting for a pair of £500 examples instead. With two operating together – either front'n'back or left'n'right of the listening zone – there would be a much more even room drive.

Furthermore size is rarely an issue when playing music, as even tiny subs (like the cute little M&K VX100) are well able to go loud enough to keep up with normal sensitivity speakers at normal listening levels. And of course the power requirements for each sub will drop proportionately, if more than one is used.

What sparked this discussion of sub-woofery was attending an excellent lecture by Dr Floyd Toole, Harman's Vice President of Acoustical Engineering, who heads up the company's large and elaborate research facility at Northridge, California. Towards the end he got onto the topic of subwoofers, and described how his home system – a 7.1 multi-channel array – used no fewer than four subwoofers, all fed the same signal, in order to get the most even room drive.

He then backed this up by showing us measurements which showed quite clearly that two subwoofers are better than one, and that four are better than two. Anyone interested in further info on this should check out the 'white papers' section on the [www.harman.com](http://www.harman.com) website.

As a parting shot, I mentioned earlier that passive subwoofers have become increasingly rare over the past decade or so, but that's not strictly true. As floorstanders have become more fashionable than stand-mounts, a new configuration of speaker which we call a 'two-and-a-half-way' has emerged. Simpler than a full three-way, especially in the crossover, these are actually two-ways fitted with additional bass-only drivers. The 'passive subwoofer' has actually migrated into the speaker box!





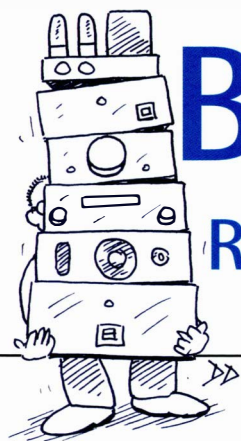

# Big Boys Toys...

## Reality and the Art of Deception

by Scot Markwell

Reality is a funny thing. We chase it so hard in Hi-Fi in the pursuit of music, truth, beauty, expression, and just plain sound that I think perhaps we occasionally get too involved in a particular microcosm to realize that we have somehow managed to stray off the path. Maybe we were looking for bass that month, or maybe inner detail and three-dimensional imaging held our imaginations for the better part of a couple years. And those horns the wife almost divorced us over made us realize the power of dynamic life. You know what I mean: we have all, at one time or another, focused so intently on some particular quality of our systems that we have neglected or ignored other aspects that are in fact needed to make a complete presentation. It is both easy to do and insidious the way that it can creep up on you. Things are usually brought home when an audiophile buddy stops round and points out that while your sound is wonderful it has strayed far enough from neutrality that it kind of sticks out like a sore thumb. It is at this point that a given system has strayed from the conventional pursuit of the recreation of reality towards a more ersatz vision of how the system's owner perceives such. Listener bias is borne out by the fact that every one of us has

a picture in his or her head of how they WANT a system to sound, regardless of how actual music really sounds. This can lead to situations that run the gamut from deeply satisfying, if flawed, sound to the embarrassing derision of one's friends and listening buddies.

After having been through more of these kinds of experiences than I care to readily admit, both good and bad, my present system is still constantly changing and I have to always be on the lookout for any straying from the garden path of proper observation and reporting on my part, but as I am a professional reviewer, this is par for the course. Recently, however, I have had disconcerting experiences with a couple of products that have opened my eyes to a couple of areas that I had previously either ignored out of dismissive scorn or lack of enthusiasm. These two happenings, while not at the level of what I would call an epiphany, have nevertheless made me realize just how seductive certain sonic aberrations can be, and how easy it is to get lulled into a comfort zone, ►

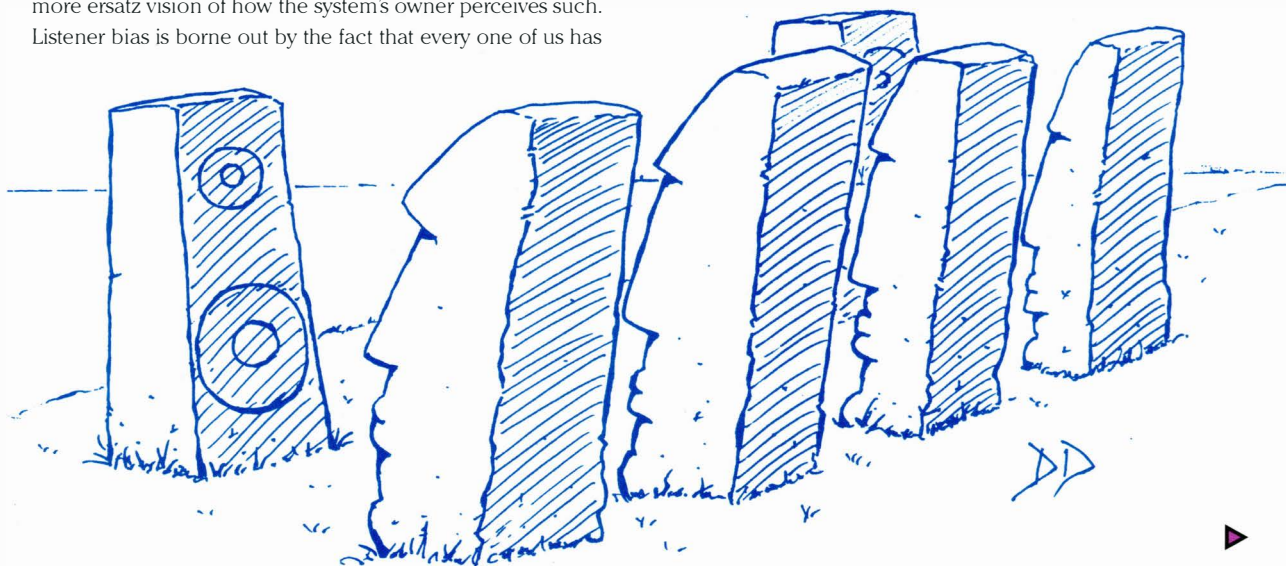

# NEWS FLASH

# 2004 A GREAT YEAR FOR IT

**MANCHESTER – LONDON & UK REGIONAL ROADSHOWS**

**5 STAR VENUES**

**SPECIAL SHOW OFFERS**

**LARGE ROOMS**

## IT'S COMING

GET YOUR DIARY'S AND WALL PLANNERS OUT. NOW IN IT'S 5TH YEAR WITH A GREAT NEW VENUE – NEW DATES – BIGGER DEALER LINE-UP – THE NORTHS PREMIER SELLING SHOW, NORTHERN SOUND & VISION WILL BE BIGGER AND BETTER THAN EVER. **HOW'S THIS JUST FOR STARTERS?**

WILSON BENESCH  
LYNWOOD  
QUADRASPIRE  
HARMAN KARDON  
AUDIONOTE  
EPOS/CREEK  
DALI  
KORATO  
OPUS 3  
HI-FI+  
AUDIOCRAFT  
AUDIOWORKS  
REFERENCE AUDIO  
SMARTHOUSE SHOWCASE  
CRESTRON  
ARTCOUSTIC  
VIVANTE

DIVERSE VINYL  
RINGMAT  
LARC  
CHERISHED RECORDS  
CUSTOM DESIGN  
DOUG BRADY  
SEVENOAKS  
ACOUSTICA  
NAIM  
FERGUSON HILL STUDIOS  
SUGDEN  
QUAD  
ARCAM  
AUDIO ANALOGUE  
BCD-ENGINEERING  
DIAPASON  
FINAL

FONE  
GRAAF  
HI DIAMOND  
KEMP ACOUSTICS  
TRIANGLE  
UNION RESEARCH  
BOSE  
SPECTRAL  
ACCPHASE  
NAGRA  
FOCAL.JM LAB  
PRO-JECT  
VIBE  
ORTOFON  
ROKSAN  
VIENNA  
BEYERDYNAMIC

BLACK RHODIUM  
SIM2  
ANDERS & KERN  
VIDIKRON  
STEWART  
FIREHAWK  
GRAVES AUDIO  
IKON AUDIO  
WEMBLEY LOUDSPEAKERS  
EXPERIENCE FILTRATION  
TRUE COLOURS  
MARTON MUSIC  
WILLIAMS HART  
MUSICWORKS  
OBELISK AUDIO-SYSTEMS  
BLUE PEARL AUDIO

### Entertainments & Special Attractions

#### Hi-fi+ 2003 – Products of the Year Awards

We are delighted to be hosting this prestigious event at Northern Sound & Vision. Look out for the Rosetted rooms that will indicate some of the winners.

#### Smarthouse Showcase

See cutting-edge technology all in an actual home setting, lounge area, kitchen, all brought together in a unique display

#### Subwoofer+ Supertweeters Stand-off!

Get the lowdown on both extremes in Suite 201, all professionally presented by Show Media Sponsors – Hi-fi+ Best sounds, best vision

Your chance to make a positive contribution to the show! Give us your choice of best rooms & displays, we've three awards to give away.

#### Home Cinema

With our new venue we have all the space we need to present this dynamic market to it's best advantage, be prepared to be impressed.

#### Class acts

Quality live entertainment will be a hallmark of the

Northern Sound & Vision show. Continuous and tasteful sessions throughout the weekend.

#### High-end audio.

In order that visitors have the best chance of hearing top quality sound, quality audio will have it's own section of the show.

#### Budget systems

Here you will find top quality systems that won't break the bank.

#### Accessory bars

Throughout the show we will have trade stands for browsing those exclusive accessories.

#### Visitor Goody Bag

All visitors to Northern Sound & Vision receive 2 FREE Hot-of-the-Press magazines, Hi-fi+ (March issue!) and Smarthouse, worth £7.25. Plus a FREE Programme, making Northern Sound & Vision the bargain show of the YEAR.

#### See & Buy?

Northern Sound & Vision is not just THE shop window – it's a selling show. Many items, including show specials, can be bought on the day!

Northern  
**2004**  
Sound & Vision  
Hi-fi & Home Cinema show  
Radisson SAS, Manchester Airport

7/8 February 2004

**PROMOTING HIGH QUALITY  
SOUND AROUND THE  
COUNTRY**

MARCH 2004

CAMBRIDGE

MAY 2004

NORTHUMBERLAND

JUNE 2004 – EAST SUSSEX

JULY 2004 – DEVON/DORSET

OCTOBER 2004 – WORCESTERSHIRE

NOVEMBER 2004 – NORTHERN IRELAND AND EIRE



NOW IN IT'S 3RD  
YEAR SO IF IT'S HIGH  
QUALITY HI-FI YOU'RE  
LOOKING FOR –  
LOOK NO FURTHER.  
IN CONJUNCTION WITH  
**MUSIC MATTERS –  
PINNER**



**FOR DETAILS OF THE LONDON, MANCHESTER SHOWS OR THE  
UK HIGH FIDELITY REGIONAL ROADSHOWS ORGANISED BY  
CHESTERFIELD COMMUNICATIONS, CONTACT: ROY BIRD**  
Tel: 01829 740650 Mobile: 07810 697123  
E-mail: roy@chestergrp.fsnet.co.uk  
Website: www.chestergroup.org

hi-fi+

WHAT'S NEW IN  
**SOUND**  
AND VISION

INTERNATIONAL  
**smarthouse**

The  
**Audio  
Works**

**ACOUSTICA**  
HI FI & HOME CINEMA



*Doug Brady Ltd*

**GET YOUR PRIVILEGE  
SHOW TICKET  
IN THIS ISSUE**



► even if you are aware of the trap before it exists.

Right. Being mysterious again. Sorry. I hate useless jabber as much as the next fellow, but a little background was necessary here to get the following accounts in their proper perspective. To begin the tale, I have to confess that I am an unabashed, whole-hearted supporter of Tommy Horning's loudspeakers. I look at them in a manner not unlike the sort of hero-worship, (mostly) love/(little) hate relationship that The Absolute Sound's Harry Pearson had with early Magneplanar loudspeakers: They would not sound really good till one cranked up the volume a lot, and then they would sometimes bottom out on hard bass notes. Never mind that they would go just low enough to not really need a subwoofer, they often as not cried out for one anyway, particularly in rooms where the dipole bass just did not blossom as well as it could. The really early ones, before Jim Winey's true ribbon tweeter did not extend out as far in the high treble as later models, and the result was a lack of air at the top. And there were other problems, discontinuities, and so on. But at the end of the day they more often than not tended to sound more like actual music than many, many of the other, more conventional loudspeakers on the market. Despite their shortcomings (which are far fewer today than in yesteryear...), the Maggies always had an alluring sense of palpability and believability; one could occasionally actually suspend disbelief and almost swear there were musicians and their instruments in the room.

The Horning Agathons that I have on hand for review are my Magneplanars: They generally sound so much like music that I am inclined to forgive their one main flaw, a gentle rolling-off of the high frequencies above about 6-7 kHz. This is as measured (playing pink noise) with a Goldline DSP30 Real Time Analyzer at the listening position. Although remarkably flat in response from about 40-50 Hz up to that roll, above it the speakers power response plummets. If I sit within a couple of feet of the speaker I can easily discern test tones up to 16-17 kHz, but they are well down in level compared to the midband.

Let us consider this. Conventional wisdom states that one wants as flat a power response in a loudspeaker as is possible, especially in the midrange and treble, and many manufacturers go to great lengths to make it so. One of the most successful in that regard is Jim Theil. If you look at measurements of his loudspeakers they will generally show a remarkably even and extended response above 3-4 kHz right out to beyond audibility. Now, with some amplifiers in some systems you can get away with that, but in many instances Theils just are way too bright and forward-sounding, at least for me. I suppose this is partly the speaker being ultra-revealing and the fact that so many recordings, especially these days, are made with relentless and overbearing upper frequencies, exacerbating the situation. But if you roll off the top end to tame the speaker, are you not going to throw

out some of the best part of the music with the crap? Again, conventional wisdom says yes. Just look at all of the compressed audio formats we have for computers and the like. They all have in common a limited bandwidth and simplified, compressed musical information. And they all sound like bollocks, if real music is the comparison. Yet they satisfy millions of souls worldwide. Is this simply ignorance and low standards on the part of so many, or is there something going on that is escaping scrutiny?

In the case of the Agathons, I find them to be, with the possible exception of my Shahinian Hawks, the most delectable, seductive, and grainless transducer I have ever had in my home system. I reviewed their big brothers, the Alkabiades Signature Golds, several years back in *The Absolute Sound*, and they had the same balance of sound, just a bit more bottom end (much bigger box). I have never heard more natural rendition of music's most basic structure: the Agathon's tonal balance is extraordinarily correct and compellingly convincing on either LP or CD playback. Its lack of virtually any overt character of its own allows the speaker to instantly and obviously showcase the differences between top vinyl replay and even the best modern digital. Yet it never bites your head off. At the same time, you can instantly hear the differences between recordings, so much so that overly-compressed or otherwise flawed software can become intolerable simply because you know that several other records sound so incredibly good. And all of this is accomplished with aplomb around a top end response that would seem to be a recipe for anything except satisfaction. Yet music seems to lose none of its snap or drive or detail with these speakers. In fact, top-end air and articulation is exemplary, as is the speaker's three-dimensional rendition of depth. I am not disappointed when I come home after a concert and listen to the Homings. This just does not make sense.

In the end, I will follow my ears. But is it a conundrum. I am trying to step back far enough to see if I have missed something, but I keep getting sucked back in. Not helping are my friends who come over and say how they love them and that they would not change a thing. Damnedest thing: I liked the speakers just fine till I did the measurements. I still adore them but I wonder if I am wrong about their authenticity. I am not done here.

The other, lesser only to the extent that I do not care as much about video as I do about audio, thing that has lately had me re-evaluate my notions about what "correct" sound should be like is an all-in-one (actually, all-in-three if you want to be really precise) Home Theater system from Nakamichi. It's called the Niro 1.1PRO and consists of a slim box that houses all of the electronics for DVDs, CDs, AM/FM radio, the power amplifiers, a small subwoofer, and a trapezoidal-shaped box that houses five drivers. The idea is to create the illusion of surround sound from several drivers in one box. I thought, ►

▶ upon my initial examination of the thing, that it had to be a joke. I mean, how could this little dinky thing hope to fill a room with sound, let alone provide a facsimile of surround? Well, I am still in the early stages of testing with this one, but I can tell you this: DVD picture quality aside, which I am not really qualified to critique, the thing actually works. Mind you, it does not really make sounds seem to come from behind you, but it does manage, especially with some material, to project a hugely wide and deep soundspace into the room. Kind of like Q-Sound in reverse. Interesting, all the while the little magic box is busy propelling sounds around the room, it manages to make voices appear as if they are coming right off the center of the TV screen: Uncanny. Totally processed and manipulated, this little system manages to make watching the telly a hell of a lot more interesting and dramatic. I have yet to play a CD in it. I am afraid of what might happen...

One last thing that I wanted to tell you about, while I have your eye, as it were, and while the thought is in my notoriously porous head: I recently was witness to an A/C power cord demonstration from the inimitable Joe Reynolds and Lars Kristensen. The occasion was the introduction of their three new power cords, and they wanted to give HP the 'ole dog and pony show. We had been happily using, on the four amplifiers that power the Alon Exotica Grand Reference speaker system, a set of four identical premium A/C cables that have received excellent press and that we were familiar with, so it was to be an interesting test. (I will refrain from mentioning the name of the "competing" brand of cable, as it is not germane to my story, but rest assured that we try very hard indeed to have the best possible sound that we can get – regardless of cost I might add).

The lowest-cost Nordost offering, the Shiva, lacked the

sheer weight and dynamic authority of the resident leads in this broadest of bandwidth systems, an unforgiving test if ever there was one. The master spake and it was quickly removed, to be replaced by the twice the price Vishnu, which seemed far more promising. Indeed, it was very close to our (far pricier) control. We listened for several minutes to the same selection we had used before and then decided to go for broke and see what the Valhalla cord was like. Lo and behold if it did not simply stomp the dog doo-doo out of anything we had played to that point. All of this was done without touching the system volume in any way, mind you. With the Valhalla on the four amplifiers, the sound seemed to gain in intensity, dynamic jump, and took on an engaging presence in the room: No hardening or glassiness to the sound, just almost as if there was an explosion of dynamic energy in the system. This happens every time I go to a Nordost demo. Just when you think it cannot get any better these guys pull a rabbit out of their hat. Now, I am not totally uneducated in electricity and mechanics and physics, but I still to this day do not understand how a power cord can make such a dramatic difference in the sound of audio components. It is such a basic thing.

Is it possible to have too great a level of authenticity in terms of dynamics and openness? I do not think so, but I certainly realize now that it is not only possible, but probable, that many systems will never perform at their best unless the owners are fanatical in pursuing every nuance. When is enough enough? I suppose that is a personal thing, but I remain true to the notion that we can never be too close to the music. And I think it is great fun to see, on occasion, just how far we have to go in terms of both playback and the understanding (or lack thereof) that goes with it. ➤

# Home Truths



by Jimmy Hughes

Leonard Bernstein once said that whenever he conducted Beethoven's opera *Fidelio*, he felt the presence of Napoleon's troops in the audience behind him - early performances of the work (then called *Leonore*) having taken place in French occupied Vienna during 1805. Okay, it's perhaps a touch fanciful. But it illustrates the way music captures and absorbs the Zeitgeist - the spirit of the time in which it was written and performed.

In 1798, when Haydn wrote his 'Nelson Mass', he subtitled

it *Missa in Angustis - Mass in time of Fear*. The music isn't 'about' Horatio Nelson - or Napoleon Bonaparte for that matter. It simply reflects the anguish and concern felt all over Europe regarding Napoleon's activities. Listening to the martial trumpets that open the work, you sense the disquiet and foreboding that stalked the last years of the 18th century. Knowing that alters your understanding and appreciation of the music.

Classical music covers such a large area, it's sometimes ▶





*Purity...*

OVERKILL  
audio

*“Some things are so naturally pure and fill you with such powerful emotions you can't imagine life without them”*

*‘The Ovations’ by OverKill Audio*

**These revolutionary loudspeakers have no equal. Featuring the two fastest drivers in the world they will truly astound you with their dynamics and agility breathing new life into your system.**

The patented ‘Firebird’ bass system generates awesome power and stunning transients whilst maintaining texture and clarity down to an amazing 20Hz! At the other end of the frequency spectrum the patented Manger driver reveals sublime detail and delicacy maintaining linearity and phase coherence up to an equally amazing 35KHz! **The ultimate full-range system.**

Compared to the best of the rest, the Ovation's bass is 20 times faster with one tenth of the distortion, and the midrange and high frequencies have ten times the speed and none of the distortions which all cones and domes are cursed with.

Having the one and only crossover point below the critical 500Hz barrier, frees the midrange and high frequencies from all crossover

distortions, allowing the Ovations to reproduce the most beautifully sculptured acoustic images with staggering dynamics, captivating detail and enchanting harmonic structures.

The internationally acclaimed Manger driver, the **world's only** bending wave transducer, is taken to a new level when it's released from the constraints of an MDF box and allowed to sing as never before.

Each 90Kg cabinet is acoustically inert. With no parallel walls, 24 pieces of 24mm CNC machined birch ply, and unique ‘gas flowed’ inner lining - they are truly a labour of love. Our 12-coat Italian marble lacquer is then hand applied gracing the Ovations with the most beautiful of finishes.

**Once heard, previous experiences and expectations will be shattered as the Ovations reproduce music the way performers meant it to be heard - with emotion and purity.**

**For a demonstration or further information call 01487 842 911 or visit our website at [www.overkillaudio.com](http://www.overkillaudio.com)**

► hard to know where to start. When I first began to explore the repertoire, it seemed important to map out the terrain so to speak. I'd tried going to the local record library and picking music at random, but it didn't always work. Often, I failed to understand or appreciate what I was hearing, being unable to place the music in any sort of context. It was as though the composers spoke a language I didn't yet understand.

Luckily I had a starting point. I liked baroque music - Bach, Handel, Vivaldi - so initially I kept to the 18th century, and only gradually moved forwards in time. JS Bach's sons, CPE Bach and JC Bach, were the bridge to the early classical period of Haydn and Mozart, and this pointed the way to Beethoven. Later on I discovered Schubert and Mendelssohn, then Schumann and Brahms. On the way I took in Dvorak, Tchaikovsky, Bruckner and Mahler.

Then came Sibelius, Stravinsky, Elgar, Vaughan Williams, and so on. Only by progressing slowly, and relating one composer to the next, could I make sense of their music and its development. Despite each composer inhabiting his own unique world, it seemed

as though the key to understanding that world depended on knowing something of the times in which he'd lived and worked, and the influences he'd drawn on to forge his own particular style. You couldn't listen in isolation and get the full picture.

Something else I realised is that music progresses. The time span between the end of the Baroque era (say) and the beginning of the early classical period is not particularly large - indeed, there's a bit of an overlap - but the difference musically is considerable. The same basic emotions are being expressed, but the means of expression are totally different. So, composers like Handel and Mozart inhabit very different worlds. This progression seemed obvious; you didn't need to think about it.

Just by listening you knew Mozart was earlier than Beethoven, who was earlier than Schubert, who was earlier than Brahms, who was earlier than Mahler - and so on. You could hear the means of expression changing and progressing. At least it seemed that way to me. So it came as a shock when I realised my wife, who has a very good ear for music, did not make these distinctions. For her, music is music; she either likes it or she doesn't. She responds to it emotionally.

Of course she can grasp the concept of music moving forwards in time as new composers came along. But how this

actually translates into music itself does not seem to register. She doesn't seem to be able to place music in a time-frame. Naturally, I attempted to explain the process - and quickly realised I couldn't! Taking Handel and Mozart as strongly-contrasted examples, I found it virtually impossible to say what it was about Mozart's music that made it 'later'.

I began by generalising, saying that, as a composer of the Baroque era, Handel's music was busier - more ornate and florid than Mozart's. But hold on - you've only to compare the plain spare overture Handel wrote for *Messiah* with (say) Mozart's bustling *Marriage of Figaro* overture to realise that such simplistic generalisations don't even

begin to scratch the surface.

In a nutshell, Mozart's music has a different feel to Handel's; the world has moved on; the social and political landscape has changed.

Even in cases where Mozart (unconsciously?) plagiarises Handel - the *Kyrie* of Mozart's *Requiem* sounds like *And With His Stripes* from *Messiah* - Mozart still sounds like Mozart. By an accident of fate, Mozart was paid to re-score Handel's *Messiah* - to give it a contemporary flavour. He greatly expanded the wind section, adding colour to the orchestration. Yet the end result still sounds like Handel - albeit, Handel decked out in Mozartian clothes.

Maybe it wouldn't work for everyone, but speaking personally music appreciation became easier the more I pieced together the bigger picture. The more I understood how different composers related to one-another and how they related to the time and place they lived in, the easier it was to understand and assimilate the forces that brought the music into being - what made it tick. And the more in-tune you are with a composer, the more you seem to get from his music.

It's perhaps akin to someone young today starting out with a taste for the Beatles, listening to their albums, then going on to explore contemporary singers and bands, as well as those of an earlier period who influenced the Beatles. Music never happens in a vacuum; it always evolves. So the more you understand about the pop music scene in (say) 1967, the easier it is to appreciate how ground-breaking the album *Sgt Pepper* was in its day.

Is that important? Perhaps - perhaps not. You'll either like *Pepper* or you won't, and no amount of 'explaining' is likely to alter that. But I recall hearing *Sgt Pepper* in the '60s, and it was mind-blowing - like nothing I'd ever heard before. In the same way, if you know the late symphonies of Haydn ►





## Revelation

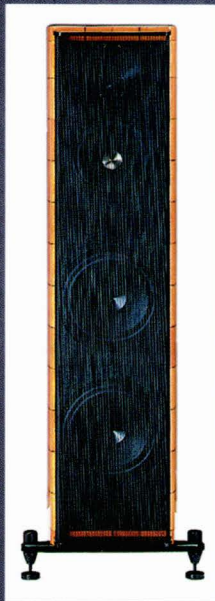

### Sonus faber

#### Amati Homage

Quite literally; sensational! The superlative Amati is a loudspeaker through which music's emotions and nuances are fully realised. Hear them at KJ West One driven by systems from: **Krell, Audio Research and McIntosh**



### Wilson Benesch

#### Act

Evolved from the universally acclaimed Act 1 and it's sibling the Act 2, this latest incarnation from Wilson Benesch promises to 'act' as the reference by which all other loudspeakers will be judged. Excellent re-sell facilities for customers who've bought earlier Wilson Benesch models from us.



### Martin Logan

#### Odyssey

The epitome of Electrostatic hybrids. Astonishing clarity and transparency underpinned by a truly persuasive bass. Audition alongside the new **Quad 989** and then decide!



### Wilson

#### System 7

Another evolutionary introduction that maximises the renowned strengths of its predecessors with enhanced refinement. Driven by suitably powerful amplifiers the System 7 can recreate a musical performance of lifelike scale, power and presence together with near ethereal subtlety. Audition the System 7 at KJ West One and discover the utterly convincing three dimensionality of which current sound systems are capable. Hear them driven by: **McIntosh, Krell, Nagra and Audio Research**



### Wilson Benesch

#### Arc

Ending the search for many customers seeking a full scale, believable soundstage for smaller rooms. Seemingly uncompromised at either end of the frequency spectrum it's both immediate and tireless.

*~ Excellence is our only compromise*

*Perfection is infuriatingly elusive, if we were to achieve it - what objectives would remain?*

*A visit to KJ West One is likely to exceed all your expectations. Amongst a vast array of high-end components are many that represent excellence in all respects.*

*Some might even claim to be as perfect as is currently possible. We have no argument with that.*

*Grounded in a love of music, we can offer a sensitive expertise as well as all the facilities you'll require to complete your search for musical purity and authenticity.*

*The incomparable display in our showroom is an invitation to audition and compare many rare, revered and exclusive items. So please call into our West End store, or make an appointment at one of our branches for a demonstration at your convenience.*

**West *kj* One**

26 New Cavendish Street  
London W1G 8TY  
Phone: 020 7486 8262/3

Northampton (01604) 637871  
Peterborough (01733) 341755

[www.kjwestone.com](http://www.kjwestone.com)



Exclusive High-end products for the discerning music enthusiast. <sup>®</sup>

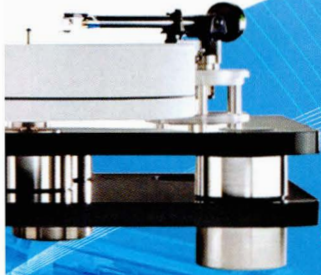

ClearAudio

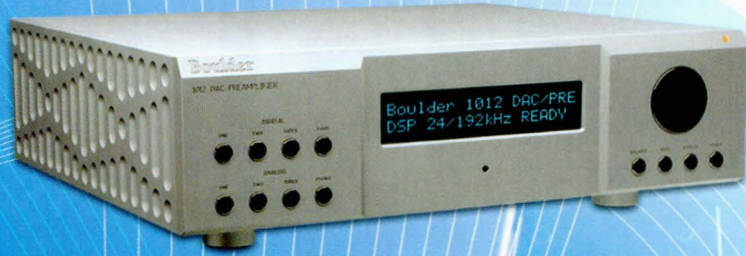

Boulder 1020 Pre amplifier

zouch audio



Advantage, Aloia, Audio valve, Burmester, Boulder, Cabasse, ClearAudio, Gamut, Hovland, Kharma, Lumley Lampros, Musical Fidelity, Plus many more...

T: 01530 414128 M: 0976 571875



Lampros 300



Audio Valve

Audio Valve Challenger

Gamut D200



Gamut CD



Aloia



Kharma



**Zouch Audio Ltd.**

The Old Coach House  
Off South St.  
Ashby De La Zouch  
LE65 1AN

Hovland Radia



Cabasse



Hovland Sapphire



Tri-Vista MF

design: leedalbv@gondarplus.com



▶ and Mozart, and perhaps the first two symphonies by Beethoven, your appreciation of how original and revolutionary Beethoven's mighty *Eroica* symphony was in 1805 can only be enhanced.

The danger for anything revolutionary or groundbreaking is that, divorced from its context, it ceases to shock and amaze. The mini skirt was shocking forty years ago - not so today. Only in the context of early '60s fashion does it shock. In classical music there's a core repertoire of key pieces that get played again and again. In order to make the music sound vital and exciting, many performers try to

recreate (so far as is possible) a sense of how that music must've sounded when it was brand-new.

As listeners we need to do the same. To listen with fresh unprejudiced ears, as though hearing the piece for the first time. It's different with music that has a specific personal relevance: music that relates to certain key moments of your life. For most of us, I imagine, pop songs current when we were growing up hold a special significance. But, when exploring music from earlier times, I believe it's vital to do a bit of research first. Only then can you hear it in the appropriate context.



# Postcard from Venus

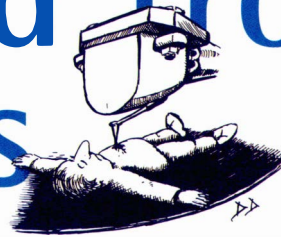

---

by L. S. Webster

---

More amazing news just in today that 'listening to music' looks soon to become the principle reason for buying hi-fi. Daisy DJ, leader of the activist organisation Partners of Nerdy Techy Spouses, (also known as PANTS) made the shock announcement after the result of a survey carried out by her team of researchers.

The surprise news will no doubt delight the many hundreds of spouses who say they never actually get to hear any music due to Repetitive Tweaking Syndrome; an annoying condition that afflicts an apparently growing number of hi-fi boffins.

Amateur hi-fi hipsters Mike Megawatt and Al Cacaphony were among the first to respond to the wild claim, and taking a few minutes away from the important business of soldering old parts into a box said they were incredulous. "We've never heard anything like it. Everyone knows the proper reason for buying hifi is to have something to fiddle around with and show off among friends, which is entirely correct and the proper way to go about things. Quite frankly, this is obscene."

Senior industry spokesman, Stevie Stereo, issued a statement applauding Daisy and her activists for their forward thinking and was forced to admit it was a radical idea. But he implied it could easily be perceived as being based more on wishful thinking than solid fact. "I don't want to suggest this was in any way rigged, but it does appear to be biased in favour of the groups' own members," he said.

Daisy and her team remained firm on their findings

though and were adamant the result signals a clear departure from traditionalist ideology. 'Megawatts' comments are nothing more than classic symptoms of denial and this only endorses our findings further; that a core group of people have not yet worked out there is a relationship between hi-fi and music. What we've also discovered is that there's no place in modern society or our living rooms for this rubbish hobby anymore. Listening to music is infinitely more preferable than listening to hi-fi, which has always been marginally less excruciating to endure than an in growing toenail. Where's the music? That's what we want to know".

Megawatt and Cacophony responded by saying, "This woman is obviously some kind of nutter. Of course, it could just be blatant propaganda, but we've never believed in spoof surveys. People need direction and we look forward to the day when every home in the country has great piles of hi-fi gadgets - just as it should be. Daisy and her activists misunderstand the importance of this and I just don't know what the world's coming to. We're going to throw our full weight behind a campaign to bring this into immediate effect. It's all very well coming up with these newfangled ideas but we must now get back to basics."

Daisy and the activists seemed totally unperturbed, saying they weren't giving up that easily and were intent on setting the new agenda by declaring they're off to a brilliant little record shop they'd heard about to buy some CD's. Which, I think you'll agree, is a pretty good place to start.



# Forest

---

Totem has spared no expense in making the Forest one of the best speakers available at any price... It's a two-way floor standing model that is surprisingly affordable, considering that it is a true super-speaker. The woofer and its aluminium dome tweeter, allow it to cover the full auditory range. Those aren't mere paper specs, either! The response is down only 6 dB at 28 Hz, a frequency most speakers can't reach. Its lock-mitred monocoque chassis, its slanted rear baffle, and its fine hand-crafted construction place it above lesser speakers of its size and price. Much of this is invisible, though by no means inaudible. As usual with Totem speakers, the fine wood veneer is also placed inside the cabinet, to equalise forces on the two sides of the walls. Why it's called the Forest? Well, where would you expect to find a totem? Well, a forest would be a good place to begin your search. However, a forest also imbues mystery, quietness and unpredictable, unexplainable power. In a real forest you are surrounded with sound, which can suddenly appear, surprise and then disappear. It can happen anywhere around you. Let the Totem Forest surprise you in the same way...

---

To receive information on our full range of products, please send your address to [info@joenit.com](mailto:info@joenit.com) or call 003215 285585

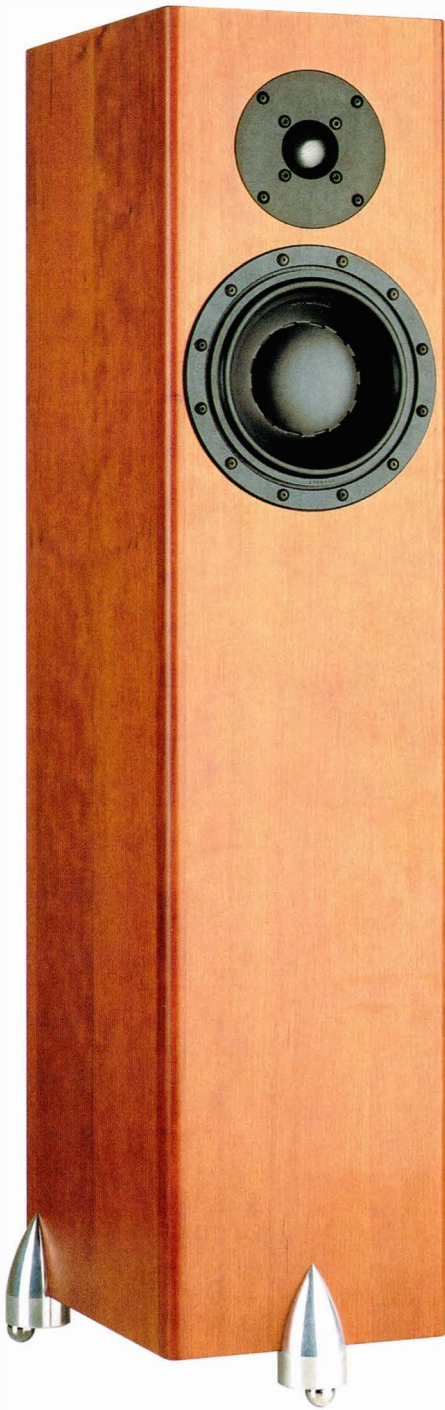

London Area

Cornflake.co.uk, LONDON, Tel: 0207 6310472  
Thomas Heinitz, BAYSWATER, London, Tel: 0207 2292077  
Audio-T, READING, Berkshire Tel: 01189 585463  
Audio-T, EASTBOURNE, Tel: 01323 731336

South  
South East

Rayleigh Hi Fi, RAYLEIGH, Essex, Tel: 01268 779762  
Rayleigh Hi Fi, CHELMSFORD, Essex, Tel: 01245 265245  
Audio-T, TUNBRIDGE WELLS, Kent, Tel: 01892 525666  
Rayleigh Hi Fi, SOUTHBEND, Essex, Tel: 01702 435255  
Visions, WESTERHAM, Kent, Tel: 01959 569977

South West  
Midlands  
North

Audio Destination, TIVERTON, Devon, Tel 01884 243584  
The Soundstage, DERBY, Tel: 01332 364000  
Audio Republic, Headingley, LEEDS, Tel: 0113 217 7294

Scotland

Romers Hi Fi Great Harwood, Lancs Tel: 01254 887799  
Loud & Clear, EDINBURGH, Tel: 0131 5553963  
Loud & Clear, GLASGOW, Tel: 0141 2210221

Wales

Audio Excellence, SWANSEA, Tel 01792 474608



TotemAcoustic.com



United Kingdom Distributor  
[wim.verellen@joenit.com](mailto:wim.verellen@joenit.com)  
Belgium Tel: 0032 15 285 585



# EXPERIENCE THE CHORD EFFECT!

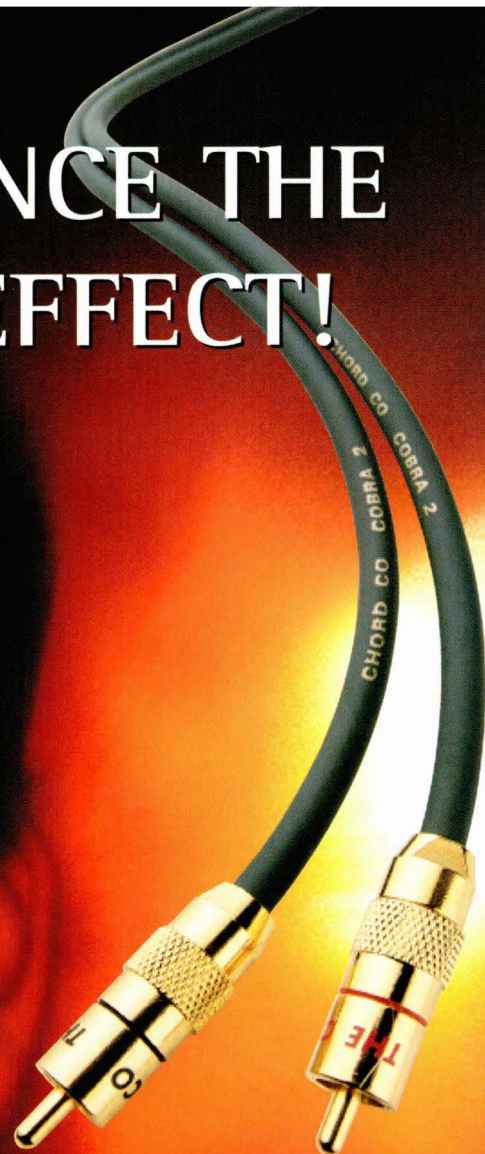

The first time you hear your sound system with Chord interconnecting cables will be the first time you've **really heard** it. Be warned - the effect can be shattering. Your eyes and ears will be opened. Your music will never sound the same again. Specify Chord cables - Hear the light!



SIGNATURE

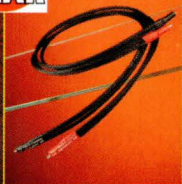

CHORUS



ODYSSEY 4



ANTHEM



CLEARWAY



FOR SALES AND INFORMATION  
CALL: 01722 331674  
FAX: 01722 411388  
E-MAIL: [CHORD@CHORD.CO.UK](mailto:CHORD@CHORD.CO.UK)  
OR VISIT US AT  
[WWW.CHORD.CO.UK](http://WWW.CHORD.CO.UK)







# An Unattainable Goal... A Short History Of Passive Linear-Tracking Tonearms.

by Roy Gregory

*Linear-tracking tonearms might well be considered the Holy Grail of analogue replay. But their history is long and convoluted, and littered with hard lessons. To really appreciate where the latest assault on this particular Everest, the Kuzma Airline, stands in the light of the saga, it's necessary to understand the trials and tribulations that have afflicted the evolution of the species. Those who've owned an air bearing tonearm in the past may choose to skip this part, having learnt the contents (or at least their practical implications) by bitter experience. For the rest of you, here's the long and tortuous road leading to the current state of grace.*

Why bother with linear tracking? It's a pertinent question given the level of engineering required to make the approach work even half successfully – especially when compared to a basic uni-pivot design or a Rega RB300! The answer lies in the fact that the cutter head on the lathe that actually cuts the groove moves in a straight line across the record. Any arm that's pivoted moves the stylus in an arc across the record, constantly changing its angle to the groove walls. Careful attention to geometry and set-up can minimise the effect, but once you've heard a decent linear-tracker then the tracing distortion that's inherent in every pivoted design becomes

increasingly hard to ignore. So hard that the theoretical issues with passive parallel trackers, the sheer level of engineering needed to overcome them, and the demands and limitations they place on turntable and cartridge design (almost) begin to seem worthwhile.

Of course, linear tracking tonearms never started out passive at all: The earliest examples, from B&O and then Rabco I believe, were

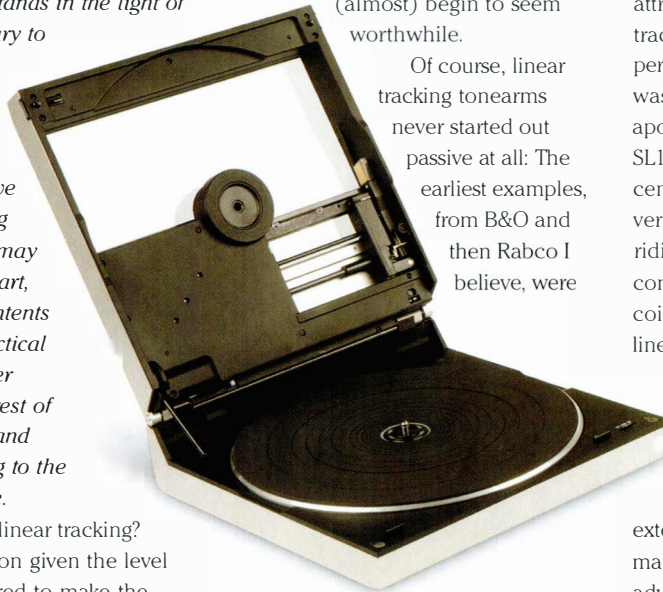

servo driven. The arm was horizontally pivoted to move through a very narrow arc. As the stylus moved across the record the armtube deflected from true tangency, and once this angular error reached a given size a sensor activated an electric motor that shuffled the pivot point forward a bit. The end result was an arm that moved laterally across the record, albeit in a series of small arcs. So not really a linear tracker at all then.

This didn't stop the approach achieving serious significance, especially once it had been picked up by Technics

and JVC. The Japanese managed to refine the servo mechanism and further reduce the tracing error, but it's difficult to avoid the suspicion that they were more interested in a plausible marketing opportunity and the attraction of (optically detectable) track programming than ultimate performance. As far as the mass market was concerned, the genre reached its apogee with the LP sleeve sized Technics SL10 and the various Mitsubishi music centres that played the record clamped vertically: From the sublime to the ridiculous. Indeed, the SL10, with its compact dimensions, integrated moving-coil cartridge, internal phono-stage and line-level output, was way ahead of its time. It also sounded pretty good too. But one fact is inescapable, it was the adoption of linear-tracking technology by the Japanese majors (and to a lesser extent by B&O) with their global marketing power and international advertising campaigns, that locked the concept so securely in the public consciousness.

And in a brief aside, audiophile companies were far from immune from the attractions of the worldwide bandwagon, with the Goldmund T3F taking honours as the most expensive, complex and ultimately unworkable iteration of the technology. This was a computer driven servo controlled tonearm in the days when computer power was measured in kilos rather than gigs! To suggest that it had a mind of its own overestimates its intelligence. It rarely did as it was asked, and often as

▶ not set off for the middle of the record unprompted – particularly alarming when you consider that your valuable stylus way perfectly in line with the platter spindle!

The genuine audiophile approach to linear tracking lay elsewhere, with passive operation. Lou Souther was arguably the first designer to pursue this route, his tonearms running on ultra-lightweight, wheeled sledges supported on quartz rails. It was an approach that was fraught with practical and theoretical problems, but Lou's dogged refinement of the original concept produced an arm that sounded better than it had any right to. The short stylus to pivot distance kept the lateral mass (and friction) low but made the arm susceptible to warp-wow, while the slight cross-record down-angle required to help the arm on its way also led to a constantly changing VTA.

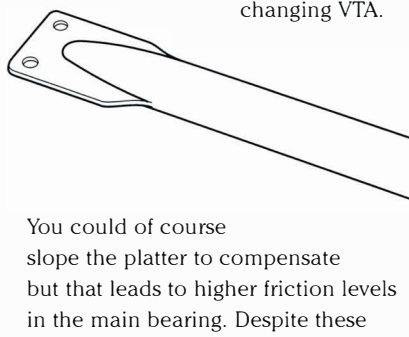

You could of course slope the platter to compensate but that leads to higher friction levels in the main bearing. Despite these issues (and, as we shall see, all arms have their compromises) the Souther designs live on at Clearaudio, and one graces the Master Reference record player sitting across the room from me now. Nottingham Analogue also produce a variation on the theme, with a longer, wheeled tonearm running on a wire, but I have no experience with the device.

Which brings us to air-bearings, and the first truly frictionless, passive parallel trackers. The earliest example I came across was the original Eminent Technology. It was crude, awkward in the extreme, but - and it's a big but - it hinted at what was possible. Indeed,

such was its performance that you could say it pointed the way, to the extent that the arm's designer, Bruce Thigpen, was contacted by New York audiophile and Eminent Technology owner Edison Price. As a lighting designer by trade, Price had a few pertinent suggestions as to how the original design might be improved. Combined with Thigpen's own thoughts on the subject, they amounted to a complete redesign, a project that was to result in the Eminent Technology Model Two, and a landmark in linear-tracking tonearms.

In essence, the Model Two dispensed with all but the captured air bearing of the original. This was a sleeve, through which a hard anodised aluminium tube ran. Tiny capillaries in the sleeve

fed pressurised air into the gap between it and the sleeve, floating the tube and allowing it to move freely through the sleeve. And I do mean freely. The first time you touch an air-bearing the lack of resistance comes as quite a shock – a fact reinforced by Louise's reaction to the Airline. Perfectly at home with the frankly bizarre operation of the Clearaudio, she was totally unnerved by the free movement of the Kuzma arm. This lack of friction

is of course the key to any air-bearing tonearm. Incorporating it in a mechanically acceptable way is the headache. The original ET used the bearing placed horizontally beside the platter, an arm-wand on one end of the tube, the counterweight at the other, the two masses designed to balance each other through the axis of the bearing and minimise tipping at either end of the arm's travel.

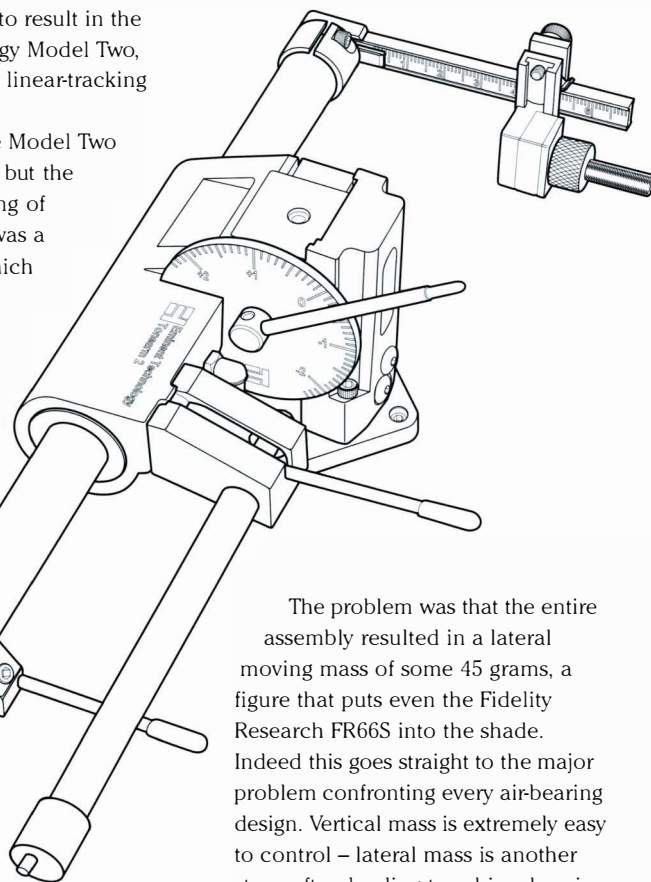

The problem was that the entire assembly resulted in a lateral moving mass of some 45 grams, a figure that puts even the Fidelity Research FR66S into the shade. Indeed this goes straight to the major problem confronting every air-bearing design. Vertical mass is extremely easy to control – lateral mass is another story, often leading to schizophrenic mechanical characteristics.

Thigpen's response was typically direct. He hung the counterweight on a lateral leaf-spring so that the cartridge wouldn't see it in the lateral plane, thus reducing the horizontal effective mass to around 25 to 30 grams – still high, but manageable with lower compliance cartridges. Meanwhile, Price went to town on the construction and ergonomics



► of the arm. The bearing was dropped to place its centre at the same height as the record surface, improving tracking of warps. At the same time he totally redesigned the arm's mounting. Molded from aerospace plastics the new structure was revolutionary. The bearing fixed to a vertical post through a curved interface whose radius was calculated to perfect tangency. A lever, detachable gauge and gear allowed the owner to move the bearing up and down the post, offering repeatable on the fly VTA adjustment without disturbing tangency/overhang. Meanwhile, the base itself employed a triangulated support plate that allowed the user to tilt the bearing in order to achieve perfect level. Theoretically less than ideal, this was definitely practical, ending the headache of trying to achieve perfect level from turntables that really weren't set-up to do so. You quickly discover that an air-bearing is far more sensitive than any spirit level.

Price also designed a superb set-up and alignment jig. But his piece de resistance was the cueing device. This was simplicity itself, an eccentric aluminium tube offering perfectly paced cueing, while a thicker end cap lifted the stylus clear of the front-edge of the record, parking it securely as well as eliminating any possibility of the dreaded side-swipe. It was a practical and ergonomic tour de force, but the best thing was that it only cost \$850, including a small aquarium pump, making it cheaper than an SME 5. It remains the sole successful example of a mainstream air-bearing tonearm, and it sold in thousands.

But all was not sweetness and light. The ET Two might have solved many of the problems associated with passive linear trackers, but it didn't eliminate them. Specifically, it

continued to suffer from its high lateral mass, an inherent flaw in the design. Indeed, any loss of pressure or blocked capillaries in the bearing and the arm would ground towards the end of a record, often grinding to an ignominious halt in the lead-out grooves, or even half-way through the last track. The heavy cartridges popular at the time, like the crystal bodied Koetsus and Kisekis merely exacerbated the problem, with their requirement for heavy counterweights.

What's more, users were tempted to place the noisy pump as far from their turntable as possible, normally on the other side of a wall.



This often meant feeding cold air into a warm environment, producing condensation and corrosion within the bearing!

At the same time it became apparent that higher pressures in the bearing, as well as helping float it, also offered better sound, and a vibrant pre-internet underground pedaled tales of bigger and better pumps and reservoirs. This eventually led to the Model Two Point Five, with a damping trough, higher pressure manifold with tighter tolerances and increased diameter bearing tube but supplied without a pump, allowing users to fit their preferred model. The Wisa L300 seemed to be favourite, some people going so far as to use several in parallel. The new bearing

delivered anything up to 8.5 psi but a slightly lower pressure of around 7.5 was often preferred. (For later reference, that's about half a bar – and that's the high-pressure version!)

At around the time the ET Two was appearing, we also saw the first Air Tangent, an expensive arm whose ergonomic shortcomings were cruelly exposed by the Eminent. In this case the bearing was arranged so that air was pumped into the circular beam, an aluminium sleeve floating on the tiny jets of air that emerged. This approach succeeded in reducing the lateral mass but was fraught with problems, the most important of which was that the sleeve only covered around one third of the beam's surface. The end result was

that it was impossible to increase the pressure in the manifold as it simply leaked from the uncovered holes. In order to park the arm at the front of the record, the beam also had to extend well forward of the plinth, while the cueing device was arbitrary to say the least. It was a potentially disastrous combination. The design passed relatively quickly into history, to be replaced by far better versions, but it shows how easy it is to get things wrong.

Another Nordic oddity was the Forcell tonearm. This made no bones about close coupling the bearing, a long narrow shaft carrying a row of holes on its top edge. These floated a sleeve as per the air tangent, although a regulator allowed you to set "ride-height". Like the Tangent, it also suffered from whistling when holes were partially covered, but ergonomically it was far better, with a decent cueing system and a clever parallelogram arrangement for VTA adjustment. Somewhat against the odds, the Forcell arm remains one of the finest sounding that I've

► ever used, offering similar clarity and dynamics to the Southers, models that it in some ways most resembles. It was however, a tweeker's nightmare, with every adjustment audible, whether we're talking VTA or the bolt that the cueing device pivoted on. Using it on a day to day basis was a short road to audio nervosa.

The next real step forward came from Rockport, the first to introduce an inverted air bearing. In this instance, the air is pumped into a sleeve that moves on a static, polished beam. It's an approach that cuts right to the heart of the genre's problems by allowing the use of a high-pressure

manifold of minimal size and mass. All at once, air-bearings started to look really practical, even if the declining vinyl market made them inordinately expensive. The Rockport arms were the wrong side of £6000, while the Air Tangent Reference (a sort of cross between the Rockport's bearing and ET ergonomics, complete with remote control VTA!) was just over £10000.

That brings us almost up to date: The Air Tangent has been replaced by a new, simpler and cheaper model that is still waiting to see the light of day: The Rockports are no more and nor are the Eminent's. In many

respects it's still the latter design that remains the most impressive. Offering superb practicality coupled to a bargain price-tag it's by far the nearest thing we've had to a genuinely successful passive linear-tracker. Its Achilles heel was its high lateral mass, imposed by the choice of bearing. But what would happen if someone applied the lessons learnt from the ET Two and subsequent experience to the bearing that graced the Rockport and later Air Tangents? And what would happen if they could drop the price at the same time? Time to take a look at the Kuzma Airline. 

# The Kuzma Airline Passive Linear-Tracking Tonearm

The preceding pages cover some of the hard lessons learnt in the pursuit of a true, passive, parallel tracking tonearm. There are the inevitable compromises that afflict any chosen design path. There are also practical considerations. In order to succeed, any arm needs to address both. Or, to put it another way, it's no good making an arm that sounds brilliant if nobody can use it. It's a salutary lesson that the superb ergonomics of the ET Two made it more approachable and accessible to a public who proved happy(ish) to tolerate the problems of getting it to run to the end of a record! Let's take a look at the Kuzma with respect to these considerations.

## The Bearing Assembly

Common to previous designs from both Rockport and Air Tangent, there's absolutely no question that the bearing used in the Airline is the best currently

available. However, you still have to realise that potential, which means feeding it properly. Kuzma supply a sophisticated, oil cooled and damped compressor, a substantial beast capable of generating up to 12 bar. In practice it actually runs the arm at 4.5 bar, compared to about 2.5 for the Rockport and later Air Tangents. More pressure and tighter tolerances mean a stiffer bearing, vital to achieving the superior rigidity available from air-bearing designs. It improves self centering of the bearing which in turn improves tangency by preventing the sleeve rocking sideways on its shaft.

So, plenty of pressure – what about operating it? The compressor is equipped with two gauges, one for reservoir pressure, the other for manifold pressure. Simply run it up to a reservoir pressure of around 8 bar, then open the outlet regulator to feed the arm the desired 4.5 bar. The air itself is fed down a small black hose of

refreshingly narrow dimensions, making accommodating its passage rather easier. The compressor feeds an inline filter and dryer unit that is placed adjacent to the turntable, eliminating the potential problems of remote siting the compressor by removing condensation (or oil mist). This then finally feeds the air into the arm, which is equipped with its own valve (so that you can shut off the air when not in use) and a basic pressure gauge so that you can keep an eye on the manifold pressure without going to look at the compressor. One other nice touch is the simple push lock air connectors that make lacing the whole thing together simplicity itself. So full marks all round then, as far as the bearing and air supply go.

## Set-Up and Alignment

Perfect alignment of any arm and cartridge is critical to its performance, but especially so if you are planning 



► to realise the potential benefits of linear tracking. The arm itself mounts to the same Linn cut-out as Kuzma's Stogi Reference tonearm, making it geometrically compatible with most turntables. That of course is not the same thing as being mechanically compatible.

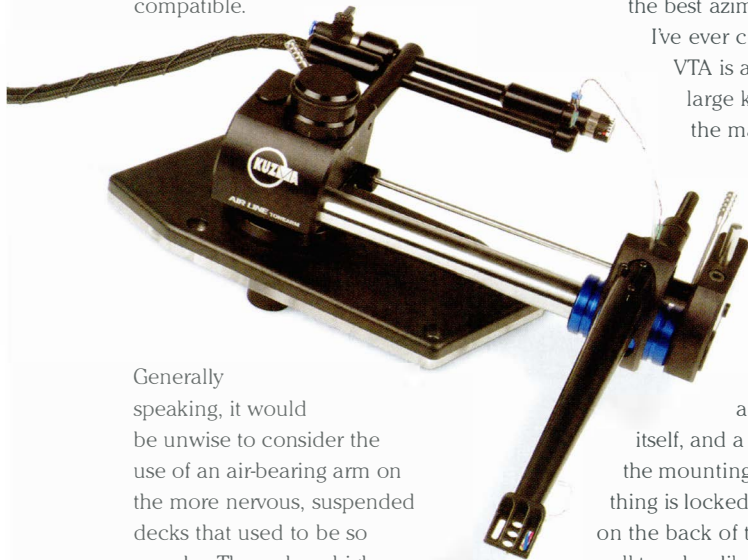

Generally speaking, it would be unwise to consider the use of an air-bearing arm on the more nervous, suspended decks that used to be so popular. These days, higher mass designs are increasingly the norm, and they are generally ideal for the Airline. Solid plinth designs present no problems at all, but you need to think about the leveling issues if you are intending to use the arm on a high-mass suspended unit. The review arm was supplied on a Kuzma Reference, which not surprisingly worked fine with its top mounted adjusters. Getting the deck level, using the arm as its own indicator was simplicity itself, although don't underestimate the precision required, especially with an arm this heavy – the Airline weighs in at a cool 2 kilos. A deck like VPI's air suspended HRX might prove more fiddly, although with its higher mass, wider stance and stable suspension, once sorted it should remain so.

The arm also arrives with a protractor/jig that helps with initial alignment. These should be mandatory with all linear-tracking tonearms. Overhang is handled by the simple but effective expedient of headshell

slots, while the massively tapered tonearm tube allows extremely precise azimuth adjustment via two locking screws and a set-screw, located near the bearing manifold. Similar in concept to the system employed on the Tri-planar, it is mechanically superior and by far the best azimuth adjustment I've ever come across.

VTA is adjusted by the large knob on top of the main mounting post. Once again it is a system familiar from the Rockport arm, but crucially, Kuzma provide both a lateral graduation around the knob

itself, and a vertical scale on the mounting post. The whole thing is locked solid by the lever on the back of the arm. It's the small touches like these that make the arm so easy to use. Even the counterweight has received a makeover, the long, narrow sleeve helping prevent resonance of the counterweight stub assembly itself.

Oh, and for those who don't believe in VTA (although why such a Luddite would buy an Airline is beyond me) the steel post that passes through the "floating" end of the arm, opposite the mounting post, can be dropped and locked in place to ensure the bearing shaft's stability. Given the massive construction I reckon that's overkill, and I'd employ the option to remove it, which certainly improves the appearance of the arm.

### Ergonomics

Once mounted, the fit, feel and mechanics of the arm are superb.

I've already mentioned the excellent hose connectors and the simple yet effective VTA adjustment. Well you can add to that a superb cueing action, complete with parking slot to keep the arm out of the way when changing records. The bearing was totally trouble free, as was the compressor.

One touch I particularly like is the one-piece arm cable. So many parallel tracking arms cop-out here. Getting the signal out of the armtube is an issue, because a poorly dressed wire can significantly increase the sideforce seen by the cartridge – in this case the audio equivalent of treading on the tonearm's coms. As a result, designers tend to opt for the lightest cable they can, simply running it out to a phono termination box. This in turn dumps the dealer/owner with the job of locating that box and providing a suitable lead-out cable. Apart from the extra cost it's just another thing to get wrong. Kuzma install a purpose designed Cardas arm-cable, enabling them to run a single conductor path all the way to the phono plugs, without impeding the arm's lateral movement. It also eliminates an audibly damaging join in the arm lead, just when the signal is at its smallest and most vulnerable.

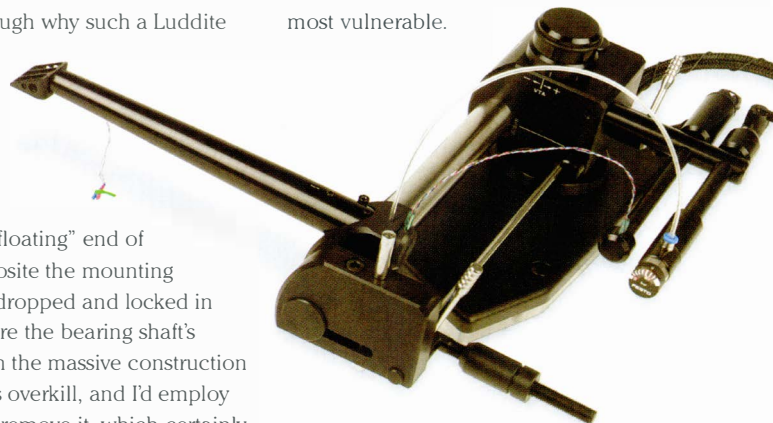

Quodos also for supplying a reasonable length of cable and terminating it with the cheap looking but superb sounding Bullet plugs. If the arrangement doesn't suit, other options also exist. ►

▶ As a package to use, the Kuzma comes closer than anything else to my ET Two ideal, and does so while playing records impeccably. It's nice to see a product that's happy to learn the lessons of the past to improve the future.

### Other Considerations

So what's missing then? Well, most notably there's no damping trough. Easy to provide, as witnessed by their presence on just about every parallel-tracker since the ET Two, I've never felt the need to use them, so I'm not going to feel the loss. Besides which, you only really get any benefits if you're using an inappropriate cartridge. I think the comment above regarding Luddites also applies here. You could argue that it would widen the arm's compatibility. I'd respond with "Why bother, given the massive range of low-compliance cartridges that will work perfectly well?"

On a more practical note, the dimensions and positioning of the mounting post leave very little clearance (about 15mm) between the arm and record. You need to bear this in mind if you are intending to mount the arm on a deck with either an oversize platter, or one that uses a peripheral clamp, like the VPI HRX or the one available for the Clearaudios. It's not impossible – but you need to check.

The final issue with the Airline is its appearance. Purely a matter of personal taste I know, but compared to many of its predecessors, the Kuzma is very big and very black. I really like it, but experience shows that my views and those of the public rarely accord.

One thing I will say is that it's refreshingly free of the gold plate that so many manufacturers seem to feel instills a touch of class. The Airline is all business, and as far as I'm concerned it's all the better for it.

I used the Kuzma arm with three different cartridges: Kuzma's own KC Ref, the Clearaudio Accurate and the Lyra Titan. In my system it was the last of these that gave the best overall balance, and which



I used the most, however, more on that later. The rest of the set-up included the Tom Evans Groove Plus, feeding either the Vibe/Pulse combination or the Hovland HP100. Power amps were the Hovland RADIA or Jadis JA30s, with either Gryphon Cantata or the latest Living Voice OBX-R loudspeakers. Cabling was Nordost's Valhalla while everything was supported on either the finite elemente HD-03 Master Reference or Clearlight Aspect racks. Mains arrived via Russ Andrews leads and blocks, the Nordosts arriving just too late to join the party.

### So, is it worth the bother?

With everything optimized the sound that greets your (by now) hungry ears is definitely worth the wait. The Airline sounds different to,

and better than any other arm I've used, assuming you put it on an appropriate 'table. (Please, please note that caveat. Mount this arm on the wrong deck and you'll open a Pandora's Box of frustration and disappointment.) Indeed, its presentation is so natural that I hesitate to ascribe it a character. However, it does have distinct properties that separate its performance from other arms, some to do with its linear tracking, others unique to it.

To a greater or lesser extent, all linear tracking arms offer a significantly more natural stereo perspective than their pivoted cousins. This arrives hand in hand with greater dimensionality and lower levels of grain. There's also a naturalness to timing and an ability

to let music breathe. The Kuzma does all of these things, and in each case to a greater extent than I've heard before. The difference between the presentation of this arm and an SME is really quite shocking, the pivoted arm sounding gray, constricted and mechanical in comparison, almost as if the signal has been strained through it.

Impressive enough, but I haven't started on what I consider to be the Airline's really unique quality. The sonic picture established by the Kuzma is astonishingly solid and stable. It's remarkable just how much most images wander and shift, a failing you only really notice when you're presented with something as rooted as the Airline delivers. But this is about more than just sheer



► physical presence. Keeping those images locked firmly in space contributes enormously to the ability of the performance to convince. In turn, that allows the listener to relax and engage. It's a bit like reducing the load on your error correction – suddenly you don't have to work nearly as hard. It's an effect I first noticed with CD players, but believe me, it applies to analogue too.

All those stable, solid, dimensional images reflect the quality of the acoustic itself. But again, the Airline extends the effect beyond previous experience. The lack of grain allows black, black space around and behind the performers, increasing the arm's transparency and focus. It also increases the immediacy, eliminating the distinction between the space in which the listener sits and the acoustic in which the performance occurs. It's a quality that first became apparent with the original Groove: The Groove Plus extended it, and so too does the Airline.

Of course, it's impossible to discuss the imaging and soundstaging of the arm without discussing the cartridge(s) being used. As I mentioned, I used the arm with three different cartridges. The KC Ref was impressively powerful and solid sounding, delivering superb presence and instrumental colour. The stage was extremely wide but a little shallow. The Accurate was dynamic and fiery but a little too forward in the bass, with a huge acoustic but poorly defined boundaries. The Titan delivered, fast, focused and extremely transparent sound, with superb dynamic discrimination within a slightly narrowed but extremely deep

and well defined acoustic space.

Reading that lot should tell you quite a bit about the performance of the tonearm. Firstly (and reminiscent of the Triplanar) it allows each cartridge to perform at its best, making the most of its particular strengths. I opted for the Titan, but it's as much a case of the qualities required by the system and listener as any inherent superiority of the cartridge itself, or its match to the tonearm. In practice, each of the



cartridges used seemed equally at home, tracking with ease whatever was thrown at them. Which brings us to the other obvious conclusion drawn from the evidence. This arm needs no help whatsoever in terms of low-frequency weight, definition or dynamics.

Bass performance sets new standards. It is tight and defined without any sense of constipation or constraint. It breathes, it has texture, excellent pitch definition and differentiation. It matters not whether you challenge it with driven electric bass, synthesised eruptions or the worst excesses of a full symphony orchestra (it's that *Tosca* again!) the Kuzma encompasses every demand and delivers without any apparent

effort or strain intruding. The sheer confidence and stability of its bottom-end is key to the whole performance of the arm. That and the way it handles dynamics.

The Clearaudio Master Reference record player has always set the standard as far as clarity, separation and dynamic discrimination goes. Until now. The Kuzma Stabi Reference/Airline player, carrying the Titan matches the German deck for clarity and separation while delivering superior dynamic range

combined with more convincing weight and colour. And it does it with total consistency, right across the range. It happily reveals the subtleties of brush and cymbal work, including

the tiny variation in weight between strikes, even when the rest of a band is cutting loose – assuming of course that the information is on the record.

That ability to define shifts in energy levels at both ends of the dynamic spectrum, combined with the total security of the spatial and low frequency foundation combine to create the second unique property possessed by this arm: ease. No arm in my experience allows music the easy expression delivered by the Airline. Dynamic level and nuance are so precisely modeled, especially in combination with the Titan, and so comfortably within the arm's compass, that the mechanics of record replay are effectively banished from the listening equation. It is similar to the influence of the Rockport Sirius III, except that there we were talking about an entire air-bearing record player, and one that didn't deliver the Airline's dynamic range. (Of course, getting the arm exactly horizontal should also mean getting the main

▶ bearing perfectly vertical, which will also minimise the audible contribution THAT makes to proceedings.)

Roll all these things together and what do you end up with? Music. More to the point, music that is convincing, because it's stable and solid yet unforced and full of energy and colour. Listen to the John Coltrane Quartet playing *Ballads* (the superb Speakers Corner re-issue – a record you really owe yourself) and the music exists in its own space and moves with its own tempo. The relationship between the players is clear without destroying the intimacy or understanding. The performance is everything: the record, the turntable and the electronics all recede from aural view. The logic is as clear as it is well established. Give a system a good enough signal to work with and suddenly the amps and speakers become a lot less obvious, simply because, just like you, they have to work a lot less hard. The Kuzma Airline does exactly that. It retains so much of the energy and information captured by the cartridge from the record's groove that everything else sounds like a pale imitation in comparison. What's more, it manages to make sense of it all too, without fear or favour when it comes to frequency.

Normally I try to explain my sonic conclusions with reference to



specific musical examples. There simply isn't the space to do so here. The copy is already overlength, and that's with the history lesson delegated to a separate piece. However, having spent so long trying to explain just why this arm is so different (and so superior) to any other, perhaps I should try and relate it to at least one musical experience.

The Analogue Productions 180g pressing of the Janis Ian album *Breaking Silence* is a sonic (particularly a dynamic) tour de force. In a vivid exception to the audiophile rule it's equally powerful musically speaking. You want to blow your mates' socks off? This'll do it every time – which is why you hear it so often at hi-fi shows. But steer away from the sheer dynamic impact of tracks like 'Walking On Sacred Ground' or 'Breaking Silence' itself and you can actually learn far more about a system. 'Some People's Lives' is the narrowest band on the whole album, despite running nearly four minutes long. Just voice and piano it doesn't demand the groove widths of the dynamic blockbusters. But listen to it with the Kuzma front-end carrying the Titan and you'll be rewarded with a piano that's big, solid, stable and unmistakably percussive. It is at once sonorous and weighty, yet the delicacy and sensitivity of the playing is captivating. The voice too, is stable and real, with the substance of a real person behind it. Yet it still retains the expressive fragility that makes this such a powerful song. It's a performance that encapsulates what's so wonderful about the Kuzma Airline. Stable, solid and totally in control, it has the confidence to allow music the full range of expression, from total bombast down to gossamer frailty. And that's based solely on its performance on the Stabi Reference. It's entirely possible that there's more to come if it's mounted

on a rigid platform like the Clearaudio Master Reference or Kuzma's own Stabi XL. Then there's always the VPI TNT HRX. My record collection has been rejuvenated in the last few years.

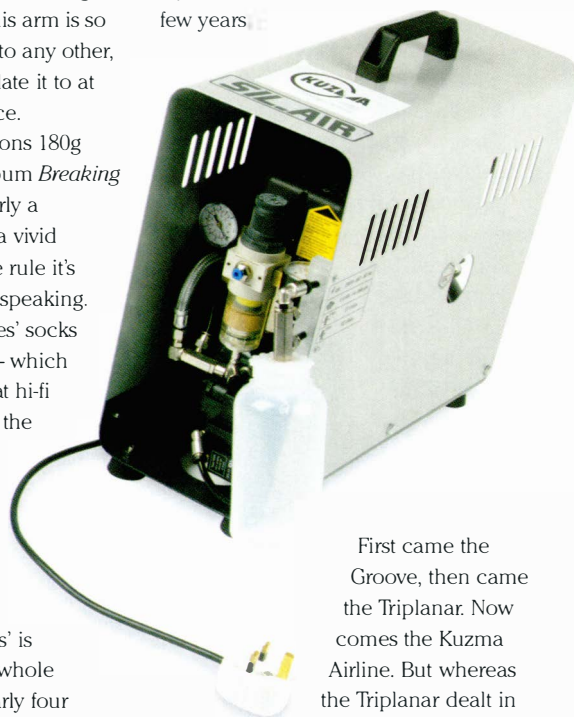

First came the Groove, then came the Triplanar. Now comes the Kuzma Airline. But whereas the Triplanar dealt in refining the already

possible, the Airline extends the performance boundaries far more dramatically. Audiofreaks are fortunate indeed to possess both the best pivoted and now the best parallel tracking tone-arm available. The Triplanar's in residence already – all I have to work out now is how (and where) exactly to accommodate the Airline. ▶+

#### TECHNICAL SPECIFICATIONS

Price: £4,700

#### UK Distributor:

Audiofreaks

Tel. (44)(0)20 8948 4153

Email. [info@audiofreaks](mailto:info@audiofreaks)

Net. [www.audiofreaks.co.uk](http://www.audiofreaks.co.uk)



# the ea series

of amplifiers by ECS



## Dealers

- |  |                      |
|--|----------------------|
| <b>Sound of Music</b>                            | <b>01892 547 003</b> |
| <b>Walrus Systems Ltd</b>                        | <b>020 7724 7224</b> |
| 11 New Quebec Street, London W1H 7RW             |                      |
| <b>Oxford Audio Consultants Ltd</b>              | <b>01865 790 879</b> |
| Cantay House, 36 Park End Street, Oxford OX1 1HJ |                      |
| <b>Kevin Galloway Audio</b>                      | <b>01563 574 185</b> |
| 11 Milton Road, Kilmarnock, Scotland KA3 7HG     |                      |
| <b>Harrow Audio's</b>                            | <b>020 8863 0938</b> |



ECS Ltd  
 Impress House, Mansell Road, London W3 7QH  
 tel: +44 (0) 20 8743 8880 +44 (0) 20 8746 4309  
 fax: +44 (0) 20 8740 4200  
 email: enquiries@ecsamplifiers.co.uk  
 web: www.ecsamplifiers.co.uk

**Whether it's music or film the EA Series will enhance your passion**

A range of amplifiers designed by enthusiasts for enthusiasts

# clearaudio



THE HOME OF ANALOGUE



**NEW 50 page full colour Clearaudio catalogue**

Call for your **FREE** copy NOW



**For more information call:**  
 The UK Distributor on **01252 702705**  
 or email: info@audioreference.co.uk  
 or visit our web site:

**www.audioreference.co.uk**



## The Studio

Hi-Fi and Home Entertainment Consultants

### “NAIM AUDIO WORKSHOP”

For the second Saturday in every month, we are pleased to offer a Naim Audio workshop. This will give you the opportunity to discover the benefits of upgrades and how to get the best out of your Naim system

For the serious enthusiast we are pleased to offer this service in your home. To arrange an appointment please contact Peter or Ted.

#### **Opening Times:**

Mon to Fri By Appointment

Saturday: 11.00 a.m. to 5.00 p.m.

The Studio  
28 Aylmer Parade  
Aylmer Road  
Haringey  
London  
N2 0PE

Phone/Fax: 020 8348 0990  
Email: [pwbc@dial.pipex.com](mailto:pwbc@dial.pipex.com)  
Website: [thenaimshop.dsl.pipex.com](http://thenaimshop.dsl.pipex.com)





# Tube Shop .com



dragons  
tails

Worlds 1st Audio Cables  
designed purely for Vacuum  
Tube Hi-Fi equipment.  
...more details @ [www.tube-shop.com](http://www.tube-shop.com)

## NEWARRIVALS@THESHOP



### Nixie Tube Clock.

The *Ultimate Vintage Timepiece*  
Atomic clock - time adjusts automatically.  
Engineered in Germany.  
...more details @ [www.tube-shop.com](http://www.tube-shop.com)

PM    Golden  Dragon 

# TUBES! TUBES! TUBES!

For all your vacuum tube needs  
[www.tube-shop.com](http://www.tube-shop.com)

or call us on:  
0870 9220404

[www.tube-shop.com](http://www.tube-shop.com)

- Accurate Signature
- Alteon
- Analog Audio System
- Anticon
- Antipon
- Audiobeta
- Audio Note
- Auro
- AVID
- Basis
- Belenole
- Blue Pearl Audio
- Brinkmann
- CEC
- ClearAudio
- Clearlight Audio
- Craft/Loft-X
- Dais
- Dual
- Dynalip Systemdisk
- Garzod
- Hi-Fiers
- Immedia
- Kuzma
- Loricraft
- Michell Engineering
- Micro Seiki
- Musical Fidelity
- Music Hall
- Nakamichi
- Nordic Concept
- Nottigham Analog
- Oracle
- Origin Live
- Pink Triangle
- Project
- Rego
- Reson
- Rockport Systems
- Kokoon
- Sci-Fi
- Simon Yorke
- SME
- Sota
- Sound by Design
- Spd
- Tenet Audio
- Thorens
- Townshend
- Transvaco
- Vendler
- Vicys
- VPI
- Vigo
- Walker Audio
- Well Tempered
- Wilson Benesch
- Zorathwaiz

## Protect Your Sound Investment

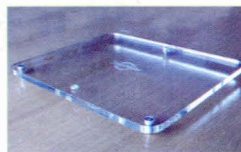

"MY FAVE NEW ACCESSORY"  
KEN KESSLER - HI-FI NEWS, DEC '03  
HI-FI SHOW & AV EXPO 2003 HIGHLIGHTS

We make high quality acrylic  
dust covers for many of today's  
& yesterday's - turntables.

Our current portfolio includes:  
**ClearCover™** lids for specific  
decks, such as the ClearAudio  
Champion & Solution ranges,  
Notts Analog Horizon, Simon  
Yorke S7, AVID, among others.

**MultiCover™** lids in two sizes  
that fit over decks such as SME,  
Wilson Benesch, Michell, Pro-  
ject, among others.

**MultiCover Deluxe** lids  
feature a gently bowed front  
to enhance visual appearance.  
All are handmade from 5mm  
clear or smoked grey acrylic.

**Bespoke Service** for any  
turntable - ask for a quotation.

**BasePlayer™** 15mm thick  
acrylic equipment isolation  
platforms with adjustable cone  
feet and an inbuilt spirit level.

These are available as a  
standalone accessory or can  
be combined with a MultiCover  
lid to offer the total solution for  
your sound investment.

ClearCover products are currently available from selected  
UK dealers and online at [hififorsale.com](http://hififorsale.com).

Please visit the website or call us for latest product news,  
dealer listings and all trade or overseas enquiries  
on: +44 (0)1923 351512 or email: [sales@clearcover.co.uk](mailto:sales@clearcover.co.uk).

## ClearCover™

HANDCRAFTED TURNTABLE COVERS  
& ACCESSORIES

[www.clearcover.co.uk](http://www.clearcover.co.uk)

ClearCover UK Limited 117A New Road, Croxley Green,  
Hertfordshire, WD3 3EN, UK

ClearCover, MultiCover and BasePlayer and their associated logo devices are registered  
trademarks of Clear Cover UK Limited. ©2003 - all rights reserved.







# Mainlining...

## Nordost's new power leads raise the bar

by Roy Gregory

Preaching to the converted can be a pretty thankless task, especially when the converted in question is yours truly. Not only am I more surprised when changing anything in or around the system doesn't make a difference than when it does, but mains cables and their influence are not exactly news as far as I'm concerned. Which made my first experience with Nordost's new power leads all the more shocking. I guess I shouldn't be surprised. After all, it was SPM that really turned my cable world upside down, and if it didn't lead me to formulate the whole concept of the importance of a coherent cable loom, then it certainly reinforced it with a vengeance. The new mains cables weren't even the first to extend that concept to include the mains wiring, so I should have been ready for the effects I was about to hear. But none of that prepared me for the shocking impact I was about to witness: and not just one shock either, but we'll get to that in a while.

Of course, Nordost have been making a mains cable for quite a while now. It's called the El Dorado and it's not bad – not bad at all. Its distinctive appearance derives from its unusual construction, formed from two, twisted, round-section cables. Each cable consists of four, stranded mono-filament conductors, held in a mylar wrap and then a foil screen. The mains lead employs the mono-filaments in one cable for live, the ones in the other for neutral and then ties the screens together for

earth. It's a decidedly different approach but one that yields good results, especially when you use it in a system that employs mono-filament signal cabling. This was the cable that convinced me to extend the system approach to embrace the mains loom. Used straight out of the wall and into equipment, with a system wired with Nordost Valhalla, it yielded better results than anything short of the Shunyata leads, and if you thought El Dorado was expensive...

The problem was, that the Nordost Power Cord didn't mix and match with other leads – at all. Plug it into someone else's distribution block and the sound went West so fast that you thought you must have imagined it ever sounding good. As Nordost never produced a distribution block of their own, that limited the use of the El Dorado to a DI set-up: and that eliminates the far from subtle benefits of star-earthing your mains supply and providing a separate, dedicated drain for it. Practicality and performance dictated that I used the versatile Russ Andrews system, thus running coherent signal cabling along with an equally coherent but different mains set-up. And it works – very well.

Now, some of you will have noticed that I've always had my



doubts about the original mono-filament interconnect, the Quatrofil. Used with the other mono-filament cables it worked well enough, but never with the same seamless musical integrity that the likes of Valhalla and Valkyrja achieve so effortlessly. Examine its construction and you'll find four, stranded mono-filaments whereas the rest of the range employ solid-cores. Whether it was this or some other reasoning that prompted the designers at Nordost I really don't know, but someone clearly felt that they could do better than the already enviable standard set by El Dorado.

Well, whoever it was, they were right. And how! The new range consists of three distinct cables, each with silver-plated copper solid-core conductors. The cheapest cable is dubbed Shiva and it consists of three, tightly wrapped 18 gauge mono-filament conductors. For those who have been asleep at the back, that means that each of the solid-core conductors has a thin Teflon thread spiral wound down its length before it is inserted into an extruded Teflon tube of insulation, thus creating a virtual air dielectric and very low losses. In the power leads, Nordost colour-code the

▶ mono-filaments to identify each conductor. They are then wrapped in an outer sheath of pale purple THV, a hybrid polymer that gets close to Teflon in electrical performance but is far, far more flexible, making sure the cables are physically manageable.

Above Shiva, you'll find Vishnu, which employs identical construction but thicker, 16 gauge conductors. The final result is about twice the thickness and twice the price. The leads come in a minimum length of two metres and can be terminated to match a whole range of different mains outlets and equipment sockets. The review leads arrived sporting rather nice, clear molded 13A plugs with either Wattgate IEC or Hubbell 20A connectors at the equipment end, although other terminations are possible as dictated by national and system requirements. The terminations are well reinforced for strain relief and the end result is neat and attractive, as well as being easy to handle and use. The only thing to watch out for is the diameter of the circular body on the Wattgate IEC which can interfere with the structure or casework on some equipment, especially that with overhanging fuse holders.

Which brings us, finally, to Nordost's piece de resistance, the Valhalla mains lead. This uses three, 16 gauge conductors for live and three more for neutral, all wrapped around a single earth wire. But here the THV sleeve is clear, allowing the silver plated surfaces to glint while the prospective purchaser examines the lead close up. Which is when you'll



discover that this is the first cable to employ Nordost's new Dual Micro Mono-Filament technology. Rather than a single thread spiraling down the length of the conductor, there are two, twisted together. This creates a thicker thread, resulting in a wider air gap for no increase in contact. Because the two threads damp each other, it also creates greater mechanical stability and resistance to vibration. This is the first time we've seen this construction, but it doesn't take a genius to work out that top-end signal and speaker leads will be following soon. Termination details and the two metre minimum length on the Valhalla are identical to the other leads – it's only the price that isn't! Don't worry, we'll get to that in a bit.

Nordost supplied me with enough of each model to wire my system, along with a single lead of each type terminated in a Hubbell. They also delivered at my request, one of Russ Andrews' unfiltered Powerblocks, so that for the first time I can actually use the Nordost leads in my preferred arrangement. Obviously, from their point of view that's hardly ideal and there will be distribution blocks on the way, but in the meantime, the new mains leads proved perfectly at home with the Powerblock, displaying none of the fickle character of the El Dorado in this regard.

With this many options, listening is far from straight forward. I adopted a two-tier approach, listening to each set of leads in the main system for a week or so, just to get a handle on

them and run them in a bit. For that I used the Clearaudio Master Reference record player, Wadia 861 CD player, Groove Plus, Vibe and Pulse, feeding the Hovland RADIA or Audiopax Model 88 amps and Gryphon Cantata or latest Living Voice OBX-R loudspeakers. It's a familiar cast list around these parts, with all but the Audiopax being long term residents. But when it came time for direct comparisons I took a leaf straight out of the Nordost demonstration book, assembling a far simpler set-up consisting of the superb Gamut CD1, a Cyrus 8 integrated amp and PSX power supply. I used this to feed the OBX-R speakers, but in all cases, the signal and speaker cable was the house favourite Nordost Valhalla, both because it's the best cable I have as well as the one I know best and because of the issue of cross compatibility I raised earlier.

Of course, there's nothing quite like starting from scratch to bring you down to earth with a bump. I started by wiring the Cyrus system with standard, albeit good quality, mains leads, plugged into a similar quality extension block. I even splashed out on a basic audiophile lead for the CD player. It's the sort of mix and match set-up I'd expect to find on a system of this sort out in the real world. I then got thoroughly used to the sound, which was roughly what I'd expected in terms of quality. Sure, you could criticise it – particularly for a greyness and grain that seeped into proceedings, but you could certainly hear what was going on. Then I went and spoil things. I introduced the Shiva into the equation and true to its namesake, it promptly laid waste the world. From the first note of the first track the yawning chasm of its superiority almost swallowed my credulity. Louise? She almost fell off the sofa!

Plugging in the Powerblock, fed ▶



▶ by Shiva and feeding Shiva to the electronics, the difference was hard to credit, not least because the music seemed so much louder. I had to back the volume control off a full graduation to achieve similar subjective levels. Using Dave Alvin's 'Abilene' for purposes of comparison, the music leapt out of the speakers, propelled by the sheer energy of the up-tempo playing.

the directness of its communication, its ability to hold your attention, draw you into a song, turn your emotions with a musical phrase. In short, it transformed the ability of the equipment to perform its most basic function. It brought life, energy and pace to proceedings and made sense of the term musical performance.

did – and everybody else I've played these leads to. And just like me you'll think you've accidentally increased the volume (only you haven't) or you've misheard so you swap back (only to discover that you didn't) or that someone's having you on (if only they were). Eventually you'll sit back, scratch your head and conclude that there really is something absolutely fundamental going on here (which there is).

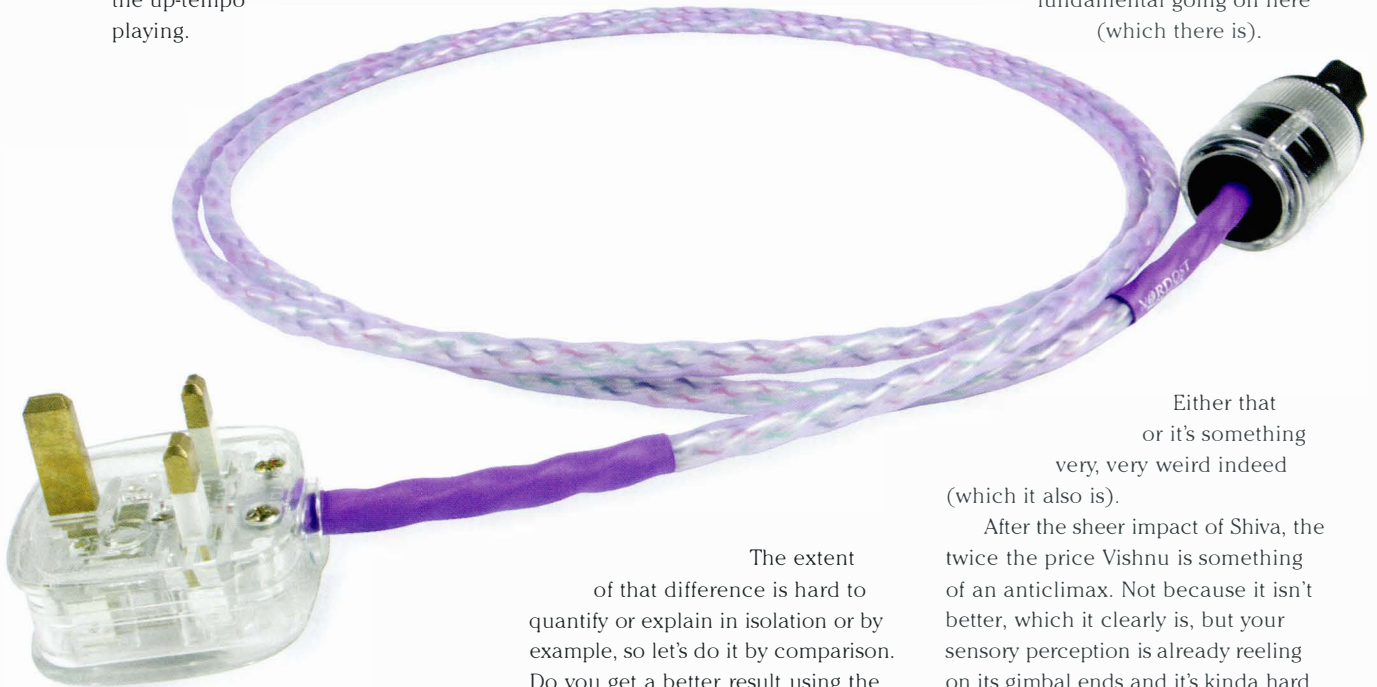

The opening keyboard gained colour, texture and substance, the guitar was suddenly a solid presence, but it was the drums that really kicked it off. They simply exploded into life, driving the track along. Suddenly the music took on a new sense of life and purpose, grabbing your attention and dragging you with it. The vocals blossomed to such an extent that it was almost as if the system had taken its foot off the singer's throat.

Now, I could go on, with more specifics and more tracks, but dissecting the performance misses the point. The real difference the Shiva brought to the system was in

The extent of that difference is hard to quantify or explain in isolation or by example, so let's do it by comparison. Do you get a better result using the PSX or the Shiva on the Cyrus 8? No brainer: it's the mains lead every time (I know because I tried it). Putting Shiva on the CD1 and the Cyrus 8 transforms the system way beyond the cost of doing so. And the cost is? Each Shiva lead costs £220, so that's £440 for a two box system. There is no way that spending that money on a better CD player, a PSX, rack, interconnects or any other upgrade is going to come close to what these leads can do. But the beauty is that you don't have to take my word for it. Borrow them from your dealer, take them home, give them a whirl. But be prepared to write that cheque, because you are going to hear it just as quickly as I

Either that or it's something very, very weird indeed (which it also is).

After the sheer impact of Shiva, the twice the price Vishnu is something of an anticlimax. Not because it isn't better, which it clearly is, but your sensory perception is already reeling on its gimbal ends and it's kinda hard to repeat that trick too often. Besides, exposure to Shiva has put you on your guard. Nevertheless, Vishnu still offers a significant step up over and above its cheaper sibling, and it does it mainly by subtlety rather than sheer impact. Moving from Shiva to the complete Vishnu set-up delivered greater bass depth and weight, but also greater texture. Along with that added weight and control of low frequencies comes a sense of authority and space: space around and behind performers, space between notes and phrases. Suddenly proceedings are more relaxed, more powerful and less frenetic. Vishnu brings control of pace to proceedings, allowing the performers another ▶

► complete level of expression and inflection. Instruments have better separation, spatially and tonally; voices have more natural character and shape. But most important of all, the music has a sense of unquestioned rightness to it. Now the performers ask questions of you rather than you asking questions of the system. It's a massive advance in terms of musical communication and authority.

But it comes at a price – in this case \$450 pounds a lead – which begs the question whether a mix and match approach might work?

I tried feeding Shiva to the Powerblock and Vishnu thereafter (hey, it was the easiest swap). I was astonished by the extent to which the uncomplicated, energetic and driven character of the cheaper cable reasserted itself. There was a little of the Vishnu's weight and colour, but none of its sophisticated pace and timing, and crucially, little of its expressive subtlety. I guess I should of known.

But there is good news. Reversing the order of the cables, with Vishnu feeding the Shivas also reversed the character and qualities of the system. More weight, more colour, more space and much more time. So, all Vishnu is better again, but the Vishnu led coalition more than held its own, easily bettering all Shiva (at an up-charge of \$230) or the Shiva fed Vishnu (at a saving of \$460). The hierarchy is refreshingly simple. Use the best lead you can coming out of the wall, the lesser leads thereafter. Hmm... the best lead you can? I guess there's only one thing for it

(...long, long drum roll) bring on the Valhalla.

Here we have a completely different kettle of fish. Where Shiva and Vishnu are svelte of proportion and cute of colour, in their attractive lilac shade, the Valhalla is an ostentatious brute of a lead. Where the others are flexible and readily accommodated, the Valhalla is stiff and springy, bursting out in embarrassing directions when you try to dress it down the back of your rack.

to the test, I thought to myself, so leaving the three Shivas in place, I simply replaced the Vishnu feeding the Powerblock with the appropriate length of Valhalla. Even watered down through the cheapest leads in the range, its quality was immediately apparent as it added tremendous focus, transparency, texture authority and purpose to the sound of the Shivas. What was happening was clearer and there was more time for it to happen in.



But look on the bright side – at least it looks reassuringly expensive. Which is just as well given the "If you have to ask..." nature of its pricing. Oh, you mean you do? Are you really sure about this? You mean, you really DO want to know? Well in that case, make sure you're sitting down, 'cos a two metre Valhalla mains lead will set you back getting on for a cool two grand. Uh huh... that's nearly two thousand of your hard-earned smackers. Can any mains lead be worth so much? That, dear reader, is just what you're about to find out – but then, I've got this sneaky suspicion that you already know the answer to that one.

Might as well put the new theory

The energy budget was managed much more convincingly, so that there was better control of pace and phrasing while at the same time the presentation was far more communicative and powerful. This was by far the best performance I elicited from the ►



► Shivas, better balanced overall than the all Vishnu set-up and extremely rewarding in both musical and hi-fi terms. Indeed, the only thing that skews the theory is the sheer cost of the single Valhalla lead, a cost that swamps both the Shiva and Vishnu.

Likewise adding the Valhalla to a Vishnu loom brings a sense of drama, tension and authority to that cable's more relaxed presentation (Please bear in mind that "relaxed" in this context is a relative term. The Vishnus' dynamic range and drive leave most mains leads standing.) It's almost as if you've just turbo charged its performance, the bigger lead unerringly filling out the weaker areas in the Vishnus' performance. Exactly as it did with the Shiva.



The bottom line here is simple. You can mix and match these leads with impunity, maybe using Shivas on your less critical source or recording components while running Vishnu on the primary chain. Simply make sure that you've got the best lead possible running from the wall to your distribution block. I've found the Powerblock excellent with these leads. Nordost will doubtless soon release their own model. My only word of caution would be to avoid anything that involves in-line filtering or isolation of any sort. Nordost are adamant that the cables work better without this and their performance certainly supports that view. Incidentally, I had no problem with the Russ Andrews parallel filters, although neither did I experience the usual, easily discernable benefit: More of a case of trading a little

crispness for a blacker background and more sonorous tone. The results will likely depend on your environment so suck it and see, although I ended up using the Purifier with the Shivas but none of the other combinations.

This ability to mix and match the leads is down to the use of coherent technology across the range, and a coherent sound too. Whilst it might seem disingenuous to suggest a performance continuum between the Shiva at \$220 and the Valhalla at \$1750, its existence is clearly demonstrated by the hybrid system experience. It's just that standing next to the Shiva the Valhalla is so far down the road that it's almost out of sight.

Nevertheless, that's exactly where we're headed.

Wiring the system with a complete suite of Valhalla leads transformed it just as completely as the Shivas had triumphed over the standard leads. I really wasn't ready for two such shocks in such close proximity. But let's get this clear from the start: the Valhalla might well represent a continuum from the Shiva and Vishnu, but it elevates system performance to another plane entirely. I've received enough flak for suggesting that you can legitimately use Valhalla interconnect and speaker cables with surprisingly modest electronics. But it does make musical AND financial sense, as can be readily demonstrated. Well, get this: the argument for using the Valhalla mains cables is even more compelling: Almost as compelling as the sound produced by the system I'm trying hard not to listen to as I write this. The Valhalla signal leads were a towering achievement, but

one that has now been eclipsed by the power leads.

What makes them so good? It's their combination of virtues. These are not the most expensive leads I've had in the house, or the first to leave all others standing. That honour lies with the Shunyatas with their ability to convey both weight and surging power. They are impressive indeed, but if memory serves (and I will be backing this up with straight comparison as soon as I can organise it) they lack the dynamic agility and finesse that the Valhallas possess, while the Nordosts

equal or exceed their grace under fire. Of course, much of this advantage rests in the area of absolute musical coherence, wherein the use of the Valhalla signal leads make a key contribution. But then that's really the point: It's all about coherence – both in terms of the music and the system wiring, with one supporting the other.

A fully wired Valhalla system (and this applies equally to the Cyrus based test rig or the full set-up used for longer listening) delivers phenomenal musical presence and purpose. Instruments and singers are solid, palpable contributors to a single, coherent whole. What they deliver and when they deliver it is never in question, absolutely defining the relationships within a piece - or even between left and right hand. I've been listening a lot to the wondrous Yvonne Lefebure on an EMI double disc (kindly sourced by RSF). With the complete Valhalla loom you hear these elderly recordings in their true light, Lefebure's effortless poise and the integrity of her lines easily transcending any limitations of the mono, 1954-6 recording chain. ►

► And effortless is the word. For all their sheer presence, focus, transparency and separation: for all their power, speed, dynamic discrimination and articulation, the Valhallas' delivery is utterly devoid of effort, strain or artifice.

are a few) proved utterly superfluous. We in the hi-fi press are way too fond of describing products that redefine the possible. Listen to



When a singer curls a lip over a sardonic lyric you accept it without question (and after a while, without surprise). When a drummer lets go you hear him hit his skins and flay his cymbals (without even noticing the speed and power demanded of the system). When an orchestra swells into a crescendo the system simply responds (without you noticing he fast approaching end-stops). Whatever the musical demand, from the widest dynamic swing to the smallest gesture or expressive inflection, the Valhallas deliver. There's no question: there's no mechanical evidence of reproduction: the music simply is. The naturalness of the presentation, the lack of dynamic constraint, the absolute individuality of the actors makes the whole experience much, much more convincing. The system no longer provides a background soundtrack to other activities. It demands your attention and rewards it equally. Comparisons with other cable systems I have here (and there

the complete Valhalla cable loom and you'll realise the extent to which, in this case, the claim is true.

The new mains leads from Nordost are an astonishing achievement. The El Dorado, costing £700, was easily able to compete with its peers. The Shiva (at £220) buries it so comprehensively that I almost feel like taking out an exclusion order to prevent unnecessary cruelty to obsolete cabling (not to mention those who have invested in it)! To achieve exactly the same level of superiority at the opposite end of the price spectrum, and to do it with an extension of the same technology

and in a product range that can be easily mixed and matched is what elevates the impressive to the sublime. Despite the price there are a surprising number of people running Valhalla and now Valkyrja signal cabling: For them, the cost of the Valhalla mains leads will represent a true sonic bargain. But the real beauty is that even those of us for whom Shiva or Vishnu represents a stretch could contemplate the purchase of just a single Valhalla. Indeed, once you've heard these leads you'll realise that, regardless of budget, they are so cost effective (especially the Shiva and Vishnu) that far from being an accessory or luxury afterthought, they should be the first name on the team sheet. Mains electricity is the foundation on which your system builds its musical performance. At last we are in possession of a cost-effective delivery system. Listen and you will buy!



#### TECHNICAL SPECIFICATIONS

##### Prices

Shiva (2m Power Cord):	£220
Each additional Metre:	£50
Vishnu (2m Power Cord):	£450
Each additional Metre:	£80
Valhalla (2m Power Cord):	£1750
Each additional Metre:	£300

Prices may vary slightly with termination.

##### UK Distributor:

Nordost (UK) Ltd  
Tel. +44(0)1352 730251  
Fax. +44(0)1352 731273  
Email. sales@nordostuk.com

##### Manufacturer:

Nordost Corporation  
Web. nordost.com



**Art Audio**

Hand crafted in  
England since 1988

Art Audio amplifiers and preamps are  
now on demonstration in Central London



The new 16 watt high current Carissa 845 SET  
To audition, please contact:

*Hear Here*

Tel: 020-8875 9696 or 07768 738372  
Email: hearhere@onetel.com

Ask for our "Beginners' Guide to Valves"

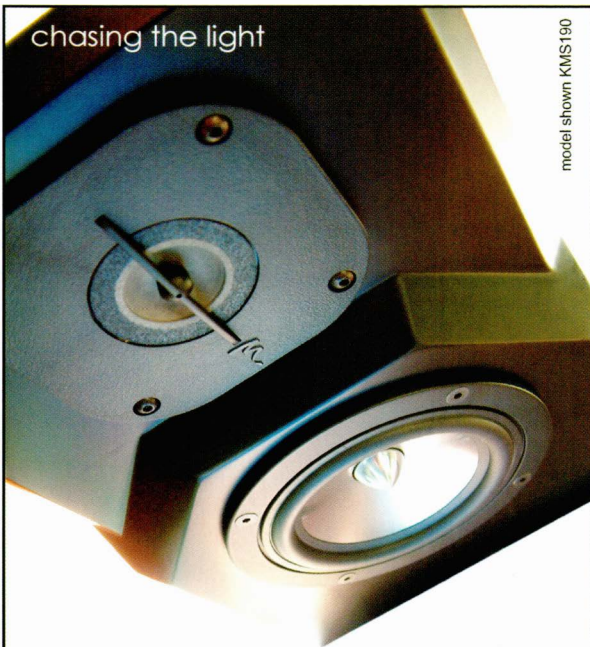

chasing the light

model shown KMS190

www.kmacoustics.com  
enquiries@kmacoustics.com  
Tel... +44 (0) 1495 769492



International dealer enquiries welcome.

## Looking For A Valve Amplifier?

More and more people are realising the sonic advantages of valve amplifiers. Hand built using simple, traditional designs our amplifiers preserve this quality. Also designed to be easy to live with and easy on the pocket!



**Stereo 40** EL34 integrated 37+37w (or 17+17 Triode)



**MB25** 300B Mono Blocks 28+28 watts



**LA3** Line preamp



**Stereo 20** EL84 Integrated

*Our range of amplifiers will drive almost any speaker and offers excellent value for money.*

<b>Stereo 20</b>	EL84 15watts integrated	£649.95*
<b>Stereo 40</b>	EL34 37watts integrated	£899.95*
<b>LA 3</b>	Triode Line Level pre amp	£649.95*
<b>MB 25</b>	300B Mono blocks (pr)	£1999.95

Features include: All Triode front end. Hand built & wired. 'Point to Point' wiring. Tape monitor circuit. ALPS Volume control. No printed circuit board. All gold plated terminals. Audiophile components. 4 & 8ohm speaker matching. Stainless steel & 6/10mm alloy plate construction. Attractive stainless steel & Plexiglas cage included. Stunning looks. Upgrade options. Superb smooth valve sound quality.

*\*Try for 30 days, refund if not delighted!*

**We do Part Exchange? your old equipment could be worth more than you think. Ask us for details.**

Order now by phone or ask for our illustrated leaflet.

Visit our new website at [www.iconaudio.co.uk](http://www.iconaudio.co.uk)

Auditions by appointment. Dealer inquiries welcome

Phone 07787 158791. Email [sales@iconaudio.co.uk](mailto:sales@iconaudio.co.uk)

**icon Audio** 351 Aylestone Road Leicester LE2 8TA

Visa and MasterCard accepted

CE marked

# SILVER ARROW AUDIO CABLES

The only things between a **Ferrari** and the road are its tyres.  
The only things between your hifi equipment should be our cables.

MAINS CABLES FROM £250    INTERCONNECTS FROM £200    SPEAKER CABLES FROM £400

All our cables are 49+ silver ribbon in a 98% dielectric format.

Bespoke products at their best.

**DEALER LIST:** A Audio Solutions (Pontefract) 01977 798844, Audiocraft (Uxbridge) 01895 253340, Matrix HiFi (Kent) 01322 281700, Noteworthy Audio (Aylesbury) 01296 422224, Premier Audio (Wakefield) 01924 255045, Voodoo Isolation (Somerset) 01643 841244, Worthing Audio (Worthing) 01903 212133

Silver Arrow Cables, 20 Telville Gate, Worthing, West Sussex, BN11 1UA Tel: 01903 212133 Mob: 07900 918882

DEALER AND OVERSEAS ENQUIRIES WELCOME

pear audio  
presents

Shahinian  
DYNAVECTOR  
Well Tempered

Stockists and Information  
from:

Pear Audio Ltd.

7 Prospect Place, Alnmouth,  
Northumberland, NE66 2RL

Telephone: 01665 830862

Fax: 01665 830051

## The Cartridge Man

We sell our own MusicMaker cartridge, digital stylus force gauge and digital turntable level. We also carry a limited range of valve equipment - Croft, E.A.R. - and pick up arms - Hadcock, S.M.E. Ortofon, Graham Slee Projects and a few other high quality products.

We also rebuild classic valve equipment, giving you a choice as the level of specification. We have in stock a range of original Mullard valves, including the sought after EL 34's. Also available is a turntable setting up service, this is free when you purchase one of our cartridges as is our Test Record.

We don't believe that quality is necessarily synonymous with massive amounts of 'dosh', we encourage customers to purchase second-hand items where appropriate. Sound quality come before cosmetics. Remember it doesn't have to cost an arm and a leg...  
And don't forget our cartridge rebuild service.

88, Southbridge Road, Croydon, CRO 1AF. tel/fax; 020 8688 6565. [www.thecartridgeman.com](http://www.thecartridgeman.com)



[www.manger-audio.co.uk](http://www.manger-audio.co.uk)

Human hearing evolved initially as a survival mechanism to locate a potential threat. Today our hearing still works by analysing the first transient pressure change from a sound source. Unlike traditional speakers, the Manger sound transducer accurately reproduces transient pressure changes to give stunningly realistic sound.

■ asr amplifiers



■ manger speakers



### precision: in sound

Contact us today and improve your audio experience forever.

- Manger Speakers
- ASR Amplifiers
- HMS Cables

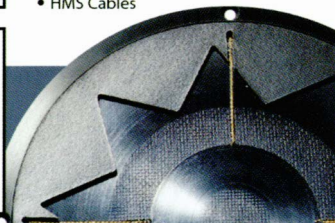

call: 0161 304 0099

mobile: 07970 908619

[info@manger-audio.co.uk](mailto:info@manger-audio.co.uk)

Manger Audio UK, Unit 10 Rassbottom, Industrial Estate, Stalybridge, Cheshire SK15 1 RH

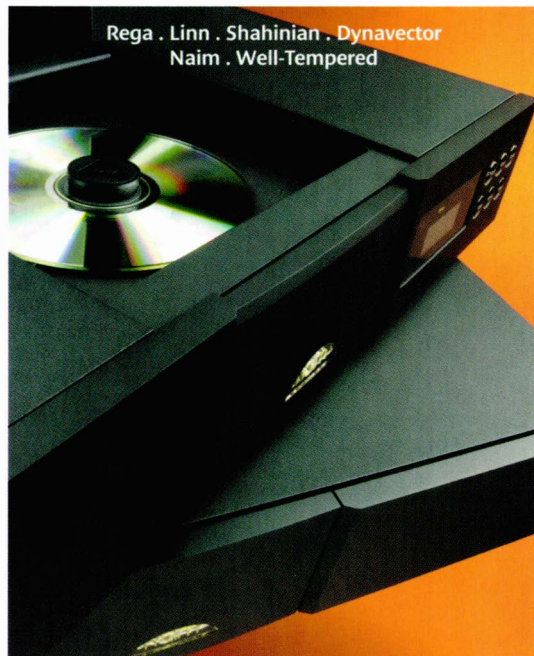

Rega . Linn . Shahinian . Dynavector  
Naim . Well-Tempered

For people who love music...and custard

We have moved to: 3 Gibb Terrace, Gibb Street,  
Custard Factory, Digbeth, Birmingham B9 4AA.  
Tel: 0121-224-7300 Web: [www.griffinaudio.co.uk](http://www.griffinaudio.co.uk)



### 'S' series

S3e

S5e

S6e

S8e

S9e

SR5

SR5

SR5



**Walls without boundaries**

Don't be contained, be entertained

Prepare for deeper, wider, higher

Let the technology work, hear the music

Reset your definition of exceptional

Experience sound without limits

Enjoy the Spendor magic

**Spendor Audio Systems Ltd**

Tel +44 (0)1323 843474

Fax +44 (0)1323 442254

[info@spendoraudio.com](mailto:info@spendoraudio.com)

[www.spendoraudio.com](http://www.spendoraudio.com)









# The Eben X-3 Loudspeaker

by Chris Binns

It has often been said that one of the key aspects of good hi-fi reproduction is accuracy to the original. As the Acoustical Manufacturing Company would have it, 'the closest approach to the original sound', assuming of course that you have an original with which to compare. There have been many impassioned arguments that the majority of 'modern' music is created in the studio, rather than the recording of a live event, as in with say, an orchestra, and therefore they can offer no immediate point of reference. As someone who spends a considerable amount of time working in a recording studio, I can see both sides of this debate, and am sometimes amused by the conclusions that people jump to, particularly when it comes to recording drums and percussion. As anyone who has played in your average rock band will testify, being anywhere in the near vicinity of someone playing a drum kit full tilt can be an uncomfortable experience: it is painfully loud at the best of times. Most recordings undergo a certain amount of compression, and with good reason; it is not only difficult to record and mix, but were it to arrive in your listening room in an unprocessed state the average loudspeaker would fall apart at the first snare beat if you tried to recreate the original volume. That is of course, assuming that you had enough power.

Given the above, I am often disappointed by the sound of drums and percussion when reproduced on hi-fi systems, but when I first heard the Eben loudspeakers I felt that here was a product that by trick or virtue was somewhat ahead of the game in this department. Each model that I heard presented this particular aspect of music with a clarity, impact and resolution that was refreshingly powerful, and offered

an exciting insight into music that I had rarely heard from a conventional moving coil design. I use the term 'conventional' a little loosely, as on the surface of it there is nothing radically different about the technology behind the Eben loudspeakers. But having lived with a pair of X3s, aspects of their performance reminded me very much of the Quad ESL 57. As well as some of the better horn loudspeakers that I have heard.

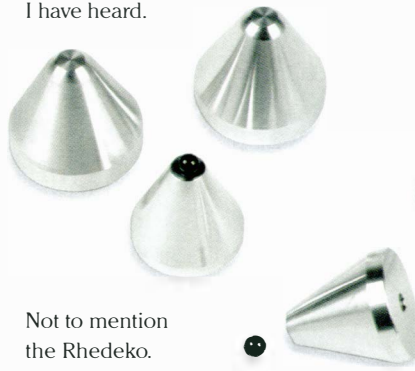

Not to mention the Rhedeko. You might be surprised to see mention of horns and the original electrostatics in the same sentence, but what they have in common is a sense of speed, coupled with a very dynamic, coherent and highly communicative mid-range. While each have their considerable drawbacks in other areas; whether it be ultimate loudness in the case of the Quads, or bass extension with the horns. The X3s, on first hearing would not seem to suffer any similar compromises, but they are every bit as fussy in their requirements, and do require considerable thought when it comes to set-up and partnering equipment.

The X3 is a tall, slim floorstander finished in a light blue-grey lacquer. The largest but one in a range of four, they all feature the same unique high frequency unit, assembled in house by Raidho, the manufacturer. The cabinet sits on a small

plinth using what are called ColdRays; a coupling system comprising cones and a ball bearing to provide a degree of isolation and resonance control (see separate review in Audio Smorgasbord). Another set of these is used between the plinth and floor, although I found that I got better results (and greater stability) on my carpet when these were substituted with RDC cones.

The story behind the Eben loudspeakers is a slightly unusual one.

Designer Michael Borresen had been working for some time on a planar tweeter, convinced that there

was more potential for accurate high frequency reproduction in this approach than with more conventional dome designs. Not to be confused with a ribbon device, the planar unit consists of a voice coil etched on to an incredibly light weight diaphragm, which is somewhere in the region of one tenth the weight of the average moving part of a normal tweeter. The magnetic field is provided by an array of neodymium pieces that sit behind the diaphragm, so it is driven over its entire surface area, giving a more precise and controlled movement. The basic concept is not new. Magneplanar built a whole range of loudspeakers using the idea, and there have been various Japanese units available for some time, but the implementation is a little different along with the quality of construction. There was however one problem. Having produced a tweeter with some rather interesting capabilities, Michael was unable to find a mid-range unit with which to partner it, and while there have always been problems combining planar devices with conventional cone drivers due to



▶ different dispersion patterns, the difficulty here was down to phase characteristics and speed. Denmark is home to a number of renowned drive unit manufacturers, and it was Audiotechnology (founded by the man who created both Scanspeak and Dynaudio) who came up with the most promising products. They were also amenable to prototyping units to satisfy his requirements.

The resulting drive units are every bit as impressive as the tweeters, and almost justify their astronomical price on looks alone. The X3 comprises five of these units, four of which cover the bass while a fifth deals with the mid-range. While they might look the same, there are subtle differences, and they are engineered to maximise their performance at the frequencies they reproduce. Thus the mid driver utilises a Kapton voice coil former (as opposed to aluminium used in the bass units) trading a little power handling for greater speed, less compression and a response that extends way up to beyond 12 kHz. It rolls off smoothly through careful engineering of the dust cap geometry.

All the units incorporate an Eddy ring both inside and outside the pole piece, and utilise a lightweight polypropylene material for the cone, traditionally noted for its low coloration and good damping properties; also for sounding rather sluggish and perhaps a little bit laid back – neither of which are criticisms that could be aimed at the Eben loudspeakers. As a result of the controlled response of the drivers, the crossover marrying them together is a simple 1st order type, consisting of top

quality 'flat wire' Jensen inductors and hand made foil capacitors. Internal wiring, rather crucially as it turned out, consists of a Nordost mono-filament cable, while single wiring is favoured via a set of good quality 4mm binding posts. The cabinet is reflex loaded through a downward firing port.

As I have already hinted, the X3's require considerable attention if one is to realise their full potential. They do not present an electrically difficult load to the amplifier, having an impedance curve that rarely drops below 8 Ohms. Unusually their requirements are more for a decent voltage swing rather than buckets of current. With an average sensitivity of 90 dB this should not be a problem, but what I found was that they needed an amplifier that was potentially as fast as they were, which seemed to rule out

much of the equipment on hand. The Rogue Zeus, for example was not really able to give the Ebens what they needed, resulting in a sound that was flat, unexciting and with a tendency to highlight what was wrong rather than right. Better was the Cyrus X pre/power combination, which proved to be a step in the right direction – but ironically it was the little Cyrus 8/PSX that proved to be a real hit. This budget priced combination had just the right 'snap' to explore the virtues of the X3's, and despite being a little rough around the edges, proved to be a worthwhile partner despite the massive price differential.

The Eben would seem to be fairly room friendly, in so much as bass performance was not drastically affected by positioning. Useful extension was evident to just below 30Hz, which while not exceptional for the size was well controlled and very even, while being able to muster plenty of kick and impact, somewhat reminiscent of an 'isobarik' design. It was this that enabled it to keep up with the mid-band, which as I have already hinted was fast and informative, although not entirely without vice. At times it seemed to suffer from a degree of coloration that manifested itself in the form of a 'cupped' sound, most often triggered by a particular vocal or string note, only to disappear just as quickly as it came. This had the effect of drawing attention to the upper-mid which could sound a bit squeaky, and mask what was otherwise a smooth transition to the treble, where the planar unit takes over. Its presentation is quite different to a dome tweeter, and takes a bit of getting used to, but offers a degree of (again) speed, clarity and openness that few if any moving coil types can match. One minor problem concerns the surround of this unit. Injection moulded in a soft polymer, it's definitely non-resonant but needs to be more precise of fit to avoid discontinuities where it meets the edge of the diaphragm. It's also near impossible to fix, rejecting all ▶





▶glues or double sided tapes I had to hand (which was quite a collection). Instead it presses into place, just not tightly enough. It also provides a small amount of horn loading, and I wonder if some of the colouration problem could be down to this?

While most loudspeaker manufacturers would lay claim to their products being highly revealing, I sometimes felt as if the X3's had the magnifying glass out, and at times listening could be quite uncomfortable. While the Cyrus served to show what a feisty amplifier could do, the Ebens craved something with a little more sophistication, and this arrived in the form of the Levinson 383 integrated, whose grace and general good manners are mixed with authority and bite. The final piece in the jigsaw necessary to achieving the staggering performance I'd previously heard from the X3's came down to substituting some fairly average mains cables with the Nordost Valhallas. I have been using Valkyra loudspeaker and interconnect for a while now, and there is a certain logic in their performance benefiting from extending their mono-filament technology to include the mains cables. After all, that's what's inside the speakers too. But I was completely unprepared for the magnitude of the improvement that took place, and it was by far the most dramatic and conclusive demonstration involving cables (of any type) that I have witnessed.

The difference in sound coming from the X3's was nothing short of startling – it was as if this was what they had been waiting for. That annoying coloration in the upper mid had all but gone, while everything sounded cleaner and more solid, and thus better presented, allowing music to flow unhindered from the speakers.

I had previously considered the Ebens to be forward in their character, but now the balance seemed to be just right, allowing them to reproduce all types of music naturally, with an evenness that had not been present before. The sound was characterised by finely etched detail that easily came away from the speakers, while leading edges were brilliantly and accurately preserved, giving an immense air of realism to many instruments, particularly those of a percussive nature such as

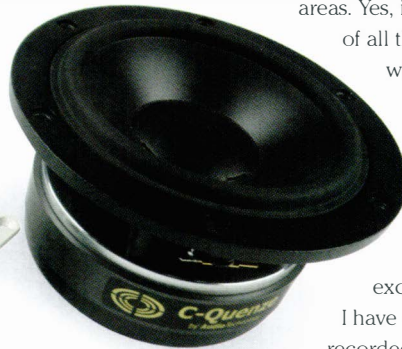

plucked acoustic guitar. I must also mention that the treble had an air and freedom to it, but not without substance, without which it can come across as artificial. These attributes also served to heighten the sense of communication and drama by not hiding the micro dynamics that go to make up so much of the life of music, and there were times when I found myself holding my breath during particularly intense passages. The soundstage was deep and wide, although sometimes the image was not projected as strongly as I would have liked, but we could be looking at a room interface problem here. The Ebens seemed equally happy to play at realistically volumes or far more quietly, where crucially all aspects of the performance remained intact, and this is not a loudspeaker that needs to be run loudly to generate excitement. They are also rather good at revealing technical shortcomings in a recording, which while not always pleasant, can be a useful attribute in my line of business. I do wonder what a pair of the baby

X-Centric's would be like as near field monitors. . . But that's another story.

The distributors tell me that the X3 is a loudspeaker that people either love or hate. That's the sort of comment that I would expect to hear about a horn loudspeaker, and for me the great beauty of the X3 is that it offers much of the performance that attracts people to more idiosyncratic designs, while not being nearly as compromised in other areas. Yes, it is very demanding of all the ancillaries used with it, and there are speakers at a similar price that are far more forgiving. But get it right and the Ebens are capable of one of the most exciting performances I have recently heard with recorded music. ▶+

#### TECHNICAL SPECIFICATIONS

Type:	Three-way reflex loaded
Drive Units:	1x Raidho planar magnetic tweeter 1x 155mm polypropylene mid-range 4x 155mm polypropylene bass units
Bandwidth $\pm 3$ dB:	30Hz – 50KHz
Sensitivity:	90 dB
Impedance:	6 Ohms (minimum)
Crossover points:	200 Hz and 3.5 KHz
Dimensions (WxHxD):	180x1350x350mm
Weight:	68 Kg ea.
Finish:	Paint finishes to order
Price:	£8000

**UK Contact:**  
Nordost (UK) Ltd.  
Tel. (44)(0)1352 730251  
Email. sales@nordostuk.com

**Manufacturer:**  
Eben by Radko  
Tel. (45)(0)9816 6027  
Email. eben@eben.dk  
Net. www.eben.dk

# The X-Factor

by Roy Gregory

Writing a follow up piece to someone else's review is always an interesting opportunity. You get to see the product through their eyes, while they get to do all the leg-work. Sounds simple huh? Well, yes and no.

CB has got his analysis of the Eben X3s absolutely spot-on. So what is there to add? Mainly that to some extent he's hiding their light under the bushel of their demands rather than highlighting their astonishing strengths. It's an understandable response given the lengths he had to go too in order to realise their remarkable potential, but then that was in no small part down to his other reviewing commitments, products that rather clashed with the Eben's requirements. Besides, it's not something I need to worry about because he's done most of the work.

The other reason is one that crops up time and again: The more challenging a product the less impressive its reviews can often seem. Of course, if it's the straight-ahead, most impressive piece of kit you've ever been fortunate enough to handle then sheer enthusiasm carries the day. But what about products that are great but different to anything else? The very conundrum of what makes them work when they do it so differently to the norm presents the reviewer with a much harder task. The seriousness of the issue tends to permeate the review, which seems to confuse readers. Is this product great or is it difficult? The answer of course is that it's both: great to listen too – difficult to analyse.

So, let's establish something right from the start. The Eben X3 is an exceptional speaker. Meet it on its own terms and it sets new standards, I suspect pretty much irrespective of price. The question is, are its terms the same as yours.

When CB says that the X3 reminds him of a horn speaker I know exactly what he means. I also understand why it reminds

and clarity of the best electrostatics combined with the dynamic range and immediacy that comes with well executed horn loading. Now

add the kind of bandwidth that normally only comes with dynamic drivers in a box and you've got a recipe that is unique in my experience. It all equals that hi-fi holy grail, the combination of speed and substance, with real energy arriving in real time.

I can also understand why CB started off by talking about drums. In many ways they are the most obvious as well as the greatest beneficiaries of the X3's astonishing abilities. But get over the initial wow factor and you soon begin to realise that that level of physical presence and separation makes every instrument (and the way it's played) a tactile experience. You can feel the human input; you can sense the energy; you experience the performance. These speakers are all about excitement. Get them working at their best and the only speaker I've heard that can better their ability to transport the sheer energy and presence of a performance into your listening room is a well set-up pair of Avant Garde Trios. They're huge, they cost twice as much as the X3s and if you think the Ebens are finicky...

But don't go getting the idea that the X3s are all about high impact music. Whilst they sound incredibly

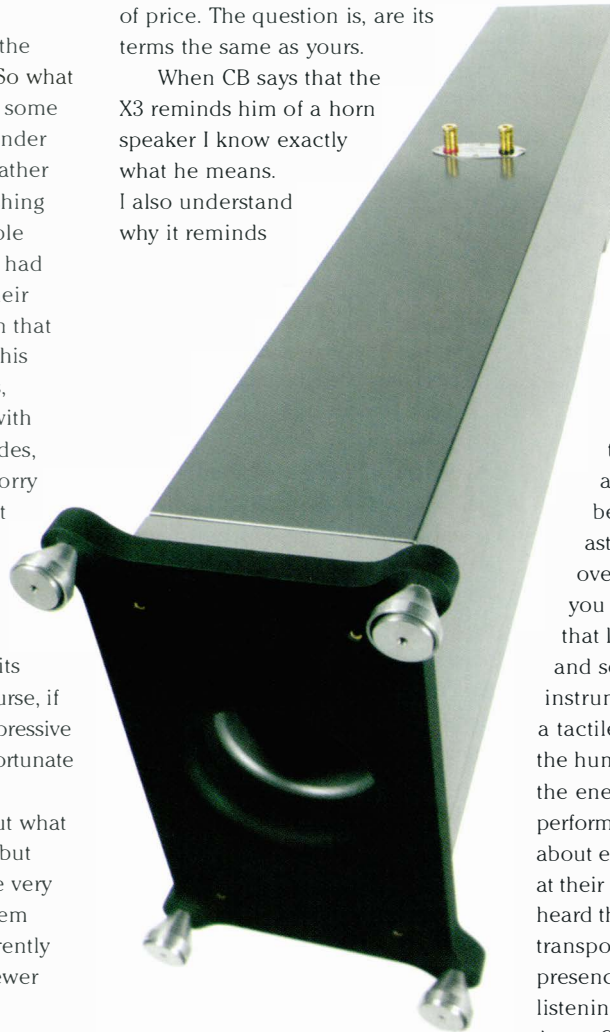

him of an electrostatic, but for my money, the Eben offers more music than either of those approaches, at least up to this sort of money. What it delivers is the speed



► real with simple blues or rock, they'll raise the hairs on the back of your neck if you play the Barbirolli Tallis Fantasia. Their micro dynamic definition works equally well on all music, without fear or favour. So voice or acoustic guitar, drum or electric bass, solo instrument or full orchestra, you get to enjoy unrivalled presence and intimacy. The Ebens make compelling music. It's performance you can't ignore and which demands your attention. It cuts right to the heart of a recording and never lets go. Thankfully though, it's the sort of insight that delivers whatever music there is in a recording rather than pulling it apart by highlighting its weaknesses.

integrated amp used with the best source you can afford. I'd love to hear these speakers with the Lavardin IT, and in contradiction to what I've just said, the Tom Evans electronics. But then, they set new standards for system coherence anyway. Likewise (and as CB discovered) you'd better make sure your cabling is up to scratch and all on speaking terms. Apparently trivial differences in set-up produce dramatic effects on the X3s' performance.

So much for the things you can deal with. The X3s are not without character and it's how intrusive you find that character that will decide whether this is the

The point is that most speakers that hang their hat on a single extreme attribute do so at the expense of a whole raft of associated weaknesses. So horns, for all their impressive strengths are all too often horribly coloured, have limited bandwidth and are generally huge into the bargain. What the Eben's do is shift the cost/benefit curve, delivering more outstanding strengths for far less collateral compromise. It's a neat trick if you can do it – and for a great many people the answer will be that the Ebens can: If they'll let them. The price might be a reappraisal of just how you put a system together. Perhaps more than any other speaker since the Apogee Scintilla, you need to budget for the driving amp as well as the speakers themselves. The saving grace is that the cost might be less than the trade-in on your old pre-power, especially if you've taken the conventional path towards your first pair of 10K speakers.

The Eben X3s are capable of delivering more sheer musical excitement from a more compact package than any other speaker I know. They may not major on the holographic imagery and constipated dynamic control that has become synonymous with too much of the high-end, but when I describe them as "You are there" I mean it in quite a different sense. They'll tell you more about the music on your records and how it got there than any number of highly touted alternatives. They'll also tell you about the state of your system if you give them the chance. I'd listen to what they have to say. It might well be uncomfortable: it might not be for you: but if it is then I suspect you'll be bowled over. Music – accept no substitute. ➤

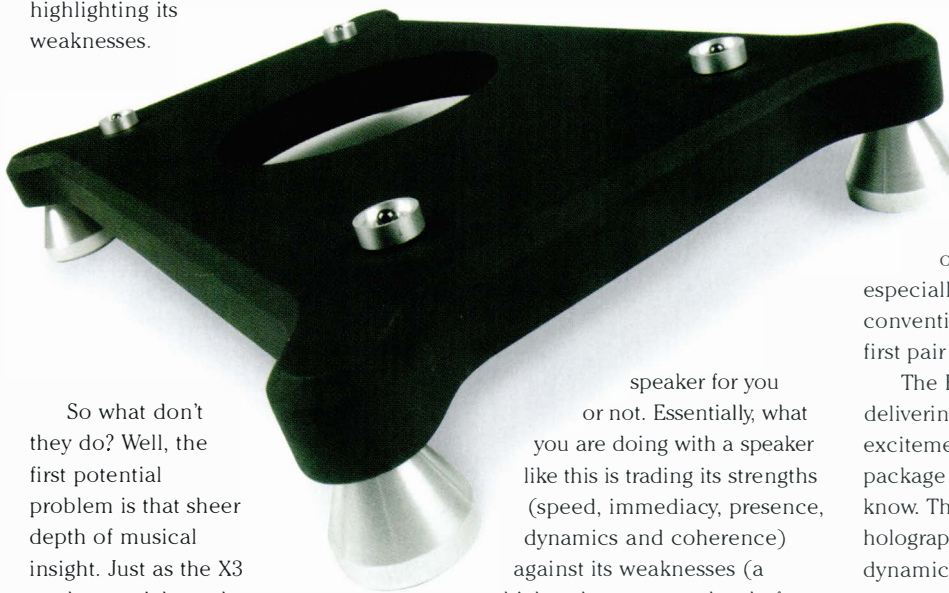

So what don't they do? Well, the first potential problem is that sheer depth of musical insight. Just as the X3 scythes straight to the centre of the performance, it's equally ruthless when it comes to the quality of the driving system or the standard of your mains. So much so that it forces a complete reevaluation of your system priorities. The Ebens are all about quality rather than quantity. They need the best ancillaries supporting a high quality signal path. So dynamically and time coherent are the speakers that any discontinuity in the driving system is instantly apparent, a situation that favours the simplicity of a small,

speaker for you or not. Essentially, what you are doing with a speaker like this is trading its strengths (speed, immediacy, presence, dynamics and coherence) against its weaknesses (a higher than average level of colouration). Now CB also covered the nature of the X3s' deviation from tonal accuracy in some depth, but let's try and put it in some kind of context. We're not talking about the colouration levels associated with the majority of horn speakers here. What's more, the better the set-up the less obvious the tonal failings become, almost as if they're exaggerated by phase or energy discontinuities elsewhere. Which makes sense if you think about it.







# The JBL K2 S5800 Loudspeaker

by Paul Messenger

The K2 series are JBL's 'audiophile' flagship models, and probably wouldn't exist at all were it not for the special relationship that the brand has with Japan's 'high end' sector. Back in Issue 21 I discussed the ins, outs and fascinating background to the magnificent K2 S9800, a twenty grand monster that would have been right at the top of my personal shopping list had I been able to afford them.

Although I managed to hang on to the S9800s for an extended loan period, all good things come to an end, and some rich b\*\*\*\*\* with as much good taste as good money eventually made Harman UK an offer they couldn't refuse. Happily around the same time the company introduced a new 'junior' version, the K2 S5800, providing something rather similar at a somewhat more affordable – though still unquestionably costly – £12,000, and me with the excuse to try out this model

Named after the world's second highest mountain, the original K2 first appeared in 1989, succeeding a 1985 model called the Everest. These models were specifically developed for the Japanese market, where JBL has, over the past forty years, built up a very different profile and image from the mass-market brand promoted in other territories. In Japan, JBL is a 'high end' brand with strong 'heritage' overtones, and while the latter factor doesn't involve the fancy nostalgia finish found in Tannoy's Prestige series models, there's a definite sense of history in the hybrid horn driver configurations which the K2s use.

Although this S5800 is the junior model to the S9800, it's not a lot smaller or lighter than its senior brother. It differs in a number of respects, however, the most significant probably being the use

of rather less exotic and costly materials in strategic places.

Where the '9800 used beryllium for the diaphragms of the mid/treble compression driver and the super-tweeter, the '5800 uses titanium and aluminium diaphragms which are much less expensive. Where the '9800 used a single 15-inch bass/mid driver with a complex motor and pricey Alnico magnet, the '5800 has a pair of 12-inchers with generous but regular ferrite magnets.

While those driver changes will have some impact, so too will the geometric differences. That use of twin 12-inch bass/mid drivers, and the fact that they're positioned above and below the centrally placed – and therefore necessarily rather low-set – mid/treble unit and super-tweeter will also have a significant effect.

Moving to twin 12-inchers has the bonus of reducing the width, and therefore the visual impact of the speaker, though it's still a substantial 43cm wide, stands well over a metre tall, and is also 41cm deep. This is physically a very big loudspeaker, no question, and a decidedly hefty one too at well over 80kg. It's hard to describe the rather four-square shape as attractive – frankly I prefer the more interesting shape of the '9800, despite its greater bulk – though it is undoubtedly purposeful, and nicely turned out too in a classy real wood veneer with a high gloss lacquer finish, over a very rigid and solid MDF substrate.

One might expect such a large enclosure to be responsible for a fair

amount of box coloration, but that didn't seem to be the case at all. Little if any vibration could be felt through the walls, even when playing the speakers loudly, so the whole thing is clearly very well put together. However, the spike coupling arrangements might have been improved – there are cones here, and little indented discs to protect a wooden

floor, but no lock-nuts, and the US pitch is not easy to find over here, even if the threaded stubs were long enough to accept them.

Although it's formally described as a three-way, the 'third' (supertweeter) only comes in at 10kHz, for the final audible octave plus ultra-sonics. This is therefore essentially a large

two-way as far as the vast majority of the audible frequency range is

concerned, and very unusual because it places the main bass-to-treble crossover point at 800Hz – some two octaves below the 3kHz adopted by the overwhelming majority.

Moving the crossover point down and away from the presence zone (where the ear is most sensitive) is a significant bonus, especially in achieving superior voice integrity and coherence. It's not possible to do this with a regular direct-radiating tweeter, but JBL's bi-radial horn – a substantial affair cast in Sonoglass resin, using a 3-inch aluminium diaphragm compression driver – has no difficulty in covering the four-octave span from 800Hz up to 10kHz. The same horn arrangement also incorporates the



▶ tiny supertweeter horn, this time with a 1-inch titanium diaphragm.

The twin 12-inchers, loaded by the large ported enclosure tuned to 30Hz, operate in parallel above and below the horns, in what's usually described as a d'Appolito configuration. The drivers themselves have Kevlar-reinforced, doped paper cones and are driven by deep motor units with massive power handling and a symmetrical magnetic field for superior linearity.

The crossover uses steep 24dB/octave slopes, has high power air-cored inductors, and actually uses a small battery in order to pre-bias the capacitors, improving their linearity and avoiding 'crossover' distortions. Presets allow a very subtle adjustment to the relative treble level.

Measurements show some similarities to those found with the '9800, but some significant differences too. Both deliver impressively neutral and smooth frequency balances, but with slightly different emphases. This '5800 has the slightly higher sensitivity – a very generous 94-95dB, and actually measures slightly 'flatter' than its senior brother overall. It's rather stronger through the bass region, and again in the presence zone, so the midband is consequently a little more laid back, giving a slightly 'cooler' overall character. As you'd expect from a speaker with such large bass drivers and box, it's intended for 'free space' siting, well clear of walls, and even under those conditions the output in my good size room was a trifle excessive below 80Hz

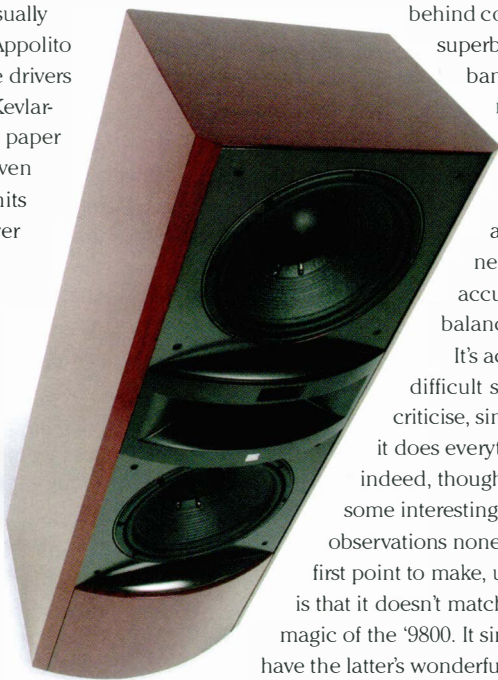

(though also happily quite smooth).

Predictably given the above, this is a seriously excellent loudspeaker, distinguished above all perhaps by its exceptional authority and grip. Not far

behind comes its superbly wide bandwidth and magnificent dynamic range, alongside a studied neutrality and accurate tonal balance.

It's actually a very difficult speaker to criticise, simply because it does everything very well indeed, though there are some interesting and relevant observations nonetheless. The first point to make, unequivocally, is that it doesn't match the sheer magic of the '9800. It simply doesn't have the latter's wonderful romantic intimacy.

Where the larger model sucks you in, with a rare ability to tickle your emotions and make your toes curl up with delight, the '5800 has a rather more matter-of-fact delivery. It's probably more accurate, in point of fact, but somehow not quite as appealing.

That said, I really like the sheer weight of this speaker, because it's so beautifully even, solid and free from boom, yet it also delivers serious bass energy with immense slam and power when the program material demands.

It's also rather fussier about set-up,

however, as those two big bass/mid drivers are operating in parallel here, each reproducing exactly the same signal. For best results, they need to behave, as far as possible, as one, as far as listeners are concerned. It's therefore vital to take the time needed to adjust the fore'n'aft 'tilt' of each speaker very accurately and precisely, so that the two voice coils of the bass/mid drivers, above and below the horns, are equidistant from the listeners' ears. Get it right and everything snaps beautifully into focus, and the speakers themselves virtually disappear, aurally speaking. In terms of stereo image precision, focus and perspectives, the '5800 definitely leaves its big brother trailing.

The image precision is all the more effective, partly because of the driver disposition, but rather more so because of the horn loading. Horns act like lenses, magnifying the sound while at the same time restricting its radiating angle. While the latter remains wide enough, laterally and vertically,

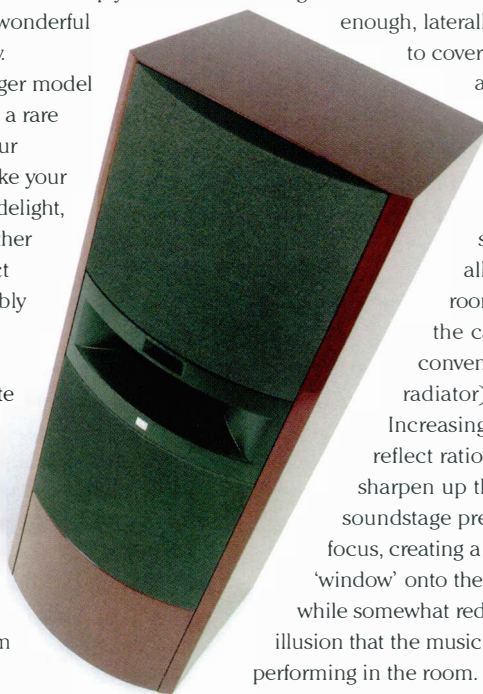

to cover the listening area with good consistency, it does mean that much less sound is spread all around the room than is the case with conventional (direct radiator) designs.

Increasing the direct/reflect ratio will tend to sharpen up the stereo soundstage precision and focus, creating a more accurate 'window' onto the recording itself, while somewhat reducing the illusion that the musicians are actually performing in the room.

I had the '5800s on hand for a number of weeks. While there were occasional interruptions as other loudspeakers came in for review, ▶



► I always went back to the JBLs as soon as I could, and invariably turned to them whenever there was a source component, amplifier or accessory to assess.

This speaker is a monitor in the true meaning of the word. It tells you what's going on, honestly and accurately, and in such an authoritative way as to command automatic and unquestioned respect and trust. That said, it isn't entirely free from midband coloration, and the midrange showed rather more of a 'horny' quality than I recall hearing with the S9800. Little 'trim pots' allow a discreet



(+1/0/-1dB) treble adjustment, which is clearly audible and a useful 'fine-tuning' extra.

Although I did most of the listening with my regular Naim NAC552/NAP500 amplification, fed from a variety of familiar and unfamiliar source components, I also tried several alternative amplifiers, and a fair few different accessories too. These JBLs simply and unequivocally laid bare the sonic differences between all the various bits and pieces further up the chain. They take no prisoners, which is exactly as it should be, their magnificent dynamic range and bandwidth and

precise imaging easily showing up exactly what's going on.

When I put the Orelle amp combo (reviewed last issue) into the mix, I was immediately aware of its superior stereo image depth and delicacy, even though the Naims were better at the extreme top end. I also enjoyed the hefty ECS monoblocks, which have oodles of muscle and a very lovely midband character.

Then there's an intriguing CD player that I've been trying out recently. This started out as a production Marantz KIS, but had been modified internally by the Trichord people, not only with one of their precision clocks, but also by the fitting of 'Never-Connected' power supplies, which isolate the internal supplies from the mains, and which could be switched on or off in this example. Via the S5800s, it was quite obvious that these substitute 'mains isolated' supplies significantly 'sweetened up' the sound.

An even more dramatic illustration of this speaker's very superior power of analysis came when the various Vertex AQ bits and pieces paid a visit. As each element in the chain was introduced, the speakers clearly delineated the consequent – the increase in perceived bandwidth, the improved stereo focus and depth, the wider dynamic range, the sweeter, cleaner top end, the superior dynamic 'punch'.

And if the '5800 impressed me a great deal, I wasn't alone. While the JBLs were in residence a number of visitors brought their components down, and after we'd spun a few discs, they invariably started making observations – often with some surprise – about just how good these rather unlikely looking speakers really were.

This is an unusual looking design, and a bulky one too. Put that with the high pricetag and that's three negatives to consider. However, in every other

respect this a truly exceptional loudspeaker that does the whole sonic and musical thing exceptionally well. And if it perhaps doesn't quite match the subtlety and delicacy of its big brother, it probably has a slight edge on sheer dynamic grip and bass drive.

The acid test for any component is how much you miss it once the company comes to take it back, and the truth about this big JBL is that I miss it a lot – nearly as much as I did its big brother. Whatever you think of the horn-loaded mid and top, which might not appeal to everyone, the bass end of both these JBLs is absolutely superb. They have an evenness, authority and dynamic tension that is revelatory, and very difficult – if not impossible – to find elsewhere. ►+

#### TECHNICAL SPECIFICATIONS

Type:	3-Way, Dual 12-Inch Floorstanding Speaker
Power handling:	300 Watts (RMS)
Impedance:	8 Ohms (claimed)
Sensitivity:	95dB (confirmed)
Frequency Response:	-6dB @ 50Hz – 40kHz (Anechoic)
Crossover Frequencies:	800Hz, 10kHz
UHF Driver:	1-inch titanium horn-loaded compression driver with 2-inch neodymium motor assembly
HF Driver:	3-inch Aluminum compression driver with rapid-flare bi-radial horn
LF Drivers:	Dual 12-inch with 3-inch voice coils
Dimensions (WxHxD):	1245x432x413mm
Weight:	84kg
Price:	£12,000/pair

#### UK Distributor:

Harman UK  
Tel 0208 731 4670  
www.jbl.com

# ROGUE AUDIO



Audiocraft - UK distributor for Rogue Audio

Call 01 895 253340 for dealer listings or to request an information pack.  
Fax 01 895 238238 Email kevinwalker@genie.co.uk

[www.audiophileusa.com](http://www.audiophileusa.com)

The Supreme Source For Your Musical Inspiration!



World's Finest Quality Used & Sealed LPs

Tel: 916.990.9321 • Fax: 916.990.9339 • P.O. Box 656 • Fair Oaks, CA 95628



# AUDIO AERO



32bit/192kHz

"the ultimate in CD playback..incredibly natural..something very special..."



..a seriously great-sounding CD player...the musicality of analogue..  
amazing liquidity....very high speed resampling...jitter-free" (Sound Stage)

The Audiophile Club PO Box 6477 London N13 4AY  
Tel. 020 8882 2822 Fax. 020 8372 3772  
sales@audiophileclub.co.uk www.audiophileclub.co.uk

ARCICI - BC ACOUSTIQUE - CARY AUDIO  
EARMAX - HARMONIC TECHNOLOGY - MARSH  
SOTA - SOLILOQUY - TICE

## ARE YOU LOSING THE PLOT THIS CHRISTMAS?

WITHOUT OUR PRODUCTS,  
YOU ARE MISSING MUCH OF THE MUSIC.  
THEREFORE, YOU RISK LOSING THE MUSICAL LINE,  
AND IF YOU LOSE THE MUSICAL LINE ...

**FOR VINYL LOVERS** Anniversary Ringmat, LP Blue Statmat and Statcap, Ringcap MkII and Ringmat Spacers. All these, including the Anniversary, make up the full Ringmat Support System.

**FOR CD, SACD and DVD SOUND (& PICTURES)** CDi Blue Statmat

**FOR ALL MUSIC LOVERS** Statfeet, Ringmat Feet, Ringmat Domes, Pure Signal Stereo & Digital Interconnects, Pure Power & Power Line Speaker Cables

**NEW PRODUCT PAGES, GUIDANCE, UPGRADE OPTIONS, PRICES, REVIEWS and much more on our Website [www.ringmat.com](http://www.ringmat.com)**

Also, LOOK OUT for  
OUR NEW [ringmat.com](http://ringmat.com) WEBSITE STORE and SHOPPING BASKET

### RINGMAT DEVELOPMENTS

PO Box 200 Brentwood Essex CM15 9FB GB

Call: 01277 200 210 Visit: [www.ringmat.com](http://www.ringmat.com) or Email: [enqhf+@ringmat.com](mailto:enqhf+@ringmat.com)

## PUTTING SOUND INTO FOCUS

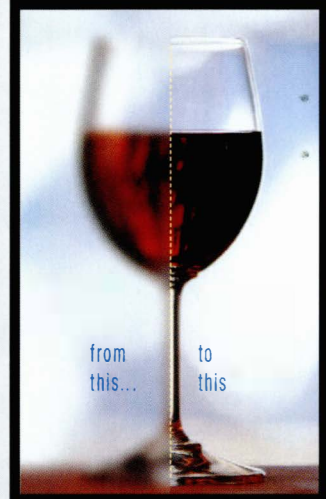

 RINGMAT



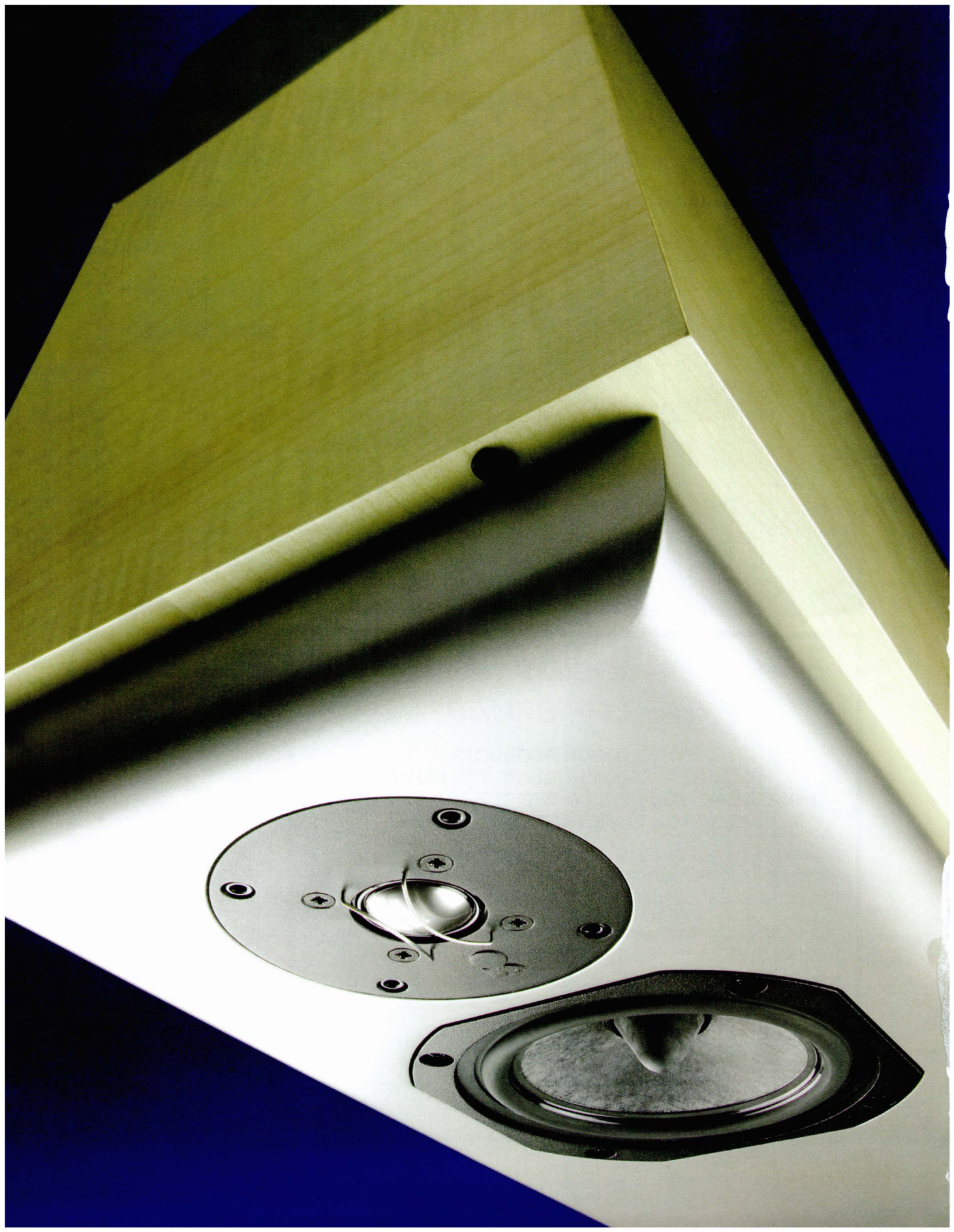



# The Revel Performa F50 Loudspeaker

by Roy Gregory

In nearly 30 issues of this magazine we've probably reviewed more speakers than any other type of product, yet one brand really stands out. Across five reviews and three different reviewers, the Revel speakers have received universal praise, offering performance well above their price. CT ended up buying the stand-mounted Gems and has used them to this day. Both CB and I would have bought the Salons if we could have afforded to, only the existence and performance of the big brother distracting from the attractions of the smaller Salon. But sonic bargains though these speakers are, cheap they aren't, which puts them beyond the budget of all but a few (albeit a few more than their peers as far as performance goes).

From the other end of the range, I was equally impressed by the baby Performa M20, a compact stand-mount that majors on presence and scale where so many find it easier to offer detail and definition. But, perhaps inevitably, the considerable cost savings mean that something has to go, and in the case it's the superbly satisfying evenness of the more expensive speakers that's sacrificed. What about a product that offers a more sympathetic and symmetrical scaling of the flagship performance? On paper at least, that's exactly what the F50 should represent.

Visually at least, the slim floorstander is very much a halfway house. The multiple drivers, tapered cabinetry and curved vertices of the expensive speakers mix and match with the cast aluminium feet and simpler appearance of the budget Performa series. They're smaller too, making for a more obvious match with European room dimensions, although this is more visual than sonic, the superb bass alignment and control of the bigger models making them feel (and sound) quite at home in even

seemingly impossibly small rooms. Technologically speaking they're distinct too, with Revel making great play of their ceramic drivers. But don't get confused with the seamless white soup bowls used by Avalon, Kharma and Lumen White amongst others. The Revel mid and bass drivers use a composite cone constructed by immersing a fibre former into an aqueous ceramic solution. The coated cone is then cured, resulting in the required light but stiff structure. The process is proprietary to Revel who are seeking to patent it. It's also yet to appear in any of their other speakers.

The tall, narrow cabinet is constructed from inch thick MDF tapered front to back (rather than top to bottom in the Salon and Studio) and with two substantial braces placed between the three 165mm bass units. All the drivers are mounted on the substantial 50mm thick and carefully profiled baffle, so no rear tweeter this time around. The midrange unit also enjoys its own separate sub-enclosure, this further stiffening the cabinet and disrupting internal standing waves. There's a massive port in the rear cabinet wall, and this and its supports add even greater stiffness. It's an arrangement that

delivers a claimed -3dB point of 32Hz, which is impressive given the speaker's dimensions and 88dB efficiency. The cabinet base is supported on four of the cast aluminium blobs, familiar from the other Performa speakers. These are threaded for spikes and in a nice touch, Revel round off the non-pointy end of these and provide plastic cap nuts and glides for different surfaces.

The midrange unit uses the same ceramic cone as the bass drivers, but this time 130mm in diameter and with the familiar fixed, rubberised phase plug seen on many of the Audax units. Not surprising as Revel developed the diaphragm technology in conjunction with the French company. Like the bass drivers, the midrange unit is shielded for use near TV sets, which is worth an extra dB of efficiency too, worthwhile in a wide bandwidth design like this one with its steep crossover slopes and 5 Ohm nominal and 3.2 Ohm minimum impedance. The tweeter is a 25mm pure titanium dome, using a neodymium magnet and Telar-57 low-carbon steel pole piece and face-plates in order to provide an unusually linear field in the magnetic gap. The pole piece is vented to a separate rear chamber that incorporates an integral ►

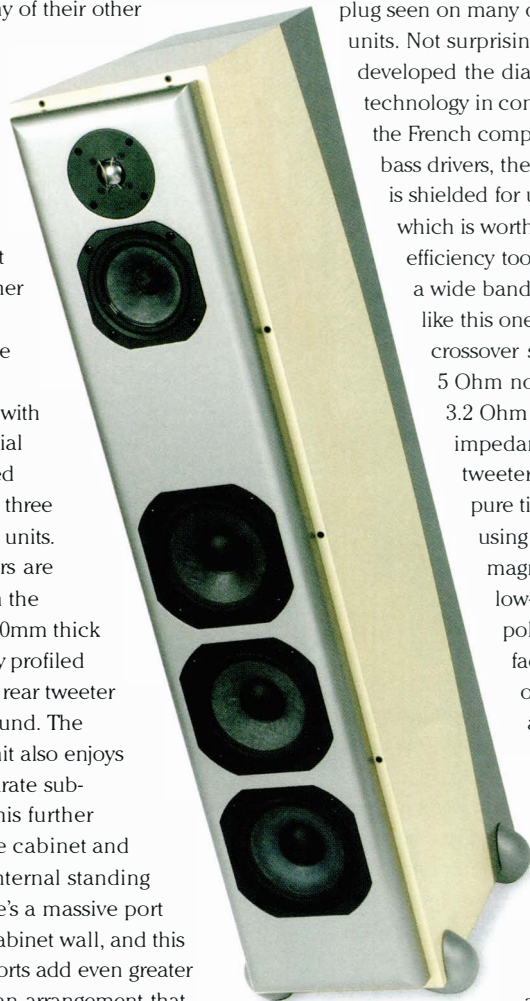

► heatsink in order to maximise both dynamics and power handling while minimising thermal compression. Like all Revel speakers the F50 plays loud without strain or complaint. No, make that REALLY LOUD. Oddly, no figure for power handling is provided by the manual: I used the F50 with the Hovland RADIA and Gryphon Antileon with no problems whatsoever. I'd be more concerned by minimum power threshold than the opposite end of the spectrum. Around a hundred serious Watts will get the best out of the F50s, less if you're looking at quality valves, although the Rogue M120 mono-blocks (or the new 150s) look like an enticing match, visually and sonically.

Setting-up the F50s was simplicity itself, despite the generous extension on offer. Like the Salon and Studio, its bass alignment is tight and controlled enough to be relatively unfussy of placement. I ended up with the speakers 55cm from the back wall, but I could have pushed them back if necessary, albeit at the cost of some soundstage depth. What is critical is that you get the speakers absolutely upright and toed well in. If you don't, the otherwise excellent imaging simply falls apart. The well-spaced and clearly labeled terminals allow bi-wiring and I'd recommend that you do so. Or at least take steps to do away with the massive metal bridges that sound really quite nasty if you actually put music through them, introducing grain and a greyness to proceedings if you use the bass terminals, a muddiness and general clogging if you use the treble.

There's one other thing that you need to consider and that's the small rotary switch mounted on the crossover plate. Familiar from other Revel designs, it allows you to trim tweeter level in five 0.5dB steps. I settled on the -0.5dB position, which again accords nicely with previous experience with Revel

speakers. But even from a quick initial listen it was obvious that my hopes regarding the F50 were about to be proved correct. They really do deliver a serious taste of the flagship models, albeit with a twist all of their own. Cut from the same cloth they might not match the finest texture and shading of the more expensive models

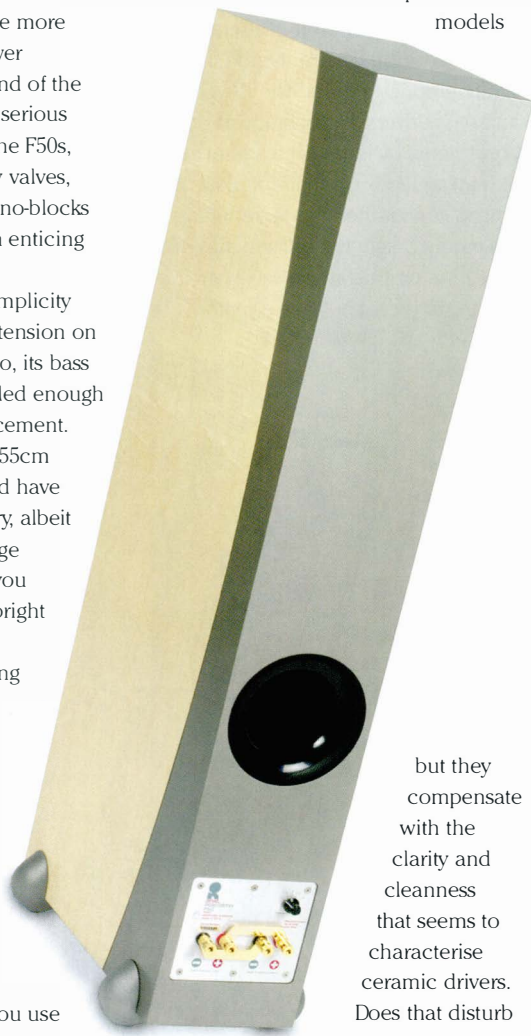

but they compensate with the clarity and cleanness that seems to characterise ceramic drivers. Does that disturb the overall

balance? As we shall see, Revel have been clever enough to mean the answer to that question is no.

The keys to this speaker are its bass performance and overall voicing. The low-end is extended and weighty enough to convince me that Revel (unlike some manufacturers) don't need to be creative with their quoted

specifications. But this is not the sort of bass that trundles across the floor towards you. This is clean, articulate, tuneful bass that delivers weight when and if it has to rather than by default. Just like the bigger Revel speakers, the F50 is devoid of the bloated spare tyre of mid-bass energy that still afflicts so many American speakers. The frequency range is a single, uninterrupted sweep from bottom to top. The linearity and precision of the bottom-end make upright bass a joy to listen to, with real notes and easily discerned pitch steps between them rather than the monotonous thrumming that passes for acceptable in all too many speaker systems.

The security and clarity of that bass is what underpins the expansive soundstage. This is the second area in which the F50 mimics its more expensive brethren. The stage is set-up behind and beyond the plane of the speakers. It brings a welcome mid-hall balance to the stereo perspective, yet the clarity of the presentation means that those who demand immediacy too (like yours truly) don't feel cheated. 'True Love Ways' from the MCA album *Buddy Holly Legend*, is a spectacular recording, capturing the acoustic space of the studio with breathtaking reality. The incidental sounds that precede the one take recording merely add to the effect. Play it on the F50s and the speakers disappear just as you'd expect. Buddy is placed a little further back than I'm used to, but he's within the acoustic with the rest of the players rather than pushed up front. But the real kicker is the acoustic space itself. From the first engineer's call you can hear the tape levels come up and the space fill out, an effect reinforced by the height and far left placement of the control room speaker that cues the track. I've heard all this before of course, but it's normally on speakers that trade bandwidth for speed. Okay, you can't hear Buddy's spit hitting the microphone (and sometimes I'd swear you could) ►



▶ but you get a scale, stability and coherence to the performance instead. Even the impossibly rounded and flubby bass on this early tube recording is cleaned up into some semblance of pitch and pace. The overall effect is looking in the window rather than being in the studio, but that's fine with me.

I guess what I'm getting at here is the speakers' ability to do two things at once.

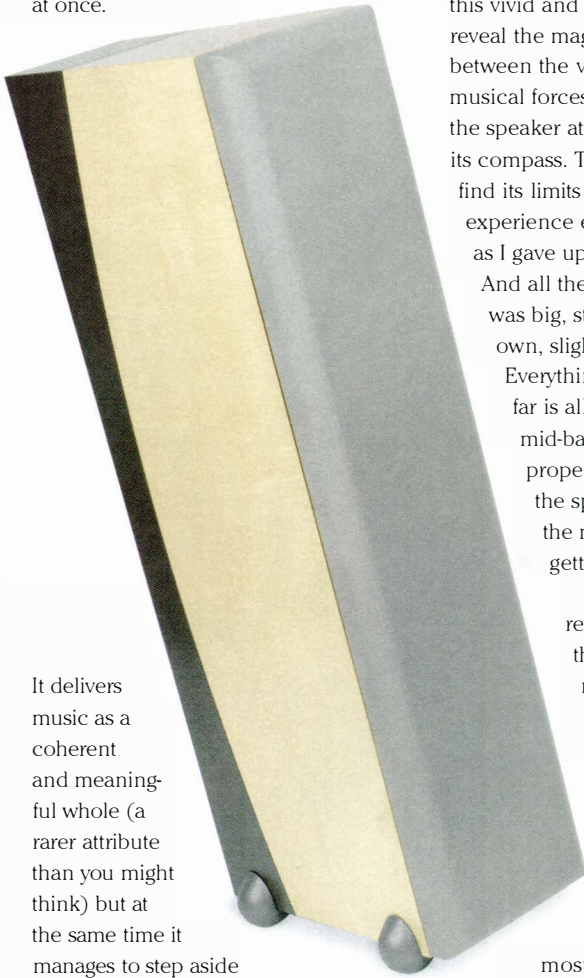

It delivers music as a coherent and meaningful whole (a rarer attribute than you might think) but at the same time it manages to step aside so that it doesn't intrude between you and the music. That above all is what it has in common with the likes of the Salon. It can't match the astonishing detail and texture that you get from the biggest speaker in the range, but the performance is scaled down so skillfully that I doubt you'll recognise the loss. The overall scale and sweep of the music remains intact and, more importantly, so

does its drama. Playing the Piatigorsky Dvorak *Cello Concerto* (RCA Living Stereo LSC-2490) in its original form, Classic Records 180g repressing and XRCD issues by way of getting a handle on the performance of the monster Blue Pearl turntable (an audio extravagance you WILL be hearing more about) the F50s were easily able both to scale the dynamic heights of this vivid and dramatic recording, and reveal the magnitude of the differences between the various versions. The huge musical forces on offer failed to faze the speaker at all, proving well within its compass. The concerted efforts to find its limits that resulted from the experience ended in abject failure as I gave up before the speaker did. And all the while, Gregor's Cello was big, stable and vibrant, its own, slightly over-voiced self. Everything that I've described so far is all about presenting that mid-band cocooned in its proper environment. That's why the speaker communicates the musical whole without getting in the way.

But the other thing that really impressed me from the foray into high-level replay was the absence of compression. This, combined with the clarity of the ceramic drivers is what makes the speaker so impervious to level. You don't hear it protesting the way most speakers do, meaning that you don't miss the sheer substance and colour that you get with its bigger brothers. Again, that grace under power is a familiar trait in Revel speakers, it's just that this time round it has been achieved in a rather different way, a classic example of cost engineering the performance of your product.

The F50 represents both a

significant technological achievement and a musical bargain. Combining a natural, unforced mid-band presented as an integral part of a coherent musical whole, underpinned by authoritative and informative bass and extending into an unobtrusive and beautifully integrated treble, it delivers a huge slice of music from a package that's financially and practically approachable. Feed it properly (it'd be a shame to forego the dynamic envelope on offer) and it'll reward you with an evenhanded delivery of whatever you choose to throw at it. Bandwidth, dynamics, scale and musical coherence: definitely a chip off the old block. ▶+

#### TECHNICAL SPECIFICATIONS

Type:	Three-way floorstanding speaker
Drivers:	25mm pure titanium dome tweeter 130mm composite ceramic mid-range 3x 165mm composite ceramic bass
Bass Loading:	Rear reflex port
Bandwidth:	33Hz - 19kHz ±1dB
Efficiency:	88dB
Impedance:	5 Ohms nominal 3.2 Ohms minimum
Dimensions (WxHxD):	294x1146x432mm
Weight:	45.4kg ea.
Finishes:	Cherry, Rose, Sycamore or Black Ash
Price:	£6495

#### UK Distributor:

Path Premier  
Tel. (44)(0)1844 219000  
Email. premier@path.co.uk

#### Manufacturer:

Revel  
Net. www.revelspeakers.com





Beryllium

M



# JMLabs Micro Utopia Be Loudspeaker

by Chris Thomas

For me, JMLabs loudspeakers have always been balanced rather conservatively. Despite the fact that they manufacture the esteemed Focal inverted dome tweeter and use it throughout the range I have never thought that they extracted quite the performance from it that Wilson have managed with the Watt/Puppy in all its various and more recent incarnations. When I reviewed the Mini Utopias a few years back my only real criticism was that JM hadn't been adventurous enough with the tweeter, opting for smoothness and a glossy subtlety at the expense of extension, impact, air and presence. Time spent with the Mezzo Utopia confirmed that this was indeed a large part of the JMLabs sound. Well, I believe that they must have thought so too as the roots of the new Beryllium tweeter models lie in their desire to extend the edges of the tweeter's performance forever upward and a fair way downward too.

Their flagship model, the truly enormous Grande Utopia, was to be the test bed for their experimentation and they attempted to incorporate a super tweeter into the already complex mix. But this was soon abandoned when they encountered all sorts of phase distortion and coherence issues even when mounting the new unit as close as possible to the existing drivers. What they wanted was a tweeter that was capable of a bandwidth of 2KHz to 40KHz (that's about five octaves) with a ruler flat frequency response across the range. Twenty years experience of designing and building some of the worlds great tweeters had bought them to the conclusion that the ideal material for such a design would be Beryllium. It's not hard to see why either. It is used largely in the aerospace field and even then, mainly as an alloy. But what a

substance for a tweeter dome, having three times the rigidity of Titanium and five times that of Aluminium plus its density is far, far lower than either of those materials. The problem was that Beryllium foil, hardly the most readily available substance anyway, was only to be found in a thickness of 45 microns and this would leave a dome weighing too much to be of any practical use. But when you have the resources of a company like JMLabs



you are not going to let a little thing like that stand in your way so they embarked on a two year program to source pure Beryllium foil to a thickness of just 25 microns.

But, rather than just bolt this new driver into their existing models, they decide to rationalise the entire Utopia range as complete redesigns with new drivers, cabinets and crossovers. What this means is that none of the older range can be updated with new components. You cannot, for instance, take a standard Micro Utopia and fit it with the new tweeter or the latest version of their 6.5 inch mid/bass driver, because that too is new and is designed

specifically to work with the Beryllium tweeter. The classic W-type mid/bass driver uses JM's power flower multi-magnet array and is formed from a laminate of structural foam, again from the aerospace industry, and a treated fibrous glass. Both the laminate composition and the thickness of these layers varies between models giving JMLabs the ability to precisely tailor the mechanical impedance of each unit to its specific application and model.

The tweeter still sits in its own box and is separated from the bass/mid box by a small gap that is used as a slot port.

I was slightly concerned that any turbulence around the hard edges of the port might have a detrimental effect on the tweeter's performance so close is it to the inverted dome but in practice these proved to be unfounded. There is a new crossover too, simpler than before, but the custom WBT connectors, though of a modified design, still offer only one set of terminals although bi-wired leads can be easily accommodated through a side hole in the post, which allows each conductor to be individually locked. It is excellent. In fact the whole cabinet is quite superbly made and finished. If you could remove the sleek side panels (which were beautifully finished in a classy burr ash on the review pair, known as Avant Garde in Utopia speak) you would find two individual boxes painted in high-gloss dark grey and arranged in a time aligned array with much edge-faceting and subtle treatment of gentle curves to avoid any early baffle reflections.

One great improvement over the old Mini Utopia is the stand that can be supplied with the Micro. The Single column supports that JMLabs used to supply looked rather chic in their gloss black finish but were horribly flimsy, ▶

▶ being built around steel tie rods and an insubstantial shell. I discarded them very early in that review if memory serves. But the new ones are superb. The central column is now aluminum, which is partially filled with sand, or similar damping material while the base and top are finished in speaker-matching lacquer. The important stand/floor interface can be either spikes, essential on a carpeted floor, or a compliant rubber foot, which can be used on a hard surface. For those with the latter I wouldn't jump to any conclusions about which is the best until you have tried both. I have a sneaking preference for the rubber feet. There are also no spikes between the speaker and the stand. Instead, four half-domed soft, rubbery dimples do the job.

There are a couple of rules with regard to placement. The first is that they need as much air around them as you can manage. This is going to vary enormously, depending on the listening room size and layout. The second is that, if at all possible, you sit without a wall immediately behind your head. The fact is that the Micro Utopia generates sound in such an energetic and vibrant way that it is very easy, with a wall straight behind, to find yourself sitting in that compressive area that tends to render the sound flat and two dimensional. The Micro seems more susceptible to this effect than any small speaker I can recall. With regard to toe-in, you have quite a choice. The dispersion of this tweeter is so broad and expansive that you can rotate them through a wider arc than normal without losing that incredible extension. What you will notice though is that the sense and point of focus will change. If you are looking for ultimate depth then have the tweeter firing either side of your head. Turn them in slightly so the tweeters are pointing straight at you and the band take a few steps forward. I quite enjoy

listening to them slightly off axis, which produces some really incredibly tangible 3-D views of individual instruments and their precise location in the mix.

With a nominal impedance of 8 ohms and a sensitivity of 89 dB you can get a pretty decent sound out of the Micro-Utopia with any number of quality amplifiers. But, rather than see what is the



least amplifier you can get away with, this JMLabs really needs to be driven by the best amplifiers out there. If you are thinking that this is a small speaker for a small room that will be fine in a system comprising a £1K CD player and a £1.5K integrated – forget it. It just aint gonna to happen. This speaker is good enough to be used with the best. Indeed its tweeter alone, which handles everything between 2.5kHz to 40kHz, has so much potential that it positively demands that

the whole system, including cables and supports, be of superlative quality. I tried every amplifier I had with these speakers and then I borrowed a couple. The list is long and the results were wildly variable. But for the purposes of this review and as an indicator of the Micro's pure potential I got the best results with my Tom Evans Vibe/Pulse line stage driving the remarkable Hovland RADIA (what a truly great amp!). The source was the Naim CDS 3 while the cabling was Nordost Valhalla throughout. The Micro Utopias really do require this level of equipment to keep them sitting at the top of their performance curve. This was the set-up I ended up with so all my listening observations should be read with this in mind.

These results will not be attainable with lesser equipment though the Micro will always show you just how good the rest of your system actually is.

The first thing that really grabs you is certainly the performance of the tweeter. The integration between it and the bass/mid driver is fantastic. Seamless and beautifully balanced tonally, the openness of the sound is a revelation.

Gone is the slightly burnished ultra high-end of previous inverted dome Focal tweeters, as fitted in their own speakers. This tweeter lifts the high frequency performance to a completely new level and when driven correctly it never, ever grows mean, pinched, compressed or brittle. It has also seemed to give JMLabs the opportunity and confidence to voice the speaker more realistically, so the rolled-off play-safe top end has gone. But the area it brings into sharpest relief is the upper midband. It illuminates this part of the sound not only by making it brighter tonally but also by shining a very bright light into the music, allowing you to literally see the frequency ▶



▶ structure of each instrument. It reminds you that even upright basses produce an enormous amount of high frequency energy, though you would never know it from some of the speaker systems around. It lets you understand and appreciate individual instruments better than any small speaker I know of by opening up the higher reaches of their natural range. Add to this the Micro's uncanny speed of response and ability to resolve ultra-fine detail and subtle expression throughout its bandwidth and you begin to see what a



seriously good loud-speaker this is. I may have been expecting a few more Hertz in the bass department but I wouldn't trade it for the sense of rhythm, control and sheer low frequency extension, tonal colour and pitch coherence. Its useable bandwidth fits the Micro perfectly.

Small speakers should always produce interesting and precise soundstages. The Micro does things somewhat differently. It does not have that impressively spacious presentation that makes the Sonus Faber Cremona Auditor so engaging. Like the Hovland amplifier, which sounds to me like its natural musical partner, it is more

compact width-wise though enormously deep. When you listen to stringed instruments for instance you are really aware of the physical depth of the sound. You hear the body and the strings and are drawn to the sheer beauty of their tone. Sustain and note decay seems to go on forever. Pianos fall into scale easily. The initial impact of hammer upon string pushes the note or chord into the room before the instrument's body takes over and the whole colourful harmonic signature hovers around it like a halo. And it is the same with the human voice. Vocally and instrumentally the Micro

Utopia always leaves music sounding drier than you remember. The JMLabs and the Hovland share these attributes along with their tight, focussed view of the world and the combination puts you in touch with the sheer physicality of music creation as well as any small speaker I have ever heard.

Rhythmically they are a tour de force and are able to unravel interwoven complexities with contemptible ease. I would often challenge the system by playing something like *Remember Shakti-The Believer* by John McLaughlin (Verve 549 207-2), an album riddled with polyrhythmic conundrums, which most systems never resolve or even get near to doing so. I cannot tell you how many times I have heard this music sound breathless, shallow, hurried and uncomfortable. Not here though as, time and time again the absolutely natural and unforced sense of grip and rhythmic movement and fluidity brought a smile as the system found the solution well within its grasp without a stutter or slip. It simply never drops a stitch.

I could go on and on about this speaker but you probably get the idea that I like it a lot. The tweeter must be amongst the very best high frequency units available today. It seems to combine all the great attributes of the

ribbon and the electrostatic with a whiff of the soft dome tweeter thrown in. But it's the overall integration into such a complete and practical package that JMLabs should be congratulated for. But please, please bear in mind that it demands accompanying equipment of the very highest quality. Anything less and you could well be disappointed and left wondering what all the fuss is about. It is not cheap, but when you look at the build quality and finish and bear in mind that you are very unlikely to see this tweeter in anything else but a JMLabs speaker for the foreseeable future, I think that the cost is wholly justifiable. I want a pair. ➤

#### TECHNICAL SPECIFICATIONS

Type:	2 way, reflex ported.
Mid/Bass driver:	6.5 inch W-type cone with power flower magnet ring
Tweeter:	Pure Beryllium inverted dome.3/4 inch. Focus ring Magnet system.
Bandwidth +/- 3dB:	50Hz-40kHz on axis
Efficiency:	89db
Internal wiring:	High purity silver plated copper
MaxPower:	100 watts
Dimensions (WxHxD):	250x425x380 mm
Weight:	17.5 kg ea.
Finishes available:	Burr Ash (Classic), Burgundy Burr Ash (Signature) Natural Burr Ash – as review pair (Avant Garde)
Price	£3600- speakers £800 – stands

#### UK Importer:

Focal-JMLab UK Ltd  
Tel. (44)(0)121 616 5126  
E-Mail. info@focal-jmlab.co.uk

#### Manufacturer:

Focal -JMLab  
Tel. (33)(0)4 77 43 57 00  
Web. www.focal-jmlab.fr

# definitive audio



## *Listen up...*

It's time to graduate, both from the high street and from conventional hi-fi. We offer a far more sensitive and sophisticated way of choosing a beautiful sound for your home. Our approach is specialised and focused, as is our product range. We have been importing, exporting, designing and manufacturing high-end, 2 channel audio for over 15 years. Our premises are located near Junction 25 of the M1 motorway in the UK where we work by appointment. If you want to move your listening experience up several gears - call us for a chat.

## LIVING VOICE



### Auditorium Avatar

Hi-Fi Plus *Editor's Choice*  
Hi-Fi Plus *Product of the Year*  
Hi-Fi Choice *Editor's Choice*

*"The Avatar is a near perfect balance of size, bandwidth, efficiency and tonal refinement. Its slim lines and small footprint deliver a genuine 94db sensitivity, and excel when it comes to delivering the scale, vibrance and colour of the music. Its unobtrusive quality allows it to cut straight to the heart of a performance, unlocking the music trapped in the recording, whilst its refinement makes it equally at home with both basic and surprisingly expensive amplification."*

Roy Gregory

Tel 0115 973 3222 Fax 0115 973 3666  
internet: [www.definitiveaudio.co.uk](http://www.definitiveaudio.co.uk) email: [shout@definitiveaudio.co.uk](mailto:shout@definitiveaudio.co.uk)  
Living Voice · Vitavox · Electrofluidics · Art Audio · Border Patrol  
Canary · DNM · Sugden · Wavac · Lyra · Monarchy · Western Electric  
Wadia · Michell · Stax · Tom Evans · Nottingham Analogue · EMT  
Kuzma · Resolution · Benz Micro · Tri-planar · SME · Van den Hul

## Doug Brady Hi-Fi

9" wide and less than 36" high, the new Wilson Benesch Curve is the most accurate speaker the company has produced.

Advanced composite structures and steel are used, with the option of the finest wood veneers. Separate 'Tactic' drivers for Bass and Mid/Bass with silk tweeter.

We also stock ProAc, Castle, Monitor Audio, AVI, Cabasse, Quad, Naim, Musical Fidelity, Chord Electronics, Rotel, Arcam, NAD, Nordost, TAG McLaren, Michell and AVID turntables, SME & Rega arms.

Demonstrations by appointment plus home trials. 0% Credit available.

Kingsway Studios, Kingsway North, Warrington. WA1 3NU.

Tel: 01925 828 009 Fax: 01925 825 773

Email: [doug.brady@dougbradyhifi.com](mailto:doug.brady@dougbradyhifi.com) Website: [dougbradyhifi.com](http://dougbradyhifi.com)





# FIRST CHOICE

The **NEW** addition of hiforsale.com Ltd's accessories catalogue is out now. Featuring an ever expanding range of class leading Hi-Fi and AV accessories from around the world. This years catalogue covers all major aspects of obtaining the best from your audio system without spending huge sums of money.

At over 90 full colour pages this is your **FREE** definitive guide.

Give us a call and reserve your copy now!

**0870 241 246 9**

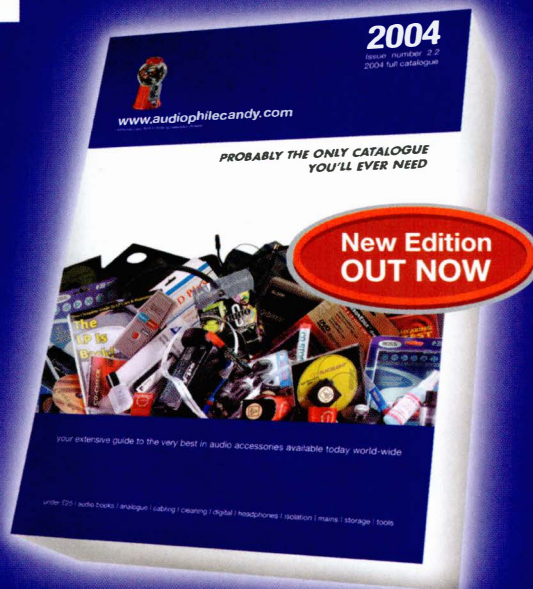

"...the Ultimatum is an exceptional achievement in every respect."

Hi Fi Choice



*Ultimatum*

by neat acoustics

+44 (0)1833 631021 [www.neat.co.uk](http://www.neat.co.uk)







# Audiopax Model 88 Mono-block Power Amps

by Roy Gregory

The more you have to do with hi-fi, the more you come to realise that there really is nothing new under the sun. It's true of hi-fi in general and it's especially true of anything involving valves. If it's hot and it glows then the chances are that either it or its constituent parts will have surfaced somewhere, doing something, at some stage before. Of course, that doesn't stop manufacturers claiming originality for their designs and even revolutionary status for their products. It's one of the reasons that I have so much respect for the understated, evolutionary approach taken by Conrad-Johnson. Besides, you would have thought that by the time somebody has opted for (or is at least considering) tube technology, they'd be well past the first flush of the new. Shouldn't reverse snobbery apply? Surely it becomes a case of the older the better. Oh, silly me, I forgot all about direct heated triodes, arguably the biggest audio marketing scam since pure, perfect sound forever.

Which makes the arrival of a valve amplifier that, even if it isn't different in a topological sense, employs that topology in what is as far as I can discern, an entirely novel manner, unusual to say the least. Even more surprising is the fact that the topology delivers readily audible and extremely significant musical benefits – something I can say with some certainty because you can actually listen to the effect of adjusting it. And where does this most unusual of beasts hail from? Why, that hotbed

of thermionic fervor, Brazil. Not exactly the first place that springs to mind, but then, the Audiopax Model 88 mono-blocks are hardly ordinary amps.

Internally the Model 88 is as unconventional as its appearance suggests. The lacquered wood side panels and base provide visual relief, while the elevated chassis that contains the active circuitry delivers a steady convection current of cooling air from the slots in its bottom to their opposite numbers in the top. Isolating these from the variable interference of things like carpets helps guarantee good thermal stability which should help long term reliability. The valves are located fore and aft in the top of the chassis, with some protection provided by the rails/handles on either side. There were no grilles or covers supplied with the review pair and nothing to indicate their availability. Connections are limited to the bare minimum: a circuit breaker to govern mains power, a single phono input and a similarly solitary set of 4mm binding posts. There is no provision for matching the output impedance of the amplifier to the load it's driving, the designer having settled on a sensible 3.5 Ohm fixed value. One practical consideration is that the binding posts have no lateral hole to accept an additional 4mm plug or bare wire, so cables terminated in a single pair of connectors, spades for preference, will make your life a lot easier.

Inside each elevated amplifier

chassis you'll find a pair of single-end amplifiers, running an ECC81 driver and an ultra-linear coupled KT88 output tube, each with its own output transformer. These are connected in series to form a single amplification channel delivering 30 watts, an unusual arrangement to say the least. The amplifiers are global feedback free and have sophisticated, choke regulated power supplies, including an HT delay on switch-on. There's an independent mains transformer for the valve filaments, and the board that supports the hardwired signal path is compliantly mounted.

The really interesting bit emerges when we get to the biasing arrangement. Outwardly at least, this is a fixed bias amp, meaning of course that it's adjustable. The bias for each output tube is adjusted by an individual rotary control on the top, front edge of the chassis: Each control is surrounded by a circle of ten red LEDs and a toggle switch. This control sweeps 180 degrees in either direction from top dead centre. Flick the toggle switch and the ring of LEDs tells you where you've set it. Easy enough so far I think you'll agree. But whereas most fixed bias amps are set to a pre-determined voltage, normally indicated when an LED goes out, the bias for the Audiopax amps is set by ear. Look inside and you discover that in fact there is a standing bias voltage applied by a conventional cathode bias arrangement, the variable element supplying the icing on top. This is very sensible as it prevents

▶ the valves being run wildly outside their operating parameters. More importantly, the designer expects you to set the bias for the two halves of each amplifier differently, as well as for each channel. It's this differential bias arrangement that is unique in my experience. How do you tell when it's correct? Despite the fact that the two amplifiers that comprise each channel are identical, and that the control range also appears identical, the left-hand control is said to effect "bass articulation and attack" while the

results I can understand why.

Now, I've spoken with CB at some length about this, but neither of us can suggest why the difference in bias voltage should effect the sound of the amplifier in the way that it so demonstrably does. Yet, play with the Model 88's controls for a while and you'll soon get a feel for what's happening. Which is of course, a long way from a complete grasp of

Indeed, such a person is essential to their proper demonstration. And while we're on that subject there are a couple of other pointers too. Like most single-ended amps power supply quality is especially critical. Don't skimp on power leads, and don't skimp on supports either. I fed the Model 88s from the Groove and Vibe with which they were perfectly happy.

As suggested by the importer, the Hovland HP100 was less successful. But that's the way it goes, so you'll need to check prospective partners in situ.

How do the Timbre Lock adjustments fit into the sound of the amps as a whole?

Well, clearly that depends on how adept

you are with the controls, their effect being by their nature both sonically and musically variable. However, as the controls tend to operate top and bottom, let's start in the middle.

Mid-band on the Audiopax amps is pure vanilla: clean, clear and open, yet with the lush, rich quality that could be described as classic valve sound. There's a beguiling warmth and intimacy to their performance that comes from the best, small, tube designs. It's rich and slightly rounded, devoid of the stark edge and unnatural hardness that so often mars more sharply etched amplifiers. Imaging is natural spacious as opposed to hi-fi precise. There's nothing forced or obvious about the sound.

So far so good: There are plenty of small, normally triode amplifiers that can make the same claims. What elevates the Model 88s above that all too ordinary norm are the small matters of musical coherence and integrity. It's precisely these qualities that so



right-hand one influences "overall smoothness and tone". You adjust the two knobs for preferred sound, then flick the switch to check the settings. Don't adjust the knobs with the LEDs lit or damage might occur. Generally speaking, settings within three LEDs of each other are to be expected, but they will also generally be different to each other. Audiopax refer to the system as Timbre Lock and having heard the

the process. The review pair were delivered and set-up by the distributor, who flew from Scotland to do it. I'm glad he did, because I wouldn't have wanted to start out from scratch on my own. In my youth, I worked for a company that sold office furniture, including a rather fine self-adjusting chair. The problem with user adjustable seats, we'd tell customers, is that while they can achieve a single, perfect position, there are also an infinite number of incorrect positions for each individual. The same thing applies to the Audiopax amp, which needs to be optimised for each individual system and room. If I were buying a pair of these amps I'd want someone seriously experienced to show me the ropes.



▶ many SETs lack, and which, once you get it right, the Audiopax amps deliver in spades. Yet the basic mid-band performance is so similar: what is it that makes one amp work where the others fail? In short, it's a question of how that mid-band dovetails with what's on either side of it. Which is of course, exactly where the Timbre Lock controls come in.

The critical element in reproducing recorded music is not actually the information per se, but much more importantly, arranging it in the right time and place. Music is a pattern and if you get some of the parts in the wrong place then the pattern changes. It no longer takes the same shape or makes the same sense. Now, if we consider the effect of the left-

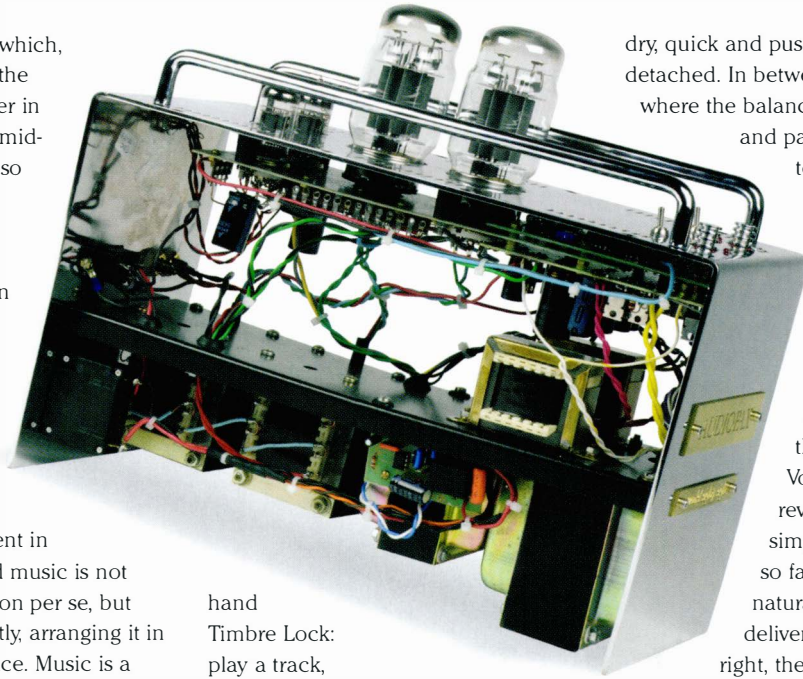

hand Timbre Lock: play a track, adjust the left and right channel controls and see what happens. Turn them anti-clockwise and the bass becomes turgid, slow and detached. Turn them clockwise and it becomes,

dry, quick and pushy – and just as detached. In between you'll hit a point where the balance between weight and pace levels out and the tempo locks to the mid-range. It's not so much the nature of the bass itself but the way it integrates with the mid: There's the pace and timing but also the dimensionality. Voice is a particularly revealing indicator, simply because we are so familiar with the natural weight and delivery. When you get it right, the voice should have solidity and presence: Not too much mouth; not too much thickness and chest.

Likewise the right-hand controls: These effect the air, space and ▶

## Something different... Inside the Audiopax Model 88

by Chris Binns

In terms of valve amplification it seems as if we have used triodes, pentodes et al in every conceivable way possible...single ended push pull, upside down – you name it, someone has done it somewhere. The Audiopax amplifier is genuinely different. Each chassis consists of two complete single ended amplifiers connected together. Not, as you might think bridged, and while the input signal is common to both, in this instance the secondaries of the transformers are connected in series. To understand this further I spoke to designer Eduardo de Lima, and discovered that the Audiopax amplifier is the result of a lot of in depth research into single ended amplification, and in particular distortion related to the loudspeaker load. After a lot of listening, he felt that the SE approach exhibited the most lifelike representation of instruments and voices, and quickly realised that one of the biggest problems

was that the breed showed little immunity to the loudspeaker load; in other words the amplifier performance changed dramatically depending on what it was driving.

To this end he set about analysing in some detail the relationship between the SE amplifier and loudspeaker, in an attempt to control or minimise the effect. For those interested, I urge you to visit the website <http://usuarios.uninet.com.br/~edelima/> where you can read some of his articles that have appeared in publications such as Glass Audio. While Eduardo was understandably a little reticent to give too much away, I did manage to glean a certain amount about the circuit design of the Audiopax. The two controls on the amplifier adjust the bias voltage of each output valve (within safe limits), which subtly alters the distortion characteristics. An effect that would be of little or no consequence conventionally – but with the two amplifiers together yields some interesting results. Particularly as the amplifiers are not quite identical, and variation of these controls provides considerable adjustment in the way the circuit

behaves with different loudspeakers; by altering the spectrum of distortion under dynamic conditions relative to output impedance, considerable differences can be heard.

Another factor that was found to have a large influence on sound quality was the coupling between output transformer and power valve. While the design uses no overall feedback, incorporating the cathode of the KT88 into the transformer windings along with the anode and the screen grid 'encapsulates' the output stage in a carefully considered negative feedback loop.

Although this has been used in push pull designs (the McIntosh amplifiers spring to mind) it has rarely been seen within SE circuitry. Quite small differences in ratios were found to have a dramatic effect on performance, and I suspect this might form part of the fine tuning of the two amplifiers. Certainly, the Audiopax amps ameliorate many of the deficiencies that normally mar single-ended amplifiers..

▶ transparency. As you rotate them clockwise the amount of air and space enclosed by the acoustic increases, as does the space between instruments within it. But go too far and the sound again becomes thin and insubstantial, the images two-dimensional.

So, as you can see, the precise setting of the Timbre Lock is critical to the presentation and musical integrity of the Audiopax amps. It's no mere gimmick or piece of marketing hype. I used the Model 88s with the Living Voice OBX-Rs and found an ideal setting for those speakers in my room. Change the speakers or change the room and you'll need to change the settings. Which is the whole point. The Timbre Lock circuitry should enable the Audiopax amps to adapt to a whole range of different circumstances and systems, meaning you'll get more performance out of them more often. Changing speakers to the Reference 3A Da Capo certainly underlined the point, completely different settings being required.

As to the sound itself, using the Timbre Lock meant that to an extent I could tailor it to my personal tastes. The result was a nice, open mid-band with good separation, underpinned by a bass that, if it wasn't the tightest at least had good weight, centered in the right place. The ability to tailor that energy spectrum was crucial to the sense of musical enjoyment and involvement. Get it even slightly wrong and the impression of great musicians having a great time simply evaporates. Play Jackie Leven's *Defending Ancient Springs* and you'd hardly describe it as rollicking good fun, but there's no missing the quality of the musicians, the cleverness of the arrangements. Just take the disjointed

rhythms that underpin the opening track 'You've Lost That Loving Feeling', the vocal arrangements that rip the track right down to basics before building it right back up. The Model 88s never put a foot wrong. No matter how deconstructed proceedings get, everything stays locked,

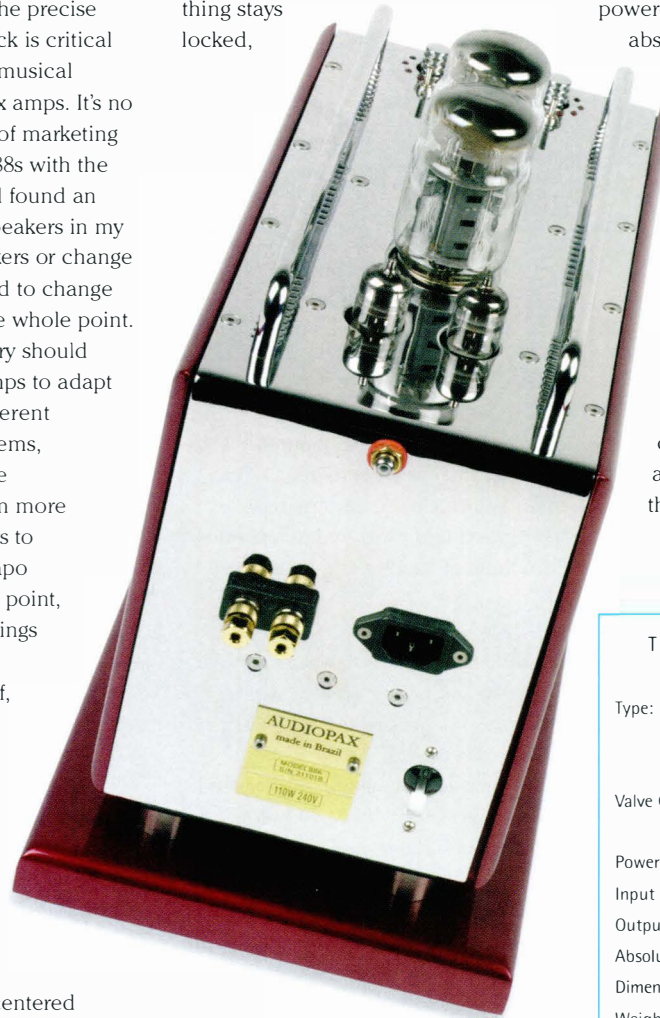

perfectly in place. Musically it's a technically demanding tour de force, and the fact that the amps reveal that so clearly and with so little apparent effort is testament to their musical integrity.

In many respects, the Audiopax amps perfectly match my musical preferences and demands. As a long time Jadis JA30 user, it's impossible to ignore the fact that the Model 88s so

readily embrace the same musical strengths (and vices). There again, the very nature of the beast is its adaptability. Just how easily they might embrace your personal desires only trial can tell. Consider them as possessing the virtues of a low-powered, single-ended triode, yet

absent the limitations at frequency extremes and incorporating a dial-a-focus facility and you're beginning to get the picture. They drive better than an SET too. I'd treat anything over 91dB as fair game, which gives you a pretty wide range of partnering speakers. If that appeals then check them out. These beautifully presented little amps certainly walk the walk and with the appropriate care they talk the talk. Audiopax and Timbre Lock get a big thumbs up from me. ➤+

#### TECHNICAL SPECIFICATIONS

Type:	Dual single-ended ultra linear mono-block valve amplifiers
Valve Complement:	2x ECC81 and 2x KT88 /Ch.
Power Output:	30 Watts into 8 Ohms
Input Impedance:	<82 Kohms
Output Impedance:	3.5 Ohms
Absolute Phase:	Inverting
Dimensions (WxHxD):	9x13.5x14.5
Weight:	19 Kg ea
Price:	From £7999 pr.

#### UK Distributor:

Precious Music Distribution  
Tel. 0141 332 5205  
Email. info@precision-music.co.uk

#### Manufacturer:

Audiopax  
Net. www.audiopax.com



## NOW YOU CAN MASSIVELY UPGRADE YOUR DECK



"It's value is nothing short of tremendous!"  
Listener Magazine on Advanced DC Motor Kit

Whatever your current turntable, the results of upgrading to our DC motor & PS unit are simply astounding. Designed as a drop in replacement for almost all turntables, the Origin Live upgrade kit offers vast improvements to all versions of Linn, as well as: Rega, Systemdeck, Roksan, Rock, Oracle, Michelle, VPI, Clearaudio, Accoustic Signature, etc.

The kit consists of a high grade DC motor, aluminium electronic control box and offboard power supply. All this provides an extremely cost effective route to truly high-end audio and is significantly superior in performance to PS upgrades at three times the price.

"The single most important upgrade you can ever make to any record deck concerns the motor drive...nothing can prepare you for the shock of going DC. In a word, gobsmacking."  
**Common Ground Magazine**

"...if you are thinking of upgrading your system...the OL DC Motor Kit should be high on your list for consideration."  
**TNT Audio**

Advanced DC Motor Kit - £339.00  
Ultra DC Motor Kit - 570.00  
Upgrade Transformer (optional) - £175

## HAVE YOU EVER WISHED YOUR RECORDS GAVE YOU MORE?

**Well now they can!** Why not transform the performance of your vinyl replay with a new generation, groundbreaking tonearm from Origin Live. If you currently own an expensive super-arm it will shock and delight you to discover how much more performance is available from a better arm. We urge you not to miss out and to arrange an audition now. The "Silver" arm at £599 is well attested to outperform the best of super arms at a fraction of the cost. As you move through the range the performance gets better and better - the performance of the Illustrious Signature is simply awesome.

"...the highest of recommendations for the Encounter tonearm: a new benchmark for musical communication, natural detail and timbral truth." **Stereo Times 2003**

"...the best tonearm I've heard..."

Hi-Fi World 2003 on the Illustrious

OL1 Fully Modified - £359.00  
Silver Tonearm - £599.00  
Encounter Tonearm - £970.00  
Illustrious Tonearm - £1570.00  
Signature Tonearm - £2500



[www.originlive.com](http://www.originlive.com)

Origin Live, Unit 5, 362b Spring Road, Sholing, Southampton, SO19 2PB tel/fax: +44 (0) 2380 578877

MM AND MC

SELECTABLE GAIN

SELECTABLE LOADING

INDEPENDENT SUPPLY

**TRICHORD RESEARCH**

Granville, Blackmore End  
Hanley Swan, Worcestershire WR8 0EE

Tel/Fax: +44 (0)1684 311600  
[www.trichordresearch.com](http://www.trichordresearch.com)

**Delphini Mk2**  
HIGH PERFORMANCE PHONO AMPLIFIER

NOW AVAILABLE WITH THE REVOLUTIONARY  
'NEVER-CONNECTED™' NOISE REDUCING  
POWER SUPPLY TECHNOLOGY

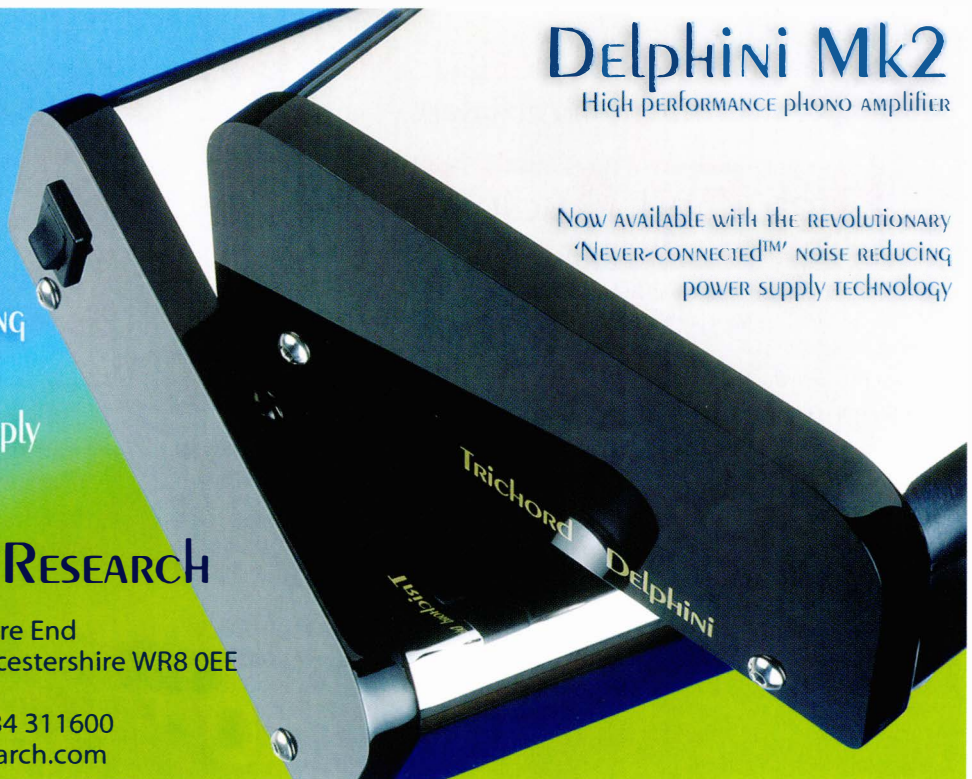

If you want only one.....

*Final*

[www.finallab.com](http://www.finallab.com)

[mail@finallab.com](mailto:mail@finallab.com)

FINAL LABORATORY tel / fax : +81 (0)564 63 3279 ● JAPAN



## High End Audio Roadshow

Enjoy convincing musical re-performances in comfortable hotel conference rooms.

Learn how to maximise your enjoyment of recorded music.

Meet our best retailers and consider a home visit.

Go home relaxed and refreshed.

Euphya

Reference Audio

L A M M

METRONOME  
TECHNOLOGIE

Renaissance  
Amplification



Free admission to all music-lovers 11am to 5pm. For full information please contact:  
Integrated Engineering Solutions Ltd - 023 8090 5020 audio solutions - 07787 543031

Reference Audio - 01474 854208 Hazlemere Audio - 01494 865829

[www.highendaudio.co.uk](http://www.highendaudio.co.uk)

### H E A R 2004

GLASGOW ?

BELFAST ?

SHEFFIELD ?

OXFORD ?

CARDIFF ?

BOURNEMOUTH ?

BUDLEIGH SALTERTON ?

To vote for a roadshow  
in your town,  
please telephone

**023 8090 5020**



# OverKill Audio presents the revolutionary...



## Spectron Digital Amplifier



"In broad strokes, this is simply one of the finest amplifiers I've yet heard. In many ways, in fact, it may be the best. It is so good, and in so many ways, that I have had to rethink all I once held true and sacred about amplifier design." - Greg Weaver, Stereo Times Dec 2002

## Stillpoints - Universal resonance damper

"The overall sonic effect of the Stillpoints is an obvious, and at times, stunning improvement in the tracking of the transient envelope of each note."

"The highest of recommendations for the Stillpoints: a terrific, extremely effective, easy to use and eminently affordable product." - Paul Szabadq, Stereo Times, Dec 2002



## Sound Application - Mains Power Conditioner

"Wow!! I have never heard any other AC product do what this does. Simply put, It is the best there is!" - Jeffrey Allen, Producer, CBS Studio Center

"The difference with the sound application MC-12S in the sound system is clearly one of the greatest improvements I have ever heard."

- Shawn Britton, Master Recording Engineer, Mobile Fidelity Sound Lab

## ERS Cloth - redirects, absorbs and diffuses EMI/RFI frequencies

"There was a noteworthy reduction in artificial brightness and hardness, along with a reduction of low-level background electronic "hash"."

- Paul Szabadq, Stereo Times, Dec 2002

Contact OverKill Audio - Tel: 01487 842911 - email: [info@overkillaudio.com](mailto:info@overkillaudio.com) - website: [www.overkillaudio.com](http://www.overkillaudio.com)

Great products, just rewards...

Distributed by:

**WOLLATON AUDIO**

Wollaton Audio, 134 Parkside, Wollaton, Nottingham NG8 2NP  
 Telephone: 0115 852 3858  
 Fax: 0115 852 3859 e-mail: [dianneallen@wollatonaudio.com](mailto:dianneallen@wollatonaudio.com)  
[www.wollatonaudio.com](http://www.wollatonaudio.com)

Monarchy Amps, Transports and DIPs • Klyne Pre-Amplifiers • Aliante Loudspeakers  
 Solidsteel Hi-Fi Furniture • Kochel Horn Loudspeakers • Wavac Amplifiers • XLO Cables & Interconnects

Check out the new Monarchy Upsampler on the Wollaton Audio website





ROGUE AUDIO



# The Rogue Audio Zeus power amplifier

by Chris Binns

Rogue Audio, both the manufacturer and their equipment, are no stranger to the pages of this magazine. In Issue 15, RG looked at the entry level 66/88 pre and power amp combination, and also interviewed two of the key personnel that go to make up the company. Previous to that, in issue 10 I had the pleasure of reviewing the fully fledged 99 pre-amp together with the M120 mono-blocks, and came to the conclusion that the system was excellent value for money. It was powerful enough to drive real world loudspeakers, put together in a way that inspired confidence for future reliability, and most of all, it encapsulated all the best bits of valve amplification without too many of the side effects.

In the interim, there have been rumours from across the water of a 250 Watt per channel amplifier, and knowing of my weakness for big valve amps, both the editor and Kevin Walker (who distributes Rogue in this country) have had a good time winding me up about it. It wasn't until the Novatel show this autumn that I actually caught sight of the mythical beast, and I then began to understand where a certain amount of their amusement stemmed from. The aptly named Zeus – was he not the ruler of the Gods in Greek mythology? – is truly enormous. Rather than doing the sensible thing and going down the mono block route (which is what I would have expected after the M120's) Rogue have chosen to build their flagship power amplifier as a stereo chassis, weighing in at a totally unmanageable 225 lbs. When I quizzed designer Mark O' Brien about this apparent insanity, I was told that the American market had a preference for stereo chassis designs, particularly when it came to AV systems; the less boxes the

better. I might have guessed. May I say at this point that my sense of humour remained intact until I had to move it, and I also have reason to suspect that RG now regrets living relatively close by – he was the poor soul who ended up with the burden.

But who needs 250 Watts per channel? If your predilection is for high efficiency loudspeakers, 250 Watts might seem like total overkill. But it only needs the sensitivity figure to drop by a few dB or so to start soaking up power, and that extra headroom becomes

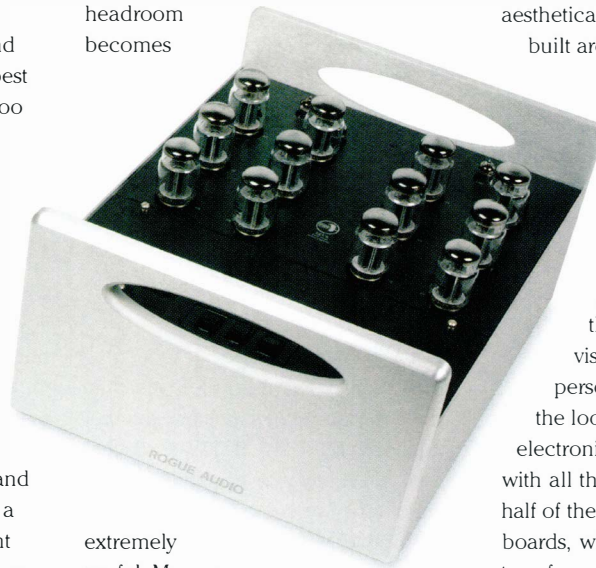

extremely useful. My own preference for smaller loudspeakers with reasonable bass extension means that efficiency tends to go out of the window, and the requirement of reasonable levels in a large room keeps my interest up in searching for really good sounding larger amplifiers; whether they are valve or solid state is to an extent immaterial.

OK, so half a kilowatt of audio power is never going to be particularly light in weight, with the possible exception of the switch mode power supply type finding increasing use

particularly with professional PA amplifiers, where the weight issue can be a big thing. Taking the thermionic route compounds the situation with the necessity for output transformers, which if they are any good have to be large, and in the case of the Zeus they are. This together with the generous power supplies (the amp is totally dual mono) and overkill construction goes a long way toward explaining the massive weight and proportions of this amplifier.

Despite its size, considerable effort has gone into making the Zeus aesthetically pleasing, with the chassis built around substantial front and

back aluminium panels with an oval cut out in them, these usefully serve as handles for manoeuvring purposes, which in case you haven't gathered, really is a two man job. I gather that the rest of the range will follow a similar visual identity, although personally I will be sorry to see the looks of the M120's change. The electronics are built around two layers, with all the valves occupying the top half of the chassis on two printed circuit boards, while the power supply and transformers sit beneath. Two fans draw air through the bottom of the unit which circulates up through the valves to maintain an even operating temperature. Connections on the rear allow for both balanced and unbalanced inputs selectable by a small toggle switch, the latter having the standard XLR socket or a 'floating RCA' type (labelled 'low Z'). Four and eight Ohm loudspeaker outputs are provided via separate sets of multi way binding posts, and mains connection is via a standard IEC socket.

There are three rocker switches that are accessible through the oval cut

▶ out on the front panel that control power on/off, standby and run, and ultra linear or triode operation. In standby mode voltages to the valves (including heater supply) are halved to reduce consumption, while allowing a fairly swift return to fully warmed up operation. The handbook does make a point of saying that the Zeus should not be left running when not in use: it draws sufficient power from the mains supply to make a bit of a dent in the electricity bill, while I would imagine the cost of replacing a dozen KT88's would make an owner more conscientious about wasting potential valve life. However, the valves are run to dissipate a fairly conservative twenty Watts or so under quiescent conditions (against a potential forty) promising a reasonable amount of hours before needing replacement, although this is dependant on how hard the amp is run.

Unlike its smaller brother, the output stage of the Zeus operates with what is termed 'fixed bias', whereby a negative voltage is applied to the control grid of the output valves to set their quiescent operating conditions, a bit like adjusting the idle of an engine on the carburettor. At the time of reviewing the M120's I was surprised that the designer opted for the alternative of cathode bias with an amplifier of that power, but due to the requirement of high dissipation resistors in line with the valves it is not really an option once you get into the realms of the kind of power that the Zeus is capable of. The big disadvantage of fixed bias is the need to measure and adjust the standing current through each valve, both periodically and when they are replaced. Mercifully, this is a straightforward operation, involving the removal of the top cover, flicking the switch for the appropriate valve and adjusting the associated trim pot until

the corresponding channel meter reads 40 milliamps. Not only is it easy to do (and thus encourage frequent checking) it also avoids rummaging around inside the amplifier amongst the potentially lethal 500 Volts or so.

Front-end circuitry is similar to that used in the M120's, consisting of a 12AX7 acting as a voltage amplifier and phase splitter, while two 12AU7's are configured as cathode followers to provide drive to the output stage,



which as I have already indicated consists of no less than six Electro Harmonix KT88's per channel to comfortably achieve 225 Watts. Each valve is individually fused so that in the event of a failure it doesn't take the whole amp down. It is worth mentioning that while there have been times in the past when I would have questioned the sanity of running an amplifier with 12 big output valves, both the quality and availability has never been better than it is at the present time.

I had on hand the Rogue 99 pre-amplifier to partner the Zeus with, while loudspeakers were the Primary monitors (which take some driving) and the Eben Acoustics X3, which offer a kind 8 Ohm load and are reviewed elsewhere in this issue.

First impressions are important. They can also be misleading, and I must

confess that I was not blown away with the first few tracks that I listened to with the Zeus. Far from being this monster with limitless dynamics and unbridled energy that I had come to expect, it sounded flat, and frankly rather tired, as if the fire within was just about to go out. I have become used to solid state amps taking considerable time to warm up, but most valve power amplifiers that I have used seem to come on song within half an hour or so. Not so with the Zeus. It needs an hour or more to 'wake up' after switch on, or this is how it seemed,

but then although I gathered it had seen plenty of use before I got hold of it, I think there well might have been some running in that needed to be done as well. At this stage, and given the above, all should have been sweetness and light, but I still wasn't convinced that I was getting

the full Monty from the Zeus – sure, it seemed as if there was plenty of power available, but it suffered from a rather stodgy, unwilling presentation that left me wanting for the more exuberant performance of the kind that I had experienced with the M120's

Discussions with both the importer and the manufacturer yielded a couple of suggestions. Using the RCA 'balanced' input (and thus incorporating the balancing transformer) changed the sound somewhat; but not really in the direction that I wanted. But increasing the bias of each valve to 50 milliamps seemed to me to make a dramatic difference. All aspects of performance seemed to jump up several notches, and crucially, there now seemed to be proper musical dynamics where that had been a distinct flatness before. Almost as striking was the substitution of a very average mains lead for a 'heavy duty' type – nothing fancy, just high current cable with sensible terminations, ▶



▶ and plugged directly into the wall rather than via the distribution block I use. I suppose its common sense really; the Zeus draws enough power for these factors to make a difference, and certainly it was more than apparent when it came to listening. The differences were particularly apparent with the Eben loudspeakers, whose speed and dynamics (apparent with other amplification) had up to now sounded as if it was being starved or held back by the Zeus, came very much to the fore.



Drums and percussion now had an impact that suggested that someone had been in the recording studio and switched all the compressors off. This was more like it. Using the four Ohm tap, the Zeus had enough juice to drive the Primary monitors to good levels, although if I'm honest I expected a little more. The bass end was tight, with a good sense of drive and rhythm, up to a certain level when it became obvious that the amp was losing control, admittedly it was pretty loud, and I was playing Nils Petter Molvar – *Khmer*, an ECM disc of uncomfortable electric jazz that has cone ruining bass content.

What came as a relief was that after my disappointing initial sessions, I was now getting a rather nice liquid mid-range performance, detailed but relaxing, the kind that people tend to associate with valve amplification. Woodwind, voices and orchestral strings

had a lovely substance to them which was full and rich, and at reasonable levels the bass kept up very nicely to give a solid and coherent performance. And the top end? Not quite as open as the midrange, but free of edginess, and good enough not to draw attention to itself. It was not, however, the last word in detail and resolution, and lacked a degree of openness and sparkle compared to some.

Switching the operating mode to triode proved interesting. I have severe doubts about being able to offer both triode and ultra-linear configuration without changing the output transformers, and I have yet to come across a design where it has proved to be anything more than a marketing gimmick, the M120's included.

However, the Zeus confounded me by offering an interesting alternative in triode mode. Although the bass lost some impact, and generally the sound became softer, it seemed to be more tuneful, and the mid and top imaging took on a characteristic 'vague' quality, but flowed in a more liquid and musical fashion. Despite the limited power output, I did spend several sessions listening in this mode.

Where the Zeus did excel was in its ability to cast an extremely stable sound stage. Again, not the last word in precision (something that good small amps seem to excel at) but expansive and deep, where instruments are portrayed in broad brush strokes rather than finely etched images. The net result is that although the Zeus sometimes lacks the ability to have you on the edge of your seat with the authority of its musical expression, it can provide drama, where necessary, by other means; namely a sheer unstoppable presence and scale that is never less than rewarding to listen to.

As the sometimes user of large

and obscure 250 Watt valve amplifiers, I guess that I had certain expectations that the Rogue should live up to. The fact that it took a bit of enticing to get these results should come as no surprise, while the end results were not quite what I expected. Despite its imposing name and general bulk it would be wrong to think of the Zeus as an unflappable powerhouse, think of it more along the lines of a valve amp with attitude. It may not possess the last word in dynamics and bass articulation, but it does have that liquid mid-range and should offer a welcome cure for solid state—it's. It is easy to use and mercifully free of the maintenance problems that afflict some powerful high-end valve equipment. Suddenly, that stereo chassis (and the reasoning behind it) doesn't seem so silly. ▶+

#### TECHNICAL SPECIFICATIONS

Type:	Stereo valve power amplifier
Inputs:	
Valve Complement:	1x 12AX7 2x 12AU7 12x Electro Harmonix KT88
Outputs:	
Output power:	225 Watts per channel (ultra-linear) 85 Watts per channel (triode)
Frequency response:	10Hz – 100Hz level unspecified
Input sensitivity:	1.0 V RMS
Dimensions (WxDxH):	19x24x12 W x D x H
Weight:	225 lbs / 101Kg
Price:	£5995

#### UK Distributor:

Audiocraft  
Tel. 01895 253340  
E-mail. kevinwalker@genie.co.uk

#### Manufacturer:

Rogue Audio Inc.  
Net. www.rogueaudio.com

KORATO

KVP 10

phono valve preamplifier

phono

CD

tuner

DVD

tape

KORATO

KVP 10

dual mono valve power supply



# Korato KVP10 Valve Pre and Renaissance Valve Mono-block Amplifiers

by Jason Kennedy

If you take a look at the Korato website you'll find, amongst other things, references to Yugoslavia rather than Serbia which local politics has elected the city of Belgrade to sit in since the turmoil of the early nineties. I find it encouraging that the citizens of this region still consider themselves to be in Yugoslavia, a once beautiful and prosperous country albeit one shackled by communism.

excessively expensive kit in the business. Clearly some Eastern Europeans are much more equal than others. This economic imbalance means that it's possible for Yugoslavians among others to build components that offer impressive material value.

gain moving-magnet stage that can cope with coils that produce a millivolt or more. Other internal components include a Noble stepped attenuator volume pot, Hovland polypropylene caps and 1% metal film resistors, the whole lot being hooked up with van den Hul CS-18/C5 cabling.

The power supply utilizes a pair of ECL 82 valves for high voltage regulation and separate toroidal mains transformers for each channel. Construction is to a high standard in both cases with good quality socketry and diamond-sawn plates fronting the wooden side cheeked, slimline cases.

The KVP10 is a feedback free design and this we are told explains why it has so much gain – they're not kidding – only with the least efficient speakers are you going to be able to turn the pot past nine o'clock, and then the power amps may not have the steam to sustain it given their 45 watt rating. Korato has taken a purist approach here which makes the pre-amp a little user unfriendly - even by tube standards.

The Renaissance mono-blocks bring the wood theme round to the front panel and sport 6CA7 output valves wired in triode configuration and running in class A. This tube is similar to an EL34 (for which it can be substituted) but is in fact a Phillips beam tetrode rather than a pentode. The 6CA7 is made in the EI factory in Yugoslavia, in the same facility that once housed the Phillips tube factory. The input tubes are 6SL7 and 6SN7 and once again internal wiring is vdH though the type is not specified. The output transformers are specified as Audio Note and therefore possibly of UK origin. Capacitors from Hovland and Solen are also employed.

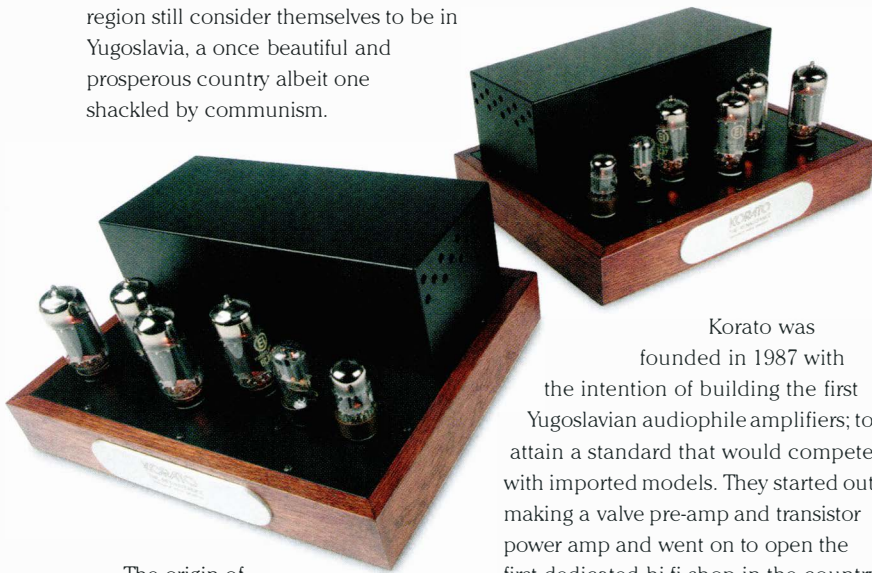

The origin of these amplifiers at least partly explains the impressive value for money they seem to represent in material terms. I don't think there are any other two-box pre-amps that cost a mere £1,450 and few if any mono-block power amps of this solidity and valve complement that come close to the \$2,000 asked for here. The Chinese undoubtedly could and maybe already do compete in this field, but so far I've not come across anything of the ilk.

Eastern block or ex iron-curtain countries are still a fair way behind Western Europe when it comes to incomes and it's remarkable that they can afford high-end hi-fi at all, let alone support importers for some of the most

Korato was founded in 1987 with the intention of building the first Yugoslavian audiophile amplifiers; to attain a standard that would compete with imported models. They started out making a valve pre-amp and transistor power amp and went on to open the first dedicated hi-fi shop in the country in 1996. Nowadays they import brands like B&W loudspeakers and make a full range of amplifiers including the three box Anniversary pre-amplifier, three other valve power amps and two transistor power amps.

The Korato KVP10 pre-amplifier is a two box, dual mono affair which takes its duality seriously. There are two leads running from power supply to signal stage and except for their union at the volume control/selector switch each channel remains alone as it passes from input to output.

Inside the pre-amp you'll find two EI-RC ECC 82 valves in the line stage and four ECC 83s from the same source in the phono stage. The latter is a high

▶ I kicked off the listening with the KVP10 pre-amp in place of my usual Border Patrol tube pre-amp, driving a Gamut D200 power amp into ATC SCM35 speakers. Bill Frisell's Continentals came across both crisper and cleaner and made me wonder if the tubes in the BP pre weren't beginning to show their age. In this company the Korato sounds quite bright and shiny which helped differentiate the multiple guitars in the band, clearly bringing out the interplay from a fairly dense mix. Timing also seems to improve with the Korato, the subtleties thereof being made more transparent in its grip. Norah Jones sounds expansive and open as ever, image solidity proving strong with the voice in particular.

Switching to the Renaissance mono-blocks proved to be more of a mixed experience, clearly the 85dB sensitivity of the ATCs is not going to be a recipe for success with any 45 watt amp but there was plenty to enjoy. Scale increases and vocal expression is enhanced with timing remaining on the same steady, upbeat keel. Less convincing is the way the soundstage becomes defocused and the bass loses depth and resolve. You still get reasonable bass but not surprisingly the drop from 200 solid state watts to 45 triode coupled ones is most notable in this department. However, keep the level at around the medium point, in other words not loud, and the result is remarkably listenable. It's not as coherent and the subtleties of musicianship are less well served which makes musical appreciation that much less easy, but if you put on something less challenging, in this case Eminem, the lyrical intelligibility helps as does the good sense of pace. Rarely is it possible to understand every word this guy raps, and no doubt there are many who'd rather not hear them at all, but the Koratos do a better job than most at revealing his lyrical expressions.

Not being an essentially cruel man I decided to stop torturing the Koratos with ATC's latest passive floorstanders and brought in my preferred speakers, the valve friendly Living Voice Avatar OBX-Rs, aided and abetted by

Townshend's Maximum  
supertweeters.



This partnership proved far more colourful and fruity, rendering the utterances of another rap outfit, the marvelously named Infesticons, with considerable aplomb. Fila Brazillia kept things ticking over with some genuinely 'phat' bass, full and juicy without being all that deep or tight, but keeping the groove rolling like an unstoppable musical tide. Playing the system a little louder didn't prove as appealing though, Bill Frisell starting to sound a little frazzled when clicking the volume control a notch nearer to nine o'clock.

Switching over to vinyl, a format close to Korato's heart as evinced by the phono stage on the KVP10, and playing Lambchop via a Tom Evan's Groove phono stage, further challenged the gain scenario when trying to play quietly. The choice between loud and seemingly next to nothing on the SPL scale not proving well suited to late night listening. But I found a usable notch and got into the dour Kurt Wagner groove with little difficulty. The soundstage lacks its customary scale at this volume

but there's no shortage of intimacy and pathos. The guy stretches self-pity to points that not even David Thomas (Pere Ubu) or Chris Ware (Acme Novelty Library) can compete with, AND makes it engaging.

The Koratos avoid the blowsiness of some tube designs but are not devoid of character: it's hard to pin down but some material sounds quite different. Somewhere in the upper mid there are peaks that can change the character of instruments or voices quite unpredictably. So much so that I started to wonder if I had found a remix of one track that had not previously turned up! It's an emphasis that can give the impression of great resolution with one track but distinct coloration on another, depending on the balance of the instruments and voices. Detail is well served but depth is not always as palpable as it can be. The Lambchop has a lot of low level instrumentation that is placed well behind the speakers. These amps reveal most of the sounds but bring them closer.

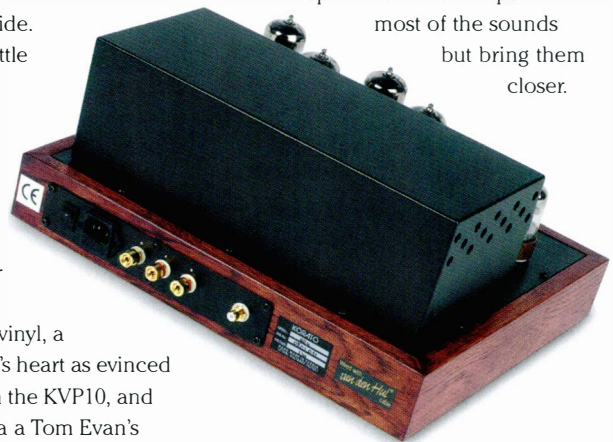

At about this time Tim Ferguson Hill turned up with his elegant acrylic horn speakers (see review next issue), so it seemed like a good idea to combine them with the Koratos. After all, the speaker is 'mungously efficient, albeit so restricted in bandwidth that a sub is essential. Unfortunately it was not a ▶



▶ very sensible combination because the volume pot range became almost non-existent, but even getting round this by reducing the output on the Resolution Audio Opus 21 CD player there was still a problem of noise floor audibility. Not a problem that was exclusive to the Koratos I should add, some tranny amps were also too noisy.

Using the Border Patrol SE300B power amp with its rather more appropriate 8 watt output and comparing the Korato and BP pre-amps revealed a slight coarseness but stronger sound from the Serbian unit. If anything it seems a little louder even with levels matched, as well as you can match with a stepped attenuator. Of course one would expect a bit more refinement from the theoretically dearer (c\$2,000) Border Patrol.

Going back to the OBX-Rs with the full Korato system after using an Ayre AX-5 integrated for a little while revealed that the tubed amps offer pretty decent resolution for the money, with a full but sharper edged sound offering greater precision if less linearity than this particular trannie design.

Revisiting the turntable, I kicked off with the Groove phono stage and then moved onto the onboard MM stage. With the Groove the Keith Jarrett Köln album lacked a little image precision but had good tone and decent resolution albeit not a full retrieval of the live ambiance available. Sticking an old Audio Innovations step-up transformer between Grasshopper and MM stage produced even more level, so much so that it was not possible to achieve good channel balance. Removing the step-up and plugging the medium output MC straight in gave a result that was a little bit relaxed but considerably more listenable/practical. Scale is a bit limited but intimacy is again very good, with transparency better than average, just avoid quiet records – noise floor is an issue with this unconventional arrangement.

Jeff Beck's tune 'Led Boots' from the Wired album revealed some appealing extra body to the sound albeit coupled with a degree of HF roll-off, nonetheless it doesn't dim the fire of this power house track.

Going back to the Groove revealed a significant improvement in pretty well all respects, but it costs more than the entire Korato pre and only does cartridges, so any other result would have been a shock. Korato's UK distributor recommends the Cartridge Man MusicMaker but says that higher output Grasshoppers also work well with this phono stage.

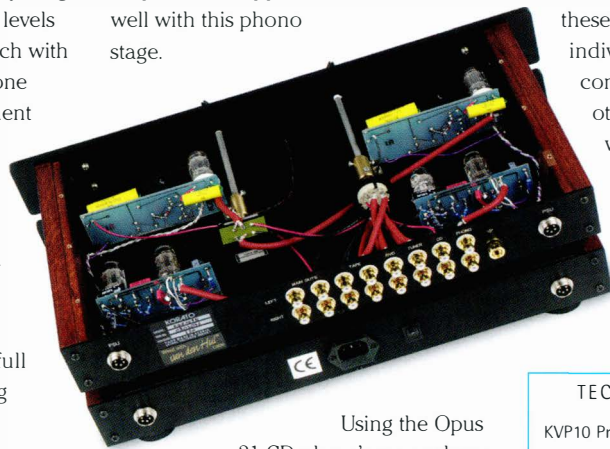

Using the Opus 21 CD player's own volume control it was possible to hear what the KVP10 adds to or removes from the sonic proceedings. Taking it away increases resolution, coherency and transparency. Putting it back introduces a fair amount of colour and some veiling.

The pre free set up reveals the Renaissance power amps to be slick operators that reveal harmonic and reverberant detail with ease. Dropping the BP SE300B in their place did not dramatically change matters. It is more delicate and fine with better bass control and clearer highs but given its higher price the differences weren't night and day.

Reading these sonic impressions they come across as a real mixed bag – but that's exactly how it was. This Korato amplification system represents fine material value for money but the sonic performance varies with system and

situation. Clearly, the high gain of the pre-amp will require a degree of care when it comes to matching both sources and speakers. Of the two elements the power amps have the greatest potential. They offer a solid, transparent sound with plenty of power for a valve design. They should be able to cope with most speakers that offer 89dB or more sensitivity and a reasonable load. But, they seem to suffer if asked to play loud in combination with the KVP 10 in a way that they didn't with other pre-amps.

The conclusion seems to be that, excellent (if characterful) though these products are, they're happier individually than used as a combination. Perhaps there are other partners in the range that would offer better results?

But considered as stand-alone units, it's great to see such high value components appearing on the market, whether they come from Serbia, Yugoslavia or both. ➤+

#### TECHNICAL SPECIFICATIONS

##### KVP10 Pre-amp

Inputs:	5x Line, optional MM phono
Outputs:	2x Main 1x Tape
Gain:	24 dB/ 46 dB
Dimensions (WxHxD):	480x65x300 mm
Dimensions PSU (HxWxD):	483x65x250 mm
Weight:	10 kg
Price:	£1450

##### Renaissance Mono-blocks

Power output:	45 W/ 8/ 4 ohms
Frequency range:	12 Hz - 40 kHz (-3db)
Gain:	30 dB
Size (WxHxD):	380 x170x 10 mm ea.
Weight:	11 kg ea.
Price:	£2000 pr.

##### Distributor:

A Audiosolutions  
01977 798844

##### Manufacturer:

www.korato.com

**We believe the next big topic in audio is energy control – mechanical energy which seriously corrupts the music**

## Killing the noise

**U**nless you install good **SUPPORTS** and **MAINS SUPPLIES** at the outset you cannot choose the main components safely. They are an **INTEGRAL PART OF YOUR SYSTEM** – not an accessory. That serious. Really??

Edgy treble and boomy bass are just two unpleasant effects that could make you plump for a duller amp or speakers lighter in the bass.

**VIBRATION** from outside the boxes destroys fine detail and can even distort the sound. **MECHANICAL NOISE** from motors, loudspeakers and transformers also travels along cables between units, **RATTLES THE CIRCUITS**, is turned into a signal and amplified through the system.

**RADIO FREQUENCY** interference, air- and mains-borne, is insidious, everywhere and getting worse.

**VERTEX AQ** draws on the company's aerospace, ultrasound and RF talents in designing its **SUPPORTS, MAINS FILTERS** and **CABLES**. These items make such big changes in system performance that you may not need that expensive upgrade!

Customers say we make some of the **BEST SOUNDS** they have ever heard, so you know we can do the same in your home. Our advice will take account of your best components and guide you where change is needed, in stages you can afford. You **AVOID EXPENSIVE MISTAKES**, enjoy music along the way and save money in the long run.

**JUST LISTEN AND YOU'LL KNOW.**

The  
Right  
Note  
*Music in the home*



**BATH**  
01225 874728

**CD:** ACCUPHASE, ACCUSTIC ARTS, AUDIO SYNTHESIS, Bel Canto, dCS (ELGAR, DELIUS PURCELL, VERDI), MERACUS, SUGDEN, WADIA. **VINYL:** BASIS, CLEARAUDIO, CROWN JEWEL, DNM, GRAHAM, THE GROOVE, LEHMANN, MICHELL, SUMIKO BLUE POINT SPECIAL, TRANSFIGURATION. **AMPLIFIERS:** ACCUPHASE, ADVANTAGE, BEL CANTO, CAT, DNM, GAMUT, HOVLAND, NAGRA, SONNETEER, SPECTRAL, SUGDEN. **LOUDSPEAKERS:** AUDIO PHYSIC, BKS, ETHOS, NEAT, TOTEM, VERITY AUDIO. **TUNERS:** ACCUPHASE, MAGNUM DYNALAB. **CABLES:** ARGENTO, CHORD CO., DNM, NORDOST, SILTECH, YAMAMURA CHURCHILL ETC. **SUPPORTS:** ARCICI, KINABALU, STANDS UNIQUE

## Boulder



without question  
the finest playback systems in the world.

call us today and find out why boulder  
amplifiers have no rivals.

t. 01892 539245  
f. 01892 616383

[www.metropolis-music.co.uk](http://www.metropolis-music.co.uk)



models shown: 1012 preamplifier dac and 2010 advanced preamplifier



# Audio Images

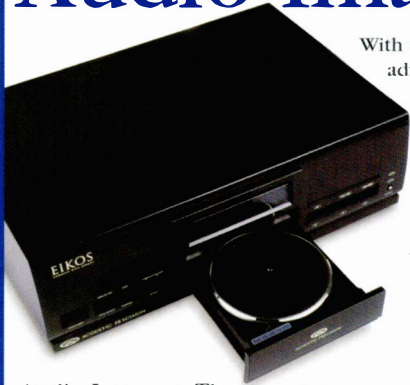

With the best choice,  
advice & service.  
For all that is  
Real Hi-Fi and  
Home Cinema

*The World's  
finest CD  
player now  
in stock*

Audio Images is The shop. Call now on 01502 582853  
128 London Road North, Lowestoft, Suffolk NR32 1HB.

- >cartridges  
lyra  
ortofon  
sumiko
- >cables  
chord company  
nordost  
van den hul
- >headphones  
grado  
stax
- >hardware  
atc  
densen  
epos  
harbeth  
imerge  
in focus  
lexicon  
michell  
naim audio  
parasound  
primare  
sme  
trichord

It's a CD player,  
Jim



signals  
hi-fi for grown-ups

l p s w i c h ( 0 1 4 7 3 ) 6 5 5 1 7 1  
w w w . s i g n a l s . u k . c o m  
B u c k l e s h a m I p s w i c h I P 1 0 O D Y



C H A I R · M A N

*Darrell Strub*

914 WESTWOOD BLVD SUITE 193  
LOS ANGELES, CA 90024

(310) 824-4811  
FAX: (310) 824-5543

## Release the full potential of your system

### STEP 1: SORT OUT YOUR MAINS

Start at the beginning! The truth is that poor mains quality ruins the sound of even the best equipment. The better the equipment the bigger the difference. Our Russ Andrews Mains Blocks and Power Cables remove mains pollution effectively, giving you a deeper more extended bass and a sweeter more natural sound.



£120  
for 4 Way Block

Yello Power Cable  
1m £29.95

Classic PowerKord™  
from £55

Phone UK Freephone 0800 373467 (quote: AP14) for a FREE  
catalogue or buy online at [www.russandrews.com](http://www.russandrews.com)



Russ Andrews Accessories Ltd, Windermere Road, Staveley, Kendal LA8 9PL.  
Int tel: 0044 1539 825500 Fax: 0044 1539 825540 Email: AP14@russandrews.com

FREE  
CATALOGUE

Stands for design



Want to hear more?

[www.ifdesigns.co.uk](http://www.ifdesigns.co.uk) Enquiries: 0870 744 1382





SACD Standard

00:00

TRACK

SEARCH OPEN/LOSE

SACD/CD

PAUSE

STOP

PLAY

FILTER

STANDBY  
POWER

KRELL



# Krell SACD Standard

by Roy Gregory

If ever a product sent (or suffered from?) mixed messages, then this is it. Take the name for starters. Not only is the Krell brand synonymous with public perception of the high-end, the product's moniker itself suggests that it's designed to define what's possible from the SACD format. Clear enough then, you might think, until you take into account the \$4245 price-tag. Hardly cheap I grant you, but not even approaching the audio stratosphere occupied by Krell's more celebrated digital components. Take the range topping KPS-25sc, a snip at \$23498. Even the baby KAV280 costs close to \$4000. And these machines only play CD. So maybe we need to reassess the obvious first impression.

The finish too is sleek and sexy. Employing Krell's latest corner extrusion and bolted plate construction, there's no denying just how attractive and classy this player looks, especially in silver. But look a little closer and you'll see that despite the unusually high button count for a high-end machine, the actual facilities are bare-bones. In fact, there's just what you get on the donor machine plus the absolute minimum of frills required to survive in the SACD Standard's home market. That'll explain the balanced outputs and multiple multi-room type connections then.

Finally there's the weight. Despite the solid, four-square looks of the machine it's far from overbuilt. Indeed, it's refreshingly manageable, perhaps suggesting that the US public have finally got over the assumption that massive, milled from solid aluminium casework guarantees good sound.

So, name and appearance aside, it seems that what we actually have here, if not exactly an entry level machine could best be considered the bottom

rung on the top ladder. I guess in this instance it's a case of Standard as opposed to Premium, suggesting that we might well see an all-singing, all dancing (multi-standard?) player somewhere in Krell's future. Only time will tell.

However, having said all that, there is at least one respect in which the Krell sets new standards, and that's disc handling. Anybody who has endured the pedantic, tortoise like operation of the



Sony top-loading SACD transport will heave a

sigh of relief as soon as they put a disc in the Krell's conventional drawer mechanism.

It reduces loading times to near CD proportions. I mean, I'm a fan of top-loading, but the interminable process demanded by the Classé Omega SACD1 is ssooooooooooooooooooooo ssslllllloooooooooowwwwwwwww that it simply drives me up the wall, especially when it ultimately fails to read the disc and you have to start all over again. No such problems with the Krell, which performed smoothly, swiftly and impeccably the whole time I had it.

I really like the way this player looks, although the red display looks pretty gaudy on the black model. Hey, at least you can dim it, even if you can't switch it right off – and you'll want to, because the player sounds noticeably better that way. I also really like having a full

complement of controls on the front panel. No more trying to decipher which of the many black buttons littering a poorly labeled remote actually does what you want. And while we're on the subject of remotes (an accessory that I personally prefer to leave in the box) the one that comes with the SACD Standard is one of the nicer models I've come across. Slim yet solid, it offers all the functions on a nicely laid out membrane type control panel. The buttons offer nice, positive latching and are even luminous, meaning that you know that you've done something and you might even know what it is. Once again Krell have thrown off their macho image in favour of a far more intelligent solution.

So what exactly does the SACD Standard offer? Essentially, this is a straight SACD player, meaning that it will handle CD, two-channel and discrete multi-channel SACD. You get the choice of balanced stereo outputs, but multi-channel means single-ended – a reasonable compromise given the price of the machine and the multi-channel equipment it's likely to be used with. You get a full complement of 12V and infra-red triggers, an RS-232 connector and 16bit/44.1K optical and co-axial digital outputs. You also get four user switchable digital filter profiles. These effect the roll-off frequency and rate of the converters, but also, confusingly, the level of the output, making comparisons confusing to say the least. Fortunately, the digital volume readout on the Gryphon Sonata pre-amp used for balanced listening made precise matching possible and repeatable, making the whole process that much easier.

Besides the Gryphon electronics and speakers, I also used the Hovland HP100/RADIA combination, with

► either the Gryphon Cantata or Revel F50 speakers. Cabling was Nordost Valhalla throughout, with either Russ Andrews or Nordost power cables. I had the Classé Omega SACD1 and Wadia 861 to serve as benchmarks, the former representing the best two-channel SACD replay I've heard, particularly from its balanced outputs.

It quickly became apparent that if you wanted to extract the best possible performance from the Krell then you needed to pay particular attention to set-up. Specifically, you need to select the preferred filter from the four options available, dim the display as I've already mentioned, and finally, you need to look at support options. Amongst the latter I found that either tall RDC cones, or Harmonix TU-202ZX tuning feet wrought clear benefits, even with the player supported on the finite elemente Pagode HD Master Reference rack. The cones delivered better resolution, detail, transparency and focus, opening out the sound which could otherwise sound rather murky. The large Harmonix feet offered better weight and more vivid instrumental colours at the expense of some separation, although either was clearly superior to the player's own rubber feet.

The filters are more complicated. Generally speaking (and after careful comparison at matched volume levels) I preferred the player set to the No. 1 position. With the requisite care paid to support and set-up, this delivered a beguiling combination of detail, delicacy and dynamics. Pace, rhythmic expression and the shape of melodies were all beautifully portrayed, as were instrumental colours and textures,

making the music at once clear and engaging. In contrast, the No. 2 filter sounded muddled, thick and congested, with clumsy and crude dynamic discrimination: Definitely a non starter. Likewise, the (much louder) No. 3 filter, which is richer and adds significant weight and body, but at the expense of a hurried feel coupled to limited dynamic expression which seems to push things permanently to the loud end of the scale. In fact, pushy is a good word to describe the overall effect.

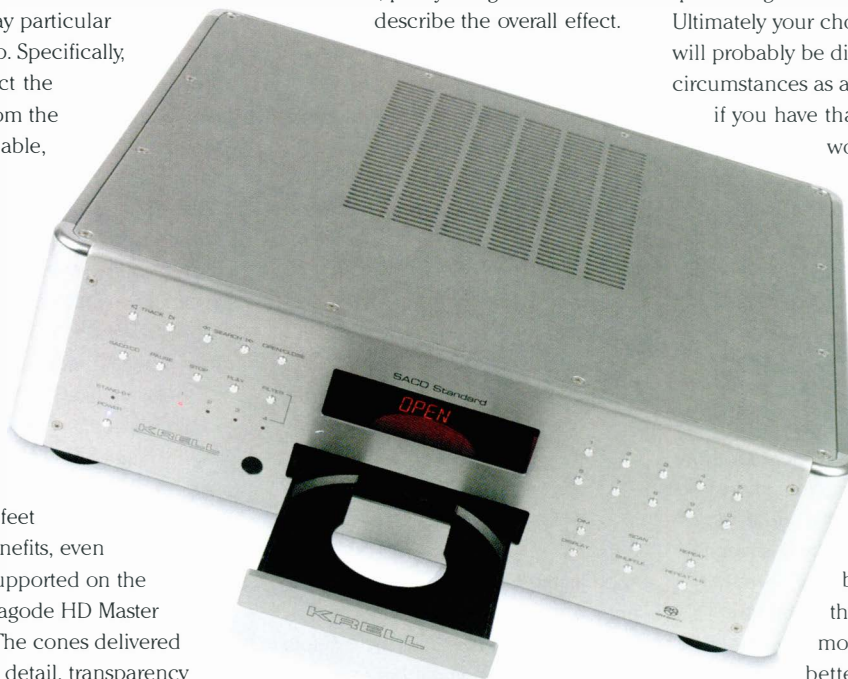

Initially impressive, don't be suckered. Long term listening soon reveals the lack of expression. Which brings us to filter No. 4, and the only really viable alternative to No. 1. Again, it's a warmer and slightly richer sound, coupled to an expansive soundstage and sweeping dynamics. But it's also softer and less focussed. Indeed, it reminds me of the sound of the LP12, with its combination of warmth at the bottom end and easy, rhythmic sweep. The conclusion has to be that the original is still the best, although No. 4 might offer relief from relentlessly bright or over dynamic discs (or systems). I stuck with the No. 1 filter for the rest of the review period, but

the ability to switch filters from the remote means you can fiddle to your heart's content.

Which only leaves the issue of balanced versus single-ended connection. Here, even with the fully-complementary Gryphon electronics, I marginally preferred the single-ended stereo outputs to the balanced option. They gave a slightly livelier and more vivacious performance, not holding on quite as tight as the balanced outputs. Ultimately your choice of connection will probably be dictated as much by circumstances as anything else, but if you have that option it's well worth experimenting with both.

Once you've got the SACD Standard up and running, the first thing you'll discover, and perhaps the most surprising, is that it's a darn fine CD player.

Comparisons with the Wadia 861 leave the Krell a tad bowed but unbroken. Whilst the bigger and much more expensive machine betters it in terms of information, textural

definition and transparency, as well as the clarity and ease of its overall picture, the SACD Standard delivers a credible facsimile of that whole. It may not match the Wadia but it's only a little behind in each important regard, placing it on a par with the likes of the cheaper 302 and the Ayre CX7. The Krell might exceed the price of those players, by around a grand in fact, but remember that it does SACD and discrete multi-channel too. The fact that it does that and makes a better than fair fist of CD replay as well, makes it unique in my experience.

Interestingly enough, the sound from CD, characterised by stability and control allied to a nice, open ►



► mid-band is cut from the same cloth as the player's SACD sound. The bottom-end is reasonably weighty, although lacking a little definition compared to the excellent separation of the mid. But it's the ease and evenness of the presentation that makes it so impressive with wildly varying musical forms. The space and presence of Dolly Varden's 'Apple Doll' is conjured from the darkness between the speakers, Miles's horn is all subtle restraint on the opening phrases of 'Surrey With A Fringe On Top'. Removed from the confines of comparison and standing alone, it's an engaging and convincing performance.

Which makes the clear superiority of its SACD replay all the more impressive. You need to be careful in making direct comparisons, the hybrid CD layer of SACD discs being far from ideal in this regard. They differ in level as often as not, as well as equalisation. Safer instead to compare different discs of known quality. I normally rely on the DCC and XRCD versions of Miles Davis's *Steamin'*, recently re-issued on SACD by MoFi. (There's even Analogue Productions' 180g version for completists!) Each of these discs is a fair representative of their format's optimum performance. Compare them on the Krell and the SACD has far more body, clarity and tonal and spatial separation (and yes,

I know it's a mono recording). It emerges, much more vividly from a blacker background, with wider dynamic range and better dynamic discrimination as a result.

How does the Krell's SACD replay compare to the Classé? Running the latter in its preferred balanced output/fully balanced electronics mode it betters the Krell by a fair margin, with a bigger stage, better separation and transparency, better weight and definition in the bass. The whole thing is just far more stable and solid. In its defence, the lighter, defter touch of the SACD Standard makes for a quicker and more rhythmically explicit presentation that's not without its own appeal. However, change the ground rules and you change the result. Switch to single-ended output and the Krell gains a little while the Classé loses – disastrously. Now the Krell matches or betters the definition and stability of the bigger machine, while running rings around its leaden, stolid low frequencies. Suddenly that extra weight becomes an embarrassment rather than a virtue.

The sound of the Krell replaying SACD mirrors its performance on CD. The bass lacks a little definition compared to the crystal clarity of the mid. The highs are clean and extended. It delivers the performance that the

format promises and it does it on everything from the Florestan Trio playing Faure to Tilson-Thomas's Mahler, McCoy Tyner to *Dark Side Of The Moon*. (Yes, I know – but it had to get in there somewhere and there's still a vicarious pleasure to be had from switching all the lights off and playing it REALLY LOUD!)

The whole SACD format, and the machines that play it, is a rapidly evolving market sector. Who is to say what will happen next? But for now the Krell SACD Standard represents an important benchmark. At a third of the price of Classé's standard setting Omega SACD1, the Krell delivers credible high-end sound with far greater versatility and in far more circumstances. And it does it from both CD and SACD, in two channels and six. It may not deliver standard setting performance in either case, but then it doesn't cost a standard setting price either. More importantly, it meets or beats its price peers on both formats, which makes it the first bargain of a new product generation. There are undoubtedly better CD players out there than this Krell. There are also players that can do a better job of SACD under their preferred circumstances. But this is the first player to do it all and do it well. It may not stretch the envelope but the Krell SACD Standard represents an enviable standard nonetheless.

## Extending the horizon...

by Alan Sircom

I always wanted to be a rebel, kicking against what everyone else says to be right. Imagine my pleased surprise at discovering the multi-channel performance of the Krell SACD Standard wasn't all it was cracked up to be. Then, imagine my dismay to discover that it really was all it was cracked up to be; both I and my system were at fault.

You see, there are two obvious issues

with the Krell. First, it needs a lengthy warm-up; not only as initial burn-in, but after any lengthy time away from a mains power source. This affects no small change on the performance of the player - cold Krell, bad; warm Krell, wonderful.

Even more important, however, is the system itself. No 'make do' home cinema hybrid multi-channel affair will

suit; this needs a dedicated multi-channel music system, laid out exactly as a good multi-channel system should. No half measures allowed; all five main speakers need to be exactly the same model and all need to be the same distance from the listener. Fail to reach these heady heights of multi-channel and you still get a good sound, but nothing so remarkable as the Krell ►

► can produce when all the cards are in its favour. Unfortunately, we are so used to 'make do' multi-channel that most systems will only show a fraction of what the Krell can really provide.

That's where I began with the Krell: Listening through a system geared toward home cinema first and multi-channel second. The SACD Standard offers a good, clean and dynamic performance, one that's a fraction better than the Sony and Marantz players of this world. That already places the Krell in a class of its own, but the level of improvement hardly makes the player's high price justified. After all, a four grand player should sound a lot better than a one-and-a-half grand player.

But, that's only the starting place. Redesigning the system to give it a more natural multi-channel sound spin, and the Krell really comes to life. Suddenly, that good dynamic performance becomes extraordinarily natural. Multi-channel SACD quickly becomes the standard to reach for. It's actually very hard to write about the performance of the Krell in a properly matched system, because it sets a reference point that regular multi-channel DVD-Audio or SACD have to go a long way to match. Disc after disc gets played; not to criticise the sound of the Krell, but to discover what they really sound like on multi-channel SACD. With classic re-masters like Dylan's *Blood on the Tracks*, you get all the unforced naturalness of the original, but with that extra multi-channel component.

Overall, this better-than-the-rest quality makes the Krell hard to pin down. It's very detailed, especially at the top-end: just the right side of brightness. It is also the most dynamic multi-channel SACD player around; most multi-channel SACD spinners sound a bit flat and thin. This is the exception. But most of all, it's

the musicality that shines through; possessed of a clean, brisk and dynamic sound, it has none of the bland character that can make the format appear a bit lifeless.

Pink Floyd's *Dark Side of the Moon* highlights the big difference between Krell-flavoured SACD replay, and everyone else's.



These tracks are so well known to most rock listeners that the slightest deviation is spotted readily. And, in most cases, the multi-channel SACD sound is precise but entirely music-free. It's as if the player is just going through the motions and the disc sounds almost unexciting. The Krell redresses the balance; it manages to keep the information levels at maximum, but also reintroduces a sense of musical information and excitement lost in the multi-channel battle.

Our Beloved Leader has passed comment on the Krell's two-channel performance, but there is a relativistic comment worth making. In CD mode, this player is up there with Wadia-lite (how's that for disparaging one of the finest CD players around at the moment?). Through single-ended outputs, the stereo SACD sound has no effective challenger, but how does the multi-channel sound match up to these heady levels? Very well, in fact; the multi-channel sound doesn't undermine the two channel sound quality in absolute

terms, but nor does it seem compromised by a wonderful two-channel performance. It simply offers the best multi-channel audio sound you can get this side of a recording studio, today. That's all. You can happily play SACD in stereo and never once make the move to multi-channel, in the knowledge that if you did decide to cross the great divide – and do it properly – the multi-channel performance is every bit as good as the two channel sound. There's not even a 'perhaps' here; it does multi-channel as well as it does stereo, and in most cases better than the system it is played through.

In a way, no matter what multi-channel system you can put together, if it has the Krell at the front, it will benefit. You will hear the Krell advantage, even if it fronts a home cinema in a box system. Ask not what the Krell can do for your system; ask instead what your system can do for the Krell. ➤+

#### TECHNICAL SPECIFICATIONS

Type:	SACD Player
Compatibility:	CD and discrete multi-channel SACD
Outputs:	1 x balanced stereo 1 set single-ended stereo/surround 1 x co-axial digital (RCA) 1x optical digital
Dimensions (HxWxD):	439x145x419mm
Weight:	11.4Kg
Finishes:	Silver or Black
Price:	£4250

**UK Distributor:**  
Absolute Sounds  
Tel. (44)(0)20 8971 3909  
Net. [www.absolutesounds.com](http://www.absolutesounds.com)

**Manufacturer:**  
Krell Industries Inc.  
Net. [www.krellonline.com](http://www.krellonline.com)



'Superb amplifier with bags of power and genuine resolution, one of the best music appreciation devices available.'  
 BorderPatrol P20, Jason Kennedy Hi-Fi Choice Summer 2002.

'.....for the first time in my experience, I'm listening to an amplifier with the linearity and directness that are supposed to be single-ended's great virtues'  
 BorderPatrol SE300B  
 Roy Gregory Hi-Fi+ issue 8.

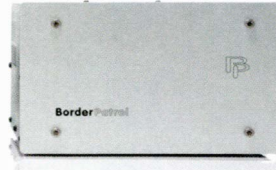

**BorderPatrol**

Tel/Fax 00 44 (0)1242 717171

e-mail bp@borderpatrol.net

www.borderpatrol.net

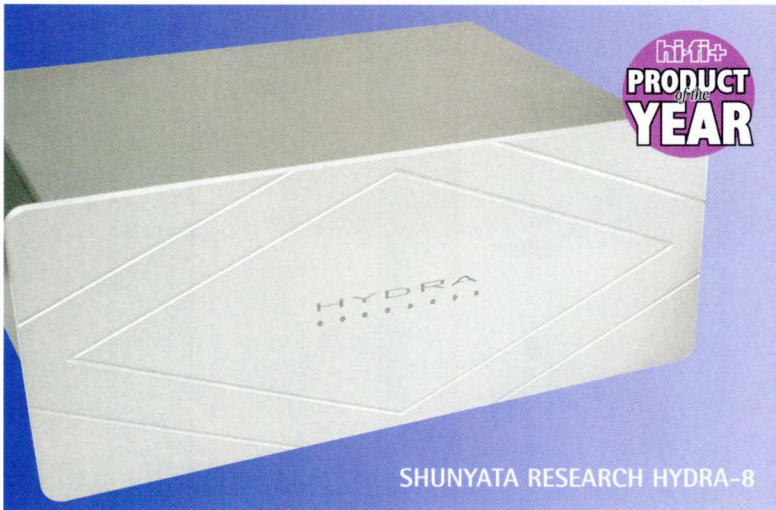

**Hi-Fi+**  
**PRODUCT**  
*of the*  
**YEAR**

**SHUNYATA RESEARCH**  
 all new HYDRA-8:  
 dual chassis, 8 outlet,  
 cryogenically treated distribution  
 centre with proprietary power  
 protection and noise-reduction.

**AUDIO ATMOSPHERE**

Penkridge, Staffordshire . 01785 711232

stuart@audioatmosphere.com

www.audioatmosphere.com

FURUTECH . GLIM . HEGEL . MACTONE  
 SEEC . SHUNYATA RESEARCH . ZERODUST . ZYX

SHUNYATA RESEARCH HYDRA-8

COME AND LISTEN TO  
 US IN ROOM 218 AT NORTHERN  
 S & V RADISSON SAS, MANCHESTER  
 AIRPORT - 7/8 FEB 2004. BRING YOUR OWN CDS

## Horns & Valves



MERLIN (VALVE AMP)

"These components go beyond being merely complementary, to the point where the relationship is virtually symbiotic" Hi-Fi+ Issue 27, Paul Messenger

KORONGLAY (HORN)

"I can't argue with the sheer magic that this combo brings to my various hifi sources"

Hi-Fi+ Issue 27  
 Paul Messenger



GRAVES AUDIO: MANUFACTURERS OF HANDCRAFTED HORN LOUDSPEAKERS AND VALVE AMPLIFIERS  
 www.valves-horns.co.uk Tel/Fax: 01442 270141 Unit 5, Bards Corner, Hemel Hemstead, Hertfordshire, HPI 3RR

**SONNETEER**  
*Brontè*





# Sonneteer Brontë Integrated Amplifier (and CD Player)

by Paul Messenger

A relatively young brand, Sonneteer was founded in 1994, since when it has strived, prospered and grown, slowly but surely building up its portfolio to around seven products, all fitting into the sub-£1,000 sector of the market. The main focus of this review is the £800 Brontë integrated amplifier, which is unusual in being a digital device, while for good measure there's also some coverage of its matching £700 CD player, also called Brontë.

The unusual bit, of course, is the amplifier. The vast majority of these – valve or solid state – are analogue devices. They take the existing (analogue format) signals that all source components provide, and expand their voltage capability using analogue electronic engineering techniques, while incorporating the capability to supply the large amounts of current necessary to drive low impedance loudspeakers.

Analogue amplification has served us well enough since the dawn of hi-fi, and it remains not a little ironic that examples of the very earliest and simplest designs – the single-ended triode valve approach – are still available today.

That said, the practical benefits of the solid state approach are substantial, so it's no surprise that the transistorised amplifier dominates the marketplace. While such devices are still overwhelmingly analogue in operation, the broad world of electronics is totally 'digital dominated' these days. Analogue techniques of all kinds are widely regarded as old-fashioned, and some reckon that digital amplification

techniques represent the future of hi-fi.

It's not a new idea. I remember talk of digital 'class-D' amps way back in the late-70s, which included plenty of discussion over possible alternative means of implementing digital techniques. Indeed, as I recall Sony actually put one into production around that time, attracting rather more attention than sales I suspect. If memory serves, this early example used a technique called 'pulse width modulation (PWM)', modelling the original analogue signal by switching transistors on and off at high speed, and creating the complexities of the waveform by varying the on/off intervals.

Things seemed to go a bit quiet for the next twenty (!) or so years, then, like buses, a number of new initiatives came along at once. Japanese multinational Sharp – originally named after a propelling pencil, and now best known for its advanced LCD technology – was the unlikely first brand to show amongst the current generation of digital amps, though its

UK sales operation was ill matched to specialist hi-fi retail.

Another early entry was the Danish Tact Audio operation. Some fine demonstrations of its unusual digital system approach have been conducted at UK hi-fi shows, but no UK distribution has been set up. A rather better known Danish brand, B&O, actually has a digital amp subsidiary, actively supplying its proprietary ICE-Power modules to other brands.

Then, two or three years ago, a whole clutch of small specialist hi-fi brands began introducing digital amps. Names involved included ESLab,

Veritas, Townshend and (from the USA) Bel Canto. These companies were much too small to have developed their own technologies 'from the ground up', so it was no great surprise to discover that all were based around a common 'digital engine' from Tripath Technology, on the US West Coast, which disingenuously describes its amplification approach as 'Class T'.

The same Tripath digital technology underlies this Brontë integrated amplifier from Sonneteer, which first appeared back in 2000. Crucially, it costs just £800 – a much more realistic figure than the £2,500+ that I've seen quoted for the other brands mentioned earlier. That said, there's nothing desperately exotic or inherently costly about the Tripath approach. The company's web-site ▶

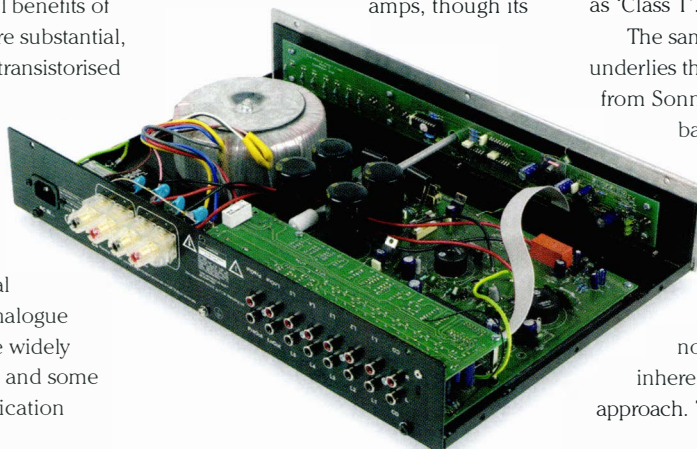
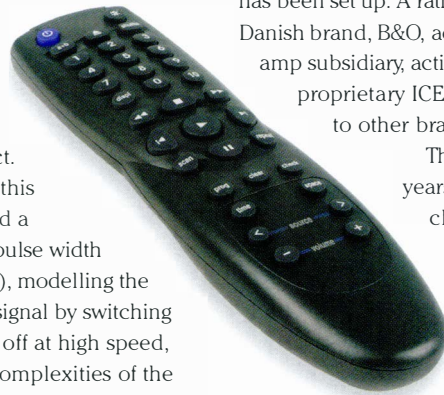

► describes how Japanese multi-nationals like Denon and JVC are starting to use versions of 'Class T' technology in AV receivers, where the inherently high conversion efficiency of digital amplification is obviously a major plus.

With amplification, however, the individual application is usually at least as important as the modus operandum. Whatever method is used to manipulate the signal itself, the true heart of an amplifier lies in using a high quality power supply to drive the loudspeaker.

And if a 'digital engine' lies at the heart of the Brontë amplifier, in most other respects it retains plenty of analogue ingredients. Indeed, Sonneteer has quite deliberately designed this amp so that it can be simply substituted for any existing analogue amp – even Sonneteer's own Champion, if you so desire.

In a very real sense, Brontë is an alternative – an interesting one, no question, but not intended to replace existing Sonneteer analogue amplifiers. Indeed, I asked one of the guys at Sonneteer which he personally preferred, and his vote went to the analogue Champion, though many customers, especially in the Far East, are opting for the digital Brontë.

Both amp and CD player are sharply styled, with chunky alloy fascias that are a little shinier than most. Inset mirror-finish sections highlight the control surfaces and the CDP display. Six obvious Allen bolts provide further decoration, and the key volume control and loading drawer are central to the overall symmetry. The rest of the casework follows the usual steel tray-and-cover stereotype.

Both components come with

inexpensive, unpretentious remote handsets – light, slim and easy to operate in one hand. The amplifier's handset is a beautifully simple and basic affair, with just a dozen buttons, while the CDP's is more system-oriented, combining the usual player control functions with the obligatory numeric keypad for direct track entry, plus the ability to

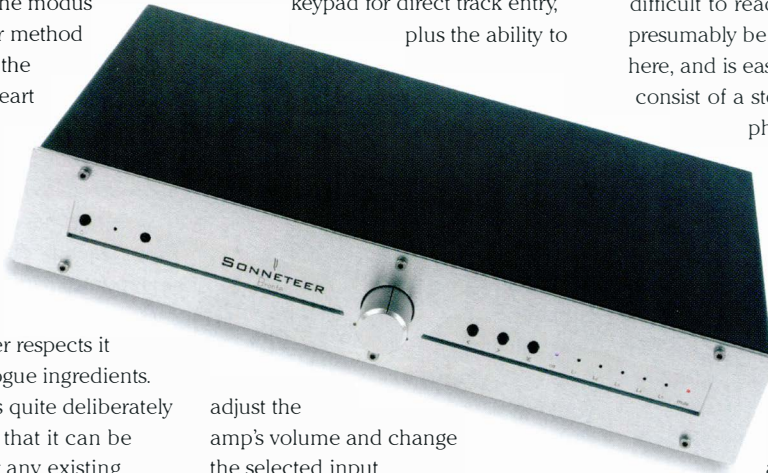

adjust the amp's volume and change the selected input.

The amplifier is claimed to deliver a very generous 150 watts per channel, and do so with an absolute conversion efficiency of 96 per cent – which means in practice that there should be little need for costly heatsinking and ventilation arrangements.

There's no phono stage here – Sonneteer can

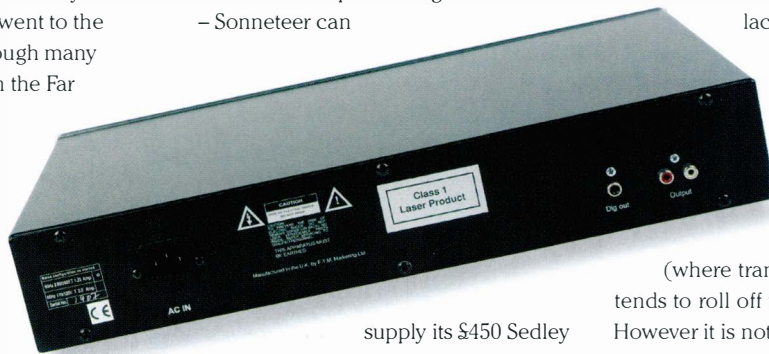

supply its £450 Sedley phono stage for vinyl users – but there is an extensive roster of six line-input pairs, plus one line-out and one pre-out phono pair. There's no balance control or mono switch here either, which are regrettable omissions in my book, though the volume control 'law' is particularly nice, maintaining close channel balance even at very low levels,

and permitting very fine adjustments here too.

The Brontë CD player incorporates advanced 24-bit/96 kHz DAC technology, and is claimed to get close to the performance of the company's more costly Byron model. The control buttons on the player itself are small and quite difficult to read, but the handset will presumably be doing most of the work here, and is easy enough to use. Outputs consist of a stereo pair of analogue

phonos – rather too closely spaced for the bulkier plugs around – plus an electrical digital phono out.

The sound of the Brontë amplifier is distinctive, and quite distinct from that found with similar price analogue amplifiers. The modus operandum here involves

modelling the signal with very fast transistor switching, and then removing all the unwanted ultrasonics by means of a low-pass filter. This perhaps explains why the sound here has an exceptionally well controlled top end, to the point

where one can criticise a slight lack of 'sparkle'.

This effect is by no means unpleasant, as it helps the ear/brain focus the attention on the midband, rather in the manner of a valve amplifier

(where transformer coupling tends to roll off the ultrasonics). However it is noticeable nonetheless, and does reduce the fine detail somewhat in consequence.

Spinning the Alison Krauss Live album – and indeed some other live recordings – I was conscious that the audience's clapping was a little muted, and that the audience itself seemed to have shrunk a little. The banjos which pepper this recording seemed a little



▶ less 'sharp' with slightly muted upper harmonics.

Which should not detract from the very beguiling mid-band, which sounds exceptionally clean, with a notably wide dynamic range and accurate dynamic tracking. And if the top-end transparency is slightly compromised here, voices were persuasively expressive and informative. Alison does have a pronounced nasal 'twang' (which might or might not be to taste!), and this was very clearly reproduced by its very coherent presentation through the vital presence region – one was fully aware that any nasality was coming from the singer and the recording, rather than the CD player or amplifier. It's here that valve amps always seem to excel, and this digital Sonneteer possesses something of the same clarity and magic, albeit with rather less of the euphonic 'bloom' one often hears with the thermionics.

Short-term dynamic impacts are very convincing; powerful yet unexaggerated in the way they punch out of the background with considerable solidity. The bottom-end sounds firm and extended, delivering plenty of weight with good coherence and timing. And stereo images are well formed, with fine space and superior depth perspectives, with choral material in particular sounding very persuasive.

It has been pointed out elsewhere that this type of amplifier can give variable results according to the speakers used. That might well be true, at least in theory, but I tried a number of different speakers during the course of this review, including costly examples like the JBL K2 S5800 and Wilson-benesch A.C.T., as well as more modest designs like the Focal-

JMlab Chorus 716S and Rega ELA, and feel that any changes due to the amplifier were largely superficial, as the underlying character of the Brontë seemed to be maintained quite consistently throughout.

One snag did emerge, when I stopped spinning CDs and switched over to FM radio, whereupon

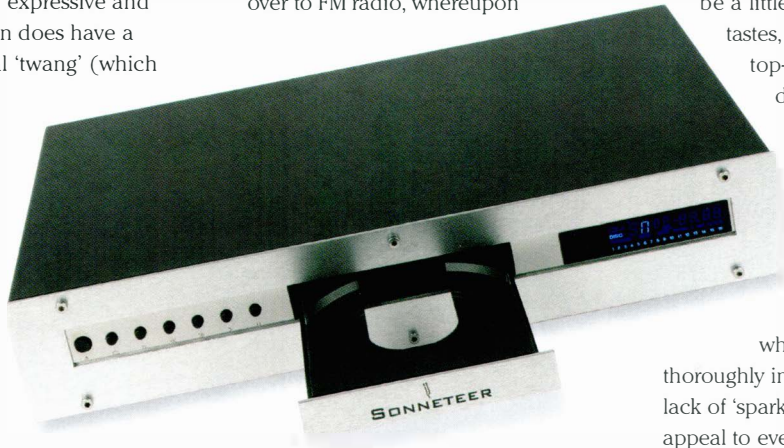

I discovered that the amplifier was creating some interference within my FM tuner – or more probably the aerial cable feeding it. It is well known that the high speed switching used by digital amps can generate electromagnetic radiation, and it's clear that this was something of a problem in my system. (The very act of switching the unconnected Brontë on caused an increase in noise when the radio was being auditioned via another amp.) I suspect careful re-siting of components and re-routing of the antenna cable could have ameliorated the problem, which didn't affect any of the other sources I used, but it remains a possible constraint nonetheless, especially for those who listen to a lot of radio.

Although not the prime focus of this review, the Brontë CD player performs quite admirably, with characteristics that seem a very good match for the amplifier. The top-end is restrained with a slight lack of 'sparkle', and the overall sound is quite gentle and notably well behaved. Yet again the mid band is a

major strength, with a very clean delivery and wide dynamic range making for a thoroughly natural all round sound that it is always inviting, if not the most invigorating around.

Bring the two components together and they make a fine match, sonically as well as aesthetically. The sound might

be a little too cautious for some tastes, and the very restrained top-end does limit the fine detail a little. But the midband is lovely, with obviously low coloration and a good sense of realism. The net result is a system that is always controlled and free from aggression,

while at the same time being thoroughly inviting and entertaining. The lack of 'sparkle' means it's not going to appeal to every listener, but it does offer an interesting and valid alternative that some will want to explore. ▶+

#### TECHNICAL SPECIFICATIONS

##### Brontë CD player

DAC:	24-bit resolution and up to 96 kHz sampling rate
Analogue out:	2x RCA (phono)
Digital out:	RCA (phono) S/PDIF
Dimensions (WxHxD):	430x70x280mm
Net. Weight:	7Kg
Price:	£700

##### Brontë digital amplifier

Power output (1kHz):	150W/ch into 4 ohms
Inputs	Six at line level
Outputs	1x Line out 1x Pre out 1 set 4mm socket/binders
Dimensions (WxHxD):	430x70x280mm
Net. Weight	13Kg
Price:	£800

##### Manufacturer:

Sonneteer  
Tel. (44)(0)208 286 6661  
Net. [www.sonneteer.com](http://www.sonneteer.com)





# The Chord Co. Signature Cables

by Roy Gregory

Nothing else I know manages to encompass both the sublime and the ridiculous quite as readily as audio cables. Most people would look no further than the Nordost Valhalla mains leads reviewed elsewhere in this issue for the evidence: Unquestionably superb in performance, they are also breathtakingly expensive. But, with plenty of prices that put even the Valhallas in the shade and too much of the sort of pseudo science that gets hi-fi a bad name, it's easy to dismiss cable companies as charlatans and profiteers. Yet, as one who has long advocated the use of what most sane people would regard as ruinously expensive cabling in even quite modest systems, I would strongly caution against underestimating the impact of your cable loom. Approach with caution and demand demonstrable benefits and you might be surprised just how critical a properly sorted cable loom is to the performance of your system.

Amidst the heady mixture of extortion and snake-oil that represents the audio cable market, I've always felt that the Chord Co have stood apart, building a solid reputation for exemplary construction and superb value for money. Look a little closer and you soon discover that it's no accident either, their products displaying a consistency of philosophy and materials that puts many of their "high-end" competitors to shame. They're innovative too, being amongst the first to introduce microwave technology to the audio arena, bringing previously unimaginable levels of performance down to prices which if not exactly bargain basement, were at least less than a student spends on beer in a term.

But there was a problem. The primary mantra in the Correct Use Of Cabling is consistency. You need

a properly thought-out and coherent approach to both your interconnects and speaker cabling, a factor that Chord are well aware of. Yet the Signature Interconnects broke new ground for the company in terms of price, almost doubling the entry fee of their previously most expensive product, and did so without the benefit of a matching speaker cable. Indeed, in reviewing them, I actually ended up employing Nordost's SPM, a fortuitous match sonically, but certainly less than ideal from Chord's point of view.

Now, almost two years on, we finally have a Signature speaker cable to go with the interconnects. It's big, awkward and expensive – all of which mean that it has more in common with the average high-end speaker cable than it does with Chord's other products, but at least it won't suffer a credibility gap with the opposition. Like the interconnect, it consists of a pair of discrete conductors, each sheathed in a nylon mesh, but this time they're twisted together. The review pair came in a contrasting red and black spiral, but a more somber all black option is also available. In either case, a beautifully machined aluminium clasp clamps the two conductors, along with their sleeves, to prevent the whole lot unraveling. It's neat and really looks the part, while also allowing easy construction of custom lengths, an important consideration with every pair being built to order. The thickness of the conductors combined with their stiffness makes for a springy cable that resists dressing, so be careful when uncoiling or twisting them into place, lest the other end whip round and have your Granny's

ashes off the mantelpiece. There's no bi-wiring capability inherent in the conductors, so if you want to exercise that option on your speakers you'll be looking at another complete run of cable. C'est la vie.

Like the Signature Interconnect, the Signature Speaker Cable presents its manufacturer with an interesting challenge. Not only does it have to compete with the established heavy-weights (and at a much lower price if Chord are to maintain their enviable reputation) but it also has to significantly

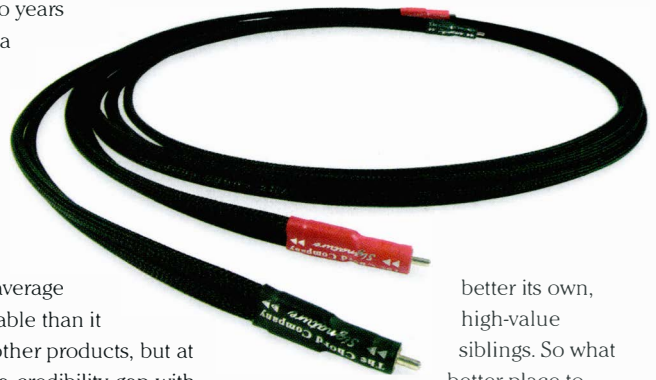

better its own, high-value siblings. So what better place to

start than a straight comparison against the established Odyssey 4, twinned up at the speaker end to run as a single wire? To keep things simple I ran a basic two-box set-up, the Wadia 861 feeding the Opera Consonance 8.8 integrated amp, which in turn drove the Audioplan Kontrast IIIis. (Would you believe that I couldn't find a single set of single-wired speakers in the entire house? But more of that later!)

Having spent a couple of hours acclimatizing to the Odyssey, substituting the Signature came as a reassuring shock to the system. The increase in speed, transparency, focus and dynamic range were all immediately obvious. Here was clear evidence of the more expensive cables' superiority in pure hi-fi terms: Enough I suspect to convince many ►

▶ a listener or prospective purchaser. But these obvious benefits are rather less than half the story. Add them together and you account for the pretty dramatic increase in immediacy and presence (hallmarks of the Signature Interconnects) but what really elevates the Signatures above the Odysseys is their ability to integrate those attributes into a coherent whole.

Take a track you know really well, preferably something with wide dynamic shifts and changes in density. I'll use Jackie Leven's 'Paris Blues' (*Defending Ancient Springs*, Cooking Vinyl COOK CD 191) as a prime example. The Signatures don't just bring impact and presence to the drumbeats, they bring pitch and texture too. The voice

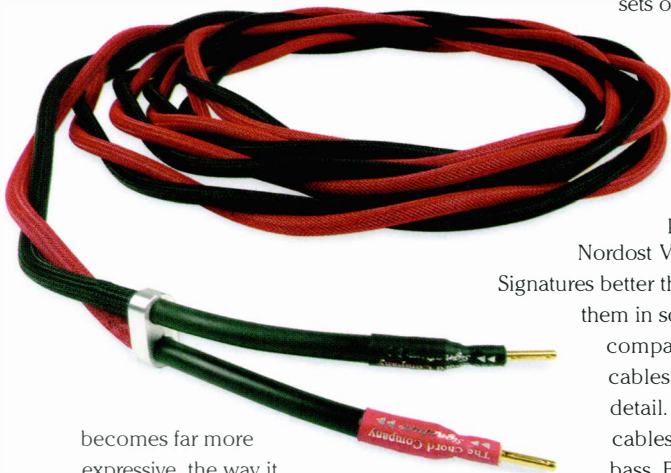

becomes far more expressive, the way it works the lyric, the way it paces its delivery and stretches the phrasing to blend with the instrumental arrangement to maximum effect. And what an arrangement! The rewired system reveals the full majesty and subtlety of the track, underpinned by the dynamic authority and pitch definition that spaces notes so unerringly precisely. The speed and micro-dynamics bring colour too, dramatically improving instrumental identity and separation. But the real kicker is the top to bottom phase integrity of the sound, which allows the music to grow and blossom, to breathe, safe in the knowledge that all that extra power, energy and definition is

safely locked in the proper time, place and proportion. There is more and what there is happens much quicker and when it jumps it goes much further, but the critical thing is that all that activity is keyed to a single grid, locked to a single purpose. If you want a system to communicate, to unleash the sense as well as the fact of the music then the Signature cables will be a good starting place.

This musical quality stands the Signatures in good stead when you put them up against the more expensive competition. As it happens, I've a few sets of expensive cabling around the house at present, all well regarded by one scribe or another. None of them has challenged the performance of the Nordost Valhallas. Well, the Signatures better them too, which places them in some pretty exclusive company. Yes, there are cables that deliver more detail. Particularly, there are cables that deliver more bass. But as soon as you insert them into the system, the overall coherence, the musical and rhythmic integrity that makes the Signatures so compelling and musically satisfying disappears quicker than a South African referee after the Rugby World Cup final. The splintered mess that remains is bent about as far out of shape as our departing official bent the laws of what was a great game.

Which brings us to the inevitable acid test and a straight comparison to Valhalla. Interesting it is too. The Signature majors on presence and substance, but it can't match the Valhalla for detail, separation and finesse. Nor can it match the flat cables'



absolute top to toe evenness, revealing a slight mid-bass prominence that delivers that extra substance at the expense of a little slowing and a slight loss of pitch and rhythmic agility. But – and it's a very big but – what is clear is that differences in technology or not, these cables are cut from the same cloth and that cloth is the fabric of music itself. The Signatures can't match the Valhallas in absolute terms, but they run them ever so close. Those who rush to judgement might even be seduced by the sheer presence and purpose of the Chord cables. Bottom line? Short of the Valhalla, or the cheaper but still mono-filament Valkyrja, these are the best sounding cables I've had at home. Now take a glance at the prices and factor in value. There's no question that they offer the biggest bang for your buck, but don't hold that against them. When I say that they compete with the biggest of Nordost's wires that's an absolute statement. Naim are not the only Salisbury company making a serious assault on the high-end. On this showing it could be Chord who have the higher foothold, doing what they do best: delivering simple excellence. ➤+

#### TECHNICAL SPECIFICATIONS

Prices:  
 Signature Interconnect  
 1m pr: £500  
 Each extra stereo metre: £400  
 Signature Digital  
 1m Phono/BNC: £210  
 Signature Speaker Cable  
 3.5m pr: £805  
 Each extra stereo metre: £230

**Manufacturer:**  
 The Chord Co.  
 Tel. (44)(0)1722 331674  
 Net. www.chord.co.uk





**Expert advice**  
**Exceptional prices**  
**Excellent Service**  
**FREE UK Delivery**

Providers of high quality Hi-Fi and AV cables from: Audience, Black Rhodium, Chord, Clearlight, DNM, Hificables, Nordost, QED, Van Den Hul, IXOS

Also suppliers for:  
 Allsop, AudioPlan, Densen, Graham Slee, Grado, RDC, Ringmat, Shure, Vibrapod



www.hificables.co.uk

**Heatherdale**  
 audio limited

202, Findon Road,  
 Worthing, BN14 0EJ

Pre-owned Equipment Available with Guarantee  
 Export Facilities Available. Visit our Web Page www.hifi-stereo.com  
 Main dealer for Mark Levinson Reference products

**SPEAKERS**

Harbeth LS512 Monitors	£995
Martin Logan Prodigy Speakers	£7995
Revel Studio Speakers Ex Demo	£7995
Revel Salon Speakers Ex Demo	£9995
Teac LS-X7 Satellite Speakers	£50
Mission 782 (Stand Mount Model)	£150
Audio Physics tempo speaker	£995
Revel LE1 sub amp Plus 2 Sub 15s	£5995
Eitax Symphony floor standing speakers	£99
Orchid PLII Speakers Ex demo	£3495
Mirage M3 S1 speakers	£1495
B+W Matrix 1 Speakers	£295
B+W CDM1 Speakers	£350
Orchid LWO Speakers Ex Demo	£2495
Epos ES12 Speakers	£375
B+W CDM1 Speakers	£395
Linn index speakers	£95
Eitax Floor Standing liberty 5+ Speakers	£140
Eitax Monitor III	£95

**PRE-AMPS**

Naim Nac 92 Pre Amp	£350
Mark Levinson ML380 Pre Amp	£3495
Mark Levinson ML380s Pre Amp	£3995
Exposure 11812 Pre Amp & Power Supply	£650

**AMPLIFIERS**

Adcom GTP 450 Tuner/Pre-Amp	£350
Chord 1200 Mono Blocks	£2995
Krell KSA 50s Power Amp	£2195
Audio Research D130 Power Amp	£1295
Mark Levinson ML334 Power Amp Mint	£3495
Lentek Integrated Amp	£495
Meridian 605 Mono Blocks	£995
Revox B250S Integrated Amp	£375
Naim NAP 90/3 Power Amp	£695
Nakamichi PA 5 Stasis Power Amp	£695
Adcom GFA 5300 Power Amp	£350
Audionote Neiro Mono Amps	£5995
Musical Fidelity P180 Amps with MF 3A Pre Amp with PSU	£995

**DACS**

CEC DX51 mk2 DAC with CEC TL5 transport...NEW	£2295
Krell Studio DAC	£850
CEC DX71 mk2 DAC...NEW	£1595

**CD PLAYERS & TRANSPORTS**

Mark Levinson Ref CD Transport + DAC	£16995
Audio Research CD2 CD Player	£1995

**MISCELLANEOUS**

Audio Note (Kondo) 2mtr interconnect	£1650
--------------------------------------	-------

Shunyata Ex Demo 1m Aries rca interconnects w/ locking connectors normal price £650	£425
Shunyata Ex Demo 1.5m Aries rca interconnects w/ locking connectors normal price £800	£495
Shunyata Ex Demo 3m Lyra Speaker C/W Spades w/ locking connectors normal price £1500	£995
Nakamichi Tri-Tracer 1000 cassette deck	£395
Nakamichi 680 3 head cassette deck	£395
Revox H11 Cassette Deck	£375
Stax SR007 omega ref (SR117 headphone & SPN0071 dual triode)	£1995
Audio Note (kondo) KSL -ACZ mains cable	£350
Audionote (kondo) 3mtr pair SPZ speaker cable	£1995
Audio Note (kondo) ksl-LP Silver litz interconnect 1mtr pair	£850
Yamaha CT-810 AM/FM Tuner	£125
Stax 40/40 Headphones	£850
1 mtr Kondo KSL LP interconnect 695	£600
5mtr Howland bi-wire speaker cable	£195
Nakamichi BX2 cassette deck	£195
Transparent Speaker Cables XLRef 15ft pair	£2750
Sanui TU-D99X Tuner	£55

Madrigal CZGel 1mt Balanced Interconnect	£275
--	------

**TURNTABLES, CARTRIDGES & TONEARMS**

Rega Planar 3 Turntable	£245
Audio Note ANS7 Transformer	£2995
Audio Note M7 Phono Stage	£2995
Koetsu Urushi Gold Unused	£POA
Koetsu Red Unused	£POA
Verdier Ebony Wood arm board	£425
Ortofon Jubilee Cartridge	£995
Lumley Stratosphere Turntable and large power supply	£2995
Michell Gyrodeck with QC Power Supply	£995

**DVD**

Yamaha DVD-S795	£145
Pioneer Elite DVD/CD/Video CD Region 1DVD	£695

We now offer 0% finance (subject to status)  
 Please phone to arrange an audition  
 Main Dealers for Mark Levinson, Thiel and Absolute Sounds  
 Switch, Mastercard, Visa Diners Club, American Express  
**Tel: 01903 872288 or Evenings 07860 660001**  
**Fax: 01903 872234**  
**E Mail: heatherdale@hifi-stereo.com**

**Hazlemere Audio**  
 If you value the best  
 (rather than just the most expensive)

*Spectral*



**Cables**  
 Siltech  
 Spectral

**Speakers**  
 ART  
 Reference 3A  
 Verity Audio

**Digital**  
 dCS  
 Opus 21 (new from Resolution Audio)  
 Oracle  
 Metronome

**Amplification**  
 Chapter Audio  
 DNM  
 Lamm  
 Nagra  
 Plinius  
 Renaissance  
 Spectral



**Supports**  
 Avid  
 Clearlight  
 Kinabalu

**Vinyl**  
 Avid  
 Garrard  
 Oracle

*Avid Acutus Turntable*

**Power supply**  
 Accuphase  
 Isotek  
 Jaya  
 Loricraft

**Audio Analogue**  
 Creek  
 Ecosse  
 Epos  
 Fanfare  
 Gamut  
 Harmonic Technology  
 Ortofon  
 Piega  
 SME  
 Sugden  
 Triangle

For an appointment (day or evening) call High Wycombe

**(01494)**  
**865829**



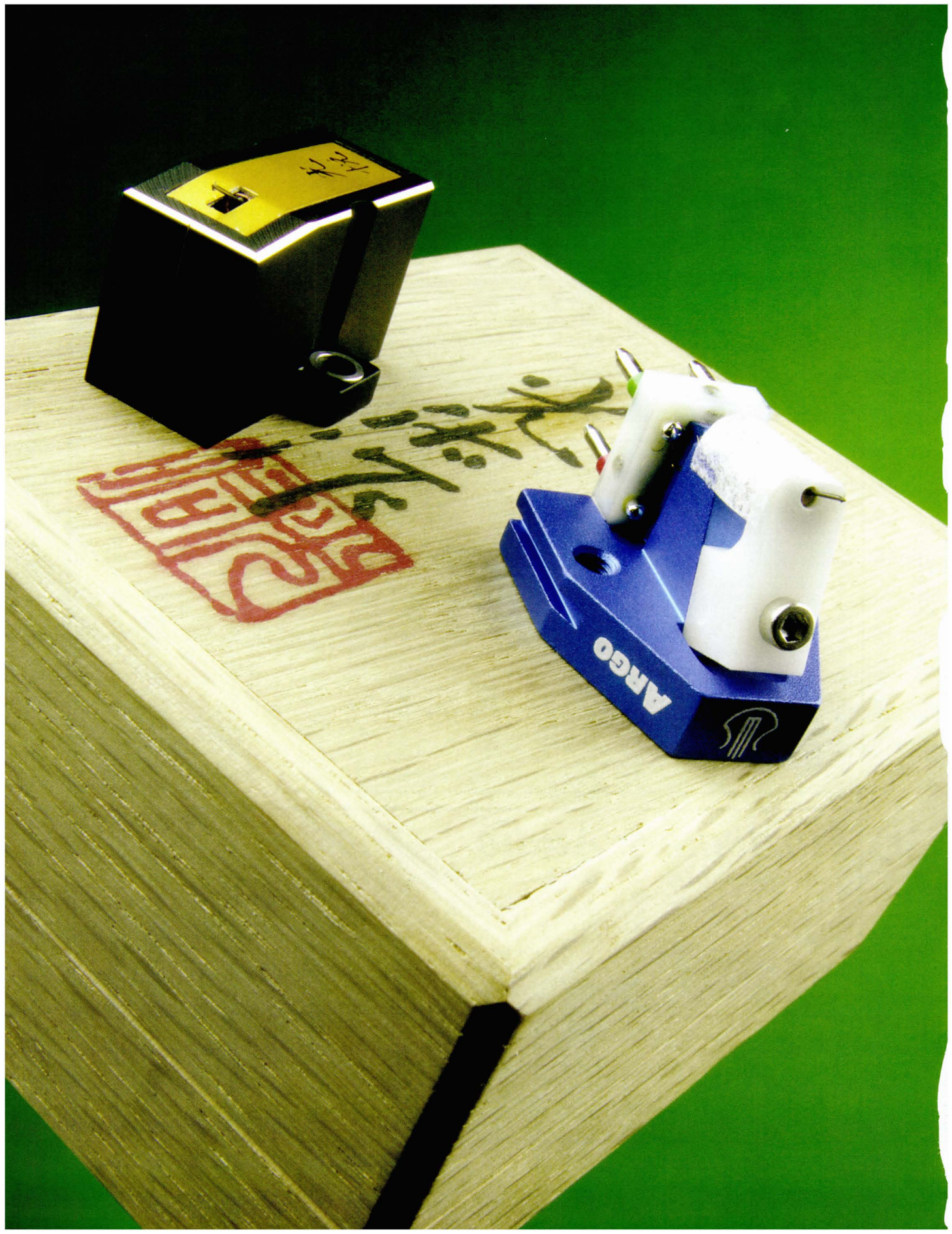



# Analogue Pic-'n'-Mix

## The Rega RB-1000 Tonearm

by Jimmy Hughes

Although it's important to have a good basic design and to use high quality materials, sometimes the difference in performance between something good and something outstanding boils down to tolerance. By painstakingly selecting each individual part for the highest quality, then assembling them with the utmost care, you can end up with results that transcend the sum of the parts. Nowhere is that truer than the world of analogue, where precision engineering and close tolerances still count for much.

Superficially the Rega RB-1000 doesn't look massively different to the RB-600. You've a different base on the more expensive arm and a redesigned bias and arm parking assembly - now made from metal rather than plastic. Cabling is improved and the finish on the arm tube is different. Of course these improved details are welcome. But by themselves they hardly seem to justify the considerable difference in selling price between the two arms. Or is there more to this than meets the eye?

Knowing the importance Rega attach to offering excellent value for money, the RB-1000 is most unlikely to be a cynical attempt to charge outrageous sums for something that in reality is only a slight improvement. You could say the RB-600 represents the best Rega can offer in a mass-produced item selling at a reasonable price. Want something even better? Then only by lavishing

much greater care on component selection and assembly tolerances can the design be taken further.

Apparently, RB-600s are assembled by a team of six who make around 50 tonearms a day. The RB-1000 is made by two or three people, and typically they only produce about 5 tonearms in a day. Parts for the RB-1000 have to fit perfectly - zero tolerance! I was told there are about twenty joints in the bearing assembly, and because of the precision involved it's possible to get to the final joint only to find it won't fit! Just one reason why the RB-1000 is so laborious to build.

Following on from this, I was surprised to learn how labour-intensive it is to finish an RB-1000 arm tube. Cast metal has an inherently poor finish, so Rega disguise this by powder-coating the surface to create a smart appearance. However, RB-1000 tubes are individually selected (having being inspected by X-Ray to detect internal flaws) and the outer surface is not coated - it's nude aluminum, highly polished. As a result RB-1000 tubes are slightly lighter than the other Rega arm tubes.

To put this into financial perspective, it costs nearly seven times as much to produce the tube for an RB-1000 compared to the other Rega arms. Incredible! Superficially, you could easily conclude that the RB-600 and

RB-1000 have the same arm tube. But there's actually a surprisingly big difference. Rega believe the extra care lavished on small but important details,

like improving finish and reducing porosity, add up to audibly better performance.

So - what is the difference? What does the extra money get you in performance terms? I'd sum it up in one word - refinement. The RB-600 is a very fine tonearm; one I could happily live with. But the RB-1000 offers a whole new level of ease and refined control missing in the cheaper arm. It's as though the pickup is finding the tortuous process of tracking the groove a great deal easier. The music reproduces with grace and subtlety, having a delicate fine-grained quality that's quite magical.

Although I can't offer hard proof, it's long been my theory that achieving such a state of affairs is greatly beneficial to the longevity of your cartridge and LP records. The more the stylus retains contact with the groove wall, the less wear and tear there is for both - and the cleaner the reproduction. ►



► Loud crescendos towards end-of-side sounded impressively solid and controlled, without that wispy edge break-up that can make the last few minutes stressful when playing difficult demanding LPs.

Of course it helps if your pickup is of comparable excellence. Initially I used Transfiguration's superb Temper W, then went to the Lyra Argo. In each case there was the same feeling of smoothness and control, coupled with a refined yet dynamic style of presentation that was sharp but well-balanced. Surface noise was vanishingly low, and although that's a credit to the cartridge (and a well-designed stylus tip) it also speaks volumes for the partnering arm and turntable.

One of the criticisms of the original Rega RB-300 was the absence of height adjustment. At the time, Roy Gandy's response was simple; in his view, achieving excellent mechanical integrity had a far greater effect on sound quality than compromising that integrity to allow adjustment. The RB-1000 maintains Roy's principles; once again there's no height adjustment! However, the arm fixing system has been altered. Now the arm is anchored to the baseboard via three screws.

I fitted my review RB-1000 to an Avid Volvere Sequel, and have to say marrying-up the two wasn't entirely straightforward. In this specific case it's partly down to the need for spacing support blocks to get the arm height correct. I found I needed two; using the main spacer on its own left the arm a fraction low, but adding a second (thinner) one left it marginally too high. Given enough spacers, it's possible to get arm height just right. But it's laborious process.

The threaded base arrangement found on the cheaper Rega arms is easier to install and adjust - but it's also less rigid and creates stresses in the base. Looking at the way RB-1000's base fixes, I'd say it's going to be more straightforward to mount on turntables

with a wooden arm board. It fixes via three bolts, and Rega liken the arrangement to a tripod. Assuming the usual height relationship between platter and base, the arm should find an elevation that's nominally correct for most cartridges.

The RB-1000 on Avid's Volvere Sequel, with either of the two cartridges mentioned, provoked numerous 'Why do I need CD?' reactions from yours truly. The sound had a gorgeous openness - a sweetness and delicacy - that CD rarely if ever approaches. Don't get me wrong; I like CD very much. It's just that the best analogue offers comparable (or better!) fine detail, allied to superior tonality. The result seems natural and right in every respect.

Not only was the sound more open and natural, there's also a bracing 'out of the speaker boxes' holographic quality that's very arresting. There's an increased sense of left-right stereo interplay too. Of course, LP cannot equal CD's 'perfect' channel separation. Yet subjectively, LP on a good player sounds wider and more dimensional - voices and instruments spread out beyond the fixed confines of the speakers, creating greater breadth. Bass sounded impressively powerful and tuneful.

So far so good. Yet in many respects it was quite difficult to 'hear' the RB-1000. It's very transparent; you listen through it, rather than to it. Which is just how it should be, of course. The music simply materialises between the speakers, sounding clear, open, and well-separated, with bright clean tone colours and excellent dynamic attack. Set all this against an inky-black silent background, and the impression is one of master-tape like precision and clarity.

Playing a recent Speakers Corner 180g LP pressing of Gunther Schuller's fascinating orchestral work *Seven Studies on Themes of Paul Klee* (Mercury SR-90282) I sat transfixed by the superb sharpness and clarity of the vintage 1960 Mercury Living Presence recording. The treble was brilliant and

very immediate, but there was richness and weight too; lovely bottom end. Tape hiss and background crackle seemed non-existent, yet the sound had excellent presence and projection.

Of course no Mercury recording is entirely free from tape hiss; indeed, many of their recordings sound marginally hissier than similar vintage offerings from Decca and EMI. It's all about getting volume levels right; playing loud enough to reveal presence and detail, but not so loud you emphasise tape noise. With CD, you often have to play the music loudly to create a sense of the music projecting out of the speakers. Here, LP did so effortlessly at moderate volume levels.

LP at its best seems to give a more strongly projected sound. Loud passages appear to expand and grow, creating the subjective impression of increased contrast between loud and soft. The typical bright Mercury tonal balance can seem rather thin on CD; on this Speakers Corner 180g reissue (via the Lyra Argo/RB-1000/Volvere Sequel) the sound was lucid, sharp, but not thin; a nice rich three-dimensional brightness, if that makes sense - not a thin/flat brightness.

As so often in hi-fi, what you don't know doesn't hurt. Those whose funds only run to a Rega RB-600 will find this arm offers superb performance and excellent value. Having spent quite a few weeks living with it, I felt very satisfied by the results produced. But the RB-1000 goes further, and at times the difference isn't subtle. Yes, it's a lot of money. But you get a lot of arm for your dosh. Precision engineering is never cheap; neither is painstaking attention to detail. You get what you pay for. 

Price: £998

Manufacturer:  
Rega Research Ltd  
Tel. (44)(0)1702 333071  
Net. [www.rega.co.uk](http://www.rega.co.uk)



# The Lyra Argo Moving-Coil Cartridge

by Jimmy Hughes

Although by no means the most expensive Lyra cartridge, the Argo is a very impressive performer. My overwhelming first impression was one of sharpness, attack, and immediacy. The tonal balance was very open; lucid and detailed, rather than rich or warm. High frequencies sounded very extended, giving the top-end a crisp highly articulate quality. Musical presentation was analytical rather than smooth or beguiling, though don't take this to imply a lack of refinement.

As so often with pickups that dispense with body covering, the Argo has a lovely openness - a complete absence of coloration. Tonally, the treble sounds very natural and extended. Transient attack was excellent; percussion instruments had impressive attack and immediacy. At the same time there's an equally impressive sense of sounds stopping. Musically, this creates a tight 'abrupt' quality. There's nothing lazy or flaccid about the Argo. It sounds very immediate and purposeful.

All this makes the Argo excellent on LPs that ordinarily sound dull and/or compressed. During the review period I played quite a few '70s pop records, and was surprised and impressed at the way the Argo managed to open-out the sound and reveal lots of hidden detail. Stereo separation was very wide, creating a broad soundstage that had excellent width as well as depth. Despite having a sharp extended treble, surface noise was very low.

Given a reasonably good LP, the music seemed to emanate from an inky-black silent background. Of course on LPs that are scratched or damaged there will inevitably be some disturbance. But the Argo is not a pickup that emphasises problems. Rather, it has a happy knack of finding the 'quiet' part of the record groove. As a result, low-level groove 'mush' (the general hubbub of gentle

ticks swishes and rustles) is minimised - even on those dodgy pressings from the '70s!

In this context the Argo proved very good at getting the most out of compilation LPs with long sides cut at lowish levels. Now you might say such LPs aren't of true hi-fi standard, and you'd be dead right. But, being able to extract a vivid strongly-profiled three-dimensional sound from a mediocre LP speaks volumes for a pickup's resolving ability at low modulation levels. It doesn't lose low-level resolution, meaning quiet passages retain plenty of presence and colour.

Output is not excessively high (0.45mV ref 5cm/s) but the general liveliness of the sound coupled with excellent transient attack creates the subjective impression of power and immediacy. I fitted my review Argo to Rega's RB-1000 arm on an Avid Volvere Sequel turntable, and felt the combination delivered outstanding quality of reproduction. As already stated, overall presentation was lucid, and detailed: sharp and analytical, rather than warm and beguiling.

In the early stages, while the cartridge was still bedding in, I wondered if the top-end was sometimes a little too frisky - creating a slightly exposed upper treble. But such notions diminished with extended use. Nevertheless, the Argo may sometimes exhibit a slight sting in the tail. For example, some original early '60s Decca classical LPs were sometimes a wee bit 'toppy' with this pickup - though isn't that simply the cartridge responding to the way such records were mastered and pressed?

It's funny, but some of my prized

vintage Decca LPs that sounded really fabulous on the hi-fi equipment I had (say) twenty-five years ago, now seem less impressive when played on the best modern gear. In cases where I've got the same Decca LP in early and late pressings, the extra smoothness of the latter now seems preferable to the brilliance and immediacy of the former. Not always, of course, but generally those early Decca LPs can easily sound over-lit.

Actually, judged over a wide range of musical material with records from

the recent and distant past,

the Argo's a pretty good

all-rounder. It's lucid

articulate qualities

aid recordings that

lack sparkle and

immediacy, while

its innate naturalness

and refinement ensure

that bright-sounding

LPs usually don't

sound too edgy or out

of control. No pickup can

be all things to all men, but this one gets closer than most. It gets a lot off every LP, no matter what it is, or how good.

Bass proved very solid and at times surprisingly powerful. But (perhaps because the treble is so crisp and open) you tend not to notice the bottom-end until it's there. Sometimes the Argo sounds deceptively light and spacious, giving an engagingly fresh open airy sort of presentation. Then, suddenly from nowhere, a bass drum comes in, or perhaps a deep organ pedal. And it surprises you. Given a good arm and turntable, bass quality should be very lucid and detailed.

Tracking ability is good. Lyra recommend a downforce of between 1.7g and 1.8g, and at these pressures the Argo copes with most records. At times you could almost be listening to CD, ▶



▶ such is the general feeling of security and freedom from background noise. The Argo certainly sounds as if it's in control; even during loud passages it retains an impressive sense of ease and refinement that is very reassuring. You rarely sense it's experiencing trouble.

The stylus seems to keep itself clean too - even when it outwardly picks up dust and fluff.

I try to keep my LPs as dust-free as possible, but it's impossible to achieve 100% cleanness. Sometimes, after a few sides, I'd notice a build-up of fluff around the tip of the cantilever. Yet this did not seem to affect the quality of reproduction - at least not in any way I could discern. Once dusted clean, the stylus tip always seemed to keep free of contamination - deposits didn't seem to build up.

A practical drawback with many open-bodied pickups is that no stylus guard is supplied - there being nothing to physically attach it to. However, not

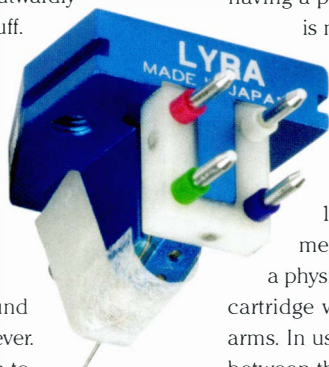

the Argo; it's supplied with a large clear plastic cover that protects the exposed tip. Because the cover is generously oversized you don't feel anxious fitting it, worrying in case you accidentally prang the cantilever while sliding it into place. With so many modern turntables not having a protective lid, having a proper stylus guard is mighty useful.

The cantilever is made from solid boron, and it's thin - very thin; you have to look hard to see it! Compliance is approximately 12cu - on the low side of medium - and this coupled with a physical weight of 6.5g means the cartridge works well in medium-mass arms. In use there's plenty of clearance between the exposed body housing and LP surfaces. And the pickup is physically stable - there's no tendency to oscillate or tremble on warped records.

Because any pickup cartridge's performance is profoundly affected by its partners - the tonearm and turntable - it's not always easy to isolate specific attributes. Nonetheless, I felt the Argo

was very good in terms of timing.

Certainly, the combination of Volvere Sequel, Rega RB-1000, and Lyra Argo created very cohesive results musically. There was something very focussed and purposeful about the sound in musical terms; the results were very involving.

From all I've written above, you might intimate that I really rather liked the Lyra Argo. I certainly did! It's a cartridge I could happily live with, being impressively open, detailed, and focussed, with excellent clarity, good tracking ability, and low surface noise. It's an outstanding all-rounder, being crisp and lively on pop and rock, while able to offer all the refinement and naturalness needed for classical music. It's top-end detail and energy might not suit bright-sounding systems. But other than that I can't see it being anything other than a pleasure to listen to. ▶+

Price: £849

UK Distributor:  
Path Premier  
Tel. (44)(0)1844 219000  
Email. premier@path.co.uk

## The Koetsu Black Moving-Coil Cartridge

by Roy Gregory

Tell a non-audiophile friend you're planning to spend £1000 on a pickup cartridge. He'll look at you as if you're crazy. But of course, in Audiophile terms, £1000 is far from being a huge sum to spend on a pickup. Indeed, in the Koetsu range it represents entry level. But it's all relative; with Koetsu prices peaking at just under £8000, the Black is comparatively cheap and affordable - big emphasis on the word 'comparatively'! Older readers may recall the original Koetsu Black. Although a steady seller for over a decade, it was dropped from the Koetsu range in 1997 or thereabouts. Now some six years later it's being

reintroduced although whether the design has changed in that time I cannot say. The pickup comes in a nice wooden box, and - that's more or less it; no mounting hardware, no descriptive leaflet telling you suggested playing weight or compliance, etc. Minimalism lives!

My guess is, the new Black does differ from the early Blacks I recall from the '80s. The original was sharp and brilliant, with a crisp open tonality and plenty of impact. The new Black strikes me as an altogether more relaxed cartridge. It's not exactly lacking in brilliance or immediacy, but overall the

presentation is notably more cultured and refined. There's a smoothness and ease I don't recall with the original cartridge; bass-treble extremes seem better balanced.

Playing one of the Lorin Maazel/DG New Year's Day concerts recorded live in Vienna, I was struck by how sweet and meliflous this early digital LP sounded. In 1983, when the disc was released, contemporary equipment made the recording seem somewhat tight and airless, with acidic string tone and a distinct lack of richness and warmth. There seemed to be very little dimensionality to the stereo ▶



▶ imagery; the soundstage was cramped and 'small' without much tonal bloom.

Some dryness remains. But now it seems pretty much the sort of natural dampening you'd expect when recording live in a hall filled to capacity. With longish LP side lengths, cutting levels are on the low side - another factor that creates the impression of a small soundstage. But the Koetsu Black wasn't fazed. Its ability to reproduce lots of subtle low-level detail ensured there was plenty of presence, even in the quietest passages. Also, the sound stayed clean - right to side ends.

Tracking ability is very good; the new Black really sounds as if it's in complete control. Playing the Maazel/DG New Year's Day LP demonstrated the Black's ability to deal effectively with bright forward-sounding discs cut at a low level. Often, records like this can be surprisingly difficult to reproduce cleanly - almost as though such ultra-fine modulation levels are hard for the stylus to trace.

One generally thinks that LPs cut at very high levels will be the most taxing - and of course in many ways they are. But discs cut at a low-level can be just as demanding, highlighting the ability of the stylus to trace tiny modulation levels. Significantly, there was little or no discernible change in sound quality over the whole LP side; the expected (inevitable?) coarsening towards side-ends did not occur. Another significant characteristic was the lack of LP surface noise. Of course it can't work miracles on dirty/worn LPs. But even on discs in less than pristine condition it's good at pulling out the music while minimising unwanted disturbances. I plumped for a playing weight of about 2g in Rega's RB-1000 arm on an Avid Volvere Sequel turntable, and results were fine - though the highish mass of the Black meant

the Rega counterweight was pushed well-back.

Cantilever is made from boron, giving excellent stiffness and rigidity. Koetsu fit their preferred quadrilateral diamond tip. The body is made from black anodised aluminum, making it easy to distinguish this model from the ever so slightly more expensive (£2799!) Black Urushi. Output is 0.42mV, and a neat plastic stylus guard is provided.

Koetsu cartridges have a long, long working life. Tip wear seems to be very very low; virtually non-existent, even given several years' use. More importantly, the cartridge innards keep their tensions and tightnesses; many cartridges rattle themselves to death over time. Not a Koetsu; even after several years' regular use the sound retains it's 'like new' clarity and solidity.

Tonally, I'd describe the Black as pretty natural and neutral in terms of balance. The sound is smooth and well-balanced, with a crisp airy treble, open-sounding mid-band, and tight solid bass. Unlike some of the '80s Koetsu cartridges, the presentation isn't especially rich or euphonic. Nevertheless, by typical CD standards, there's definitely something sweet and mellifluous about the way the Black makes music - a refined civilised quality. Overall, the impression is one of unexaggerated naturalness.

Transients sound fast and crisply delineated; the sound stops and starts very precisely. Yet there's none of the 'in your face' forwardness that such quality sometimes imply. The original Black could, I recall, sometimes be a little aggressive - a wee bit 'hi-fi' on the wrong recording. The new Black seems much

better behaved, retaining its poise and control to a very high degree. There's no lack of treble brilliance when called for, but overall the impression is one of control and refinement.

I started this review by pointing out that the Black is Koetsu's entry level model. And so it is; the next model in the range costs half as much again. Which begs the question - what exactly do you get by spending more? When the entry level model is so outstanding, is there any point considering the other pickups in the Koetsu range? A good question. At times, as I listened to the Black, I found myself wondering if vinyl gets any better - it was that good.

Having experienced some of the more expensive Koetsu cartridges in years past, I know the Black doesn't quite have the incredible delicacy and three-dimensional holographic imaging qualities of its more costly brothers. It's difficult to put the difference into words. I'd describe it as a combination of effortless ease allied to a shimmering filigree tonality and vivid presence; ear candy as its very best! But, closer to what was on the original mastertape? Perhaps.

Then again, perhaps not.

The Black strikes me as a very honest cartridge. It gives you the music cleanly and truthfully; without obvious embellishments or exaggerations. It's essentially neutral and natural.

Nonetheless, it offers attractive tonal qualities that are beguiling and very easy on the ear. Me? I loved the Koetsu Black. Simple as that! ▶+

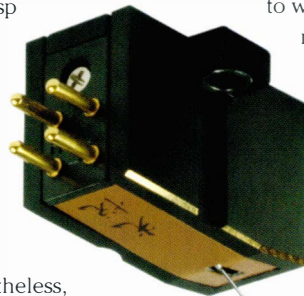
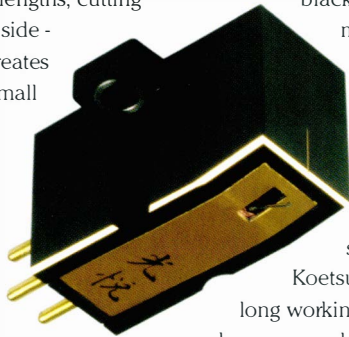

Price: £995

UK Distributor:  
Absolute Sounds  
Tel. (44)(0)20 8971 3909  
Net. [www.absolutesounds.com](http://www.absolutesounds.com)

Stockists of:

NAIM

DYNAVECTOR

WELL TEMPERED

MICHELL

SHAHINIAN

PMC

ROYD



adventures in hi-fi

*we're passionate about music, are you?*

Tel: 01942 234202  
www.adventuresinhi-fi.com

5 BISHOPGATE  
CRAWFORD ST.  
WIGAN  
WN1 1NL

Tue-Sat  
10am - 5.30pm

AUDIONET  
ATC  
AVI  
AYRE  
AUDIO SYNTHESIS  
BRYSTON  
CHORD  
CLEARAUDIO  
GAMUT  
LEXICON  
LYRA  
NORDOST  
PRIMARE

# Audio Reflections

PSAUDIO  
PMC  
REL  
RED ROSE  
REVEL  
SME  
STAX  
TAG McLAREN  
TOM EVANS  
TRANSFIGURATION  
WILSON BENESCH  
WADIA

FOR SALE - GAMUT D200, PS AUDIO HCA2, POWERPLANT P300, RED ROSE M5

TEL: JOHN BLEAKLEY (LEEDS) 0113 2049458 : SIMON TRICKETT 0113 3873609

E-MAIL: info@audioreflections.co.uk FAX: 0113 2533098

CLEARAUDIO CHAMPION

AVI INTEGRATED AND CD

BRYSTON 148 SST

TOM EVANS - NEW GROOVE PLUS

ATC SCM-35

NEW AUDIO SYNTHESIS DAX

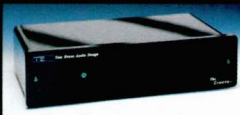

## STOCKISTS OF LEADING HI-FI

- A careful selection of the best Hi-Fi to suit most budgets.
- Two comprehensive listening rooms.
- Expert advice on building a system.
- Expert advice on improving existing systems.
- Home installation service.
- Call in for more information or a demonstration.
- 0% Finance Available on request.

# Basically Sound

NORWICH · NORFOLK

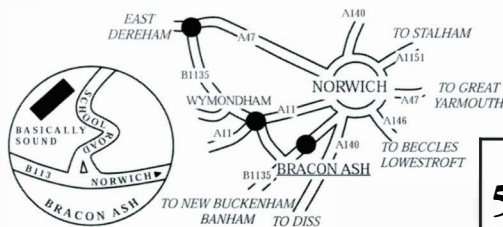

01508  
570829

CLOSED MONDAYS  
AND SUNDAYS

Basically Sound of Norfolk, The Old School, Bracon Ash, Nr. Norwich, Norfolk NR14 8HG  
www.falcon-acoustics.co.uk

NOW ON  
PERMANENT  
DEMONSTRATION,  
THE COMPLETE  
RANGE OF  
NAIM AUDIO  
EQUIPMENT,  
INCLUDING THE  
CDS 3, 552 AND 500.





# new audio FRONTIERS

hi-fi retail

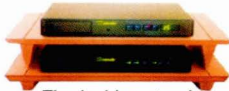

The Isoblue stand  
a new reference

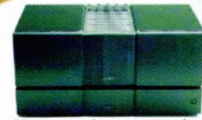

Now on demonstration  
the amazing Naim NAP 500

Dynavector moving coil  
cartridges, the best there is



43 GRANBY STREET  
LOUGHBOROUGH  
LEICESTERSHIRE  
LE11 3DU

TEL: (01509) 264002  
FAX: (01509) 219900

E-mail:  
naf@replete.freemove.co.uk



exclusively available in Ireland

ACOUSTIC ZEN CABLES, AUDIENCE CABLES, ADVANTAGE,  
BAT, BOULDER, HOVLAND, KARMA, LUMLEY, PASSLABS



WE ARE ALSO STOCKISTS OF ACOUSTIC ENERGY, ARCAM, AMPHION,  
AUDIO PHYSIC, AUDIOMECA, AVID, CYRUS, CLEARAUDIO, KEF, MARANTZ,  
MUSICAL FIDELITY, MISSION, O'HEOCHA, PROJECT, ROKSAN, ROGUE AUDIO,  
RUARK, TRIANGLE, UNISON RESEARCH, VPI PLUS MANY MORE...

8-9 SCOTCH STREET CENTRE  
DUNGANNON, N IRELAND. BT70 1AR  
T. 028 8775 3606  
E. DAVID@KRONOSHI-FI.CO.UK

multi-room and home  
cinema products  
also available



OPENING HOURS: MON-SAT 10:00-5:30 / CLOSED WED/SUN > FOR DEM FACILITIES PLEASE BOOK IN ADVANCE < WWW.KRONOSHI-FI.CO.UK



# LAMM

Quite simply...  
the world's best  
audio electronics



Distributed in the U.K. by:  
Integrated Engineering Solutions Ltd.  
(023) 8090 5020 (tel.)  
(023) 8070 4073 (fax)  
info@highendaudio.co.uk  
www.highendaudio.co.uk

www.lamindustries.com



power amplifiers: M1.1, M2.1, ML1.1, ML2

preamplifiers: LL2, L2

phonostage: LP2







# The Real Deal

## Pro-ject 1 Xpression Turntable... and Tube Box Phono-stage

by Alan Sircom

Let's be honest, most of us Hi-Fi+ readers and reviewers are a snobby bunch. A £200 turntable is the nursery slopes of hi-fi, even with a £300 valve phono stage in tow. After all, many of us wouldn't baulk at blowing £500 on a set of cartridge tags if we thought the improvement justified the expense.

Away from our heady hi-fi sensibilities, £200 is all most people would spend on a record player. In fact, £200 is considerably more than most people would spend on a turntable, which demonstrates why Pro-ject is one of the most successful hi-fi vinyl spinning companies around at the moment. Pro-ject's Debut deck comes in at around £100 and outsells every other hi-fi turntable by a large margin. Trouble is, a £100 deck as good as the Debut makes 'selling up' a hard task for the dealer; it's good enough to make the next models in the Pro-ject range difficult to justify; you'd have to start looking at decks costing £300 or more to make the upgrade worthwhile. Or that was the case until very recently. The new Pro-ject 1 Xpression raises the bar for £200 decks from Pro-ject, and – by extension – the performance of vinyl replay at the price.

The deck is very similar to the existing Pro-ject 1 turntable, but with a significant twist – the tonearm's armtube is made from carbon-fibre. That's right – a £200 turntable complete with a carbon-fibre tonearm. Apart from the next-generation tonearm materials (chosen for its weight and lack of resonant properties), the

arm includes the usual Pro-ject open bearing design and includes easy VTA adjustment, or even azimuth adjustment at a pinch. The rest of the deck is good budget fare, with a specially balanced cast aluminium platter and felt slipmat, belt driven by an AC motor on a solid MDF chassis. There's no speed control as standard (you have to change the position of the belt on the motor spindle, a la Rega decks), but you can also get an optional £50 'Speed Box' to electronically change the speed – but we didn't test that this time.

A suspension-free deck does require a good vibration-free location to work properly; and Pro-ject also supply an optional wall bracket for around £70. While the Xpression is not the most feedback-prone deck around, there's not much isolation or levelling on hand and a well isolated, level turntable bracket is a good investment.

As part of the package, the turntable comes with a serviceable cartridge, the Ortofon OM10. This should be considered a starting position at best; you can upgrade by swapping to a Stylus 20, but the best option would be to start over again. And it's here that the quality of the carbon-fibre arm shines through. For those of us trained the classic (Classik?) Linn way, a £200

turntable should always be partnered with a moving magnet cartridge, ideally one costing about £50 or less. Throw that idea away with the Pro-ject 1 Xpression; this has an arm that can take frankly mental cartridge combinations.

Naturally, with Henley Designs strong ties to Ortofon, the company would like to match the deck with something Ortofonny;

to this end, Henley supplied the deck with an Ortofon MC25FL moving coil cartridge. But, you could easily swap this for a real star performer from outside the Ortofon camp, like a Benz-Micro, a Dynavector, or a Sumiko Blue Point Special. I wouldn't recommend partnering the

Pro-ject 1 Xpression with a Koetsu Black, but the deck/arm combination falls only slightly short of that mark.

Of course, if you are planning on using a £500 cartridge – regardless of the sort of turntable it sits in – you are going to need one hell of a phono-stage to make the best of it. Enter the £300 Pro-ject Tube Box. A valve-based dual-mono phono-stage with a pair of ECC83 double triodes, the Tube Box was initially specified by Henley as an up-market turntable stage for the best Pro-ject decks in the range. Although seemingly expensive by Pro-ject standards, this useful



► box has sold more than 100,000 units, which represents something truly incredible in a format that was notionally on the skids a generation ago.

The Tube Box is brutally simple in its execution. The front of the box has two little glass windows and a ventilator grille along the top. It's got a big button on the front panel with an almost redundant blue LED above it (the glowing tubes are a dead giveaway regarding its power status). Power is fed via an external plug-top supply. You can also adjust the Tube Box to suit a wide variety of cartridges; 47kOhm MM, or 100Ohm, 220Ohm or 1kOhm MC, all adjustable from a set of DIP switches on the bottom of the case.

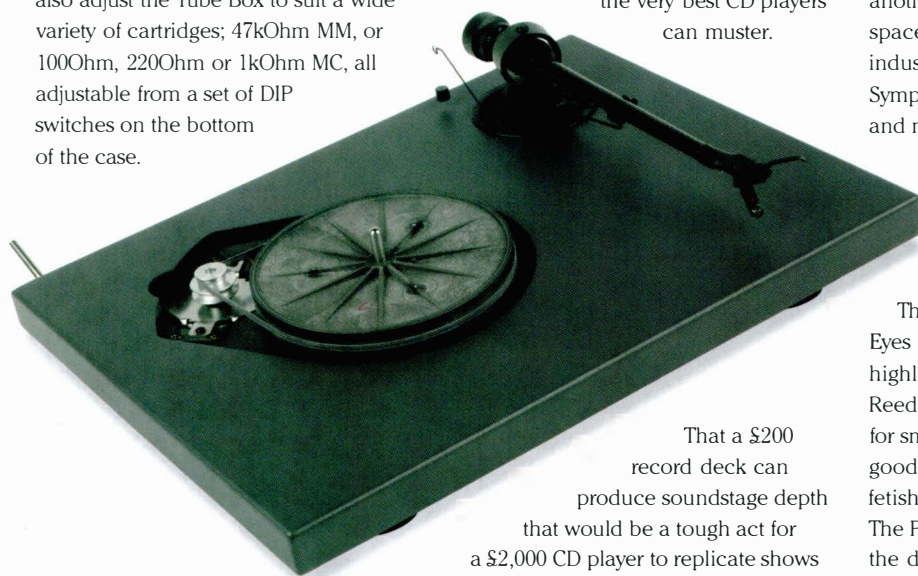

It's not exactly the prettiest box in hi-fi, but it looks solid enough to withstand a blast from a mortar shell, and many an audiophile will forgive a product for brute styling if it looks like something the Scorpion Tank dragged in. Aside from the glowing front panel and a Pro-ject logo, the corrugated black gloss alloy case looks like it could be something knocked together out of the Maplins catalogue. It also requires a large amount of running in; those valves need a good few dozen hours to bed in, although you could keep the Tube Box running constantly; you may find it best to power it down at the close of every listening session as it does run hot to the touch.

Listening to both deck and phono

stage instantly reminds you why LP is still a going concern even in this age of multi-channel digits. Taking the deck first: it's a minor revelation. You don't get sound this good from cheap CD. In fact you'll be hard pushed to get this sort of sound from any source this side of £500.

There's a sense of naturalness to the sound of the Xpression. It makes a three dimensional bolus of sound between the speakers, with accent on depth information. The player reaches far back into the soundstage like only the very best CD players can muster.

That a £200 record deck can produce soundstage depth that would be a tough act for a \$2,000 CD player to replicate shows us, a) this is a very fine record deck, b) that CD really isn't all it's cracked up to be or, c) all of the above.

The musicality of the Xpression is not to be sniffed at. It is one of the most, er, expressive players you can get at the price, and beyond. Out came the *Silly Sisters* – June Tabor and Maddy Prior's eponymous first album – and the harmonies hang together like a pair of fantastic-voiced folkies out on the lash. Switch over to the Stone Roses and the rhythm is precise yet always fun. Both recordings can be undermined by the lack of vocal clarity; the former from the folk-vocal equivalent of Yngwie Malmsteen plank-spanking, the latter indistinct due to the ingestion of copious amounts of recreational pharmaceuticals and a very dense

dance mix. Yet, in both cases, the vocals are clearly defined and easy to follow, as is every other instrument in the mix.

So where does it sound like a £200 player. Well, it hides its low price extremely professionally, from a musical standing. It isn't the most detailed performer around and the sound is ever so slightly geared toward the small scale. Big orchestral works have a degree of foreshortening, both in terms of soundstage width and sheer detail. It's like the orchestra has to sit on one another's laps to squeeze into the small space between the speakers. The industry-standard Athena Rachmaninov Symphonic Dances had all the rhythm and much of the dynamic energy that the disc can offer, but just failed to cram the whole orchestra into the picture.

Play something less large scale and the Xpression shines.

The Velvet Underground's Pale Blue Eyes retains plenty of charm but also highlights the lyrical beauty of Lou Reed's fragile voice. There's a tendency for smaller, lighter decks to only sound good on small-scale music; the Rega fetish for folk music is a perfect example. The Pro-ject 1 Xpression is not like that; the detailing and solidity allow the player to handle almost everything with ease and beauty. It only shows its cheap status on the biggest orchestral or Phil Spector-esque wall-of-sound recording.

The arm is a real wonder. No, it's not going to out-perform a Graham and – in absolute terms – probably only offers Rega RB300-level performance, but the carbon-fibre armtube does make for a wonderfully neutral tonality and plenty of space and air. That's where it scores highly; it has that ring-free rightness about the sound that is usually the domain of more up-market arms. It has a distinct character about the sound, but that sound is a bit like an SME V in microcosm. It's controlled, taut, clean and entirely free of overhang. It's also a bit lacking in zing, a bit like an SME, too, but if anything it is even more



► dynamically free than more solid arms. Of course, that dynamic freedom comes at the expense of the bass, which lacks 'architectural' solidity.

We cannot stress this strongly enough; the deck as it stands is limited in performance only by that Ortofon OM10 cartridge. It's not a dreadful-sounding cartridge, but it is far removed from what constitutes good hi-fi sound. Change it as soon as possible, but change it for something good – it's a waste of a good deck to swap the OM10 for something like an Audio-Technica AT-91. The arm is good enough to accept a decent moving coil cartridge, so feed it one. You'll be surprised.



Lastly comes the phono stage. It's an obvious hi-fi cliché to call anything with valves 'warm', but like any cliché, it comes with a fair degree of truth entailed. This is a very warm-sounding phono stage, but more warm and inviting than warm and woolly. The phono-stage invites you into the music, making things interesting and comfortable, but not in a soft or deliberately euphonic manner. It is detailed, too; not the stark, bare-faced detail of a bright CD player, but clean and precise. But best of all, the Tube Box is extremely lucid and coherent; musical performances just 'hang' together like real musicians do, and this makes turntables sound even more

like the real world, and yet again shows why vinyl sounds better than CD. You can get a CD player that has the naturalness of the Xpression/Tube Box, but you'll need to spend Wadia money to do it. That makes the Project a bargain, although it also makes many similar record deck/phono stages a bargain, too.

The Tube Box works well as a stand-alone product, even one far removed from the rest of the Project range. If Project had no provenance as a turntable manufacturer, simply on the

basis of the Tube Box alone, the company would gain a reputation for quality vinyl sound. The £300 phono-stage market is a surprisingly crowded one, but the Tube Box fits in snugly. Its warm, full sound with that deep soundstage makes it a perfect alternative to the likes of the detail-freak stages from Tom Evans, for example.

Taken separately or together, the Project 1 Xpression and the Tube Box represent all that's great about vinyl, especially vinyl replay in the 21st Century. Both are the jumping off point for good hi-fi sound; they have that high-end sonic character, but without the OTT

build, finish and price tag of true high end products. Of the two, the Xpression is the real star; there are other good phono-stages at the £300 mark, but the Xpression – with that fantastic carbon-fibre arm – sets a standard that can only be bettered by doubling the price tag. It cries out for a cartridge that costs much more than the deck itself. ►+

#### TECHNICAL SPECIFICATIONS

##### Project 1 Xpression Turntable

Type:	Belt-driven non-suspended turntable
Speeds:	Manually selected 33/45rpm speeds (optional Speed Box)
Platter Mass:	2.2kg
Maximum speed deviation:	+/- 0.5%
Stated Wow and Flutter:	+/- 0.1%
Stated Rumble:	-70dB
Dimensions (WxHxD):	415x118x334mm
Weight:	6.3kg

##### Tonearm

Effective Length:	218.5mm
Effective Mass:	9.5g
Overhang:	18.5mm
Cartridge Mass:	3.5g – 6.5g
With Optional C/W:	6.5g – 9g
Price:	£200

##### Project Tube Box Phono-stage

Type:	Dual mono valve design (features 2x ECC83)
Sensitivity:	Selectable MM/MC
Adjustability:	Selectable impedance for MC cartridges
Output Voltage:	300mV/1kHz at MM input (Gain 40dB) 300mV/1kHz at MC input (Gain 60dB)
Stated Noise Floor:	MM -89dB/MC -79dB
Subsonic Filter:	18dB/octave at 18Hz
Dimensions(WxHxD):	130 x 80 x 160 mm
Weight:	1kg (without PSU)
Price:	£300

##### UK Importers:

Henley Designs Ltd,  
Tel. (44)(0)1235 511166  
Net. [www.henleydesigns.co.uk](http://www.henleydesigns.co.uk)

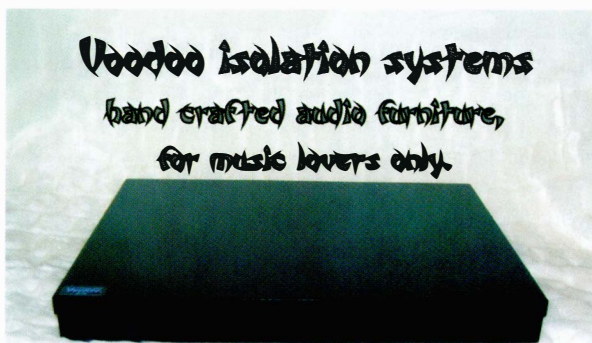

PNEUMATIC ISOLATION PLATFORMS, INTEGRATED RACKS  
SPEAKER PLATFORMS AND STANDS. EXCELLENT REVIEWS  
A CHOICE OF REAL WOOD FINISHES. CUSTOM WORK UNDERTAKEN.  
ALSO THE RANGE OF EXCELLENT SILVER ARROW CABLES.  
TEL. +44 (0) 1 643 841244 E-MAIL. voodooitek@hotmail.com  
DEMOS BY APPOINTMENT

## THE EMPORIUM

www.emporium.dircon.co.uk

We are not just the UK's largest vintage and used HiFi stockist. We LOVE HiFi. We have endless patience and will work with you until you get it right. Martin, one of our customers liked us so much, he gave up his career to work for us full time!

Call or visit (by appointment)  
11am - 5pm, Mon to Sat.

PRICES RANGE FROM £100 TO £10,000

email: [emporium@despammed.com](mailto:emporium@despammed.com)  
tel/fax: 01379 870873  
MAIL ORDER AND EXPORT SPECIALISTS

## hi-fi+ Subscription Form

In order to ensure prompt arrival of your copy of hi-fi+, it is safest to take out a subscription. This lasts for a year, or 8 copies, and means that your magazine is delivered to your doorstep immediately it is published. No more fruitless journeys in search of audio enlightenment, and no more worries about missing an issue.

In order to apply, simply fill in the form, legibly (!), and drop it in the post.

### UK, Western Europe & Rest of the World:

#### One Year Subscription / 8 Issues

Within the UK, \$28.50 Western Europe, £37.25  
For the rest of the world (excluding USA/Canada) \$46.00

#### Two Year Subscription / 16 Issues

Within the UK, \$48.00 Western Europe, \$65.00  
For the rest of the world (excluding USA/Canada) \$80.00

#### Contact:

hi-fi+ Subscriptions, Unit 12 Albany Business Park  
Cabot Lane, Poole, Dorset BH17 7BX, UK

#### Or call:

Andrea Chick on Tel: 44 (0)1202-659380  
or Fax: 44 (0)1202-659540

#### Via the web: [www.hifiplus.com](http://www.hifiplus.com)

### USA & Canada:

#### One Year Subscription / 8 Issues

USA, \$65.00 US Canada, \$72.00 CN

#### Two Year Subscription / 16 Issues

USA, \$130.00 US Canada, \$144.00 CN

#### Contact:

US: DirectMag, PO. Box 2165, Williamsville, N.Y., 14231  
Canada: DirectMag, 695 Westney Rd. S, Suite 14, Ajax, Ontario,  
L1S 6M9

#### Or call:

Tel: Toll Free 1-877-474-3321 or Fax: 1-905-619-2903

#### Via the web: visit DirectMag @ [www.magamall.com](http://www.magamall.com)



### ABOUT YOU:

Title -----

Forename -----

Surname -----

Address -----  
-----

Country -----

Postcode/Zipcode -----

Daytime Tel -----

I would like my subscription to start from issue: -----

One Year  Two Years

### PAYMENT:

UK  Europe  Rest of World

Cheques to be made payable to Hi-fi+ Publishing limited.  
(drawn on a UK bank)

US  Canada

Checks to be made payable to DirectMag.

Visa  Access/Mastercard

Card No -----

Expiry Date -----

Switch

Card No ----- Issue No -----

Expiry Date -----

Signed ----- Date -----

How did you hear about us?

shop  web  airlines  friend  other -----



# Duende Criatura Tube Rings

by Roy Gregory

Tube dampers: an ever present in the tweeker's armoury, but one with a distinctly chequered past. Who can forget those Sorbothane damping rings that melted over time and slithered down the tube to contaminate the pins and sockets? Indeed, tube damping seems to have been an open invitation to every audio inventor out there, each looking to invent a better mousetrap. Why? Because the mechanical damping of tubes delivers a clearly audible advantage. It only takes a quick AB comparison to convince even the most sceptical of listeners, and if it's your baby/invention/device doing the damping then it's hard to resist the conclusion that a grateful audio world is going to beat a path to your door. But you couldn't be more wrong.

There are a number of problems with damping valves, not the least of which is the relatively small number of people who actually run valve amplification. (you can forget guitarists, perhaps the biggest potential market, on the basis that they actually WANT distortion!) But the next problem is consistency. It's easy to make a damping device that works short-term. It's harder to maintain that effect over a period of months or years. Finally, there are the practical issues of size and cost. Most thermionic amplifiers use enough tubes and pack them tightly enough together that anything bulky or expensive becomes self-defeating.

To date, I've only found two valve dampers that actually deliver sonically and in terms of longevity. One is the Sicomin damper, a small composite sleeve that fits over pre-

amp valves like ECC83s (or EL84 output tubes – but they're the exception). It certainly works and goes on working. The problem is that they're not cheap and as far as I'm aware, they only come in the smaller diameter. This lack of definite knowledge is the other problem. I got mine some ten years ago. I don't know if they come in larger sizes or not, or if they're even still available.

My other success story is the Pearl Valve Cooler, a metal concertina sleeve that clamps over your valve, held in place with a rubber O ring round its circumference. These are claimed to mechanically damp your tube (in which regard they are spectacularly successful) and increase its life span by allowing it to run cooler (on which subject I have no evidence). The problems with the Pearl were simple. Standing out

a centimeter or more from the circumference of the valve, actually fitting them was a problem in many cases. The company suggested that in tight installations you could actually dispense with the O ring and interleave the fins of the coolers, almost like the teeth of cogs. Unfortunately, devoid of the clamping ring the coolers simply rattled against the valve, actually making the sound worse. The other issue was the rubber O rings themselves: The heat from the valves caused them to break, thus leaving you with an unclamped damper. This made regular inspection and replacement essential, which was a real pain if you are talking about an enclosed chassis or pre-amp. Nevertheless, if you could put up with the hassle then the Pearls were the show in town, and they're still available



from Moth Marketing  
(Tel. (44)(0)1234-741152,  
[www.mothgroup.com](http://www.mothgroup.com))  
However, trawling round the Frankfurt show this year, I came

► across a new damper, stunning in its simplicity, dramatic in its effect. Manufactured by Duende Criatura in Holland, and named simply Tube Rings, these are Teflon hoops that are slit so that they can be expanded to fit over a valve bottle. There's a groove around the outside and this locates a titanium C spring to provide the necessary clamping tension. They are manufactured in eight standard sizes and fitting is simplicity itself. You just slide the ring over the top

of the tube and position it level with the top-plate of the internal metalwork. Once in place they stay put, and recent substitution of brand new samples for ones that have been in use for a good six months produced no identifiable difference in effect, which bodes well for longevity. Indeed, the only real limitation on their use is that the valves involved must have parallel sides.

In use, the benefits of the Tube Rings are sonically on a par with the Pearls (although without any cooling benefits). You get crisper and greater dynamic range, a blacker background, better focus, deeper and more powerful bass. In fact, all the things you'd expect from a good valve damper. But it's the magnitude of the differences that really impresses. You'll not be straining to hear them and they are both musically significant and hi-fi relevant. The sheer increase in clarity and separation makes it far easier to hear exactly what is going on within the music, while the increased dynamic range, control and discrimination make performances much more expressive, involving and realistic. Even CB, a notorious sceptic when it comes to such

devices, was left open-mouthed with surprise when I demonstrated their effect on the Audiopax amps. Not bad for such a simple, cheap and trouble free tweak I think you'll agree. Anybody with a tube amp, especially an open chassis model should investigate these plain looking little rings immediately. The fact that you'll probably be getting them mail order means that you can try them safe in the knowledge that you can return them if unconvinced, but somehow, I think you'll be keeping them once you hear the effects. They're now considered essential as far as I'm concerned, and bring new meaning to the term 'Simply The Best'. ►+

### Prices and Sizes

Diameter	Tube Types	Price
9-10mm	6021W, 6111WA etc	€14-52
19-22mm	ECC83, EL84 etc	€14-52
26-29mm	6SN7 etc	€17-24
27-32mm	EL34, 5AR4 etc	€21-78
36-39mm	KT90, 6L6GC etc	€24-14
39-42mm	2A3, 300B etc	€25-50
44-48mm	KT66, KT88, 6550 etc	€25-40
53-58mm	211, 845, 813 etc	€31-78

Note - all prices in Euros.

Rings are supplied in packs of two.

Special sizes can be produced at the same price as the next size up.

Supplier:

Duende Criatura

Tel. (31)(0)596 633650

Fax. (31)(0)596 634703

In the USA, contact:

Divergent Technology

Net. [www.divertech.com](http://www.divertech.com)

# Eben Acoustics ColdRay Isolation Feet

by Roy Gregory

Better known, internationally at least, for his work with Nordost, Lars Kristiansen has always also ploughed his own, parallel furrow. And very fertile it's proved, generating the Aavik furniture designs, the Pulsar Points

and now the Eben speakers reviewed in this issue. Take a look at the pictures that accompany that review and you'll see that the speakers incorporate their own feet rather than spikes. Well, even if you don't have

the deep pockets necessary to own the Eben X3s, you can have a little part of them, because those feet are available separately.

Called ColdRays (Why?) they look at first glance like blunt, ►



► upward facing cones. But there's much more to them than that. These are a composite structure consisting of a simple, upward facing cone and a covering, concentric shroud. The cone has a small dimple in its tip and this supports a ball bearing, which is what the



shroud sits on. That ball can be either steel or ceramic, depending on what you want to spend, but if you want what the

Coldrays do then the ceramic option delivers a lot more of it. Those who start on steel can always upgrade for the difference in price.

Conceptually, the ColdRays are first cousins to the finite element Ceraballs. The difference is that the Ceraballs use a rubber O ring to damp and locate the top cap. In the Coldrays it is deliberately left un-damped, to act as a tuned resonator. That's the way they sound too. With anything that comes from Lars you pretty much now what to expect – clarity and dynamics in spades. That's exactly what the Coldrays deliver. Place them under just about anything and you'll hear an increase in transparency, focus, clarity and dynamic range. Just don't expect them to cover anything up. If your system is lacking pace, that's one thing, but if it lacks coherence then the 'Rays are simply going to make it that much more apparent. They tell you exactly what's going on, but their brutal honesty makes no allowances for bruised sensibilities and dented

egos. Just don't shoot the messenger: if it sounds worse with ColdRays then the chances are the system needs to seek major surgery rather than minor tweaking.

So, if you love detail and a system that can make you jump, then look no further than the ColdRays. If you want sheer clarity then ditto. But there's more to them than that. In the same way that they increase dynamic range and discrimination (the precision with which the system delineates shifts in level, large and small) they also maintain separation with level. Even when things get really loud and busy, the ColdRays help to keep things distinct and stable. So they don't just deliver dynamics, they help you handle them too.

In this latter respect (and not surprisingly) the ColdRays share the attributes of the earlier Pulsar Points, and the comparison is interesting. The ColdRays easily better the aluminium Points, but the Titanium ones are another matter. Here it's swings and roundabouts, with the Ceramic ColdRays delivering better transparency and focus, and slightly better detail and speed, but the Titanium Points have a trump card in terms of their substance and power – the one aspect in which the ColdRays detract. The bottom line is that preferences will be system dependent - but what price a Titanium ColdRay? Just around the corner?



Lars is unusually reticent regarding the possibility, but I for one wouldn't bet against it. Having played with the standard ColdRays the prospect is enticing indeed.

If it's clarity and dynamics, dramatic contrasts and excitement you seek, then the standard ColdRays deliver, but make sure that those impressive hi-fi attributes aren't undermined long term by the slight leanness that comes with them. If your system is sounding a little flat, flabby and just a tad lazy, or if you find your attention wandering, the Coldrays will get things back on line – with a vengeance. But be careful what you learn – the truth can hurt. ►+

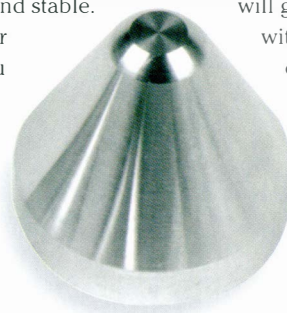

Prices:

- Set of four ColdRays (steel) £50
- Set of four ColdRays (ceramic) £95
- Set of four ceramic balls £45

UK Distributor:  
[hiforsale.com](http://hiforsale.com)  
 Tel. (44)(0)870 241 2469  
 Net. [www.hiforsale.com](http://www.hiforsale.com)

Manufacturer:  
 Eben Acoustics  
 Tel. (45)(0)9816 6027  
 Net. [www.eben.dk](http://www.eben.dk)

# The Harmonix TU-202ZX Tuning Insulator

by Roy Gregory

“That’s a hell of a name for what basically amounts to a block of wood!” It’s an understandable reaction on first acquaintance with the TU-202s, which are, after all, very big and made of wood. As far as I can tell, the wood in question is close grained, each foot being turned from a dual layer block,



each layer itself laminated from wide strips glued edge to edge. The strips in each layer are orientated at an angle to each other. It’s a classic disruptive structure, but one’s that difficult to discern due to the heavy stain used to finish the Insulators in an attractive deep red, so don’t take me to task if I’m wrong here. The top and bottom surfaces of each TU-202 are covered in black velvet, while the turned relief line and tapered upper help to minimise the visual impact. Even then, the Harmonix feet are kinda hard to miss when you place them under components, and they won’t win any prizes for making your equipment prettier.

However, they may well make it sound quite a bit better. Unlike some supports or isolators, the TU-202’s effect is immediately obvious. What’s more, in my admittedly limited experience, they’re remarkably consistent in that effect, whether under CD players or amplification. To date I’ve used them with considerable success under the

Wadia 861, Krell SACD Standard, Opera Consequence 8.8 valve integrated amp and the venerable Densen Beat. In each case, the Harmonix feet have brought a warmth and richness to proceedings which imbues music with increased power and impact. Much of that extra energy and power is located in the mid-bass, lowering the overall centre of gravity and counteracting any tendency to brightness or strain in the treble. At the same time the dimensions and volume of the soundstage seem

to increase, while



the warmth and richness create a fuller and rounder tonal balance.

Of course, whether you want those things is going to depend on your system and your preferences, but in a world where we seem to be moving ever closer to hi-fi, the Harmonix feet are a welcome step back in the direction of music. If you want further proof of that just listen to their effect on the new XRCD of Britten conducting his *Young Person’s Guide To The Orchestra* (JVCXR-0226-2), placed between the rubber feet of the Opera valve amp and the top shelf of the Pagode HD-03 Master Reference rack. The system gains purpose and a majestic

grace as it tracks the towering opening tutti, the broader deeper soundstage adding to the sense of power and the orchestral sweep of the music. The timpani solo is bolder, the skins with more texture and air, the other percussion instruments, sharper and more solid. The bassoon phrase that underpins the opening to the woodwind interlude takes on a wonderfully expressive, plodding quality.

There just seems to be more life and energy in the music, but without it becoming more forward or forced.

Is there a downside? Isn’t there always? The Harmonix feet will step the focus and transparency in your system down a notch. You’ll lose the extreme separation and pared away, etched presentation that characterises too much hi-fi these days. Of course, that’s not necessarily a downside at all.

It just depends on the way the balance and attributes of your system lean. But if you want an injection of colour and presence into your music, the TU-202s will happily deliver it. As with all such devices you just need to be careful what you wish for and beware of too much of a good thing. ▶+

Price: £395/set of four

UK Distributor:  
Audiofreaks  
Tel. (44)(0)20 8948 4153  
E-mail. info@audiofreaks.co.uk

Manufacturer:  
Combak Corporation  
Net. www.combak.net



# The Naim Audio NAP 300... Again

by Chris Binns

This autumn will see the first anniversary of Naim Audio launching their new range of electronics.

A grand and ambitious project for any company, for the Salisbury based manufacturer it has represented a makeover that effectively brought their equipment into line for the 21st century; aesthetically, sonically and in terms of flexibility. While PM and RG gave the NAP 300 a full review in issue 22, I have been using

one for the last few months to explore territories a little further outside the boundaries of a full Naim system. Uh, excuse me? While I am quite aware that twenty years ago such behaviour would have had me lynched or, at best, cast out as a heretic, I have been exploiting the more relaxed attitude that the company have developed toward the use of their products. As such I have used the NAP 300 as I would any other power amplifier: So, not exclusively in a Naim system, not always with a Naim pre-amp and, horror of horrors, not always with their speaker cable.

I should say that by their own admission, the new power amplifiers are more stable than the original versions. With those it was imperative

to use them with a Naim pre-amp (where the interface between the two effectively set the working bandwidth, especially important with vinyl replay) and the correct length and type of loudspeaker cable to provide series inductance for stability. In this day and age the former might well be less of a concern but even with the new amps, when using other

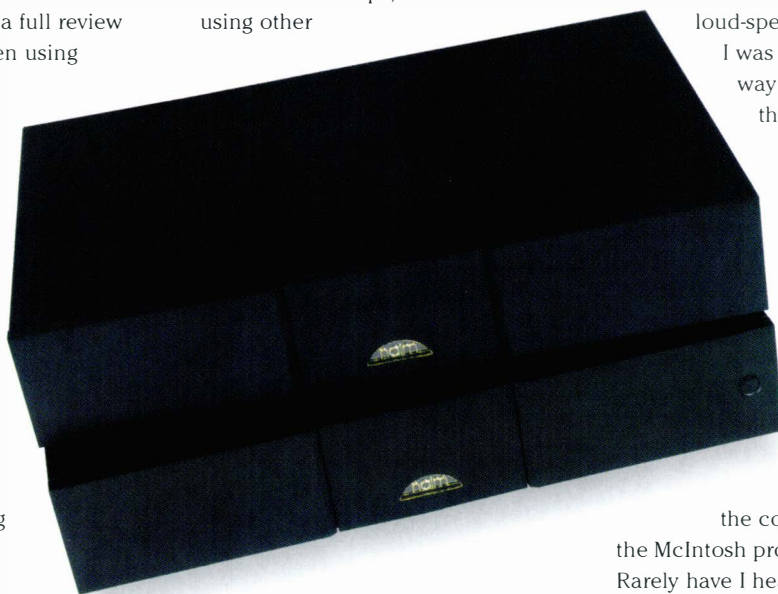

speaker cable, I measured the inductance of a 5 Metre length compared to NAC 05 to ascertain that I wasn't too wide of the mark. However, one word of warning; I would still advise considerable caution against the use of certain cables, Naim make it quite clear that there are particular electrical requirements for safe operation of their amplifiers. If in doubt, check with the factory.

I ended up using Nordost Valhalla

and Valkyra cabling, while pre amps ranged from the Naim 282 through to the McIntosh C2200 (which uses valves, and bear in mind that I live close enough to the Naim factory to feel the seismic rumblings of displeasure...)

I have absolutely nothing against the Naim pre-amps. Under certain conditions, with the Eben X3 loud-speakers for example,

I was very happy with the way that it sharpened the performance up, and gave the 300 a sense of speed and purpose that the X3's needed and positively thrived on. But under different circumstances, with my own loudspeakers or the JMLabs Nova Utopias,

the combination with the McIntosh proved a revelation. Rarely have I heard such precision coupled with delicacy and grace, attributes that are brought to the fore by the sheer cleanliness of the sound. I don't mean sterile or clinical, but a finely etched quality that is the product of the spaces between musical notes or beats being empty, with no fuzz or grain. The texture of sounds was beautifully rendered with detail and articulation, but never over forcefully, a trait I always associated with the older Naim power amps. The system had that

▶ wonderful quality of being truly intimate with say, a quiet voice or solo instrument one second and then expand with real drama and impact the next, regardless of the type of music that I was asking it to reproduce. Imagine the alluring and seductive mid-range that people always think valve amps should have, coupled with the dynamic drive of something like the Bryston 14B ST. That was what I found so attractive about the sound of the C2200/NAP 300 combination. It had me well and truly hooked for hours at a time. Just as successful was the Hovland HP 100 pre amp, which while lacking quite the sense of purpose and 'balls out' of the Mac, delivered even greater detail, space, texture and dimensionality. At times it offered the kind of walk in sound-stage that you'd normally associate with the US high-end – and that through a Naim power amp!

On the subject of power delivery, although on paper the 300 would seem to offer little more than the '250, in practice there is a large gulf. Much like the older 135's, the extra available headroom particularly, into lower impedances, makes it sound like a much bigger amp. On the very rare occasions that it ran out of steam, it does so with such grace that you barely notice. But that is not the whole story, as the

300 is a better amp in every sense, and has the ability to make the 250 sound a bit grey and unrefined.

In the same way, returning to NAC A5 after using the Nordost Valkyrja

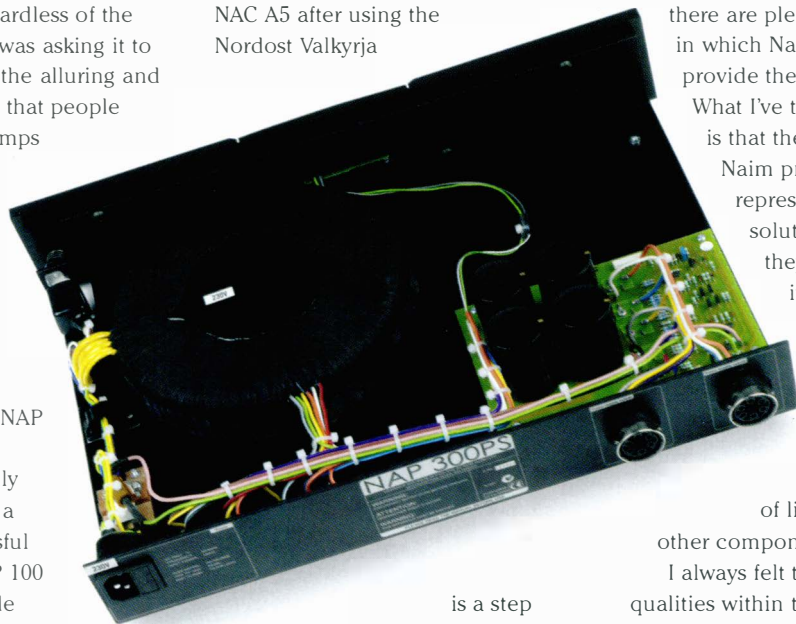

is a step straight backwards in sound and musical quality. RG covered this in considerable detail in his follow-up to PM's original review, so I'll simply refer you back to that piece, but it's an experience that underlines just how far the Naim electronics have come (and their speaker cables haven't).

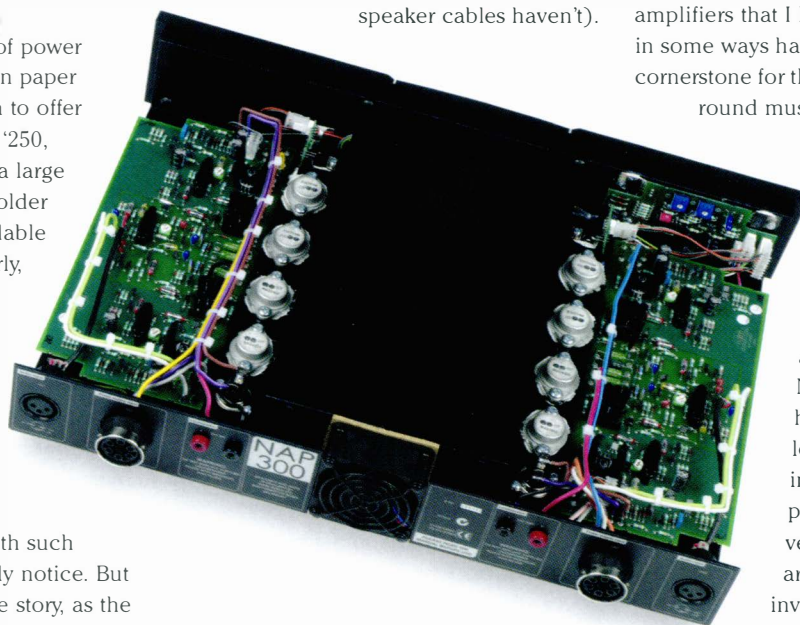

I haven't written this piece to undermine or run-down the performance of the Naim pre-amps.

Indeed, as I suggested earlier, there are plenty of circumstances in which Naim's own electronics provide the perfect match.

What I've tried to underline is that the rules have changed. Naim products no-longer represent a single-brand solution in the way that they used to. Not only is it acceptable to mix and match them, it's distinctly worthwhile, the power-amps in particular taking on a new lease of life when used with other components and cabling.

I always felt that there were qualities within the NAP 300 that could perhaps be highlighted more easily by (cautiously) trying other ancillaries. It has proved to be a really worthwhile experience, in that it has explored attributes that are not so readily apparent when partnered with say, the 282. What it has revealed is that the 300 is one of the best power amplifiers that I have ever used, and in some ways has provided the cornerstone for the most satisfying all round musical entertainment

that I have had from my system for a very long time. Now would be a good time to put aside your preconceptions and prejudices. Naim's electronics have come on leaps and bounds, in terms of performance and versatility. The results are well worth investigating. ➤



# Replacement Counterweights for Rega Arms

by Jimmy Hughes

To some people, all a counterweight does is sit at the other end of the tonearm and balance out the cartridge. Yet, while that's fundamentally true, it actually does far more than that. For example, depending on weight and design, the counterweight can significantly influence the effective mass of the arm and with it the resonant frequency of the whole arm/cartridge assembly. Whether or not the weight is decoupled affects the resonant peak, and with it bass quality.

Ideally, to minimise effective mass, the counterweight should sit as close as possible to the fulcrum. Doing so enhances the mechanical stability of the arm/cartridge combination, enabling the pickup to track warped LPs with greater ease and security. Every arm and cartridge has a point at which it goes into resonance - usually somewhere around 15Hz. If the resonant frequency is excessively low, the arm/cartridge combination may physically oscillate.

If the resonant frequency is too high, and strays up into the audio band, the result can be thick heavy bass. In practise, the chances of a gross mismatch today is much less than it was (say) twenty or thirty years ago. Nowadays, there simply isn't the wide variety of arms and cartridges. Most pickups offer medium to low compliance, and most tonearms are medium mass - making everything nice and compatible; problem solved!

The resonant frequency of a particular arm and cartridge is decided by a combination of cantilever compliance and arm mass. But the extent of the resonant peak can be reduced by decoupling the

counterweight. This flattens the peak, spreading the resonance over a broader area. In the mid '70s, Dual made a very specialised highly de-coupled counterweight for the arm fitted to their 701 direct drive turntable to improve tracking and stability.

But perhaps the most interesting approach came from Roksan a decade or so later - the so-called Intelligent Counterweight fitted to the original Artemiz and later Tabriz ZI. I was quite floored by the improvement, particularly at the bass end. It worked by suspending a low-slung weight on a uni-pivot, allowing the mass to move at very low frequencies while maintaining coupling at higher frequencies. The effect was to liberate the whole sound, particularly lower down.

The three weights for Rega type tonearms reviewed here offer nothing quite as radical as Roksan's Intelligent Counterweight, but each produces a worthwhile mix of virtues. One of the difficulties of a test like this is that it seeks to evaluate the effect of one component on another; obviously, you can't actually 'listen' to a counterweight - you can only assess and compare the effect it has on a given arm and cartridge compared to another counterweight.

Before starting, it's perhaps worth making the point that the supplied Rega counterweight is not terrible. If you currently find the sound of your record player with Rega arm and standard counterweight unacceptable, then it's doubtful that changing to one of the three weights tested here would transform the sound into something wonderful. The sort of changes produced are a refinement of existing

standards rather than a complete and utter transformation.

For the tests I used an Avid badged RB-300 fitted to Avid's excellent Volvere Sequel turntable. Cartridge was Transfiguration's Temper W moving coil. To make sure I kept playing weights identical while changing weights (no easy task) I used the superbly accurate Cartridge Man digital stylus scales.

## Michell Tecno Counterweight

Price: £67.95

Contact: Michell Engineering

Tel. (44)(0)20 8953 0771

Net. [www.michell-engineering.co.uk](http://www.michell-engineering.co.uk)

In some ways, Michell's Tecno Counterweight is perhaps the most comprehensive design of the three. With the Michell system you not only replace the counterweight, you also replace the rear stubshaft on which the counterweight sits. Incorporated into this new assembly is a means of measuring and adjusting stylus downforce. Since the Rega RB-300 already has a built-in spring for downforce adjustment, it might seem that having this is useful only for the RB-250.

However, some feel having a spring downforce adjustment is a bad thing, sonically. Why? Because the spring resonates at certain frequencies in sympathy with the music. Rega's downforce spring is unusual in that it actually imposes an upwards force when set to zero. This lowers the effective mass of the arm by making sure the counterweight sit closer to the fulcrum. To take the spring out of circuit, therefore, you need to set the playing weight gauge fully clockwise to

▶ maximum - so it reads 3.5g

Michell recommend you use their rotating gauge to set the playing weight. Each division represents 0.1g. Therefore, if you wanted to set a playing weight of 1.5g, you'd position the whole counterweight assembly so the arm achieves equilibrium, then turn the dial clockwise and count off 15 divisions. So, one incidental benefit of the Michell system is the opportunity it offers to adjust tracking weight very precisely and predictably in extremely fine increments.

The 'outrigger' arrangement of the counterweight spreads the load on the arm bearings, while lowering the centre of gravity. Michell also supply large and small weights to cope with cartridges of different mass, making their system more versatile. Unfortunately, try as I might, I couldn't remove the stubshaft from my Avid modified RB-300. I therefore had to dispense with Michell's tracking gauge, attaching the counterweight sub-assembly direct.

Perhaps because there's no decoupling, the Michell Tecno Counterweight produced a noticeably tighter more sharply defined sound than the others. The bottom end was very crisp and firm, while treble was bright and immediate. With the Tecno Counterweight, things sounded more lucid and detailed, but sonically the effect was less flattering and forgiving than it had been with the supplied rubber-decoupled counterweight.

Listening to *Nina Simone Sings the Blues* (a recent 180g Speakers Corner LP reissue) things like tape saturation were more noticeable. Now, these 'faults' are faults that afflict the original mastertapes. As dynamic levels increase and the music grows louder and busier, there's some tape squash. Because of the extra brightness and detail produced with the Tecno Counterweight, this distortion is made more apparent.

The Tecno Counterweight produced noticeable gains in areas like focus and lucidity. If you like music to sound tight and precise, then this is the weight for

you! But be prepared for faults and limitations in source material to show up more - the penalty for all that extra detail. It may well be that the rigid Tecno weight also reveals limitation in the Rega arm, especially when it's partnered with an expensive high performance moving coil pickup.

#### **F2 Titanium counterweight**

Price: \$129US

Contact: Kerry Audio Design

Tel. (001)613 834 7178

Email. gkerry@sympatico.ca

In many ways this was my favourite of the three weights, sonically. It produces a lucid yet very smooth and forgiving sort of sound that ensures good detail without exaggerating faults. Weighing 115g, it's the biggest of the three weights, but much of the mass (a good two-thirds) lies below the bearing line. The choice of titanium was apparently dictated by the resonant properties of this material. When struck it produces a short well-damped 'blip' compared to stainless steel, that rings.

You can almost sense this when you pick up the F2; it feels inert without being 'dead' or over-damped. This quality is carried over into the sound, which combines smoothness and refinement with excellent fine detail and crisp immediacy. The Michell Tecno weight offers greater brilliance and attack, but the F2 sounds easier and more natural. I felt it gave the music increased depth, enhancing spatial qualities to create a more holographic effect.

The makers emphasise the sonic importance of their three-point contact decoupling interface between F2 counterweight and rear stubshaft, saying it's one of the crucial differences between their product and the others. The securing allen bolt is nylon tipped to prevent damage to the subshaft when tightened up. Incidentally, owners of the RB-250 and its derivatives will need to replace their grooved

stubshaft with a smooth RB-300 type to use the F2 weight.

It was interesting to play the Nina Simone LP previously referred to, and hear faults and limitations in the sound magically diminish. For example, tape saturation during peaks subjectively seemed much less evident. Actually, you could tell the saturation was still there, but somehow (because difficult loud passages now sounded more relaxed and effortless) the recording now seemed cleaner and smoother. It sounded like the cartridge was having an easier time of things.

#### **The Heavy Weight**

Price: £89.95

Contact: hififorsale.com

Tel. (44)(0)870 241 2469

Net. www.hififorsale.com

From a sonic standpoint, The Heavy Weight occupies something of a mid-point between Michell's Tecno weight and Kerry Audio Design's F2 Titanium. It's got much of the former's immediacy and bite, with some of the latter's smooth open refinement. The Heavy Weight is a very low-slung design that positions the bulk of the mass below the arm bearing axis. Because of this assymetric distribution of mass, it's important the weight is not allowed to tilt to either side.

Doing so would upset the even spread of load on the two lateral bearings. So, always make sure the fixing allen bolt is pointing vertically before you tighten down!. The weight looks to be made of stainless steel, and a plastic sleeve introduces a small degree of decoupling while maintaining a reasonably solid interface. Interestingly, the instructions recommend setting the Rega's spring tracking adjustment to maximum and using external scales to set down force.

Although, personally speaking, I still retained a slight overall preference for the F2 Titanium weight, the Heavy Weight provided an extremely



▶ enjoyable listening experience. As previously mentioned, it more or less combined the positive sonic attributes of the two other counterweights, giving a smooth but detailed sound that was lucid and articulate. It proved analytical without being overly revealing, and produced a well-balanced result.

### Conclusion

While doing the tests, I can't truthfully

say I noticed any significant improvements in tracking or stability. However, because of the increased weight and more favourable mass disposition, all three counterweights should help make life easier for the pickup. Even if the improvement hardly shows in an obvious tangible sense - for example, suddenly being able to play a badly warped LP that had always previously caused the stylus to groove jump - there could still be benefits.

The more accurately the stylus tracks the groove, the lower record and stylus wear will be. Also, the cleaning effect of the stylus on the groove wall should increase, helping to reduce surface noise. However, these are subtle long-term benefits - not necessarily things that immediately stand out in A/B comparisons. So - a worthwhile upgrade for those with Rega arms? Yes - definitely. I can't see you being disappointed whichever of the three you choose.

# More on the Reference 3A de Capo and Royal Virtuoso

by Roy Gregory

When I reviewed the small yet bluff, simple and unassuming de Capo loudspeaker from Reference 3A it's fair to say that I was pretty bowled over, making it one of my products of the year. Easy enough to drive with 30 or so Watts due to a combination of reasonable efficiency and its non-existent cross-over, it was an unusual yet profoundly satisfying solution for those using small solid-state or push-pull valve amps. Its directness of musical communication proved to be the perfect foil to a small, rhythmically coherent yet agile partner, but the real ace in its hand was an innate sense of balance and musical weight that caught more than one visitor by surprise. For what is a relatively compact box, the de Capo manages to produce enough bass weight and power to convince, not so much as to get it (or its partnering amplifier) into trouble. The result is a wonderful combination of easy dynamics and musical purpose that really brings a performance to life and allows it to breathe.

Now, the de Capo isn't exactly cheap, ringing the till at \$2500, plus the price of stands, but Reference 3A make a deluxe version for those who like the musical honesty of the two-way stand-mount but want more. Called the Royal Virtuoso it was reviewed by PM in Issue 26, but while he liked it well enough, he wasn't as enamoured as I'd been by its cheaper sibling. Which I must admit left me slightly surprised as I'd expected great things from the more expensive model. As a result I arranged a return fixture to try and get to the bottom of this. Maybe the Royal Virtuoso simply wasn't as good as its \$4000 price tag demands? Or maybe I'd got the original de Capo wrong? Either way, I was intrigued enough to want to find out.

The first thing I noticed about the Royal Virtuosos is that they come packed individually. It's just as well, because they're significantly heavier than the two to a box de Capos. This cuts straight to the heart of the differences between the two speakers. After all, with two drivers and a single

capacitor to play with, you don't get a whole lot of alternatives. The Royal Virtuoso uses the same in-house designed and built bass-mid unit as the de Capo, coupled to the same tweeter, although it's now a slightly different (and much better) unit than the one that I originally reviewed, resulting in the de Capo-i designation of the current model. Fair enough, as the treble was the one area that I felt let the original down. The current version has both more air and greater definition. Both speakers direct connect the bass-mid unit and use that single cap to roll in the treble. It's as simple as first order can get and guarantees the maximum retention of musical texture and micro dynamics, at the expense of a less than ruler flat frequency response. That's fine by me.

That leaves the cabinet, and it's here that all the effort (and money) has been spent. The de Capo has a pretty conventional cabinet, its sloping front baffle coupled to a braced and damped MDF box, the rear panel supporting basic

► bi-wiring terminals and a large reflex port. Apart from that there's little to report.

The Royal Virtuoso is an entirely different kettle of fish. The front baffle is apparently identical, as is the

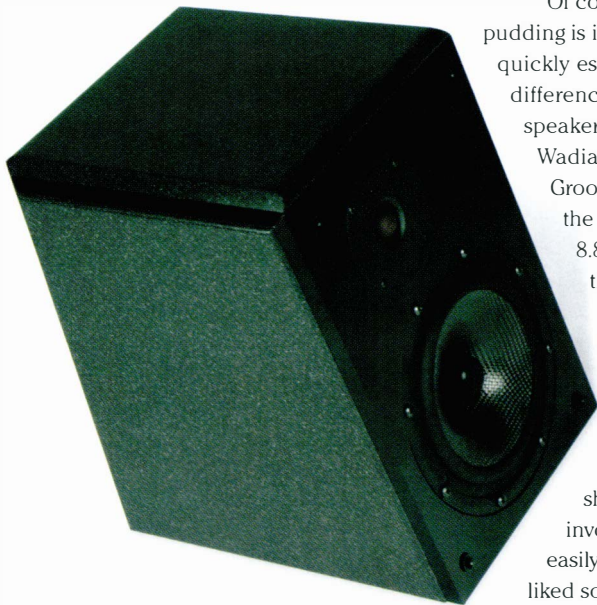

cabinet's base. But the sides and top both sport contoured Corian panels laminated onto the existing carcass, while the rear panel has been massively reinforced with a faceted MDF plate anything up to 30mm thick. Gone is the small plastic molding that supports the terminals on the de Capo, replaced by a substantial metal plate supporting a pair of the excellent Cardas combi-terminals. The reinforcement around the port mouth has been heavily contoured to prevent turbulence or any disturbance in the port's operating parameters. The end result is a dramatic increase in the mechanical integrity of the structure that combined with the added weight should provide the drivers with a less intrusive environment and a more effective mechanical reference. Of course, unless you've seen the de Capo, this is rather less obvious. Not the paneling you understand, but the direction the designer has taken. Presented with the Royal Virtuoso

in isolation it's easy to understand how you could reach the conclusion that this is just an expensive but basic box, as opposed to a simple box done expensively, a subtle but important distinction.

Of course, the proof of any pudding is in the eating, and listening quickly establishes the sonic differences between the two speakers. Hooked up to the Wadia 861 and Blue Pearl/Groove Plus front-ends feeding the Opera Consequence 8.8 integrated amp, I put the two speakers through their paces.

The de Capo was its satisfyingly familiar self, sure-footedly handling rhythm, dynamics and musical shape. It's an inviting and involving presentation that easily reminds me what I liked so much when I reviewed them, and why I requested a pair on long-term loan. Which makes the change to the Royal Virtuosos that much more of a shock. Name a hi-fi parameter and the more expensive model easily outperforms its junior sibling. It's markedly more dynamic and transparent, offering much better detail, focus and texture. The background is blacker and the soundstage gains depth and volume. All good stuff – but it's also where you have to start being careful. The efforts to stiffen the cabinet and provide a better mechanical reference for the moving parts have proved so effective that they've actually subtly altered the voicing of the speaker. This is no simple case of swapping one for the other and spotting the differences. The two speakers actually need to be

positioned rather differently. In my room, the de Capo works best at around 23" from the wall. The royal Virtuoso needs to be placed significantly closer at a distance of 18". The more I listened to the two speakers the more convinced I was that this variation is at the root of the differences in performance between them – and mine and PM's response as well.

You don't need to be Einstein to work out that the Royal Virtuoso has a leaner overall balance, founded on a lighter bass end. It's better defined, more tuneful and far more transparent, and although if anything it goes slightly deeper, certainly more intelligibly than the de Capo, it doesn't have the sense of weight that goes with the cheaper speaker. Therefore it doesn't have the de Capo's immediate sense of balance and rightness. Listen to the



Royal Virtuoso immediately after the de Capo and it's obviously a better speaker in almost every way. But listen to it alone and you don't get that simple sense of obvious communication that comes from the basic model. It's almost as if the extra performance delivers more information but ends up making



▶ less obvious sense of it. An interesting twist on the less is more theory.

Does that make the de Capo the better speaker? Not at all: It simply makes it the more accessible one. In comparison, the Royal Virtuoso is more demanding of both the listener and the system. It certainly helps



to step up to it from the musical basis of the de Capo – almost as if that teaches you where the performance is coming from. As I said in my original review, the real strength of the de Capo is that it covers its tracks so well. In absolute terms, there are plenty of things that it doesn't do – you just don't notice until you compare across to other products. It's a sure sign of an innately balanced performance. The Royal

Virtuosos open the window a fair bit wider and that cuts both ways. It tells you more about the music, but it also tells you more about the speaker. The Royal Virtuoso is an excellent product that delivers great insight into both recordings and the performance that's on them. If that's what you're after then you'll value its clear superiority to the de Capo and you'll happily pay the difference

in price and take the necessary trouble over the driving set-up. If on the other hand, your object is the simple enjoyment of music then the de Capo is an incredibly attractive proposition – even if it would be nice to replace the resident pair with the Royal Virtuoso. ➤



# hi-fi+

## Back Issues

If you missed out on earlier issues of Hi-Fi+, and want to complete your collection, you can order them by calling:

**+44 (0)1202 659380**

or by visiting our website:

**www.hifiplus.com**



### Prices:

Issues 1, 5, 6, 9, 12, 14 - Sold Out  
 Issue 2 - £4.75  
 All other issues - £3.95

### Postage & Packing:

UK - Free  
 Western Europe - £1 per magazine  
 Rest of World - £1.50 per magazine

UK orders are sent by Parcel Post, please allow 2 weeks for delivery.

Overseas orders are sent by surface mail.

# Record Reviews

## How To Read Them















The information contained in the record reviews is presented in the following way. Albums are identified by label and serial number. Beneath this you will find one or more icons which denote the available formats for the recording. The first icon refers to the format reviewed.

The ratings at the bottom of each review reflect the reviewer's opinion of the recording quality, and musical merits of the album. You'll soon realise that a great many musically significant albums offer less than wonderful sound. Don't let it put you off! For your information the scale rates a standard, good quality pop recording as slightly below average.

The reviewers are identified by their initials.



They are:- Chris Binns, Pete Christie, Dave Davies, Roy Gregory, Jason Hector, James Michael Hughes, Jon Maple, Reuben Parry, Dave Ayers, Andrew Hobbs, Chris Thomas, Mark Childs, Simon Groome, Michael Mercer, Richard Clews.

### Key to Icons

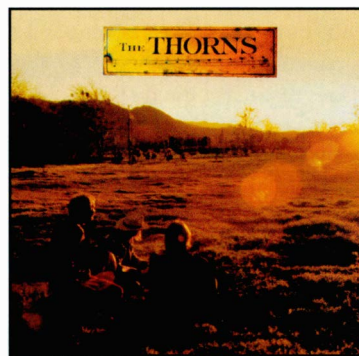
-  CD
-  Gold CD
-  HDCD
-  XRCD
-  Double Disc
-  DVD
-  SACD
-  Hybrid SACD
-  Multi-Channel
-  120g LP
-  150g LP
-  180g LP
-  10" LP
-  Availability As S/H LP
-  Vinyl Double Album



The Thorns

Columbia C86958  

A barrage of acoustic, electric, baritone and bass guitars. Sidemen playing pedal, lap steel and twelve strings. Ukulele, dulcimer and mandolin enriching this mellow and over-ripened West Coast rock music that from its opening bars transplants you to another sun-drenched and seemingly carefree land. These are the aural delights, so reminiscent of the Byrds and the Boys, which towel dry more than a dozen Matt Sweet, Pete Drogue and Shawn Mullins songs. They are the gunslinger guitarists whose attractive harmonies and engaging vocals muse over missed opportunities, relationships on the edge of collapse and the strained emotions running out of control. Their prickly observations about life heard in 'No Blue Sky', 'Such A Shame' and 'Among The Living' sets these stark images that catch you unawares with their tales of loneliness, contempt and decay against some incandescent instrumental arrangements which radiate warmth as they mimic the passions revealed in the lyrics. Sentiments echoed through Roy Brittan's sublime work on the piano and reinforced by an underlying presence in the shape of that master of stick and skin, Jim Keltner. An album with soft tones that still possesses bloody razor sharp edges.

RP

Supplier: [www.vivante.co.uk](http://www.vivante.co.uk)

RECORDING  
MUSIC







## King Crimson

### The Power To Believe

SANCD155 (CD)

King Crimson of late are sounding more and more like their early 70's selves. You can pretty much predict that a new album will have many instrumentals based around heavy chord progressions, a number of improvisations that may or may not hit the mark, and a few 'songs'. However, on *The Power To Believe* the improvisations are either absent, or so intuitive that I have failed to spot them. So much the better, for here King Crimson have managed to produce their best album for years: in fact one of their best ever. There is a sense of structure here that was missing from the previous CD, and although KC have metamorphosed into a metal monster, it is one with intelligence. I must admit I found myself wondering how the CD would be if Bill Bruford were still the drummer, as Pat Mastelotto's style is very bombastic, giving certain tracks such as 'Level Five' a battering ram effect. Elsewhere 'Dangerous Curves' is the evil mutant brother of *Larks' Tongues In Aspic's* 'Talking Drum', and one of my favourite tracks here. All in all, if you ever liked King Crimson but found their most recent stuff a bit impenetrable, get this. If you've never met them before, then get this. Excellent!

DA

RECORDING  
MUSIC



## Natalie Macmaster

### In My Hands

Rounder 11661-7025-6 (SA)

If you want stonkin' fiddle driven songs with a twist of new wave Celtic cloth bleeding its rich colours through some seriously fat production values then Natalie Macmaster is the girl for you. Her arrangements (mainly with guitarist Geordie Sampson) have rejuvenated traditional pieces such as 'Blue Bonnets Over The Border' and 'Flora Macdonald'. While elsewhere in 'Welcome To The Trossachs' due reverence is still paid to the style and craft of yesteryear. This is a track which haemorrhages into five other vignettes including 'Gravel Walks Reel' and 'Colonel Thorton'. Yet the two songs that will definitely leave you yearning for more are 'Get Me Through December' which is beautifully sung by Alison Krauss and the title track that is the only one to feature Natalie Macmaster lead and backing vocals. The attraction lies in her refreshingly sassy pop deliberation in the delivery of sexually charged lines like "I see your shape and I'm attracted. I touch your neck and I'm tempted". An exquisite recording does not quite paper over the fact that for a fiddler Macmaster is one hell of a siren and more of that is needed here.

RP

Supplier: [www.vivante.co.uk](http://www.vivante.co.uk)

RECORDING  
MUSIC

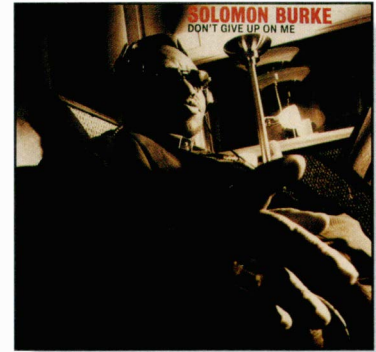
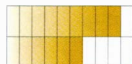

## Solomon Burke

### Don't Give Up On Me

Fat Possum Records dbk 104 (180g)

Burke, the king of rock and soul, has an immense presence. A charismatic, impassioned and powerful interpreter, his take on songs by the likes of Van Morrison, Tom Waits, Brian Wilson, Bob Dylan and Elvis Costello summons forth performances whose intonation, phrasing and every vocal nuance are soaked in gospel, blues and soul music traditions. With the Blind Boys of Alabama backing him up on Mann and Weil's 'None Of Us Are Free', Burke gives an irresistible message about the harshness of life, proving that these soulful cadences have a deeply rooted social conscience beneath them. A fluid, heart rending and reflective track such as 'The Other Side Of The Coin' (Nick Lowe) transports us into the realm of a conflicted preacher, which is of course territory that Burke understands only too well having spent many years leading his own ministry. The band, including Jay Bellerose (drums & percussion), David Palmer (piano & keyboards), David Piltch (bass), Chris Bruce (guitar) and Rudy Copeland (organ) exquisitely and poignantly underlines all the yearning, raw pain, exhilaration and spiritual gravity that is embodied within his song craft.

RP

Cherished Record Co. Tel: 01579 363603

RECORDING  
MUSIC

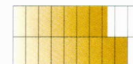



Julia Fordham

Concrete Love

Vanguard Records SANCD 140

Was it really fifteen years ago that Julia shot to fame with the hit single 'Happy Ever After' taken from her eponymous debut LP? I guess it must be. Well, in the intervening decade and a half there have been other albums such as *Porcelain* but none really captured the initial enthusiasm for this white soul singer whose bold, seductive and larger than life delivery of a line wooed millions. Compare *Concrete Love* (her 2002 release) with those early outings and you immediately notice how her sexually charged vocals have ripened to sound a lot like Dusty Springfield. Here Julia's voice, which can still seemingly hold a syllable forever, is an inescapable focal point that has musical layers of modern highly polished soul beating beneath it. The songs all written or co-written by Fordham meander through this romantic material with themes of yearning, adoration and sacrifice. Many of them though pull their punches and there are too few of those tracks like 'Missing Man' or 'Foolish Thing' which don't plaster over the cracks in her heart. On these, love proves elusive, but for this kind of reinforced "concrete love" Fordham shows she is a wry, ironic and contrary mistress who messes with your head.

RP



Frank Black and the Catholics

Show me Your Tears

Diverse Records DIV006LP

This is a daring release that flies in the face of commercialism to bring us the very personal and hard hitting views of Frank Black in thirteen self-penned and self-absorbed songs. His brand of moody and atmospheric indie rock has the textural depth of a Dostoyevsky novel. Brooding, angry and full with that sharp taste of despair, *Show Me Your Tears* even more memorably still, has the fortitude to get beyond all this Twenty-First Century isolation and destructiveness to deliver a succinct four-letter rebuke on the subject of death and divorce in 'Horrible Day'. There's plenty of passion and desire too. An opening and sexually charged 'Nadine' musically couples that unrelenting beat of man's desire to lyrics which seem to stalk this black-clad, white-skinned girl whose perfume puts them under an endorphin induced spell. Recorded live to two track and without edits, the Ray Staff mastered LP enhances these images further through an innate sense of immediacy that can be felt within the bite and urgency which surrounds wry guitar notes bent by Black and fellow band members David Philips and Rich Gjlbert.

RP

Supplier: [www.diverserecords.com](http://www.diverserecords.com)

Tel: 01633 263526

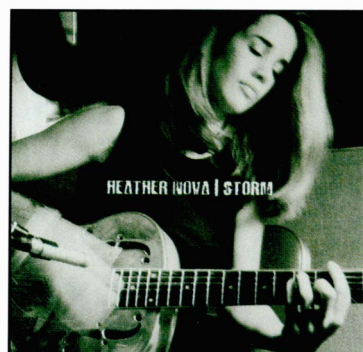

Heather Nova

Storm

Saltwater Ltd ABB 205

Vocals stretched through with emotion, notes wavering as her passion rises, quivering lyrical intensity and the sweet double-tracking of a gorgeous voice as the counterpoint to these drama-filled highs are classic Heather Nova moments. The pared back to nothing simplicity of arrangements for little more than bass, piano, Hammond B3 and guitar allows for an even deeper experience of her telling insights on the human condition which rightly concludes during the title track that we sometimes need a little pain in our lives. Behind this assertion lies a belief that to truly enjoy love's finer points, those joys of companionship and a profoundly uplifting and fulfilling bond with another person you should have first suffered its flip side - the heart-piercing loss of someone you love, the betrayal, abandonment and emptiness. It typifies the piquant qualities heard throughout all eleven of the songs on *Storm*. Echoes of this inner turmoil ripple across 'Fool For You', 'Drink It In', 'Let's Not Talk About Love', 'All I Need' and 'Everytime'. A rare, notably intelligent and imaginative slant on the kind of themes that everyone sings about but few are capable of carrying off with such delicious turbulence.

RP







## Blackmore's Night

### Ghost Of A Rose

SPV Records SPV08574992 (CD)

Anyone who has followed Richie Blackmore's career after he left Rainbow will be well aware of what's on offer here. For the uninitiated, Blackmore's Night have little in common with Rainbow or Deep Purple. Yes, there is some of that trademark guitar playing on show (check out the fluid solo at the end of 'Way To Mandalay'), but what they really specialise in as a form of updated medieval folk.

Lead vocals are handled by Richie's partner Candice Night, a golden voiced beauty with a touch of the Stevie Nicks about her. As well as contributing fine vocals Candice plays all manner of unusual instruments: Shawms, Cornamuse, Chanters, Pennywhistles and the charmingly named Rauchpfeife (whatever the hell that is). As well as handling guitar Blackmore weighs in on the Hurdy Gurdy and Renaissance drum. Sandwiched in amongst band originals are two covers, Jethro Tull's 'Rainbow Blues' and a highly moving rendition of John Baez' 'Diamonds And Rust', which comes mighty close to eclipsing the original. Of self-penned material 'Queen For A Day Parts 1 and 2' is a highlight. Part 1 is a gentle folk song which melts into part 2, a full on jig complete with handclaps, dancing violins and amazing fluid acoustic guitar solo – It's a highly intoxicating brew.

If you go down to a record store and purchase this you're definitely sure of a big surprise!

AH

RECORDING   
MUSIC

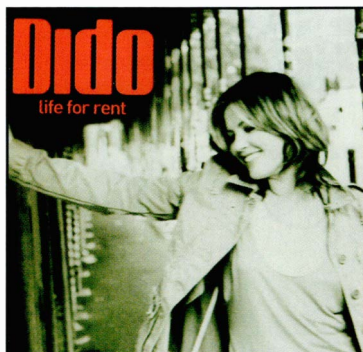

## Dido

### Life For Rent

Arista 82876545982 (CD)

For the eleven songs penned largely by Dido and Rollo Armstrong, the direction taken for their supporting instrumental packages differs greatly to those uncluttered and simply focused arrangements on Heather Nova's *Storm*. Dido's predictable contemporary sounds bristle with keyboard and booming drum programming, while the mixes add layer upon layer of musical confectionery. She does air some interesting views on meaningless sex through that drink and drug induced haze of 'Stoned' and the return home after a two-week holiday romance in 'Sand In My Shoe' will be a familiar story for many teenage and twenty something fans. But this grit underfoot is ultimately little more than an irritation. She could and probably should have probed much further into the raw emotions, the uncertainty and vulnerability present within this summer of hedonism. Instead we are compelled to listen to adolescent diary entries as she longs for those days and nights with her beau. Perhaps I'm being too critical. She is a diva for that generation and this album reflects the shallowness of their concerns. The singing too is very Dido – syrupy warm, naggingly catchy, flat and quite monotonous.

RP

RECORDING   
MUSIC



## Ian Parker

### Inside

RUF Records RUF 1094 (CD)

Head Honcho of RUF Records, Thomas Ruf, has amassed a glittering array of talent on his fabulous label: Walter Trout, Candy Kane, Aynsley Lister and Michael Hill, to name but a few. Although his roster is blues based he's not afraid to put his money into artists who stray outside of the genre and Ian Parker definitely falls into this category.

Parker's a 25 year old from Birmingham who's got it all in his locker. He's a riveting guitar player with a throaty, soulful voice and a stack of great songs, and having just witnessed him live I can attest to his talents as a stage performer too. *Inside* is a ripper of a debut, absolutely bristling with confidence and assurity, an album where Parker and his first class band produce one killer song after another in a rich tapestry of musical styles.

'Misfits and Fools' opens with a fluid, earthy solo and develops into a real bump n' grind rocker, whilst the tender ballad 'Burden of Pain' (which could have been lifted from *Sign o' the Times*) contains Parkers most passionate vocal. Most artists would take 3 or 4 albums to produce something this good; that Parker's done it at the first attempt is testament to his talents. I perish to think how far this kid can go.

AH

RECORDING   
MUSIC

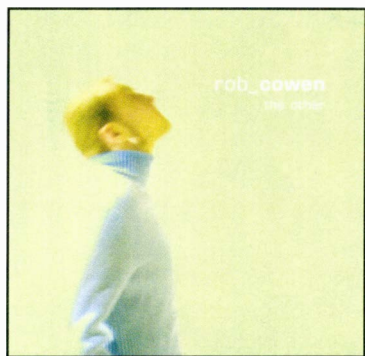

Rob Cowen

The Other

Stubborn Records STUCD001 

It's refreshing when you discover an artist from this country who can move you with his songs and lyrics. It makes you realise that talent does exist in this fair island of ours, and that we still have much to offer to the ears of our long suffering music lovers.

Rob Cowen is a Northern lad who began his career singing in bands, but swiftly realised that what he really wanted was to be a solo artist. He hauled himself off to America where he played to appreciative crowds in the cafes of Greenwich Village and the West Coast of Seattle. Upon returning home, he linked up with producer Richard Dover and set to work on this little treasure of an album.

Quintessentially English and with a masterful approach to song-writing that would make Ray Davies a proud man, *The Other* weaves its way into your subconscious. Skip to any song you like and discover this man's lovely way with words.

"I wish I was a fisherman with steely eyes and cartoon hands" he sings on 'Utopia', before adding later in the song "I wish I was a millionaire with fancy clothes and coiffured hair"

*The Other* is a tumble across the English landscape seen through a keen eye and a poet's heart, and it's about bloody time we produced a talent that gave us something to shout about.

AH



Michael Weston King

A Decent Man

Floating World FW016 

Erstwhile front-man and songsmith in chief for the highly rated but perennially undersold Good Sons rises, phoenix-like from the ashes of that experience. It's not his first solo outing, but it's his first since the status became permanent and he uses the opportunity to spread his compositional wings. The nine self penned tracks (plus covers of Neil Young's 'Love In Mind' and Pete Townshend's 'Blue, Red Et Grey') are somehow more intimate and personal than his group work. There's a nice line in sardonic self-parody (the title track and 'When You Leave The Spotlight') and human fragility ('Celestial City' and 'The Wooden Hill') that reminds you just what a great song-writer MWK is. Underpin that with the musical genius of Jackie Leven at the controls (and on guitar) and it's a powerful brew. Even more so live, so catch them if you can. The recording here is excellent although devoid of audiophile pretensions: It's clean, open and direct, making the most of the telling lyrics with driving instrumental arrangements and subtle musical asides. There's intelligence and a sense of humour at work here. It's a wonderfully adult riposte to the banal drivel that constitutes the charts these days. Tie up the kids and make them listen!

RG

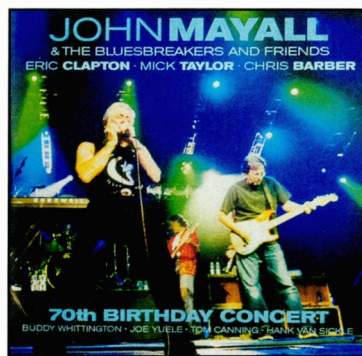

John Mayall

70th Birthday Concert

Eagle Records EDGCD246 

I recently reviewed John's latest studio album 'Stories' in these very pages, which was a rich return to form. Now hard on its heels comes this double album recorded for his 70th Birthday and bringing together blues breakers past and present. Most music fans are aware that the Bluesbreakers were the band that introduced a young Eric Clapton to the world, but he was just one of many legendary guitarists who went through its revolving doors. Others read like a who's who in rock and blues and include Peter Green, Mick Taylor, Jeff Beck, Walter Trout, Coco Montoya and current Guitarist Buddy Whittington.

70th Birthday reunites Mayall with Mick Taylor and his contributions include some fine slide and lead on classics like 'Blues For Lost Days' and 'Walking On Sunset'. But the biggest cheer of the evening is saved for Clapton, who Mayall introduces as "An old mate who hasn't graced the same stage as him for the best part of 38 years". Clapton's recent solo albums have been dull affairs but he really sparkles here, ripping into some old nuggets with a verve and passion that proves he can still cut the proverbial mustard when he puts his mind to it.

By the time you read this review there should be a companion DVD on the shelves – Eagle really are spoiling us something rotten!

AH







## Karen Matheson

### Time To Fall

Vertical Records VRTCD 002 (CD)

Karen Matheson possesses a lovely voice. She brings elegance, authority, substance and warmth into a dozen pensive songs that wander through love's trials and tribulations. Her gentle expressions of kindness and knowing insights about the brittle nature of romantic entanglements personalise those bittersweet moments when the stabbing pains of indulgence or denial materialise. The acoustic and electric guitarist James Grant wrote half of these wispy folk-pop numbers. Backing the pastoral imagery of 'Morning', 'Time To Fall' and 'All The Flowers Of The Bough' with incandescent arrangements for the BT Scottish (string) Ensemble, their craft also extends to the resonant reworking of the Robert Burns 'Bonnie Jean' and a traditionally sung 'An Ataireachd Ard' (The Surge Of The Sea) which is a song that reveals Matheson's maturity as a performer. Sessions engineered and mixed at the Secret Music and Cava studios in Glasgow draw out the delicacy and poise of the vocals, vibrant guitars, firm-noted piano chords and the enriched midrange where strings reign supreme. A carefully crafted and thoughtful marriage of timeless themes and the musical threads found in the modern crossover genre are fully realised on this album.

RP

RECORDING  
MUSIC

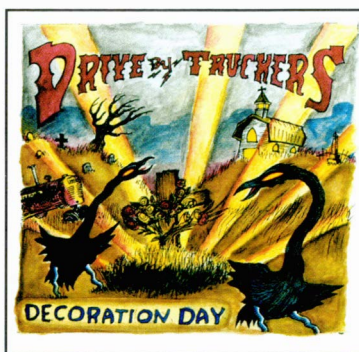

## Drive By Truckers

### Decoration Day

New West NW5047 (CD)

Much has been written about the Drive By Truckers love of southern rock legends Lynyrd Skynyrd, fuelled in no small part by the sprawling double album *Southern Rock Opera*, which paid considerable homage to their heroes. They are not, however, carbon copies of Skynyrd. Yes, they have come from America's deep south and yes, they have three lead guitarists, but their sound has an identity all its own.

The Truckers are led by Patterson Hood, a man who sings it like he's lived it, and one third of the band's potent guitar strike force. The other two are long term song-writing partner Mike Cooley and newest member Jason Isbell. Isbell joined in the fall of 2001 on just half a day's notice but in a short space of time has become an integral part of the set up, even weighing in with a couple of his compositions, the county tinged 'Outfit' and the epic title track.

The Truckers tackle all sorts of issues in their lyrics, from brother/sister incest ('The Deeper In') to life on the road (The spitting 'Hell No, I Ain't Happy') and even a song about being stood up at the altar ('My Sweet Annette').

*Decoration Day* is the sound of a band with their feet hard on the pedal: it's rootsy, punky, raucous, brash and tender and above all else – undeniably southern.

AH

RECORDING  
MUSIC

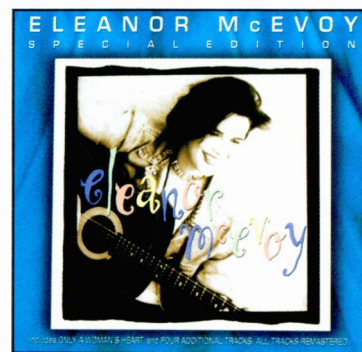
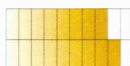

## Eleanor McEvoy

### Special Edition

Market Square Records MSMCD 127 (CD)

Dusting down this eponymous debut disc ten years after it was originally released has not only maintained Eleanor's profile before that promised and quite intriguing change of direction materialises on next year's new CD, but it is also takes another important step on her quest to regain artistic control of these earlier albums. However, this beautifully repackaged digipack has substantially more to offer than just these eye-catching cosmetic changes. There are four additional tracks including: 'Wilderness', 'Cat's Eyes' and 'Et C'est Bien' (the French version of 'It's Mine') and 'Corazon de Mujer' (the Spanish version of 'Only A Woman's Heart'). These generously take the music beyond an hour mark and at the same time remind us of Eleanor's wider appeal within Europe. Tidying up the sound for those sensitively scored and lyrical songs about loneliness and heartbreak has opened out the memorably sweet string arrangements and contrasting chords of Jim Tate's electric bass but still retains that pared back trademark sense of intimacy when Eleanor plays acoustic guitar. In a CD full of high points listen out for the uncompromising 'Apologise', the philosophical and emotional insights heard in 'Breathing Hope' and the inner resolve of 'Go Now'.

RP

Supplier: [www.vivante.co.uk](http://www.vivante.co.uk)

RECORDING  
MUSIC



# Sonic Satori



by Michael Mercer



## Missing Misery

### Elliot Smith dies at 34

Academy Award-nominated writer and performer Elliot Smith seemingly took his own life on Tuesday, October 21st. The final details surrounding his death were not available at the time of this issue's publication. The writer and performer of 'Miss Misery' from Gus Van Sant's 1997 film *Good Will Hunting*, was found dead at his home in Los Angeles of an apparently self-inflicted knife wound to the chest. He was a mere 34 years old. Statements like "the music world has lost yet another promising artist" detract from the harsh realization that this young man was capable of removing himself from the world so violently. Smith's songs were often melancholic, yet wonderfully orchestrated ballads and while his albums were usually morose to the core, they were carefully crafted bodies of work. A refreshing departure from shelves full of albums with one or two quality tracks aimed at the airwaves and the rest just record filler. There was a wholeness to his writing, and a level of honesty lacking in this generation of musicians and pop stars. In his short music career Smith released a total of six albums, two on major label Dreamworks, *XO* and *Figure 8*. Both major albums, while indicative of his somber state, were full of hair-

raising, infectious melodies that were his sonic staple. It seemed at times the only voice capable of harmonizing with Smith was his own, as he exuded an emotive quality that was undoubtedly unique to his experiences. His lyrics were often alcoholic (yes indeed he was) tales of addiction and loneliness. Elliot was not shy about his sadness nor did he make any apologies for using the music as a release for the seeming troubles surrounding his life. However, when not in the studio or performing he was known for his significant financial contributions to the homeless and it was rumored that he would occasionally put fans unable to purchase his concert tickets on his personal guest list. As with all great artists, Elliot Smith's words are immortalized in the music that he has left for the world to discover. His passion, talent, musicianship, and goodness will be sorely missed.

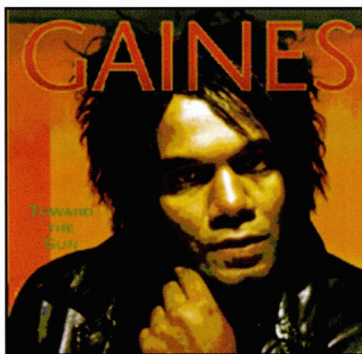

## Jeffrey Gaines

### Toward the Sun

Artemis Records

The 1990's spawned a singer/songwriter explosion. There was a sea of artists fitting the category, and unfortunately, many of them sounded basically the same. Not to rob them of their musical virtues, but there were certain commonalities amongst the large group of artists within the genre at the time. Jeffrey Gaines stood out from

the rest. Perhaps it was his love of drawing and painting (which turned to love of music in his teens) that gave him such a unique sound, or, more importantly, a different lyrical style. The view of the world through his eyes was a refreshing departure from the norm. *Toward The Sun* is appropriately titled. The record is motivational and eye-opening. Certainly well studied in the works of Elvis Costello (or a huge fan), his vocal delivery is quite similar here. He brings a rawness and vulnerability to the songs that spark the deepest of emotions. "Love Me" is a strong ballad, meandering through the solemnity of separation and the desire to be with a loved one. "Without You" is warm, yet lyrically despondent. The song speaks of being lost without his partner, his soul mate. How many of us have been in this position? Claiming to be "no good without you," Gaines gets to the heart of what it means to be in a true partnership. I do not intend to mislead you with regard to the subject matter in *Toward The Sun*. There is nothing earth shattering within the words themselves. The tracks touch on common feelings, but it is Gaines' uninhibited perspective and the willingness to express it that makes this record, and his others for that matter, so important to folk/rock music. No smoke and mirrors, no political banter (there has been enough of both lately). The sonics are fair. Guitar strings are tight, and the drums are a bit punchy. The greatest part of the album with regard to the sound is Gaines' vocal delivery. It is sharp and the nuances are well captured (they chose the perfect microphone for his style). There is a seeming lack of warmth in some of the tracks which is odd, as this type of music lends itself to warmth by nature. This could have been lost in the mastering process, or at the mixing desk, who knows. These faults do not outweigh the musical merit by any means. We were fortunate enough to catch Gaines last summer. He played a small venue: a room with a bar, a small stage, and some tables. Considering the fact that he had just finished up a tour with the Allman Brothers, we knew we were in for a treat. I look forward to more from him.

### Toward the Sun

RECORDING  
MUSIC





# Audio Fidelity Rebirth of a record label?

by Reuben Parry

A couple of years ago, I was in a state of software mourning. The West Coast audiophile reissue label, DCC Compact Classics, had ceased trading. So, why all the undisguised gloom for a Company half way across the World? Well, throughout the '90s they consistently impressed me with the excellence of the titles that were selected for their gold CD and 180g vinyl releases. Each new arrival was eagerly anticipated. Thumbing along the spines again today reminds me of how big a vacuum was left behind: Ella Fitzgerald swinging *The Cole Porter Song Book* GZS-1079; the Doors' *L.A. Woman* GZS-1034; *Elvis Is Back* LPZ-2037; *Pet Sounds* LPZ-2006; *Court and Spark* LPZ-2044; Sonny Rollins' *Saxophone Colossus* LPZ-2008; *Ray Charles and Betty Carter* LPZ-2005; together with some intriguing classical LPs like the Villa-Lobos *Uirapuru* LPZ-1003 culled from the Everest back catalogue, all really stood out. This terrific music was brilliantly re-mastered by the incomparable Steve Hoffman and it remains as a lasting testament to the prime mover at DCC, Marshall Blonstein.

Now there is a new chapter being written in the Marshall Blonstein story. As President of the recently constituted Audio Fidelity label he has once again entered the gladiatorial re-issue arena with a number of hybrid Super Audio Compact Disc and 180g vinyl titles. Digitally, this is the format with which to smite down thine enemies. The muscular words, "dual layered" and "hybrid", exude large dollops of audiophile testosterone and in this instance we have a technology whose credentials really deliver what they promise. Yet all that imperious hardware of course counts for very little unless you possess the expertise to squeeze out every last drop of potential from these recordings. To that end

Marshall has recruited some familiar faces from his days at DCC. Steve Hoffmann gives a typical master class and Roberta Ballard is once again on hand to cast a practised eye over the manufacturing process. The music is safe in their hands.

Moreover, Blonstein is the kind of leader who also likes to give his recording projects an element of direction. As a result the first four CD titles (all rather incestuously licensed from DCC) fall under two distinct headings. There is the "Legends of Rock'n'Roll" category and a "Classic Jazz" series. There are also LPs in the pipeline, and these should form the basis for a future article. So, at the moment we need only concern ourselves with the SACDs, though if the vinyl comes anywhere near close to the

quality of his DCC pressings then

the Audio Fidelity LPs waiting in the wings are a mouth-watering prospect.

Superficially, while original artwork has in part been retained, the disc liners do have an individual and cold looking industrial aesthetic about them, which itself is something of an acquired taste. However, I do approve of their useful accompanying artist liner notes, as well as original recording details and production credits that touch upon the equipment and personnel employed for these transfers. Overall you'd probably expect an audiophile product to look plusher, but cutting corners is a necessity when your U.S. recommended retail price for a single SACD is only \$15.98. In pounds Sterling that's around a tenner each! Obviously at this wonderfully accessible price point something has to give. Here, I'm pleased to say, Audio Fidelity have put the functional ahead of the florid. Consequently, ►



▶ where the sound is concerned, no sacrifices have been made.

Which leads me to the debut disc, *The Zombies Greatest Hits* AFZ 001. I have to admit that my initial gut reaction to the release of a *Zombies* title was one of palpable surprise. Clearly this St. Albans-based quintet did enjoy a degree of success in the Sixties through their nicely crafted harmonies, strongly backed up by Rod Argent's innovative keyboard work and the breathy voice of Colin Blunstone. These two combined well enough to ensure that their music had a degree of originality about it. Albums like *Begin Here* and *Odyssey & Oracle* were well received, but you can hardly compare them to a contemporaneous *Rubber Soul* or *Beggars Banquet*. Therefore, I think it's fair to say they never really had that truly great LP in them.

Meanwhile, tuneful and modestly charting U.K. singles – even 'She's Not There' only reached number twelve – on their own seem to be equally undeserving of serious attention. I suppose if you are going to indulge in a *Zombies* transfer then that tried and tested route of a compilation disc makes the most sense, though this too is often a far from satisfactory solution because of its inherently disjointed structure. So I'm back to the question of why should anyone bother to issue an SACD featuring Hertfordshire's finest? After a little research, I thought I had the answer, and it's quite a simple one.

While success at home continued to elude them, *The Zombies* fared much better abroad - especially in the States. As good songs repeatedly fell by the wayside in the U.K., the group did manage to achieve some notable moments across the pond. 'Time Of The Season' was a massive U.S. hit. 'She's Not There' peaked at number two and 'Tell Her No' was yet another top ten entry. But this Trans-Atlantic crossover failed to suppress those pent up frustrations that were to eventually lead to the break up of the band. Stop-start solo careers followed. I suppose that in their own way *The Zombies* dovetailed in very nicely with the plethora of Californian surfer bands that were unbelievably popular in America at the time. They shared that notional cult status, yet there's was a more sharply crafted image much in keeping with the British beatnik genre. Searing vocal harmonies often boldly cut through their darker jazz-influenced improvisations and minor key melodies to become the focal point. Moreover, these moody and unexpectedly incisive subtleties are beautifully

presented by SACD's high resolution, a factor that gives new musical insights.

Although I wouldn't be crass enough as to make spurious and idle comparisons with a creative genius like Brian Wilson, perhaps a reappraisal of the Chris White and Rod Argent song writing team is overdue. They are certainly well represented on this CD. A dozen Argent credited tracks sit alongside a further seven White originals. There's even a rare Colin Blunstone penned composition, 'Just Out Of Reach', which was featured on the 1965 soundtrack recording, *Bunny Lake Is Missing*. Yes, all the big tunes are present and correct as well,

but where this album excels is in its support for those songs that appeared as B-sides and EP releases. A minor classic like Chris White's, 'I Love You', lifted from the Decca 45 (F12225), or the Rod Argent authored, 'She Does Everything For Me', Decca 45 (F12584), are milestones which plot the evolution of a band. *Greatest Hits* in this context is a misleading title. It works better if we think of this as an album devoted to a better understanding of the undead. It certainly draws our attention to some hitherto overlooked song writing

strengths and the accomplished musicianship spread throughout the group. Hugh Grundy is an impressive drummer and Paul Atkinson's fretwork is a revelation. However, because it remains essentially a musical release this sets it apart from a collection like the 1997 Ace Records four CD box set, *Zombie Heaven*, which in concerning itself with unissued material and alternate takes, comes across more as an historical document.

The remaining releases in this first batch all fall into a "Classic Jazz" category, but I believe it's fair to say that they too represent some unexpected choices. When I think of classic jazz albums and personalities, I think of giants with the stature of a Miles Davis, Sonny Rollins or an Art Pepper, and their groundbreaking recordings of the Fifties and early Sixties. Here, though, three CDs that challenged my preconceptions confront us. Two of them, Mel Torme *The London Sessions* and Buddy Rich *The Best Band I Ever Had*, surfaced in 1977, while The Cal Tjader Quintet's *Latin + Jazz = Cal Tjader* was a 1968 "live" recording from the Red Onion in Aspen, Colorado. They make for an interesting triumvirate. ▶





► Have you heard the one about the crooner, a drummer and the vibes player? Well, this was an instance where the rock beneath Gryphon Records, Norman Schwartz, produced them all. He provides a link between a singer of classic contemporary songs, the big band genre and exotic, sun drenched rhythms, and his handling of these markedly different forms is a revelation.

Leading the way is a wonderful jazz orchestrated *The London Sessions* AFZ 002, an album which Mel Torme himself described as, "the finest album I have ever made". This is a remarkable statement from a man whose career from child prodigy to an impeccable interpreter of the great standards spanned the best part of eight decades. In many ways Torme was one of those old fashioned entertainers who brought a whole basket of talents to the table: Drummer, pianist, dancer, arranger, composer, actor and above all else a singer blessed with perfect pitch. Comparisons to Sinatra are not misplaced. Vocally, they were of course very different. Francis Albert was a rich baritone, Torme much softer hued, but both men approached the contemporary songbooks and the structure of an individual song with unmatched levels of care and professionalism. The timing and delivery of a line, subtle shifts in emphasis, the tiniest changes of inflexion, that attention to the smallest and seemingly most inconsequential of details always remained important to them. It sets their interpretations apart from most others. They also insisted on surrounding themselves with the finest of musicians and arrangers, which makes for great sounding albums. *The London Sessions* is no exception.

The eight Christopher Gunning arrangements here work through some varied material. They range from an almost infamous Stephen Sondheim 'Send In The Clowns' and Mort Dixon's 'Bye Bye Blackbird', to more modern compositions like Stevie Wonder's 'All In Love Is Fair', Billy Joel's 'New York State Of Mind', as well as a Ewan McColl 'The First Time Ever I Saw Your Face' and the Janis Ian penned 'Stars'. Torme swings them all and in doing so explores the hidden depths to these songs while at the same time giving us a close up and personal view of his own state of emotional well being. Autobiographically, Torme's recent divorce provides the backdrop to this recording project, so this music is treated as

a part of the cathartic experience.

We know that there was an intensive period of planning and pre-production activity for this album, but the one thing that comes across in every instance is the unforced and seamless presentation of the music. Torme literally finesses his way through these songs. He stands there in front of a full orchestra – no backing instruments were added afterwards – and gives one of those outstanding performances. Steve Hoffman's re-mastering process reveals the development of this close-knit relationship between musicians and soloist while almost incidentally picking out the refined musical details like that fat-fingered bass playing on 'Send In The Clowns'.



The third SACD, Buddy Rich's *The Best Band I Ever Had* AFZ 003, comes from auspicious beginnings of its own. The original live to Two-Track recording was a direct-to-disc LP cut at the RCA Victor Studios in New York. Relinquishing the control and the comfort blanket that Studio technology provides is a big step to take for any producer. However, although this was Norman Schwartz's first venture into this rarefied field of recording, he made some intelligent decisions that helped to underpin the entire production. The Buddy Rich Band was familiar to him.

Moreover, they were acknowledged to be a really tight and cohesive outfit. Just what you need from your musicians when equalisation, noise suppression, overdubbing, mixing and editing are no longer an option. He'd previously recorded this crew in these very same studios and went about setting up the band in exactly the same way as before. Basically, Schwartz kept the number of things that could go wrong to a minimum. Even the selection of five solid jazz standards in 'Birdland', 'Bouncin' With Bud', 'Cape Verdean Blues', 'Fiesta' and 'Funk City Ola', seems to reinforce the damage limitation philosophy employed here. Well, whatever your views, this cautious approach works.

One of the other considerations is Buddy Rich. Although renown for his improvisation and dynamic drum solos, he shows here that even when sat outside of the limelight a drummer must still continue to deliver the rhythmic muscle that drives his musicians and the music in general, ever forward. This was of course learned back during the







sounds of music

For the very best deals on the finest products available, visit:

[www.sounds-of-music.co.uk](http://www.sounds-of-music.co.uk)

there's no finer sound.

**Noteworthy Audio**  
 Selected products from Audio Note, Avantgarde, Chord, Electrofluidics, Heart, Isotek, JM Labs, Lowther, Living Voice, Merlin, Michell, Ortofon, PMC, ProAc, Pure, Quad, Rega, Ringmat, Rose, Shanling, Silver Arrow cables, SME, Something Solid, Talk Electronics, Tannoy, Von Schickert and many more...

36 Buckingham Street,  
 Aylesbury, Bucks  
 Tel: 01296 422224  
[www.noteworthyaudio.co.uk](http://www.noteworthyaudio.co.uk)

# Infidelity

INDECENTLY GOOD HI-FI

Buying hi-fi should be a delight.

If choosing your new hi-fi in a civilised and relaxed atmosphere from a well-chosen selection of genuine performance equipment appeals, then we are for you. Bring along your own records or CDs, we'll provide the coffee, and hear the difference we can make.

9 High Street, Hampton Wick,  
 Kingston upon Thames, Surrey KT1 4DA

Telephone: 0208-943 3530

Open: Tues - Fri 10.30am - 7pm  
 Saturday 10am - 6pm.



# Radlett Audio

EST. 1978 CONSULTANTS

THE HIGH-END SPECIALIST SINCE 1978

ATC, Audio Analogue, Avantgarde, Ayre, Bryston, Copland, EAR, Isotek, JM Lab, Lyra, Mark Levinson, Naim Audio, Notts Analogue, PMC, ProAc, Rega, Revel, Roksan, Sonus Faber, Stax, Spendor, Sumiko, Wadia and lots more.

9 Holywell Hill, St. Albans, Herts, AL1 1EU

Tel: 01727 855577

Fax: 01727 858727



THE INNOVATIVE  
 HI-FI, HOME CINEMA  
 AND MULTI-ROOM  
 RETAILER/INSTALLER

## ORANGES & LEMONS

Friendly and efficient service 0% Finance available

JUICY FRUIT FROM LONDON'S FRESHEST RETAILER

ARCAM B&W CABLE TALK CASTLE CHORD CREEK  
 DENON EPOS LINN MARANTZ NAD NAIM NEAT PMC  
 QED REGA ROKSAN ROTEL RUARK STANDS UNIQUE  
 SOUNDSTYLE YAMAHA XANTECH and many others

020 7924 2040

61/63 WEBBS ROAD, SW11

website: [www.oandhifi.co.uk](http://www.oandhifi.co.uk)



# the sound sanctuary



The only choice for music lovers looking for the highest quality sound.

Naim, Linn, Rega, Musical Fidelity, Chord Electronics and Wilson Benesch plus esoteric audiophile brands such as Wavac, Klyne and Monarchy.



Castle Sound & Vision, the region's leading hifi, home cinema and multi room specialists

48 - 50 Maid Marian Way Nottingham NG1 6GF Tel: 0115 958 4404  
[www.castlesoundvision.com](http://www.castlesoundvision.com)

Get the Most from Your CD's & Vinyl!  
Simply add a **Dynavector SuperStereo** processor

"...produces astonishing results ..." "...you need to hear this to appreciate the magnitude of the improvement ..."  
*Roy Gregory, Hi-Fi +*

"...extraordinarily convincing...simply sounds more natural ..."  
*Paul Messenger, Hi-Fi Choice*

"Indispensable for listening to music"  
*Stereo Sound, Tokyo*

The Adp-2 processor, £895, reviews and info direct from:

**Dynavector SuperStereo**  
Tel/Fax. 01202-767873  
E-mail. [dynavector@onetel.net.uk](mailto:dynavector@onetel.net.uk)  
Net. <http://web.onetel.net.uk~dynavector>

**PRODUCT YEAR** **EDITOR'S CHOICE**

**Audiosolutions**

**KORATO**

**opus 3**

**www.a-audiosolutions.co.uk**

**Hi-Fi News**  
Industry Awards  
Hi-Fi News  
2003

**BADA**  
BRITISH AUDIO DEALERS ASSOCIATION  
the symbol of security

**Music Matters**

The finest hi-fi, Home Cinema and Multi-room systems -  
from a selected range of suppliers

*On demonstration:*  
Arcam, Audio Net, Base, Bowers & Wilkins,  
Chord, Cyrus, Dynaudio, Epos, Isotek, KEF,  
Living Control, Marantz, Meridian, Musical Fidelity,  
PMC, Project, Rel, Wilson Benesch  
*And much, much more.....*

Demonstrations available by appointment  
020 8420 1925  
344 Uxbridge Road, Hatch End, Pinner, Middlesex HA5 4HR  
Open Tuesday - Saturday 10am - 5:30pm

**TIME TO TRY ...**



Stockists of:  
Naim Audio  
Conrad Johnson  
Wadia  
J M Lab  
Dynavector  
Rega Research  
Cardas  
Totem Acoustic  
Sugden  
Proac  
Spendor  
Quadraspire  
and others ...

**Audio Republic, 78 Otley Road, Headingley, Leeds, LS6 4BA**  
Tel: 0113 2177294 [www.audio-republic.co.uk](http://www.audio-republic.co.uk)

Keep your hi-fi+  
magazines in  
immaculate condition  
with these specially  
designed binders.



You can order yours by  
calling **01202 659380**  
or via the website at  
[www.hifiplus.com](http://www.hifiplus.com)

**hi-fi+**

**diverse vinyl**

LP mail order specialists  
Over 3500 brand new  
LP titles in stock  
Call for a catalogue

**01633 259661**  
or visit  
[diversevinyl.com](http://diversevinyl.com)





## François Couperin

### Keyboard Music, Volume 1 Angela Hewitt

Hyperion CDA67440 

While the music of Angela Hewitt's favourite composer – Johann Sebastian Bach – with its more abstract style, easily adapts to being played on either harpsichord or piano, Couperin's style is more closely allied with, and enhanced by, the characteristics of the former's sound. But, with a dry sounding Steinway and her sparing pedal use, Hewitt manages to overcome any shortcomings with her choice of instrument. There are three *Orders* on this beautiful release: the *Sixth*, *Eighteenth* and *Eighth*. The opening *Sixth* – pioneering when first composed – is totally enthralling, with Hewitt drawing every detail from the textures, particularly in *Les barricades mystérieuses*. The *Eighteenth* is full of contrast, with the unassuming placed side by side with the ostentatious, while the *Eighth* includes a *Passacaille* that could simply be Couperin's finest work for keyboard. Hewitt lets each embellishment flow naturally by utilising great sincerity, drawing the listener into the performance and making her affection for the music obvious. Throughout, she supplies a most committed performance; with outstanding touch and control allowing each piece to evolve with tremendous elegance and style, and Hyperion has captured the acoustic of Henry Wood Hall with aplomb, all resulting in an excellent release.

SG

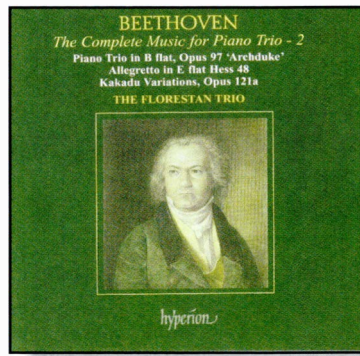
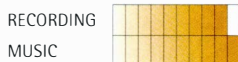

## Beethoven

### Complete Music for Piano Trios, Vol. 2 The Florestan Trio

Hyperion CDA67369 

This lovely disc opens with Beethoven's ever-popular *Archduke Trio* before offering two lesser known works as bonuses – an early *Allegretto* and the wonderfully witty and zestful *Kakadu Variations*. But it is the account of the *Archduke* that remains the high point, with a performance to rank alongside the absolute best. The opening theme of Susan Tomes' piano sets the tone, with its easy flowing tempo, awash with expression, and this is taken up by the other players, revealing the natural togetherness that remains a characteristic of this ensemble. This may be a performance in the true "classical" manner, with others providing grander or more romantic accounts, but the Florestan's imbue Beethoven's most massively scored trio with great intimacy and lyrical tenderness, providing the piece with a luminosity rarely achieved. While the *Scherzo* may appear a little faint-hearted at times, there is generally a rhythmic quality that stimulates the calm, especially in a finale full of character, with sudden moments of levity. But they never lose sight of the overall elegance of the work, and it is this balance of sublime details and their comprehensive foresight that produces such a radiant account.

SG

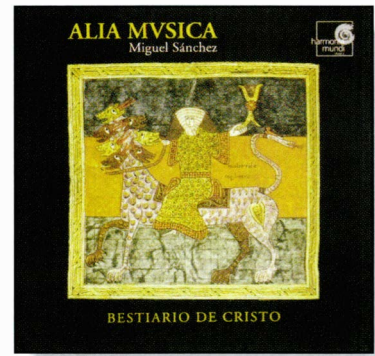

## Bestiario de Cristo

### Alia Musica/Sánchez

Harmonia Mundi HMI 987033 

This collection of fourteen vocal works, and four instrumentals, taken from 13th Century manuscripts held in Paris and Spain, concerning the religious symbolism of animals – hence the title of "Bestiary of Christ" – is another compelling release from the excellent ensemble, Alia Musica, and their director, Miguel Sánchez. By means of various vocal styles, a number of animal representations, from moths to dragons, are introduced. Each of these creatures and their characteristics are woven into religious metaphors, symbols or values through the deployment of the poetry, and there are some excellent and extensive notes for the more interested listener, offering an introduction to the significance of the texts and the context of each song. But there is little for all but the most learned of listeners to distinguish these songs from countless other contemporary religious pieces, despite being structurally sophisticated, melodically appealing and skillfully written. What brings this disc to the fore is the quality of the performances, with this accomplished group providing a most pleasant and often sensitive listening experience. They are genuinely dedicated musicians, who continue to bring early music enthusiasts a rich repertoire of the rare and unusual, and with beautifully sympathetic engineering, this release has to be a top recommendation.

SG





**MacMillan**  
**Why is the night different?**  
**Tuireadh/Memento/Emperor**  
**String Qt./Robert Plane**

BIS CD-1269 (CD)

James MacMillan's music harks back to the modernist innovations of the 1960s: being full of complex, dissonant harmonies and is often difficult for timid audiences to fully appreciate. The most austere piece among this collection of his chamber music is *Visions of a November Spring* – his first string quartet. It begins in a disconcerting manner with deformed string effects, proceeding through tormented convulsions and edgy gestures, and ending with eerily distressing harmonies. His second quartet, *Why is the night different?* comes from the Jewish rite of commemoration on the first night of Passover, the Sedar, and retells the tale of the Israelites flight from Egypt. Macmillan employs a highly illustrative musical technique, with the instruments behaving like characters in a play and the first violin assuming the role of narrator. *Tuireadh*, for clarinet and string quartet, was composed as a memorial for the victims of the Piper Alpha oilrig disaster. It is tense, gut-wrenching music, and comes complete with agonized shrieks and anguished weeping. The disc ends with the much calmer, hymn-like *Memento*, which, like the previous pieces, is performed with total assurance. With sound of exceptional clarity and impact, the result is a superb, if somewhat harrowing release.

SG



**Schubert**  
**Piano Sonatas D.598, D.599**  
**and D.560**

Murray Perahia  
 Sony S2K 87706 (CD)

Murray Perahia has always instilled his performances with lyrical qualities, while being fully aware of the composition's overall structure; qualities at the heart of these performances of Schubert's last three piano *sonatas*. But, he also conveys more urgency, making less of distinct minutiae, enforcing a greater diversity of expressions and colour. This is particularly apparent in the *A Major, D.959*, where he gives the *scherzo* a stronger rhythmic core than in his 1987 recording for CBS. In the opening *Allegro*, where he now opts for the repeat, he adds refinement, clarifying and intensifying the music, as he does in the slow movement, which is tauter, conveying warmth and body. This approach to the slower movements is apparent throughout all three pieces, but Perahia just lacks Uchida's sensitivity and Richter's control. In the *B-flat Major, D.960* some of Rubinstein's tenderness eludes him also, while the *scherzo* lacks a little sincerity and character, but the way he launches into the finale, shattering the previous movements mood, gives the work fantastic clarity. But, with a performance of the *C Minor, D.598*, full of unflustered virtuosity, this release ultimately reveals how Perahia is developing as a most intelligent pianist.

SG

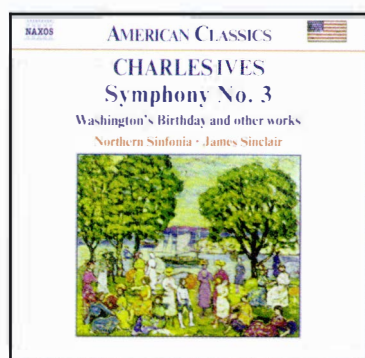
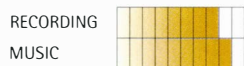

**Ives**  
**Symphony No. 3 "The Camp**  
**Meeting", Washington's Birthday**

Northern Sinfonia/Sinclair  
 Naxos 8.559087 (CD)

Being the world's foremost authority on the music of Charles Ives does not necessarily guarantee James Sinclair's interpretations are going to be totally successful. But happily his musicianship reveals the same empathy and there is a certain quality to these performances that make them among the finest of Ives' music ever recorded. Sinclair presents each work with great lucidity of texture, with the composer's moments of dissonance adding to the disparity of harmonics. While the majority of the music on this disc is gentle and beautifully relaxing, especially during the *Third Symphony*, he also utilises some tempi of the more spirited variety. *The Unanswered Question*, with its distinct communication between the inquiring trumpet and the answering of the remaining winds, is presented in record time, making this performance all the more persuasive. During *Washington's Birthday*, the barn dance is supplied with wonderfully optimistic rhythms, while the two final pieces, taken from *Three Places in New England*, display much enthusiastic humour. The Northern Sinfonia play with total discipline and self-assurance throughout and the engineering captures every ingredient of this most welcome issue with great balance, all making this impressive release highly recommended.

SG







## Brahms, Bartok, Liszt, Dohnanyi Piano Sonata No.3, 15 Peasant Songs, 2 Etudes, Rhapsody No.3

### Annie Fischer

BBC Legends BBCL 4054-2



Annie Fischer's prized and highly regarded original piano recordings of the 1950s and 1960s for the Columbia label remain far from the reach of most ordinary mortals. So it makes this BBC 20bit transfer of a live mono recording made during the 1961 Edinburgh Festival a particularly welcome one. Play this CD and you will begin to understand just how her reputation came to be founded upon that combination of pure unadulterated natural talent, spontaneous readings and thoroughly expressive performances. She could almost be described as too gifted. The casual approach to rehearsals and the recording process in general meant that the Hungarian-born Fischer was infuriatingly under-recorded. Whilst she was always prepared to endlessly play passages in search of expressive perfection, the suggestion that there should be a second take to iron out technical faults was almost invariably received with indifference. Here, at Usher Hall in Edinburgh the luxury of returning to touch up the tape did not exist and the result is a recital disc of such fluency, passion, dazzling virtuosity and musical communication that any occasional blemish in its delivery has no relevance to the realisation of these works. She shrugs off that notoriously

difficult pacing for the *Brahms F Minor Sonata* yet effortlessly retains the supplest of grips. Fischer allows her music to ebb and flow within the composer's prescribed vision for this Sonata but never loses sight of the greater unfolding drama tantalisingly held before us. It can be heard through the lyricism of a slow movement that builds towards a series of radiant climaxes and beyond, with resonant dynamic phrases which ripen, open out and drench us with their images of rare beauty. This account feels right because it is perceptive, ruminative, sensitive and assured when and as required. Elsewhere, Annie naturally excels when playing the music of her fellow countrymen. In Bela Bartok's earthy exploration of humanity, the *Fifteen Hungarian Peasant Songs* are sympathetically and genuinely developed. Careful attention is paid to his sprung rhythms and those vocal-like qualities of the score. This allows an articulate soloist like Fischer (who possesses flair, imagination and poetry in their hands) to evoke that full range of instrumental colours and those inextricable feelings of elation, passion or frailty which accompany them. It is easy to picture the rural setting and a simple yet hard life for those that lived there when she

plays these vignettes. For them Fischer's evocative artistry is both visual and tactile in nature. The tanned skin and callused hands, weary smiles and joyous country-dances are brought to life in these finely etched performances that mimic a wider spectrum of instrumental nuances to recreate their images.

In Franz Liszt's *Trois Etudes No.3* and *Grandes Etudes de Paganini No.6* there are a couple of technical hiccups but they do not detract from the beautiful sweeping flights of fancy and intelligent phrasing teased from these keys. The conclusion to this sparkling Edinburgh night is an encore piece in the shape of a delightful *Rhapsody in C Major, Op.11 No.3* by Erno Dohnanyi. This closing lyrical encounter has majestic melodies placed alongside contrasting passages of sustained driving momentum, which shows Annie Fischer at her stylish and creative best. A clean and dynamic sounding re-master memorably picks out those nice little changes in tempo, weight and emphasis as well as the physical shape and sound of decaying piano notes, not just here but throughout all of these works. A wonderful opportunity to hear one of the great Twentieth Century pianist in their element.

RP

RECORDING  
MUSIC





**Sibelius**  
**Rondo of the Waves:**  
 The Oceanides (Yale and Final  
 versions); and other works  
 Lahti Symphony Orchestra/Vänskä

BIS-CD-1445 (CD)

This is BIS' 51st volume in an ever increasing monument to a complete edition of Sibelius' work. They have previously explored the genesis of works such as the *Violin Concerto* and *Symphony No. 5*, but they now reveal the development of other works, starting with *The Oceanides*, commissioned in 1914, for an American visit. Originally called *The Rondo of the Waves*, the original piece found its way to Yale University Library, before Sibelius' extensive reworking. The Yale version has long been known of, but only now makes its debut, and is supplemented by an even earlier version. Hearing how one of Sibelius' masterpieces emerges from its confused beginnings is a lesson in the creation of greatness, especially when performed with such sensitivity and tonal polish – Osmo Vänskä and his Lahti players are true champions of Sibelius' work. But this release is more than just an academic look at the composer's compositional methods. The disc also holds astounding performances of the composer's lesser-known pieces, including the wonderfully ethereal piece for wind; *Cassazione*. With the bonus of excellent sound, this simply has to be one of the most notable new releases of Sibelius' music for a number of years.

SG



**Shostakovich**  
**Symphony No. 7 "Leningrad"**

Kirov Orchestra/Rotterdam  
 PO/Gergiev

Philips 470 845-2 (CD)

Performing Shostakovich's grand wartime symphony necessitates the largest of orchestras, utilising vast forces, particularly in the strings and brass. So it is not surprising to find Gergiev utilising both the orchestras of which he is principle conductor – interestingly from cities that suffered similar wartime fates. Despite the conductor being a little free with the composer's tempo directions, Gergiev delivers a performance that still propels the music with a particular momentum. He employs fairly tight rhythms throughout, creating a forceful and striking interpretation of rich textures. Many of his recordings have been tremendously revealing, using every detail to project his vision of the music, and the same can be said of this live performance. He manages to convey the extent of emotions, successfully generating both anguish and jubilation while still offering the sensation of great determination. The two orchestras blend with great effect, producing some exceptionally dynamic climaxes that are outstandingly portrayed by the engineering, producing a disc of demonstration quality. Philips has captured both the sonic magnitude and the reverberation of the concert hall brilliantly, resulting in a gripping listening experience that is a worthy addition this work's already impressive discography.

SG

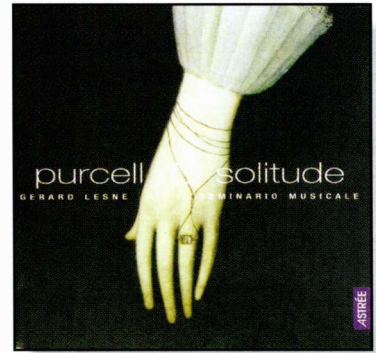

**Purcell**  
**O Solitude**

Gérard Lesne/II Seminario  
 Musicale

Naïve E 8882 (CD)

Until Schubert, Henry Purcell was certainly the most prolific songwriter in Europe and arguably the greatest, filling his songs with topics from virtually every characteristic of his volatile age. Although Purcell himself was a countertenor, I doubt if this, or any collection of his songs for countertenor could have been better served than here. Gérard Lesne performs this diverse set with extraordinary eloquence, revealing the composer's remarkable creativity and versatility. In the opening *O Solitude, my sweetest choice!* he supplies a most heartfelt rendering, while his singing of the celebrated *If music be the food of love* is beautifully animated. He fittingly concludes the program with *An Evening Hymn (Now that the sun hath veil'd his light)*, bidding goodnight to the world with one of Purcell's most distinguished yet poignant marches. Throughout he is ably assisted by the stylish performances of the expert ensemble II Seminario Musicale, who were found by Lesne himself nearly twenty years ago, and who also perform instrumental interludes throughout. With such performances, superbly captured by engineering of the highest standard, this is one of the finest recitals of its kind available.

SG





# Vivante

Unit 6, Fontigarry Business Park,  
Reigate Road, Sidlow, Nr Reigate,  
Surrey RH2 8QH. UK.

tel: +44 (0)1293 822 186  
fax: +44 (0)1293 820 509  
email: sales@vivante.co.uk  
web: www.vivante.co.uk

© vivante productions. all rights of the producer and of the owner of the recorded work reserved

fall in love with the music

vinyl classics for christmas

**Jennifer Warnes: *The Well***

Everything about this disc is right. The pressing quality is first rate; the art work and inner sleeve with lyrics are presented to the highest standards. The music is of course the work of a true artist. Tracks include: *And So it Goes, You don't know Me* and *The Well*.

Cisco 180g LP £25.95



**Doc Watson: *Southbound***

A highly recommended album of folk, bluegrass and country from the man. Tracks include: *Sweet Georgia Brown, Tennessee Stud, Nothing To It* and a definitive version of Tom Paxton's, *The Last Thing On My Mind*.

Cisco VSD-79213 LP 180g £25.95

**Joan Baez: *Farewell Angelina***

Joan Baez is one of the most enduring artists from the 1960's. *Farewell Angelina* (1965) was Joan's third album and features songs from Woody Guthrie, Donovan and of course, Bob Dylan. The album features Joan, an acoustic guitar and the very minimum of backing or instrumental ornamentation. Her voice is pure and pristine and so distinctive that no one but her could be doing what she does. *Farewell Angelina* is an enjoyable album that folkies everywhere will enjoy.

Cisco VSD-79200 LP 180g £25.95



## ADVERTISERS INDEX

A' Audio Solutions	138
Absolute Analogue	11
Absolute Sounds	2
Adventures in HiFi	108
Audio Atmosphere	93
Audio Images	87
Audio Reference	35
Audio Reflection	108
Audio Republic Ltd	138
Audiocraft	58
AudioFreaks	7
Audiophile Club	59
Audiophile International	58
Audio-T	13
B&W	obc
Basically Sound	108
Border Patrol	93
Castle Sound & Vision	137
Chestergroup	46
Chord Electronics	8
Clear Cover Ltd	37
Definitve Audio	68
Diverse Vinyl	138
Doug Brady HiFi	68
Dynavector Superstereo	138
European Circuit Solutions	35
Final Lab	76

Glacier Audio-Atma-sphere	19
Graves Audio	93
Griffin Audio	47
Gryphon Audio	22
Hazlemere	101
Hear Here	45
Heatherdale	101
HifiCables.co.uk ltd	101
Hififorsale.com	69
Icon Audio	45
IF Designs	87
Infidelity	138
I E S	76
Joenit	24
KJ West One	21
KM Acoustics	45
Kronos HiFi	109
Lamm	109
Manger Audio	47
Metropolis Music	86
Music Matters	138
Neat Acoustics	69
New Audio Frontiers	109
Nordost	ibc
Noteworthy Audio Ltd	137
Oranges & Lemons	137
Origin Live	75

Overkill Audio	16
Overkill Audio	77
Path Premier	ifc
Pear Audio	115
Radlett Audio	137
Ringmat	59
Russ Andrews Accessories	87
Signals	87
Silver Arrow Audio Cables	115
Sounds of Music	137
Spendor Audio Systems Ltd	47
Strub	87
The Cartridge Man	115
The Chord Company	25
The Emporium	114
The Right Note	86
The Studio	36
Trading Station	146-8
Trichord Research Ltd	75
Tube Shop	37
Vivante	143
Voodoo Isolation Systems	114
Walrus	4
Wollaton Audio	77
Zouch Audio	12

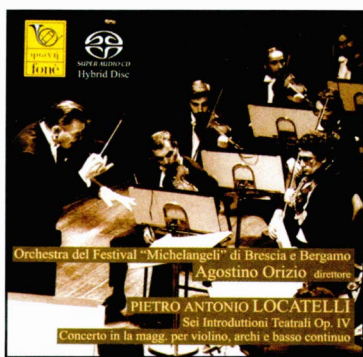

Locatelli

Introduzioni Teatrali OP.IV  
Concerto in A Major  
Orizio / OCFMBB

Fone 004 SACD (SA)

Locatelli was a native of Bergamo and these Festival "Michelangelo" Brescia Bergamo musicians (who truly shine under the sympathetic direction of Agostino Orizio) give beguiling and virtuoso performances of the four *Teatrali* and that expressive *Concerto in A Major* for violin, strings and basso continuo. Each of the *Teatrali* is divided into three sections and was probably used as an overture to operas by other composers of the day. Yet, because they remain firmly rooted within an Italian Concerto Grosso tradition, these melodic, sensitively scored and sonorous pieces stand out in their own right as tightly structured, independent and highly emotive vignettes. At twelve and a half minutes long, the *Concerto* is nearly twice the length of *Introduzioni II*, the longest of the *Teatrali*, and this allows Locatelli's more stately and considered craft to develop some defining moments of pathos and melancholia especially in the moving Largo. The venue, (an ambient Palazzo Grande in Brescia), the valve/analogue equipment and a perceptive and highly accomplished recording by Fone impresario, Cesare Ricci have all successfully transferred to this, the premier digital format. Listen out for the sumptuous, beautifully formed and sustained violin notes held out forever in the closing Allegro.

RP

Supplier: [www.vivante.co.uk](http://www.vivante.co.uk)



Dvorak

Symphony No 8 & 9  
'From the New World'  
Iván Fischer,  
Budapest Festival Orchestra

Philips 478 617-2 (SACD)

These two works are often coupled, only partly because their combined playing time is about right for a single release. They have a natural affinity, presenting contrasting but complementary moods. The *eighth* is predominantly lyrical and clearly old Europe in style. The *New World*, inspired by a visit to the United States, has something of the urgency and dynamism of New York, though the musical language remains unmistakably European, Dvorak's valedictory symphonies have appeared many times on disc, but of all recent recordings this one is surely the best. Slavic performers playing Slavic music was always likely to pay dividends, and Fischer's exuberant personality provides the coup de grace. The *eighth* is given a spacious, measured reading with an almost folksy familiarity, warmth and grace which brings the various parts into sharp relief. The *New World* is a more propulsive work, and it shows in a performance that is often electric. Both performances are nothing if not idiomatic, with a real pulse and forward momentum. The orchestral players, who must have absorbed the music as infants over their corn flakes, have a clear affinity with the music, but still manage to invest the performances with a winning freshness and gusto.

AG

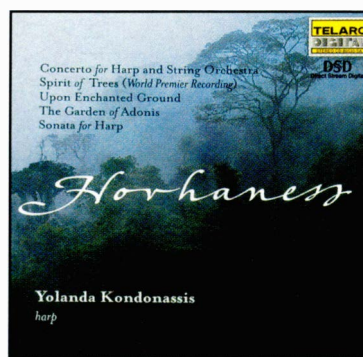

Hovhaness

Works for Harp  
Kondonassis

Telarc CD-60530-SA (SA)

Alan Hovhaness was heavily affected by mysticism and a long held interest in the music of the European Middle Ages and Renaissance. Consequently his compositions often have that remarkably pervasive quality about them which successfully blends those distinctive personalities found amongst Occidental and Oriental influences as well as works ancient and modern. The *Concerto for Harp and String Orchestra*, *The Garden of Adonis*, *Upon Enchanted Ground*, *Sonata for Harp* and a World premier recording of *Spirit of Trees* heard here are expertly and powerfully played by the American harpist, Yolanda Kondonassis. Their instrumental scoring is melodic, rhythmically flowing, stylish and imaginative with the flute, cello and giant tam-tam joining the harp's incandescent voice for the bright exchanges on *Upon Enchanted Ground* and David Leisner's guitar for *Spirit of Trees*. Plucked and sustained strings pinch and cushion their way through a swaying and dance-like *Concerto*. Those bright flourishes and every graceful contrapuntal hand gesture in the *Sonata* have even their most delicate and lightest of touches revealed by a recording which proves SACD's almost magical ability to accurately reproduce the textures, tonal and harmonic properties of the most unusual and diverse of instruments.

RP

Supplier: [www.vivante.co.uk](http://www.vivante.co.uk)





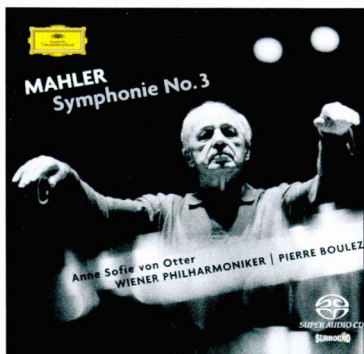

**Mahler**  
**Symphony No 3**  
 Anne Sophie von Otter / Women's  
 Chorus of the Vienna Singveriens,  
 Vienna Boy's Choir, Boulez, VPO

DGG 474 298-2 

If there is one composer whose works have benefited disproportionately from the introduction of high-resolution multi-channel audio, it is surely Gustav Mahler. The music is predominantly large scale with a complexity that is almost inevitably diminished in recordings. The emotional core of this work is the slow, solemn song *Sehr langsam* sung ravishingly by Anne Sophie von Otter against a muted orchestral accompaniment, which is followed in one of the most startling transitions in all symphonic music into the bright, breezy *Lustig im Tempo und keck im Ausdruck* sung by a double chorus of womens' and boys' voices. Although SACD is no complete cure for the limitations of black vinyl and compact disc, it is beginning to close the gap. The Third has a beauty and complexity that doesn't always work on disc. Here it comes across as loose limbed (but tight in ensemble) yet superbly focussed, with an almost tactile quality and presence. The DGG sound is almost unrecognisable from the messy manipulative mixes characteristic of the Karajan era. Open, spacious and atmospheric, this Third is also the most successful performance (along with *Das Lied von der Erde*) of the ongoing Boulez Mahler cycle.

AG



**Junior Wells**  
**Come On In This House**

Telarc SACD-63395 

His reputation as a stylish blues harmonica player was cold forged on vinyl back in the mid-1960s when he traded solos with the superb Buddy Guy. Here, thirty years later, the singing of Junior Wells and his weeping harp bend the notes that shed some big heartfelt tears on this 1996 recording. This time it's emotional undercurrents are reserved for classic Sonny Boy Williamson material in songs like 'Trust My Baby' and 'The Goat' or for those laconic Tampa Red tracks such as 'King Fish Blues' and 'She Wants To Sell My Monkey'. The naturalness and warmth in his delivery is complemented on this mainly acoustic album by the terrific slide and steel guitar playing of Corey Harris, John Mooney and Alvin "Youngblood" Hart. Elsewhere the legendary Sonny Landreth lays down strong electric slide solos for 'Why Are People Like That?' and some telling support work in 'Give Me One Reason'. Bob Sunda fires in those honest acoustic and six-string electric bass lines which alongside a rock solid Jon Cleary acoustic piano tuck in so nicely behind the assertive, gritty and seasoned Wells vocals as they illuminate a powerful and emotionally rousing mood of the Delta. The corrugated tin roofs, clapboard walls and that special kind of inner musical strength which unites close knit rural communities are all evocatively recreated.

RP

Supplier: [www.vivante.co.uk](http://www.vivante.co.uk)



**Bach**  
**St Matthew Passion**  
 Schoenberg Choir, Harnoncourt,  
 Concentus Musicus Wien

Das Alte Werk 8573 81036-9 

Once described by the academic Adolf Bernhard Marx as "the greatest and most sacred work of music", the *St Matthew Passion* is a true masterwork of undeniable beauty, grandeur and – yes – passion. It is the cumulative impact of the music that tells more than any of the individual performers or movements. Similarly, although the soloists are excellent in every case, it is the raptness and controlled fervour in the combined forces that really speaks to the listener. The orchestral and vocal forces are beautifully blended, and the Schoenberg Choir provides scale and weight to frame the work. The surround sound recording does just what it should, which is to anchor the front image and provide a sense of depth and physical structure, while the surround channels add space and substance to the sound. As well as being an excellent recording of a fine performance, this disc perfectly encapsulates the power of the DVD-Audio format. The disc includes a 5.1 DVD-Audio recording, along with a stereo DVD-A down-mix and a stereo Dolby Digital track for DVD-Video players, plus supporting still video information including a picture gallery. All this for a work with a playing time in excess of 161 minutes, is shoehorned onto a single disc!

AG

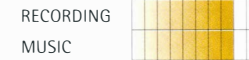

The Hi-Fi Company's

# Trading Station

The leading reseller  
of carefully used  
and mint condition  
hi-fi components  
and systems.

Buy, sell, exchange.  
Commission Sales.

www.hifitradingstation.com

The Trading Station  
35Cowgate Peterborough PE1 1LZ

Phone: 0870 608 8211

email: audiotrader@talk21.com

BUSINESS HOURS: Tues - Sat: 10am - 5.30pm  
CLOSED MONDAYS

ALL MAJOR CREDIT CARDS ACCEPTED\*  
\*NEXT DAY DELIVERY AVAILABLE  
COMPETITIVE FINANCE TERMS FOR  
PERSONAL CALLERS

## ●Vinyl

ACOUSTIC RESEARCH EB101	£275	£148
ALPHASON Sonata		
Atlas PS./HR 100S-MCS	£2000	£995
ARISTON Q Deck	£199	£ 98
CONOISSEUR BD2	£250	£125
DUAL CS506 (Black)	£175	£ 80
DUAL CS 505 Silver	£150	£ 88
DUAL CS503-1 Concept	£180	£ 88
GOLDRING Lenco GL85 white	£175	£ 75
LINN LP12 (Black) LVX/K9	£1500	£575
LINN LP12 Afro (no tonearm)	£1300	£375
LINN LP12 Rosewood/Akito	£750	£894
LINN LP12 Lingo / Ekos / Archive	£3500	£1998
LORIAN Transformer	£700	£356
LUXMAN PD282 (Rosewood)	£595	£320
MICHELL Gyrodec	£870	£740
MICHELL ISO Phono Stage Ex-dem	£895	£646
MICHELL ISO/HERA Phono Stage	£895	£448
MICHELL Gyro/Orbe Update		
QC/MEC/CLAUD	£3000	£1698
MICHELL ISO Phono Stage	£895	£298
MISSION 775 / Goldring 1040	£795	£398
ORACLE Alexandria	£1500	£650
ORTOFON MCA10 Phono Trans	£125	£55
PROJECT 6.9	£600	£300
REGA 25/Rega cart As new	£1695	£895
REGA Planar 2 (No arm)	£200	£75
SME 10A with 309 Tone Arm XDem	£3410	£2896
SME20/2A	£5273	£4486
SYSTEMDEK Mission 774/ATOC3	£600	£195
TECHNICS IZ10 incl. Flight case	£600	£298
THORENS TD 318 (black lacquer)	£350	£195
THORENS TD160 No cover	£279	£160
THORENS TD150 Rare		£190
TRICHORD Dino inc large PS	£600	£398
UNISON Phono 1 + PSU	£850	£478
VOYD Reference inc arm	£14,995	£3998
WELL TEMPERED Record Player	£2,300	£1,695
WILSON BENESCH Full Circle	£1995	£1495

## ●Digital Sources

ARCAM Alpha One CD	£300	£149
ARCAM Alpha 9 CD	£799	£350
ARCAM Diva CD73	£400	£328
ARCAM Diva CD92	£800	£494
AUDIO MECHA		
Damnation Tran + Upgrade	£1250	£439
AUDIO MECHA Maghista	£2200	£1398
AUDIO SYNTHESIS DAX 2	£1700	£896
AUDIO SYNTHESIS Transcend	£1200	£596
AVI S2000MC REF	£1395	£598
CAMBRIDGE AUDIO Cdi CD Plyr	£500	£95
DCS Elgar	£9500	£5495
DCS Elgar	£9500	£6498
DPA The Little Bit - DAC	£350	£95
EXPOSURE CD Player	£999	£629
KENWOOD DP7090 CD Plyr	£399	£129

KENWOOD DP-X9010 Trans	£400	£199
KINSHAW Overture DAC	£300	£75
KRELL KPS 25 CD/Pre	£24,998	£12,996
LINN Karik CD	£1850	£1098
LINN Mimik	£875	£304
MARANTZ CD85	£450	£195
MARANTZ CD17Ki	£1250	£748
MERIDIAN 203 DAC	£499	£228
MERIDIAN 207 CD/Pre	£700	£299
MERIDIAN 506	£1200	£695
MERIDIAN 508 CD	£1500	£798
MERIDIAN 562 Digital Controller		£450
MERIDIAN 602/606 (Trans/Dac)	£3000	£796
MICROMEGA Stage 2	£750	£396
MICROMEGA Solo	£750	£255
MICROMEGA Stage 3	£1000	£398
MICROMEGA Micro-DAC	£499	£149
MUSICAL FIDELITY		
Ilu-Vista 3D CD/Pre	£3000	£2198
NAIM CD1	£1999	£948
NAIM CD3	£1000	£495
ORELLE DA10T Trans	£900	£375
PERPETUAL TECHNOLOGY		
Upsampling DAC	£695	£496
PROCEED PDT3/PDP3		
Trans/DAC	£3999	£1800
QED Reference DAC	£299	£99
REGA Planet	£500	£350
ROKSAN kandy CD Player	£500	£199
ROTEL RCD965BX	£350	£175
SONY CDPXA2ES CD Plyr	£250	£98
SONY SCDX 940 SA CD	£700	£335
TEAC VRDS 10 (CD Player)	£699	£450
TECHNICS SLP2000 Ref	£1200	£198
THETA DATA Basic Trans	£2400	£749
THETA PEARL CD Trans	£1400	£898
THORENS		
TD C2000(Trans)/ TDA2000(DAC)	£2000	£1198
TRICHORD Pulsa (Series 1)	£1900	£1298
WADIA 860CD	£6995	£4998

## ●Amplifiers Solid State

ARCAM Delta 60	£280	£148
ARCAM P75	£435	£296
ARCAM Xeta 2	£500	£95
ARCAM Alpha 6 Plus Int	£350	£195
ARCAM Alpha 9 Power	£495	£295
ATC SCA2 Inc Phono	£2900	£1698
AUDIO ANALOGUE Donizetti	£650	£455
AUDIO ALCHEMY Kraken	£400	£156
AUDIO ANALOGUE Bellini (blk)	£595	£355
AUDIO ANALOGUE Puccini SE	£650	£345
AUDIO INNOVATIONS Alto	£395	£148
AUDIOLAB 8000A	£450	£175
AUDIOLAB 8000C Pre	£495	£295
AUDIOLAB 8000S	£800	£395
AUDIO RESEARCH D400	£3498	£1495
AUDIO RESEARCH LS3B	£1300	£696
CHORD SPM900	£1550	£898

CHORD SPM600	£2200	£1395
COPLAND CSA 14	£1500	£745
COUNTERPOINT Solid One	£1950	£695
CYRUS AV5 AV Pre	£1000	£428
CYRUS ACA7 Pre	£600	£356
CYRUS II	£275	£125
CYRUS AV Master	£450	£198
CYRUS Pre	£700	£345
CYRUS Power	£700	£358
DENON AVP-A1D Digital Pre	£2500	£698
DENON AVP-A1D		
Digital integrated AV amp	£2500	£895
DNM Pre2/PA1	£2800	£898
ELECTOR MFL Pre	£500	£148
ELECTROCOMPANIE EC3 MC	£2200	£1188
ELECTROCOMPANIE 2 Pre/Power	£1500	£355
EXPOSURE 7/8 Pre & Pwr	£1100	£405
EXPOSURE 18/21 Pre & Pwr	£2000	£795
GALACTRON MK2121	£1200	£598
GAMUT 200	£4000	£1998
HARMON KARDON AVR85 AV Rec	£1000	£498
HARMON KARDON Citation Pwr	£1200	£249
INCATECH Claymore Amp	£400	£175
KENWOOD L07C Pre	£500	£155
KRELL KST100 Power Amp	£2995	£1796
KRELL KAV250a	£3495	£2198
KRELL FPB300	£9500	£4995
KRELL FPB300 Cast	£10,995	£5995
LFD I51 Pre	£1000	£375
LINN LK1	£450	£194
LINN LK2	£550	£299
LINN LK1/LK2	£1000	£495
LINN LK280 Spark P.S.(2)	£1600	£495
LUMLEY A2100 Power	£750	£398
LUMLEY Passive Pre	£250	£128
MARANTZ (orig) SM10 Power	£700	£498
MARK LEVINSON 27.5 Pwr	£6000	£2798
MERIDIAN 501.2 Pre	£780	£476
MERIDIAN 502 Pre	£1295	£695
MERIDIAN 556	£995	£698
MERIDIAN 565 Processor	£3300	£1796
MERIDIAN 601 DSP Pre	£2700	£1695
MICROMEGA Tempo 2	£750	£398
MUSICAL FIDELITY A3CR	£1500	£678
MUSICAL FIDELITY F22 Pre	£1500	£595
MUSICAL FIDELITY XA2 Int	£800	£296
MUSICAL FIDELITY Dr Thomas	£699	£275
MYRYAD A120 Power	£500	£255
MARANTZ PM7200G	£350	£245
MICHELL Argo	£575	£425
MICHELL Argo/Electro Mono's	£2495	£1496
NAD 910 AV Pre/902 2ch Pwr	£450	£175

Sell your carefully used and  
mint condition hi-fi. Combine  
the power of our adverts, web  
site and database for results.



<b>NAGRA</b> PL-P Bal Pre + remote	£5395	<b>£3996</b>
<b>NAIM</b> NAC 42 Pre	£400	<b>£125</b>
<b>NAIM</b> Nait 3 Int.	£700	<b>£296</b>
<b>NAIM</b> NAIT 5	£799	<b>£595</b>
<b>NAIM</b> NAP 160 power	£895	<b>£495</b>
<b>NVA</b> AP30 Int.	£350	<b>£175</b>
<b>ORELLE</b> SA100 Intgrtd	£500	<b>£198</b>
<b>PARASOUND</b> HCA1 506		
6 Chanel Power	£2995	<b>£1296</b>
<b>PIONEER</b> A400	£225	<b>£ 75</b>
<b>PIONEER</b> C90A Pre	£500	<b>£175</b>
<b>PS AUDIO</b> IV Pre Incl. MC/MM	£600	<b>£295</b>
<b>SUGDEN</b> C51/P51 Pre/Pwr	£500	<b>£248</b>
<b>QUAD</b> 303 Power	£200	<b>£ 95</b>
<b>QUAD</b> 44 Pre (scratched case)	£450	<b>£155</b>
<b>QUAD</b> 405 Power Amplifier	£350	<b>£198</b>
<b>QUAD</b> 34	£400	<b>£198</b>
<b>QUAD</b> 66	£699	<b>£356</b>
<b>ROGERS</b> Cadet 3 Int. vintage	£200	<b>£ 95</b>
<b>ROKSAN</b> Caspian DSPAV Pre	£900	<b>£548</b>
<b>ROKSAN</b> Caspian Pwr	£710	<b>£498</b>
<b>ROTEL</b> RC1070	£399	<b>£195</b>
<b>ROTEL</b> RB985 Power Amp	£900	<b>£498</b>
<b>SPHINX</b> Project 2 Pre	£1600	<b>£798</b>
<b>SPHINX</b> Project 12 mono.s	£3000	<b>£1495</b>
<b>SONY</b> SDPEP9ES (Digital)	£600	<b>£298</b>
<b>SONY</b> VA333ES (AV System)	£799	<b>£495</b>
<b>SONY</b> TAE-1000ESD Pre	£495	<b>£248</b>
<b>TAG McLaren</b> F3 Prozor	£1500	<b>£648</b>
<b>TAG McLaren</b> F300 Pwr	£1200	<b>£498</b>
<b>TALK ELECTRONICS</b> Storm	£650	<b>£375</b>
<b>TESSERAC</b> Pre	£1500	<b>£598</b>
<b>THORENS</b> TTA 2000 Power Amp	£1000	<b>£398</b>

## ● Amplifiers Valve

<b>TOWNSEND</b> Elite 600 Pre	£500	<b>£195</b>
<b>YAMAHA</b> C4 / M4 Pre Power	£800	<b>£255</b>
<b>AUDIO INNOVATIONS</b> L1 Pre	£300	<b>£145</b>
<b>AUDIO INNOVATIONS</b> 800 Monos	£1200	<b>£598</b>
<b>AUDIO INNOVATIONS</b> 800 Mk1	£1500	<b>£688</b>
<b>AUDIO PRISM</b> Debut (Red Rose)	£2800	<b>£1495</b>
<b>AUDIO PRISM</b> Mantissa (Red Rose)	£3000	<b>£1695</b>
<b>AUDIO RESEARCH</b> LS1	£1500	<b>£696</b>
<b>AUDIO RESEARCH</b> LS2B Mk2 pre	£3000	<b>£1495</b>
<b>AUDIO RESEARCH</b> VT100 Mk1 Pwr	£5500	<b>£3498</b>
<b>BEARD</b> M70 monoblocks	£1800	<b>£1296</b>
<b>CARY</b> Pre-amp	£3500	<b>£1495</b>
<b>CARY</b> CAD 300SE Monoblocks	£5000	<b>£3998</b>
<b>CONRAD JOHNSON</b> PV 10AL Pre	£1400	<b>£676</b>
<b>CONRAD JOHNSON</b> PV 10 Pre	£1600	<b>£845</b>
<b>CONRAD JOHNSON</b> PV11 Pre	£1950	<b>£998</b>
<b>CONRAD JOHNSON</b> Prem 8 Monos	£16,000	<b>£9755</b>
<b>CONRAD JOHNSON</b> Premier 140SA	£7000	<b>£5248</b>
<b>CR DEVELOPMENTS</b> Carmeta (Pre)	£900	<b>£345</b>
<b>CROFT</b> Super Micro Pre	£450	<b>£295</b>
<b>GAMMA</b> Era Reference Pre	£4000	<b>£1998</b>
<b>GAMMA</b> HBC 'The Beastie'	£2000	<b>£1298</b>
<b>GRAAF</b> 13.5 Pre	£3950	<b>£2168</b>
<b>HOVLAND</b> HP 100 + MC Phono	£5750	<b>£3996</b>
<b>JADIS</b> DA30 Integrated	£3500	<b>£1946</b>
<b>JADIS</b> JA50 Monoblocks (Current)	£5890	<b>£4446</b>
<b>JADIS</b> Defy 7 Power		<b>£2698</b>
<b>LUMLEY</b> Ref 250 monoblocks	£6500	<b>£3996</b>
<b>LUMLEY</b> Ref 120 Monoblocks	£3500	<b>£1998</b>
<b>PAPWORTH</b> TVA50	£2000	<b>£1098</b>
<b>PM COMPONENTS</b> 845 mono.s	£3000	<b>£1495</b>
<b>QUAD</b> 22 + 2 monoblocks		<b>£455</b>
<b>QUAD</b> Forty two	£4000	<b>£2995</b>
<b>UNISON</b> Mystery One	£1750	<b>£1198</b>

## ● Tuners Tape Misc

<b>ACOUSTIC RESEARCH</b> RD-06	£200	<b>£48</b>
<b>ARCAM</b> DAB10	£800	<b>£345</b>
<b>AUDIOLAB</b> 8000T	£800	<b>£445</b>
<b>DENON</b> DRM 22	£200	<b>£55</b>
<b>HARMAN KARDON</b> TK912 Tuner	£125	<b>£58</b>
<b>LEAK</b> FM Stereophetic Tuner	£150	<b>£75</b>
<b>LUXMAN</b> ST50 (Rare)	£900	<b>£555</b>
<b>MERIDIAN</b> 504	£800	<b>£445</b>
<b>MICROMEGA</b> FM tuner	£300	<b>£145</b>
<b>MYRIAD</b> T30 tuner	£250	<b>£128</b>
<b>NAIM</b> NAT 01 tuner	£2000	<b>£1398</b>
<b>NAKAMICHI</b> 480 block	£495	<b>£196</b>
<b>NAKAMICHI</b> 481Z (Silver)	£495	<b>£166</b>
<b>NAKAMICHI</b> CR7E	£1500	<b>£895</b>
<b>NAKAMICHI</b> RX202E	£600	<b>£255</b>
<b>NAKAMICHI</b> 600	£400	<b>£198</b>
<b>QUAD</b> FM2 tuner	£200	<b>£125</b>
<b>QUAD</b> FM3 tuner	£200	<b>£95</b>
<b>QUAD</b> FM4 tuner	£300	<b>£198</b>
<b>REVOX</b> S Series System	£1550	<b>£1148</b>
<b>REVOX</b> D36 (Reel to reel)		<b>£348</b>
<b>REVOX</b> E36 (Reel to reel)		<b>£298</b>
<b>REVOX</b> Pro H577 (Reel to reel)	£950	<b>£398</b>
<b>REVOX</b> A77 2 track (Reel to reel)	£750	<b>£378</b>
<b>REVOX</b> PR99II 2 track (7.5/15ips)	£1500	<b>£595</b>
<b>REVOX</b> B910 Pro cassette deck	£1500	<b>£548</b>
<b>REVOX</b> A76	£500	<b>£295</b>
<b>ROGERS</b> Ravensbrook Tuner	£150	<b>£95</b>
<b>ROKSAN</b> Caspian Tuner	£600	<b>£298</b>
<b>ROTEL</b> RT820L Tuner	£120	<b>£45</b>
<b>SILTECH</b> HF-9G3 S.E.DIG. (1M)	£230	<b>£158</b>
<b>SILTECH</b> LS-100-G3 (2.5M)SPK	£1200	<b>£698</b>
<b>SILTECH</b> SQ-288G3 BAL (1M PAIR)	£350	<b>£228</b>
<b>SUGDEN</b> T51 tuner	£250	<b>£128</b>
<b>SONY</b> ST5730ES	£700	<b>£295</b>
<b>STAX</b> 3030 Basic L/Phones	£550	<b>£376</b>
<b>STAX</b> Lambda Nova Classic Headphones	£700	<b>£498</b>
<b>TEAC</b> A1500 (Reel to reel - 7" spools)	£400	<b>£198</b>
<b>TRANSPARENT</b> Ref Spkr (0.75M)	£2250	<b>£1495</b>
<b>TRANSPARENT</b> Ref XL SE (3M)	£4611	<b>£2875</b>
<b>TRANSPARENT</b> Ref XL SE (1M)	£3915	<b>£2295</b>
<b>TRIO</b> KT9XL Tuner	£300	<b>£128</b>
<b>YAMAHA</b> TC800 GL (classic)	£300	<b>£ 95</b>

## ● Loudspeakers

<b>ACOUSTIC ENERGY</b> AE2 MKII	£1500	<b>£895</b>
<b>ACOUSTIC ENERGY</b> AE3	£3500	<b>£1795</b>
<b>ACOUSTAT</b> Model 2 Electrostatics	£2500	<b>£674</b>
<b>ACOUSTAT</b> Spectra 1100 Hybrid electrostatics	£1500	<b>£578</b>
<b>ACOUSTAT</b> Model Cex, valve powered electrostatics	£2000	<b>£ 748</b>
<b>ACOUSTIC ENERGY</b> AE120	£800	<b>£ 295</b>
<b>ACOUSTIC PRECISION</b> Elkos	£650	<b>£348</b>
<b>ARISTON</b> Speakers	£300	<b>£175</b>
<b>AUDIOSTATIC</b> ES300 Electrostatics	£1500	<b>£578</b>
<b>AUDIONOTE</b> AN/E (Inc stands)	£2900	<b>£1498</b>
<b>AUDIONOTE</b> ESP (Inc stands)	£1850	<b>£1098</b>
<b>AUDIO PRO</b> B250 Sub	£1000	<b>£356</b>
<b>B&amp;W</b> P4 (Cherry but marked)	£700	<b>£349</b>
<b>B &amp; W</b> CC6 (centre)	£200	<b>£ 75</b>
<b>B &amp; W</b> FCM8 THX (R.L. & Centre)	£2400	<b>£696</b>
<b>B &amp; W</b> DM4 (circa 1975)	£200	<b>£ 55</b>
<b>B &amp; W</b> 601 Mark III	£195	<b>£95</b>
<b>B&amp;W</b> 601-3	£275	<b>£178</b>
<b>BKS</b> 107 II Hybrid ribbons	£1750	<b>£995</b>
<b>CASTLE</b> Warwick	£200	<b>£ 88</b>
<b>CASTLE</b> Chester (Walnut)	£799	<b>£478</b>
<b>CASTLE</b> Durham (Marked)	£230	<b>£95</b>
<b>CASTLE</b> Howard S2	£1400	<b>£598</b>
<b>CELESTION</b> SL6S	£ 250	<b>£ 155</b>
<b>CHARTWELL</b> PM310	£250	<b>£ 95</b>
<b>DALI</b> 400	£1000	<b>£356</b>
<b>DCM</b> Time Windows	£600	<b>£155</b>
<b>DYNAUDIO</b> SDA 2.8	£800	<b>£ 378</b>
<b>ELAC</b> CL310i	£850	<b>£548</b>
<b>ENSEMBLE</b> Primadonna RARE	£10,000	<b>£2,995</b>

## Can't find what you want?

Our **Wants List** is seen by thousands of visitors to our web site. Add your details now - you could get a result!

<b>GALE</b> 401 With Stands	£500	<b>£196</b>
<b>GAMMA ACOUSTICS</b> Epoch 5	£3000	<b>£495</b>
<b>HALES</b> Signature System 2	£4000	<b>£998</b>
<b>HECO</b> 10'SH	£150	<b>£88</b>
<b>HEYBROOK</b> HB1	£150	<b>£45</b>
<b>HARBETH</b> HL III Monitors	£500	<b>£198</b>
<b>HEYBROOK</b> HB2R	£279	<b>£125</b>
<b>HEYBROOK</b> Heystack (Rosewood)	£500	<b>£296</b>
<b>IMPULSE</b> H7 (Black)	£1000	<b>£299</b>
<b>Impulse</b> H6	£1200	<b>£58</b>
<b>Infinity</b> Alpha 40 (black lacquer)	£600	<b>£255</b>
<b>INFINITY</b> 8 Kappa	£1895	<b>£1195</b>
<b>JBL</b> TLX12	£95	<b>£128</b>
<b>KEF</b> 104AB (circa 1975)	£200	<b>£ 75</b>
<b>KEF</b> 70 Speakers	£250	<b>£125</b>
<b>KEF</b> Q15	£200	<b>£ 98</b>
<b>KEF</b> Ref 101/2	£500	<b>£155</b>
<b>KEF</b> Studio Monitors (circa 1965)	£400	<b>£125</b>
<b>KEF</b> Ref Mod 1	£1300	<b>£798</b>
<b>KEF</b> Ref 2/2 (Black)	£1800	<b>£998</b>
<b>KEF</b> Q35 (Black)	£350	<b>£179</b>
<b>KEF</b> Cube (EQ Box)	£700	<b>£246</b>
<b>LEAK</b> (orig.) Sandwich 12 ohm 12"	£400	<b>£148</b>
<b>LEAK</b> Sandwich 200 Black	£250	<b>£ 95</b>
<b>LEAK</b> Sandwich 2030 Black	£175	<b>£ 75</b>
<b>LEAK</b> Sandwich 250	£200	<b>£ 95</b>
<b>LEAK</b> Sandwich 600	£400	<b>£155</b>
<b>LINN</b> Nexus (Black + stands)	£500	<b>£239</b>
<b>LINN</b> Kaber (Rosewood) ACTIVE	£2500	<b>£999</b>
<b>MAGNA</b> PLANAR 1c Imp	£1400	<b>£595</b>
<b>MEADOWLARK</b> Shearwater	£2990	<b>£1498</b>
<b>MERIDIAN</b> DSP5000 (24bit)	£4200	<b>£2695</b>
<b>MERIDIAN</b> M3 Active	£1000	<b>£ 298</b>
<b>MERLIN</b> TSM-SE (Mint)	£1600	<b>£998</b>
<b>MISSION</b> 725 (Black & Light Oak)	£550	<b>£295</b>
<b>MISSION</b> 733 (Black)	£200	<b>£99</b>
<b>MISSION</b> 751 (Black)	£330	<b>£189</b>
<b>MISSION</b> 753 (Rosewood)	£799	<b>£425</b>
<b>MISSION</b> 755 (Centre - Rosewood)	£350	<b>£148</b>
<b>MISSION</b> 752	£550	<b>£275</b>
<b>MONITOR AUDIO</b> Studio1 2	£1200	<b>£646</b>
<b>MONITOR AUDIO</b> Sid 14 (Marked)	£900	<b>£299</b>
<b>MORDAUNT</b> SHORT Pageant	£180	<b>£75</b>
<b>MORREL</b> Bass Master Oak Marked	£1600	<b>£599</b>
<b>MUSICAL FIDELITY</b> Ref 2	£250	<b>£ 98</b>
<b>PINK TRIANGLE</b> Ventrical	£1500	<b>£950</b>
<b>PROAC</b> Studio 1 Mk 2		<b>£380</b>
<b>PROAC</b> Tablette 50	£600	<b>£395</b>
<b>PROAC</b> Tablette 2000	£649	<b>£495</b>
<b>PROAC</b> Super Towers	£1000	<b>£695</b>
<b>PROAC</b> Future 1	£5,995	<b>£4,258</b>
<b>QNR</b> Monitors (Black)	£1200	<b>£369</b>
<b>QUAD</b> ESL63	£3500	<b>£1495</b>
<b>QUAD</b> ESL63 Black + Stands	£3500	<b>£1998</b>
<b>REGA</b> XEL (Black)	£990	<b>£640</b>
<b>REGA</b> Elo (Black)	£950	<b>£646</b>
<b>RUARK</b> Broadward (Rosewood)	£700	<b>£329</b>
<b>RUARK</b> Solstice	£5000	<b>£2998</b>
<b>SNELL</b> J3 High Sensitivity Monitors	£770	<b>£349</b>
<b>SNELL</b> E2	£500	<b>£245</b>
<b>SOUNDLAB</b> Dynastats	£3200	<b>£1100</b>
<b>SPENDOR</b> SA1 mini monitors	£400	<b>£155</b>
<b>TANNOY</b> Buckingham	£5000	<b>£1600</b>
<b>TANNOY</b> Devon	£750	<b>£298</b>
<b>TANNOY</b> M3	£200	<b>£ 75</b>
<b>TANNOY</b> DC2000	£200	<b>£ 95</b>
<b>TARGET</b> RS4 (circa 1977) scratched	£250	<b>£125</b>
<b>TARGET</b> TMI (circa 1977) scratched	£200	<b>£ 75</b>
<b>THIEL</b> CS2.2 Discoloured veneer	£2500	<b>£996</b>
<b>TOWNSEND</b> Ribbon Hybrid	£750	<b>£195</b>
<b>TRIANGLE</b> Icare	£1500	<b>£345</b>
<b>WHARFDALE</b> 519	£275	<b>£ 95</b>
<b>YAMAHA</b> NS200	£250	<b>£175</b>
<b>YORKSHIRE</b> Hifi 1-3	£195	<b>£ 78</b>

and there's more

The Hi-Fi Company's **Trading Station**

**EX-DEMONSTRATION & DISPLAY ITEMS NOW AVAILABLE FOR SALE**

We work closely with several high-end retailers and can offer you great savings on their top quality ex-demonstration and display items. All stock listed here is offered in 'as new' condition unless otherwise stated, complete with boxes, instructions and full manufacturers' warranties. Some excess stock items are brand new, in unopened boxes.

www.hifitradingstation.com

The Trading Station  
35 Cowgate Peterborough PE1 1LZ

Phone: 0870 608 8211

Business Hours: Tues - Sat: 10am - 5.30pm CLOSED MONDAYS

**ALL MAJOR CREDIT CARDS ACCEPTED\***  
**\*NEXT DAY DELIVERY SERVICE**  
**COMPETITIVE FINANCE TERMS FOR PERSONAL CALLERS**

<b>ARIEL ACOUSTICS</b> Mod 8 + stands EX-DEM	£5679	<b>£3596</b>	<b>MONRIO</b> MP1 mono 110 watts	£600	<b>£417</b>
<b>ATC</b> SCA2 including phono	£2700	<b>£1698</b>	<b>MONRIO</b> MP1 mono 135 watts	£700	<b>£457</b>
<b>ATC</b> 100's Active	£8995	<b>£5998</b>	<b>MONRIO</b> MP2 2-channel x 135 watts	£950	<b>£697</b>
<b>AUDIO ALCHEMY</b> ACD2 CD Player	£1000	<b>£246</b>	<b>NAGRA</b> PLL Pre EX-DEM	£5395	<b>£3996</b>
<b>AUDIO ANALOGUE</b> Puccini, manualsilver	£595	<b>£397</b>	<b>NAIM</b> CDS	£1195	<b>£954</b>
<b>AUDIO ANALOGUE</b> Donizetti Mono Silver	£550	<b>£347</b>	<b>NAIM</b> Intra 2	£865	<b>£694</b>
<b>AUDIO ANALOGUE</b> Maestro Amp	£2900	<b>£1797</b>	<b>NAIM</b> NAC 112	£660	<b>£524</b>
<b>AUDIO MECCA</b> Mephisto Transport	£2200	<b>£1398</b>	<b>NAIM</b> Nait 5	£845	<b>£674</b>
<b>AUDION</b> Silver Knight 300B Intgrtd EX-DEM	£1125	<b>£876</b>	<b>NAIM</b> NAP 150	£795	<b>£634</b>
<b>AUDIO RESEARCH</b> DAC5 D/A	£2335	<b>£1297</b>	<b>NAIM</b> NAT 01	£2500	<b>£1398</b>
<b>AUDIO RESEARCH</b> VT200/2 Pwr EX-DEM	£11982	<b>£9586</b>	<b>NAIM</b> NAC 82 Pre EX-DEM	£2500	<b>£1994</b>
<b>AUDIO RESEARCH</b> LS25 Mk2 EX-DEM	£5795	<b>£4636</b>	<b>NAIM</b> CDS/XPS Mk2 EX-DEM	£6265	<b>£4994</b>
<b>B&amp;W</b> THX System EX-DEM	£4975	<b>£1996</b>	<b>NAIM</b> Credo EX-DEM	£1425	<b>£994</b>
<b>EAR</b> 834P Valve Phono Stage EX-DEM	£549	<b>£436</b>	<b>OPERA</b> SP1 (Cherry) EX-DEM	£525	<b>£426</b>
<b>GRAAF</b> 13.5 BII Pre EX-DEM	£3950	<b>£2746</b>	<b>PATHOS</b> Classic One (50 watt)	£1150	<b>£797</b>
<b>GRAAF</b> GM20 OTL EX-DEM	£2950	<b>£2356</b>	<b>PATHOS</b> Twin Towers EX-DEM	£3250	<b>£2596</b>
<b>GRAAF</b> Venticinque	£2250	<b>£1197</b>	<b>PATHOS</b> Logos EX-DEM	£3250	<b>£2596</b>
<b>GRAAF</b> VTS.35.5 (five channel power amp)	£2500	<b>£1397</b>	<b>PIONEER</b> DVR7000 DVD Recorder EX-DEM	£1299	<b>£896</b>
<b>KEF</b> XQ1	£999	<b>£744</b>	<b>PIONEER</b> SD-T 5000 50" (4:3) Projection TV	£3999	<b>£1496</b>
<b>KEF</b> XQ5	£1999	<b>£1494</b>	<b>PIONEER</b> PDP 503 HDE (50") Plasma	£6995	<b>£5495</b>
<b>KRELL</b> KPS28 CD Player EX-DEM	£8998	<b>£6746</b>	<b>PRIMARE</b> V20 DVD Plr EX-DEM	£2500	<b>£1996</b>
<b>KRELL</b> KCT Pre-amp EX-DEM	£9998	<b>£7996</b>	<b>PROAC</b> Response 1.5 (Rosewood) EX-DEM	£1970	<b>£1296</b>
<b>KRELL</b> FPB300c	£10995	<b>£5995</b>	<b>PROAC</b> Response 2.5 (Lt Oak) EX-DEM	£2700	<b>£2148</b>
<b>LINN</b> LP12 / Lingo / Akita (black)	£2699	<b>£1994</b>	<b>REGA</b> Naos (Cherry) EX-DEM	£998	<b>£794</b>
<b>LINN</b> LP12 Ecos Archive inc Lingo (blk)	£3500	<b>£1998</b>	<b>REGA</b> ARA (Cherry) EX-DEM	£255	<b>£214</b>
<b>LINN</b> Klassik Movie EX-DEM	£1995	<b>£1596</b>	<b>REGA</b> ELA EX-DEM	£750	<b>£418</b>
<b>MARTIN LOGAN</b> Aeon Speakers EX-DEM	£3148	<b>£2646</b>	<b>REGA</b> Cursa Pre Amp	£548	<b>£434</b>
<b>MARTIN LOGAN</b> CLS II Limited Edition	£6700	<b>£5776</b>	<b>REGA</b> Maia	£498	<b>£394</b>
<b>MERIDIAN</b> DSP33 Digital Speakers	£2595	<b>£2076</b>	<b>REGA</b> Jupiter CD	£998	<b>£794</b>
<b>M&amp;K</b> VX100 Sub EX-DEM	£754	<b>£634</b>	<b>SME</b> 10A with 309 Tone Arm EX-DEM	£3410	<b>£2896</b>
<b>McINTOSH</b> MC122 Power Amp FINAL	£1249	<b>£796</b>	<b>SONUS FABER</b> Amati Homage EX-DEM	£11850	<b>£9996</b>
<b>McINTOSH</b> MC7108 8Chnl Pwr Amp FINAL	£2549	<b>£1496</b>	<b>SONUS FABER</b> Concertino EX-DEM	£599	<b>£529</b>
<b>McINTOSH</b> MX135 AV Control Centre FINAL	£7990	<b>£3996</b>	<b>SPENDOR</b> S6	£1299	<b>£994</b>
<b>McINTOSH</b> LS320 Speakers EX-DEM	£1998	<b>£1296</b>	<b>SPENDOR</b> S8 Cherry - Slight cabinet damage	£1700	<b>£1346</b>
<b>McINTOSH</b> LS340 Speakers EX-DEM	£4798	<b>£2996</b>	<b>SPENDOR</b> S9	£2499	<b>£1996</b>
<b>McINTOSH</b> CS36 Centre Speaker v	£2495	<b>£1626</b>	<b>TDS</b> Audio Transformer	£349	<b>£266</b>
<b>MERIDIAN</b> 557 Stereo Power Amp EX-DEM	£2549	<b>£1996</b>	<b>THETA</b> Casanova Pre EX-DEM	£4478	<b>£2996</b>
<b>MERIDIAN</b> DSP33C Centre EX-DEM	£1355	<b>£1146</b>	<b>TRIANGLE</b> Zays Ambre	£1295	<b>£ 897</b>
<b>MERIDIAN</b> DSP5000C (Dig Centre) EX-DEM	£1995	<b>£1594</b>	<b>TRICHORD</b> Pulsa Series One DAC	£1900	<b>£1298</b>
<b>MICHELL</b> Gyro SE EX-DEM	£870	<b>£740</b>	<b>UNISON RESEARCH</b> Unico 1	£775	<b>£597</b>
<b>MICHELL</b> Delphini Phono LPSU EX-DEM	£895	<b>£738</b>	<b>UNISON RESEARCH</b> S2	£1295	<b>£697</b>
<b>MICHELL</b> Delphini Phono SPSU EX-DEM	£998	<b>£798</b>	<b>UNISON RESEARCH</b> S8	£3100	<b>£1997</b>
<b>MISSION</b> 78C (Centre) EX-DEM	£350	<b>£274</b>	<b>UNISON RESEARCH</b> Power 35	£1500	<b>£897</b>
<b>MISSION</b> 782 Speakers EX-DEM	£699	<b>£554</b>	<b>UNISON RESEARCH</b> Feather One	£895	<b>£447</b>
<b>MISSION</b> M51 Speakers EX-DEM	£600	<b>£474</b>	<b>UNISON RESEARCH</b> Feather One Remote	£995	<b>£527</b>
<b>MONRIO</b> Asty 55W,line int.amp silver	£550	<b>£347</b>	<b>WILSON BENESCH</b> Full Circle	£1995	<b>£1496</b>
<b>MONRIO</b> Asty PH55 W.line + phono silver	£650	<b>£397</b>	<b>WILSON</b> Cub (Black Laminated) EX-DEM	£5495	<b>£3496</b>
<b>MONRIO</b> Asty ST, remote volume silver	£600	<b>£447</b>	<b>WILSON</b> Cub (Gloss) EX-DEM	£6890	<b>£3996</b>
<b>MONRIO</b> Asty-Player (24/96) silver	£750	<b>£527</b>	<b>WILSON</b> Sophia (Black) EX-DEM	£11992	<b>£9596</b>
<b>MONRIO</b> HP-1 (120 watts power amp) silver	£895	<b>£597</b>	<b>WILSON BENESCH</b> Orator EX-DEM	£2900	<b>£2524</b>
<b>MONRIO</b> 188.2 (DAC) silver	£595	<b>£227</b>	<b>WILSON BENESCH</b> Actor EX-DEM	£3999	<b>£2998</b>
<b>MONRIO</b> Bitmatch CD-player/transport silver	£695	<b>£297</b>	<b>WILSON BENESCH</b> Act-1 EX-DEM	£6999	<b>£4499</b>
<b>MONRIO</b> MC-25 power amp silver	£900	<b>£447</b>	<b>WILSON BENESCH</b> Act-2 EX-DEM	£8999	<b>£5999</b>
<b>MONRIO</b> MC-2005 power amp silver	£1350	<b>£497</b>			





Prokofiev

### Symphonic Suite Of Waltzes Schwieger / Kansas City Phil.

Cisco Music CLP 7002 **180g** **1**

This is a very pretty record indeed. As well as Gypsy Fantasy from the Stone Flower, there are excerpts from an enchanting and quite magical Cinderella ballet and the Mephisto Waltz, which is a timely reminder that Serge Prokofiev also wrote for the cinema and not just the concert hall. The Symphonic Suite itself neatly divides up into six cameos. They showcase the simple lyricism, parody and humour of a composer who proved himself to be equally at home writing great symphonies under the constraints of the Soviet system as he was with those sweeping rhythmic and melodic lines so suitably employed for these fairytale themes. Hans Schweiger and his Kansas City players bring a delicacy and lightness of touch to this music which belies their status as a provincial orchestra under the baton of a second tier conductor, though it is worth noting that Schweiger did understudy Erich Kleiber for three years before the Second World War. The lifelike 1959 direct-to-two-track recording is quite stunning. Not only do these engineering solutions beautifully develop the rich tonal colours present in this music, but they also ensure that the rapid dynamic shifts in weight and emphasis are fully realised.

RP

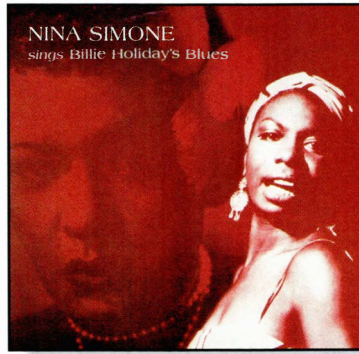
Supplier: [www.vivante.co.uk](http://www.vivante.co.uk)

Nina Simone

### Sings Billie Holiday's Blues

Get Back GET2022 **180g**

Nina Simone's interpretation of pop, soul, jazz or blues standards are always compulsive listening and the reworking of these eight songs either penned by or closely associated with the greatest jazz singer bar none could have been musically irresistible. Both divas were noted for their courageous public stands against racism so the inclusion of an unbearably haunting and consciousness raising 'Strange Fruit' resonates across the decades. Scintillating performances of Berlin's 'This Year's Kisses' and Comden's 'Just In Time' stand alongside classic Holiday numbers like 'Tell Me More & More Than Some', 'Fine & Mellow' and 'Don't Explain'. There's no little humour too in a tongue in cheek and quite earthy exploration of 'Give Me A Pigfoot And A Bottle Of Beer'. Unfortunately, whether the vinyl is slab-like or wafer thin, if the source material is badly transferred and poorly re-mastered then all aspects of the release suffer. Could Get Back have done a worse job? I doubt it. This LP sounds deplorable. It is compressed and lacks detail, while any warmth originally present has evaporated and with it much of the natural attraction in Simone's soulful approach has disappeared as well.

RP

Cherished Record Co. Tel: 01579 363603

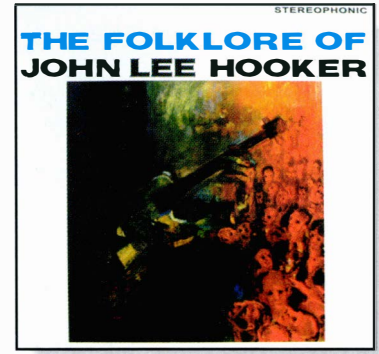

John Lee Hooker

### The Folklore of John Lee Hooker

Get Back GET7516 **180g**

This is an illuminating album spread across three Vee Jay label recording sessions - two from the Chicago Universal Studios in January 1961 while 'Tupelo' and 'The Hobo' were laid down at the Newport Folk Festival on 25th June 1960 with Bill Lee playing string bass in support. It mixes an old solo R&B format with those new directions in blues music. Here, JLH fronts a tight little band that includes a legendary Jimmy Reed (harmonica & guitar), Quinn Wilson (bass), Earl Phillips (drums) and William "Lefty" Bates (guitar) for 'I'm Mad Again', 'Want Ad Blues', 'Hard-Headed Woman' and 'I'm Going Upstairs'. Elsewhere, the traditionalists can still warm to his gripping and frequently anguished rendition of the Mississippi delta country blues that emotionally roams across the distress felt in 'My First Wife Left Me' and a sense of outrage and ingratitude of 'Five Long Years'. An undisguised pain courses through every sinew. In the powerfully honest vocal lines and through those vigorous, persistent and frequently dark chords achieved on his acoustic and electric guitars. This giant of the blues movement delivers a hugely important record, one that charts the development of his music away from that of a lone musician and into the realms of the folk blues genre.

RP

Cherished Record Co. Tel: 01579 363603

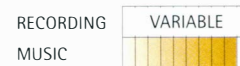



Muddy Waters

Sings Big Bill Broonzy

Speaker's Corner LP-1444 **180g**

This reissue of a 1960 Muddy Waters LP from the Chess label shows what can be achieved if the source material is expertly transferred. Yes, the original tapes are less than ideal. There's a booming bass line that takes some controlling but Speaker's Corner have done their utmost to rein it in, and instead raise the distinctive wide open Waters vocal profile. Detailed attention has also been given to the supporting musicians and this is where it differs so markedly from Get Back's sonically challenged Nina Simone release. However, they do have at least one thing in common and that is their musically significant repertoire.

Waters was a close friend and pupil of Big Bill Broonzy and his homage to a man who broadened the appeal of blues music way beyond those local folk roots until it was embraced by a nation is never less than intuitive. Both men were at one time or another field hands toiling in the oppressive heat of the Mississippi Cotton Belt. Both understood life's dissatisfactions, the inherent suffering, an inner anguish and that remarkable sense of pride born out of shared adversity which allows this genre to rise above all the poverty and racism. Both could play abrasive guitar and holler, shout, cry and really sing the blues. The ten tracks here range through these emotions. A mournful

'Lonesome Road Blues'. The sweet irony of 'Southbound Train' when the future for many impoverished black rural workers lay in the opposite direction, to the cities of the North. An evocative 'Just A Dream' that recaptures a happy time of women and whisky tempered by the stark realities of life. And the wicked glint in Muddy's eye as he develops a jaundiced yet humorous view of a man who learns that his best friend definitely ain't no woman in the Waters penned 'I Done Got Wise'. Piano, harmonica, guitar and drums (not credited) form a tight little backing band who help recreate a tactile sense of those torments heard in 'Double Trouble', 'Mopper's Blues' and the deeply thoughtful 'When I Get To Thinking'. They put an awful lot of flesh on the giant Big Bill Broonzy frame. This is a priceless and beautifully anecdotal insight. Enough to remind us all that there is far more to the recorded legacy of one McKinley Morganfield than his ubiquitous Folk Singer LP.

RP

Cherished Record Co. Tel: 01579 363603

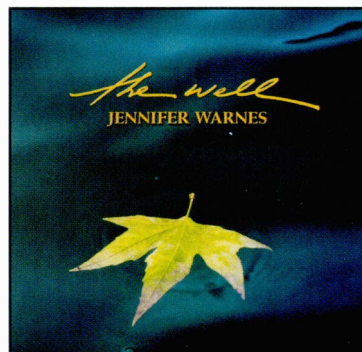

Jennifer Warnes

The Well  
Cisco

CLP7009 **180g**

Hurried transfers can often castrate the superb resolution and highly detailed quality found in recordings that started out life as CD releases. The Well however has been a long time in coming and this delay is largely down to the close artistic involvement of Jennifer Warnes with the production of this beautifully pressed LP. The wait has been worthwhile. This Bernie Grundman mastered LP sounds immaculate. For example, the palpable clarity, precision and dynamics secured in the reproduction of guitars (acoustic and pedal steel), violins, viola, cellos and piano which back Jenny's finely sculpted vocal thread heard on 'Prairie Melancholy' are given an infusion of delicacy, warmth and intimacy. Where the CD lifted a veil on proceedings, playing the record then goes on to fill in a void that I had not previously noticed. Even when Jenny so easily switches in and out of styles from folk to blues diva and in those songs that show her talent as a roots pop singer or country casual, there is still a sense of greater rhythmic certainty and coherence. It provides a mortar that ties in those transparently polished instrumental slabs.

RP

Supplier: [www.vivante.co.uk](http://www.vivante.co.uk)





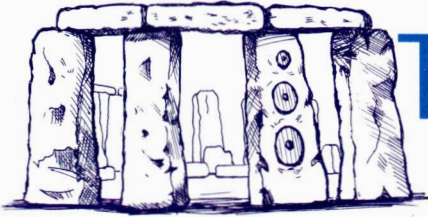

# The History Man

by Richard S. Foster

In issue 27 (page 132) in my review of the first of the great Mercury re-issues by Speakers Corner, I mention how my musical tastes have changed over the years. In the mid-80s when I “discovered” the general audiophile classical market of RCA ‘shaded dogs’, Mercury Living

Presence, and the catalogues of Decca and EMI, I felt I had died and gone to heaven. Those records contained some of the greatest performances committed to vinyl (certainly in the stereo era) and of course the sound quality was outstanding. For several years, there was nothing but bliss on my turntable.

Then it began . . . the feeling of living in a time-warp. I thought the only great records of the stereo era were recorded between 1954 and 1964 (yes, I’m aware that although some of these gems were recorded in the 1954 through early 1958 years, they weren’t fully released as vinyl, until the fourth quarter of 1958 - at least in America).

But I started to find many recordings from the 1970s English catalogues very satisfying musically . . . but I still felt I was locked into a period-in-time, classically speaking.

The 1990s began my exploration into the world of mono recordings and artists from a different era with very different styles of playing.

While I loved many of the performances on these records, they were difficult for me to enjoy with a stereo stylus. Even with the mono switch of my line stage (Herron Audio) engaged, there was still too much noise from the records. This of course has to do with a stereo styli tracing too deeply into the groove of a mono record where there is no information.

Then in February of 2001, I began to hear rumours of a “mono” Helikon cartridge to be manufactured by Lyra. In the e-mail list, Phonogram, I made the following comment about the mono Helikon in March 2001, “Now,

when it comes to MONO . . . I have been absolutely thunderstruck with what I’ve been hearing with the MONO Helikon. It has rendered some recordings which were quite noisy with either of my stereo cartridges absolutely incredibly quiet - and the detail and information . . .

My initial impressions of this cartridge are way over the top. I think this cartridge provides better sound quality of my mono recordings than either the stereo Helikon or the Clearaudio Insider Reference played with my line-stage’s mono switch engaged. It is absolutely incredible and I can assure you it will become a mainstay in my playing of mono recordings. Lyra has hit a grand slam home run with this product, and anyone who has a large or much loved MONO record collection, should look at this cartridge.”

There is one key word in the above paragraph that will make sense in a few minutes. I’ve mentioned in an earlier issue of this magazine about the e-mail list I co-founded with James Durkin in 1997. We now have two lists, one dedicated to vinyl (phonogram) and one for equipment and DIY individuals (equipment).\*

If you’ll allow me to ramble on for a few more minutes, this may all make proper sense . . . Phonogram consists of a large number of enthusiasts whose tastes are as broad as the oceans. I’ve tried some suggestions from some of the list members and have not really fallen for much of what had been offered up. Then I was goaded and pushed by one Oswaldo Martinez over his love for AC/DC and especially their album

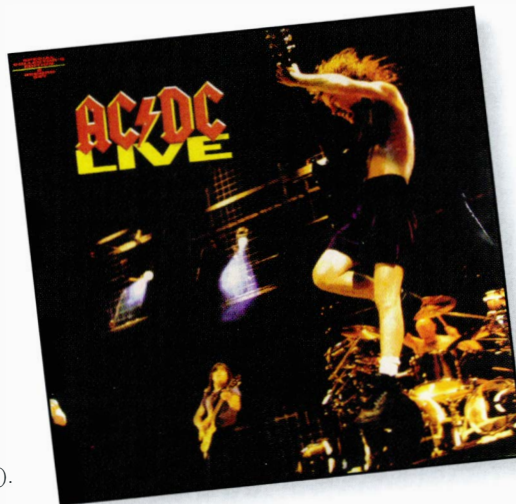

\*For those interested, please send an email to: [majordomo@phonogram.net](mailto:majordomo@phonogram.net). In the first line of your email type: info phonogram or info equipment. Instructions on how to join the lists will be sent to you.

► *Back in Black*. He waxed rhapsodically about what a great group they were and how well this album was recorded and on and on ad nauseam.

Oz is a friend and he volunteered to send me his album for me to audition. At the time I was living with a large system consisting of Acarian Audio Phalanx loudspeakers and their Poseidon sub woofer system. Large tube amps ran the Phalanx's and a pair of monster Krells ran the subs. Friends in Toronto fondly referred to this system as 'Three Mile Island'.

The LP arrived and on the table it went. I was stunned! I don't know what I expected as I had no real idea who AC/DC were! I thought them to be some heavy metal noise group and had already made up my mind I was not going to like the album because I just thought it couldn't be that good. Boy was I wrong. The album was outstanding. Oz was right, it was very well recorded and it REALLY ROCKED! My impressions now are they are one of the great rock and roll bands . . . period.

My search began for my copy and thanks to ebay . . . a great copy resides in my collection (even though I am now looking for a US promo - John T are you reading this?!)

In the fifth paragraph of this article I mention that I was thunderstruck with the mono Helikon. Thunderstruck is not a word I use very much. And of course I had absolutely no idea that AC/DC released a song of this title on their album *Razor's Edge* in 1990. Incidentally, the UK copies of this album were all pressed in Germany (Atco: WX366 is the album number while 7567-91413-1 is the CD issue.) BUT, the real "Jewel in the Crown" was introduced to me by another Phonogrammer, Mr. David LeClaire. David LOVES British 45 rpm issues (from the 60 s on up) and he sent me a copy of a 12" 45rpm of 'Thunderstruck' on UK Atco: B8907T.

Look . . . I'm not going to go much further other than to say to you that this 45 will absolutely blow your mind (not to mention what it will do to your system). Yes, it rocks, yes, I've always previously believed that only acoustic (and classical at that) could tell you what a system was or wasn't capable of doing, but that's before I heard this 45rpm gem. I'm telling you to RUN, CALL, WRITE OR E-MAIL your local supplier of British vinyl and GRAB A COPY OF THIS! It's simply stunning.

But be warned . . . this record could damage your system if it's not up to snuff. It contains thunderous bass information, great dynamic swing, and just for fun it really damn well rocks!

Phonogram has been a great source of knowledge of many people willing to share the knowledge

they have in so many areas related to our hobby and of course our musical tastes. For me to find a "new rock band", in the year 2002, that I love, is just way cool. Thanks guys.

Now for the newest piece of news that I am sure most of you are already aware: Sony has re-issued, in glorious analogue sound (of course there are a few records that were recorded digitally so no analogue exists) the entire commercial releases of AC/DC. You can buy your favorite album individually or go over the top as I did and buy the 15 record set housed in a black slip-case.

These are also available in compact disc for those whose tastes run in the digital domain. I've done some comparing with some of the originals that I own and although this is far from definitive, Sony (using Sterling Sound in the US) did a fantastic job. For further information on this set, please visit the new official (Sony) website that has been prepared for this at: <http://www.acdcrocks.com>. A site I find truly interesting with loads of information is located at <http://www.ac-dc.net/>. There you will be able to follow the development of the band from 1973 to 2003. And lest I forget, in North America, there are three outstanding DVDs that belong in everyone's AC/DC collection: *No Bull Live* - Plaza De Toros, Madrid (1996) [40192-2]; *Stiff Upper Lip Live* [40232-2] a great live concert in Germany . . . and the newest and most wonderful: *Live at Donnington* [EVD 56963] a fabulous two hours at Castle Donnington from 1991. My two faves are *Stiff Upper Lip Live* and *Live at Donnington*, but ALL of these are in fantastic Dolby Digital5.1 sound. I can't tell you how happy my neighbours are with me.

For what it's worth, I'm still a babe-in-the-woods with this group, but I love *Back in Black*, *Highway to Hell*, *Let There Be Rock*, *For Those About To Rock*, and because it has just about everything great on it, the two record set *AC/DC LIVE*.

Great rock and roll not to be missed . . . no matter how old or young you are. And you thought I just loved classical? Shame on you.





# VALHALLA

"Special. Very special indeed. .... I was genuinely impressed by the SPMs, feeling that they established new standards in many important areas. The Valhallas have just rendered them obsolete as any sort of reference. 'Tis ruined that I am."

Roy Gregory Hi Fi + Issue 9

## NORDOST (UK) Ltd

Unit 7, Aber Park Industrial Estate,  
Aber Road, Flint, Flintshire CH6 5EX

Tel: +44 (0) 1352 730251

Fax: +44 (0) 1352 731273

Email: sales@nordostuk.com

## NORDOST CORPORATION

200, Homer Avenue,  
Ashland, MA 01721, USA.

Tel: (508) 881 1116

Fax: (508) 881 6444

Email: sales@nordost.com

Please visit our web site at:  
[www.nordost.com](http://www.nordost.com)

Hi-Fi+  
EDITOR'S  
CHOICE

EDITOR'S  
CHOICE  
Hi-Fi+ NEWS

AWARD  
WINNER  
Hi-Fi+ NEWS

Hi-Fi+  
PRODUCT  
of the  
YEAR



**B&W** Bowers & Wilkins

> *A B S O R B E D*

With every beautiful note  
I'm where I want to be

THE NEW B&W

704



[www.bw700.com](http://www.bw700.com)

For your virtual tour of the B&W 704 and 700 Series please visit our site, or call +44 (0)1903 221 500





# A Treat for you, your ears & your eyes

At the Northern Sound & Vision Hi-fi and Home Cinema show 7/8 February 2004 at the superb Radisson SAS, Manchester Airport, there will be hi-fi systems on demonstration that may make you believe the musicians are in the room. There will be home cinema displays that will be more realistic than you can probably imagine – *come and deceive your senses for the day.*

Northern Sound & Vision, with it's superb new venue, will be bigger and better than ever. Many of *hi-fi and home cinemas* finest companies are expected to attend (see overleaf or our website for latest details). Some of the names you may be unfamiliar with but believe me there will be some exceptional visual and audio products on show with many *Special Show Offers* available for purchase. Not only that, but there will be *live entertainment* on both days plus, for the first time, the Smarthouse Showcase will exhibit *cutting-edge home technology* in one of this superb hotel's largest suites.

(SEE OVER FOR FURTHER DETAILS)

## Northern 2004 Sound & Vision Hi-fi & Home Cinema show

Radisson SAS, Manchester Airport

7/8 February 2004

### Use your Privilege Ticket below

## SEE OVER TO SAVE YOURSELF EVEN MORE MONEY!

Parking extra: Either 'on-site' in the Radisson SAS car park at displayed rates or our overspill car park.

For the latter we will have regular shuttle buses from the Hotel Entrance.

### Northern Sound & Vision 2004 7/8 February, 2004

The Radisson SAS (FOLLOW THE SIGNS FOR TERMINAL 2 FROM M56 JUNCTION 5)  
Chicago Avenue, Manchester Airport

Opening times: Sat: 10am - 6pm. Sun: 10am - 5pm

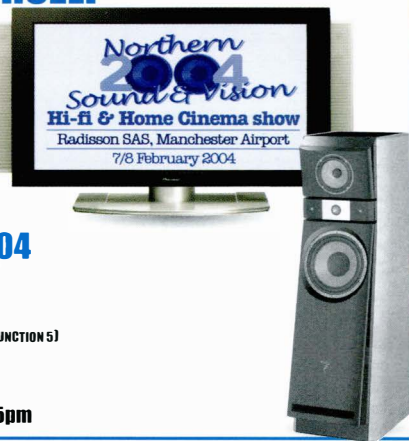

Northern  
2004  
Sound & Vision  
Hi-fi & Home Cinema show  
Radisson SAS, Manchester Airport  
7/8 February 2004

Privilege Ticket  
>>> ADMIT ONE <<<

REDEEM AT THE SHOW  
ON EITHER DAY AND

PAY  
ONLY £5

(Normal 'on the day'  
admission £7.00)

## Entertainment & Special Attractions

### Hi-fi+ 2003 - Products of the Year Awards

We are delighted to be hosting this prestigious event at Northern Sound & Vision. Look out for the Rosetted rooms that will indicate some of the winners.

### Smarthouse Showcase

See cutting-edge technology all in an actual home setting, lounge area, kitchen, all brought together in a unique display.

### Class acts

Quality live entertainment will be a hallmark of the Northern Sound & Vision show. Continuous and tasteful sessions throughout the weekend.

### High-end audio.

In order that visitors have the best chance of hearing top quality sound, quality audio will have it's own section of the show.

### Home Cinema

With our new venue we have all the space we need to present this dynamic market to it's best advantage, be prepared to be impressed.

### Budget systems

Here you will find top quality systems that wont break the bank.

### Visitor Goody Bag

All visitors to Northern Sound & Vision receive 2 FREE Hot-of-the-Press magazines, Hi-fi+ (March issue!) and Smarthouse, worth £7.25. Plus a FREE Programme, making Northern Sound & Vision the bargain show of the YEAR.

### See & Buy?

Northern Sound & Vision is not just THE shop window - it's a selling show. Many items, including show specials, can be bought on the day!

Now in it's 5th year with a Great New Venue - New Dates - Bigger Dealer Line-up - The Norths Premier Selling Show, Northern Sound & Vision

will be bigger and better than ever.

### How's this just for starters?

WILSON BENESCH	RINGMAT	FINAL	SIM2
LYNWOOD	LARC	FONE	ANDERS & KERN
QUADRASPIRE	CHERISHED-	GRAAF	VIDIKRON
HARMAN KARDON	RECORDS	HI DIAMOND	STEWART
AUDIONOTE	CUSTOM DESIGN	KEMP ACOUSTICS	FIREHAWK
EPOS/CREEK	DOUG BRADY	TRIANGLE	GRAVES AUDIO
DALI	SEVENOAKS	UNION RESEARCH	IKON AUDIO
KORATO	ACOUSTICA	BOSE	WEMBLEY-
OPUS 3	NAIM	SPECTRAL	LOUDSPEAKERS
HI-FI+	FERGUSON HILL-	ACUPHASE	EXPERIENCE-
AUDIOCRAFT	STUDIOS	NAGRA	FILTRATION
AUDIOWORKS	SUGDEN	FOCAL JM LAB	TRUE COLOURS
REFERENCE AUDIO	QUAD	PRO-JECT	MARTON MUSIC
SMARTHOUSE	ARCAM	VIBE	WILLIAMS HART
SHOWCASE	AUDIO	ORTOFON	MUSICWORKS
CRESTRON	ANALOGUE	ROKSAN	OBELISK AUDIO-
ARTCOUSTIC	BCD-	VIENNA	SYSTEMS
VIVANTE	ENGINEERING	BEYERDYNAMIC	BLUE PEARL-
DIVERSE VINYL	DIAPASON	BLACK RHODIUM	AUDIO

Please complete your details below before using ticket

Name: .....

Address: .....

.....

.....

Town: .....

County: .....

Post Code: .....

Tel No: .....

email: .....

.....

Please tick box if you agree to be contacted by email:

We promise that we will only use the information submitted herewith for internal purposes. This information will not be given or sold on to any third party organisations. We may contact you in future to inform you of business-related matters. If you do not wish to receive news, updates or details of special offers and events from us, please tick this box

SAVE MORE MONEY.

Bring friends or family with you and save save save!  
**ONE** extra friend or family and everyone pays just £5 each.  
**TWO...** you pay £4 and your friends or family pay £5 each.  
**THREE...** you pay £3 and your friends or family pay £5 each

**TO TAKE ADVANTAGE OF THESE OFFERS YOUR FRIENDS OR FAMILY MUST NOT BE ON OUR EXISTING DATABASE!**

FOR DETAILS OF SOUND & VISION 2004, MANCHESTER ORGANISED BY CHESTERFIELD COMMUNICATIONS, CONTACT: Roy Bird  
Tel: 01629 740650  
E-mail: roy@chestergrp.fsnet.co.uk  
website: www.chestergroup.org  
Mobile: 07610 697123