

# hi-fi+

Issue 15 - Jan / Feb 2002  
UK £3.95

REPRODUCING THE RECORDED ARTS

## Stairway to...

### ► Futures

*Karan Acoustics  
Renaissance  
Red Rose  
Synthesis  
Spendor*

### ► Growth Potential

*Canary Audio  
Border Patrol  
Rogue Audio  
Clearaudio*

### ► Blue Chips

*Audio Research  
Monitor Audio  
Papworth Audio  
Schroeder  
Rotel*



# Nº 2001 PLAYLIST

**mark levinson**  
MADRIGAL AUDIO LABORATORIES

The first edition of the new Mark Levinson No.2001 Playlist is now available. This eighty-page book is filled with detailed colour images of the components and describes both the conceptual and technical qualities that set Mark Levinson apart.

The Mark Levinson story has never been explained more clearly or more completely. The price including delivery is £9.95. To obtain a copy please contact:

**PATH**  
*Premier*

Path Premier  
Dormer Road, Thame Industrial Estate, Thame, Oxfordshire OX9 3UD  
Tel: +44 (0) 1844 219000 Fax: +44 (0) 1844 219099  
Email: premier@path.co.uk



# Editorial

## Editor

Roy Gregory

## Contributors

David Ayers  
Chris Binns  
Mark Childs  
Pete Christie  
Dave Davies  
Simon Groome  
Jason Hector  
Andrew Hobbs  
Jimmy Hughes  
Michael Mercer  
Paul Messenger  
Reuben Parry  
Peter Russell  
Chris Thomas

## Photography

Simon Marsh

## Cartoonist

Dave Davies

## Design

Creative Byte  
Unit 12, Albany Business Park  
Cabot Lane, Poole, Dorset  
BH17 7BX

## Printed By

Stones The Printers, Banbury

Hi-Fi+ is published six times  
a year by; Hi-Fi+ Publishing Ltd

## The Editorial Office

can be contacted at;

Hi-Fi+ Editorial  
Unit 12, Albany Business Park  
Cabot Lane  
Poole, Dorset  
BH17 7BX  
United Kingdom  
Tel. (44)(0)1202-659380  
Fax. (44)(0)1202-659540  
Net. [www.hifiplus.com](http://www.hifiplus.com)

All Rights Reserved.

Not one word of Hi-Fi+ may be reproduced without the written consent of the Editor. We are perfectly happy to co-operate, but we don't want quotations to appear out of context.

It's the end of the year, the first Issue of 2002 and that means it's time to look back across the preceding twelve months with an eye to selecting likely candidates for the second set of Hi-Fi+ Awards to be announced at the Bristol Show and published in Issue 16. Of course you, the readers, can indulge in the time honoured process of second guessing the entirely arbitrary judging process, but from where I sit, the most refreshing aspect of the likely contenders is the fact that a year ago I doubt you'd have predicted any of them.

The demise of small, enthusiast, performance driven manufacturers has been widely predicted by other magazines and writers, yet it's exactly these companies that have produced the most impressive products to darken our doors this year. Whether that's simple chance or a ground swell in the market as a whole who can tell, but I for one have been suggesting that the industrially designed and marketing led mediocrity that has been failing to deliver hi-fi performance for the last few years is finally wearing thin. Perhaps the customers for those products are moving on to the A/V market, and the companies who service them are moving on too. Whatever the reason, in terms of the sound delivered for your hard earned cash, this year has seen some real breakthroughs. Long may it continue!

Roy Gregory



# EXPERIENCE THE CHORD EFFECT!



The first time you hear your sound system with Chord interconnecting cables will be the first time you've **really heard it.**

Be warned - the effect can be shattering.

Your eyes and ears will be opened. Your music will never sound the same again.

Specify Chord cables -  
Hear the light!

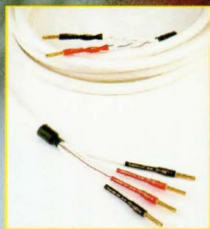

FOR SALES AND INFORMATION CALL: 01722 331674  
FAX: 01722 411388 E-MAIL: [CHORD@CHORD.CO.UK](mailto:CHORD@CHORD.CO.UK) OR VISIT US AT [WWW.CHORD.CO.UK](http://WWW.CHORD.CO.UK)

# Contents

## Equipment+

### Regulars

- 4 News
- 6 Letters
- 10 Columns
- 21 Manchester Show Report

### Equipment Reviews

- 32 Audio Research LS25/2 line-stage and VT100/3 power-amp
- 36 Renaissance Amplification RA-01 monoblocks
- 42 Synthesis Harmony pre-amp and Renaissance power-amp
- 46 Interview with Rogue Audio's Mark O'Brien and Mark Walker
- 50 Rogue Audio 66LSR pre-amp and 88 power-amp
- 56 Papworth TVA-8 integrated valve amplifier
- 60 Border Patrol choke regulated power supplies
- 66 Canary Audio CA-608LV integrated valve amplifier
- 70 Red Rose Music R3 loudspeaker
- 76 Karan Acoustics KA I-180 integrated amp
- 80 Spondor S3/5 loudspeaker
- 86 Monitor Audio Gold Reference GR-60 floor-standing loudspeaker
- 90 Interview with tonearm manufacturer Frank Schroeder
- 94 Schroeder Reference tonearm

### The Real Deal

#### – budget gear that works

- 98 Rotel RA1060 integrated amplifier

### Audio Smorgasbord

- 104 Superb new headphones from Etymotic Research, upgrading the Clearaudio Champion turntable, rumblings from Korea, a really heavy weight stand and the Statmat reincarnate.

## Music+

- 114 Popular and Contemporary Music
- 122 Country Casuals – three of country music's more adventurous female talents; Karla Bonoff, Kathy Mattea and Beth Nielsen Chapman
- 126 Jazz
- 129 Classical Music
- 134 Audiophile Music

### Departments

- 40 Back Issues & Subscriptions
- 84 Monitor Audio dealer listing
- 128 Hi-Fi+ Binders
- 133 Advertisers' Index

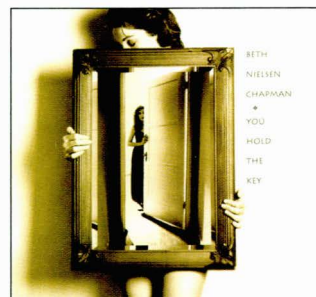
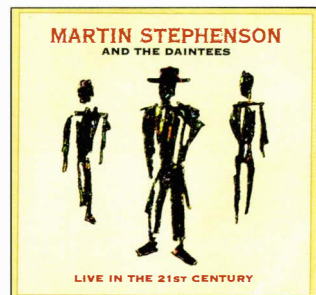
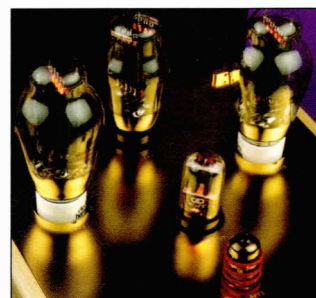
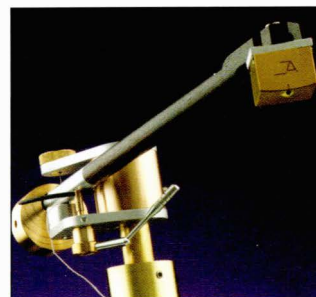

# Absolute Sounds Closed Door Demonstrations

Is nowhere safe? There I was in Washington DC, I answered the phone and had Ricardo Franassovici berating me loudly for getting my facts wrong. Contrary to my assertion in the Issue 14 Novotel Show Report, Absolute Sounds had been running their traditional closed door demonstrations, reinstated in part because I'd complained about their absence last year. Well, mea culpa. My only excuse is that they weren't doing it on the trade days when I visited their extensive display, and having been banned from exhibiting I'd seriously exhausted the show's potential by the time the public days arrived. I even got a weekend off for once.

Excuses aside I'm really glad to be corrected on this point.

Having been rattling on for ages about the need for this industry to get out there and demonstrate the benefits it has to offer, it's especially nice to see a lead coming from the top. With Absolute Sounds again taking up the challenge presented by the confines of even the larger hotel rooms, that means that alongside Path Premier, the public now have the option to hear even more of the seriously high-end products on offer in this country, presented in properly structured demonstrations. This year they were concentrating on the new Krell loudspeakers, although with so many interesting new products from Wilson Audio and Martin-Logan as well, that must have been a tough decision. ➤

# Vinyl Enjoying Rude Health

Despite reports to the contrary and the arrival of new, high-resolution digital formats (does that mean that CD is now officially 'low-resolution?'), the venerable LP record seems to be going from strength to strength. Not only are there increasing numbers of current pop titles appearing in the 12" format, the hardware side of things is hotting up too. New cartridges seem to be an almost weekly occurrence, and following hot on the heels of important new products from Ortofon and Lyra, we now have the interesting prospect of the Dynavector DV-XX2 adding further spice to the already hotly contended £1000 market. But perhaps the most fascinating prospect of all comes from Scantech, with a special mono version of their already exceptional Helikon cartridge. Add in an increasing flow of mono re-issues from Speakers Corner, not to mention the absolute mountain of used mono vinyl at give away prices, along with the Gibbert phono stage mentioned in Issue 14, and we have the beginnings of a serious resurgence

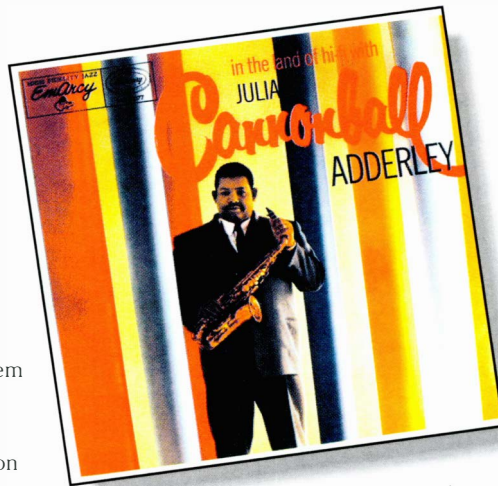

of interest in pre-stereo recordings. Of course, whilst that hardly touches pop, both jazz and classical have a rich heritage of early microgroove LP releases, with fabulous performances available to those not suffering from stereo fixation.

What's even stranger is that the proposed move to five channel set-ups for serious reproduction might actually add even greater impetus to the mono movement by inadvertently offering the necessary hardware for

optimum playback. (Not to mention the possibilities regarding three-track classical masters from the likes of RCA, Mercury and Decca – or even new three-channel recordings!)

What ever the reason behind it I have an ever growing heap of vinyl replay hardware clamouring for my attention, including a plethora of budget phono stages and modified Rega arms. All I need to do is hunt out a couple of decent sub £200 cartridges and there's the makings of a budget vinyl feature. Suggestions on a postcard please. ➤

# Walrus Systems

11 New Quebec St, London W1

## Arguably the best speakers ...

allaerts  
aloia  
amazon  
apollo furniture  
argento  
audible illusions  
audio note  
audio physic  
avantgarde  
breuer dynamic  
brinkmann  
canary audio  
carfrae  
cartridge man  
cat  
clearaudio  
coph nia  
croft  
decca london  
dnm  
duevel  
dynavector  
ear yoshino  
ergo  
final lab  
graham  
incognito  
lyra  
michell engineering  
morch  
musical fidelity  
nordost  
nottingham  
analogue  
ortofon  
papworth  
phy cables  
pluto  
pro-ject  
rega turntables  
ringmat  
shun mook  
sme  
spendor  
stax  
sugden  
sumiko  
tci cables  
tom evans  
townshend audio  
transfiguration  
trilogy  
tron  
vaessen  
van den hul  
verdier

... and turntables in the world are on permanent demo (subject to booking, please) in our Central London store. In fact, you'll find probably the largest selection anywhere in Britain of vinyl playing equipment and valve amplification, in our tiny, overcrowded (but perfectly formed) shop.

And, a whole host of other stuff to keep you amused for hours.

As you know, specialist hi-fi, especially the turntable, needs careful setting up, and our service is second to none, with many years of experience. And, if it goes wrong, we sort it out for you, very often in our shop, usually whilst you're waiting, with the same enthusiasm as when we sold it to you - ask our competitors if they do that.

Look forward to seeing you soon - Les and Pete.

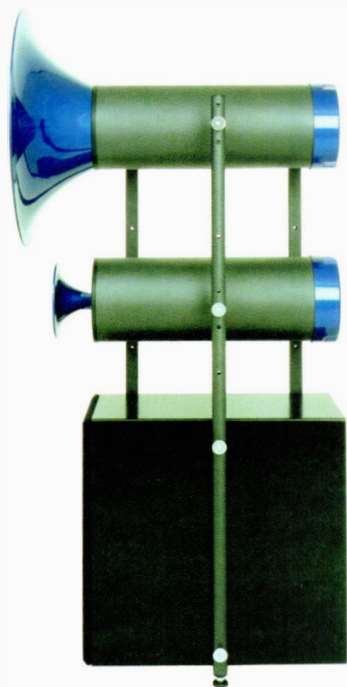

**Avantgarde Uno (Midnight Blue) - £6809 - the ultimate high sensitivity speaker. In fact, maybe the ultimate speaker period (with the exception of Avantgarde's own bigger models!).**

The box-less design, combined with accurate horn geometry give you low colouration, openness, and incredibly explicit detail and soundstaging.

All from a speaker capable of running from a 10 Watt amplifier - what else could you possibly want!

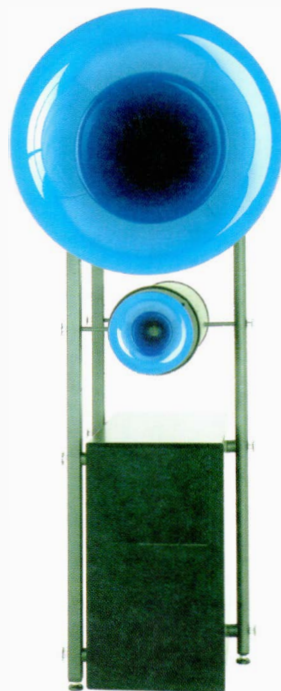

**JC Verdier "Platine Verdier" - £4250 (arm and cart extra) - shouldn't need introduction to well-versed audiophiles. This magnetically levitated platter turntable system with outboard motor is widely regarded as one of the finest analogue sources in the world.**

**Musical Fidelity Nuvista CD - £2999 - Yes, I know we don't get out of bed for digital products normally, but this one is too exceptional to ignore! The Nuvista would be good value at twice the price; it brings to CD the life and vitality more usually associated with Vinyl. Sit back and enjoy!**



\* interest free credit available on most items, subject to status \*

tel: 020 7724 7224  
fax: 020 7724 4347  
email: mail@walrus.co.uk  
web: www.walrus.co.uk



# Incoming!

Please address letters to the Editor at Hi-Fi+, Unit 12 Albany Business Park, Cabot Lane, Poole, Dorset, BH17 7BX.  
or via the web-site at [www.hifiplus.com](http://www.hifiplus.com)

Hi Roy,

Just a few comments on the very informative, thought-provoking and probably unique demonstration of SACD, DVD-A, Vinyl and CD which you organised at the Manchester Hilton Hotel recently.

First of all, while it wasn't possible to make the 'Definitive' comparison between all four formats - six if multi-channel is included - because of the lack of any recordings compatible with all systems, it would indeed be churlish for anyone to seriously argue that your demo wasn't as good as was humanly possible to achieve, and I for one am grateful for your effort.

To cut to the chase, the conclusion which you expressed was that all the formats were capable of excellent playback, so finding the 'best' could leave us all basically chasing our tails. Even with the array of front-end talent available at your disposal, varying recording quality/equalisation or mixing ensured that the playing field was almost always tilted one way or the other; this I'd wholeheartedly agree with - up to a point. It probably would be impossible to conduct this 'definitive' comparison even if there was a universal recording out there (where is there a \$5000 DVD-A player to compare with the Marantz SA-1?), mainly because all we'd be doing is judging the playback quality of the particular player being used, not the actual software/medium itself. Even two CD players at a given price-point can sound more divergent in presentation than differing formats, and which was the better CD player would depend on taste. At the end of the day, the new Hi-Res digital formats were trumpeted as being far superior to CD, when in my experience they are not; 96/24 in theory must trump 44/16 everything else being equal, but if it were just a question of numbers and sampling rates, then DVD-A would use its full 192/24 spec would it not? Also, if the sonic purity of DSD recording accounted for the SACD camp's eulogising of its technology, I'd say that until recently DSD had to be converted to PCM for mixing, so the argument dissolves completely. The CD DAC which I use has no 'brick-wall' filter making it similar to SACD in this respect, and I'm convinced that it is this that hamstring PCM in mainstream Redbook playback.

The crux of the matter is simple, in that as we all agreed at

the demo on Sunday, we're entirely at the mercy of the recording process whichever medium we choose; depending on what the engineers put on the disc, our music system will either sound gloriously involving with seductive vocals, soaring violins etc, or will have us shaking our heads and thinking that maybe the next upgrade or newest format could deliver audio nirvana.

Yours Sincerely,

**Chris Redmond**

via E-mail

*This is only one of the many letters we've received following the Manchester Show Demonstration (described in full on pageXX for those who missed the actual event) but it seems to sum up their general tenor as well as raising a few interesting points of its own.*

*As regards DVD-A and its 192kHz/24bit capability, there are indeed a small number of demonstration discs that use the full stereo bandwidth available from the format. However, the operative word here is stereo. Don't forget that the commercial reasoning behind the new high-resolution standards is to do with discrete surround sound as much as it is to do with higher quality per se. In other words, the perceived advantage of DVD-A over DVD-V is that it allows the engineer to encode a full six channels of 96kHz/24bit sound (although in practise that probably requires the application of MLP compression), a feat that is beyond the data storage or retrieval capabilities of the video format. However, that's only one way in which the high-resolution disc could be formatted. Purist labels might well decide to run with a 192kHz/24bit stereo format whilst at the other end of the spectrum, someone might want to record the entire works of Harry Potter on a single 16bit disc. Make that JRR Tolkien and you're probably talking mono too. This was the reasoning behind the second half of the demonstration. Not a case of what you could do, but more one of what the manufacturers actually expect you to. In other words, as far as the electronics conglomerates and music industry are concerned, high-resolution audio, whether it's stored on SACD or DVD-A, is indelibly linked with the notion of discrete surround replay.*





# Hazlemere Audio

We offer music lovers the opportunity to increase their enjoyment of music.

Objective advice,  
comfortable listening rooms,  
home demonstrations,  
superb customer service  
and some of the world's  
finest equipment.



*Full range of Oracle products on permanent demonstration, including turntables, CD players, transports and amplification.*

**Now demonstrating in new showroom and studios**

Accuphase, ART, ATC, Audio Analogue,  
B.C. Acoustique, BKS, Clearaudio, Creek, Crimson,  
DNM, Epos, Fanfare, Gamut, Harmonic Technologies,  
Helios, Mirage, Monrio, Nagra, Passlabs, Plinius,  
Opera, Ortofon, Rehdeko, Resolution, Reson, Rockport,  
Sugden, Totem, Triangle, Trilogly, Unison Research.

**For an appointment (day or evening)  
Call High Wycombe  
(01494) 865829**



"An excellent cable: full, solid bass, neutral balance and layered complexity." - Home Entertainment Magazine



**2005  
PRODUCT  
YEAR**



Start from Clearaudio's basic turntables and trade up to their award winning Master Reference.

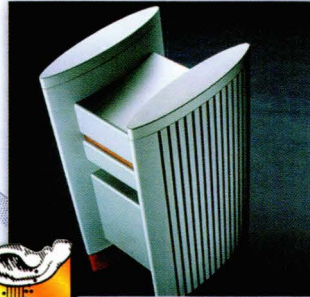

The worlds only super fidelity amplifiers, featuring 99.9996% purity across the entire audio range, and universal power corrected power supplies



Spirit Mk3, rendering faithfulness to the original recorded sound



Alola Italian tube timbre amplification featuring their 'Inductive Power Supply'



Audio Reference are the UK Distributors for Acapella, Alola, Argento, Cabasse, Clearaudio, C.A.T., Gamut Audio, Graham, Halcro, Shakti, Shun Mook, and Transfiguration. For a free information pack contact us on: Tel: 01252 702705, e: [info@audioreference.co.uk](mailto:info@audioreference.co.uk)

# ULTIMATE SONICS

DISTRIBUTORS OF QUALITY AND AFFORDABLE HIGH END  
HIFI AND HOME THEATRE EQUIPMENT

The Ultimate solution for all electrical mains problem  
**Hear The Difference**

## PS Audio Power plant



AC regeneration - the most sophisticated solution available

## Ultimate Outlet

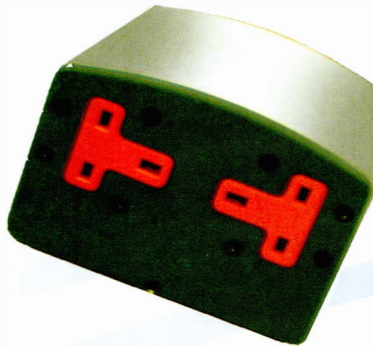

New high current Ultimate Outlet from PS Audio - reduces mains noise and improves sound quality. Innovative circuitry means that it performs like no other.

## Synergistic research



Best in test - Hi-Fi Choice  
Reviewed by Jimmy Hughes



**PS Audio Lab Cables** - as always, the affordable option

**Try one in your system - 14 days no obligation trial**

For more product information visit our web site at [www.ultimate-sonics.com](http://www.ultimate-sonics.com)  
Check out our pre used pages on the web for bargains.

**Tel:** 0208 5340134 **Fax:** 0208 534 0234 **Email:** [sales@ultimate-sonics.com](mailto:sales@ultimate-sonics.com)

**Question:** Is this the best amplifier ever built?

**Answer:** oui, si, ya, nai,  
ja, igen, yes,  
haan, ken, evet,  
chai khan, ano,  
da, hai, ia.....

*In any language the answer is the same*



**The Veritas P400 Digital Power Amplifier.**

**400 watts of pure power.**

**Made in England without compromise.**

**V E R I T A S**

**Veritas Horn Systems Ltd**

Manor Farm Barns  
Glandford, Holt  
Norfolk NR25 7JP  
Tel: 01263 741417 Fax: 01263 740937  
e-mail: p400@veritashifi.co.uk  
web: www.veritashifi.co.uk

*" the most musically complete  
power amplifier I have used"*

Ivor Humphreys, HiFi News

# Playing The System

by Roy Gregory

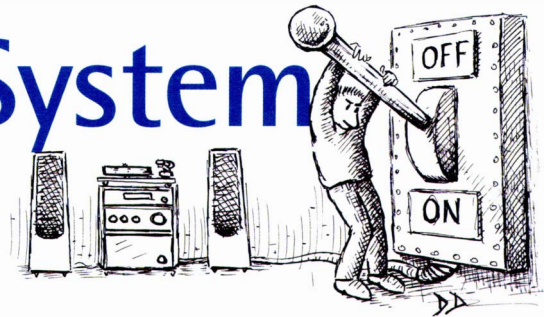

A few days ago I shocked myself. You see, as a reviewer there are times when I have so much equipment through the house that my own system gets effectively sidelined. Recently I've had so many amplifiers to test, as well as an on-going love affair with the little Monarchy Audio SM70, that my own Jadis JA30s have been gathering dust. So much so in fact that it suddenly occurred to me that LB, who was visiting, had never heard them. Well, I had to put that right so on they went. Wow! In the intervening time I'd forgotten just what an astonishingly, spectacularly, wonderfully musical amplifier the little JA30 is. "Why don't you use these all the time?" she asked. Why indeed? I asked myself.

After all, you'd think I'd know by now. I've only owned them for 12 years! And that, once my grey cells really started to turn, emerged as the most amazing fact of all. Not just that I could own such a product for so long, never having had a moments trouble from the small but incredibly dense units, but that even after all this time they can banish all comers with such dismissive ease. Which just goes to show that a really good product this year is still a really good product several years down the track. And it seems I'm not the only one enjoying these regressive tendencies. Much as CB admires the transparency and refinement of the Audio Research VT100, he can't help missing the animal power and impact of the altogether less cultured D115, an amp with a similar vintage to my JA30s. And PR seems to be more and more enamoured of his Quad ELS57s, which really is a vintage design.

But all these examples pale into insignificance in the context of a recent experience. Visiting Harry Weisfeld of VPI I discovered him in the midst of plumbing in an astonishingly expensive phono stage alongside his normal \$6000 unit. Front-end was a TNT Hot Rod mounting a 12" JMW tonearm and Dynavector DV-XX2 but it was the amplification and speakers that were most interesting. The speakers were ribbon di-poles of Harry's own design driven by an original Macintosh 275 power amp and Marantz's first ever solid-state pre-amp design. Nothing if not eclectic. Anyway, we sat down to compare the performance of two phono stages with a combined retail value of nearly

\$15000. The reference unit was a model of focus, transparency and refinement, the new comer a bolder and altogether more romantic performer. The problem was that the strengths of one merely highlighted the weaknesses of the other, and vice versa, rendering both unacceptable.

Then started the convoluted search for sonic nirvana. Being phono stages neither unit was short of adjustments, the newcomer positively bristled with them, all with lovely blue back-lighting on their controls. And that's before you even start to think about playing with cables, supports and all the other arcane devices available to the dedicated tweaker (and let's face it, Harry's produced more than a few of his own over the years). Even simply ringing the changes with gain and loading was a complicated enough procedure given the sheer range of options. As the uncharacteristically silent Harry (suffering severe laryngitis) danced around the equipment racks making adjustments and swapping cables, I got to assess the results, which was a singularly frustrating experience. Whilst we could move the performance of each unit in the desired direction, neither could stretch as far as the competition required, so that whilst the results were hi-fi impressive they lacked any real musical balance. That was when Harry slapped his forehead in true Marx brothers fashion and croaked "There is one thing that I've forgotten" and promptly disappeared behind the racks again.

As soon as the needle hit the groove I could tell that we'd finally made some progress. Weight without wallow, focus without emasculation. Okay, so it didn't match the best of either extreme but at last there was a real sense of musical balance. "That's much better" I said, "what did you do?" When Harry could stop laughing he finally croaked "I fed the cartridge straight into the moving-magnet input on the Marantz!" A sobering thought indeed.

Now whilst I'm not actually suggesting that a 25 year old Marantz design was generally superior to the massively expensive alternatives on offer (and indeed, in several very obvious ways it clearly wasn't), there's no escaping the fact that in this context at least, it offered a musically more valid performance. What actually gives me pause however, is what this suggests about our attitude to audio advancement. ►

► Over the years we have become so obsessed with the notion that we can extend and further extend the performance of components, and manufacturers have become so concerned with demonstrating that fact to justify ever increasing prices, that the whole industry has become focussed on audio minutiae rather than overall musical performance as a whole. The demonstrable difference has become the Holy Grail of product development; tighter bass, greater transparency, better focus. The problem is that we've stopped asking whether these 'advances' actually make the music more intelligible or communicate any better. We get more detail, more resolution, more bandwidth, but it doesn't necessarily make more sense.

The problem with trying to advance any aspect of audio performance is that there are no signposts. You want to make a car go faster, get a straight road and a stopwatch. The effect of each and every modification can be precisely gauged (as long as your methodology is right). The fact that

no stopwatch exists for audio performance helps explain why so many people have spent so much time trying (and failing) to develop meaningful measurements for hi-fi equipment. It also explains why so many manufacturers and reviewers cling to them despite their known inadequacies (the measurements that is).

Setting off into the hi-fi wilderness, it's only faith and self-confidence that tell the designer which way to go. It's hardly surprising that the audible difference takes on the significance of a compass needle to early mariners, but its value is illusory without the framework of an overall context. Once upon the time we were so fixated with the notion of a fixed reference that different became synonymous with worse. Perhaps now we need to realise that different doesn't necessarily mean better. Our only true reference is the music we replay; our only signposts are over our shoulder. With Christmas just around the corner perhaps it's only appropriate that it really is behind you. ►+

# Home Truths



by Jimmy Hughes

Sooner or later I knew the call would come. I just didn't expect it quite so soon. But come it did, and in a trice Chord's DAC 64 was boxed up and on its way to someone else. If you saw my review in issue 14, you'll have an idea of the impact this product had on me. Inevitably, losing it was going to make a big difference to my hi-fi system. I wasn't looking forward to listening without it...

As luck would have it, the DAC-64's departure coincided with a few days break I planned to take. With it gone, I deliberately didn't play my system. By putting about a week between my final listening session with it, and going back to a conventional CD player, I hoped to 'forget' the improvement made. With no immediate before and after comparison, time would perhaps make the losses less obvious.

Basically, I was trying to minimise the let down that

would no-doubt hit me when I listened to my system using a standard CD player once again. Once the impression made by the DAC 64 faded, things would seem perfectly alright when I next listened. Of course, in absolute terms the sound would not be as good, but with no direct comparison, hopefully the difference wouldn't seem too huge.

Actually, it's easy to get carried away doing A/B comparisons - convincing yourself that differences are much bigger than they are in reality. The really telling comparison comes when you live with a new product, then go back to what you had before. Leaving a week between the comparisons should really highlight just how significant a difference the DAC-64 had made.

When you live with something, inevitably some of the novelty value wears off. Which means the



▶ good points are less likely to blind you into overlooking areas that are perhaps not so good. So I was intrigued to hear how things sounded when I listened again. If the DAC-64 really was as good as I said in my review, even leaving a week between comparisons would not lessen the disappointment!

And disappointment was exactly what I felt when I next listened. The soundstage felt small, as though everything was now slightly squashed. There wasn't quite the same dynamic contrast between loud and soft, nor the extremes of brilliance and warmth tonally. Nor was fine detail as lucidly defined. Musically, the presentation was blander and more generalised.

The sound wasn't terrible; it was still listenable. But something vital was missing. With less separation between voices and instruments, less space around individual notes, transient attack felt softer, and as a consequence the music seemed less focussed and immediate. Quiet passages were more recessed. Discs that had sounded rich and vivid with the DAC-64 now seemed vague and colourless.

Not that every moment spent with the DAC-64 had been musical bliss. Sometimes, its presentation could be a little too focussed and immediate, creating vivid contrasts bordering on the extreme. I had to learn to set volume levels a notch or two lower than usual. Played too loudly, the sound could easily become overly forward, lending a penetrating hectoring quality to climaxes.

What a pity I no longer had the Acoustic Precision Eikos CD player to hand for A/B comparisons to the DAC-64! I don't think the Eikos sounded quite as dramatically different and special as the DAC-64. The star quality of the latter was more palpable. The Eikos was gentler on the ear and more listenable. Its musical presentation was easier to come to terms with.

By contrast, the DAC-64 seemed more radical in the way it portrayed music. Going through my CD collection was more of an adventure; with the DAC-64 you never quite knew what the next disc would sound like. There were big positive variations in sound quality from one CD to another. It would consistently expose detail I'd never heard before.

CDs that, for one reason or another, had never ever sounded quite right were transformed. As levels of hash and grain were eliminated, fresh detail was revealed. In such cases, the DAC-64 was no doubt correcting the timing errors and jitter problems that make some digitally-recorded CDs sound congested and harsh. But the benefits were often just as positive on CDs from analogue sources.

The DAC-64 seemed to open-out the soundstage so that you got more sense of the acoustic in which the

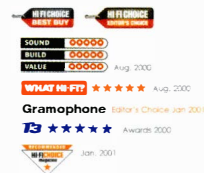

**PMC**

0870 4441044  
www.pmc-speakers.com  
sales@promonitor.co.uk

## Stars

Ashford (Kent)	Soundcraft HiFi	01233 624441
Aylesbury	Northwood Audio	01296 428790
Birmingham	Griffin Audio	0121 622 2230
Bournemouth	Sultans HiFi	01202 555512
Brighton	The Powerplant	01273 775978
Brighton	Jeffries HiFi	01273 609431
Bristol	Roafords	0117 944 1010
Cardiff	Audio Excellence	02920 228565
Cheltenham	Audio T	01242 583960
Chelmsford	Royleigh HiFi	01245 265245
Chester	Audio Excellence	01244 345576
Colwyn Bay	Electratrader	01492 548932
Doncaster	The HiFi Studios	01302 727274
Dundee	Sounds Perfect	01382 226592
Dunstable	Technosound	01582 663297
East Grinstead	Audio Designs	01342 314569
Edinburgh	Loud & Clear	0141 221 0221
Eastbourne	Jeffries HiFi	01323 731336
Enfield	Audio T	020 8367 3132
Epsom	Audio T	01372 748888
Exeter	Audio Excellence	01392 491 194
Glasgow	Loud & Clear	0131 226 6500
Glasgow	Stereo Stereo	0141 246 4079
Gimsey	Manders HiFi	01472 351391
Guildford	P.J. HiFi	01483 504801
Hailox	Huddersfield HiFi	01442 366832
Hitchin	David Orton	01462 452248
Hull	The Audio Room	01482 891375
High Wycombe	Audio T	01494 558585
Ipswich	Seven Oaks Sound & Vision	01473 286977
Kettering	Classic HiFi	01536 310855
Kingston	Infidelity	020 8943 3530
Lakeside	Royleigh HiFi	01708 680551
Leamington Spa	Stratford HiFi	01926 888644
Leeds	Image Audio	0113 278 9374
London (W1)	The Cornflake Shop	020 7631 0472
London (NW)	Audio T	020 7794 7848
London (SE)	Billy Vee	020 8318 5755
London (SW)	Auditorium	020 7384 3030
London (SW)	Oranges & Lemons	020 7924 2040
London (W)	Thomas Heinz	020 7229 2077
Manchester (Greater)	Adventures in HiFi	01942 234202
Manchester	Replay	0161 202 9922
Newcastle Upon Tyne	Lintone Audio	0191 477 4167
New Malden	Unle! Sound & Vision	020 8942 9567
Millon Keynes	Technosound	01908 604949
Nottingham	Nottingham HiFi	0115 924 8320
Norwich	Basically Sound	01508 570829
Oxford	Audio T	01865 765961
Portsmouth	Jeffries HiFi	0239 266 3604
Rayleigh	Royleigh HiFi	01268 779762
Reading	B&B HiFi	01189 583730
Sheffield	Moorgate Acoustics	0114 275 6048
Southampton	Audio T	023 8925 2827
Southend	Royleigh HiFi	01702 435255
St Albans	Rodlett Audio	01727 855577
Stafford	Acoustica	01785 259199
Swansea	Audio Excellence	01792 474608
Taunton	Mike Manning	01823 326688
Tunbridge Wells	Audio T	01892 525666
Worthing	Phase 3	01903 245577
Worcester	Worcester HiFi	01905 612929
Yeovil	Mike Manning	01935 479361
York	The Sound Organisation	01904 627108

# NORDOST

MAKING THE CONNECTION

Loudspeaker Cable

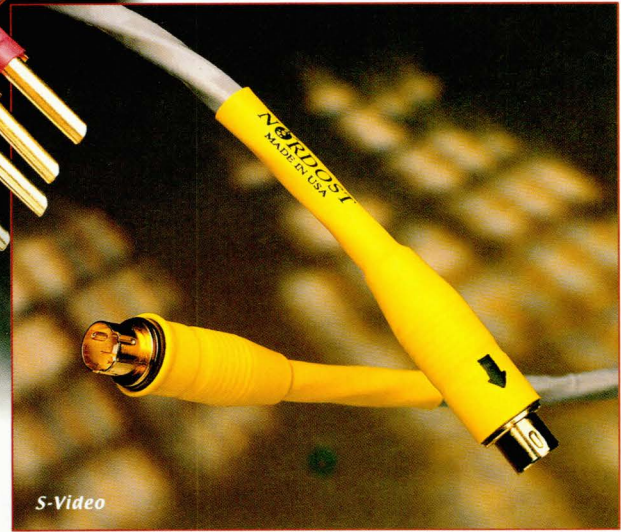

S-Video



Resonance Control

Digital

*..between technology & Home Entertainment.*

## **NORDOST (UK) LIMITED**

Unit 7, Aber Park Industrial Estate,  
Aber Road, Flint, Flintshire CH6 5EX, UK.

Tel: +44 (0) 1352 730251

Fax: +44 (0) 1352 731273

email: [enquiries@nordostuk.com](mailto:enquiries@nordostuk.com)

## **NORDOST CORPORATION**

420 Franklin Street, Framingham,  
MA 01702 USA.

Tel: 508 879 1242

Fax: 508 879 8197

email: [nordostflatline@msn.com](mailto:nordostflatline@msn.com)

Please visit our web site at:  
[www.nordost.com](http://www.nordost.com)

Interconnects

▶ recording was made. The ambient depth around voices and instruments was often strikingly portrayed. Although I'd tried (so far as possible) to make my system relatively independent of limitations in source quality, the differences were nevertheless sometimes quite huge.

Of course, no good hi-fi system can be truly unaffected by source quality - if it were, it would simply make every recording sound exactly the same. Which can't be right. My goal was and is a system that's not hyper-sensitive to flaws and limitations in its source material. I want a system that accentuates positives, while minimising any negatives.

To achieve this, I employ a coterie of transformers and valve line stages between CD player and amplifier. These devices help make the music sound fuller and more solidly focussed, and I'm addicted to what they do. However, were the DAC-64 to become a permanent part of my hi-fi rig, I'd definitely investigate the possibility of eliminating one or more of these in-line devices.

Given the limitations of standard CD, having these 'extras' in the signal path gives distinct benefits. However, having a superior quality source component changes things. The increased sense of focus and added solidity of the DAC-64 may mean that a simpler signal path might now be better. Alas, I didn't get to do any experiments along these lines.

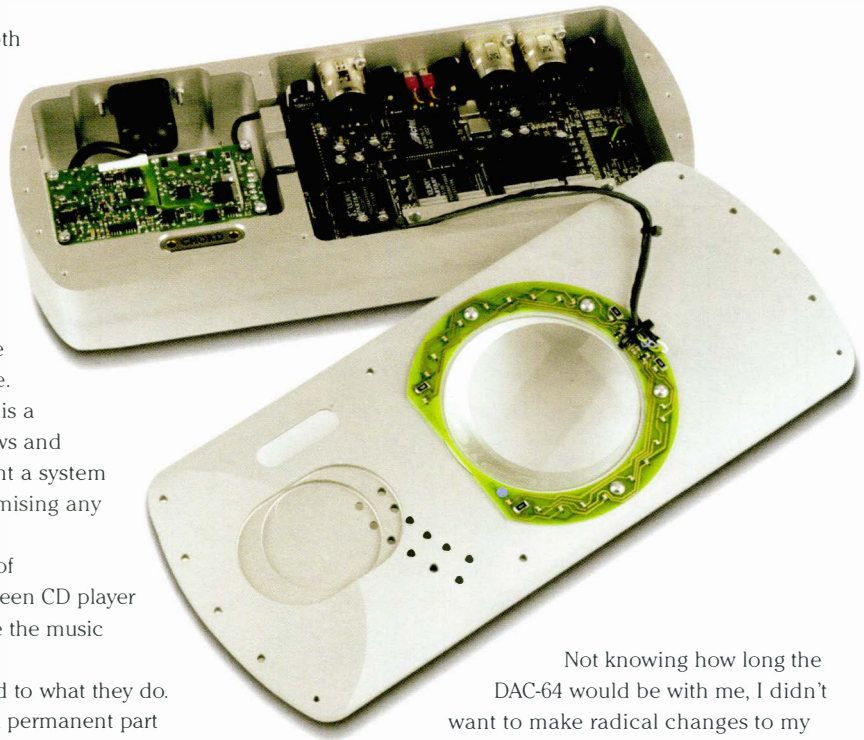

Not knowing how long the DAC-64 would be with me, I didn't want to make radical changes to my system. To be honest, my transformers and line stages have become a bit of a crutch; psychologically I find it difficult to part with them. Those of the Less is More school of hi-fi might disapprove, but believe me having these 'extras' works.

Of course, there's much to favour the purist approach. But how practical is it? Is it the path to audio nirvana? Many think you only have to maintain the absolute purity of the signal to achieve great sound. But what if the source is compromised? Some recordings are technically better than others - so what's needed is a hi-fi system that capitalises on the positives without emphasising the negatives.

Anyway, the DAC-64's gone. And life has to carry on. I can live without it - just! Over the past three or four weeks since it went, I've gradually re-acclimatised. But listening to music via a standard CD player is not as exciting, or as involving, or as enlightening. So far I've not been able to come up with a tweak that gets back what's been lost. But I'm working on it.. ➤





# Avalon FOR the LOVE of music

*Unique association of technical excellence and brilliant musical performance. Art, emotion and technology combined in products of exemplary quality and visual distinction.*



**AUDIOFREAKS**

*Distributors of fine Audio & Home Theatre Equipment*

15, Link Way, Ham, Richmond, Surrey TW10 7OT. Tel: 020 8948 4153  
Fax: 020 8948 4250 email: info@audiofreaks.co.uk www.audiofreaks.co.uk

# conrad johnson FOR the LOVE of music

*Valve and solid state technology applied in a manner others can only seek to achieve. The last of the big names to remain dedicated to pure valve circuits.*

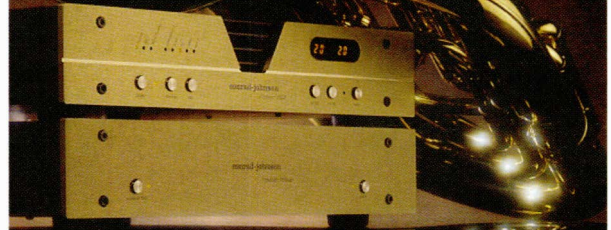

Premier 17 Line / 15 phono valve preamplifiers

**AUDIOFREAKS**

*Distributors of fine Audio & Home Theatre Equipment*

## THE NEW AFFORDABLE PHONO AMPLIFIER FROM TRICHORD RESEARCH

# DINO

Moving Coil  
Moving Magnet  
Switchable Gain  
Switchable Loading  
Super Regulators  
Discrete Output Stage  
Upgradeable Power Supply



Tel: +44 (0)1684 573524  
Fax: +44 (0)1684 577380

[WWW.TRICHORDRESEARCH.COM](http://WWW.TRICHORDRESEARCH.COM)

# Postcard from Venus

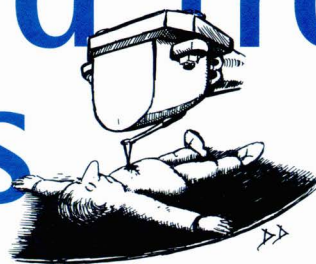

by L. S. Webster

In these morally whimsical days where people are measured by what label they wear, car they drive, type of organic tea they import etc, a recent and exhaustive survey of women aged between 25 and 60 has thrown up some rather surprising results. Keen pursuers of high fidelity will be delighted to learn they were voted the coolest of all hobbyists, winning by a considerable majority over and above all other categories listed. A large number of those women asked agreed they would willingly put up with snoring, duvet theft and socks on the bathroom floor in exchange for cables on the lounge floor. One glamorous diva reportedly said, “hi-fi eccentricity is definitely the latest cool”, and went on to say she was happy to have acoustic damping pads stapled to the walls in return for her aurally sophisticated bloke.

Just kidding, sorry, I couldn't resist – one day, maybe. In your dreams. In fact, what I did come across the other day was much more realistically depressing. According to the latest government figures announced in the annual round up of the state of the nation (UK2002), one in six men are likely to remain single all their lives. I suppose this may or may not be depressing depending on your point of view. It might even be cheery news for some, or perhaps just confirmation of what you already knew.

Single audiophiles will now be able to tinker away to their hearts content without a sniff of a thought for anyone else or having to put up with tiresome questions about hi-fi intricacies, safe in the knowledge there will never be a partner issue to add into the equation or any of the bothersome haranguing and cajoling usually required for that one last upgrade. You may as well just get on with it then fellas. I say fellas because the overwhelming evidence suggests that less than 1% of women buy the type of hi-fi in this tome, (for reasons that must be delved into one day).

However, less gloomily, help is at hand for those men who wish to maintain relationships whilst going through a hi-fi phase, via guidelines specially devised by the

audio-autocracy and interested parties, cunningly termed - The Wife Acceptance Factor (WAF). No – honestly. I agree it may sound dangerous to some at first and could easily have been dreamt up by some bozo of a Tim Nice But Dim but it is actually quite smart really, and solid proof that experience and longevity has indeed rewarded these people with wisdom and a sense of humour. Personally I have a suspicion they've read *Men Are from Mars*. The term WAF- perhaps it should be PAF (but then PC isn't PC anymore) recognises how persistently strange high-end audio is; or as those audiophiles amongst you may argue, how strange it is perceived to be, and it addresses the fact that most women only buy hi-fi by proxy. So it is a reference point that can be used to determine how far it is possible to go, or to be accurate, how much will be tolerated by their partner. But what most of you don't realise is that whilst our role might appear passive, we women have a far more highly developed relationship with things hi-fi than you ever imagine.

From a female perspective, you see, especially a newcomer, having a partner with an avid interest in hi-fi can often be a dumbfounding experience, provoking some screamingly funny scenarios not to mention jaw-dropping sights. It's really quite baffling, yet initially it seems like a natural enough concept; I mean who doesn't like listening to music, and who wouldn't like decent hi-fi? Exactly. And of course he keeps going on about 'musicians playing live in the room', which you are completely suckered in to. So this is how it all starts, and before the intimidating price tag has even been mentioned out goes that quaint mini-system and the crafty devil tries to sneak in an oilrig!

The transition is alarming and the apparatus is bewildering; it is big and moody with knobs on, and he likes that. It elbows its way onto the home front, heaving the furniture out of the way; everything is rearranged to accommodate it, and each piece arrives with a trail of essential paraphernalia and encyclopaedic sized manuals (or should that be scruffy ►

*Lumley*  
**LAMPROS**

*Designed for the purist,  
the music lover and the rest  
of the family*

Any colour  
and any wood finish



**Distributed by:** Metropolis Music, 6 London Road, Tunbridge Wells, Kent, TN1 1DQ  
Tel: 01892 539245 Fax: 01892 616383

Distributors for Boulder, Passlabs, B.A.T. Advantage, Hovland, Burmester, SAT, VTL, Sound Lab, Kharma, Meadowlark, Copulare, Acoustic Zen

**There are well-known amplifiers. There are highly-regarded amplifiers.  
Then there is Spectral – recognised throughout the world as the leader.**

**Spectral – the “Reference”**

The keys to the Spectral sound – fine detail, startling immediacy, dancing rhythms and amazing clarity – stem from their **ULTRA-FAST RESPONSE**.

Spectral amplifiers **RISE** and **SETTLE** in 10 millionths of a second after the **FAST TRANSIENTS** and **COMPLEX HARMONICS** of a violin or trumpet, or the 1,000,000 to one ratio of loudest to quietest signals. Imagine the complexity of a full orchestra.

We hear this astonishing nimbleness as natural **“PRESENCE”**, increased **DYNAMICS** and a wider palette of **TONE COLOURS**. We also hear more of the musicians’ technique – bowing, plucking, breathing – and so more of the emotion.

Spectral products evolve from the **LIVE**

**EVENT**. Designer Prof Keith Johnson is the driving force behind **REFERENCE RECORDINGS**, and also the inventor of HDCD recording.

You should hear the new Reference-level **DMC-30S** preamp and the Series 2 **DMA-150** power amp before you buy **any** other high-end amplification.

Visit [www.spectralaudio.com](http://www.spectralaudio.com) for more.

Customers say we make some of the **BEST SOUNDS** they have ever heard, so you know we can do the same in your home. Our advice will take account of your best components and guide you where change is needed, in stages you can afford. You **AVOID EXPENSIVE MISTAKES**, enjoy music along the way and save money in the long run.

**JUST LISTEN AND YOU’LL KNOW.**

**The  
Right  
Note**  
*Music in the home*



**BATH**  
01225 874728

**CD:** ACCUPHASE, ADVANTAGE, AUDIO SYNTHESIS, dCS (ELGAR, DELIUS, PURCELL AND VERDI), MERACUS, PASS, SUGDEN, VVADIA. **VINYL:** AUDIO SYNTHESIS, BASIS, CLEARAUDIO, DNM, (THE) GROOVE, GRAHAM, LEHMANN, MICHELL, STRATOSPHERE, SUMIKO BLUE POINT SPECIAL, TRANSFIGURATION. **AMPLIFIERS:** ACCUPHASE, ADVANTAGE, BALANCED AUDIO TECHNOLOGY, CAT, DNM, GAMUT, HOVLAND, NAGRA, PASS, SONNETEER, SPECTRAL, SUGDEN. **LOUDSPEAKERS:** AUDIO PHYSIC, BKS, ETHOS, LUMLEY, MAGNEPLANAR, NEAT, TOTEM, VERITY AUDIO. **TUNERS:** ACCUPHASE, MAGNUM DYNALAB. **CABLES:** ARGENTO, CHORD CO., DNM, HOVLAND, NORDOST, SILTECH, SPECTRAL, YAMAMURA CHURCHILL ETC

► A4 photocopies held together with staples?). The techno-speak jargon comes complimentary. For a while, imaginary lines have to be drawn along the floor as bits of it are shifted from left to right by infinitesimal amounts. It's called 'positioning'. The whole lot has to be rigorously scrutinised and tested and astonishingly, you are informed the cables have a pre designated 'direction'; a clear indicator that he must be watched with a careful eye from now on. But that's nothing; things are about to get seriously spooky, because once he's finished with the positioning he's got to get on with the fine-tuning. This involves placing hysterical small blobby things all over it, and then making meticulous adjustments with tiny action man sized tools. Don't start - I know it's true.

Certain parts of its main body will be unceremoniously tossed aside and he will shout things like, "Perfect! Just listen to the difference, this is absolutely the last thing I will change".

Sometimes there are more bits in the spare room than on the pile downstairs. He has now gone officially mad, though strangely he feels smug: doubtless something to do with the Y chromosome. Eventually it grows in grandiosity and size, and friends' stare at it placidly wondering what those 'light bulbs' are for. Meanwhile, enlightened counterparts pop round to admire the metamorphic mass and discuss shape; texture, detail and other equally fascinating qualities, all normally associated with a Tate exhibition piece. This pattern of wierdy behaviour will continue like an oscillating fan until finally,

every last nuance of 'performance' has been extracted, (which is when you can see little spiky things on top) and at last the home can become a harmonious, melodious sanctuary. But he's fooling no one; in fact you could safely bet your entire shoe collection that once he discovers a new addition the process will be repeated.

Maybe I should point out that the body language is a dead give away when he's on the lookout for a new toy. The female antennae pick up the signals straight away because he begins to adopt the attitude of a slightly dejected animal for a while. Sure enough, a mere yawn

of a gap later following a thinly disguised re-arrangement of stuff, yet another anonymous black box is spotted in and amongst the rest of the heap; and the obvious skip in his step confirms that your eyes do not deceive you. Sorry chaps, women were not granted an extra dollop of intuition for nothing, you know.

Women know all too well that blokes are predisposed to techy interests and if it wasn't hi-fi it could easily be something either much worse or inately boring, like plane spotting (although even that has its plus side, like free holidays courtesy of the Greek government). And if it can become a great pleasure in life to assuage curiosity by means of hi-fi, which it can it seems, this leads necessarily to the age old cliché, that for some at least the struggle is

greater than the end result. An even more convincing argument when you consider it provides the perfectly seductive opportunity of exploring music at the same time, so why not? Personally I really can't see what the problem is. After all, not only do we get to enjoy the fruits of his labour without actually getting involved in any of the annoying, tedious stuff ourselves - and frankly most women are too busy getting on with the important things in life to bother meddling like this anyway; but there are other tangible benefits too, not least of which is that it all occurs for the most part, within well defined boundaries. And then of course the double chocolate chip fudge topping on the cake is that it ensures the mutually satisfying pleasure of listening to music together, which is the whole point, and

I suspect it is the reason why so many women are prepared to tolerate the domestic upheaval (though I grant you it may not always appear so).

Just before anyone gets too carried away though, it's worth knowing that while he's rubbing his chin and sucking his teeth over the minutiae she'll probably be holding her sides and wiping her eyes with mirth. Horrid and cruel I know, but so much more fun this way - and don't forget she's the one coercing him back to sanity when he's clearly become certifiable. But as I say, in the end I'm all for it, just as long as I can have shared possession of the remote control too.

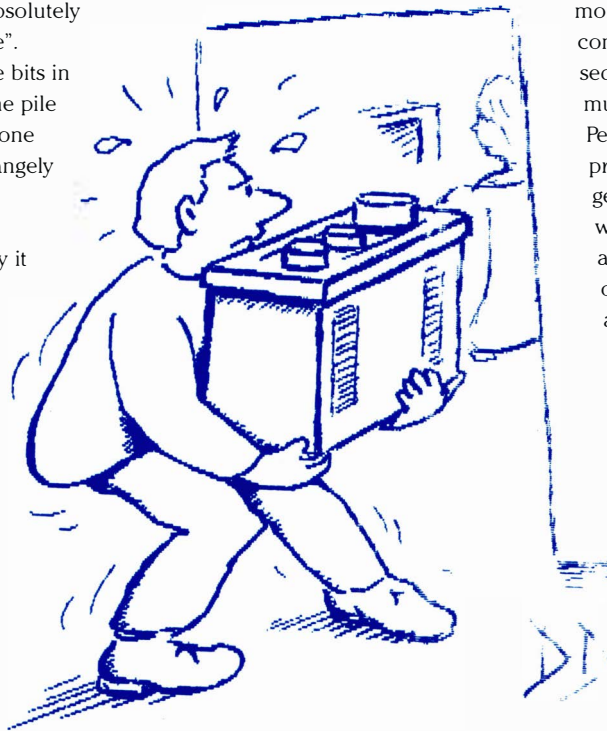

# Doug Brady Hi-Fi



Chord DAC 64

We have the full ranges of B&W Nautilus, CDM-NT, CM, 600 & 300 ProAc, Castle, Tannoy, Ruark, Monitor Audio, Naim Audio, Musical Fidelity, Audio Synthesis, Michell Engineering, AVID, Exposure, Nordost Cables, Demonstrations by appointment plus home trails. 0% Credit available.

Kingsway Studios, Kingsway North, Warrington. WA1 3NU.

Tel: 01925 828 009 Fax: 01925 825 773

Email: [doug.brady@dougbradyhifi.com](mailto:doug.brady@dougbradyhifi.com) Website: [dougbradyhifi.com](http://dougbradyhifi.com)

## Silence Mains Noise with The Silencer

hi-fi+  
PRODUCT  
of the  
YEAR

"When we listen to our systems we are actually hearing the mains, yet the vast majority of us take the quality of our electricity supply very much for granted. Big mistake. Huge! A well-sorted mains supply is the biggest and most cost effective upgrade you can make to any system. The Russ Andrews products offer all the hardware you need, unique and effective solutions as well as a clear and logical approach. Essential to realising the full potential of the system you already own."

hi-fi+, Issue 10 - Mar/Apr 2001

The Silencer ★★★★★

"Inexpensive, easy to use, very effective...enhances depth and clarity, giving a deeper, broader soundstage with increased dynamic range."  
*Jimmy Hughes, Hi-Fi Choice, October 2000.*

HI FI CHOICE  
BEST BUY  
Oct '00

The Silencer  
£39.95

This incredibly effective and simple to use mains filter has been flying out of the door ever since we introduced it a year ago. And no wonder! Small, but 'perfectly formed', The Silencer eradicates mains noise and harmonics at the source, it also protects your equipment from high voltage mains spikes and lightning strikes.

Just plug in next to any noisy appliance and listen to the difference. What could be simpler?

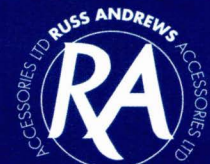

• 15<sup>TH</sup> ANNIVERSARY •

"For the best cables, CDs and accessories"

Mail Order Direct  
on UK Freephone  
**0800 373 467**

quoting ref: AP12  
and request a catalogue

Full Refund Cable Upgrades

Lifetime Guarantee

30 Day Home Trial

Expert Advice

Russ Andrews Accessories Ltd.,  
FREEPOST NWW881A,  
KENDAL, LA8 9ZA.

Tel: +44 (0)1539 825500

Fax: +44 (0)1539 825540

E-mail: [AP12@russandrews.com](mailto:AP12@russandrews.com)

[www.russandrews.com](http://www.russandrews.com)

# COUNTDOWN TO



**22 - 24 February 2002**

10am - 5pm every day  
at the Marriott Hotel,  
Lower Castle St., Bristol

#### GETTING TO THE SHOW

By train: Temple Meads Station is a short distance from the Marriott and is accessible by bus, foot or taxi.

By car: from the M4 take J19 (M32 - Bristol). Follow signs for City Centre and RAC signs to the Show.

**SOUND & VISION**  
THE BRISTOL SHOW



Easy local parking in Broadmead and Bond Street NCPs.

ORGANISED BY

**audio** X  
EXCELLENCE

**audio** T

*Great Value Sound & Vision*

in association with

**WHAT HI-FI?**  
SOUND AND VISION

# SOUND & VISION

## THE BRISTOL SHOW

**SEE & HEAR ALL THE LATEST PRODUCTS UNDER ONE ROOF, INCLUDING...**

- ACOUSTIC ENERGY:** The AEGO P5 home cinema system and AEGIS EVO Series
- ARCA FURNITURE:** A stunning new furniture range
- ARCAM:** FMJ+ THX home cinema components make their UK debut along with the DiVA CD62 entry level CD player
- AUDIONET:** The UK launch of the this leading German electronics brand
- B&W:** The new VM1 range and the outstanding Nautilus™ 800 Signature
- CELESTION:** The revolutionary new AVF302 loudspeaker
- CYRUS:** Amazing new Icon X4 loudspeaker along and the latest DVD 7 & CD70 high-end CD / DVD players
- SPENDOR:** New 'S' Series loudspeakers
- WILSON BENESCH:** The new Odyssey Series including the Chimera loudspeaker
- WHAT HI-FI? SOUND & VISION:** There in person to answer all your questions

**GREAT DEALS AND SPECIAL OFFERS AVAILABLE ONLY AT THE SHOW - PLUS YOUR CHANCE TO WIN SOME SUPERB PRIZES IN THE SHOW COMPETITION**

#### Admission

Adults £6.00; Students/OAPs/UB40s £3.00;  
Accompanied children under 16 free

#### BRANDS ON SHOW INCLUDE:

A.R.T. Audio, Acoustic Energy, AR Phantom, Arca Furniture, Arcam, Atacama, Audionet, Audioplan, Audioprism, AVID, B&W, Bandridge, Beyer Dynamic, Boston, Bow Technologies, Bryston, Bullet Plugs, Cable Talk, Case Logic, Celestion, Chapter Audio, Cherished Records, Chord Electronics, Clearlight Audio, Connect Link, Creek, Cura, Cyrus, Denon, Diverse Vinyl, DNM reson, Echo Busters, Eton Subwoofers, Dynaudio, Eclipse, Ecosse, Elac, Epos, Emotive Excellence, Exposure, Fujitsu, Harman Kardon, Hi-Fi +, Hi-Fi Choice, Hi-Fi World, HNE Systems, Home Entertainment, Imerge, Ixos, Ixotica, Jamo, JM Lab, KEF, Klegg Audio, Living Control, Living Voice, Loewe, Marantz, Mark Levinson, Meridian, Michell Engineering, Miller & Kreisel, Ministry of Sound, Mission, Moon Electronics, Monster Cable, Musical Technology, Musicworks, Myrrad, NAD, Naim Audio, Nordost, Optimum International 2000, Ortofon, Parasound, Partington, Pioneer, PMC, Primare, Pro-ject, ProAc, Prowire, PSB, Puresonic, Quad, Quadraspire, Redstripe, Rega, Reference Audio, REL, Relaxa, Resolution Audio, Revel, Roksan, RPG, Ruark, Russound, S.A.P., Sennhesier, Sequence, Sim Audio, Sonic Link, Sonus Systems, Sony, Sound Organisation, Soundstyle, Spendor, Standedesign, Stands Unique, Stax, Steinhart Audio, Straightwire, T3, TAG McLaren Audio, Talk Electronics, Tannoy, Target, Teac, The Chord Company, The Direct Disc, Totem Acoustics, True Colours Industries, Tube Technology, van den Hul, Veda Products, Venus Futuretech, Veritas, Videologic, Vibe Technology, Vienna Acoustics, Vivanco, Vivante Music, Voodoo Isolation, VPI Record cleaning machines, Wharfedale, What Hi-Fi? Sound & Vision, Wilson Benesch, XTC, Yamaha and many, many more...

For the very latest information on new product launches check

[www.bristolshow.co.uk](http://www.bristolshow.co.uk)

# Manchester Hi-Fi Show 2001

by David Ayers



November 18th / 19th, it must be the hi-fi+ sponsored show at the Manchester Airport Hilton. This is the first time we have sponsored such an event, and also the first time I have attended the Manchester show. With a complicated demonstration in the hi-fi+ room, about which more later, and a stand to organise, a show report to write, and the magazine's name at stake, it was with a mixture of anticipation and trepidation that I checked into the hotel on Friday night. A quick stroll round the exhibition showed the normal amount of (controlled) pandemonium that is the precursor to any show. So far so good.

10a.m. Saturday, stoked up with a good helping of the hotel's English breakfast buffet, it's time to take on the slaving hoards about to descend on the poor unsuspecting exhibitors. With magazines at the ready, our brand new binders on show, and tickets for the hi-fi+ demonstration to hand we stood our ground. In the end the show started not

so much with a flood, as with a stream. Whilst this may be an indication of the newness of the event itself, the fact that the custom was spread evenly throughout both days had the useful effect of allowing fairly easy access to the whole exhibition, apart from the odd bottleneck.

Quadraspire were demonstrating their new Q4 Reference Table using a Naim CD player moved between supports. In an effort to be diplomatic, the other support remained nameless, but was in fact a well known and very popular 1980's welded steel affair. While this clearly showed the advances that have been made in rack technology, and the improvements that can be had by trading in your old supports, it said little about the Q4's place in the current scheme of things. At £670 for the 4 shelf version, it is not expensive for such a sophisticated design. Clearly Quadraspire are very excited about this product, and hopefully we will have a review soon. (tel +44 (0) 1225 333360, sales@quadraspire.com,

[www.quadraspire.com](http://www.quadraspire.com))

Avid, makers of the Acutus turntable that Jimmy reviewed in issue 6, were demonstrating in conjunction with Chapter Audio. The system on show comprised the Acutus turntable, the LFD Phono Stage, the £4995 Chapter Two power amp, and a pair of Tannoy TD8 'speakers. This is only the second time I've seen the Acutus in the flesh and it really is a beautiful piece of work. Also, on static display was Avid's new(ish) baby, the Volvere. It uses many of the Acutus' design principles while keeping an eye on costs. Pitched at around £2,000, it is up against some very strong competition. (Avid: tel +44 (0) 1832 710370, info@avidhifi.co.uk, www.avidhifi.co.uk).

Rega mounted a stealth demonstration, where visitors were invited to mosey round the room looking at the products whilst being gently serenaded by the new £750 Ela 'speakers. On show was the funky ▶



► new silver livery for the electronics range, and very nice it was too. (tel +44 (0) 1702 333071)

As is often the case, Doug Brady and Wilson-Benesch were working together. This time they had W-B's new baby, the £2,400 ARC 'speakers. Unfortunately I didn't get time to hear them, but they are basically a smaller brother to the excellent Discovery speaker. Also on static display was the new Chimera speaker, another big beastie along the lines of the Bishops. I couldn't help being struck by the immaculate finish; if the sound matches the looks they will be very special indeed. (tel: +44 (0) 114 2852656, info@wilson-benesch.com, www.wilson-benesch.com)

I have no idea how Audio Synergy managed to lever the gigantic £16,000 ART Impression 'speakers into their room, but coupled to the Sugden Masterclass CD player and integrated amplifier with Townsend Isolda cryogenically frozen cables they managed to shatter the standard show rules about big speakers sounding bad in small hotel bedrooms. With oodles of serious bottom end, the old rocker in me was suitably impressed. (Audio Synergy: tel +44 (0) 1924 406016, info@audiosynergy.co.uk ART: +44 (0) 1292 319416, info@loudspeaker-art.com www.loudspeaker-art.com)

Dropping in on Southampton residents I.E.S., makers of the ►

## The Hi-Fi+ Multi-Source Demonstration

by Roy Gregory

As sponsors of Hi-Fi 2001 in Manchester, I felt strongly that we should be providing exactly the sort of demonstration that I've been complaining so volubly has become an endangered species at UK hi-fi shows. Having made the decision to do so, it only remained to decide what exactly we should demonstrate. Having just run a series of articles whose gist seemed to be how difficult it was to reach any comparative conclusions regarding SACD and DVD-A, what better place to start?

Of course, things evolved somewhat from that point, and what we ended up with was altogether more complex. Having pointed out that it's almost impossible to draw any meaningful conclusion by direct comparison between SACD and DVD-A, I was keen to organise a comparison relative to known references, and to do so through a politically neutral and recognisably high-end hi-fi system. With that in mind we put together (with considerable help) a four-source stereo system as follows.

Turntable:	Clearlight Audio Recovery / Incognito RB300 / Lyra Helikon / Tom Evans Groove Phono Stage
CD Player:	Tom Evans Eikos
SACD Player:	Marantz SA-1
DVD-A Player:	Onkyo
Pre-amp:	Canary Audio CA-803 Four Box
Power-amps:	Canary Audio CA-309 Monoblocks
Speakers:	Living Voice Avatar OBX
Cables:	Nordost Valhalla
Mains Cables:	Russ Andrews
Racks:	Clearlight RDC

Source wise, the intention was to get the best SACD and DVD-A players available, along with suitably impressive record and CD players. I think we succeeded admirably, and the rest of the system was equally up to the mark, especially in terms of sheer cost: no less than eight Western Electric 300Bs make a statement for audio extravagance against which even the

Nordost Valhalla pales.

We started by playing a different piece of chamber music on each source just to get everybody acclimatised (you can't of course get anything that's available in all four formats). Then we compared the record and CD players to the SACD player using *Kind of Blue*. Next we repeated the experience, but this time comparing the existing standards to the Onkyo DVD-A machine using *Buena Vista Social Club*. The conclusions were interesting



to say the least. In the first case (using the analogue original) the general consensus favoured the record player using the Classic Records speed corrected 180g pressing, over the Sony Master Sound gold CD or SACD. However, once we moved onto the *Buena Vista Social Club*, derived from a 24bit/96kHz master, and despite using a 45rpm single sided pressing, the turntable's superiority had been significantly eroded. It seems the source and pedigree of the master tape is all-important. Hmm...

But of course, where the new high definition digital formats are concerned, that's only half the story: What about multi-channel? So the second half of the demonstration concentrated on a rather more realistic set-up, certainly more akin to the kind of thing that the formats' promoters would like to see you using. This was built around Pioneer's sub-£1000 multi-standard DV-747A play-anything player, feeding the discrete 5.1 inputs of a Classe Audio SSP75 Pre-amp and a quintet of Crimson 540 monoblocks. Just for good measure we added another three OBX speakers, and wired the whole lot with something approaching 120m of Chord Co. Odyssey speaker cable and no fewer



than six pairs of Chorus interconnects. We also added an £1100 Marantz CD17 Mk.11 by way of a reference.

We started by playing the *Bueno Vista* CD on the Marantz CD17, followed by the DVD-A on the Pioneer, first in stereo, then in discrete multi-channel. This we followed up with a range of DVD-A and SACD releases, again in both stereo and multi-channel. But the piece de resistance had to be the new Telarc *1812*, one of only two recordings in the world currently available in both DVD-A and SACD formats. Drawn from the same DSD master tape and played on the same player and system, here at last should have been the definitive comparison, only it didn't quite work out like that. In a classic case of things not being quite what they seem, these two apparently identical discs sounded totally different to each other. They might even have been different performances, so vast were the

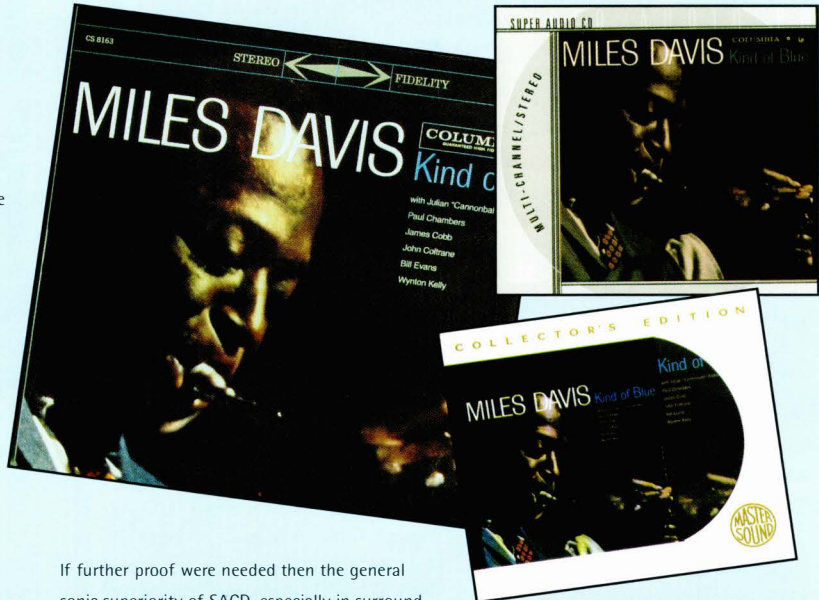

If further proof were needed then the general sonic superiority of SACD, especially in surround mode, shows the benefits of the studios' greater experience with the format.

The good news is that we have four viable formats, each of which, done properly, is capable of delivering excellent musical results. A great record on a decent turntable will still beat an indifferent SACD, and vice versa. Add in multi-standard players like the Pioneer (which stood up surprisingly comfortably to the challenge from the CD only Marantz CD17 Mk.11) and we

don't need to worry about buying software we won't be able to play. The future might be confused but for once we can simply sit back and let the industry sort itself out, and if a title is available in more than one format just buy whichever we prefer.

Finally, it remains to thank those people and companies without whom we couldn't have organised this demonstration. Special thanks go to John Bamford of Pioneer and Harry Oikawa of Marantz, who gave so freely of their time to help run things and answer peoples' questions. Thanks also to Definitive Audio, Tom Evans, Russ Andrews, B&W (Classe), Onkyo, Nordost,

The Chord Co, Vivante and Hififorsale.com for their generosity with loan equipment. I hope those who visited found it interesting. We certainly did. In fact as JB remarked: "You do realise that this is probably the only time that anyone has ever done this

comparison – ever!" Having lived through the set-up (just!) I can understand why.

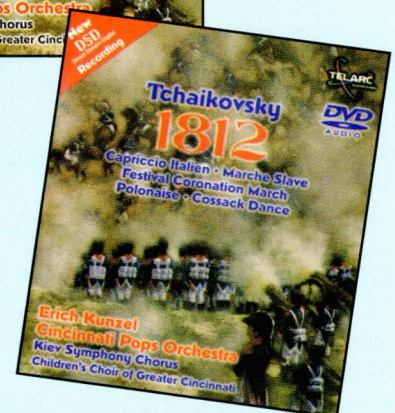
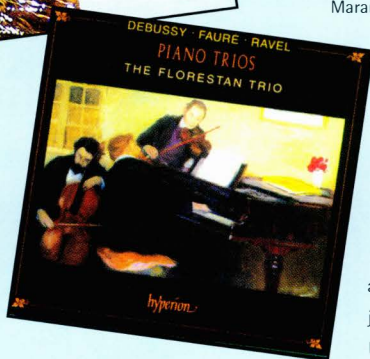

differences in tonal balance, EQ, soundstage perspective and surround mix. Which just serves to underline the general conclusion; if the quality of recordings rests in the hands of the studio engineers, then giving them more channels to play with makes their role even more critical to the final outcome.

► Renaissance Amps, I listened to their monoblocks fed by a Marantz CD17, a Passion Ultimate passive pre-amp, driving a pair of Wilson-Benesch ACT1 'speakers. If you still harbour any lingering views on valve amps being warm and woolly, then have a listen to this system. "Lively" was the word that I wrote in my notes. (Integrated Engineering Solutions Ltd: +44 (0) 23 8090 5020, sean@highendaudio.co.uk www.highendaudio.co.uk )

I.E.S are also the UK distributor for Lamm, and they were being showcased next door. With a Meridian 506 transport feeding the Chord Electronics DAC64 that Jimmy loved in the last issue. The Lamm part was made up of the new XLP2 phono stage, the L2 Reference two-box dual mono, pure class A pre-amp with valve regulated power supply, and the ML2 monoblock power amps. Together with Discovery 'speakers from Wilson-Benesch, and their Full Circle turntable, plus cables from Philosophy, the sound was panoramic and pain free.

Down at the end of one of the corridors, Audio Note were demonstrating a complete system, comprising the TT2 turntable, the Audio Note cartridge, the Meishu 300B integrated amp, the CDT2 transport with the new \$4,000 balanced DAC3, topped off with the AN-J 'speakers. Audio Note continue to plough their own furrow in the hi-fi field, but I have to say that I warmed to the system over the period of time I was in the room. (tel: +44 (0) 1273 220511, www.audionote.co.uk )

New company Reference Audio were showing a range of speakers. The £1,890 Axis FS was on demonstration when I was there. Fed by a SAT CD player and Musical Fidelity amplification, the sound was meaty, beaty, big, and bouncy. I really enjoyed my brief encounter with these speakers, they really rock. (The Loudspeaker Manufacturing Company Ltd. Tel: +44 (0) 1474 854208, sales@referenceaudio.co.uk www.referenceaudio.co.uk )

Metropolis, who are now the Import and Distribution wing of Sounds of Music, had a very attractive system on demonstration. With an Advantage CD player, the Hovland HP100 pre-amp (issue 8's cover item), the Hovland Sapphire power amp, and the Lumley Lampros 200 'speakers. All this powered from a Burmester power conditioner. After playing my King Crimson CD through this system, I wasn't sure if I'd used the wrong remix of the chosen track, such was the amount of extra information the system gleaned from the little silver frisbee. Great looks, great sound, but then the complete system, without stands or cabling, costs £22,290. Manchester bank managers should expect a stream of audiophiles, cap in hand over the next few months. (Metropolis: +44 (0) 1892 539245, Hovland: tel: +1 209 966 4377, www.hovlandcompany.com )

Zouch Audio were showing another Metropolis system, this time using the Burmester 001 belt driven CD Player, 935 Mk2 Pre-amp, 956 Mk2 Power-amp, and Kharma Ceramique CE3 speakers. An interesting contrast to the previous Metropolis offering, this system was less about resolution, and more about life and energy. My toes were tapping. (Zouch Audio Ltd Tel:+44 (0) 1530 414128)

I bet Living Voice's Kevin Scott was knackered after the show, after bringing not only the Definitive Audio system, but also 5 Avatar OBXs for the hi-fi+ room, and assorted amps etc. Thanks Kevin, and another thankyou for introducing me to Tosca's *Chocolate Elvis* CD whilst I was visiting the room. The Definitive system comprised a Helios Model 1 CD player, the Canary Audio CA-608 LV with Border Patrol MB PSU integrated amp (reviewed on page 66), Living Voice interconnects and power cables, Electrofluidics Monolith 20/20 speaker cables, and the Avatar OBX speakers. Having heard the system



I could easily hear why Roy enjoyed the OBXs so much in Issue 14. With speed, impact, and a great deal of clarity the system was really singing. (Definitive Audio Tel:+44 (0) 115 973 3222, shout@definitiveaudio.co.uk www.definitiveaudio.co.uk )

It must have been a good time for me to visit this end of the corridor, because next door Redline introduced me to another new CD, this time by The Gotan Project. Played through a mainly Moon system driving a pair of Living Voice Avatar 'speakers, it was immediately put on my must buy list. It's a fair bet that a system that makes you want to buy unfamiliar CDs is producing music via hi-fi, and not vice versa. I was very struck by the styling of the Moon electronics, very reminiscent of the current Mark Levinson range. Nice. (Redline Scotland Ltd: tel: +44 (0) 131



226 1981 redline.info@virgin.net www.red-line.co.uk )

The prize for the 'most different' demonstration must go to Dynavector for their 'SuperStereo' room. 'SuperStereo' is designed to enhance the performance of any system by restoring hall acoustics and ambience. The system comprises ►

▶ a processor and the addition of two small speakers that are placed near to the listener, but facing the main pair of speakers. Switching the processor in and out really brought the sound out into the room. The idea is that any system, budget or otherwise, can be so improved. We have a processor for review, and we'll let you know in due course. (Tel: +44 (0) 1202 767873, [dynavector@onetel.net.uk](mailto:dynavector@onetel.net.uk) <http://web.onetel.net.uk/~dynavector> )

Audio Counsel are now producing their own mains blocks, in 4-gang and 6-gang versions. Their demonstration using Naim electronics with Royd RR2 'speakers was pretty convincing, but then that was to be expected given that hi-fi+ has been banging on about the need for good mains since its inception. (Tel: +44 (0) 161 428 7887, +44 (0) 161 633 2602)

Talking of mains solutions, [hififorsale.com](http://hififorsale.com) were showing a very interesting new product from IsoTek. The IsoTek SubStation is a component sized mains conditioner and distribution unit. Each of the output sockets can be separately conditioned, thereby effectively separating your components from mains interactivity. Filter and isolation modules are available, the latter in varying power ratings. This would appear to be a product that sits between the simpler mains blocks and the full blown mains regenerators, such as the Accuphase. Keenly priced, this would seem to be potentially a product to watch out for. (Tel: +44 (0) 870 2412469, [theteam@hififorsale.com](mailto:theteam@hififorsale.com) [www.audiophilecandy.com](http://www.audiophilecandy.com) )

JM Labs were unveiling something a bit different, for them, the new Electra range of 'speakers. Why different? Because the voicing of these speakers is substantially changed from their other ranges. They will appeal to those of you who maybe admired the JM Lab sound, but found it a bit lacking in grunt – so that would be me then. I enjoyed my short stay in their room listening to the competitively priced Electra 926 (£2,099)

on the end of some more Moon electronics. I think this is a pretty shrewd move on their behalf, opening up their market to a brand new set of listeners. (Focal-Jmlab UK Ltd Tel:+44 (0) 121 616 5126 [info@focal-jmlab.co.uk](mailto:info@focal-jmlab.co.uk) [www.focal-jmlab.fr](http://www.focal-jmlab.fr) )

For those of you whose listening

hear it, as they also distribute the Lavardin range of amplifiers. Combined, the two compliment each other producing a very clean and high resolution sound, which on first listen didn't seem to have that 'picked apart' quality that other high res systems sometimes suffer. (Audiocraft +44 (0) 1895 2253340 [Kevinwalker@genie.co.uk](mailto:Kevinwalker@genie.co.uk) )



experience needs to be coupled with good looks (say no more), then Reference Music Systems were demonstrating one of those 'how did they get so much sound out of something so small' systems. Comprising their new T65 range of electronics and the Revelation Series One 'speakers with external crossovers, the sound stage was incredibly large. RMS reckon the Revelations go flat right down 32hz, but sadly that ain't going to happen in a small hotel bedroom. On the day the results spoke for themselves; at a cost of around nine grand, excluding source but including a great deal of chic, this could be a bargain. (Tel: +44 (0) 1246 200096 [avondaleaudio@mail.com](mailto:avondaleaudio@mail.com) )

Earlier this year I visited the Frankfurt high end show, and was very struck by the resolution of Finland's Amphion 'speakers. At the time they had no distributor in the UK, but now they have been picked up by Audiocraft, who obviously know a good thing when they

Out in the corridors, the music sellers were in abundance. It was good to see Cherished Records, Diverse Vinyl, Vynoodle, and Vivante making their way 'oop north', and between them they could provide music for every taste.

So, was the show a success? No show is devoid of quibbles but this one had fewer than most, and the enthusiastic visitors made a nice change from the recurring depression of Hammersmith. Talking to the exhibitors, the organiser, and members of the public, it was clearly an enjoyable experience. I certainly found a higher than normal percentage of rooms making real music, and not horrible hi-fi, and that has to be a recommendation. Maybe the structure of the hotel is better than average, I don't know, but whatever the reason I came away feeling that I heard several systems to which I would happily give house room, which is certainly unusual. Roll on next year. ▶

# A retailer's view

## from Derek Whittington of New Audio Frontiers

Weather wise it was a perfect weekend for a hi-fi show. Cold, damp and with a grey overcast sky, perhaps the only acceptable alternative would have been to stay in bed (and believe me after the travesty that was the Hammersmith show I was tempted to give Manchester a miss). There was however good reason to brave the M6 northbound car park, not the least of which was editor Roy's SACD / DVD-A demonstration. In my capacity as a hi-fi retailer I like to keep my eye on the ball and there were some very interesting products and people at the show. To be truthful it was good to know that the show was at Hilton Manchester, which is on the approach to the airport, as there were absolutely no road signs to guide you to the venue.

Once through the reception check in procedure it was the usual scene with hi-fi accessories, LP's and CD's to purchase.



In pole position but with a room the size of large shoebox was that old soldier, importer and distributor John Jeffries of Metropolis. His system comprised the new Lumley Lampros speakers, driven by a pair of the extraordinary Metropolis 100 watt single

valve, single ended, class 'A' monoblocks. Each measuring in at about the size of a two drawer filing cabinet these monster power amps are not the most domestically friendly beasts but what a sight! Sourced by a Burmester 979 CD transport into a Boulder 1012 pre-amp (with inbuilt DAC) this is one serious system and the music it made did not belie its awesome physical presence (or the modest Lottery win needed to buy it).

The very amiable Anna Tooth of The Naim Label (accompanied by her vivid pink hair colour) was a site for sore eyes at a male dominated event in what is still regrettably a male dominated interest. As usual Naim Audio's eye-catching display of Compact Discs attracted much interest and judging by the activity around the stand, sales were not insignificant. Down the corridor in the Dulles suite the long awaited Naim AV2 processor and new Allae loudspeakers were being demonstrated. Naim retailers who specialise in AV will no doubt be very happy with the AV2. Unlike its predecessor the new model is bang up to the minute and includes decoding for Dolby Pro-Logic 2, Dolby Digital and DTS (with facilities for DTS-ES 6.1). Also on board is a 7.1 input for use with DVD audio or SACD multi channel. This may well give the likes of Lexicon, Madrigal and even our very own Meridian some serious competition. Certainly Naim system users will be very happy to have a truly worthy Naim add on to expand into Home Cinema with. The AV2 can function both as processor and or pre-amp and was feeding the new Nap 175

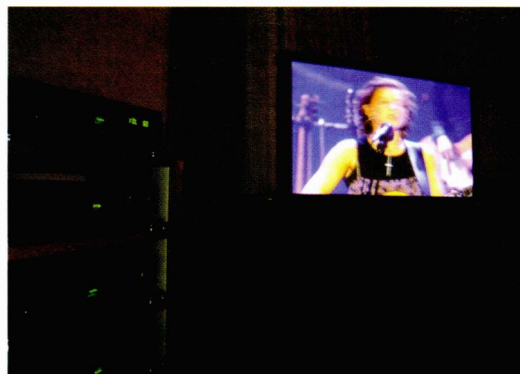

power-amp (rear and centre). The front left and right speakers ran from a Nap 150 power amp. The clear, crisp and colourful picture came from an NEC Plasma monitor and it has to be said that the sound was exciting, compelling and very easy on the ears (quite unlike the eye wateringly aggressive noise so many AV systems seem to make).



Christmas was very much in evidence in the Rega Research room, where a cotton wool snowy landscape scene created the backdrop for Rega's display. A pair of light oak Ela's and a stand full of electronics in Rega's new silver livery looked very seasonal. ▶

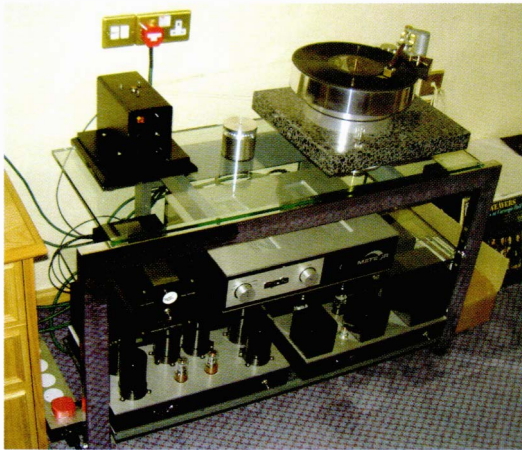

▶ The people from G.T. Audio distinguished themselves by making a very pleasing sound from both vinyl and CD. It was the Ocellia Tilia loudspeakers that initially attracted my attention. Each using a single high (98dB) efficiency 8inch, time aligned, coaxial full range driver these speakers sounded very natural and musical. The vinyl source in this system was a Verdier Platine turntable, Schroeder model 1 tonearm and Allearts MC1B cartridge. Valve amplification was by Tron.

Newish boy on the block Stuart



Smith of Audio Atmosphere was making nice noises with an Audio Synthesis CD transport, played through Dax and Desire pre and power amps and Audiovector speakers. Power Snakes,

Power Cords, Pierre Gabriel inter-connects, Argento speaker cables and a Gutwire mains distributor joined the big bits together. Stuart who operates from Penkridge in Staffordshire is a distributor for all these products. The cables are already awaiting review at Plus Towers, so expect an in depth assessment soon. For the LP record enthusiast this show had

there is life in the old black discs yet. Vivante dominated the event with an impressive stand and a wonderful choice of new vinyl (and CD). Cherished Records, Direct Disc and classical music specialists Vynoodle offered a mouth watering selection of pre-owned LP's, to the detriment of the contents of my wallet. Having all but depleted my bank balance I paid one more visit to the Vivante stand, only to succumb to a stunning Ella Fitzgerald boxed set of the *George and Ira Gershwin song books*. Oh well, better to have music and no money than money and no music. Manchester and its surrounding area's have long been able to support a large number of specialist dealers so perhaps not surprisingly several retailers were represented.

My old mate Dave Fitten of Audio Counsel (Oldham) and his crew were manning the controls of the new Densen Beat XS CD player. Playing through Densen's 200 pre and 300 XS power-amp and a pair of Royd's well reviewed RR2's this was one of the nicest sounds being made at this show and under the usual far from ideal listening conditions. Dave's system was refreshingly devoid of hi-fi gizmology. Mains power came through an Audio Counsel distribution block (absolutely no VDR's, no filters just hard wired Crabtree unswitched 13 amp sockets, correctly earthed and in a sturdy white pressed steel box). Speaker cable was Kimber 8PR terminated with screw

fitting Pomona 4mm plugs. Inter-connects were Rega Couple twin phono to phono. Using Klotz microphone cable and Neutrik Profi Plutz, at £69.00 a pair Rega have an as yet undiscovered gem of an interconnect here which must be heard. The elegant Isoblue modular equipment stand system was the choice for this venue, its simplicity of design and beautiful all wood construction making it a popular conversation piece. This very affordable Audio Counsel system showed clearly that high performance hi-fi does not have to be freaky and tweaky or look like an electronics lab experiment gone wrong.

Long time dealer Doug Brady (Liverpool) was giving the new Chord SPM 6000 mono power amplifiers one of their first public airings. Massively engineered and in the style we have come to expect from Chord, the SPM 6000 joins an already very comprehensive range. In complete contrast to the Audio Counsel set-up Doug's system commands jaw dropped attention. This is domestic hi-fi that makes no attempt to be discrete. No amount of careful disguise with pot plants, Indian rugs and ethnic earthen wear will hide this gear so why bother. And besides, when you spend this kind of money surely it is your god given right to show it off to your pals isn't it? The system comprised an Audio Synthesis Transcend CD transport through a Chord DAC 64 and a Chord pre-amp with Wilson Benesch's stunning looking Chimera, 'Discovery' and ARC loudspeakers. When I was in the room the ARC loudspeakers were in use and the resulting sound was delightful. Doug's selection of Compact Discs was I am happy to report, devoid of any 'audiophile' demo recordings so real music was the order of the day. What a relief!

Larry Ogden and Audio Works (Cheadle) were in evidence, along with their Music Works mains distribution units and mains cables, attracting a good crowd as expected. The

► great debate on the importance of mains distribution and the value of filters and conditioners rumbles on. Music Works products are currently riding on a wave of popularity no doubt fuelled by Larry's persuasive words and foot tapping demonstrations as well as the good press they have received.

When it comes to the love of music there are few who show more enthusiasm and excitement on discovering a new tune than Kevin from Definitive Audio. This is a man who recently took 300 compact discs on a cycling holiday! Needless to say many of the definitive sounds at Manchester could be heard in room 164 (forgive the pun). Anyone who uses Kruder and Dorfmeister to demo hi-fi gets my vote. The system? Yet another pair of Living Voice Avatar OBXs (two and a half pairs are used in the hi-fi + SACD / DVD-A comparison!) this time on the end of a 25 Watt class A turbocharged Canary 608. Helios CD player, Border Patrol MB power supply and Monolith cables all made for a very musical and enjoyable experience



And so, finally, a look into the future. I am of course referring to the Hi-fi + SACD / DVD-A demonstration. During the course of the show a series of 'closed door' demo's took place in the JFK Suite. Organised by editor Roy and enabled by Pioneer man John Bamford with Harry Oikawa from Marantz, this was destined to be a very interesting comparison. Notwithstanding the great difficulties of

obtaining identical software in all formats and trusting that the engineering of the various formats will be similar, a head to head comparison took place. Using Miles Davis's 'Kind Of Blue' (I will never tire of listening to this sublime, improvised jazz classic) it was interesting to hear participants in the comparison express surprise at the altogether superior sound that came from the turntable. Was it mere chance that the record player was first up, or was this a 'top down' demo I thought to myself. Anyway, as the comparison progressed it became obvious to me that vinyl LP and conventional CD are clearly superior, with SACD lagging behind. At this point I must add that there were some subtle differences in sound between formats that may well be a result of the re-engineering of this Analogue classic into CD and SACD versions. For example after the introduction (piano, bass, drums) the horns make their entrance. On standard CD the horns appear forward and a little hard on the ears (unlike the LP). On the SACD this forwardness and hardness is

even more noticeable. Both digital versions of the Miles Davis could not match the infectious, compellingly foot tapping and rhythmically involving quality of the Analogue original. Overall the tonal balance on CD and SACD was a little lighter, with Paul Chambers bass part somewhat bleached out and conspicuously less of the sound of the studio coming across. Strangely

the SACD version seemed a little faster paced than either CD or LP yet lacking the sheer grooviness and rhythm of vinyl. As the comparisons progressed with orchestral and choral music it became more and more obvious that SACD and DVD-A pose no threat to conventional CD.

Moving on to the second system we were able to compare a Pioneer DV-747A

Multi Standard player against a like priced conventional CD player, a Marantz CD17ii. In two-channel mode and using a choral recording the sound was dull, uninteresting and generally lacking in detail. In surround mode the sound stage was enlarged in so much as the engineering of the surround effects transported the listener forward into the choir. Generally this surround effect was also lacking in detail and resolution with high pitched voices taking on a 'squeaky' character. Also a curious and uncomfortable phase shifting seemed to take place that gave the impression of the listener being pulled and pushed around the sound stage. Compare the sound of a well-produced CD in a conventional CD player against an identical disc in a DVD player and what you will experience with the DVD player is a kind of blandness that can make listening much less enjoyable. This 'dumbing down' of sound quality can be experienced on FM radio. Tune into BBC Radio 3 or 4 and listen for example to the quality of speech. Re-tune to Radio 2 and you will hear the effect of compression and limiting hardening the sound and seemingly adding sibilance. Re-tune once more to Radio 1 and you will experience a further reduction in the naturalness of the sound with more hardening and sibilance. Any multi standard playback system will be a compromise simply because it has not been designed to maximise quality of sound reproduction or picture quality. The attraction of Multi Standard is the convenience of one piece of hard-wear for all five-inch Digital discs and I was not surprised to find the sound quality of the Multi Standard player consistently inferior to any of the other formats we auditioned in the comparison. But then I guess it was a lot cheaper. These observations are necessarily very personal, but that's the whole point. Finally, serious congratulations to Harry Oikawa and John Bamford for their skill in staging a very complex series of comparisons.





Listen and believe  
TotemAcoustic.com

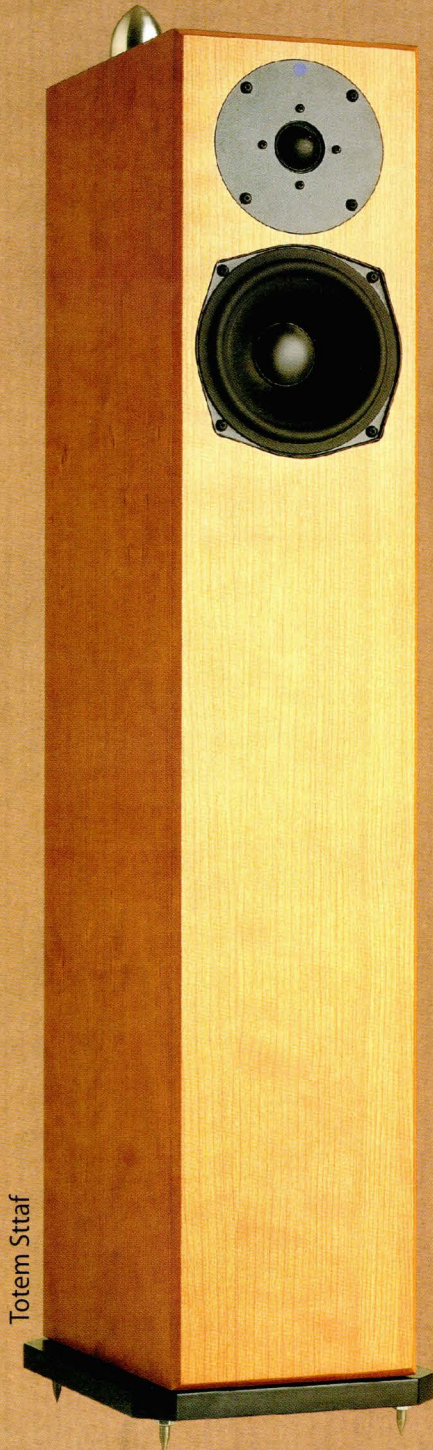

Totem Sttaf

joenit

United Kingdom Distributor  
wim.verellen@joenit.com  
Belgium Tel: 0032 15 285 585

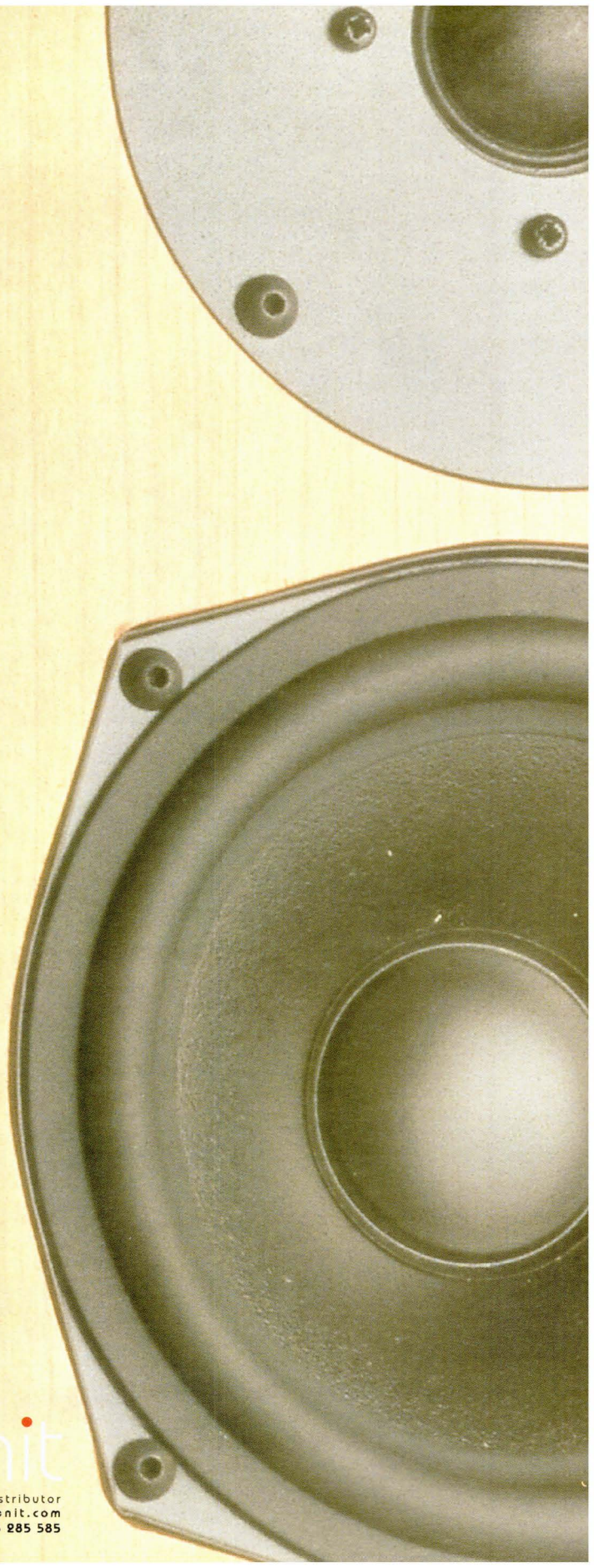

# Some of the *best* kept secrets in HiFi

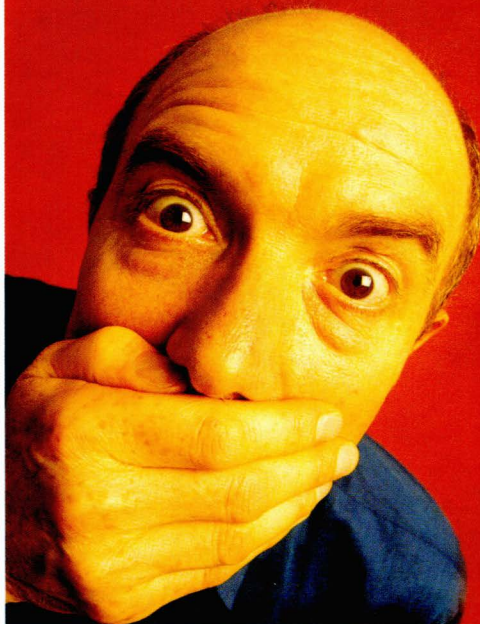

- **Aliante Loudspeakers**  
*Superb sound quality combined with Italian style from Plininfarina*
- **Audio Valve Amplifiers**  
*Valves get easy to use with automatic valve adjustment*
- **Monarchy Amps, Transports and DIPs**  
*High end at low cost*
- **Klyne Pre-Amplifiers**  
*Sonic perfection in pre-amps*
- **Kochel Horn Loudspeakers**  
*The speakers Mozart would have used and loved*
- **Wavac Amplifiers**  
*The single ended legend (100wpc!)*
- **XLO Cables & Interconnects**  
*Simply the Best in the World*

Distributed by:

## WOLLATON A-U-D-I-O

Wollaton Audio, 134 Parkside, Wollaton, Nottingham NG8 2NP  
Telephone: 0115 928 4147

## MICHELL GYRODEC SE

A SYMBOL OF PRECISION

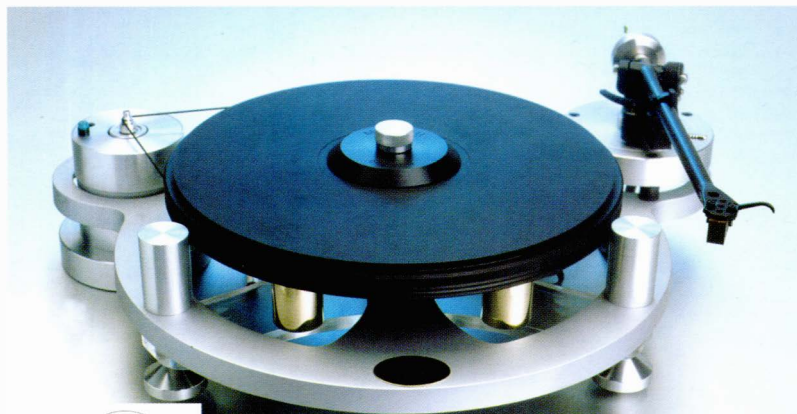

**WHAT HI-FI?**  
June 1999

Michell Engineering, 2 Theobald Street, Borehamwood, Herts WD6 4SE  
Tel: 0208 953 0771 Web: [www.michell-engineering](http://www.michell-engineering)





# WILMSLOW AUDIO

Loudspeaker specialists for almost 40 years

- Range of replacement drive units from Vifa-Scanspeak, Peerless, Morel etc, for use in AR, Gale, Heybrook, IMF, KEF, Mission, ProAc, Rogers, TDL plus many others.
- Comprehensive stock of components, capacitors (Ansar, SCR & Hovland), QED cable, damping and grille materials.
- UK's largest supplier of kit loudspeakers - all on demonstration

Phone today for your FREE catalogue or check out our Website.

## WILMSLOW AUDIO

50 Main Street, Broughton Astley, Leicester  
 Tel: 01455 286603 Fax: 01455 286605  
 Website: www.wilmslow-audio.co.uk



## STOCKISTS OF LEADING HI-FI

- A careful selection of the best Hi-Fi to suit most budgets.
- Two comprehensive listening rooms.
- Expert advice on building a system.
- Expert advice on improving existing systems.
- Home installation service.
- Call in for more information or a demonstration.
- 0% Finance Available on request.

# Basically Sound

NORWICH • NORFOLK

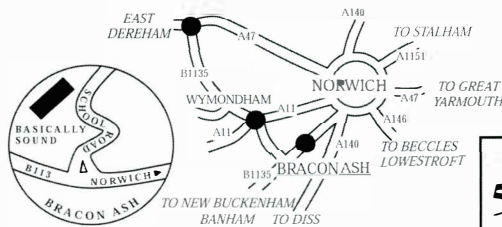

01508  
**570829**  
 CLOSED MONDAYS  
 AND SUNDAYS

Basically Sound of Norfolk. The Old School, Bracon Ash, Nr. Norwich, Norfolk NR14 8HG  
[www.basicallysound.co.uk](http://www.basicallysound.co.uk)

AUDIONOTE  
 AUDIO ANALOGUE • BEYER  
 BRYSTON • CABLE TALK  
 CREEK • DENON • EPOS  
 FINAL • GRADO • JM LAB  
 NAIM AUDIO • OPERA  
 PMC • PROAC • QED • REGA  
 ROYD • SENNHEISER  
 SOUNDSTYLE • STAX  
 TALK ELECTRONICS • TEAC  
 TARGET XLO AND MANY MORE



## Heatherdale Audio Ltd

202, Findon Road, Worthing, BN14 0EJ

### Brand New TONEARMS

Eminent Technology Air Bearing Tonearm  
 Normal Price £2500 **Our Price £1495**  
 Eminent Technology (Magnesium Wand)  
 Air Bearing Tonearm  
 Normal Price £2800 **Our Price £1695**

### Brand New BOW WAZOO

Integrated Amplifier  
 Normal Price £2500 **Our Price £1995**

### SPEAKERS

Celestion A1 Speakers £495  
 Audio Note AN E/SP Walnut Finish Speakers £995  
 B&W DM 601 Speakers with Stands £125  
 Dynaudio Audience 10 Speakers £195  
 John Bowers Active Speakers £695  
 Meridian A500 Speakers £595  
 KLH Speakers £195  
 Mission 782 Loud Speakers (Stand mount model) £250  
 AVI Nutron III Speakers £350  
 Main Dealers for Orchid Speakers.

### PRE-AMPS

EAR 864 Pre Amp £99  
 NAD 114 Stereo Pre-Amp £99  
 Perreux 5M6P Pre-Amp £2750  
 350P Power Amplifier £150  
 Naim Nac 42.5 Pre-Amp £175  
 Musical Fidelity "The Pre-Amp" £175  
 Musical Fidelity MVT Pre-Amp with Phono-Stage & PSU £495  
 Exposure 21 Pre-Amp NEW with remote £890  
 Classe Audio DR6 Pre-Amp with Power supply and Phono Stage (cost new £3900) £1995

### AMPLIFIERS

Audio Note Neiro Power Amp £5495  
 Perreux 5M6P Pre-Amp £3695  
 350P Power Amplifier £175  
 Naim 120 Power Amplifier £995  
 Rogers E40a Integrated Amplifier with phono-stage (NEW) £3395  
 Audionote P4 Mono-blocks £3995  
 Exposure 11/12/Sup8 £995  
 Audio Note Neiro Power Amp £5495

### Pre-owned Equipment Available with Guarantee

Export Facilities Available. Visit our Web Page [www.hifi-stereo.com](http://www.hifi-stereo.com)

### Main dealer for Mark Levinson Reference products

Audio Research VT60 Power Amp £1295  
 Bow Wazoo Integrated Amp Brand New norm price £2500 our price £1995  
 Audio Note Neiro Power Amp £5495

**CD PLAYERS & TRANSPORTS**  
 Teac VRDS 9 CD Player (mint) £650  
 Rotel 9708X CD Player £130  
 Theta Jade CD Transport £1295  
 Meridian 602 CD Transport, 563 DAC Inc. £445  
 Balanced Connecting Digi Link £445

**DACS**  
 Mark Levinson ML30.6 Reference DAC (ex-demo) £11995  
 MSB Link DAC III with PSU, Base, HDDC and Upsampler £850

**MISCELLANEOUS**  
 Quad 77 System Power Amp, Pre-Amp, CD Player & Tuner £2995  
 Beyer Headphones 811 £110  
 Audio Note ANS7 MC Transformer with M7 Phono-Phono Stage £8995

Selection of MIT Cables available at discounted prices

**TURNABLES, CARTRIDGES & TONEARMS**  
 Michelle Gyro Dec with Out-Board Power Supply £895  
 Project Debut Gloss Black £99  
 KOETSU Red T Cartridge (Brand New) £995  
 Hadcock Tone Arm (mint) £445  
 Koetsu Itoigawa D Cartridge (Brand New) £4495  
 Koetsu Urushi Cartridge (Brand New) £1995  
 Thorens TD125 Turntable £295  
 Helius Silver Wired Tonearm £995

We now offer 0% finance\* (\*subject to status). Please phone to arrange an audition  
 Main Dealers for Mark Levinson, Thiel, and Absolute sounds  
 We accept Switch - Mastercard - Visa - Diners Club - American Express

**Tel...01903-872288 or Evenings...07860-660001**  
**Fax...01903-872234**  
**E Mail address; heatherdale@hifi-stereo.com**



audio research

VOLUME

GAIN

BALANCE

PHONO INPUT

VACUUM TUBE  
REGULATOR

ON STEREO BAL IN PROCESSOR MONITOR OPERATE

POWER MONO SE IN INPUT INPUT MUTE

MODEL LS2S  
HIGH DEFINITION

audio research

VACUUM TUBE  
POWER AMPLIFIER

MODEL VT100  
HIGH DEFINITION®

VOLUME

# Audio Research LS 25 Mk2 line stage and VT 100 Mk3 power amplifier

by Chris Binns

How do you define the term 'high-end'?

A phrase often used in connection with hi fi, I haven't the faintest idea when equipment suddenly becomes high-end as opposed to...what?

Maybe it's the addition of an extra zero on the price tag.

I don't think the term existed (in this country at least) until the late seventies, a time when the Linn-Naim system philosophy ruled the roost, and the most expensive hi fi system you could buy was probably the tri-amped active Isobarik system. I think (Ricardo Franassovici) of Absolute Sounds can be credited with introducing (into this country at least) the equipment that whetted our appetite and gave birth to the term high-end, and one name that seemed to be synonymous with the concept was Audio Research.

Founded by William Z. Johnson over thirty years ago, the company came in to existence with a strong belief in the superiority of valve technology, at a time when everyone else was going solid state crazy. Being a tube nut in the 1970's must have been a lonely experience, but if any one man can lay claim to reviving the fortunes of the vacuum tube, it must be Mr Johnson.

Using his experience of modifying and refining original Dynaco equipment, he soon started making his own designs, such as the now legendary D79 power amplifier and S P6 pre amp...the rest is history.

My first encounter with Audio Research products was in the late seventies and something of an eye opener for me. At the time most available British valve amplification

used circuitry that was taken straight from the GEC or Mullard application books, and was somewhat unrefined in performance. Sure, listening to original Leak or Radford amps showed off many of the finer points of the genre, while the more powerful contemporary offerings of the day seemed something of a backward step. The appearance of amplifiers such as the SP6 / D79

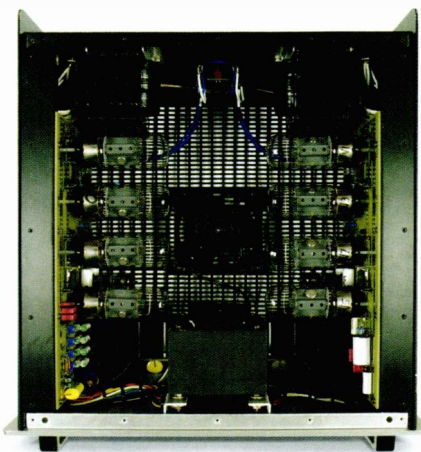

combination represented a far more sophisticated and innovative approach to thermionic design, and served to highlight the fact that no radical design or evolution of valve technology had taken place in this country for many years. Which of course was not the case with the Audio Research amplifiers; each new product represented a development from an earlier design, and by the time I heard a D70 (the baby of the then available range) driving a pair of Quad ELS 63's, it was like a breath of fresh air. This was how I imagined valves could sound, and I make no secret of the fact that the

experience rekindled my interest in thermionic amplification.

The LS25 and VT100 look...well much like any other Audio Research product. The aesthetic styling hasn't changed for many years, which at least makes it instantly recognisable. Both units have brushed aluminium panels with black casework. On the power amp this now encloses all the electronics rather than just the valves. The pre amplifier has the usual spade toggle switches complimented by rotary controls. These differ from earlier models in that they are now logic controlled and a twist from the centre detent advances the function. Thus input selection is now done via relays situated behind the input sockets cutting down on internal wiring. Another benefit is that the volume control is far more accurate than the traditional mechanical device in terms of channel balance, and with over 100 individual steps plus the three position gain control, a wide range of different levels can be accommodated with critical volume adjustment. A ring of green Led's surround each rotary control and above each switch to give a visual indication as to the units status.

Other facilities provided by the LS25 include separate switchable processor and tape monitor loops, a mono switch (something that I find extremely useful) and a selector switch for balanced or single ended operation. Both modes are available for all six inputs, loops and outputs, hence the massive collection of high quality connectors on the back panel.

A couple of minor points – I notice

▶ that Audio research units now use standard IEC mains connectors rather than a captive mains lead, which is far more satisfactory, and there is provision for remote start up of other equipment via a 12 Volt output jack. High quality selected components are used throughout, while a new and innovative J-fet input circuit drives a cathode coupled output stage giving a low output impedance, while all the power supply rails are regulated.

The VT 100 is straightforward enough with just a power switch on the front panel. At the rear, input is selectable between balanced or single ended, while 4 and 8 Ohm tapped loudspeaker outputs are provided via a single set of binding posts. These do not easily accept 4mm plugs, encouraging instead the use of spade terminals, particularly if multiple cables are required. Each channel comprises four Russian sourced 6550 pentodes to produce a comfortable 100 Watts, these are run in an ultra linear configuration; most previous Audio Research designs that I have encountered have favoured the less common pentode mode. What has remained however is their use of cathode coupling the output valves to the transformer, with considerable benefits particularly at lower frequencies. Matched pairs of replacement valves are recommended, but with considerate use life expectancy should be reasonable. Bias adjustment is reasonably straightforward but necessitates careful use of a digital voltmeter and a steady hand. A single fan provides air circulation within the enclosure; it is barely audible under most conditions.

Both the LS25 and the VT100 have undergone a certain amount of development to earn their mark 2 status, and both benefit from the use of a hitherto undiscovered Russian military valve, the 6H30. A considerably larger and more powerful valve than

the 6922 (ECC88) used in the mark one versions, it has enabled Audio research to half the number of valves in the pre-amp and the driver stages of the VT100, and potentially offers considerable benefits in sound quality.

Setting up and using the Audio Research combination was easy enough,



and to my relief both units had had considerable use, taking very little time to settle down. Interconnection was via the balanced inputs. My immediate impression was how comfortable the sound was, relaxed and easy going, but never dull - and I spent a happy evening listening to music rather than characterising the equipment, always a good start. With the next listening session I was able to put things more into perspective, and describe how the combination was performing.

Poise, delicacy and refinement were the first things that struck me about the LS25 / VT100 combination, coupled with a high degree of authority which worked well with most types of music. Not entirely what I had expected

– previous Audio Research gear that I have owned or listened to has had a warm, fruity, almost punchy quality to it which gave music a degree of impetus, at the expense of some transparency. With the latest combination, the tables have been turned, and the sound is more accurate, detailed, transparent and focussed. With no disrespect to Audio Research, I have in the past questioned the high definition tag that appears on their equipment, because I never felt that it was their forte. With the LS25 / VT100 combination I can honestly say that it is, but not to the extent of dissecting the music in the way that some equipment that majors on detail can.

Realistic volume levels were easily achievable, and via the 4-Ohm tap I had no difficulty driving the Primary monitors. Bass quality was good, with plenty of extension, but a little bit light footed rhythmically: drum and bass type music lacked some authority and impact. Bear in mind though that the last power amplifier I had been using was the Bryston 14B



ST, probably the best I have heard in this respect. With orchestral music however, the Audio Research demonstrated a remarkable ability to fill the room with an orchestral climax, and in conjunction

with its good imaging capabilities could be breathtaking. Playing the Naxos recording of Vaughn Williams *Job – a masque for dancing* I was reminded of just how dynamic this piece of music is, springing from a beautifully imaged solo instrument to full orchestra in a split second. The sound expanded to fill the room not only in volume, but

▶ also in scale, rendering the whole performance frighteningly realistic.

Mid range quality was exemplary, and reproduction of voices was particularly good. Last Sunday, having just been to Salisbury cathedral for the advent carol service, I ended up playing a recording of Tavener choral music late in the evening, and the results really were something quite special, with the voices and ambience of St John's chapel beautifully portrayed.

The moment of delicate civilisation didn't last however, and I was soon playing far less subtle material in the form of the first Tom Petty album.

As I have already said, rhythm and

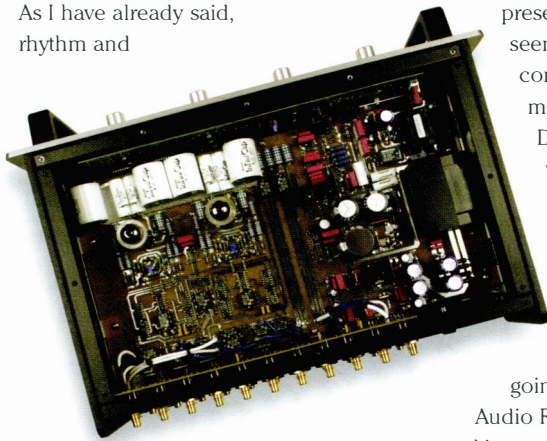

drive seemed less impressive that I would have expected, and here the opening track was a case in point. Normally this track is as hard hitting as it gets, and although tonally the Audio Research was on home ground it lacked the drive to really propel the music along. Without this energy, the music became almost pointless and I begin to notice how bad the lyrics were, got a bit embarrassed and ended up putting something else on.

Curiosity got the better of me, and I couldn't resist the temptation to try the units separately, so I hooked up the LS25 to the Bryston 14B. Previous Audio Research pre-amps that I have used have always sounded gorgeous – but my one criticism has always been that they have a slight veiling effect, a little bit soft focus if you like. It's a

character trait that I noticed with the SP8 through to the last one I spent any time with, the LS2. This is not the case with the LS25. All of the positive attributes I have described were intact, but the system now had a real sense of drive and purpose, and made the best of whatever material I put through it.

Although I swore to myself that I wouldn't do it, I dragged out my old (recently re-valved) D115 power amp and put it in the system. First things first, it sounded unrefined and muddy compared to the VT100, lacking in resolution and detail. But...music just steamed out of it with a big-hearted presentation that the VT100 seemed to miss. I felt the combination was inherently more enjoyable with the D115, but a friend of mine who witnessed the whole escapade disagreed, preferring the cleanliness and controlled refinement of the VT100. But its me writing this review, so I'm going to tell you what I think.

Audio Research are continually working to improve their products, and I think it is fascinating to see the development that has taken place over the last twenty years. The family blood-line runs strong – just look at the visual similarity between the D115 and the VT100. The refinement that has been incorporated into these two products is indisputable, and in the case of the LS25 MK2 it has been spectacularly successful, achieving exactly what I hoped it would to produce a great sounding, highly desirable product. However, I confess to being a little disappointed with the VT100. In this case that refinement has been wrought at the expense of some of the animal grunt that older models had, and employed to such good effect in making music instantly engaging. Personally, I miss that in the VT100, which has done little to undermine my

long standing love affair with the D115. However, others won't agree, marvelling at the finesse, control and detail that comes from the VT100. Either way, expensive though they are, were you to buy one or both of these units you can rest assured that Audio Research will happily service it for you in twenty years time, just like my D115. As they say in their brochure "our products are workhorses not museum pieces". ➤+

#### TECHNICAL SPECIFICATIONS

##### LS25 Mk 2

Inputs:	6x line (single-ended or balanced)
Input impedance:	120 K Ohms balanced 60 k ohms SE
Outputs:	2x main, 2x tape, 1x processor, single-ended or balanced
Output level:	2 Volts
Output impedance:	650 Ohms balanced, 325 Ohms SE
Frequency response:	1 Hz – 100 kHz +/- 5 dB
Dimensions (WxHxD):	480 x 134 x 298mm
Weight:	8.2 Kg
Price:	£5799

##### VT 100 Mk 3 Power amplifier

Power output:	100 Watts per channel
Power bandwidth:	15 hertz – 80 kHz – 3dB
Input sensitivity:	1.9V for rated output
Input impedance:	200 K Ohms balanced 100K Ohms single ended
Valve compliment:	8 X 6550 matched 4 X 6H30
Dimensions (WxHxD):	483 X 222 X 495
Weight:	29.9Kg
Price:	£6400

##### UK Distributor:

Absolute Sounds  
Tel. (44)(0) 208 971 3909  
E-mail. (44)(0) 208 879 7962  
Net. [www.absolutesounds.com](http://www.absolutesounds.com)

##### Manufacturer:

Audio Research Corporation  
Net. [www.audioresearch.com](http://www.audioresearch.com)



6X4

6X5

6X6

6N76T

6X8

6X9

22W CLASS A TRIODE AMP

# Renaissance Amplification RA-01 Valve Amps

by Roy Gregory

What's that saying about a prophet in his own town? As the editor of a hi-fi magazine you get more than your fair share of what can be most kindly described as speculative calls. The ones that come from the guy who has carved a turntable from a solid block of Welsh granite, and just as soon as replaces the Morris Minor engine that he's using to drive the 24 Stone platter at present with something a little quieter (he got the parts for the silencer from the skip behind Kwik-Fit) how would we feel about reviewing it? How can I put this – thank you but no. So, when you get a call from someone who lives just round the corner offering you a pair of triode mono-blocks for review, your first response tends to be of the “Oh no, not again?” variety. Then he tells you that he wants to sell them for six grand a pair, and sends you a publicity shot of his pride and joy sat in the stubble of a corn field and you know you are in trouble. Not only are we talking valve crazies here (and there's no one quite as crazy as a valve crazy) but he lives within half an hour's drive. Batten down the hatches and prepare for boarders!

All of which shows just how wrong you can be and how dangerous it is to leap to conclusions. Closer examination of the offending brochure revealed a number of potentially interesting aspects to the design. Okay, so it uses 300Bs, not necessarily a good sign as there's more hype and pseudo religious bull spoken about this particular triode than all the others put together (and

we're talking about a fertiliser rich environment here folks), but at least it uses them in a push-pull topology rather than slavishly following the single-ended fashion parade. Then there's the very nicely finished and not a bit DIY wooden chassis and non-magnetic top-plate. Finally, these guys also import the highly eclectic, mega expensive and really rather wonderful Lamm amplifiers from America, so at least they've got a serious frame of reference.

Enter then the Renaissance amplifiers, first offspring from the fertile imaginations of IES, or Integrated Engineering Solutions to you. The very fact that the people behind this product earn their real money doing hi-tech electrical engineering design and development is itself cause for confidence, a confidence that is reflected in the amplifiers themselves. As I've already mentioned, this is a triode mono-block, based around a pair of valve rectified 300Bs. The chassis is a low oblong with its narrow side forwards, a metal box at the back housing the transformers. The radiussed wooden side panels are beautifully finished and available in a variety of different hardwoods to contrast with

the brass top-plate. In one of the more sensible examples of engraving on a hi-fi product, each of the five valve sockets is identified by type. Rated output is 22 Watts, and the company claim that the normal caveats regarding easy loads and efficient speakers need not apply, a proposition that they underlined by using a pair of diminutive Wilson-Benesch Arc loudspeakers at the Novotel show.

In fact, there's nothing remotely quaint about these amps. They are all about sensible, solid engineering. The fit, finish and general presentation is more reminiscent of the Japanese high-end than British cottage industries, even down to the provision of an elegant and effective valve cage which doesn't totally destroy



their appearance. However, there is one practical issue that mars this otherwise impressive first impression. The socketry (one phono for input, a pair of five way binding posts for output, an IEC socket and chassis earth terminal) is arranged in a deep, narrow slot across the back panel. It's a disposition that makes use of serious cables fitted with anything other than 4mm plugs a complete impossibility, as well as making multiple connections for

► bi-wiring similarly impractical. That means you're going to need cables terminated with a single pair of 4mm plugs, and tied together if you want to bi-wire. The depth of the slot makes correct identification of the terminals difficult unless you can see the amp from directly behind, and even the Watt-Gate IEC plug on a Kimber mains lead had trouble fitting in. It's a strange oversight on a product that is otherwise a model of practicality and whilst it's easy enough to sort out, it does need attending to.

Further underlining the engineering background behind these amps, they proved completely trouble free in operation, with nary a glitch to indicate their displeasure at the standard array of indignities imposed in the course of the review process. The only thing you really have to watch out for is warm-up time. From cold they exhibit none of the bleached and pinched sound that characterises so many valve amps when first switched on. It's a quality that helps disguise far more insidious failings. When first fired up the Renaissance amps present you with a wishy-washy muddle of a soundstage clumped between the speakers. So reminiscent is this of the majority of single-ended amps that you'll probably assume that's what you're going to get. Likewise, the timing integrity is non-existent. Music lacks any sense of drive or dynamic tension. The end result is that everything sounds 'Nice' with a capital N, but there ain't no music. Thankfully, around forty-five minutes of run time sees the sound gelling into something altogether more convincing, which is

just as well or this would have been one of the shortest reviews in history. Although IES favour the use of a passive control with their amps, it's not an approach that works well with anything remotely resembling a full-range speaker, or with a vinyl source.

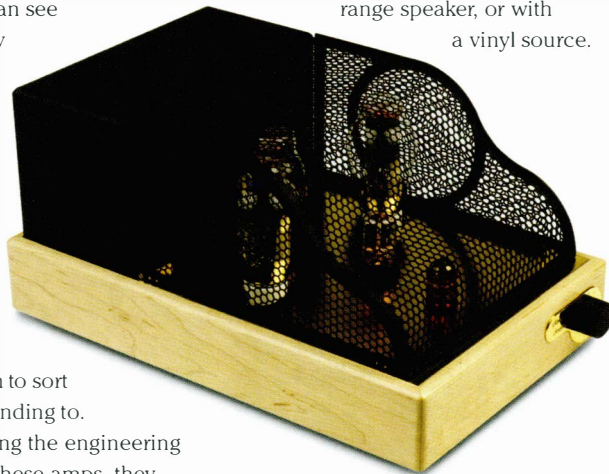

I used both the Klimo Merlin and the Klyne pre-amplifiers, along with the Living Voice Avatar OBX and Audioplan Kontrast III speakers. Sources varied from the Eikos CD player and Marantz SA-1 SACD player, to the Clearlight Recovery turntable, mounting an

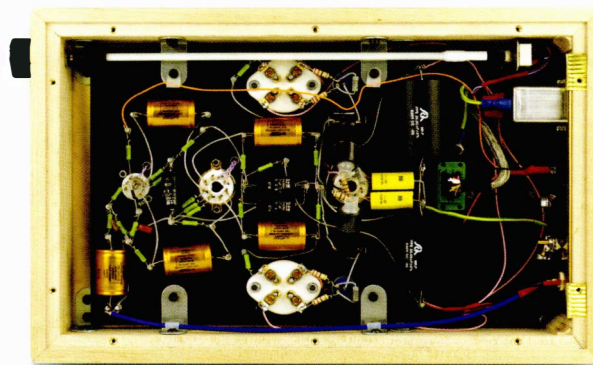

Incognito modified Rega arm and Lyra Helikon cartridge.

The first thing to note about the Renaissance amps is that they have a distinct threshold of operation. Below a certain level they lose colour and rhythmic coherence, rendering music drab and boring. Where that

level sits depends on the partnering equipment. It was highest with combination of the solid-state Klyne pre-amp and Living Voice speakers, considerably lower with the Klimo and the Audioplans, which seems to indicate that both speaker efficiency and electrical interfacing are issues with this amplifier. Interestingly for a relatively modestly powered triode amplifier, it actually seems to thrive on having something to get its teeth into. Certainly, its combination with the 90dB Audioplans was spectacularly successful. Fortunately, even in the least advantageous combination the problem was ameliorated by the amps' complete lack of glare or nastiness. These are amplifiers that you can play at a reasonable volume for hours on end without fear of fatigue. However, people who regularly want to listen at low levels will need to consider this issue.

The thing that really sets the Renaissance amplifiers apart from the crowd is the way in which they manage to deliver their warmth and rich tonality without losing the musical plot. So often, what valve aficionados refer to as "musicality" is anything but musical: It's a cloying roundness and harmonic generosity that robs music of purpose, pace and interest. Sure, it avoids the ear searing glare and pinched tonality of too many solid-state designs, but it does so at the expense of rendering musically flaccid, just like a vicar's tea party – unlikely to offend but equally incapable of stimulating either. Yet despite their classically rich presentation, interest levels with the Renaissance amps never droop. Musical tension they have in spades, drama and dynamic purpose are present in abundance, and this from amps that are neither obviously



► fast, nor especially focussed and transparent. Indeed, they couldn't be farther from the kind of raw immediacy that typifies those designs that wear rhythmic and dynamic integrity on their sleeves. It's an interesting conundrum and one that warrants serious consideration.

First of all, let's consider the performance as a whole. Listening to the spectacular and dramatic Oue/Minnesota performance of Rachmaninoff's *Symphonic Dances* (Reference Recordings RR-96CD) these amps manage to effortlessly combine both the lyrical sweep and explosive dynamic crescendos of the piece. They offer a massive soundstage stretching well outside the speakers, yet the acoustic as a whole is wonderfully coherent, the performance has an organic integrity. Even the loudest climax is built from beautifully scaled steps, rising ever higher without the orchestra collapsing into your lap, while the bass weight and power add a real sense of scale. It's this holistic quality which is the key to the amps' performance.

Looking at the other end of the musical spectrum, Gillian Welch's album *Time (The Revelator)* (Acony ACNY-0103) lacks a little of the raw immediacy that characterises this small, intimate recording. However, it loses none of the clarity or the intricacy of the guitar lines, or the subtle shifts in pace and timing that give the music its direction and purpose. Yet, as I mentioned earlier, these amps excel in neither the ultra transparency or the micro-dynamic resolution that normally typify those designs that handle this most basic of musically expressive building blocks so well. Indeed, play something like the thrashy 'Piece of Crap' from *Sleeps With Angels* and you realise that if anything the Renaissance amps mute and round the leading edges of the

notes, removing the offensive raw edge that Neil Young has worked so hard to create. How then do they manage to convey music with a rhythmic and dynamic capability to match their tonal sophistication?

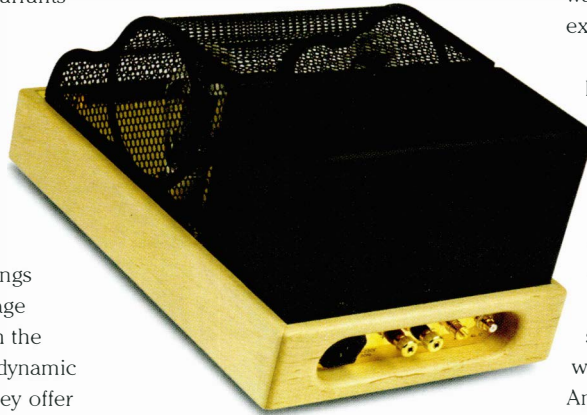

The secret is in the placement of the notes. The Renaissance amps might not be the last word in leading edge or dynamic discrimination but they get the energy of each note in the right place and they scale the variation in the energy levels convincingly too. What's more they manage to do it right across the range from bass up to mid-treble. Extreme high frequencies tip back slightly, losing a little of their energy (and this with the Nordost Valhallas). Whilst this can rob triangles of the ability to cut through an orchestra, or brass of a little of its natural brilliance (Miles' trumpet on *Steamin'* springs to mind) it also adds to that cuddly sense of warmth that helps allow instruments a realistic richness and colour. (There is also the option of using Western Electric 300Bs which might well improve things – at a price).

The proof of their ability lies in DG's recording of Steve Reich's complex and convoluted *Six Pianos*. The shifting evolution of rhythmic and chord patterns that make up the 24 minutes of music are enough to give a hi-fi system the heeby-jeebies, and they do. It's incredible how many components

simply fall apart, reducing the intricate structure to unpleasant noise, aided and abetted by a less than wonderful recording. The Renaissance amps don't just carry you through the whole 24 minutes, they pull you into the six way process while muting the worst excesses of the light, bright recording.

What IES have achieved with the Renaissance amps is a combination of the tonal and harmonic qualities that so many people seek in single-ended designs, with a level of musical organisation and dynamic coherence that normally evades exactly those products. The result is musically engaging and satisfying, offering plenty of substance, weight and motion to proceedings. And you can get that performance out of real world speakers. The Renaissance mono-blocks join the Border Patrol 300B as the only triode amplifiers that I've used that I'd happily live with at home, which makes them members of a very select group indeed. ►+

#### TECHNICAL SPECIFICATIONS

Type:	Push-pull triode mono-block
Valve complement:	1x 6922, 1x 6SN7GT, 1x 5U4G, 2x 300B per channel
Rated output:	22 Watts into 8 Ohms
Input Impedance:	220 kOhms
Dimensions (WxD):	275 x 220 x 430
Weight:	15kg ea.
Finishes:	Solid hardwood surrounds in Ash, Black Walnut, English Oak, Maple and Utile or Black Ash/Aluminium.
Price:	£5995 pr.

#### Manufacturer:

Integrated Engineering Solutions  
Tel. (44)(0)2380-905020  
Fax. (44)(0)2380-704073  
E-mail. [info@highendaudio.co.uk](mailto:info@highendaudio.co.uk)  
Net. [www.highendaudio.co.uk](http://www.highendaudio.co.uk)

# hi-fi+

REPRODUCING THE RECORDED ARTS

## Back issues

If you missed out on earlier issues of HiFi+, and want to complete your collection, you can order them by calling

**+44 (0) 1202 659380**

or by visiting our website:

**www.hifiplus.com**

Issue 1,6 and 9 - **Sold Out**, Issue 2 - £4.75

Issues 3-11 - £3.95.

Postage & packing: UK - Free. Europe - £1/magazine.

Rest of World - £1.50/magazine.

UK orders are sent by Parcel Post,

please allow 2 weeks for delivery.

Overseas orders are sent by surface mail.



### ABOUT YOU;

Title -----

Forename -----

Surname -----

Address -----

-----

-----

Postcode -----

Daytime Tel -----

### PAYMENT;

UK  Europe  Rest Of World

One year  Two year

Cheques to be made payable to Hi-fi+ Publishing Limited.

(drawn on a UK bank)

Visa  Access/Mastercard

Card No -----

Expiry Date -----

Switch

Card No ----- Issue No -----

Expiry Date -----

Signed ----- Date -----

## hi-fi+ Subscription Form

In order to ensure prompt arrival of your copy of hi-fi+, it is safest to take out a subscription. This lasts for a year, or 8 copies, and means that your magazine is delivered to your doorstep immediately it is published. No more fruitless journeys in search of audio enlightenment, and no more worries about missing an issue.

In order to apply, simply fill in the form, legibly(!), and drop it in the post. Oh, and we won't supply your details to the double glazing or insurance industries. You can rest safe in the knowledge that the only junk mail you'll receive has been sent by us!

And the cost of all this peace of mind?

### One Year Subscription / 8 Issues

Within the UK, \$28.50 For the rest of Europe, \$37.25

For the rest of the world, \$46.00

### Two Year Subscription / 16 Issues

Within the UK, \$48.00 For the rest of Europe, \$65.00

For the rest of the world, \$80.00

### Contact:

hi-fi+ Subscriptions, Unit 12 Albany Business Park  
Cabot Lane, Poole, Dorset BH17 7BX

### Or call;

Jayne Gage on Tel. 44(0)1202-659380  
or Fax. 44(0)1202-659540.

### Via the Web;

**www.hifiplus.com**

## TURBOCHARGING YOUR REGA ARM



### "Nothing less than total dynamite" HI-FI WORLD

If you are the proud owner of any Rega arm why not utterly transform it into the league of super arms with the Origin live structural modification:- £75. This modification will enable your Rega to perform at a level exceeding that of arms costing over £1200. Rewiring with high grade litz cable is also offered at an additional £70 and external rewiring is £70. All these modifications are available in kit form if you wish to do the job yourself or you can send us your arm for us to do the work.

"I have to say the Rega modifications turn this humble arm into a real Giant killer. Gone is the rather grey, sterile sound of the cooking Rega. Instead, tonal colour is fresh, dynamics have great speed and impact, and the sound stage is huge." HI FI WORLD SUPPLEMENT NOV 97 (structural modification to an RB250) WHAT HI-FI MAGAZINE gave this modification a 5 star rating.

For arm modifications we normally return your arm in 2 - 3 days.

### OTHER KITS & PRODUCTS FROM ORIGIN LIVE INCLUDE:-

- TURNTABLES (Kits & Retail)  
"the best sounding deck here ...sounds fantastic"  
WHAT HI-FI MAGAZINE group comparison test of 8 leading turntables
- SILVER 250 TONEARM £599 Probably the best tonearm available at any price (except for the Silver Taper).
- SILVER TAPER TONEARM £1225
- DC MOTOR UPGRADE £262 suitable to upgrade all turntables including Linn Lingo, Armageddon, Roksan, Thorens, Ariston, Rega, Systemdek etc £262. Well reviewed as a massive upgrade for all turntables.

### FULL INFORMATION ON WEB SITE OR CONTACT:-

Origin live, 87 Chessel Crescent, Bitterne, Southampton SO19 4BT

Tel: 023 80442183 / 80578877 Fax: 023 80398905

**E MAIL:** [originlive@originlive.com](mailto:originlive@originlive.com) **WEB SITE:** <http://www.originlive.com>

# Nemesis

AUDIO NOTE IN SOUTH CROYDON

**SALE**  
OF AUDIO NOTE  
EX-DEMONSTRATION EQUIPMENT  
PHONE FOR DETAILS.

Once in a while an Audio System comes along that is all things to all men. Audio Note have achieved this with their "**Zero Deluxe System**". Using the classic combination of valves and horns it possesses see through effortless sound, out of the box imaging, stunning control and dynamics and high end digital technology. The matching micro casework has a professional build quality. This system represents true high end performance at an affordable price.

To all those that have bought unwisely in the past Audio Note's Zero System represents retributive justice.

Appointments only

**020 8686 9331**



- Previously owned equipment available
- Servicing and repairs to all makes of Hi-Fi
- Valve amplifier rebuild specialists
- Turntable fine tuning - Best in Business

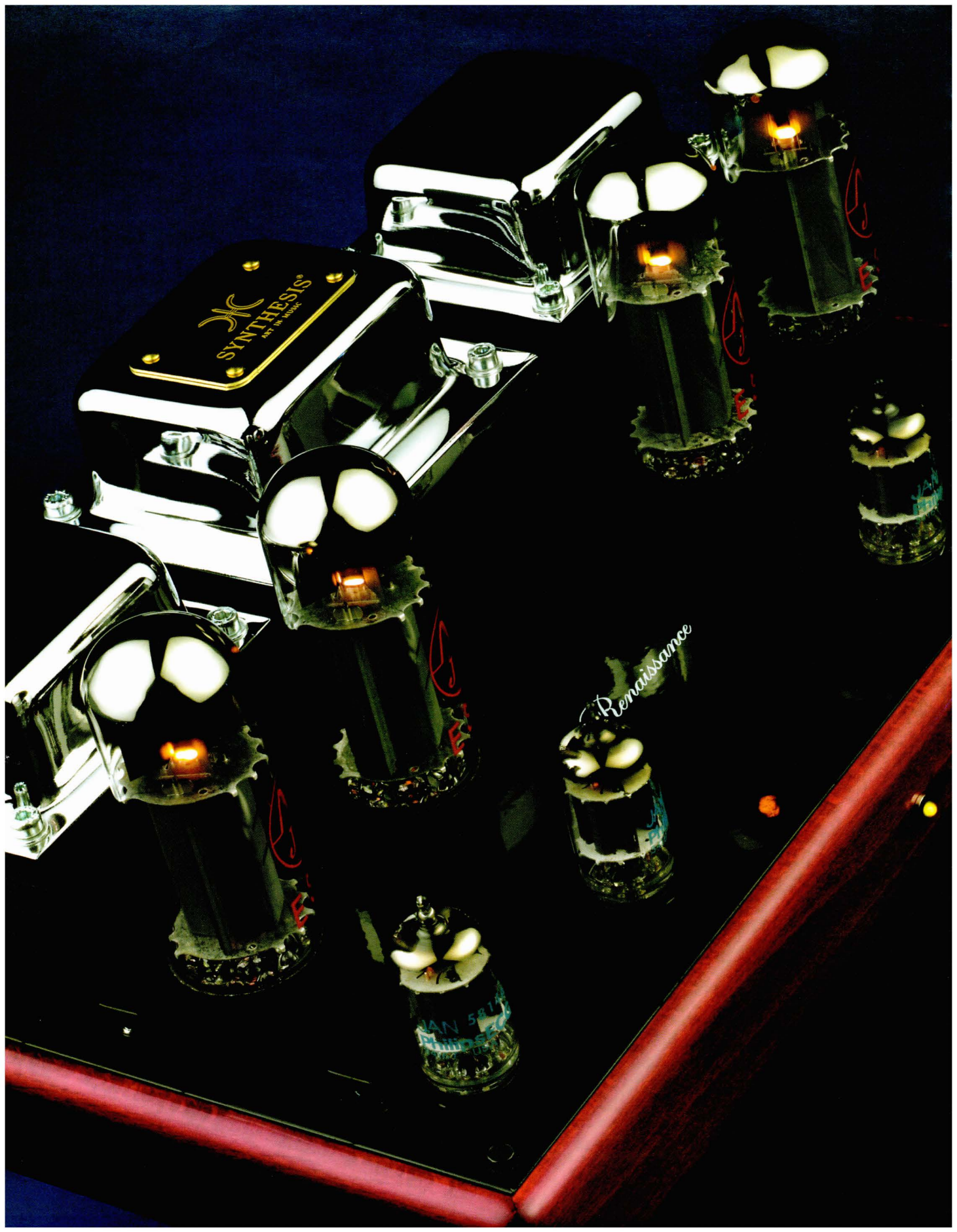

SYNTHESIS<sup>®</sup>  
ART BY MONTBLACK

Renaissance

LAN 50  
PEN

# The Synthesis Harmony pre-amp and Renaissance power amp

by Chris Binns

I knew it was bound to happen... but I didn't think it would be quite as extreme as this; one week I am playing with a system of almost unlimited power, and the next I come crashing down to earth with next to nothing. Consider this – the Bryston 14B had an output capability of near enough three kilowatts; I was now reduced to a mere hundredth of that. That's fifteen Watts per channel. Someone, somewhere obviously felt that the balance needed redressing – this was my penance for being a power crazed monster earlier in life.

But, one of the capabilities I look for in a system is the ability to reproduce all kinds of music (with the complete exception of Country and Western) at realistic levels in my living room; with whatever loudspeakers I choose to use. Which most of the time are not super efficient: due to the fact that I dislike large loudspeakers, and want decent bass extension, the inevitable compromise is a lack of super high efficiency. Also there will come a time, probably sooner than I anticipate, when I will have a smaller room and neighbours to contend with - at the moment I do not suffer these restrictions and am happiest when I have a system that will let rip, should the desire take me. Given these parameters, low powered amplifiers do not usually fit the bill except under exceptional circumstances, or of course, reviews. But I am also aware of the fact that there is often a compromise in

designing large powerful amplifiers, and for every Watt of loudspeaker driving capability, they move further away from the agility and general musicality that a lot of small amplifiers seem to manage. Massive power supplies and multiple output devices do have a downside.

So when I do get to use lower powered amplification, there is a certain amount of reconfiguring that has to be done, mainly concerning suitable loudspeakers. But the results can be well worth the effort – witness the results I got with the single-ended SAP OTL amplifier or the Graaf GM20 using the Quad electrostatics (Issue 5)

Did I mention single ended? Before you get too excited, may I tell you that the Renaissance power amp most

uses fixed rather than cathode bias, all for a measly fifteen Watts. Instead the designers have opted for the horribly unfashionable push-pull configuration using the common EL34 output valve, but - they are connected to run in triode mode. And certainly, the fixed bias would seem to be just an added complication for a circuit of this power output. One has to ask, why?

Addressing these points in order; It's push-pull. Hurrah! I am probably the last man on earth not to have been won over by all this SE malarkey, and even the editor, whom I can normally count on for support was caught using a pair of SE triodes recently. All

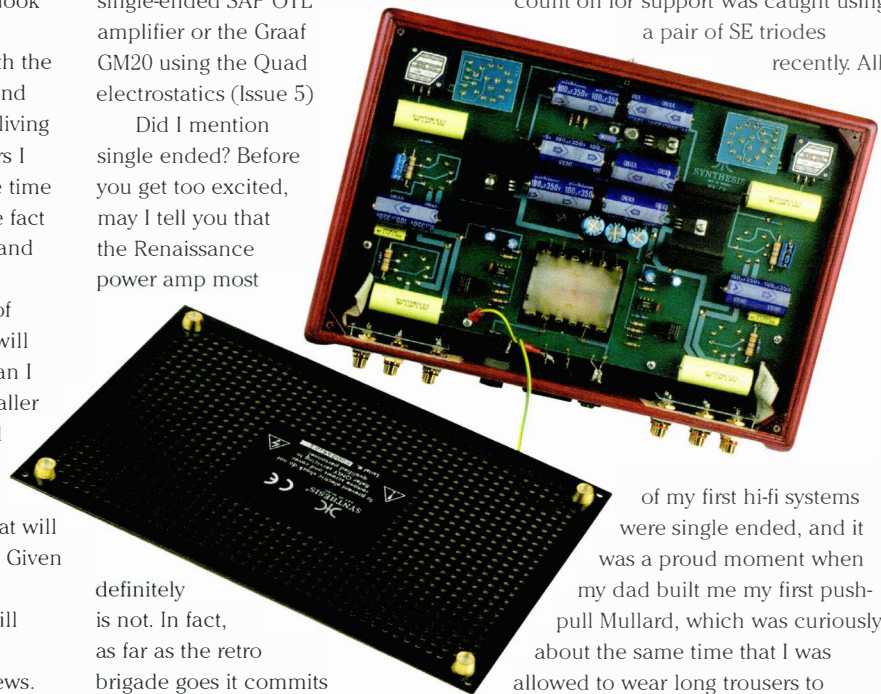

definitely is not. In fact, as far as the retro brigade goes it commits three cardinal sins – it is not single ended, it does not use triodes, and it

of my first hi-fi systems were single ended, and it was a proud moment when my dad built me my first push-pull Mullard, which was curiously about the same time that I was allowed to wear long trousers to school. I just can't bear the thought of all that magnetic flux in the output ►

▶ transformer going to waste.

The use of an EL34 pentode is an interesting point, as purists would no doubt feel that even when wired to operate as a triode, the

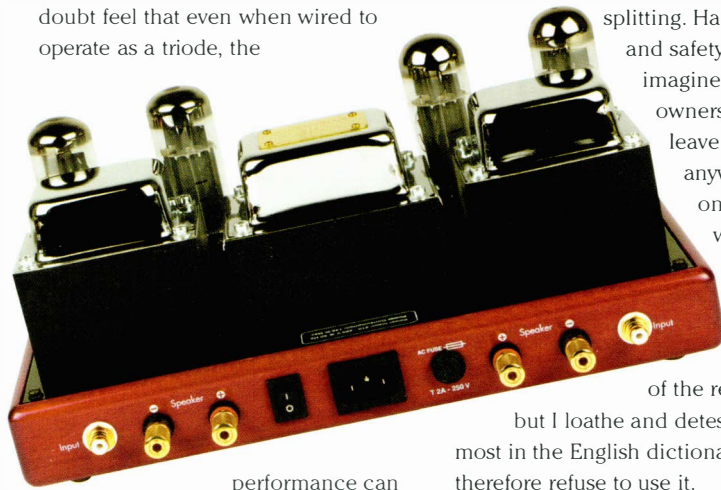

performance can not approach that of the real thing. Nor is it directly heated, another prime requirement for amplifier design circa 1920.

Fixed bias is more often used where higher power output is a consideration, and I do think it has quite a marked influence on sound quality, giving more bite when the amp is pushed toward its limit. It is unusual to see it in amplifiers of this power rating. It is perhaps worth mentioning that as part of their range Synthesis also make a more powerful model, the Encore which uses 5881 valves configured to provide about 25 watts per channel, but looks more or less identical.

So the Renaissance flies in the face of fashion. So what? Designed and manufactured in Italy, the Synthesis immediately endears itself to you by looking... well, wait till you see it; I defy anyone not be mildly seduced by its good looks. To start with it's neat and compact, the size of a piece of A4, with a beautiful clear red lacquered wooden plinth, and this is coming from someone who doesn't like wood finishes. This is complemented by a gloss black top plate with three chrome capped transformers. Removing the matching cage reveals the eight valves,

two EL34's per channel, complimented by two smaller 12AU7 type for voltage amplification and phase splitting. Hang health and safety – I should imagine that most owners would leave this off anyway. There is one four letter word that would easily sum up the looks of the renaissance,

but I loathe and detest it above most in the English dictionary, and therefore refuse to use it.

The unfortunately named Harmony pre-amp continues the aesthetic theme of the Renaissance by being the same size, with the wooden plinth and top plate, and just the single mains transformer flanked by the valve cages. With the controls on the top, the layout reminds me of the kind of ancient demonstration equipment I used to encounter in the physics lab at school. Audio circuitry is based around two 12AU7 valves per channel. These are paralleled to give two directly coupled stages, the cathode of the latter being



the main output. Both heater and HT supplies are regulated, while the four inputs are connected directly to the volume control via the selector switch. The tape output is

unbuffered and comes straight from the selected input, so if not actually recording it would be wise to leave this unconnected to avoid loading the source. Both the volume control and the selector switch are separate for left and right channels, something that I find a real pain in the proverbial when it comes to listening. Internal construction of both units is neat and tidy with all components bar the transformers situated on one double sided board. Output from the pre-amp is muted for a minute or so until all voltages have stabilised.

Only a complete idiot would connect the amplifier I have just described up to a pair of inefficient, difficult loudspeakers such as mine, but on the basis that I wanted to get it running as soon as possible, that's exactly what I did. Results weren't quite as dire as you might think, and by moving the speakers a few feet closer to the settee I enjoyed a couple of hours of extremely pleasurable listening. True, I did limit my musical selection to gentle acoustic/vocal music, but it was enough to remind me of the magic that some smaller amplifiers can provide. Whether I was just pointedly listening out for the limitations I don't know, but I found myself quite distracted from a

supposedly heartfelt conversation that a girlfriend was trying to have, by John Martyn singing 'Solid Air'. The gentle intimacy of this track played through the Synthesis was quite beguiling

and would have proved far more helpful to her state of mind than ▶

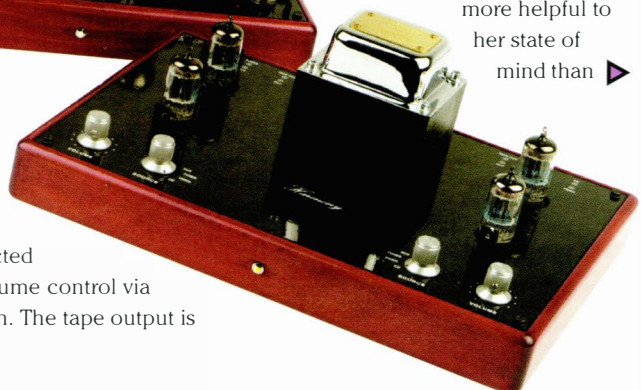

▶ anything I could have said.

Only marginally less silly was using a pair of Audiovector F3 loudspeakers with the Synthesis. Although comparatively efficient, having used them for the last couple of months it has become obvious that they need plenty of control at the bottom end, hardly the forte of a small valve amp. But then again... Although I was not getting the 'corner turning' precision that something like the Bryston can give, it highlighted just how sharp and tactile the bass performance of the little Renaissance was. Provided one did not go wild with the volume control, kick drum had surprising speed and energy, endowing music with great pace and drive. Like I said, not the normal behaviour for a small valve amp, and streets ahead of any SET that I have heard.

Midrange and top end had a wonderful liquid quality to it, and female vocals such as Eva Cassidy were reproduced exceptionally well, with loads of space and

ambience around the performer, while the live recording had all the intimacy of the club just right. And such emotion... listening to the track 'Autumn Leaves' brought a lump to my throat. The pre-amp proved to be equally at home with CD or Vinyl (fed from the Pass Labs phono stage), and a quick listen to it in isolation showed it to have quite a warm character, a bit lacking in resolution, but always comfortable to listen to. I found it reminiscent of the Klimo pre amp that I reviewed a couple of years ago in Issue 3.

Until fairly recently, a fifteen Watt per channel amplifier would have presented considerable problems with system matching – small amplifiers and efficient loudspeakers were out of vogue. These days there is enough of a choice to make it far less of a problem. On the basis of what I have heard of the Synthesis amplifier, it amply demonstrates all the things that small amplifiers are good at, but does not suffer the negative aspects of the single ended triodes that I

have heard, and found difficult to come to terms with. I'm thinking in particular of their bottom end

performance, which seems to be spongy and lacking in bite, with a tendency toward a vague and somewhat distant presentation, that is more

than just a product of their limited power output. I often wonder whether the enthusiasm that some people have for single-ended triodes is misplaced – what they are hearing might have more to do with good low power amplification rather than the output devices and configuration used. All I can say is that I would far rather live with the Synthesis than any of the single-ended designs that I have so far heard. It has a grip and authority completely out of proportion with either its size or its rated output, combined with the benefits that normally accrue from small push-pull valve designs. It's also compact, beautifully finished and nicely styled. In fact, and against my better judgement, there's only one word to really describe it, and that has to be cute. ▶+

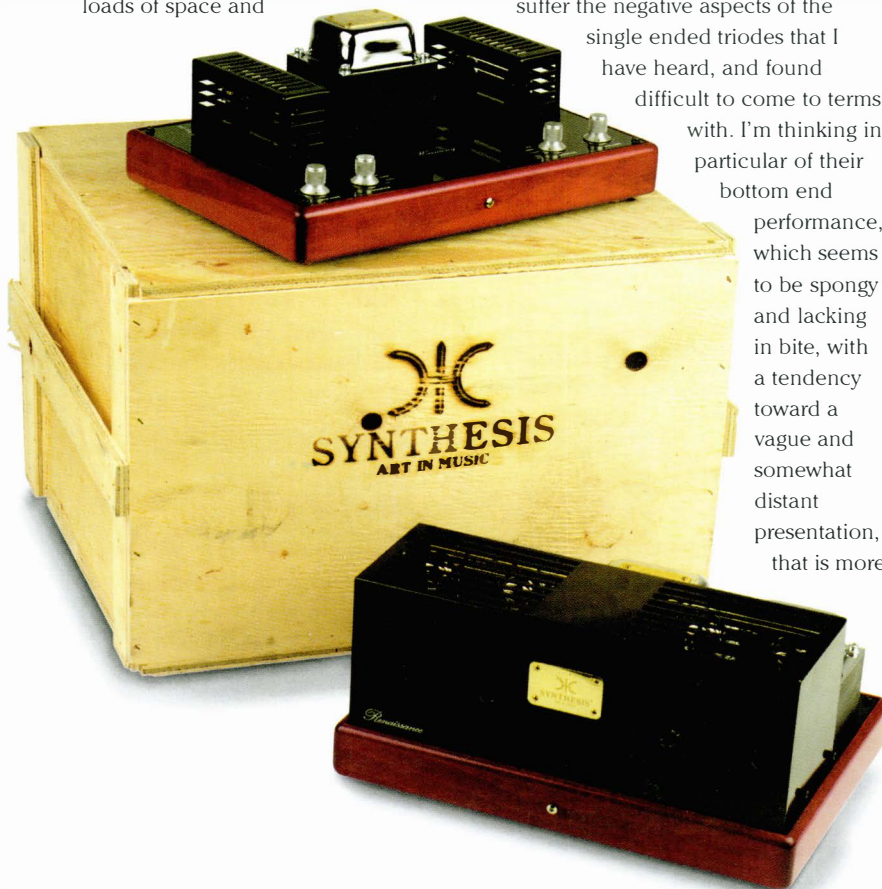

#### TECHNICAL SPECIFICATIONS

##### Harmony pre-amp

Inputs:	4 Line level
Input impedance:	100 K Ohm
Input sensitivity:	Unspecified
Output impedance:	1.5 K Ohm
Frequency response:	20Hz – 20Kz
Valve compliment:	4 X 12UA7 (ECC82)
Dimensions (WxHxD):	320 x 220 x 120mm
Weight:	5 Kg
Price:	£699.00

##### Renaissance power amp

Input sensitivity:	1 Volt
Input impedance:	82 K Ohms
Power output:	15 Watts
Output impedance:	6 Ohms
Frequency response:	20 Hz – 20 KHz
Valve compliment:	4 X EL34 4 X 12AU7
Dimensions (WxDxH):	320 x 220 x 160mm
Weight:	10 Kg
Price:	£949.00

##### UK Distributor:

Audiofreaks  
 Tel. (44)(0)208 948 4153  
 Fax. (44)(0)208 948 4250  
 E-mail. [Info@audiofreaks.co.uk](mailto:Info@audiofreaks.co.uk)  
 Net. [www.audiofreaks.co.uk](http://www.audiofreaks.co.uk)

# Rogue Audio's

## Mark O'Brien & Mark Walker

by Roy Gregory

*Rogue Audio is a small company with a big reputation in its home market. Whereas most of us associate US valve amps with high priced exotica from the likes of Audio Research or Conrad-Johnson, Rogue are busy producing great looking, great sounding products which retain their bargain price tags even after they've crossed the Atlantic. That's rare. Rare enough to find out what makes the company tick.*

**RG. Rogue Audio represent part of a third generation of US high-end valve manufacturers. Marantz, Fisher and Macintosh would be the first: the likes of Audio Research, Conrad-Johnson and VAC the second. Then comes companies like Hovland and you guys. How did you get started?**

**Mark O'Brien.** That's interesting because I never thought of it as a generational thing. But I guess you get started because you believe that you can do it better than the people who've gone before. You have to believe that (laughs), but only time will tell if you're right. I've been into hi-fi my whole life really, designing speakers and amps and stuff since I was a little kid. So I'd built a lot of gear, but mainly speakers and solid-state amps and I'd heard some good sounding tube systems from people like Audio Research, but mostly they were too expensive. Eventually I decided to buy a pre-amp from one of the better known companies (who shall remain nameless). I got it home and it sounded terrible – really muddy, with no bottom end and no detail.

**RG. This was a product with a reputation I take it?**

**MO'B.** Oh yes. Big company, still around. So I came to the conclusion that the really good stuff I couldn't afford so I'd better build something. That's when I built some really bad tube pre-amps. But after a while I started figuring out what I was doing wrong. Designing tube equipment is totally different to anything else in electronics. You're dealing with high voltages which make it difficult not from a design point of view but in terms of sourcing components and finding good components that will handle the voltages. So after fooling around for a while I started to actually produce a few units that sounded pretty good which is when I started thinking about turning it into a business.

**RG. Where does your background in electrical engineering come from?**

**MO'B.** I have a degree in Physics from Cal Poly, after which I worked as a research physicist at Bell Labs for a number of years, and that afforded me a great opportunity because most of the people I worked with had degrees in electrical engineering which they got back in the '40s and '50s when tube gear was current. So here was a great resource: Bell Labs Doctors available, not to help me with design, which I wanted to do myself, but to answer questions for me. They also allowed me to build up this amazing library of text-books too. Later, when I really decided to make a go of it I got some partners, Mark Walker and Phil Cook, which was when I decided I needed a bit more marketing expertise so I went and got an MBA.

**RG. So how did you get involved with this?**

**Mark Walker.** Basically I was suckered into it. Mark and I worked together on a number of projects at Lucent (Bell Labs), we were having a couple of beers one night in a bar and he suggested we start this amp company.

**MO'B.** I got him drunk!

**MW.** And he took advantage of me. Anyway I told him he was crazy and I blew him off. He kept coming back and this went on for like six months or so and eventually I agreed to do the mechanical design for him, after which he could do what he liked with it. So I did the design, sourced the chassis parts, got 'em in, started building them and after that I'm not sure what happened. Here I am.

**RG. One of the things that I like about the Rogue amps is that they're the first valve amps in a long time that have both a highly developed identity and one that looks different to everything else, which I think is really important.**

**MO'B.** We think that's important too. At first we made a lot of prototypes that looked like V8 engines and stuff that "Real Men" would want to own. But my sister runs a real up-scale ►



► design agency, an architectural firm, so eventually we drafted her in and she helped out on the visual design of the 66 (pre-amp) and 88 (power-amp). After that Mark sort of took the ball and ran with the theme, keeping a single product lineage.

**RG. So when did all this happen?**

**MO'B.** We talked about it a lot in early '95. I hammered together a formal business plan in April '95 and we incorporated in '96 and in '97 we had a static display at the Stereophile show in San Francisco. We had a static display and that's where we picked up our first retailers.

**RG. What products do you make now and are they the same products you've always made?**

**MO'B.** We make the 66 pre-amp available with either a phono-section or remote control volume (but not both). The 88 is a stereo amplifier with 60 Watts per channel. Those were our first two products and came out simultaneously. Then came the M120 mono-blocks followed by the 99 remote control pre-amp with optional phono-stage. Then came the Tempest integrated and now over this past year we have unveiled the Magnum models of all these products, which have done amazingly well for us.

**RG. So what are the Magnum series?**

**MO'B.** The Magnum series product are the same basic circuits but with better components. In terms of the power-amps that means much larger output transformers, ultra-premium coupling caps, upgraded tubes (and 6550 rather than EL34 output tubes), predominantly Vishay resistors and a much bigger power supply with a couple of modifications. Then there're gold tube sockets, better binding posts and a number of cosmetic improvements. On the M120s that costs an extra \$800, or \$400 an amp. That's outstanding value for money. The transformers alone cost us over \$100 a piece, which gives you some idea. The same thing goes for the pre-amps, but there the changes are mainly for component type, connectors, that sort of thing, and the cost increase tends to be a little smaller.

**RG. Your products are remarkable for being so affordable in an industry that almost prides itself on being unaffordable. Do you plan to keep it that way or do you see yourselves moving upmarket?**

**MO'B.** Our roots are in providing affordable yet sonically excellent gear and we'll always remain there because that's where we really feel we can contribute to the high-end. In designing stuff that is really premium in performance but applying our engineering talents (we all came from a design

and manufacturing background) to keep the products affordable. Easy to construct and reliable yet still operating in a top level way. It doesn't preclude the possibility of more expensive gear but I think that our products will always remain value orientated, regardless of price.

**RG. The other thing that is very obvious about the range of products that you make is that they don't follow fashion as such. Instead they follow sound engineering principles. So for example your amps are efficient, ultralinear pentodes while most of the competition are hell-bent on producing triodes.**

**MO'B.** There's a couple of reasons for that. I don't think that single-ended triodes are anything more than a fad that'll last a couple of years. The benefits of push-pull are very real, and whilst I've heard great sounding single-ended systems, in the real world the pros of push-pull outweigh the cons. At least in most peoples' systems. Another factor is that one of the ways we can keep our gear affordable is to do a brisk volume. Whilst everything is hand built it still has to appeal to the widest possible audience and that means fitting in with the widest range of system requirements that you can. That means it has to match peoples' expectations in terms of sound quality, power output and load tolerance in as many cases as possible. I don't think it would be possible to produce a super quality single-ended design that would appeal to enough people to make it viable to produce.

**RG. It would be inherently expensive?**

**MO'B.** Yes. One way we can keep our products affordable is to re-use circuitry and components in a number of designs. So all our power-amps use pretty much the same driver circuit and that keeps our parts inventory small, allowing us to do strategic supply management much more easily, making the whole operation more efficient. A single-ended design would require a completely different parts inventory which, because of the lower volume would sit around for a long time, costing us more money, which in the end the customer ends up paying for.

**RG. So what new products does Rogue have in the pipeline?**

**MO'B.** Well, we're working on two phono stages. One should be available in November, the other for CES (January). The first is an all solid-state design, using leading edge op-amps and passive RIAA. It's got multiple stages of regulation so that it's a real quiet unit and we worked hard to eliminate all the RF problems that afflict phono amplification because of the very high gain. The second is a reference quality tube

▶ phono section which also has a solid-state boost so that you can use cartridges with an output of 0.1mV and below.

**RG. So the tube section will accept something like a Lyra Helikon straight in?**

**MO'B.** Oh absolutely. As a matter of fact the phono section in our 99 pre-amp will do 0.5mV and up. (A fact verified by a surprised CB when he reviewed the Rogue combination in Issue 10.) It sounds very nice – pure tube, passive RIAA. I was surprised. I took the 99 to a reviewer who specialises in single-ended amps and vinyl and he was doing a survey of different tube phono sections. He said the 99 was the quietest of the bunch, yet the whole phono stage and pre-amp cost less than any of the phono sections he had on test. They all sounded great...

**RG. It does seem that solid engineering is a keynote of what you are doing.**

**MO'B.** Absolutely. We were all senior engineers at Lucent and we definitely prefer to rely on engineering rather than trial and error. Of course there's a little of that too but I think it's interesting that the importance of parts quality is often way overstated by manufacturers. You can make a great design sound good even with mediocre parts, but no matter how many premium parts you throw at a flawed design it's always going to be flawed. It'll never sound good.

**RG. After the phono stages, what then?**

**MO'B.** I don't know if I should tell you (chuckles). We've gotten a lot of requests from stores in large metropolitan areas for a large stereo amplifier. Mono-blocks in apartments are a nuisance and they'd like to have a stereo amp capable of delivering 100 Watts in triode mode, over 200 in ultralinear. So we're working towards that – a product that can compete against the likes of the Audio Research VT200, will have all the bells and whistles like balanced inputs but still be reasonably priced.

**RG. At the moment the M120s represent one of the few affordable routes to serious valve power. Everybody else building amps with that sort of output are doing it very expensively.**

**MO'B.** Yeah, and they're not doing anything that we're not. The M120s were absolutely a design that happened because I wanted them for myself. That's the best part about running an audio company: you want some 120 Watt mono-blocks then you design one and put it into production. But we hit a home run with that piece for just those reasons: it sounds great, it

looks great, it's reliable and at that price it's the only game in town. It benefits from our experience with the 88 of course, but it's our best selling bit of gear, which is interesting because it's also the most expensive.

**RG. We've had the collapse of the far-eastern market and the expected down turn in the US. As a result a lot of the male jewellery brands have either disappeared or had to retrench and return to the lower levels of their home market. They've found it a very different place to the one they left. How do you see the US market changing?**

**MO'B.** I think the most obvious thing is that the hyper expensive gear seems to be going away. The big companies can no longer support themselves on the sale of big ticket items – people just don't seem to be buying them in the same numbers that they were. I'd like to think that part of the reason is that people are realising that they no longer have to spend the sort of money that they used to in order to realise the same performance. That they're recognising the value inherent in our and some other people's products. In fact to some degree I think we're responsible for the well being of quite a lot of audiophiles by driving some of the bigger players into the less expensive product areas. They're coming into the market that we've owned in the US for the last few years. We're fortunate that when we started Rogue Audio the economic heyday for audio companies had already passed so we were never able to build up the sort of overhead and manufacturing infrastructure that larger companies are now struggling to maintain. Some of them are seeing pretty tough times because their market has gone away. That's why we're seeing so many new or re-vamped budget ranges from the big players.

**RG. The valve situation in the US seems to be rather confused at the moment. There seems to be this rush to triodes while the big amps from the likes of Audio Research and conrad-johnson, even the M120s, are taking something of a back seat, certainly in terms of press exposure.**

**MO'B.** I'd say that that was certainly true two years ago but I think it's definitely on the wane. That's exactly the sort of question I ask retailers – how's the single-ended stuff going? Lot's of people will disagree with me on this but I get the impression that it's definitely diminishing, even in terms of relevance.

**RG. The people who want it have got it...**

**MO'B.** Well yeah, and quite frankly, single-ended amps are so simple that the people who want them can build them themselves. It's a wonderful thing to do – there're lots of kits ▶

► out there. It's something a lot of people who are fascinated with valves want to do – burn their fingers a bit.

**RG. What place do you see valves occupying in audio's future?**

**MO'B.** Well, I think that it's virtually impossible to build a really cheap, reliable, good sounding valve amp. The audio marketplace isn't as large as it was - we're never going to mass-produce tube amps. Nevertheless, for people who are serious about audio it seems that just about everybody migrates towards tubes. They get tired of the edginess of solid state sound, they know that transistors cause cancer (smiles) and after a while they get into tubes. So I think that the people who get into, and remain into audio will eventually wind up with tubes. I genuinely believe they sound better, and now the majority of serious amp manufacturers are making tube equipment. There'll always be the serious solid-state amps like Krell, but I don't think they'll ever replace or even seriously challenge tubes.

**RG. You don't see a threat from the multi-channel and home cinema market?**

**MO'B.** No absolutely not. In fact I can see the multi-channel market actually helping two-channel audio. Four or five years after home theatre really got popular and we're taking calls all the time from people who want to keep their home theatre set up but they see two channel as the natural home for music. The other thing is that we get asked for a lot of pre-amps with home theatre by-passes so that people can integrate their home theatre into their stereo system. The two channel sounds better, but trying to run two systems results in a living room that looks like an appliance store so being able to integrate is really important and we see a lot of that.

**MW.** About a third of the pre-amps that we ship now have home theatre by-passes.

**MO'B.** I actually see the growth of home theatre as a way of leading people back into two channel.

**RG. Because you hand build everything does that allow you to offer options to people?**

**MW.** We get requests for special options all the time. A lot of things we can do, a lot we can't, but within certain parameters if there's something we can do we'll do it and it's made easier by the fact that we build each unit to order.

**RG. What sort of volume of business do you do?**

**MO'B.** We prefer to keep the actual figures pretty close to the vest, but we're real happy if we ship much more than a hundred units a month. Let's say we do over a thousand units a year. We've become real popular and we take customer service real seriously. We do whatever it takes to make sure that whoever owns our equipment is happy with it and that's great because we've got a tremendous buzz on the internet, and that's helped us a lot. Basically we've all been treated badly too and we try not to do that to our customers.

**RG. What proportion of your production goes overseas?**

**MO'B.** Not a lot really – around 20%. But it's increasing and that's something we're going to start working on. Until now we've really just let it develop naturally because when you first start building gear you get bugs and you have pieces returned for silly reasons. That's a lot more of a problem if they're in Saudi Arabia than if they're in Ohio.

**RG. One of the problems that faces anybody shipping value for money product abroad is that what's a bargain in its home market can look like expensive exotica by the time it turns up overseas. One option is to impose price parity, but that tends to produce a dramatic price hike at home.**

**MO'B.** We've managed to avoid both those problems to some degree by factoring in a distributor's margin from the start. It means our products are a little more expensive abroad but consumers are smart; they understand that it takes money to send an amplifier to Turkey and they're willing to support that cost. But it's very frustrating to us when we see gear that we consider should be affordable selling for much higher prices than it should abroad. Fortunately consumers don't put up with that for very long, especially with the internet. That's a great equaliser – people know how much something should cost and that keeps everybody honest.

**RG. Where do you source your tubes?**

**MW.** All over – it depends on the type. We use a lot of eastern European tubes, JJ and Teslavac. A lot of new-old stock such as 6SN7s and even some Chinese tubes can sound good.

**MO'B.** We've had a lot of trouble with noise on modern 6SN7s, and reliability. Finally we managed to source several thousand 50 year old Russian military units. They look exactly like the ones they make now, it's just that their performance is stellar.

**MW.** It's always a case of running around looking for good tubes at the right price, but then that applies to everything we do. I guess that's what the company is all about. ►+



PHONO

CD

TUNER TAPE

AUX 1

AUX 2

BALANCE

MUTE

POWER

# Rogue Audio 66 LSR Pre-amp and 88 Power-amp

by Roy Gregory

Ever wonder where the valve equivalent of the pared down, solid-state “budget esoterica” integrated amplifiers are? You know, a drive most things, good sounding basic design for less than \$500. Well sorry to disappoint you but it's never going to happen. The inherent nature of the technology makes it impossible. That might seem like a strong statement but let's examine the facts. Valve circuits employ much higher voltages than solid-state equivalents making the components they employ more expensive. Add to that the fact that both the quality of the valves themselves and the output transformers is absolutely critical to overall musical performance, and that good ones cost money, and the parts bill is starting to escalate. Next factor in a decent power output and suddenly we need big valves (or lots of small ones) and big transformers to go with them, which as well as being even more expensive, also require a large (and expensive) chassis to contain them. I'm afraid that good, competent, all-round valve amps are always going to be the expensive preserve of the dedicated enthusiast.

So what are we to make of the Rogue Audio 66 and 88? Here we have a genuine pre-power combination enclosed in stylish and beautifully executed casework. The 66 pre-amp uses a separate outboard power supply, offers six inputs and a choice of remote control volume or a MM phono-stage. With mute and balance too, the only thing missing is a mono switch, and let's face it, that's just a personal foible

that most people will never use. The 88 power-amp is contained in a substantial, fan-cooled enclosure finished with Rogue's distinctive milled aluminium faceplate. Inside you'll find a round dozen tubes, with four KT88s arranged in ultra-linear output pairs providing a healthy 60 Watts per channel. Take the lids off both units and you'll find evidence of cost cutting hard to find. There might not be the dusting of “audiophile” brand name components (more on that subject later) but as Rogue are quick to point out, those are very much the expensive icing on the cake. All the fancy bits in the world can't turn a poor basic circuit into a good one. Much more important they reason, to worry about getting it right in the first place.

The 66 and 88 represent a set of seriously well engineered and presented, classic valve amps. They are large, heavy and imported. Nothing unusual there then. The difference is that they only cost £1295 and £1495 respectively, and that's for products that have been brought across the Atlantic.

Not surprisingly, Rogue Audio has built an enviable reputation for value in their home market. It's a reputation that started with the 66 pre-amp and has embraced each and every subsequent product, including the 99 pre-amp and M120 monoblocks previously reviewed

by CB. What's more interesting is that these aren't simple me-too or re-hashed application circuits. The Rogue products are carefully considered and implemented designs in their own right: Hardly surprising given the design and engineering credentials of the company's owners. Indeed, there are a number of unusual features, such as the application of fixed bias, even in the powerful M120s. Dig a little deeper and you'll find other nice touches like the mechanically isolated transformers in the power-amp. There's no mistaking the thoughtful and considered choices that have been made in the design and development of these products.

Looking at specifics, the 66 pre-amp has its own, highly regulated, off-board HT supply. The line stage employs a pair of 12AU7s, and if you go with the phono option then that adds a further four 6DJ8s. The balance and volume pots are sourced from Noble, another case of spending money where it matters. The unit that arrived for review was the 66LSR complete with its solidly built two-button remote control. Not being a fan of remotes I would have preferred to try the phono option, but understandably these are far rarer beasts in this day and age. The remote works fine, with a decent range of operation, but



▶ I'd have liked better level indication on the pre-amp, and a mute button would have rounded things off nicely.

The 88 power-amp is a model of common sense. It offers a pair of phono inputs and single sets of binding posts for each channel. Internal adjustments allow you to optimise the transformers for 4 or 8 Ohm loads, and there's even a switch to allow the output stage to be reconfigured into triode mode (if you absolutely must). The cooling fan is temperature controlled, and rarely activated in my colder than average listening room. When it did (with the cat asleep on the top grille) it made nothing more than a low murmur and I can't see it disturbing anybody. In use, both units were completely fuss free, testament to the sound engineering that's gone into them. Internally, the amp makes use of massive regulation that accounts for the high component count. Overall, the 88 weighs in at an impressive 55lbs dead weight, just in case you thought that a few material corners had been cut along the way. It's an impressive package, regardless of price, but pitched at £1500 it has the look of a real bargain. Having said that, there's only one way to find out.

I used the Rogue amps between the Eikos and Marantz SA-1 digital front-ends and Living Voice and Audioplan Kontrast speakers, the latter providing a particularly happy match. Vinyl replay was provided for by the Clearlight Recovery, armed with an Incognito Rega arm and Lyra Helikon cartridge. The Groove stepped in to amplify the signal. Both the Rogue units fitted perfectly into my Clearlight RDC racks, and accommodation shouldn't be a problem. For those who don't get on with the sculpted silver faceplates, there's also a black option.

It's a matter of personal opinion, but I'd take the silver every time.

It's rare indeed to receive a pair of equally matched pre and power amps for review and the Rogue's are no exception.



Generally speaking it is the pre-amp that suffers, and so it is here. The only surprising aspect is the 66's stellar reputation in the US. It makes me wonder what these guys are listening to. However, before we get carried away let's make it clear that the 66 is far from a bad product. In fact it's actually pretty good. The problem is that it's eclipsed by the truly outstanding performance of the 88 power-amp.

Listening as a pair it's the 66 that dominates proceedings. Playing the wonderful opening track from Gillian Welch's *Time (The Revelator)* (Acony Records ACNY-0103) it is hard to miss the pre-amp's influence. I hear it in a broadband tint that robs the guitars of individuality and the voice of colour.

There's a consistent texture there too, not exactly a grain, more like orange peel, that homogenises the harmonic structure of the notes. Finally, there's a hesitancy and lack of melodic fluidity, and this on music where the melodic line is both everything and beautifully delivered. Sounds pretty damning huh? Well, on the plus side the 66 offers presence and emphatic dynamics, excellent separation and excellent top to bottom evenness, which are no mean achievements in a pre-amp at this price. I'm tempted to pass it on to PR with his recent experience of the Crofts for a second opinion.

Pre-amps have always been the hardest part of the amplification equation, with worthwhile models being countable on the fingers of one hand. The only stuff around for comparison with the 66 is both proven and more expensive, so whilst it's easy to criticise the little Rogue Audio unit I'm not sure you can do any better for the money, and that's really the point, because the 88 deserves better - a lot better.

Substituting the Klimo Merlin, a similarly specced but rather more expensive unit,

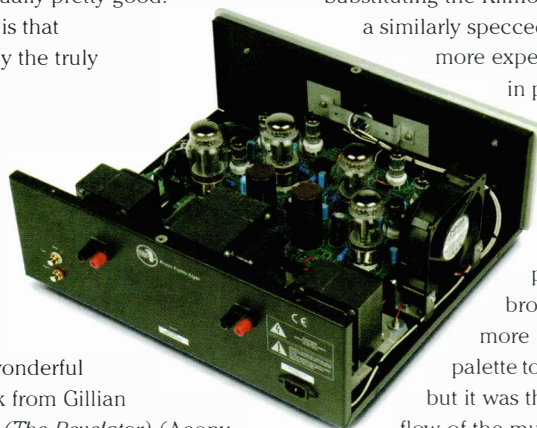

in place of the 66 allowed the 88 to spread its wings. The new pre-amp brought a much more natural tonal palette to proceedings, but it was the timing and flow of the music that was transformed. The shape and sustain of the notes, the way they are stretched, the subtle little dynamic graduations that accent the melody ▶

► were all far more convincing. With music as sparse as this (two acoustic guitars with an occasional backing vocal) the believability of the presentation is critical to its enjoyment. Each and every deviation stands out like the moustache on the Mona Lisa. What the Rogue Audio 88 allows is the music to enjoy its full range of dynamic and temporal expression without imposing itself on proceedings. Of course that's what low powered, single output pair, push-pull valve amps are renowned for. The difference is that the Rogue offers a healthy 60 Watts per channel which will happily embrace a whole host of distinctly real world speakers.

Turning to the other end of the spectrum Eiji Oue's fantastic performance of the Rachmaninoff *Symphonic Dances* (Reference Recordings RR-96CD) gave the 88's power delivery full rein. But the really impressive thing, in a piece of music which depends on dynamic contrast for its impact and the quiet passages for its effect, was not so much the sheer power and volume of the loud passages, but the fact that the crescendi arrived exactly on time. Dynamic scaling was excellent, allowing each orchestral layer to build on the last, but it was the way in which blasts of broadband energy were delivered right across the lower registers without any slurring, emphasis or lag that really delivered the full orchestral impact. It's a trick which eludes far too many real power house amps, and whilst the 88 isn't in that league it has power enough for most of us.

Equally impressive were the quieter passages, revelling in the 88's broad, stable yet intimate sound stage.

The complex and constantly shifting contrasts of Rachmaninoff's score were beautifully preserved, held separate without ever being dismantled. Transparency and tonal colours are good, but it's this rhythmic and organisational suppleness that makes the Rogue so musically expressive. Whether it's a case of conjuring the individual contributions of the Minnesota players under Oue's baton or the stark intimacy

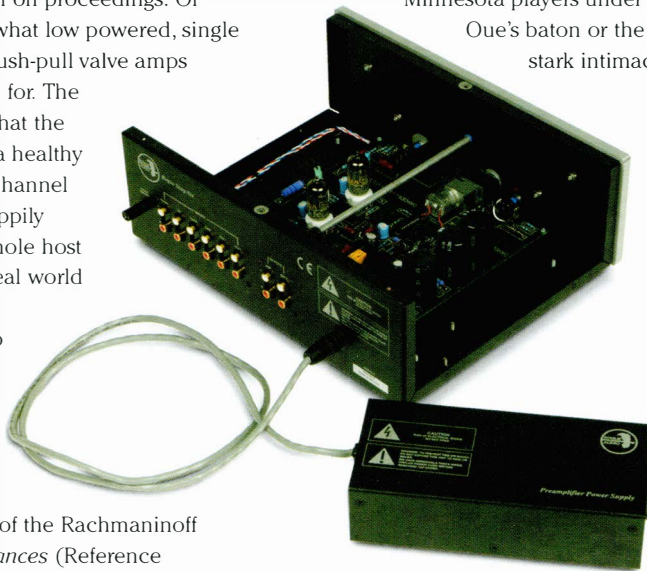

of Gillian Welch, the Rogue proves equal to the task. I've deliberately chosen examples from opposite ends of the scale simply because that's where so many amps fall down. The Rogue doesn't, because it gets so many of the basics right. Its sure footed stability and the evenness of its energy delivery enabling it to survive in really exotic company whilst demanding more performance than the 66 can provide. Fortunately, the answer lies in Rogue Audio's own 99 pre-amp, which at £2000 does for line stages what the 88 does for power-amps.

But that's not the whole story. Given the performance of the Rogue Audio amps it was inevitable that someone would ask just what might be possible with better componentry. Well, the answer exists in the shape of the Magnum editions, more expensive

versions of the basic Rogue products, built with audiophile bits, and in the case of the power amps, better output valves and transformers. The upgrades add £200 to the cost of the 66 and £400 to the 88, and yes, they are retrofittable, although the precise logistics of that for UK customers are still being considered. So, whilst the jury's still out on the 66 and the Magnum version might well swing the vote, the 88 is a definite star. It could just be that elusive all-rounder I've been searching for. The 88 Magnum sure has a hard act to follow, but hey, I'm reviewing it in the next issue so all will be revealed. ►+

#### TECHNICAL SPECIFICATIONS

##### Rogue Audio 66 LSR Pre-amp

Type:	Valve line-stage
Valve Complement:	2x 12AU7 4x 6DJ8 in optional phono stage
Inputs:	6x single-ended line
Outputs:	2x single-ended main
Output Level:	1.5V
Overall Gain:	23dB (line stage) 40dB (phono stage)
Dimensions (WxHxD):	356 x 140 x 280mm
Finishes:	Silver or black
Price:	£1295

##### Rogue Audio 88 Power-amp

Type:	Ultralinear valve amplifier
Valve Complement:	4x 12AU7, 4x 12AX7, 4x KT88
Power Output:	60 Watts into 8 Ohms
Input Sensitivity:	1.0V
Dimensions (WxHxD):	464 x 178 x 400mm
Weight:	55lbs
Price:	£1495

#### UK Distributor:

Audiocraft  
Tel. (44)(0)1895 253340  
Fax. (44)(0)1895 238238  
E-mail. kevinwalker@genie.co.uk

#### Manufacturer:

Rogue Audio  
Net. www.rogueaudio.com

# Heatherdale Audio

Mark Levinson Reference  
Mark Levinson  
Revel  
Madrigal  
Thiel  
Lyra  
Stax  
Martin Logan  
Copland  
Sonus Faber  
Proceed  
Koetsu  
Ortofon  
Mitchell  
Clearaudio  
Graham Tonearms  
VPI Record Cleaners

Heatherdale Audio  
202 Findon Road  
Worthing  
BN14 0EJ  
Tel: 01903 872288  
Fax: 01903 872234  
heatherdale@hifi-stereo.com  
www.hifi-stereo.com

Look

Listen

*Lumley*

## METROPOLIS

*Your search is over*

Pure single ended

Pure class 'A'

100 watts into 8 ohms

Electronics ten years guarantee

Valves three year guarantee



**Distributed by:** Metropolis Music, 6 London Road, Tunbridge Wells, Kent, TN1 1DQ  
Tel: 01892 539245 Fax: 01892 616383

Distributors for Boulder, Passlabs, B.A.T. Advantage, Howland, Burmester, SAT, VTL, Sound Lab, Kharma, Meadowlark, Copulare, Acoustic Zen



AUDIO NOTE  
AUDIO PHYSIC  
BEL CANTO  
ES LAB  
ROGUE AUDIO  
DCS  
DYNAVECTOR  
ACCUPHASE  
JM LABS  
KOETSU  
LIVING VOICE  
LAVARDIN  
GRYPHON  
AVANTGARDE  
NAGRA  
MARANTZ  
SPECTRAL  
VERITY AUDIO  
SONY  
SME

DEMONSTRATION  
BY APPOINTMENT ONLY

SCOTLANDS  
PREMIER  
HI-FI  
DEALER

tel: 01563 574185  
fax: 01563 536027

**KEVIN GALLOWAY audio**

email: [info@kevingallowayaudio.co.uk](mailto:info@kevingallowayaudio.co.uk)  
[www.kevingallowayaudio.co.uk](http://www.kevingallowayaudio.co.uk)

**The best hi-fi, backed up by the experience  
and service to make it work**

**Visit us on the South Coast**

**Find us at:**

Movement Audio  
588 Ashley Road  
Parkstone, Poole BH14 OAQ  
Tel: 01202 730865

**Chord Electronics  
amps and DAC now  
on demonstration**

**movement  
audio**

[www.movement-audio.co.uk](http://www.movement-audio.co.uk)

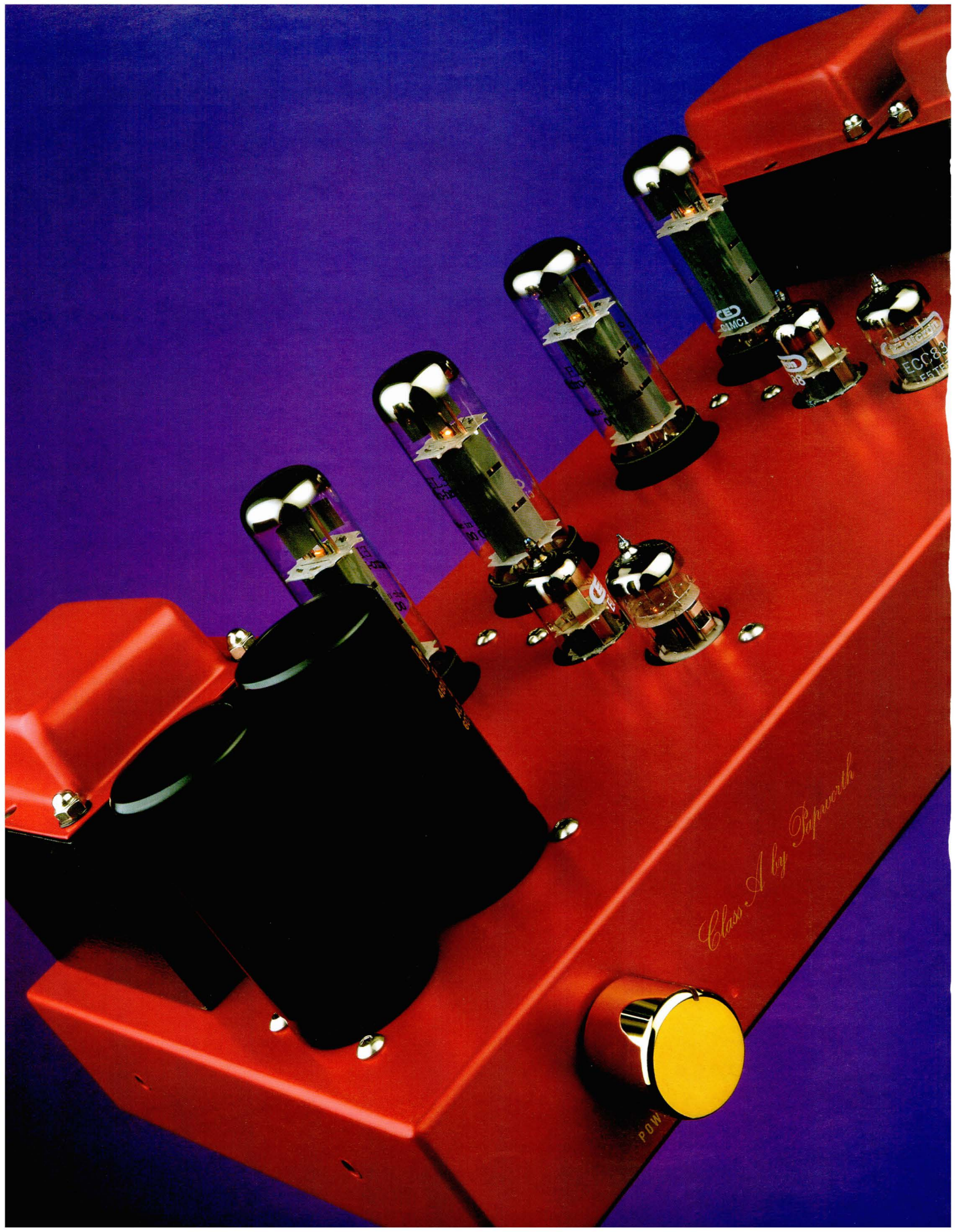

*Class A by Papworth*

POW

ECC83  
EFT86

6X4

6X4

6X4

6X4

# Papworth TVA 8 Integrated Valve Amplifier

by Jimmy Hughes

My hi-fi system definitely needed a shot in the arm - no question. Ever since I lost the services of Chord's superb DAC-64, things haven't sounded quite right - see my regular comment whinge this month. A change was required: fresh blood. But what price a new amplifier being the answer? Actually, I'd have thought it most unlikely. The amplifier I currently use - an EAR-859 - is an excellent device, combining outstanding resolution, fine detail, with an engaging unobtrusive naturalness. I've used it contentedly for about four years now, and have long felt it gave an overall quality of sound that would be difficult to better. It's not an amp for headbangers or those wanting something loud and in your face. But, providing you don't need more power than it offers, it's an exceptionally capable product, sounding effortlessly dynamic and focussed on the one hand, and beautifully smooth and natural on the other. I love it. And that's why it's stayed in my system so long.

So, imagine my surprise when I tried Papworth's TVA 8 and heard something that combined all the good points of the 859, with increased transparency, depth, and dimensionality. Since the DAC-64 went, things had sounded a shade flaccid and lacklustre. Brilliance and excitement were lacking; the music wasn't sounding as involving or

as exciting as I'd have liked. Given the fact I was using a good but (by DAC-64 standards) average DVD player as my source, the culprit seemed easy to identify. Basically, I needed a better front-end...

Which is why the improvement made by the Papworth proved so surprising. It's a lovely sounding amplifier; smooth,

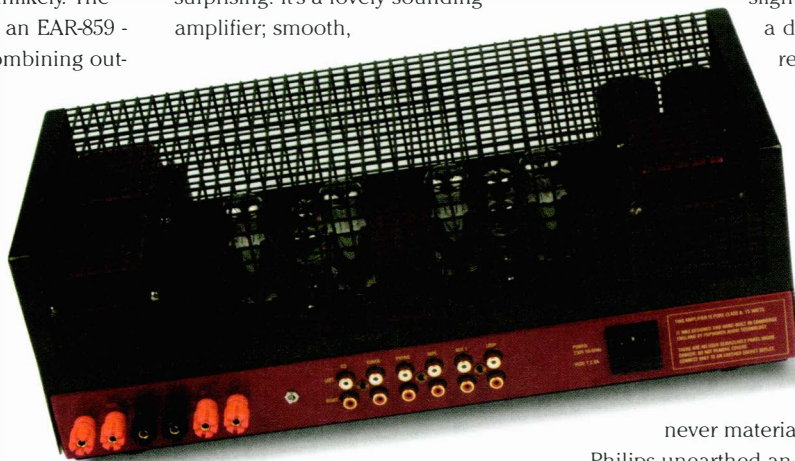

clean, and very well-balanced. First impressions were of a lively engaging musical presentation, with lots of depth and space around voices and instruments. Detail was very crisply portrayed, allowing all sorts of subtle dynamic inflections and changes of pitch to register with exceptional clarity. It allowed the music to breathe and expand - what more could one ask for?

I was initially impressed by the way the Papworth seemed able to reveal all kinds of delicate nuances and fine details, while at the same time giving a strongly projected and often excitingly dramatic musical presentation. Playing Martha Argerich's fiery Philips account

of Rachmaninov's *Third Piano Concerto* (446 673-2) the Papworth really brought out all the raw edge-of-the-seat dramatic qualities of the playing. Yet it did so without obvious excesses and exaggerations.

Previously, this recording (first issued in 1995) had disappointed slightly. Rach 3 is a difficult concerto to reproduce, and the Philips sound seemed to lack brilliance and sparkle. Argerich fans had long wanted her to record the work, but for some reason a studio recording

never materialised. Instead, Philips unearthed an analogue radio performance taped live in Berlin back in 1982. The Tchaikovsky concerto with which it's paired on CD dates from 1980 - another analogue radio broadcast.

I'd known the Tchaikovsky since its release on LP over twenty years ago, and once again it's never been an easy recording to reproduce. The orchestra sounds slightly boxy and opaque, and overall the recording lacks ventilation. At the same time, the upper frequencies have a slightly grainy quality. Miraculously, the TVA-8 seemed to bring out all the previously absent colour and tonal brilliance, revealing in the process the excitement and tension of both live performances. ▶

▶ Again and again I was struck by how communicative and involving the TVA-8 made things sound. And not just the Argerich recordings mentioned above. Other less volatile musical performances suddenly took on a fresh lease of life. It's a very 'fast' amplifier: swift-paced, lively, and excellent at portraying rhythmic drive. Although I wasn't using an outstanding digital front end, subjectively it almost sounded as though the DAC-64 was back in the system again.

There was the same improved clarity and separation, and a similar sense of spatial dimensionality. There was a similar sense of authority and dynamic abruptness; like the DAC-64 the TVA-8 could produce a solid commanding musical presentation that really grabbed your attention. Okay, in absolute terms the sound almost certainly wasn't as good as it had been with the DAC-64. But heard in isolation it didn't seem too far behind.

What also impressed was the naturalness of the sound. There was no sense of the increased clarity and excitement being created by tonal balance exaggerations. The TVA-8 was a just shade brighter than my 859, but not by much. No doubt the increased brightness/sharpness did help to focus detail more positively. But surprisingly the extra immediacy was not accompanied by an increase in treble roughness or edginess. Indeed, the opposite; I'd actually say my 859 sounded grainier than the TVA-8.

My 859 seems less lively in the 'presence' region, giving a sound that's more contained and less effervescent. The TVA-8 is more immediate and direct; the music all but leaps from the speakers. It gives an impressively vivid holographic presentation that's both engaging and beguiling. As a result,

the sound is full-bodied and big - much bigger than you'd believe possible given the low-power of the design. It's 15W going on 500W. At least that's what it often sounds like...

Inevitably, there are restrictions on power. To hear the TVA-8 at its best you'll need efficient speakers - say 95dB

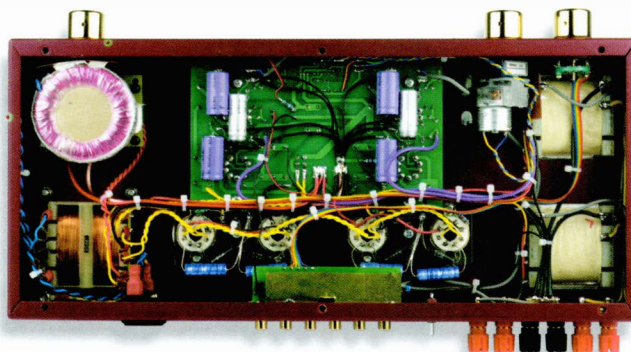

for 1W, or greater. Which isn't to say you can't use anything less sensitive - you can. But, maximum volume levels will be restricted. My Impulse H-1s are about 96dB/1W, and for nearly all kinds of music the TVA-8 sounded adequately powerful. But, I did run into trouble on one or two discs, including the Argerich Rachmaninov 3 mentioned earlier.



Trouble is, the TVA-8 sounds so clean and engaging, it all but begs you to turn up the volume. This is a good sign, of course. But, unless your speakers really are ultra-sensitive, you may find power reserves are breached during heavy climaxes. Although the TVA-8 operates well when played at lowish volume levels, you may want to turn

things up to achieve maximum impact. Subjectively, the amp seems so effortlessly big and powerful, it's quite a shock when you suddenly hit the end stop.

In this context I'd say the TVA-8 clips more aggressively than my 859. The latter tends to compress and saturate more than clip - you sense it softening transient edges and damping-down climaxes. Often, it does this so smoothly you're hardly aware the amp's reached its power limits. The TVA-8 is inclined to coarsen slightly under pressure, and occasionally break-up when really pushed. Using sensitive speakers makes the most of what power there is. Actually, I didn't help matters by using the TVA-8 on its 4 Ohm loudspeaker setting; choosing

the 8 Ohm output gives perhaps a couple of dBs extra volume - quite significant. But I prefer the 4 Ohm sound; tonally it's slightly darker, but better separated with increased clarity. The 'correct' output impedance for your particular speaker is always the one that sounds loudest - increased volume level indicates a better impedance match between output transformer and speaker.

However, the lower impedance seems to impart greater firmness and control. I've actually rewired my 859 so it runs off the 4 Ohm tap on the output transformer. But it's for you to try yourself. Experiment and see! Another tip - try using the TVA-8's

▶ tape output socket (marked Loop) as your main input. Because you're by-passing the main input selector, you get a cleaner shorter signal path. And better sound. But doing this is only practical if (like me) you primarily use just a single source.

Papworth rate the TVA-8 at 16W output. This is the point at which clipping occurs. Distortion is about 0.5% at 10W - mainly second-harmonic. Input sensitivity is 290mV, and frequency response is given as 35Hz to 22kHz within 0.5dB. These specifications are good but hardly earth-shattering. This is definitely an amplifier that sounds better than figures would lead you to expect. It's an amplifier for listening to rather than measuring.

Papworth Audio Technology are based in Cambridge. Given that they apparently specialise in 200W monoblok amplifiers with excellent specifications - most of which go for export - how come they decided to produce the TVA-8? I'm told it was Papworth's answer to a request from London specialist dealers Walrus who wanted a low-powered parallel single-ended high quality tube amplifier offering outstanding sound quality, stability, and reliability.

The circuit took 18 months to finalise. The basic requirement was for a good reasonably-priced, straightforward, uncomplicated, consistent, untemperamental amp. It was also vital for the design to achieve very low residual noise and hum, enabling it to be used with ultra-sensitive speakers. Electroharmonix EL-34s were chosen, and the circuit uses the valves well within their BVA ratings - so they're not stressed. This should increase valve life, not to mention improving long-term reliability.

Regarding noise, I can confirm that the TVA-8 is remarkably silent - even pressing my ear close to the drive units I could hear no hiss or hum. My Impulse H-1 horn speakers are by no means the most sensitive speakers on the market,

but they're efficient enough to have revealed noise from one or two amplifiers in the past. Papworth give a noise rating of -95dB unweighted (ref 15W) for the TVA-8 - a very impressive figure.

Mechanically, the TVA-8 isn't quite as silent as it is electrically. There's slight noise from the tubes, and some faintly audible transformer buzz. But nothing too serious - unless you're sitting right next to the thing. Styling is attractively Retro or dull '50s four-square depending on your point of view. But the finish is very nice indeed - a rich dark burgundy red stove enamel, applied in three coats. Knobs are gold plated, and (surprise!) the volume can be adjusted by a remote handset.

Although the output is said to be Class A, the amp runs cooler than one might've expected. The caged top ensures excellent ventilation, while protecting the tubes from prying fingers. There's a switch on the back to disconnect mains ground, enabling you to quickly choose the option that delivers minimum hum. However, as the heart of your system, the amplifier should be earthed, with other components being grounded when they're connected to it.

A superb amplifier then; one that really does impress with its combination of vividness, detail, dynamics, and dramatic musical portrayal. Add to this sheer unexaggerated naturalness and you've a recipe for the (near) perfect amplifier. Power output is limited, so to experience the TVA-8 at its best you need sensitive speakers. Hearing it has certainly made me think twice about my own EAR-859 - and there aren't very many amplifiers I can say that about.

I think my 859 may need re-valving. I've used it for well over four years, and it had at least two previous owners before I got it! So perhaps it's comparative lack of pep is down to aging/ aged tubes. But I don't want to take anything away from the TVA-8, which really has made a deep impression. It's incredibly engaging and involving musically, while

at the same being mightily impressive at all the hi-fi things like depth, imaging, detail, and dynamics.

Yet perhaps what I like best of all is the TVA-8's ability to reproduce music vividly without sounding overtly 'Hi-Fi'. While listening to the Argerich Rachmaninov *3rd Concerto*, all I could think of was the greatness of the music, the superb quality of the solo playing, and how exciting it must've been to have actually attended the live concert from which the recording was taken. It's superb at conveying the thrust and physical excitement of great music-making, yet wonderfully subtle and delicate too.

There you have the TVA-8's great strength - turning inanimate recordings into living breathing musical performances. In this sense it's neither an amplifier for rock or classical. It's great at both; combining smoothness, refinement, and naturalness with attack, dynamics and immediacy. At £1699 it's quite keenly priced too; you could pay far more and not end up with an amplifier half as good. ▶+

#### TECHNICAL SPECIFICATIONS

Type:	Parallel single-ended Class A valve integrated
Inputs:	5 line inputs
Input sensitivity:	290mV
Outputs:	1x speaker, 1x tape
Valve Complement:	2x EL34 / channel
Rated Output:	16 watts / 8 Ohms
Dimensions (WxHxD):	450 x 210 x 170mm
Weight:	16kg
Finish:	Burgundy
Price:	£1699

#### UK Distributor:

Walrus Systems  
Tel. (44)(0)207-724-7224  
Fax. (44)(0)207-724-4347  
E-mail. Mail@walrus.co.uk  
Net. www.walrus.co.uk

#### Manufacturer:

Papworth Audio Technology  
E-mail. Info@papworthaudio.demon.co.uk

B

**Border** *Patrol*



# The Border Patrol Power Supplies

by Roy Gregory

When it comes to buying hi-fi, most of us are forced to take the cost/performance/value for money triangle into account. It applies when we buy our first system; we know what we'd like but we're limited to what we can't quite afford. It applies to our later upgrades. In fact, it applies with a vengeance to upgrades because as soon as we replace something in the system the question of depreciation raises its ugly head. Sure, we don't think of it like that because to us the upgrade seems cheap: the cost of the new unit less what ever we get for what it's replacing. It's a bargain; at least that's what we tell ourselves, our wife, girlfriend, partner and anybody else who'll listen. Which is a nice way of deluding ourselves because the actual cost of the new unit is the purchase price plus whatever we've lost on the outgoing one. You've had the use of it, but don't think you got it for free. Unless that is, you can upgrade without throwing out your original purchase.

Ever wonder why Naim are so successful? Now you know. It's all those add on boxes (as well as the fact that if you don't want the box you've got, then somebody else will). Which of course is only any good if you own a Naim system – or a valve amp, because what a Supercap does for a Naim set up, a Border Patrol power supply will do for most of the thermionic alternatives. They even do it in a similar fashion, by grafting on a high quality regulated supply, but there, not surprisingly, the similarities end.

Don't valve amps have high quality power supplies built in? Not like this they don't, but to understand why that is we need to look at a couple of typical

power supply topologies. In a valve rectified circuit of the type most commonly applied to current valve designs (see diagram below) the degree of regulation is defined by the size of the input capacitor, generally something in the region of 10 micro-farads. The problem is that, in turn, the size of that capacitor is limited by the current capability of the valve that precedes it in the circuit, which limits its ultimate effectiveness as a regulator.

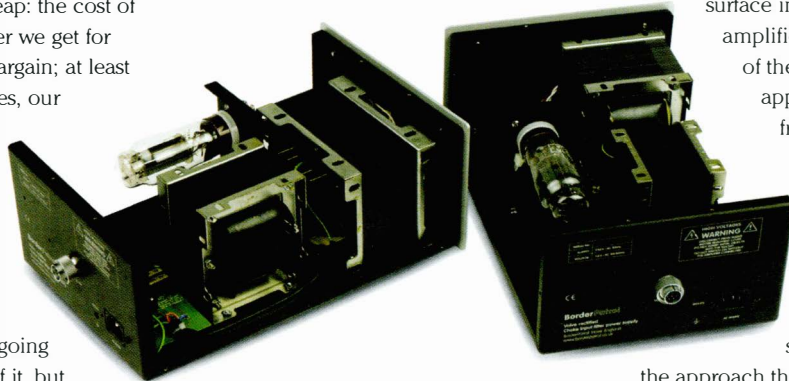

Don't valve amps have high quality power supplies built in? Not like this they don't, but to understand why that is we need to look at a couple of typical power supply topologies. In a valve rectified circuit of the type most commonly applied to current valve designs (see diagram below) the degree of regulation is defined by the size of the input capacitor and the size of that capacitor is limited by the low current capability of the valve rectifier. Consequently the regulation of the supply is poor. Why do we want good regulation? Because without it we get the fat ponderous bass, poor dynamics, flat compressed sound and inability to play anything but the simplest passages of music that characterises so many valve amplifiers.

The obvious alternative is to use

solid-state regulation. Bridge rectifiers will pass plenty of current (just look at the size of the input capacitor in the circuit diagram below) but are guilty of themselves producing high frequency switching noise. Which is why many people eschew their use, and those who do use them often employ a choke to try and block any spurious noise (and yes I know that there have been some serious advances in solid-state regulator design, but most of those are yet to surface in the world of valve amplification). So either of the common approaches suffers from problems when it comes to supplying clean, well-regulated power. But there is an alternative, the choke regulated supply, and this is

the approach that Border Patrol employ. Back in Issue 8 I reviewed their 300B power amp, an unusual two box design, and basically, what we're talking about here is the power supply section of that amp, but applied to other designs.

The obvious alternative is to use solid-state regulation. Solid-state rectifiers can pass plenty of current so the input capacitor can be much bigger (just look at the size of the input capacitor in the circuit diagram below) and the regulation therefore better but solid-state recs are guilty of producing high frequency switching noise which adds metallic edginess to the sound and pollutes the noise floor of the amp robbing the sound of resolution and low level information. Solid state rectifiers are usually used with smoothing resistors, rather than smoothing chokes (check out the Audio Innovations

supply) and this approach offers very little high frequency attenuation so any mains borne HF rubbish finds its way into the amplifier and further pollutes the sound. So either of the common approaches suffers from problems when it comes to supplying clean, well-regulated power. But there is an alternative, the valve rectifier-choke regulated supply, and this is the approach that Border Patrol employ. Border Patrol claim a valve rectifier used in a choke input filter topology gives an ideal combination of regulation, high frequency attenuation and lack of electronic noise. Back in Issue 8 I reviewed their 300B power amp, an unusual two box design, and basically, what we're talking about here is the power supply section of that amp, but applied to other designs.

At first sight engineering a universal power supply for a whole host of different power amps might seem like an incredibly complex task, however, it's considerably simplified by the inherent simplicity of valve circuits themselves. Each Border Patrol supply can produce a single regulated voltage of 300+ Volts and applies it to the HT circuit of the amplifier. But given that the vast majority of the more commonly used valves run at between 300 and 430 volts, that means that they can be set to embrace any amp using EL34, 6L6, EL84, 300B or 2A3 output valves, amongst others. As many cheaper amplifiers, such as the Audio Innovations 800 that Gary loaned for listening purposes, employ a single HT supply, that means the whole amplifier benefits from the external regulation supplied by the Border Patrol. That leaves the unit's own mains transformer with only the heaters to worry about. There are of course output valves that run at far higher voltages, such as the 845 and 211 triodes, and whilst it would be theoretically possible to build a choke regulated supply capable of delivering the thousand or so Volts that they demand, it would be monstrously expensive. Add to that the prospect of

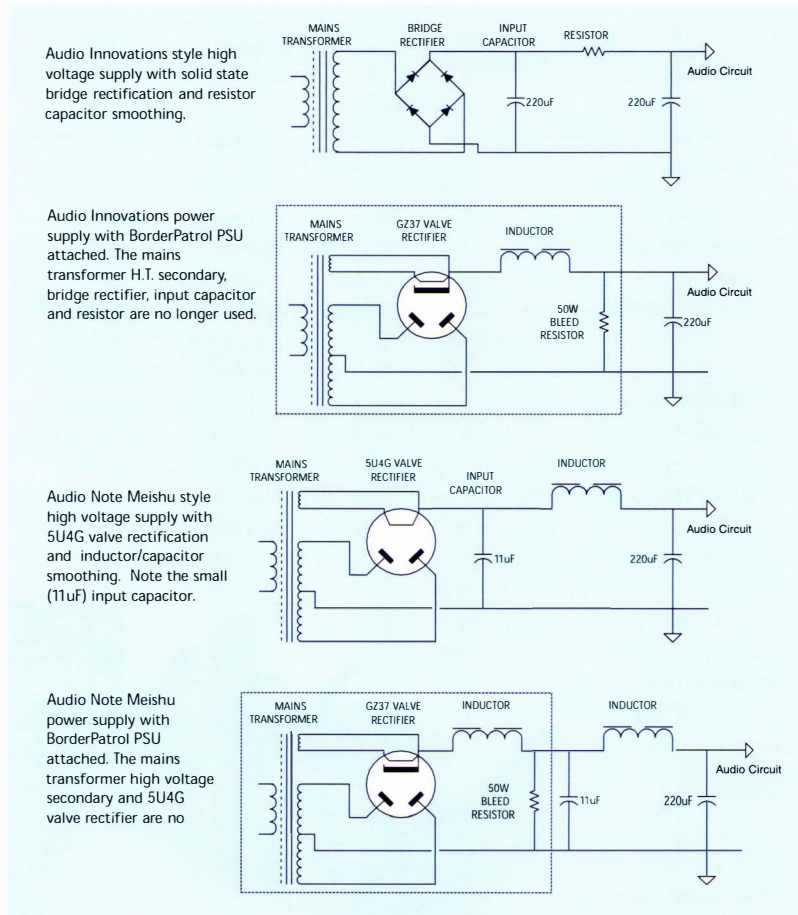

passing that kind of voltage down an umbilical and into the amp and it's easy to understand why Gary is reluctant to follow that course.

At first sight engineering a universal power supply for a whole host of different power amps might seem like an incredibly complex task, however, it's considerably simplified by the inherent simplicity of valve circuits themselves. Each Border Patrol supply can produce a single regulated voltage either 300, 390 or 430V and applies it to the HT circuit of the amplifier. But given that the vast majority of the more commonly used valves run at between 300 and 430 volts, that means that they can be set to embrace any amp using EL34, 6L6, EL84, 300B or 2A3 output valves, amongst others. As many cheaper amplifiers, such as the Audio Innovations 800 that Gary loaned for listening purposes,

employ a single HT supply, that means the whole amplifier benefits from the external regulation supplied by the Border Patrol. That leaves the unit's own mains transformer with only the heaters to worry about. There are of course output valves that run at far higher voltages, such as the 845 and 211 triodes, and whilst it would be theoretically possible to build a choke regulated supply capable of delivering the thousand or so Volts that they demand, it would be monstrously expensive. Add to that the prospect of passing that kind of voltage down an umbilical and into the amp and it's easy to understand why Gary is reluctant to follow that course.

So having established the operating context I guess I ought to describe the Border Patrol units in a little more detail. There are two outwardly identical models, the Standard at \$595 and



► the MB (answers on a postcard please) at £995. The essential difference between the two is that the MB is capable of delivering 350mA of current to the Standard's 250mA, necessitating a much larger transformer and choke, along with a noticeably heavier overall weight. Owners of the Standard model can have

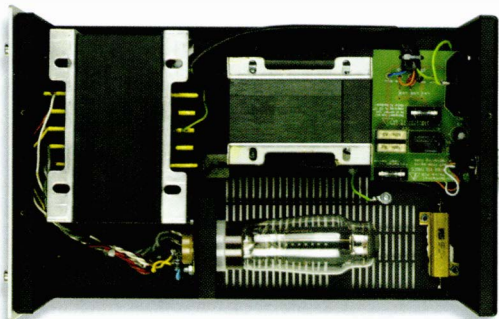

it upgraded to MB status for £450, on which more later. Going back to the general schematics that we used earlier, this is how the Border Patrol supplies cut into the circuit.

The first thing to notice is how the GZ37 rectifier valve feeds directly to the large choke which is then responsible for the regulation, making the valve's current capability irrelevant to the question of quality. Basically, the bigger the choke the better the regulation it provides. Note also that the input capacitor is bypassed in the Audio Innovations. Being a push-pull amplifier the circuit topology actually provides a degree of self-cancellation of power supply ripple and thus requires less smoothing. The same isn't true of single ended designs, as we shall see. The second thing is that the Border Patrol transformer works at a higher voltage than the original. Like many things that sound good, choke regulation isn't the most energy efficient way of doing the job, which helps explain why you don't find choke regulated supplies fitted as standard (except in the aforementioned Border Patrol amp and the Pure Music amps reviewed in Issue 12). They need big transformers, large chokes and big boxes to put them in. All of which are

expensive. Add to that the fact that the chokes are prone to mechanical noise and create huge hum fields and it should be obvious that it's far from straightforward to get the best out of the technology, requiring considerable skill and patience to deliver the full potential.

In use the donor amp is fitted with a hard-wired umbilical which is connected via a substantial locking socket to the Border Patrol unit. As well as carrying the regulated HT back to the amp, this wire also carries voltage from the amp's heater supply to the Border Patrol, where it operates the main power relay. The benefit of this is two fold: it provides remote switch on for the supply,

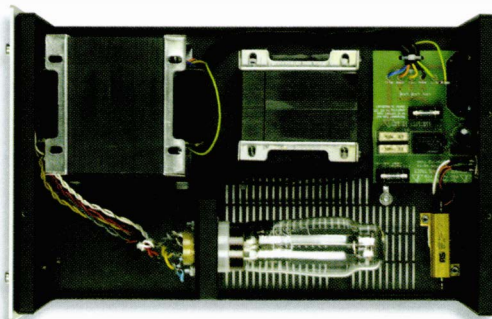

meaning it can be tucked away, but more importantly it also makes it impossible for HT to reach the valves without heater voltage, thus avoiding potentially disastrous consequences. Both Border Patrol units are finished in black painted casework with identical silver aluminium front panels. The effect is workmanlike rather than impressive, but then as I mentioned earlier, you'll probably want to tuck them away anyway.

Gary supplied the power supplies along with the Audio Innovations 800 and Audio Note Meishu amps already described. These were fitted with rear panel switches so that they could be played as standard or connected to either of the Border Patrol supplies. At the same time he delivered the Canary Audio 608 integrated, reviewed elsewhere, with and without the MB

power supply, so I won't dwell on that here. However, it should be noted that the Border Patrol supplies are simply a blood transfusion for ageing valve amps. Whilst they'll transform both vintage (Leak, Radford) and valve renaissance designs (Croft, Audio Innovations and Art Audio) they are equally at home with and just as applicable to brand new purchases, either when you buy them or as an upgrade.

We started listening with the AI 800, a fairly standard ultra-linear EL34 design, remembered chez Gregory mainly for its easy, open midrange rather than as an outstanding amp in its own right. The kind of product whose school report might have read "polite enough but really could do better". And how! Adding the BP Standard PSU brought immediate

gains in almost every aspect of performance: greater transparency, a blacker, quieter background, better separation, better focus and crisper, wider dynamics. The soundstage was clearer and much more coherent, the playing was tighter and the performance musically and rhythmically more coherent. Playing 'The

Thing You Love (Is killing You...)' (Dolly Varden *The Dumbest Magnets*) the individual instruments and voices each took on a more separate and identifiable character: the guitar placed stage-right suddenly grows a body and harmonic complexity, the tambourine becomes a ring of distinct rattles rather than an irritating tizz. But the really important thing is that despite the increased colour and separation, musically speaking the band pulls in closer together. The chemistry in the performance, the players playing off of each other, the careful interweaving of the two voices becomes clearer and stronger. Diane Christiansen's voice loses the edge and grain that characterised the performance of the standard amp. Now it was smooth and direct and communicative, singing straight to you. ►

▶ Now this isn't a subtle change in performance, or a musically trivial one. It isn't cosmetic or a question of taste. It cuts right to the heart of the amp's function and creates better, more credible music. Substitute the MB PSU in place of the standard model and you extend that tendency even further. The bass gains additional authority, you can hear the bottom of the bass drum and guitar now, rooting their notes with a proper foundation. More importantly, the sound grows in temporal sophistication. Now it's the band that defines the pace and attack of the song, controlling events and their destiny.

If I was impressed by the performance on the Innovations amp, it did nothing to prepare me for the transformation wrought on the Audio Note Meishu, a £3500 single-ended integrated running one 300B per channel. In stock form this amp could only be described as disappointing. The musical picture it paints is grey, flat and disjointed, with no separation to talk of and no dynamic discrimination. The overall effect is congested and messy, exacerbated by a splashy tendency and very poor control: All in all a bit of a sonic disaster area.

Adding the BP Standard PSU brought about a Cinderella makeover of the kind that daytime TV producers can only dream about. It was as if the milling herd of musical notes had been rounded up and sent off in a single direction. Now the music had a sense of unified energy and purpose. Individual instruments and voices were properly separate and took on something approaching their real colour. All of a sudden the rhythm and pace of the music hove into view like a ship out of the fog and we were off and running. Diane Christiansen's acerbic delivery regained its sardonic twist, the musicians started to actually play together. In fact, it's difficult to overstate the magnitude of this improvement. Any Meishu owners out there would be shocked to the core: the designer should

seek a very, very dark room.

Once again the MB PSU extends the tendency, bringing authority and definition at the frequency extremes to the extent that you could even follow bass lines (an impossibility with the amp in standard trim). Don't assume that because the description is rather glib this is any less important than what the Standard model achieves. It is actually even more fundamental, with the music gaining a solid foundation and temporal base. The end

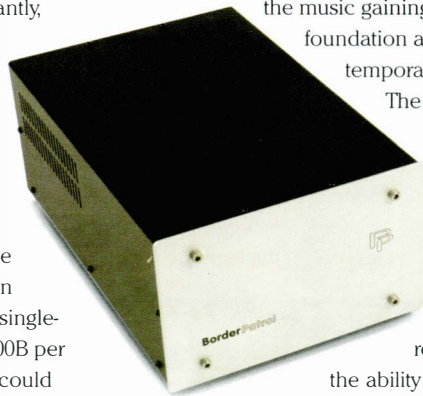

result is the ability to convince and transport the listener, which is what really good hi-fi is all about. There's no law of diminishing returns here, but the good news is that if you've invested in the Standard supply you can always have it upgraded to MB status at a later date.

Why the BP supplies should have such a staggering effect on the Meishu is open to question. Gary believes that it reflects the fact that the inherent simplicity of single-ended designs allows you to hear the power supply that much more clearly: Certainly, the evidence of his own 300B amp (reviewed in Issue 10) supports that view. In the case of the Meishu they succeed in turning a very nasty, soggy mess into something very respectable indeed, averting the necessity for replacement, saving you from financial disaster and a stricken conscience. I mean, who are you going to sell it to?

The performance of the Border Patrol supplies is impressive indeed both with single-ended and push-pull designs. Because they add value to an existing unit their return on outlay is even higher,

easily outperforming more conventional upgrades in monetary as well as sonic terms. Like all modifications they'll invalidate the guarantee on the existing amplifier, something to consider if you are purchasing it brand new. However, in that case I'd talk to your dealer about taking that on. After all, it's in his interest to make the sale. The only other consideration is that the modification should be undertaken by one of Border Patrol's qualified dealers: HT is no place for enthusiastic DIY! With those two provisos dealt with I can't recommend the Border Patrol power supplies highly enough. Well thought out and executed, they represent a perfect way of realising the hidden potential inherent in a literally thousands of systems out there. If you're using a valve amp and you're looking for an upgrade: if you're using a valve amp and you'd like to hear what it can really do: if you're using a valve amp and you're just down right sceptical: give Border Patrol a call and arrange a demonstration. I'd be surprised if you're only surprised: shocked is generally nearer the mark. ➤+

#### TECHNICAL SPECIFICATIONS

Type:	Choke regulated HT power supply
Output Voltage:	Adjustable - 300, 390, 430V
Peak Current Capability -	
Std:	250mA
MB:	350mA
Dimensions (WxHxD):	345 x 220 x 145mm
Weight:	11kg STD 15kg MB
Finish:	Silver faceplate, black chassis
Price -	
Std:	£595
MB:	£995
Upgrade Std to MB:	£450

#### Manufacturer:

Border Patrol Ltd  
63 Berriedale Avenue  
Hove, BN3 4JG UK  
Tel/Fax. (44) (0)1273 276716  
E-Mail. bp@borderpatrol.net

# definitive audio



...land of opportunity and adventure...

We could tell you that Definitive Audio is the most highly acclaimed audio specialist in the country. Thankfully we don't have to, other people have been doing it for us.

We are regularly featured in specialist journals, underground fanzines, high circulation glossies and even the odd radio programme. The interest is flattering.

Paul Messenger described us as having "The crucial X factor that makes a good system great".

Jason Kennedy said, "Every time I visit Definitive Audio the systems sound better and better".

Alan Sircom said our £3.5k system "...breaks almost all the rules... I have encountered few systems that sound as good as this one - at any price".

We could go on - but enough of the trumpet blowing. Our real success lies in providing an open-minded environment that is free from hype, a quality of relationship with our customers that is second to none, and an experience that is as reassuring as it is refreshing.

Our showrooms are situated in a roomy Victorian mill 1 mile from Junction25, M1.

Please ring for appointments, general enquiries or for more information.

## LIVING VOICE



hi-fi  
PRODUCT  
YEAR

hi-fi  
EDITOR'S  
CHOICE

EDITOR'S CHOICE  
HI-FI CHOICE  
magazine

### Auditorium Avatar

Hi-Fi Plus *Editor's Choice*  
Hi-Fi Plus *Product of the Year*  
Hi-Fi Choice *Editor's Choice*

"The Avatar is a near perfect balance of size, bandwidth, efficiency and tonal refinement. Its slim lines and small footprint deliver a genuine 94db sensitivity, and excel when it comes to delivering the scale, vibrance and colour of the music. Its unobtrusive quality allows it to cut straight to the heart of a performance, unlocking the music trapped in the recording, whilst its refinement makes it equally at home with both basic and surprisingly expensive amplification."

Roy Gregory

AMEX • VISA • MASTERCARD

Tel 0115 973 3222 Fax 0115 973 3666

internet: [www.definitiveaudio.co.uk](http://www.definitiveaudio.co.uk) email: [shout@definitiveaudio.co.uk](mailto:shout@definitiveaudio.co.uk)  
Living Voice • Helios • Border Patrol • Art Audio • SJS Electroacoustics • Wadia  
Vitavox • Lowther • MF • Nott'm Analogue • Western Electric • SME • Canary

it sounds better neat



neat acoustics

tel: 01833 631021 fax: 01833 630022

e-mail: [bob@neat.co.uk](mailto:bob@neat.co.uk)

<http://www.neat.co.uk>

neat ELITE

music to the **n**<sup>TH</sup> degree

See us  
at Novatel  
Room 3096

VOLUME



CANARY AUDIO®  
VACUUM TUBE INTEGRATED AMPLIFIER  
*Handcrafted in California*  
CA-608

POWER



TUNER  
AUX  
LD  
CD  
SELECTOR



# Canary Audio CA608 LV Integrated Amp

– Or, Dr. Strangelove goes to town...

by Roy Gregory

Back in Issue 6, CB reviewed a new and impressively bulky integrated valve amplifier from Canary Audio. He welcomed its excellent construction and solid, no nonsense design based around a couple of pairs of push-pull EL34s, concluding that, at its introductory price it represented a serious bargain. We weren't the only ones who were impressed. Kevin Scott of Definitive Audio, designer of the Living Voice speakers saw in its bluff shape and simplicity the perfect partner for his Auditorium floorstanders. Even after a very necessary price increase from the previous loss-leader levels to a rather more realistic \$2250, the CA608 remains an impressive performance package. But, like all products built to a price it involves a number of fairly obvious compromises when it comes to the internal components. Intrigued by the clean simplicity and useful output of the basic circuit Kevin began to wonder just how much those compromises were holding back. Thus was born the CA608 LV.

Starting with the standard unit Kevin went straight for the usual suspects. Out went the ALPS volume potentiometer to be replaced by a high quality TKD stepped attenuator. Next to go was the simple four-pole source selector, this time replaced by an ELMA gas evacuated model. Finally, and in true Definitive Audio style, the coupling caps were round filed to be replaced by the excellent Hovland film and foil

designs. Of course, stacking a product with this kind of high-zoot hardware has a deleterious effect on its purchase price. In this case the small matter of \$750, however as we shall see, it's money well spent. The icing on this particular cake comes in the form of the Border Patrol power supply, reviewed elsewhere in this issue, and a standard

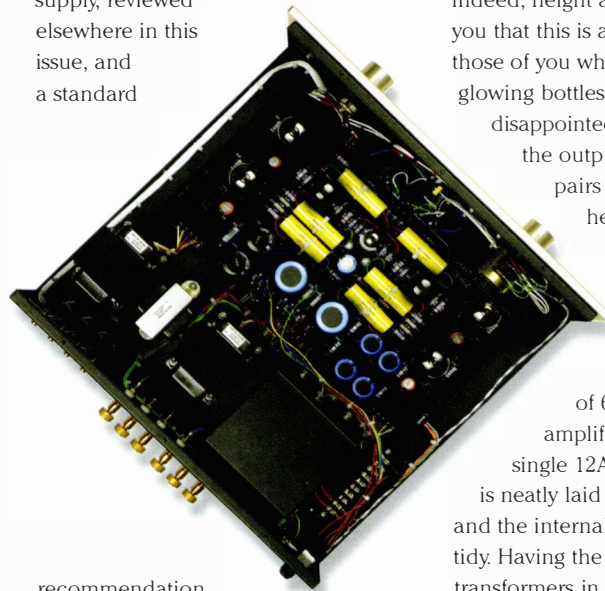

recommendation as far as Kevin is concerned. Having heard the results I can only concur. In this guise the amp becomes the CA608 LVBP, but if you go the whole hog and order the big supply then it's the LVBPMB. Of course, by this point you'll have almost doubled the purchase price of the original design, which explains why it's an approach that no sane manufacturer would adopt.

But we're getting ahead of ourselves. For those of you who missed the original review a brief recap is in order. The Canary Audio CA608 is a classic ultra-linear power stage built into a substantial enclosed casework, rather like a Copland but lacking the latter's svelte Scandinavian exterior. Indeed, height aside there's little to tell you that this is a valve amp at all, and those of you who like the look of little glowing bottles are going to be sadly disappointed. As mentioned earlier, the output stage employs single pairs of EL34s, biased fairly heavily into Class A for about 25W/ch (they'd deliver around 20W in pure Class A). Phase splitting is undertaken by a pair of 6SN7s, while voltage amplification depends on a single 12AX7A. The whole circuit is neatly laid out on a single PCB, and the internal wiring is especially tidy. Having the mains and output transformers in a row across the back of the chassis makes it awkward to handle, but that's nothing new for a valve amp.

The CA608 provides four line level inputs and outputs for a single pair of speakers tapped for either 4 or 8 Ohms. There's no line stage proper or tape output, which really makes this a switchable input power amp. People wanting to run A/V systems should look elsewhere. The front panel is ▶

▶ available in either blue or the champagne finish supplied for review. Externally there's nothing to distinguish the LV from the standard version, although a glance through the lid grille clearly reveals the large and very yellow Hovland caps.

The thing which makes the Canary such an appealing prospect, just like the many similar designs that have preceded it over the years, is its combination of the delicacy and communicative attributes of a small and essentially simple valve amplifier with a rated output capable of driving real world loudspeakers. As CB noted, the CA608 is no powerhouse, but it's surprisingly capable as long as you don't try to pair it with anything too inefficient or awkward to drive. Team it with a speaker that actually offers sensitivity in the low nineties, like the Living Voice Avatar or the OBXs that I had on hand, and the results are astonishing. Which is exactly what got Kevin so excited in the first place.

So what exactly does the LV offer over the standard version? Once it's run in, a lengthy process thanks to the Hovland caps, the benefits are far from subtle. The modified CA608 is altogether more refined and sophisticated than the standard version. It's hard to know where to start, but perhaps the most obvious changes are the increase in transparency and bandwidth. The modifications remove a whole layer of grain from the recorded acoustic, allowing you to see far further into the performance and giving a much more palpable sense of the space around and between the players. And lest you think that confines the benefits to acoustic recordings rest assured that the benefits are just as relevant to close

miked vocals and multi-track pop productions. Indeed, the shape and depth of the bass lines on Tosca's *Suzuki in dub* (G-stone 012 CD) are dramatically improved, adding variety, texture and mobility to an already impressive mix. If this doesn't get you gyrating in private

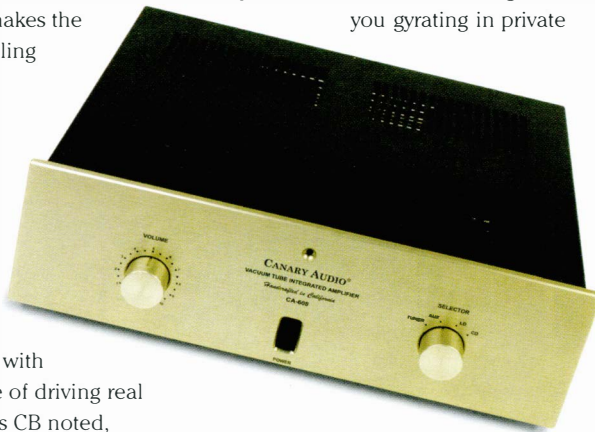

(not a pretty sight in my case) then nothing will. And that new found assurance at low frequencies is mirrored at the top end of the spectrum, with an obvious increase in air and focus.

Less immediately apparent (until you swap back, when you wonder how you missed it) is the increased tonal and temporal resolution. Notes start and decay far more naturally, with better placement and more obvious relationships between them, making for far greater ensemble understanding within recordings. Individual notes offer far more complex harmonics and individual instruments have much more identifiable tonal identities. The result is a lush and more highly developed tonal range combined with a crisper and far more transparent presentation, making the performance both more immediate and engaging, but most importantly of all, more believable.

So far so good, and definitely value delivered for money well spent, but the

real fun starts with the addition of a Border Patrol power supply. That lifts the performance from the merely impressive to the downright imposing. If you read the Border Patrol review elsewhere you'll see that their power supplies come in two different varieties, priced at £600 and £1000 respectively. I'm going straight for the big boy here. Why? Because I've already explained the differences between the two units in the Border Patrol review and those observations hold good here too. But mainly because it makes so much musical sense: Once you've heard the benefits the financial considerations are reduced to the "How am I going to find the money for this?" level.

What does the MB power supply bring to the party? In a word, authority: It takes the impressive bandwidth, tonal colour and transparency of the LV modification and injects power, precision and dynamic tension into the mix. The results are simply astonishing. The majestic sense of graceful power belies the modest rated output, bringing drive and purpose to



music on demand and a palpable delicacy where required. The presence and substance of the music is independent of level, and for once the images and soundstage are consistent through dynamic shifts.

Playing the *Adagio* from the Argenta Edition *Concerto de*

► *Aranjuez* (the Speakers Corner box set) on the Clearlight/Incguito/Helikon through the Groove phono stage and the CA608 LVPBMB demonstrates the point perfectly. Yepes' instrument is rich and solid at the front of the stage, the distance between him and the orchestra clearly defined. His playing of the opening melody is full of poise, the phrases liquid and delicate, his hesitations, the notes he sustains and those he delays, clear both in fact and purpose. The why of the playing is so wonderfully apparent that I've rarely heard this beautiful performance sound quite so compelling. Yes, I can get greater transparency and a little more immediacy, better focus and better low level resolution, but those things are going to cost a huge amount of money and won't necessarily make the music any more understandable or emotive.

But what really impresses me is the LVPBMB's ability to apply the same sense of substance and harmonic richness to the instruments in the orchestra, whether they are playing individually in support of the solo guitar, or en masse in the ensemble passages. There's a sumptuous weight and warmth to the sound that brings body and presence without muddying the midrange or rounding the dynamics. Turn the power supply off and suddenly you lose the acoustic, the space between the soloist and the orchestra, but most importantly, you lose the creative tension and drama of the performance. The delicate balance of the orchestra and soloist is lost, the power and purpose in Yepes' playing. Just listen to the opening passage; the strength and dynamism of his strumming has gone, not to mention the rhythmic clarity that defines the pace and timing of the strums. Without the power supply it simply sounds as though he's playing as hard and fast as he can. With the BPMB back on line

that clearly isn't the case, a fact which becomes only too apparent as the *Allegro con Spirito* develops.

*Con Spirito* indeed!

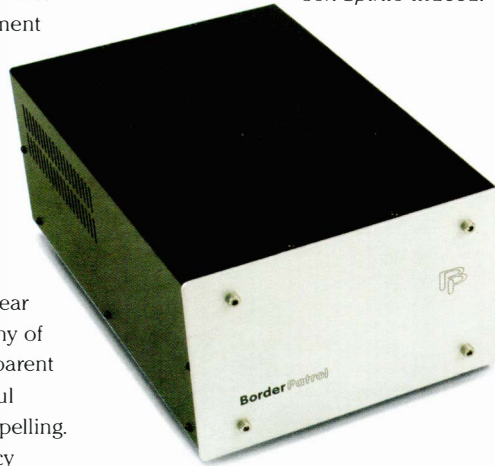

This ability to reveal the internal chemistry within the musical performance gives the modified Canary an uncanny ability to capture the mood of a piece. Nick Cave's majestically doom laden *The Boatman's Call* (Mute Stumm142) never seems ponderous on the LVPBMB. Instead it has its own heaving, subterranean power providing a dark momentum to the tracks. Songs that can sound samey on lesser systems assume greater individuality and you begin to understand that, contrary to first impressions, this is an album of love songs. The depth of feeling is inescapable, the mixture of hope and foreboding a strangely powerful mix, a dark draught the Canary reveals in all its compelling power. But lift the stylus and swap the record for Nanci Griffith's upbeat 'Listen To The Radio' (*Storms* MCA/Alto AA 004) and the mood changes instantly, picking up on the hitch-kick rhythm and optimistic energy of the song. There's power in the bass lines but it's there in the delicate voice too, ensuring that it never gets swamped, even in tracks like 'Leaving The Harbour'.

It's this combination of grace and power that makes the modified Canary such a fun amp to use. Listening is easy, devoid of the edge or thinness that

so many products project as high definition. It doesn't have the clarity of a Lavardin or the absolute confidence and stability of the Karan, but it cuts straight to the heart of the music and it's the message that holds your attention. It responds so enthusiastically to dynamic demands that you'll wonder where all that power and substance is coming from, but at the same time it retains the delicacy and liquidity that small valve amps are justifiably renowned for.

I've saved the best bit for last. Existing owners of CA608s can get their amps upgraded for the difference in price. Combine that with the power supply options and you've got what amounts to an instalment scheme. The CA608 might start life as the baby in the canary range, but get it modified and you turn it from a domestic pussy cat into a Bengal Tiger! ➤

#### TECHNICAL SPECIFICATIONS

Type:	Ultra-linear valve integrated amplifier
Rated Output:	30W/ch into 8 Ohms
Inputs:	4x line level
Input Impedance:	100kOhms
Input Sensitivity:	1.0V
Line Outputs:	None
Valve Complement:	4x EL34, 2x 6SN7 1x 12AX7A
Dimensions (WxHxD):	480 x 152 x 500mm
Weight:	28kg
Finishes:	Blue or champagne anodised
Prices:	
- CA608LV:	£3000
- CA608LVBP:	£3600
- CA608LVBPMB:	£4000
LV Modification to existing unit:	£750

#### Manufacturer:

Living Voice  
Tel. (44)(0)1159 733222  
Fax. (44)(0)1159 733666  
E-mail. shout@livingvoice.co.uk  
Net. www.livingvoice.co.uk

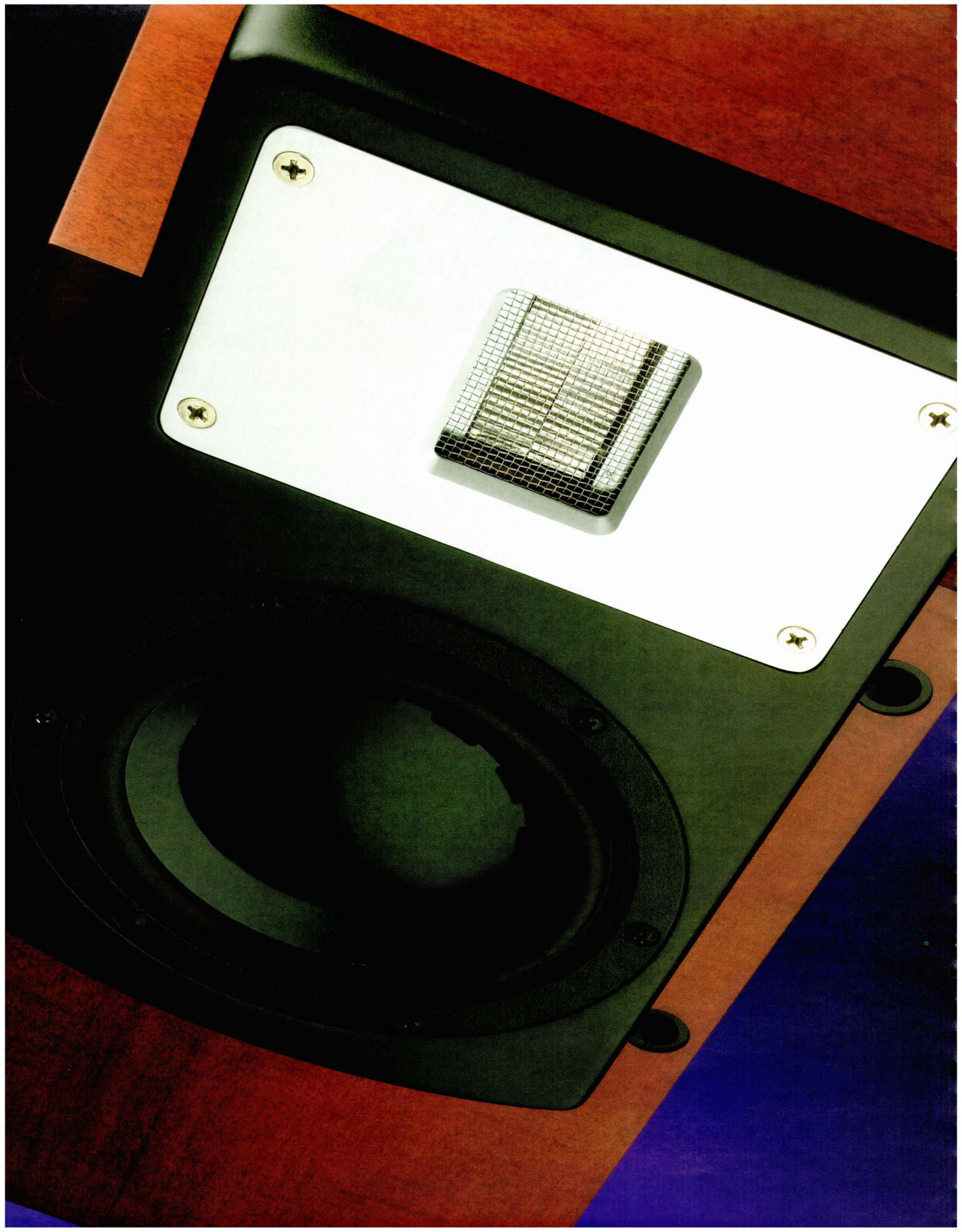



# Red Rose R3 Loudspeaker

by Chris Thomas

Since leaving the business that still bears his name back in the early 80's, American audio guru Mark Levinson went on to found Cello as well as providing his sonic expertise on a number of movie projects. Cello made some reputedly great audio and home cinema components, but at stratospheric prices, which put them firmly out of reach of all but the wealthiest. Then in 1998 he was gone from Cello, only to emerge more recently as head of Red Rose Music. As I recall from an interview somewhere at the birth of Red Rose, Levinson seemed to be saying that the American market had lost its way. Equipment was too expensive, too complex and quite often offered no tangible musical improvements over the cheaper components people were being told to upgrade from. This was music to my idealistic ears and something I absolutely agree with. His words seemed perhaps to herald the dawn of a new standard of audio, reasonably priced, less complex and dedicated to those who just wanted superb quality music in the home without having to mortgage their lives for the privilege.

Not that the first two products did an awful lot to confirm my hopes though. An eight and a half grand valve amplifier and a small two way speaker at three and a half grand, without stands, is hardly bringing music to the masses is it? And yet there was something intriguing about the hardware. Having seen the speakers for the first time their completely

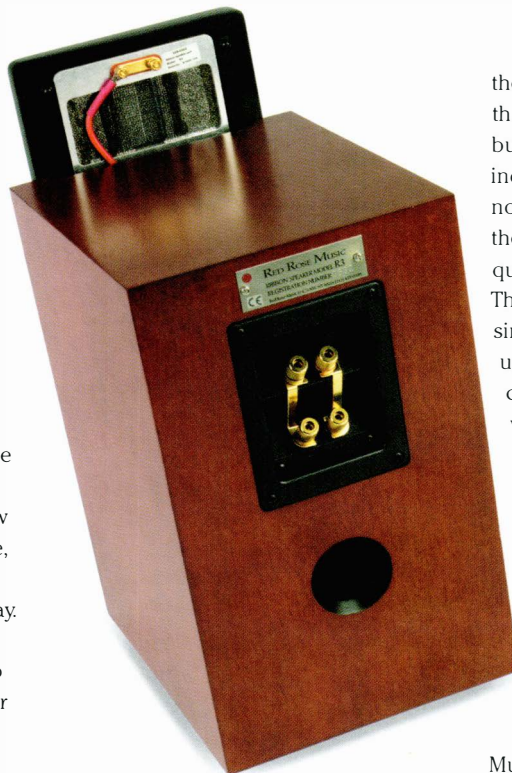

unassuming looks and very modest proportions screamed simplicity. Rather like the footballer who wears white boots, they just had to be good or they would look rather silly, especially at the price. So when I got a chance for an extended loan I took the plunge. And now, some 6 weeks later I am very glad I did.

The R3 is a small box, rear ported, two-way system that couples a 135mm Dynaudio bass/mid driver with a ribbon tweeter designed by Swede Bo Bengtsson. These are mounted closely together on a baffle that extends above the cabinet to place the ribbon in free air. The cabinets

themselves are relatively light and feel thin-walled. I did not get a look inside, but their weight would seem to indicate that any internal bracing is not of the high mass variety as are the vast majority of what Americans quaintly call bookshelf speakers. Their visual appeal is certainly one of simplicity. There are, for instance, no unnecessary cosmetic features to the cabinet to enhance their perceived value by turning them into pieces of furniture, fancy bevelling of edges or exotic rare hardwoods. Nor is there any enormous, expensive looking jewellery jutting from the rear. Instead, the R3 is plain, functional, has modest bi-wired gold plated connectors, and, at first glance, looks about £1000 worth of speaker.

I would need stands and The Musical Design Company, the Red Rose importers, were kind enough to loan me a pair of their own slate stands designed for the R3's, at the same time mentioning that, given a medium mass design, the speakers were remarkably stand-tolerant. This proved to be the case as I tried them on the excellent and cost-effective Kudos stand and the taller supports from my own Revel Gems, both with superb results. But I did prefer the balance and sound of them on MDC's own designs and they also bought the tweeter to just the right height. I quickly discovered that the R3 is quite happy with a variety of amplification, though obviously it must be of a very high quality. At 87dB efficiency and with a nominal impedance of 4 Ohms they seem

▶ a reasonably easy prospect for any serious amplifier. For the majority of my listening I used my own Spectral DMC-12 pre and DMA-100 power amplifiers though I did try both the Jeff Rowland Concentra integrated and the Canary Audio CA-608 LV valve design as well, both with terrific results.

With the exception of backs-to-the-wall designs, this must be the least sensitive speaker to placement that I have ever used. MDC's advice to "Just put them where you think they should be" again turned out to be spot-on. They want to be a metre or so from the rear wall with a modicum of toe-in, enough, in my room, so I could still see the inner cabinet walls from the listening position and that's about it. You won't need to make micro adjustments before the soundstage snaps into focus, as this is one ribbon tweeter that positively encourages off-axis listening.

Nothing really prepared me for the amount or quality of bass that flows from these things. Tight, pitch coherent, agile and not at all the sort of thing

I was expecting from such a small, low mass cabinet. No comparatively sized speaker, that I have heard, has ever produced this degree of extension with control. I am told it is fairly flat down to 40Hz and I can believe it. Surely it must be a trick I thought. An artificial bass hump cunningly incorporated into the crossover to trick the ear into an unreal assumption. Well if there is, then it seems to have little or no discernible side effects that I can hear and none of the boxy bass I was half expecting. I have heard floor-standers without as much low end energy, extension and vitality. In fact energy is a good word to describe these speakers. Right up through the mid-band to the tweeter's operating area they are extremely responsive, detailed and dynamic. But this is more interesting and real-world dynamism. The tweeter is smooth in that, in comparison to more conventional domed types, it does not exaggerate the leading edges of notes or events and therefore seems less explosively dynamic. But its transition from soft to loud never feels compressed and this can lead you to think that the R3 is a little slow and a bit soft at first. But, although this is not the fastest or sharpest speaker I have heard, try a piece of suitable music and you will realise that it can loose energy and change direction very quickly indeed. It is quick to respond but only when it needs to be, though this aspect of their performance



also lies, to a great extent, with the driving amplifier.

But the real brilliance of the design lies in the way the two drive units integrate to allow the music an overall coherence, rhythmic harmony, perspective and tonal colouring that puts you in touch with the recording and keeps drawing you into the performances. The music sounds as if it is all coming from the same place. This is rare, at any price. Even at the very top end of the speaker price scale you will be hard pushed to find this level of musical cohesion. You will certainly find speakers that will have greater detail and those that allow you to better analyse individual recording characteristics, if that's your thing. You will quite easily hear tweeters that have more high frequency extension, presence and airy transparency. Mid-bands will be illuminated with greater relief and more stunning clarity and they will exist in ever broader and more cavernous soundstages. They will ▶

► be good fun and great Hi-Fi, but too often they will shred the music into its constituent parts and present them to your ear as a disassembled series of events. Impressive, but not music. The R3 is exactly the opposite of this and Levinson has built a speaker that will appeal purely to music lovers, as the thing it does the best is to play music in all its glorious complication.

I mentioned the tonality of the R3 and, for me, this is one of the speaker's real strengths. Tonal colour is not normally something that you associate with such small boxes yet it is a quality that musicians strive for endlessly and sometimes fanatically. Vicente Amigo's superb *Ciudad De Las Ideas* (BMG 78495-2) illustrates this perfectly. 'Cordoba (Solea)' is an introspective piece where Vicente shows you the whole palette of the flamenco guitar, an instrument quite different to the outwardly similar classical guitar in that it is built primarily for speed of response and attack. I was completely captivated by the variation and subtlety of shade that the R3 revealed. Whether playing a chord, a line of melody, a blistering staccato run, or just a single hanging note, there was never that monochromatic sound that I hear from so many small speakers. Only a truly great musician who has completely come to terms with their instrument has this level of expression available to them and when they use it with such dexterity, technique and confidence it positively glows, bringing the piece to life and making it so much easier to engage with on an emotional level. And the way in which the R3 scales the music is superb. Un-amplified acoustic instruments are always a difficult proposition to record especially when supported by naturally louder drums, bass and percussion and most audio systems tend to launch the solo instrument to the front of the mix, detaching it from the ensemble. Perhaps it is because its sense of image and soundstage is a little thick and not

of the ultra precise and pinpoint variety. But, whatever I was listening to, I was always aware of the contribution of each instrument and how it was musically intertwined into the piece. And the good news is that one of the R3's best features is the ability to consistently produce these qualities regardless of volume. Even at very low late night listening levels there is little drop off either in bandwidth or tonality and this, in my experience makes this Red Rose just about unique when it comes to comparatively sized enclosures which often need a certain amount of level to really start performing. Another common trait is that, when you turn them right down, the bass is the first to go and the sound loses body, colour and shape. But pump a bit of power into the R3 and it just grows louder. Raw sound levels are not really what this speaker is about nor are they at their most exciting when pushing out heavy rock music, as they don't have that real bright "edge" or sense of compression to their performance. This is one speaker that you may well find yourself listening to at lower than usual levels.

The tweeter lacks that real extended high frequency sparkle and air that make the top Scanspeak and Focal models so appealing. I am very used to this characteristic as my own Revel Gems/Spectral set-up really excels in this area. Though it does go some way towards making up for this by the sheer range of inner detail and textures it opens up. But there is such sweetness to the overall balance and shape of the sound that, after a short time, I never really noticed it. It seems obvious to me that the nature and response of this particular ribbon is a fundamental reason why the two drivers integrate so brilliantly. If I were being very picky I would also say that the mid-band could be a little more transparent. It's all too easy to say the R3 is flawed because it does not do this or that as well as speaker A or B

and would be better if it did. If you feel that way then look elsewhere and good luck. The beauty of the R3 to me lies in the fact that it has an almost perfect balance of attributes. It's small, unobtrusive, very easy to site, works very well on a wide range of music and all aspects of its musical performance are uniformly excellent with no obvious weak points. It is absolutely true that if you dissect it, there are other speaker systems in the same price bracket that will offer improvements in different areas. If you judge your audio system with Hi-Fi terminology you may not find much appeal in the R3. But if your appreciation of a product and its ultimate desirability is based purely on the amount of musical enjoyment and involvement it gives you, then I would say you should certainly take a long and serious listen to them. They might not look £3500 worth, but they certainly sound it. 

#### TECHNICAL SPECIFICATIONS

Type:	2-way, rear vented.
Drivers:	135mm Dynaudio mid/bass Ribbon tweeter.
Sensitivity:	87dB
Impedance:	4 ohms nominal.
Dimensions (HxWxD):	410x200x260mm
Weight:	16.5 lbs.
Finishes:	Contact dealer.
Price:	£3500 per pair

#### UK Distributor:

Musical Design Company,  
PO Box 4146,  
Epping,  
Essex.  
Tel. (44)(0)-1992 573030  
Net. [www.mdc-hifi.co.uk](http://www.mdc-hifi.co.uk)

#### Manufacturer:

Red Rose Music. New York. USA.  
Net. [www.redrosemusic.com](http://www.redrosemusic.com)

# the **AUDIO CONSULTANTS**

We believe in a natural presentation, a realistic tonal balance and a layered soundstage. Never aggressive, these systems will give long term listening satisfaction – just like being in the best seats in the house. **REFINED MUSICAL SYSTEMS FOR AN ELEGANT SOUND.**



**Living Voice loudspeakers** Auditorium £1500.  
Avatar £2500. Avatar OBX-R £4000.



#### **Red Rose Rosette System**

Rosette 1 integrated amplifier 50wpc £2000. Rosebud Compact ribbon loudspeakers £3000. This system produces an amazing high-end sound for such a compact units. Close your eyes and you could be forgiven for believing you were listening to floor-standers!



#### **Triangle loudspeakers**

Antal 202 £850. Celiux 202 £1095.

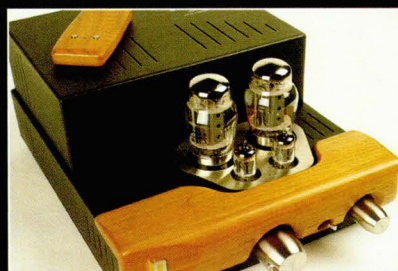

**Unison Research S2K integrated amplifier**  
16wpc single-ended using KT88 tubes. £1295

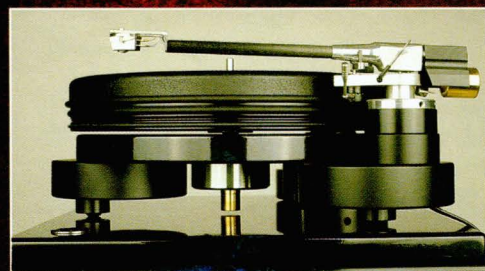

**Nottingham Analogue Space Deck** with new style Space Arm £1378. Clearaudio Aurum Beta S cartridge £270. Upgrade kit to add sintered carbon top platter £365.

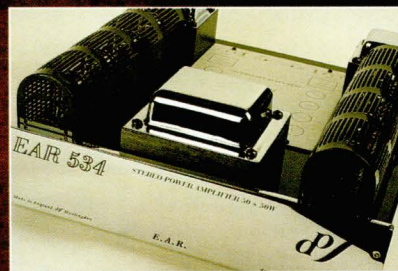

**EAR 534 valve amplifier 50wpc class A**  
Can be bridged to mono £2200. With balanced inputs £2300.

Audio Analogue • Avalon Acoustics  
Beauhorn • Benz-Micro • Cabasse • Cadence  
Cardas • Clearaudio • conrad-johnson  
Diapason • EAR/Yoshino • Esopower • Final

GRAAF • Kuzma • Living Voice  
Loricraft • Lyra • Magnum Dynalab  
Nordost • Nottingham Analogue  
Opera • Pathos Acoustics

Pagode Equipment Supports • Red Rose  
Resolution Audio • SME • Shun Mook  
Transfiguration • Triangle • Tri-Planar  
Unison Research • Wadia

After more than 10 years in central London, we have decided to relocate to a much more convenient demonstration facility in Berkshire. This has been inspired by the fact that driving into and around London has become increasingly difficult, and expensive, in recent times.

Our new premises have free and easy parking, immediately outside the building. Conveniently located between Reading and Basingstoke, we are approximately 15 minutes drive from either Junction 12 on the M4 or Junction 6 on the M3.

In this way we can serve those living in the Home Counties and still be within reach of those in London (60 minutes drive from West London and 80 minutes from Central London). Those in the South West will also now find us more convenient to visit.

The new unit has 2 demonstration rooms, which will make assessing our select range of prime audio products even easier to compare. We have a home evaluation scheme for those who might find this method more convenient.

[www.audioconsultants.co.uk](http://www.audioconsultants.co.uk)

7 Comet House, Calleva Park, Aldermaston Reading, Berkshire RG7 4UA

T 0118 981 9891

E [info@audioconsultants.co.uk](mailto:info@audioconsultants.co.uk)

*Demonstrations by appointment,  
Mondays to Saturdays 10:00 to 18:00.  
Part exchange welcome. Ex-demonstration  
and previously owned equipment listed  
on our website.*

# The Cartridge Man

We sell our own MusicMaker cartridge, digital stylus force gauge and digital turntable level. We also carry a limited range of valve equipment - Croft, E.A.R. - and pick up arms - Hadcock, S.M.E. Ortofon, Graham Slee Projects and a few other high quality products.

We also rebuild classic valve equipment, giving you a choice as the level of specification. We have in stock a range of original Mullard valves, including the sought after EL 34's. Also available is a turntable setting up service, this is free when you purchase one of our cartridges as is our Test Record.

We don't believe that quality is necessarily synonymous with massive amounts of 'dosh', we encourage customers to purchase second-hand items where appropriate. Sound quality come before cosmetics. Remember it doesn't have to cost an arm and a leg... And don't forget our cartridge rebuild service.

88, Southbridge Road, Croydon, CRO 1AF. tel/fax; 020 8688 6565. [www.thecartridgeman.com](http://www.thecartridgeman.com)

# pear audio

presents

## Shahinian

### DYNAVECTOR Well Tempered

Stockists and Information  
from:

Pear Audio Ltd.

7 Prospect Place, Alnmouth,  
Northumberland, NE66 2RL

Telephone: 01665 830862

Fax: 01665 830051



## ORANGES & LEMONS

JUICY FRUIT FROM LONDON'S FRESHEST  
HI-FI & AUDIO/VISUAL RETAILER

Friendly and efficient service

Free home demonstrations • 0% finance available

ARCAM • B&W • CABLE TALK • CASTLE ACOUSTICS  
CREEK • DENON • EPOS • LINN • MARANTZ • NAD • NAIM  
REGA • ROKSAN • RUARK • YAMAHA and many others

### 020-7924 2040

61/63 WEBBS ROAD, SW11  
[www.orangesandlemonshifi.com](http://www.orangesandlemonshifi.com)



## signals

hi-fi for grown-ups

Ipswich (01473) 655171

fax (01473) 655172 email: [enq@signals.uk.com](mailto:enq@signals.uk.com)  
[www.signals.uk.com](http://www.signals.uk.com)



TAIWAN  
1982

# Karan Acoustics KA I-180 Integrated Amplifier

by Roy Gregory

There have always been products that look the way they sound. Not literally of course, but in a more impressionistic sense. Take the Spectral amps as an example: their slim, clean, uncluttered exterior has always seemed to me the perfect reflection of their fast, clear, open sound. Or how about the original c-j equipment, whose characteristic golden sonic warmth (much diminished in each succeeding generation) was suggested so accurately by the colour of their faceplates. Perhaps it's not surprising when a unit's performance and its appearance are so often the product of a single mind. Perhaps that's why, in these industrially designed days, it seems to be happening less and less.

I don't know whether Milan Karan is responsible for the way his products look or not, but the KA I-180's appearance is the perfect metaphor for the no-nonsense solidity of its sound. From the deco contours of its beautifully sculpted fascia to the perfect symmetry of both its front and back panels, from its grunt inducing 19kg weight to the superb fit and finish of the casework, it simply exudes contained power and refinement. Place it on a rack and its unflappable confidence is unmistakable: Which surprise, surprise, is exactly how it sounds.

Now, at this point you could of course turn straight to the conclusion, the way a lot of people do. You could, on the other hand, read on and learn a little more about this impressive newcomer, like the way it handles the deep, surging slabs of bass that

characterise Tosca's *Suzuki in dub* (G-stone 012 CD). With upwards of eight or nine individuals involved in re-mixing the various tracks ('Busenfreund' appears in four different versions, 'Annanas' in three) there's a surprising array of bass sounds and textures on display. The KA I-180 keeps things impressively solid and driving without ever diminishing the tonal and textural discrimination that separates the various bass lines. Each is delivered pitch perfect and solid, tactile and mobile. Likewise the sweeping flanges and sudden switches in musical density leave the amp utterly unflustered. It changes pace effortlessly, with no exaggerated histrionics to upset the flow of proceedings or introduce a fault line into the carefully constructed musical jigsaw.



There's a compact, muscular coherence to the sound of the Karan. Its contained performance is able to control and encompass the musical ebb and flow without apparently constricting or constraining them. To do so requires a deft balancing

of virtues, which in turn relies on a firm foundation, provided in this case by the utter stability, spatial and temporal, of the musical picture provided by the amp. In fact, if you're expecting sonic fireworks, it's easy to remain unimpressed by the KA I-180: you hear that solid bass, but it's surprising how easy it is to take everything else for granted. To do so would be a mistake. Likewise, it would be easy to conclude that the Karan amp is all about bass and bombast, incapable of subtlety, and that too would be a mistake.

Play the Martzy 'Kreutzer' (Coup d'Archet COUP 003) and you'll marvel at the weight and subtle sonority of the piano, the way its chords float in the air, their complex harmonics developing in front of you. Then there's the power and purpose of Martzy's bowing; undiminished despite the perfect control of sustain and decay. The relationship between the two instruments, so central to the drama and impact of the piece is perfectly preserved, the chemistry further underpinned by the superbly solid foundation provided by the piano. But perhaps the most impressive (and least obvious aspect) of the performance is the way in which the balance of the two instruments remains undisturbed, despite the sense of weight and power that the amp lends to the piano accompaniment. This is a case of correct presentation rather than "enhancing" or building on what's actually there. It's not difficult to boost or exaggerate the low frequency ▶

► performance of a product in search of impressive impact or “slam” (an adjective I’ve never felt inclined to apply to live, un-amplified music). The proof of the Karan’s capabilities lie in the way it floats the notes, allowing them to breathe and develop, whether they’re played at ppp or ff. They are never overly loud or muscle bound - they are beautifully defined dynamically and perfectly placed.

The reason I’ve spent so long describing the low frequencies is that everything else literally builds on them. That essential foundation creates the basis for the stability and coherence of the midrange. Voices and instruments are locked in space, especially those that require the delivery of plenty of energy on demand. Brass tutti and snare strikes are both handled with complete confidence, drawing attention to the way that other amps often allow them to pull towards the centre of the soundstage. Ah yes, soundstage? The Karan doesn’t possess the sort of wide open, walk in expanse that is so beloved of some audiophiles. However, what it offers is a completely stable view of the performance that is internally beautifully proportioned even if it lacks the floaty air and indistinct boundaries that attract so much positive comment.

It’s a presentation that is perfectly in keeping with the rest of the amp’s performance. This is not an obviously transparent or fast sounding product. It’s not outstandingly dynamic or tonally lush. But listen to something you know well and you’ll discover that everything’s there, it’s just not being highlighted on a selective basis. What’s more, I’d be surprised if the sense of organisation

### What’s in a name?

Karan Acoustics might be a new name in the West, but the parent company was founded some fifteen years ago, just outside Belgrade, Yugoslavia. Just surviving this turbulent period in that country’s history is something of a feat. To produce a range of serious high-end hi-fi is impressive indeed.

The KA I-180 is the smallest unit in the range, but shares its essential features with the larger and more expensive models. Contained in the substantial aluminium casework is a massive 680Va toroidal transformer, driving a fully balanced circuit via an equally impressive power supply. The output stage employs ultra-fast RET bi-polar devices and the circuit is DC coupled. You get three single-ended inputs, one with a balanced option, record out and single sets of binding posts for speaker connection. Front panel controls are limited to a pair of large rotary knobs, one for source select (indicated in the front panel display) and the other for volume. The unit comes with a really nice circular remote control that appears to be made from a nylon moulding. Whether or not that’s the case, it’s far nicer to use than the overweight aluminium items that seem to be unavoidable these days. Although it only offers control over level, that’s the thing you actually need, and my only complaint is the lack of a visual analogue on the front panel control to avoid nasty

surprises when switching sources. Those who are seriously concerned can always provide their own.

There’s also a high quality mains lead supplied and yes, it should definitely be used. Despite its high power rating it would be a mistake to think that the KA I-180 is a drive-anything powerhouse of the kind so popular a few years ago. A brief outing with the awkward load provided by a pair of Martin-Logan CLS 11zs revealed its discomfort in the presence of really low impedances, giving it a dark and turgid air. Back in the real world of 88dB boxes and four Ohm loads it began to show its true colours. The company’s claims for Class A operation are best taken with a pinch of salt too, as the heat sinks aren’t even close to the requirement and it doesn’t run hot anyway. All of which shouldn’t be allowed to detract from the amplifier’s exceptional sonic performance. Indeed, one of the most surprising aspects of my time with the Karan was its combination with the 94dB efficient Avatar OBXs, a speaker I’d connected with a view to investigating the kind of rhythmic and micro-dynamic limitations that so often characterise large solid-state designs. The KA I-180 was having none of it, revelling in the speakers’ speed and precision. It really is an example of that rarest of beasts, a powerful amp that manages to deliver that power without you noticing. Or to put it another way – it sounds a lot smaller than it is. Which is a real compliment, believe me.

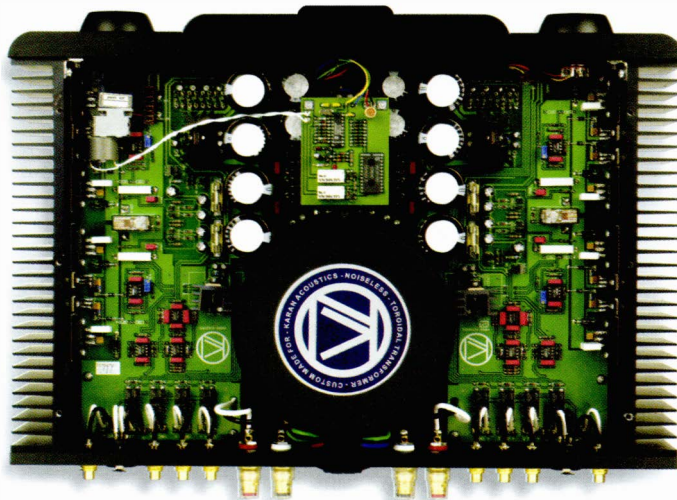

‘Forest Fire’ (Lloyd Cole’s *Rattlesnakes* Polydor LCLP1) I was struck by the reverb on the drum crashes that provide the punctuation at the end of each stanza. That sense of space turned them from a full stop into an exclamation mark, making their contribution that much more emphatic as well as opening the way for the next verse to flood into.

and spatial definition doesn’t actually add to your understanding and enjoyment of familiar music. Listening to

Absolute dynamic range is of a scale with the soundstage. In other words it’s not the widest (Karan make separate stereo and



▶ mono amplifiers for that) but within its compass it is perfectly discriminated and scaled. The result is that the music's all-important structure and internal relationships remain intact, preserving the performance and holding your interest. In other words you won't notice, and if you do it won't worry you.

'Forest Fire', long a dynamic test track for me was its old enjoyable self, even displaying a few new wrinkles. I forgot to even worry about the overall dynamic range. As Rolls Royce salesmen are fond of saying, it seemed sufficient.

One thing this amp will never lack is musical substance.

Outwardly a model of uncluttered common sense, the KA I-180 brings similar virtues to its musical performance, and if you think that's a back handed compliment, don't. No basic integrated amplifier is going to match the performance of the serious pre-power combinations out there. It isn't going to cost as much

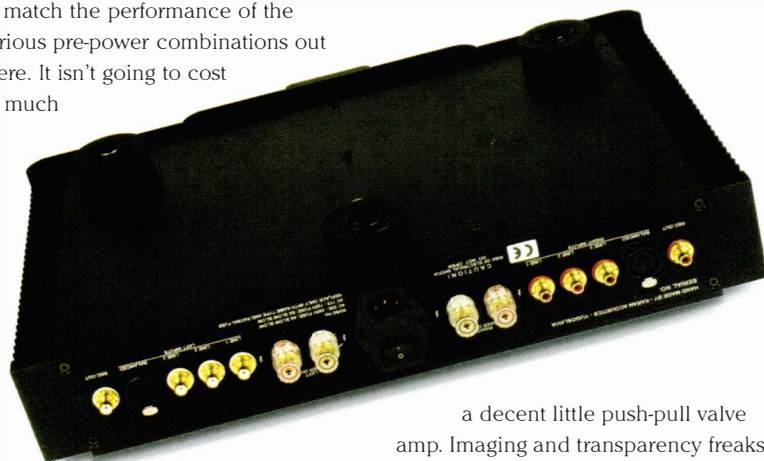

either. The secret is not to throw the baby out with the bath water. The Karan amplifier treads that tight rope with astonishing dexterity for one so young. Don't think this is a chopped down version of anything. Its performance is rooted in musical validity rather than

the hi-fi spectacular, and like that other perfectly balanced middle-weight, the Lavardin IT, it is capable of embarrassing not a few of its much more expensive rivals.

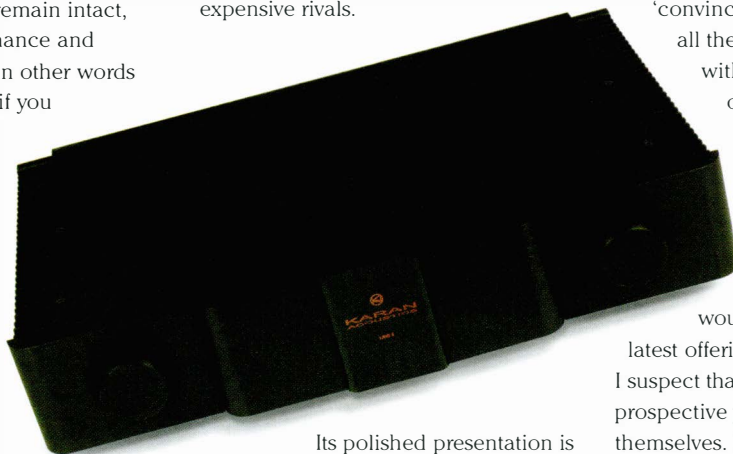

Its polished presentation is engaging and rewarding, delivering the kind of rhythmic and timing integrity so beloved of the British, combined with the grip and definition so eagerly sought by the Americans. The result is, in many respects, better balanced than either and ultimately more rewarding.

This isn't an amp for everyone. You don't get the fragile mid-band beauty of

a decent little push-pull valve amp. Imaging and transparency freaks might find it condensed and shut-in, but in each case they'd be chasing illusions rather than reality. The Karan delivers an astonishingly satisfying slice of the musical spectrum. If you want more then the company will happily deliver that too – at a price. Live with the KA I-180 for a few weeks and you'll

soon start to notice what other amps leave out rather than the other way round. If you want a one word summation then I'll settle for 'convincing'. It's natural balance of all the musical virtues combined with its lack of obvious or intrusive vices makes this an easy amplifier to forget – leaving you with the music.

The performance of the Karan has me wondering just how it would stack up against the latest offerings from the likes of Krell. I suspect that's a question a lot of prospective purchasers will be asking themselves. Me, I'm too busy enjoying it, and besides there are more pressing things demanding my attention. The record needs changing! ➤

#### TECHNICAL SPECIFICATIONS

Type:	Solid-state line integrated amplifier
Inputs:	3x single-ended line with one balanced option
Outputs:	1x tape, 1x speaker
Power Output:	180 Watts / 8 Ohms 300 Watts / 4 Ohms
Bandwidth:	DC to 300 kHz, -3dB
Dimensions (WxHxD):	495 x 110 x 380mm
Weight:	19kg
Finish:	Black
Price:	£3990

#### UK Distributor:

Audiofreaks  
Tel. (44)(0)208 948 4153  
Fax. (44)(0)208 948 4250  
Net. [www.audiofreaks.co.uk](http://www.audiofreaks.co.uk)

#### Manufacturer:

Karan Acoustics  
E-mail. [vox@eunet.yu](mailto:vox@eunet.yu)  
Net. [www.karanacoustics.com](http://www.karanacoustics.com)



spendor

spendor

spendor

# Spendor S3/5 Loudspeakers

by Pete Christie

My wife wants a new cooker. She has come to the conclusion that our ancient “New World Manhattan” has burnt its last cake. The knobs are falling off, the eye level (or in my case, waist level) grill is prone to spontaneous combustion, and the annoying “ting – ting” of the alarm clock thingy is apt to go off at all hours of the day or night for absolutely no reason at all. It stands, an icon to 1970’s design, listing gently to the left in the corner of the kitchen. The problem is, we quite like it, and even though I don’t use it all that often, I have got used to it, and have now just about got to grips with how to operate it. It fits the available space – almost, and is part of the family. But – it has to go. Spares are almost non-existent, and if it blows up (like its predecessor) we’ll be forced to live on take-aways or corn flakes.

What we need is a new one, just like the old one but with the advantage of having all its bits in fine working order. My life could continue with the minimum fuss and bother, and all parties concerned would be satisfied.

That’s the problem. Try finding a direct replacement for any household appliance and you immediately encounter the progress curse. I’m no Luddite, I am writing this on a natty laptop computer (on my lap!), and will send it down the telephone line using the e-letter system of the worldwide interweb do-dah thing. It makes my life easier. However, I only use the part of

the system that I actually need. There is at least 80% of this computers’ capability that I never touch. I don’t need it, I don’t want it, and I am unsure as to why I had to pay for it. But – you are forced to have it. There is no choice. The “market” dictates that none of us can live without it, and we’re stuck with it.

This is exactly the problem I have with hi-fi in general, and my trusty old LS3/5a’s in particular. I have often wondered what I would do when these tried and trusted old friends finally gave up the ghost. I mean, although they are not actually ancient, they are certainly “of an age”. Resplendent in their very 70’s teak veneer and ageing brown front cloth, it’s only a matter of time until something in the drive unit department pegs it, and I will no doubt be in the invidious situation of trawling through the small ads trying to source suitable replacement parts. This, as I know, would prove costly – very costly. Bass drivers have to be replaced in pairs, and since the demise of Rogers a few years ago, the chances of turning up a matched pair are diminishing rapidly!

The market is full of highly

desirable and for the most part, thoroughly commendable small loudspeakers that tend to offer various interpretations of “sonic truth”.

Consider the old “looking at the world through rose-tinted glasses” analogy. To my personal knowledge, there are at least thirty various marques currently available in the £400 - \$650 price range, each offering subtle variations on the sound reproduction theme. Which one is the most accurate is an impossible question to answer, as they all offer a “view”

of the music which tends to be subtly coloured and altered. They are all fairly good, and they are all different. They have to be. They have been designed by lots of different people to fulfil much more than simple sound reproduction. They have to look good, and usually, fit in with a complete range of loudspeakers of which they, the bookshelf models are the least expensive or “entry level” components. It is quite probable that the choice of wood veneers and grille materials are a greater factor in design and manufacture than the drive



► units themselves, and that short-cuts which enable a couple of quid to be shaved off production costs will always be taken.

So where does that leave the audiophile with a limited budget and a shortage of space?

Probably hanging on to an ageing pair of LS3/5a's, that's where! Then RG asked me if I'd care to "have a go" at a pair of Spendor bookshelf speakers that bore the strangely reminiscent suffix of S3/5 in the model number, you can probably guess my reaction.

A smallish box duly arrived, and with suitable reverence, was carefully opened to reveal something wonderful. A modern take on a classic loudspeaker. Pale wood veneer cabinets, full length black grilles with the Spendor logo beneath. Fairly weighty – as you might expect, and the overall impression of a serious bit of kit!

As this was a brand new pair of speakers, I guessed they would need a fair bit of running in, so I connected them up and left them playing to themselves for a week or so before taking them home for a serious listen.

During this period I did something that I don't usually do – I read the information that came with them. (You know that blokes don't read the instructions!)

I fully expected the normal "thank you for purchasing this product... clean with a soft cloth... avoid strong sunlight..." stuff, but was suitably impressed with something altogether more useful. Along with a five-year warranty card came two A4 sheets. The first, a single sided piece, was

entitled "S3/5 Specification", and was exactly that, and more. Beneath the normal "numbers", it went on to give a thoroughly educational description of where to position the loudspeakers –

and why, with response curve graph to illustrate! It also gave possibly the best description of what bi-wiring can achieve, and how to do it that I have ever seen. The second sheet, "Technical Datasheet" was double sided, and covered the aspects of setting up, wiring up, cable quality, loudspeaker power ratings, stereophonic

reproduction, polarity, programme quality (and, inevitably, how to care for your loudspeakers!), all detailed in clear, concise, plain English.

The care and attention used in assembling and presenting this information proves that Spendor are not treating their speakers as a mere commodity – they are far more serious than that!

A quick visit to their web site confirmed my suspicions – the S3/5's have been designed to be a modern version of the LS3/5a's making full use of more

modern materials.

Is this the answer to my prayers? – Only one way to find out!

I took them home and compared them to my old Rogers. Size-wise, the Spendor S3/5's are an inch narrower than the LS3/5a's, and are half an inch deeper, so there's not much in it. The main visual difference is that the Spendors do look better. The grilles as with the originals are designed to be sonically "invisible" and can stay on. Using a Helios 2 CD Player connected to a Shearpe Audio Phase 2 amplifier with a van den Hul D102 interconnect and van den Hul CS122 speaker cables, I was intrigued to see if the young pretenders could match the old monarchs.

I selected a handful of my favourite CD's and began with the Daniel Lanois album *Acadie* (Opal 7599-25969-2), and the track "St. Anne's Gold". This is a wonderfully spatial, haunting instrumental piece by the Canadian musician, and I am happy to say that the sound emitting from the loudspeakers was just as it was the last time I played it.

Pinpoint imaging and atmosphere by the bucketful! The music flowed effortlessly and all the component parts were clearly defined.

I picked my way through a wide variety of material trying to find fault. Tricky recordings were as enjoyable as the safer, glossy production jobs. Pink Floyd's *Division Bell* (EMI 7243 8 28984 2 9) was a walk in the park. Sinatra's

*Songs for Swingin' Lovers*

(Capitol CDP 7 46570 2) was a walk in Central Park. Tom Waite's *Raindogs* (Island 826 382 2) was a late night

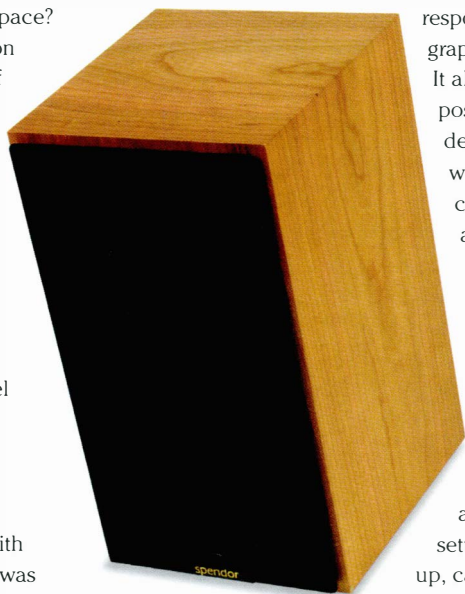

▶ walk in a car park!

It was becoming clear that I was enjoying myself. The Beatles classic *Sergeant Peppers Lonely Hearts Club Band* (Parlaphone CDP 7 46442 2) sounded as fresh and innovative as it did when it was first recorded, and I couldn't help but wonder if they listened to the original mix through a pair of earlier versions of these little gems. I suppose it's highly likely. Someone out there is bound to know!

The more I played, the more convinced I became that these speakers were fitting the bill, and that I would need a blind-fold test to really pick out any difference between the original LS3/5a's and the new kids on the block.

I sauntered through classical pieces, empty and sparse to huge symphonic works such as Mahler's *Symphony No. 8* performed by Claudio Abbado and the Berlin Philharmonic Orchestra (Deutsche Grammophon 445 843 2). A thundering rendition which really worked the whole system! OK, with small speakers there was no chance that I was getting a real "live" performance, but size issues aside, I was given a damn fine window through which the atmosphere and performance shone quite brilliantly. The soundstage was stunningly laid before me, and details were presented with a degree of accuracy that were quite literally mind-boggling!

So how do I rate these tiny heirs apparent?

Well, as far as I could ascertain, the only audible difference between the Spondors and the Rogers was a slightly firmer top end which I attribute to the running-in process. As I said earlier, I had given these brand new speakers a week or so of continuous running, followed by the weeks at home, but I still feel that they

could do with considerably more use before they'll be totally relaxed. This is not unusual. The Rogers LS3/5a's were notorious for the length of running-in time they necessitated, so this need not be a problem.

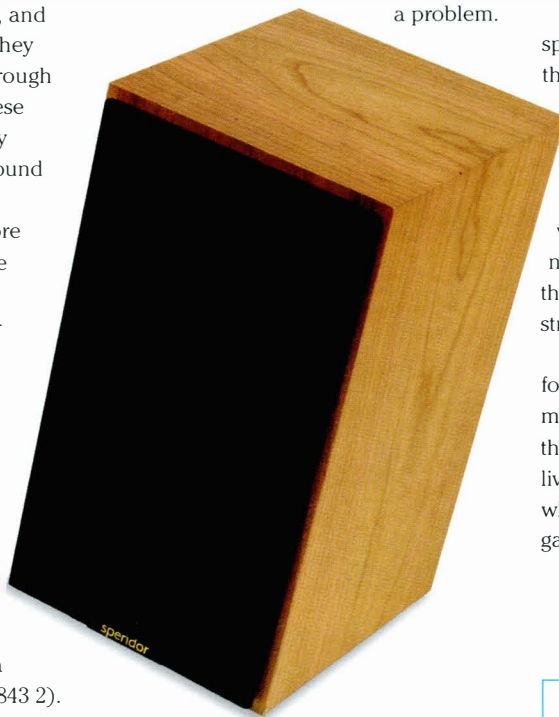

And anyway, we are only talking about a minute added crispness.

I feel I need to point out that the original LS3/5a's were designed as studio monitors of "unparalleled neutrality" for the BBC, and were made under licence by several British loudspeaker manufacturers (including Sendor) from way back in the early seventies

If a monitor works properly, there would be little need in changing the design. So nobody did. The last new pair of Rogers LS3/5a's passed through our shop four years ago, and apart from being bi-wirable, and finished in a rosewood veneer, they were largely identical both visually and sonically to all the other LS3/5a's ever made. To satisfy the terms of the BBC licence, all LS3/5a loudspeakers had to sound the same. If you are about to record

the LSO at the Royal Albert Hall and somebody knocks a monitor over and it breaks, it needs to be replaced with an identical unit. You can't use your brother-in-law's ghetto blaster. This is the BBC we're talking about!

These are true monitor loudspeakers. They will tell the truth about the music you put through them.

This, to me, is a positive bonus. However, they will make any bad recordings or "iffy" productions stand out like a sore thumb. Be warned, cuddly they are definitely not! They do not add, neither do they take away. They give it to you straight – whether you like it or not!

It is obvious to me that I have found the perfect replacements for my LS3/5a's. Sendor have delivered the goods, and thankfully, the legend lives on. All I want to know now is where am I going to find a replacement gas cooker? ▶+

#### TECHNICAL SPECIFICATIONS

Low/Mid Frequency Unit	
Sendor 130mm Homopolymer Polypropylene	
High Frequency Unit	
19mm Soft Dome	
Crossover Point:	4.5 kHz
Nominal Impedance:	8 Ohms
Frequency Response:	80 Hz to 20 kHz (+/- 3dB)
Pair Matching:	Within 1 dB
Power Handling:	70 Watts
Sensitivity:	84 dB/1 Watt/ 1 metre
Maximum SPL:	100dB @ 1 metre
Cabinet Size (WxHxD):	165 x 305 x 180mm
Weight:	4.7kg
Price:	£500.00

#### Manufacturer:

Sendor Audio Systems Ltd  
Tel. (44)(0)1323 843474  
E-mail. [Info@sendoraudio.com](mailto:Info@sendoraudio.com)  
Net. [www.sendoraudio.com](http://www.sendoraudio.com)

**MONITOR AUDIO STOCKISTS**

**LONDON**

Technique 26 High Street, Wimbledon Village, 0208 9449040  
 Classic Hi Fi School Lane, Kettering 01536 310855

**SOUTH**

Audio T Excellence See Ad Page 20  
 Sound Perfection Nightree House, Mawgan, Helston 01326 221372

**SOUTH WEST**

Audio T Excellence See Ad Page 20

**WEST**

Radfords Hi Fi 12 James Street West, Bath, Avon 01225 446245

**MIDLANDS**

Hi Fi In Harmony 68 Stratford Road, Shirley, Solihull 0121 745 5880  
 Sound Academy 152A High Street, Bloxwich 01922 473499

Sound Academy 111 The Parade, Sutton Coldfield 0121 321 2445  
 Sound Academy www.soundacademy.co.uk  
 Sound Academy email:sales@soundacademy.co.uk

**NORTH**

Doug Brady Hi-Fi Kingsway Studios, Kingsway North, Warrington, Cheshire 01925 828009 See Ad.Pg.19

Sound of Music 93-95 Nantwich Road, Crewe 01270 214143  
 The Hi Fi Showrooms 12a West Street, Congleton, Cheshire 01260 280017

Romers Hi Fi 94-96 High Street, Rishton, Blackburn 01254 887799  
 Replay 64 Flixton Road, Urmston 0161 202 9922

**SCOTLAND**

Loud & Clear 26 Hamilton Place, Edinburgh 0131 2266500 Ad Pg 102  
 Loud & Clear 520 St Vincent St, Glasgow 0141 2210221 Ad Pg 102

**HOME COUNTIES**

Northwood Audio 98 Cambridge Street, Aylesbury 01296 428 790

**AUDIO RESEARCH STOCKISTS**

**LONDON**

Acoustic Arts 101 St Albans Road, Watford 01923 233011  
 K J West One 26 New Cavendish Street, London 020 7486 8262/3  
 O' Briens Hi Fi 60 Durham Road, London 020 8946 1528

**SOUTH**

Sounds of Music 10-12 Chapel Place, Tunbridge Wells 01892 547003 See Ad. Pg.17 & 54  
 Heatherdale Audio 202 Findon Road, Worthing 01903 872288 See Ad. Pg. 54 & 84

Audio T Excellence See Ad Page 20

**SOUTH WEST**

Audio T Excellence See Ad Page 20

**EAST ANGLIA**

Audio Images 128 London Road, Lowestoft, Suffolk 01502 582853 See Ad. Pg. 102

**WEST**

Oxford Audio Consultants Cantay House, Oxford 01865 790879

**MIDLANDS**

Chantry Audio 16-18A Eldon Street, Tuxford, Nr Newark 01777 870372  
 Midlands Audio Exchange 181 Franche Road, Kidderminster 01562 822236 See Ad. Pg.103

**NORTH**

Audio T Excellence See Ad.Pg.20

Loud & Clear 26 Hamilton Place, Edinburgh 0131 2266500 Ad Pg 102

Loud & Clear 520 St Vincent St, Glasgow 0141 2210221 Ad Pg 102

**HOME COUNTIES**

Audio T Excellence See Ad.Pg.20

**IRELAND**

Cloney Audio 55 Main Street, Blackrock 00 353 1288 9449

**PLATINE VERDIER**



**GT AUDIO**

5 Upper Road, Higher Denham,  
 Buckinghamshire, England. UB9 5EJ  
 Telephone: 01895 833099  
 e-mail: sales@gtaudio.com

**www.gtaudio.com**

*Distributors for: Acoustic Masterpiece, Air Tight, Allaerts MC Systems, Audiocraft  
 Avantgarde Acoustic, Koetsu, LYS, PHY-HP, Schröder tonearms, TRON, J.C. Verdier.*

# Hi-Fi and Home Cinema have a new GOLD standard

## WHAT HI-FI?



### Gold Reference 20

'Fast and dynamic sound with bags of resolution... An excellent product from Monitor Audio that deserves to continue the long standing success of the Studio 20SE. We have no choice but to recommend them highly.'

## WHAT HI-FI?



### Gold Reference 10

'Beautifully judged pace and detail; no shortage of bass weight. Few speakers just 36cm tall are capable of a sound with so much conviction... the GR10's carry on Monitor Audio's enviable reputation for great standmounters.'



**MONITOR AUDIO**

*As close as it gets*

Rayleigh, England.  
01268 740580  
info@monitoraudio.co.uk  
www.monitoraudio.co.uk

# Connoisseur Audio



**CHORD DAC 64**  
On Demo - probably the most significant new product available for CD playback  
**£1900**

## NEW EQUIPMENT/EX DEMO MODELS

ENEW E

**CHORD**  
DAC 64 (£1900) and d CPM 3300 (£5595) on demo, full range available Visit our web site for full details, prices, specifications and reviews

**PS Audio**  
PS600 with multiwave on demo - Amazing review, see what can be achieved with mains regenerative - £2700  
Visit our web site for full details, prices, specifications and reviews

**Audio Note**  
Full range available, many items on demonstration - Visit our web site for full details, prices, specifications and reviews

**STAX Headphones**  
Full range available - Visit our web site for full details, prices, specifications and reviews

**Perpetual Technologies**  
If you read the HiFi News review on the amazing P-1A Digital to Digital processor and the P-3A Upsampling DAC 24/192, you will realise just how good they actually are at £1099 & £799 respectively they will transform your CD playback in a way you could never have imagined. Visit our web site for full details, prices, specifications and reviews

**CEC**  
Full range of these amazing Belt drive CD players transports and DACs available including the incredible TL512 Belt drive CD player with 24/356 upsampling for only £1425 - on demo. Visit our web site for full details, prices, specifications and reviews

**Conrad Johnson**  
Full range available, visit our web site for specifications, prices & reviews.

**Dynalab Tuners**  
Full range available, visit our web site for specifications, prices & reviews.

**EAR**  
Full range available, visit our web site for specifications, prices & reviews.

**Verites**  
P400 Digital power amp 240w - on demo 2995

**Manley Labs**  
Stingray Integrated Valve amplifier - on demo 2195  
Parist pre amp on demo 1650  
50w Monoblocks on demo 2250

**Unison Research**  
Full range available, visit our web site for specifications, prices & reviews.

**Kuzma**  
Stedi S with Stogi S tone arm on demo 1245

**HEART**  
CD 6000 valve CD player. If you can find a better sounding CD player for up to £1,000 we would like to know what it is!! - on demo 590

**Plinius**  
8100 100w on demo 1450  
Jorah Phon stage on demo 599  
8200 Integrated 175w withphono stage 2250

**Pathos**  
Classic One - on demo 995  
Twin Towers RR - Hybrid valve & solid state the best of both worlds. HiFi News loved it, so will you - on demo 3250

**Audio Analogue**  
Full range available, visit our web site for specifications, prices & reviews.

**Audio Physic Speakers**  
Full range available, visit our web site for specifications, prices & reviews.

**Craft**  
Full range available, visit our web site for specifications, prices & reviews.

**Opera speakers, Triangle Loudspeakers, Monitor Audio, Benz Micro, Lyra, Sumiko, Dynovector**  
Visit our web site for specifications, prices & reviews.

## NEW EQUIPMENT/EX DEMO MODELS

ENEW E

**Final Electrostatics**  
0.3 ex demo 1495 995  
0.4 NEW - on demo 2500 2195

**Loth-X**  
Orthello precision turntable on demo 1145

**Great HiFi news review** 400

**All new Aura floorstander on demo 980b efficient** 750  
**All new Aura floorstander on demo 980b efficient** 1600

**Lavardin**  
Full range available, visit our web site for specifications, prices & reviews.

## USED EQUIPMENT

**Turntables/Cartridges/Phono stages**  
EAR B34P Signature MM/MC all valve phono stage 390

**Brandnew Mitchell Gyrodec SE with acrylic cover and record clamp RB300** 1175 795

**Ortofon Jubilee boxed unused** 1250 699

**SME 309 Boxed New** 629  
**SME IV - Boxed NEW** 890

**Audio Note R-2a phono stage. Boxed new. Unused** 450 350

**Linn LP12, Valhalla, Itak, boxed** 690

**Ortofon Rahmann boxed new** 1200 649

**Michell Gyrodec, clear plyth/cover. RB300 & QC PSU, Boxed as new** 1695 995

**Michell Gyro SE with RB300. Boxed as new** 995 695

**Amplifiers (Pre, Power, Integrated)**  
Audion Black Shadow 845 Mono's, Stunning. 2 months old, Boxed 2000 3800

**Balance of Audion warranty** 5000 3800

**Audion Premier 2.0. 2 box with MM/MC phono stage.** 2000 1100

**Lavardin IT, boxed as new. Veryrare** 3250 2600

**Moon IS Boxed NEW - black fascia** 2600 1999

**Graaf GM20 D1L - boxed as new** 3200 1895

**Pathos Twin Towers RR - boxed as new** 2400 1995

**Primarc A30.1, new model with pre-out. Boxed new** 1500 1250

**Rakson ROKL2.5 pre S1.5 power on d BS1.5 PSU** 3500 1695

**Quad 34 - Boxed unused. Very rare** 275

**EAR B34L, all valve line stage, as new** 550 350

**Speakers**  
AudioPhysic Virgo 11 - ex demo 3000 1999

**Meridian DSP 5000 active speakers boxed** 4125 2595

**Quad ESL 63's, boxed** 3300 1595

**Gershman Avantgarde RX-20. Boxed** 4900 2990

**Verity Fidelis in Makara finish. One owner. Boxed** 7300 5900

**Wilson Watt/puppies 5.1** 18000 6900

**JM Labs Mezzo Utopia - boxed new** 7400 5600

**JM Labs Mini Utopia with matching stands - boxed** 4900 2900

**Monitor Audio GR20(new model) boxed as new** 1595 1095

**A.R.I. Art 2 speakers, boxed as new in Piano Lacquer** 6000 2695

**Martin Logan Acarius 1 boxed as new** 2700 1995

**CD Players/Transports/DAC's**  
Marantz SA-1 super audio CD player. boxed new still under warranty 5600 3995

**Marantz CD-7 Boxed, ex demo, 2 year warranty** 3000 2900

**Sony SCD-1 New. Boxed unused** 4000 3400

**Sony SCD-1 Boxed as new, 12 months old** 4000 2600

**Audio Note CDT Zero. Boxed new unused** 500 390

**Electrocompaniet EMC-1, Boxed as new** 2500 1450

**Primarc D30.2 24/96 new model. Boxed new** 1500 1195

**Sonogogge (Conrad Johnson) S022 Boxed new** 850 390

**Linn Kark II with Numerac DAC both fitted with brilliant PSU, Boxed as new** 3000 1395

**Dealers for :- Manley Labs, Craft, Kuzma, Conrad Johnson, Benz Micro, Cards, Loth-X, Lavardin, Unison Research, Opera, Audio Analogue, Final, Michell, Pathos, Graaf, LAT, Monria, Diapason, Espowew, Ecosse, Verites, Plinius, Triangle, EAR, CHORD, PS Audio, GEC, Perceptual Technologies, MonitorAudio, STAX**

**01592 630652**

E mail : info@connoisseuraudio.co.uk

**www.connoisseuraudio.co.uk**





# Monitor Audio Gold Reference GR-60 Loudspeaker

by Roy Gregory

Things aren't always what they seem. Take the Monitor Audio GR-60 for example. On the surface it's all relentlessly modern and up to the minute, from the slim but deep cabinet dimensions to the all-metal driver line-up, right down to the pointed phase-plug and dimpled cone surfaces which would doubtless make the drivers travel further if you chose to hit them with a stick. Styling is best described as twenty-first century constructionalist and the overall appearance wouldn't look out of place in an Ikea catalogue. Nothing if not modern. But hidden inside those slim hipped dimensions and balanced on the stylish plinth is a – wait for it – three-way speaker. And not some pretend, pseudo two and a half way out to impress with a lot of drivers. This is an honest to God, old fashioned and deeply unfashionable three-way, albeit with a bit of recent thinking thrown in. It's a bit like finding Deep Purple dressed as Five. But then Ian Gillan never learnt to do his shirt up either.

Of course, what goes around comes around, and three-way (or more) boxes are rapidly becoming the benchmark for serious high-end flagship designs. It's just that you don't tend to see them down in the realms of real world purchases. Having said that, this is Monitor Audio's flagship so why not. More to the point, although they don't have the historical profile of companies like KEF and B&W, or their high-end presence, they've been around nearly as long,

producing solid rather than spectacular product based on proven technology. At least that's the way it used to be.

Time was that opening a Monitor Audio box meant unwrapping a pair of slim and compact two-ways, more often than not sporting a beautiful and exotic veneer. Pretty but



undistinguished, which added up to pretty undistinguished.

All that changed with metal driver technology in the mid-eighties. Celestion might have started the metal dome tweeter ball rolling but it was Monitor Audio who were instrumental in adding serious momentum, following that up with metal coned bass-mid drivers, all added to their traditional virtues. Indeed, for some years the products suffered from the kind of churlish suspicion that the hi-fi industry reserves for anything that simply looks too

pretty. Perhaps that accounts for the move to the slightly more butch styling sported by the current range.

Given the brand's reputation for fancy finishes I was somewhat surprised to discover that the review pair had been delivered in black oak veneer. However, opening them up I was confronted with the first obvious indicator that the company clearly knows exactly what they're doing. I have to say that the carefully fitted driver surrounds in their silver finish complemented the silver drivers perfectly, offset by the slim lines of the black cabinets. It was closer

examination of the drivers themselves that betrayed the GR-60's guilty secret, confirmed by the tri-wiring terminals on the rear.

Although the three largest drivers are all an identical 140mm in diameter, the top one is a bona fide mid-range driver, the lower two bass drivers, each housed in a separate and differentially reflex loaded enclosure, one firing forwards, the other back. This is intended to spread the resonant frequency of the ports thus smoothing

and extending the low-frequency bandwidth

as well as adding efficiency. The midrange driver also enjoys its own sub chamber, and this and the baffle between the bass drivers

will help to brace the long cabinet panels: rigidity is also helped by the thick 22mm MDF material used throughout. Both the bass and mid

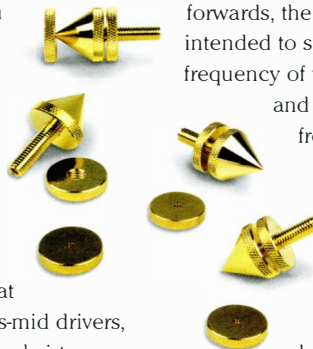

► drivers appear to use the same basic aluminium/magnesium alloy cone, but with different motors. The midrange unit also features a bullet shaped fixed phase plug. The dimpled surface of the drivers is claimed to result in a more rigid structure, distributing bending modes and allowing a lower overall mass. It's a claim that's backed up by a substantial white paper, so those of an academic bent can investigate further if they choose. High frequency duties are handled by the company's familiar 25mm metal dome, but this time constructed of the same alloy and ceramic coating as the bass and mid drivers. That keeps the driver materials consistent, definitely a good thing as the units multiply in number.

Before I go any further I really must mention the excellent plinth and spike system supplied with the GR-60s. Although hardly novel it is beautifully executed and with a speaker this tall more than simply cosmetic. The plinth broadens the footprint and attaches to the bottom of the speaker with four machine screws. The spikes arrive in a small plastic case which contains not just the conical feet themselves, complete with nice, large diameter knurled locking discs, but all the tools you might need to assemble (or disassemble) the speaker, a cleaning cloth, dimpled glides to protect polished floors and, glory be, a spirit level. Again, with a speaker this tall getting them vertical is a vital and oft overlooked consideration, and this excellent hardware makes the job extremely easy. Full marks to Monitor Audio – if only a few vastly more expensive products could follow suit.

So why a three-way

design? The traditional reasons really. The use of a true mid-range unit allows you to push your cross-over points well outside the critical midrange, but at the expense of a more complex crossover and the problem of trying to blend the output from three rather than two drivers. As I said, it's an approach that is coming back into fashion, with excellent examples available from KEF, B&W, Kharma and Avalon to name a few. The difference is that none of those models come close to the GR-60's £2300 price tag, with most of them doubling it. Whichever way you look at it this is a lot of speaker for the money.

Whether or not the three-way's theoretical advantages can outweigh its burdens depends on the skill of the designer. One less than obvious advantage that the GR-60 enjoys is the identical size and profile of its mid and bass drivers. Because of this they'll enjoy identical dispersion characteristics at the crossover point, removing this critical give away from the equation when it comes time to blend the drivers' outputs. Anything that eases that particular task should be welcome indeed. It's also further evidence of the care that Monitor Audio have applied to maximising the benefits of their chosen topology. The cross-over has also benefited, eliminating all series capacitors in the midrange filters, so

designer Dean Hartley is clearly aware of the potential pitfalls and has worked hard to avoid them.

The next surprise arrived on switch on. Not the biggest fan of metal drivers I was expecting a cold, hard, detailed and un-dynamic sound.

I couldn't have been more wrong (although the speakers take half an hour or so to warm up from stone cold – remember those cold nights in the middle of December?). Instead music was presented with warmth, weight and, yes, I never thought I'd say it but, generosity too. This really is an honest to God three-way. And as such

it benefits from appropriate partnering equipment. Control at bandwidth extremes is essential to get the most out of any three-way and the Monitor Audios are no exception. Don't get the idea that the bass is loose or hard to control – in fact it's quite the opposite – but you need some quality power to extract the full benefit. I wished I'd had the sadly departed Karan Acoustics KA I-180 to hand, but in its absence I turned to the Rogue Audio 88, a rather more realistic match at £1500. It was an audio marriage made in heaven! One under whose influence I played all four sides of *Made In Japan* (DCC LPZ(2)-2052) – very loud indeed – for the first time since before I did my O-levels. These guilty secrets are catching. ►

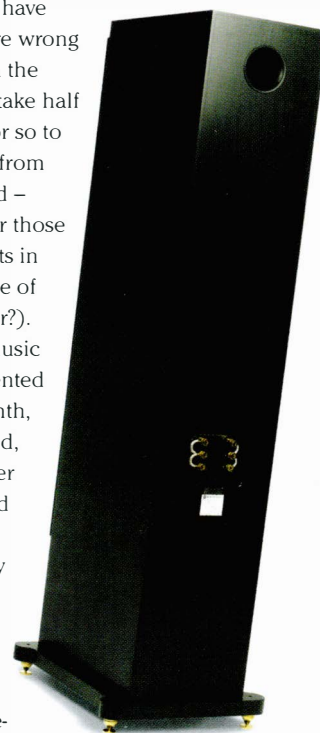
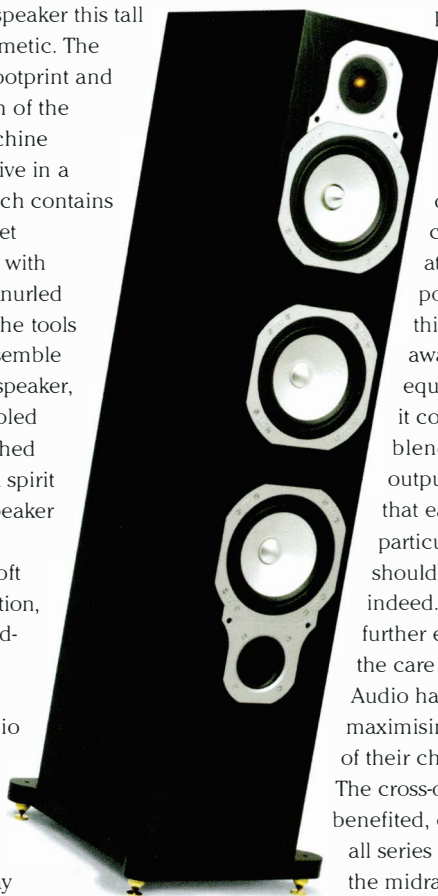

► In fact, the one thing missing from the GR-60 package is a sign saying “Play Loud”. It’s not that you need to, it’s just that they enjoy it so much that the influence is infectious. I was soon flicking through the record collection looking for something that

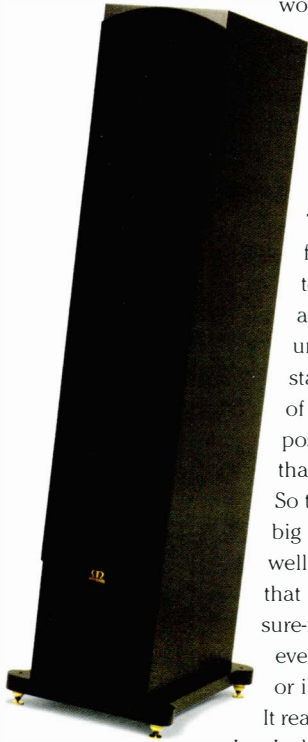

would really extend their capabilities. You know, turn their silly grin to more of a grimace. That I never found it is testament to a certain unburstable staying power, of which they possess more than me. So they do the big thing really well, with a bass that is deep and sure-footed without ever being turgid or immobile.

It really excelled on Joe Jackson’s live set

*Summer In The City* (Manticore/Sony SK89237), delivering a confident, stable foundation to the occasionally frantic proceedings, easily differentiating the pitch of Graham Maby’s deeply undulating bass line opening to ‘Another World’. But where it misses out is in terms of sheer impact and speed on really sudden bass transients like the ones that punctuate the opening track. The performance on the Reference Recordings *Symphonic Dances* disc (RR-96CD) is fascinating. The scale and power of the opening is beautifully conveyed, with a colossal overall soundstage, doubtless

a function of the good extension at both frequency extremes. But the transparency and internal focus of individual instrumental voices can’t match the impressive immediacy of a high efficiency paper coned design like the Living Voice Avatar. No surprise there. You pay your money and you take your choice; scale, power and bandwidth or intimacy, colour and dynamic expression. There’s no speaker close to this price that does it all. The surprising thing about the GR-60 is how successfully it covers its micro-dynamic tracks, smoothing things off and adding just a smudge of warmth right through the range rather than leaving notes cold and foreshortened. It’s an extremely listenable compromise and one that contributes considerably to the speakers’ high level listenability and the lack of fatigue during long listening sessions.

Go looking for their lower limits and you’ll find them. The Martzy *Kreutzer* is a case in point. The bowing is smoothed, lacking some of its jagged vitality and vibrant colour. The piano on the other hand is wonderfully solid and present. It’s a case of musical swings and roundabouts,

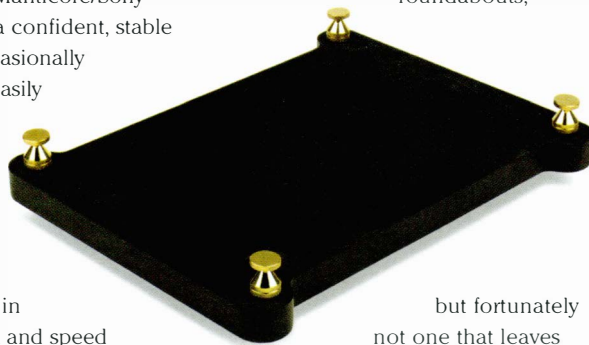

but fortunately not one that leaves you dizzy and disoriented.

Martyz’s masterful reading of Beethoven’s complex score is perfectly apparent. What you are being invited to choose is the style of the presentation – a Turner or a Van Gogh – rather than the view itself. The GR-60 treads an unashamedly three-way

path, majoring on scale, power and presence. It’s just that the JBL L96 never looked like this – and it never had this degree of finesse either.

If you want to build a system around a low-powered amp and listen to small-scale acoustic recordings on it then there are other speakers that I could suggest. If on the other hand you’re interested in a wide bandwidth and supremely competent all-rounder (with excellent cross-over A/V potential then look no further. There are other speakers out there that do a similar job to the GR-60, just not at this sort of price. It’s a genuine flagship speaker, and offers flagship performance. In fact, the only thing that isn’t flagship about it is the cost of ownership, and for that Monitor Audio are to be heartily congratulated. ➤

#### TECHNICAL SPECIFICATIONS

Type:	Three-way floor-standing loudspeaker
Driver Complement:	1x 25mm C-CAM Aluminium/Magnesium Tweeter 1x 140mm RST Aluminium/Magnesium Mid-range 2x 140mm RST Aluminium/Magnesium Bass Drivers
Bass Loading:	Differential reflex
Bandwidth:	28Hz – 30kHz, -3dB
Nominal Impedance:	6 Ohms
Sensitivity:	90dB
Dimensions (WxHxD):	200 x 1060 x 330mm
Finishes:	Black Oak, Natural Oak, Cherry, Rosemah
Price:	£2299.00

#### Manufacturer:

Monitor Audio  
Tel. (44)(0)1268-740580  
Fax. (44)(0)1268-740589  
E-mail. [Info@monitoraudio.co.uk](mailto:Info@monitoraudio.co.uk)  
Net. [www.monitoraudio.co.uk](http://www.monitoraudio.co.uk)

# Interview with Frank Schroeder

by Peter Russell

*By way of preparation for reviewing Frank Schroeder's distinctly different tonearm, I took the opportunity to get the low-down on its design from the man himself. We met at the Frankfurt show, and rather than trying to describe the technicalities of the arm's operation and evolution, I'll just let Frank get on with it...*

**PR. Frank, perhaps we could start by talking about where the idea for your arm came from in the first place?**

**FS.** It all started when I was eighteen, twenty years ago when I was a student. I have always had a love for music and played violin in a string quartet so I am in touch with real music. My job, working for the government, also involved me in taking people, to concerts, fortunately I was able to decide what to go to listen to. The government paid so it was the best of both worlds. In Berlin there is such a lot of opportunity to go out and enjoy first class musicians and up and coming people who are full of enthusiasm. I consider myself lucky not living in the countryside here (near the Kepinsky Hotel, Frankfurt).

But, back to the main point. I finished school when I was seventeen and started studying immediately at the University of fine Art in Berlin. I went into sculpture and graphic design, which is my original training, along with industrial design. I did the sculpture on the side. My parents thought that I was wasting my time. I told them from the beginning that I would just do this to gain some knowledge, basically to enjoy myself. At the time I was making kinetic objects, which were representing random machines that could look different at any given moment in time. Oh yes, and I picked up watch making at this stage of my life.

**PR. So how did this interest in kinetic sculpture and watch making translate into making tonearms?**

**FS.** This is loosely interconnected. When you deal with kinetic objects you have to deal with numerous problems to with energy transmission, storage, rejection or application of friction; these machines were rather complicated. The idea of using something else and not a conventional bearing stemmed from both watch making and the kinetic objects. Springs have been used as a bearing in watch making for over five hundred years. Even a precision watch will have less of a mechanical loss than conventional knife-edge bearings or steel spring bearings. But you have other problems with steel spring bearings in watch making. I was also aware of the concept of a torsional pendulum; a clock is just another application of such a bearing.

I had a music system; I guess I had had one since I was fourteen or so. I recognised the limitation of the components. Some of the stuff was too expensive to replace with something I considered to be an improvement. But other things like the turntable and the tonearm I thought, well okay, this is something I could do. I had the machinery and I had got some ideas. So without fully realising all of the facts that this torsional or thread bearing would have, I built several models and each model showed me how not to do it, or what should be or could be possible. The idea of a magnet came into play when I realised that whenever you were to use threads or a conventional bearing with a ball race you introduce relative movement towards each other. That's why I came to magnets. You have always to achieve utmost stability. The system should not have any option of where the physical components can go. That's why I tried magnets first. ►

► **PR. One arm which uses a similar principle of a suspended thread, but with a silicone bath is the Well Tempered, did that influence you at all?**

**FS.** I did not see the Well Tempered until 1984. I don't know when it entered the market, but I thought Ah, someone had the same idea but they did a few things differently. First of all this system is not a stable one. I don't want to talk too much about this but so that you understand where I am going. The centre of gravity of the whole system is quite a bit above the spring and if you were to put it into equilibrium it would fall either this way or that way. When I looked at the Well Tempered I thought, Ah two threads, that should be good but it touched at two individual points so the anti skating will be a problem. Anyway I came up with a functioning model with a single thread first. And it was very similar to what I have now. The problem then was I thought that I had exactly what I didn't want: the bearing point was above the centre of gravity. The only magnetic material that allowed me to drill a hole through it was Samarium Cobalt embedded in some sort of resin. This does not have by far as high an energy content as pure sintered Samarium Cobalt or what I am using now, Neodinium. So while it did work, I could not get the quality of the bass response because the bearing did not have enough resistance against deflection. It is far more than twenty-fold now compared to the first arm. I thought okay first of all I have to omit this idea of a single thread. The only way to get the bearing level, on the same plane as the centre of gravity of the counterweight and the cartridge, is to use two threads and a tension on the side. This way you can go lower and I can slide the middle post in and out a little bit and allows me a very fine adjustment.

**PR. Okay Frank then how do you maintain the stability of the magnet in the structure of the arm?**

**FS.** Ok these magnets are attracting magnets and this is very important. A lot of people look at the arm and think that it is floating in the air. They then call it a magnetic bearing. It is not a magnetic bearing in the sense of physics, since it is not carrying any load. On the other hand whilst it is not carrying any load, it is what provides resistance to deflection. So in

actuality it does carry some of the load but it is a lateral load. My first goal was to reduce friction because all the tonearms I have had, either because of limitations of quality control or inherent in the design have been compromised. I then started to look at damping as I was just using constrained layer damping that was available; I was experimenting with all sorts of materials, various alloys, aluminium, combining them with a thin skin of more compliant materials etc. It occurred to me that each of these materials reduced the sonic characteristics only to a certain degree. The sonic characteristic of the

material was more pronounced in this design since the energy has nowhere to go.

**PR. Presumably you had to experiment with different combinations of material to deflect the inherent mechanical energy?**

**FS.** Precisely. What the constrained layer damping is also all about is to cut the spikes in the resonance spectrum and smooth them out. I was therefore first looking for materials that did not have very pronounced spikes or would have them in a region where it would be easier for me to control it. I found this in wood and the first piece of wood that I used was ebony.

**PR. Why did you use wood, why not aluminium or carbon fibre. Was it an intuitive decision, what was your thinking behind it?**

**FS.** Yes I did that at the beginning but I was never totally, thoroughly happy. I always felt, and I was measuring it and the measurement would show that you could control the resonance characteristic and you would almost always have to damp what is already there. Almost at the same time, my then girlfriend's father was restoring old furniture in Pittsburgh. I spent a lot of time in the USA and he had a very old table that he was supposed to shorten because it would not fit in their domestic environment. I asked him for some of the wood from the furniture. I was immediately impressed by the incredible density. The way that when it was tapped, just a simple test, it did not exhibit any of the high



► frequency features. It had its own resonant frequency there was no doubt. So I was making an arm out of this wood with the cabling on the outside with just some plain tape. It sounded considerably, I mean considerably better. I was using a Spectral MCR which was a fine cartridge, perhaps lacking a little bit in the fundamentals, exaggerating the upper harmonics with a touch of grain also, well the grain was practically gone. So this was a good start. I had made two arms of different thickness. I then said where could I get some more wood. It is difficult to get the right materials; wood that is aged and where all the moisture has not dried out. If it is totally dried out then it will soak up humidity again. Some of the woods contain a lot of resin or natural oils and ebony is one of them and Jacaranda, depending on its origin has more or less oil. Now I apply a particular type of oil that will not stay on the surface but sinks into the wood and very intensely to saturate the wood. Starting with about twenty coats, a process that sometimes can take three weeks. What the oil does inside the wood, it fills the cavities and somewhat solidifies. It is like oiling your floor at home, it will not become rock solid or create a reflective surface, which I wanted to avoid. I tried for instance aluminium with a non-reflective surface but when I measured it, it had more peaks higher up the frequency spectrum. The next problem was that if I was to sell it to people I could only sell it to...well from 1984 I had some friends visiting me and they liked the sound so much that they said that I should really open a company and make them. They asked me to build one for them and they would pay me for it. I said, yes sure I can do that so up until last year at the Frankfurt show when I displayed my arms I had made about sixty arms in twenty years. What got me to the High End show last year is that one of the speaker manufacturers who happened to come by a dealer friend of mine in Berlin who stocks the arms was convinced to try it. He did and loved it. When this speaker manufacturer came by, he had trouble with his Souther arm, some resonances, mistracking etc. Well I said that it might be the arm, not necessarily the cartridge. We put the cartridge in one of my arms at the Dealer's and it sounded absolutely fine. So he said I will have to have this arm. This was a week before the show so I went to work and made one for him and he said that I must bring the arm to the Show. This was a bad time for me so I could only spend a couple of days at the show. The arm got a little bit of media attention and I met Martina from Loricraft and she was immediately impressed with the arm and its construction principles. She offered to represent me and the arm was presented at the London show and the CES in the States, so it got more exposure. I had people asking me to make the arm, not too many, which I was happy with. At this show (Frankfurt 2001) I suddenly get lots of people asking me if they can use my arm.

**PR. Frank can you tell me about the various types of tonearm that you manufacture?**

**FS.** Yes I do a number of different tone arm lengths. This is not because I think that different lengths will result in different sonic properties. If a customer has a pre drilled turntable I will accommodate individual requirements. I do not think that 12-inch arms are necessarily superior to similarly designed 9-inch arms. In the case of the SME 3012 it is the added mass on the knife-edge bearings that makes the difference and makes it the better arm. Of course it is much more difficult to control the torsional upper mode of the arm if you have twelve inches. Everybody says that it has less of a tracing error. Now that might be so, but if the arm is properly designed the resulting distortion from tracing error is a function of set up. Most people get the overhang right but not always the offset angle. With a twelve inch arm there is a higher margin of error.

**PR. Lets get back to your arm in terms of set up. Can you run through the various adjustments?**

**FS.** Yes you can obviously adjust the vta, azimuth and in the case of the Reference Arm, this is done in repeatable increments. The counterweight has a horizontally running screw by which you can shift the centre of gravity ever so slightly. Initially you have to set it by turning the counterweight one way or another so that you get what appears to you a parallel orientation of the cartridge and the surface of the record. But as you know it is not always a perfect world and the stylus is not always perfectly aligned in the cantilever. Some stylus shapes are not so susceptible to vta and azimuth alignment. For others it is extremely critical. The damping is adjustable as well. The magnets not only provide the necessary resistance to deflection but they are also an eddy current brake. Every movement of the magnets relative to each other results in the magnetic force lines to move to the surrounding aluminium and that induces an opposing force. Another problem in designing the arm is that ideally, you do not need a lot of vertical movement in a tone arm. Initially I was concerned that I should have various a singularity magnets but in practice it does not make any difference. You would only induce more force lines. In the smaller arm there is high permeability, a pole piece in the back basically resulting in the force lines being restricted and contained. There is a thread here and a hole and a small countersunk dimple to take up the knot. The most difficult, even more difficult than drilling a hole through a twelve inch piece of wood, is drilling a 0.3mm hole into a magnet of sintered material which has a hardness of 9 on the scale. Only a diamond bit can do it. The next problem is when you want to drill a hole in it you have to use a special method ►

► invented by the watchmakers in Britain. The next problem is that because the material is strongly magnetic, how do you get the waste material out of the shaft you are drilling? It takes me now, and initially it took me an hour per millimetre and now four hours for a six-millimetre hole. Every third or fourth magnet I throw away because the drill I use gets stuck and you cannot start from the beginning again. It is one of the reasons I have to charge what I am charging for the arms. It looks dead simple. I do not use any glue or anything or resins. All of the pieces in the arm that go together are a just fit or family bonded. I use very fine tolerances. I have to work to fine tolerances because of interchangeability of tubes (arms). If one is two hundreds of a millimetre thicker it will not fit. The front part that takes up the aluminium alloy mounting piece for the cartridge is made from one solid piece. It also allows you to control the coupling of the cartridge to the arm tube. There is an inner brass sleeve, which prevents people from tightening so that the wood splits. One of the advantages of wood is that it allows you to compress the cartridge mounting plate with the arm tube without damaging the arm. We all know that when you have two machined flat surfaces together the area where they actually meet is comparatively small. In this case the wood on the underside of the arm gets compressed to a degree by the mounting plate. You then have a far higher contact area than conventional aluminium headshells.

Set up is quite simple. A tone arm is only as good as the person who sets it up. I always, until last year, if someone buys an arm from me directly in Germany go and set up the arm which is part of the purchase price. I can then be sure that the customer gets one hundred and twenty percent of the performance.

**PR. How do you go about matching your arms to the cartridge? Do you have a range of arm wands?**

**FS.** My arms will match cartridges from 5gms to 35gms and in extreme case 50gms. I can accommodate the arm to the customer's requirements. The same goes as far as the internal wiring. If a customer has a preferred tone arm wire I will use this as long as it does not compromise the mechanical performance of the arm. I do have my preferences but I have tried most cables. The wiring can be used somewhat as a tone control. I would not say that one cable is definitively better than another. My standard wire is the Incognito. On the reference arm I prefer a cotton wrapped cable because it offers a little bit less resistance as far as movement is concerned. I weave the wires similar to Kimber, which produces a better sound and I use a very small diameter hole through the wooden arm. I do not have to dampen the arm as there are no eddy currents as there are in a conductive arm.



# AUDIOPHILE 2002

## LE MERIDIAN HEATHROW

### 19-21 APRIL 2002

## THE ULTIMATE HI-FI SHOW



VINYL CD SACD DVD-A DVD-V

The Audiophile Club, PO Box 6477, London, N13 4AY, UK

Tel: 44(0)20 8882 2822 Fax: 44(0)20 8372 3772

show site: [www.audiophile.co.uk](http://www.audiophile.co.uk) e-mail: [show@audiophileclub.co.uk](mailto:show@audiophileclub.co.uk)





# Schroeder Reference Tone arm

by Peter Russell

The word unique must be one of the most misused words in the English language. Something is either unique or it's not. It is like pregnancy. You cannot be a bit pregnant, just as something cannot be a bit unique. In the world of analogue replay there are a very few products which you can point to and say that it is so fundamentally different to anything else that it redefines the way we see such a product and what it can deliver. One can think of the Verdier Platine with its opposing magnets, or the Well Tempered turntable, which can lay claim to two paradigm shifts in the way we think of turntable and arm design: the bearing with its oil filled well and thrust pads, and the arm with its filament suspended tube and silicone bath/bearing. Uniqueness is a rare and precious commodity in the world of analogue. Only too often limits on investment in time and money prevent the search for alternative approaches to familiar methodologies.

Here in the Schroeder arm we have a cross between the principles which underlie the Platine Verdier

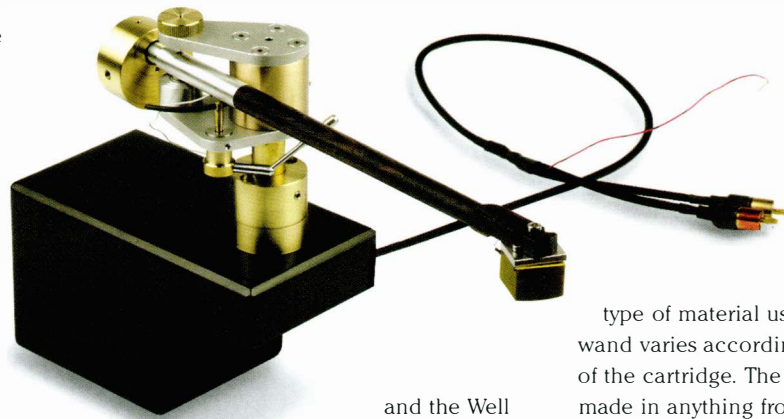

and the Well tempered tone arm. The use of magnets is restricted to the use of attracting magnets that stabilise and damp the bearing whilst the arm tube is supported by a single filament. I don't want to repeat, in detail, the principles behind the arm as this is covered in the accompanying interview with designer Frank Schroeder. I will refer to them as far as they affect the functionality of the arm in every day use. The arm under discussion here is the Reference and is the top of the range of a series of arms that starts with the Model 2, then Model 1 and culminates with this one. The model numbers coincide with the sequence in which the arms were developed!

What we are considering here in the Reference is a bespoke approach

to tone arm design. This is not an off the shelf product where tens of arms are part of a production run. Here the

type of material used for the arm wand varies according to the mass of the cartridge. The arm can be made in anything from balsa wood to ebony, aluminium or carbon fibre. It all depends on the mass of the cartridge, whether it be 5grams or 50 grams. You can specify three different tone arm lengths; 8.5, 10, and 12 inches, but I am sure that if you wanted a different length, Frank would oblige. This individual matching does not stop here as you can choose from a range of different tone arm wire; Audionote silver wiring, Cardas, Ortofon six 9s, Incognito and Schroeder's solid core copper with lacquer insulation. If all this sounds too much of a good thing then it is. To decide on the mix of variables most appropriate for you and your cartridge and turntable you really will need the advice and knowledge of the importer. Remember this is a bespoke tone arm and just as with a suit from Saville Row there will be more



▶ than one fitting! For this reason the Reference will be sold directly through GT Audio to ensure that the arm is optimised for the customers needs. This level of service will be available for the Model 1 (£2,000), whilst the Model 2 (£1200) will be available directly from dealers.

Having lived with the arm now for some few months in a number of iterations as we optimised the arm for the turntable and the Allearts cartridge, it became apparent that this arm is actually in a process of continuous development. Normally I would spend a considerable time elaborating on the technical construction and functionality of the arm before exploring its sonic signature. This time I will make the sort of statement that is usually reserved for the final sentence of a review. If you want to hear your music presented anew, with aspects and surprises you've never experienced before then somehow you have got to get your hands on this arm. I don't care if you bribe, beg threaten or just downright plead with the Importer, just get this arm on your deck! There I have said it. I am more known for my English understatement, so for me to make unequivocal statements like this, either I am smoking something or I have taken leave of my senses. Neither is actually the case. I suppose it is a bit like when you are on holiday in a place which is familiar to you, but for once, you get up early in the morning and suddenly as you walk outside, you see the landscape caught in the light filtering through the mist, erasing the familiar and

highlighting the hidden. Listening to the Schroeder arm is a bit like the road to Damascus, once trodden, never forgotten.

So is this arm all 'sweetness and light?' Hardly. It may not have the weight and bottom end heft of other arms, nor does it have the hewn out of rock presentation of the notes, but it does have emotion. I have a feeling that I must have hit on a lucky synergy; the Verdier turntable, the Schroeder arm and the Allearts cartridge. I would have liked to have tried it with an alternative cartridge of a similar mass

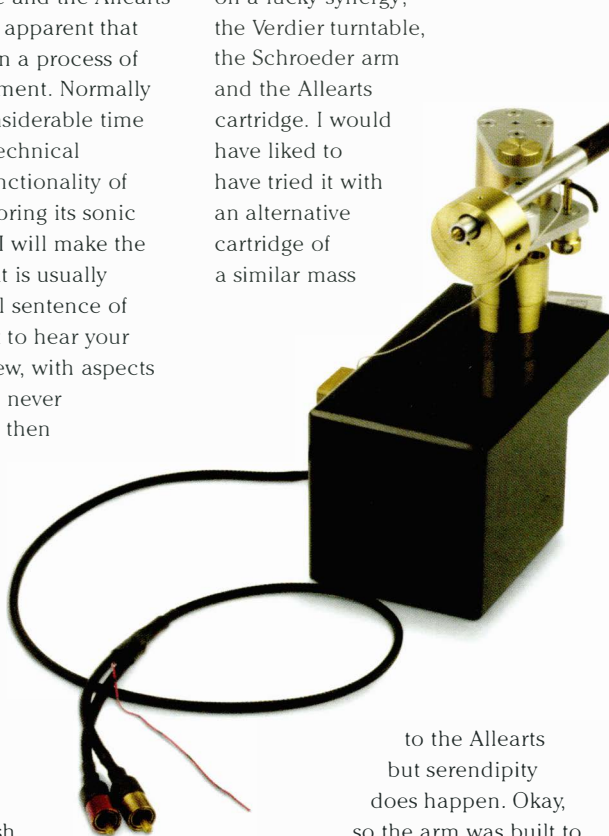

to the Allearts but serendipity does happen. Okay, so the arm was built to work optimally with this cartridge, and putting the Allaertz on the Audiocraft arm made you realise just how open and transparent the Schroeder arm really is. It may not be the last word in authority and vice like control but it is just so transparent. It is not really a matter of detail; rather it is as if the artifice of a mechanical and electrical device which insinuates itself between you and the musical experience, has been removed.

Now I know that this is not really possible, but when listening to this arm/cartridge/turntable combination this is what it does. Interestingly, putting my Insider Reference on the arm did not work at all which underlines the importance of matching the arm mass to the cartridge. If you are one of those people who just turn to the

conclusion of the review and are only interested in the end point rather than the journey, then you can turn to another page. But if you are passionate about analogue and intrigued by the introduction of a new and unique arm then read on.

Setting up the arm was straightforward once we had specified the height from the top of the arm board to the top of the platter. Whilst the arm does come with spacers to accommodate the different distances, it is really recommended that you get the distance right so that there is no more than a couple of centimetres between the top of the mounting block and the underside of the arm pillar. I always use an original Dennesen Geometric Soundtractor protractor marketed by Sumiko. Clearaudio produce a more up market version in Perspex. This enables you to get the overhang set up as accurately as possible, and with the dimple in the mounting screw at the pivot point accuracy is assured. Cartridge mounting is relatively easy as long as you remember to initially mount the cartridge in the mounting plate using only one of the bolts so that you can swivel it to enable the arm wires to be attached to the cartridge pins. Final adjustment can be completed with the second bolt ▶

► in place and the alignment grid on the Soundractor.

VTA is adjusted by a central Allen key inserted into the top of the arm pillar and rotated to raise and lower it. One full turn adjusts the arm by 0.7mm. Please note that to lower the arm one has to unwind the Allen key a couple of turns and then depress the top of the pillar by hand, raising is accomplished automatically by turning the key. Anti-skating is adjusted by rotating a large knurled disc at the top of the pivot point and allows for very fine adjustments, whilst varying the gap between the two magnets effects damping. Initially the gap can be set by inserting a business card between them and adjusting to obtain a sliding fit. There is a provision for varying the degree of tri-axial freedom of the arm, inherent in all unipivots, by dropping a small amount of silicone into a narrow well in the top magnet. This is a trial and error exercise depending on the cartridge used. Finally, azimuth is fine-tuned by turning the eccentric counterweight clockwise or anticlockwise. There are two opposing Allan slotted weights in the counterweight which can be adjusted if you want the counterweight to look perfectly symmetrical about the arm wand.

I make no apologies for going through the features of the Reference arm in so much detail as it serves to demonstrate the sheer intricacy and thought that has been applied to this arm. This 'build to fit' philosophy is carried through to the ability to optimise the arm in all its dimensions in an attempt to realise the potential of analogue.

Given all the above and the uncharacteristic eulogy earlier on, how do we describe the performance of this arm without it being an anticlimax. Usually when you listen to an arm for the first time there is that feeling of uncertainty and

caution: Uncertainty because you are not sure which of your audio reference points are being challenged, and caution because it takes time to pinpoint the differences you are hearing. With the Schroeder Reference this did not happen. The impact was immediate, the shock was visceral and my ability to articulate the experience deserted me. Yes, I could go on about its remarkable ability to strip away the veils of grain in its clarification of resolution, its gentle exercise of authority without intruding between the listener and the performance, its intimacy and deftness of touch as it displays dynamic contrasts, and the feeling of space and depth in large choral works which can be quite breathtaking. I could also mention its ability to deliver a quality of bass out of a pair of Quad ELS 57's I have never heard before, but that is a personal thing. However, these are all aspects of the natural rather than the hi-fi vocabulary. There is very little, if anything, that this arm actually adds to the music. Its hallmark lies in its delicacy of touch, and naturalness. What I am left with is a performance which, when I played my favourite music, totally involved me in the experience. I was never disappointed, I never felt cheated and I always felt that I was a participant in the performance.

At a price of £3,000 you get a tailor made tone arm, precision built as only a watchmaker can, with all the operational flexibility to appeal to the analogue perfectionist. To ensure that the arm is able to realise its potential you will need to avail yourself of the importer's knowledge and skills to optimise the arm for your cartridge and turntable. In an age of mass-market products whose raison d'être is lowest unit cost, to find someone like Frank Schroeder who still

believes in, and is capable of, the kind of personal service you usually associate with handmade suits, is both reassuring and remarkable. Whilst this arm will not transmute lead into gold, it will give you access to another musical dimension. 

#### TECHNICAL SPECIFICATIONS

Arm Type:	Damped unipivot
Bearing:	Single thread torsion bearing, magnetically stabilised and damped
Arm length:	User defined; 8.5ins-12ins
Tonearm wands:	Carbonfibre, jacaranda, ebony, bamboo, pertinax, aluminium or others as suited
Price:	£3000

#### UK Distributor:

GT Audio  
Tel. (44)(0)1895 833099  
Fax. (44)(0)1895 834159  
E-mail. [sale@gtaudio.com](mailto:sale@gtaudio.com)  
Net. [www.gtaudio.com](http://www.gtaudio.com)



ROTEL  
STEREO INTEGRATED AMPLIFIER RA-1050

VOLUME

POWER

PHONES

SPEAKERS

OFF A B A+B

CONTOUR

L-1 L-2 OFF H LH

PHONES

TUNER

TAPE

# The Real Deal

## Rotel RA-1060 Integrated Amplifier

by Jason Hector

The first thing that strikes you about the performance of this amplifier is that, excuse me while I butcher an advertising slogan, it does exactly what it says on the tin. This amplifier sounds how it looks; powerful.

The Rotel RA-1060 amplifier stands out from the crowd in many ways, not least looks. It is black when all around it seem to be silver; it looks aggressive when pretty styling is in; hell it even has the pride of the American scene, grab handles. But beyond the cosmetic this amp is still pretty non-conventional, at least for 2001. You see when its competitors are stripped for speed high-end pretenders (no features cause they wreck the sound, right?) the Rotel, is a fully featured device with two sets of switchable speaker outputs, remote control, pre-amp output and horror of horrors, a tone control ... yep ... a tone control. It's like a blast from the past. Mind you it's worth pointing out, before you throw this review away in horror, that these aren't the standard bass and treble controls you might expect on the average entry level device, but a "contour control" which offers bass or treble boost by a fixed amount. To be honest the control was left out of circuit (or at least it was switched off) for my listening tests but I could see a use for it in a system where the 1060 was required to drive some secondary small speakers in a dining room or kitchen. In this case the control could be just the thing to balance up a less than ideal pair of speakers or their position. I think that the high level of

features goes a long way to explaining this amplifier's existence: It offers a lot of convenience in a simple and user-friendly single box package. But don't let yourself be put off by all of this convenience, this amplifier offers excellent sound quality as well.

Rotel have actually been going for 40 years and have a great pride in their products which is certainly shared by Gamepath, their enthusiastic distributors in the UK. They are a company that regularly produce equipment that performs better than the price would suggest and the

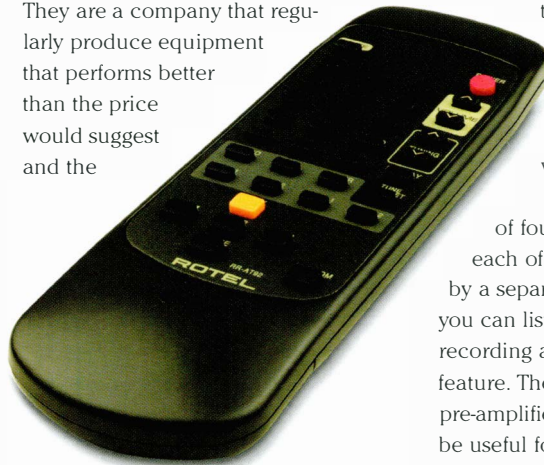

balance of virtues always seems to be well judged, with musical integration at the top of the design list. To achieve this quality they aren't afraid to raid the worlds component suppliers to ensure they have the right part for the job. The accompanying literature informs us that components will be bought from the UK, Germany, Japan and the US and I guess beyond. The 1060 uses a toroidal transformer, manufactured in house, that accounts for a large

percentage of the weight of the amp, and this is coupled to a fast, low impedance power supply which is "highly regulated" and also features Rotels' own slit foil capacitors. Rotel also claim that the precise timing of the music is maintained through "symmetric circuit traces" and, unusually at this price, polystyrene and polypropylene capacitors are used in the signal paths. Looking inside and bearing all of this in mind you do get the feeling that the 1060 has been thoroughly designed. From personal experience I know that Rotel equipment is also very reliable.

The amplifier offers a total of four inputs and two tape loops each of whose source is controlled by a separate recording selector, so you can listen to one source while recording another, yet another useful feature. There is also one set of pre-amplifier outputs which would be useful for bi-amping or a simple multiroom system. The inputs and outputs are relay switched and source selection is remote controlled. Source connections are all via gold plated phono sockets. The two sets of speaker outputs (which should make bi-wiring easy) are via good and meaty multi-way binding posts suitable for 4mm plugs or spades. The amplifier also features a headphone output which, even with my down market 'phones', managed to offer most of the superior sonic quality available at the speaker

▶ outputs. All of the controls feel good to use and along with the neat but functional styling help create a quality impression.

The remote is not just capable of controlling the amplifier but also Rotel CD players, DVD players and tuners. It was pretty good to use as well, with better layout than found with many more expensive bits of equipment. It worked from a good distance and range of angles. The only issue was the speed the volume control moved at with my relatively efficient speakers. Just a touch of the button had the in room volume leaping by too many dB's, but thankfully there is also a very useful mute switch on the remote.

There is no phono stage built into the amp (the only missing feature?) but the Rotel standalone unit is the obvious match. In fact partner this Rotel pairing with a P25 turntable from Rega and you could build a fuss free vinyl solution with excellent performance.

I feel like I need a disclaimer here before I start describing sound quality. I have been very hard on the 1060 for much of the review. I have slotted it in place of £6000 of pre and power amplification and listened to it extremely critically. Some would say this is a bit unfair, but I believe this sort of test is the only way of finding out the real performance envelope. In fact you should use the sheer fact that I was happy treating the amp this way as an indicator of the high confidence I developed in its performance. I also tried the amplifier with some small Rega Aras and the extremely revealing Royd RRI loudspeakers, along with various CD players and was consistently impressed. I received a run-in unit but it still seemed to take a week of admittedly intermittent use before the 1060 really started performing consistently, which was a surprise.

In general this amplifier showed good dynamics with plenty of rhythmic drive which was obvious with Metallica – *Metallica* (or the black album). This long player is a series of complex heavy metal symphonies with powerful distortion laden chords and driving rhythmic bass and drums. That goes some way toward describing this album;

an excellent new album from the past king of melancholy, providing a good test of the amp's harmonic and timbral accuracy. Several of the tracks feature Cohen duetting with some fine female singers. The Rotel was quite happy with this music

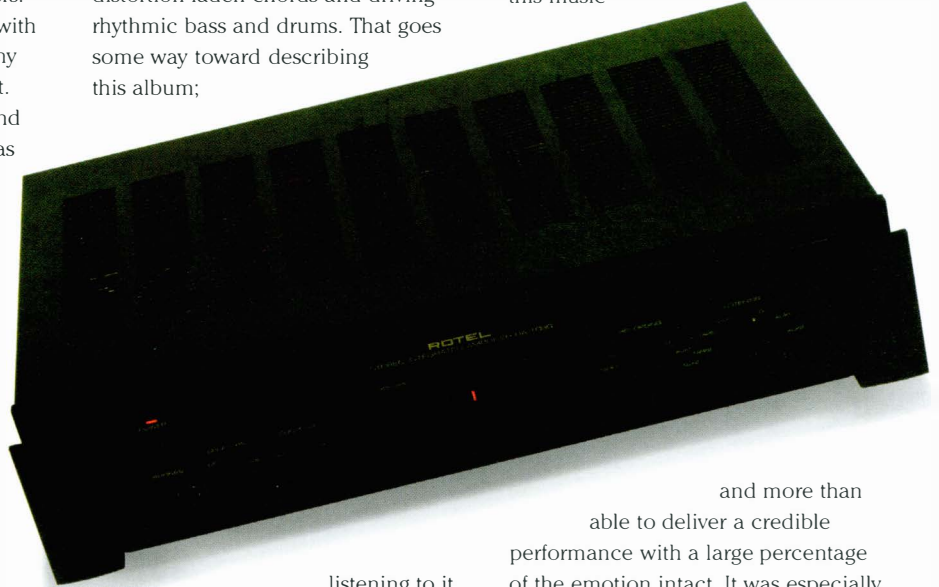

listening to it should be a physical as well as aural process. In fact this album is a superb test of a system. At all times there is a need to provide dynamic contrast and detail right across the frequency spectrum and ideally this should be done at high volumes. The 1060 was right at home and rocked both me (and my neighbours) world. Control of the speakers was impressive so that even when the track was at full tilt the drum strikes for example rose and fell very quickly with plenty of impact. Of course the amplifier was not capable of fully passing all of the detail through to the speakers and a general thickening and muffling of the sound, heard as a rounding off of transients and reduction of detail, was apparent when things really got going. But with plenty of drive in the bass and an articulate sound, capable of following the complex rhythms it puts out at considerably higher prices, to shame.

Leonard Cohen's *Ten New Songs* is

and more than able to deliver a credible performance with a large percentage of the emotion intact. It was especially interesting because of the completely different scales that the singers are exploiting. Unsurprisingly Mr. Cohen is at the lower end with a very deep and throaty performance. The system with the Rotel was clearly able to integrate the musicians and yet the voices (and the backing instrumentation) were well separated and did not bleed into each other too much. The midrange was natural, vital for believable vocals, but lacked the final level of clarity. But when pushed to the limit (back to the Metallica album) there is some graininess. The detail of the harmonics in the voice, the low level phrasing, vocal modulation during notes for example, was largely absent. In isolation this did not detract from the enjoyment of this album and you need to spend a hell of a lot more than £600 to recover this aspect of a performance.

A recent find (thanks Drew) is *Rabbit Songs* from Hem which is beautiful Americana folk music (Country by any other name would ▶

▶ sound as sweet ...) which relies on a fabulous female vocal over largely acoustic instrumentation which really spot-lit the amplifier. The Rotel demonstrated the other side of its character now with a surprising delicacy which I believe stems from its good speaker control. Leading edges of plucked guitar notes for example are well formed, if a little

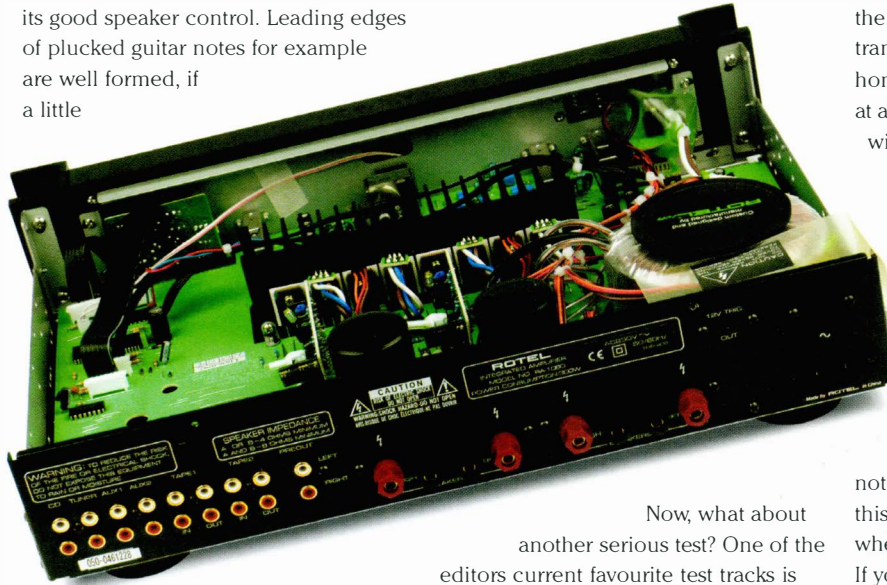

truncated at the tail. The piano on this album is very well recorded (pianos twenty feet across do tend to falsely dominate proceedings I find). The percussive nature was well presented and string tone was handled with aplomb by the Rotel which managed to time and integrate the musical strands very persuasively. Absolute transparency across the frequency band was a little constricted but I think this should be expected at the price, listening to this amplifier was always very easy for me.

During experimentation with other partnering equipment I found the 1060 thrived on a good source and this amplifier deserves a CD player at least as good as the top Rotel, the 991, or something seductive like the Sugden CD21a. Speakers should be easy because of the powerful nature of the amplifier, just make sure they can play a tune or two or you will miss a large part of what this amp is capable of.

I tried several cable combinations including several Chord company speaker cables and Naim NACA5, settling on the NACA5 because of its edgier treble and potent bass performance which seemed to suit the 1060.

Now, what about another serious test? One of the editors current favourite test tracks is the *Gladiator* soundtrack and this was presented in a full bodied (should that be bloodied?) manner. To pick out illustrative examples, the counterpoint of the guitar in the opening track was well presented although as the song progressed the fast playing seemed to lose its impact. The suspense was adeptly handled and the climatic moments fared equally well, although the congestion mentioned before was evident at these times and the layered but separate strands started to blur together. Brass was suitably brassy and the timing during the more tuneful moments was excellent. When I was just listening to this amplifier sans reviewer hat, it was good fun to use. String tone and the harmonics of the instruments were also well portrayed. The deep bass that is present all over this album was never allowed to wallow which was impressive. But (and there is always a but) I felt that the treble was closed in and turning on the high frequency contour control did not

solve the problem, in fact it made the problem more obvious. Image width and depth also suffered and this is probably related to the recessed treble performance. I do have a sneaking concern that the switched speaker outputs and other features in or around the signal path are the cause of these transparency and treble issues. To be honest though these problems are not at all major at this price, when partnered with the brighter and more explicit presentation from a pair of loudspeakers like the RR1's the whole issue was less prominent.

This product demonstrates that Rotel are better capable than most of creating very good balance between the need for function, price and sound quality and it is obvious from enjoying this amplifier that sound quality has not been the first casualty. At the price this amplifier has to be one of the best, whether you need the features or not. If you are looking for a powerful integrated amplifier that is capable of an enjoyable dynamic musical presentation then look no further, its that simple. ▶+

#### TECHNICAL SPECIFICATIONS

Type:	Line integrated amplifier
Inputs:	4x Line, 2x Tape
Outputs:	2x Speaker, 2x Tape, 1x Pre-amp, 1x Headphone
Rated output:	60Watts / channel into 8 Ohms
Input sensitivity:	160mV
Input impedance:	33kOhms
Dimensions (WxHxD):	430 x 92 x 355 mm
Weight:	7.8kg
Price:	£600.00

#### UK Distributor:

Gamepath Ltd  
Tel. (44)(0)1908 317707  
Fax. (44)(0)1908 322704  
E-mail. info@gamepath.co.uk



**Loud & Clear**  
HI-FI & HOME CINEMA

*Scotland's premier Naim dealer*

520 ST. VINCENT STREET, FINNIESTON, GLASGOW **0141-221 0221**  
26 HAMILTON PLACE, STOCKBRIDGE, EDINBURGH **0131-226 6500**  
[www.loud-clear.co.uk](http://www.loud-clear.co.uk)

# Audio Images



With the best choice, advice & service. For all that is Real Hi-Fi and Home Cinema

*The World's finest CD player now in stock*

Audio Images is The shop. Call now on 01502 582853  
128 London Road North, Lowestoft, Suffolk NR32 1HB.



2 Star Lane  
Ringwood  
Hants.  
BH24 1AL  
Tel: 01425 461230  
Fax: 01425 472054

...Join the dots!

## phonography

Arcam, Rega, Rotel, Naim, Densen, Royd, Shahinian, Dynavec, Ortofon, Cura, Dynaudio, Chord, Quadraspire

# Infidelity

INDECENTLY GOOD HI-FI

Buying hi-fi should be a delight. If choosing your new hi-fi in a civilised and relaxed atmosphere from a well-chosen selection of genuine performance equipment appeals, then we are for you. Bring along your own records or CDs, we'll provide the coffee, and hear the difference we can make.

9 High Street, Hampton Wick,  
Kingston upon Thames, Surrey KT1 4DA  
Telephone: 0208-943 3530

Open: Tues - Fri 10.30am - 7pm  
Saturday 10am - 6pm.





**Mains Cables**  
**Power Distribution Centres**  
[www.audioatmosphere.com](http://www.audioatmosphere.com)  
[stuart@audioatmosphere.com](mailto:stuart@audioatmosphere.com) 01785 711232

## the leicester hi-fi company

St. Martin's Square  
Leicester LE1 5EW

Arcam		Pro-ject
Cyrus		B&W
Crimson		Marantz
Chord		Bryston
Nautilus		Epos
NAD		Tag McLaren
ProAc		Videologic

Tel: 0116 2539753  
[info@leicesterhifi.co.uk](mailto:info@leicesterhifi.co.uk)  
web: [www.leicesterhifi.co.uk](http://www.leicesterhifi.co.uk)



# World's Best Turntable.

Sounds the best, looks the best, at the best dealers.  
Phone for enlightenment.

Audiocraft (Uxbridge)	01895 253340	Loud & Clear (Scotland)	0131 555 3963
Definitive Audio (Nottingham)	0115 973 3222	M.A.X (Birmingham)	01562 822236
Brady HiFi (Liverpool)	01925 828009	Premier Audio (Wakefield)	01924 255045
Kronos HiFi (Ireland)	02887 753606	Progressive Audio (Kent)	01634 389004
		Sounds Perfection (Cornwall)	01326 221372

## AVID

7 Yeomans Close, Catworth, Huntingdon, Cambridgeshire, PE28 0PL, England.

● Tel: 01832 710370 ● Fax: 01832 710436 ● Email: info@avidhifi.co.uk ● Web: www.avidhifi.co.uk



www.midlandaudiox-change.co.uk

# MAX

Midland Audio X-change

### Nagra VPA Monoblock Amplifier

If you have been praying for a classic amplifier that can reliably transport you past all the electronics and present you with a magnificently convincing musical experience, your prayers are answered - the Nagra VPA Vacuum tube Power Amplifier is here.

Imagine 50 Watts per channel, Pure Class A Triode Monoblock amplifiers sheathed in machined-aluminum towers about the size of a large dictionary - they simply bring absolute magic to the heart and pure delight to the eyes.



MAX

Suppliers and installers of  
High Quality Audio Systems

47 Laboratory	Kuzma
Accuphase	Lavardin
Audio Physic	Mark Levinson
Audio Research	Martin Logan
Avid	Michell
Basis	Nagra
Benz Micro	Primare
Cardas	ProAc
Clearaudio	Rega
Conrad Johnson	Resolution Audio
Copland	Siltech
Dcs	Sonus Faber
DNM / Reson	Spectral
Electrocompaniet	Nordost
Finite Elemente	Sugden
Graaf	Transparent Audio
JM Labs	UKD
	Verity Audio

call John Roberts Tel / Fax: 01562 822236

181 Franche Rd • Kidderminster • Worcs • DY11 5AD

e-mail: sales@midlandaudiox-change.co.uk

Mobile: 07721 605966

## new audio FRONTIERS

hi - fi retail



The Isoblu stand  
a new reference



Now on demonstration  
the amazing Naim NAP 500

Dynavektor moving coil  
cartridges, the best there is



43 GRANBY STREET  
LOUGHBOROUGH  
LEICESTERSHIRE  
LE11 3DU

TEL: (01509) 264002

FAX: (01509) 219900

E-mail:  
naf@replete.freemove.co.uk

# Etymotic Research ER-4P In-Ear Headphones

by Roy Gregory

Once was that headphones were an essential part of every high quality hi-fi system. Big, closed back cocoons with nasty plastic ear pads that made you sweat but were de rigueur. Nowadays, it's no longer the case and 'phones are way down most people's priority list. Those that need them for their system have them; the rest of us probably have an old pair of Sennheiser HD440s left over from college, lurking in some long forgotten corner. Yet, ironically, the overall use of headphones has increased dramatically, mainly in conjunction with high quality portable sound from Walkmen, Discmen, Mini-Discmen and just about any other "-men" Sony can think up. Sound on the move has become a part of everyday life, and the quality of the sound available from today's best portables is pretty impressive. Shame the same can't be said of most of the earphones supplied as standard.

Enter then the Etymotic Research ER-4 series, in-ear 'phones with a difference. These babies don't just nestle in the entrance to the ear canal they actually fit right inside. At £267 they aren't exactly budget items, but their unique approach ensures that they enjoy certain very real and worthwhile advantages over the competition. Look at the picture and you'll see that each ear-piece is fitted with a set of soft plastic concentric



umbrellas, tapering to the tip. These are moistened before you insert the phones into your ears and form a series of sealed baffles between your ears and the outside world (foam torroids are supplied as an option). It's a surprisingly effective seal too, eliminating a huge amount of background noise, the bugbear of all portable listening, as well as preventing the escape of intrusive leakage of the sort seemingly designed specifically to upset your neighbour. If there's one thing worse than listening to something you don't want to, it's not

quite listening to it instead. And when I say that there's no leakage from the ER-4s I mean none.

This isolation (the manufacturer claims around 25dB) means that not only can you hear more low level detail in your recordings, you can do it at lower listening levels too, making for an altogether less fatiguing experience. Faced with a

transatlantic trip, I wasn't slow in obtaining a pair to try out. The cheap seats of a Boeing 747 are a pretty stern test for any sound system, with a very high ambient noise level and very poor source quality (if you're relying on the in flight entertainment).

The ER-4Ps passed with flying colours. Not only did they replay music wonderfully well from a Sony MZ-R90 Mini-discman, but they managed to render the IFE dialogue intelligible, even if they couldn't do anything about the quality of the material. Now I know why I've never played *Tomb Raider!* And what's more, they did it at around a quarter of the volume required by the supplied headphones. Back on the ground, they even survived 20 minutes at level 19 on a stepper, which goes to show just how securely they fit. The plastic baffles were also immune to sweat, unlike the foam covers

► of most in-ear models.

They did especially sterling service when it came to the tedious task of transcribing interviews from the R90, which leads me to the next point. Although at first having something imbedded in your ear feels downright alien, even a little uncomfortable, it's remarkable how quickly you adapt to it. I can't say you're going to forget they're there, but long term comfort, even four or five hours at a time, simply isn't an issue.

So by now you'll have gathered that I was pretty impressed with the ER-4Ps: impressed enough to see how they stack up against conventional 'phones. But before I go any further perhaps I should explain that the P is only one of three

similarly priced models. It's optimised for portable use, sacrificing the last word in sonic performance for extra efficiency. There's also a less sensitive S model, optimised for sound quality, and a binaural B model as well. Given that the MZ-R90 drove the Ps with gusto, I'd suggest that it's certainly worth trying the S model with the portable of your choice.

Meanwhile, back to the home listening for which I drafted in the resident Sennheiser HD600s driven from a Sugden Head-master. Source was a Wadia 861, so no scrimping there. To say I was surprised by the results is an understatement. Starting with the HD600s I was greeted by their traditional warm, enveloping welcome. Plenty of weight and a reasonably out of the head experience. Changing to the ER-4Ps (they even supply a nice, tightly fitting, gold plated quarter inch

jack adapter) I was astonished by the dramatic increase in transparency, detail and separation. This is not subtle. The effect is definitely inside your head but somehow that perfectly suits the crispness and articulation of the delivery. And I'm not just talking detail and cosmetics here. Whether it's down to the closer

The only other issue is the use of tiny foam filters in the ends of the ear-pieces. These get clogged and need replacing so a permanent supply is required. Whether they can be cleaned I don't know (I can't see why not) but I'd be inclined to obtain a goodly supply at the time of purchase.

That aside I'm happy to give these 'phones the highest recommendation. Whether you need them for use at home or on the



coupling or not I simply don't know, but the ER-4Ps also represented a step up in temporal and rhythmic integrity. They didn't just give you more detail, they organised it better for you too. So, whilst I'm reluctant to award clear winners in this kind of comparison, in this instance it seems unavoidable. The in-ear phones romped home by a length, and then some. And let's remember that this is the model that's been compromised for greater efficiency. Of course that could be exactly why they do that voodoo that they do so well!

Problems? Well, the lead could be quieter, especially the plastic barrel where the phone leads split, although this tends to effect all in-ear designs. Knock it with nothing playing and you'll get quite a shock, but don't be concerned as in practice it's a lot less of a problem than you might imagine.

move their performance and practicality is simply superb. If you need them for both then their purchase is a no brainer. I know they're expensive, but nothing else anywhere near the price even comes close or offers the security and versatility. This is, quite simply, an exceptional product. ➤+

ER-4P

£267.00

**UK Distributor:**

UAS Enterprises Ltd  
131 Southampton Rd  
Ringwood  
Hants  
BH24-1HT  
Tel. (44)(0)1425-481234  
E-mail. [Info@pjbox.co.uk](mailto:Info@pjbox.co.uk)  
Net. [www.pjbox.co.uk](http://www.pjbox.co.uk)

# Clearaudio Champion Turntable Level 1 Upgrade

by Peter Russell

In Issue 13 I reviewed the Champion Turntable by Clearaudio and talked about an upgrade path. Fortunately Clearaudio is one of those few turntable manufacturers who recognise that not all audiophiles have large sums of disposable income crammed into a pair of trainers to be spent on audio goodies. With the Champion you can start with the 'basic' and, as funds and inclination dictate you can progress and improve your original turntable.

The level 1 upgrade pack consists of a second acrylic base with the same cut outs as the original into which are screwed three feet with shock absorbent pads, together with an isolation base for the motor unit. This serves to not only set the motor at the right height for the now raised platter, but also to act as an isolation and damping mechanism for the motor. The accompanying manual advises you not to level the turntable by adjusting the new feet but to use the spacers provided. This is to preserve the integrity of the rigidity of the three feet that support the deck. The whole point about this is to create a further layer of isolation from both airborne and mechanical vibration. A further supply of white cotton gloves is

provided to isolate you from the acrylic as you assemble the deck. The whole assembly process only takes a few minutes and makes the deck look as if it cost twice the original purchase price.

Is it worth spending £645.00 on this upgrade? The answer has to be yes. Given that the point about the level one upgrade is to do with isolation then you would expect to hear a tightening up of the soundstage and increased image stability and this is exactly what you get. But there is more to it than that. The music is

presented as part of a larger soundstage and with clearer definition at the extremes; music at the periphery

becomes more bounded and marked whist the impression of depth is extended to the back of the concert hall. On percussive guitars the notes have an increased energy and

impact that really get your attention. It is only when you hear vocals that you realise that without the additional isolation there is a smearing of the voice as it adjusts its intensity and dynamic range. Adding the upgrade still

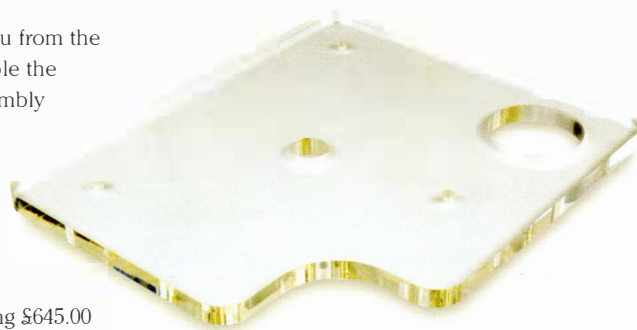

preserves the Champion's analytical articulation and clean presentation but with much more precision and control. I understand that there is yet another upgrade available for the deck, involving a thicker platter and correspondingly more massive arm base. On the evidence of Stage 1, Stage 2 should be well worthy of investigation. Upgrades to existing equipment (something of a turntable tradition) are a great way of adding value to your original purchase - as long as they work. This one does, and all Champion owners should examine the possibilities it offers at the earliest practical opportunity. ➤+

For further details contact:

**Audio Reference**

Tel. (44)(0)1252-702705

E-mail. [info@audioreference.co.uk](mailto:info@audioreference.co.uk)

**Manufacturer:**

Clearaudio Electronic GmbH

E-mail. [clearaudio@t-online.de](mailto:clearaudio@t-online.de)

# Kind Of Blue

## The Statmat Reincarnate

by Roy Gregory

The Statmat has long been a favourite accessory amongst the Plus reviewing staff. I use one; DA uses one; JMH uses one, DD uses one. Even Simon the photographer uses one. The effects are far from subtle and entirely positive, even if the explanation for them is far from clear.

The basic Statmat, a thin plastic disc with an odd pattern of printing and cut-outs, has been with us for quite a while, the only real criticism being their occasional tendency to hang up on the disc clamp, necessitating a trip inside your CD player (or DVD machine) to retrieve the errant device. There's even a special version to use with the Pioneer stable platter mechanism, and clearly that avoids the truant tendencies that can afflict their conventional brethren.

Now comes Son of Statmat, or maybe that should be Statmat's bigger brother. Statmat CDi Blue to give it its proper name, is actually a composite construction of two Statmats stuck to either side of a thin blue substrate. The one above is attached at three discrete, equidistant points: the one below is a slightly modified mirror image of the one on top, but only attached at two, off centre points. The resulting structure is considerably more substantial than the standard flimsy version, although you must let its physical bulk go to your head. The underside in particular is prone to flapping around, and careless handling could easily result in it folding under itself, resulting in a crease which will prevent it sitting flush against the disc, limiting its effectiveness. If the unthinkable happens, simply place the

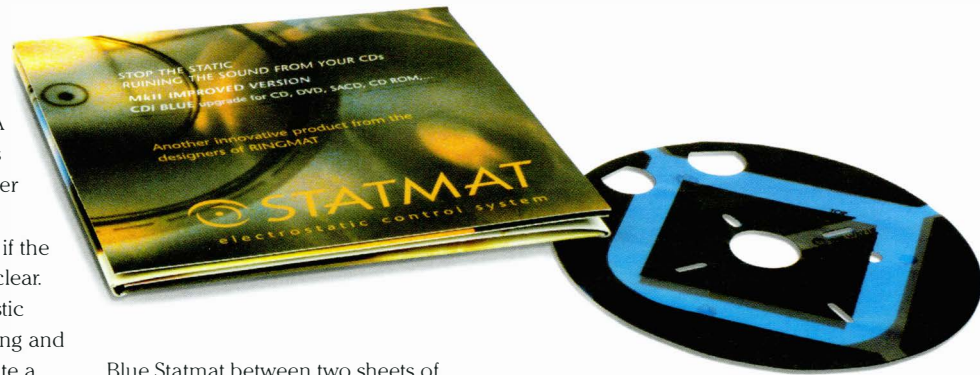

Blue Statmat between two sheets of clean paper on a flat surface, and beneath the heaviest book you can find. I can also recommend VPI bricks for this function, even you can spare them from your mains transformers. Using the CDi Blue is otherwise identical to the standard version, except that it'll cost you £37.50 as opposed to £19.95.

Returning to a non-Statmatted disc by way of a reference was quite a shock. The standard Statmat adds so much weight, space, focus and low level detail to the music that it sounds hopelessly anaemic and plasticity without it. Using 'Tenderness On The Block' as an example (Shawn Colvin *Fat City* Columbia CK 47122) the finger snaps and tambourine that open the track have far more body and detail, while the guitars and voice are far more solid, weighty and rounded. The sense of space between the instruments and overall focus are massively improved. It's exactly the sort of richness and resolution that so many listeners love about a decent record player.

Moving up to the Blue Statmat the improvement over the standard version is more subtle but in many respects more fundamental. It extends all the

performance benefits of the original but the initial impression is less impressive than the difference between the standard version and the raw disc. That's partly because it has less to work with, but also because less of the improvement is tonal and more has to do with spatial coherence and resolution. The instruments and soundstage now move completely free of the speakers, each image being significantly better proportioned and far more precisely located in the depth plane. That might not sound like much but listen to a few discs, revert to the standard version and see if you want to live with the lack of solidity and musical coherence that results. It may be expensive for what it is but the CDi Blue delivers full value and is just as highly recommended as the original. ➤+

Further Information from:

**Ringmat Developments Ltd**  
Tel. (44)(0)1277 200210  
Net. [www.ringmat.com](http://www.ringmat.com)

# The Stello CDA200

## – upping the ante in the value stakes

by Roy Gregory

For years now, companies have been designing products for their domestic markets but building them in the Far East in an effort to keep their production costs down.

It started with budget electronics, but increasingly it's an approach which has been grasped (perhaps clutched would be a better term) by companies with far loftier aspirations and reputations. Recent examples

include the Marsh electronics and perhaps more famously, Red Rose. With a burgeoning experience in manufacturing and designing high-end electronics it was only ever going to be a matter of time before the producers decided to go into business on their own account. Of course it's been done before in other industries with clones and copies springing up left right and centre. The bicycle market is a prime example, with everything from clipless pedals to full on frames flooding the western world, and all at bargain prices. The problem is that copies are one thing, but real knowledge is required to generate worthwhile new designs: Which is exactly where April

Music come in. As one of South Korea's leading high-end distributors they are ideally placed to take advantage of the growing local manufacturing expertise.



The long term plan includes two complementary ranges; Eximus, a serious assault on the high-end, and the more affordable Stello. What we have here is the first offering from the latter line, an integrated CD player with more than one trick up its sleeve. Hidden inside its sleek and stylish exterior (and I do mean sleek and stylish) is just about everything a performance (or fashion) conscious audiophile could want. You get up-sampling, digital inputs, separate transformers for analogue and digital stages, sophisticated clocking and balanced outputs. With its 24bit/192kHz capability and

connections for two external digital sources (one co-axial and one optical) your investment in all that expensive digital hardware is, at least nominally, future proof. Unsurprisingly, it's a specification that reads like an audiophile wish list. Of course, facilities and

performance are far from the same thing, however lift the lid on the CDA200 and the internal construction and parts count is suitably reassuring. Much of the critical circuitry is encapsulated

which could, of course, hide a multitude of sins, but there are easier ways to shave a few bucks, and it would be wildly out of character with the obvious care that's gone into the rest of the circuitry.

All in all, balancing the specification, appearance and internal construction, if this product came from a European company I'd peg the price well the wrong side of two thousand, probably closer to three thousand pounds. Instead, by the time the Stello CDA200 lands on these shores April Music estimate that it will retail for

► under fifteen hundred, and remember, these guys know a thing or two about importing and distribution. That's got to make it interesting: the question is, does the performance match the appearance?

I started by using the Stello as a straight 44.1 CD player, and it quickly established its credentials. Refreshingly free of mechanical digitalis, it allows music to breathe and flow at its own pace rather than imposing itself on proceedings. Even in this mode it leans to the refined and detailed, with an open, transparent sound. It lacks the dynamic heft, engaging substance and authority of players like the Resolution Audio or Marantz SA1, but then it lacks their hefty price tags too. Instead you get information and organisation, insight and texture.

The competition at its target price is another matter, with few products offering greater low frequency drive without paying a heavy price in other areas, and none capable of matching the CDA200 for sheer useable information. Indeed, in those terms it actual gives the resident heavy weights a serious run for their money. Its musical style might lean toward the cerebral rather than the emotive but this is definitely a machine that cuts to the musical quick.

Engage the up-sampling and you extend that character even further, with a readily appreciable increase in focus, resolution and transparency. Playing the Corelli *Concerto Grosso* from *The Tube* (Tacet 74) both dynamic discrimination and the space between the players is significantly more explicit with the CDA200 running at 192kHz. There's also a greater sense of the

recorded acoustic. But the real improvement is temporal, with the placement, leading-edge and duration of notes is far more accurately and vividly revealed. It brought a much greater sense of immediacy and musical engagement, and if it didn't add to the player's overall weight or the grounding of its bass, it brought some welcome added authority and a more emphatic delivery.



The extra resolution of the 192kHz up-sampling isn't always a shoe-in. With it comes a leaner and less congested midrange, but it's one that can leave lower quality recordings sounding exposed and introduce an element of glare to their upper mid and lower treble. In this case the 96kHz option is preferable, adding a warmer and more rounded quality combined with some welcome added resolution over and above the standard 44.1. The beauty of course is that you do have the option. If you don't like the microscope provided by 192 then you can pull back a little by engaging 96. You still feel the need for a little more body and you're prepared to sacrifice detail and transparency? Switch to 44.1. This level of versatility can only be welcome (better still if it was included on the remote control), but more than that it indicates the integrity of the

engineering in this player. Not all up-sampling works anywhere near as successfully as this, regardless of price. Indeed, whilst this player won't fool you into thinking that you're listening to a state-of-the-art machine it's musically more valid than many of the seriously expensive pretenders to that crown. The impressive thing about the Stello is that it manages to graft the benefits of up-sampling onto an already impressively expressive performance without upsetting the apple cart.

The CDA200 CD player will be joined by a matching integrated amp later in the year: It promises to be a powerful combination. Those looking for greater substance and body, more weight and absolute authority might well look elsewhere, but they'll inevitably pay a price for the pleasure.

This Stello machine sets astonishing new standards for resolution and transparency at its proposed price. If the company can hit that target (and there's every reason to assume that they will) then they'll be throwing down a gauntlet to those companies competing in the vital middle ground. It's not a perfect player, or all things to all men, but it is a mighty impressive first effort. If April Music can build on this foundation then they'll cause serious ripples in the high-end. ➤

For further information, contact:

**April Music**

Tel. (82)2 3446 5561

Fax. (82)2 3446 5564

E-mail. [simonlee@audio.co.uk](mailto:simonlee@audio.co.uk)

# Performance Developments Triadd stand

by Jimmy Hughes

Although it's perfectly possible to mount the various components that go to make up a hi-fi system on existing items of furniture, most enthusiasts accept that superior results will only be obtained when a proper specialist equipment support stand is used. For those wanting a stand of exceptional rigidity, the products of a new company Performance Developments are worth looking at. They're offering a range of supports that can be tailored to match individual requirements.

Although the company is able to custom-build stands to cater for individual requirements, they produce a basic four-tier version designed to meet the needs of all but those with big systems that require a more elaborate complex support rack. Called the Triadd, it's a triangular stand with three 50mm dia support turrets of varying heights. These allow shelf heights to be adjusted to accommodate components of differing height - for example, extra space on the lower shelf for a large power amp.

Depending on the version chosen, each shelf is either 6mm or 10mm thick, with holes drilled to accept three Performance Developments dampers. These oil-filled aluminum supports consist of two tight-fitting

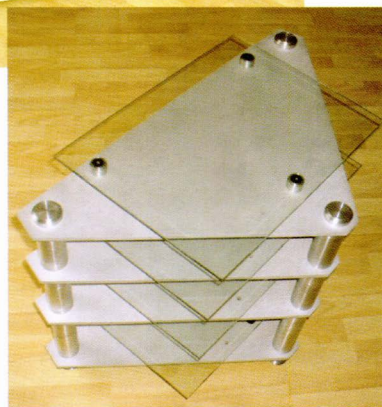

halves, providing a rigid yet slightly decoupled 'foot' on which sits a 6mm thick toughened glass shelf. The whole stand sits on cone feet, and the company supply a set of matching support cups, allowing you to put the stand on a polished wooden floor without scratching the surface.

Total weight of the stand depends on the exact combination chosen. But my review stand comes in at about 42kg. For those wanting something even more rigid and high-mass, there's a version using 20mm thick granite

shelves available at extra cost. Further options include stainless steel, acrylic, glass, and solid wood of various types. If there's a specific finish or material required, just ask. My stand was the basic aluminum version, supplied with a natural silver-grey textured surface.

The Triadd is fairly broad, ensuring plenty of free area either side

of most typical 17mm wide hi-fi components. In domestic situations (like mine) where space is limited, this may not altogether be an advantage - a conventional rectangular stand will be more practical. Nevertheless,

I managed to squeeze the stand into the limited space available, twisting it slightly to the side. Knowing that turntables are often the best barometer of a stand's effectiveness, I mounted my Kuzma Stabi on top and played some LPs.

There was an immediate impression of tightness - a sense of control. Bass seemed firmer, and



▶ overall the sound felt more solidly focussed and weighty. Stereo imaging was slightly better in terms of pin-point sharpness and precision. The Kuzma Stabi turntable has a fairly warm/loose kind of sonic presentation; it sounds rich and full, rather than lean and detailed. Given this, the sonic changes introduced by the Triadd were almost wholly beneficial.

With regard to the various options available, it seems likely that moving towards softer more compliant materials like wood or acrylic would sacrifice some of the precision and immediacy of the glass and aluminum version, resulting in

a slightly warmer more voluminous presentation. Going in the direction of granite would almost certainly have the opposite effect, creating a tighter, leaner, drier sort of

presentation, placing the emphasis on clarity and separation.

Prices for the four tier Triadd stand range from \$1250 for the version with 6mm shelves and supports, to £1295 for 10mm shelves

and supports. The granite alternative ranges from £1430 to £1475, with

combinations using other materials available on request. If ordering direct, it might be possible to deliver and set up the stand

providing you live within a reasonable distance of the company's base in Redditch, Worcestershire. ➤

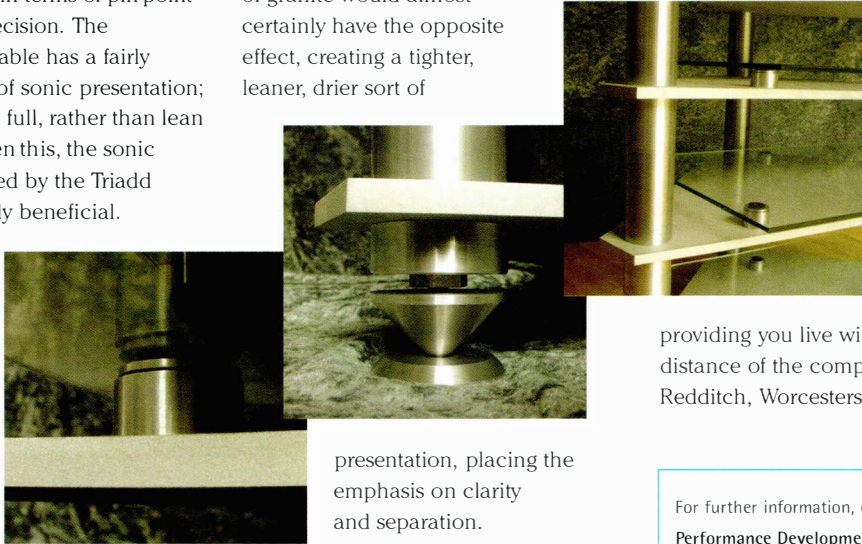

For further information, contact:

**Performance Developments**

Tel. (44) (0)1527 522413

E-mail. [info@performancedevelopments.co.uk](mailto:info@performancedevelopments.co.uk)

Net. [www.performancedevelopments.co.uk](http://www.performancedevelopments.co.uk)

## FREE Hi-Fi Upgrade...

hiforsale.com's AudiophileCandy  
2002 accessories catalogue



Our brand new 2002 catalogue is available **NOW** completely **FREE** of charge, order online at [www.audiophilecandy.com](http://www.audiophilecandy.com) or give us a call,

**0870 241 246 9**



...a fresh idea for finding high fidelity accessories, as well as being able to read detailed information about each one quickly and easily. At hiforsale.com's 'AudiophileCandy' you'll find the very best in class leading audio accessories from around the world.

## hi-fi+

"...as many of these accessories are unobtainable from conventional dealers, are system and situation dependent, but can make a very worthwhile difference to the sound of your system, it looks like a win, win situation to us." - HiFi+ Magazine

## ...Grab Your Copy **NOW**

# WELCOME TO LIVE MUSIC IN YOUR HOME

## THE EXCITING NEW WORLD OF RINGMAT AND STATMAT

**Imagine** - your favourite artists performing in person in your own home! Imagine how this would sound if you listened on LP, CD or DVD. How would it differ?

Fix this difference in your mind, for it is now possible to obtain this extra dimension from hi-fi systems if they are enhanced using our new Ringmat and Statmat products. Results from even inexpensive systems are simply amazing. Ringmat and Statmat are not replacement components for your hi-fi system but work with it to remove that "veil" which previously has always differentiated "live" from pre-recorded sound.

**Ringmat** products are de-coupling components that are used for supporting LPs and electronic hi-fi equipment and speakers in a way totally different from more traditional forms of support.

**Statmat** products derive from very thin film coated with special conductive inks to form very powerful, though passive, electronic devices. The use of this film, in conjunction with the Ringmat products, removes that "veil" from the reproduction of recorded music. The film is used in various ways, such as placing it on the label side of a CD, DVD, SACD, or CD-ROM disc, or placing it under an LP. It should also be placed under all equipment and speakers.

And now **Ringmat Audiophile Cables** will carry the signal from source to speakers without the losses that usually occur with hi-fi systems.

### VINYL

For vinyl lovers, the basis for good sound has to be the support of the LP on the platter. **Ringmat** is the pre-eminent record mat for virtually all turntables, either the XLR at £50 or the new Anniversary at £70.

Further improvements on a massive scale can then be achieved by using:

- **LP Blue Statmat** and **Statcap** to remove static;
- **Ringmat Spacers** to remove resonance from your turntable and platter and to fine tune stylus rake angle/VTA, and;
- **Ringcap** to remove vibrations emanating from the centre of the record.

All of these can be purchased separately or in one fell swoop as the **Ringmat Support System**, the best value for money upgrade possible for any turntable.

### CD, SACD, DVD, CD-ROM

For digital sources, the **CDi Blue Statmat** at £37.50 will totally transform playback, removing all that edginess and those other unwelcome features associated with using the silver disc. Close to top analogue performance without quite surpassing it, but wait until SACD has matured as a media source...

### UPGRADING

If you have earlier Ringmat or Statmat products, these can be exchanged for the latest versions at a special upgrade price.



### YOUR WHOLE SYSTEM

All your components and speakers should be protected from static and other unwanted electronic fields by using **Statfeet** underneath each of them. They should also be supported by **Ringmat Feet** and/or **Ringmat Domes**, as appropriate for each component's design and situation. We can advise you on this.

The icing on the cake is **Ringmat Audiophile Cables**. We researched these because no other cable provided the level of performance required to realise the potential of other Ringmat and Statmat products. The speaker cable is available now and the interconnects later in 2002.

### MONEY-BACK GUARANTEE

All products purchased from us have a no-quibble money-back guarantee as well as help and advice in getting the best out of our products in your system.

### DON'T MISS OUT!

dial 01277 200 210  
visit [www.ringmat.com](http://www.ringmat.com)  
or e-mail us at [enqhifi+@ringmat.com](mailto:enqhifi+@ringmat.com)  
NOW

 RINGMAT

### RINGMAT DEVELOPMENTS

PO Box 200 Brentwood  
Essex CM15 9FB GB

## PERFORMA PLUS+

### HiFi Stand and furniture suppliers

Our company offers not only a standard range of equipment support systems with our proven and copyrighted damper system but also each item is built to order therefore each unit can be tailor made to your requirements. Finally offering individual designs as illustrated by some of our computer generated images shown.

Computer generated imaging allows you to be happy with your design prior to purchase and if desired total exclusivity.



Offering a wide range of materials including wood, aluminium, granite, marble, glass and stainless steel. Using modern imaging techniques and CAD design, we offer truly one off designs as well as standard parts from our range of developments.



Some images of one of our standard range stands. A full aluminium billet high mass fully damped stand with glass beds.



### Performance Developments

Performance House  
90, Cheswick Close  
Redditch, Worcestershire. B98 0QQ

Tel: 01527 522413

Email: [info@performancedevelopments.co.uk](mailto:info@performancedevelopments.co.uk)

Web: [www.performancedevelopments.co.uk](http://www.performancedevelopments.co.uk)

Many other products developed at request such as matching furniture.

Deliveries from 4 weeks upwards, some standard equipment available for immediate delivery.

Prices starting at £95.00 for platform supports, damper sets at £60.00 per set of 3 and standard range fully damped stands from £900.00

*record cleaning machines: record cleaning fluid: tonearms:  
turntables: incognito arm cables: arm rewire: pearl coolers:  
sovtek tubes: thirty series amplifiers: phono stages: power  
conditioners: spur installations: cables: headphone amplifiers:  
distribution boards: ben duncan projects: distribution boxes:  
amplifiers: cartridgeman products: test lp: test cds: stylus  
balances: leyline cable systems: mains cables: accessories:  
ringmat: statmat: decca cartridges: audiophile vinyl: audiophile  
cds: cardas: densen: michell:  
hfn accessories: record/cd care:  
books, books & more books!*

**moth**  
GROUP

Moth Group. 10 Dane Lane, Wilstead, Bedford, England. MK45 3HT

Telephone ++44(0)1234 741152 Fax ++44(0)1234 742028

e-mail: [moth@britishaudio.co.uk](mailto:moth@britishaudio.co.uk) [www.britishaudio.co.uk](http://www.britishaudio.co.uk)

# Record Reviews

## How To Read Them

The information contained in the record reviews is presented in the following way. Albums are identified by label and serial number. Beneath this you will find one or more icons which denote the available formats for the recording. The first icon refers to the format reviewed.

The ratings at the bottom of each review reflect the reviewer's opinion of the recording quality, and musical merits of the album. You'll soon realise that a great many musically significant albums offer less than wonderful sound. Don't let it put you off! For your information the scale rates a standard, good quality pop recording as slightly below average.

The reviewers are identified by their initials.

They are:- Chris Binns, Pete Christie, Dave Davies, Roy Gregory, Jason Hector, James Michael Hughes, Jon Maple, Reuben Parry, Dave Ayers, Andrew Hobbs, Simon Groom, Mark Childs.

### Key to Icons

-  CD
-  Gold CD
-  HDCD
-  XRCD
-  Double Disc
-  SACD
-  120g LP
-  150g LP
-  180g LP
-  Availability As S/H LP
-  Vinyl Double Album



### Alligator Records 30th Anniversary collection

#### Various Artists

Alligator Records ALCD 112/3 

Let's start with a brief history of Alligator Records. It was formed in 1971 by 23 year old blues enthusiast Bruce Iglauer who used a small inheritance to record and release the eponymous Hound Dog Taylor and The Houserockers: 30 years later Alligator now has a formidable roster of some of the finest blues men and women in the world and boasts a catalogue of over 190 titles. *The 30th Anniversary* collection sits nicely along side the 20th and 25th Anniversary collections, but differs from the other two in that it offers one set of studio recordings and another of live sets. It opens with one of Alligator's brightest new talents, Johnny Copeland's daughter Shemekia. 'Turn up the Heat' is taken from her fine debut of the same name but if you really want to hear 'The New Etta' in all her glory track down newie *Wicked* (ALCD 4875) – It's aptly titled! Space doesn't allow for a full breakdown of this album's treasures but a deserved mention must go to Michael Burk's 'Got a way with Women'. It is taken from the marvellous debut 'Make it Rain' (ALCD 4878) and showcases his tough BB style vocals and scorching Albert King influenced guitar playing. *30th Anniversary* contains 145 minutes of essential Blues at a budget price – don't miss it!

AH

RECORDING	VARIABLE
MUSIC	



Physical Graffiti

Led Zeppelin

Classic Records/Swan Song SS2-200 1198 **180g** **4**

I must say that I was really looking forward to the arrival of this, the Classic Records reissue of the seventh Led Zeppelin LP. My original (UK) pressing sounds like the mould releasing agent had been substituted with sand, so crunchy and unpleasant is the sound. With Classic's flawless track record (groan!) with the Zeps to date, my expectations were high. Going straight for the jugular I dropped the stylus into the groove at the start of 'Kashmir'. Oh bliss! Oh joy! No more ripping, tearing, shredding sounds, no more peak distortion, just an incredibly clear rendition of this magnificent track. Page and Plant may have brilliantly reinvented the song for their *No Quarter* album, but then that was their only option as the original version could never have been bettered.

*Physical Graffiti* stands as Zep's most accomplished work encompassing many differing styles and attitudes across its four sides, from the sprawling blues workout of 'In My Time Of Dying' to the stomp funk of 'Trampled Underfoot', from the summery pop of 'Down By The River' to the orchestral 'Kashmir'. Yet, even though it threatens to break apart, there is a cohesiveness, somehow none of the tracks could have belonged on any other Zeppelin album. So for rock fans *Physical Graffiti* is another "must buy", and for audiophile rock fans then this pressing is the bees knees.

DA

Supplier: Vivante - [www.vivante.co.uk](http://www.vivante.co.uk)



Tosca

Chocolate Elvis

G-Stone CD 006 **CD**

There's a loose amalgam of musicians and remixer's centred, at least from this perspective, on the Kruder/Dorfmeister axis. It embraces bands and performers as diverse as Baby Mammoth and Bullitnuts and regardless of whose name appears at the top of the sleeve, the whole convoluted mass seem to chip in on an ad hoc basis, especially when it comes to the dub albums *Suzuki in dub* and *Chocolate Elvis*. Which of course makes both those albums the perfect departure point for a trip into the K&D nether world.

The aesthetic conceit of a black Elvis impersonator gives you some idea of the intelligence and sense of humour that's at work here. Dub reggae in a Graceland style is the order of the day, with electronic orchestration the modus operandi. But don't get the impression that this is just more mindless dance music. These guys can play, real instruments as well as their electronic counterparts, and it's the seamless blending of the two that makes these discs so listenable. They involve real layering and textural variation, hooked to the kind of subterranean bass lines that start your toes tapping from the hip. Deep, deep bass and serious dynamics, mixed with a serious sense of humour are a compelling combination. Even that die-hard rocker DA was moved to move, if you get my drift.

RG

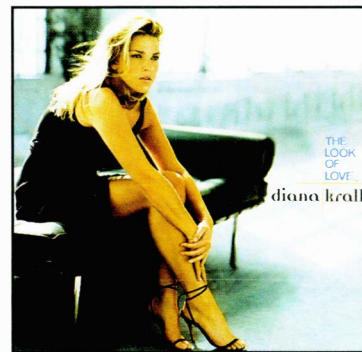

Diana Krall

The Look of Love

Verve 549 846-2 **CD**

With an international reputation as a fine pianist and singer, Diana Krall has previously performed with her own trio. But this new album has a fresh approach, with lavish orchestral arrangements and backings of lush strings - obviously in an attempt by Verve to broaden her appeal. While this approach is understandable, much of the unpretentious, straightforward clarity of intimate interplay on albums like *All For You - A Dedication to the Nat King Cole Trio* is lost, reducing the impact of her excellent piano work. On this release Diana Krall performs ten standard love songs, opening with a soft, bossa nova styled 'S'wonderful'. This gentleness is prevalent throughout the majority of tracks, with her more vibrant, penetrating side only coming through on three or four songs. Although she puts feeling and passion into most of her individual performance, it is the overly sweet strings that impair an otherwise nice recording. The sound is very good, if not totally natural, with a number of elements being mixed together.

I hope this new, over-elaborate style that Verve has assigned this wonderful Canadian performer, is not a sign of things to come. Of course, this trend was also imposed on Nat King Cole.

SG



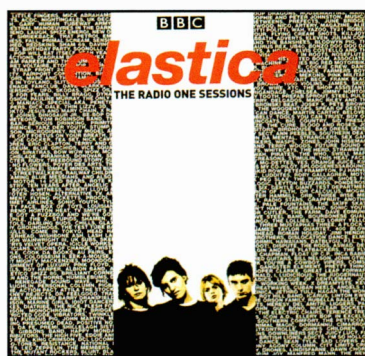

Elastica

The Radio One Sessions

BBC/Strange Fruit SFRSCD101

If anyone should release the summation of Elastica's career, then *The Radio One Sessions* would be the first choice. After all it was one Steve Lamacq, evening session stalwart for many a year, that first signed Justine and Co.

If you can forget the constant line up changes, the constant comings and going, the celebrity boyfriend, the anagrams, the tabloid baiting, the heroin, the broken promises and long waits, Elastica were fabulous. And that's what this album does. It collects the best (with a few exceptions) from the previous eight years and puts it back to back. And it's great.

And the first surprise is that everything makes sense. The huge disparity between the Elastica of 1994 that recorded *Elastica* and the Elastica of 2000 that recorded *The Menace* disappears. Instead this album provides a seamless progression that leads from their new wave roots to their modern climax. Elastica were essentially a live band. And this album catches this side of them perfectly. The choice of songs is superb, blending the singles with the b-sides and a few previously unreleased gems. And all are recorded by the sound men there at the Beeb. When turned up loud it sounds like Elastica are there, right in your living room, giving the best renditions they ever did. Remind yourself of the excitement they caused, remind yourself of 1994, buy it.

MC  
SONICS  
OVERALL

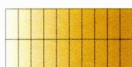

The Evinrudes

Drive Me Home

Flying Sparks TDBEP0057

"If I was the Pope I'd get undressed, take off my robe and my bullet proof vest, put on Levis and a pair of Chuck Taylors, leave the Vatican, go live in a trailer.

If I was a man I'd rule this planet, I'd beat up Michael, hang out with Janet, have me a child bride – a sweet little sophomore, daddy's little debutante, you know, the girl next door."

There's nothing predictable about the duo that constitutes the Evinrudes. Destined to be a sheep farmer and a lawyer respectively, Brian Reed and Sherry Cothran took an unmarked left on their career paths and ended up gigging roots rock with a sense of humour and a serious attitude. Beautifully played and sung with a truly great voice, these are songs and lyrics that actually deliver the impact and uncanny accuracy that smart weapons only dream about. An EP that covers the album *Little Red Stars* and the forthcoming *Someone Has To Be Pat Boone*, these six tracks deliver a punch beyond all expectation. Buy, consume, wait for more but never neglect the message.

"Somebody stop me before I tell the truth, I'm a little angry, maybe a little too stoned, you better cover my mouth, you better drive me home."

RG

RECORDING  
MUSIC

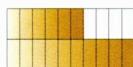

Gene

Libertine

Contra CONTRA 2CD

Whenever people talk about Gene words like "survivors" and "hardy" spring to mind. Back when they started, a middle of the road pop band sounding somewhat like the Smiths was a safe bet. But situations change, and Gene's found they had nothing to differentiate themselves from the rest of the britpop leftovers. Years left in the wilderness would be enough to finish all but the most determined bands, but not Gene. With a strong fan-base behind them they began a slow metamorphosis. With *Libertine*, they complete their transformation from indie also-rans to a distinct band in their own right, building on their previous (excellent) album *Revelations*. *Libertine* has an orchestrated, dance floor feel, shaking away to the beat of a tambourine. Gone are the Smiths and Weller influences, Gene now fly by themselves. Eleven, well written, solid songs, all performed with adept skill and subtlety form the back bone for the album. But its Rossiter's vocals that sets the thing alight. The songs still crawl amongst the dirt of the city streets, with tales of messy break-ups and domestic violence, but all are sung with angelic innocence.

They may not be about to start a revolution, but *Libertine* is a good solid album that makes the world that bit more interesting.

MC

RECORDING  
MUSIC



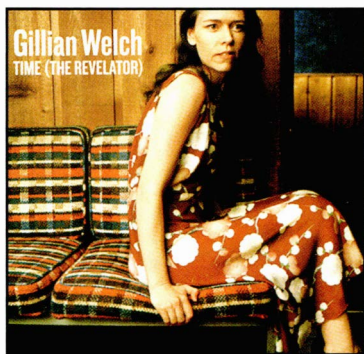

Gillian Welch

### Time (The Revelator)

Acony ACNY-0103 (CD)

The Coen brothers know a thing or two about cinema, and judging from the seriously underrated *Oh Brother Where Art Thou*, they know a thing or two about music too. The blue grass sound track to that movie has already spawned a spin-off concert film and rocketed Gillian Welch to well deserved prominence. *Time (The Revelator)* is her latest album and it's the original article. Those who like their country cut with a mixer might find this a bit straight up for their taste, but those who prefer their spirit neat will lap up the sparse exposure of this recording: Two acoustic guitars, Welch's voice and occasional backing from producer/accompanist David Rawlings. It's a raw and immediate experience, devoid of any comfort giving padding or distance, and all the better for it. The self-penned songs match the hard-hitting presentation, stretching from the country standard 'Red Clay Halo' to the acerbic edge of 'My First Lover'. It's an impressive line-up and delivered with skill and feeling made all the more effective by the unobstructed access offered by the recording. Despite the limited variety of forces available the songs never seem to lose their freshness or the album its appeal. If it's your thing then this is a disc that'll stay near the top of your ready use pile for years to come. Well worth a try.

RG

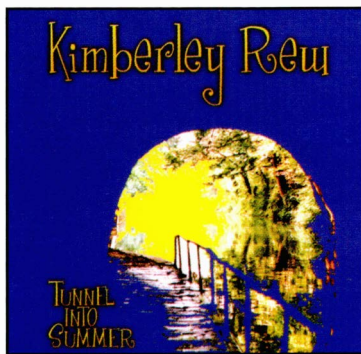

Kimberley Rew

### Tunnel Into Summer

Hypertension 0195 HYP (CD)

With a CV as long as your arm and an impressive array of supporters to back him up, you could be forgiven for asking Kimberley who? After all, despite the credentials it isn't exactly a household name. Except that there's not a reader out there who'll have been spared exposure to his greatest success. As principle song writer for Katrina and the Waves it was Rew who penned the almost narcotically catchy 'Walking On Sunshine'. We'll gloss over the Eurovision winning 'Love Shine A Light' and instead concentrate on the associations with The Kinks, Squeeze and Robyn Hitchcock. Indeed the majority of this, his first solo album, is produced by Squeezes' Andy Metcalfe with extensive backing from Glen Tilbrook. And if that hasn't got your attention then the music certainly will. From the joyous opener 'Simple Pleasures' (the track that gets closest to the catchy naivety of 'Walking...') to the gentle poetry of 'Honey Is That Love' this is a deft and sure footed roller coaster ride through a landscapes of accents musical and vocal. It's a more mature view of the world that informs as well as entertains, and if Rew hasn't lost his touch when it comes to working a hook under your skin, he's confident enough to let his lyrics do the talking too. Then there's always that deeply unfashionable but oh so entertaining instrumental that rounds the whole thing out.

RG

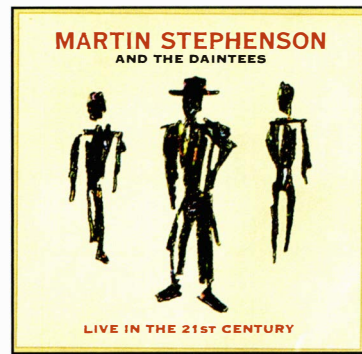

Martin Stephenson And The Daintees

### Live In The 21st Century

Fresh Ear Records FRESH CD 101 (CD)

Raw, earthy, improvisational and sometimes drifting in and out of tune, *Live In The 21st Century* is one for the ranks of the devoted. They will unhesitatingly part with the necessary ackers to add this disc to their collections. And why not. The recording was (as anticipated) inconsistent because this generous, 75 minute! CD was atmospherically taped, in situ, before an enthusiastic club audience. An opening, 'Wholly Humble Heart', warms them up nicely with its familiar rocky cadences. And although the later tracks, 'Left Us To Burn' and a blusey, 'Orange (Is The Colour Of Joy)', wobble just a little, the topical and frequently witty nature of those folk songs which follow will leave you in a forgiving mood where niceties of tone and technique are concerned. Numbers like 'Soloman', 'Goodbye John' and 'We Are Storm' finds Martin and Anthony and Gary Dunn at their best. Even new boy, drummer Alex Ross, excels in the gentle delivery of each pointed observation or ironic aside. The "you are there" level of intimacy (and perhaps you were?) is perhaps the most rewarding aspect of this album. It's a genuine, unpretentious and often anecdotal musical experience. Nobody stands on ceremony and the bands' interaction with the crowd is mutually infectious as a result.

RP





Ooberman

Running Girl

Rotodisc ROTOCDD001

Two years after Ooberman charmed their way into the charts with *Shorley Wall* they have returned to make our world a brighter place. This is a band that have had to learn the hard way that kitsch sugar-pop and grand press stunts don't add up to a surefire hit. Dropped from their label after office politics moved against them they found themselves cast out of the public eye.

And it may have been the best thing for them. Returning on their own label Rotodisc they have had the time to do things right. Gone are the grandiose clichés that dogged *The Magic Treehouse* and in their place are singularly gorgeous songs about pixies, ghosts and ice wolves.

Its still every bit the Ooberman that teased us in '98, every bit as eccentric as before. In fact the songs sit very nicely beside the quiet moments from their previous LP, but this time they are imbued with a sinister edge, as if, at any moment something could leap out from the shadows. There may be influences behind *Running Girl* but it's a better man than I that can recognize any. Ooberman have always made characteristic music, boldly striding in the opposite direction to the zeitgeist and this is no exception. However, while their previous album was bogged down with sentimental syrup, this album is a summer breeze.

MC

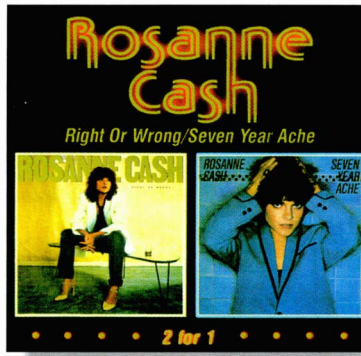

Rosanne Cash

Right or Wrong/ Seven Year Ache

Raven Records- RVCD 129

Raven Records are an independent label based in Australia who are developing the rather pleasing habit of releasing classic back catalogue by seminal artists of varying musical backgrounds. One to definitely buy is Mink De Ville's *Cabretta/Return to Magenta* (RVCD 59), and another essential purchase is this little gem from one of the original queens of new country. *Right or Wrong* and *Seven Year Ache* have long been deleted in this country, a travesty considering the wealth of quality songs and breathtaking musicianship displayed in their grooves. Nevermind, those lovely raven chaps have restored them to former glories and even added a tasty bonus track for good measure ('Ballad of a Teenage Queen') featuring Rosanne's father Johnny and The Everly Brothers. These albums closely resemble the feel of Emmylou Harris's *Country Masterpieces*, *Elite Hotel* and *Luxury Liner*. Not surprising when you see the musical credits. Most of Emmylou's superb band are here; James Burton, Albert Lee, Glen D Hardin, Rodney Crowell – even Emmylou herself! Great songs are in abundance too. Tom Petty's 'Hometown Blues', Steve Forbert's 'What kinda Girl', four stunners from then husband Rodney Crowell, and four from Rosanne herself, including the timeless *Seven Year Ache* (apparently written about Rodnet's philandering ways.) It's a real joy to see these wonderful albums available again.

Well done Raven – and keep em coming.

AH

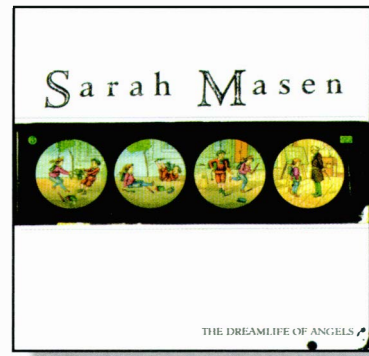

Sarah Masen

The Dreamlife Of Angels

Epic EK/ET 85311

The spiritual offspring of Emmylou might be a provocative appellation, but listening to Sarah Masen it's one that's hard to resist. Straight out of America's country heartland comes a voice of crystal purity blessed with phrasing and feel far beyond her years. She even has that doe-eyed fragility, that just waiting to get broke look that has haunted and reflected Emmylou's eventful career. And here too you'll find the sudden flash of steel, the glint of a sharp edge hidden in the folds of apparent innocence. Impressed? You should be, and not a little scared, because vision this clear doesn't happen along everyday. Get over the latent power and pain of 'Girl On Fire' and she blindsides you by rehabilitating an irredeemable ghost from your past. "Why is this so familiar?" you ask yourself, and then the shocking truth finally dawns: 'Give A Little Bit', once the idealistic hippy high point of Super Tramps' gloriously naïve path across the star spangled heavens is pared away and cut down to a delicate, essential truth. Out of the mouths of babes...

For all her youth and visual delicacy Sarah Masen is a force to be reckoned with and one that seems destined to grow and bloom. Put this one at the top of your Christmas list: it's the perfect antidote to all that over indulgence.

RG







## Stacey Kent

### The Tender Trap

Candid CCD 79751 

Miss Kent's voice has a distinctly old fashioned feel to it. This is not meant as a criticism. Yet the timing, soulful intonation and rhythmic delivery present in Stacey's interpretation of some wonderful popular standards is such that it's easy to imagine her confidently improvising a scat at any moment. That she chooses not to comes as a surprise, but then the style does still remain firmly rooted in a golden age of Fifties and Sixties jazz. Consequently, you would be unlikely to mistake this singer for one of the modern, identikit jazzettes like Patricia Barber or Holly Cole. Unfashionable by comparison? Yes, almost certainly. However, as with her Fred Astaire tribute LP, *Let Yourself Go* (Grooveland GLS 106), reviewed in Hi-Fi + issue 11, this earlier album, (which has terrific numbers penned by Cole Porter: 'In The Still Of The Night'; Irving Berlin 'They Say It's Wonderful'; the Gershwins 'They All Laughed', and of course Heusen and Cahn's title track), simply recreates a marvellous mood where the beauty of their songs, caressed by Kent's clean phrasing and snappy beat, are drenched in romantic poignancy. Great, sympathetic support from a five piece combo, that includes the melodic tenor sax of Jim Tomlinson and seriously good David Newton piano fill-ins, just pluck at the heartstrings all the more.

RP

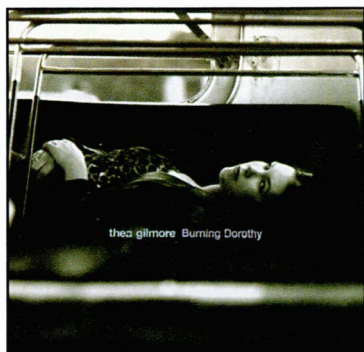

## Thea Gilmore

### Burning Dorothy

Shameless Records SHAME 1200 

Sales are usually a convenient vehicle for getting rid of all the old tat. Occasionally, though, an uncut diamond will mysteriously appear in the bargain bins. HMV, in a city which feeds forever off the reputations of a certain Fab Four, generously marked down Thea Gilmore's exceptional 1998 debut disc, *Burning Dorothy*. As Thea has been at pains to explain BD is in no way a homophobic allusion and anyone making that inference is thoroughly mistaken. Instead, this album attacks a "Wizard of Oz" mentality which seeks to perpetuate the modern myth that all you have to do to resolve life's difficulties is "click your heels" and return to a cosy apple-pie world in Kansas. An urban landscape polemic on relationships gone bad, sexism, exploitation and the degradation of women, this is a timely reminder that the music scene has a lot more to offer if only you're prepared to look beyond the proliferation of tame girl bands and their cover songs. Beautifully written lyrical ballads: 'Militia Sister', 'People Like You' and 'Throwing In', are doubly challenging because they marry a love song genre to uncomfortably jarring images like, "And she can be a hole in the mattress/ Of a back alley bedroom/Where each frame of her life is blue and stained with/People/People like you". These songs stand alongside the gauntlet thrown down by those traditionally hard-edged, rock numbers: 'Sugar', 'Instead of the Saints' and 'Get Out'. Punchy stuff.

RP

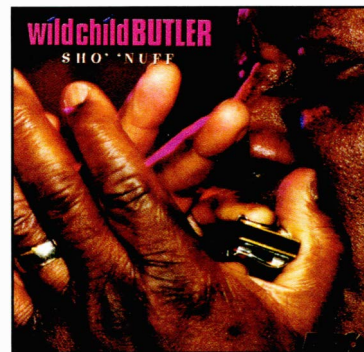

## Wild Child Butler

### Sho' Nuff

Analogue Productions APO 2015 

At 64, George "Wild Child" Butler is another of those excellent bluesmen that Analogue Productions seem to find in abundance. He is the authentic bluesman, learning his trade over years of painful difficulties, giving his music the feel of past experiences and lessons in life. This is country blues at its best, with Wild Child – a Willie Dixon protégé – singing and playing the harmonica with a polished rawness, reminiscent of Howlin' Wolf and Muddy Waters, both with whom he has played. Musically this CD reveals his mix of inherent acoustic blues and more powerful, up-tempo style. This is not over-elaborate music, just simple blues, played from the soul. He is surrounded by other talents from the Analogue Productions stable – namely Jimmy D. Lane (acoustic and electric guitars throughout), and Jamie Lee Robinson (acoustic guitar, on one track) – as well as Bob Stronger (Bass) and Sam Lay (Drums) – both old friends – with superb performances by all.

The recording is up to Analogue Productions' usual high-standards, with the natural acoustics of Blue Heaven Studios assisting in the excellent results. This is superb album that shows just what the blues is, or at least should be, all about.

SG

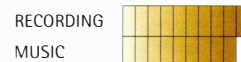

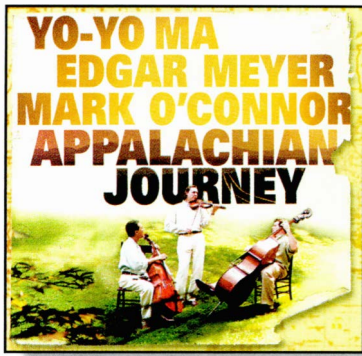

Yo-Yo Ma/Edgar Meyer/Mark O'Connor

Appalachian Journey

Sony SK66782 (CD)

Continuing my evaluation of Sony's recordings of Appalachian music, this album is full of spontaneous virtuosity, showing wonderful, improvisational communication between the performers. It is of course a follow-up to *Appalachian Waltz*, reviewed in the last issue, with additional contributions on a few tracks by James Taylor and Alison Krauss. Each performer still shows their own individual style and continues to draw on the influences and techniques of the others, but there seems an even greater empathy. With a number of albums of assorted collaborations between the members of the core trio, they now show remarkable unison and singularity.

The music reveals feelings of nostalgia, enhanced by arrangements that illustrate melancholia and elegance, but permeated with glimpses of dance-like joviality. The overall observation of musical style is more distinctly American than the other "Appalachian" albums, and is therefore more seamless and defined. The sound quality is up to Sony's usual high standards, being rich in tone and fairly immediate, and the recording reveals plenty of life and texture.

While I am not generally a fan of "cross-over" recordings, this CD is another great release of wonderful music that compliments this thoroughly entertaining series of recordings.

SG  
RECORDING 

■	■	■	■	■	■	■	■	■	■
■	■	■	■	■	■	■	■	■	■

  
MUSIC

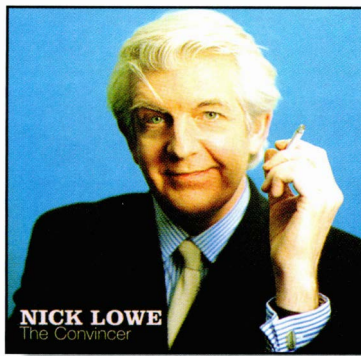

Nick Lowe

The Convincer

Proper PRPCD 012 (CD)

What a year. Firstly, Michael Owen stuffs the Germans with a blistering hat trick, then comes old campaigner Sir Nicholas of Lowe with this stunning new album to complete a memorable hat trick of his own. It was always going to be difficult to follow *The Impossible Bird* but Nick pulled out all the stops and made an even better album with the sublime *Dig my Mood*. Now he's gone and topped that with what is possibly the best album he's ever made.

That's some feat. Mind you, anyone who's followed the career of this hugely gifted artist can't be surprised by the consistently high standards he's achieved over the last 20 years plus. After all, this is the guy who recorded one of the finest pop songs ever with 'I love the sound of breaking glass' (your mum wouldn't know who sang it but I bet she could sing you the chorus!) He might be in more reflective mood these days but his ear for a killer melody is as strong as ever. All 12 songs are majestic but opener 'Homewrecker' is the best here and is quite possibly the finest he's ever written. The lyrics are pretty caustic but just listen to the emotion in the voice – quite stunning. Nick Lowe is the consummate songwriter and *The Convincer* gets my vote for album of the year. As Vinnie would say..."The boy done good".

AH  
RECORDING 

■	■	■	■	■	■	■	■	■	■
■	■	■	■	■	■	■	■	■	■

  
MUSIC

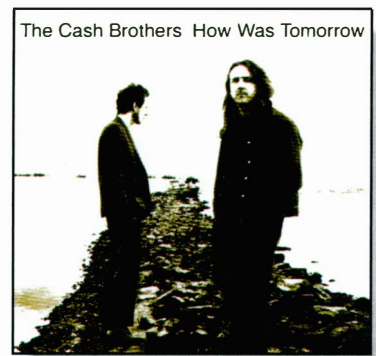

The Cash Brothers

How was Tomorrow

Zoe Records 1019 (CD)

Strange the way things turn out. I was trawling through my record collection looking for something to suit my mood when I stumbled upon a long deleted album on Island Records by Andrew Cash entitled *Boomtown*, a fine record full of rocky road songs and life experiences. Unfortunately Cash never recorded for Island again and I had always wondered what had happened to him. Three days later this dropped on my doormat and my curiosity was satisfied. *How Was Tomorrow* finds Andrew working with his brother Peter on a fine collection of acoustic led rockers and moody, country inflected numbers. The brothers voices harmonize brilliantly and the quieter numbers remind me of Simon and Garfunkel, especially on the beautiful 'The only one' and moody opener 'Raceway'. Further highlights come in the shape of 'Night Shift Guru', about the hopelessness of working in an all night take-away, and the utterly brilliant 'Nebraska', a real heart-breaker where man loses woman, and takes off in his car with sadness in his heart and Springsteen's 'Nebraska' playing on his stereo. Not the best album to put on to cheer yourself up! *How Was Tomorrow* treads a generally downbeat path but rewards the listener handsomely with repeated plays (as the best albums always do). It's also really refreshing to see genuine talent receiving a second chance, a rarity considering the short-term gain mentality within the music industry.

AH  
RECORDING 

■	■	■	■	■	■	■	■	■	■
■	■	■	■	■	■	■	■	■	■

  
MUSIC

# PUTTING VINYL FIRST

5000 great album titles  
one catalogue



first**vinyl**.co.uk

tel: 020 8989 6428

also featuring vinyl and cds from the hi>fi+ music review

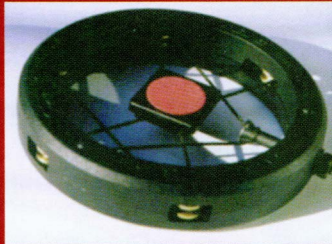

**cd-str5**  
- damping  
resonance  
for better  
sound!

**Audio  
Kauftip!**

**cd-str5**, 1 Mortimer Cottages, Mortimer's Cross,  
Nr. Leominster, Hfds. HR6 9TG England (UK)

Tel: (+44) (0) 1 568 708 739

Fax: 0870 134 5074

cd-str5@talk21.com www.hi-fi-accessories.com

**GutWire**



... SIMPLY ANALOGUE

Exclusively available from  
**AUDIO ATMOSPHERE**

01785 711232 stuart@audioatmosphere.com  
www.audioatmosphere.com

**Vynoodle**  
Classical Music on Vinyl

- Thousands of LPs in excellent condition
- Penguin Guide and TAS listings
- Same day posting worldwide
- No profit made from P&P
- All LPs VPI cleaned

Catalogue 01332 760587

List online at [www.vynoodle.co.uk](http://www.vynoodle.co.uk)

- Credit cards welcome
- Callers welcome, please phone first

71 Harrington Street, Peartree, Derby DE23 8PB

VPI Turntables & Record Cleaning Machines

Arguably the  
**Best** ★

For more information on these and other VPI products  
+ our huge selection of Audiophile CD's and Records  
please contact us at

**Cherished Record Company**

PO BOX 21 LISKEARD PL14 5YP TEL 01579 363603 FAX 01579 363604

VISIT OUR WEBSITE [www.cherished-record-company.co.uk](http://www.cherished-record-company.co.uk)

# Country Casuals

by Reuben Parry

There was a time when country music seemingly fell into neat little packages. Singing cowboys like Jim Reeves; buxom “Dolly Parton” blondes and those bad old boys – Johnny Cash amongst them – vied for our attention. These big, indelible caricatures were imprinted upon the psyche to such an extent that the fluid, genre-crossing possibilities present in this medium were not always fully realised. Today, though, it’s not quite so easy to define exactly where country, folk, pop and rock begins or ends. Boundaries have become well and truly blurred by bohemian musicians who are much more prepared to invent and reinvent themselves (sometimes over-and-over again) in an exploration of artistic avenues, or at least until the right commercial formula is struck. You only need listen to that chameleon-like entertainer Eileen Regina Edwards (Shania Twain) to appreciate the potential for change that exists. She went from Nashville demo tapes in 1991, through a deeply personal debut album that dealt with the death of her parents, to those four top ten country hits taken from her 1995 release, *The Women In Me*. And, of course, that predominantly poppy and global success, *Come On Over*, needs no more than a passing mention from me – but I digress.

The musicians who really engage, the ones I return to with an unerring regularity, are those effortless cross dressers of substance that are just as likely to be sublime songwriters as well. I have an insatiable appetite for the likes of Nanci Griffith, Alison Krause, Jenny Warnes and



the Mary Chapin Carpenters of this world. All deserve, and will undoubtedly receive, more column inches in the future. But a search for new blood should go beyond a charting of their careers to the next album release. There is an almost bottomless pool of talent out there waiting to be drawn deeply from. Yet, the old adage can often be proved true. Whilst as creatures of habit you can lead us to water, we are on occasions extremely reluctant to move out

from beneath our comfort blanket to take a sip.

Three good reasons to be a little less circumspect are my country casuals: Karla Bonoff, Kathy Mattea and Beth Nielsen Chapman. These genre-straddlers, who’ve frequently provided the raw materials for other higher profile performers, are deserving of considerable airplay in their own right. Examples of their work? Well, there’s a breezy Karla Bonoff penned title track, ‘Tell Me Why’, for the legendary Wynonna Judd’s second album, while Chapman has written number one country chart hits for Lorrie Morgan, Willie Nelson and Trisha Yearwood, as well as having her songs recorded by blusey rockers of Bonnie Raitt’s stature and jazz artists like Ute Lemper. More recently, Elton John raised her profile further with his memorial concert performances of ‘Sand and Water’ – the title track to Chapman’s third album. Kathy Mattea, meanwhile, has since signing for Mercury Records in 1983, been a mould-breaker – one of those pioneers in country’s left-of-centre new wave who have rejuvenated a predictable medium.

Bonoff’s career had auspicious beginnings. As a teenager, writing and playing in a vibrant

late Sixties L.A. folk-rock scene, she served an early apprenticeship under Frank Hamilton of The Weavers; made appearances at the Troubadour and put together a four-piece band, Bryndle, with a founder member of Linda Ronstadt's Stone Poneys, Kenny Edwards. Though they signed for A&M Records, Bryndle were musically ahead of their time. Despite cutting an album (never released) and a Lou Adler produced single, they did not experience any of the success enjoyed later by songwriter groups like the Eagles or Crosby, Stills and Nash. When the band eventually went its' separate ways, Edwards and Andrew Gold teamed up with Linda Ronstadt, and it was they who introduced her to Karla's songs. Three of these were to feature strongly on the *Hasten Down The Wind* album, while Ronstadt's superb 1989, *Cry Like A Rainstorm – Howl Like The Wind*, finds Bonoff penned songs sitting conformably alongside those of the great Jimmy Webb.

Meanwhile, Karla who'd signed to Columbia Records as a solo artist, was releasing albums of her own, headlining tours and scoring hits with 'Home', 'I Can't Hold On' and 'Personally'. Two subsequent LPs, *Restless Nights* and *Wild Heart of the Young*, (which featured musicians like Joe Walsh, Peter Frampton and J.D. Souther) cemented Bonoff's burgeoning reputation. However, it's her forth album, the 1988 *New World* (Gold Castle Records 171014-1) which will be the subject of this review. A strong, polished Mark Goldenberg produced 120gr LP has nine Bonoff originals and a single cover, the A & D Williams love song, 'How Long', that kicks off side one. It sets the tone for what's to follow. Lyrical, sweetly-crafted excursions into the realms of friendship, memory and romantic optimism or pessimism dictate the mood. Two of the songs here, 'All My Life' and 'Goodbye My Friend', are featured on *Cry Like A Rainstorm*. The former, as duet between Ronstadt and Aaron Neville, won a Best Vocal Performance Grammy.

Returning to *New World*, these same songs compare favourably. As an example listen to the lines "Oh we never

know where life will take us/ We know it's just a ride on the wheel/ And we never know when death will shake us/ And we wonder how it will feel" ('Goodbye My Friend') which really benefit from Karla's attractive, clearly enunciated vocals. An exquisite West Coast delivery (without typically country twanginess) on these lyrics is an enviable asset in a cross-dresser. Her abilities, though, are not limited to writing and singing. On this track she works those keyboard skills, while elsewhere Karla goes on to share acoustic guitar duties with the formidable Peter Frampton, who provides classic solos for 'Tell Me Why' and 'Still Be Getting Over You'. At the end of this album you are left in no doubt that Miss Bonoff is

a versatile musician who's appreciated and supported by her peers - a solid recommendation in itself. Additionally, the recording is of a decent standard. Instruments and vocals (including those of Karen Blake and Kenny Edwards) are nicely separated in a warm, ambient soundstage.

As a biographical postscript, after the release of *New World*, Karla toured Japan (to considerable acclaim); worked on motion pictures, performed to adoring audiences alongside Bonnie Raitt and John Prine, and then, with Edwards, Gold and Wendy

Waldman, decided it was time to reform Bryndle. At the end of 1995 there was an album release from the Music Masters label which included the show stopping collaborations 'Daddy's Little Girl' and 'On The Wind'.

The second of my innovators, Kathleen Alice Mattea, was born on June 21st 1959 in Charleston, West Virginia, and as a contemporary of Nanci Griffith, she has proven through eleven albums to be an equally diverse and prolific artist. One who has felt entirely at home exploring gospel, Celtic and ethnic influences or playing rootsy bluegrass. In these hands country music has laterly moved in unorthodox directions. However, her grounding as an acoustic-based folk singer provides a naturally solid musical foundation for these restless departures of form to the outskirts of a genre. In witnessing two periods when the country scene narrowed it's horizon to a point of near stagnation (namely the mid 1980s

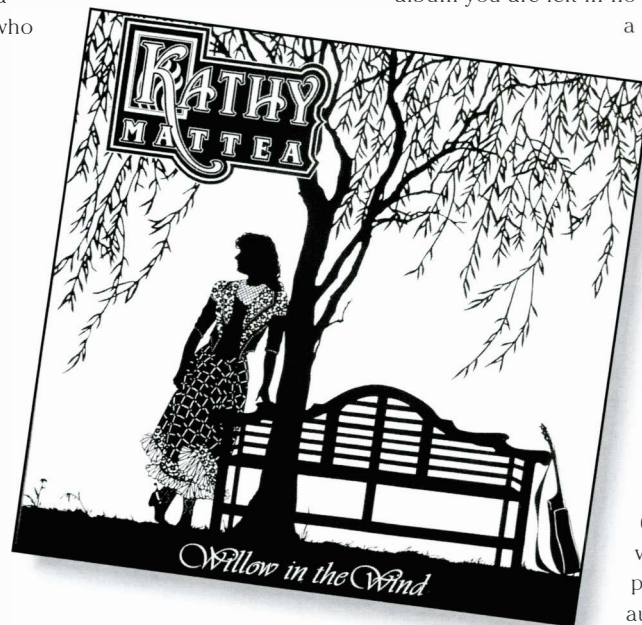

and the “Garth Brooks” phenomenon of the early 1990s) Kathy has cemented her role as a force for change. “Your life is a series of landmarks” says Kathy “and I’ve always tried to convey the internal and spiritual lessons learned by them in my music... Sometimes it can be a little frightening leaving what one knows so well. But these changes are exactly what make you grow as an artist... It’s a way of connecting your past to your future”. It’s also a philosophy that has served her well.

Whilst she has, in more recent projects for Nerada Records, shown a willingness to adapt and make use of Celtic instruments or ethnic drumming as vehicles to role back the perceived boundaries of country music, it is sometimes not always these dramatic shifts in structure or composition which have the most lasting effects. Small, incremental movements in style are often more easily accepted, which is one of the reasons why I’ve chosen her 1989 Mercury release, *Willow In The Wind* (836 950-1), for comment. This sounds and looks like a “Country” album. Nothing revolutionary about the LP sleeve artwork or the photo of Kathy in repose on it’s reverse, either. But of the many awards Mattea has earned, this record was to be a recipient of a coveted gold disc and the Grammy for Best Female Vocal Performance for the song, ‘Where’ve You Been’, that was co-written by her husband Jon Vezner. Clearly, this LP is accessible, powerful and popular – which is on the surface a convincing set of reasons to adopt the subtle approach to change. Whether it possesses that truly distinctive and enduring quality would of course be open to argument. Naturally, this pin prick approach has a drawback – it

runs the risk of being swamped by the familiarity resonant in country and western music. Perhaps this is why she has eventually sought out less conventional sources of inspiration.

Returning for the moment to those ten tracks on *Willow In The Wind* reveals a pretty pattern of typical country songs dealing in love, longing and loss-songs like ‘Come From The Heart’ (Susanna Clark) and ‘Love Chooses You’ (Laurie Lewis), that are interspersed by folkier numbers from the pens of Wendy Waldman, ‘True North’, and the Patrick Alger ‘She Came From Fort Worth’, that are stylistically reminiscent of Nanci Griffith. Occasionally, though, her chord structures have a hint of Cajun or bluegrass about them, but predominantly the notes from Kathy’s custom black-stained Maple 612-C Florentine cut-away Taylor guitar remain Tennessee bound. Mark Miller’s recording, fixed at Jack’s Tracks Nashville Studio is strong on vocal

presentation but weaker where his mixing desk is concerned. The best I can say about that is at least the soft focus instrumental halo surrounding Kathy’s pleasant delivery is inoffensive. Sliding in at the end is a hard to categorise Beth Nielsen Chapman. With that triple-barrelled name you could almost be forgiven for thinking she was a Lonestar Star

State girl at heart. In fact her family settled in Montgomery, Alabama after a varied if somewhat nomadic existence courtesy of the United States Airforce. A self-taught guitarist, Beth wrote her first song at the age of

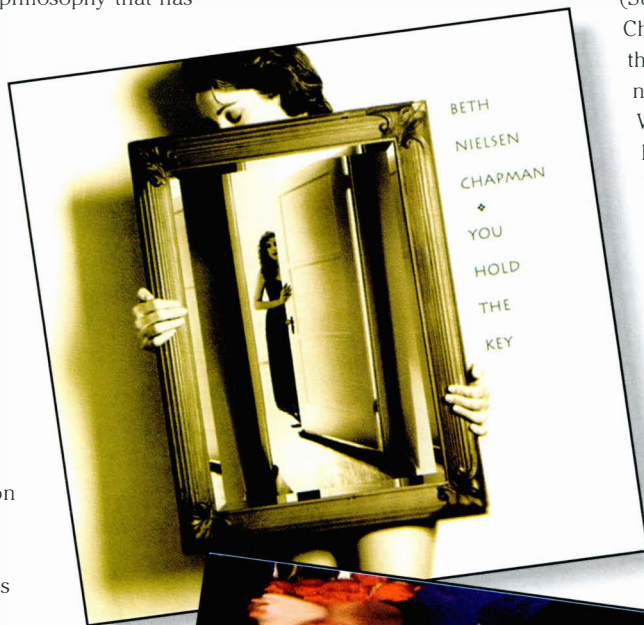

eleven – only when she attended piano lessons was it realised that instead of reading music from the page, she was learning it by ear. Having such a good ear has had its disadvantages. Without those musical notation skills the use of a tape recorder for singing ideas is essential. Chapman recalls going to lunch with Janis Ian, “She had this idea – this melodic idea came to her and she picked up a napkin, and she wrote this little five-line thing, and she wrote the melody down. That just blew me away. I thought, man, I wish I could do that. It just looks so cool if nothing else!” This unusual quality is reflected throughout her CDs.

Often Beth begins her songs with a sound – forming the melody out of this idea before, maybe months later, writing perfectly attenuated lyrics. Interestingly, when composing on guitar her songs tend to be quite folk, while those hatched on the piano keys are more likely to be pop, jazz or classical orientated. Her compositional techniques are that diverse. Yet, this prodigious ability developed from humble origins – the Riverview Plaza lounge in Mobile, Alabama, where a touring Buddy Johnson (of Beach Boys fame) encouraged Beth to sing her own songs and leave for Nashville to establish herself as a musician who loves writing country music, but refuses to accept a country artist tag.

Pick any one of three well-recorded Beth Nielsen Chapman albums produced for Warner’s Reprise label by long-term ally, Jim Ed Norman, and you won’t be disappointed. A self-titled 1990 debut (9 26172-2); the follow up, *You Hold The Key*, from 1993 (9 45233-2), or the incandescent 1997, *Sand And Water* (9362-465-2), which is centred upon the decline and loss of her husband, Ernest, to a rare lymphoma condition, have an irresistible focus and sense of power surrounding them. Especially so in the case of *Sand And Water*, where the song writing is inspired by those memories of her husband. An unimaginable emotional journey who’s highs and tension-filled lows shape this cathartic experience. Coincidentally, the fluctuating moods found in these songs also seem to mirror those

periods of remission sometimes seen with cancer sufferers.

Unsurprisingly, top ten AC and NAC hits have flowed from all of these discs. The beautifully crafted and intelligently conceived patterns of notes, chords and lyrics deserve no less. When you listen to Chapman, Mattea and Bonoff, it’s quite evident that Beth Nielsen Chapman is the most compositionally versatile of the three – and for that matter the one who in the time frame of a CD can

move furthest away from an idiomatic country sound.

When she hits the notes in songs like, ‘Happy Girl’, and ‘All The Time In The World’, and there’s a band of fellow musicians such as Stuart Smith (electric guitar), Sam Bush (mandolin), Dave Pomeroy (bass) and Brian Barnett (drums) behind her, then we are given highly articulate pop music. Conversely, the opening track on *Sand And Water*, ‘The Colour Of Roses’, finds Beth closely accompanied by the piano of Matt Rollings. The architecture of this song follows a far more classical tenet. While later still, on tracks including, ‘Seven Shades Of Blue’, it’s the folk

textures which come to the fore as she gently plays solo guitar. As her voice intentionally waivers at the vocal peaks and the notes decay, that’s when a semblance of C & W reappears. Can you get any more casual than that?



Karla Bonoff:  
New World

RECORDING   
MUSIC

Kathy Mattea:  
Willow In The Wind

RECORDING   
MUSIC

Beth Nielsen Chapman:  
Self-Titled

RECORDING   
MUSIC

You Hold The Key

RECORDING   
MUSIC

Sand And Water

RECORDING   
MUSIC

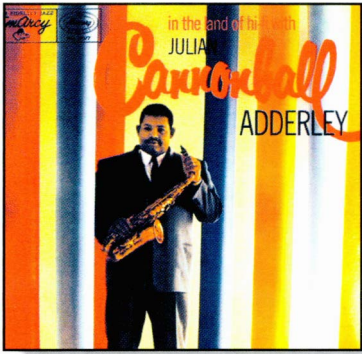

Julian 'Cannonball' Adderley

In the land of hi-fi with...

Speakers Corner/EmArcy MG36077 **180g** **3**

This album catches Cannonball, along with brother Nat, at the dawn of a burgeoning solo career. It also encapsulates a pivotal moment in the development of jazz, the emergence of the next generation, heralded by Miles Davis and John Coltrane, both of whom would later share a stage with the Cannonball. Having said that his company here is hardly less impressive. A handpicked ten-piece selected by arranger/conductor Ernie Wilkins it constitutes nothing less than a condensed big band, offering similar power but greater dexterity. It's a mouth-watering prospect and right from the start it never disappoints. There's a mix of standards and new compositions here, and standouts are hard to pick because the overall standard is so exceptional. Forced to it, I'd go for 'T's Tune' and the Harold Arlen penned 'Between The Devil And The Deep Blue Sea', the latter a particular showcase for Cannonball's alto sax. The solos sparkle throughout, but as with all great bands it's the ensemble playing that hits home and really conveys the sheer energy and fun that drives this performance. The sound is glorious living mono and its directness serves the musicians well. This album is a rare treat and one to enjoy over and again – and what a great sleeve!

Supplier: Vivante – [www.vivante.co.uk](http://www.vivante.co.uk)

RG

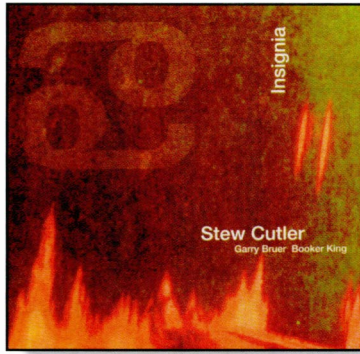

Stew Cutler, Gary Bruer, Booker King

'Insignia'

Naim cd 058 **CD**

Ho hum I thought, another jazz CD from naim. I was a few tracks into this disc before I realised that it possesses a hidden quality, an added bonus if you like. More of this later. This gently swinging set is pretty enjoyable played, as I started my review, as a late night chill-out set. At moderate volumes, the punchy, warm recording brings the best from King's bass lines, which along with rolling percussion work from Bruer nicely offsets Cutler's guitar lines. There's nothing that'll particularly shake the world here, no barriers being broken, but sometimes this kind of music making is just what you need. The band are clearly having a good time and after a gruelling day at the salary coalface this was welcome stuff. It's just as I was really settling into the album that the hidden quality hit me. It was maybe a hint of Bill Frisell in the playing who's music I invariably like to play loud, that inspired me to turn the volume up. It was immediately obvious that whilst it sounds great at low volumes, this music really thrives at 'realistic' neighbour bothering levels. The set really took on another dimension – very, very close to the punch and solidity of a live band. So there you have it 'two' albums in one CD: A late night relaxing session, or a truly dynamic, tooth rattling treat. One of Naim's best and highly recommended.

Supplier: Naim

DD

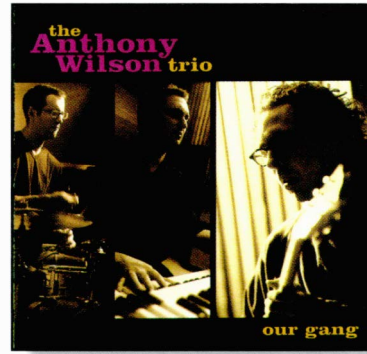

The Anthony Wilson Trio

Our Gang

Groove Note GRV 2008-2 **CD**

I have to confess that despite being a multi award winning guitarist, Anthony Wilson was news to me. Seems I've been missing out since this album is something of a treat. Leading a trio that includes the splendidly named Joe Bagg on Hammond B3, and Mark Ferber on drums this is a really accomplished set. There's a relaxed precision about the playing and interplay of all three that drew me in from the first notes of the opening (title) track. Wilson is a big fan of Bill Doggett, the great Hammond player who's trio peaked in the '50's, and he was inspired to form his trio around his love for what he describes as this groove 'Harlem barroom style'. Nothing wrong with that and this CD does a great job of capturing a good part of the essence of that sound along with a feel all of its own. It's much more 'nightclub' than 'Harlem barroom' for me – there's a slickness to the playing (thankfully without resorting to the saccharine) – that lifts it from the alley. The band tackle a wide range of material taking in Ellington, The Beatles ('I Want You – She's so Heavy), to standards like 'Luck be a Lady'. The recording is one of Groove Note's very best superbly capturing the tonalities of the Hammond, Wilson's guitar work and the weight of the percussion.

Supplier: Vivante – [www.vivante.co.uk](http://www.vivante.co.uk)

DD







## Orchestra Baobab

### Pirates Choice



World Circuit WCD 063 

From the label that brought you 'Buena Vista Social Club' (admit it, it did once sound really fresh and new), comes this release from the Senagalese band Orchestra Baobab. The band was formed in 1970 to play at the opening of Dakar's Baobab Club and many of the players were lifted from the then top Senagalese performers The Star Band. Latin music had always had a strong influence in Senegal and Orchestra Baobab absorbed this, particularly Cuban music, adding a distinctly African influence of their own. The result, superbly exemplified in this set which was originally released in '82 is enthralling. Whether covering more overtly Cuban material like the opening track 'Ultra Horus', the gently floating guitar lines of 'Coumba', or the more overtly African feel of 'Werente Serigne', the effect is a gently uplifting and totally delightful treat. It's become a staple at home and I've yet to pop it in the CD player and remove it before the last notes of the final track have died away. This is very special music: a true merging of two distinct idioms that really works. The band broke up soon after the original recording was released so this, and it's companion bonus CD of 6 additional tracks is a real treasure. Highly recommended.

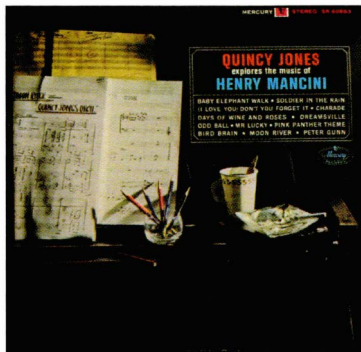
DD



## Quincy Jones explores the music of Henry Mancini

Speakers Corner/Mercury SR60863  

Did I commit foul and unspeakable acts in a past life? Is it now my eternal punishment to review Sixties kitsch? In this instance great big dreamy, sweet-toothed dollops of the stuff, whose melodies (including those from Charade, Moon River, Peter Gunn and Baby Elephant Walk) float around the room with the big band arrangements of Quincy Jones. Being Jones there are plenty of finger-clicking improvisational moments – the knee-slapping Osie Johnson and humming bowed bassist, Major Holley, who have been recorded with such spectacular clarity in a reworking of the Pink Panther theme, are also cases in point. Obviously, this whole album is a time capsule drawing deeply from that period. Musically, some of these songs like 'Days Of Wine And Roses' and a jazzy, waltzing 'Moon River' have travelled well down the decades to become popular standards. So did some of the players. Among the top musicians on display are Clark Terry (trumpet), Tools Thielmans (guitar), Roland Kirk (reeds) and vibes man, Gary Burton. Plying their trades during three Phil Ramone produced recording sessions over the 5th and 6th February 1964 adds another dimension to a transparent, highly detailed and instrumentally forward Mercury source.

Supplier: Vivante - [www.vivante.co.uk](http://www.vivante.co.uk)

RP

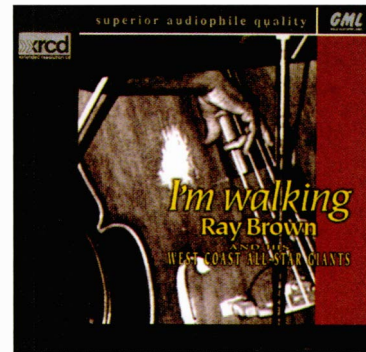

## Ray Brown and his West Coast All-Star Giants

### I'm Walking

GML- XRCD-30331 

Brown has to be the best known bass player in jazz, and is certainly one of its most prolific. Stints with Charlie Parker, Dizzy Gillespie and Bud Powell led ultimately to 15 years in the Oscar Peterson Trio, territory he still revisits even now. Instrumental in establishing the MJQ (which he still managed until very recently) Brown has remained prolific long past the point where his contemporaries have retired (in one way or another).

This is a 1990 recording, but don't let that put you off. For once the appellation All-Star actually does justice to this band, with only the name of vibes player Ichiro Masuda raising a slightly puzzled frown. But don't worry on that score either. Brown's affection for the vibes is well documented through his multiple collaborations with Milt Jackson, and he knows a great player when he hears one. The album features seven Brown compositions amongst its ten tracks including 'Freddie' which bears rather more than a passing resemblance to 'So What' run together with 'Freddie The Freeloader' but none the worse for all that. However stand-out track has to be 'Time After Time' whose extended tempo and sparse arrangement provide the perfect showcase for Brown's pitch perfect playing, with space a plenty for the rest of the band. Recording is good, but it's the performance that grabs your attention, with a really live feel to the band's playing.

Supplier: Vivante - [www.vivante.co.uk](http://www.vivante.co.uk)

RG





# Super Audio CD

opus  
3

## SACD-multichannel albums (Hybrid Discs\*)

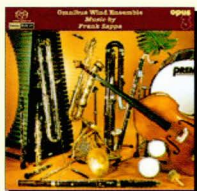

19423  
Omnibus Wind Ensemble  
"Music by Frank Zappa"

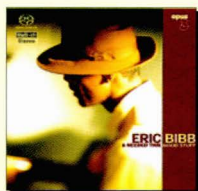

19623  
Eric Bibb  
"Good Stuff"



22011  
Global Percussion Network  
"Rauk"



19824  
"Tiny Island"  
("Eric Bibb-band")



19420  
Test CD 4  
(Various)

## SACD-stereo albums (Hybrid Discs\*)



19516  
Musica Sacra  
(Choir-Organ-Saxophone)

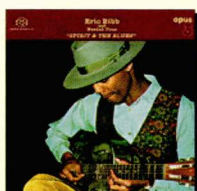

19411  
Eric Bibb  
"Spirit & The Blues"

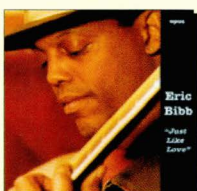

21002  
Eric Bibb  
"Just Like Love"

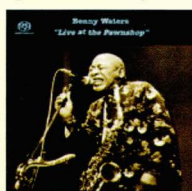

19911  
Benny Waters  
"Live at the Pawnshop"

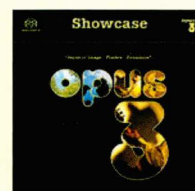

21000  
Showcase  
(Various)

\*Can be played on any standard CD player.

For more information such as world wide distribution etc. - please visit our web site: [www.opus3records.com](http://www.opus3records.com)

## Keep your hi-fi+ magazines in immaculate condition with these specially designed protective binders.

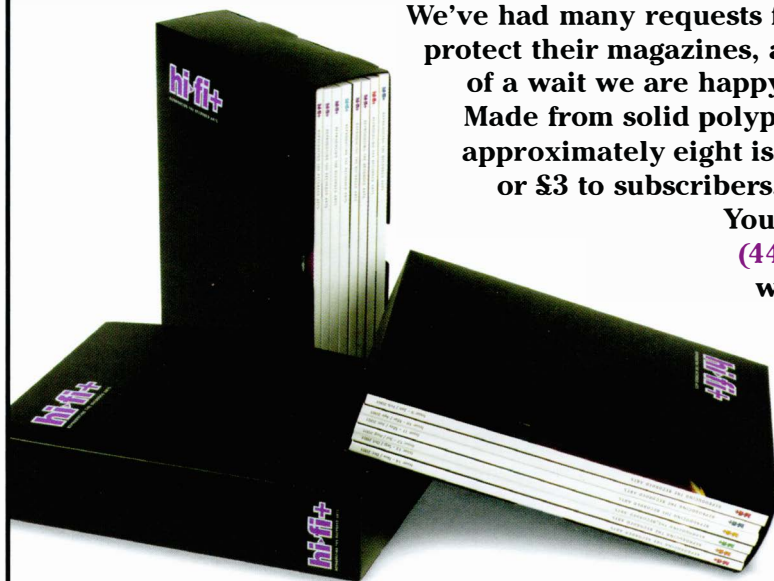

We've had many requests from readers for binders to protect their magazines, and finally, after something of a wait we are happy to announce their arrival. Made from solid polypropylene each one will hold approximately eight issues and they cost £5 each, or £3 to subscribers, with £1.50 p&p per order.

You can order yours by calling (44)(0)1202-659380 or via the website at [www.hifius.com](http://www.hifius.com)



Hi-Fi+, Unit 12,  
Albany Business Park,  
Cabot Lane, Poole, Dorset  
BH17 7BX,  
United Kingdom



**Bartók**  
**Concerto for Orchestra/Four**  
**Orchestral Pieces/Hungarian**  
**Peasant Songs.**  
**LPO/Botstein**

Telarc CD-80564 (CD)

No recording of the *Concerto for Orchestra* has come close to Reiner and the Chicago Symphony Orchestra's outstanding release for RCA, from the 1950s. Botstein directs a respectful performance here, but never quite manages to achieve Reiner's natural precision, with a lack of enthusiasm, especially in the *Gioco Delle Coppie*, making it sound a little over-full. This impassionate approach also appears in the *Elegia*, although to a lesser extent. The quicker movements are handled better, but Botstein still frustratingly tries to slow things down, except in the *Intermezzo Interrotto*, which is taken too fast. The *Finale* is handled, after a slow start, with concentrated assurance. The *Four Orchestral Pieces*, with their more ardent, shadowy qualities, suit Botstein better, bringing out Bartók's influences of Debussy and Hungarian funeral music. Obviously, this Hungarian influence is strongest in the *Hungarian Peasant Songs*, where Botstein reveals their dance-like qualities well. The recording, made in Walthamstow Town Hall, is up to Telarc's usual high standards, being clear and detailed, yet warm, and it is good to hear the left/right split of the first and second violins. While this CD is generally satisfactory, with some formidable competition it cannot be regarded as a first choice.

SG



**English String Miniatures,**  
**Volume 3**

Royal Ballet Sinfonia/Lloyd-Jones

Naxos 8.555069 (CD)

With the success of Hyperion's *Light Music Classics* series, Naxos have followed suit with these *English String Miniatures*. With this third volume, the Royal Ballet Sinfonia, under David Lloyd-Jones – an excellent exponent of British Music – give us first-rate performances of this collection of comparatively obscure, but highly entertaining works.

The only really familiar personalities are those of Gerald Finzi, whose sublime *Romance* is one of the highlights on the disc, and Gustav Holst, whose *Brook Green Suite* is one of the few familiar pieces. Less well-known are *An 18th Century Scherzo*, by Haydn Wood, and William Blezard's *Duetto*, which includes some deft pizzicato work. Bruce Montgomery, who is better known for supplying the music to all the "Doctor" and early "Carry On" films, composed the vibrant, yet enthralling, *Concertino for String Orchestra* which closes the CD.

The sound of the Orchestra is very good, with vivid, yet natural, warm timbres and an impressive depth to the acoustic, which brings out playing of poignancy and charm, directed by the intuitive baton of Lloyd-Jones.

Although this release includes lightweight music that is relatively unknown, it has plenty of charm, is always entertaining and is of course excellent value for money.

SG



**Gustav Mahler**  
**Symphony No 5**

New Philharmonia  
 Sir John Barbirolli

EMI 5 66910-2 (CD)

Barbirolli's EMI *Mahler 5* was my introduction to the work – way back in 1970. I still remember buying the LPs; the experience – music, performance, sound – was overwhelming. It was easily the best orchestral recording I'd ever heard, and despite the passage of thirty years remains among EMI's finest achievements technically. The performance is very weighty and serious, almost dogged in places, with measured tempi and great concern over nuances of phrasing and balance. It sounds as though the conductor had rehearsed the work very thoroughly, making sure every detail was in place. The first two movements and finale are very disciplined, but the *scherzo* is less polished – ensemble and intonation could both be tighter. Recordings and performances of *Mahler 5* were comparatively rare then, and doubtless the New Philharmonia were tackling a work they'd played infrequently – possibly never. But for the most part they play with the utmost precision and power. No question; Barbirolli's *Mahler 5* set the standard for recordings of this work for decades to come, both musically and technically, and hearing it again confirms its reputation as a classic performance. For this new CD transfer, EMI have improved the sound, resulting in greater impact and transparency. Tape noise is lower too, and there's slightly more hall ambience (Watford town hall) compared to the previous Studio CD issue. A disc that should be in every Mahler collection!

JMH





**Gustav Mahler**  
**Kindertotenlieder; 5 Ruckert**  
**lieder**  
**Janet Baker, Halle and New**  
**Philharmonia Sir John Barbirolli**

EMI 5 66981-2

The artistic collaboration between the two JB's, Janet Baker and John Barbirolli, was a very close one, and the performances on this disc bear testimony to their shared perfectionism and care over subtle detail. The account of *Kindertotenlieder* remains among the most deeply felt and moving ever committed to disc – rightly enjoying classic status among collectors. The interpretation is a painstaking one that strives above all to communicate the brooding sombre intensity of Ruckert's words and Mahler's music in a manner that's intimate and personal rather than public. There's something distressingly vulnerable about Janet Baker's voice that makes her *Kindertotenlieder* unbearably sad. The *5 Ruckert lieder*, originally coupled with Sir John's famous account of *Mahler 5*, and the *Lieder eines fahrenden Gesellen* show Dame Janet at her most sensitive and intense. Again, there's a delicate vulnerable quality to the voice, despite its dynamic range and power – qualities which suit music and text beautifully. As a bonus, EMI have included the Halle recording of *Ich bin der Welt abhanden gekommen* (from the *5 Ruckert songs*) that was left off the previous full-price CD transfer. Barbirolli so loved this particular recording, he asked for it to be played at his funeral. Remastering has improved the sound quality of these late '60s recordings, increasing presence and tonal body, while lowering tape noise.

JMH



**D'India**  
**Libro Primo de Madrigali, 1606**

La Venexiana

Glossa GCD 920908

Sigismondo D'India was a contemporary of Monteverdi, and if this recording is anything to go by, an equal of the better-known composer. These *Madrigali* possess astonishing, contemporary harmonies that have the capacity to move the listener. They undulate in waves of delightfully intertwined melodies and phrasing that are so splendidly vibrant they convey lyrically, lucid feelings of adoration and desire, grief and lamentation. The seven voices of La Venexiana sing with astonishing diligence, producing sounds of articulation and purity. Each madrigal is superbly executed with the distinct voices seamlessly matched. There is a complete lack of vibrato, giving the performance a great intensity, and the performers are able to unpeel layers of sound, becoming in turn fervently vibrant in each specific line of replicated song, producing waves of music that sweep over the listener and subconsciously carry them away. The recording is superb, possessing absolute clarity with just enough acoustic presence to create a vivid atmosphere and space around and between the performers. This beautiful disc is unreservedly recommended, possessing some of the most gracefully sung madrigals on disc, and demands repeated listening so that reading the text does not distract from this overwhelming listening experience.

SG



**Jean Sibelius**  
**Symphonies 2 and 4**

CBSO,  
 Sakari Oramo

Erato 8573-85776-2

How remarkable, given the present economic climate, to see a French label release a CD of Sibelius symphonies. It must be a first! Sakari Oramo gives crisp lucid accounts of both works, emphasising clarity of texture and emotional coolness, rather than taking a more subjective romantic approach. The *Second* symphony gets a performance of bracing directness that highlights the music's clean linear outlines. But – where's the passion? Where's the drama? Emotionally, the temperature remains low, and there's a certain lack of involvement despite committed playing from the orchestra. Similarly, the darkly scored *Fourth* is played with little sense of mystery or atmosphere; one doesn't feel tensions rising, or the music growing and building towards climaxes. What's missing is any impression of meaning behind the notes – it's as though the music meant nothing in itself. The recording doesn't help, being bright and sharply defined, but rather glassy and lacking in warmth or atmosphere. Although 24bit, it has the thinness of tone and high frequency glare that gave early digital recordings a bad name. With a total playing time of 80 minutes, the disc certainly offers outstanding value in terms of quantity. But the quality of both performances is disappointing, despite some impressive moments. If, however, you like cool objective Sibelius, don't hesitate...

JMH





**Mahler**  
Symphony No. 4  
(with discussion disc)  
Tilling/Philharmonia O./Zander

Telarc 2CD-80555 (CD)

While this is a frank performance, it reveals the views of Benjamin Zander more than the composer. Despite the Philharmonia playing with their usual freshness and zeal, there is the constant feeling that they are being reined back, in the name of accuracy. Every nuance of the score is heard, but the underlying theme seems to be that this is a lesson on the structure of the work, rather than a performance to entertain and enthral, lacking the comprehensive vivacity and enchantment prevalent in performances by Klemperer, Chailly or Gatti. Zander's engaging and instructive discussion disc adds to the performance's analytical feel. Camilla Tilling is excellent in the *Das Himmlische Leben*, singing with rare beauty and sublime angelic tone, but this youthful charm is hampered by somewhat dark orchestral textures and a slightly slow tempo.

The sound matches the performance well, with a detailed and dynamic quality that clearly exposes every accent. But it does not come across as cold as, or systematic as Zander's direction, with Sony's DSD system supplying natural warmth. While there is much to recommend this disc, Zander's lack of appreciation for the overall identity of this symphony means it is not a first choice.

SG

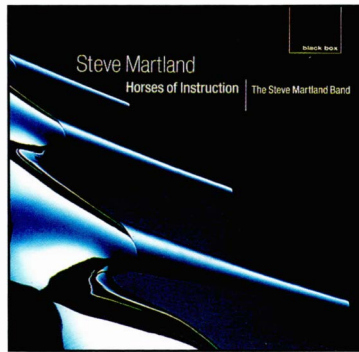

**Martland**  
Horses of Instruction

The Steve Martland Band

Black Box BBM1033 (CD)

For those unfamiliar with the "classical" music of Steve Martland, this release may be shocking, with influences coming from his various backgrounds in classical, jazz, rock, and studio music, producing sounds that are predominantly high impact, but with moments of beauty, and occasionally tenderness. This is complex music of intensity and power, with irregular variations that can leave his audiences stunned from the corporeal and emotive experiences of a performance.

The Steve Martland Band comprises eleven players, containing rhythm section of guitar, bass and drums, alongside a brass section of saxophones, trumpet and trombone, with piano, percussion and violin. Being Martland's own band, the ensemble understands and relates to these works perfectly, continually driving the music forward with playing of virtuosity, with bold and direct results, producing extreme opinions of either esteem or irritation.

The studio recording is direct and punchy, providing impact to match the performance. This is orchestral music's "new wave" that puts two fingers up at the classical establishment.

While this music will not be to everyone's taste, this CD succeeds in creating much of the incredible energy and enthusiasm of Martland's live performances, and so is an indispensable guide to both his band and his compositions.

SG



**Shostakovich**  
Symphonies Nos. 1 and 15

Cincinnati Symphony O.  
López-Cobos

Telarc CD-80572 (CD)

While the pairing of Shostakovich's first and last symphonies with Telarc's usual admirable sound looks especially generous, López-Cobos directs a somewhat uninspiring performance. There is a certain amount of wit and passion missing from the *First*, with the youthful vigour and satire of this "graduation piece" absent from the opening movement. The second movement lacks some of the mystery from its central section, and while the *Lento* is nicely sorrowful and tragic, the *Finale* requires more of the dramatics that should be instilled by the changing moods and tempos. The *Fifteenth* fails to fully penetrate the uncertainties of mortality to expose the images of infancy, optimism and satire that lie beneath the surface. The Cincinnati Symphony Orchestra play well enough but never seem allowed to entirely convey their abilities.

The engineering is excellent, with plenty of depth of tone and impact, but there is a slight lack of width to the soundstage during the *First Symphony* that gives a slightly constricted ambience to the violins.

For great Shostakovich, interpretations by Russian conductors remain a first choice, with fine performances by Berglund, Haitink, Previn and a few others also recommended. On this evidence, López-Cobos cannot be added to this list.

SG





**Stravinsky**  
**Rite of Spring; Petroushka**  
**Firebird; Orpheus\***  
**Royal Concertgebouw; LSO\***  
**Sir Colin Davis**

Philips 464 744-2 (CD)

Huge dynamic range. Massive forces. There's little to touch Stravinsky's *Rite of Spring* when you want to test hi-fi systems to their absolute limit. And frighten the neighbours. By today's standards, Sir Colin's 1977 Philips account no longer amazes with its sheer impact; there are later digital recordings which offer fatter bass and more sheer brute force. Yet Davis' version is still among the most powerful ever recorded. There's a controlled ferocity that threatens to boil over at any moment, and the impression of titanic forces just held in check creates a palpable sense of tension and drama. The recording is powerful and clean, with an impressive sense of scale that has rarely been bettered. *Petroushka* was taped a year later, and receives a racy witty balletic performance with great care taken over detail - for example the delicious terracing of trumpet dynamics in the final tableaux (track 20). *Firebird* completed the cycle, and (at the time) set new standards (technically) for recordings of this score. As with the other works, there are no tricks or gimmicks - just the music sensitively played and crisply phrased. Davis once said how lucky he was to have recorded the three great Stravinsky ballets with such a crack orchestra, and it's true; the playing is excellent. But performances as good as this don't happen by accident, and the conductor's direction is inspired.

JMH

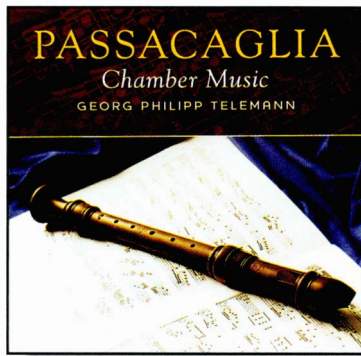

**Telemann**  
**Chamber Music for Recorders,**  
**Viola da Gamba and Harpsichord**  
**Passacaglia**

Linn CKD 170 (HD)

Much of the music on this release may be familiar, with some works having long been fashionable in both concert and the recording studio. Two pieces - the *Trio Sonata in C major* and *Sonata in D major* - belong to Telemann's innovative fortnightly periodical *Der Getreue Music-Meister*, with the beautiful sonata for Viola da Gamba having an especially enthralling opening. The *Trio Sonata in B flat major* and *Trio Sonata in F major* come from the composer's last published work, the fine chamber anthology *Essercizii Musici*, while the remaining works are less well-known. Passacaglia play with much enthusiasm and charm, supplying disciplined tempi and some pleasant textural effects. But there is also an occasional lack of sparkle in some of the slower movements, where there can be a hint of heaviness. Elsewhere the ensemble's infectious and sensitive phrasing gives the performance some critical energy. Sound-wise, this disc is pretty good, with a nice, pleasing tone and generally good ambience, but there is a lack of separation and space between the players, and an occasional sense of closely mic'd instruments. While this is pleasant sounding and entertaining CD, it lacks some of the excitement of the very best releases.

SG

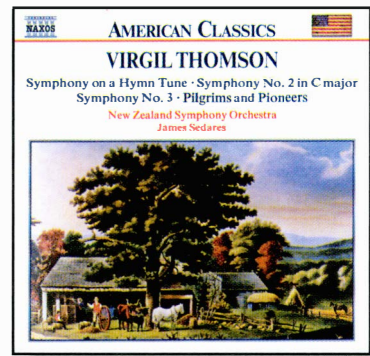

**Virgil Thomson**  
**Symphonies 2, 3 and**  
**'On A Hymn Tune'**  
**Pilgrims and Pioneers**  
**Sedares, NZSO**

Naxos 8.559022 (CD)

Thomson, an inspirational yet demanding pillar of American 20th Century classical music has been little recognised on this side of the Atlantic, which is a great crime for there is something quintessentially appealing and uplifting about much of his music. His best known works are *The Plough That Broke The Plains* and the *Suite from The River* (offered on a wonderful Stokowski re-issue from Analogue Productions, and an essential purchase). This recent issue in the Naxos American Classics series allows you to venture further into his repertoire, containing three short symphonies (only the 3rd makes it past the 20 minute mark) and another piece of incidental music, this time from the World's Fair film *Pilgrims and Pioneers*. There are no great surprises here, just more of the same joyously skittish orchestral music that typifies *The Plough*. Thomson isn't afraid of orchestral forces but uses them sparingly and thus to great effect. The result is moments of great delicacy balanced against huge orchestral sweeps, the transitions often occurring with breathtaking speed and dynamism. It makes for a heady and accessible brew with almost universal appeal. Only the Poe-faced could fail to enjoy this. The recording isn't quite to the standard of some of Naxos' recent English music efforts, but with music like this it's almost beside the point.

RG



## UPGRADE YOUR HI-FI WITH SOME AUDIOPHILE RECORDINGS

Vivante Music Ltd specialises in the mailorder of audiophile standard recordings on all high-end formats including 180 gram Vinyl, Gold CD, SACD, DVD-A, XRCD and HDCD. We also supply a range of accessories including the Nitty Gritty record cleaning machines.

### DIGITAL:

Analogue Productions →	CDs from £16.95
AudioQuest →	CDs from £16.95 and SACDs from £21.95
Chesky Records →	CDs from £16.95, SACDs from £21.95
Dorian →	CDs from £16.95
First Impressions →	CDs from £21.95, XRCDs from £23.95
Groove Note →	CDs from £21.95 and SACDs from £24.95
Hyperion →	SACDs from £24.95
JVC XRCD →	XRCDs from £23.95
Linn →	CDs from £15.95
Mapleshade →	CDs from £16.95
Mosaic →	Box sets from £39.95
Naim →	CDs from £15.95
Reference Recordings →	CDs from £8.95
Sheffield Labs →	CDs from £17.95
Sony →	SACDs from £24.95
Tacet →	CDs from £16.95, DVDA's from £24.95
Telarc →	CDs from £16.95
Turtle →	CDs from £16.95 and SACDs from £24.95
Waterlily →	CD's from £16.95 and SACDs from £24.95

### ANALOGUE:

Alto →	LPs from £21.95
Absolute Analogue →	LPs from £21.95
Analogue Productions →	LPs from £21.95
Cardas →	LPs from £17.95
Classic Records →	LPs from £25.95
Groove Land →	LPs from £21.95
Groove Note →	LPs from £25.95
Speakers Corner →	LPs from £21.95
Tacet →	LPs from £21.95
Testament →	LPs from £21.95

Please contact us for a full catalogue. Vivante publishes a monthly newsletter, *On The Record*, which highlights new releases on all audiophile formats, includes special offers and is free to all our customers. Please call to receive your copy.

## Vivante

Unit 6, Fontigarry Business Park, Reigate Road, Sidlow,  
Nr Reigate, Surrey RH2 8QH

tel: 01293 822 186 • fax: 01293 821 965

email: sales@vivante.co.uk • web: www.vivante.co.uk

## ADVERTISERS INDEX

Audio Atmosphere	Pg 102	hi-fi-accessories.com	Pg 121	Path Premier	IFC
Audio Atmosphere	Pg 121	hififorsale.com	Pg 111	Pear Audio	Pg 64
Audio Consultants	Pg 74	Infidelity	Pg 102	Performance Developments	Pg 113
Audio Image	Pg 102	Joenit	Pg 29	Phonography	Pg 102
Audio Reference	Pg 7	Kevin Galloway	Pg 55	PMC	Pg 12
Audio T	Pg 20	Leicester Hi Fi	Pg 102	Ringmat Developments	Pg 112
Audiofreaks	Pg 15	Loud Et Clear	Pg 102	Russ Andrews Accessories	Pg 19
Audiophile Club	Pg 10	Michell	Pg 30	Signals	Pg 64
Avid	Pg 103	Midland Audio Exchange	Pg 103	Sounds of Music	Pg 17&54
Basically Sound	Pg 84	Monitor Audio	Pg 85	The Cartridge Man	Pg 64
Cherished Records	Pg 121	Moth Marketing	Pg 113	The Chord Company	Pg 2
Chord Electronics	OBC	Movement Audio	Pg 55	The Right Note	Pg 17
Connoisseur Audio	Pg 85	Naim	IBC	Trichord	Pg 15
Definitive Audio	Pg 65	Neat Acoustics	Pg 65	Ultimate Sonics	Pg 8
Doug Brady	Pg 19	Nemesis	Pg 41	Veritas	Pg 9
First Vinyl	Pg 121	New Audio Frontiers	Pg 103	Vivante	Pg 133
GT Audio	Pg 84	Nordost (UK)	Pg 13	Vynoodle	Pg 121
Hazlemere	Pg 7	Opus 3 Records	Pg 128	Walrus	Pg 5
Heatherdale	Pg 54	Oranges Et Lemons	Pg 64	Wilmslow	Pg 84
Heatherdale	Pg 84	Origin Live	Pg 41	Wollaton Audio	Pg 30

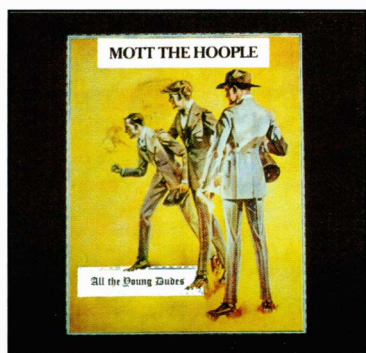

Mott The Hoople

All The Young Dudes / Mott

Absolute Analogue / Columbia 65184/69038 **180g**

There are two reasons for re-pressing albums on 180g vinyl. The most common is to make something collectable more accessible, a laudable aim when originals are changing hands for well in excess of a hundred pounds, but one that has unfortunately led to a scatter gun approach to the output of certain favoured labels. The stream of new releases has diluted the quality and reputation of the results.

The second reason is to represent musically important discs that were poorly served by their original pressings, and that, in some ways more commendable aim, is the case here, with Absolute Analogue's long awaited re-release of these two Mott albums. Mott The Hoople? Well, yes. It's easy to forget just how influential they were until you play these albums, then it all comes flooding back. Released in 1972, *Dudes* is unmistakably Bowie-esque, with Ziggy providing not just the title track but the production as well, while Mick Ronson turns up as string arranger. It's none the worse for that, although the high points for me are the first and last tracks. The opener is a glorious cover of Lou Reed's 'Sweet Jane', unrecognisably upbeat and full of an unlikely hope, but it is 'Sea Diver' that really points the way to things to come.

Freed of Bowie's impressive but all too obvious directorial influence, *Mott* really sees the band stretching their wings. Hunter and Ralphs are at there creative best mixing the multi-faceted instrumentation to varied textural effect. From the familiar opening chords of 'All the Way from

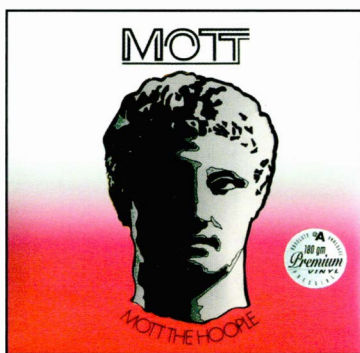

Memphis', on through 'Ballad of Mott' to the closing notes of 'I Wish I was your Mother' with its Mandolin and shades of Alex Harvey, *Mott* is a stylistic roller coaster, a cascade of musical invention. Sax insertions from Andy Mackay help to underline an instrumental line-up that's different for every track. Holding it all together is Hunter's sardonic lead vocal, never more effective than in the straight ahead four-bar rocker 'Drivin' Sister' with its abrupt down change and violent coda. It's a surprising and surprisingly enduring cocktail that wears it's artistic heart firmly on its sleeve (even down to the reproduction of D.H.Lawrence's 'A Sane Revolution' on the back of the beautifully reproduced original UK sleeve, complete with acetate fold out). In fact the impressive sleeve on *Mott* is a perfect metaphor for the care and attention to detail that's gone into this project. These are all analogue pressings from the original two-track masters, beautifully cut by Ray Staff, and pressed at RTI. Both records come with a booklet containing details of the recording and production along with extensive comments from the band. Neither of these records started out as an audiophile darling or particularly wonderful production, but this is the best you're ever going to hear them.

RG

Contact:

Absolute Analogue, PO Box 30429, London NW6-7GY  
Tel/Fax. (44)(0)208-459-8113  
E-mail. Absolute\_Analogue@email.msn.com

All The Young Dudes



Mott



Rachmaninov / Strauss  
Piano Concerto No. 1/Burleske

Janis, Reiner, CSO

Classic Records / RCA LSC - 2127 **180g** **1**

For a lover of rarely heard and recorded works Classic's remaster of the short, one movement concerto *Burleske* must be a priceless addition to the catalogue. Written when Richard Strauss was only twenty-one, and before his great Germanic repertoire overwhelmed audiences, this sardonic commentary upon those spectacular concertos penned by the likes of Franz Liszt reflects a youthful, witty and brilliant mind at play. Most, however, will focus on an equally virtuoso performance of the *First Piano Concerto* where Byron Janis, Fritz Reiner and the incomparable Chicago Symphony musicians once again prove that these scores flow through their veins. The soloist's fabulous technique and wilful impetuosity (especially during the second movement finale) will draw most attention. It is a stunning combination that has sometimes been unfairly accused of lacking genuine expressiveness. Needless to say I like the headstrong approach adopted by Janis. This Concerto was one of only a few early compositions to survive Rachmaninov's exacting gaze and, although he later extensively revised it, enough evidence of his own ardent, boyish spontaneity certainly remains to substantiate an interpretation of this nature. Sonically a sumptuous, solid and notably well-proportioned (in relation to the orchestra) piano, should win over any waverers.

Supplier: Vivante - Tel. (44)(0)1293 822186

RP









## Rachmaninov Symphony No. 2

Boult/LPO

Classic Records/RCA Victorola VICS 1139  

Even by 1965, when this English recording for RCA was first released, Sergei Rachmaninov's Symphonies still did not enjoy anywhere near the international popularity that they possess today. Back then, outside of the Soviet Union and those excellent Yevgeny Svetlanou Melodiya performances, there was to my mind few truly great versions of the *Second Symphony*. Here, however, Sir Adrian Boult's disciplined, sweeping and richly melodic (if slightly cut) reading is an interpretively serviceable one. Although I would not place it at the very top of the Rachmaninov re-issue list (a position comfortably held by Andre Previn and the LSO's Testament ASD 2889 LP) this does remain a solid and well-rounded account in most departments. Our conductor, as previously alluded to, marshalled his troops to communicate the composers' wide-ranging emotional lyricism. Accomplished London Philharmonic playing convinces without unnecessarily drawing attention to itself – special mention should be given for a slow movement which in lesser hands can often feel indulgent and over romanticised. Technically, Classic have advanced the overall sonic stature of this recording. Top end strings (which previously tended towards raggedness) are tidier and better organised, but I sense that the treatment of the lower bass ultimately makes too much of a concession to the "Hi-Fi" audience.

Supplier: Vivante – Tel. (44)(0)1293 822186

RP



## Tchaikovsky Symphony No. 5

Mravinsky/LPO

Speakers Corner/DGG SLPM 138658  

Eugen Mravinsky's awesome Leningrad readings of the later Tchaikovsky *Symphonies* – are renditions of distinction which during the past forty years have rarely been out of the catalogue. An acutely prophetic and doom-laden work (even the waltz-like third movement closes with an unexpected return to that powerfully impassioned and dominating principle "motto" theme) is brought to life throughout a truly vital and extremely energetic interpretation that, importantly, does not overlook softer lyrical moments like a first movement recapitulation given by the bassoon. Even while a notion of tremendous foreboding permeates nearly every facet of this score, Mravinsky still successfully adopts some remarkable speeds. Few have injected such a sense of pace and urgency in a tempestuous finale without compromising the composer's greater vision. As a performance its only shortcoming is an unsteady horn solo in the slow movement. As a record it has never sounded better. Tulip label originals, with their absence of fine instrumental detail and opaque sound, detracted from the overall effect. Speakers Corner have reversed that trend to revive the recording's full potential through a clean-cut, resonant and weightier remaster which has much improved presence.

Supplier: Vivante – [www.vivante.co.uk](http://www.vivante.co.uk)

RP



## Knappertsbusch Conducts Wagner

Knappertsbusch/MPO

Speakers Corner / Westminster WST – 17032  

The New York founded Westminster label is an interesting departure from those Decca and Deutsche Grammophon releases previously chosen by Speakers Corner's Kai Seemann for his reissue classical music catalogue. Undoubtedly, the Westminster's will receive greater attention in America and Japan, where original LPs are more highly prized than in the U.K. Nor does it seem likely that this particular repertoire of overtures (*Tannhäuser*) and preludes (*Die Meistersinger*, *Parsifal*, *Tristan and Isolde*) will inspire a sudden groundswell of enthusiasm either. Which is not to say that these Hans Knappertsbusch/Munich Philharmonic performances are not engaging – they are terrific accounts – but one has to ask, why Wagner? Would the prospect of a grandly-scaled setting for these operatic orchestrations have anything to do with it? A rhetorical question because, yes, I think that these scores and the new "up and at 'em" remaster of this studio recording should give most systems a thorough work out. Sleeve notes that include two-track, dynamic, frequency and technical data, together with a disposition of performers, all seem to support this theory. However, that is not the philosophy to boldly explore repertoire which was envisaged at the label's inception, and espoused in an excellent history of Westminster that comes with the album.

Supplier: Vivante – Tel. (44)(0)1293 822186

RP





Ella Fitzgerald Sings The George And Ira Gershwin Songbooks

Ella Fitzgerald, Nelson Riddle and his Orchestra

Speakers Corner  
Verve MG VS-6082-5 **180g** **3**

In this day and age, with the audiophile market flooded with and depressed by ill advised re-issues of poor quality and less merit, how refreshing to see a company not just take on a project like this, but to do so with real commitment. Speaker's Corner are to be commended for their faith and vision, qualities that have resulted in one of the really outstanding releases since Chesky really started the whole ball rolling.

These records arrive in a beautifully finished and substantial box featuring the original, and in the UK rare, Bernard Buffet artwork. Open it and delve inside to discover the five 180g LPs, individually packed in heavy duty gloss white card outers, each with a label window to make it easier to identify the discs with a minimum of handling.

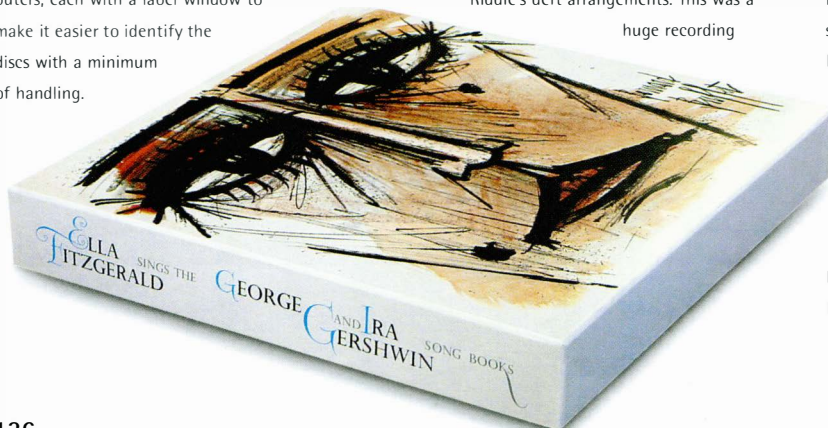

Pull one out and admire the beautifully flat pressing and the clean cut, as well as the nicely reproduced Verve labels. And don't overlook the

"Stereophonic" blaze, because unlike the earlier *Cole Porter Songbook* (also available from Speakers Corner and another must have album) this 1959

recording actually made the dawn of two channel. But there's more to come. First up is a 10" EP with the three *Preludes* on one side and the *Ambulatory Suite* on the other. Then comes a plain white folder containing five 12" square art paper prints of the original Bernard Buffet sleeve art. Finally you reach the bottom of the box and nestling between protective shoulders you discover the piece de resistance, a 48 page hardback book offering a brief illustrated biography of the Gershwins and individual notes on each and every track.

It's hard to overstate just what an impressive overall package this is. Of course, it's not worth the candle if the music isn't up to scratch, but with Ella, Nelson Riddle and the Gershwins recorded by Verve at the height of their powers that's hardly likely. Thankfully, Speakers Corner have matched that pedigree with the quality of their pressings.

The sound is rich, warm and sumptuous, at once open and intimate. Ella's flawless phrasing is unmistakable and perfectly complemented by

Riddle's deft arrangements. This was a huge recording

project when Verve embarked on it, absorbing six months of studio time and countless months of planning. Remarkably, the performances are consistently excellent right across the musical

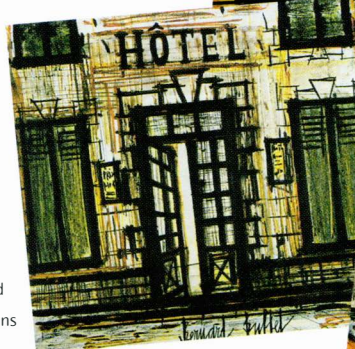
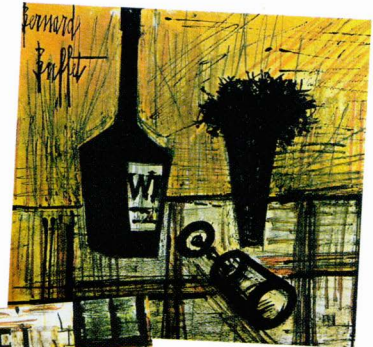

range, from Broadway show tunes through to straight jazz, via ballads and ragtime. Such is the Gershwin canon that it's almost pointless to pick out the high points as everyone will have their own favourites, but on a personal note 'Fascinatin' Rhythm' and 'Nice Work If You Get It' get my vote.

Musically essential, qualitatively superior and beautifully presented this is a dream release for all Ella fans. Serious record collectors everywhere should be reaching for their flexible friends. Music lovers should too. If ever there was a record that everybody should own this is it. I'd give it 11 if I could.

Supplier: Vivante - Tel. (44)(0)1293 822186 RG

RECORDING  
MUSIC

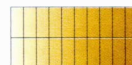



Faithful to your music



Music as it was meant to be heard • Systems start from £3000

For your nearest stockist call +44 (0)1722 332266. Or visit [www.naim-audio.com](http://www.naim-audio.com)



*So you think you've  
heard music?*

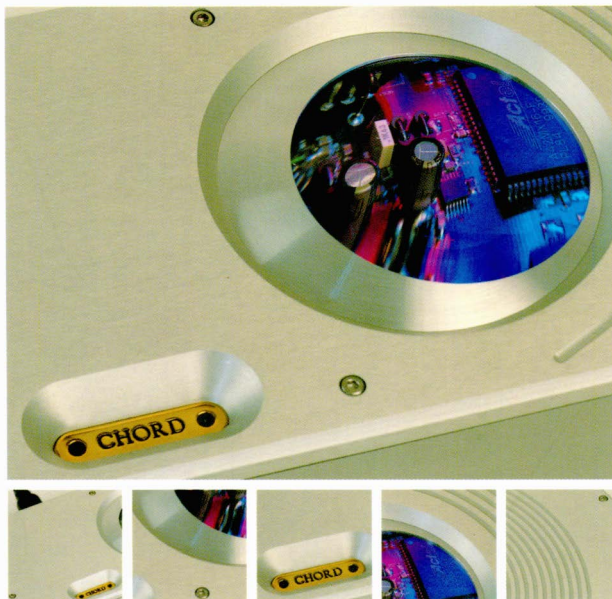

*Think again.*

The Chord DAC64. The world's first 64-bit digital-to-analogue converter.

Regarded by the press as 'stunning', the DAC64 is result of our innovation and engineering excellence, and will deliver new levels of sound quality from any digital source.

Each solid aluminium unit is hand-built to uncompromising standards to your specification.

So, to unlock the real potential of music, please contact us on 01622 721444, email [sales@chord.softnet.co.uk](mailto:sales@chord.softnet.co.uk), or visit [www.chordelectronics.co.uk](http://www.chordelectronics.co.uk)



Chord Electronics Limited