

# HI-FI WORLD

SEPTEMBER 2022 UK £5.00

www.hi-fiworld.co.uk

FREE READER CLASSIFIED ADS IN THIS ISSUE!



HIFI ROSE RA180  
integrated amplifier



EXPOSURE VXN  
phono stage



AUDIO TECHNICA AT-LPW30  
turntable



## Q ACOUSTICS CONCEPT 30

loudspeakers



WIN A PAIR OF MISSION QX-2  
MKII LOUDSPEAKERS WORTH  
£399! (UK ONLY)

SEPTEMBER 2022



9 770961 766215

SIX PAGES OF LETTERS - THE BEST WINS BLUE AURA'S  
SUPERB BLACKLINE PG1 TURNTABLE! (UK ONLY)

# Winning performance



## Audiophile quality at a realistic price

The multi-award-winning Chord Company cables feature the latest high-performance shielding and our unique ARAY technology, first introduced on our flagship products and now benefitting all ranges.

A wide variety of analogue and digital interconnects are available alongside high-performance speaker, tone arm, mains power and HDMI cables. We also supply stand feet, contact cleaner and the acclaimed English Electric 8Switch and 16Switch.

Proudly designed in England since 1985 by a dedicated team of music, cinema and game lovers. Used and recommended worldwide by a host of professionals, including record producers, studio engineers, musicians and hi-fi manufacturers.

Ask your nearest Chord Company retailer for a demonstration/loan - including the new Chord Company PowerHAUS mains blocks.

Find out more: [www.chord.co.uk](http://www.chord.co.uk)

# CHORD<sup>TM</sup>

COMPANY



# welcome

## EDITOR

Noel Keywood  
e-mail: [editorial@hi-fiworld.co.uk](mailto:editorial@hi-fiworld.co.uk)

## DESIGN EDITOR

Faiza Chunara  
tel: +44 (0)7399 361 785  
e-mail: [adproduction@hi-fiworld.co.uk](mailto:adproduction@hi-fiworld.co.uk)

## PRODUCTION EDITOR

David Noble  
tel: +44 (0) 207 286 1270  
e-mail: [classifieds@hi-fiworld.co.uk](mailto:classifieds@hi-fiworld.co.uk)

## SALES MANAGER

Louise Palfrey  
mob: +44 (0) 7917 047 548  
e-mail: [louise@hi-fiworld.co.uk](mailto:louise@hi-fiworld.co.uk)

## ADVERTISING EXECUTIVE

Rose Williams  
mob: + 44 (0) 7956 885 189  
e-mail: [rose@hi-fiworld.co.uk](mailto:rose@hi-fiworld.co.uk)

## PUBLISHER

Noel Keywood  
e-mail: [publisher@hi-fiworld.co.uk](mailto:publisher@hi-fiworld.co.uk)

## FREE READERS CLASSIFIEDS

tel: +44 (0) 207 286 1270  
e-mail: [classifieds@hi-fiworld.co.uk](mailto:classifieds@hi-fiworld.co.uk)

## SUBSCRIPTIONS

tel: + 44 (0) 1442 820 580  
fax: + 44 (0) 1442 827 912  
e-mail: [hifiworld@webscribe.co.uk](mailto:hifiworld@webscribe.co.uk)

## PHOTOGRAPHY

David Noble  
tel: +44 (0) 207 286 1270

## WRITERS

Paul Rigby, Martin Pipe,  
Chris Frankland, John Pickford.

## hi-fi world

Audio Web Publishing  
Office 052  
464 Edgware Road  
London  
W2 1AH  
[www.hi-fiworld.co.uk](http://www.hi-fiworld.co.uk)

## verdicts

●●●●●	<b>OUTSTANDING</b>
●●●●	<b>EXCELLENT</b>
●●●●	<b>GOOD</b>
●●●	<b>MEDIOCRE</b>
●●	<b>POOR</b>
£	<b>VALUE</b>



Long ago Arcam produced their Black Box DAC. It was very good – we used one in-house for some time – but styling? Forget it. The HiFi Rose RA180 amplifier is opposite: it has had some serious design effort to inject visual intrigue: gears turn around before your eyes and a mechanical pointer moves horizontally – it is no bland black box. Visually ornate – but does it work in hi-fi terms as the Arcam did so well? You can find out on P18.

There are many ways to make a high quality phono stage.

Exposure use their own long-successful approach of top quality discrete electronics (no silicon chips) combined with rigid power supplies, quiet and able to sustain short term musical peaks. The result is a large and expensive two box combination. But how does it sound? Find out on p64 where vinyl expert John Pickford gives it expert attention.

In our Letters section and News there's talk about the enjoyment that can be had from VHF/FM. The wonders of listening to high quality live studio chat through a Leak Troughline tuner I know well: with no storage medium in the way this is an intense audio experience. I've done many studio talks from small, sound damped studios with a decent mic in front of me and know that you get a strong connection right to the person at the mic. See Letters on p24 to read more.

Easy to think VHF/FM is now old tech of no merit – but is it? In News on p7 we learn that America has not been told VHF/FM is outdated and unworthy (as we have in the UK and Europe). There they still value quality VHF/FM radio to bring music into people's everyday lives without vagaries of internet, wi-fi and all else. I hope we can take a close look soon at the McIntosh MR89 tuner that serves VHF/FM in the USA, especially if it has a digital Software Defined Radio front-end since they provide astonishing performance.

The old technologies of VHF/FM radio and LP are still with us and thriving. Hi-Fi World can tell you why. I hope you enjoy.

**Noel Keywood**  
**Editor**



## INFORMATION FOR SUBSCRIBERS

For subscribers paying by Direct Debit, Webscribe Ltd have changed their banking provider and future Direct Debit payments will be processed under Originator's Identification Number 287789. This will not affect your subscription or Direct Debit schedule in any way. Please contact Webscribe on 01442 820585 or [contact@webscribe.co.uk](mailto:contact@webscribe.co.uk) if you need any further information.

## testing (see [www.hi-fiworld.co.uk](http://www.hi-fiworld.co.uk) for full explanations of all our tests)

To ensure the upmost accuracy in our product reviews, *Hi-Fi World* has extremely comprehensive in-house test facilities, and our test equipment - from big names like Rohde & Schwarz and Hewlett Packard - is amongst the most advanced in the world.

Loudspeakers are measured using a calibrated Bruel & Kjaer microphone feeding a Clio-based computer

analyser, using pulsed and gated sinewaves, in a large room to eliminate the room's influence. Pickup arm vibration is measured with a Bruel & Kjaer accelerometer.

No other UK hi-fi magazine has in-house testing, and none has access to such advanced tests across all types of equipment. That's why you can depend on *Hi-Fi World* reviews.



## ELECTRONIC MAGAZINE

Go to our website [www.hi-fiworld.co.uk](http://www.hi-fiworld.co.uk) to buy an electronic version of this magazine, individual issues, back issues or a subscription.

Distributed by Select Publisher Services Ltd. P.O. Box 6337, Boumemouth, BH1 9EH UK Tel +44 (0) 1202 586848

Printed by Precision Colour Printing Halesfield 1, Stirchley, Telford TF7 4QQ, United Kingdom Tel: + 44 (0) 1952 585585

Our Agents in Malaysia Millennium Hi-Fi & AV Simon Chang Showroom & office, 500-1-3 First Floor Wisma Indah (Shen Court), Jalan Tun Razak 50400 Kuala Lumpur, Malaysia

Tel: 603 9283 8171 Fax: 603 9281 3762 e-mail: [info@millennium-audio.com](mailto:info@millennium-audio.com)

All unsolicited submissions and goods are at the owner's risk. We accept no responsibility for such submissions, nor do we undertake to return them.

No material may be reproduced from this magazine without the publisher's written permission. © Audio Web Publishing Ltd

# contents



**LOUDSPEAKERS**  
**Q ACOUSTICS CONCEPT 30**  
**LOUDSPEAKERS 10**  
A pair of high quality stand mounters from venerable Q Acoustics. Noel Keywood listens.

**AMPLIFICATION**  
**HIFI ROSE RA180 AMPLIFIER 18**  
An extraordinary steam-punk styled amplifier reviewed by Noel Keywood.

**CONNECTED FIDELITY AC-2K BALANCED POWER SUPPLY 36**  
Balance your mains supply to the hi-fi with this cryogenically treated transformer. Noel Keywood enjoys the result.

**CABLES**  
**QED XT3 POWER CABLE 58**  
Martin Pipe listens to a new, affordable power cable.



# SEPTEMBER 2022

VOLUME 32 : NO. 7

## FEATURES

### 32 NORTH WEST AUDIO SHOW

Hi-Fi World heads north to Cheshire for the popular North West Audio Show.

## OLDE WORLDE

### 46 OLDE WORLDE

Martin Pipe rescues a Sony TC-186SD cassette deck to look closely at 1970s cassette deck technology.

## VINYL

### 62 NEWS

All the latest and greatest vinyl releases for you, from the pen of Paul Rigby.

### 64 EXPOSURE VXN PHONO STAGE

A high quality discrete transistor phono stage gets close attention from John Pickford.

### 71 AUDIO TECHNICA AT-LPW30 TURNTABLE

Noel Keywood spins LPs using a budget turntable from Audio Technica.

### 77 AUDIOPHILE BOOKS

Three books: Ready Steady Go; Buying into Britpop; Shindig!, reviewed by Paul Rigby.



## REGULARS

### 7 NEWS

Words from the world...

### 17 COMPETITION

Your chance to win a pair of Mission QX-2 MKII loudspeakers worth £399.

### 24 MAIL

Six pages of your views, wonderful as always...

### 30 SUBSCRIPTIONS

Ensure your copy every month and save money too!

### 40 WORLD STANDARDS

Updated guide to the latest and greatest hi-fi hardware on sale.

### 51,53,55,57 OPINION

The team get to grips with matters music, hi-fi and life!

### 60 AUDIOPHILE VINYL

Paul Rigby rounds up the latest audiophile vinyl releases

### 78 DIAL-A-DEALER

A comprehensive guide to UK hi-fi retailers.

### 79 CLASSIFIEDS

Second-hand bargains.

### 80 NEXT MONTH

What we hope to bring you in the next sizzling issue...

### 81 ADVERTISERS' INDEX

### 82 CLASSIC CUTS

White Plains album – 'White Plains', reviewed by Paul Rigby.



# BLADE

Now with Metamaterial  
Absorption Technology



A sound statement. An icon that engages every sense.

## BLADE

A bold and striking presence, BLADE pushes the boundaries of what is possible with sound. The world's first Single Apparent Source loudspeaker now with Metamaterial Absorption Technology.

Authorised Retailers



Listen and believe

**KEF** 60  
YEARS

email:news@hi-fiworld.co.uk

# news



## SAD BUT TRUE

How many products get a 'lift' with a coveted (albeit screen-printed) celebrity signature somewhere prominent these days? Sometimes, though, rather more thought goes into branded product – as here, thanks to the Masters of Puppets themselves. Ladies and gentlemen, we bring you the Metallica Limited Edition Turntable – the latest (and loudest?) addition to Pro-Ject's Artist Collection.

That look, as angular as a heavy-metal axe and the solo screaming from it, could not be more appropriate...the £1,149 price, well maybe less so. Take away the distinctive 'heavy' (OK, the deck weighs 4.5kg) mirror-finished MDF plinth and the glass platter that visually-complements it so well, and we have a recognisable belt-drive 33/45 design that can also be made to spin 78s without too much trouble.

Pre-fitted to the bayonet-fitting headshell at the end of the 8.6in. S-shaped aluminium tonearm is an Ortofon-made Pick it S2 C – no relation to Death Magnetic! Further details: [Henley Audio, www.henleyaudio.co.uk](http://Henley Audio, www.henleyaudio.co.uk)

## LOWTHER STORY

Although their sound isn't to everyone's taste, Lowther speakers benefit from valve-friendly efficiency and are endowed with an openness and effortless speed that many appreciate. The distinctive full-range drive units (and many of the cabinets they're fitted to) can trace their roots to a mid-1930s collaboration between audio pioneer Paul Voigt – of domestic corner-horn fame – and the manufacturer O.P. Lowther. However, fans of these speakers haven't seen a new design for three decades.

This changes with the 1.2m-tall Almira ("from £12,000" a pair), described as a "2.3m single folded quarter-wave generic Voigt horn with floor-facing exit". Each is built around an 8in. DX3 drive unit, but – in a departure from Lowther tradition – also features a phase-compensated 20mm supertweeter. Veneer sets and top-cover grilles can be specified when ordering these speakers, which are "handmade in Great Britain".

Further details: [www.lowtherloudspeakers.com/shop](http://www.lowtherloudspeakers.com/shop)

## PX MARKS THE SPOT

With its newly-developed active noise-cancellation system, claimed to avoid the musicality degradation normally associated with wireless headphones, the 'over-ear' Px7 S2 is described by maker B&W as its "best example of the genre" to date.

Within the earcups, the "ultra-fast" 40mm high-resolution drive-units – specially designed for the Px7 S2 – are mounted at angles. The distance between the listener's ear and the driver is therefore constant across the entire surface of the diaphragm, aiding soundstaging. Behind the driver lurks electronics of commensurate standard. They feature proprietary B&W DSP and Qualcomm's 'aptX Adaptive' wireless technology, for 24-bit hi-res audio and automatically-optimised Bluetooth connectivity; USB-C and 3.5mm analogue are 'wired' alternatives.

A six-microphone arrangement enhances call quality, as well as noise-cancellation, while physical buttons and an app aid configuration and everyday use. The £379 Px7 S2, which will deliver up to 30 hours of use from a single USB-C charge, is available with grey, blue or black finishes.

Further details: [www.bowerswilkins.com](http://www.bowerswilkins.com)



## NEUTRONS WITH ATTITUDE?

Launched at the recent NWA show, Leema Acoustics' full-width Quantum range is the culmination of "several years" work. The four all-new UK-built constituent components will, according to Leema co-founder Lee Taylor, sell for "£1,500-£1,700". In terms of sources, we have the Electron CD player – with ubiquitous Sabre ES9018 DAC and not-so-common headphone output – and Positron streamer.

Details of the latter are sparse, but if it's like existing streamers from the Welsh firm it will play music from the most popular services as well as locally-networked and USB storage.

Quantum amplification consists of the Neutron DAC/preamp – which boasts a multi-input DAC, MM/MC phono stage and analogue inputs both balanced and unbalanced – and its companion Graviton Class A/B power amp, which is specced at 150 Watts (8 Ohms) per channel (enough for the loudest hip-hop!).

Further details: [www.leema-acoustics.com](http://www.leema-acoustics.com)

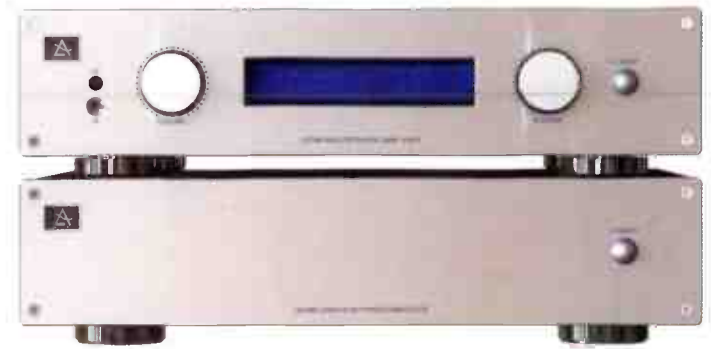

## BURGUNDY BEEF

Better-known for its speakers, French outfit Elipson has branched out into 'serious' hi-fi amplifiers with its P1 preamplifier (£1,899) and matching A2700 stereo power amp (£2,999). The P1 features three line inputs (two phono, one XLR), remote control, headphone amp and switch-mode power supply.

It will feed the A2700 via unbalanced or balanced means, and can be upgraded with two internally-firing modules. One is the £699 MDAC I, a Sabre ES9028-based hi-res (32/384) DAC with USB, coax and optical inputs. The other is the MPH II phono stage (£499), suitable for MM or MC cartridges. A version of the preamp with both modules already onboard, the £2,799 P1F, is also available.

The A2700, a definite muscle amp, is claimed by Elipson to deliver 2x400W into 8 Ohm loads; for the truly power-hungry, there's also a mono bridged mode. Elipson describes the A2700 as "an iron fist in a velvet glove", implying it can deal with the subtleties too.

Further details: *Avoke*, [www.avoke.co.uk](http://www.avoke.co.uk)



## PRECISION HAS ITS PRICE...

Named after its country of origin ('CH' stands for Confoederatio Helvetica, the Latin translation of Switzerland's official name), CH-Precision has announced a matching DAC for its recently-introduced D1.5 CD/SACD player/transport.

The C1.2 benefits from a four-fold increase in 'under the bonnet' computing power relative to its C1 predecessor, enabling it to – amongst other things – run a "revised and refined" proprietary PEtER signal-processing algorithm.

The C1.2 is compatible with MQA, as well as DSD/DXD and hi-res PCM, and is Roon-Ready. The thermally-compensated master clock is MEMS-based, while attention to power supplies has "significantly lowered the digital noise-floor". Thanks to a bypassable hybrid digital/analogue volume control, the C1.2 can act as a preamp. A 'base' configuration (with one digital input card) sells for €32,850 – USB, analogue inputs and Ethernet are extra. In keeping with CH-Precision's "design ethos", C1s can be upgraded to C1.2 spec for €4,000.

Further details: [www.ch-precision.com](http://www.ch-precision.com)



## KIMBER DOES THE STRAND

Also making their UK debut at the North-West Audio Show, courtesy of Russ Andrews, were new versions of Kimber's long-established 4PR (£145, 2.5m pair) and 8PR (£290, 2.5m pair) speaker cables. They employ the clever VariStrand construction technique, as used in the Utah firm's 'Select' series.

Here, the conductors comprise wire strands of mixed diameter for a more even frequency response. Instead of the silver conductors found in Select exotica like the KS6000 flagships, though, the 8-strand 4PR and 16-strand 8PR rely on Kimber's own high-purity oxygen-free electrolytic copper – which, we're told, has "industry-leading conductivity of 102% IACS...with very low induction".

The polyethylene dielectric gives the two 'Base series' cables their distinctive red/black colour. Also shown at the NWA were standard (£749) and 'signature' (£1,399) versions of the Russ Andrews SuperRouter, a "class-leading RF grounding device" with sophisticated filter technology, audio-grade components and nickel terminals.

Further details: [www.russandrews.com](http://www.russandrews.com)





## A GREAT FACE FOR RADIO!

In New York, where McIntosh lives, good ol' analogue radio is still cherished. Despite new kids on the block like streaming, the percentage of Americans listening to radio has – it transpires – remained steady since the '70s. Furthermore, radio still plays a key role in discovering new music! No wonder that, despite the temptations of the Internet age, McIntosh decided to launch a new AM/FM tuner.

After hearing through industry body RAJAR that 50 million Brits still listen to radio, the American firm decided to launch the MR89 here. Thankfully, it can be configured to accommodate different global radio standards and mains voltages – a deliberate ploy, McIntosh's engineering team told us exclusively, because it allows the company to "sell one tuner model around the world".

The caveat is that, thanks to import duty and VAT, you'll pay £6,800 for one here (in the US, it's a 'mere' \$5,500). Naturally, the MR89 has the iconic black glass frontage and blue-backlit analogue output level meters – a good visual check of stereo separation, we're assured – although radio-related signal conditions are instead shown on the fluorescent display positioned amidships.

This will also display frequency, stereo mode, preset number (up to 20) and Radio Broadcast Data System (RBDS) data – different enough from our own RDS, admitted McIntosh, to be incompatible. Most intriguing of all are the digital audio outputs, which jostle for rear-panel space alongside the analogue (balanced/unbalanced) ones.

They suggest the MR89 is a SDR (Software Defined Radio) design, instead of relying on the traditional analogue techniques on which superficially-similar vintage McIntosh tuners are based. When asked for confirmation, McIntosh skirted around the issue – but did assure us that "the MR89's analog FM performance is the highest of any tuner we've ever delivered, including the revered all-analogue MR78"! Other features include a bundled AM antenna, an enhanced stereo-blending function, remote control, 'Softmute' (which reduces audio output when encountering weaker transmissions or interstation noise) and 'Highcut' (to tame aggressively-bright broadcasts).

Further details: [www.finesounds.uk](http://www.finesounds.uk)



## DIAMOND LIFE

Rotel's 60th-anniversary celebrations continue with the launch of the 'Diamond Series' DT-6000 CD transport/DAC (£1999) and RA-6000 integrated amplifier (£3999). Sharing a "new industrial-design language" and "contemporary styling", they are nevertheless unmistakably Rotel!

Yet another ESS convert, the DT-6000 equally-divides the eight 32-bit DAC sections of a Sabre ES9028 PRO between the left and right channels in a dual-differential configuration for "exacting clarity...with exceptionally low noise". The DT-6000 also features a tray-loading CD transport, balanced/unbalanced outputs, audiophile-grade components, coaxial/optical inputs and USB port for MQA and DSD playback.

Rated at 350W per channel into 4 ohms, the 18.8kg RA-6000 has an on-board phono stage, three unbalanced phono inputs, a balanced XLR input and switching for two pairs of speakers. An onboard DAC (TI this time) can be fed from aptX-HD Bluetooth, PC-USB or six conventional digital inputs (3 optical, 3 coaxial). Black and silver finishes are available.

Further details: [www.rotel.com/en-gb](http://www.rotel.com/en-gb)

## CHANGING UP

Linn's iconic LPI2 turntable has undergone countless changes since its early-1970s introduction, but the latest round of upgrades – focused around a new tonearm and cartridges – is particularly comprehensive. The "entry-level" Krane tonearm, previously-fitted to new decks, is now available as a £1,350 upgrade for existing LPI2s.

A suitable partner is the £800 Koil moving-coil cartridge which, Linn claims, marks a worthwhile step up in performance from its established Adikt moving-magnet design. They are available in complete packages, as the Majik LPI2 MC and Majik LPI2 MM respectively. At the 'Selekt' mid-point of Linn's proposition are the all-new Arko gimballed tonearm (£3,000), and the 'elite' Kendo MC cart (£2,800) that's "designed to pair perfectly" with it.

According to Linn the Arko's gimballed design, implemented with 7075-grade aluminium, makes it more stable and rigid than alternative designs like unipivots. The Selekt LPI2, pre-fitted with Arko and Kendo, retails for £10,570.

Further details: [www.linn.co.uk/uk/turntables](http://www.linn.co.uk/uk/turntables)





# Not So Small

**Q Acoustics Concept 30 loudspeakers are small but ambitious. Noel Keywood listens.**

**P**rice £899. What? The Concept 30s are small Q Acoustics loudspeakers, but not of their usual budget nature. The “concept” here appears to be teasing out higher quality from a small loudspeaker – not a novel idea but one with a successful history, from Rogers LS3/5a to Wharfedale Diamond.

Always good to get more from a small cabinet because they're cheaper to manufacture and transport, and they appeal to the missus. Or should I say they blend in with the curtains better (!). Whatever, Q Acoustics follow this train of commercial thought with the Concept 30, question being: does it justify its existence? And to start at the end, the answer is “yes”, if a high quality mini is what you want.

In the company's now-large range of loudspeakers the Concept 30s sit below the similar Concept 300s that come in at £2499 and are slightly bigger, but above the 3030Is at £300 that are slightly smaller. That's one large price range as small two-ways go.

The Concept 30 measures 284mm high, 180mm wide and 319mm deep overall including rear projection of terminals. Weight each is 7.9kg – quite heavy for the size – and they are solidly built.

Rap the cabinets and the '30s sound dead, helped by a sturdy aluminium front sub-panel and a multi-layer Gelcore construction that damps high frequencies. The finish is glossily immaculate. Small, light cloth grilles attach by magnets and they are acoustically transparent. At rear are substantial bi-wire terminals.

As you can see from our pictures, this is a conventional two-way design with small 125mm (5in) bass/midrange unit that appears to be a formed plastic,

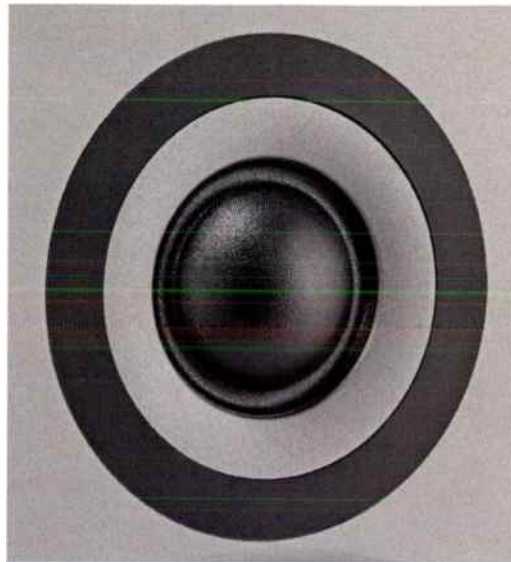

*What appears to be a fabric dome tweeter 25mm (1in) diameter, sits in a shallow horn depression to improve flatness and sensitivity. It is smoothly contoured in to prevent obstruction to surface waves.*

with central dust cap of the same material. The tweeter is a 25mm (1in) woven silk dome it appears, but again Q Acoustics don't specify the material used. No aluminium here so none of its sheen I'll note, which is fine by me. The crossover sits on an isolated platform attached to the cabinet's base to reduce vibrations into it. Bass loading is by a rear facing reflex port, tuned to 50Hz our measurements show.

Peculiar were a pair of stands Q Acoustics provided that were none too stable; we used our own conventional stands instead.

## SOUND QUALITY

Initially I connected up the Concept 30s to our Creek Voyage i20 amplifier but,

like the Concept 50 I reviewed some months ago (Mar22 issue), the combo gave a soft sound lacking verve. Moving to PrimaLuna's Evo300 Hybrid amplifier with its wideband, fast FET power amp changed this, bringing in both sparkle and grip. This is a matter of symbiosis: sometimes the Creek will be preferable to the PrimaLuna, just not in this case.

Spinning CDs was our Oppo BDP-205D Universal player with its



*The base has a solid aluminium panel that internally supports the crossover and externally can be bolted to a stand.*

CHORD

Chord Electronics Ltd.

# Anni



## ULTIMATE DESKTOP AUDIO

Anni offers the ultimate desktop audio experience. A compact integrated amplifier, Anni introduces our next-generation ULTIMA technology to both headphones *and* compact loudspeakers for the first time. Anni: class-leading amplification for desktops everywhere.



[chordelectronics.co.uk](http://chordelectronics.co.uk)



**Bi-wire terminals at rear allow for bi-wiring or bi-amping (separate bass and treble amplifiers), as with all such bi-wire loudspeakers. At this price however some may wish to bi-amp.**

ESS ES9038Pro DAC, connected direct to the PrimaLuna. HI-res came from a MacBook Pro running on battery for isolation, connected by USB to the Oppo to benefit from ESS conversion to analogue. Cables were from Chord Company.

From the off the Concept 30s came across as balanced and refined. As measurement had suggested there was no shriek from a prominent tweeter, nor hissy high treble. However, the upper mid-range was strong, pushing out a lot of detail in the edgy live recording of Willy DeVille singing Spanish Harlem, his voice thrusting out strongly. Some edginess here, but since that's in the recording our reference electrostatics show, the Concept 30s were being honest in effect. They throw out badness. Overall however, my early impressions were of a smoothly balanced and correct sound.

As the music rolled by I realised that the good impression these loudspeakers give comes from a relatively sweet tone. With Antonio Forcione playing Tears of Joy his guitar strings had a honeyed twang. Trumpet and piano

good recordings, but blemishes were revealed too.

As Q Acoustics claim, the Concept 30s are free from colouration – and this was another way their sound came over as easily natural. Lack of box echo and panel resonance helped clear their delivery of the colourations that shout “coming from a box”, allowing the sound stage to float freely between and slightly ahead of the cabinets. Add in good revelation of stage depth in a recording and the result is – and was – convincingly live, at least from recordings with microphones.

Bass quality was impressive from such small cabinets. In my 17ft long lounge these little things played the deep bass intro to Holy Cole's Train Song firmly and with dynamic bounce, hitting the lows with precision. It seemed almost laughable how well they conveyed the sense of this track at low frequencies, if not the visceral heft a bigger cabinet provides. They can play the lowest bass notes measurement showed and this was obvious. I was impressed.

It was with the Minnesota

"It seemed almost laughable how well they conveyed the sense of Holy Cole's Train Song at low frequencies"

rang out clearly from Josefine Cronholm's In Your Wild Garden, her vocal also standing out firmly between the loudspeakers, well projected forward. There was a smoothness to the sound from

Orchestra playing Korsakov's Dance of the Tumblers (24/96) that I became aware the Concept 30s are 'fast'. This performance had a pace I have not heard before, with cleanly defined



**A pair of foam bungs is supplied to damp down bass if necessary, but these are not bass heavy loudspeakers. The bungs may well help in a small, boomy room.**



website: [www.jordanacoustics.co.uk](http://www.jordanacoustics.co.uk)

tel 01202 911 886 email [ask@jordanacoustics.co.uk](mailto:ask@jordanacoustics.co.uk)



## Sonus faber LUMINA

Type: Floorstanding Loudspeakers

**Sonus faber  
Lumina V  
£2,499/pair**

**0% FINANCE EXAMPLE\***  
Initial 20% deposit of **£499.80**,  
then **£166.60** per month for  
**12 months\***.

Scan QR Code



Type: Floorstanding Loudspeakers

**Sonus faber  
Lumina III  
£1,999/pair**

**0% FINANCE EXAMPLE\***  
Initial 20% deposit of **£399.80**,  
then **£133.20** per month for  
**12 months\***.

Scan QR Code



Type: Standmount Loudspeakers

**Sonus faber  
Lumina II  
£999/pair**

Scan QR Code



Type: Standmount Loudspeakers

**Sonus faber  
Lumina I  
£799/pair**

Scan QR Code



Want to trade-up or looking to change a product? Call or email to find out how we can help you.

kettle drum strikes and snappy interjections from brass; there was no smear or overhang to pollute time domain definition. But the rasp to brass in this recording was a little 'obvious' shall I say. And with Fleetwood Mac's *Dreams* (24/96) cymbal clashes from Mick Fleetwood's drum kit had similar rasp, plus some splash. So with both *Classical and Rock*, strong upper midband projection brought out some coarseness in the upper midrange. Whether this was due to cone break-up in the bass/midrange unit or just strong projection of distortion in the recording is not something I can easily be sure about, our electrostatics suggesting there is some rasp in the recording but not to such an extent.

**CONCLUSION**

The Concept 30s offer a refined sound that has all of the purity claimed for the sturdy, braced, Gecore damped cabinet used. Add in a pair of quality drive units well



*The bass/midrange unit and tweeter smoothly match into the front panel to ensure a similarly smooth frequency response under measurement.*



**Q Acoustics use a thermo-plastic cone with matching central dust cap for continuity of sound, since high frequencies radiate from the cap, as always with any such drive unit.**

integrated electrically and the final result was impressive. I especially enjoyed their smooth accuracy. They have, I'll note, a forward sound with strong projection of upper midband detail that on complex orchestral works could throw brass sections forward. This character trait apart they conspicuously offer great sound quality at the price, if not with the bass heft a bigger cabinet provides.

**MEASURED PERFORMANCE**

Unlike the Concept 50 loudspeaker tested in our March 22 issue, the smaller Concept 30 measured flat across the audio band, its tweeter being set to match output from the small bass/midrange unit. With only minor perturbations right across the frequency range colouration from local resonances will be low, and the tweeter itself runs flat without peaking, suggesting smooth treble. Integration between drive units was good, giving consistent results off-axis.

Output from the small bass/midrange unit falls away slowly below 200Hz our analysis shows, to suit close-to-wall mounting. The roll down is relatively slow and the rear port tuned to 50Hz (red trace) provides a little extra power low down, but this is not a bass heavy loudspeaker.

Our impedance trace shows by the width of the dip around 50Hz where the port operates, that the bass unit is well damped, leaving fairly narrow residual peaks. The usual rise occurs as frequency increases due to inductance in crossover and voice coil, impedance falling above 2kHz as the tweeter comes into the picture, drawing current. Impedance minimum is 4.7 Ohms (d.c.r.) and overall impedance measured out as exactly 6 Ohms, making the Concept 30 a standard load.

Producing a loud 87dB sound pressure level (SPL) from one nominal Watt (2.84V) of input, the Concept 30 is impressively sensitive for such a small cabinet – around 85dB is common; 40W or more will be enough to go loud.

This is a smoothly accurate loudspeaker that will sound detailed but without treble sharpness. It runs low but will not have especially heavy bass, being suited to near wall placement in a small-ish room around 14ft long maximum. NK

**FREQUENCY RESPONSE**

*Green - driver output  
Red - port output*

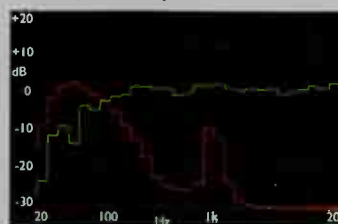

**IMPEDANCE**

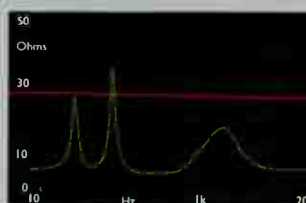

**Q ACOUSTICS  
CONCEPT 30 £800**



**OUTSTANDING** - amongst the best

**VERDICT**

A balanced and refined sound, lively and fast. Conspicuously capable all round.

**FOR**

- pure and uncoloured
- lively and fast
- sensitive

**AGAINST**

- limited bass weight
- brash at times

Q Acoustics  
+44 (0) 1279 501111  
www.qacoustics.co.uk

# AUTOMAT

# FOR THE PEOPLE



April 2022

## Pro-Ject **A1** AUDIO SYSTEMS

### FULLY AUTOMATIC TURNTABLE

The A1 turntable combines Pro-Ject's philosophy for toe-tapping Hi-Fi sound with the ultimate convenience of a fully automatic drive system. Featuring true audiophile design elements throughout its sleek, minimalist construction, it's ready to play straight out of the box. Simply set your speed, hit start, and let A1, take care of the rest.



Internally mounted precision belt drive system



Built in switchable phono pre-amp



Precise mechanics with automated start and stop



Pre-Adjusted Ortofon OM10 Cartridge



Distributed by Henley Audio

T: +44 (0) 1235 511 166 | E: sales@henleyaudio.co.uk | W: www.henleyaudio.co.uk | F: HenleyAudioUK | Y: HenleyAudio





# WIN

## A FANTASTIC PAIR OF MISSION QX-2 MKII LOUDSPEAKERS WORTH £399 IN THIS MONTH'S GREAT GIVEAWAY!

[www.mission.co.uk](http://www.mission.co.uk)

**H**ere's your chance to win a pair of Mission QX-2 MkII loudspeakers we reviewed in the March 2022 issue. Read the review excerpt below and answer the questions.

"Mission don't use paper or metal cones in the QX-2 MkII, but a modern composite cone comprising pulp with acrylic fibres. Point number one – this is not a metal cone, so it won't have a bright or ringy quality. I knew I could expect a darker sound. In a novel

arrangement a rear cone made of this material drives a front fibre dish made of the same material, explaining the drive unit's unusual appearance and perhaps unusual sound.

There's a rubber surround with serrated acoustic damping frame in front of it that contributes to an appearance of teeth. These scatter reflections Mission say, and tapered indentations have been added to the tweeter surround and even the rear port for similar purpose. Even though a budget speaker, the chassis is rigid cast alloy casting rather

than pressed steel with two ferrite magnets to energise the yoke.

The 'speaker itself, in physical form, is quite large and a tad tubby, measuring 220mm wide, 300mm deep and 320mm high – purposed for stand mounting, but you could also shelf mount it. There's a rear port but these only need a few centimetres (1in) of rear breathing space. Unusually, Mission fit a solid aluminium base and top plate that add weight and rigidity – and also suited our top-spiked stands".

For a chance to win this great prize, just answer the four easy questions at right. Send your entries on a postcard only, by 12th September 2022 to:

**September 2022 Competition,  
Hi-Fi World magazine,  
Office 052  
464 Edgware Road  
London  
W2 1AH**

### QUESTIONS

[1] What is the cone material?

- [a] aluminium
- [b] glass
- [c] pulp/acrylic
- [d] bubble gum

[2] The chassis is made of -

- [a] bamboo
- [b] cast alloy
- [c] copper
- [d] titanium

[3] The magnets are -

- [a] ferrite
- [b] Alnico
- [c] soft iron
- [d] samarium cobalt

[4] The base is -

- [a] concrete
- [b] pig iron
- [c] sponge
- [d] aluminium

### RULES AND CONDITIONS OF ENTRY

- ONLY ONE ENTRY PER HOUSEHOLD
- MULTIPLE ENTRIES WILL BE AUTOMATICALLY DISQUALIFIED
- PURCHASE OF THE MAGAZINE IS NOT A PRE-CONDITION OF ENTRY
- NO CORRESPONDENCE WILL BE ENTERED INTO
- THE EDITOR'S DECISION IS FINAL
- NO EMPLOYEES OF AUDIO WEB PUBLISHING LIMITED, OR OF ANY COMPANIES ASSOCIATED WITH THE PRODUCTION OR DISTRIBUTION OF THE PRIZES, MAY ENTER

**ENTRIES WILL BE ACCEPTED ON A POSTCARD ONLY**

**PLEASE ENSURE YOU PUT YOUR TELEPHONE NUMBER & POSTAL ADDRESS ON YOUR ENTRY OTHERWISE THE ENTRY WILL NOT BE ACCEPTED**

**JUNE 2022 WINNER: JBL HDI-1600 LOUDSPEAKERS  
Mr. Brian Nissim of Hendon, London**

# Punk Power

A powerful steam-punk styled amplifier, reviewed by Noel Keywood.

**T**he undeniably novel RA180 amplifier from HiFi Rose (Korea) is classic steam punk at front and almost mystifying at rear. What are all those loudspeaker sockets for? I'll tell you, plus a lot more that puts this £5499 amplifier into a category of its own.

Here are the basics. The RA180 has four hi-tech Class D modules inside, that throw out 200W each. There are wideband amplifiers for Left and Right channels, plus additional treble

amplifiers also for Left and Right, that come with frequency and level controls. Yes, it gets complicated – and I haven't started!

Staying with the basic design ethos, this is to provide independent amplifiers for the bass and treble sections of bi-wire loudspeakers (bi-amping), should you wish to do so. If not then the two amplifiers of each channel can be switched to BTL mode (bridged) to double available power, giving 400W. There were so many issues here I'll have to

cover them later.

This explains why there are four pairs of chunky loudspeaker sockets, but HiFi Rose fit eight pairs in total so the RA180 can connect to A or B loudspeakers – if not at the same time.

In the spirit of steam-punkedness, HiFi Rose fit a phono stage with a bewildering array of adjustments able to correctly equalise discs from long, long ago, including 78s. Most will want to use RIAA here, clearly marked. A small slide switch at rear selects MM or MC cartridge.



These unusual features of the RA180 explain all the front panel controls, if not the adornments. There are bass and treble tone controls that can be switched out, a 'high-pass' tuning section that can be switched out, a complex Phono preamp section, a slide control for channel balanced and – yes – that funky volume control with its gears, back illumination and physical pointer to show volume level. Whoa! Behind lies a motorised potentiometer that can be remote controlled.

This is not a digital amplifier in that there are no digital inputs, including Bluetooth. Some of the cut-off slopes and filter behaviours looked digital to me during measurement, suggesting internal ADC/DAC but no tell-tale anti-aliasing filtering appeared below 100kHz so I could not be sure. The tone control behaviours were like nothing I have seen before, and they even had influence when switched out (!), leaving me a bit

baffled. An unusual topology where the Bypass switch doesn't do it

The handbook has a 'wi-fi settings' section but there's no wi-fi hidden inside that my router, 'phone or computer could detect.

Also strange was that the amplifier's main wideband modules did not measure flat with tone control switched out (Bypass) and similarly neither did the HF (treble) modules when set to flat (Bypass). Running in BT (bridged) mode gave the same result.

Output from the HF module could be adjusted for frequency and degree of attenuation, but there was no extra gain available to flatten frequency response. So this is a not an amplifier with flat frequency response; it is tailored to have a warm sound balance. The HF module needs more gain so it can be tweaked to increase HF as well as decrease it, so users at least have that option when bi-amping.

Why would anyone want to

tweak the high-pass frequency of a tweeter feed when the crossover network in a loudspeaker has been designed to do this correctly? I don't know; I fail to understand the thinking here. And since the main amplifier is wideband with no low-pass filtering there is no potential for active filtering. It's all a bit peculiar in engineering terms, if not in fiddle factor. I carefully read the supplied instruction manual and website info but was unenlightened.

As HiFi Rose claim, their Class D amplifier modules work very well our measurements showed, suffering none of the usual problems of Class D, notably high frequency switching distortion, load dependant frequency response and current slewing. They even tolerated an inductive load, so top marks here. It's a sophisticated Class D amplifier, powered by a chunky switch-mode power supply our internal shots show.



# THE REFERENCE

Now with Metamaterial  
Absorption Technology



Detail Remastered. An icon redefined for tomorrow.

## THE REFERENCE

The essential for any audiophile. Handcrafted by the masters who set the standard for audio quality, THE REFERENCE has been the benchmark for loudspeakers and sound reproduction. THE REFERENCE is an embodiment of KEF's philosophy and the relentless pursuit of perfection. Now with Metamaterial Absorption Technology.

Authorised Retailers



Listen and believe

**KEF** 60  
YEARS

World Radio History

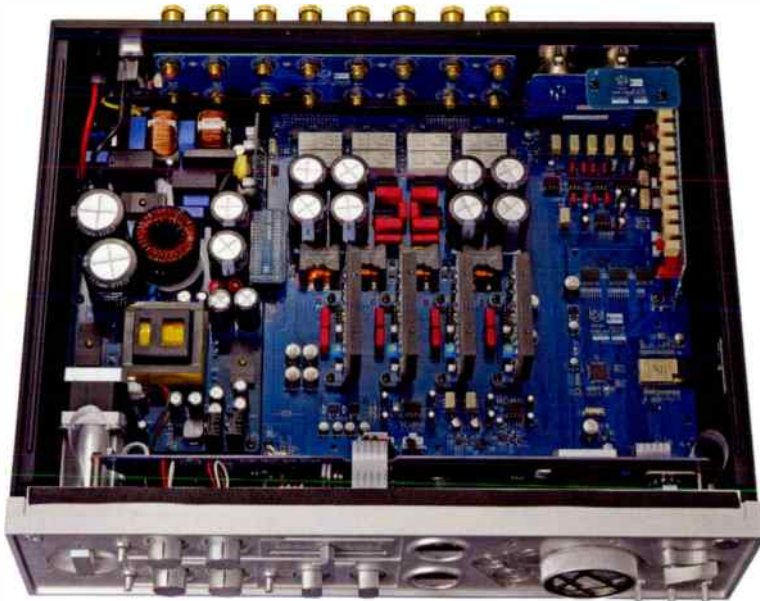

**At centre lie four Class D amplifier modules, above them output network inductors and capacitors vital to Class D. At left is a large switch-mode power supply and at right the preamplifier board.**

This is a solidly built and well finished unit, weighing a substantial 16.7kg, measuring 430mm wide, 130mm high and 380mm deep. There is a remote control with volume and input selection, power on/off and mute, but no filter functionality for settee tweaking.

The gears, wheels and lights looked and felt good, all slickly smooth. Not quite the authenticity of my valve amplifiers but I get the feeling HiFi Rose were trying to invoke this idiom. The small meters show input level, not output power, because there is a low-ish input overload ceiling of 1V line and 3V balanced.

**SOUND QUALITY**

The RA180 was connected to

our Martin Logan ESL-X hybrid electrostatic loudspeakers through Chord Company Signature Reference screened loudspeaker cables. Sources were our Oppo BDP-205D CD player with its ESS ES9038Pro DAC, plus a MacBook Pro connected to this player via USB for hi-res / DSD replay. Connection to the HiFi Rose was through Chord Epic balanced analogue cables. I started out using the wideband main amplifiers only.

Immediately obvious was a silky smooth presentation quite the opposite of traditional Class D with its "broken glass" treble, as if someone somewhere was trying to ensure that subjectively the amplifier could or would never be labelled "Class D". There were

nicely placed fine details on a wide sound stage that had both depth and a good sense of atmosphere. It all came across as smooth and easy going, quite lovely in its own way, being a relaxing delivery rather than a challenging one. Switching in the tone controls to add some sparkle up top was no great success: there was more treble but not of liquid clarity.

There were – inevitably – occasions when the contrived tonal balance became obvious. With bass heavy tracks such as Loreena McKennitt's Gates of Istanbul the opening bass line was close to overwhelming. This also brought attention to bass quality that was a tad soft. There was a solution: it is to turn treble up by a very small amount (its action is coarse), not turn bass down.



**At top left, bass and treble tone controls with a Bypass switch that did not fully bypass them. Below are high-pass controls for the HF amplifier, again with Bypass switch. The Phono input (bottom right) has LF and HF adjustment to provide a wide variety of commercial equalisations from the past.**



**Loudspeaker sockets for bi-amped A and B channels occupy much of the rear. At left are balanced inputs (top) and line inputs (below), plus a single subwoofer output. The BTL mode switch lies beneath the speaker sockets.**

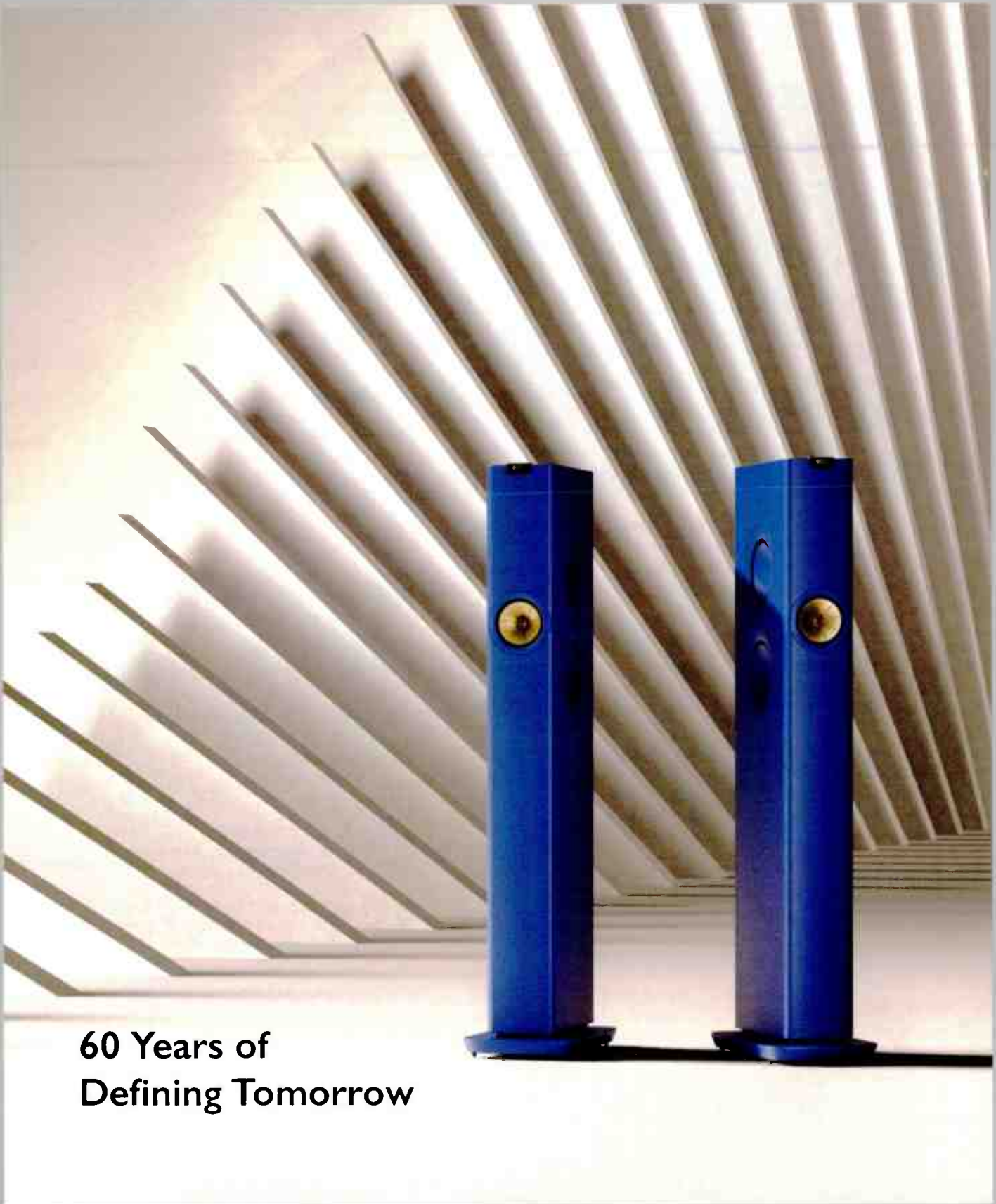

## 60 Years of Defining Tomorrow

### LS60 Wireless – Shaping the future of High-Fidelity

Designed by Michael Young in collaboration with the KEF product design team, this contemporary design addition to the KEF family defies the limits of audio performance with its iconic slim structure. The LS60 Wireless is a celebration of 60 years of sound innovation with a clear eye on the future high-fidelity experience.

AirPlay2, Chromecast, Spotify, Tidal, MQA, HDMI eARC, and more.



Listen and believe



Adding an extra set of cables to run the loudspeakers bi-amped made little difference, with identical tonal balance favouring low frequencies.

**CONCLUSION**

If the Bypass functions of this amplifier worked properly to



The large volume control drives a main gear that in turn spins two secondary gears (L & R). It also drives linear dial at top to show volume level. At left the meters show input level to warn of overload.

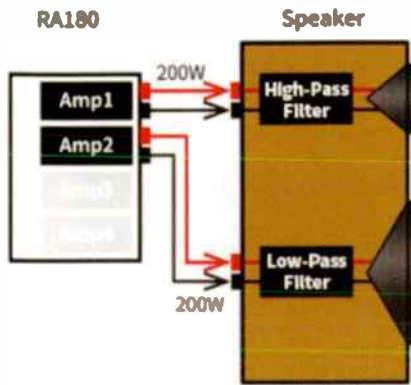

**Bi-Amping Connection**

With bi-amping the 'HF' amp with adjustable high-pass filter (Amp 1) feeds the tweeter of a two-way 'speaker, and the 'Main' amp (Amp 2) feeds the bass/mid. unit.

give flat frequency response it would have helped make it more acceptable I feel.

But perhaps I am missing the point. With its funky appearance comes a funky Beats-style sound that's aimed at a generation intrigued by gears, wheels and things that go round and round. There's a lot to attract in this

package, including strong bass.

If you are drawn by the RA180's steam punk style and a warm easy sound, reminiscent of the period it seemingly represents, then it has no competition and is No 1 in a field of one. But with obvious engineering weaknesses easily curable, at best 4 Globes from an audiophile point of view.

**MEASURED PERFORMANCE**

The HiFi Rose RA180 amplifier produced 200 Watts into 8 Ohms and the same into 4 Ohms due to current limiting kicking in. So as claimed this is a 200W amplifier. There is a BTL switch at rear that can double power (400W) by bridging the amplifiers. I tested with this set to Off.

Frequency response wasn't flat from the broadband output sockets even with bass and treble controls Bypassed (and Pure Direct on). There is +1dB of bass shelf- lift below 1kHz and -1dB cut above, enough to give a warm sound. Strangely, the controls still had some effect in Bypass mode, turning treble up reduced it! In active mode their lift and cut characteristics were massive. Frequency response could be brought near to flat with controls On and treble turned up slightly.

Anyone buying this amplifier would probably choose to use 'Main speaker out' to the bass section of a bi-wire loudspeaker, and 'HF speaker out' to the treble unit, as per the company's diagram. However, there is no additional gain available in the HF section to raise treble level, the Gain control only provides attenuation (which is why

maximum is marked 0dB).

Surprisingly, the phono section set to MM or MC did measure flat with the Turnover controls set to RIAA (not Flat) and the preamp switched on, but Subsonic off. Switching subsonic on introduces steep bass cut below 50Hz. Sensitivity and overload figures were satisfactory, the meters showing input level past which distortion rises, 0dB (full scale) being a low 1V via Line in and 3V via balanced in, above which distortion HiFi Rose slowly, as if a peak compression circuit or similar was operating. This also resulted in inconsistent distortion behaviour with high level input signals, the sign of a running overload protection strategy, likely at chip level.

The RA180 has a non-flat response so will sound different to the norm, softer and with stronger bass. This apart it measured acceptably well. **NK**

<b>AMPLIFIER</b>	
Power (8Ω)	200W
Frequency response	4Hz-98kHz
Distortion (10kHz, 1W, 4Ω)	0.03%
Noise (IEC A)	-98dB
Sensitivity	200mV

**PHONO**

Frequency response	40Hz-20kHz
Distortion (-60dB, 24bit)	0.1%
Sensitivity (MC/MM)	0.5/5mV
Overload (MC/MM)	5/25mV

**FREQUENCY RESPONSE**

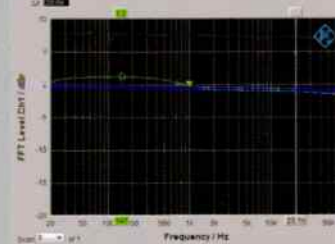

**DISTORTION**

THD at 0dB	Level (dB)	Frequency
Ch1: 0.0188 %	2.0994 V	10.000 MHz
Ch2: OFF	OFF	OFF

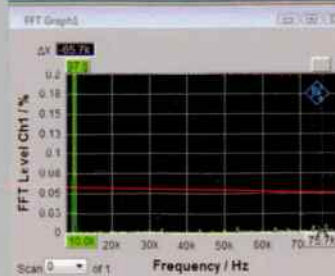

**HIFI ROSE RSA180 £5499**



**EXCELLENT - extremely capable.**

**VERDICT**

Warm smooth sound and plenty to play with.

**FOR**

- appearance
- smooth easy sound
- Phono stage equalisations

**AGAINST**

- uneven frequency response
- ineffective Bypass functions

Henley Audio  
+44 (0)1235 511166  
www.henleyaudio.co.uk

# Mail

## LETTER OF THE MONTH PRIZE

Answers by: NK - Noel Keywood; PR - Paul Rigby;  
MP - Martin Pipe; JP - John Pickford.

**Visit our website at:  
[www.hi-fiworld.co.uk](http://www.hi-fiworld.co.uk) or send your  
emails to [letters@hi-fiworld.co.uk](mailto:letters@hi-fiworld.co.uk).**

**Letter of the month wins a superb  
Blackline PG1 turntable!**



### BLUE AURA BLACKLINE PG1 TURNTABLE

<https://www.blueaura.co.uk/product/pg1-turntable/>

**A BLUE AURA BLACKLINE PG1 TURNTABLE is on it's way to JOHN SPEIGHT, Letter of the Month winner in our August 2022 issue.**

## Letter of the Month

### FIXING CASSETTE

*I thought you and your readers would be interested to learn of Wilkinson Hi-Fi based in Nelson who I discovered following a recent house move from West Midlands to Staffordshire. Wilkinson Hi-Fi restored an unused and valuable piece of equipment for me and saved a piece of personal history.*

*It was in December 2021 during my house move that I was reminded that I had a Pioneer cassette deck stored away in the loft of the house in its original box. The deck is a Pioneer CT-939 Mk II; a substantial machine near the top of the then Pioneer range I recall; bought new; that had developed a fault a few years into ownership; where a previous repair attempt had come undone.*

*I have circa 60 cassette tapes, most own recording on type VI tape during the 1980s, and generally copies of LPs some on an Aiwa ADM800K cassette deck that I owned before the Pioneer deck and some more recent recordings on the CT-939 Mk II. I believe Aiwa was brand of Sony and the ADM800K was another fine cassette deck. In*



**A Pioneer CT-939 MkII cassette deck. "I was surprised about the fidelity of the sound from a recording I had made on a Maxell cassette MX90 from 1983! Lovely" says Karl Kozurek.**

*my younger days I kept details of the each of piece of music or track, the date and time it was recorded, the source, the Dolby type used, the machine it was recorded on, and some details of the original recording venue taken from the LP sleeve. Looking at some of these tapes again, I was pleasantly reminded of how neat my handwriting was then and with me fitting all the details into the card that came with the cassette! Of course, although I have a few blank cassettes I cannot remember when I last recorded to cassette.*

*The CT939 MK II had developed an electrical fault in that it randomly changed tape type I to IV which rendered it to storage. I bought a new Pioneer CTS 550S to replace it although seemingly technical more*

*advanced it has Dolby S it does not feel as well built or substantial as the CT-939 Mk II and I had a nagging doubt about its fidelity compared to the CT939 Mk II.*

*House move completed and settled into my new home, knowing too that cassette has rekindled interest generally, an internet search showed Wilkinson Hi Fi as a repairer of vintage equipment. I telephoned the shop, spoke to a chap called Hilton, who said they would look at it but no promises to fix it, and off it went. A few weeks later the machine was fixed - the tape types stable and belts changed for a fair price. I played a cassette again on the CT-939 Mk II and I was surprised about the fidelity of the sound from a recording I had made on a Maxell*



cassette MX90 from 1983! Lovely.

Unknown to me though there was a new fault about to show itself with the motorised pinch roller which spooled some of that precious tape and wrapped it around the roller. I had to cut the tape and extract the debris from the roller: my heart sank! Back to square one but worse I had lost a tape – some of my personal history. At least that is what I thought.

Wilkinson took the machine back, sorted the new fault, checked and resoldered more connections just in case, spliced my precious tape back together. I lost about 5 or seconds at no cost to me short of paying to send the machine back. Fantastic service. Its simply great that we have places like Wilkinson Hi-Fi so I thought worth a mention.

The CT 939 Mk II now sits in my second, part vintage system, comprising Technics SL110, SME 3009 Series II Improved arm refurbished by SME Limited (wow what a difference that made), a Shure V15 type III with Doug Saunders replacement stylus (though I have the original Shure stylus too that looks okay), a Yamaha CT710 refurbished by AmpLabs, a matching CT710 tuner, and KEF 104ab speakers with the crossovers having replacement modern components and sporting a foam look-a like original Kef grill provided by Wilmslow Audio Limited rather than its stock cloth grill. I am frequently surprised how good music sounds through that second system; made a little more enjoyable with the CT-939 Mk II.

I still have the CTS 550S as back up. In my first or main system I have a refurbished Nakamichi CR4 deck though I suspect the CT-939 Mk II is the better of the two decks. I generally listen to LPs, CDs and FM radio and a few cassettes. Friends and family are equally surprised by these little old cassettes!

Yours faithfully  
**Karl Kozurek**  
**Staffordshire**

Hi Karl. That is interesting to know since cassette decks are a peculiar old technology, a derivative of the open reel tape recorder of course, that few really understand nowadays or can find spares for, such as belts, pinch wheels, motors, heads and what have you. The rubber parts can degrade simply through age, sometimes turning to goo. But when working

## Wilkinson's Hi-Fi

Products ▾ HiFi Repairs ▾ Second-Hand Online Shop ▾ Contact Us Information ▾ Basket

Welcome to our busy Service Dept. Specialising in 60's - 90's Japanese & English equipment.

Easier service work. cleans, cassettes/CD tweaks is 7-todays

**"Fantastic service. Its simply great that we have places like Wilkinson's Hi-Fi" says Karl Kozurek.**

well they can give fine sound quality – analogue of course! – as your Pioneer obviously does. That Wilkinson Hi-Fi can splice up a damaged tape is impressive – full marks to them. It's a delicate process that takes skill and patience. I suspect many readers will be interested in their skills.

As Pioneer made some superb decks at that time, the CT-939 MkII being a premium three-head, your hearing does not deceive you! **NK**

### ARM LENGTH

In the July 2022 issue there are two references to the use of Rega tonearms on non-Rega turntables. On page 30 reader Joe Wdowlak refers to the use of a Rega RB300 on a Lenco GL75, while on page 43 Martin Pipe recommends the use of an RB250 or RB300 on an Ariston RD80 to replace the Linn LVV originally fitted.

I believe that the effective length of the original arm fitted to the GL75 and that of the Linn LVV is 229 mm (9.0 inches), whereas the effective length of the RB250 and RB300 is about 8 mm greater at 237 mm (9.3 inches). This is a significant discrepancy, which I suggest should be brought to the attention of your readers.

Many years ago, after replacing the rubber V-blocks on my father's GL75 for the second time I decided to replace the original arm with a

Linn Basik, which worked very well once the height of the Linn mounting base / collar had been machined down by a few millimetres to avoid the dust cover making contact the counterweight.

Regards,  
**Owen Clingan**

Hi Owen – and thanks for the warning. Both height and effective length are assembly issues that can make fitment difficult, but special plinth mounts are often available nowadays, the vinyl revival being global and on the 'net. **NK**

### THE WONDER OF NOISE

I've been having a lot of fun (mostly seeking out and comparing old and new versions of great performances from the past, and so I was intrigued to read Noel Keywood's opinion about LP and RIAA equalisation in the July issue last month.

On first read I was nodding away, but something has been nagging at me (I do ponder such things as I walk in the woods and fields) ... "background groove noise [leads] to a sense of size, scale and stage depth because of RIAA EQ?". Groove noise?

I can understand low level background noise from the original recording being amplified and equalized in a way to cause this effect.

I can understand the equalising 'down' of the highest frequencies having an effect too: the "attenuating



**Rega's mightily impressive RB300 tonearm, a one-piece casting with tapered arm tube, moving on high quality bearings. But "at 237mm", "8mm longer" than many others Owen Clingan says, making turntable dimensions important.**

distortion harmonics" you refer to, because these frequencies have been relatively 'amplified' to a huge degree when pressed to vinyl.

So, yes, I can understand this contributing to that sense of space and depth indeed. However, if it was groove noise, then surely most vinyl pressings would possess that illusory magic? The notion also suggests that all a producer has to do is equalize for vinyl, and the rest will take care of itself. I'd suggest mastering for vinyl is needed too.

To be fair I see this more and more. On the other hand, there are lots of 'EU public domain pressings' of great recordings that have gone out of copyright, and the vinyl appears to have been mastered from a basic, I am presuming CD, digital source. The couple I have bought sound small scale, flat and lifeless. Now I check carefully before buying. I've just this minute replayed one of these horrors against the excellent 60s original to remind myself how dreadful it is. The answer is astonishingly, disgracefully, "there should be a law against it", dreadful.

Instead there is a law for it. The company behind this particular pressing is called Saga, "specially selected by" a major national retailer. To add salt to the wounds it has a copyright notice on the sleeve, and prohibits copying under EU law! Perhaps Saga think that pressing to LP will result in "a sense of size, scale and stage depth" not present on whatever they used as a master, and can flog'em on that basis? It has 'remastered' on the label as well. Let's not give'em the tiniest chink of an excuse.

I think that you are onto something though with RIAA, and it is fascinating. I've often wondered about the compression / decompression effect of vinyl replay, and those 'electromagnetic converters'!

I wonder if it might be possible to measure comparative sources a little like you measure equipment (e.g.: original recording vs recent digital remaster vs audiophile analogue vs other)?

I wonder what 'information' exists in the background in these older recordings, and is then amplified with the RIAA effect (if it is). I wonder if there might not be lessons there for modern recordings. Record and keep background low level noise. I wonder if analogue to digital converters have a problem recording ambience, in the same way I understand DAC's

seem to have trouble converting low level signals back, or if analogue tape/LP compression somehow absorbs and amplifies them. I do wonder about such things. So there are a few other advantages to LP playback that spring to mind.

It handles silence much better (because there is always a level of noise). It's compressed, and it has much lower dynamic range than digital. If you think about it, natural sounds as we hear them never, ever emanate from total silence. Digital silence on a phone speaking with someone is eerie, because it's silent ... "are you still there, yes, ok, let's carry on"...

With analogue compression we can get 'punch', and the perception of dynamics without blowing our heads off after quiet bits... I listen to high resolution digital too, and being blown away can be mightily impressive, but strengths can be weaknesses and vice versa.

Here is a wonderful example of digital mastering exploiting the dynamic range of digital: This is "Modern Times" by Bob Dylan. Track

2 is a quite beautiful love song and called "Spirit on the Water". This track on LP has a disconcerting effect of asking me to 'listen for more' ... but the information just isn't there. The CD does not have this problem, the ESS Sabre DAC seems to play back 102% of the information. The LP is almost gasping for air, instead of providing it.

What is the point of

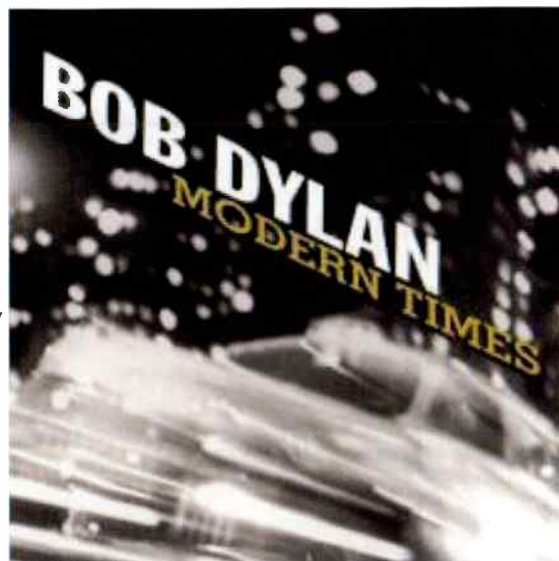

**Modern Times by Bob Dylan. "The ESS Sabre DAC seems to play back 102% of the information. The LP is almost gasping for air" says Simon Meneely.**

dynamic range if music is mastered like this? Maybe good for listening while mowing the lawn, or in Piccadilly Circus. I have many modern recordings where the LP sounds remarkably like the 24 bit original. Sometimes it can't match the dynamics. I have 24 bit recordings that show massive scale.

The LP's "special something" still seems to require special ingredients. Recording in analogue often seems to help digital mastering because it isn't having to handle silence. These recordings can let LP do its thing too. Maybe the latest Analogue to Digital Converters will do the same - a number of more recent recordings I have bought are suggesting this.



Dynamic Range Day

What is the Loudness War ?



The so-called "Loudness War" is entirely based on a modern myth - a fairy-tale full of nonsense that has somehow hypnotised the entire music industry for the last ten years - and is permanently damaging the music we listen to as a result.

**The subject of Dynamic Range in music programme is a big one, well covered on this website. It's easy to measure peaks, but difficult to ascertain minimum level.**

I understand most vinyl today is pressed with digital lathes, so the contradictions are rife. I'd love a repeat investigation of this too. Is this more mechanical type of digital conversion different?

So what are the magic ingredients? RIAA may hold the answer ... I just don't see how it can be groove noise, unless the noise is related to the source recording, but finding out if or how the latter was indeed the case, would be magical indeed.

Where I am at least, a summer walk is different to a winter one. In summer there is a quiet thrum of life in the background. Let's hear it for the noise.

**Simon Meneely**

Hi Simon. It being a column I was generalising about thoughts on my mind. Go to a hi-fi show and listen to analogue master tape, from which all LPs (except Direct Cuts) derive. Apart from its smooth natural character it quite obviously isn't LP. If LP derives from it then the sound is arguably not correct, if lovely all the same. And by "noise" I meant low frequency noise which is different from that grainy stuff our attention is drawn to because our ears peak at 7kHz. But I cannot be adamant, it is conjecture, one I make after hearing a silent groove (rumble test) LP via a flat preamp, as well as music – not nice at all. But an interesting experience.

Early digital recordings slaughtered music – a pet topic of mine. I recall hearing a classical performance that was bathed in a sea of distortion that seemed to ebb and flow: it was a strange experience. Much like yours with that Saga recording. It is difficult to know the provenance of recordings unless they come from a company like Chasing the Dragon, whose recordings are a sonic salvation. On which note their album Big Band Spectacular has both a direct cut and master tape transcription and – shame – I prefer the latter! It's slightly silkier, which seems to contradict everything.

I take your point about there always being background noise in real life: pure silence barely exists. But the ear/brain are able to interpret different types of "noise" – meaning background sound – with extraordinary ability and place it in context. Go to [dynamicrangeday.co.uk](http://dynamicrangeday.co.uk) for more

on the topic, and check out Loudness War in a Google search. This is a much debated hot technical topic.

It's possible to measure music quality from disc, but only in limited fashion. For example it isn't possible to measure distortion in a changing music signal, this measurement requires a steady sinusoidal tone. It is possible to measure bandwidth and spectral content averaged over time, both of which give useful info. There are Dynamic Range measuring tools for music, one being DRoffline that I have used to good effect when judging whether CDs are fit for product review purposes.

But these figures, whilst hard to gather, don't fully and completely represent the quality of what we perceive I feel.

"Noise" may not be a problem, that depends on what we mean by the simple term "noise". It gets complicated here. **NK**

### FIXING A CHORALE

I wonder if you could advise please. I have a pair of Monitor Audio RX1s which I find are great monitor speakers, ideal for my small man-cave of 14 x 7.6. In mounting them on wall brackets I was lucky to find some useful room nodes which allowed significant bass extension. The

## BIG BAND SPECTACULAR!

Unique Audiophile Double Album



### The Syd Lawrence Orchestra

Glenn Miller • Benny Goodman • Artie Shaw

Disc One - Live Studio Session Directly Cut To Vinyl

Disc Two - Same Session Via 24 Track Mixdown To H\* Tape © 30 ips

DVD - A Behind The Scenes Look At How The Albums Were Created

A Unique Opportunity to Compare The Sound of a Direct Cut Disc to an Analogue Tape



**Big Band Spectacular, by the Syd Lawrence Orchestra. This superb live direct-to-disc recording also comes with master tape transcription so the two can be compared. They sound obviously different.**

rest of my system is based round a 1979 Trio receiver, the KR9600 with 150W of MOSFET power. Sources are Naim CD5 and Flatcap, SL1210mk2 turntable with AT95SH Shibata tipped MM cartridge, and JVC cassette deck.

I enjoy a clear, warm sound with image more behind the speakers rather than invading the listening space because sat in the middle of the group I am listening to seems totally unrealistic. Music tastes vary between, rock, folk, classical, with occasional oddballs. If pressured, I would choose emotion over accuracy.

My problem is the RX1 metallic tweeter. When I bought these speakers around 6 years ago, they brought some much-needed clarity which was lacking from my old faithful home-made KEF Chorales (1973).



**KEF Chorales that Andy Entwistle built from a kit in 1973. How to upgrade its T27 tweeters?**

I am always impressed with the sound of the RX1s and they tick all but one box. As my ears have deteriorated, I have had to rely more and more on hearing aids. Brilliant though they are, my Oticon Synergy Senses are emphasising the metallic edged sound of the tweeters.

Having heard the Quad S2s at the Bristol Show a few years ago I started to consider these as replacement speakers as the ribbon tweeter was very impressive. However, since my brother bought a pair of S3s, I have found the bass from these to sound boxy. Maybe they were not fully warmed up?

From my description above I guess you would recommend listening to the Linton Heritage. Reports do seem to fit my needs. However, they are more than my preferred budget of

**The massive toroidal transformer inside Airlink's ASF3000MP balanced power supply, plus complex RF output filtering on a big circuit board.**

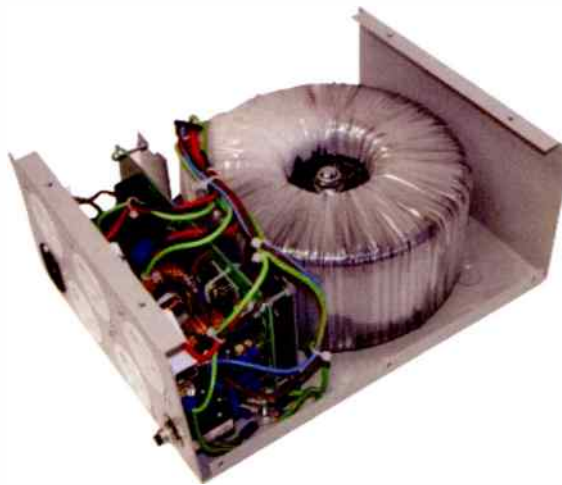

around £600-£700.

Having read David Tutt's column where he recommended tweeters to replace the T27s of my Chorales, an alternative could be a DIY approach. Soft domes like the drop-in replacement he recommended, the Morel Classic CAT 298 may be enough to meet my needs. I could also upgrade the crossovers with the Falcon 37K. My old woofers, the B200s were replaced with superior Coles B2000 some time ago (recommended by KEF engineers after they ran out of cones for the B200). I could manage this in stages. However, if the result is less than abilities of the RX1s I could have wasted £200. I would be grateful to hear what you think.

Kind regards,  
**Andy Entwistle**  
**Wiltshire**

Hi Andy. You could well try experimenting in this fashion but it is impossible for me to predict the

result. If the tweeter you choose is equally or more sensitive than the KEF T27 – likely since this is an old design – then all you need do is connect a resistor in series with it to reduce level to what suits you. For this buy ten 1Ω carbon film resistors (3W) and increase value progressively from 1Ω upward until you find the right value.

I suggest you contact Falcon Acoustics who are experts with all things KEF, past and present. They will have better knowledge than I of such a mod., T27 replacement being a common issue. **NK**

### GO FERRITE

In the article on the "RF Blocker" in the July issue, by Martin Pipe, he points out that results will "vary according to your individual circum-

stances" and this is undoubtedly true.

My system is modest and simple, comprising a Naim Uniti and an Innuos ZENith MkII, so there isn't much in the way of significant upgrade available to me apart from trying to make sure that the mains supply is as clean as possible. To this end I have a 1.5kW Airlink balanced transformer, fed via an MCRU "DC Blocker" and a Russ Andrews "Ultra Purifier". Russ Andrews "Zapperators" are fitted to the output terminals of the Uniti to reduce incoming RF noise.

On an individual basis, it is difficult to say whether this work has had much impact but, as a whole, bass is firmer and the soundstage wider than it once was.

There didn't seem much more I could easily do but, over time, I have gradually fitted ferrite rings across the system, from the incoming tails on the electricity meter, to all mains leads, especially on the hi-fi and those associated with dimmers or LED lamps.

The sum of the whole is that when I play familiar recordings I now have more fine detail. At what point it actually came about I will never know, it sort of crept up on me. In particular I have a number of Alan Parsons and Dire Straits albums where voices in particular seem to have gained more detail.

So, my advice would be, if you do something to "improve" your sound, and it doesn't appear to make an immediate difference, don't just remove it and look elsewhere. Look on it as a stepping stone that might enable the next upgrade, however small, to make a difference, and you might be amazed.

Regards,  
**Dennis Holliday**  
**Sevenoaks**  
**Kent**

Hi Dennis. Thanks for your experiences on this mysterious subject. I'll note that Airlink have a balanced transformer with RF output filters that readers may be interested in, our picture showing the large ASF3000MP (£999) for illustrative purposes. Airlink have videos explaining the issues, and provide extensive technical notes on their website – well worth reading. Generally, 1.5kW will do for most systems.

I call it "mysterious" by the way because it is difficult to know the intrinsic cleanliness of a supply, but my experience is that a balanced transformer improves sound quality noticeably. **NK**

### THOUGHTS ON REVERB

In July's Hi-Fi World Noel Keywood touches a couple of times on a subject that got me thinking. That of Reverb. The first mention comes in his review of KEF's Reference 1 Meta loudspeakers, which he says provided a 'convincingly correct' sound.

Noel reports Antonio Forcione's guitar strings in Tears of Joy as being 'silky clear and easy on the ear', with a 'great insight into the performance, well rendered background reverb bringing in a sense of life'.

Reverb is so important in recorded sound. Anyone playing the electric guitar will know the big difference between the dry sound and the same with a touch of reverb added. Yes, that brings a sense of life too. Quite likely guitar amps will use spring reverb, and have one knob for adjustment (too many controls and people spend too much time listening



**Leak Troughline valve tuner. "Neville Roberts reported being able to tell where a performance was coming from by the background acoustic" says Melvyn Dover.**

to the effect rather than the music). Add too much, so that the amp uses mainly reverbed signal, and the result is a mishmash of metallic and cabinet sounds.

It seems to me reverb is something which is taken away and then added, or at least used. Manufacturers test and measure loudspeakers in an anechoic chamber. We all know the listening room has a big effect on the resulting sound. Reverb is part of the overall broadcast acoustic and purists find it fine to hear as long as it's part of the original recording. An experienced radio listener provided with a good quality recording can identify where a piece of classical music is coming from by the acoustic. If I remember rightly, back in 2012 in his articles on modifications to the Leak Trough-line FM tuner Neville Roberts reported being able to tell which performance was coming from by the background acoustic.

Home listening deadens reverb - carpets and curtains for a start - but it's still there. Louder volumes must alter the amount that reaches the ears. Yet having a reverb knob on a hi-fi amp is a definite no-no. But would it be an advantage? Adding reverb to the recorded reverb? The home listening room must do that to some extent anyway, even if it's reduced to a convincing level by room furnishings.

Noel refers to reverb a further time in the same magazine when he talks about RIAA equalisation, and

part of its 'psycho-acoustic' effect having 'strong low frequency reverb content'. Reverb applied to only certain frequencies? More food for thought.

Best wishes,  
**Melvyn Dover**

Hi Melvyn. Reverb is commonly added to recordings in the mixing stage to bring in a sense of a natural acoustic, one with depth, so it is indeed a crucial component to music. And the dear old Leak Troughline was a wonder in exactly this respect, live studio speech in particular a "being there"

experience. What a shame the days of VHF/FM are numbered. **NK**

### RADIO LUXEMBOURG

I did find Paul Rigby's thoughts through his opinion statement (Aug'22) to be very stimulating. Which basically refers to ones biased opinions. Which is human nature. This happens to us all from an early age, starting with those of our parentage. In the sphere of the way we can listen to music, which for some, actually the vast majority, are happy to listen through their phones, radios and bluetooth speakers.

I remember as a child (60's), the utter joy I achieved by listening to Radio Luxembourg through a tiny solid state tranny, mono, one ear headphone. I was very happy with that. Over the years, I have invested in the world of High Fidelity, my serious listening being many CDs, FM radio and vinyl.

As Paul rightly points out, these formats are only a way of holding data/information and the way of releasing that can be complex and again for some, a very expensive task. But, as my previous memory showed, the same joy needn't be ignored.

I do not wish to impose my biased view of formats which are only a facsimile of that stored data. I'm in total agreement, I also believe 'ears' are the finest measuring devices. Even though one of them now, is only running on 40%. So, look after them... they're great devices, and free to almost all. Enjoy, while you can....

Many Thanks  
**Ashley Trafford,  
Winchester**

### TUNE IN TO THE FASCINATING HISTORY OF RADIO LUXEMBOURG



**I remember the utter joy I achieved by listening to Radio Luxembourg" says Ashley Trafford.**

# SPRING INTO SUMMER

VISIT OUR WEBSITE: [www.hi-fiworld.co.uk](http://www.hi-fiworld.co.uk)

**A SUBSCRIPTION TO HI-FI WORLD  
MAKES THE PERFECT GIFT FOR  
YOUR NEAREST AND DEAREST.**

**SAVE**

...up to

**20%**

Subscribe today and you will get a special discounted rate giving a **saving of 10% to 20%** off the cover price. That's an amazing **£4.50 - £4.00** per issue including postage.



***So don't delay, take out a subscription today!***

FOR BACK ISSUES ENQUIRIES PLEASE CALL

**01442 820580**

OVERSEAS SUBSCRIPTIONS IF YOU LIVE OUTSIDE THE UK,  
PLEASE CALL FOR OUR LATEST PRICES

**+44 (0) 1442 820580**

**SO WHAT ARE YOU WAITING FOR? CALL NOW!!!  
SUBSCRIPTION HOTLINE 01442 820 580**

Lines open Mon-Fri 9.00-5.00 or (weekend answering service available)

FOR OUR  
ON-LINE MAGAZINE  
GO TO [WWW.HI-FIWORLD.CO.UK](http://WWW.HI-FIWORLD.CO.UK)

email:  
[hifiworld@webscribe.co.uk](mailto:hifiworld@webscribe.co.uk)

# WITH HI-FI WORLD

## WHY SUBSCRIBE TO HI-FI WORLD?

- 12 issues a year delivered straight to your door.
- Be first to grab a bargain in our "Free Reader Classified Ads" section.
- Run by dedicated hi-fi engineers and enthusiasts.
- Hi-Fi World has become famous for its informative reviews and radical kit designs.
- PLUS!** Subscribe by Direct Debit and receive a 20% discount on a yearly subscription (UK only).

### Instruction to your Bank or Building Society to pay by Direct Debit



Please fill in this form and send to:

Hi-Fi World, Subscriptions Department Unit 4 College Road, Business Park, College Road North, Aston Clinton HP22 5EZ

Originator's Identification Number

2	8	7	7	8	9
---	---	---	---	---	---

#### Name and full Postal Address of your Bank/Building Society

To: The Manager	Bank/Building Society
Address	
Postcode	

Name(s) of Account Holder(s)

Branch Sort Code

--	--	--	--	--	--

Bank/Building Society Account Number

--	--	--	--	--	--	--	--	--	--

Reference

HF

#### Instruction to your Bank or Building Society

Please pay Webscribe Ltd Direct Debits from the account in this Instruction subject to the safeguards assured by the Direct Debit Guarantee. I understand that this instruction may remain with Webscribe Ltd and, if so, details will be passed electronically to my Bank/Building Society.

Signature(s)

Dale

Bank and Building Societies may not accept Direct Debits Instructions for some types of accounts  
**The guarantee should be detached and retained by the Payer**

#### The Direct Debit Guarantee

- This Guarantee is offered by all banks and building societies that accept instructions to pay Direct Debits
- If there are any changes to the amount, date or frequency of your Direct Debit Webscribe Ltd will notify you 10 working days in advance of your account being debited or as otherwise agreed. If you request Webscribe Ltd to collect a payment, confirmation of the amount and date will be given to you at the time of the request
- If an error is made in the payment of your Direct Debit by Webscribe Ltd or your bank or building society you are entitled to a full and immediate refund of the amount paid from your bank or building society
- If you receive a refund you are not entitled to, you must pay it back when Webscribe Ltd asks you to
- You can cancel a Direct Debit at any time by simply contacting your bank or building society. Written confirmation may be required. Please also notify us.



### 6 monthly Direct Debit:

Pay 27.00 every 6 months saving 10% off the yearly subscription rate of £60.00

### Annual Direct Debit:

Pay £48.00 every 12 months saving 20% off the yearly subscription rate of £60.00

### Annual payment by debit/credit card:

Pay £54.00 saving 10% off the yearly subscription rate of £60.00

### Your Details

Title \_\_\_\_\_ Forename \_\_\_\_\_

Surname \_\_\_\_\_

Address \_\_\_\_\_

Post Code \_\_\_\_\_

Daytime Tel: \_\_\_\_\_

Email: \_\_\_\_\_

Please debit my  VISA  MASTER  MAESTRO  AMEX (SWITCH)

Security No:    (last three digits printed on the signature strip)

--	--	--	--	--	--	--	--	--	--	--	--	--	--	--	--	--	--	--	--

Valid from Date: \_\_\_\_/\_\_\_\_/\_\_\_\_ Expiry Date: \_\_\_\_/\_\_\_\_/\_\_\_\_

Switch card issue No:

Cardholder Signature: \_\_\_\_\_

#### Outside UK:-

EUROPE Airmail **£60.00**   
 OVERSEAS Airmail **£80.00**



**TERMS & CONDITIONS:** You will receive 12 issues per year. Minimum subscription term is 12 months. Prices include P&P and are correct at the time of going to press. All prices are quoted in sterling. Offer available for UK subscribers, only. For enquiries relating to overseas pricing call + 44 (0) 1442 820 580.

## Send this form to:

Hi-Fi World, Subscriptions Department Unit 4 College Road, Business Park, College Road North, Aston Clinton HP22 5EZ

# The North West



Increasingly popular is Britain's North West Audio Show, held at spacious De Vere Cranage Hall in Cheshire, one of England's northern counties where specialist audio remains popular amongst UK audiophiles. This was the 7th year for the show organised by Kris Sawicki. Set in lovely countryside, it attracts UK manufacturers and now plenty from overseas as well, happy to attend a busy, friendly but less hectic show. With free entrance and a glass of bubbly for visitors, a great atmosphere packed with major brands – a show to look out for.

We were there over the weekend of 18th-19th July 2022 and bring you some of the highlights.





# Audio Show



*KEF Blade loudspeakers were sounding good in the KEF room – in the background here are their new LS60 Wireless Blades.*

## YOU REALLY MUST HEAR THIS



*A Bergmann Magne air-bearing, parallel tracking turntable looking dramatic in the Doug Brady room. It uses an air-pump to float the arm freely on a bed of air so it can track inward unimpeded.*



*An exotic selection of top Ortofon SPU moving coil cartridges from Ammonite Audio with Glanz tone arm able to cope with their weight. Prices reduced for show goes too.*





**HI-FI WORLD**  
"OUTSTANDING-  
Amongst the best!"  
August 2019

**Hi-Fi Choice**  
RECOMMENDED

**Hi Fi World**  
"Best Valve  
Amplifier"  
NEW Stereo 40 MK IV £2699

New Upgraded Model. Now With Headphone Socket

**HI-FI WORLD**  
"Well Made  
Loud Sounding"

See us at  
North  
West  
Audio  
Show  
De Vere Cranage Estate  
18 - 19 June 2022  
audioshow.co.uk

2021  
PRODUCT  
OF THE  
YEAR

designed by  
*David Shaw*

**Bluetooth**  
Option Available

LA4 MK III £1799

Versatile line stage pre-amplifier to match valve or solid state power amplifiers.

*Innovative Designs  
From Icon Audio*

**Hi-Fi World**  
"OUTSTANDING-  
Amongst the best!"  
March 2019

**Hi-Fi World**  
"OUTSTANDING  
PRODUCT"

See our full range of  
Loudspeakers  
Amplifiers  
Pre-amplifiers  
Phono stages at:  
iconaudio.com

60 + 60 Watts Triode  
115 + 115 Watts UL  
Tung Sol KT150/170  
£4699

MB90 MK II Monoblock Power Amplifiers many features

**HI-FI WORLD**  
"OUTSTANDING-  
Amongst the best!"  
March 2019

**Hi-Fi World**  
"OUTSTANDING  
PRODUCT"

Stereo 300 MK II £4399

Sublime Sound From Vintage 300B Triodes

**Bluetooth**  
Option Available

**HI-FI WORLD**  
"OUTSTANDING-  
Amongst the best!"  
August 2019

Stereo 25 MKII from £1599

Simplified ST40 30W UL, HQ Headphone Socket

**Hi Fi World**  
"Best Valve  
Amplifier"

**HI-FI WORLD**  
"OUTSTANDING-  
Amongst the best!"  
August 2019

Stereo 30se £2699

Single Ended Pure Class A, 28W UL, 18w Triode

**HI-FI WORLD**  
"OUTSTANDING-  
Amongst the best!"  
August 2019

**Hi-Fi World**  
"OUTSTANDING  
PRODUCT"

PS1 MKII MM/MC £1749

Our fantastic value pure valve phono stage. MC and MM

**Hi-Fi Choice**  
RECOMMENDED

PS3 MKII MC/MM £2999

Pure Valve Phono Pre-amplification At Its Best!

**HI-FI WORLD**  
"OUTSTANDING-  
Amongst the best!"  
August 2019

**Bluetooth**  
Option Available

HP8 MKII £999

Smooth non-fatiguing Triode Sound, Match 8-600 Ohms

**Hi-Fi World**  
"OUTSTANDING  
PRODUCT"

**HI-FI WORLD**  
"OUTSTANDING-  
Amongst the best!"  
August 2019

NEW ST 60 MK IV £4199

Outstanding Performance 80w UL, 50w Triode

**STOCK CLEARANCE LIMITED OFFER**

**FREE FLOOR STANDING LOUDSPEAKERS WITH THESE AMPLIFIERS\***

Buy any of the integrated or power amplifiers in this advertisement and get a pair of our superb MFV 3 floor standing speakers normally £1,295 free of charge!  
Or upgrade to the MFV 3 Super with real cherry or walnut veneer for only £250.

\*See our website or contact us for more information. Ts & Cs: Excludes other offers, while stocks last, excludes delivery charge  
We often have brand new "B Grade" models discounted due to small cosmetic marks. Contact us or see our website for information





*Nagra of Switzerland were showing a classic system complete with small illuminated meters, a trademark of their style.*



*For great sound quality at a show get an open-reel recorder, like the Teac seen here at left. It was providing music to an array of Audio Detail valve amplifiers.*



*Vertere's MG-1 MkII Magic Groove turntable (or record player as the company call it) was looking good, fitted here with their own arm and cartridge.*



*Brook Audio were using a pair of KerrAcoustic K100 mk.2 with 3in dome midrange and ribbon tweeter. These monsters weigh 78kg each, price £19k+.*

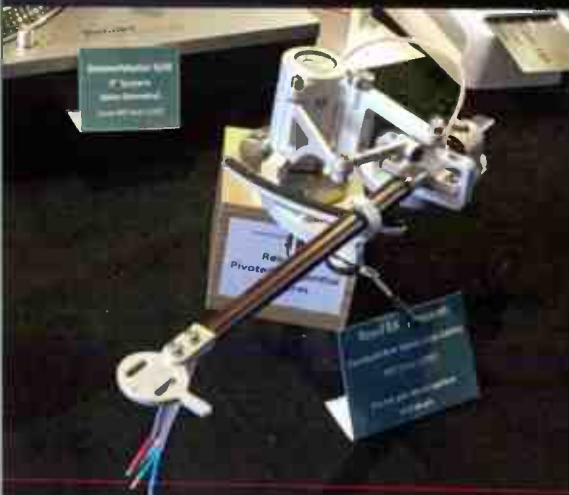

*The fascinating Reed 5A tangential tone arm, for which there's an interesting YouTube video to explain its complex geometry. Price £6950.*



*Lowther's new Almira loud-speaker (£20k) with its quarter wave Voigt horn at left, with the larger TP2 (£17k) folded corner horn at right. Traditional and impressive.*



©

A  
BA

# Power Balance

A balanced mains transformer from Connected-Fidelity is plugged in by Noel Keywood.



**T**here are so many ways to 'improve' the mains, all quite different. Here's one of them – a balanced mains transformer – an AC-2K from Connected-Fidelity, the price of our version a substantial £2890, but there is a model at £1995. That's way more than the £500 or so Airlink Transformers charge for their seemingly similar models, so let's look at all this. And the subject in general.

Before I get to details of Connected-Fidelity's AC-2K, here's what it does. Inside lies a very large (and heavy) transformer that splits incoming 240V mains from a wall socket into two 120V supplies relative to earth. The hi-fi still sees 240V but there are now two power lines and ground leakage noise currents cancel, something I have confirmed with a spectrum analyser. It's seemingly not a huge gain (leakage currents are small), yet with high quality DACs in particular, stray noise currents can wreck performance, which is why isolating transformers are now being used to provide galvanic isolation on digital inputs. Yep, transformers again.

Providing a balanced mains supply also makes equipment less potentially dangerous, important in busy recording studios where electrocution isn't unknown, and also on building sites where water is present. Most homes are less hazardous; it's the reduction in mains noise that is a benefit.

Long power lines far from power stations are likely to be noisy, especially when loaded by industrial / agricultural equipment. If you live close to a power station, as I do (St John's Wood, London) noise will be lower. How to cope with such variance? Ask for a home demo. There will be benefit, but, by how much?



**A huge toroidal transformer dominates the internal space. It feeds a large contact breaker – the white box at bottom right. The transformer sits on an isolating plate to suppress vibration and noise into the chassis.**

plenty enough for even a large hi-fi, including valve amplifiers.

Circuit wise, there is an electronic soft-start on the primary line and an RCBO circuit breaker on the output to protect the transformer from overload. The transformer has an electrostatic screen, but there are no RFI suppression circuits to reduce differential mode noise. An external RFI filter would be needed for this.

The transformer is all but silent and it sits on a platform that isolates it from the case, so as not to transmit noise via this path. There is a voltage output display from the secondary and a single 13A output socket at rear, other socket types being available.

The case measures 186mm high, 230mm wide and 330mm deep, weight is a liftable 16kg and it feels pretty solid. There is a 10A 20mm primary fuse mounted

depends upon your locale.

Another undiscussed issue is that waveform clipping is used at power stations to stabilise mains voltage and this produces around 3% distortion of the waveform. It appears this is common practice across the UK and probably outside it too. A balanced supply will provide no benefit here, only a mains regenerator like Power Inspired's AG1500S can cure this problem. But there's mumbling about regenerators from amplifier manufacturers, who'd rather their wonders were connected directly to a power station, rather than a 1500W solid-state power amplifier



**At right a large 16A input socket that demands use of a special heavy duty lead. Above it lies the main power switch and at top right a smaller switch for the front panel voltage display.**



**Our review sample came with a 1.5m cable with Furutech 16A IEC C20 connector to match the AC-2K input socket and a heavy duty 13A UK plug with gold plated pins. Made by Chronos, it is an available option.**

(I see irony here), which is what regenerators sort-of are. A big transformer like that in the AC-2K provides a stiffer connection than a regenerator, also a simpler and potentially more reliable one.

The AC-2K has some unique features. Most surprisingly the whole unit is cryogenically treated, both iron core and copper wire windings. This affects the martensite within the transformer's steel lamination, improving its magnetic properties. The 2K bit means it can handle up to 2000 reactive Watts which is

internally, accessible through the removable top panel.

My local power station was having a good time during the review period: it was sunny and 28C outside so air-con free Londoners weren't using much of the stuff, the AC-2K hovering around 245V under test. Distortion+noise on incoming mains measured a fairly steady 3.8% and from the transformer 3.5% – so some slight reduction. My own balanced transformer, a huge beast I have been using

for 25 years, gave the same result. Which is why I say if you live close to a power station quantifiable differences are not great from any balanced transformer, but they do improve sound quality all the same.

**SOUND QUALITY**

I used the AC-2K with our basic review system comprising Martin Logan ESL-X electrostatic loudspeakers with their energising supplies running from it, as well as our PrimaLuna EVO300 Hybrid amplifier (MOSFET output/valve pre) and Oppo BDP-205D Universal player with ESS ES9038Pro DAC to play CD and hi-res from a USB connected MacBook Pro running from battery only. Plugging this little lot in showed no wilt in output volts; it supplied the current with ease.

Much like the transformer I usually use, the AC-2K smoothed and deepened the sound stage, putting space between instruments like the violins of the Trondheim soloists playing behind Marianne Thorsen as she worked her way through Mozart's Violin Concerto No 4 (24/96). The performance took on greater focus and insight, bringing a sense of stronger dynamic life. There was some extra verve to strings over my own transformer I felt. When Marianne Thorsen launched into her glorious solo it was a riveting experience: I could not be anything other than deeply impressed, held onto her glorious playing.

What I was not expecting – and that hit me straight away – was profound bass power and resolution. The opening bass line of Fleetwood Mac's Dreams (24/96) thundered through the room – where did that come from I wondered? PrimaLuna's big MOSFET power amplifier has prodigious bass power but it was muscled up and went deeper with the AC-2K. I was even getting rumbling subsonics from Antonio Forcione playing Tears of Joy (CD) – the body of his acoustic guitar throwing out lows I did not know were there. The opening up of the low end helped bring atmosphere and strength to performances generally.

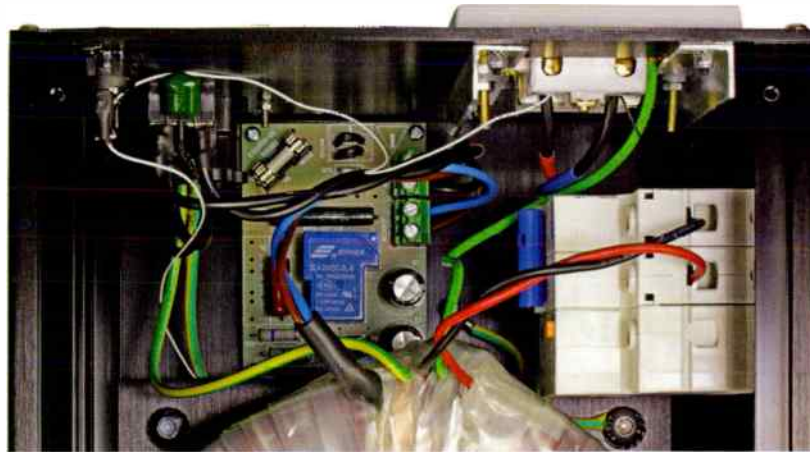

**A 10A input fuse (top left on the green circuit board) sits in the transformer's primary to provide extra protection. At top the single 13A output socket is for UK use; for overseas use alternative sockets are available.**

**CONCLUSION**

The AC-2K is a well built and finished unit, its voltage output display attractive too. With compact dimensions it can be easily accommodated and runs silent without consuming power

clean incoming supply was subtly wonderful. For this alone – its ability to make me want to listen – I have to give it full marks. For all those without a power station nearby, sound quality improvement should be even greater. Expensive

"The opening bass line of Fleetwood Mac's Dreams thundered through the room"

when switched on. So fit and forget. It's impact on sound quality even in my city location with a

I know, but worth checking out I'd suggest. It made listening a real pleasure.

**MEASURED PERFORMANCE**

Our mains waveform shot shows condition at time of test, but it's much like measurements we have made regularly for some years, being a 245V sinusoid peak clipped and triangulated. Total distortion and noise measured 3.8% incoming, and 3.5% out from the transformer, with dominant 5th harmonic at 250Hz, plus an array of higher harmonics up to 1kHz. Frequency 49.9-50.1Hz.

This is a common result for a clean urban supply. Long power supply lines from a distant power station will suffer higher levels of noise and distortion and are likely to benefit more from a balanced supply.

Transformers store large amounts of energy in their magnetic field and this additionally smooths current delivery and may explain improved bass resolution of the AC-2K. NK

**MAINS WAVE FORM**

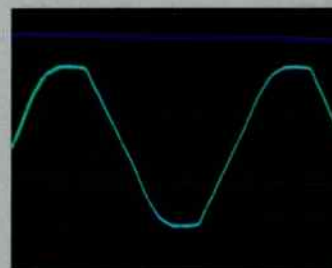

**DISTORTION**

THD at 0dB	Level 100dB	Frequency
3.5049 %	36.621 V	50.115 Hz
OFF	OFF	OFF

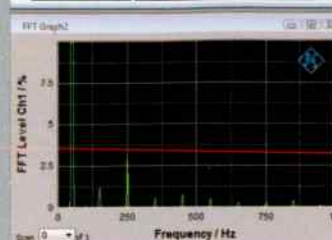

**CONNECTED FIDELITY AC-2K £2890**



**OUTSTANDING - amongst the best.**

**VERDICT**  
Subtle yet deep improvement to sound quality. Impressive.

**FOR**  
- improved resolution  
- deeper bass  
- stronger dynamics

**AGAINST**  
- expensive

Connected Fidelity  
+44 (0)1491 629629  
www.connected-fidelity.com



# WORLD STANDARDS

Your guide to the best products we've heard that are currently on sale in the UK...

## TURNTABLES

**AVID INGENIUM** £800  
Great bass response and upper midrange detail allied to clarity makes this a must-hear at its price-point.



**CLEARAUDIO INNOVATION** £6400  
Expensive, but offers great results from a finely honed and beautifully finished belt drive turntable, with servo control from the platter to keep a grip on tempo like few others. Can be fitted with a Clearaudio tangential arm, or any conventional design. Awesome.



**INSPIRE MONARCH** £4,350  
A rebuilt from the ground up Technics Direct Drive, having blistering pace and dynamics allied with smoothness, sophistication and purity of tone. A true reference.



**LINN LP12SE** £3,600  
The UK's most iconic turntable, the legendary Sondek goes from strength to strength. New Keel sub-chassis and Radical DC motor add precision and grip to one of the world's most musical disc spinners. Expensive though.

**MICHELL GYRO DEC** £1700  
Wonderful styling coupled with great build and finish make this turntable a delight for friends and family. It has an attractive clear acrylic dust cover, and you can mount just about any arm. A current design standard.



**PRO-JECT ESSENTIAL DIGITAL** £300  
A budget turntable that turns in a great analogue performance, but also has a hi-res digital output. Send 24/96 across your lounge via optical cable to a DAC and get great audio quality. Or record LP to your laptop.



**REGA RP3** £550  
The first of the super-quality Regas, little compromised by price and featuring Rega's outstanding RB303 tonearm, suitable for MM and MC cartridges. A standard at the price point.

**TIMESTEP EVO** £2100  
The famous Technics SL-1210 MkII Direct Drive but with improved plinth, isolation, main bearing and power supply, plus an SME arm (add £1500). DD convenience, rock steady pitch and fab sound at a great price. Our in-house reference.



## TO NEARMS

**ORIGIN LIVE ENCOUNTER MK3C** £1,745  
Origin Live combines carbon fibre and ebony to marvellous effect in its new 12-inch arm. Creamy and rich in presentation, the Encounter delves deep into the mix for a satisfying listen.

**HADCOCK GH-242 EXPORT** £810  
Consummately musical, lyrical sounding tonearm, but needs the right turntable.

**ORIGIN LIVE ONYX** £450  
Easy, smooth, creamy nature that reminds you why you're listening to vinyl in the first place. Essential audition at the price.



**REGA RB303** £300  
A one piece tapered casting makes this arm's structure almost unrivalled. Great dynamics and superb imaging, for MM and MC. Reference quality for peanuts.

**SME 312S** £1,600  
Twelve inch magnesium alloy tapered arm tube plus SME V bearings. An insightful yet smooth and relaxed sound. Superlative build completes the package. Our Editor's steed.



**SME 309** £1500  
A one-piece tapered 9in arm finished like a camera and slick to use. Superlative SME quality and sound at affordable price.

**SME V** £3000  
Offers rapid fire timing and a sense of precision, plus rock solid dynamics. Top dollar for deep pockets.

## CARTRIDGES

**AUDIO TECHNICA AT-OC9 MLIII MC** £420  
A fine sounding MC with strong bass and super fine treble from a great stylus – yet inexpensive.

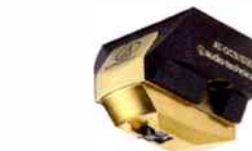

**AUDIO TECHNICA AT-F3/III MC** £150  
Great value entry level moving coil with detail and grip you just can't get from similarly priced moving magnets.

**BENZ MICRO ACE SL MC** £595  
Smooth, lucid and full-bodied, award-winning, hand-made cartridge from Switzerland.

**BENZ MICRO WOOD SL MC** £945  
Highly finished Swiss moving coil that plays music with riflebolt precision.

**DENON DL-103** £180  
A popular and much loved budget MC with big bass, smooth treble and deep sound stage. Fantastic value.





**LYRA TITAN I MC** £3,500  
 Breathtaking speed and dynamics from LP, helped by diamond coated, boron rod cantilever.



**ORTOFON 2M MONO SE MM** £80  
 A mono cartridge purposed for The Beatles in Mono microgroove LPs. Fitted with a top quality Shibata tip. Fab for the four.



**ORTOFON 2M BLACK MM** £400  
 As good as it gets from MM. Fabulous detail and insight from a Shibata stylus, good bass and excellent tracking.

**ORTOFON CADENZA BRONZE MC** £1,400  
 A mid-price MC with a slightly livelier presentation than the super smooth Cadenza Black. High-end sound at midband price – great value.



**ORTOFON CADENZA BLACK MC** £1,800  
 Ultra smooth and dimensional moving coil with bass and punch aplenty. Lovely stylus.

**ORTOFON A95 MC** £3,750  
 Fast and extremely detailed, this is an MC cartridge that sets standards.

**REGA CARBON MM** £35  
 Budget price for a competent cartridge with a fairly unflappable nature. Ideal for beginners.



**GOLDRING 1012GX MM** £250  
 A glorious sounding cartridge with solid bass and strong dynamic punch, plus excellent treble from its Fritz Geiger stylus. Fun and affordable.



**SHURE M97XE** £80  
 Big warm sound, but great tracking and bullet proof stylus protection from damped guard. A survivor.

**VAN DEN HUL DDT-II SPECIAL MC** £995  
 Long-established cartridge from Holland with an open and dynamic sound.

**PHONO PREAMPS**  
**CAMBRIDGE AUDIO 651P** £200  
 Clean, concise sound from MM and MC cartridges at a very low price. A real bargain.

**ICON AUDIO PS3 MKII** £2,500  
 All valve MM phono stage with MC transformer option, graced by big, spacious and relaxed sound.



**LUXMAN EQ-500 PHONOSTAGE** £4,495  
 A fully-equipped phono stage from Japanese manufacturer Luxman that offers comprehensive cartridge matching allied to superb sound.



**LEEMA ACOUSTICS ELEMENTS ULTRA** £1,199  
 Smooth and detailed sound with the ability to accommodate most modern cartridges. Exceptional value for money.



**PRO-JECT TUBE BOX DS** £425  
 Compact MM and MC phono stage with valve output circuit and a big sound.



**QUAD QC24P** £995  
 MM and MC, oodles of gain, a volume control – and valves! Looks superb and sounds even better: smooth, atmospheric and big bass.

**TIMESTEP T-01 MC** £995  
 New, minimalist phono stage that sonically punches well above its weight.

**PREAMPLIFIERS**  
**ICON AUDIO LA-4 MKIII** £1,400  
 Uses early 6SN7 triodes for liquid sound. Has plenty of gain and a remote control into the bargain.



**MF AUDIO CLASSIC SILVER** £4,500  
 One of the best preamplifiers we've heard at any price, this transformer-coupled marvel does very little wrong. It's powerful, clean and open, yet delicate. Its sound is unmatched at or near the price.

**MING DA MD7-SE** £1,520  
 A valve preamplifier with an open, effortless sound and a big soundstage. It has plenty of gain so will accept any source and drive any power amp. A real beauty.



**INTEGRATED AMPLIFIERS**  
**ARIAND PRO845SE** £1,499  
 Pure single-ended valve magic. Low-powered but immediately gorgeous, easy-going yet forcefully dynamic at the same time.



**AUDIO RESEARCH VS160** £3,500  
 Power house sound with enormous pace and punch from traditional U.S. muscle master Audio Research. Breathtaking, but expensive.



**CAMBRIDGE AUDIO AZUR 651A** £350  
 Dual-mono construction and meaty toroidal power supply combine to produce a solid and sharp sound with sonics far beyond its price point.

**CREEK EVOLUTION 100A** £1,500  
 Superb build and smooth confident sound make this powerful amplifier a benchmark.



**CYRUS 8DAC** £1,400  
 Trademark shoebox-sized Cyrus integrated now offering 88Watts per channel, plus DAC. Svelte delivery from a dainty case that fits in anywhere – and isn't Class D!

**EXPOSURE 1010** £495  
 Entry-level integrated from Exposure has excellent upper mid-performance with an almost valve-like sound.



**ICON AUDIO STEREO 60 MKII** £2,800  
Excellent tube integrated with plenty of power and an expansive soundstage, plus KT150 tube option and bias meter for easy adjustment.



**NAIM NAIT 5SI** £925  
Naim's fabled entry-level integrated amplifier is updated to si status. Demos Naim's superbly muscular sound at entry level.

**SUGDEN A21SE** £2,480  
Class A amp with fantastic sound quality producing hard, sculpted images, deep detail and tight bass. Just don't expect disco-like sound levels!



**POWER AMPLIFIERS**

**AUDIO RESEARCH VSI75** £7,498  
Powerful, fast valve sound that makes everything else look weak at times. Needs careful matching but well worth the effort.

**AUDIO RESEARCH VS115** £5,000  
Oodles of power with enormous punch. Rafael Todes said it provided "shock and awe" while retaining incredible smoothness and texture.

**ICON AUDIO MB845 MKII** £7,600  
With 120W from big 845 valves right down to low frequencies, this power amplifier has massive dynamics and bass swing, yet is easy on the ear.



**ICON AUDIO MB81PP** £15,000  
Big Russian transmitter valves deliver 200W from these massive monoblock amplifiers. Frightening in every sense.

**MCINTOSH MC-152** £4,995  
Stunningly insightful sound with enormous bass punch from a uniquely designed transistor amp. Amazing audio, a league up, if expensive.



**QUAD ELITE QMP MONOBLOCKS** £2400 PR  
The proverbial iron fist in a velvet glove. Plenty of power but delivered with an assured and confident nature. Smooth on top and easy on the ear but can rock out when needed.

**QUAD II-EIGHTY MONOBLOCKS** £6,000 PR  
Powerful and expansive sound from modern design monoblocks that also look lovely. Superb – used by us as a reference.



**LOUDSPEAKER FLOORSTANDER**

**B&W 803 D3** £12,500  
B&W's updated statement floorstanders deliver depth and definition with breathtaking speed and authority, aided by a diamond coated tweeter. Expensive – but enormously impressive.

**CASTLE AVON V** £1,600  
A big floorstander at a modest price that suits the average room. Refined ribbon treble and deep bass give it a great delivery.



**EMINENT TECHNOLOGY LFT-8B** £2,500  
Excellent U.S. planar magnetic loudspeaker at bargain price. Utterly superb - a must hear.

**EPOS K2** £1,000  
A fun sound that is tidy all round and very engaging, with solid bass. Music as you hope it to be.

**FOCAL ARIA 926** £1,400  
Simple, clean, neutral sound – easy going but well engineered and affordable.

**MARTIN LOGAN SUMMIT X** £16,698  
Matches Martin Logan's XStat electrostatic panel to a powerful subwoofer to provide extended, powerful bass. Dramatic sonic purity. Awesome – all but unmatched.



**MARTIN LOGAN ELECTROMOTION** £2,500  
Martin Logan's budget baby XStat hybrid electrostatic. Fits into any lounge to give electrostatic levels of clarity and imaging.



**QUADRAL CHROMIUM STYLE 8** £1,700  
A supremely smooth yet open sounding loudspeaker. Clean and detailed treble from a fine ribbon tweeter. Accurate yet informative and enjoyable. Pure class.

**QUADRAL ORKAN VIII AKTIVS** £6,200  
Active loudspeaker with tight, powerful bass, perfect accuracy and detailed treble from a ribbon tweeter.



**Q ACOUSTICS 2050I** £480  
A large floorstander at a budget price. Offers high sensitivity and big sound and has very few flaws for the price.

**SPENDOR SP100 R2** £6,495  
Retro looks but a sound that's hard to match. Spendor's 12" bass unit provides massive low-end grunt with a room-filling sound.



**SPENDOR A3** £1,300  
Fine little floorstander with a smooth, natural midband and even tonal balance. Ideal for smaller rooms.

**TANNOY DEFINITION DC10 TI** £6,000  
Enormous power with great projection. Glorious subsonics too. Need little power to go very loud and have superb finish into the bargain.



**TANNOY KENSINGTON** £9,950  
Big but not overpowering, punchy modern sound from classic cabinetry. Need little power to go very loud and suit a traditional home, or castle.



**LOUDSPEAKERS STANDMOUNT**

**ACOUSTIC ENERGY NEO 1 V2** £225  
Civilised sounding speaker with fast and tuneful bass.

**ACOUSTIC ENERGY AE1 CLASSIC** £845  
Brilliantly successful remake of an iconic design; not flawless, but surely one of the most musical loudspeakers ever made.



**ELAC BS243** £1,000  
More transparent and spacious than they've a right to be at this price, these refined mid-price standmounters represent top value.



**EMINENT TECHNOLOGY LFT-16A** £1,200  
U.S. planar magnetic bookshelf loudspeaker with unrivalled mid-band and treble. Hear it before all else.

**WHARFEDALE DIAMOND 220** £200  
Builds on the success of previous Diamond ranges with better bass, more detail and a greater sense of scale.



**KEF L550** £800  
Supremely musical mini-monitors which sound much bigger than they look.



**MARTIN LOGAN MOTION 35** £1,300  
Folded Air-Motion tweeter gives a taste of Martin Logan's electrostatic sound in a standmount. Different from the standard mini-monitor and all the better for it.



**PMC TWENTY.21** £1,575  
Transmission line loaded standmount with a big box sound from a compact cabinet. Punches well above its weight.



**Q ACOUSTICS 2020i** £165  
Great little bargain-priced stand-mounts with a friendly, fun yet surprisingly refined sound. Hard to better for a pair of starter loudspeakers.

**WHARFEDALE DENTON** £500  
A beguiling mixture of retro looks with modern, high-technology drive units. The Denton has an easy-going, big-hearted sound with a touch of trad warmth that should appeal to many.



## HEADPHONE AMPLIFIERS

**CREEK OBH11** £150  
Designed specifically for low to medium impedance (30 Ohm – 300 Ohm) headphones the little Creek has a marvelously well-judged sound

**CHORD MOJO** £399  
Class leading portable DAC and headphone amp with ability beyond all else. Big, open spacious sound.



**EIPHPHANY EHP-02** £99  
PP3 battery-powered portable gives great sound quality at an almost giveaway price. Happy with the output from an iPod or CD player, the little epiphany is a true bargain.



**ICON AUDIO HP8 MKII** £650  
The HP8 MKII valve-based headphone amplifier brings the spacious sound of valves to headphones. And it matches 'em all.



**FIDELITY AUDIO HPA 100** £350  
Great little headphone amplifier with a lively yet refined and open sound.

**MUSIC FIRST PHONE BOX** £276  
Brings a big stage, plenty of detail and rich, deep colours to the sonic spectrum.



**OPPO HA-2** £250  
Remarkable performance and sound from ESS Sabre32 DAC in a slim portable package.



## CD PLAYERS

**AUDIOLAB 8200CDQ** £949  
Inspired CD player and DAC with price-performance ratio like no other. Capable of matching designs costing much more.



**CANOR CD2+** £3,100  
Musically coherent and tuneful valve-driven CD player from Slovakia. Lovely liquid sound.



**CAMBRIDGE AUDIO AZUR 651C** £410  
Snappy modern presentation from this budget CD player. Cracking audiophile entry point for any digital fan.

**CHORD RED REFERENCE MKIII** £16,000  
A unique and massive engineering exercise that could well be the best CD player available. Chord's Pulse Array DAC technology produces a musical experience like few others. A true reference player.



**ESOTERIC K-03** £9,495  
Superb high-end silver disc spinner that is beyond criticism. Devoid of its own character but has a flawless presentation.



**EXPOSURE 101** £395  
Detailed player with fine sense of timing should be an automatic entry on any demo list at this price.

**ELECTROCOMPANET EMP-1/S £4,650**

Epic in scale, lavish in tone and exuberant in its musicality - this is a memorable SACD spinner. Quirky in operation and modest in finish, though.



**OPPO BDP-105D £1200**

Universal player and DAC that makes CD and Blu-ray (+DVD) sound deep, spacious and full bodied. Reference quality that's affordable.



**REGA APOLLO-R £550**

Rega comes up with a fine CD player again. Tremendous detail and an easy, unforced sound at all times. Few bells and whistles but made up for by its superb sonic ability.

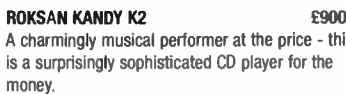

**ROKSAN KANDY K2 £900**

A charmingly musical performer at the price - this is a surprisingly sophisticated CD player for the money.



**TUNERS**

**CAMBRIDGE AUDIO AZUR 651T £299**

Value-packed AM/FM/DAB and DAB+ ready tuner. Precise and detailed with excellent resolution of spoken word.



**CREEK DESTINY 2 £550**

Creek's tuner expertise shines through in the Destiny 2. This AM/FM receiver is wonderfully three-dimensional and smooth.



**MAGNUM DYNALAB MD-90T £1,900**

Exceptionally able, but commensurately priced, audiophile tuner that cannot fail to charm.



**DACS**

**AUDIOLAB M-DAC £600**

Excellent sound from ESS Sabre32 DAC and impressive flexibility with a unique range of filter options make this a stand-out product. Low price is the icing on the cake.



**AUDIOLAB Q-DAC £250**

Stripped-down version of Audiolab's M-DAC loses some features but retains much of the sound, making it a veritable bargain.

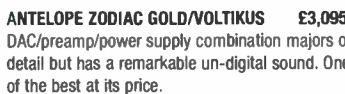

**ANTELOPE ZODIAC GOLD/VOLTIKUS £3,095**

DAC/preamp/power supply combination majors on detail but has a remarkable un-digital sound. One of the best at its price.



**CHORD 2QUTE HD £990**

Superb build quality and exceptional sound from this compact unit. Boasts the ability to handle DSD direct via USB and has an exceptional soundstage. One of the best DACs you can buy.



**DCS DEBUSSY £8,000**

DCS's bespoke 'Ring DAC' circuit gives a beautifully-fluid, almost analogue sound that encourages long listening sessions. Not cheap but worth every penny.



**NORTHERN FIDELITY DAC £650**

Packed full of features, including Bluetooth and USB, this ESS Sabre32 equipped DAC offers crisp, insightful sound at low price.



**METRUM OCTAVE £729**

Unique two-box digital-to-analogue converter with great sound at a great price. Cuts upper treble, though.



**NAIM DAC £2,400**

Superb high-end digital converter with a probing, punchy and forensically-detailed sound.



**TEAC UD-501 £699**

Feature-packed DAC with benefit of DSD playback. Superb sound means little to touch it at the price.



**RESONESSENCE INVICTA MIRUS £4,499**

One of the most highly spec'd DACs available, with a smooth yet enthralling presentation. Few approach it.



**NETWORK PLAYERS**

**CHORD DSX100 £7,500**

Chord's proprietary DAC circuit shines in their top-of-the-range streamer. Near-through clarity with a sound rich in detail, dynamics and soundstage.



**CAMBRIDGE AUDIO NP30 £399**

Budget offering from Cambridge offers a great introduction to network streaming.

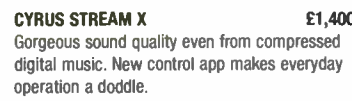

**CYRUS STREAM X £1,400**

Gorgeous sound quality even from compressed digital music. New control app makes everyday operation a doddle.



**CONVERT TECHNOLOGIES PLATO £2999.00**

A network player with amplifier that does it all, including turn LP to hi-resolution digital, and add cover artwork from the 'net.



**NAIM NDX £2,995**

Clean, incisive and very detailed sound with Naim's traditional pace and timing make this one of the best network music players around.

**NAIM ND5XS £2,175**

Great sound quality with traditional Naim heft. A wonderful DAC with full 24/192 handling. Only the display could be better.

**NAIM NAC-N172 XS** £1,650  
A pre-amp/DAC/streamer package provides a taught, rock-solid presentation with a tonally rich midband and a superior sense of rhythm.



**PRO-JECT STREAM BOX RS** £1,095  
Unusual valve-based streamer/preamp with variety of inputs and a lovely liquid sound. Not the most detailed but compensates with sheer musical verve.

**QUAD PLATINUM DMP** £2,500  
Combined CD/network player has all the usual Quad elements but with added zest and detail that brings life to everything you care to play.



**DIGITAL SOURCES**

**ASTELL&KERN AK100 MKII** £569  
Portable high-definition digital player with superb sound quality. Punchy and fast.



**FiO X3** £150  
Fabulous value player with nice easy sound and full range of abilities. Small and light. For newbies.

**LOT00 PAW GOLD** £1,500  
Reference quality sound; it's like carrying your hi-fi in your pocket. Equivalently large too, but stunning headphone quality.



**NAIM HDX** £4,405  
Interesting one-box network-enabled hard-disk music system that gives superb sonics together with impressive ease of use.

**NAIM UNITILITE** £1,995  
A 50W amplifier with traditional Naim heft, a CD player and vht/fm radio, plus network input and Bluetooth make this a great all-in-one.



**PORTABLE SPEAKERS**

**BAYAN SOUNBOOK** £149.99  
Superb design and great sound make for one of the best portable Bluetooth speaker/radios on the market. Not the cheapest – but worth every penny.

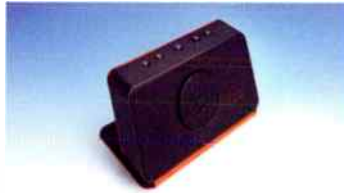

**IRIVER IBA-50** £69  
Big, warm sound with plenty of volume and clean at high levels. Muscular sound compared to many rivals.

**CABLES**

**BLACK RHODIUM TWIST** £71/3M  
Twisted to fight off radio frequency, the Black Rhodium speaker cable is easy on the ear with a fine sense of clarity and focus. A remarkable performer at the price.



**MAINS CABLES R US NO.27** £95  
Offers a sprightly pace with a precise nature. Fast performance enhance frequencies and beautifully etched detail.



**CHORD SIGNATURE REFERENCE** £900  
Majors on timing, detail and openness. Capable of getting the best from most systems and a recommended upgrade.



**TELLURIUM Q BLACK** 280/3M £804/M  
A deep, dark, velvety performer that's nevertheless highly musical, it represents excellent value as mid-price cables go.

**TELLURIUM Q SILVER OIAMOND** £804/M  
An open, natural and transparent sound that is difficult to beat, from these great loudspeaker cables.



**HEADPHONES**

**AUDEZE LCO-3** £1,725  
A planar magnetic 'phone that offers monitor quality. Strong sound with silky, dark quality that others struggle to match.



**B&W P3** £170  
Beautifully presented headphones from the loudspeaker specialists. Feed them a good quality source signal and they reward with excellent sound.

**JAYS V-JAYS** £49  
Wonderful little budget over-ear portable 'phones with a clean, clear sound to beat the best of the rest at the price.



**NOBLE K10 INC. FITTING** £1,279  
Custom fit in-ear phones with 10 drivers deliver a sound that is out of this world. Personal and perfect.



**OPPO PM-1** £950  
Planar magnetic phones with a warm, easy but big bodied sound that draws you in. Need a lot of drive, but deliver superb bass.



**SENNHEISER HD700** £599  
Tremendously fast with a strong, focussed, lower-frequency range and a firm bass punch.



**YAMAHA HPH-MT220** £150  
Purposed for indoor monitoring yet light and comfortable enough to be used on the move. Excellent sound quality marred only by a slight warmth to vocals.

# Sony TC-186SD Deck

**Martin Pipe re-acquaints himself with an old friend.**

**B**y the long hot summer of 1976, cassettes were no longer a sonic joke – thanks, most obviously, to chrome/pseudochrome (IEC 'Type II') tape formulations and the Dolby B noise-reduction system. Less obvious from the outside were refined mechanisms that improved tape-to-head contact and all but banished audible wow and flutter, together with advances in the heads themselves. Sound quality was by then, for most listeners, good enough to displace reel-to-reel as regards everyday recordings of radio programmes and LPs – furthermore, the cassette had none of its quarter-inch predecessor's 'lace-up' inconvenience. Although Sony's Walkman was still some years off, music centres – which added a cassette deck – were selling by the container load to aspirational families who wanted music reproduction of a reasonable standard.

Most of the cassette decks then available were flat top-loaders, operated by mechanisms with piano-key transport controls set into the facing edge of the cabinet – usually with headphone and microphone sockets on the narrow frontage too. The cassette compartment and other controls – recording-level knobs or sliders, with the associated backlit moving-coil meters nearby, plus Dolby and tape selection – tended to be built into the top panel alongside the cassette hatch. As these can be highly-effective dust-traps, it wasn't uncommon for manufacturers to supply a turntable-like smoked-plastic cover.

In the mid-70s, Aiwa and Technics were among the first manufacturers to solve such problems with more elegant front-loading cassette decks. These could be stacked with other gear – cassette deck at the bottom, amp on top and tuner in the middle. Eventually, such arrangements would go mass-market as the 'rack system', thereby spelling the end of the music-centre. This brings us neatly to the Sony TC-186SD (1976-79) featured here, which was sold as a wooden side-cheeked system with matching TA1630 amplifier and ST2950F tuner – an attractive proposition with brushed-aluminium frontages that gave them an expensive look.

The TA1630 is a budget integrated amp with a modest 22 watts per channel output (8 Ohms, 0.5% THD), a switchable presence midrange boost in addition to the usual loudness function, a phono stage that began to exploit the potential of the then-dominant playback medium and - unusual

for the price – provision for two recording decks (one of which plugged into a front-panel 6.35mm jack).

Equally-unusual was the radio's short-wave coverage – it could be continuously-tuned from the 16m band to the 49m band – of the ST2950F, a traditional 'scale and pointer' analogue design that also offered medium wave, long wave, and – to fulfil its hi-fi credentials - FM/VHF, with obligatory stereo decoder. Sony's advertising claimed the latter could "practically lift Broadcasting House into the sky and plonk it in your sitting room"!

I'm sure that the amp, tuner and complete systems sold well, but the undoubted star of that particular show was the TC-186SD cassette deck. Selling for approximately £110 it was the most affordable front-loading cassette deck from a named brand (Amstrad's heavily-advertised – and similarly-Dolbyed – 'Executive' 7070 could however have been yours for under £100 in 1977).



*The TC-186SD isn't suitable for recording onto metal (Type IV) tapes, although it will play them with the 'EQ' switch set to the 'CrO2' position. Also visible are the Dolby and limiter switches, concentric recording level controls and rarely-used mike inputs.*

# Cassette



However, the robustly-made Sony deck was extensively-featured. It's fitted with 'Ferrite and Ferrite' heads – Sony's answer to rival Akai's 'GX' technology, and considerably harder-wearing than the metal-faced heads fitted to the Amstrad.

Unusually for the time, Sony's record/play head has a parabolic profile for better low-frequency performance. Separate three-position bias and equalisation switches matched these proprietary heads to ferric (Type I), Type II or the short-lived hybrid ferrichrome (Type III) tapes you could buy at the time.

The instruction manual contains a table listing the permutations of switch positions needed to make the most of mid-'70s tapes including long-extinct formulations like Agfa Super HD, TDK SD and Scotch Classic. Others, like Maxell UD and TDK SA, persisted for somewhat longer. Next to these manly toggle switches are concentric controls

that adjust the recording levels, in conjunction with large and readable VU meters, and there's also a switchable limiter to tame unexpected 'bursts' that could cause oversaturation distortion. There's no multiplex filter, switched or otherwise, to prevent a badly-adjusted FM tuner's 19kHz and 38kHz multiplex residue from 'beating' audibly with the deck's bias/erase oscillator. But then again, the TC-186SD's choice of a high frequency (105kHz) for its oscillator means the respective beat frequencies would be 67kHz and 86kHz. These may be inaudible, but the intermodulation distortion that might result isn't; one hopes that the ST2950F has well-designed MPX filters on its outputs!

As with the aforementioned top-loaders, the TC-186SD has 6.35mm sockets for headphones and microphones. Its rear-panel line inputs can be changed between phono and DIN ('REC/PB') sockets by means of a slide switch. Plugging mikes into the front panel

mutes the inputs but only if that switch is in the DIN position, this inexpensive model lacking the ability to mix between the two.

The deck's all-mechanical transport has a simple 3-digit tape counter, and is fitted with a large belt-driven flywheel to keep wow and flutter to a theoretical minimum. Auto stop is offered in

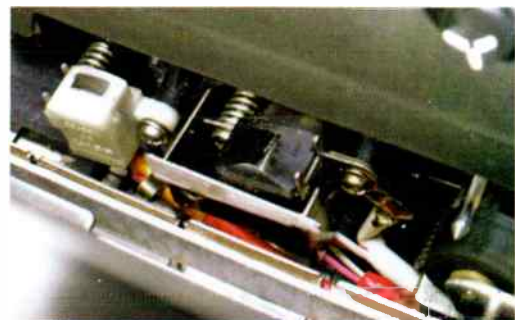

*Seen here is the record/playback head (centre) made of 'Ferrite and Ferrite', considerably harder-wearing than the soft mu-metal heads fitted to most '70s decks. At left in a white housing is the erase head, and at far right capstan and pinch roller.*

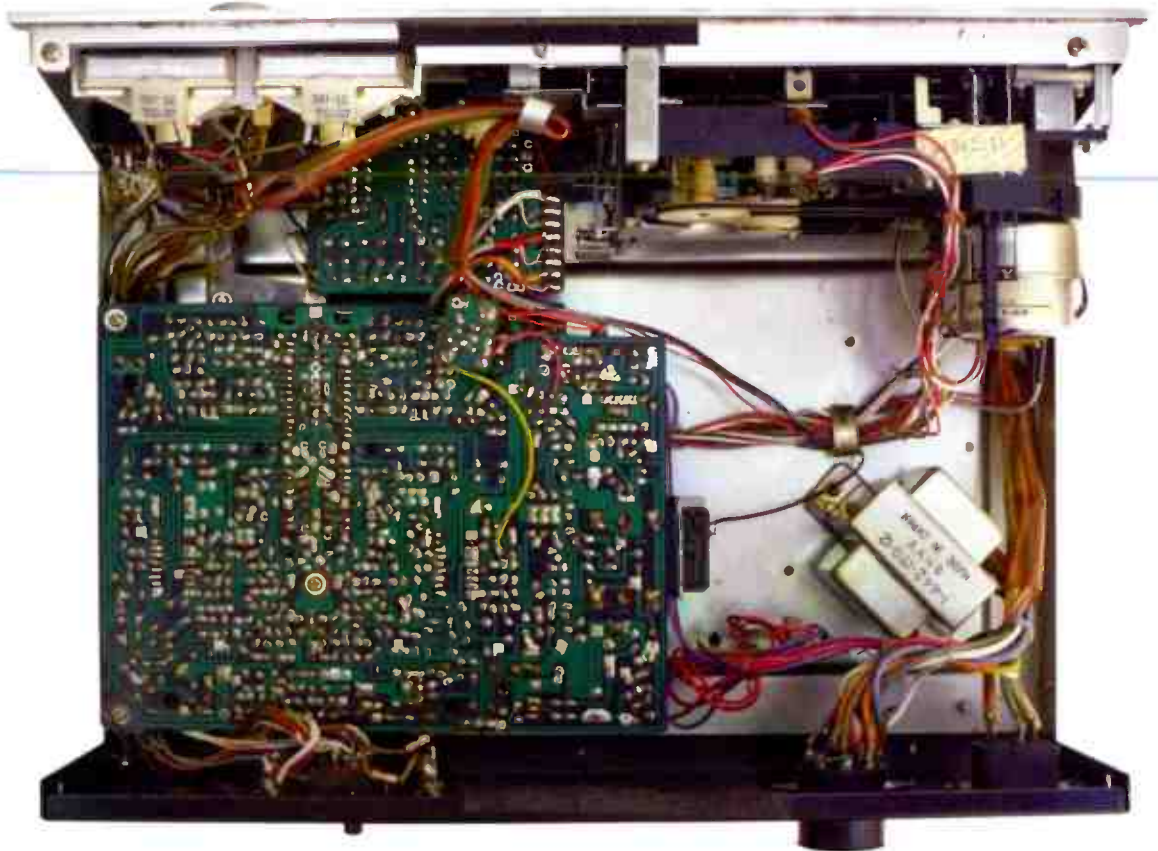

*The PCB is mounted 'component side down', making access to components (including the reel play switches - the two vertical columns of solder pads) very difficult - not least because the casework lacks a removable base plate. Calibration is relatively-straightforward, though, as pre-set adjustments can still be made with reference to accessible test points.*

all modes, but the mechanism is unsuitable for use with a timer because its pinch-roller remains engaged to the capstan in 'record' or 'play' even when the power is off.

Sony specified a single DC motor for motive power, meaning

that tape speed is independent of mains frequency (many '70s cassette decks, especially top-loaders, relied instead on synchronous motors with different pulley steps for 50Hz and 60Hz mains). On which subject, the UK/international version of the TC-186SD was equipped with a multi-voltage mains transformer - a voltage selector-cum-fuseholder on the rear panel is set appropriately. Unusually for gear of this vintage, there's an IEC mains inlet rather than a captive cable.

The machine you see here, an Audiojumble refugee, was in such great shape it could have come out of the original Sony carton - even the original manual was intact. Having owned one of these machines in the mid-80s, nostalgia got the better of me. It was to lead me to newer and more advanced decks with extra features and higher performance. Comparing this deck with, say, a 1986-vintage Nakamichi BX-300 - with its three heads and microprocessor-controlled closed-loop dual-capstan mechanism - the benefits of ten

years' cassette progress was obvious.

However it's not just the machines that have improved over time. I have a vintage (1975-1977 era) TDK SA C60 - i.e. precisely the sort of tape for which the TC-186SD would have been set up in the factory. There's an obvious difference between source and replay with this Sony, treble saturation giving the sound a splashy and compressed character. It all sounds rather congested, granular and less than hi-fi, although Dolby (and the 70s equalisation characteristic) all but banished tape hiss during quiet passages. Interestingly, Sony used the same CX-064 Dolby chip in higher-end products of the era - among them the STR-7800SD Dolby FM receiver and EL-7 Elcaset deck.

Lower down the scale, things fare better; acoustic guitar, for example, retains considerable detail and authenticity. Also praiseworthy thanks in part to Sony's contoured head are low frequencies from organs and bass guitars, which - provided you've

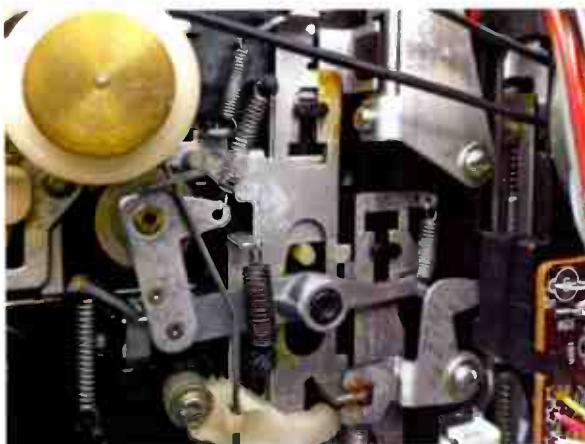

*When the transport is disassembled, you get to see the impressive number of springs, plates, cams and clutches that make it work! Dried grease in this areas can seize parts like these, stopping one or more functions from working correctly.*



set the recording levels correctly - are clean and extended. However, wow occasionally spoilt organ works - slight instability was also noticed with Oliver Lake's sax contributions to Bjork's Anchor Song. I found that in this respect the TC-186SD is greatly-influenced by the cassette you feed into it. The aforementioned TDK SA was fine, but a later TDK budget Type II cassette (CD-ing 2 C90) was almost unlistenable. A shame, because the tape inside is of considerable potential. A rival budget Type II tape from Sony (CDit II, C90) proved to be far more compatible with the TC-186SD in mechanical terms, with no slurring to speak of. The newer tape also yielded a far more open and extended sound than the vintage SA, and indeed with this tape loaded the performance of the TC-186SD was comparable with much newer machinery. A mid-70s ferric tape (BASF LH, as listed in the manual) sounded dull and lifeless, but switching to a cheap-as-chips Maxell UR C90 (you could find 'em in poundshops!) yielded far more acceptable results with a surprisingly crisp and incisive treble. I suspect that Sony's



**A Sony ad. points out that the TC-186SD's performance matches that of its TC-645 deck in all key regards bar one – frequency response. Under most circumstances, it claims, you wouldn't tell the difference between the two – but Fido might.**

recorded cassettes. Even with the azimuth optimised (the relevant screw is accessible after unclipping the cassette-housing cover), most sound rather dull. As I found it, the machine featured here would play - but the pitch was slow. This was easily fixed by adjusting a preset whilst playing a test tape.

I then discovered that although it would fast-forward correctly, the transport would continue fast-forwarding when changed to rewind mode! What's going on? Dried grease deep in the

an added benefit, you get to see the impressive number of springs, plates, cams and clutches that make it all happen!

Impressively, the original drive belts and idlers were within spec; this particular machine had obviously been used sparingly and then stored carefully. The dried grease seems to be quite a common problem, if Internet forums and 'spares or repair' eBay listings are anything to go by.

A subsequent fault, leading to random 'meter flutter' and oscillations, was traced to dirty contacts in the two PCB-mounted slide switches that flip the deck between play and record modes. Getting to these switches so that cleaner spray can be injected and worked in isn't easy, as the PCB is mounted 'component side down' and the cabinet's base plate isn't removable (the matching tuner's is, funnily enough). Unscrew the rear panel, though, and there's sufficient clearance (just about) to gain access.

On the whole, though, the machine is a lot of fun and with the right tape can sound surprisingly-good. Visually, too, it's classy with the aluminium frontage and glowing 'retro' analogue meters that you'll only find on esoterica nowadays. These old soldiers were popular choices between 1976 and 1979, and even after the passage of more than four decades are fairly common. Expect to pay anything between 99p and £50 for one, depending on condition.



**In this completely-mechanical transport, everything's driven with mechanical linkages. We can also see the belts, DC drive motor and capstan's flywheel (which must be removed to reveal the dried grease-stricken components).**

machine is slightly-underbiased for these newer formulations, but not low enough to cause distortion.

The TC-186SD isn't perhaps the best machine to play (or archive) your collection of pre-

bowels of this internally-busy machine led to seized parts, and as soon as these had been dealt with all was well. The amount of disassembly required is however extensive, but not impractical - as

# Klipsch®

REFERENCE

Klipsch  
**EDITION  
2022**

NEXT GENERATION

## REFERENCE

Series WITH  DOLBY ATMOS™



### *All new 90° x 90° Tractrix Horn*

Klipsch's exclusive Tractrix horn technology is now edge to edge, increasing directivity control over a larger bandwidth of frequencies. The classic 1" aluminium LTS tweeter delivers the power, detail and emotion of the live music experience with the cleanest most natural sound possible.



### *Spun Copper TCP Woofers*

Utilizing trickle-down technology from the highly acclaimed Reference Premiere series, TCP woofers have steeper cone shape for a smoother response, improved accuracy and greater transparency whilst the additional ribbing ensures less cone break-up at higher frequencies.



### *Home Cinema System*

The Klipsch Reference Base home cinema speaker range offers a complete hemisphere of rich, detailed sound and at the greatest value possible. Your music and movies will never sound the same again.



### *Get Some Height*

For film lovers the Reference series offers both inset and external DOLBY ATMOS speaker toppers. Like their bigger counterparts both incorporate the 90 x 90 degree tractrix horn and spun copper TCP woofers immersing you in a bubble of sound.



Distributed by Henley Audio

T: +44 (0) 1235 511 166 | E: sales@henleyaudio.co.uk | W: www.henleyaudio.co.uk | Facebook: HenleyAudioUK | YouTube: HenleyAudio

# "something hatched up in Transylvanian laboratories long ago"



Noel Keywood

**P**loughing through various on-line reviews of the EAR834P phono preamplifier I was taken aback by how few mentioned its moving coil (MC) input uses step-up transformers. I saw a cursory mention, with no explanation.

Remembering what great store famed designer Tim Paravicini (EAR) put on these items, also Andy Grove of Audionote – both of whom I worked with – I thought it a good idea to cover this topic in a column. Anyone who wants the best from vinyl with an MC cartridge should know about them.

It's my experience also (after being lectured by Tim and Andy!) that if you want to hear what a quality MC is capable of, this is the way to go. Oh, and let me mention also that MC authority Ortofon say: "Quite simply, a good transformer is the best way to audition an MC cartridge with the highest performance possible".

Unanimity exists from those that understand and have heard what transformers mean to sound quality, yet the knowledge does not seem to have got very far – even in today's busy market for all things vinyl. On-line reviewers in particular don't really understand or appreciate the role and importance of these perhaps-uninspiring little things.

Why? Perhaps because they emerge from the past. We're not talking funky modern tech such as USB or Bluetooth here, just bits of wire that catch nobody's attention. And they suffer "issues", as you might expect.

What issues? Well, cost is one, as always. Premium grade MC transformers with Faraday screens, silver wire, special cores etc typically hover around £800 per

pair, Ortofon's top ST-80SE is €1800, but I see a pair of Glasshouse MC transformers designed by Andy Grove are a very reasonable £96 per pair, whilst Audionote's top MC tranny is £1570 (apiece), both from HiFi Collective.

Phew! These are eye-watering prices for amplifier manufacturers who might want to use such a thing in their latest vinyl wonder-stage. They would be used to dealing with ICs that seemingly do the same job for £1. Consequently, MC preamps with transformers are uncommon and because of that poorly understood.

You can use MC transformers as a stand-alone device that provides 1:10 step up that you plug into an MM input, but then you're trusting that input is a good one – and likely not.

It's best to get a phono stage with transformers built-in, because any manufacturer doing this will be aware of the issues. Often they come with valves, such as the EAR 834P I mentioned earlier, or the Icon Audio PS3 MkII I use. Reason being circuit simplicity, no overload issues and a big, spacious valve sound transistors do not provide.

Such transformers are rarely found in transistor preamps even though they are quieter than transistors, by up to 6dB. The brutal truth is transistor preamps follow budget constraints; expensive transformers don't fit into this approach. We are looking at different worlds here, one commercial, the other audiophile. Coils of wire sound clearer, darker and deeper than arrays of solid-state junctions, especially when the copper is 99.99% pure and silver coated, but they're bulky and expensive.

A peculiar wonder of the moving coil cartridge is there's nothing in it. A curse and a blessing.

The coil of wire attached to the top of the stylus cantilever has to be super light weight or it will degrade tracking. That means very few turns of ultra-fine wire. This gives source impedance of 5 Ohms Ortofon say for their superb Cadenza series – very low. There's little voltage as a result but there is power – and a step-up transformer exploits this. Most are 1:10 step-up but they could be much more – a future possibility. For the time being 1:10 is good enough, chosen because it conveniently feeds an MC input into an MM phono stage, slickly combining both.

A 1:10 transformer, as most are, has few coil turns on primary or secondary and no limitation on weight or quality of wire used, so can be optimised. High purity copper wire, silver plated wire or pure silver wire are all used. Such wire effectively replaces amplification by active devices (valves or transistors) and here you can see that the notion of purity through the exploitation of fundamental electrical principles is being used by designers that understand these things. Clever stuff.

We are not talking modern day semiconductor engineering here, rather than exploiting the wonders of that ugly old device, the transformer. A dusty relic from yesteryear, it bizarrely uses electromagnetic induction, seen as weird and deeply Victorian to digital engineers, something hatched up in Transylvanian laboratories long ago.

But Tim de Paravicini and Andy Grove both knew better, understanding how the transformer is crucial to exploiting the little wire that lies in an MC cartridge.

I got involved in all this and agree with them: you're best off using an input transformer with MC cartridges. Nothing quite compares. ●

# HI-FI WORLD

## ON THE APP STORE

App Store > Entertainment > audio web publishing ltd

**Hi-Fi World** 4+

audio web publishing ltd >

Details Ratings and Reviews Related

Screenshots iPhone iPad

**HI-FI WORLD**

Offers In-App Purchases

This app is designed for both iPhone and iPad

Rating: 4+

**TOP IN-APP PURCHASES**

1. Hi-Fi World Dec 2015 £3.99
2. Hi-Fi World Subscription £8.99
3. Hi-Fi World August 2015 £3.99
4. Hi-Fi World September 2015 £3.99
5. Hi-Fi World June 2015 £3.99
6. Hi-Fi World May 2015 £3.99
7. Hi-Fi World December 2015 £3.99
8. Hi-Fi World February 2015 £3.99
9. Hi-Fi World November 2015 £3.99
10. Hi-Fi World December 2014 £3.99

LINKS

Privacy Policy

© 2014 Hi-Fi World

**Description**

Hi-Fi World brings you the best in hi-fi...from around the world!

- We listen and measure products in depth, at our London offices.
- Expert opinion from a team of renowned writers, musicians and engineers.
- International standard measurements using Rohde & Schwarz test equipment...

**Information**

Developer: audio web publishing ltd  
 Category: Entertainment  
 Updated: 7 Dec, 2014  
 Version: 1.0  
 Size: 9 MB  
 Rating: Rated 4+  
 Family Sharing: Yes  
 Compatibility: Requires iOS 5.0 or later. Compatible with iPhone, iPad, and iPod touch.  
 Languages: English

**DOWNLOAD OUR APP ON APPLE AND ANDROID  
 DOWNLOAD FROM iTUNES OR GOOGLE PLAY**

**iPad, iPhone, iPod, Tablets OUT NOW!**

# "Music Hall runs through the sixties and into today's music"



Paul Rigby

It's interesting how words evolve. Where they come from. What they mean. How that meaning changes. In hi-fi we are now familiar with the word 'mobile' whose usage has now become unpredictable. It can go anywhere at any time. In terms of headphones, digital audio players, DACs and so on.

'Mobile', as a word, has a primitive, base history. Mobile arrives from the word 'mob'. A mob has always followed Britain and British history, more so as you roll back the years to the age of Victoria – and further still.

The mob could also go anywhere at any time. It was also unpredictable. The mob could make you famous or could tear you to pieces. The mob could fight you a war. It would also topple you in revolution.

Britain. England especially, has always done well in terms of the mob. Never forget, when you see violence in football crowds. When you see the streets full of anti-war, pro-war, anti-hunt, pro-hunt, anti fuel tax, anti poll tax, anti anything protestors, it derives from a grand tradition. The mob is obnoxious. It's designed that way.

Music and the music industry exists because of the mob. It is because of the mob that Music Hall was founded and prospered. The mob wanted it. They needed it. Life was hard. Work was tough. The Music Hall provided an outlet and the mob smiled upon it.

Music Hall was a place for the mob to eat and to drink and to get drunk and to heckle and shout and to throw things at the performers who didn't reach their high standards.

It was a place for them to be proud of who they were, sitting

cheek by jowl with the rich classes in Britain's capital. It was a place to spread news and discuss events of the day in song. It was the place the mob created their first singing stars. Fame could be yours if you swam in the same currents as the mob. If the mob liked you, you could drown in money and finery. In flash cars and flash foods. They could also drag you to the very pits of hell too, if they'd had enough of you.

Singer Marie Lloyd was famous for reflecting the notions of the populace. For reflecting back their grievances with the rich and the powerful. She represented the poor and the down-trodden. She provided a mirror. She allowed the ordinary person to no longer feel alone in their misery. She told them that yes, she knew and she understood and she wasn't going to let them get away with it. The mob loved her for it.

When WWI turned up that collective of people then became ultra-patriotic. In fact, Music Hall is where the word 'jingoistic' comes from "We don't want to fight but by jingo if we do/We've got the ships, we've got the men, we've got the money too". These are the lines from songwriter G.W. Hunt and singer G.H. McDermott.

The mob created Music Hall and Music Hall reflected their social commentary. That thread carried on unabated and emerged fit and healthy though the sixties and seventies.

It was still there. It hadn't changed. The mob was still able to make you a star if it liked you and the influence of the Music Hall structure, that template and that way of thinking, formed the bedrock of the rock stars we

know and love today.

Half of the band Queen's entire act was based upon Music Hall. Listen to any of their early albums and you will hear distinct Music Hall flavours in their song writing and arrangements.

Ray Davies from The Kinks was overtly vocal in his connection with Music Hall. His song writing was full of character and characters and stories of people and events that emulated and aped Music Hall. He told The Guardian newspaper "For me personally, it was blues music – Big Bill Broonzy, John Lee Hooker, Spanish guitar playing and a lot of jazz and, of course, I inherited the love of Music Hall and old English traditional songs. Put that together and you have our music".

The Small Faces were seemingly plucked from the very heart of the Music Hall culture. They had a cheeky, cockney sparrow, fast witted, quick reaction method to the music and fizzed and sparked exactly like a Music Hall act.

For many of the London (and elsewhere) bands and stars you know and love, their extended families would have been steeped in Music Hall memories and traditions. The sixties was not that far away from the core Music Hall ethos, after all. Memories were still fresh. People were still alive who had either performed or visited these establishments.

So when you look at the sixties and you see new and revolutionary. What you in fact see is new and evolutionary. There is a distinct line that runs from those old Music Hall times, through the sixties and into today's music. It's a distinctly British vibe and its one to be cherished. ●



TRANSFORM YOUR SYSTEM WITH A  
MUSIC FIRST AUDIO PREAMPLIFIER

CALL TODAY 01424 858260

www.mfaudio.co.uk info@mfaudio.co.uk



# eleanor mcevoy love must be tough

LIMITED SPECIAL EDITION OF LOVE MUST BE TOUGH AVAILABLE AS SACD (PLAYABLE ON ALL CD PLAYERS).  
THE ORIGINAL LP IS AVAILABLE FROM DIVERSE VINYL.

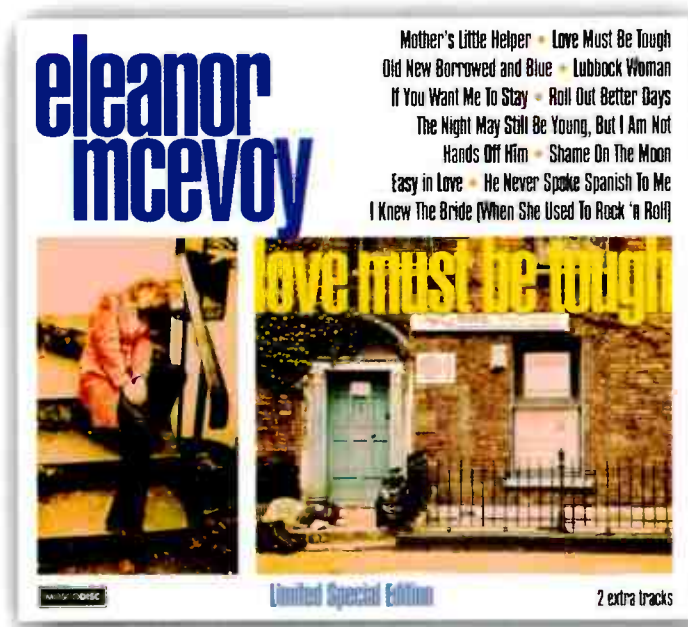

A homage to Americana, further tales of love and passion gained, lost and fought over, including songs written by Eleanor McEvoy with Johnny Rivers, Rodney Crowell, Brad Parker and Dave Rotheray.

Featuring tracks originally recorded by Terry Allen, Priscilla Bowman, Rodney Crowell, Nick Lowe, The Rolling Stones, Sly Stone & The Texas Tornados, with two extra tracks—The Fratellis 'Whistle For The Choir' & 'Please Heart, You're Killing Me'.

.....  
"Eleanor is the most real-sounding woman you'll ever hear on disc. The album is a great mix of originals and well-chosen covers that she makes entirely her own." — Classic American

"This is a superb blend of covers & originals. Like a female Van Morrison, she swings from the Stones to Dave Edmunds and from country to jazz, the most booze-sodden balladry since the Pogues. McEvoy sounds like the sort of woman who might greet you with a bottle of red one night and a rolling pin the next". — Truck & Driver ★★★★★ *Album of the Month*

"This is a band album, rich with brass and Hammond organ, and we're back in the Sixties again in some smokey nightclub... Love Must Be Tough may have been around for a while but it still may be the best thing you'll hear this year." —Dai Jeffries *RnR, May 2021*

eleanormcevoy.com

# "The visual spectacle of the performance is instead built around realistic digital recreations"



Martin Pipe

Last month, I detailed my ongoing battle with Virgin Media who, like other telcos, is switching subscribers from traditional landline technology to VoIP (Voice over Internet Protocol). As you may recall, it is handling the matter with spectacular incompetence.

Since last month's installment my VM-subscribing parents were sent, without notice, a DiY kit with installation instructions. Well into their eighties, they just don't feel comfortable messing around with wires, especially as their phone socket and modem just happen to be in different rooms.

Having advised them to switch to VM in the first place, I felt duty-bound to get it fixed! To be fair, though, the explanatory VM leaflet did explain that an outage-resilient service would be provided 'free of charge' to those afraid of being cut off, and that a technician could be booked to do the necessary work – those reliant on multiple phone-points (including infirm and disabled customers) are advised to give them a call. After sorting out my parents, I returned home to discover another facet of VM's ongoing PR disaster.

Any call I tried to make on my own line ended up in VM's call-centre – as if I had dialled '150' – exceptions being the NHS 111 hotline, and (one hopes!) 999 calls. It was alas early Saturday evening, and nobody in 'support' was available. I was however able to reach someone helpful from its O2 division who put me in touch with an overseas call-centre working on VM's behalf.

It turns out that VM is deliberately withholding the ability to make outgoing calls, essentially-forcing customers with obsolete

VoIP-incompatible modems (like mine) to organise their replacement.

By amazing coincidence, my ability to make calls was magically restored after making an appointment! I then registered in no uncertain terms my disgust at VM's behaviour, the fettling of a 'paid-for' service and hours spent listening to lame 'call-hold' music. I was offered – and accepted – £50 goodwill compensation, to be deducted from subsequent bills. Checking my account at the time of writing, it was alas clear that no such compensation had been paid. Yet another VM let-down.

Had some kind of techno-timewarp transported VM and its VoIP charade to Sweden circa 1973, there's a chance that ABBA might not have written Ring Ring – a song in which a woman waits in vain for the guy she fancies to call. Its upbeat melancholy would become characteristic of the group's future work. ABBA entered the three-minute song into Sweden's Melodifestivalen competition, with the hope that it would become the country's 1973 Eurovision entry.

Although their efforts failed, ABBA fared somewhat better the following year with a little ditty called Waterloo. This propelled the iconic foursome into the international limelight, and pop music was changed forever!

Ring Ring isn't on the 20-song setlist of today's ABBA Voyage concert residency, currently occupying a specially-built 3000-capacity ABBA Arena within London's Queen Elizabeth Olympic Park.

Waterloo is, of course, alongside so many of the subsequent hits the band notched up until they split in 1982 (The

Day Before You Came, a late composition featured on The Visitors LP and one of my favourites, didn't make it either).

The Voyage tour, named after the 2021 comeback album that contributes two songs, is as famous for the tech as it is for the legendary music being played. For a start, none of the band are actually present. The visual spectacle of the performance is instead built around realistic digital recreations – dubbed 'ABBAatars' – of the four band members, as they were in their late-seventies prime. Such projected imagery, accompanied by 500 pre-programmed moving lights, is the fruit of Disney subsidiary Industrial Light and Magic's 21st-century motion-capture technology.

The whole shebang is synchronised to pre-recorded vocals that are backed by a 10-piece live band, and heard through no fewer than 291 speakers powered by a claimed 870kW of amplification. Concertgoers are however impressed, some having enjoyed the \$175m 90-minute show several times.

All four ABBA members are still alive...and can literally sit back at home, raking in the money from comfortably-off baby-boomers who were fans in the '70s and want a nostalgia trip.

Where will it end up? Might developments of the concept be able to conjure up lifelike models of dead stars from AI analysis of video and film footage, thereby recreating Hendrix, Elvis and Bowie? 'Hybrids' where Freddie Mercury can rejoin Queen, and Charlie Watts the Rolling Stones? And now the Beatles can in theory reform...virtually. Clever tech is one thing – but, as I've learned from VM, it's important to get the 'people stuff' right too. ●

# MUSICAL FIDELITY

## M2 SERIES

**M2SCD** | Premium Detailed  
Audiophile CD Player

Powerful Audiophile  
Integrated Amplifier | **M2Si**



## THE PERFECT PAIR

NEVER SETTLE FOR ANYTHING LESS THAN  
PERFECT MUSICAL FIDELITY

**M2SCD**



June 2019



February 2021

FIND OUT MORE AT:

[HENLEYAUDIO.CO.UK/PRODUCTS/M2SI](http://HENLEYAUDIO.CO.UK/PRODUCTS/M2SI)  
[HENLEYAUDIO.CO.UK/PRODUCTS/M2SCD](http://HENLEYAUDIO.CO.UK/PRODUCTS/M2SCD)



**M2Si**



January  
2019



June 2019



February  
2021



Distributed by Henley Audio

T: +44 (0) 1235 511 166 | E: [sales@henleyaudio.co.uk](mailto:sales@henleyaudio.co.uk) | W: [www.henleyaudio.co.uk](http://www.henleyaudio.co.uk) | [f: HenleyAudioUK](https://www.facebook.com/HenleyAudioUK) | [y: HenleyAudio](https://www.youtube.com/HenleyAudio)



# "One piece of chart revisionism involves The Beatles' Please Please Me"

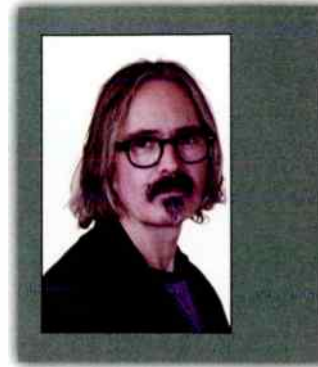

John Pickford

**A**s I write, Kate Bush has just reached No 1 in the UK singles chart with *Running Up That Hill*, 37 years after it was originally released. The song has gathered a new generation of fans following its repeated use in the hugely popular Netflix programme *Stranger Things*, set in the mid-1980s.

Originally reaching No 3 upon release in 1985, Bush has broken three world records with this historic chart-topper. At 63 years old she is the oldest woman to achieve a No 1 hit single, while 37 years is the longest time it has taken a record to top the charts. And having reached the top with her debut release *Wuthering Heights* in 1978, this latest success creates the longest gap between chart toppers for any artist.

But the thing that stokes my interest in this remarkable achievement is the way the charts were manipulated to allow this to happen. You see, with streaming now responsible for a large part of a song's chart performance, certain measures have been put in place to keep the singles chart contemporary and prevent ancient Beatles recordings or fan-favourites from Adele and Ed Sheeran constantly clogging up the Top 40. To qualify as a 'sale', older songs need to be streamed twice the number of times as current releases.

However, when a tune such as *Running Up That Hill* becomes genuinely popular again, the artist can apply to have this rule removed to place it on a level playing field so to speak. The week before it reached the top, Bush's song actually beat the official No 1 in terms of number of streams

but had to wait for the 2-for-1 rule to be dropped before it took its place at the summit.

While Kate Bush's record-breaking achievements are remarkable, the revival of old-gold hits is nothing new. The early 1970s saw several 50s and 60s hits receive a new lease of life during the first of many waves of rock 'n' roll nostalgia. In 1985 a series of TV commercials for Levi's jeans led to a string of revived hits, three of which (*Stand By Me* by Ben E. King, *The Joker* by The Steve Miller Band and *Should I Stay Or Should I Go* by The Clash) reached No 1.

Back in those days before streaming, when all physical sales were equal, there was a different type of chart manipulation going on and it certainly wasn't to benefit reissues of old hits. Most singles appeared as both a regular 7-inch and a 12-inch, which often featured an extended mix of the lead track along with additional, exclusive tracks; if you were a die-hard fan of the artist you bought both.

I remember buying the latest release from my 80s favourites on the standard 7-inch vinyl, a limited edition 7-inch double pack, a 12-inch and cassette single.

Some bands would make their latest release available with several picture sleeve variations, each one featuring the image of one band member. And although the identity of chart-return shops was supposed to be secret, the record company sales reps all seemed to know exactly which stores to target with these special 'promotional deals'...

One piece of chart revisionism involves The Beatles' first chart-topper *Please Please Me* in 1963. Legend has it that following

the definitive take, producer George Martin announced, "Congratulations gentlemen, you've just made your first number one!" He was right, the single raced up the charts, hitting the top in NME, *Melody Maker*, and *Disc* (there was no 'official' chart until 1969). However, the industry magazine *Record Retailer* (also used by *Record Mirror*) placed the Beatles at number two.

When the first edition of *British Hit Singles* appeared in 1977, the chart chosen for releases between 1960 and 1969 was, you've guessed it, *Record Retailer*. Pop historians have long argued that the RR chart was far less accurate than either NME or *Melody Maker*. In 1963 RR mined information from just 30 shops, whereas *Melody Maker* compiled its chart from 100 shops.

Official chart history now denies *Please Please Me* was the group's first chart topper and Apple, The Beatles' company, went along with this when compiling their compilation of the group's No 1 hits; it was left off the collection even though their debut single *Love Me Do* (UK No 17) was included because it topped the charts in America.

The Rolling Stones similarly had their run of number ones interrupted in 1966 when *Record Retailer* had 19th *Nervous Breakdown* stall at No 2. And if the 'official' compilers took their information from the largest survey, The Who would not be without a UK No 1 single. As Pete Townshend announces on the *Live At Leeds* album when introducing *I'm A Boy* "... which, according to the *Melody Maker* was our first number one in England I think for about half an hour". The audience laughed. ●

# In Close Proximity



## Martin Pipe tries QED's latest mains cable

**A** more affordable alternative to QED's XT5 IEC mains lead (reviewed in the January 2021 issue) is the recently-launched XT3, which also makes use of the firm's proprietary 'X-Tube' construction. Here, the conductor's copper strands are uniformly-wrapped around a central LDPE (low-density polyethylene) insulator – the 'tube' of the name – instead of merely bunching them together, as is typical practice. The idea is to minimise the proximity effect, a recognised electromagnetic phenomenon in which the impedance of adjacent conductors rises with frequency. Music consists of highly-complex waveforms spanning a range of frequencies, and as a result there is – alleges QED – a kind of subjectively-perceptible



'impedance modulation'. By modifying the spread of current through QED's unusual hollow construction, the effect is reduced.

QED originally developed X-Tube cabling in the 1990s to route audio signals from amplifier to speakers, with no mean success. Since then QED has somehow managed to "specifically tune" its construction for the very different job of carrying power (high voltage, and at a constant 50Hz – as opposed to those intricate 20Hz-20kHz collections of audio frequencies).

safety criteria (QED pays a lot of attention to such concerns, and indeed lists the EN standards it complies with).

Yet for all this, the XT3 is fairly flexible and not so heavy it will "lift your amplifier or audio streamer off the floor"!

Although I couldn't get inside the plug at the IEC end of the operation, the 13A plug was rather more accommodating. With its cover removed, I noticed a standard 'lead free' fuse - and that the three wires feeding the plug pins resemble those of the standard (albeit decent gauge) variety. In other words, there's no obvious evidence of the X-Tube construction I recall from QED's speaker cables! I contacted QED with my findings, and a plausible explanation was offered. "When the cables are terminated, the LDPE core is 'snipped out' from the stripped end of the wire, so that maximum contact is made to the plug terminal" – there's no longer any plastic in the mix. The conductors are then

immediately obvious, when the XT3 was used to connect the Stereo 200 to the mains, was a surprising improvement in tautness and definition. More texture was evident in the bass-guitar contributions of no fewer than three musicians across Paul Weller's classic Stanley Road album, as well as the synthesised low-end prominent in tracks from Prelude Records' 'Absolutely' disco-funk compilation. This was relative to a bog-standard 2m IEC mains lead; maybe there's something in QED's theory that, although there are many miles of cabling (and several substation transformers) between the power station and my home, the "small cross-sectional area" of the average cable acts, despite its shortness, as a bottleneck when it comes to the "smooth transfer of current to domestic devices".

With preamps, which don't draw as much power, this isn't quite as much of an issue. Yet with the Pre-XR fed with mains via the XT3, I found subtleties and performance space to be more apparent – live Radio 3 concerts on FM (or a high-bitrate stream) are particularly revealing here. I also tried the hires recordings I listened to when I reviewed the XT5 – for example, Emily Palen's Blue Coast outing

"More texture was evident in the bass-guitar contributions of no fewer than three musicians across Paul Weller's classic Stanley Road album"

Aimed at quality-conscious budget audiophiles and owners of midrange systems, a 1m version of the XT3 – as reviewed here – will set you back £79, or about half the price of the equivalent XT5. It's immediately clear where at least one saving has been made. Although QED has specified the same MK 'Toughplug 655' three-pin plug as fitted to the more expensive model, the IEC C13 plug at the other end of the XT3 is moulded on (and therefore, unlike the XT5's, is not replaceable).

The cable in between is substantial, with a 10.2mm outer jacket diameter, because the X-Tube construction ensures that the constituent PVC-insulated wires within are themselves larger than usual.

That said, only the live and neutral wires – the conductors of which total 1.5 mm<sup>2</sup> of "99.999% oxygen-free copper" – are 'X-Tubed'. According to QED, the earth has been left alone and is of "conventional geometry" to meet

"twisted together, and screwed into the plug". You'd only see the core (or "rod", as the QED engineer called it) if you cut the cable – somewhat wasteful! – ahead of the plug strain-relief and "peeled it back". On the whole, the standard of construction is very high – even though you can't actually see the 'clever stuff'.

I tried the XT3 with Cyrus's top-of-the-range Pre-XR preamp and Stereo 200 power amp, as reviewed last month, together with Quadral Aurum Wotan VIII floorstanding speakers and various sources both analogue and digital. Something that was

Light in the Fracture and the LSO/Nosedá recording of Britten's War Requiem – and found that most of the dearer cable's benefits had successfully made the journey. If your amplification isn't integrated, you might need to buy two such cables to achieve the full benefit. However, even then the combined outlay of approximately £160 is less than some are asking for one IEC cable! QED cables benefit from extensive availability, and as a result it shouldn't be difficult to find an XT3 (or two) to try in your own system.

#### SIZES AVAILABLE

£99 2m and £119 3m versions also available

#### QED XT3 £79 1M VERSION



**OUTSTANDING** - amongst the best.

#### VERDICT

An IEC mains lead with audible benefits that doesn't cost the earth.

#### FOR

Clever tech, well-made. Improvements in impact and detail evident.

#### AGAINST

IEC plug moulded on.

Q Acoustics  
+44 (0) 1279 501111  
www.qacoustics.co.uk



FRANK BLACK

Honeycomb/Paley & Francis/  
Nonstoperotik  
Demon

**D**emon has reissued three late-period LPs that combine the older Black Francis monicker with the more familiar solo Frank Black title.

'Honeycomb' initially appeared on the Back Porch label in 2005 featuring the likes of Spooner Oldham and Steve Cropper and all of this while a Pixies reunion tour was underway.

The old hands give this album a sense of gravitas that allows Black to offer a sophisticated level of song here. Its very singer-songwriter in its presentation which is not really a Black 'thing'. So it's nice to hear how Black approaches the milieu. In fact he infuses it with country, folk and blues but there is lightness and whimsy here too.

Next is 'Nonstoperotik' (2010) which, as you might guess, is full of sexual tension and charged passion. Often suppressed

into a deceptively restrained delivery. 'Lake of Sin' is a good example of that. It's a fascinating LP that's draped in classic melodies but featuring Trojan horse lyrics.

Also from Demon is 'Paley & Francis' (2011) featuring Reid Paley (ex-The Five, a post punk band plus his own solo singer-songwriter work) which sounds what it is, two singer-songwriters getting together for a quick mash up but with a slight twist of the twisted. There's a certain low key, slightly stripped feel to this one. 'Ugly Life' is a highlight for me.

Mastering? I remember Frank Black was adamant that Mobile Fidelity leave the clinical edge on their Pixies reissues. There's nothing actually clinical here but there is a definite compressive feeling in the upper mids and treble. Nothing aggressive but you can almost feel it on the ears. All three LPs are worthy of investigation.

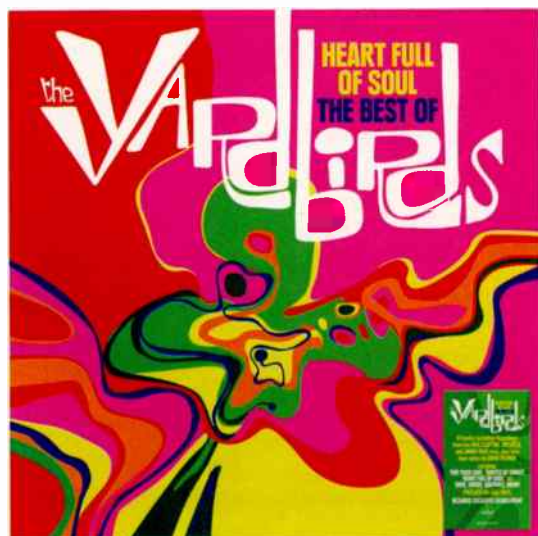

THE YARDBIRDS

Heart Full of Soul, The Best Of...  
Demon

**T**his collection has been created with the assistance of the band – although just who that might include hasn't been revealed.

I'm happy to see these tracks filtered through to vinyl. Firstly, because vinyl was the band's home in format terms. It represents their history and their muse. Secondly, The Yardbirds were the most significant blues and R&B rocking outfits from the sixties, in terms of what they did and how they did it.

They had a searching adventure in their music that attracted a host of talent including the famed lead guitarists of the time and onwards: Jeff Beck, Eric Clapton and Jim Page. These men added to the band's high-energy delivery that gave their work fizz and power.

They also featured some excellent songs, sometimes with

the help of more talent, outside of the band. For example, the revered single 'For Your Love' was penned by future 10cc man, Graham Gouldman. Another single 'Heart Full of Soul' was also penned by Gouldman. Both of those tracks are here, on this compilation.

In mastering terms? This is a period suite of recordings that were trying to reach fans through the technologies of the time: Dansette record players and transistor radios with speakers the size of milk bottle tops so you'll need to adjust your expectations. Studios adjusted their masters to suit. Bass is recessed, mids are thin and treble peaky. Not so good on a modern hi-fi.

Quality varies because this is, please remember, a compilation. If you can enter into the word of the time then bathe in the vintage sound and have a whale of a time.

**M**y guess is that most McVie fans will have first heard her work on the Fleetwood Mac LP 'Rumours', in which she sang the title track of this collection although, possibly surprisingly, you won't be seeing that LP's 'Oh Daddy', 'You Make Loving Fun' or 'Don't Stop' on this release, produced and remixed by the legendary Glyn Johns – he of Beatles fame.

Even that famed title track has been remixed using the original vocal track alongside an orchestral backing.

Most of the songs here derive from two solo works, 1984's 'Christine McVie' and 2004's 'In The Meantime' plus two previously unreleased studio recordings. 'Slowdown', written for the 1985 film 'American Flyers' and 'All You Gotta Do,' a duet with George Hawkins.

I realise that Sony holds the rights to her debut LP, 'Christine

Perfect' (1970) and maybe she felt that her Fleetwood Mac work has enough light shining upon it but the tracklisting here does nevertheless have a restricted feel. It actually feels like it falls between two stools. Is it a highlights package of two albums? Is it a rarities package? Is it a remix package? It seems to be neither one thing or another.

Even so, I'm still happy that it's here. In mastering terms? Mastering is pretty good. There's a slight compressive feel to the upper mids and I wish that side had been removed but it's not an egregious addition.

As for the new Songbird remix? It's syrupy, clumsy, clunky and slow. The orchestra is a ball and chain around the vocal which slows to a crawl. The orchestra actually feels disconnected. As if it's playing on its own, possibly in a spar, without any relation to the vocal. No. No. No. For the love of heaven, no!



## CHRISTINE MCVIE

Songbird: A Solo Collection  
Warner

**A**ll the way from Quebec in Canada and with a shifting line up to keep everyone on their toes, the same could be said for their musical content, influenced by Britain's New Wave of British Heavy Metal, prog of a seventies variety plus hard-edged punk.

Their fusion of styles ranges from thrash metal to prog to death metal to hard rock, adding jazz elements plus weirdness. And they've been filling their riffs with political commentary, science fiction trips, dystopian flavours and more.

Formed in 1982, the band launched their debut album in 1984 with 'War & Pain' and have been churning them out since.

This new box set is quite a beast. It focuses on the band's time with the Noise record label and includes the umlaut-swamped albums on splatter-coloured discs

featuring 'Rrrröööaaarr' (1986; thrash energy in a groove), 'Killing Technology' (1987, songwriting prowess makes an appearance), 'Dimension Hatröss' (1988; arguably the best of the three albums here offering more mature songwriting and experimental arrangements) plus a host of rarities including 'Dimension Hatröss – The Demos', 'No Speed Limit Weekend '86' and the 'Chaosmongers' DVD, featuring a mini documentary plus a previously unseen concert from 1987 and an audio recording of the WWII show from 1985.

There's a 12" x 12", 40 page book of photography, new interviews and a 'Körgull' figurine USB drive containing MP3 audio of all the albums including bonus tracks.

Fans will love it but anyone interested in thrash and heavy rock with imagination and soul should also grab a fully loaded credit card.



## VOIVOD

Forgotten in Space  
BMG

# vinyl section

## contents

SEPTEMBER 2022

[www.hi-fiworld.co.uk](http://www.hi-fiworld.co.uk)

### EXPOSURE VXN PHONO STAGE 64

A high quality discrete transistor phono stage gets close attention from John Pickford.

### AUDIO TECHNICA AT-LPW30 TURNTABLE 71

Noel Keywood spins LPs using a budget turntable from Audio Technica.

### AUDIOPHILE BOOKS 77

Three books: Ready Steady Go; Buying into Britpop; Shindig!, reviewed by Paul Rigby.

### CLASSIC CUTS 82

White Plains album- 'White Plains', reviewed by Paul Rigby.

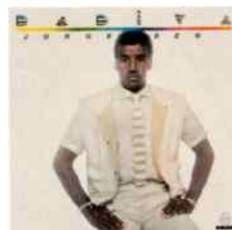

### VAMPI SOUL

A selection from Spain's Vampi Soul label includes Viento Sur's 'Experimental & Fusion Music from Argentina' ([vampisoul.bandcamp.com/album/viento-sur](http://vampisoul.bandcamp.com/album/viento-sur)) from the 80s label, Melopea, is a compilation of synth pop, folk and ambience.

Next? Brazilian Jorge Ben and his soul-funk outing, 'Dádiva' (1984) certainly adds a samba glow but soul fans should check out this one.

## news

### SCHIZO FUN ADDICT

Apparently there's only fifty-eight copies of 'Fate Chaser', a lovely, one-sided, three-tracked, clear-vinyl 10" in a white outer sleeve, caked with Jake Winter's multi-colour acrylic (?) paint core dumped on the front sleeve (<https://www.fruitsdemerrecords.com/fatechaser.html>) plus 3D glasses and 3D label!

Phew! The music? Hazy, dreaming psychedella with twangy guitars and shuffling backing vocals of the sort that might go on for four hours if no-one said 'stop'.



### WHITESNAKE

Half of the press blurb for this release has been printed on the front sleeve. This 'Greatest Hits' (Rhino) double in a gatefold features sixteen tracks including 'Here I Go Again' and 'Still of the Night' and has been remixed and remastered, David Coverdale being involved in production.

### BLUENOTE

New on the classic label is Charles Lloyd Trios and 'Chapel' featuring the great Bill Frisell and Thomas Morgan. Lloyd is the main squeeze here but the trio as a whole rolls forward in an easy, sometimes mournful, oft relaxed frame of mind.

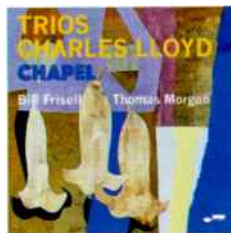

### JERRY REED

More from Bear Family, another 10" and Reed's 'The Rocking' U.S. Male': a twelve-track 10", another twenty five on an included CD plus booklet plus post card. It includes tracks covered by others including a certain Elvis Presley and Gene Vincent. Great value.



### MERCURY

...is the new LP from The Range (Domino; [www.dominomusic.com/uk](http://www.dominomusic.com/uk)). It's highly commercial, chart-friendly, electronic dance music aimed at big sales and making lots of money. It hooked me. And certainly there's lots of those.



### ARP

... or Alexis Georgopoulos, has released a new LP called 'New Pleasures' (Musica; [arpetc.bandcamp.com/album/new-pleasures](http://arpetc.bandcamp.com/album/new-pleasures)), an instrumental electronic album. Despite the Japan reference ('Eniko'), this is an intriguing, multi-style, pop-coated beats outing.



## CHRIS BANGS & MICK TALBOT

Covered by a sleeve displaying fake ringware, peeling price sticker and a 'remaindered cut slot', 'Back to Business' (Acid Jazz; [www.acidjazz.co.uk](http://www.acidjazz.co.uk)), Bangs (underground 80s dance) and Talbot (ex-Style Council), come atcha with funky soul-jazz.

## SOCA

Or Soul of Calypso, a mainly Trinidadian brand that developed in the 1970s. Arrow was all over this flavour, hitting Top of The Pops with 'Long Time', I remember. 'Hot Hot Hot: The Very Best of Arrow' (BMG) packs in ten tracks.



## JOE BENNETT & THE SPARKLETONS

I saw this South Carolina rock'n'roll outfit performing a super higher-energy version of 'Black Slacks' on The Ed Sullivan show in 1957 (maybe they were nervous!), via YouTube, with aptly named Howard 'Sparky' Childress looking all of twelve years old (he was fourteen). This Bear Family ([www.bear-family.com](http://www.bear-family.com)) 10" fourteen tracker is packed with more of that energy.



## DEMON DUO

From the UK audiophile outfit Demon ([www.demonmusicgroup.co.uk](http://www.demonmusicgroup.co.uk)) is a reissue of the Valentine Brothers' 1979 self-titled debut, original released on Source, Remember the hit, 'Money's Too Tight (to Mention)'? That's them. Classic rich, romantic, vibrant soul voices. Soul fans need this one.

Speaking of rich soul vibes, but with disco flavours this

time, Demon is offering Harold Melvin and the Bluenotes' (Featuring Sharon Paige) via 'The Blue Album' (1979). It's first vinyl reissue.

Also check out the thirty-three track, gatefold compilation, 'Northern Soul Anthems' featuring Melba Moore, The Valentines, Free Payne and more.

## SZUN WAVES

Szun Waves has released 'Earth Patterns' (Leaf; [szunwaves.bandcamp.com/album/earth-patterns](http://szunwaves.bandcamp.com/album/earth-patterns)). Luke Abbott, saxophonist Jack Wyllie (Portico Quartet) and drummer Laurence Pike (Triosk/PVT/Liars) offers synth-based jazz improv of symphonic magnificence.



## MUNSTER

From the Spanish audiophile label comes Telegraph Avenue's 'Vol.2' ([munster-records.com/en/](http://munster-records.com/en/)) who combined psychedelic rock with Latin rhythms. Formed in 1969 in Peru, this compilation offers English vocals and sounds like a classic, obscure, energetic, seventies UK rock outfit. Well worth tracking down.



## ...AND FINALLY

Check out multi-instrumentalist Yarni Pigna's self-titled release (*EMK/Kartel*; [yarni.bandcamp.com/album/pigna](http://yarni.bandcamp.com/album/pigna)). This nine-piece jazz funk ensemble certainly mixes it up.

Drummer, Florian Arbenz is back with jazz improv and 'Conversatipn #5' alongside Jojo Barradas, Tineke Postma, Rafael Jerjen and European flavours. Jazz played with...confidence! They know their direction.

Alex Izenberg's 'I'm Not Here' (*Weird World*; <https://alexizenberg.bandcamp.com/album/im-not-here>) sounds like a spaced-out Randy Newman. Give this one time.

London-based Findlay's 'The Last of the 20th Century Girls' (<https://findlaymusic.bandcamp.com/album/the-last-of-the-20th-century-girls>) is competent but this psyche/indie outing is ultimately vanilla.

Moskus' 'Paper Fuglen' (*Hubro*; [www.hubromusic.com](http://www.hubromusic.com)) offers ambient, meditative yet exploratory jazz. It goes nowhere. But sometimes that's ok.

Also on Hubro is Nils Økland's 'Glødetrådar' blending European jazz flavours, rock guitar and improv. The restrained energies add weight to the message.



# Double Exposure

A reference phono amplifier adjustable to accommodate any cartridge, Exposure's VXN grabs John Pickford's attention.

If you're serious about vinyl replay, there's no two ways about it; you need a serious phono stage. Retailing at £1,790, Exposure's new reference level VXN Phono

Amplifier is designed to be paired with the British company's VXN series Power Supply, which costs an additional £1,010. For the ultimate performance, Exposure recommends using two supplies,

one for each channel, bringing the total cost of the three-box ultimate reference system to a whopping £3,810. For this review we've kept things relatively simple and wallet friendly (£2,800) with





the two-box option.

Whether or not you choose to go the whole hog, keeping the highly sensitive phono circuitry completely isolated from the power supply is a good idea, ensuring low noise and maximum performance from the amplifier.

The MC/MM compatible VXN Phono Amplifier is a dual-mono design, which offers optimum performance for stereo replay, however there isn't a mono switch to enable the best, and quietest performance from monophonic records. This may not be an issue for many potential users, however those – such as myself – with a large collection of pop and jazz recordings from the 1950s and 60s will miss the benefits of reduced groove noise a mono switch brings.

What you do get though, are dipswitches on the back panel for adjustable loading and gain settings, making the VXN suitable for all types of cartridge. Separate inputs are provided for moving magnet and moving coil cartridges and an MM/MC push-button switch is located on the front panel.

A maximum of 66dB of gain

is on offer, more than enough for low-output MC cartridges, and 12 loading values for MC are available from 32 ohms to 1000 ohms, so you can precisely optimise the amp to bring out the best from any cartridge.

As you might expect from a phono stage of this quality, discrete transistors are used

"Rhythmically, the VXN's performance was spot-on, with the easy grace and pace only expressed by the very best solid-state and thermionic equipment"



**ortofon**  
accuracy in sound

**2M**

The 2M Series, so named after the abbreviation of Moving Magnet cartridges (MM), features Ortofon's split-pole pin technology for a flat frequency response, a high output for easy integration into any system and a striking visual design inspired by the facets of a diamond. Beginning with the **2M Red**, a reliable all-round performer with an open and dynamic sound, and moving up to the popular **2M Blue** with its nude-mounted elliptical stylus; the range is great for those looking for quality vinyl sound on a budget. Through the **2M Bronze** and **2M Black** models, the bigger budget delivers upgraded cartridge body materials and even more impressive stylus profiles for true high-end sound experiences. The award winning **2M Black LVB 250** sits at the top of the range thanks to its Shibata diamond, nude mounted on a boron cantilever for an intricate, delicate and detailed sound performance that simply cannot be beaten.

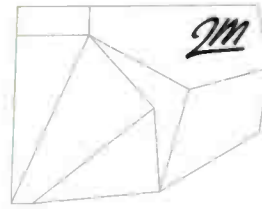
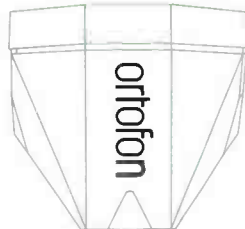
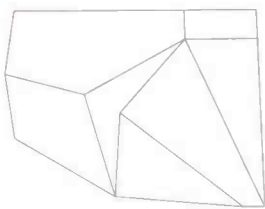

**2M Red**

September 2013    May 2007

**2M Blue**

**HI-FI WORLD**

September 2013    May 2007

**2M Black**

September 2020    December 2011

**2M Black LVB 250**

September 2020    May 2021    EISA Award 2021    April 2021



Distributed by Henley Audio

T: +44 (0) 1235 511 166 | E: sales@henleyaudio.co.uk | W: www.henleyaudio.co.uk | f: HenleyAudioUK | y: HenleyAudio

World Radio History

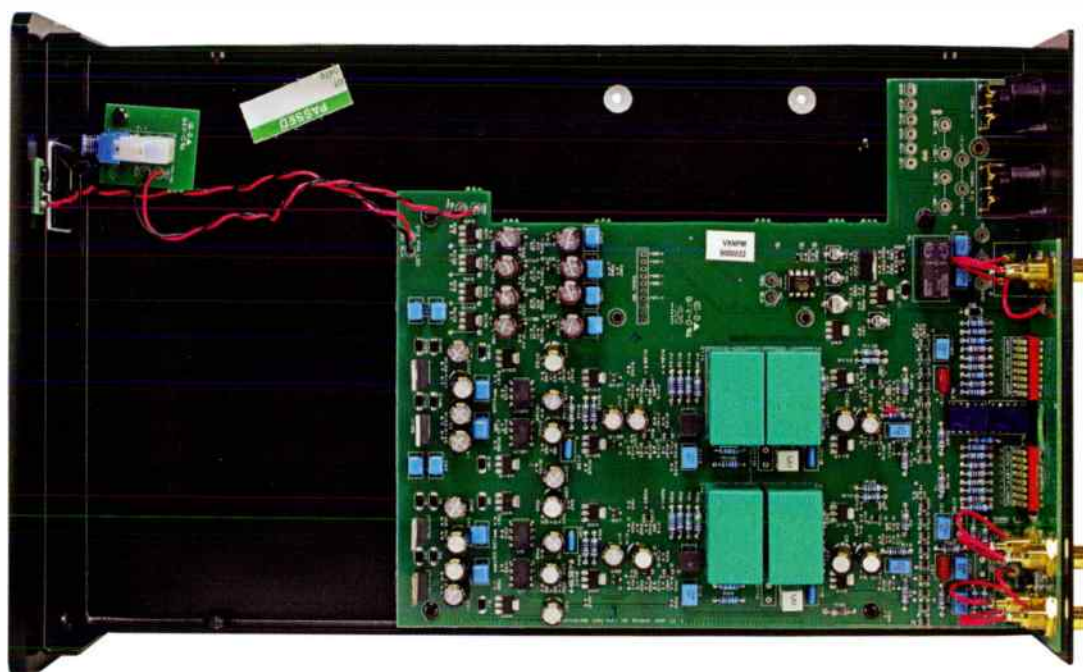

*Fully discrete transistors (seen at right) are used in the signal path, with no integrated circuits Exposure say. Those ICs on the board appear power supply related.*



*The rear panel carries phono socket inputs and outputs; there are no balanced XLR connectors. MC and MM gain are set by DIP switches (red), and so is MC loading. At right are the two VXN Power Supply input sockets.*

the audio circuits, so there are no cheap and cheerful integrated circuits in the signal path to compromise performance. Premium resistors and capacitors are used throughout and Exposure informs us that very high quality Polypropylene capacitors are used in critical areas of the RIAA equalisation. In practice, the noise floor is vanishingly low.

The partnering VXN Power Supply also hosts top-flight components, featuring a high capacity shielded transformer and high speed rectifier diodes; cables are supplied to connect the DC output from the PS to the DC input on the amp. Naturally, Exposure does not recommend using the Phono Amplifier with any other power supply than the VXN. Each unit measures 89mm

x 218mm x 348mm and the aluminium casework is designed to control both resonance and stray magnetic fields, Exposure says. And to paraphrase Henry Ford, you can

have it in any colour you like, as long as it's black.

### SOUND QUALITY

Exposure states "the VXN Phono Amplifier may take up to 48 hours to run-in before reaching its optimal performance. Each subsequent run-in will then take about 20 minutes". I initially powered-up the VXN system around an hour before serious listening (the units had already been run-in for the Measured Performance tests) and noticed no improvement in sound quality in the hours that followed. Subsequently, I followed Exposure's 20 minute warm up period and achieved similar results, so in the current climate of high



*Supplied DC cables to link the VXN Phono Amplifier to its partnering VXN Power Supply.*

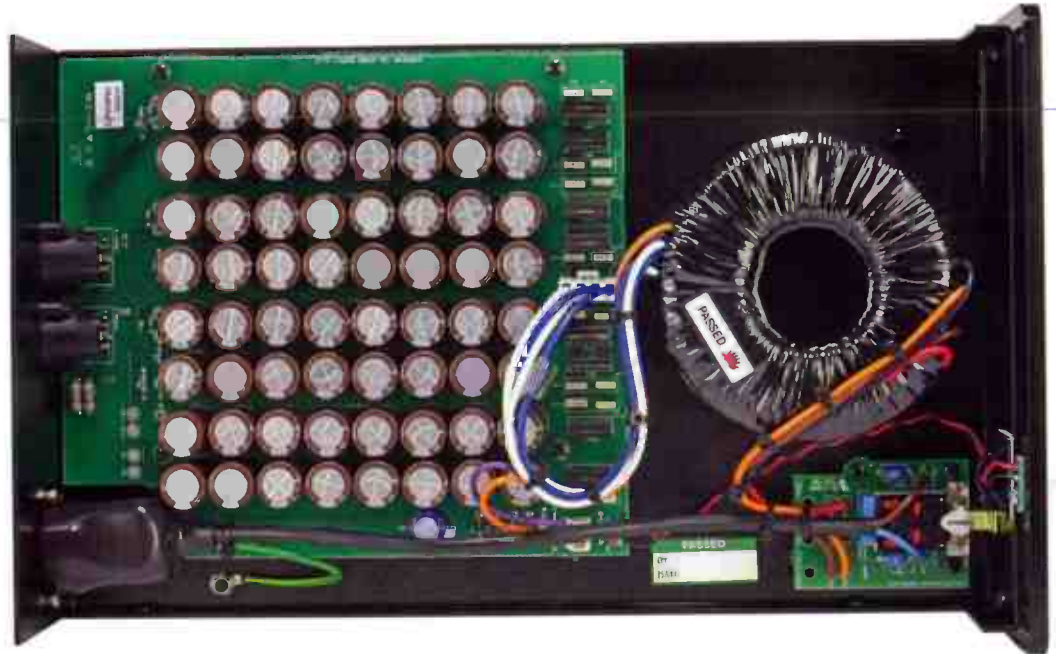

*Under the hood of the VXN Power Supply lies a high capacity toroidal transformer. It feeds banks of electrolytic capacitors (via rectifiers) that store electrical charge, to cope with transient supply demands from the preamp.*

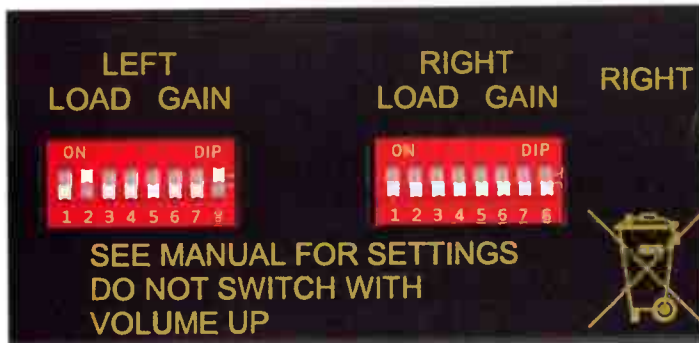

*Impedance values for MC are selectable from 32 – 1000 Ohms, 100 Ohms being the usual option and available here. MC gain can be adjusted to a maximum of 66dB, sufficient for low output MCs. MM is 47k only with no capacitance options. DIP switches are set in combinations as shown in the Handbook.*

energy prices and other environmental concerns, there's no need to leave the units permanently switched on, I would suggest.

Swapping out my Icon Audio PSI valve phono amp for the solid-state VXN combo altered the character of my reference system noticeably, especially in the bass department. Here, bass lines sounded firmer, faster and more fluid, making them easy to follow

and providing a solid foundation for sounds further up the frequency spectrum.

Playing Lou Reed's Walk On The Wild Side from a first pressing of Transformer (RCA 1972) revealed texture in the double bass only available through extremely capable systems. The initial transients from fingers plucking

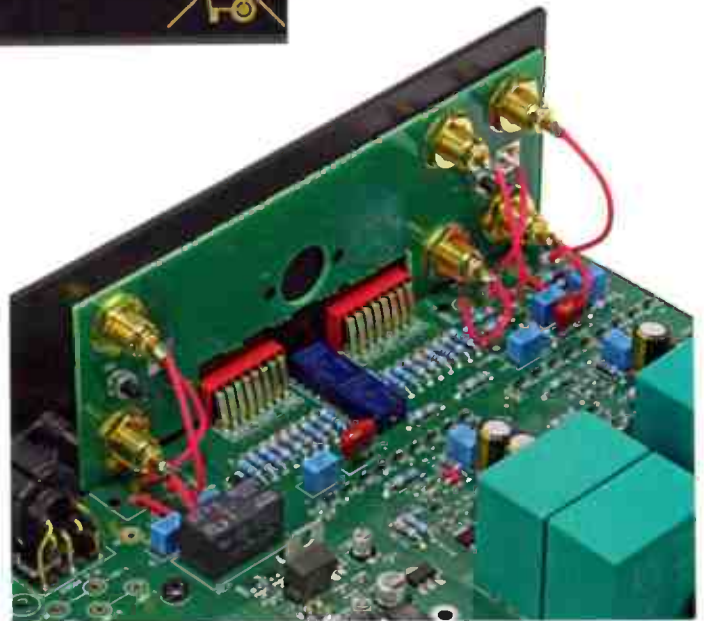

*Behind the rear panel, the input and output sockets, DIP switch pins, banks of loading resistors and a small line of black ants – the SMD discrete transistors. Also visible are big, block-like polypropylene capacitors used in the RIAA equalisation and small-signal sealed relays.*

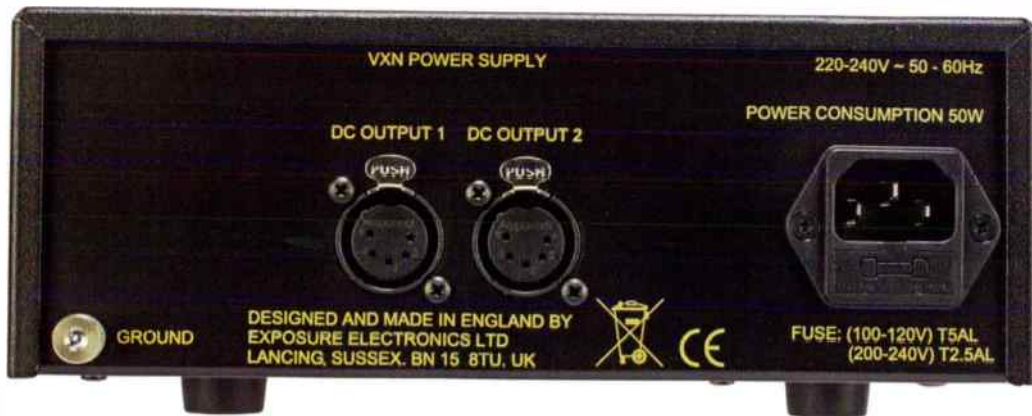

Rear view of the VXN Power Supply showing left and right DC output connectors along with its IEC mains power socket.

strings married with the full-bodied resonance of the notes sounded incredibly convincing and the odd occasion of fret-buzz added to the real-to-life presentation of the performance.

Timbre and timing from midrange audio was first-rate; Lou Reed's close-mic'd vocal had me mesmerised, even though I've played this track dozens of times. And the sound of female backing voices emerging from studio reverb was breathtaking.

Rhythmically, the VXN's performance was spot-on, with none of the mechanical nature of inferior transistor amplification but rather the easy grace and pace only expressed by the very best solid-state and thermionic equipment.

Spinning the title track of Lee Morgan's *The Sidewinder* (Blue Note mono 1964), a groovy soul-jazz tune, further revealed the VXN's ability to swing and, as the amp has no tendency towards brightness or hard-edged treble, the horns sounded nicely rounded, with just the right amount of bite and rasp, but thankfully none of the added harshness or glare I've heard elsewhere. I would normally engage the mono switch on my PS1 to eliminate unwanted groove noise and reduce crackle with this well-played LP, however the quality of sound in all respects allowed me to tune out the noise and enjoy the music.

## CONCLUSION

Although I'm a valve aficionado at heart, I do appreciate solid-state done right and Exposure knows how to do it extremely well. I

retain a 20-odd year old XVII preamp (with decent MC phono stage), which is still giving superb service in a friend's system – I could never bring myself to part with it completely.

Exposure's reference VXN Phono Amplifier may not be the bargain of the century, however it's not unnecessarily expensive when compared with units from other high-end manufacturers; its performance

is on par with the very best phono amplifiers available, regardless of price. A true reference product, then.

### REFERENCE SYSTEM

*Thorens TD124 turntable*  
*Michell Tecnoarm*  
*Benz Micro Ace*  
*Icon Audio PS1*  
*Leak TL12 Plus (with passive control)*  
*Tannoy Berkeley 15" HPD*

## MEASURED PERFORMANCE

The VXN phono stage was accurately equalised on both MM and MC, even at full MC gain of 66dB where inadequate overall stage gain results in bass wile. Below 30Hz bass rolls away to measure a useful -14dB at 15Hz for warp filtering purposes. The warp filter cannot be switched out.

A high output swing of 9V allowed satisfactory input overload values to be achieved. Gain values measured exactly as stated, with a maximum of x1850 (65.4dB) at the MC 66dB setting. With output noise measuring 237 $\mu$ V equivalent input noise measured a low 0.13 $\mu$ V – not as low as a transformer (0.08 $\mu$ V) but usefully close. Hiss will be just about inaudible even with low output MC cartridges.

Although there is a wide range of input loads for MC, there are no capacitance options for MM. The front LED does not change colour between these settings either.

The VXN measured very well all round, and was quiet for a discrete stage. NK

Frequency response 30Hz-20kHz  
 Distortion (-60dB, 24bit) 0.07%

Gain	
MM	40-55dB
MC	58-66dB
Input load (MC)	33-1000 $\Omega$
Overload	9V out

### FREQUENCY RESPONSE

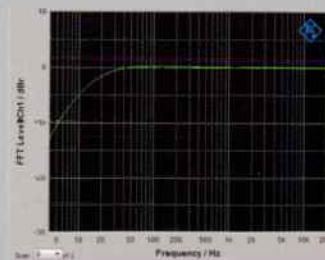

### DISTORTION

THD (%)	Level (dB)	Frequency (Hz)
0.0777 %	5.3865 V	999.97 Hz
OFF	OFF	OFF

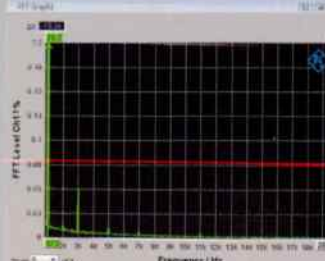

**EXPOSURE VXN  
 PHONO AMPLIFIER**  
 £1,790

**VXN POWER  
 SUPPLY** £1,010



**OUTSTANDING - amongst  
 the best.**

### VERDICT

Highest quality vinyl replay that can be tailored to suit all types of cartridge.

### FDR

- tonal accuracy
- fine dynamic expression
- user adjustability

### AGAINST

- no mono switch
- no balanced connection

Exposure  
 +44 1273 423877  
 www.exposurehifi.com

good  
looking  
...kit!

tuner

aux

tape

**WORLD DESIGNS**

classic valve amplification

[www.world-designs.co.uk](http://www.world-designs.co.uk)



HIGH-END SHOWS | NEWS | REVIEWS

# Go Vinyl!

An easy way to go vinyl is with Audio Technica's AT-LP30W, Noel Keywood thinks.

**A**lways nice to review an Audio Technica (Japan) turntable or cartridge, since they're intelligently engineered, easy to set-up and use. And that was the case with the budget AT-LPW30 belt drive turntable I'm reviewing here, price just £289.99. For that princely sum – or pauper's sum – you get a complete package with cartridge and phono stage. Can't be bad.

I was bemused to find two platter mats amongst the usual array of bits that come with any such turntable: one of ribbed rubber, the other a flat felt slip-mat. Which sounds



best? Generally ribbed rubber gives a slightly deader sound and the ribs better support an LP's surface, especially when dished, but some prefer felt.

The mats – one or t'other – sit on a light die-cast aluminium platter, helping damp it down. Driving the platter is a d.c. servo motor with two speeds: 33rpm or 45rpm. Speed change is electronic, so no need to manually move the belt between different pulley diameters, just turn a knob at front of the plinth.

Audio Technica don't spring any surprises at this price and they keep set-up as simple as possible, following a tried and tested pattern. Because anti-skate bias is built into the arm, adjustable by a small knob, there's no bias weight to fiddle with. The alloy platter is dropped onto the tapered motor shaft and, by a bit of deft finger work, the rubber belt slipped over the motor pulley.

A separate bayonet fixing headshell fitted with an AT-VM95C moving magnet (MM) cartridge must be plugged in, the arm balanced and tracking force set to 2gms using a scale on the counterweight, so no stylus force gauge needed.

There is a swankier AT-LPW40

variant (£319.99) with walnut veneer, black carbon-fibre tone arm and AT-95E cartridge. That's E for elliptical stylus profile, whilst the more basic AT-95C has a conical stylus – as simple as it gets. No great disaster though: you get vaguer treble from a conical – less insight at high frequencies.



**Audio Technica's bayonet fixing removable headshell comes fitted with their own AT-95C budget MM cartridge with basic Conical stylus assembly, colour coded blue. It can be upgraded easily and cheaply to better stylus profiles.**

As I fiddled with the bits to put them together my fingers told me this was not a Japanese turntable, as the arm in particular was a trifle loose on its vertical bearing and the counterweight dial a slack fit. Peering underneath led me to a Serial Number in Chinese characters, plus a Made in China legend – an OEM product then.

My underside inspection also revealed two interesting little holes in a plastic cover, one marked 33

app can do the job so those who are pitch sensitive – usually musicians – can tweak the LP30W to set it right – see our boxout. As delivered the platter was running +0.5% fast – a small error.

The arm is satisfactory, rather than lovely. It has a lightweight feel and the arm rest and safety clip are insubstantial, but the vital clip that prevents accidents worked well. The manual lift/lower lever felt basic. There are no auto systems of any sort, so no auto-stop at the end of an LP side. However, when balanced out the arm floated freely, laterally and vertically, and the headshell has a decent finger lift for hand cueing. At the price a decent offering.

The removable headshell makes cartridge changing easy and measurement shows removables don't affect arm behaviour. In practice they can be upgraded at low cost for better results, so I favour them in this price range.

The phono stage is MM only and can be switched in/out via a rear slide switch. With it switched in the turntable gives a Line output suitable for any amplifier, with it switched out the cartridge signal can be sent direct to an external phono stage of higher ability, even one able to handle moving coil cartridges for those with such ambitions.



**Anti-skate (outward bias) is conveniently applied by a dial on the arm base, shown here. Easier than the simple thread and weight system that's still common. The horizontal bearings are adjustable ball races.**





**A flat MDF veneered plinth on four non-adjustable feet, supporting motor and main bearing. It needs a flat and stable platform free from vibration.**

Where the cheaper (£220) Lenco LBT-188 I reviewed last month had a lovely deep gloss walnut veneered plinth, the AT was more prosaic, its black veneer visually unengaging. Functional rather than pretty. But build quality was good all-round.

Power comes from an external wall wart, delivering 12V/0.5A. This means there is no mains earth and no chance of an earth loop to cause hum, rendering the LPW30 hum free.

### SOUND QUALITY

I used the Audio Technica with our Creek Voyage i20 amplifier that comes with an excellent internal phono stage, as well as Line input so as to hear the internal stage, but I did not spend too long here as these things are peas out of a pod, manufactured somewhere in China, their gain always a low x60 (36dB). This just means you have to

turn volume up a little. Cheap and cheerful they may be but accurately equalised so no great sonic disaster.

Loudspeakers used were our Martin Logan ESL-X hybrid electrostatics connected by Chord Company Signature Reference screened cables.

Immediate impression when

underpinned the track firmly and there was plenty of body in the sound as you hope and expect from LP, Mark Knopfler's vocals clear at centre stage. In keeping with a decent arm the stage was wide, open and had a fine sense of depth, making for an atmospheric delivery.

"I also became aware of the turntable's fine speed control, the band coming over as fast and almost clinically well timed"

set to Phono and connected to the Creek's phono stage – a soft sound. But one in keeping with vinyl expectations: no hard spits or pops, no graunchy digital-style treble. Easy going, laconic. Bass guitar in Dire Straits Ride Across The River

Further up the frequency band treble was vague, as expected from a simple conical stylus. This affected strummed guitar from Neil Young's Tell Me Why where the strings lacked bite and there was general vagueness. I also got to hear some



**At rear a single pair of phono socket outputs switchable from Line to Phono. The Line output utilises an internal phono stage, the Phono output is direct from the cartridge, to feed an external preamplifier. Also here is a push-button power switch for the 12V power input.**

## STOP SPEEDING

If a turntable runs fast it will raise musical tempo and some people, especially trained musicians and music teachers, are sensitive to it. Around 1% error, fast or slow, is considered maximum before pitch error can be detected. Accurate speed is important.

Where a.c. synchronous motors of the past were speed locked to mains frequency, today's d.c. servo-motors from China can be speed adjusted. Should turntable speed and musical pitch bother you this is something to bear in mind. They have better speed stability than a.c. motors and speed adjustment is possible too, as in the AT-LPW30.

Audio Technica say nothing about such adjustment in their User Manual. Likely because – traditionally – to adjust speed a test LP is needed, plus a way of reading frequency of the 3150Hz test tone it produces. This is not an easy adjustment to make at home. Or it wasn't until recently.

Times have changed and you can now measure turntable speed with your iPhone! No need for electronic test equipment, just buy an RPM app. for \$15 (free trial available), place 'phone on platter and get a near-instant readout. Cheap and simple, yet also very accurate; it uses the iPhone's in-built accelerometers.

I did this with the LPW30 and RPM told me it was running +0.62% fast, within a whisker of the +0.5% figure shown by our Wow&Flutter meter reading an accurate and stable DIN 45 545 test disc. You must calibrate RPM first (it self-calibrates) and use longest average for such accuracy.

Was the LPW30 easy to adjust? Not really. There is a small adjuster (board mounted mini-potentiometer) buried deep in a dark hole, turned by a small flat bladed jewellers' screwdriver. I've dealt with these two-bob jobs many times before and know 'em well. I felt the blade sink home easily but the calibration is very coarse, a small twist giving big speed change. I got to +0.15% after nudging the adjuster and felt that was good enough, so speed adjustment to good accuracy is definitely doable, taking 15-20minutes or so.



**The RPM app's readout of speed as +0.63% fast, an acceptable error. Adjustment reduced this.**

**The wow/flutter figure of 0.20% looks high, but it is a basic unweighted value.**

midband hardness of tone.

Spinning Big Band Spectacular from the Syd Lawrence Orchestra made clear the clarity and punch of this modern recording wasn't obvious.

At this point I spotted an Audio Technica headshell with Ortofon 2M Black cartridge mounted in it and made a quick change! This brought the sound stage into focus and provided punch to drums in the intro to Sing Sing Sing (Syd Lawrence Orchestra), making for a very high quality vinyl sound. It was here that I also became aware of the turntable's fine speed control, the band coming over as fast and almost clinically well timed (which they are as a band of skilled musicians used to playing live).

OK, 2M Black is a £500 MM cartridge but it demonstrated that the LP30W is capable of providing such a sound. And Audio Technica offer a cheaper upgrade path

through a wide range of styli for the AT95, up to Microlinear (£130) and Shibata (£190) tip profiles, for more refined and concise treble.

The internal phono stage had a slightly sharper sound and lighter bass than that of the Creek but this wasn't out of place with the AT95C, less suiting the 2M Black. Volume had to be

cranked up substantially as well. Still a good enough stage though with no great weaknesses, certainly



**The main bearing has a brass taper to mate with and hold the platter. Tightly machined with no slack, this is a high quality item common to Chinese manufactured turntables, contributing to speed stability.**



*A neatly finished tonearm with removable headshell that has a usable finger lift. Further back lies an effective arm clip on the rest to prevent accidents, and beside it a cue lever actuating a damped lowering platform.*

none to compromise LP's basic qualities. I thoroughly enjoyed using this turntable: it made vinyl fun and a great listen.

**CONCLUSION**

The AT-LP30W is a well judged

product all-round: easy to set up, easy to use, upgradable and – importantly! – of good sound quality as delivered. You do get to hear the limitations of a budget cartridge but this is inevitable. There is a clear upgrade path

through the fitment of better styli to the AT95 body and they won't break the bank.

Easily a top budget turntable then, right up amongst the best, or even the best at this price point. Wholeheartedly recommended.

**MEASURED PERFORMANCE**

The 3150Hz test tone of a DIN 45-452 test disc varied from 3164-3168Hz on our Wow&Flutter meter. This is a very small amount of speed change (wander), resulting in a low DIN weighted Wow & Flutter value of 0.08% (0.05% to Japanese JIS standard). Speed error was +0.5%; around 1% is considered audible as a change of pitch so this is acceptable and speed can be adjusted.

The arm has a substantial bending mode at 350Hz our analysis of vibration with a Bruel&Kjaer accelerometer on the head shell shows. This is a relatively high frequency, due to light weight cartridge/headshell assembly, and light stiff tube. There was some high frequency disturbance too. With a narrow peak however, it doesn't encompass a lot of energy and is a decent result for a budget arm.

Phono stage equalisation was accurate and there is a small degree of warp filtering (-5dB at 5Hz) to lessen loudspeaker cone flap. Gain was low as always from China-sourced turntables, measuring x60 (36dB) where x100 (40dB) is a standard.

The AT-95C cartridge tracked reasonably well, just clearing a 60µm lateral cut at 300Hz on our CBS STR-112 test disc. The maximum 45µm vertical cut was cleared too, albeit with obvious second harmonic distortion from VTA error. Frequency response (JVC TRS-1007) rolled down slowly toward high frequencies, measuring -2dB at 10kHz – enough to give an obviously soft, even slightly warm sound, somewhat in vinyl tradition, if less accurate than is possible nowadays.

A good if not perfect set of results, speed being a tad fast, and the arm lively. NK

**SPEED VARIATIONS (W&F)**

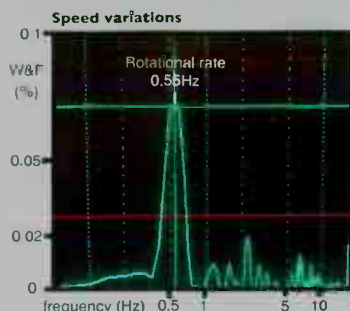

Speed error	+0.5%
Wow	0.1%
Flutter	0.1%
Wow & Flutter (DIN wtd.)	0.08%

**ARM VIBRATION**

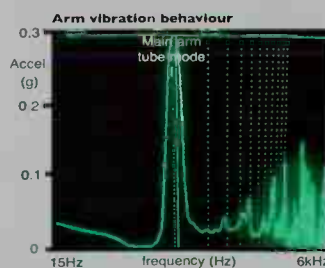

**FREQUENCY RESPONSE**

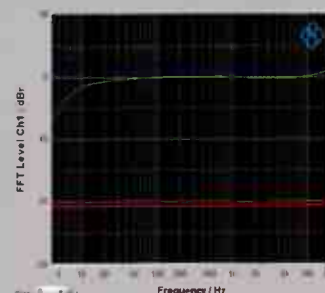

**AUDIO TECHNICA AT LPW30 £290**



**OUTSTANDING - amongst the best**

**VALUE - keenly priced**

**VERDICT**

A superb budget package, easy to set up and use – and with fine sound.

**FOR**

- smooth vinyl sound
- easy to set up
- easy to use

**AGAINST**

- vague treble
- sombre finish
- non adjustable feet

Audio Technica  
+ (0)113 277 1441  
www.eu.audio-technica.com

# SUMIKO

PHONO CARTRIDGES



IMMEDIATE, CLEAR, AND DETAILED

*Wellfleet* <sup>NEW</sup>

NEXT-GEN MOVING MAGNET  
PHONO PICKUP

Wellfleet stylus can be used to upgrade existing Rainier, Olympia & Moonstone cartridges.



Distributed by Henley Audio

T: +44 (0) 1235 511 166 | E: sales@henleyaudio.co.uk | W: www.henleyaudio.co.uk | f: HenleyAudioUK | y: HenleyAudio

# Gimme The Facts, Man!

Taking a turn for the reference, Paul Rigby looks at information-brimming tomes, this month

## READY STEADY GO!

Subtitled 'The Weekend Starts Here: The Definitive Story of the Show That Changed TV', this is a large format hardback whose physicality cannot go unmentioned. Really. This is a book spanning just under 32 x 31 cm and it weighs... a lot. That's because this book is jammed with high-quality images of the show itself, in front and behind the camera, the stars of the moment close up and widescreen, the people in the audience, the host Cathy McGowan, outside in the London streets, poster art, press clippings, a large episode guide and a list of just who appeared on the show.

There's even photos of McGowan accompanied by stars like Cilla Black and more, helping the famous Biba boutique to move into their new premises on Kensington High Street.

This book is filled to the brim with visual goodness. Then there's the story itself. Without McGowan sadly, who refused any formal approaches and just wants the quiet life these days. Her words are brought to us via the archives however, plus over 100 new interviews from a host of people involved with the show, from directors to secretaries to dancers and the stars themselves via members of: The Hollies, The Animals, Georgie Fame, Rod Argent, Brian Poole, Colin Blunstone and more. Each is titled and given paragraphs to comment on a particular chapter theme.

A quite stunning book. Oh and for you hi-fi fans? Check out the Cathy McGowan-branded, Dansette Transit portable record player!

## BUYING INTO BRITPOP

An A4-sized paperback from ace collector, Rob Fiddaman who is a memorabilia and collectable expert for a range of genres across music history but who specialises in nineties-era Britpop. Rob has even advised myself when I've written my Most Wanted collectables

column for the UK's Record Collector, news-stand magazine.

The man knows his stuff so it's great to see his thoughts trapped on these illustrated pages.

This is a book that introduces the reader into collecting Britpop items. The emphasis here is the love of the music and the love of the times. It's not about value and investments and making a fast buck. Saying that, there are some choice items illustrated here including glasses worn by Noel Gallagher, a tambourine used by his brother Noel, maracas used by Bez from The Happy Mondays plus a signed drum skin from the band, Space.

The focus is the images. Accompanying each are, in effect, extended captions. In addition to that, Fiddaman provides a memoir of thoughts and feelings and memories.

It's a great personal account that allows us a peek into one man's musical passion.

## SHINDIG!

This is a hardcore reference book for fans of the US TV show, Shindig! But also anyone who has an interest in TV history, music history, band history and more. It's an ideal confluence of information. A source packed with detail that serves as a crossroads for further research.

Running from 1963 to 1966, this book takes each episode, one at a time, including the three early pilot episodes and it crams.

For example, Episode 37 from 26 May 1965 tells us that guests included The Rolling Stones, Jimmie Rodgers, Jackie DeShannon, Howlin' Wolf and more.

You get a list of who sung what and when on that show, when each performance was taped, where each song derives in album terms, how it charted as a single, was it a B-side?, the set dressing if applicable, if the song was a cover then from whom and more.

A fine work of reference and an obvious work of love.

**Title:** Ready Steady Go!

**Author:** Andy Neil

**Publisher:** BMG

**Price:** £39.99

**Pages:** 267

**Contact:** Amazon



**Title:** Buying Into Britpop

**Author:** Rob Fiddaman

**Publisher:** Private

**Price:** £12.99

**Pages:** 55

**Contact:**

[www.vinylexchange.co.uk](http://www.vinylexchange.co.uk)

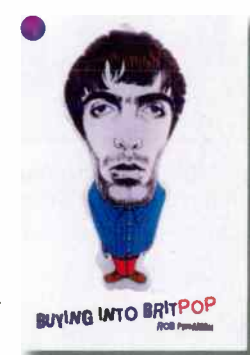

**Title:** Shindig!

**Author:** Peter Checksfield

**Publisher:** Private

**Price:** £11.95

**Pages:** 186

**Contact:** Amazon

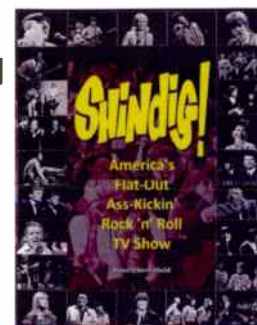

# Dial A Dealer Directory

directory of Hi-Fi Dealers throughout the UK and Ireland



**Inspire Hi-Fi**  
**www.inspirehifi.co.uk**  
**+44 (0)1246 268887**

**2 CHANNEL AUDIO SPECIALISTS**

Including our own bespoke award winning turntables and a comprehensive range of turntable upgrades.

While you wait servicing and upgrades available.

Linn Sondek LP12 upgrades and servicing. Demo's by appointment.

ROKSAN ORTOFON SUMIKO PROJECT MUSICAL FIDELITY KLIPSCH UNISON RESEARCH KUZMA YAMAHA MONITOR AUDIO AUDIO TECHNICA ORIGIN LIVE AUDIO ORIGAMI HI-FI RACKS STAX HI-FI RACKS LEHMANN OPERA CUSTOM DESIGN



**HI-FI WORLD**  
**★★★★★ £**  
MONOPULSE SA LOUDSPEAKER £1590  
 OUTSTANDING - amongst the best  
 VALUE - keenly priced

**MonoPulse**

**Reality in front of you**

9 High Street, Hampton Wick,  
 Kingston upon Thames, Surrey KT1 4DA  
**Open: Tuesday - Saturday 10am - 6pm**  
**0208 943 3530**

**Infidelity**  
 MUSIC & CINEMA SYSTEMS

NAIM, LINN, REGA, ARCAM, B&W 800 SERIES, PMC, FOCAL, DYNVECTOR, KUDOS, VELODYNE, STAX, LYRA, OPPO, TANGERINE AUDIO, TELLURIUM Q.

**SEE AND HEAR THE VERY BEST**

CEDIA MEMBER **clarity**

TO ADVERTISE HERE  
 PLEASE CALL  
 ROSE WILLIAMS ON  
 +44 (0) 7956885189  
 OR EMAIL:  
 rose@hi-fiworld.co.uk

DESIGNED & HANDMADE IN SCOTLAND

**Equator**



Our high-precision Achromatic RCA and Z plugs are designed to have minimal impact on the signal – with virtually nothing added, nothing taken away – resulting in improved sound quality.

Now standard on Element, Equator, Hyper & our new Ailsa cables.

Equator Achromatic Speaker Z

**ACHROMATIC**

LOW MASS  
 NON-MAGNETIC  
 COLD-WELD  
 CONNECTOR

**ATLAS**  
 the performance connection  
 atlascables.com



# free reader Classifieds

**TERMS AND CONDITIONS:** Only one advert per reader. No Trade adverts. This section is strictly for readers selling secondhand hi-fi equipment only. Maximum length per advert is 30 words, Adverts over 30 words will not be accepted. Telephone numbers and E-mail addresses are treated as one word. Model numbers are treated as one word i.e. Quad 303 = two words. Email your advert to; [classifieds@hi-fiworld.co.uk](mailto:classifieds@hi-fiworld.co.uk) or fill in the form on page 81 and post it to Hi-Fi World Free Readers Ads, Office 052, 464 Edgware Road, London W2 1AH. Sorry, we cannot accept adverts over the telephone. The Publisher reserves the right to judge submissions.

PIONEER PD91 CD player, owned from new, £995. Pioneer PL590 Direct Drive turntable, SME Series Three, £1500. Exceptional condition. Audio Technica AT637 electronic stylus cleaner, boxed, unused, £100. Tel: 01708 457 691

B&W 805 D3, as new, boxed, with stands. £3500. Revel M22, as new, boxed, with stands, £800. Mission 770, very good condition, £300. Tel: 07908 431 807

MUSICAL FIDELITY Series X-A1 intergrated amplifier. 50 watts per/channel. Mint. Boxed. £375 ono. Please call 07505 057 414 London/Hampstead.

LONDON DECCA Gold cartridge. Bought 1992. Appx 10 hrs used. Untouched since. Boxed. Inspection welcome. Olympus OM2N black. Comes with single frame motor drive. Mint. Please call 07505 057 414. London/ Hampstead.

AUDIOLAB 8000M single monobloc (British version) in black and in working condition £210 (ono) Isotek intium mains cable 1.5 metres in length £50. Tel: Andy on 01484 427426 or Email: [andrewstringer476@yahoo.com](mailto:andrewstringer476@yahoo.com).

MARANTZ CD85 £495 Audio Note Japan QSSC silver RCA interconnects pair £395. Kelvin Labs Integrated £450 Tel: 0113 2579043

MARTIN LOGAN 800x subwoofers, a pair, along with Wi-Fi senders, receivers and the ML PBK microphone and tripod. Less than 1 year old and with all original packing and manuals. £1950 ono. Psvane TII 12AX7's, a factory matched pair, few hours only in original box. £60. Psvane TII 12AU7's, a factory matched pair, few hours only in original box. £60. Tel: Steve 07985 975 546

ALMARRO 318b SET integrated amp. Serviced few years back with new power valve's £650. Asking £950.00 ono. Contact Robert. Email: [ram\\_electrical\\_leeds@yahoo.co.uk](mailto:ram_electrical_leeds@yahoo.co.uk) (East Leeds area)

REGA DAC 28954 used one year. Logitech UR Ultimate Ears green, used once . Marantz CD 60000SE K1 Signature. Offers. Phone Colin on 07540 853 629 (Merseyside)

QUAD 44 Pre amp. £250. Mission speaker cable, two four metres, £50. Audio Technica AT637 electronic stylus cleaner, boxed, unused, £100. Pioneer PL550 Direct Drive turntable, £550. Tel: 01708 457 691.

ICON AUDIO SE30. £1250. Excellent condition. Valves all have around 200hrs use. Original (substantial) packaging included. Tel: Adrian on 07931 548 755 evenings and weekends or Email: [adrianandemmal@gmail.com](mailto:adrianandemmal@gmail.com)

MARANTZ PM8006 integrated amplifier. 6 months old. Champagne silver colour. All original packaging, manuals and remote included. Great condition. £825 ovno. Tel: Tom 07902 407 885. Email: [trgdyson@hotmail.com](mailto:trgdyson@hotmail.com) (South Bucks)

RADFORD MA15 monoblocks (pair), £3500. Radford SC22, £500. Radford FMT2, £350. Audio Research D115 Mk2, £1500. Conrad Johnson PV10A phono, £1200. All owned 25 years plus. House purchase forces sale. Tel: 07584 571 301

ROGERS LOUDSPEAKERS LS6/a2, Serial - 17177. Black, bi-wireable, 8 ohms. Flat frequency response +/- 2dB. Fully working. 28 x 30 x 51 cm. 89dB sensitivity. Excellent condition. £175. Possible delivery local-ish. Tel: 0115 974 3646 (Nottingham)

WANTED: AUDAX HM-210 CO, carbon cone bass driver used in Hi-Fi World KLS3 design. Tel: John 07930 289 650

REGA RB300 tonearm with Origin Live structural and wiring upgrades. Excellent condition. £150. Denon DL-304 MC cartridge, boxed, little use. £150. Tel: Ian 01273 842 097

AUDIO CASSETTES, 100 sealed, various makes, types, lengths. £200. Denon POA 440A monoblock power amps. £1000. QED DiscMaster phono stage, £50. JVC 1770 vintage cassette deck. Exceptional. £150. Tel: 01708 457 691

MUSICAL FIDELITY amp John Sampson upgraded (£1,400) P270 power to phenomenal "P470". Pictures available Speed, grip, musicality, comparable amps £2k + Asking £1,850. Downsizing sale Please contact Tom 07809 554 827 (West Yorks)

PRIMARE i30 amp. Black, boxed with remote £650. Tel: Bill 02084 649 055 or Email: [billmilla@virginmedia.com](mailto:billmilla@virginmedia.com) (Bromley)

SONY TC-K61 IS Dolby B.C.S 3 head, very light use, owned from new Excellent condition £150. Sony ST-SA 3 ES high end RDS tuner FM-AM Tuner very light use. £100 Both black. Pickup, Milton Keynes. Email: [terrypaulaok@hotmail.co.uk](mailto:terrypaulaok@hotmail.co.uk)

REGA ELEX-R amp. 1 year old. All packaging remote etc. As new condition. £625. Collection only from Slough. Tel: 07398 642 586 or Email: [johnakeanelangley@gmail.com](mailto:johnakeanelangley@gmail.com)

WANTED: LECSON Lynette LB1 speakers in any condition. Have been looking for ages. Tel: Alex 07939 116 779

CHORD SIGNATURE ARAY 1.5m mains cable, hardly used, as new and boxed £330. 2no sets Naim cups and balls with 2no 455x345x10mm grey toughened glass £65 Tel: 07785 733 202 (Chichester, Sussex)

ORTOFON 2M Blue cartridge. Boxed. Excellent condition. About 30 hours use. £120 ono. Tel: 07894 988 879 or Email: [andy@shearer1.com](mailto:andy@shearer1.com)

SOUND STYLE Hi-Fi/TV tables (2) rectangular, 3 shelves, black steel, black glass. Hold up to 6 units or 1 TV, 4 units. £40 each. Email: [walcherry@yahoo.co.uk](mailto:walcherry@yahoo.co.uk) (Ross on Wye)

WANTED: Top quality HiFi separates and complete systems, Naim, Linn, Cyrus, PMC, Audio Research etc, fast, friendly response and willing to travel/pay cash. Please call me on 07815 892 458 or Email me at [pogsonp@aol.com](mailto:pogsonp@aol.com)

WILSON DUETTE II speakers & stands. Obsidian Black. All accessories, instructions etc. Condition as new. Little used. £10.5k (RRP £26k). Can demonstrate. Tel: 07704145987 (AM only). Email: [norbertstefan@yahoo.co.uk](mailto:norbertstefan@yahoo.co.uk)

WANTED: TECHNICS RS-1500 tape recorder with remote, service manual and instruction book. Also Uher SG-631 tape recorder. Tel: 01902 870 605

ICON AUDIO Stereo 40 MkIII with Jensen caps and recent valves. £800 ono. Buyer collects. Tel: 07531835575 (Glos)

RUSS ANDREWS Torlyte base and shelf unit. In excellent condition, total height 439mm. £370 inc. P&P. Tel: Graham 07815295227 (Durham)

PICK UP THE OCTOBER 2022 ISSUE OF HI-FI WORLD ON SALE AUGUST 31ST 2022, OR SUBSCRIBE AND GET IT DELIVERED TO YOUR DOOR: SEE PAGE 30

# NEXT MONTH OCTOBER 2022 ISSUE



## iBASSO DX320

Next month – a surprise. We test the new top portable player from IBasso, their DX320, that uses a new high quality DAC. And it isn't from ESS of California who now dominate the market, but ROHM of Japan – using their latest (2020) BD34301EKV DAC chip. iBasso say they "carefully designed circuitry and implementation to allow all the quality to shine through". Next month we measure and listen to this new player/chip combo. Don't miss finding out the truth.



# FREE READER CLASSIFIED ADS ORDER FORM

**STOP PRESS**

**ADVERTISERS INDEX**

Absolute Sounds OBC

Atlas Cables 78

Chord Electronics 12

EnjoyTheMusic.com 70

Grand Activation IBC

Henley Audio 16,50,56,66,76

Icon Audio 34

Infidelity 78

Inspire Hi-Fi 78

Jordan Acoustics 14

KEF 6,20,22

Mikam Sound 54

Music First 54

Monopulse 78

The Chord Company IFC

World Designs 70

**TERMS AND CONDITIONS:** Only one advert per reader. Maximum length per advert is 30 words, Adverts over 30 words will not be accepted. No Trade Adverts. This section is strictly for readers selling secondhand hi-fi equipment only. Telephone numbers and E-mail addresses are treated as one word. Model numbers are treated as one word i.e. Quad 303 = two words. Sorry, we cannot accept adverts over the telephone. The Publisher reserves the right to judge submissions.

You can email your advert to us at: [classifieds@hi-fiworld.co.uk](mailto:classifieds@hi-fiworld.co.uk) or write or type your advertisement copy in block capitals with one word per box and post it to us at:

Hi-Fi World Free Readers Ads,  
Office 052  
464 Edgware Road  
London  
W2 1AH

**WE WILL ACCEPT PHOTOCOPIES OF THIS FORM**

**We cannot accept adverts over the telephone**

1	2
3	4
5	6
7	8
9	10
11	12
13	14
15	16
17	18
19	20
21	22
23	24
25	26
27	28
29	30

Name: \_\_\_\_\_

Address: \_\_\_\_\_

Post Code: \_\_\_\_\_

Daytime Tel: \_\_\_\_\_

**FREE READER CLASSIFIED ADVERT COPY DEADLINE FOR OCTOBER 2022 ISSUE 12TH AUGUST 2022**

# WHITE PLAINS

## WHITE PLAINS

### 7T's



"The basic harmonic qualities from the band are quite delightful and easy on the ear"

Sometimes. Sometimes you've just got to get your teeth into sparkling, airy, lively seventies pop, draped with so much melody that 10 fingers and toes are really not quite enough to accomplish the required tapping.

White Plains are one of those groups that haunted the charts back in the seventies but very few people actually remember them. Yet their hit singles are staples, even now, of the radio.

Smash hit singles such as 'My Baby Loves Lovin'', 'When You Are A King', 'Julie Do Ya Love Me' and 'I've Got You On My Mind' have 'The Seventies' running through them like a branded stick of rock.

If you haven't had the pleasure, just who on earth were White Plains? Well, that's a tough one to answer because this was a group who never stood still in terms of their line up, despite core members hanging around but their song-writing source was Roger Cook and Roger Greenaway who some of you might remember performing as David & Jonathan from 1966 who wrote the hits 'This Golden Ring' and 'You've Got Your Troubles' for the UK outfit, the Fortunes (and later Blue Mink, The Hollies and others).

White Plains was packed with British veterans of the scene. Singer Peter Nelson had missed the charts despite releasing a host of singles, sometimes with Robin Shaw, another White Plains member. Tony Burrows was ex-The Kestrels and The Ivy League. All three joined and hooked up with former Ivy League member Neil Landon to form The Flower Pot Men to produce a No.4 UK hit, 'Let's Go to San Francisco' in 1966.

After a while that band had run its course but there were still potential hit singles hanging around the slightly rejigged line up. There was still potential there. For example, one of the final tracks recorded by The Flowerpot Men was that future White Plains smash, 'My Baby Loves Lovin''. It was Decca man Dick Rowe, the man who rejected The Beatles (his strike rate remained impressive but popular history chooses to ignore that), who suggested that the guys start afresh with that song book as White Plains.

Roger Greenaway stepped up to be the front man, Pete Nelson, Robin Shaw and Tony Burrows handled the backing vocals, Burrows also had a hand on the contemporary hits,

'Gimme Dat Ding' by The Pipkins, 'Love Grows' by Edison Lighthouse and 'United We Stand with the Brotherhood of Man'.

The White Plains self-titled debut arrived on Deram during September 1970 mixing the new band with tracks from The Flower Pot Men.

White Plains shared the vocals around, as voices were not in short supply in this band. Roger Cook was also the Blue Mink lead vocal at that time.

Tracks on the album feature interesting histories. For example, 'Taffeta Rose' was written by Jerry Lordan and one Hank Marvin and had already been a single for the band, Brotherly Love. Another track, 'Summer Morning' had also been a single for Vanity Fare.

This was a time when producers like Cook and Greenaway would rotate songs from one umbrella group to another and back again.

Later, in 1971, White Plains would also issue a second album called 'When You Are A King' which featured more hits and more melodic fare.

Both albums can actually be found on a recently released 3CD set called 'White Plains: The Collection' (via the 7T's label). You'll find one CD for each album with a number of extra tracks appended to each. A third disc features a host of rarities including later spin-off groups. This multi-gatefold collection includes the band's entire story in song and written down via the included booklet.

The band called it a day after releasing the single, 'Ecstasy' in May of 1974. Success was proving harder to find so the band split at the end of that year.

To me, White Plains sounded akin to The Move. There's a flavour of Roy Wood in there. There's some Jeff Lynne in there as well. That slightly nasal quality mixed with melodic hooks, a driving beat and a musical flow that never jars. The basic harmonic qualities from the band are quite delightful and easy on the ear.

What I like about the 7T's box set is that it puts people to hit singles, it puts names to faces. It supplies context and reminds us that these pieces of pop ephemera were created by real – and rather talented – individuals. They deserve to be remembered. **PR**

Do not underestimate the role of a 'tiny' fuse, a good fuse can restore the potential of your replay system.

Pd Audio's fuses, using metal molecular activation technology, launched 4 series: Element, Innovation, Hyper and Master, to meet the different needs of music enthusiasts.



*Fascination Of Technology*

Metal molecular activation technology is to increase the electron flow per second thus improving the dynamic range and reducing the background noise.

# ENOUGH SAID

"Setting a new standard for tube amplification."

Jeff Gornus - *TONEaudio*

EVO 400 Tube Preamp & EVO 400 Tube Poweramp

"Tube Magic."

Vance Forrester - *The Absolute Sound*

EVO 100 Tube Digital Analogue Converter

"It is in combination that the PrimaLuna Evo 300 duo shine. This isn't magic synergy or tweaking the response of one to suit the other."

Alan Sircum - *10Fi Plus*

EVO 300 Tube Preamp & EVO 300 Tube Poweramp

"The PrimaLuna EVO 400 Integrated surpasses its predecessor, the DiaLogue Premium HP Integrated, thereby inheriting the throne of the best integrated tube amplifier in the world"

Max Dolissen - *Music Emotion Magazine*

EVO 400 Tube Integrated Amplifier



 **absolute sounds ltd.**

International Distributors & Consultants of Best-in-Class Hi-End Audio & Video Systems

58 Dartmouth Road, London, SW20 0TW

T: +44 (0)20 89 71 39 09

[absolutesounds.com](http://absolutesounds.com) [info@absolutesounds.com](mailto:info@absolutesounds.com)

 **PrimaLuna®**

For Your Nearest Dealer Please Visit

The [Absolute Sounds Website](http://Absolute Sounds Website)