

HI-FI WORLD

FEBRUARY 2022

UK £5.00

www.hi-fiworld.co.uk

FREE READER CLASSIFIED ADS IN THIS ISSUE!



EXPOSURE 3510
amplifier



NAIM UNITI ATOM HE
headphone amplifier



LENCO LS-55
turntable



FOCAL ARIA 906 K2 LOUDSPEAKERS
SENNHEISER CX PLUS IN-EAR HEADPHONES
THE CHORD COMPANY GroundARRAY CONNECTORS
OLDE WORLDE – VINTAGE HITACHI DA-7000 CD PLAYER

COMPETITION



A CHANCE TO WIN A ZEN CAN HEADPHONE AMPLIFIER OR ZEN PHONO STAGE (UK ONLY)

EXCLUSIVE

ACOUSTIC ENERGY AE320 loudspeakers

FEBRUARY 2022



02 >
9 770961 766215



SEVEN PAGES OF LETTERS - THE BEST WINS A PAIR OF ACOUSTIC ENERGY'S NEW AE100² LOUDSPEAKERS! (UK ONLY)

Winning performance



CHORDTM
COMPANY



Audiophile quality at a realistic price

The multi-award-winning Chord Company cables feature the latest high-performance shielding and our unique ARAY technology, first introduced on our flagship products and now benefitting all ranges.

A wide variety of analogue and digital interconnects are available alongside high-performance speaker, tone arm, mains power and HDMI cables. We also supply stand feet, contact cleaner and the acclaimed English Electric 8Switch and 16Switch.

Proudly designed in England since 1985 by a dedicated team of music, cinema and game lovers. Used and recommended worldwide by a host of professionals, including record producers, studio engineers, musicians and hi-fi manufacturers.

Ask your nearest Chord Company retailer for a demonstration/loan - including the new Chord Company GroundARAY.

Find out more: www.chord.co.uk



Grand Prix

welcome

EDITOR

Noel Keywood
e-mail: editorial@hi-fiworld.co.uk

DESIGN EDITOR

Faiza Chunara
tel: +44 (0)7399 361 785
e-mail: adproduction@hi-fiworld.co.uk

PRODUCTION EDITOR

David Noble
tel: +44 (0) 207 286 1270
e-mail: classifieds@hi-fiworld.co.uk

SALES MANAGER

Louise Palfrey
mob +44 (0) 7917 047 548
e-mail: louise@hi-fiworld.co.uk

ADVERTISING EXECUTIVE

Rose Williams
mob. + 44 (0) 7956 885 189
e-mail: rose@hi-fiworld.co.uk

PUBLISHER

Noel Keywood
e-mail: publisher@hi-fiworld.co.uk

FREE READERS CLASSIFIEDS

tel: +44 (0) 207 286 1270
e-mail: classifieds@hi-fiworld.co.uk

SUBSCRIPTIONS

tel: + 44 (0) 1442 820 580
fax + 44 (0) 1442 827 912
e-mail: hi-fiworld@webscribe.co.uk

PHOTOGRAPHY

David Noble
tel: +44 (0) 207 286 1270

WRITERS

Paul Rigby, Martin Pipe, Chris Frankland.



Big loudspeakers able to shake a building don't come cheap. One of the most memorable reviewed by us recently (Dec 21 issue) was JBL's HDI-3600, an imposing floorstander with thunderous bass yet a price tag of £3198. That's well below so many others with similar pretensions. But in this issue we have for delectation the Acoustic Energy AE320 – a floorstander that similarly packs a powerful punch low down. If you dream of seismic lows that move the body it could be the one, the speaker of your dreams – price just £1599. Don't miss reading about it on p11.

Another classic British product that appears in this issue is Exposure's new 3510 amplifier. Very deliberately a honed update of the way it was done long ago, it uses well developed circuitry in Class A/B output configuration, equipped with modern transistors. The result is low distortion and excellent load tolerance, unlike that of Class D amplifiers. Add in a huge linear power supply and the end result is worth hearing thinks Martin Pipe, as he explains on p18.

Yet another great British brand – Naim – also appear in this issue. You can find them on p66 where we look at their Uniti Atom HE streamer/headphone amplifier. With numerous balanced headphone outputs this is for headphone aficionados that want a smooth Naim sound from the internet or from their own home-network sources, not forgetting Bluetooth from the 'phone. The HE is a different way of doing things.

Lenco's budget LS-55 turntable seems to offer it all from the vinyl LP, including digital recording to a flash-drive, replay from that drive and Bluetooth output. But with all this costing just £135 there were drawbacks we found. Read about them on p73 to find out why a turntable like this is not the bargain it appears.

I hope you enjoyed Christmas and wish you Happy New Year, but sadly the magazine and I won't be at February's Bristol Show in sunny 2022 because it has just been cancelled due to the accursed bug. Better luck in 2023 perhaps!

Noel Keywood
Editor



hi-fi world

Audio Web Publishing
Office 052
464 Edgware Road
London
W2 1AH
www.hi-fiworld.co.uk

verdicts

●●●●● **OUTSTANDING**
●●●● **EXCELLENT**
●●● **GOOD**
●● **MEDIOCRE**
● **POOR**
£ **VALUE**

amongst the best
extremely capable
worth auditioning
unremarkable
flawed
keenly priced

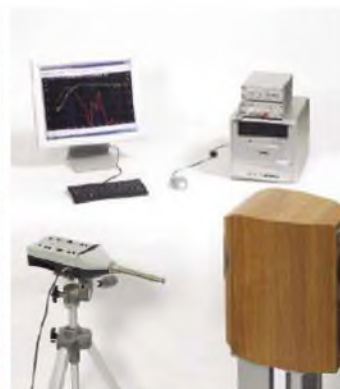

testing (see www.hi-fiworld.co.uk for full explanations of all our tests)

To ensure the upmost accuracy in our product reviews, *Hi-Fi World* has extremely comprehensive in-house test facilities, and our test equipment - from big names like Rohde & Schwarz and Hewlett Packard - is amongst the most advanced in the world.

Loudspeakers are measured using a calibrated Bruel & Kjaer microphone feeding a Clio-based computer

analyser, using pulsed and gated sinewaves, in a large room to eliminate the room's influence. Pickup arm vibration is measured with a Bruel & Kjaer accelerometer.

No other UK hi-fi magazine has in-house testing, and none has access to such advanced tests across all types of equipment. That's why you can depend on *Hi-Fi World* reviews.

ELECTRONIC MAGAZINE

Go to our website www.hi-fiworld.co.uk to buy an electronic version of this magazine, individual issues, back issues or a subscription.

Distributed by Select Publisher Services Ltd. P.O. Box 6337, Bournemouth, BH1 9EH UK Tel +44 (0) 1202 586848
Printed by Precision Colour Printing Halesfield 1, Stirchley, Telford TF7 4QQ, United Kingdom Tel: + 44 (0) 1952 585585

Our Agents in Malaysia Millennium Hi-Fi & AV Simon Chang Showroom & office, 500-1-3 First Floor Wisma Indah (Shen Court), Jalan Tun Razak 50400 Kuala Lumpur, Malaysia
Tel: 603 9283 8171 Fax: 603 9281 3762 e-mail: info@millennium-audio.com

All unsolicited submissions and goods are at the owner's risk. We accept no responsibility for such submissions, nor do we undertake to return them.
No material may be reproduced from this magazine without the publisher's written permission. © Audio Web Publishing Ltd

contents



LOUDSPEAKERS
ACOUSTIC ENERGY AE320 LOUDSPEAKERS 11
New affordable floorstanders with deep bass and a fast sound impress Noel Keywood.

FOCAL ARIA 906 K2 LOUDSPEAKERS 34
Hi-tech stand-mounting loudspeakers with K2 sandwich-construction cones get Noel Keywood's attention.

DIGITAL
NAIM UNITI ATOM HEADPHONE AMP 66
Martin Pipe checks out an interesting digital headphone amplifier from Naim that's also a streamer.

AMPLIFICATION
EXPOSURE 3510 INTEGRATED AMPLIFIER 18
Exposure release a classic analogue hi-fi amplifier. Martin Pipe enjoys its sound.



FEBRUARY 2022

VOLUME 31 : NO. 12

CABLES

40 CHORD COMPANY GROUNDARAY

Martin Pipe is puzzled by a range of earth tuning plugs (we think) from cable experts Chord.

OLDE WORLDE

63 HITACHI DA-7000 CD PLAYER

In the early days CD players were expensive. Martin Pipe checks out Hitachi's budget alternative from the 1980s.

HEADPHONES

58 SENNHEISER CX PLUS WIRELESS EARBUDS

Cable-free Bluetooth headphones at a great price. Martin Pipe investigates.

VINYL

70 NEWS

All the latest and greatest vinyl releases for you, from the pen of Paul Rigby.

73 Lenco LS-55 TURNTABLE

A budget turntable package with ceramic cartridge and digital comes under the scrutiny of Noel Keywood.

77 AUDIOPHILE BOOKS

Three books – The Electric Muse Revisited, Growing Out Of It, The Police, reviewed by Paul Rigby.



REGULARS

7 NEWS

Words from the world...

17 COMPETITION

Win an ifi Zen CAN headphone amplifier or Zen PHONO phono stage in this month's great competition with two prizes, one for each winner.

26 MAIL

Seven pages of your views, wonderful as always...

38 SUBSCRIPTIONS

Ensure your copy every month and save money too!

44 WORLD STANDARDS

Updated guide to the latest and greatest hi-fi hardware on sale

51,53,55 OPINION

The team get to grips with matters music, hi-fi and life!

56 AUDIOPHILE CD

Paul Rigby rounds up the latest audiophile CD releases.

78 DIAL-A-DEALER

A comprehensive guide to UK hi-fi retailers.

79 CLASSIFIEDS

Second-hand bargains.

80 NEXT MONTH

What we hope to bring you in the next sizzling issue...

81 ADVERTISERS' INDEX

82 CLASSIC CUTS

The Drifters, Under the Boardwalk, reviewed by Paul Rigby.



THE REFERENCE

The benchmark of benchmarks.

Hand-built by KEF's master craftsman in the UK, the Reference embodies KEF's history, heritage, philosophy and singular need to be the benchmark of sound reproduction.

Listen and believe **KEF** 60 YEARS

A, FANTHORPE LTD / HULL : fanthorpes.co.uk
 CRITERION AUDIO / CAMBRIDGE : criterionaltd.co.uk
 LOUD & CLEAR / GLASGOW : loud-clear.co.uk/glasgow
 MARTINS HI-FI / NORWICH : martins-hifi.co.uk
 OXFORD AUDIO CONSULTANTS / OXFORD : oxfordaudio.co.uk
 ROBERT TAUSSIG / LONDON : roberttaussig.co.uk

AUDIO AFFAIR / BIRMINGHAM : audioaffair.co.uk
 HI-FI EXCELLENCE LTD / COVENTRY : hiflix.co.uk
 LOUD & CLEAR / EDINBURGH : loud-clear.co.uk/edinburgh
 MUSICAL IMAGES / EDGWARE : musical-images.co.uk
 PETER TYSON / CARLISLE : peterbyson.co.uk
 SONORITY DESIGN / BRIERLEY HILL : sonoritydesign.co.uk

AUDIO T SWANSEA / SWANSEA : audiet.co.uk/audiet-swansea
 HOME MEDIA / MAIDSTONE : home-media-limited.co.uk
 LYRIC HI-FI / BELFAST : lyrichifi.com
 NINTRONICS / WELWYN GARDEN CITY : nintronics.co.uk
 PETER TYSON / NEWCASTLE : peterbyson.co.uk
 UNILET SOUND & VISION / NEW MALDEN : unilet.net

email:news@hi-fiworld.co.uk

news

TAPE-TO-DISC TRANSFER

Whenever Nagra is mentioned, you'll think of beautiful Swiss tape recorders. Many years on, and these exceptionally-constructed machines are prized by analogue audiophiles. Nagra still makes professional recording devices, albeit digital ones, and "security devices...for law-enforcement and official government agencies". Since 1997, though, high-end hi-fi has accounted for an increasing slice of its business. To celebrate 70 years since the arrival of its first product, a hand-cranked portable tape recorder, Nagra has launched its \$175k Reference Anniversary Turntable. This substantial yet precise disc-spinner, built from aerospace materials and belt-driven from two quartz-referenced brushless DC motors, is pre-fitted with a carbon-fibre tonearm. Both, Nagra explains, were "designed from the 'ground up' to work together as a system". For many, say Nagra, said system will be "proudly passed down from generation to generation - like many Nagra III tape recorders". You'd better move fast, though, as only 70 will be made.

Further details: Nagra, bit.ly/3Ga8BZx



LITTLE DENMARK

Billed as Copland's new 'entry-level' integrated amp the £2,988 CSA70 is, unlike its CSA100 and CSA150 brethren, a purely solid-state affair. The Danish company does however tell us that the CSA70's power amp section (2x70W into 8 Ohms) shares the same circuit topology of the two costlier models. To cover as many bases as possible the distinctively-Copland CSA70, billed as the 'little' integrated, includes MM phono input, three line-level analogue inputs, a Wolfson-based DAC that can be fed from four independently-selected digital inputs (one USB, one coaxial and two optical) and provision for headphones. Support for aptX HD Bluetooth, the fifth digital input, is optional. The 13kg CSA70, said to take awkward dynamic loads in its stride, also boasts the shortest possible internal signal paths, remote control (the volume knob is motorised), heavy-duty speaker terminals and preamp outputs both fixed and volume-controlled. Black and silver CSA70s are available.

Further details: Absolute Sounds, bit.ly/3lv3ueq



B&W PLAYS THE MIDNIGHT BLUES

For some time, Bowers and Wilkins has offered its iconic Nautilus flagship in a 'midnight blue' colour scheme. The latter has now filtered down to the more affordable 700 Series, two models of which have been given this striking metallic treatment. These are 'Signature' versions of the Nautilus-inspired 705 two-way standmount (£3,000) and 702 three-way floorstander (£5,500), both of which feature proprietary B&W Aerofoil-profile woofers and top-mounted (anyone remember the DM7?) 'Carbon Dome' tweeters. The three woofers of the larger 702 are augmented by a decoupled Continuum-coned FST midrange driver. B&W's finishing process involves applying seven coats of metallic-finish paint and lacquer to produce a "rich, lustrous finish". Furthermore, a 'Signature' identity plate is fitted to the rear panel.

Further details: Bowers and Wilkins, bit.ly/3GbyKqP

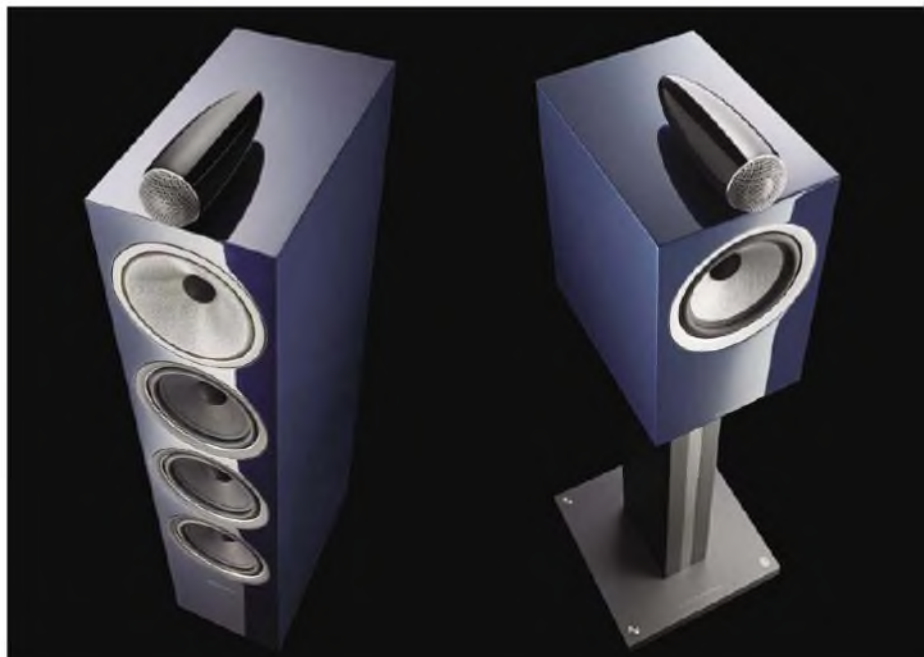

AUDIOLAB GOES OMNIA-DIRECTIONAL

To its £1,599 Omnia, described by maker Audiolab as an “all-encompassing audio solution”, the purchaser need add only speakers. Unlike many all-in-ones, the Omnia has a built-in CD player. Based on the 6000CDT’s transport, this is claimed to yield music from scratched CDs that lesser hardware would reject.

The Roon-Ready Omnia handles hi-res network playback via Ethernet or Wi-fi, thanks to the app-controlled DTS Play-Fi platform. Streamed audio, computer USB, mass-storage USB, Bluetooth 5.0 or coaxial/optical digital sources are converted into analogue by a MQA/DSD-compatible DAC based on ESS9038 Reference chipper. These, or your choice of analogue sources (there are three line-level inputs, plus MM phono) drive speakers via the Omnia’s discrete 50W power amplifiers. However, a headphone socket is also included for personal listening.

There’s no conventional tuner but the Omnia supports Internet radio, as well as a multiplicity of streaming services including Spotify, TIDAL and Qobuz.

Further details: [Audiolab, bit.ly/3G3LYG6](http://Audiolab.bit.ly/3G3LYG6)



SHADOW AND LIGHT

Astell&Kern’s latest is the £449 Acro BE100, a ‘house-styled’ Bluetooth speaker. The angled shapes of the mesh speaker grille - “influenced by the reflective interplay of shadow and light”, A&K tell us - and top-mounted volume knob will be familiar to anyone with previous experience of its products.

Clad in faux leather, the BE100’s ported wooden cabinet hosts a 3.5mm analogue input that can provide an alternative to the 24-bit aptX HD/LDAC-ready Bluetooth 5.0 connectivity.

Behind the grille lurk a 4in. Kevlar-coned mid-bass driver and 1.5in. silk-dome tweeters, which allow the BE100 to reproduce stereo audio. They are powered by 55W of Class-D amplification, driven in turn by a ‘digital crossover’ and dedicated ‘hi-fi grade’ 32-bit DACs. Also onboard are dynamic-range control for speaker protection, a low-jitter clock for the digital circuitry, bass/treble tone controls and status indication via volume-control backlighting. You can choose between black and white finishes.

Further details: [Astell&Kern, bit.ly/3lh6vyY](http://Astell&Kern.bit.ly/3lh6vyY)

MEZE WAXES LIRICAL

No stranger to these places, Romanian transducer specialist Meze Audio has launched the £1,899 Liric, its first closed-back planar-magnetic headphones “for listening in and outside the home”.

A ‘portable planar’ has long been in the sights of the firm’s founder, Antonio Meze. Marking a third collaboration with Rinaro Isodynamics, the Liric (Romanian for ‘Lyric’) is based on a scaled-down version of Rinaro’s ‘Isodynamic Hybrid Array’ driver. This features ‘Phase-XTM’ technology, claimed by Rinaro to minimise the phase non-linearity issues that allegedly plague closed-back designs.

The improvements to spatial imaging are, we’re told, particularly noticeable with binaural recordings. Meze has partnered two of these 30 Ohm drivers with its ergonomic framework and circumaural ovoid earcups, which are implemented using materials like fibreglass-reinforced polymer, high-grade magnesium, leather and aluminium. According to Meze the 391g Liric will deliver a “similar audio experience... to (its) Empyrean”, a fine open-back model that also features Rinaro drivers.

Further details: [SCV \(UK distributor\), bit.ly/321leLO](http://SCV(UK distributor).bit.ly/321leLO)



FULL STEAM AHEAD!

You’ve had to wait three years for it, but there’s now a matching preamplifier for designer Dan D’Agostino’s £125k-a-pop Relentless monoblocks – oddly steampunk-influenced designs that each weigh a quarter-ton, and pump out 1.5kW. The £165k Relentless Preamplifier comprises three vertically-stacked chassis. Between the central enclosure that contains the controls and line-conditioned power supply (separate

150VA transformers for analogue audio, and everything else) are individual chassis for the feedback-free circuitry of each audio channel.

The latter features a “completely-unique” temperature-stabilised discrete-FET input stage with >1 Megohm input impedance and can handle 30V signals without clipping. Other features include distinctive Bluetooth remote, five relay-switched balanced-only inputs, 2-source/2-zone support, home-cinema

FOR YOUR REFERENCE

New from Grado Labs are the Reference Series RS1x (£800) and RS2x (£600) open-back dynamic headphones which, as the suffix suggests, feature the Brooklyn firm's fourth-generation 'X' drivers. Those of the RS1x are of 50mm diameter, and built into wooden cups consisting of a maple sleeve, hemp core, and corobolo outer ring.

The RS2x, meanwhile, features 44mm drivers and housings made of maple and hemp wood. Grado appreciates wood for its "warm and embracing tonal abilities", but the RS1x and RS2x are its first headphones to be built around the latest 'X' driver - which, relative to its predecessor, is claimed to offer increased magnetic power, a voice-coil of lower effective mass and a 'reconfigured' diaphragm. Both hand-built models feature 99.9dB (1mV) SPL, 38 Ohm impedance, 'L Cushion' earpads, white-stitched leather headbands, and 8-conductor cables (terminated in unbalanced 3.5mm plugs). Left and right drivers are matched to within 0.05dB. Further details: [Grado Labs](https://www.gradolabs.com), bit.ly/31nUdxS



IT'S ALL GREEK TO ME...

There's now a more affordable alternative to Athens-based Lab12's £3,295 melto2 phono preamp. To meet a lower price point, the £1995 melto1 loses the menu-driven sophistication, input selector and balanced connectivity of its bigger brother. It is nevertheless, like the melto2, a "no-compromise" valve-based design that can accommodate MM or MC cartridges. Inside, you'll

find feedback-free circuitry based around four carefully-matched NOS ('new old stock') double-triodes, for "more natural... analogue sound". On the rear panel are DIP switches, one row per channel, that configure the input stage's impedance (32 ohms to 100 kilohm) and provide capacitive loading of up to 300pF. Not as easy as 'dialling in' settings, but how often do you change cartridges? Other features include balanced PCB topology, separate grounding paths and toroidal mains transformer. The melto2 is said to be capable of a "well-balanced 3D sound stage with wide frequency response, giving you pure, musical realism".

Further details: [MCRU \(UK distributor\)](https://www.mcrucy.com), bit.ly/3re4VS9



TWO INTO ONE WILL GO

With trademark hip-flask styling, iFi's latest xDSD Gryphon DAC/headphone amp builds on the performance and features of 2018's xDSD, by adding to its repertoire the analogue inputs and balanced headphone drive of the similar-vintage xCan. Hence that allusion to the mythical eagle/lion hybrid.

Described as "high-end audio you can take wherever you go", the £599 device features a hi-res Burr-Brown DAC chip that's compatible with single/double-speed DXD and PCM, DSD formats following a different signal path. USB, S/PDIF and hi-res Bluetooth digital inputs arrive at the DAC via an XMOS processing chip.

Your headphones, balanced or unbalanced, are driven by iFi's proprietary 'PureWave' amplification, which is claimed to deliver 1W into 32 ohms. A top-mounted LED strip reveals information like volume, battery condition and incoming signal format. Other features include MQA support, selectable digital filters, 215g weight, a Qualcomm Bluetooth 5.1 engine, bass-boost for open headphones and 8-hour battery life.

Further details: [iFi](https://www.ifiship.com), bit.ly/3dcDArl

bypass and precision volume control. There's no phono stage, but an optional (and as-yet-unpriced) streaming module is expected soon. With appropriate sources and speakers, we're probably looking at a £1m hi-fi system! However, at over £400k for a complete kit the Arizona-built Relentless isn't the world's most expensive amplifier. Those honours go to the \$2m 1.8-ton 120kW (!) 'Opera Only', by Italy's Andrea Pivetta.

Further details: [Absolute Sounds](https://www.absolutesounds.com), bit.ly/3lv3ueq





Hi Fi World "Best Valve Amplifier" NEW Stereo 40 MK IV £2599
New Upgraded Model. Now With Headphone Socket



Hi Fi World "Best Headphone Amplifier" New 300B option £2499
Bluetooth Option Available
NEW HP205D DHT Headphone Amplifier £2999
designed by David Shaw
High Definition With The Relaxing Sound Of WE Vintage Directly Heated Triodes



Innovative Designs From Icon Audio
60 + 60 Watts Triode
115 + 115 Watts UL
New Tung Sol KT150
£4499 pair
MB90 MK II Monoblock Power Amplifiers many features



Hi-Fi WORLD "OUTSTANDING Amongst the best" March 2018
hi-fines OUTSTANDING PRODUCT
Stereo 300 MK II £4199
Sublime Sound From Vintage 300B Triodes

See our full range of
Loudspeakers
Amplifiers
Pre-amplifiers
Phono stages at:
iconaudio.com



Bluetooth Option Available
Hi-Fi WORLD
Stereo 25 MKII from £1499
Simplified ST40 30W UL, HQ Headphone Socket



Hi-Fi World "Best Valve Amplifier"
Hi-Fi WORLD
Stereo 30se £2599
Single Ended Pure Class A, 28W UL, 18w Triode



hi-fines HIGHLY COMMENDED
PS1 MKII MM/MC £1649
Our fantastic value pure valve phono stage. MC and MM



Hi-Fi Choice RECOMMENDED
PS3 MKII MC/MM £2899
Pure Valve Phono Pre-amplification At Its Best! Smooth non-fatiguing Triode Sound, Match 8-600 Ohms



Hi-Fi WORLD
Bluetooth Option Available
HPB MKII £999



hi-fines OUTSTANDING PRODUCT
NEW ST 60 MK IV £3999
Outstanding Performance 80w UL, 50w Triode

Buy direct from us or through one of carefully chosen dealers or distributors:

| | | | |
|---|--|---|--|
| <p>Audio Affair Birmingham, B9 4AA Tel: 0121 224 7351 Web: www.audioaffair.co.uk</p> | <p>SMC Custom Installations Shrewsbury SY1 3TJ Tel: 01743 234945 Web: smccustominstalls.co.uk</p> | <p>Shropshire Hi Fi Westbury SY5 9QP Tel: 01743 232317 Email: shropshirehifi@gmail.com</p> | <p>Analogue Seduction Whitlsey Peterborough Tel: 01733 350878 Web: www.analogueseduction.net</p> |
| <p>Audio Gold Crouch End, London Tel: 0208 341 9007 Web: www.audiogold.co.uk</p> | <p>Wilkinsons Hi Fi Nelson, Lancashire Tel: 01282 612901 Web: www.wilkinsons.tv</p> | <p>Canada: Audloarcan Barrie, Ontario, Canada Tel: +1 249 880 5040 Web: www.audioarcan.com</p> | <p>Australia: Decibel Hi Fi Coopers Plains QLD 4108 Tel: 0486 022 877 Web: www.decibelhifi.com.au</p> |
| <p>Germany: TCG Handels GmbH Nordhorn 48531, Germany Tel: +49 (0) 5921 78849 27 Web: www.tcg-gmbh.de</p> | <p>USA: Music Direct Chicago IL 60660 USA Tel: +1 800 449 8333 Web: www.musicdirect.com</p> | <p>Spain: Union Musical Casa Werner Barcelona 08010, Spain Tel: +34 933 021 792 Web: www.werner-musica.com</p> | <p>WANTED! HIGH QUALITY DEALERS IN MOST AREAS/COUNTRIES</p> |

Thinking of buying valve amplification?
You are welcome to contact us regarding compatibility or other questions. We are small & friendly and helpful!
With many years experience of valves in Hi Fi

B GRADE & EX-DEMO BARGAINS!
Technically perfect Fully Guaranteed. Audition in our Leicester showroom. Most models available. See our website, email or ring for availability. Subject to availability* Prices vary.

Go Low

Acoustic Energy's new AE320 floorstander digs deep finds Noel Keywood.

Acoustic Energy have an audience, a long standing fan base that includes me. Their efforts to combine excitement with fundamental accuracy rightly has followers – and the new AE320 floorstander I'm reviewing here won't frighten them away, especially at a price of £1599 (UK).

Tall and slim, the AE320 has been designed, they say, to appeal to overseas buyers demanding more volume to fill big rooms – one reason for multiple drivers. This is a floor stander rated to take 200 Watt amplifiers and, with a high sensitivity of 88dB (loud) from one Watt, it does not need such power in any case. But there you are – a sort-of mission statement. A loudspeaker able to go loud, "suitable for medium to large rooms" they say. Think 15ft long up to 25ft long.

Not blessed with an absence of neighbours, I got up to high volume for short periods only, spending most time at medium to loud.

For a clean, fast sound the AE320 uses three of the company's ceramic/aluminium sandwich 130mm (5in) cone drive



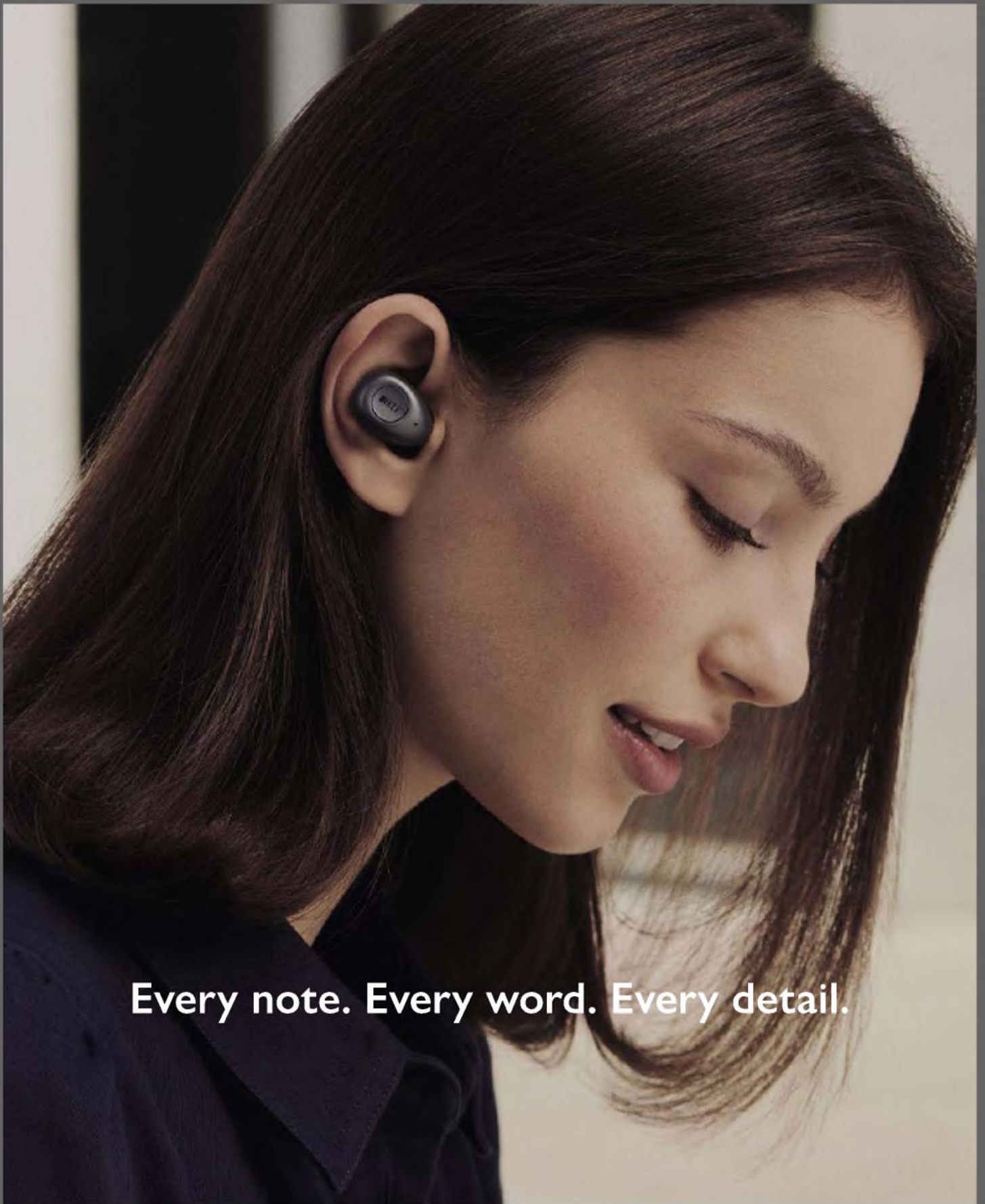

Every note. Every word. Every detail.



Mu3 noise cancelling true wireless earphones
Sound by KEF. Design by Ross Lovegrove.

We are purists at heart, at KEF, we believe in natural, accurate sound. The Mu3 earphones are the next evolution in that quest. Designed by Ross Lovegrove – pioneer in design and ongoing KEF collaborator - sculptural beauty and engineering excellence come together for audio that's brimming with life in all its astonishing complexity. Old favourites, new tunes, underrated or overplayed, this is music as it was meant to be heard.

Listen and believe

KEF 60
YEARS



The 28mm aluminium dome tweeter is larger than most (25mm) and is aided by a shallow waveguide to give smooth output up to 20kHz.

good dispersion. The bottom two drivers act as extended bass units working up to 250Hz, the next up is a midrange unit that contributes to bass (slow roll-off). It works up to 3kHz before handing over to the large 28mm aluminium dome tweeter that sits in a shallow depression that acts as a waveguide, reaching up to 18kHz.

The midrange unit sits in its own closed chamber, whose walls act to stiffen the cabinet. Acoustic Energy point out. The two bass units are loaded by a rear chamber vented by a slot port that our measurements showed gave strong low bass – an important feature within this ‘speaker’s sonic make-up.

The base is weighted by sand in a sealed chamber, making the cabinets heavy at 26kgs; spikes are supplied. Dimensions are 1m high, 175mm wide and 320mm deep and mono-wire terminals are fitted, so no bi-wiring. Finishes are Black, White or Walnut real veneer.

SOUND QUALITY

The AE320s were run in, even though they had seen use as early demo samples. Drive amplifier was initially a PrimaLuna EVO 300 Hybrid connected by Chord Company Signature Reference screened cables, but I moved on to our Icon Audio Stereo30 SE that was a better match. Delivering music into the amplifier was our Oppo BDP-

205D acting as a CD player, used for its ESS ES9038Pro DAC driven by a linear power supply, giving top sound quality from silver disc.

Hi-res came from a MacBook Pro running Audirvana+ software player to handle PCM and DSD, sending it via USB (DoP) to the Oppo’s USB input.

As an overview, the AE3020s were as clear, projective but naturally balanced and smooth as I had expected, knowing what Acoustic Energy aim for. What took me by surprise – sort-of – was the presence of obvious low bass. I say “sort-of” because measurement had suggested a lively presence from strong port output. But what to expect subjectively? Here goes.

I wasn’t aware that Antonio Forcione’s Tears of Joy (CD), a close-miked acoustic guitar piece, had any low frequency content so was surprised to hear obvious lows coming from this recording, what sounded like a synth backing track adding in sporadic drone; it was low and powerful in my 17ft long room, lifted from the mix to become obvious. There was a reason: my room’s main (length) mode at 33Hz co-incided with this ‘speaker’s port output at 35Hz. For most of the time I heard lively lows as a result, being surprised at just how many tracks had info in this region. There were tracks where the port became overwhelming, notable being Loreena McKennit’s Gates of Istanbul (CD) where sustained deep bass notes were too strong. They would have been less obvious in smaller (14ft) or bigger (>20ft) rooms than mine. This is a room matching issue, raised by a port with strong output where room gain occurs. The simple solution was to put acoustic foam into the ports, just a small amount had a big effect I found. Half an old (wooly) sock would do.

As delivered the AE320’s port will give strong low bass, making for a powerful sound. These are not bass-light ‘speakers, yet upper bass was quite dry in nature, so think – not a fulsome sound yet with strong deep bass. This would

please most listeners I believe.

Moving up the audio band, vocals were projected well, without the over-emphasis a raised upper midband can bring, one of those acoustic tricks some designers like to use. Acoustic



The rear carries a slot port that delivers powerful low bass. Below lie mono-wire terminals and at bottom there’s a cap for the sand chamber that adds weight and stability.

Every note. Every word.
Every detail.

LS50 Wireless II



LS50 Wireless II - The Ultimate Wireless HiFi

When you first listen to the new LS50 Wireless II, close your eyes. You'll find it hard to believe that a sound so pure is coming from such compact wireless speakers. That's because our unique Metamaterial Absorption Technology (MAT™) eliminates the high-frequency distortion inside the speaker. So keep your eyes closed and keep listening; there's a whole world of streamed music to enjoy.

AirPlay2, Spotify, Tidal, Qobuz, Internet radio, HDMI, and more.



Listen and believe





Three 130mm (5in) cone ceramic/aluminium sandwich drive units, topped by an aluminium tweeter, for consistency of material and sound. The two lower units handle bass, the third bass/midrange.

Energy play it straight here: their cones give a crisp yet even sound that possesses no intrinsic warmth, unlike coated paper or various damped plastics.

Tracks like Alison Goldfrapp's *Let it Take You* (CD) with sporadic synth beats highlighted some boxiness in the sound, a slightly boofy quality. But Ms Goldfrapp crooned seductively in the way she does and the AE320s did a great job in making her album *Supernature* thoroughly enjoyable. Clean and clear, without any sharpness from the tweeter – something I greatly appreciate, something the company consistently achieve.

But I wasn't quite happy: I felt they were a tad hard compared to what I know of AEs in the past and this prompted me to change over to our Icon Audio single-ended valve amplifier that is the epitome of silky smoothness. It worked: the 320s now sounded smooth and easy, even bass

receded a little and by just the right amount. Cymbal crashes in Fleetwood Mac's *Dreams* (24/96) calmed down and I could more easily play The Eagles *Somebody* (CD), an edgy, compressed track that is sonically challenging. The 'speakers are best not partnered with a brighter-balanced transistor amplifier I learnt. Think Naim, Creek, Exposure as a suitable match.

relative to each other, something Classical needs more than Rock. The Stereo30 SE added in a sense of stage depth to make this and other classical works sumptuous in presentation.

CONCLUSION

The AE320 is a compact floor standing loudspeaker whose deep bass reach gives it a sense of heft others rarely achieve. JBL's

"There was a fine sense of scale here, brass sections rasped out strongly and kettle drum thundered"

The Minnesota Orchestra took on large form playing Korsakov's *Dance of the Tumblers*, from *The Snow Maiden* (24/96). There was a fine sense of scale here, brass sections rasped out strongly and kettle drum thundered in the background, strings were smooth. The speaker's accurate balance kept all frequencies in order

large HDI-3600s managed this but at twice the price, illustrating the value of what is on offer here. The snappy character of the ceramic/aluminium drivers needs sympathetic amp matching, a softer milieu being best in my view, but perhaps this is a matter of taste. At the price I'd rate the AE320s as a great package, one well worth hearing.

MEASURED PERFORMANCE

Frequency response of the AE320 stretches from a low 30Hz up to 20kHz our third-octave analysis of pink noise shows. Other measurements made clear the forward response rolls down slowly and smoothly below 200Hz to -2dB at 100Hz and -6dB at 55Hz, a characteristic suitable for near wall use.

The port has very strong output at 35Hz, providing strong subsonics, especially with Rock where lows in the 30Hz region exist – not uncommon with synthesisers. So dry controlled bass, but with a big low-end kick.

There's no plateau treble lift for artificial enhancement, the tweeter working smoothly to 18kHz except for a small peak at 10kHz.

The drive unit immediately below the tweeter covers the midrange and some bass, whilst the two lower units identically cover all lows up to 250Hz, acting in effect as wide range bass units. They are loaded by a slot port at rear. It's resonant, making the 'speaker a reactive load, rather than resistive. It gives less damped, livelier bass.

Overall impedance was high at 8.4 Ohms making the 'speaker a light load in terms of current draw, and this can be seen in the impedance trace as height above the x-axis. All the same,

voltage sensitivity was good, 88dB being delivered from one nominal Watt (2.8V) of input. That's loud, making amplifiers down to 40 Watts sufficient for very high volume.

The AE320 follows Acoustic Energy's design approach of producing a fast yet accurate sound. With fine results all round the AE320 will perform well in use, with powerful subsonics.

NK

FREQUENCY RESPONSE

Green - driver output

Red - port output

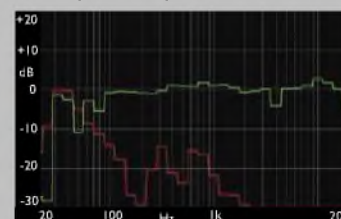

IMPEDANCE

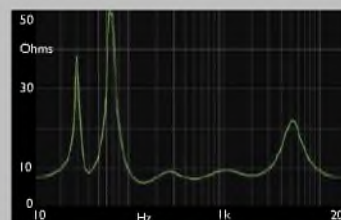

ACOUSTIC ENERGY AE320 £1599



OUTSTANDING - amongst the best.

VALUE - keenly priced.

VERDICT

Fast, clear and very strong lows. A punchy and exciting sound.

FOR

- tonally balanced
- powerful deep bass
- fast and crisp

AGAINST

- slightly hard character
- room sensitive bass
- slight boxiness

Acoustic Energy
+44 (0)1285 654432
www.acousticenergy.co.uk

NEWCASTLE & CARLISLE SHOWROOMS



B&W 800 Series / Nautilus Dealers • Naim Statement
Linn Klimax / LP12 experts • KEF Blade and Reference centre
Chord Music Cables

Interest free credit • Parking • Atmos home theatres
Part exchange considered • Ex demonstration deals available
Lovely coffee, real people and great advice

naim



Bowers & Wilkins

KEF



Carlisle

The Maltings,
Shaddongate, CA2 5TE

E: sales@petertyson.co.uk
Mon - Sat: 9am - 5:00pm

01228 546 756



Newcastle

Unit 6 Kingston Court,
Kingston Park, NE3 2FP

E: sales@petertyson.co.uk
Mon - Sat: 9am - 5:00pm

0191 285 7179



WIN

IN THIS MONTH'S GREAT GIVEAWAY – IFI'S ZEN CAN HEADPHONE AMPLIFIER & ZEN PHONO PHONO STAGE – ONE PER WINNER FOR TWO WINNERS.

www.ifi-audio.com

Here's your chance to win either a Zen Can or Zen Phono from iFi, one item per winner for two winners. State your preference on entry. Read a review excerpt below and answer the questions.

"In brief outline, Zen Phono is able to cope with all cartridges, from budget moving magnet (MM) types through to the lowest output moving coil (MC) types. A small slide switch at rear has four positions, numbered 1,2,3,4. Logically (to an electronics engineer) position 1 offers lowest gain and is intended for MM cartridges. Position 2 offers more gain and is for high output

MC cartridges purposed for MM inputs. Then comes position 3 that iFi say is for "low output" MCs, although to my mind this is for standard MCs, all of which have low output. And finally there is position 4 to cater for "very low output MCs" as iFi put it.

This range covers all cartridges on the market, position 4 being unusual for a phono stage at the price. Very low output MCs are esoteric and usually expensive. It's common to pay ten times the Zen's asking price for a stage with sufficient gain to cope with a very low output MC, so that's a plus point straight away. Zen was spectacularly – almost unbelievably – quiet via its 'low output MC' and 'very low output

MC' inputs. I had to double check the measurements.

Internally iFi say the Zen is fully balanced on each channel, not difficult with ICs yet uncommon practice. Running fully balanced cancels noise and distortion and – I find – in general gives a more pristine, if sometimes surgically correct sound. But the nice point here is that iFi provide a balanced output to exploit this and, they say, it is "the recommended output". The Zen develops a signal twice as strong from its balanced output than from the RCA phono socket outputs and more than enough to transmit audio down a long line from turntable to distant amplifier".

For a chance to win this great prize, just answer the four easy questions at right. Send your entries on a postcard only, by 4th February 2022 to:

**February 2022 Competition,
Hi-Fi World magazine,
Office 052,
464 Edgware Road,
London,
W2 1AH.**

QUESTIONS

[1] The rear slide switch has -

- [a] four positions
- [b] an electric motor
- [c] rubbery bearings
- [d] LED lighting

[2] Position 4 is -

- [a] not there
- [b] for Bluetooth
- [c] "unusual"
- [d] redundant

[3] Zen was -

- [a] gold plated
- [b] jet powered
- [c] thermionic
- [d] "spectacularly quiet"

[4] the balanced output was -

- [a] twice that of phono
- [b] same as phono
- [c] meagre
- [d] lethal

RULES AND CONDITIONS OF ENTRY

- ONLY ONE ENTRY PER HOUSEHOLD
- MULTIPLE ENTRIES WILL BE AUTOMATICALLY DISQUALIFIED
- PURCHASE OF THE MAGAZINE IS NOT A PRE-CONDITION OF ENTRY
- NO CORRESPONDENCE WILL BE ENTERED INTO
- THE EDITOR'S DECISION IS FINAL
- NO EMPLOYEES OF AUDIO WEB PUBLISHING LIMITED, OR OF ANY COMPANIES ASSOCIATED WITH THE PRODUCTION OR DISTRIBUTION OF THE PRIZES, MAY ENTER

**ENTRIES WILL BE ACCEPTED ON A POSTCARD ONLY
PLEASE ENSURE YOU PUT YOUR TELEPHONE NUMBER &
POSTAL ADDRESS ON YOUR ENTRY OTHERWISE THE ENTRY WILL NOT BE ACCEPTED**

**NOVEMBER 2021 WINNER: BLACK RHODIUM WALTZ S LOUDSPEAKER CABLES
Mr. Richard Lockwood of Hulme, Manchester**

Past Power

Exposure's 3510 integrated proves, to Martin Pipe, that transistorised amplification remains supremely relevant today.

As supplied, the £2,250 Exposure 3510 integrated featured here seems to take us back in time a decade or three – and that's no bad thing. In terms of signal-processing, the West Sussex-based manufacturer has followed in the direction it started in 1974 and knows very well. Classic ana-

logue solid-state circuitry is used throughout, the power amplifier being a time-honoured Class A/B design rather than one of those 'fashionable' Class D switching types. The review sample wasn't equipped with a DAC or Bluetooth facilities, our 3510's only digital circuitry being the microprocessor that looks after input switching and the moto-

riser (i.e. remote-controllable) ALPS volume pot. This no-nonsense – but nevertheless attractive, in its black or titanium finish – amplifier is part of a range that includes a preamp, plus mono and stereo power amps. Splash out another £300 for an internally fitted phono stage or £410 for DAC alternative. Compatible with coaxial or USB (computer)



sources, this supports hi-res PCM and DSD but not Bluetooth. The 3510's only front-panel socket is a 1/4in (6.3mm) headphone jack that, as per tradition, automatically mutes the 'speakers when a plug is inserted.

You can't have both DAC and phono board inside an amp, but whatever you choose to have fitted is selected as the first input – in addition to this are three unbalanced line-level inputs for conventional sources. If neither option is installed, the sockets – high-quality gold-plated RCA phono types, like the others present on the 3510's rear panel – becomes a fifth line input.

LEDs confirm input selection, which is by front-panel knob or the remote. A fifth input, marked 'AV', that when selected bypasses the 3510's volume pot. There are also Tape inputs and outputs

To avoid potentially disastrous feedback problems, the latter are sensibly muted whenever the tape input is selected. It's a shame that amplifier manufacturers no longer offer a proper monitor 'loop', with controls that divert listening from the source to the tape in sockets. Exposure's designer Tony Brady told me that "there is no call...I can't remember the last time someone asked for it".

Some might regret the lack of balanced XLR sockets. The preamp outputs, the levels of which are changed by the volume control, are available on two parallel-connected RCA phono sockets. They enable the 3510 to drive active subwoofers or – anyone for bi-amping? – extra amplifiers. Note that as standard the 3510 is ready for bi-wiring, two sets of speaker sockets being provided. These outputs

will accept 4mm plugs but, since they're not binding-post terminals, bare wire isn't catered for. They can't be independently switched on or off, for speakers in different rooms.

A peek inside the 3510 reveals an exceptionally-high standard of internal construction – as befits price. Two pairs of output transistors, mounted on a mid-section heatsink, are used for each power-amplifier channel. A hefty toroidal mains transformer is the 3510's largest and heaviest single component. Connections to the chassis-mounted rear sockets are made by wire – a hand-assembly job. It's better than board-mount connectors that suit machine assembly.

SOUND QUALITY

Most of my listening was done using a Cambridge Edge





TRIANGLE

MANUFACTURE ELECTROACOUSTIQUE



40th
ANNIVERSARY

Two iconic models reinvented in a Limited Edition

 MADE IN
FRANCE

Distributed exclusively in the UK & Ireland by **SCV Distribution**
For your nearest dealer call 03301 222500 | www.scvdistribution.co.uk

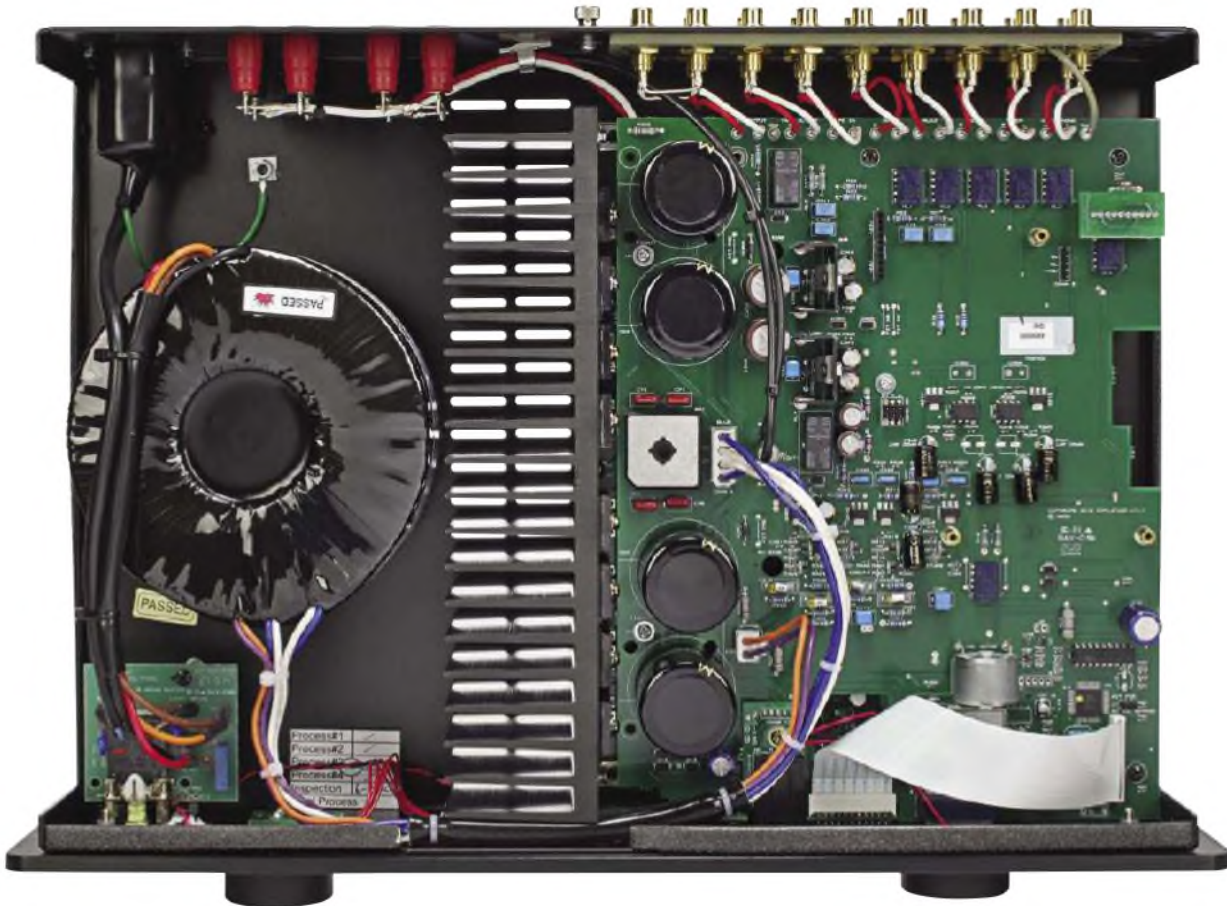

Excellent internal construction – as shown here. Of note: encapsulated relays for source switching (top right) and motorised Alps volume control (bottom right). Two pairs of output devices, mounted on a mid-section heatsink, are used for each power-amplifier channel. Powering it all is a hefty toroidal mains transformer (left).

streamer as a streaming-radio and networked playback source, the amplified result being fed to a pair of Quadral Aural Wotan VIII speakers (a good price match). Headphone (Focal Utopia) listening was also tried, as was vinyl courtesy of a Technics SL1200 Mk3 and AT440MLb MM cartridge; a Pro-ject Phono Box S2 was used to convert the latter's signals into a form that could drive the 3510's line input.

In many respects, the presentation is not dissimilar to that of the smaller XM5 model I reviewed four years ago. The vocals of the music I played – whether those of Leonard Cohen, Beth Gibbons, Thom Yorke or Hannah Reid – were given presence, detail and intimacy. I was hooked on every word, every breath, every nuance. I found



that guitars, whether acoustic or amplified, conveyed well. Rory Gallagher's searing Strat, as captured on the MFSL CD (FLAC rip) of his Irish Tour '74 - the year Exposure was born – effortlessly convinced with power and atmosphere.

Also noteworthy is the 3510's performance in the lower octaves. It sounded clean and its tautness was maintained, even at the higher listening levels that suit Irish Tour '74. Clearly, the power at its disposal is of benefit here. The impact of the audience footstomps on the Gallagher album

(alongside the odd buzz or two!) maintain the live atmosphere, helping to release the excitement and energy of those long-distant gigs into my room.

Meanwhile another Fender guitar, specifically the bass of Ohio Players' Heaven Must Be Like This (Skin Tight from... err, 1974, FLAC CD rip), was bestowed with a delicious analogue warmth that's almost valve-like: I could revel in Marshall Jones's playing without losing sight of the overall musical picture. A more recent track, London Grammar's Hey Now (If You Wait, FLAC CD rip), demonstrates this amplifier's ability to reach satisfyingly-deep in terms of bassline – this track is a demo fave for a good reason!

This remote's 'mute' function is relay-driven, for faster response than winding down the motorised volume control. Unfortunately, the remote cannot switch the amp into or out of standby – although it did interact with my Cambridge Edge streamer!

Klipsch®

REFERENCE



R-51M

HIGH QUALITY BOOKSHELF SPEAKERS

Leveraging a 1" aluminium tweeter mated to Klipsch's proprietary Tracrix horn-loaded technology - the R-51M bookshelf speaker delivers incredible acoustics to fill your home with loud, crystal-clear sound and robust bass like no other ordinary bookshelf speaker can.



* Shown with R-100SW Subwoofer



Distributed by Henley Audio

T: +44 (0) 1235 511 166 | E: sales@henleyaudio.co.uk | W: www.henleyaudio.co.uk | f: HenleyAudioUK | : HenleyAudio



Plenty of connectivity here, with no fewer than six line inputs - the first of which can be fed by an internally fitted DAC or phono stage option. The gold-plated chassis-mounted phono sockets, together with the two sets of parallel-connected 4mm speaker sockets, are hand-wired.

"a natural sense of space, together with the communication of breathing noises and guitar string-chatter, helped draw me in"

The sheer dynamics of Holst's Planet Suite (Colin Davis/LSO, FLAC CD rip) fell easily within the 3510's grasp. I was given insight into the performance, courtesy of its ability to resolve instrumental detail and convey a realistic stereo spread.

In terms of musical flow, the 3510 did not disappoint. Everything in Its Right Place (here, quite literally true!) and Idioteque, from Radiohead's Kid A (FLAC CD rip), were delivered with the necessary attack and urgency.

So too were the insistent rhythms that punctuate the sharp brassy and distinctive sound of Afrobeat pioneer Fela Kuti's keyboard during the lengthy Unknown Soldier.

With the stripped-down bluegrass of Garrett Brennan's Alta Powder Day (2.8MHz DSD64) a natural sense of space, together with the accurate communication of breathing noises and guitar string-chatter, helped to draw me in – whether I was listening through 'speakers or headphones.

CONCLUSION

Exposure's 3510 amplifier proves that more traditional solid-state technology can, if executed well, satisfyingly deliver the musical goods. Ours sounded

beefy when required, yet was capable of channelling the most delicate subtleties – all in a musical manner. Unless you're an active tape freak or possess numerous XLR-interfaced source components, the 3510's connectivity and superb sound quality should ensure it a place at the heart of many a decent hi-fi system.

MEASURED PERFORMANCE

The Exposure 3510 produced 136 Watts into an 8 Ohm load (quoted value), increasing to 225 Watts into a 4 Ohm load. Most loudspeakers are now 6 Ohms, into which output is 165 Watts, so that's the figure delivered in practice. It's more than enough to go very loud in all situations.

Output impedance was very low at 0.05Ω giving a high electrical damping factor of 160, which will impose strong 'speaker cone control.

Frequency response measured flat from 8Hz to 20kHz (-1dB), unaffected by load value and volume control position. As our analysis shows however, output is starting to fall above 10kHz and this is sufficient to lessen any sense of sharpness, giving the smooth analogue balance Exposure favour (like Naim).

Distortion values were very low measuring 0.01% up to near full output (1kHz). At 10kHz the figures changed little, just 0.1% at 1W into 4 Ohms as our analysis shows, and typically 0.02%. Harmonics decreased steadily in level with rising order and did not modulate with changing level, suggesting subjectively distortion free sound.

Our sample came without MM phono stage or DAC.

The Exposure 3510 measured

well, having plenty of power and very low distortion. It is a classic analogue power house successfully designed for smooth distortion free sound. **NK**

| | |
|-----------------------------------|------------------|
| Power (8Ω) | 136W |
| Frequency response | 8Hz-20kHz |
| Distortion (10kHz, 1W, 4Ω) | 0.01% |
| Noise (IEC A) | -101dB |
| Sensitivity | 300mV |

FREQUENCY RESPONSE

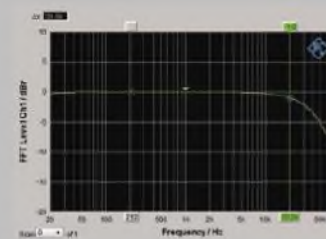

DISTORTION

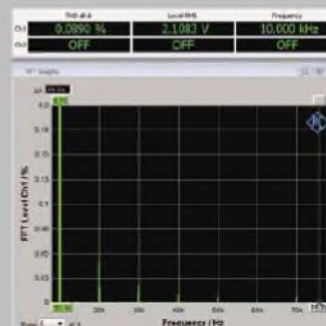

EXPOSURE 3510 INTEGRATED
£2,250



OUTSTANDING - amongst the best.

VALUE - keenly priced.

VERDICT

A practical and highly-musical design, based on tried-and-tested technology. Well worth auditioning.

FOR

- muscularity and refinement in the same package
- plenty of inputs
- internally fitted DAC or Phono options

AGAINST

- no XLR sockets
- no amp standby facility
- plastic remote

Exposure
+44 1273 423877
www.exposurehifi.com



website: www.jordanacoustics.co.uk

tel 01202 911 886 email ask@jordanacoustics.co.uk



MCINTOSH C12000

2-chassis Valve/Solid-state Preamplifier

Hybrid Preamplifier
£16,990

0% FINANCE EXAMPLE*
Initial 20% deposit of **£3,398** then
£453.07 per month for **30 months***.

The C12000 Preamplifier is the next generation of McIntosh's acclaimed two-chassis preamplifier design. Splitting audio and control/power into separate chassis delivers pure sound reproduction of the highest order.



MCINTOSH MC3500 MK II

An iconic 1960s amplifier reimagined

Valve Monoblock
£16,995

0% FINANCE EXAMPLE*
Initial 20% deposit of **£3,399** then
£453.20 per month for **30 months***.

Painstakingly reimagined by McIntosh's expert team of engineers and designers for a new generation of music lovers, the MC3500 Vacuum Tube Amplifier Mk II delivers an incredible 350 watts and performance to match.



*0% Finance examples above are subject to status & conditions

ISOTEK V5 TITAN

Power Cleaning System

£4,499

0% FINANCE EXAMPLE*

Initial 20% deposit of **£899.80**, then **£149.97** per month for **24 months***.

The new V5 Titan is a progression of IsoTek's original multi award-winning design. Whilst utilising the unique Direct-Coupled technology, the circuit has been radically updated with 50% increased PCB copper-loading. V5 Titan is the ultimate high current conditioner in the smallest form factor.

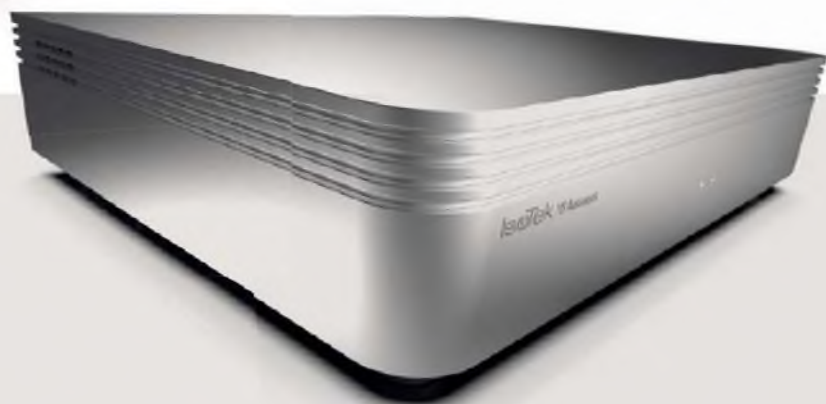

“

It drew the sound together in the way only the very finest of this type of product can. That's a joy to find at any price.”

Hi-Fi+, 200th Issue



ISOTEK V5 AQUARIUS

Power Cleaning System

£2,599

0% FINANCE EXAMPLE*

Initial 20% deposit of **£519.80**, then **£115.51** per month for **18 months***.

The original Aquarius was one of the most cost-effective power cleaning upgrades money could buy. The new V5 model takes the Aquarius concept to an even higher level. Delivering absolute power, the V5 Aquarius provides six outlets: two high-current outlets for amplifiers and four medium-current sockets for preamps, source and network components.



Visit www.jordanacoustics.co.uk to find out more

Mail

LETTER OF THE MONTH PRIZE

Visit our website at: www.hi-fiworld.co.uk or send your emails to letters@hi-fiworld.co.uk.

Letter of the month wins a pair of Acoustic Energy NEW AE100² bookshelf speakers

Answers by: NK - Noel Keywood; PR - Paul Rigby; MP - Martin Pipa; JP - John Pickford.



ACOUSTIC ENERGY AE100² BOOKSHELF SPEAKER

<https://www.acoustic-energy.co.uk/>

[subject to availability - Satin Black, Satin White and Walnut vinyl veneer]

A PAIR KEF Q150 LOUDSPEAKERS are on their way to DAVID MANSELL, Letter of the Month winner in our January 2022 issue.

Letter of the Month

SOFT FURNISHINGS

System set up and placement are clearly very important factors in getting the best out of whatever kit one might be using, whether it be speaker positioning, what your hi-fi components sit on, reducing or eliminating vibration, dealing with reflected sound, etc, but I'm keen to know your opinions on room acoustics, specially the use of sound diffusers / absorbers.

I realise that you have probably covered most aspects of this subject over the many years that I've been a subscriber, soft furnishings being that happy middle-ground where me and my partner can actually agree on, but I'd be interested in your views on sound diffusers / acoustic panels / bass traps, etc., and their use, application and positioning within a domestic hi-fi set-up.

Looking into the costs, it would appear on the face of it that the use of sound diffusers / absorbers represents good value for money for an upgrade that would theoretically improve the sound of any system. Are there any makes and models that hi-fi enthusiasts looking to improve their room acoustics should consider, or is



Large-area lined curtains with deep pleats absorb a lot of sound, creating a quiet room free from reverberation. A great way to improve sound quality and the home at the same time.

Shown: Laura Ashley Josette at John Lewis.

there a DIY route that one could take to get the same or similar results?

How many do you need, where should they go, what placement is most effective – back wall, corners, side walls? And in what circumstances should you diffuse and when should you absorb? Thanking you.

Ian Davies

**Thornton-Cleveleys,
Lancs.**

Hi Ian. Yes we have covered this topic many times but it is always worth repeating for those who missed our coverage. And this is an area where improving acoustics can improve the living environment – as you and your partner agree.

I'll go right into that. This cuts out hard walls and floors, and a generally minimalist environment that echoes. Interestingly it also cuts out over damped environments that sound acoustically dead, bit like an anechoic chamber – a place that drives some people mad. See YouTube videos about this.

Somewhere in-between is the ideal room from a purely biological stand point, an observation I make because this is ultimately a matter of personal preference. The observations here are based on my experiences.

Firstly, consider curtains. When floor-to-ceiling, full room length and lined, these are wonderful variable absorbers, as you will hear when drawing them. I fitted such curtains long ago and prefer them closed; my son promptly opens them when I leave the room! But at least it's a choice you can make. Drawback is price of course, that can run into thousands. "Dad, when are you going to change those 1980s curtains?" When I can afford to.

An obvious curtain source is John Lewis, whose website has a calculator and all the gruesome detail you'll need about pleats, linings and what have you. Or go to <https://www.direct-fabrics.co.uk/curtains/acoustic> where there is a lot of information specifically about acoustic curtains, including a video. These keep sound out as well as damping down sound inside. Google 'acoustic curtains' for even more.

On the wall opposite the curtain should be some absorption too – and here I use a small (2ft

x 4ft or so) colourful, patterned rug hung from the picture rail. It is positioned where sound from the speaker hitting the wall will bounce off to meet my ear at the listening position (see diagram). When a mirror on the wall shows an image of the loudspeaker from the listening position you have the right spot. A rug here is usually enough to damp down reflected energy. Use absorber panels if you so wish. However, there's no need to over-do it or the room will become dead. With 590mmx590mm tiles use four in a square (£100-£300 total). Or you can put foam behind a rug. StudioSpares have a wide range.

Carpet on the floor will absorb a lot of acoustic energy and Ikea even advertised a thick carpet as suitable for this purpose that we used in an office: it worked well. You can use an underlay also. Again, possibly best not to go too far. But carpets and underlays also damp down noise transmission from and to rooms below, so there are other benefits.

The ceiling is a weird one. Very high ones are a disaster I have found, from a rented flat with ceilings so high a step ladder was needed to change a bulb. There was no ceiling reflection: it was like listening in an open field. The sound stage existed between the speakers only. You can hang sound

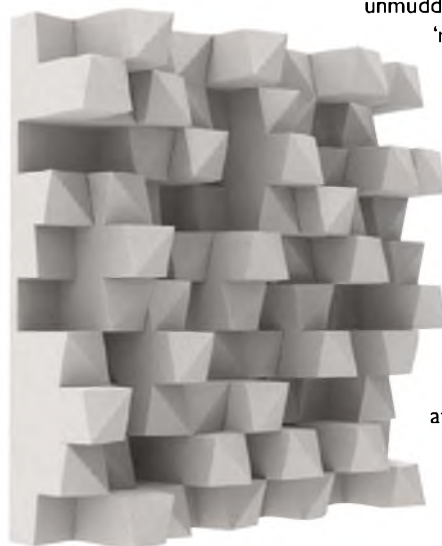

An Artnovion Myron E Diffuser, StudioSpares, £79. Scattering Range: 350Hz to 6000Hz. Size 590mmx590mm. These are very effective.

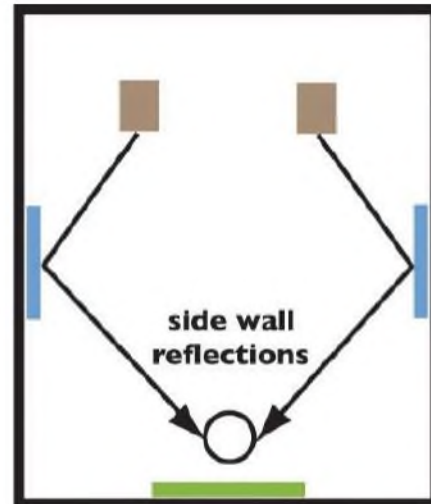

Put sound absorbers (blue) on side walls where a mirror on the wall shows an image of the loudspeaker from the listening position. Use foam tiles or a rug.

Behind the settee put absorptive foam over a deep diffuser (green) to eliminate rear wall reflections. Move the settee out 1ft.

diffusers to cure this, attached to a hard wooden board. Use white diffusers and it will look like a ceiling – even add some lights. If the ceiling is low (<8ft) best to use diffusion panels, since they will give a feeling of height to the sound stage by breaking up reflections.

Diffusers or absorbers? Diffusers will give you a livelier sounding room, but there will still be a well focused sound stage unmuddled by late reflections off

'room boundaries' (walls, ceiling, floor). I've used them extensively in the past and very much like the result (see Artnovion Myron E at StudioSpares). It's better than a heavily damped room in some respects, that some loudspeakers can struggle to light up. Diffusers should be attached to side walls by those who want a clean, bright room and the same sort of sound, but without the sonic

muddle. They can be covered by acoustically transparent cloth as disguise and to deflect dust, as they are dust traps. Use four 590x590mm tiles in a group (circa £300) – see our diagram. I'd strongly recommend floor carpet

in these circumstances though, even if just a central rug covering a large area to provide some absorption. Always best to strike a balance.

Absorbers damp things down acoustically, to an end point of a room sounding dead. Just how dead you like a room to sound is up to you. As you stuff it reverb time will fall until it starts to become eerily quiet. I've worked in a few big anechoic chambers (GEC Hirst Research Centre, National Physical Laboratory) and they are 'interesting': you can hear yourself think. Although more disconcerting was NPL's echoic chamber (aka reverberation chamber) where sound never died out. It was completely beyond normal experience. Go in there with the missus and she'll never stop talking.

Stuff a room by adding foam filled furniture. I recall listening in my 17ft x 14ft long lounge when empty, then shortly after when a three seat settee, two seat settee and armchair had been added: they radically damped down bass, by acting as foam absorbers. Many settees have space under them and foam can be put there, to add

low frequency acoustics and bass quality which is another subject. It is also why I said look for hidden spaces under settees to add more foam, since it will help. Corners are high pressure but low displacement points: you can absorb energy outside them where displacement is higher, using foam in settees instead.

I like to keep to real ways of improving room acoustics because it is relatively easy to do. You can use furniture and furnishings to get a great sound in a room that is good to live in and 'partner harmonious' too – hopefully! **NK**

CAMBRIDGE R50 SPEAKERS

In the November issue your Opinion section about the Cambridge R50 loudspeakers brought back some of the most enjoyable memories! At that time, the latter part of the 1960s, I had them initially teamed up with the Cambridge P40, soon to be followed by the P60 and then the P100 respective amps, also with my then treasured Revox A77 (which to this day I regret ever selling). The R50s had replaced some elderly Celestions, if my memory serves me correctly.

This all took place in my first old cottage, which due to the interior



"Neat SX speakers I find tremendous in handling all the different genres of music" says Donald P. McLeod Hawkins.

simply beautifully constructed and as I remember, weighing 98lbs apiece, costing £98.00 each: a fine example from the Bert Webb stable!

I will not bore you with the details, suffice to say, that many, many years down the line I parted



NPL's anechoic half-chamber (with hard floor). Totally silent. Over-furnish a room and it will sound similarly dead.

more damping.

Corner absorbers? These are the one item I have never got to work. The reason is, I suspect, they need to be volumetrically large and stretch from floor to ceiling, which is impractical for most of us. But here we are getting into

design arrangements, sported a 20ft plus lounge that was only 11ft wide, great for listening and as far as I was concerned, this was the centre of my universe in the cottage of hi-fi.

I was most interested in your general comments about tall column speakers as I felt that the R50s were



"Cambridge R50 loudspeakers brought back some of the most enjoyable memories!" says Donald P. McLeod Hawkins.

with the R50s in a deal that involved a beautiful walk-in wardrobe being constructed which did make me terrifically popular at that time!

Several other column speaker models later, I fairly recently acquired a pair of Neat SX speakers which I find tremendous in handling all the different genres of music I enjoy, maybe the fact that the designer is a musician accounts for these being such superb speaker units?!

**Kind regards,
Donald P. McLeod Hawkins,
Gloucestershire.**

Hi Donald. You had an all-Cambridge system then, including the great R50s – impressive. I bought a Cambridge P50 amplifier that looked lovely. Great styling. It was very “fast” in its sound but I became aware of crossover distortion and, indeed, when measured it had an unlovely 0.3%. Next it went ‘phut’ after being moved. When I looked inside a stray wire clipping had rolled under one of the output transistors bolted to the base plate, shorting it out. Lovely, but not lovely!

The R50 loudspeaker was distinguished by its KEF B139 bass unit loaded by a transmission line and your 20ft long room would have been a good match. A KEF B110 mid-range and T27 tweeter were supplemented by a Coles super-tweeter. It was such a modern-looking loudspeaker at the time, as were your P40 and P100 amplifiers.

Anyone interested in re-creating an R50 should take a look at a set of drive units made available by Falcon Acoustics, price £1051 for eight drivers in total. They allude to Chris Rogers who produced basic plans that I re-drew and compiled for publication in Hi-Fi Answers (August 1975) when editor. It was massively



"The poor sound quality of early Joni CDs is often down to conversion to HDCD encoding" says David Pearce.

popular as a reprint back then, when transmission lines were the stuff of dreams and DIY a popular topic. The R50 was a product of those times. **NK**

LISTENING TO JONI

The poor sound quality of the early Joni CDs is often down to conversion to HDCD encoding in the mid 90s. I believe her entire catalogue was actually HDCD at one time. Unfortunately HDCD is not transparent to playback on a regular CD player, whatever the marketing claimed at the time and even worse, ignorant file tweaking later has often broken the HDCD flags, so a HDCD player does not decode them either.

Regards,

David Pearce.

Hi David. Thanks for that insight, which is fascinating. Seems like you are an expert in the business. So readers understand what this is all about, the letter you refer to was from Peter Sherwood and printed in our October 2021 issue. It said of Joni Mitchell –

“Being a lifelong fan of the Divine Joni I could hardly wait to acquire

the new boxed set of her first four albums on CD. I have the whole cannon of her output in the form of both CD and vinyl, but always have found her earlier work on CD to be full of digital nasties making listening painful at times. No doubt due to the poor quality of many “early” analogue to digital masters, an issue frequently addressed by Noel K.

My appetite being thoroughly excited by the positive editorials in the Music Press prior to release I rushed out and bought the package. The presentation of which is super, well printed, mat card, pleasing essay and a satisfying tactile feel. Getting home – straight to the high-fi.

Oh dear! Am I hearing this properly? “Blue” sounds exactly the same as my original CD complete with the familiar wince points! Check the others: “Clouds” as my original, “Ladies of the Canyon” as my original, “Song to a Seagull” much improved.

So what’s going on? I check very carefully the recording notes on the packaging and can only find any reference to remastering/mixing on “Seagull”. Is it my ears?



A streamer like the Cambridge CXN (V2) £799 shown here is easier to use than a laptop and may suit Nick Miller-Jones.

No! Second opinions confirm my perception.

Needless to say a return journey to HMV ensued, who I know sell their goods in good faith, even though manufacturers are sometimes guilty of the opposite”.

HDCD (High Definition CD) was, as you describe, a product of its time where 16bit resolution could be enhanced to 20bit to give a smoother sound free from graunchy quantisation noise. Wikipedia has a lot more detail on its history and the technology. Great shame when it affects a good artist who was – ironically – trying to improve CD sound quality. **NK**

WHICH MAC?

A quick question (I hope): I am replacing my ailing 2010 MacBook Pro with another Mac laptop. I want to play Tidal, Spotify, Radio 3 etc out to a DAC. Which is best for audio, MacBook Air or Pro, and what features should I look for?

Or should I be looking at a streamer?

Many thanks in advance,
Nick Miller-Jones.

Hi Nick. I use a MacBook Pro when interfacing via USB (to play DSD) and run it on battery to avoid earth currents that can badly degrade the dynamic range of external DACs our Rohde&Schwarz UPV analyser shows. The mains charging supply must not be connected in order to ‘float’ the Mac for this purpose. It’s an idealised review set-up, not an especially convenient way to play music.

A streamer would be easier to use in the lounge I feel; sitting with a laptop picking through huge lists of music data is not my idea of relaxation or fun. I use the MacBook as I like to hear DSD in addition to PCM when reviewing. You will likely use it connected via wi-fi to receive the internet and then feed CD quality PCM (Tidal) out to a DAC (by cable?). It’s all a bit awkward – but then a laptop will do so much more than act as a music source and this is perhaps what you also want from it.

I am unaware of any differences in audio between these Macs. As you know, Mac audio can handle PCM at sample rates up to 768kHz or perhaps higher so no problems with Tidal, Spotify et al. Remember that output sample rate is set in



Ortofon Verismo removable stylus guard. Getting it wrong is an expensive mistake.

the peculiar Audio Midi control panel that lurks in Utilities, within the Applications folder – and you should select 44.1kHz for CD.

To warn you, streamers commonly rely on control from an app, run on iOS (not macOS), meaning an iPhone or iPad, connected into the local router through wi-fi. So if you go down this route you’ll need one or the other too. I hope this helps. **NK**

REVIEWING CABLES

In Alan Scott’s letter Reviewing Reviews in the December issue he refers to Martin Pipe’s review of a £2k mains cable. Alan quotes Martin as saying “if you hear no difference don’t buy them”. I would have said “if you hear no improvement over your existing mains cable commensurate with an outlay of £2k, do not buy them”. The word difference may not be an improvement as I’m sure many people can testify.

Regards,
Mike Bickley.

ON GUARDS

For several decades now I’ve been an avid hi-fi fan and owned a good variety of hi-fi, starting in the 1970s with Amstrad 8000 amplifier / Garrard SP25 turntable and Solavox speakers. For anyone who can remember, these offered a basic and, in the case of Amstrad, sometimes unreliable nod to hi-fi. But you could listen to music quite cheaply which is what mattered at the time.

Over the ensuing years I moved upwards through better quality hi-fi culminating in Quad 34 / 405 amplifier set-up / Thorens TD160

with Audio Technica AT31 moving coil cartridge and Quad Electrostatic speakers (radiators as people commented on more than one occasion). The sound was brilliant and I lived with this system until mortgage and marriage priorities put such hi-fi on the back burner.

I had to move back down the scale, which felt like starting all over again, but family commitments ruled. Now in my 70th year my love of hi-fi / music hasn’t diminished. Only the limitations of age affect my enjoyment with slight hearing loss and slightly arthritic fingers, the latter making tweaks to the system a bit more daunting or simply the operation of placing the stylus on a record.

My system at the moment consists of Yamaha AS701 amplifier / Thorens TD160 / SME 3009 arm (saved from oblivion) / Audio Technica ATVM95E and Elac Debut 6.2 speakers which I enjoy but the urge to improve things is never far from my thoughts.

However, through all these changes and hi-fi ups and downs there remains the one weak link that only a handful of manufacturers have tackled and that is the stylus guard. An item that costs next to nothing that can wreak havoc on any system of any price as I’ve found out to my cost. A piece of plastic



A safe and easy solution: the high quality flip down guard used by Audio Technica in their VM740/50/60 series of quality MM cartridges.

that has to slide on to the cartridge body in the hope that it will protect the stylus but on occasion does the opposite.

This simple nerve wracking manoeuvre has resulted in expensive stylus replacements as it catches the cantilever going on. Now I simply leave the guard off, defeating the whole point of it, but at least it’s cheaper than a new stylus.

Shure and maybe one or two others solved this problem and, despite purists saying it degraded the sound,

the fact that it did the job well of protecting a delicate and expensive item was, in my opinion, worth the trade-off. If only more manufacturers could resurrect this system it would save mine and maybe others nerves and wallets.

Which brings me round the long way of saying how much I agreed with NK's comments in December's issue which prompted me to write. Thanks for a great magazine that deals with the real, affordable world of hi-fi that I can relate to.

Julian Little.

Hi Julian. Thanks for your response to my querulous comment: I felt certain that others must be irritated by clunky stylus guards, but no one talks about it. Am I the only one scared by them?

I almost feel guilty at complaining, long ago, that flip-down stylus guards degrade sound quality. As you say, it is worth it just to avoid the threat a slide-on guard poses. As a reviewer of expensive moving coil cartridges I'm faced with a bizarre array of slide-on guards that frighten me, since most will destroy the cantilever if I make one false move.

Happily, an Audio Technica VM750SH MM I use has a lovely flip down guard. Trouble here is the cartridge is difficult to attach and the stylus assembly very difficult to insert until you learn how to get it correctly aligned. Great sound quality though and a good upgrade for your AT95E, if more expensive at £365.

No doubt in my mind that Shure's drop-down guard that cleaned the groove, eliminated surface static, damped the arm and protected the stylus was ingenious and the best guard ever. **NK**

GO LOW

Reading Chris Frankland's article on subwoofers in the September 2021 edition I can say that I had a very similar experience, although my discovery was more a case of curiosity.

A few months ago I had repositioned my whole system and had it sounding great, except moving the speakers (a set of floorstanding ELAC FS247s) into the room robbed them of some of their bass. My amp is an NAD Masters M3 and all the controls

have to be operated by the remote. I decided to tweak the bass to see if that helped. Not as easy as I thought!

Browsing through the manual (after trying everything else) I was surprised to see it had the ability to add a Subwoofer. Why would anyone want to add a subwoofer to a stereo set up I wondered?

That got me curious so after reading up on the subject the consensus was that a subwoofer could have a really positive effect on the sound. In our back room I have a Paradigm 5.1 speaker set up which has a subwoofer. This was relocated and connected and Holy Toledo Batman, I was stunned by how the music had taken on a richer more fuller sound soundstage and added clarity as well. Bass was not overdone



Klipsch R-100SW subwoofer. "I was blown away by how the subwoofer had transformed the music" says Geoff Hoad.

but bass extension was back.

It was obvious the Paradigm subwoofer was designed for loud cinema type sounds and lacked finesse. But I knew I had to have one so after doing my research, purchased a Klipsch R100SW from their Reference Series. After getting the levels adjusted I sat down to listen. Bass was more distinct but the whole range of sound had improved. If I had been happy with the sound before I was blown away by how the subwoofer had transformed the music.

So Chris, I agree with everything you said and I highly recommend giving it a try. It's inspired me to go through my record and CD collection and to start buying more music. Thanks for a great magazine!

**Geoff Hoad,
Sydney,
Australia.**

Hi Geoff. Subwoofers seem to have gone out of fashion a bit lately and I think few people truly appreciate quite how fundamental and wide-ranging an improvement they can make to a system. Of course they will give extra bass weight, and that was your main reason for trying that route, but as you discovered the improvements they bring to the whole soundstage and throughout the frequency range is an unexpected bonus. I am glad it worked for you. **CF**

WAD 300B MONOBLOCKS

I enjoyed your piece "... mish-mash one that worked brilliantly" (Jan.22 HFW) and had a similar experience this week. I have been playing vinyl via a step-up transformer into my "room-heater" pre-amp with built in MM phono stage (Audio Note M6). In the evenings I've connected the speaker-out to Stax headphones as there is no line out on the M6.

I considered buying a separate MM phono stage to enable me to bypass the M6. And then... I remembered that about 30 years ago I had built the WAD 3-box kit (phono, preamp and their power supply). It took me a few hours to find in my overcrowded (hi-fi kit museum) of an attic. But once the Phono stage was connected to the step-up and then to the Stax energiser [valve Kimic modded] the music was absolutely magical. I couldn't believe just how good the WAD phono stage was!

But... another find, hiding under old suitcases in my attic, was a pair of the WAD Push-Pull 300B monoblocks that I remember building at about the same time to go with the pre-phono combination. Also a shoe box full of valves plus 10 x 300Bs I used to like valve-rolling. I stopped using them, I recall, because of a loud pop from the speakers whenever I switched them off. The caps had been upgraded to Black-Gates and I made a number of other mods and, more worryingly, "improved" the design [my apologies to Andy Grove]. But after 30 years of gently ageing grey-matter, I can't remember what I did or why.

I'd really like to refurbish the P-P Monoblocks and bring them back into use and maybe upgrade some components and use some silver hook-up wire, also found lurking in a box under the eaves. Seems like a fun

MUSICAL FIDELITY

M2 SERIES

M2SCD | Premium Detailed
Audiophile CD Player

Powerful Audiophile
Integrated Amplifier | **M2Si**



THE PERFECT PAIR

NEVER SETTLE FOR ANYTHING LESS THAN
PERFECT MUSICAL FIDELITY

M2SCD



June 2019



February 2021

FIND OUT MORE AT:

HENLEYAUDIO.CO.UK/PRODUCTS/M2SI

HENLEYAUDIO.CO.UK/PRODUCTS/M2SCD

M2si



January
2019



June 2019



February
2021



Distributed by Henley Audio

T: +44 (0) 1235 511 166 | E: sales@henleyaudio.co.uk | W: www.henleyaudio.co.uk | [f](https://www.facebook.com/HenleyAudioUK): HenleyAudioUK | [y](https://www.youtube.com/HenleyAudio): HenleyAudio

project for Winter.

But what I can't find are the build instructions and circuit diagrams of the WAD monoblocks. I'd very much like to get back to the original design spec. and try and figure out what I changed. Also, what valves go where the shoe box has about 50 of varying types [I bought a lot of NOS Cryo. versions].

And so I would be really grateful if you can point me in the right direction to get the original paperwork and circuit diagrams.

Best regards,

Edward Martin.

Hi Ted. As your amps are monoblocks I presume you are alluding to 300B PSE (parallel single-ended) published in the October 2000 Hi-Fi World DIY Supplement (we also had a 300B push-pull amplifier, but it was a stereo chassis, not a monoblock). These are scans from a Supplement; we do not now have instructions. World Designs (<http://www.world-designs.co.uk>) may be able to help here, including their forum and technical expert John Caswell.

The "pops" are worrying since they should not be there. Possibly an upgrade capacitor you installed is under-rated and failing. Check all voltages of course, and take great care because of the very high voltages. Wear the safety gloves supplied if you still have them; high voltage gloves are available on the 'net.

I'm a bit surprised to see no fuses in this amplifier since they are needed to protect the output transformers should a valve fail. Some designers leave them out, feeling they compromise sound quality but I always wanted protective fuses to avoid the extensive damage a valve failure can cause. You may be able to install in-line fuses; use an ac/dc clamp meter to measure currents. The 425V feed to the output transformers needs fusing at least, in my view. With 40V across each 470Ω cathode resistor each 300B is running at 85mA so the two are drawing 170mA through the primary and around 200-250mA (fast blow) fuse appears about right.

I hope this helps you make sense of those mono blocks, since with ten 300Bs to try out you've got some rolling and great sounds ahead of you. **NK**



World Audio Design 300B PSE amplifier monoblocks produced 20 Watts each. Designed by Andy Grove.

**300B PSE MONOBLOC
CIRCUIT DIAGRAM
SIGNAL CIRCUIT**

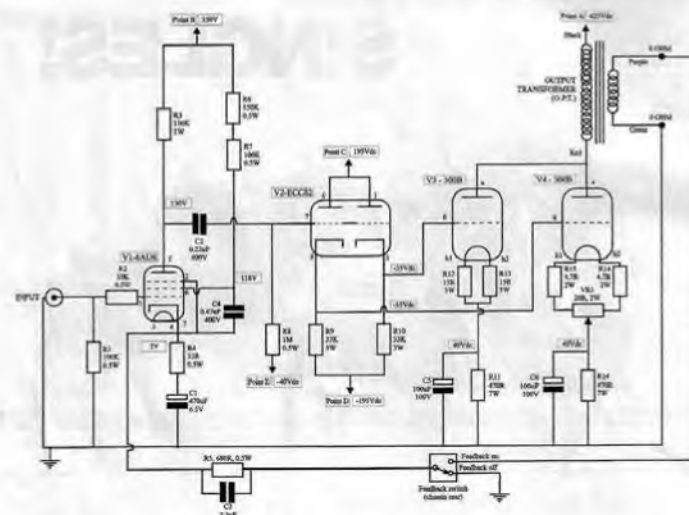

VALVE PIN LAYOUT

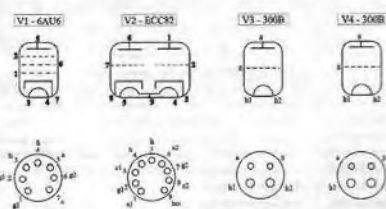

Views are from underside unless so stated
A, B, G1 = heater. G2 = heater (center tap). G = cathode. A = anode. G = grid. G2 = G3 = no connection

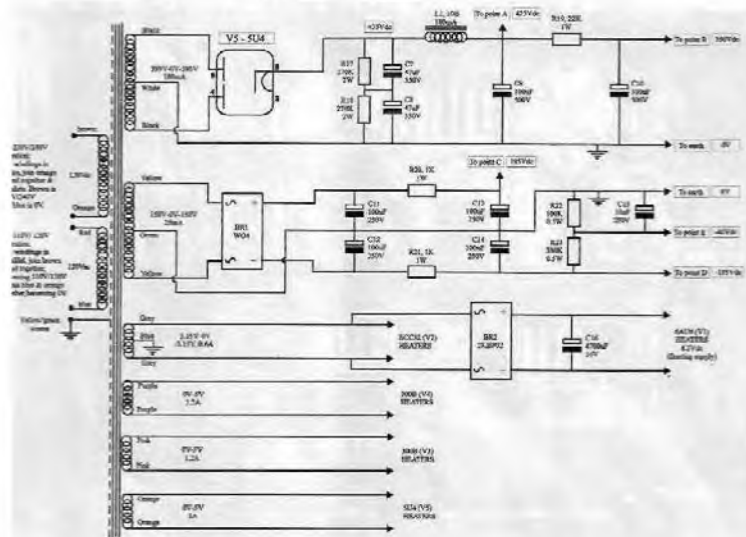

Material Difference

Focal release an Aria 906 loudspeaker with K2 sandwich cone. Noel Keywood checks it out.

Focal like using different loudspeaker cone materials – I recall both flax (Kanta) and slate-fibre (Chora) in their loudspeakers – and they

sounded good. By this I mean “neutral”, unlike the bright sound of a metal cone for example, or the quacky sound of Bextrene. Their Aria K2 906 I’m reviewing here (£900) uses yet another material

that comes from a range of K2 car speakers that have multi-layer ‘sandwich’ cones, an idea Leak introduced long ago using polystyrene with an aluminium foil skin. I should note that the Aria range





Focal's own-design 25mm inverted dome tweeter using aluminium/magnesium for light weight and stiffness. It fires into a shallow waveguide to aid dispersion and improve sensitivity.

"the Focals had good projection, Johannette Zomer soaring out wonderfully singing *Lascia chi'io Pianga* from Handel's *Love and Madness*"

also use flax, and there's an Aria 906 with flax cone, but I'm looking at a K2 coned variant here.

Doubtless, Focal's modern cones are slimmer, lighter and altogether more technologically sleek than that used by Leak long ago, but the idea remains: a light but stiff composite cone that doesn't colour the sound. To achieve this in the 906 it has a dual-layer 16.5cm (6.5in) diameter bass/midrange driver; Focal's spec sheet saying this is a "single skin" K2 cone with Aramid fibre layer on a "very light foam layer" for a "precise sound free from colouration".

This bass/midrange unit works up to 2.8kHz they say, crossing over to Focal's 'TNF tweeter' that has an inverted aluminium/magnesium dome said to give better dispersion than conventional domes. It has a smaller diameter, lighter rear drive (voice) coil for improved speed. The inverted dome is a 1in (25mm) diameter unit like most, equipped with Poron memory foam suspension. This driver fires into a shallow Urethane covered waveguide for improved

dispersion.

Measuring 390mm high, 225mm wide and 280mm deep the K2 906 is a large bookshelf / standmount design, coming in at a manageable weight of 8.5kgs. Focal provide it in Ash Grey finish only with an artificial leather front panel – and ours looked smart. There's a lightweight front grille frame with acoustically transparent cloth that made no difference to performance

on or off, measurement showed.

The rear carries mono-wire terminals only.

SOUND QUALITY

I drove the Aria K2 906s from our Creek Voyage i20 and alternatively from a PrimaLuna EVO 300 Hybrid amplifier. Sources were an Oppo BDP205D CD player with its ESS ES9038Pro convertor, and Bluetooth from the i20 to provide DSD and hi-res from an iPhone 11X, with 24bit resolution via an Onkyo HF player app. This was fed from the Creek's pre-out into the PrimaLuna.

As expected from measurement, the Arias were clinically correct in tonal balance and just about colour free. Did I get to hear the forward firing port? Yes, but only when running them loud with heavy Rock having strong bass, like the strong metronomic synth beat from Safri Duo's *Samb Adagio*. Then I heard boxiness and complaint, but at normal-loud levels they were clean enough.

Also as measurement predicted there was no sense of general warmth or fullness, instead a dry neutrality that was in its own way impressive. An academically correct sound I felt.

Running my torture tracks



The K2 coned sandwich construction bass unit is loaded by a front firing port. This only became audible at high volume with heavy bass.

DEBUT CARBON EVO

**IT'S TIME FOR EVOLUTION.
OUR MOST BELOVED
TURNTABLE DESIGN.
REFINED IN EVERY ASPECT.**

Through the years we have constantly kept improving the Debut formula, moving with technologies and fashion trends to ensure it was always the best option for its price. With Debut Carbon Evo we have created a superior sounding classic product, evolved to meet the modern era's expectations.



Steel platter with TPE damping



NEW Motor suspension with better damping



Electronic under-deck speed control



Height-adjustable metal feet



Gold plated RCA connectors



8,6" one-piece carbon tonearm



Electronically regulated belt drive system



Pre-adjusted Ortofon 2M Red cartridge



Hi-Fi World,
November 2020



Hi-Fi News,
December 2020



Hi-Fi Choice,
November 2020



AV Forums,
November 2020



StereoNet,
October 2020



A port-free rear panel allows the speaker to be pushed hard against a rear wall. Terminals allow mono-wiring only.

At right - cabinet and box label this 'speaker Aria 906 K2, but website and literature think its Aria K2 906. Take your pick.

A small sense of midrange push brought the elaborate harpsichord work to the fore, underlining that the Focal is a revealing loudspeaker, in an understated fashion. It delivers massive detail within such complexity that I could sit and enjoy, without moving to the edge of the seat. Well lit, not over lit.

CONCLUSION

The Aria K2 906 was clean, clear and light on its feet. It teased



out a wealth of information and projected it strongly. Not a big, warm sound so much as a dryly analytical one. They need an amplifier with bass punch to liven the cones and with this I found them impressively capable.

picked out a few characteristics that measurement had predicted. Spinning Nils Lofgren's Keirih Don't Go (CD) I got to hear rising treble above 6kHz from the tweeter as a sharp, thin hiss from the furiously strummed strings when volume was cranked up but for the most part – meaning with most music – this was not apparent. Higher guitar strings in tracks like Dreams from Fleetwood's Mac's Rumours (24/96) were picked out strongly though, making the tweeter's contribution obvious.

When pushed right against the rear wall of my 17ft long lounge there was fast bass, but not deep bass, even when pushed hard with Lady GaGa's Bad Romance that has big energy around 30Hz. They were refined and teased out the essence – but walls remained steady and neighbours happy. So not ground shakers.

When I moved from torture tracks to more everyday material, especially vocals, the Focals had good projection, Johannette Zomer soaring out wonderfully singing Lascia chi'io Pianga from Handel's Love and Madness (DSD). With Rock there was a fine sense of dynamic contrast, especially with the powerful sounding PrimalLuna that sympathetically energised these Focals, but this is an expensive amplifier unlikely to be used with a sub-£1k loudspeaker.

Running through a gamut of

classical, strings were clearly lit and well differentiated – as Bach's Concerto for Flute, Violin and Harpsichord (DSD) made obvious.

MEASURED PERFORMANCE

Focal consistently engineer their loudspeakers for flat response, avoiding the use of treble lift for artificial enhancement. And that approach can be seen in the Aria K2 906 where the bass/midrange unit reaches up to 3kHz before crossing over to the inverted dome tweeter that extends smoothly up to 20kHz. If anything there is a slight roll down up to 5kHz, enough to ensure treble does not get hard or fierce with poor quality CD. Upper treble above 6kHz does start to lift however, the tweeter rising to +2dB at 20kHz.

Output continues down smoothly to 60Hz before rolling away fast. The port (red trace) is tuned to 50Hz, also shown by the dip in the impedance trace, and this helps out a little with low bass. On balance though, whilst the 'speaker reaches low Focal don't lift lower frequencies to add warmth or body to the sound. As a result it will sound dry.

Lack of peaks and dips suggests low colouration. There is little higher frequency output (box noise) from the forward firing port (red trace), so box honk should not be obvious.

Overall impedance measured a high 8 Ohms with pink noise, the 4.4 Ohm minimum set by d.c. resistance, as our impedance trace shows. This gives

lower current draw than usual, but also restrains sensitivity to 87.5dB from one nominal Watt (2.8V) of input. It's still a good figure though, amplifiers of 60W or more being suitable for high volume.

The Aria K2 906 is a well engineered, accurately balanced loudspeaker for near wall use where it will give detailed, dry sound. **NK**

FREQUENCY RESPONSE

**Green - driver output
Red - port output**

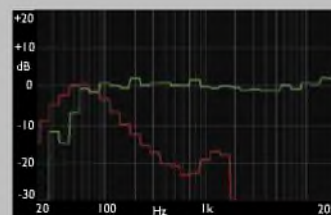

IMPEDANCE

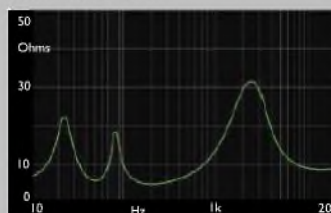

FOCAL ARIA K2 906 £900



EXCELLENT - extremely capable.

VERDICT

Clean and fast, but light bass.

FOR

- reasonably even balance
- detailed
- clean

AGAINST

- lack warmth
- lack low bass
- hard character

Focal
www.focal.com

THE IDEAL ANTIDOTE

VISIT OUR WEBSITE: www.hi-fiworld.co.uk

**A SUBSCRIPTION TO HI-FI WORLD
MAKES THE PERFECT GIFT FOR
YOUR NEAREST AND DEAREST.**

SAVE

...up to

20%

Subscribe today and you will get a special discounted rate giving a **saving of 10% to 20%** off the cover price. That's an amazing **£4.50 - £4.00** per issue including postage.



So don't delay, take out a subscription today!

FOR BACK ISSUES ENQUIRIES PLEASE CALL

01442 820580

OVERSEAS SUBSCRIPTIONS IF YOU LIVE OUTSIDE THE UK,
PLEASE CALL FOR OUR LATEST PRICES

+44 (0) 1442 820580

**SO WHAT ARE YOU WAITING FOR? CALL NOW!!!
SUBSCRIPTION HOTLINE 01442 820 580**

Lines open Mon-Fri 9.00-5.00 or (weekend answering service available)

FOR OUR
ON-LINE MAGAZINE
GO TO WWW.HI-FIWORLD.CO.UK

email:
hifiworld@webscribe.co.uk

Ground Levelling

Martin Pipe's curiosity is piqued by Chord's GroundARRAY noise-reduction device.

Some intriguing gizmos recently came my way. My first reaction was to return this set of five vape-like aluminium tubes, with a 'thank-you' note to the effect that they were unnecessary as I haven't smoked a cigarette for more than a decade! Then I noticed, at the end of each elegantly-machined cylinder, a different connector – USB type-A, male XLR, BNC, RJ-45 (i.e. Ethernet) or RCA/phono. Evidently, these must be rather specialised 'e-cigs'...or something else altogether! Closer examination of one revealed an embossed legend: "CHORD GroundARRAY". Near the opposite end of the device, which is capped by a 'C' logo, are embossed 'ribs'. These presumably help the user to grip its body, when attaching or detaching the GroundARRAY to or from the appropriate socket.

A little delving later, and it turns out that the GroundARRAY is actually an innovative hi-fi accessory manufactured by The Chord Company of interconnect

and speaker cable fame. It's billed as a "next-generation high-frequency noise-reduction device". My first thought is that it's a high-tech shorting plug, of the sort that Chord already sells for some Naim products. The job of a shorting plug is essentially to 'ground' an input, and in doing so help to reduce noise. Indeed, I have found shorting plugs on the unused inputs of vintage equipment I've bought in the past. Fine for phono sockets – but potentially-disasterous for USB and network ports.

In any case, I measured the resistance between the phono model's central pin and barrel. This was infinite i.e. 'open circuit'. I also noted that the BNC version didn't have a central pin. I contacted Chord about this, just in case the sample was damaged. This is apparently deliberate, I was told, because "it doesn't connect to the signal". Evidently, then, the GroundARRAY works along completely-different lines to those of a shorting plug. Chord's units are sealed, and cannot easily be taken

apart for examination. The Ethernet variant does however have a grub screw. The plug was loosened after its removal but could not be removed from the body, some kind of tough but not completely-inflexible resin holding it in place. The plot thickens!

Pressing Chord further, I was given the following explanation: "GroundArrays, which have been developed over years, can be thought of as RFI absorbers or exchangers". Derived from the proprietary TunedARRAY mechanical-tuning system (as used in Chord's flagship interconnects), they work by "reducing residual noise on the earth, and are not designed to 'fix' noise but further reduce its effect...they're connected in parallel, not series, and do not enter the circuit. They connect only to earth, and provide a potential gradient". The "carefully-chosen materials inside each GroundARRAY cylinder are set in resin", which explains why they cannot be opened/inspected. I then looked in vain for patents that could provide



me with further information.

Clearly, the GroundArray isn't going to yield its secrets to me without a fight. Disassembly of a GroundArray, which is "made in Wiltshire, using UK labour", would be destructive. Given that they're not particularly cheap – £550 a pop – I doubt that Chord would appreciate such terminally-intrusive investigation. And in any case, I have a deadline to meet! As well as the five demonstration units I was sent for review, there are GroundARRAYs terminated with female XLR, HDMI and 5-pin DIN plugs. The availability of an HDMI version demonstrates that Chord is gunning for the AV market, as well as hi-fi. Indeed, Chord states that the GroundArray concept is suitable for DVD/Blu-ray players, TVs and projectors as well as computers, amplifiers, subwoofers, CD players, DACs and (presumably active) speakers.

Basically, you plug them into spare connectors. Experiment with different sockets, and settle on the one that gives the best results – a 'quieter' picture onscreen, or 'blacker' silences in the gaps between your music. Given that the GroundArray is quite heavy and long (10cm or so), you're advised to install it where accidental 'knocking' is unlikely – a rear-panel connector, most obviously. I can imagine serious damage being caused to your equipment if you're not careful. GroundARRAYs, Chord

explains, are "most effective when used across several devices" in your system. They can be used "individually, or in multiples such as...left and right outputs. Chord also advises plugging GroundARRAYs into the unused digital inputs of DACs and streamers.

I tried different GroundARRAYs with a wide array of hi-fi equipment, among them the Naim Uniti Headphone Edition (here driving Focal Utopia headphones) and Exposure 3510 integrated amp reviewed this issue, the Cambridge Edge streamer and power amp I've been using for a good while now, Quadral Aurum Wotan VIII speakers, a Prism Callia DAC and an Arcam A49 amp. A Technics SL1210 Mk3, AT440MLb MM cartridge and Pro-ject S2 Ultra phono stage took care of vinyl. Through this equipment I played a wide variety of music, varying from chamber, choral and fully-blown orchestral works to pounding synth-driven dance music – hi-res, CD-derived and streamed radio. I was expecting to hear subtle improvements, as can be experienced after changing cables or flipping between the different digital filters of a DAC. To be honest, though, I couldn't hear any appreciable difference – regardless of the specific sockets I plugged the device into.

Is it hokum, then? In all fairness, some have reported transformational performance improvements;

I should point out that GroundARRAY won Chord a prestigious 'Grand Prix' in Japan last year (bit.ly/3DHOxvX). So maybe there is something in it. It should be noted that I hold Chord in high regard, and indeed I awarded one of its products 'Cable of the Year' in the last issue of HFW. Perhaps valve equipment, which is more prone to microphony than solid-state gear, will benefit more from GroundARRAY. My advice is, as with esoteric cables, to arrange a home trial with your dealer. If these unusual cylinders give you more of the music and less of the noise, then keep them in your system (if not in circuit). If not, send 'em back for a refund. Simple as.

CONCLUSION

Although the equipment I partnered them with is hardly in the super-fi category, these beautifully-made accessories didn't make any significant difference to the enjoyment of my music – despite several weeks of experimentation. However some 'super-fi' users have reported worthwhile results from the GroundARRAY – my advice is to try before buying. Be careful how you install them, though – 10cm extrusions from front panel sockets are accidents waiting to happen!



**CHORD
GROUNDARRAY
£550**
VERSIONS WITH USB
TYPE-A, RCA PHONO,
5-PIN DIN, XLR
MALE, XLR FEMALE,
BNC, RJ45 AND
HDMI CONNECTORS
AVAILABLE



GOOD - worth auditioning

VERDICT
GroundARRAY might prove worthwhile with esoterica. It did not work for me.

FOR
- construction
- many different connectors catered for
- far too neutral - neither adds, nor takes away

AGAINST
- Expensive!
- I couldn't hear any noticeable difference
- very long design restricts positioning

The Chord Company
<https://bit.ly/3pJfmu0>

Sonus faber

LUMINA



Affordable luxury: Lumina rewrites the rules.

Lumina distils Sonus faber's 35+ years of knowledge and expert craftsmanship, creating a collection that exceeds even the highest of expectations.

New models added

Lumina has expanded to include the new (larger) Lumina II stand-mount and Lumina V floorstander, complementing the award-winning Lumina I, III and CI models.

Speakers you want to see and hear

Whether stereo or a multi-channel, Lumina pushes the performance envelope to new heights and beyond.

sonusfaber.com

To find your nearest dealer, please visit:
finesounds.uk/dealers





WORLD STANDARDS

Your guide to the best products we've heard that are currently on sale in the UK...

TURNTABLES

AVID INGENIUM £800
Great bass response and upper midrange detail allied to clarity makes this a must-hear at its price-point



CLEARAUDIO INNOVATION £6400
Expensive, but offers great results from a finely honed and beautifully finished belt drive turntable, with servo control from the platter to keep a grip on tempo like few others. Can be fitted with a Clearaudio tangential arm, or any conventional design. Awesome



INSPIRE MONARCH £4,350
A rebuilt from the ground up Technics Direct Drive, having blistering pace and dynamics allied with smoothness, sophistication and purity of tone. A true reference.



LINN LP12SE £3,600
The UK's most iconic turntable, the legendary Sondek goes from strength to strength. New Keel sub-chassis and Radical DC motor add precision and grip to one of the world's most musical disc spinners. Expensive though

MICHELL GYRO DEC £1700
Wonderful styling coupled with great build and finish make this turntable a delight for friends and family. It has an attractive clear acrylic dust cover, and you can mount just about any arm. A current design standard



PRO-JECT ESSENTIAL DIGITAL £300
A budget turntable that turns in a great analogue performance, but also has a hi-res digital output. Send 24/96 across your lounge via optical cable to a DAC and get great audio quality. Or record LP to your laptop



REGA RP3 £550
The first of the super-quality Regas, little compromised by price and featuring Rega's outstanding RR303 tonearm, suitable for MM and MC cartridges. A standard at the price point

TIMESTEP EVO £2100
The famous Technics SL-1210 MkII Direct Drive but with improved plinth, isolation, main bearing and power supply, plus an SME arm (add £1500). DD convenience, rock steady pitch and fab sound at a great price. Our in-house reference



TO NEARMS

ORIGIN LIVE ENCOUNTER MK3C £1,745
Origin Live combines carbon fibre and ebony to marvellous effect in its new 12-inch arm. Creamy and rich in presentation, the Encounter delves deep into the mix for a satisfying listen.

HADCOCK GH-242 EXPORT £810
Consummately musical, lyrical sounding tonearm, but needs the right turntable.

ORIGIN LIVE ONYX £450
Easy, smooth, creamy nature that reminds you why you're listening to vinyl in the first place. Essential audition at the price.



REGA RR303 £300
A one piece tapered casting makes this arm's structure almost unrivalled. Great dynamics and superb imaging, for MM and MC. Reference quality for peanuts

SME 312S £1,600
Twelve inch magnesium alloy tapered arm tube plus SME V bearings. An insightful yet smooth and relaxed sound. Superlative build completes the package. Our Editor's steed.



SME 309 £1500
A one-piece tapered 9in arm finished like a camera and slick to use. Superlative SME quality and sound at affordable price.

SME V £3000
Offers rapid fire timing and a sense of precision, plus rock solid dynamics. Top collar for deep pockets

CARTRIDGES

AUDIO TECHNICA AT-OC9 MLIII MC £420
A fine sounding MC with strong bass and super fine treble from a great stylus – yet inexpensive.



AUDIO TECHNICA AT-F3/III MC £150
Great value entry level moving coil with detail and grip you just can't get from similarly priced moving magnets.

BENZ MICRO ACE SL MC £595
Smooth, lucid and full-bodied, award-winning, hand-made cartridge from Switzerland.

BENZ MICRO WOOD SL MC E945
Highly finished Swiss moving coil that plays music with riflebolt precision.

DENON DL-103 £180
A popular and much loved budget MC with big bass, smooth treble and deep sound stage. Fantastic value.



LYRA TITAN I MC £3,500
Breathtaking speed and dynamics from LP, helped by diamond coated, boron rod cantilever.



ORTOFON 2M MONO SE MM £80
A mono cartridge purposed for The Beatles in Mono microgroove LPs. Fitted with a top quality Shibata tip. Fab for the four.



ORTOFON 2M BLACK MM £400
As good as it gets from MM. Fabulous detail and insight from a Shibata stylus, good bass and excellent tracking.

ORTOFON CADENZA BRONZE MC £1,400
A mid-price MC with a slightly livelier presentation than the super smooth Cadenza Black. High-end sound at midband price – great value.



ORTOFON CADENZA BLACK MC £1,800
Ultra smooth and dimensional moving coil with bass and punch aplenty. Lovely stylus.

ORTOFON A95 MC £3,750
Fast and extremely detailed, this is an MC cartridge that sets standards.

REGA CARBON MM £35
Budget price for a competent cartridge with a fairly unflappable nature. Ideal for beginners.



GOLDRING 1012GX MM £250
A glorious sounding cartridge with solid bass and strong dynamic punch, plus excellent treble from its Fritz Geiger stylus. Fun and affordable.



SHURE M97XE £80
Big warm sound, but great tracking and bullet proof stylus protection from damped guard. A survivor.

VAN DEN HUL DDT-II SPECIAL MC £995
Long-established cartridge from Holland with an open and dynamic sound.

PHONO PREAMPS

CAMBRIDGE AUDIO 651P £200
Clean, concise sound from MM and MC cartridges at a very low price. A real bargain.

ICON AUDIO PS3 MKII £2,500
All valve MM phono stage with MC transformer option, graced by big, spacious and relaxed sound.



LUXMAN EQ-500 PHONOSTAGE £4,495
A fully-equipped phonostage from Japanese manufacturer Luxman that offers comprehensive cartridge matching allied to superb sound.



LEEMA ACOUSTICS ELEMENTS ULTRA £1,199
Smooth and detailed sound with the ability to accommodate most modern cartridges. Exceptional value for money.



PRO-JECT TUBE BOX DS £425
Compact MM and MC phonostage with valve output circuit and a big sound.



QUAD QC24P £995
MM and MC, oodles of gain, a volume control – and valves! Looks superb and sounds even better: smooth, atmospheric and big bass.

TIMESTEP T-01MC £995
New, minimalist phonostage that sonically punches well above its weight.

PREAMPLIFIERS

ICON AUDIO LA-4 MKIII £1,400
Uses early 6SN7 triodes for liquid sound. Has plenty of gain and a remote control into the bargain.



MF AUDIO CLASSIC SILVER £4,500
One of the best preamplifiers we've heard at any price, this transformer-coupled marvel does very little wrong. It's powerful, clean and open, yet delicate. Its sound is unmatched at or near the price.

MING DA MD7-SE £1,520
A valve preamplifier with an open, effortless sound and a big soundstage. It has plenty of gain so will accept any source and drive any power amp. A real beauty.



INTEGRATED AMPLIFIERS

ARIAND PRO845SE £1,499
Pure single-ended valve magic. Low-powered but immediately gorgeous, easy-going yet forcefully dynamic at the same time.



AUDIO RESEARCH VS160 £3,500
Power house sound with enormous pace and punch from traditional U.S. muscle master Audio Research. Breathtaking, but expensive.



CAMBRIDGE AUDIO AZUR 651A £350
Dual-mono construction and meaty toroidal power supply combine to produce a solid and sharp sound with sonics far beyond its price point.

CREEK EVOLUTION 100A £1,500
Superb build and smooth confident sound make this powerful amplifier a benchmark.



CYRUS 8DAC £1,400
Trademark shoebox-sized Cyrus integrated now offering 88Watts per channel, plus DAC. Svelte delivery from a dainty case that fits in anywhere – and isn't Class D!

EXPOSURE 1010 £495
Entry-level integrated from Exposure has excellent upper mid-performance with an almost valve-like sound.



ICON AUDIO STEREO 60 MKIII £2,800
Excellent tube integrated with plenty of power and an expansive soundstage, plus KT150 tube option and bias meter for easy adjustment.



NAIM NAIT 5Si £925
Naim's fabled entry-level integrated amplifier is updated to Si status. Demos Naim's superbly muscular sound at entry level.

SUGDEN A21SE £2,480
Class A amp with fantastic sound quality producing hard, sculpted images, deep detail and tight bass. Just don't expect disco-like sound levels!



POWER AMPLIFIERS

AUDIO RESEARCH VS175 £7,498
Powerful, fast valve sound that makes everything else look weak at times. Needs careful matching but well worth the effort.

AUDIO RESEARCH VS115 £5,000
Oodles of power with enormous punch. Rafael Todes said it provided "shock and awe" while retaining incredible smoothness and texture.

ICON AUDIO MB845 MKII £7,600
With 120W from big 845 valves right down to low frequencies, this power amplifier has massive dynamics and bass swing, yet is easy on the ear.



ICON AUDIO MB81PP £15,000
Big Russian transmitter valves deliver 200W from these massive monoblock amplifiers. Frightening in every sense.

MCINTOSH MC-152 £4,995
Stunningly insightful sound with enormous bass punch from a uniquely designed transistor amp. Amazing audio, a league up, if expensive.



QUAD ELITE QMP MONOBLOCKS £2400 PR
The proverbial iron fist in a velvet glove. Plenty of power but delivered with an assured and confident nature. Smooth on top and easy on the ear but can rock out when needed.

QUAD II-EIGHTY MONOBLOCKS £6,000 PR
Powerful and expansive sound from modern design monoblocks that also look lovely. Superb – used by us as a reference.



LOUDSPEAKER FLOORSTANDER

B&W 803 D3 £12,500
B&W's updated statement floorstanders deliver depth and definition with breathtaking speed and authority, aided by a diamond coated tweeter. Expensive – but enormously impressive.

CASTLE AVON V £1,600
A big floorstander at a modest price that suits the average room. Refined ribbon treble and deep bass give it a great delivery.



EMINENT TECHNOLOGY LFT-8B £2,500
Excellent U.S. planar magnetic loudspeaker at bargain price. Utterly superb - a must hear.

EPOS K2 £1,000
A fun sound that is tidy all round and very engaging, with solid bass. Music as you hope it to be.

FOCAL ARIA 926 £1,400
Simple, clean, neutral sound – easy going but well engineered and affordable.

MARTIN LOGAN SUMMIT X £16,698
Matches Martin Logan's XStat electrostatic panel to a powerful subwoofer to provide extended, powerful bass. Dramatic sonic purity. Awesome – all but unmatched.

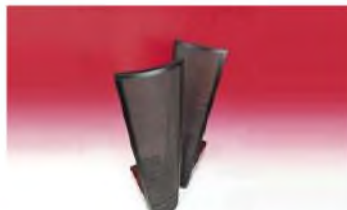

MARTIN LOGAN ELECTROMOTION £2,500
Martin Logan's budget baby XStat hybrid electrostatic. Fits into any lounge to give electrostatic levels of clarity and imaging.



QUADRAL CHROMIUM STYLE 8 £1,700
A supremely smooth yet open sounding loudspeaker. Clean and detailed treble from a fine ribbon tweeter. Accurate yet informative and enjoyable. Pure class.

QUADRAL ORKAN VIII AKTIVS £6,200
Active loudspeaker with tight, powerful bass, perfect accuracy and detailed treble from a ribbon tweeter.



Q ACOUSTICS 2050i £480
A large floorstander at a budget price. Offers high sensitivity and big sound and has very few flaws for the price.

SPENDOR SP100 R2 £6,495
Retro looks but a sound that's hard to match. Spendor's 12" bass unit provides massive low-end grunt with a room-filling sound.



SPENDOR A3 £1,300
Fine little floorstander with a smooth, natural midband and even tonal balance. Ideal for smaller rooms.

TANNOY DEFINITION DC10 Ti £6,000
Enormous power with great projection. Glorious subsonics too. Need little power to go very loud and have superb finish into the bargain.



TANNOY KENSINGTON £9,950
Big but not overpowering, punchy modern sound from classic cabinetry. Need little power to go very loud and suit a traditional home, or castle.



LOUDSPEAKERS STANDMOUNT

ACOUSTIC ENERGY NEO 1 V2 £225
Civilised sounding speaker with fast and tuneful bass.

ACOUSTIC ENERGY AE1 CLASSIC £845
Brilliantly successful remake of an iconic design; not flawless, but surely one of the most musical loudspeakers ever made.



ELAC BS243 £1,000
More transparent and spacious than they've a right to be at this price, these refined mid-price standmounters represent top value.



EMINENT TECHNOLOGY LFT-16A £1,200
U.S. planar magnetic bookshelf loudspeaker with unrivalled mid-band and treble. Hear it before all else.

WHARFEDALE DIAMOND 220 £200
Builds on the success of previous Diamond ranges with better bass, more detail and a greater sense of scale.



KEF LS50 £800
Supremely musical mini-monitors which sound much bigger than they look.



MARTIN LOGAN MOTION 35 £1,300
Folded Air-Motion tweeter gives a taste of Martin Logan's electrostatic sound in a standmount. Different from the standard mini-monitor and all the better for it.



PMC TWENTY.21 £1,575
Transmission line loaded standmount with a big box sound from a compact cabinet. Punches well above its weight.



Q ACOUSTICS 2020i £165
Great little bargain-priced stand-mounts with a friendly, fun yet surprisingly refined sound. Hard to better for a pair of starter loudspeakers.

WHARFEDALE DENTON £500
A beguiling mixture of retro looks with modern, high-technology drive units. The Denton has an easy-going, big-hearted sound with a touch of trad warmth that should appeal to many.



HEADPHONE AMPLIFIERS

CREEK OBH11 £150
Designed specifically for low to medium impedance (30 Ohm – 300 Ohm) headphones the little Creek has a marvelously well-judged sound.

CHORD MOJO £399
Class leading portable DAC and headphone amp with ability beyond all else. Big, open spacious sound.



EPIPHANY EHP-02 £99
PP3 battery-powered portable gives great sound quality at an almost giveaway price. Happy with the output from an iPod or CD player, the little epiphany is a true bargain.



ICON AUDIO HP8 MKII £650
The HP8 MKII valve-based headphone amplifier brings the spacious sound of valves to headphones. And it matches 'em all.



FIDELITY AUDIO HPA 100 £350
Great little headphone amplifier with a lively yet refined and open sound.

MUSIC FIRST PHONE BOX £276
Brings a big stage, plenty of detail and rich, deep colours to the sonic spectrum.



OPPO HA-2 £250
Remarkable performance and sound from ESS Sabre32 DAC in a slim portable package.



CD PLAYERS

AUDIOLAB 8200CDQ £949
Inspired CD player and DAC with price-performance ratio like no other. Capable of matching designs costing much more.



CANOR CD2+ £3100
Musically coherent and tuneful valve-driven CD player from Slovakia. Lovely liquid sound.



CAMBRIDGE AUDIO AZUR 651C £410
Snappy modern presentation from this budget CD player. Cracking audiophile entry point for any digital fan.

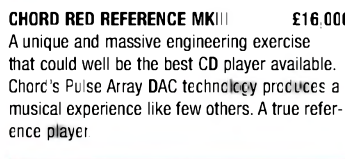

ESOTERIC K-03 £9,495
Superb high-end silver disc spinner that is beyond criticism. Devoid of its own character but has a flawless presentation.



EXPOSURE 101 £395
Detailed player with fine sense of timing should be an automatic entry on any demo list at this price.

ELECTROCOMPANIET EMP-1/S £4,650

Epic in scale, lavish in tone and exuberant in its musicality - this is a memorable SACD spinner. Quirky in operation and modest in finish, though.



OPPO BDP-105D £1200

Universal player and DAC that makes CD and Blu-ray (+DVD) sound deep, spacious and full bodied. Reference quality that's affordable.



REGA APOLLO-R £550

Rega comes up with a fine CD player again. Tremendous detail and an easy, unforced sound at all times. Few bells and whistles but made up for by its superb sonic ability.

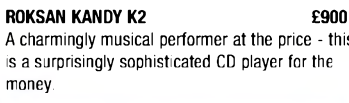

ROKSAN KANDY K2 £900

A charmingly musical performer at the price - this is a surprisingly sophisticated CD player for the money.

TUNERS

CAMBRIDGE AUDIO AZUR 651T £299

Value-packed AM/FM/DAB and DAB+ ready tuner. Precise and detailed with excellent resolution of spoken word.



CREEK DESTINY 2 £550

Creek's tuner expertise shines through in the Destiny 2. This AM/FM receiver is wonderfully three-dimensional and smooth.



MAGNUM DYNALAB MD-90T £1,900

Exceptionally able, but commensurately priced, audiophile tuner that cannot fail to charm.



DACS

AUDIOLAB M-DAC £600

Excellent sound from ESS Sabre32 DAC and impressive flexibility with a unique range of filter options make this a stand-out product. Low price is the icing on the cake.



AUDIOLAB Q-DAC £250

Stripped-down version of Audiolab's M-DAC loses some features but retains much of the sound, making it a veritable bargain.

ANTELOPE ZODIAC GOLD/VOLTIKUS £3,095

DAC/preamp/power supply combination majors on detail but has a remarkable un-digital sound. One of the best at its price.



CHORD 2QUTE HD £990

Superb build quality and exceptional sound from this compact unit. Boasts the ability to handle DSD direct via USB and has an exceptional soundstage. One of the best DACs you can buy.



DCS DEBUSSY £8,000

DCS's bespoke 'Ring DAC' circuit gives a beautifully-fluid, almost analogue sound that encourages long listening sessions. Not cheap but worth every penny.

NORTHERN FIDELITY DAC £650

Packed full of features, including Bluetooth and USB, this ESS Sabre32 equipped DAC offers crisp, insightful sound at low price.



METRUM OCTAVE £729

Unique two-box digital-to-analogue converter with great sound at a great price. Cuts upper treble, though.

NAIM DAC £2,400

Superb high-end digital converter with a probing, punchy and forensically-detailed sound.



TEAC UD-501 £699

Feature-packed DAC with benefit of DSD playback. Superb sound means little to touch it at the price.



RESONESSENCE INVICTA MIRUS £4,499

One of the most highly spec'd DACs available, with a smooth yet enthralling presentation. Few approach it.



NETWORK PLAYERS

CHORD DSX100 £7,500

Chord's proprietary DAC circuit shines in their top-of-the-range streamer. Hear-through clarity with a sound rich in detail, dynamics and soundstage.



CAMBRIDGE AUDIO NP30 £399

Budget offering from Cambridge offers a great introduction to network streaming.

CYRUS STREAM X £1,400

Gorgeous sound quality even from compressed digital music. New control app makes everyday operation a doddle.



CONVERT TECHNOLOGIES PLATO £2999.00

A network player with amplifier that does it all, including turn LP to hi-resolution digital, and add cover artwork from the 'net.



NAIM NDX £2,995

Clean, incisive and very detailed sound with Naim's traditional pace and timing make this one of the best network music players around.

NAIM ND5XS £2,175

Great sound quality with traditional Naim heft. A wonderful DAC with full 24/192 handling. Only the display could be better.

NAIM NAC-N172 XS £1,650
A pre-amp/DAC/streamer package provides a taut, rock-solid presentation with a tonally rich midband and a superior sense of rhythm.



PRO-JECT STREAM BOX RS £1,095
Unusual valve-based streamer/preamp with variety of inputs and a lovely liquid sound. Not the most detailed but compensates with sheer musical verve.

QUAD PLATINUM DMP £2,500
Combined CD/network player has all the usual Quad elements but with added zest and detail that brings life to everything you care to play.



DIGITAL SOURCES

ASTELL&KERN AK100 MKII £569
Portable high-definition digital player with superb sound quality. Punchy and fast



FiiO X3 £150
Fabulous value player with nice easy sound and full range of abilities. Small and light. For newbies.

LOTOO PAW GOLD £1,500
Reference quality sound; it's like carrying your hi-fi in your pocket. Equivalently large too, but stunning headphone quality.



NAIM HDX £4,405
Interesting one-box network-enabled hard-disk music system that gives superb sonics together with impressive ease of use.

NAIM UNILITE £1,995
A 50W amplifier with traditional Naim heft, a CD player and vhf/fm radio, plus network input and Bluetooth make this a great all-in-one.



PORTABLE SPEAKERS

BYAN SOUNDBOOK £149.99
Superb design and great sound make for one of the best portable Bluetooth speaker/radios on the market. Not the cheapest – but worth every penny.



IRIVER IBA-50 £69
Big, warm sound with plenty of volume and clean at high levels. Muscular sound compared to many rivals.

CABLES

BLACK RHODIUM TWIST £71/3M
Twisted to fight off radio frequency, the Black Rhodium speaker cable is easy on the ear with a fine sense of clarity and focus. A remarkable performer at the price.



MAINS CABLES R US NO.27 £95
Offers a sprightly pace with a precise nature. Fast performance enhance frequencies and beautifully etched detail.



CHORD SIGNATURE REFERENCE £900
Majors on timing, detail and openness. Capable of getting the best from most systems and a recommended upgrade.



TELLURIUM Q BLACK 280/3M
A deep, dark, velvety performer that's nevertheless highly musical, it represents excellent value as mid-price cables go.

TELLURIUM Q SILVER DIAMOND £804/M
An open, natural and transparent sound that is difficult to beat, from these great loudspeaker cables.



HEADPHONES

AUDEZE LCD-3 £1,725
A planar magnetic 'phone that offers monitor quality. Strong sound with silky, dark quality that others struggle to match.



B&W P3 £170
Beautifully presented headphones from the loudspeaker specialists. Feed them a good quality source signal and they reward with excellent sound.

JAYS V-JAYS £49
Wonderful little budget over-ear portable 'phones with a clean, clear sound to beat the best of the rest at the price.



NOBLE K10 INC. FITTING £1,279
Custom fit in-ear phones with 10 drivers deliver a sound that is out of this world. Personal and perfect.



OPPO PM-1 £950
Planar magnetic phones with a warm, easy but big bodied sound that draws you in. Need a lot of drive, but deliver superb bass.



SENNHEISER HD700 £599
Tremendously fast with a strong, focussed, lower-frequency range and a firm bass punch.



YAMAHA HPH-MT220 £150
Purposed for indoor monitoring yet light and comfortable enough to be used on the move. Excellent sound quality marred only by a slight warmth to vocals.

Look Like Me

E A B E
 eleanor mcevoy
 A E E
 naked music
 A E E E E7 A
 not think my aim in life should be to look like all of the rest of the girls I see
 A6 Amaj7 A6 Am6 Am6
 see them looking at each other but me, you see, like,
 Am7 E (Go to verse 2 below)
 I want to look like me



MOSCODISC

Naked—the album, on vinyl & CD.

Naked—the book, music & lyrics by Eleanor McEvoy, paintings by Chris Gollon and photos by Shane McCarthy.

CD and vinyl available through Claddagh Records, IAP Fine Art, online and in all record stores.

Book available from IAP Fine Art, Hot Press and all good book stores.

“A master craftswoman at work, her songs as evocative as ever” —The Irish Post

“Nothing short of a classic” ★★★★★ —Maverick magazine

“Naked Music is an excellent album from one of our finest performers” ★★★★★ —R2 magazine

“Eleanor McEvoy is one of those artists who can do no wrong... what a voice!” —Alex Lester, BBC Radio 2

eleanormcevoy.com

iapfineart.com

mosco.ie

"you don't want to know how professionals assess sound quality either"



Noel Keywood

I'm not the only one at it. There are companies and organisations around the world that must also judge sound quality – and if they get it wrong it affects us all. So how do “professionals” judge sound quality? Get your hanky out and be prepared to cry.

I first got a hint of the problem when reading about the development of MP3 in a lecture by the assertive Karl Heinz Brandenburg of the German Fraunhofer Institute. How – I asked myself – did you deride MP3 has no affect upon sound quality? Simple: they listened to it. And came to the conclusion – forcefully stated – that around 90% of musical information could be thrown away without anyone noticing. Hmmmm...

By what method and with what equipment did they reach this conclusion? What were the test conditions and were the tests conducted by an independent audience that had no commercial interest in a system that Fraunhofer today explain became a “worldwide audio standard that had a positive effect on the German economy”. Nothing.

As Philips once told us CD was perfect and “all else gaslight”, Fraunhofer told us MP3 was equally perfect with no mention of how they reached this conclusion. And since then MP3 has become the whipping boy of digital compression systems – and rightly so. It strips music of organic form.

Leaving me interested in how professionals conduct listening tests. I was to find out.

Digital compression schemes must be assessed subjectively for their impact on sound quality. And boy are there a lot, not just from Fraunhofer and the Motion Picture Expert Group, but Microsoft, Apple, Dolby, Sony and many more. That's

a lot of listening tests going on around the world. How are they being carried out and with what equipment? All these companies must be using high quality audio systems surely?

Researching Bluetooth for a column in the October 2021 issue, which uses aptX compression, I hit a gem – a paper about the ‘subjective assessment of small impairments in audio systems’ from the International Telecommunications Union, BS.1116—3 from the BS series they say :-). Sadly, that's the only funny bit: it otherwise made glib reading.

Such papers consistently repeat certain mantra, the main being blind A/B/C comparisons and statistical analysis techniques – pointless when the basic tests are inept, producing worthless data.

And that is what I read here. They say twenty people are needed for a useful result: perhaps, but not all in the same room at once. I've organised and participated in many such trials and no more than five is tolerable. Otherwise no one has an ideal listening position and their ears are shielded by others. There must be silence and no opinion signalling. No lunch breaks at the pub either!

Always best for one person to listen under no pressure, in control of music selection and able to choose length of exposure. But this is very difficult to do in practice, especially if twenty people have to pass through in sequence. It means around ten days of listening with problems of non-arrival, lateness and much else. In other words, such testing is very difficult to execute – and expensive. Doing this many times – as you have to – is impracticable.

The real breaker in this report was that of programme material. It is vital to choose programme that is able to “break the code” in the case

of digital compression systems that the ITU appear to be talking about here (they don't say!). The older schemes like MP2 and MP3 went to pieces with massed strings, that became a blurred mess. They possess high frequency energy in a complex pattern the ear is able to interpret and understand.

Programme material has to be selected for listening tests yet there's no appreciation in this paper of programme spectral content, dynamic range, nor human sensitivity to speech, vocals or musical instruments.

In fact, the human side is totally missing. And without suitable programme material that is both realistic yet challenging, there's no point in continuing. Differences will not be revealed, leading to the conclusion the compression scheme is perfect. Is that what happened with MP3?

The paper is hugely detailed in areas known about, such as listening room acoustics, and statistical techniques, but bizarrely silent about central issues such as the replay system itself (hardware) and the listening conditions.

This look at a 25 page technical document on “how to assess sound quality” neatly illustrates the difficulties by its cloaked ineptitude. Too much virtue signalling, not enough understanding. But this is what goes on in the background where conditions audiophiles expect to work under, such as a nice peaceful lounge not populated by twenty people, and music more challenging than that from Engelbert Humperdinck is used. You don't want to know what the neighbours get up to and you don't want to know how ‘professionals’ assess sound quality either!

How would I do it? Simples. I'll cover this next month. ●

isoTek®

The power to perform



Make room for a new Titan.

Crafted from a single block of aluminium, the new V5 Titan joins IsoTek's portfolio of class-leading power optimisation solutions.

With a dedicated high current power cleaning system, the V5 Titan offers three independent power-cleaning networks in a single chassis: two outputs for high-current amplification and a third for an active subwoofer. These use multiple independent power cleaning networks that dramatically reduce Differential Mode mains noise cross-contamination between output sockets.

Titan delivers absolute power and unrestricted current delivery within the confines of energy company and regulatory limits.

isoleksystems.com

To find your nearest dealer, please visit:
finesounds.uk/dealers



"So, when your favourite group splits, you know who to blame"



Paul Rigby

One of the principle reasons that bands split up is down to 'musical differences' which, as you and I both know, can mean just about anything.

It can, of course, mean just that, which is often the most surprising thing of all. It can also, now I come to think of it, come down to girlfriends imposing themselves upon the rest of the band and sleeping on a mattress while the rest of the guys are trying to get some work done in the studio. Thank you very much indeed. Actually. If that's all right with you, John.

But many of the reasons that culminate in the eventual disintegration of any one band falls to this one word: money.

There's nothing that makes a musician feel as unloved as not getting a fair shake.

It's all about credit. It's about the land grab, isn't it? Once those starry young fools, the same silly sods who can't do enough for everyone involved at the beginning and "we're just glad you be here".

When those self-same kids wise up and realise that they're being taken for a ride by the record labels and suddenly understand that it's the song writer who makes all the money and they're subsisting on pocket money and they're all getting older and "Am I destined to be a homeless derelict with a few memories and ten ex-wives?" Then the conversations become serious.

This increasingly nagging subject. This talk about the source of monetary wealth for the lucky few song writers attached to successful bands. This growingly important matter. It has caused more arguments and court cases and the fracturing of bands and

personal relationships than just about anything else.

Isn't that right, Pink Floyd? And to some extent The Beatles? The Smiths? The Jam?

Is this why the members of Queen always looked so calm, collected, happy and content? Because they split the cash four ways? I would wager that yes, that was the case. Actually, I don't know the exact details of the cash split. I do know that the likes of Blur, REM and U2 had the sense to look around them before they jumped into the murky world of rock music management and rock music contracts.

All three, so I'm given to understand, give 20% of the takings to the song writer. After that, the remaining 80% of the income is evenly split between the band (including the song writer who is now seen as a musician in the same band). This means that everyone is getting a fair slice of the pie.

And why not? Writing the song is incredibly important but so is the arrangement of that song and its final composition which often features incredibly important contributions by the rest of the band. Shouldn't they feel valued and part of a team in such circumstances? I think so.

Let me ask you this. I wonder how Herbie Flowers feels. Herbie Flowers, the long-standing, much respected and highly talented guitar player who has appeared on his own records and many others. An industry legend is Herbie. How does he feel when his iconic bass line on Lou Reed's 'Walk on the Wild Side' results in exactly zero monetary-based credit? Reed is quoted as the songwriter but surely, where would that song be without Flower's bass line? Hmmm?

If Herbie had said, "OK, Lou.

I'll just sit here, shall I? You record that song with your acoustic and I'll wait. No rush ol'son." That song would have been a shadow. Flowers deserved a formal credit for his part in the arrangement. And I don't know, did he have anything creative to say in songwriting terms relating to that bass line, perhaps?

How about 'Come Together' from the Beatles? Where would that song be without Ringo's drums? A much aligned musician is Ringo but he's critical on that song. Critical.

And this is all down to tradition and a pre-group way of thinking. It's a Tin Pan Alley mindset. A Brill Building way of doing business.

That is "...my friend and I are the song writers. We've just finished it. Here it is. Now, would you like to sing our song, Mr Singer? OK, you get paid for doing whatever you do, we get paid for writing that song. For selling the sheet music".

That 'us and them' structure never changed when the revolutionary popular group/band became a dominant form. When band members began to write their own songs in and around the early sixties.

At that time, a hit record was suddenly more than 'just' the song. The song was bespoke to a particular set of musicians at that time and no other. And that group contributed the house sound that turned the song into something unique.

Trouble was, the trad way of writing songs was never changed or updated.

So, when your favourite group splits, you know who to blame. A conservative music industry who, when faced with change, rather than innovate, runs screaming back to a secure template that they know works...and pays. ●



June 2021



Sept 2021



Ceramic sockets for continued oxidization free connection



Power Stage: EL34 Tubes
Output stage: ECC82



Iron Silicon output stage for higher frequency reproduction



High power output, can run most Speakers

ROMA 96DC+

The Synthesis Roma 96DC+ is a 25W Class A stereo integrated amplifier, utilising four high-quality EL34 and two ECC82 valves in the design. Featuring a variety of digital and analogue inputs, including a moving magnet phono stage; it is both a high-end performer and a wholly convenient solution for music lovers.



Distributed by Henley Audio

T: +44 (0) 1235 511 166 | E: sales@henleyaudio.co.uk | W: www.henleyaudio.co.uk | Facebook: HenleyAudioUK | YouTube: HenleyAudio

"the film uncovered other early British electronic-music composers, Brian Eno and Daevid Allen, for example"



Martin Pipe

During WWII the Nazis used magnetic tape recording to disseminate Hitler's speeches via German radio. Captured 'Magnetophons' found their way to the US and Britain after the war, forming the basis of a burgeoning new industry that peacetime Germany also benefited from. In 1961 Grundig announced that it had sold 100,000 of its TK20, an affordable single-speed (9.5cm/s) half-track mono machine for family use or budding musicians. Indeed, a TK20 was used by the Quarrymen...and we all know what became of them.

Long-distance and international phone calls were prohibitively expensive in the early 1960s, but tape provided an alternative. 'Tapesponding' relied on the exchange of reels via post. You would record your contribution onto tape – usually a small spool of the stuff, suitably packaged by manufacturers like Scotch, to keep postage costs down. Tapesponding allowed recorder owners to stay in touch with distant relatives – but subsequently the concept expanded to strangers.

The British Recording Club was affiliated to 'local' tape-recording and cine societies in towns and cities around the country. Every month, the BRC published long lists of tapespondents in its magazine ATR (Amateur Tape Recording). Each entry would contain the name, occupation and (unimaginably today!) address of the tapespondent – together with a description of the recorders at their disposal (to ensure tape compatibility; TK20s, I note, were popular), musical tastes, languages

spoken and a tally of hobbies, to get the ball rolling.

Tapespondents were usually UK-based and male. However, most directories contained a smattering of would-be correspondents in countries like the USA, Australia, South Africa and Ireland.

ATR published much more than tapesponding lists. In addition to the staple magazine fare of news, reviews, columns, interviews with celebrated tapists (January 1961's ATR featured Russ Conway) and advertising were short plays, written for tape-recording clubs, and technical features. From the latter, avid readers could build mixers, grasp the fundamentals of magnetic recording, learn how to edit and develop microphone technique.

A prominent name here was Fred Judd who was ATR's technical editor. Some of his articles explored pre-synthesiser electronic composition, sound-processing like tape loops and musique concrete. The latter, which manipulated 'found sounds' to creative effect, could have been made for tape recorders; exponents of this 'electroacoustic tape music' included Stockhausen and Schaeffer. Judd won at least one major prize for his compositions, some of which were used by TV (most famously, Space Patrol and The Tomorrow People). He had a primitive synthesiser operational by 1963.

Experimentation with musique concrete and electronics took place in broadcasting studios, notably those of the ORTF. Such techniques were also the stock-in-trade of the BBC's Radiophonic Workshop, which – as electronic musical experimenter and filmmaker Ian Helliwell reminds us,

in the newly-published second edition of his absorbing book *Tape Leaders* – was a "closed shop, geared towards servicing BBC productions". Although some experimenters (among them female pioneers Daphne Oram and Delia Derbyshire) were at some point employed by the BBC, most British work in this field was undertaken in private self-funded facilities.

The idea for the book came in 2011, when Helliwell made *Practical Electronica* – a feature-length film about Judd. He visited Judd's widow, who gave him access to archives and tape recordings. Research for the film uncovered other early British electronic-music composers. Some of them (Brian Eno and Daevid Allen, for example) would become more familiar names. They, along with Oram and Delia Derbyshire, are biographed in *Tape Leaders*.

Tape Leaders also covers early British synthesiser studio and manufacturer EMS (Electronic Music Studios) and the men behind it – Peter Zinovieff, David Cockerell and Tristram Cary. This groundbreaking organisation explored the musical potential of DEC's PDP8 minicomputer, as well as producing iconic synthesisers like the VCS3 and Synthi models (used by performers like Pink Floyd and Jean Michel Jarre, as well as the Radiophonic Workshop). There is excellent use of nostalgic imagery from the 1960s and 1970s and Helliwell has also assembled a CD of early electronic pieces by some of the authors in his compendium. This CD accompanies the £25 book, which is published by Velocity Press (bit.ly/3p8iAaD). Essential reading and listening, if you're interested in electronic music. ●

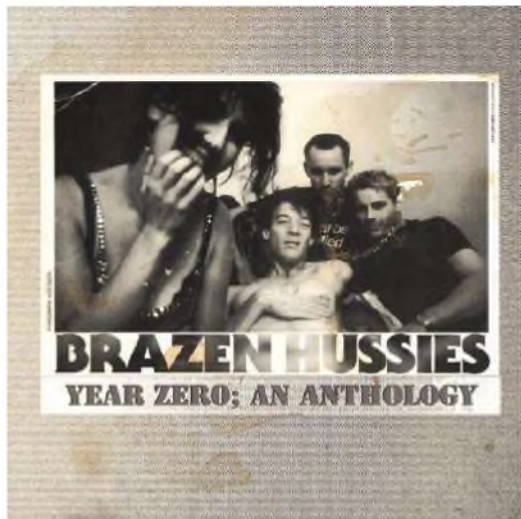

BRAZEN HUSSIES

Year Zero: An Anthology
 Jezus Factory

An Anthology you say? So then, that means that albums have been combed, hit singles collected, tours have had their live gems picked and prodded and a gamut of rarities have been found amongst the dust bunnies under that speaker stack...the one in the corner. Over there by the bucket of water and Dettol.

Well no, not really. This band only ever released five tracks. And they were scattered like Dandelion seeds in the wind, as it were, over singles and compilations.

London based and 'alive' from 1996 to 2004, this rock, 4-piece band reminds me of Lou Reed in some ways. Lou Reed's brain, that is. So not necessarily in sound terms but in terms of mind set. Reed and the Brazen Hussies shared a similar playful disrespect for the song form, a fascination with discordance and a city

sound that smacks of too much traffic, too many people, bright lights, broken lights, dim alleyways, threat, danger and edge. Whether that be the mugger's knife or the decaying urbanity.

There's also a fresh and playful element here that mixes rock with an appealing harmonic integration so you end up with a sort of punk rock meets soul meets disco effect. The aggressive with the gentle. The melodic with the jarring. The tuneful with the chaotic.

I see this album for sale on the Internet and I see it under tags like punk and hair rock and prog and I don't recognise any of these things. This music is serious. Really. It's experimental. It reflects deep thought. Meticulous preparation. Don't dismiss it. Give it the respect it deserves.

Oh, incidentally, the CD and LP versions have a different track order. So, if the music doesn't confuse you, the sleeves will.

AUDIOPHILE CD



THE PRETTY THINGS

Live At The BBC
 Repertoire

Emerging from the beat era and then the R&B and psychedelic scenes, the British-based Pretty Things were never the stars they probably should have been. Then again though, I'm not sure their music or even demeanour would have suited that status. Their rather shabby appearance sign-posted their 'don't care' attitude and a sense of the dangerous and the brutal that just wouldn't have washed in the finer halls of stardom.

Even fans of The Rolling Stones who delighted in that band's dark and roughish presentation would have thought twice about meeting a Pretty Thing down a dark alley.

Saying that, guitarist Dick Taylor was part of the early Stones line up before he and Phil May started the Pretty Things as a going concern. Their work moved through the core rock structures yet they found time to experiment

producing what is arguably the first rock opera in S.F. Sorrow (1968) with Parachute (1970) their rock/psyche/pop masterpiece.

The band would split and fracture but always return, finding creditable come-back LPs in the nineties, naughties and beyond with reissues rekindling their oeuvre.

The band have become rock fixtures. Famous for not being famous. Oozing street cred by the plastic cup full.

This six-disc compilation tracks their rocking progress from 1964 to 2018 within three gatefold sleeves plus a packed, forty-three page book that sits within a slipcase outer.

Shows featured include the Saturday Club in 1964, Top Gear in 1968, Sounds of the 70s in 1970, Radio 1 Session in 1972, John Peel's Show in 1974, In Concert in 1975, Mark Riley's show in 2018 and a whole lot more besides.

Ventura was active during the forties and fifties as an alto saxophone player and then, later on the tenor sax on which he settled upon for the duration. His entry into music came one day while working at the Philadelphia Navy Yard when he received an invitation to join the Gene Krupa band. An event that was just a little uncommon. Because he valued his regular weekly pay cheque he – and let this one sink in – turned them down. Krupa, to his credit, didn't mutter obscenities and move on but actually called him again for another go. This time Ventura accepted and became a soloist, along with Roy Eldridge and singer Anita O'Day.

I find Ventura an enigma because this was a guy who tried to deliver bop to a wider audience. He even ultimately ran a band called Bop for the People. But surely Ventura was a

swing artist? Was the notion of bop a jazz style that he could capitalise upon? Realising that maybe swing had had its day as a mass consumer music medium? Perhaps – and the move would certainly bring him into contact with some of the greats including Bennie Green, Charlie Parker and Buddy Rich.

Ventura's work was down to earth but never shoddy. His solos were clean. You can hear that on 'Adventure With Charlie', initially produced by King in 1957 with John Coates, Jr. on keys, Billy Bean on guitar, Gus Nemeth on bass and Tony DeNicola on drums. The players contrast but also complement, the music blends ballads with mid tempo movers.

On this CD, you also get 'Gene Krupa: Jazz Trio Live at the Band Box' from January 1953, recorded live at New York's old Birdland which is a useful bonus for fans.



CHARLIE VENTURA

Adventure With Charlie
Jasmine

AUDIOPHILE CD

The first of two newly released albums, 'Voices in my Head' is a new double album gatefold, limited to just 100 copies, and exclusive to CD! That put a smile on my face. I'm happy to see a bit of love come CD's way. Vocals are included via Ditsea Yella, Eireann Musique and Lara Dennis. Apparently, included with this CD is a download of li2c's previous album, 'Special X'. Although I didn't see that extra within my review sample. This album is li2c's determination to do a vocal-orientated album and, well, I have to say that I disliked it intensely. I was actually annoyed. I felt the lyrics and vocals – shipped in by li2c's collaborators – diluted the power of li2c's music which I normally find affecting, moving and powerful on its own. The voices and lyric work on this release moved this li2c album to the Me Too

pile or, worse, the 'Yoof' circuit. I found them superfluous.

Yes, there are instrumental versions of a lot of the vocal version on Disc 2 but I feel that these are compromised because they are made with vocals in mind which skews their inherent structure in the first place. There are spotted highlights here but not enough.

'10 Chords' is intriguing because I feel this notes a progression of the li2c direction from a largely Tangerine Dream-esque signature style to one that is infused with anger. A more industrial feeling speaking more of angles, resistance, energy, force and a sense of the harsh, the unyielding and the fractious. Whether this reflects commercial considerations or reactions to personal events I'm not sure. It's an intriguing move, however and one to keep an eye on.

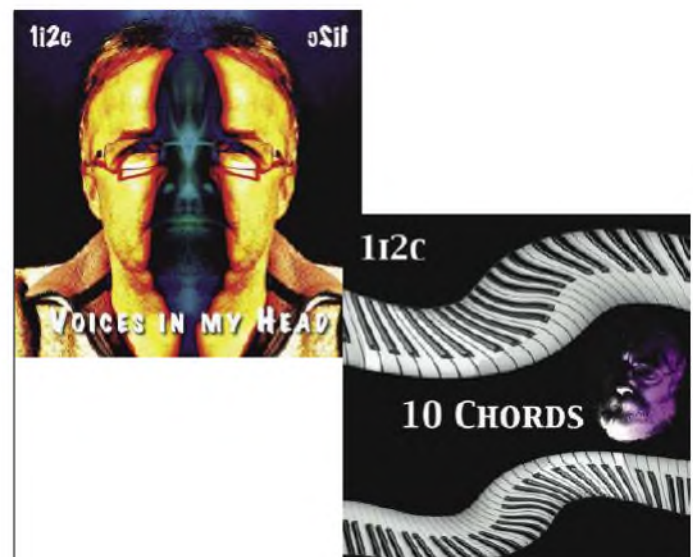

li2c

Voices in My Head/10 Chords
Pink Dolphin/li2c

Mini Marvel

Martin Pipe's ears host Sennheiser's midrange wireless IEM contenders.

Bluetooth IEMs – in-ear monitors – never cease to amaze me, and not just because they're so effective at freeing the listener from tangle-prone cabling. Into each tiny bud must be crammed not only the transducer (and associated acoustic chamber) but a Bluetooth wireless receiver, digital signal processing, DAC, amplifier, control system and

the battery needed to power it all! Some also build in microphones, and all that accompany them. Not only are there space constraints, but these marvels of micro-engineered sound technology must be low in weight to ensure comfort, and prevent gravity from doing its worst. Sennheiser has managed to produce not one, but three such 'True Wireless' devices. Midway between the 'entry-level' CX

(£99) and 'high-end sound-tuned' Momentum 2 (£189) sits the £129 CX Plus featured here.

Weighing a mere 6 grams each, the CX Plus will deliver 8 hours on a single charge. When not in use the two buds are stored in a special hinged case, magnets snapping them into position. This case has enough internal battery capacity to provide a total 24 hours of use, and keep the buds





To ensure the earbud contacts always make contact with the sprung pins of the charger, fairly powerful magnets are used. As can be seen, they are mounted in the case.

'topped up' when you're not listening to them. The case is itself charged via a USB-C connection. No mains unit is supplied, but you get a USB-A cable for charging via a PC. To accommodate all that sophisticated electronics, the IPX4 moisture-resistant bodies of each bud are noticeably larger than the average budget 'wired' IEM but sculpted to comfortably fit your pinnae and ear canals.

To their nozzles, which direct the output of the 7mm 'TrueResponse' moving-coil transducers towards your ears, are attached your choice of 'tip' – four different sizes are included. Into the opposite ends of each CX Plus bud are set buttons that – depending on how they're pressed, and the equipment you're partnering with them – sequence through tracks in either direction, pause playback, change noise-cancellation mode and adjust volume. The Bluetooth 5.2 radio link to your device supports the AAC, aptX, aptX Adaptive and SBC codecs meaning the CX Plus should give decent sound quality in a majority of scenarios.

Active noise-cancellation is supported, and the beamforming MEMS (micro-electromechanical system) 'chip' microphones – two in each bud – that make such cancellation possible are also used for hands-free phone calls. The CX Plus buds, which are marked to identify the specific ears into which they should be inserted, fit very nicely and are comfortable to wear for extended periods.

They stayed in position, thanks not only to their shape and lightness but the lack of wires. I easily partnered them with two Bluetooth 'sources' – a Sony Nexperia 10 Android phone, loaded with the VLC app, and an Astell&Kern SR25 personal music player. A female voice confirmed pairing and other operational parameters.

Both of my devices were remembered, although when switching between them I had to shut the buds away in their case thereby effecting a crude 'reset'. Using a mobile device, it's possible to draw on the features of Sennheiser's free 'Smart Control' App (Android/iOS). This acts as a 'usage guide', enables firmware updates and allows you to configure the buds – noise-cancelling behaviour, equalisation, 'Transparent Hearing' (ambient pickup, akin to the 'talk-line' function of early Walkmen) and (it turns out!) managing the devices to which the CX Plus is paired.

I found that, as delivered, the midrange sounded rather sharp, imparting a rather nasal character to speech although rock guitar seemed to benefit. After several hours of 'burning-in', the tonal balance shifted. The presentation had by this time settled on a crisp and incisive upper-midrange and treble, with plenty of attack and a well-defined stereo image. Such forwardness does aid subjective clarity – this was particularly noticeable with Radiohead's *Idioteque*, the complex machine-driven rhythms that lurk in the background being easily discernible. Various house-music cuts, and Talking Heads' *Born under Punches*,

demonstrate that bass isn't particularly impactful.

However, what you do get is fluid and punchy; it's definitely a case of quality over quantity here. There was alas an annoying tendency for the Bluetooth connection to drop out randomly. One channel, and then the other, would 'blip' before audio was restored; this happened with both the Sony and the A&K. The noise-cancelling feature isn't the most



The eartips fit to the nozzle of each CX Plus, behind which lurks a 7mm moving-coil driver. Also visible are apertures for the microphones that make hands-free calls and noise-cancellation possible.

effective I've heard, but it doesn't mangle the music as badly as some. Even with Bluetooth, the CX Plus is a damn sight more musical than the sonic joke that is the average smartphone headphone amplifier.

CONCLUSION

On the whole, the CX Plus is a well thought-out package. Its wireless circuitry introduces lossy compression, and so to minimise sonic impairment it's a good idea to store music losslessly on your playback device. Although a system like this is never going to be as transparent as a direct wire link between player and transducers, the CX Plus nevertheless does a worthwhile job – for many listeners, the marginal subjective impairment and occasional dropouts will be more than outweighed by the convenience and practicality offered.

As well as the CX Plus earbuds themselves, £129 buys this neatly-curved 'charging case', a USB charging cable and four different sizes of ear-tip.



SENNHEISER CX PLUS, £129



EXCELLENT - extremely capable.

VERDICT

Sennheiser has spent time on the design of the CX Plus. In performance terms, it's more than acceptable although some rivals fare better

FOR

- decent overall package
- punchy and detailed presentation
- upgrades most smart-device audio systems

AGAINST

- occasional dropouts
- rather subdued bass

Sennheiser
bit.ly/3ITSyRM



SOUNDECK

Especially for vinyl lovers...
**THE NEW DESIGN Soundeck
PM Platter Mat**

"All we can say is WOW. It is a very favourable improvement"

J K

"It's hard to put into words the dramatic improvement the PM brings to my SL-1200"

Frank T

"My view? Genius thinking outside of the box. Physics at work for much improved record playback"

Walter D

email sales@soundeck.co.uk to request information, receive a link to videos & reviews or discuss special sizes/projects



Available in 295mm 292mm or 285mm
Material SDS 4mm aluminium laminate

Price £90 inc VAT

online shop & info www.soundeck.co.uk

IAN HARRISON HI-FI SALE!

HIFI AT DISCOUNT PRICES. FREE NATIONWIDE DELIVERY

Email: ian.harrison@mercian.myzen.co.uk

SPECIAL OFFERS!! SALE! UP TO 40% OFF!!

**VAN DEN HUL MC10S £725, ORTOFON QUINTET RED £210,
PROJECT PHONO BOX DS £150**

TONERMS

AMC
CARTRIDGE MAN
GRAHAM
HADDCK
HELIUS
MICHELL
MORCH
MOTH
ORIGIN LIVE
ORTOFON
PRO-JECT
REED
ROKSAN
SUMIKO

HEADPHONE AMPS

CREEK
FIDELITY AUDIO
GRAHAM SLEE
ICDN AUDIO
LEHMANN
PRO-JECT
SUGDEN

AMPLIFIERS

CREEK
EAR/YOSHINO
ICDN AUDIO
QUAD
SUGDEN
TOM EVANS
VALVET

ACCESSORIES

DIGITAL STYLUS GAUGES, RECORD CLEANING MACHINES, CLEANERS, AUDIO CASSETTES

CARTRIDGES

AIR TIGHT
BENZ MICRO
CARTRIDGE MAN
DECCA LONDON
EMT
GOLDRING
GRADO
IKEDA
MY SONIC LAB
NAGAKA
ORTOFON
SUMIKO
SOUNDSMITH
VAN DEN HUL
ZYX

SPEAKERS

ACAPPELLA
CABASSE
EPOS
HARBETH
ICDN AUDIO
OPERA AUDIO
Q. ACOUSTICS
QUAD
TAYLOR ACOUSTICS

CD PLAYERS

CREEK
EAR/YOSHINO
ICDN AUDIO
QUAD
SUGDEN

PHONOSTAGES

EAR YOSHINO
GRAHAM SLEE
ICDN AUDIO
LEHMANN
MUSICAL
SURROUNDINGS
PARASOUND
PRO-JECT
PURE SOUND
QUAD
ROTHWELL
TOM EVANS
TRICHORD
WHEST AUDIO

CABLES

BLACK RHODIUM
IXOS
KUBALA-SOSNA
PEERLESS
PRO-JECT
QED
SUPRA
WIREWORLD
ZENSATI

RECORD CLEANING

PROJECT
MOTH
WIRELESS
BLUESOUND

TURNTABLES

ACOUSTIC SIGNATURE
ACOUSTIC SOLID
AMAZON AUDIO
INSPIRE
LUXMAN
MICHELL
MUSIC HALL
PRO-JECT
REED
ROKSAN
SRM TECH
THORENS

HIFI FURNITURE

ALPHASON
ATACAMA
CUSTOM DESIGN
HI FI RACKS
MUNARI
MUSIC TOOLS
NORSTONE
QUADRASPIRE
SOUNDSTYLE
TRACK AUDIO

HEADPHONES

AUDEZE
BEYER
ERGO
FOCAL
GRADO
SENNHEISER
ULTRASONE



WORLD DESIGNS

classic valve amplification

www.world-designs.co.uk

The AC-2K Balanced Power Supply

A major upgrade for your audio system that provides more musical enjoyment.



**DEEPLY
GROOVY**
9/10

'...the inclusion of the AC-2K was tantamount to a major component upgrade because, well, that's exactly what it is. It's feeding the entire hi-fi system with low noise, cleaned-up power. Grab yourself an AC-2K and, in my book, that will be money well spent.'

Paul Rigby, *The Audiophile Man*.

Further information at www.connected-fidelity.com. Contact us to arrange an AC-2K demonstration, in your own home or at your local Hi-Fi Dealership. Email: info@connected-fidelity.com. Tel: 01491 629 629.



HIGH-END SHOWS | NEWS | REVIEWS

Cheap as chips



Martin Pipe gets under the bonnet of a 1988-vintage Hitachi DA-7000, a machine intended to bring CDs within reach of more people than ever before.

By the late 1980s, CD players were gaining popularity. The silvery digital discs that listeners respectfully placed on their motorised trays had revolutionised the music industry, paving the way for the next decade – one that would prove extremely lucrative, not least because extensive back-catalogues could be ‘repackaged’ for consumers who had already bought the vinyl albums or cassettes! There was also the newly-introduced CD-ROM, offering computer-data storage capacities of a magnitude that must have seemed unfathomable at the time.

However, it was music that drove public demand for the format in 1988. CD was resilient, convenient and sounded good. But back then it was a new and

expensive technology. In packaged hi-fi systems the electronics was in one enclosure. In these cases an expensive matching CD player, designed for stacking underneath, was sold separately. That way the customer wouldn’t have to shell out for CD if it wasn’t immediately-required, but could upgrade afterwards. But such a budget optional CD player wasn’t much cheaper than the rest of the equipment put together! This was, after all, high-tech stuff back in ‘88... Super low cost CD players were needed to reach the budget market.

And so to the Hitachi DA-7000 featured here. Hitachi was once a serious contender in specialist hi-fi. It made some decent tuners, receivers, turntables and cassette decks. This enormous Japanese corporation also helped

to popularise MOSFETs, came up with Class G amplification (‘Dynaharmony’) decades before anybody else and invented a cog-free ‘Unitorque’ direct-drive motor. By the time the DA-7000 was available though, Hitachi was in the process of strategically withdrawing from a declining ‘genuine’ hi-fi market. This mid-width CD player was designed to match mass-market Hitachi audio like the HRD-MD03 – a single box containing a twin cassette deck (with Dolby B), three-band analogue tuner and 30W per channel amplifier.

However, the DA-7000 – then the most affordable CD player in Hitachi’s line-up – could also be used to upgrade ‘pre-CD’ audio systems that featured an auxiliary stereo input, such as earlier rack systems and music centres,



It may not be the world's most sophisticated CD player, but there's nevertheless plenty going on inside the DA-7000. In the thirty or so years since its availability, much of that circuitry has been crammed into a chip or two.

whether or not they were made by Hitachi. It is as basic as CD players can be, with an analogue output on phono sockets (no S/PDIF here!) and little in the way of programmability. Back then, connections were all analogue, external digital cabling, interfacing with digital inputs and outputs being for the high-end only.

No provision was made for remote-control, the user having to press buttons on the front panel instead (one thinks of old tellies here). The function legends printed on the buttons of our specimen, found inside the VCR compartment of a TV stand abandoned by a local auction room, are rather faded as a result!

There was evidence of the disc

tray having been forced open, the loading belt – sticky black gunk by the time this DA-7000 came my way – had probably started slipping at some time in the player's history. After I replaced the belt the machine worked perfectly – pretty good for a complex piece of consumer electronics that's more than 30 years old! Two seven-segment LEDs visually-confirm the track currently being played.

An upgraded version, the DA-7200, was supplied with a handset, and featured a more informative fluorescent display with timing as well as track number. In other

respects, the players are identical and share the same service manual.

A closer look at the circuitry described in this document reveals that a single (mono) DAC – an obscure Hitachi-made chip known as the HA12096 – is shared between the left and right channels. In the 1980s, 16-bit DACs were expensive devices. If you can get away with one, instead of two, then you've saved money. This is important for manufacturers of budget gear, where costs must be shaved in order to remain competitive in a price-driven market. Hi-fi designers could only afford to allocate one DAC per channel even in their more upmarket CD players; the number of DACs was often proudly-disclosed in catalogues.

This 'single-DAC' process may seem strange today, but was common at the time – especially in Japanese players. Basically, the



Like every other CD player, from the Sony CDP-101 to the latest models reviewed in this magazine, the DA-7000 relies on an optical pickup with semiconductor laser. This one still works; appropriately enough, a 1980s Hitachi slogan was 'in a word, reliability'!

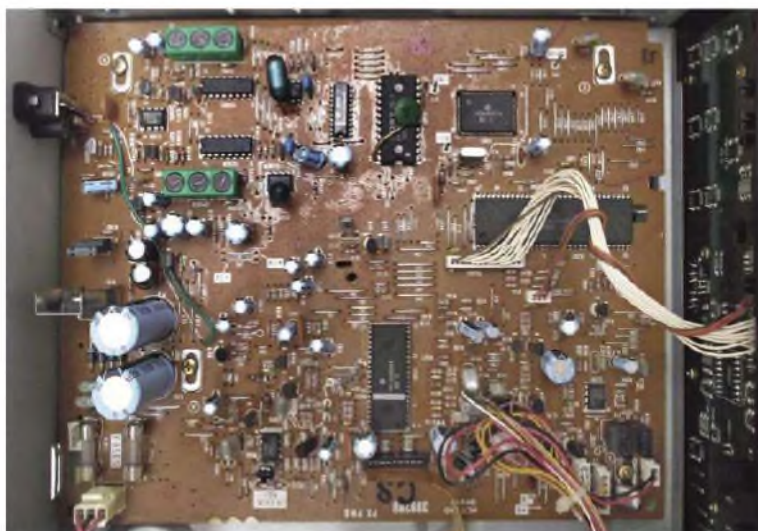

Reliant on 1980s technology, the DA-7000's main circuit board is rather busy. The DAC section occupies the top left of the board – its 22-pin Hitachi chip and output filters (the green lumps) are clearly visible. You can also see the micro-controller and two dedicated LSI chips.

DAC's conversion duties alternate between the left and right channels at high speed (microsecond timing!). When one channel is being converted, the other of course isn't. To fill in the gaps, which would be audible as glitches, an analogue-memory technique called sample-and-hold is applied. Basically, the voltage of the channel being decoded is stored in a capacitor and, using fast electronic switching, fed to the audio output during the instant when the DAC's attention is on the other channel. There are two of these circuits, one for each channel, known as 'degitchers'.



Not much to see here – only a captive mains lead and phono sockets yielding an analogue line-level signal of 2V maximum, CD's Red Book standard. In the 1980s, digital outputs were rare – even on high-end CD players, let alone this one.

In the DA-7000, such arrangements add no fewer than four extra chips – albeit cheap op-amps and CMOS switches – to the player's bill of materials. However, the outputs require relatively-complex filters to remove any residual switching noise. These can, alas, introduce frequency-dependent phase problems. With the associated passive components and circuit-board 'real estate', the DA-7000's arrangement can't have been particularly cheap to implement. It says something about the expense of early consumer DACs, and the ingenuity of engineers when faced with a challenge. Later variations of the approach use additional digital processing and faster single-channel DACs. Here, the data coming off the disc is 'upsampled' to 88.2kHz before conversion, enabling the use of simpler (and kinder!) output filters.

Even decent DAC chips are inexpensive nowadays, and so there's no need for such cheese-paring – even in the cheapest and nastiest of digital audio players.

In Europe, things were rather different – with two-channel DACs even at the beer-money end of the market. Amstrad's CDX400 midi system included turntable, tuner, twin tape, 3-band equaliser, 2x10W amp, 2-way speakers and CD player. In 1988, Argos sold this lot for

£199 – in contrast, the DA-7000 alone retailed for around £150. The CD player behind the CDX400's

"our specimen was found inside the VCR compartment of a TV stand abandoned by a local auction room"

front panel was a Philips-made transport...with TDA1541 stereo DAC. Not that you'd be able to hear the difference between this respected DAC and Hitachi's 'multiplexed' mono-DAC arrangement, through the Amstrad's mediocre amp and speakers.

To put it kindly, the DA-7000 is not one of the best-sounding CD players out there. It's gritty, bright to the point of harshness and bereft of the subtleties that bring you closer to the music. Through a Marantz PM66-SE Ki amp and TDL RTL2 speakers, I found listening fatigue set in after only half an hour. I wonder how much of this can be blamed on the single-DAC

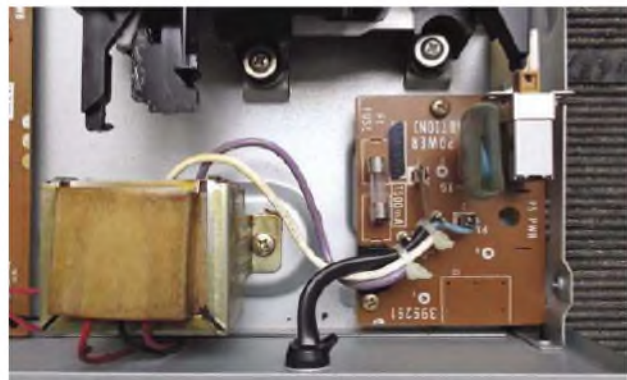

Today, switch-mode power supplies are the rule as they're cheaper and more efficient. In contrast the DA-7000 relies on a conventional (and easier to repair) 'linear' supply, fed by a frame transformer at left.

circuitry? Last year, I revisited Technics' SL-P550 CD player – which dedicates a DAC (specifically a Burr-Brown PCM56P) to each channel. This model, also from 1988, sounds much better

sively-bright presentation would have been impressive when heard through their mid-fi speakers. It would have certainly sounded better than a naff 'bundled' turntable spinning crackly LPs, and all that treble would have come as a shock to someone used to the dullness of an economy cassette deck. Furthermore, the DA-7000 was free of the hiss and wow associated with the latter. This cheap late-1980s introduction to the wonders of CD probably did gain new converts to the format – consider, in passing, just how poor the average LP pressing was at the time – but it is of little interest today. Even a modest personal CD player will better it.



Only the most basic functionality graces the DA-7000. No provision has been made for remote-control, the user having to press front-panel buttons instead. Two seven-segment LEDs visually-confirm the track currently being played.

Salisbury not-so-plain

Martin Pipe falls in love with the gem that is Naim's Uniti Atom 'Headphone Edition'

Way back in the mists of time (OK then, 2009) Naim launched its original Uniti 'all-in-one'. A 'music centre' for the 2010s, it combined FM/DAB/Internet radio, DLNA/uPnP-ready streaming client, USB playback, an interface for the-then de rigeur iPod, amplifier and CD.

Today's Unity 'family' – four models, plus a CD transport, look very different.

Streaming is now the Uniti's raison d'être. Tuners and phono stages have gone the way of the iPod interface, Bluetooth is now fitted and only one current Uniti – the full-width Star – has slot-loading CD built in.

It's assumed that Atom buyers,

including those choosing the Headphone Edition I am reviewing here, will be getting their music from streaming services – Tidal, Spotify Connect and Internet radio (including Naim Radio, craftily stored as a 'preset' on the review sample). Google's Chromecast is built-in, for app-based access to services like Deezer, Qobuz, Plex, TuneIn, Soundcloud and Pandora





The top panel contains the specially-made volume control unit – a backlit rotary-encoder. Naim built the Atom HE’s power supply around the large toroidal transformer that dominates the main enclosure. No switch-mode supply here.

via a smartphone or tablet. Airplay is supported for iTunes and Apple devices, while the Bluetooth section supports aptX HD for “high definition quality” from compatible devices.

Like the original Unity, the Atoms offer uPnP/DLNA-ready networked-audio clients, albeit more responsive and capable ones, as befits ten years of technical progress. I, along with many others, use uPnP technology to facilitate NAS (Network Attached Storage) music libraries that can be accessed from multiple players around the house. I have for a long time been a fan of this concept, as it makes your entire music collection speedily-accessible – no more records or CDs to track down! Use programs like Exact

Audio Copy to ‘rip’ CDs for upload to your NAS, and you’ll get by without a Core.

All Unity models will handle hi-res in lossless FLAC/ALAC, WAV or DSD (64/128) form. In addition to lossless CD-resolution material (I use FLAC), lossy codecs like MP3, AAC and WMA can be played – indeed, these are essential for the Internet radio feature. Room is supported if you’re using compatible gear, for a neater music-browsing experience.

Both Atoms are supplied with an RF (not infra-red) remote. This elegant black slab lets you select sources, sequence through favourite preset radio stations, control volume (complete with white-LED level indication), skip tracks in either direction and adjust

display brightness. There’s also a multiroom feature, should you be fortunate to have other Uniti hardware around the house. To make the most of Naim’s platform, though, you’ll need the app. It’s needed to, for example, choose uPnP tracks for playback and define radio stations as ‘favourites’ for speedy access.

As well as streamed sources are ‘local’ USB playback (up to 20,000 tracks per storage device, Naim told us!), a single line-level analogue input (an external phono stage is needed for vinyl) and three digital inputs, two of which are optical. To one of these could be attached an existing CD player.

The first Atom variant, launched in 2018, was designed for use with speakers, incorporating a 40 Watts per channel amplifier. The second model, featured here, is the £2,699 ‘Headphone Edition’ (HE). Although the original Atom has a simple headphone amp with 3.5mm socket, the HE goes to town when it comes to ‘canned listening’. At the expense of the speaker-level amps and HDMI connectivity, you get the ability to drive no fewer than three pairs of headphones – simultaneously, if need be.

On the front are 6.3mm (unbalanced) and 4.4mm (balanced) Pentaconn sockets, augmented by a rear-panel 4-pin XLR for balanced ‘phones. However, Naim also allow the Atom HE to be used with active speakers and power amps – or as a source for existing systems. In addition to ‘preamp output’ phono sockets with ground-lift switch, as also found on the ‘amped’ model, is a pair of balanced XLRs. In other regards, though, the two Atoms are to all intents

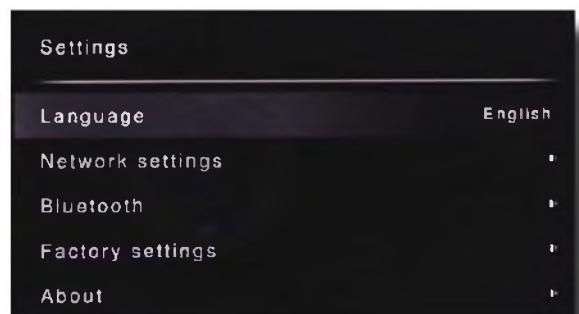

The Atom HE’s comprehensive setup menus allow most aspects of the unit to be customised – among them network, Bluetooth and language as can be seen here. Output level of the preamp cannot be fixed, nor the white LEDs switched off.



On the front panel are two headphone sockets (6.3mm/Pentaconn), plus a USB socket for music playback from a 'mass storage' flash drive. Dominant is a 5in. colour screen; it isn't a touch screen though.

and purposes identical. Indeed, the same brief 'Quick Start Guide' seems to serve both models.

USE AND PERFORMANCE

For all its inner complexity, the Atom HE is easy to set up. Plug in, and let it 'pair' with the remote. A firmware update may be required. While this is proceeding, install the Naim app. This 'seeks out' compatible players on your network (as supplied, Uniti products automatically-adapt themselves to work with the latter). Once the Atom HE has been found, it can be configured to suit individual circumstances. There's Bluetooth and the Chromecast feature allows



Naim's backlit remote control select sources, sequences through favourite 'preset' radio stations, controls volume, skip tracks in either direction and adjusts display brightness. The app is more powerful, though.

compatible apps to route audio, without lossy compression, to the Atom HE via the network. Just as simple to select are the various external inputs, or the streaming services directly-supported by the unit.

It's also easy to go through folders on a network (or USB devices) for tracks to play. Entering the folder and clicking on a track plays

it; however, it's also possible to highlight the folder and play its entire contents in sequence. Artwork and track information is displayed on the highly-readable 5in. colour screen.

I used the Atom HE with a pair of Focal Utopia headphones – quite apt, given that the French firm is owned by Naim's parent company and Focal's transducers are recommended by Naim. The unit also happily drove Meze Audio's Empyrean, another superb example of high-end headwear that happens to share the Atom HE's price tag.

The balanced line output was used to feed a pair of professional-use Adam Audio A5s, active nearfield monitors with revealing ribbon tweeters. After plugging in headphones, the external output is automatically-muted and the volume changed to the last-used 'headphone' level. Unplug them, and it reverts to the previously-set line-level. Naim has also provided a front-panel headphone 'override' button, for manually-toggling between the two modes.

SOUND QUALITY

With the Utopias, the first thing I noticed was exquisite levels of detailing that helped draw me into the music. This worked with well-recorded orchestral music, such as my hi-res LSO/Nosedá recording

of Britten's complex War Requiem, as it becomes easier to pick out individual performers. The tonal colour of their instruments (or, in this case, choral voices) was easier to distinguish within the mix. Analytical, yes, but musically-convincing too.

The Naim also proved to be effective with layered rock

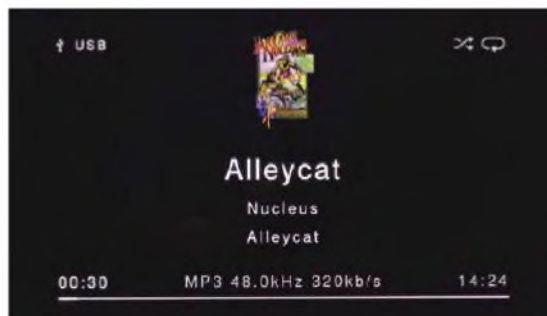

The colour screen shows cover art, track/album details and running times. Unlike the Atom HE's other illuminations, it can be set to 'time out' for late-night listening sessions.

music. With Fitter Happier, from Radiohead's OK Computer? this atmospheric musique concret-ish piece consists of an Apple Mac-generated voice accompanied by treated piano, effects and other weirdness. Also in there is some spoken word; such was the resolving power of the Atom HE/Utopia combo that it was intelligible, instead of blending with the other elements.

Historically, Naim products (notably amplification) are famous for their musicality, speed and timing. And so it was with the Atom HE. Percussive material like electronic and dance music – Kraftwerk's Tour de France Soundtracks, for instance – was



Due to lack of space, Naim put the 4-pin XLR balanced headphone output on the rear panel, alongside the unbalanced and balanced pre-amp outputs, provision for a single unbalanced line-level source and three digital inputs. There's also another USB, and an Ethernet alternative to the onboard Wi-Fi.

carried with rhythmic snap and immediacy. You get the excitement as was intended by the artists, but in no way is it exaggerated – something that can lead to listening fatigue. Percussive dexterity can be confused with a mild treble boost, which emphasises snares and hi-hats, but the Atom HE is tonally-neutral.

At the other end of the scale bass lines, whether strung or electronic, were satisfyingly deep yet correctly proportioned. The latter weren't particularly evident with the small-ish Adam A5 active

"the first thing I noticed was exquisite levels of detailing that helped draw me into the music"

speakers, which are best used with a subwoofer, but the musicality and impeccable timing were.

CONCLUSION

There are minor gripes – you can't kill the lighting for late-night listening, and more attention should be paid to front-panel usage

(a touch-screen, for example) – but on the whole, the Uniti Atom Headphone Edition is quite an achievement. With headphones, or a power amp and speakers of suitable quality, it offers an enjoyable yet clutter-free listening experience from today's digital media.

MEASURED PERFORMANCE

The Uniti Atom Headphone Edition is at heart a digital device with digital inputs that feed the analogue headphone and line outputs through an internal DAC. That means the analogue line inputs go through an additional conversion process, via an ADC (analogue-to-digital converter).

Fed a 192kHz sample rate digital signal via the electrical S/PDIF input, frequency response extended to 22kHz only, as our analysis shows, where 96kHz is possible. Naim amps band-limit at around 22kHz in any case so this is consistent with their design approach, and also CD quality commercial music servers. Whilst the S/PDIF electrical input worked to 192kHz sample rate the optical did not, managing 96kHz; this input will fall silent if fed 192kHz sample rate PCM.

With distortion from a digital input of 0.09% at -60dB and EIAJ Dynamic Range of 106dB (both 24bit) results from the DAC are slightly better than CD, but not comparable with current top quality DACs. These results apply to all digital inputs except Bluetooth that has a different signal path and processing.

Here distortion was high at around 0.28%, affected by noise, a dynamic range 100dB and frequency response curtailed to 16kHz. Again, Bluetooth can give better results than this.

With the analogue inputs frequency response reached 22kHz and distortion was low at 0.014% at high level, but with ADC and DAC in the path, distortion at -60dB rose to a high value of 0.35%.

Gain from analogue inputs to outputs (phono & XLR) was low at x1.7, with output max at 5V. Gain to the headphone output was x4 and the headphone socket (6.3mm) could swing a high 7V, enough for insensitive Planar Magnetic phones.

The Uniti Atom Headphone Edition gives CD quality, matching CD quality from commercial music sources (Tidal etc). It does not offer hi-res. performance. **NK**

| DIGITAL IN | |
|----------------------|-----------|
| Frequency response | 6Hz-22kHz |
| Distortion (-60dB) | 0.09% |
| Separation | 91dB |
| Output (headphone) | 7V |
| Noise | -103dB |
| Dynamic Range (EIAJ) | 106dB |

FREQUENCY RESPONSE

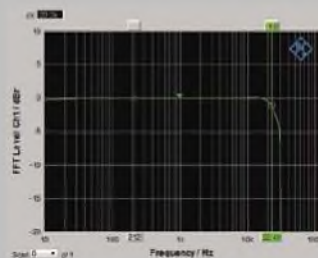

DISTORTION

| THD @ 4 | Level @ 4 | Frequency |
|----------|-----------|-----------|
| 0.0957 % | 11.594 mV | 987.00 Hz |
| OFF | OFF | OFF |

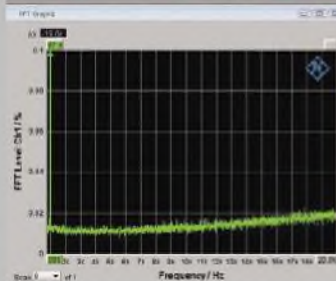

NAIM UNITI ATOM HE £2,699



OUTSTANDING - amongst the best.

VALUE - keenly priced.

VERDICT

The Uniti Atom HE is highly-flexible, and sounds great with anything you care to play through it.

FOR

- considerable flexibility in a neat package
- sublime and musically-engaging performance
- versatile and capable headphone provision

AGAINST

- can't turn off front-panel illumination (for late-night use)
- no fixed-output 'source' mode for line outputs
- touch-screen would be welcome!

Naim Audio
+44 (0)1722 426 600
bit.ly/30k1COH

vinyl section

contents

FEBRUARY 2022

www.hi-fiworld.co.uk**LENCO LS-55 TURNTABLE 73**

A budget turntable with ceramic cartridge, digital recording and Bluetooth, reviewed by Noel Keywood.

AUDIOPHILE BOOKS 77

Three books – The Electric Muse Revisited, Growing Out Of It, The Police, reviewed by Paul Rigby.

CLASSIC CUTS 82

The Drifters 'Under the Boardwalk' reviewed by Paul Rigby.

EFTERKLANG

The band's latest album, 'Windflowers' (*City Slang; cityslang.com*) arrives on limited clear vinyl

and includes a lyric sheet. Been a while since I listened to this band and maybe I'm off base here but their style seems to have evolved a fair bit – in a good way. 'Alien Arms' is a beautiful, pastoral ballad. 'Beautiful Eclipse' is a musing, day dream and 'Lady of the Rocks' is an electronica diary entry. Lovely stuff.



news

SOUP

Limited to 100 copies 'Visions' from Norwegian band Soup is presented on marble blue vinyl and within a shiny "Holographic rainbow laminate" gatefold sleeve. Adding a 16-page photo booklet and single-piece art work, this is a concept piece of Norwegian prog. It's grand approach, uplifting set pieces are never afraid to hang off an epic hook for a long, long time. Nor is this album afraid to hit either side of the dynamic range. There's ballads, there's grandeur, there's complexity. I love it.

**PIXIES**

Thirty years? Blimey, time do fly. The 30th anniversary of 1991's Pixies' 'Trompe Le Monde' (*4AD; 4ad.com*), is essentially a Black Frances solo work that combines many of the best facets of the group's earlier works and adds some useful ballads to boot. Kim Deal's increasing song-writing chops were rewarded by the good lady being wholly marginalised by Frances, here. Nice. The band would split after this one. Sacked by Frances by fax. Still, brilliant album.

P.O.D.

And don't forget the full stops. 'Satellite' (Atlantic) combines that metal, punk, rap et al, nu-metal mixture. Originally released in 2001 and reissued on two discs. This was and remains an album of inspiration and hope and an excuse for living. Something Tool and Korn were not delivering at the time.

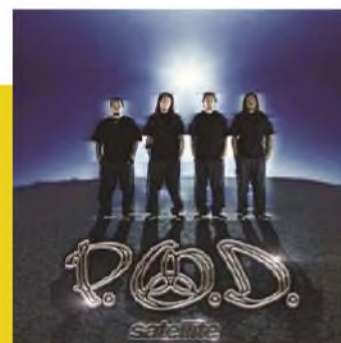



FIRST BOY ON THE MOON

The self-titled album from this Swedish rock/pop combo (firstboyonthemoon.bandcamp.com) offers plenty of jaunty, mid to high-tempo, hook-laden, bouncy, arm-waving, skippy rock that will put a smile on your face. You'll end up making your coffee to the rhythm of this album, you mark my words.

HOO

...release 'We Shall Never Speak' (bigpotatorecords.bandcamp.com/album/we-shall-never-speak). I'm sure I heard these tracks the last time I drove in the fog. A place where you see shadows of ghosts and echoes of your imagination. The band call it space rock or krautrock but it's too woozy for either. This is the music you hear when you've been doped by that person you've just met, as they riffle through your pockets for your credit cards.



WATERBOYS

A reissue of the 1990 album, 'Room to Roam', and spread over two discs within a gatefold. This release has had the full treatment, though. Abbey Road has been all over this one, giving it the half-speed treatment. You need to play it at 45rpm too. The upshot is a boost in sound quality.

As for the album itself? It takes a step back from the magnificence and Big Music of the likes of 'The Whole of the Moon' and comes over all introspective, introverted and self-absorbed with a scoop of the Celtic in approach. There's a folkish atmosphere on this one.



GOV'T MULE

This bluesy, hard rockin', grizzled jam band is back. We're going blues covers and blues originals on this one. 'Heavy Load Blues' arrives as a double album gatefold (Fantasy; fantasyrecordings.com) looks back at Elmore James, Junior Wells, Howlin' Wolf and more. This is blues, weighed heavy with emotion, with slow application, scratchy guitars and smoky Hammond organs. It's packed with emotion, the sort that accumulates like mud on an old tyre.

JARVIS COCKER

'Chansons d'Ennui Tip-Top' is the man's first solo LP in twelve years. Using the Wes Anderson film, 'The French Dispatch' as inspiration, it offers covers of a dozen French classics. Cocker is well suited to the melodrama emanating from much of this material. I'm not sure if I can take Cocker's breathy, faux French seriously, though. Because I'm not convinced he is. Oh, Stereolab fans, look out for Laetitia Sadier on 'Paroles Paroles'.

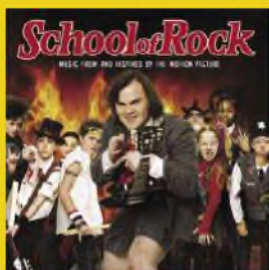

SCHOOL OF ROCK

Released as a limited-edition, gatefold, orange vinyl pressing this one features tracks from Led Zeppelin, The Who, T.Rex, The Ramones, The Black Keys, The Darkness and more. Side D arrives with etched art.



POPPY ACKROYD

Ackroyd messes with instrument's heads. Sure she plays violin and piano but this London-born, Brighton-based composer, throws in the odd drumstick with them, attacked them with picks, scrapes them with her fingers...She plays instruments like some people do gardening. On 'Pause' (One Little Independent; www.olirecords.com), a neo-classical outing, Ackroyd is gentle, caring, attentive, sometimes hesitant, always loving towards the music itself.

MANDOKI SOULMATES

László "Leslie" Mándoki, a German-Hungarian musician, has a new double album out called 'Utopia for Realists' (Inside Out). As a producer, the man is connected. It looks like he's called in some favours here too because this jazz-rock album features names. Lots of names: Ian Anderson, Jack Bruce, Midge Ure, Nik Kershaw (!), Al Di Meola, Eric Burdon and many more.

The music wanders from soft rock to harder jazz to jazz-prog. It's a right ol'journey. More so as many musicians had to phone in their music from remote locations.



HI-FI WORLD

ON THE APP STORE

App Store > Entertainment > audio web publishing ltd

Hi-Fi World 4.4
audio web publishing ltd >

Details Ratings and Reviews Related

Screenshots IPHONE IPAD

HI-FI WORLD
Get
Offers In-App Purchases
This app is designed for both iPhone and iPad

Rating 4.4
TOP IN-APP PURCHASES

1. Hi-Fi World Dec 2015 £3.99
2. Hi-Fi World Subscription £8.99
3. Hi-Fi World August 2015 £3.99
4. Hi-Fi World September 2015 £3.99
5. Hi-Fi World June 2015 £3.99
6. Hi-Fi World May 2015 £3.99
7. Hi-Fi World December 2015 £3.99
8. Hi-Fi World February 2015 £3.99
9. Hi-Fi World November 2015 £3.99
10. Hi-Fi World December 2014 £3.99

LINKS
Privacy Policy

© 2014 Hi-Fi World

VINYL NEWS AND REVIEWS SECTION SEE PAGE 70
HI-FI WORLD
FEBRUARY 2022 UK £5.00 www.hi-fi-world.co.uk
FREE READER CLASSIFIED ADS IN THIS ISSUE!

ACQUSTIC ENERGY AE320 loudspeakers

COMPETITION
WIN A PAIR OF THE NEW BANG & OLUFSEN BEOLAB 28 SPEAKERS

EXPOSURE 320W amplifier

NAIHI UNITI ATOMHE turntable

LENGO LS-33 turntable

SEVEN PAGES OF LETTERS - THE JURY WINS A PAIR OF ACQUSTIC ENERGY NEW SET OF LOUSPEAKERS (UK ONLY)

contents

- 18 **STRAND CD/DSR/STEREO AMPLIFIER**
- 66 **AMP WITH POWER ALLOCATOR**
- 34 **TOP FIVE CD COLLECTORS**
- 58 **REVIEW OF FIVE WIRELESS HEADPHONES**
- 18 **LENGO LS-33**

LOUDSPEAKERS
ACQUSTIC ENERGY AE320 LOUSPEAKERS

LOCAL ANALOG LOUSPEAKERS

DIGITAL
NAIHI UNITI ATOMHE AMP

AMPLIFICATION
EXPOSURE 320W INTEGRATED AMP

WIRELESS
LENGO LS-33

FEBRUARY 2022
VOLUME 31 NO 12

CABLES
CHORD COMPANY GRADIENTARY

OLD WORLD
WITCHAMOR CO. PLATE

HEADPHONES
Sennheiser HD 600 Plus Wireless

WIRELESS
Sennheiser HD 600 Plus Wireless

REGULARS
NEWS
REVIEW
MAIL
SUBSCRIPTIONS
WORK'S STANDARDS
ADVERTISER INDEX

Description
Hi-Fi World brings you the best in hi-fi... from around the world

- We listen and measure products in depth, at our London offices
- Expert opinion from a team of renowned writers, musicians and engineers.
- International standard measurements using Rehd & Schwarz test equipment...

Information

| | |
|----------------|---|
| Developer | audio web publishing ltd |
| Category | Entertainment |
| Updated | 7 Dec, 2014 |
| Version | 1.0 |
| Size | 9 MB |
| Rating | Rated 4+ |
| Family Sharing | Yes |
| Compatibility | Requires iOS 5.0 or later. Compatible with iPhone, iPad, and iPod touch |
| Language | English |

**DOWNLOAD OUR APP ON APPLE AND ANDROID
DOWNLOAD FROM iTUNES OR GOOGLE PLAY**

iPad, iPhone, iPod, Tablets OUT NOW!



Entry issue

Will the £135 Lenco LS-55 turntable give you a decent entry to vinyl replay? Noel Keywood thinks not.

So you have CD or a streamer, or hundreds of music files on the phone. You are a thoroughly modern listener, not at all interested – even wary of – the vinyl LP. All that religion and a

stylus that will self destruct at glass of wine No 3. Would a turntable like the Lenco LS-55 I'm looking at here, price just £135, be a good entry point?

The answer is "no". Here are the reasons why, so you know what

to expect at this end of the market and what you should buy instead, for yourself or others.

Down to the nitty gritty. Read the literature as we did and no tracking force for the cartridge is stated. Our limit, for the safety of



A light aluminium arm tube with flexible plastic headshell, carrying a clip-on ceramic cartridge. Tracking force nominally 5gm and not adjustable. Upgrade is not possible.

our LPs, is 3gms: the Lenco came in at 4.5gms when measured. That ruled out the use of valuable test discs, as well as our high quality review LPs, to avoid damaging their grooves. We used sacrificial LPs instead.

What the literature carefully avoids mentioning is that a ceramic cartridge is fitted, not a hi-fi moving magnet (MM) type. It clips into the arm and cannot be upgraded to something better with standard 1/2in fixing centres. And since there is no way of adjusting down force of the arm, there's no point in any case!

A little bit of time spent on the 'net showed a wide range of budget turntables using this non-adjustable arm and cartridge combination. Looks like it is coming from one source, the Dongguan Ang Chung Electronic Technology Co (China) is quoted.

Replacement styli for the cartridge come from many suppliers it seems, two costing £14.69 on Amazon for example. Styli are sapphire, downforce is 5gm, with a range of 4-6gms, but

you will rarely see this quoted. You get what you're given here. There are no options for improvement. See our box-out on Ceramic Cartridges for more detail.

Alternatives? For £279 Lenco offer the L-3808 Direct Drive that is far above the LS-55 in ability. The

"There are many other low cost turntable packages out there that use the same arm/cartridge assembly: beware of them all".

arm has a conventional removable headshell with 1/2in fixing centres able to accept any hi-fi cartridge, but comes with the AT-3600 (£30) that has a fine performance.

If this turntable is too extravagant then look at alternatives with arms that accept cartridges attached by two screws set 1/2in apart – and ensure down force can be adjusted, usually achieved by rotating a rear

counterweight.

The cheapest Lenco on offer with these features is the L-91 it appears, price £200. Sold out everywhere is the Audio Technica LP60XUSB and its variants, circa £130. It has an Audio Technica dual-magnet MM cartridge that is likely to be decent, but again it is fixed into the head shell, tracking force appears non-adjustable and is not quoted – not a good sign. Let's get back to the Lenco.

The LS-55 has an impressive range of features and ability at a ridiculously low price. Moreover, it looks and feels good in the flesh, even if the arm and platter don't bear close inspection. It is a three-speed (33,45,78rpm) belt drive with auto-start at arm lift and optional auto-stop (but

not lift). There's an onboard stereo amplifier rated at 5W per channel, with small loudspeakers on the plinth's underside. With a well built wooden plinth sitting on solid legs, the volume control is easy to use and it does not upset play, the plinth and arm sitting on a spring isolation system. Nice hinged dust cover too.

At rear lies an Aux input (3.5mm socket) to plug in other



A small 3.5mm jack socket accepts analogue inputs from external players. Phono sockets provide output for an external amplifier where tone controls could be used to improve tonal balance.

devices. Also, there is an input socket for the external 9V power supply, making this turntable safe for children as there are no high voltages.

The "phonograph" will record to a USB memory stick (flash drive) in MP3/WMA compressed formats, and recordings can be played from USB too. There is a Bluetooth transmitter to send LP sound to outside devices, like similarly equipped headphones. Also, there are audio output phono sockets.

Spinning Everybody Hold Still from the delightful Grace Jones (Living My Life) brought forth a very tinny sound with strong high treble but little bass. Measurement showed bass was -20dB below



The one-piece removable plastic stylus assembly of the LS-55's cartridge incorporates a plastic cantilever, anchored by a thin, compliant hinge. The stylus is sapphire.

treble – a massive gain error. And this was from the Aux out sockets, not acoustic output from

the small loudspeakers, showing just how unbalanced the sound was. It's not a cost issue since getting equalisation right (it's not RIAA) would simply be a matter of altering a few component values (there was plenty of spare gain): the amplifier stages are just poorly designed.

Speed accuracy was good, but speed stability mediocre, warbling and drunkenness being obvious on a test tone (W&F=0.4%).

So there you are. This budget turntable offers a lot and looks good. It even has auto-power off with a spoken warning that took me by surprise; there's a woman in the house, where's she hiding? Under the turntable!

But sound quality was poor, poorer than it need be even at the price: a bit of EQ would have helped put some body in the sound. And 4.5gm downforce from



Two small loudspeakers are fixed to the underside to make the LS-55 much like an all-in-one record player from the 1960s. Even 5 Watts of power is similar.

the cartridge is going to wear out LPs.

This makes the LS-55 not a good way to enter the realm of vinyl replay. There are many other low cost turntable packages out there that use the same arm/cartridge assembly, possibly all made by the same company. So beware of them all. This is not hi-fi, it is budget audio – and differences are large our measurements show.

Such turntables, including the LS-55, are a poor choice as entry to LP, for the old or the young. Don't buy grandad one of these to remind him of old times, nor your young daughter to hear Taylor Swift. Far better is available for little more, in Lenco's own wide range and from others. As a rule of thumb, if it costs less than £200 you have not got a bargain, but something with poor sound that will mistrack and damage LPs.

CERAMIC CARTRIDGE

The ceramic cartridge is a nightmare from the past, that isn't hi-fi, so much as basic audio. And that was its status back in the 1960s when fitted to record players. Not a lot has changed.

This type of cartridge uses two small piezo-electric transducers to produce relatively high output. Trouble is they are incompressible so prevent the stylus moving easily in the groove. To stop it jumping out high tracking force is required, around 5gm, and even then tracking is poor, meaning these things damage and wear out LPs.

Ceramic cartridges can be recognised by the small plastic bridge that cradles the cantilever, connecting it to the piezo-electric sensors. Higher quality moving-magnet (MM) cartridges lack this. Back in the 1960s the popular Acos ceramic cartridge had a distinctive flip-over microgroove/78 tip option, but today's ceramics lack this, probably because 78s are not in common use. A microgroove stylus is too small for 78s.

Because ceramic cartridges don't use a magnet and a coil of wire to produce a signal their output does not match that of the cutting lathe used to produce an LP, meaning the sound balance is incorrect. They do not suit RIAA equalisation of phono stages and their high output can overload them, so are commonly run straight into an amplifier. But they still need equalisation, without it giving a thin, bright sound from LP by approximately reproducing its RIAA pre-equalised sound balance that boosts treble and cuts bass. All a bit of an ad-hoc mess in engineering terms but this is what to expect from a ceramic cartridge. You get sound – but that's about all.



The cantilever of a ceramic cartridge sits on a bridge that connects it to the piezo-electric sensors. The cantilever here is aluminium, the LS-55's was red plastic. Lovely!

LENCO LS-55
£135



MEDIOCRE - unremarkable

VALUE - keenly priced

VERDICT

Bright thin sound, due to lack of electrical equalisation. Unpleasant.

FOR

- low price
- facilities
- easy to use

AGAINST

- scratchy sound
- poor tracking
- excessive tracking force
- can't be upgraded

www.lenco.uk

nucleus

by

roon



SIMPLY THE BEST WAY TO EXPERIENCE ROON

High-quality powerful fan-less optimised streaming server, powered by roon OS.



July 2018*



April 2018*

*Reviews of the original Nucleus+, which has the same technical performance of the 2019 revision but with a different look.

FIND OUT MORE AT

HENLEYAUDIO.CO.UK/PRODUCTS/ROON-NUCLEUS

INCLUDES

1

YEAR FREE
ROON
SUBSCRIPTION



Distributed by Henley Audio

T: +44 (0) 1235 511 166 | E: sales@henleyaudio.co.uk | W: www.henleyaudio.co.uk | [HenleyAudioUK](https://www.facebook.com/HenleyAudioUK) | [HenleyAudio](https://twitter.com/HenleyAudio)

Back Tracks

Three books that look back – at Folk, at Madness, at The Police. All great reads, thinks Paul Rigby.

THE ELECTRIC MUSE REVISITED

When this book was initially published back in 1975 it chronicled just how folk had been modded, tweaked and thoroughly messed about with. To the enhancement of the genre as a whole, I reckon. That essential book remains here. The important chapters remain.

What you've got now is an updated form with Robin Denslow adding more text to bring the story up to date. And that is a story all on its own. The tale of folk hitting the skids, then rising again and then doing what most musical genres have tended to do during the more recent years, mixing with everything else to form a melange.

That is squeezed into around an additional 100 pages or so. So you get a précis of sorts but the essentials are there.

There's a nice blend of 'in the moment' critique (Part 1) together with 'hindsight' editorial giving two flavours within the same book. I'm glad Part 1 hasn't been changed or updated. It offers a unique historical take on the genre at that important time. This book might not offer an ultimate history of folk but it's an important reflection and opinion on the genre in all its forms and times.

GROWING OUT OF IT

Saxophonist and co-founder of the band Madness, Thompson's book reminds me of Will Sergeant's (Echo & The Bunnymen) first biography 'Bunnyman'. Both linger on the early days. Sergeant's ends in the late seventies. This volume ends in 1980.

Thompson extracts direct quotes from the other people involved in his reminiscences who often add valuable perspective. This is a delightful addition. It adds meat to the story.

We hear of Thompon's traumatic time at the 'Approved' school in Chafford. Pupils (inmates) were taught in army barracks huts. Trust issues followed that

experience.

We hear of early musical influences, Thompson living with his Uncle or in a convenient squat and socialising in youth clubs. The Madness roots kick in somewhere after page 100. Then we're off into the madness of Madness.

Thompson does wonder if the band's long life in the industry has been helped because Madness are never overly political. As many other groups were at the time. An intriguing thought.

This is a revealing, deeply personal book but also an excellent band memoir. Recommended.

THE POLICE

A sort of warts'n'all account of the band's history. The ups and downs, the relationship breakdowns and the splits. But there's plenty of core information for the fan here.

Big breath: I never knew Sting arrived to the band with a whopping great book of lyrics - just ready to go; the lads also wondered whether the group's reggae outings demanded that Sting should affect a Jamaican accent (imagine!); the drum part on the hit single 'Message in a Bottle' was assembled from six different parts; organised by manager Miles Copeland, a New York prison photo-op was interrupted by a NY detective asking the prison staff "How does it feel locking up a bunch of white guys for a change?"; during a concert in Argentina an over-eager cop tried to grab and assault a female fan only to be kicked in the face by Andy Summers. The crowd went wild; the time Bill Oddie's daughter scared the life out of her dad by opening the front door and declaring "Dad? It's the Police!" It was only Andy looking to buy Oddie's house.

So, yea. That kind of thing. Full of stories, full of events, full of being in a band like The Police. A cracking read.

Title: The Electric Muse Revisited: The Story of Folk into Rock and Beyond

Authors: Robert Shelton, Dave Laing, Karl Dallas and Robin Denslow

Publisher: Omnibus

Price: £18.99

Pages: 301



Title: Growing Out of It: Machinations Before Madness

Author: Lee Thompson

Publisher: Omnibus

Price: £16.99

Pages: 273



Title: The Police: The Adventures of Sting, Stewart and Andy

Author: Caroline & David Stafford

Publisher: Omnibus

Price: £20

Pages: 280

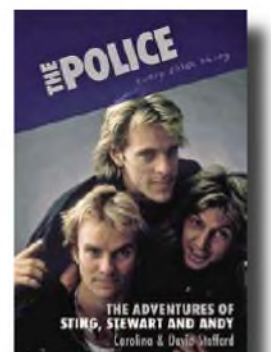

Dial A Dealer Directory

directory of Hi-Fi Dealers throughout the UK and Ireland.



Inspire Hi-Fi
www.inspirehifi.co.uk
+44 (0)1246 268887



2 CHANNEL AUDIO SPECIALISTS
 Including our own bespoke award winning turntables and a comprehensive range of turntable upgrades.
 While you wait servicing and upgrades available
 Linn Sondek LP12 upgrades and servicing Demo's by appointment.

ROKSAN, ORTOFON, SUMIKO, PROJECT, MUSICAL FIDELITY, KLIPSCH, UNISON RESEARCH, KUZMA, YAMAHA, MONITOR AUDIO, AUDIO TECHNICA, ORIGIN LIVE, AUDIO ORIGAMI, HI FI RACKS, STAX HI FI RACKS, LEHMANN, OPERA, CUSTOM DESIGN



MonoPulse
The realism of a stage

9 High Street, Hampton Wick,
 Kingston upon Thames, Surrey KT1 4DA
Open: Tuesday - Saturday 10am - 6pm
0208 943 3530

Infidelity
 MUSIC & CINEMA SYSTEMS

NAIM, LINN, REGA, ARCAM, B&W 800 SERIES, PMC, FOCAL, DYNVECTOR, KUDOS, VELODYNE, STAX, LYRA, OPPO, TANGERINE AUDIO, TELLURIUM Q.

SEE AND HEAR THE VERY BEST

CEDIA MEMBER 

iBasso Audio DX220



5.0 inch 1080P Sharp Full Screen/Dual ES9028PRO/On Cell Touch Panel/Octa Core CPU/Android 8.1 OS/MQA/XMOS USB-DAC/Femtocell/Oscillators/Quick Charge/Replaceable AMP Card

Available to order from AMP3.
 Hi-Fi World readers: 5% off the DX220 using voucher code
 HIFIDX220 at amp3.co.uk

DESIGNED & HANDMADE IN SCOTLAND

Equator



Our high-precision Achromatic RCA and Z plugs are designed to have minimal impact on the signal – with virtually nothing added, nothing taken away – resulting in improved sound quality.
 Now standard on Element, Equator, Hyper & our new Ailsa cables.

Equator
 Achromatic
 Speaker
 Z

ACHROMATIC

LOW - MASS
 NON-MAGNETIC
 COLD - WELD
 CONNECTOR

ATLAS
 the performance connection
 atlascables.com

free reader Classifieds

TERMS AND CONDITIONS: Only one advert per reader. No Trade adverts. This section is strictly for readers selling secondhand hi-fi equipment only. Maximum length per advert is 30 words, Adverts over 30 words will not be accepted. Telephone numbers and E-mail addresses are treated as one word. Model numbers are treated as one word i.e. Quad 303 = two words. Email your advert to; classifieds@hi-fiworld.co.uk or fill in the form on page 81 and post it to Hi-Fi World Free Readers Ads, Office 052, 464 Edgware Road, London W2 1AH. Sorry, we cannot accept adverts over the telephone. The Publisher reserves the right to judge submissions.

GARRARD C2 cartridge carrier, unused, £30. Free postage. Cable Talk Three speaker cable, two eight yards, terminated. £70. Technics EPC205Mk3 cartridge, integrated headshell, unused, £300. Tel: 01708 457 691

NAIM NAIT XS, excellent condition, boxed, manual, Chord RCA interconnect cable. £625. Tel: 07864 034 087 (Eastbourne)

WANTED: Top quality Hi-Fi separates and complete systems, Naim, Linn, Cyrus, PMC, Audio Research etc, fast, friendly response and willing to travel/pay cash. Please call me on 0781 5892458 or Email me at pogsonp@aol.com

2 NAKAMICHI CR-7 Tape Decks, £2600 (or £1300 for one deck) Both near mint and used regularly. One deck, light in tape well not working. I believe both to be gear drive. One recently serviced by Peter Dolman and the other a few years back by B&W England. Tel: 07983 864 126

REGA PLANAR 6 Deck Ania MC Rega Fono £650 Roksan Amp MkIII £250 Roksan CD KDI MkIII £250. Focal 714S Speakers £50. Immaculate condition. Tel: Dan 07702 598 322

DENON PMA 2500 NE amplifier. Boxed as new. £1500. Tel: 07908 431 807

PROAC TABLETTE Reference 8 Signature black speakers, little used £595 Musical Fidelity M6 Dac, original box, £500 mint condition. Also Meridian 101, with dual amps and 103 tuner and power supplies £600. Tel: 01704 628 968 or 07968 769595

MERIDIAN RARE black 101b pre, 104 tuner, 105 (2xmono amps each with power supply) so stacked 3 high in pairs £550. Tel: 07968 769 595 (Southport)

MUSICAL FIDELITY X-A1 Series intergrated amplifier. 50watts per channel with external power supply. Mint condition. Boxed. £375 ono. Please Email: zylandaroya@yahoo.com

LONDON DECCA Gold phono cartridge. Bought in 1990. Was mounted on Linn Ittok arm, and used for one week. Boxed, 'mint', as new as you can imagine. Please Email: zylandaroya@yahoo.com

MYTEK BROOKLYN DAC+ near mint condition and fully working order. £975 ovno. P&P incl. Tel: 07508 035 671 or Email: andy.aldrige@gmx.com (Cumbria).

ICON AUDIO MB845 Mk.I monoblock amplifiers. Upgraded to SE version with new Mundorf capacitors. New 845 valves on one amp. Boxed. Great powerful sound. Sensible offers. Tel: 07717 752 288 Email: captain_b99@yahoo.co.uk. (Bristol)

NAKAMICHI 550 Dual Tracer portable tape deck reviewed by Martin Pipe in March '21 issue. Stored in loft 25 years but now needs attention. Mains PSU and service manual. Also Nakamichi microphones and add-on capsules Offers. Tel: Kevin 0779 602 1637 Email: kevingldg@btinternet.com.

EXPOSURE 3010 S2D amplifier 110watt complete with onboard DAC, was £2,200 new. Linn Classic CD/DVD engine, 2 Channel or 5.1 amp built in, plus FM radio. Sensible offers please. C on C. Tel: 07810 311 268 or Email: hollingberys@gmail.com

ICON AUDIO Stereo 25 upgraded with Jensen caps and Psvane KT88 output valves, perfect condition, looking for £900 but open to sensible offers, collection only Cambridge area, please phone Tim on 01353 665 059

MARANTZ 17K1 Signature CD Player in black finish with gold remote. Excellent condition, great sound, owned from new. Captive lead version. Demo welcome. Collection only. Norwich area. Tel: Mike 07973 671 915

KENWOOD KX9010 three head cassette deck, £300. JVC 1770 cassette deck, £150. Mission speaker cable, two four metre lengths bi-wire, solid core, £50. QED DiscMaster phono stage, £40. Tel: 01708 457 691

NORDOST RED Dawn Rev. II Biwire silver speaker cable. 3 metre length. Banana terminations. £525 (Original packaging) Tel: 07810 278 818.

MUSICAL FIDELITY X-A1 series integrated amplifier. 50 watts per channel. Mint condition. £375 ono. Will gladly demo. Tel: 07505 057 414. (Camden/Hampstead, London)

NOTTINGHAM ANALOGUE Hyperspace turntable, 10" Ace Space arm and NA plinth. Excellent working order and very good condition. Cash on collection only. £2500. Tel: 07505 583 615 (Nottingham.)

NEXT MONTH

MARCH 2022 ISSUE

MISSION QX-2 MKII

This new stand mounting loudspeaker from Mission you must read about. It costs just £399 and can do things few rivals can match. Yes, we've already measured and listened to them. Read what we found after lengthy use of a loudspeaker Mission have spent much time on, they tell us.



Also, we hope to bring you –
IFI PRO ICAN SIGNATURE AMP & IPOWERS ELITE PSU
Q ACOUSTICS CONCEPT 50 FLOOR STANDING SPEAKERS
BLACK RHODIUM INTRO SPEAKER CABLE
BLUE AURA BLUE 1 MIDI SYSTEM
JBL LS2 CLASSIC SPEAKERS
...and much more.

This is a selection of what we hope to bring you, not a complete list. We regret that due to a wide range of issues, we cannot guarantee that all products listed above will appear.

**PICK UP THE MARCH 2022 ISSUE OF HI-FI WORLD ON SALE JANUARY 31ST 2022,
OR SUBSCRIBE AND GET IT DELIVERED TO YOUR DOOR: SEE PAGE 38**

ADVERTISERS INDEX

Absolute Sounds 0BC
 Atlas Cables 78
 Audio T 44
 Connected Fidelity 62
 EnjoyTheMusic.com 62
 Fine Sounds 42
 Henley Audio 22,34,36,54,76
 Ian Harrison 60
 iBasso Audio 78
 Icon Audio 10
 Infidelity 78
 Inspire Hi-Fi 78
 Jordan Acoustics 24,25
 KEF 6,12,14
 Mikam Sound North Ltd 50
 Monopulse 78
 Peter Tyson 16
 SCV 20
 Select Audio IBC
 Soudeck 60
 The Chord Company IFC
 World Designs 60

FREE READER CLASSIFIED ADS ORDER FORM

STOP PRESS

TERMS AND CONDITIONS: Only one advert per reader. Maximum length per advert is 30 words. Adverts over 30 words will not be accepted. No Trade Adverts. This section is strictly for readers selling secondhand hi-fi equipment only. Telephone numbers and E-mail addresses are treated as one word. Model numbers are treated as one word i.e. Quad 303 = two words. Sorry, we cannot accept adverts over the telephone. The Publisher reserves the right to judge submissions.

You can email your advert to us at: classifieds@hi-fiworld.co.uk or write or type your advertisement copy in block capitals with one word per box and post it to us at:

Hi-Fi World Free Readers Ads,
 Office 052
 464 Edgware Road
 London
 W2 1AH

We cannot accept adverts over the telephone

WE WILL ACCEPT PHOTOCOPIES OF THIS FORM

| | |
|----|----|
| 1 | 2 |
| 3 | 4 |
| 5 | 6 |
| 7 | 8 |
| 9 | 10 |
| 11 | 12 |
| 13 | 14 |
| 15 | 16 |
| 17 | 18 |
| 19 | 20 |
| 21 | 22 |
| 23 | 24 |
| 25 | 26 |
| 27 | 28 |
| 29 | 30 |

Name: _____

Address: _____

Post Code: _____

Daytime Tel: _____

FREE READER CLASSIFIED ADVERT COPY DEADLINE FOR FEBRUARY 2022 ISSUE 14TH JANUARY 2022

THE DRIFTERS

UNDER THE BOARDWALK 1964



"Their own smooth, gentle soul sound would be trampled upon by a newer, harder brand of soul"

There are few R&B groups out there that have had the impact on music and, by association, the pop charts as the Drifters.

There are also few groups that have experienced so many ructions and changes.

When Dominoes lead singer, Clyde McPhatter left that group in the late forties, it was dedicated music fan and record collector Ahmet Ertegun who pursued and signed him up to his newly formed little publishing project that he liked to call Atlantic.

Ertegun encouraged McPhatter to start a group all of his own which McPhatter did – he called his new outfit, the Drifters... because apparently, the group's members 'drifted' in to the new group from other collectives. And drift they did. McPhatter riffled through over a dozen friends before he settled on his chosen few.

When that first group was found, they released a single which didn't do a lot. So that group was summarily dumped and a new outfit was created in its place under McPhatter. This one hit the spot and also No.1 in the charts with the song, 'Money Honey', a candidate (one of many) for the 'first ever rock'n'roll record'.

The line ups continued to change, though. Then McPhatter himself left in 1954 for a solo career. David Baughn followed, then Bobby Hendricks, Johnny Moore, Charlie Thomas, Benjamin Earl Nelson who then changed his name to the more familiar Ben E. King, and Johnny Williams. Then the sixties hit and Rudy Lewis entered the fray. In addition to that, line up changes and management changes were happening with some gusto behind the scenes.

Nothing stayed the same when it came to being associated with the Drifters, it seemed.

This album, 'Under the Boardwalk', would be released after the 'Our Biggest Hits' release that also appeared in the same year, 1964. In fact, the two albums shared a track listing and a basic sleeve art design until the single 'Under The Boardwalk' hit the charts. This would be the band's final Top 10 hit. So, in album terms, that track was in, the earlier song 'Drip Drop' was out and the sleeve art changed to note that tweak.

The release of this album remained a

little muted though because the group had lost their lead singer of four years, Rudy Lewis. A marathon time for any group member, never mind a lead singer. It has been reported that Lewis was a gay man when the social mores of the time meant being gay was particularly tough on the individual. Hence, Lewis kept his sexual orientation to himself. He also reportedly suffered from an eating disorder and had issues with Heroin. Although the latter has been contested.

With the tragic loss of Lewis, Johnny Moore stepped back into the fray once more, as lead tenor. He would be the group's longest lasting lead singer.

So what you get with this album is a strange mixture of tracks cut when Lewis was in the chair but Moore sang lead and other songs that were successful for the Lewis-lead group, such as 'Up on the Roof' and 'On Broadway'.

Both singers share the spotlight spoils here and both do superbly well. Even the producer, Bert Berns did a magnificent job behind the desk, guiding the band through their final recording successes.

After this release, the group would suffer. Their own smooth, gentle soul sound would be trampled upon by a newer, harder brand of soul emanating from the likes of Otis Redding and Wilson Pickett. The Drifters found it hard to adjust.

They even suffered in the UK during the height of their US success because their own hit singles were covered by other UK artists which tended to take the glory away from the Drifters.

It wasn't until the new breed of rock bands hit the charts in the mid sixties that the Drifters found a new swathe of recognition and respect. Drifters songs were covered by the Rolling Stones, the Moody Blues and Cliff Bennett, for example.

You can check out this album in a unique form via the new box set from Strawberry called 'We Gotta Sing: The Soul Years 1962-1971'. A 3CD set found in a clamshell box, the collection presents a chronological list of all of the recording sessions the group recorded for the Atlantic label between 28 June 1962 and 5 January 1971. The set includes lots of interesting background information plus line up changes, credit information and more. **PR**

PASS

Introducing the XP-12 & XP-17



Enjoy the Experience

Pass Laboratories, Auburn, CA 95602 | 530.878.5350 | passlabs.com

Distributed by Select Audio | Tel 01900 601954 | www.selectaudio.co.uk

selectaudio[©]
exquisite audio products

C O P L A N D

DANISH STYLE MAKES INSTRUMENTS SING!



When it comes to elegant design, it's hard to outclass the Scandinavians. At the heart of this is the Danish company Copland. For more than 30 years, Copland has designed and produced a dream team of fine audio musical instruments with their captivating analogue and precision digital devices.

Take the new CTA 408. This hybrid valve line and phono integrated amplifier delivers a healthy 75W per channel.

It exudes classic design and the minimalism that typifies Copland's aesthetic lines with its enchanting valve and MOSFET hybrid technology.

Technology alone is not enough. You need passion and drive to make a sound as good as Copland makes. The CTA 408 brings that passion for music, design, and technology into your home and will make your system truly sing!

 **absolute sounds** ltd.

International Distributors & Consultants of Specialised Hi-End Audio & Video Systems

58 Durham Road, London, SW20 0TW

T.+44 (0)20 89 71 39 09

absolutesounds.com info@absolutesounds.com

COPLAND

For Your Nearest Dealer Please Contact Absolute Sounds